



**BE CAREFUL: NOTICE THE DIFFERENCE**



**UWAGA: RÓŻNE KLOCKI**



**Printed in EU**



**WARNING: CHOKING HAZARD-**

Toy contains small parts.  
Not for children under 3 years.

1

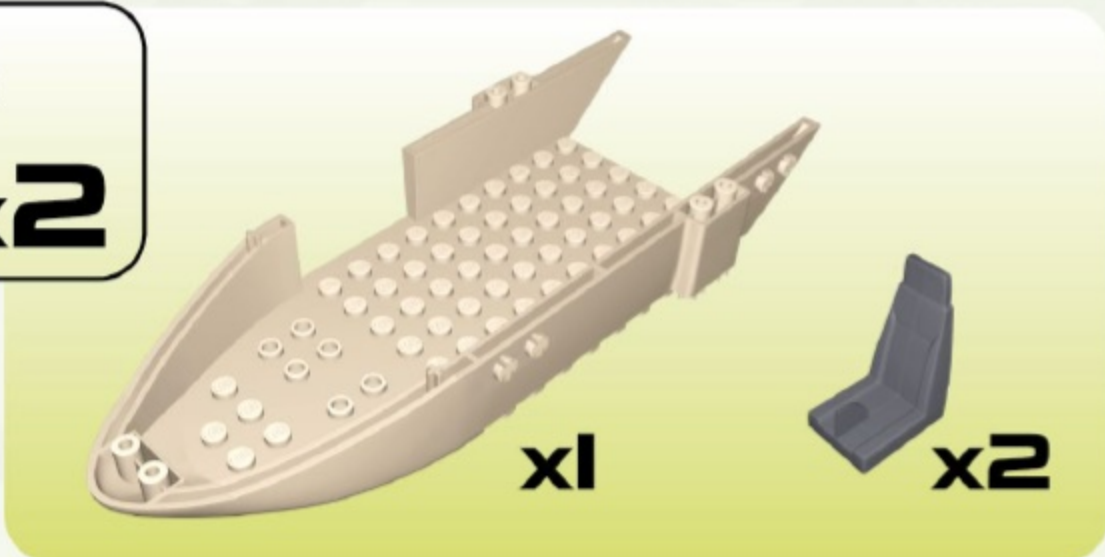
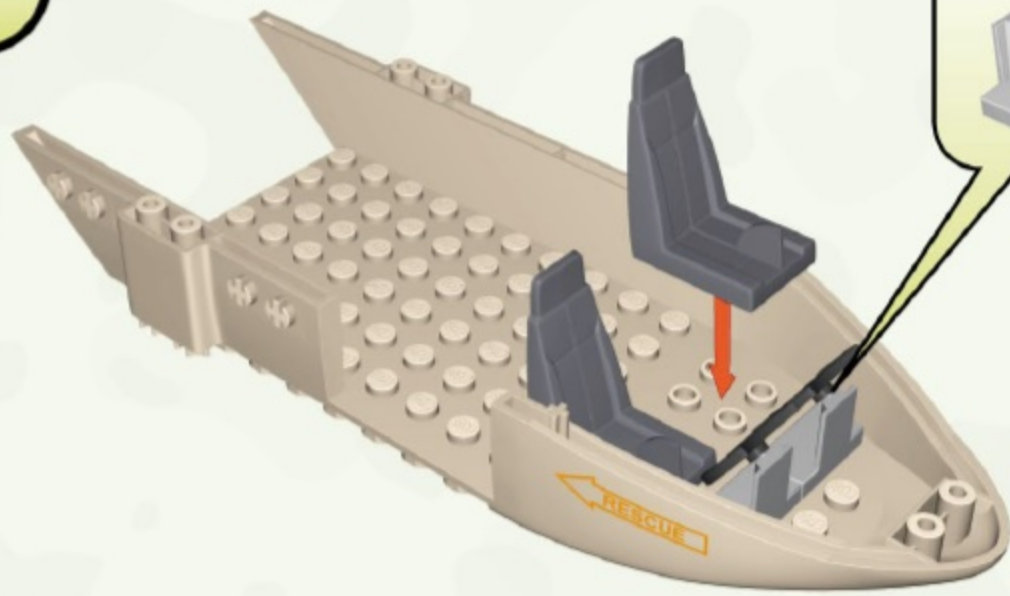

2

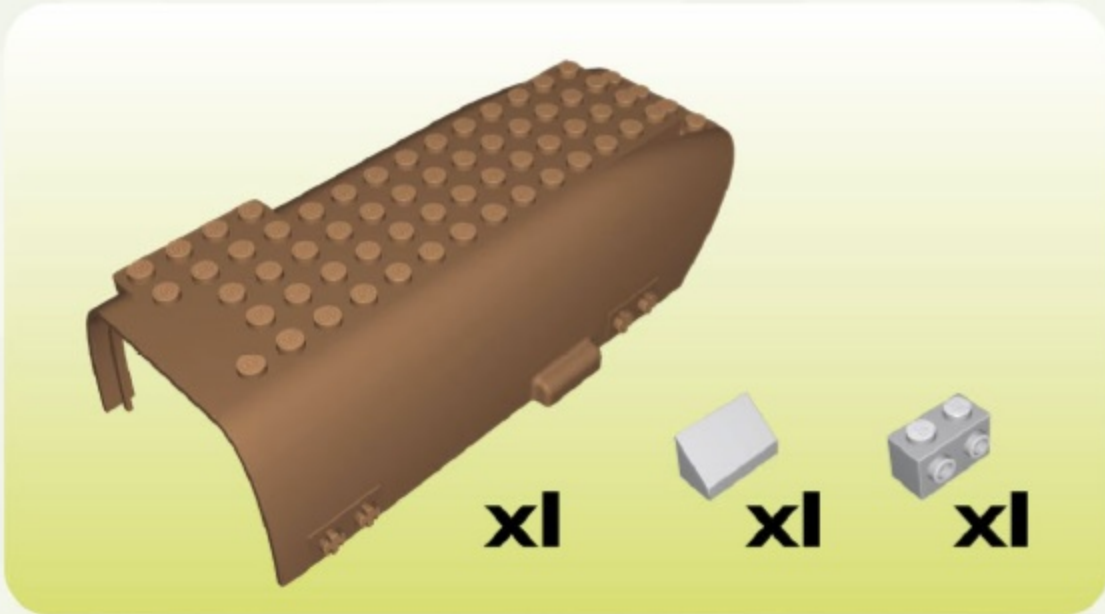
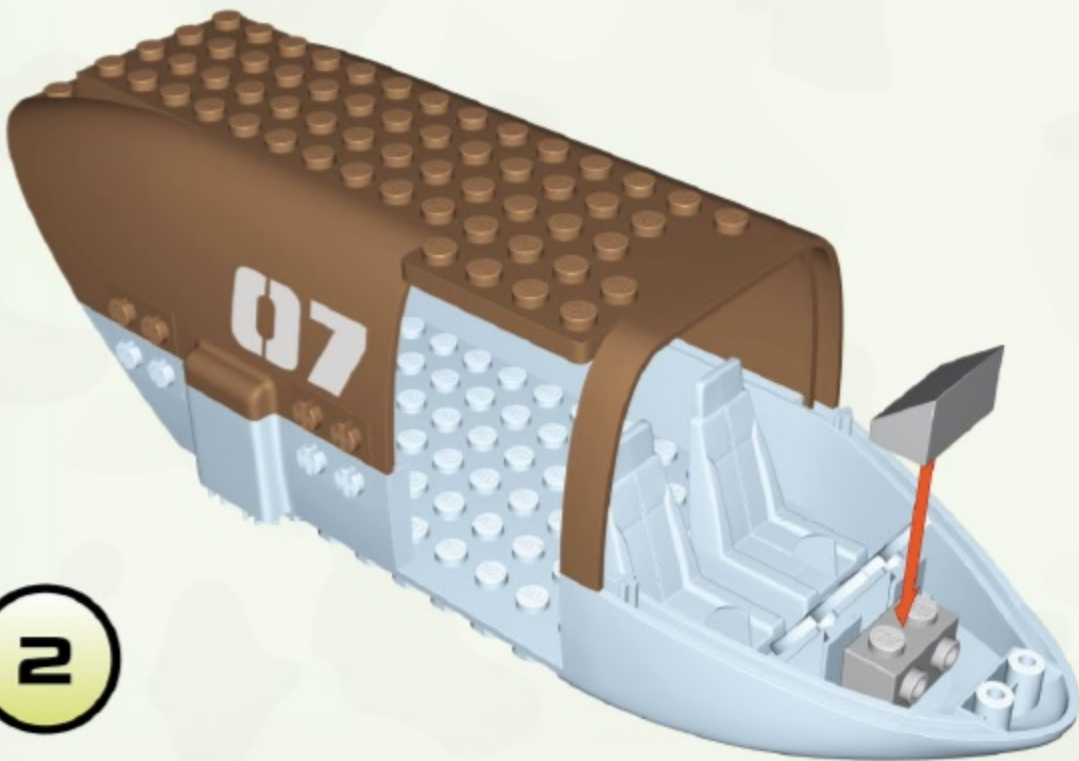

3

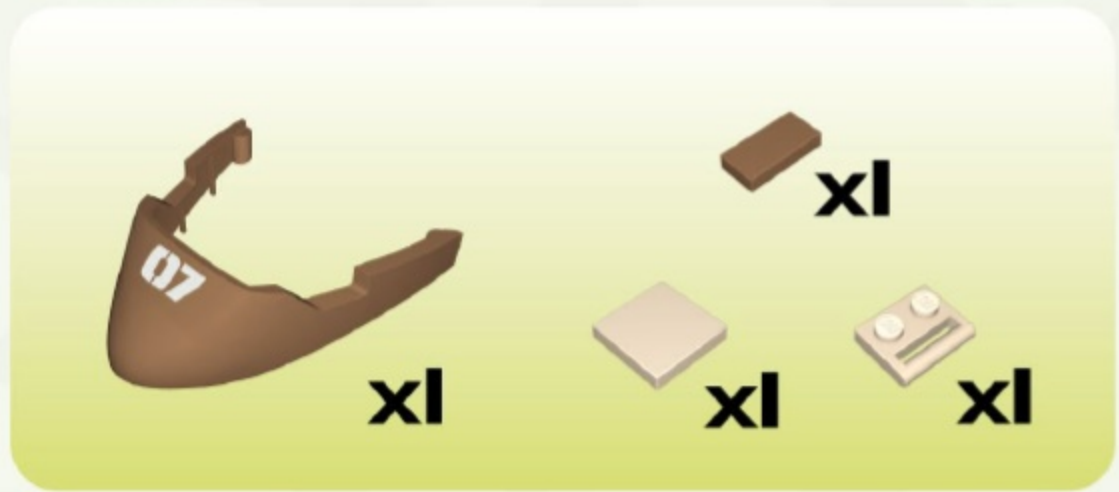
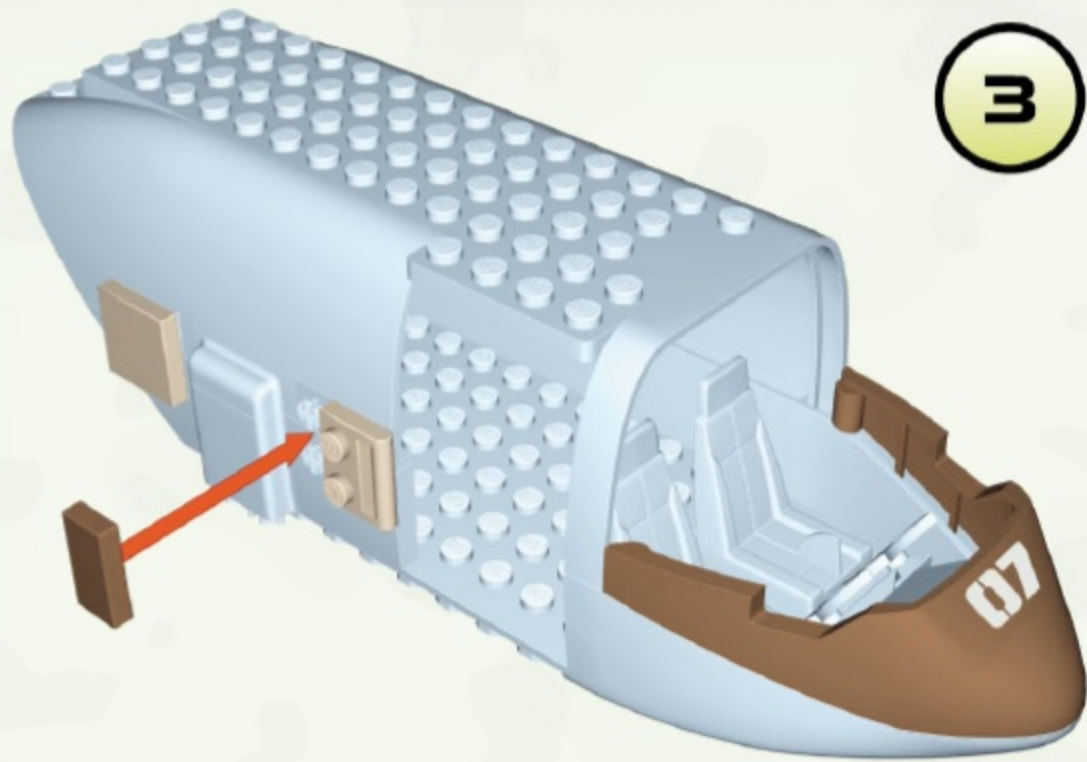

4

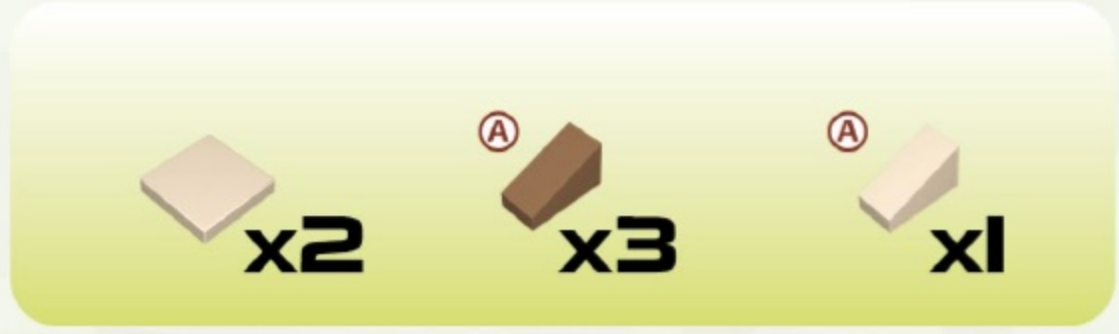
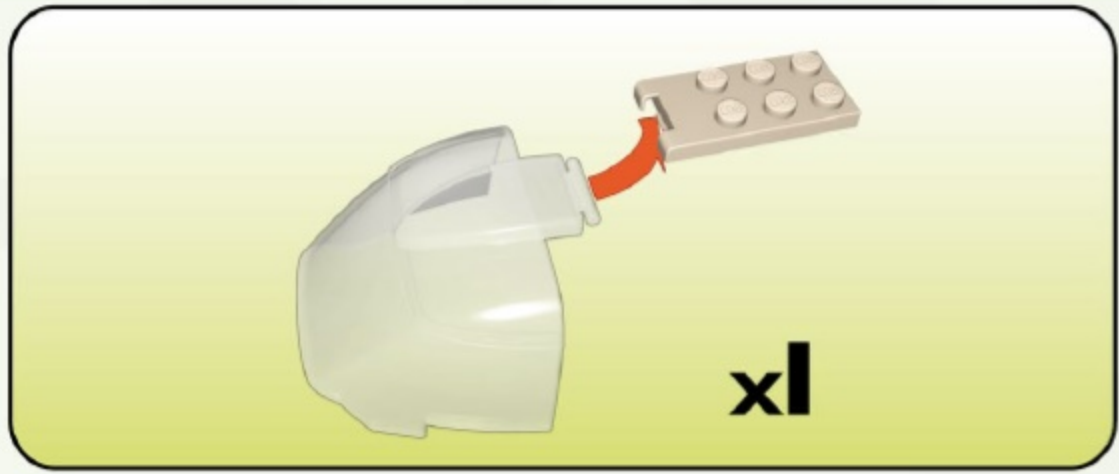
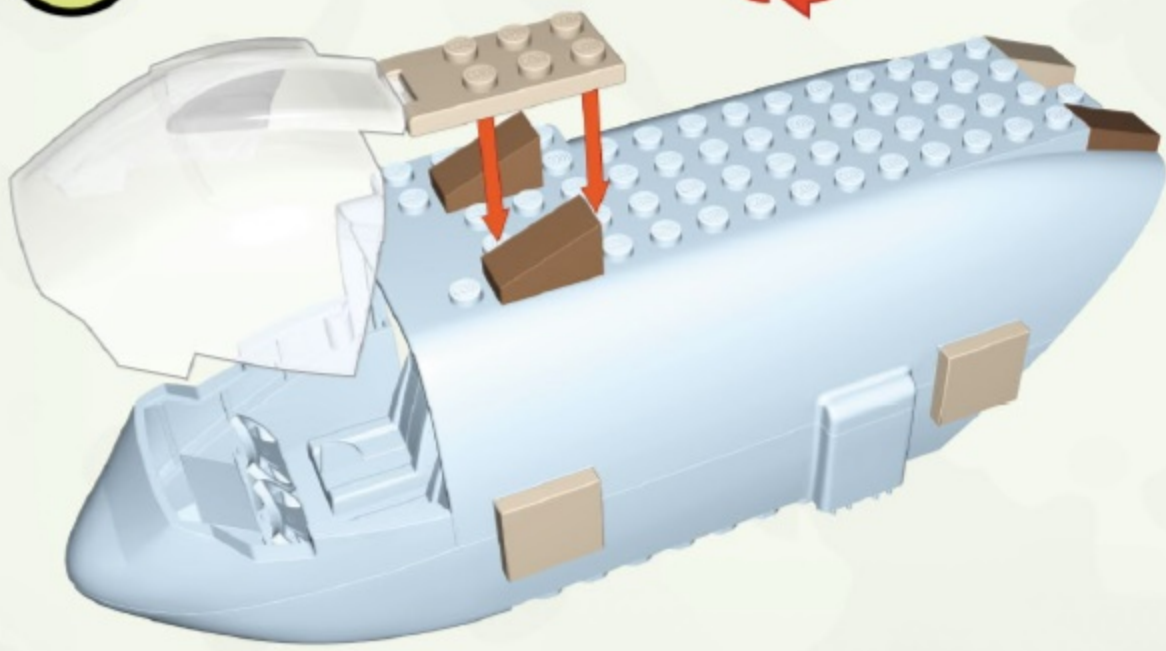

Four panels showing the assembly of a component:

- Two grey 1x5 Technic bricks are shown.
- A brown 1x5 Technic brick is placed on top of the grey bricks.
- A tan 1x5 Technic brick is placed on top of the brown brick.
- A brown 1x5 Technic brick is placed on top of the tan brick.

Parts list for this step:

- Grey 1x5 Technic brick: x1
- Grey 1x2 Technic brick: x2
- Tan 1x3 Technic triangle: x1
- Brown 1x3 Technic triangle: x1
- Grey 1x2 Technic brick: x3
- Tan 1x2 Technic triangle: x1
- Brown 1x2 Technic triangle: x1
- Light brown 1x2 Technic brick with hole: x2
- Brown 1x2 Technic brick with hole: x2

**5**

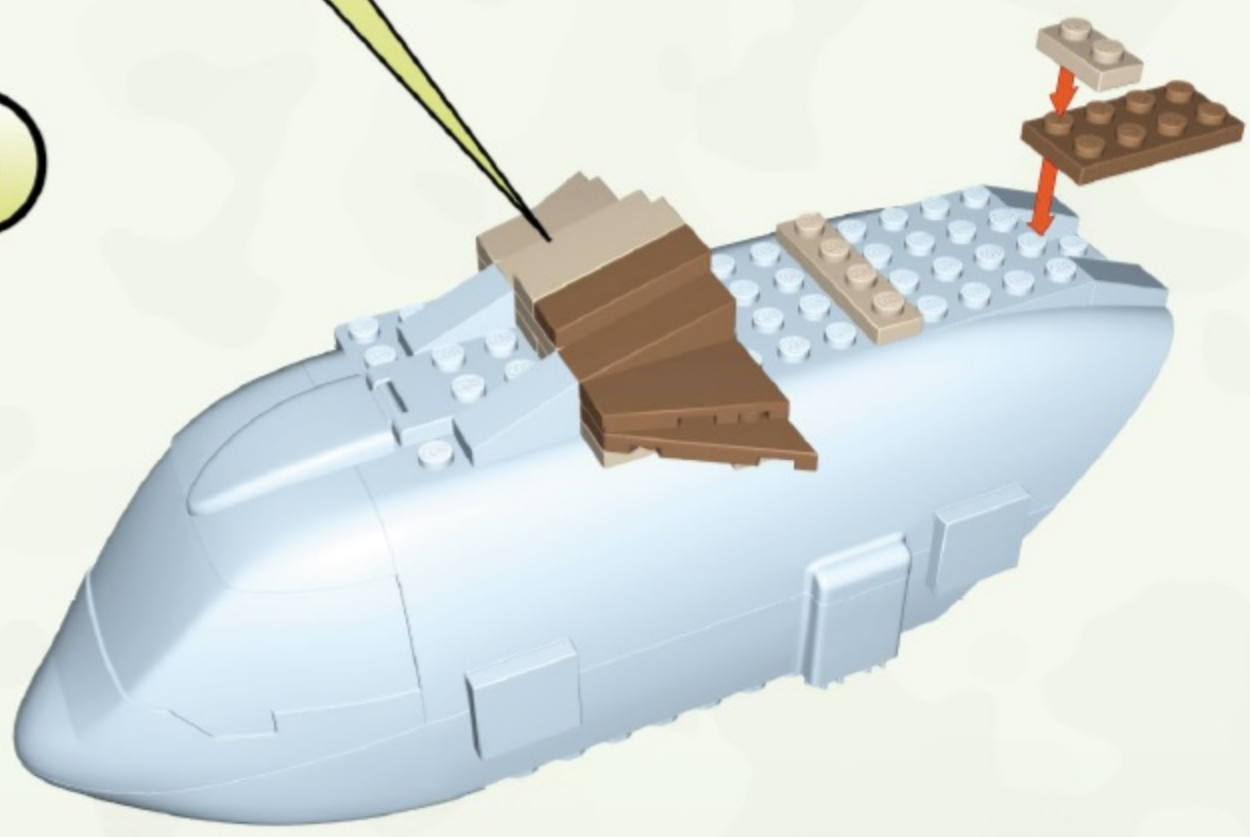

Parts list for the main assembly view:

- Grey 1x5 Technic brick: x1
- Brown 1x5 Technic brick: x1
- Grey 1x2 Technic brick: x1

The assembly sequence consists of four steps:

- Step 1: A tan 1x4 brick with a hole is shown. A tan 1x2 brick with a hole is being placed on top of it, as indicated by a red arrow.
- Step 2: A tan 1x2 brick with a hole is being placed on top of the assembly from step 1, as indicated by a red arrow.
- Step 3: A tan 1x2 brick with a hole is being placed on top of the assembly from step 2, as indicated by a red arrow.
- Step 4: A tan 1x2 brick with a hole is being placed on top of the assembly from step 3, as indicated by a red arrow.

Parts list for this step:

- Tan 1x4 brick with hole: x1
- Tan 1x2 brick with hole: x2
- Tan 1x2 brick with hole: x2
- Tan 1x2 brick with hole: x1
- Brown 1x2 brick with hole: x1
- Brown 1x2 brick with hole: x1
- Tan 1x2 brick with hole: x1
- Brown 1x2 brick with hole: x1
- Grey 1x2 brick with hole: x1
- Tan 1x2 brick with hole: x1

6

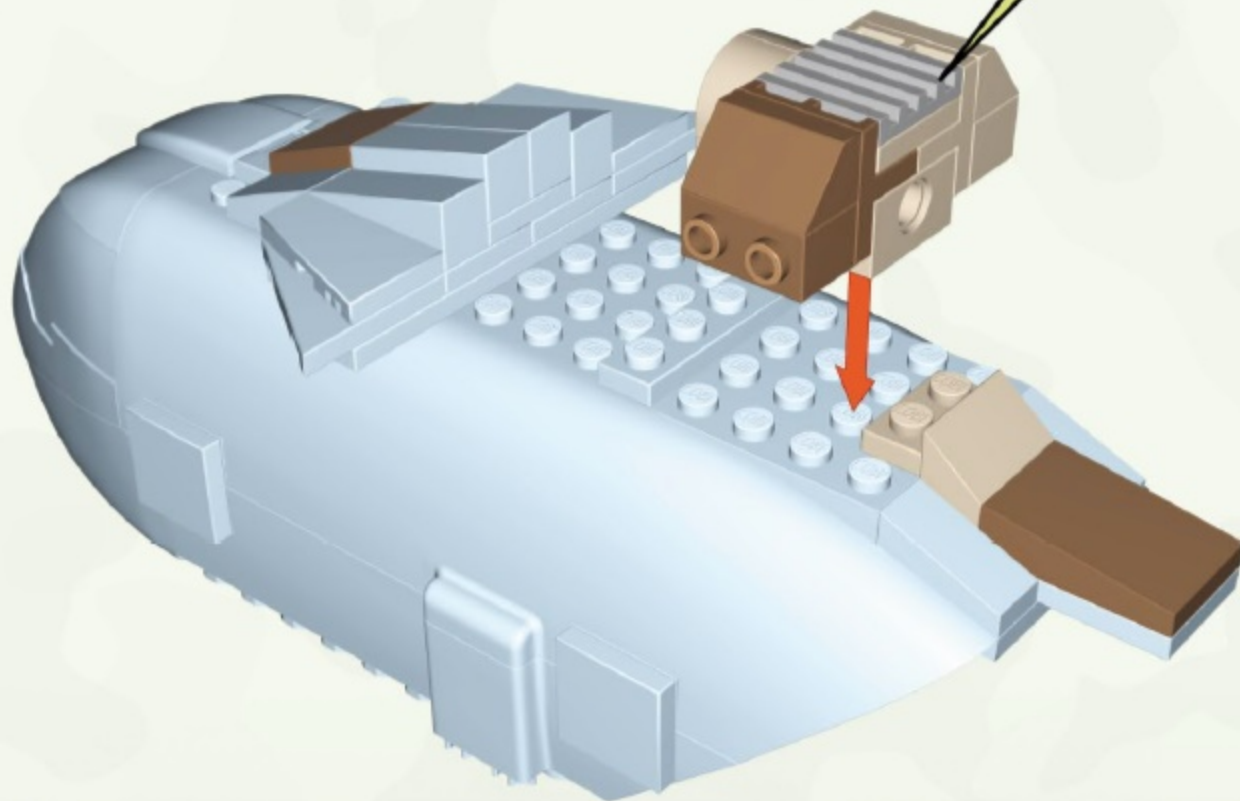

Parts list for this step:

- Brown 1x2 brick with hole: x1
- Tan 1x2 brick with hole: x1
- Tan 1x2 brick with hole: x1
- Brown 1x2 brick with hole: x1

7

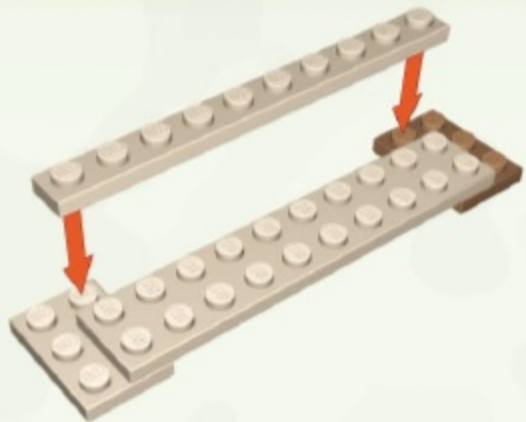

8

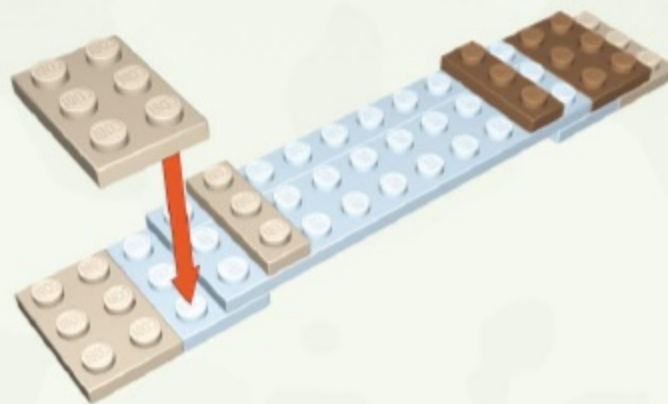

9



10

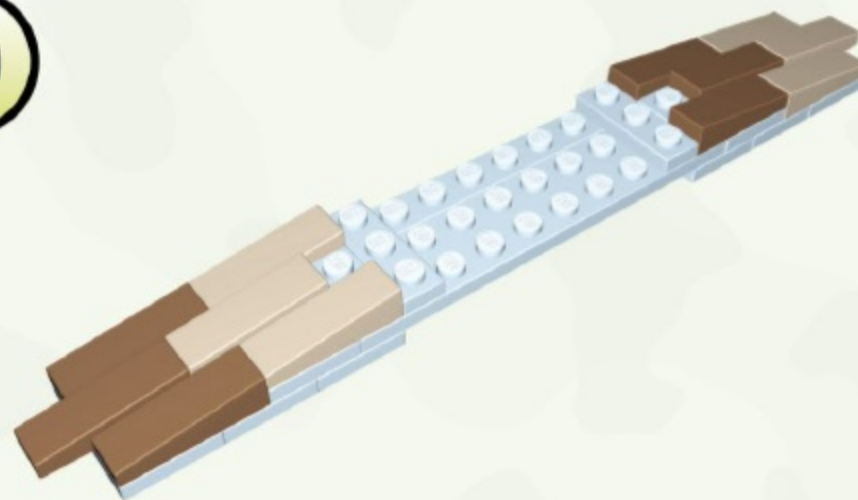

11



x1



x1

12

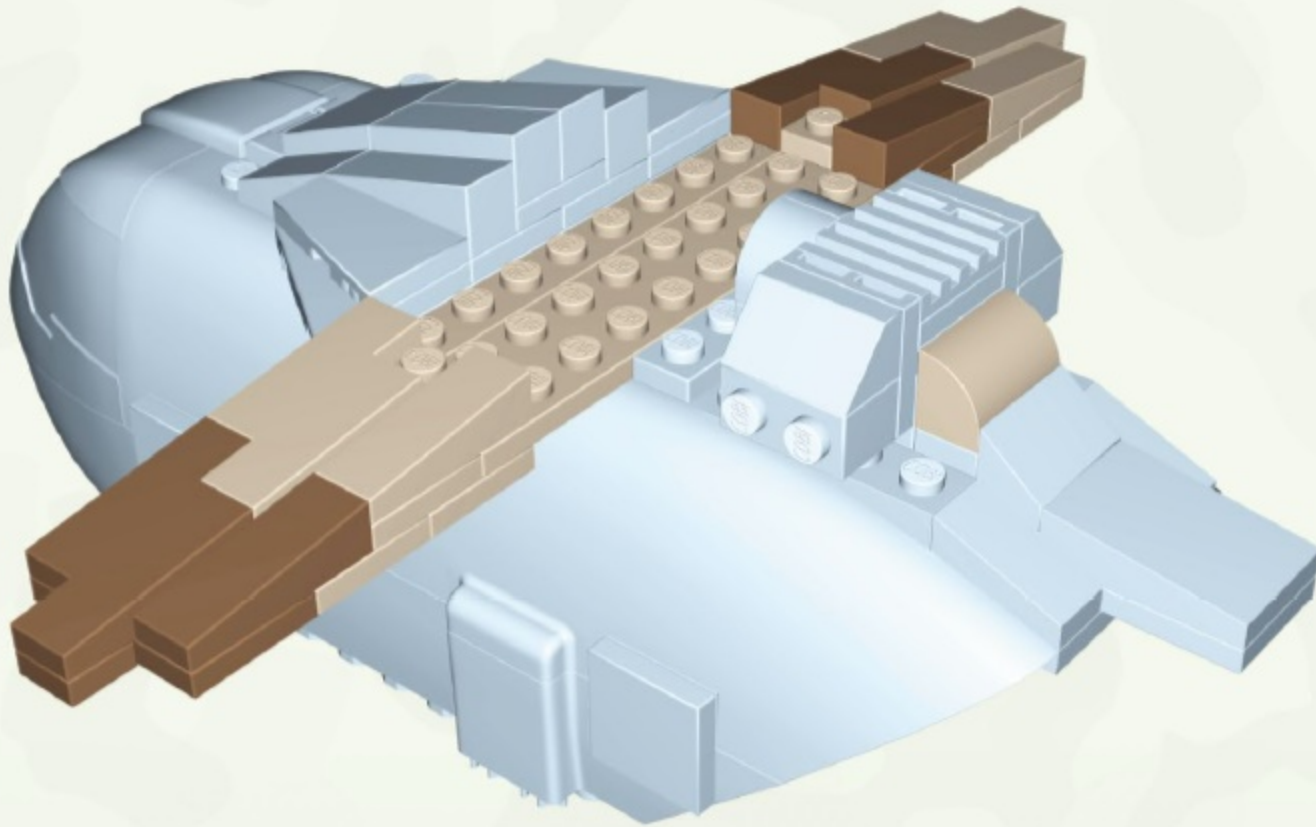

x1

13

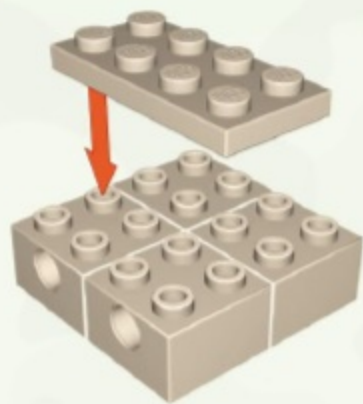

x4



x1

14

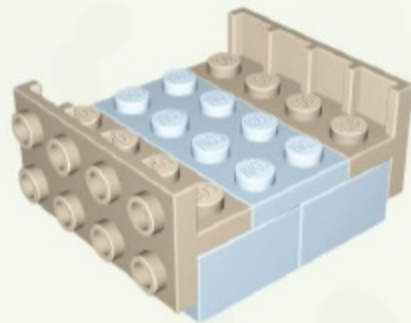

x2

15

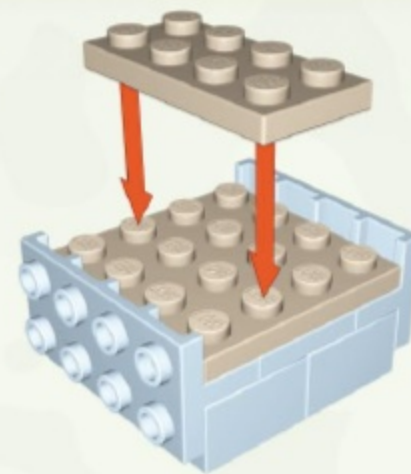

x1



x1

16



x1



x4

17

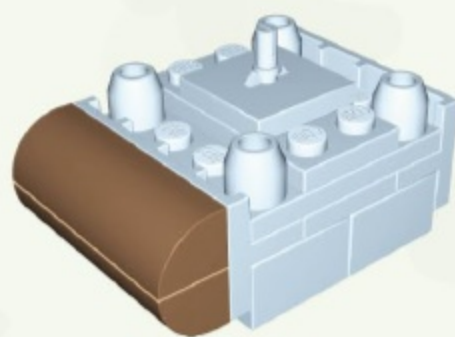

x2

18

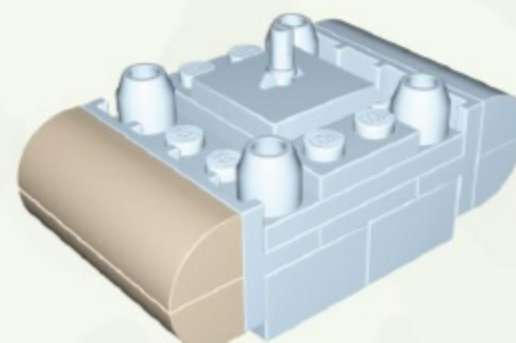

x2



19

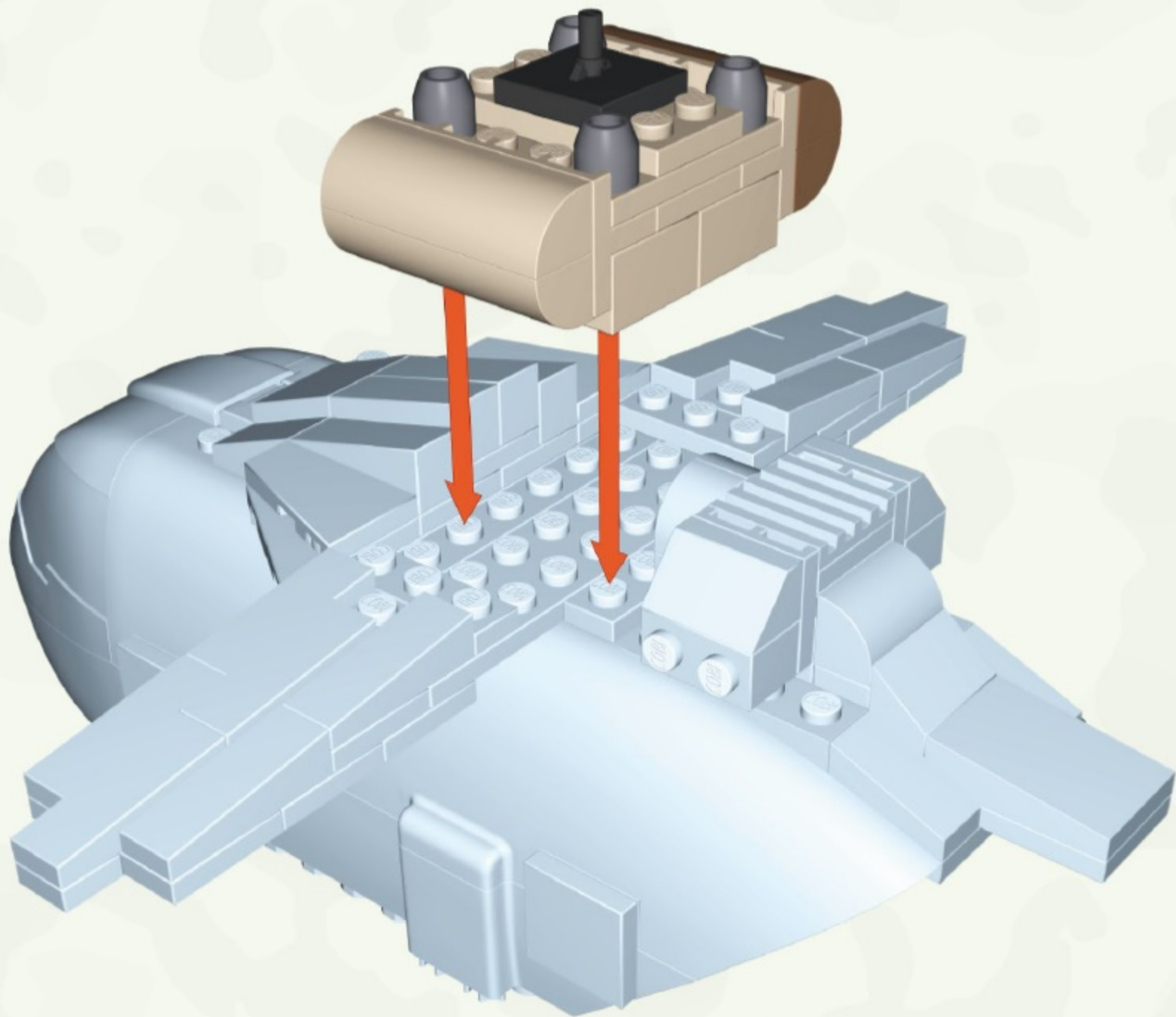

20



x2



x1

21

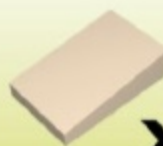
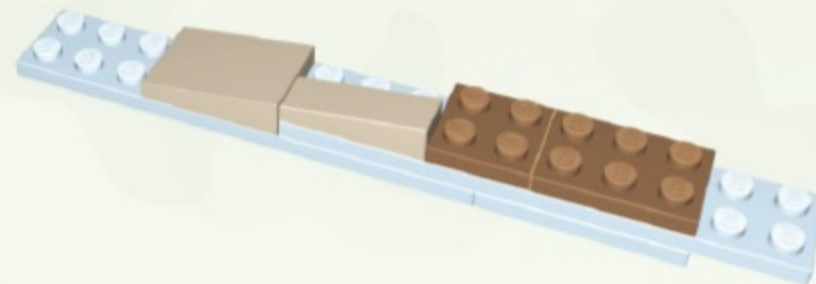

x1



x1



x1



x1

22

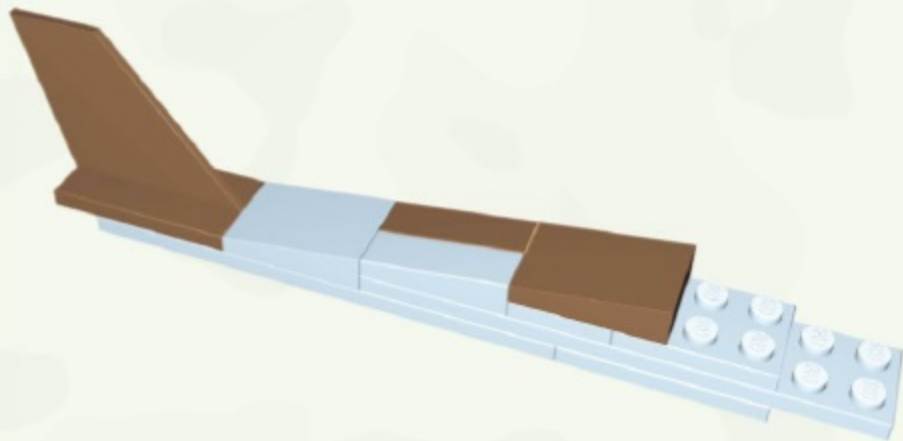

x1



x1

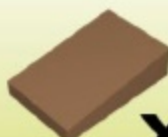

x1

23

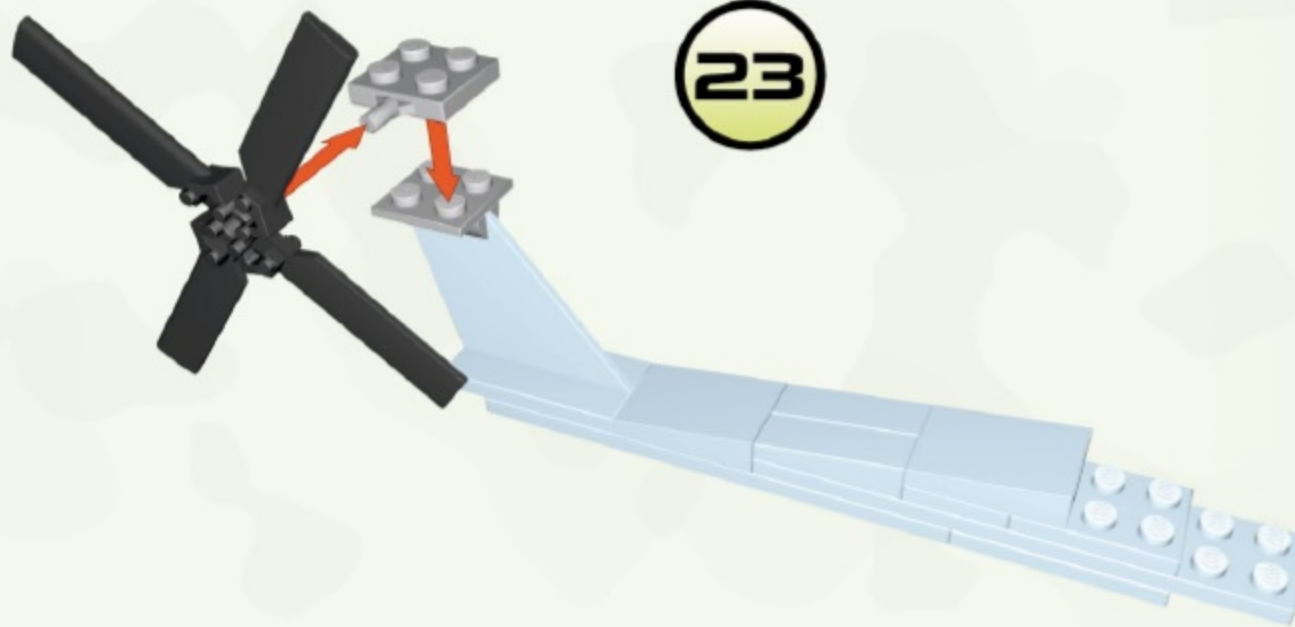

x1



x1



x1



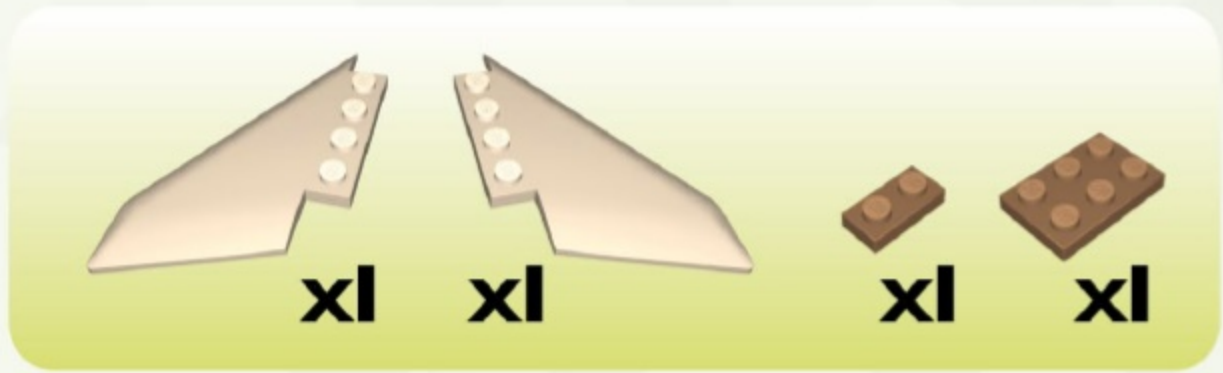

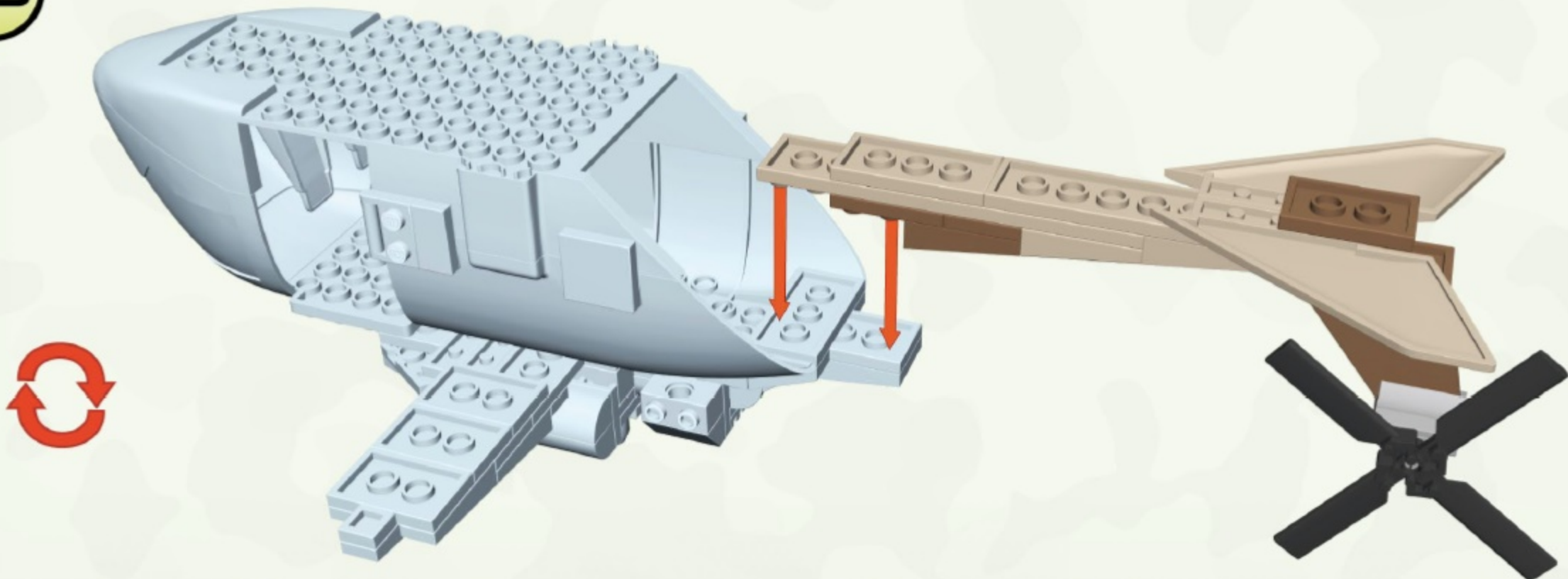

24

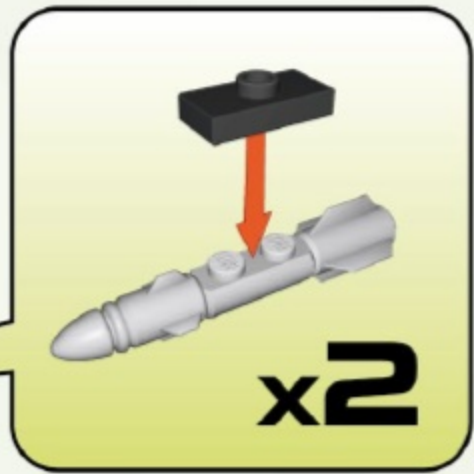
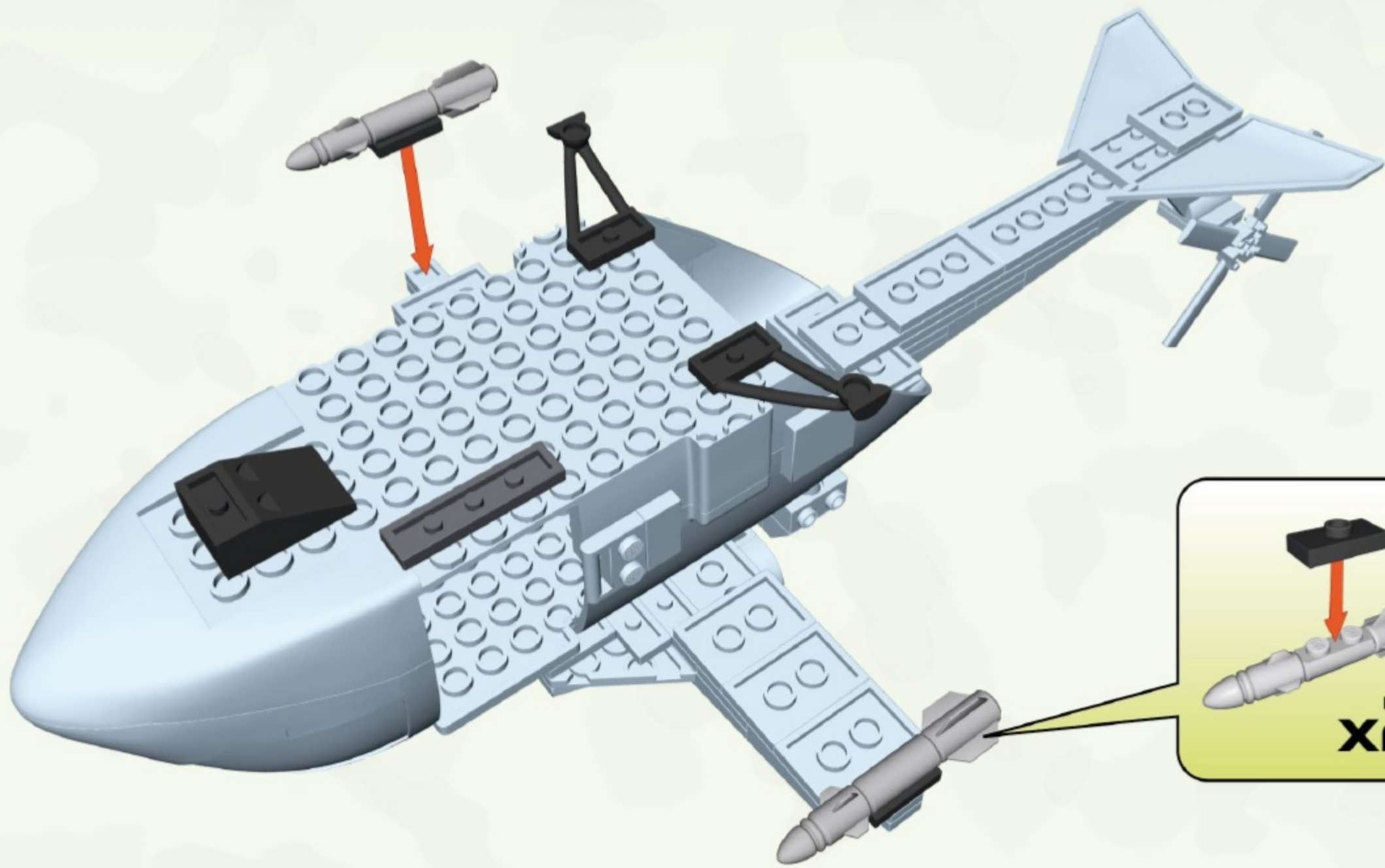







25

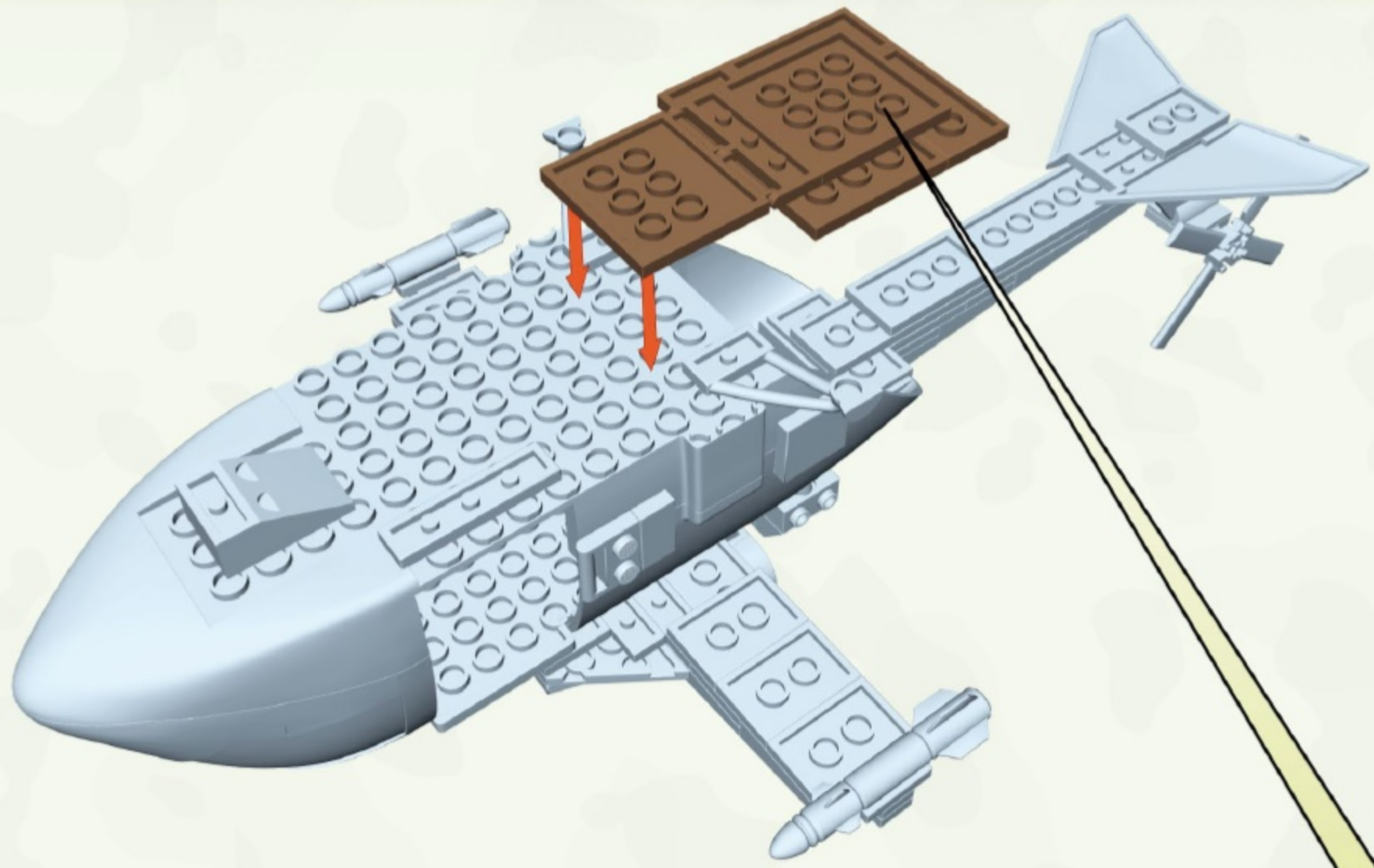







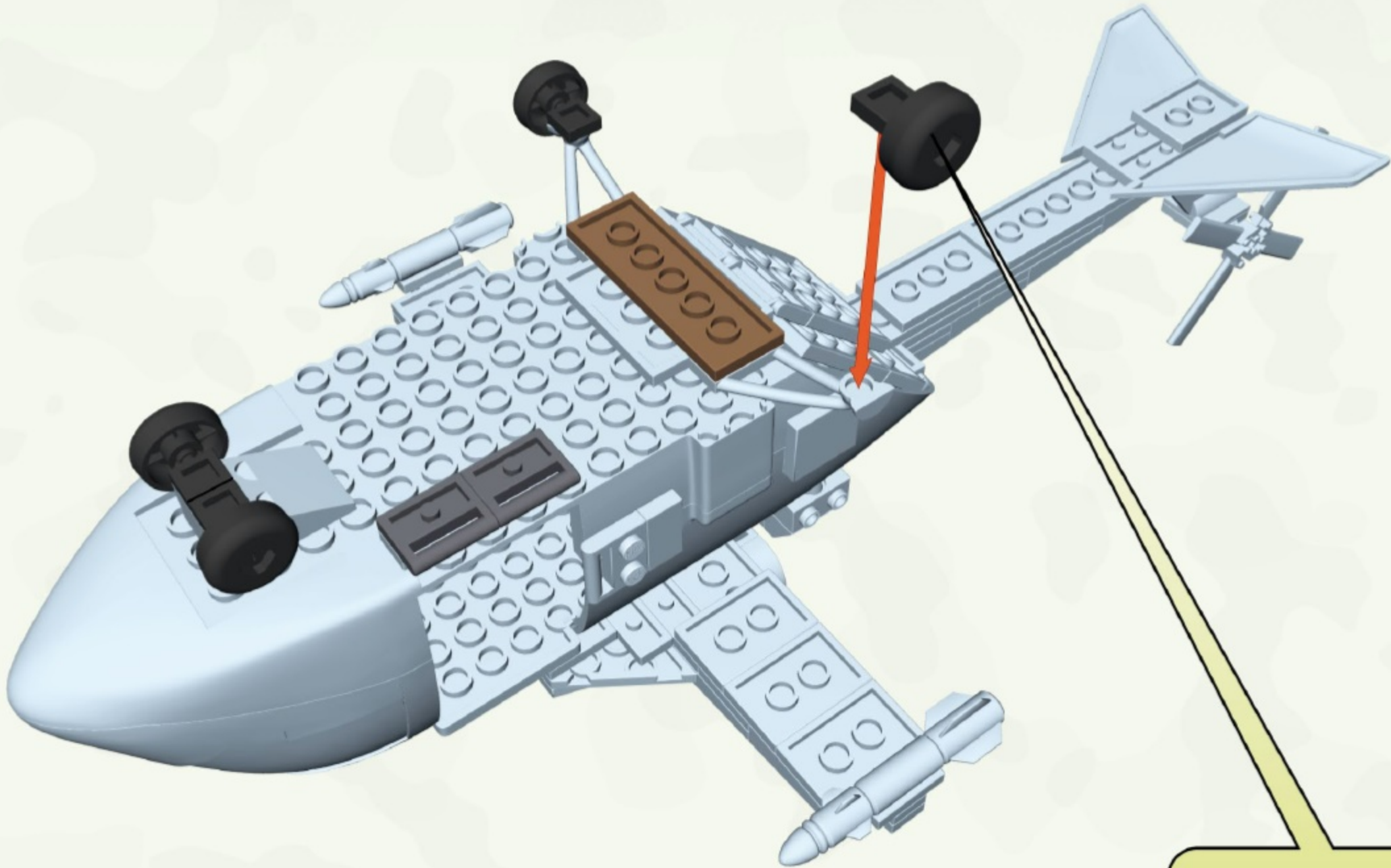

-  x1
-  x1
-  x1
-  x1
-  x2
-  x2



 <b>x2</b>	 <b>x1</b>	 <b>x1</b>
 <b>x1</b>	 <b>x1</b>	 <b>x1</b>



 x2    x1    x4    x4

 x4

29 - 34

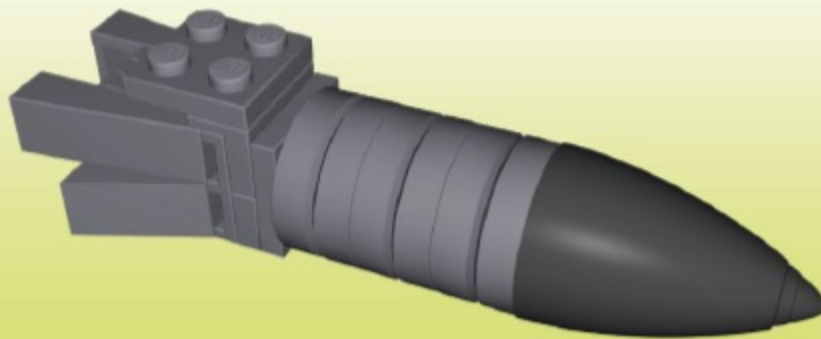

x2

29

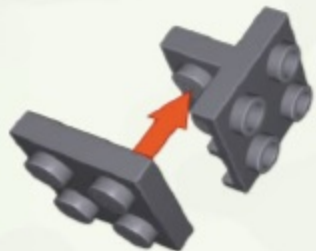

30

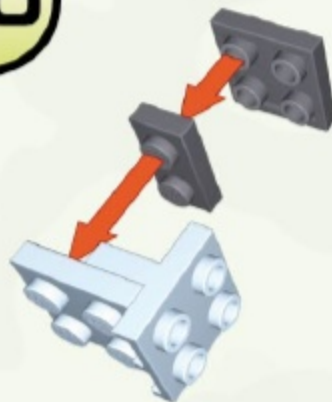

31

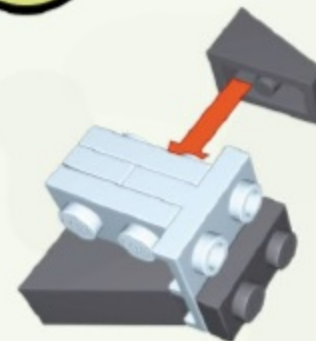

32

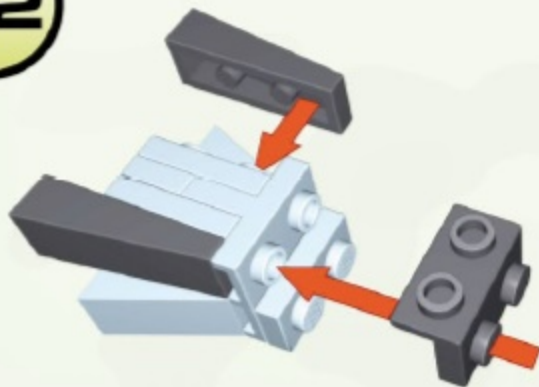

33

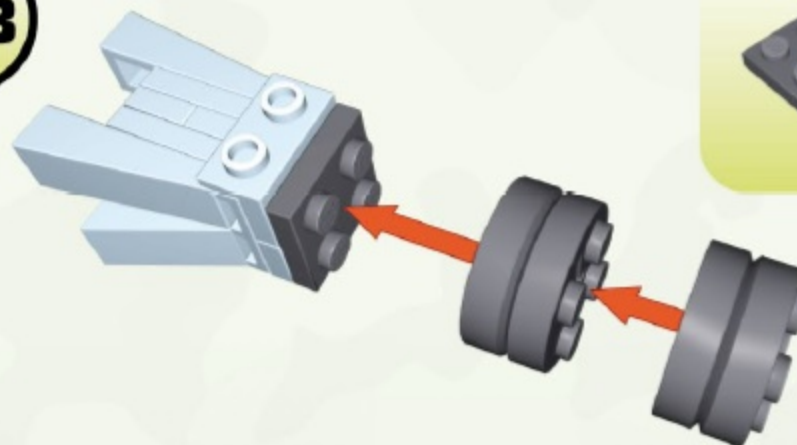

34

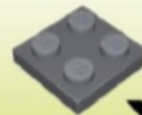
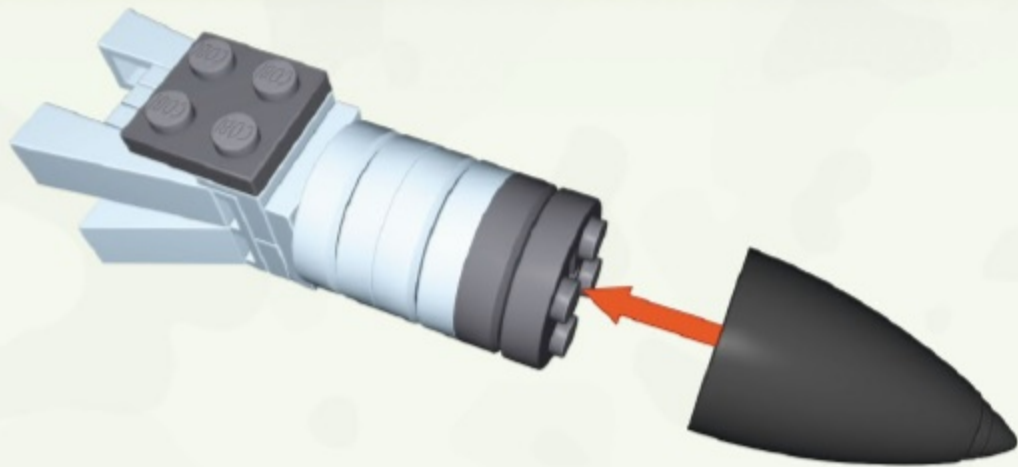

x1



x1



x1

35

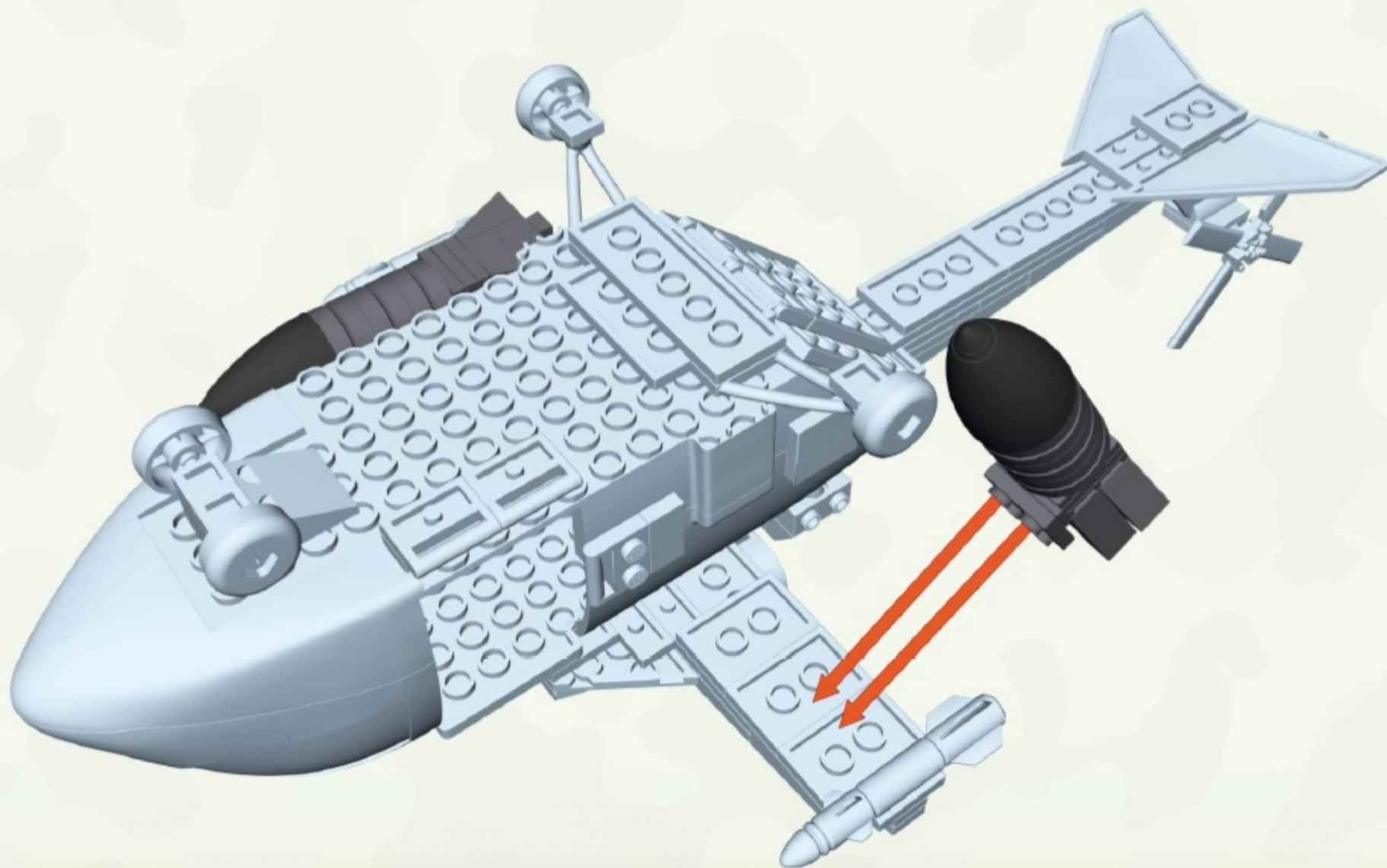



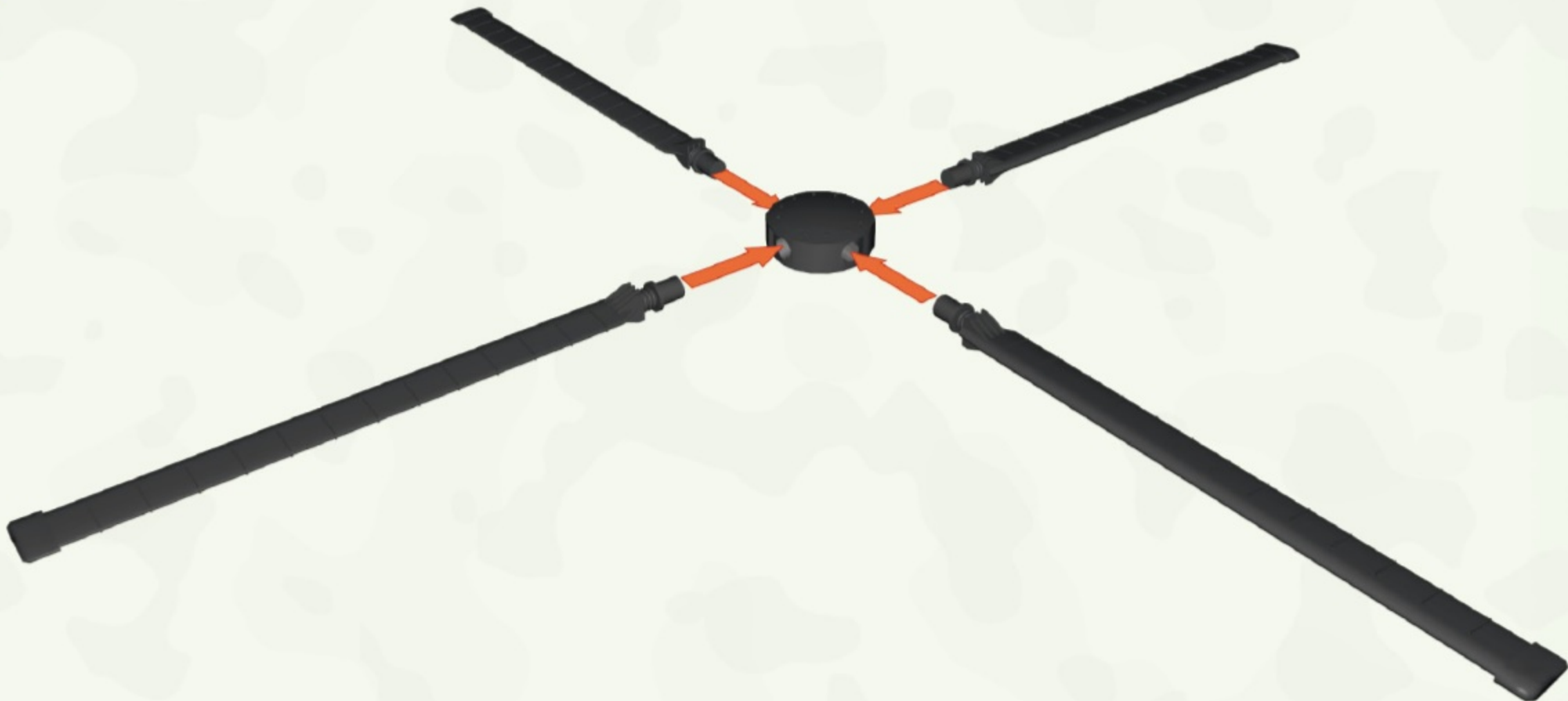

x4



x1

37

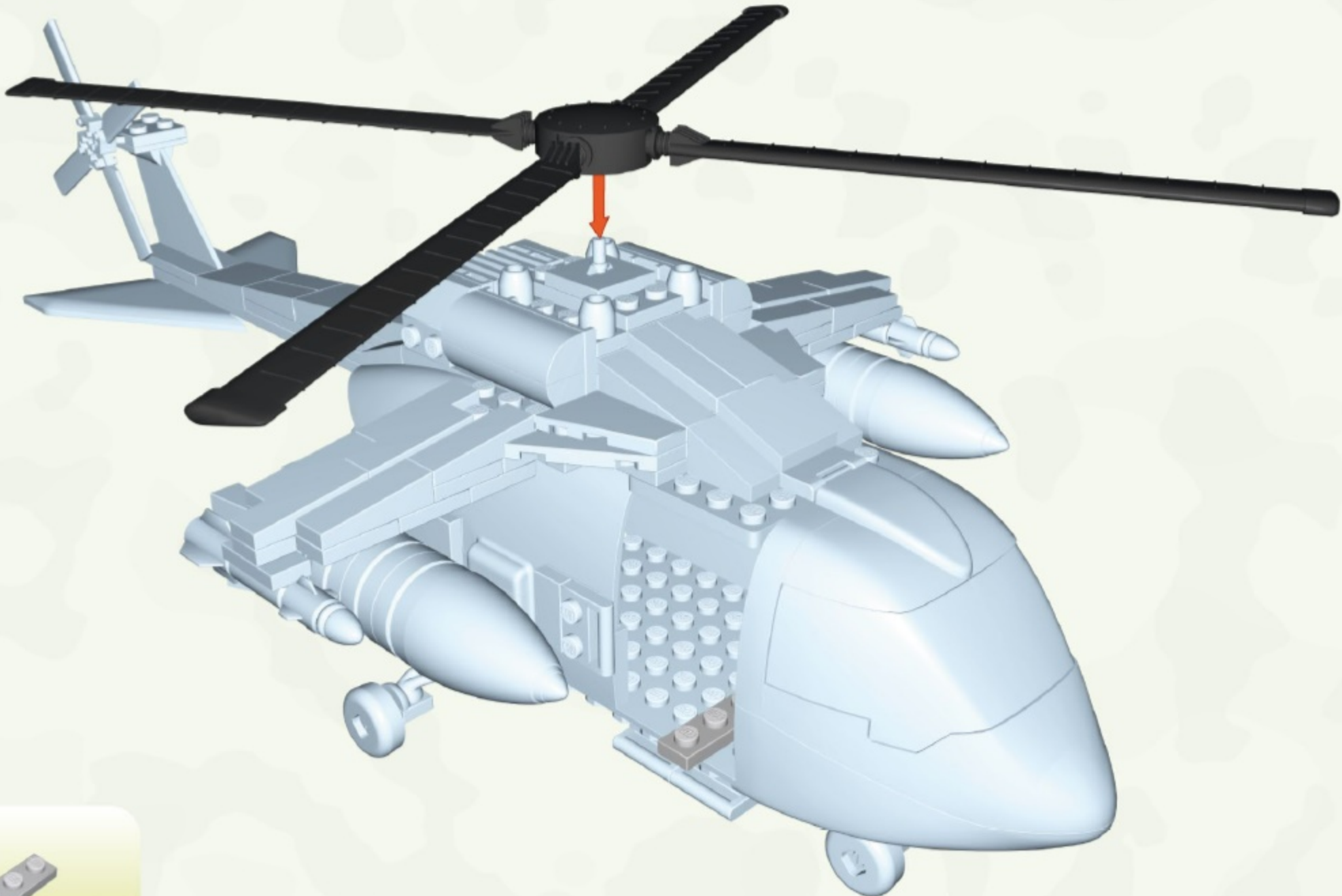

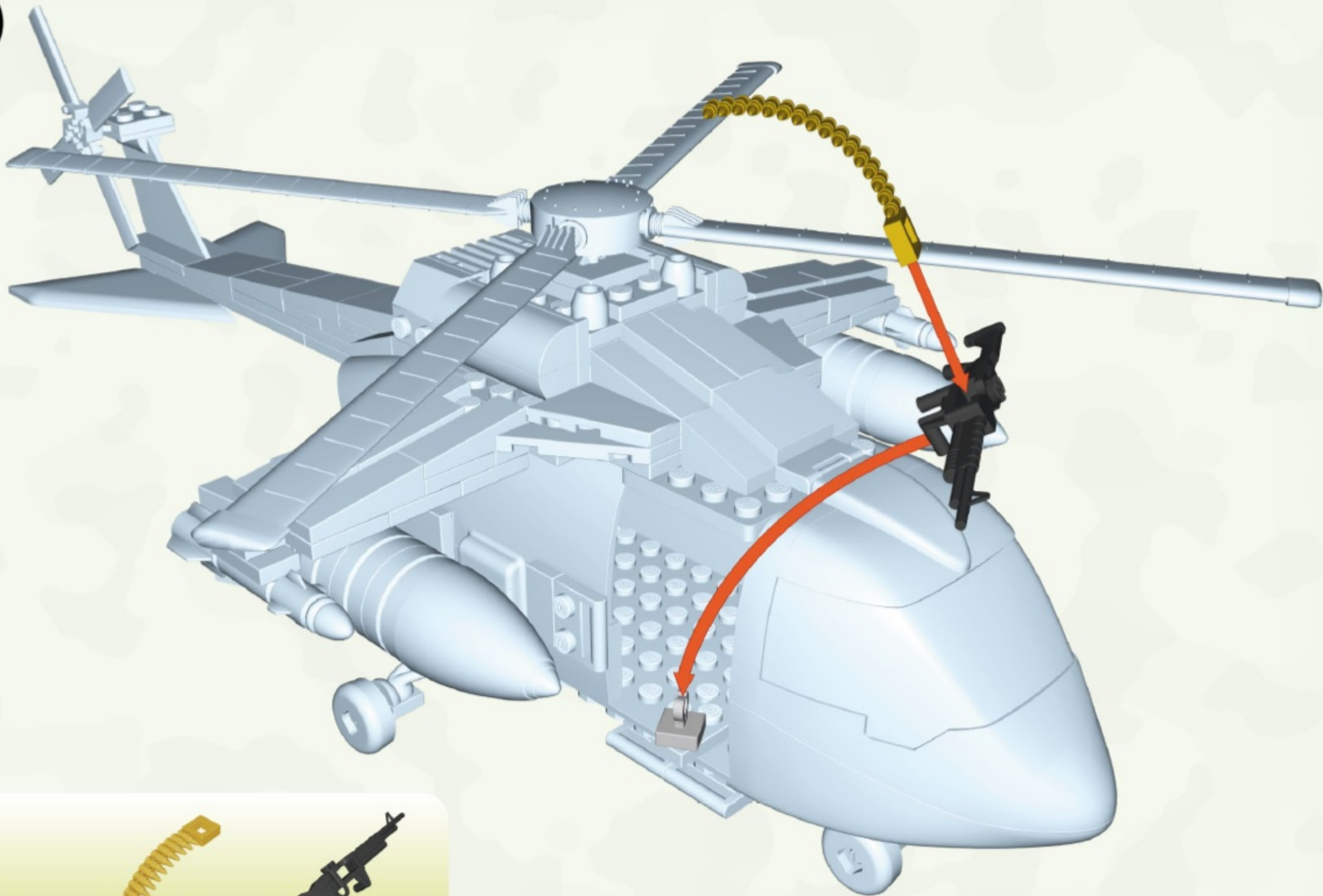

x1



x1



x1



**HOWITZER**  
2190



**ATV WITH MORTAR**  
2191



**SMALL HELICOPTER**  
2192



**LIGHT ARMY TRUCK**  
2340



**ARMORED VEHICLE**  
2318



**HOVERCRAFT**  
2319

