



**WARNING: CHOKING HAZARD-**  
Toy contains small parts.  
Not for children under 3 years.

**Printed in EU**



**BE CAREFUL: NOTICE THE DIFFERENCE**

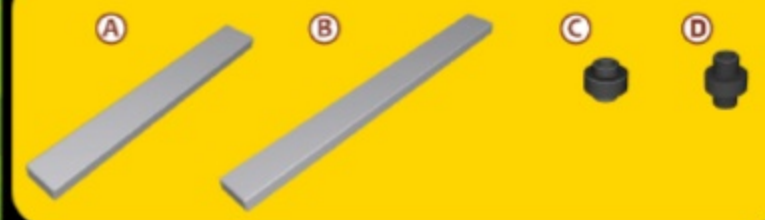

**UWAGA: RÓŻNE KLOCKI**

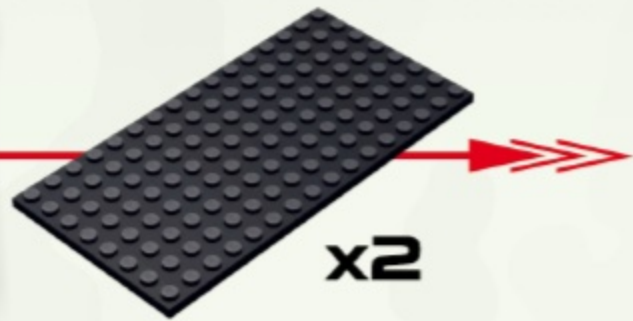

1

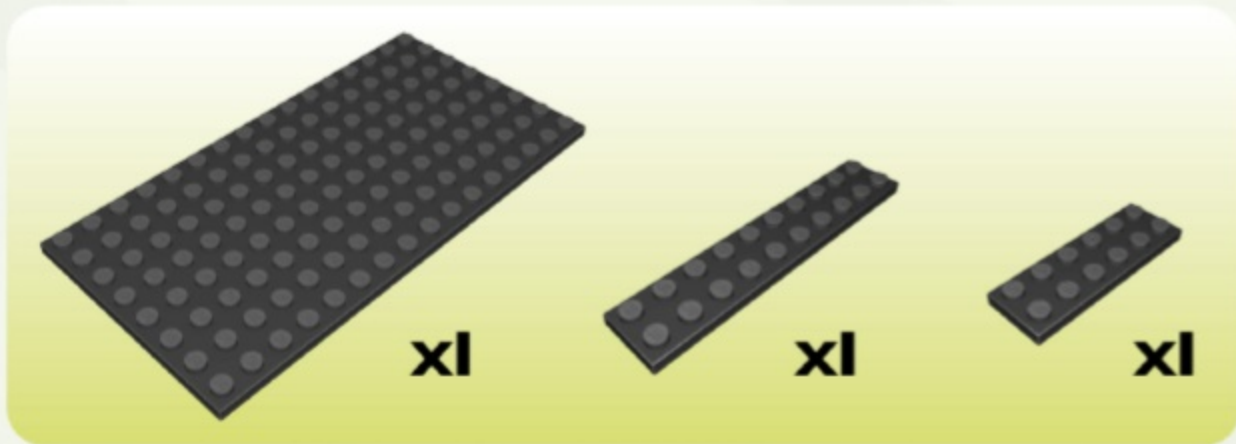
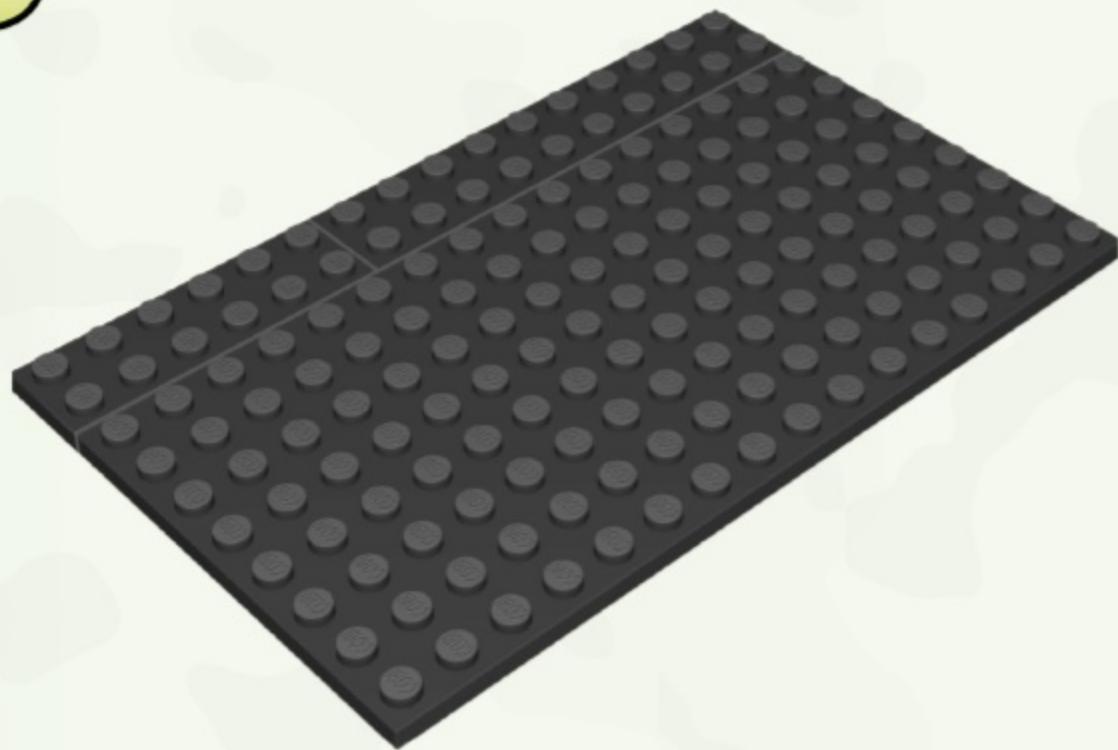

2

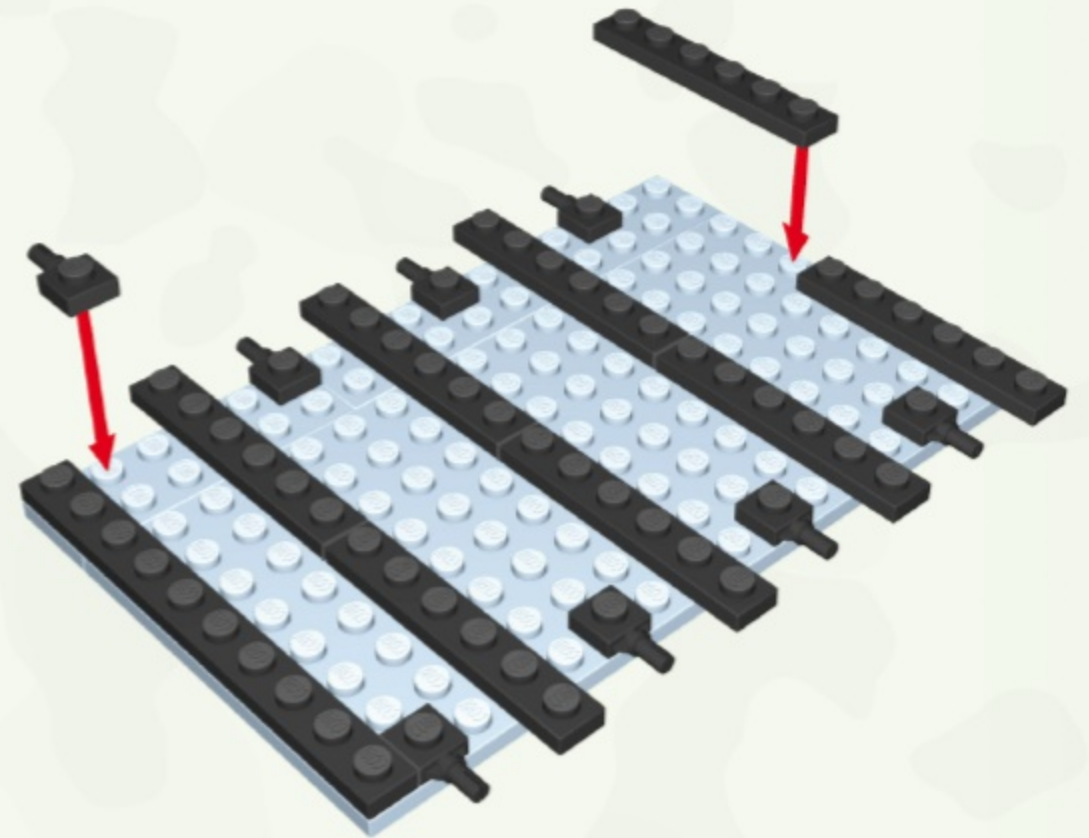

3

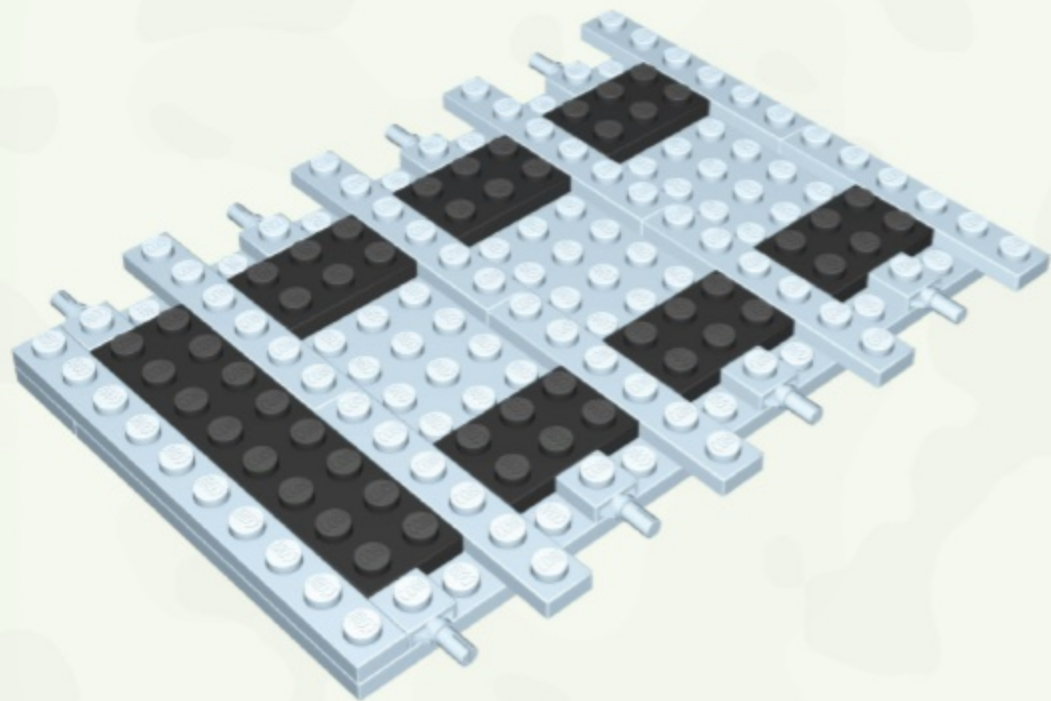

x1



x6

4

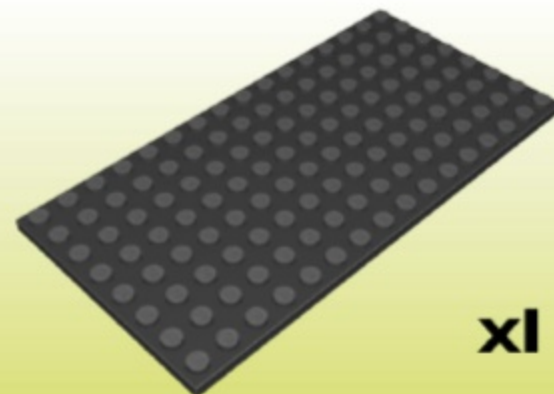
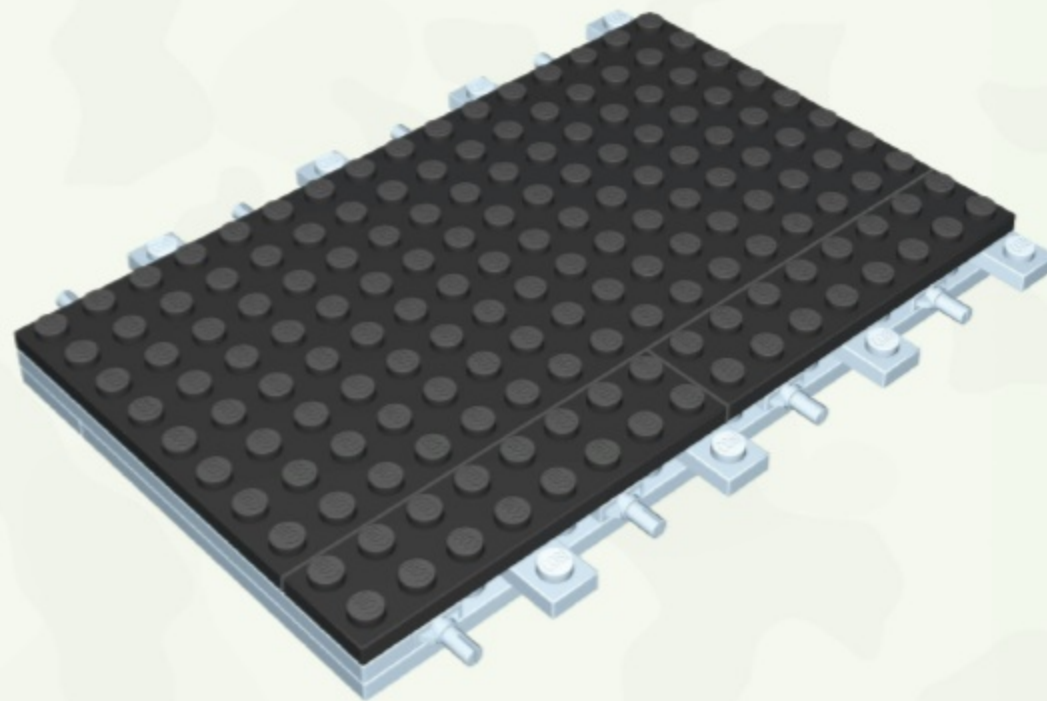

x1



x2

5

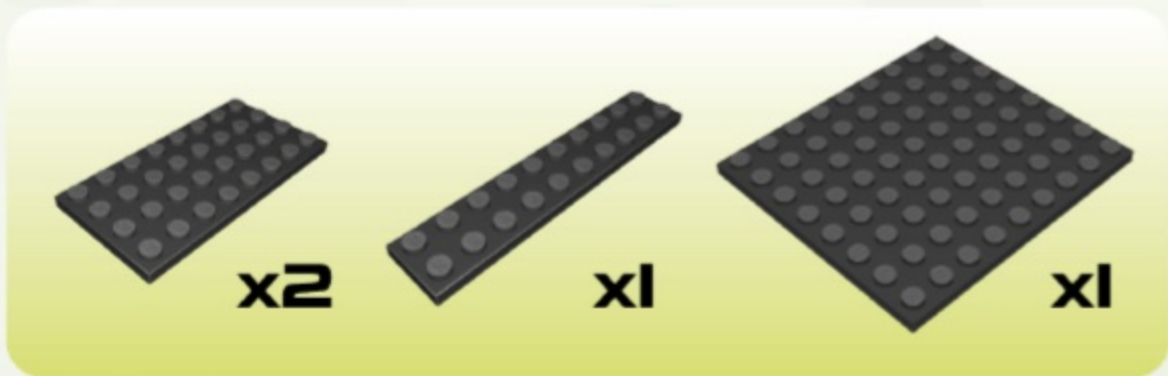
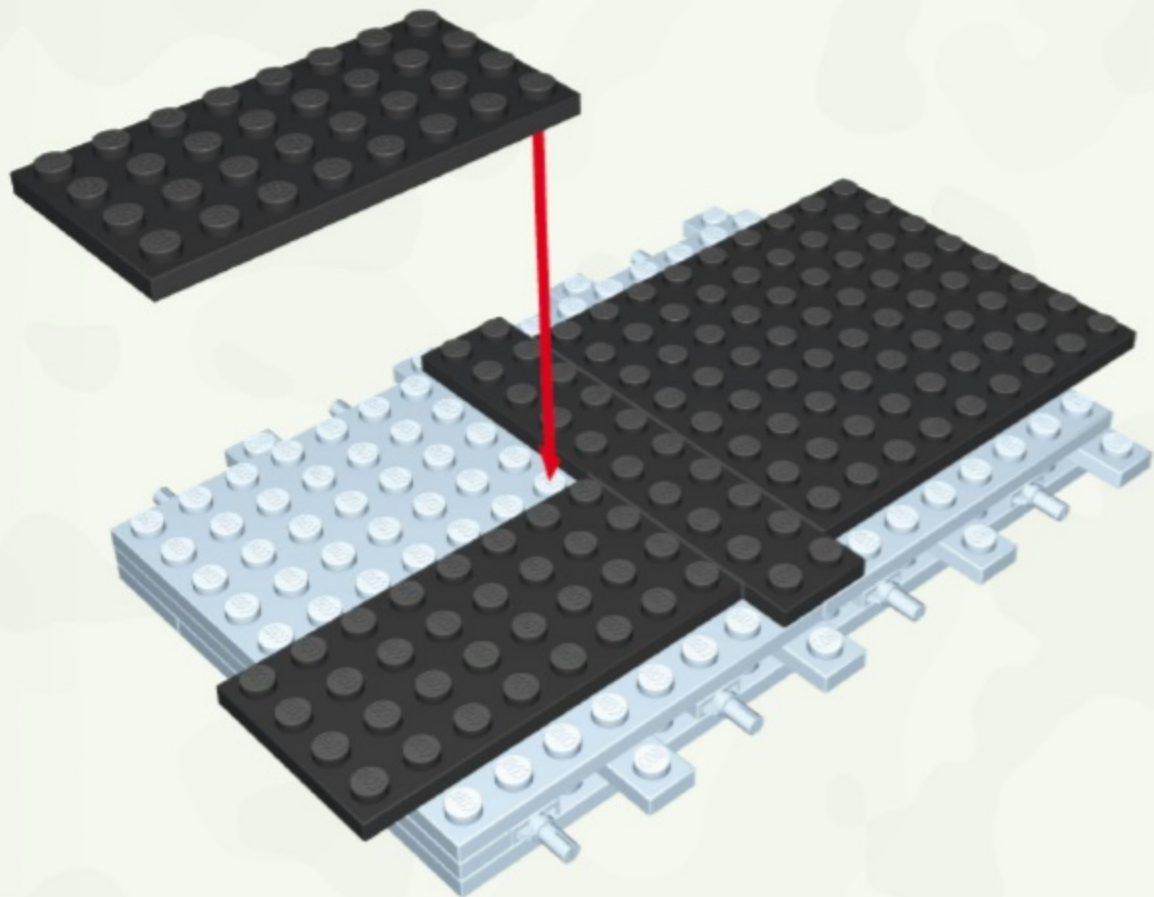

6

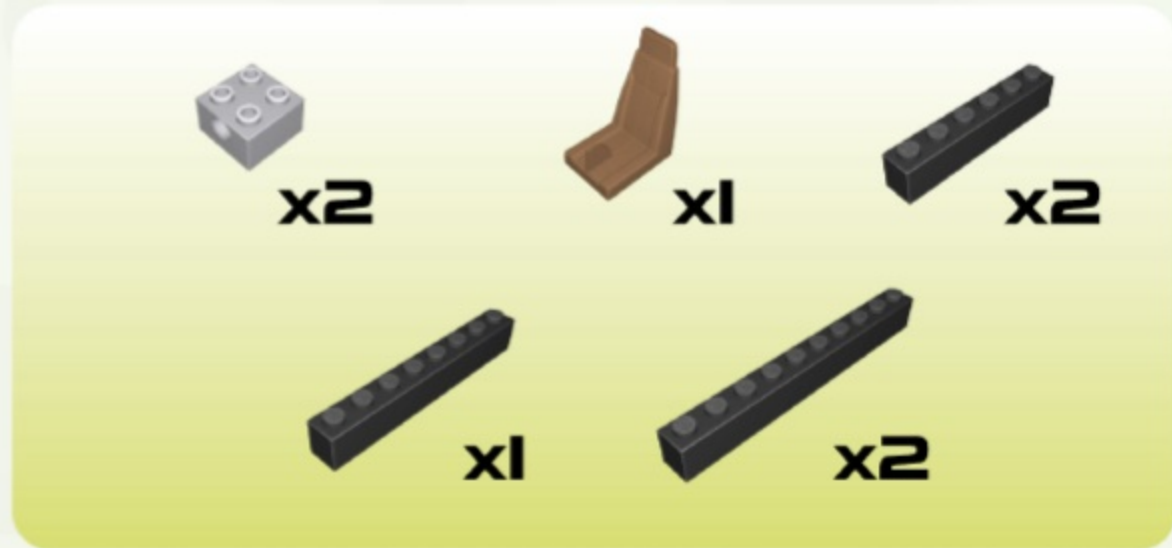
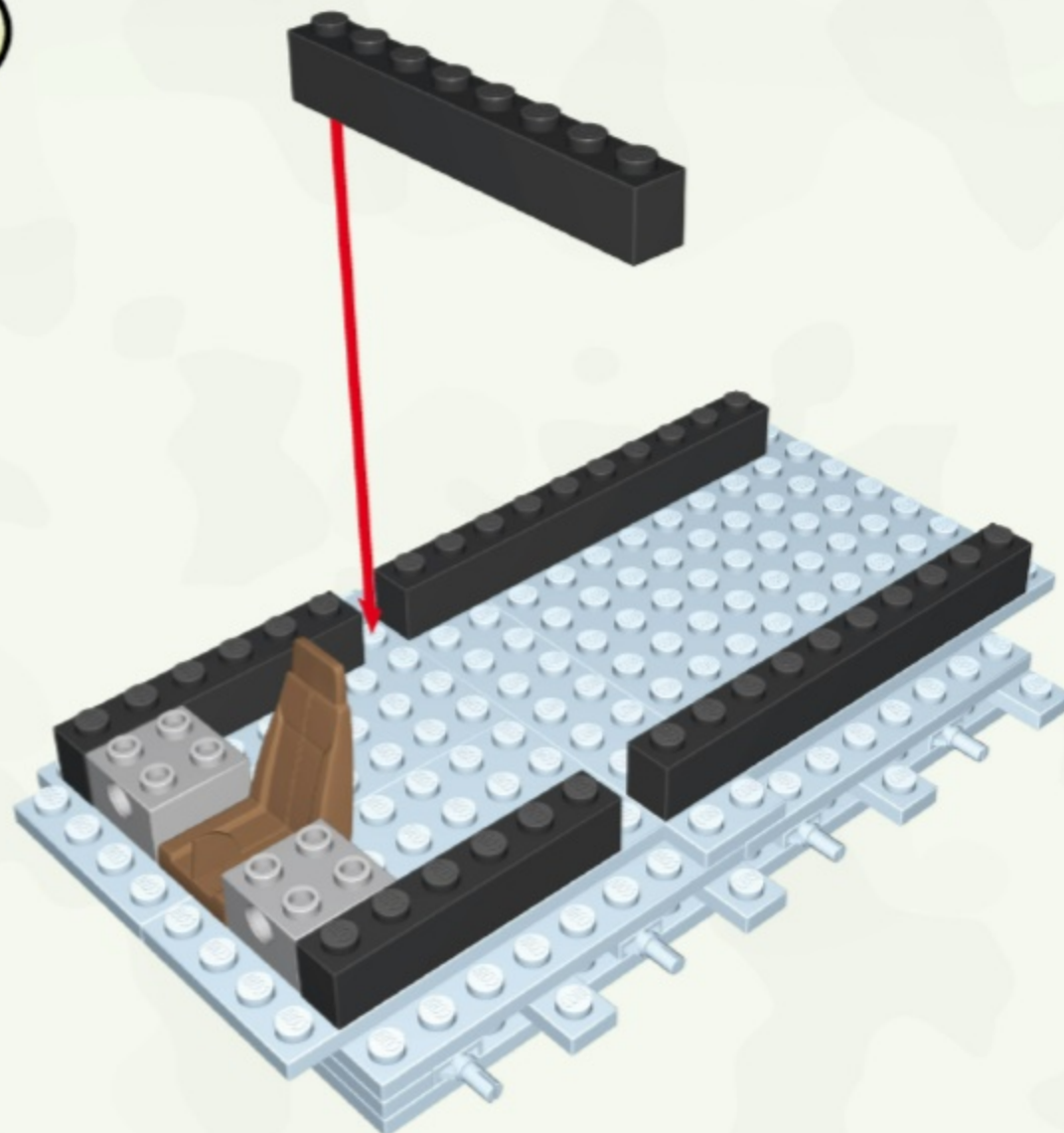

A

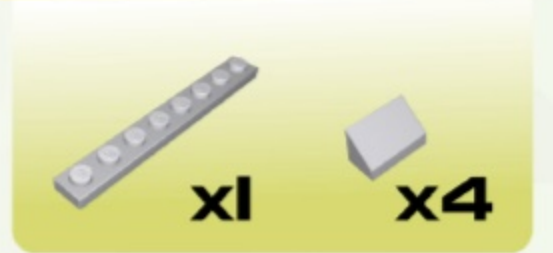
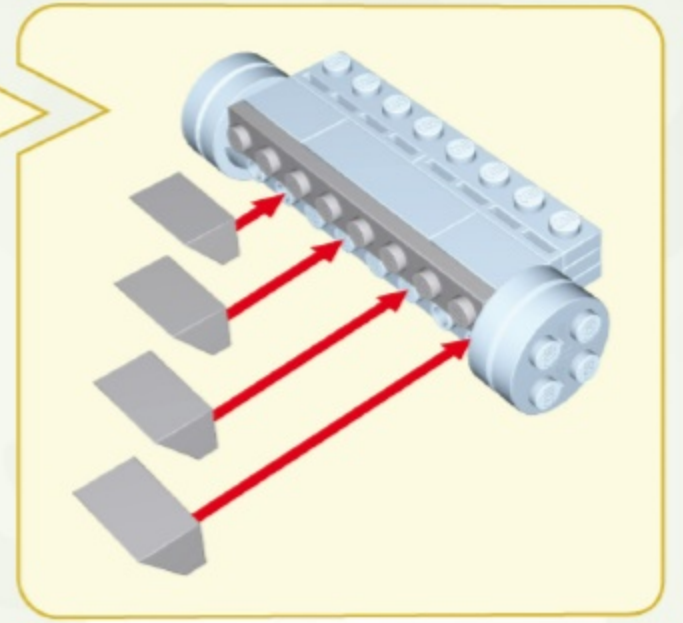
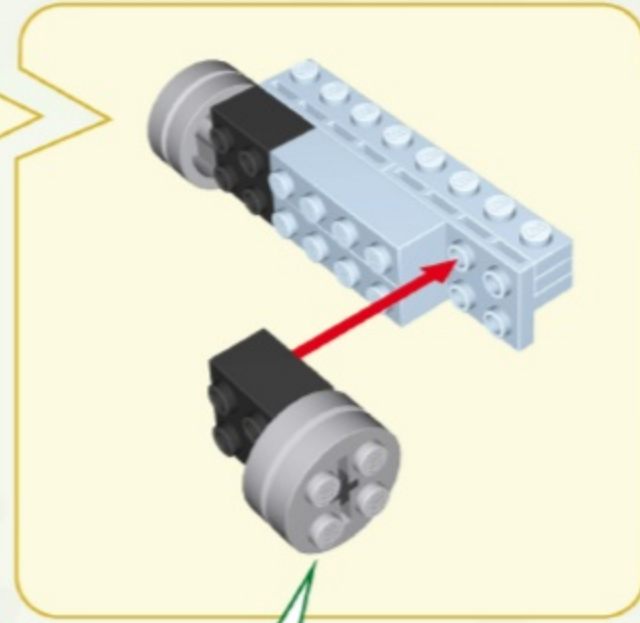
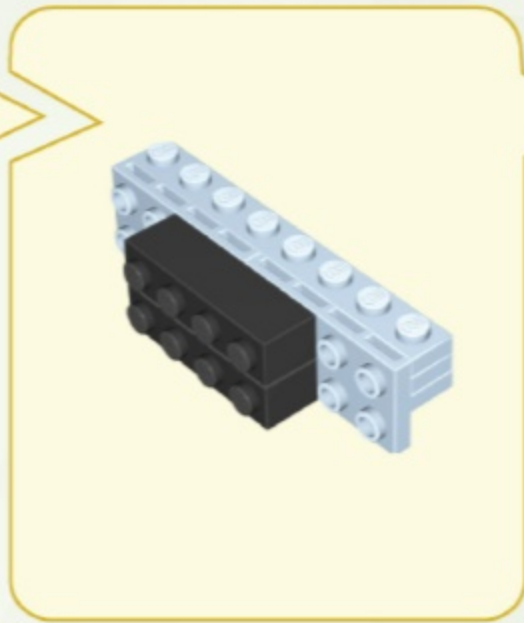
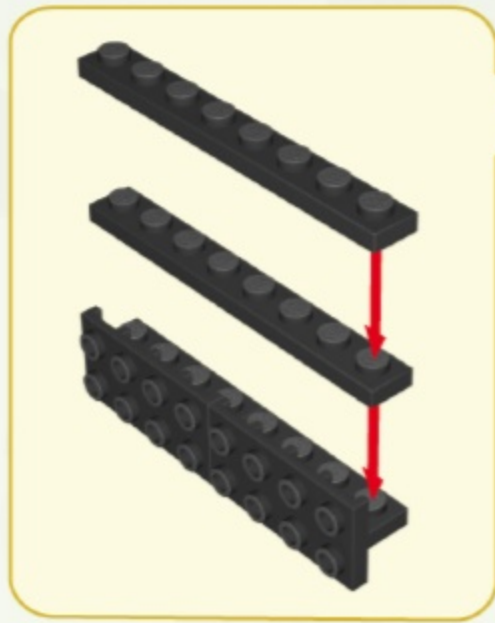

7

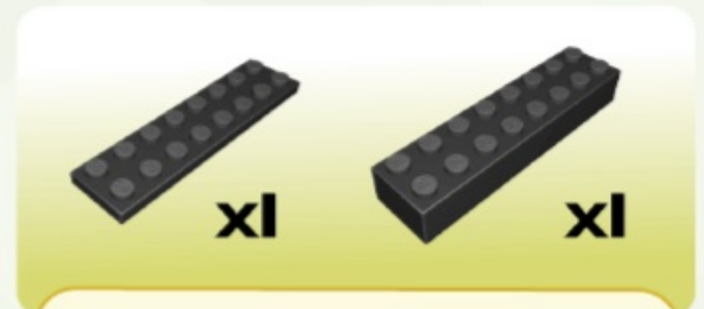
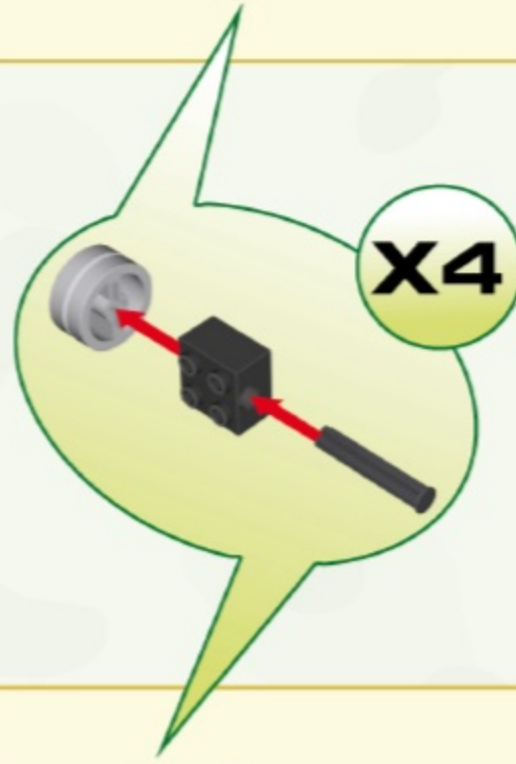

B

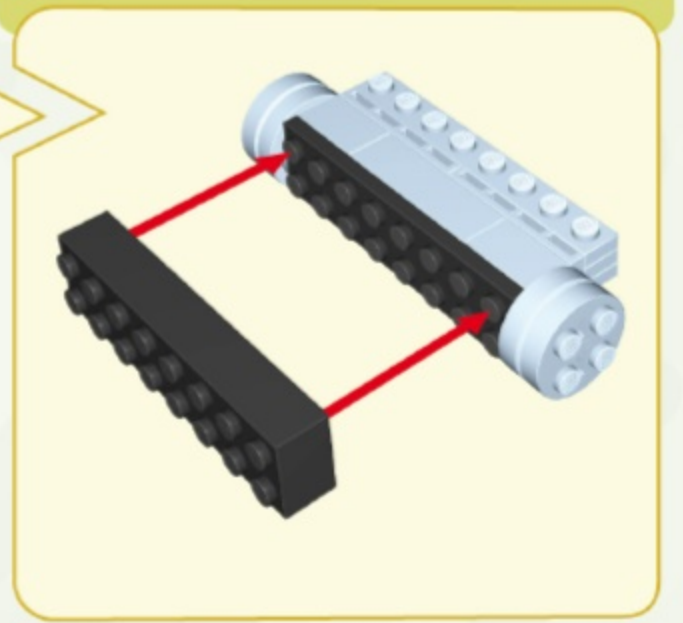
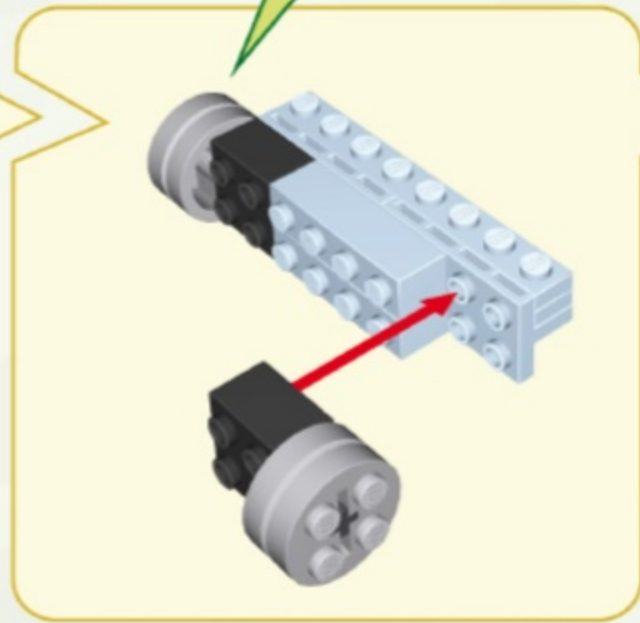
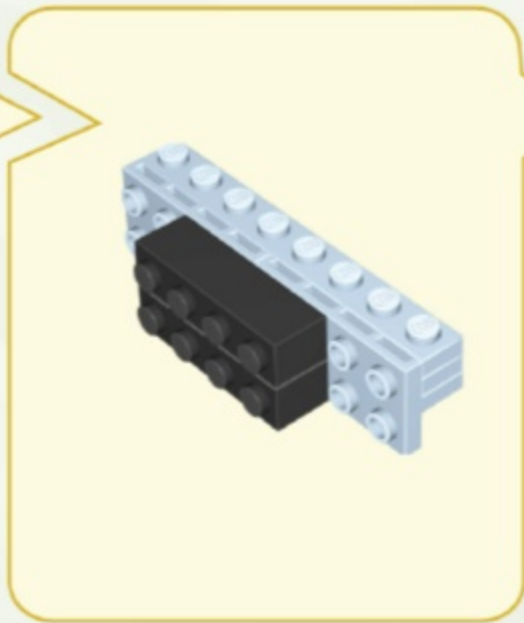
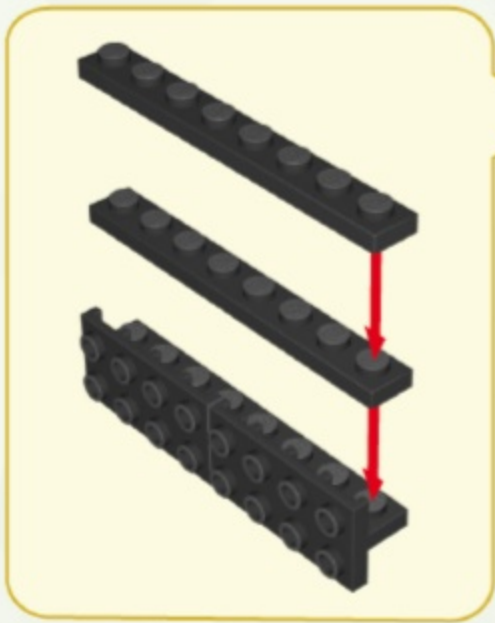

8

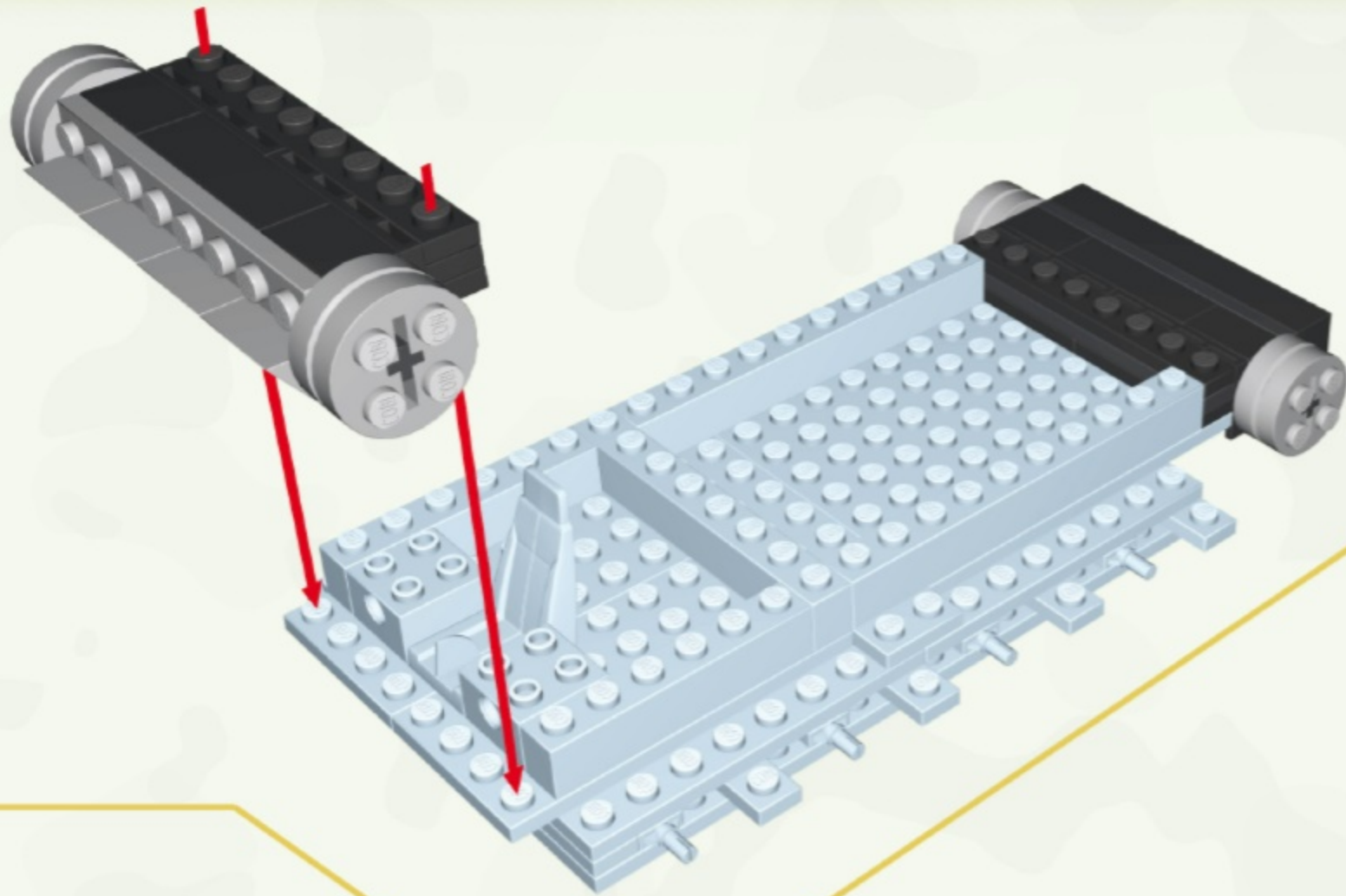

9

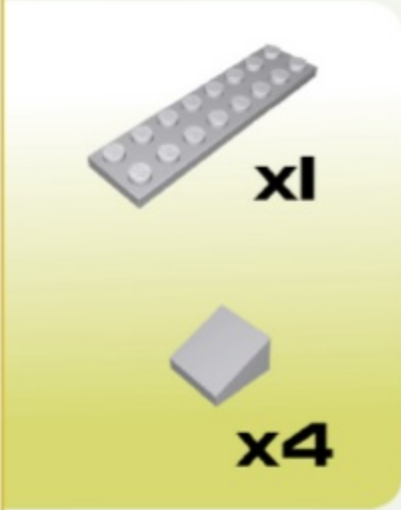
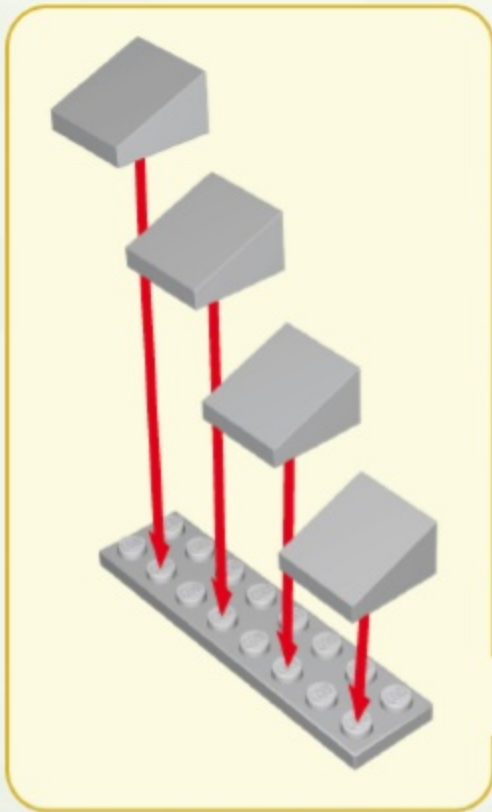
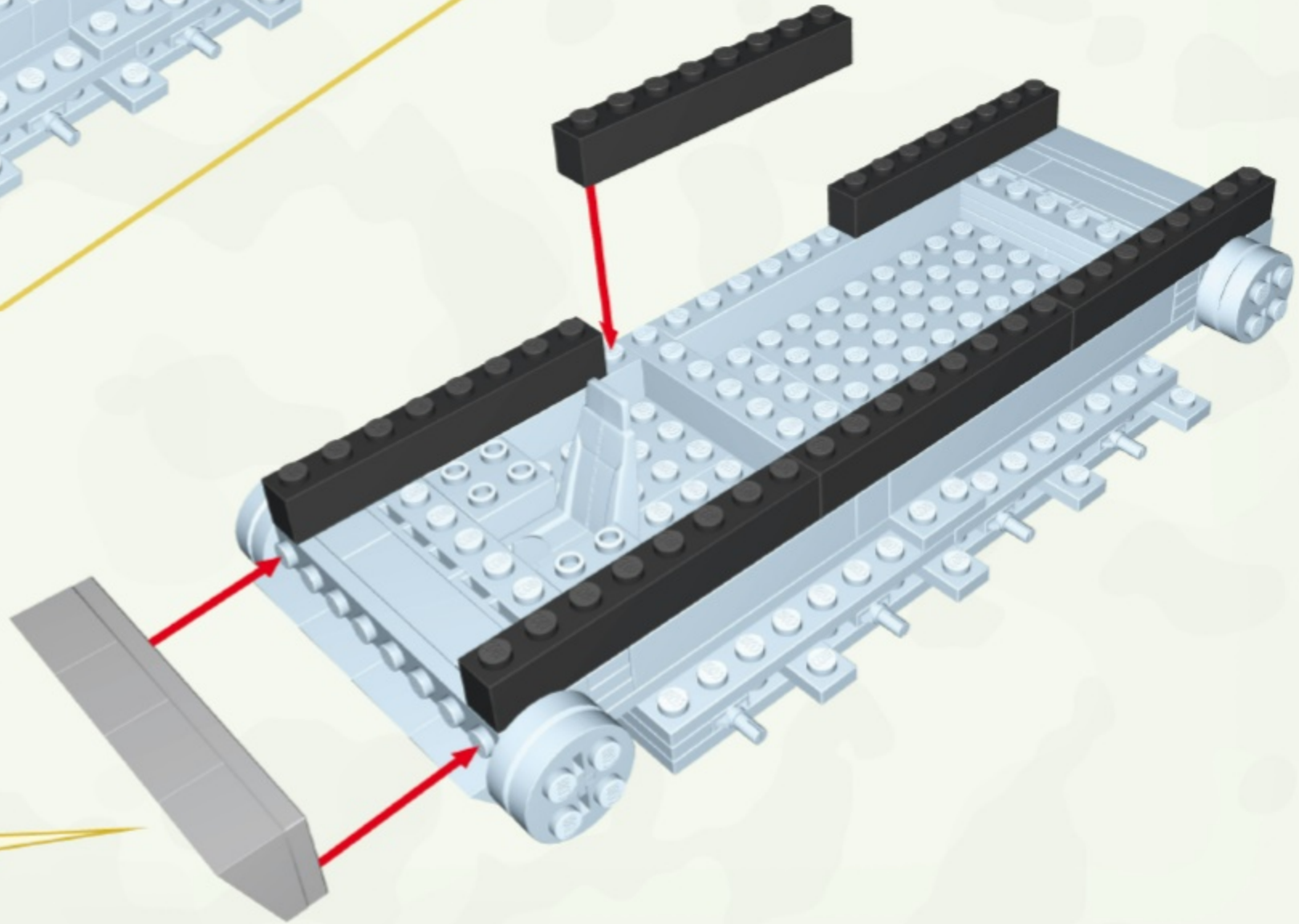

10

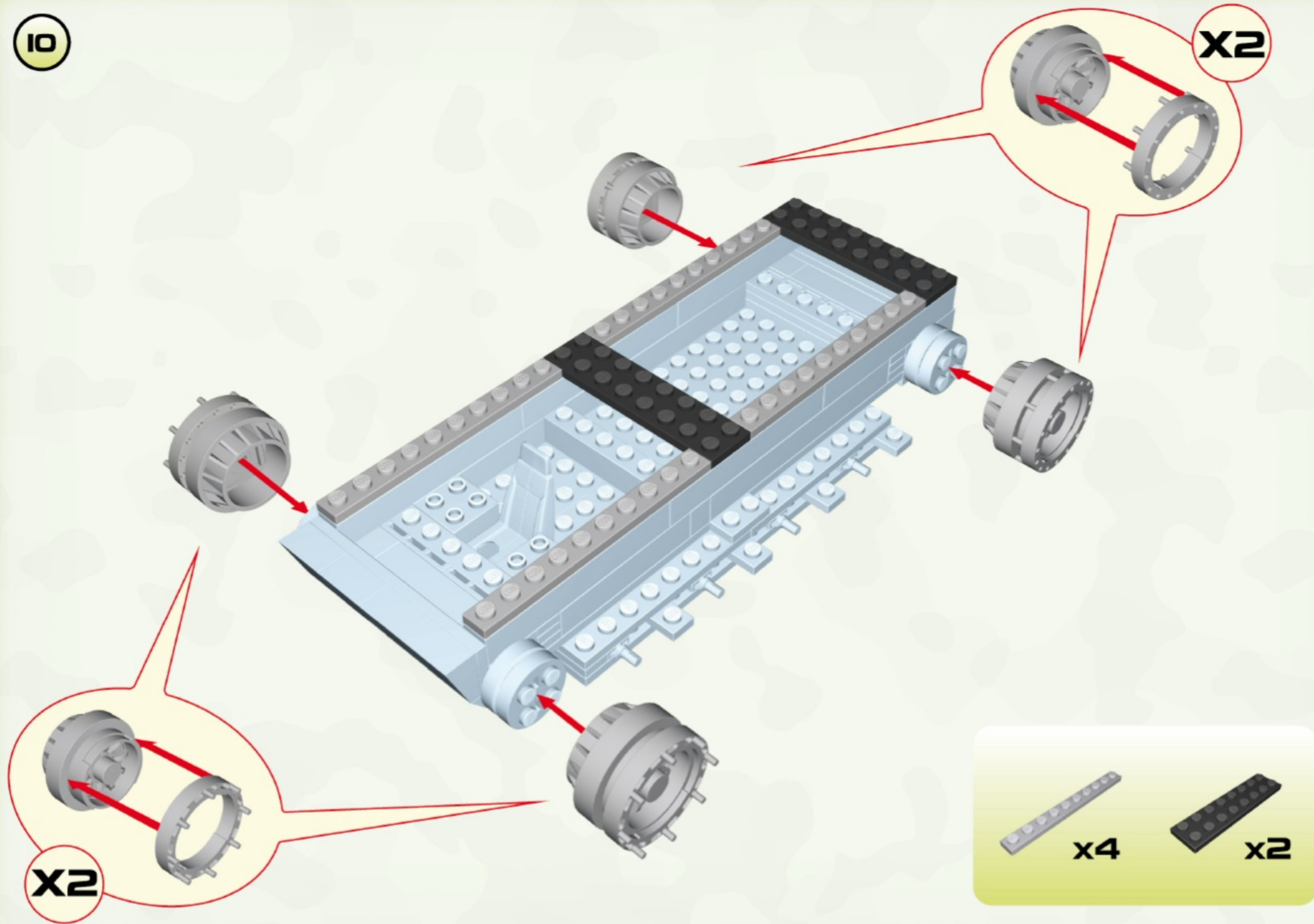

X2

X2

x4

x2

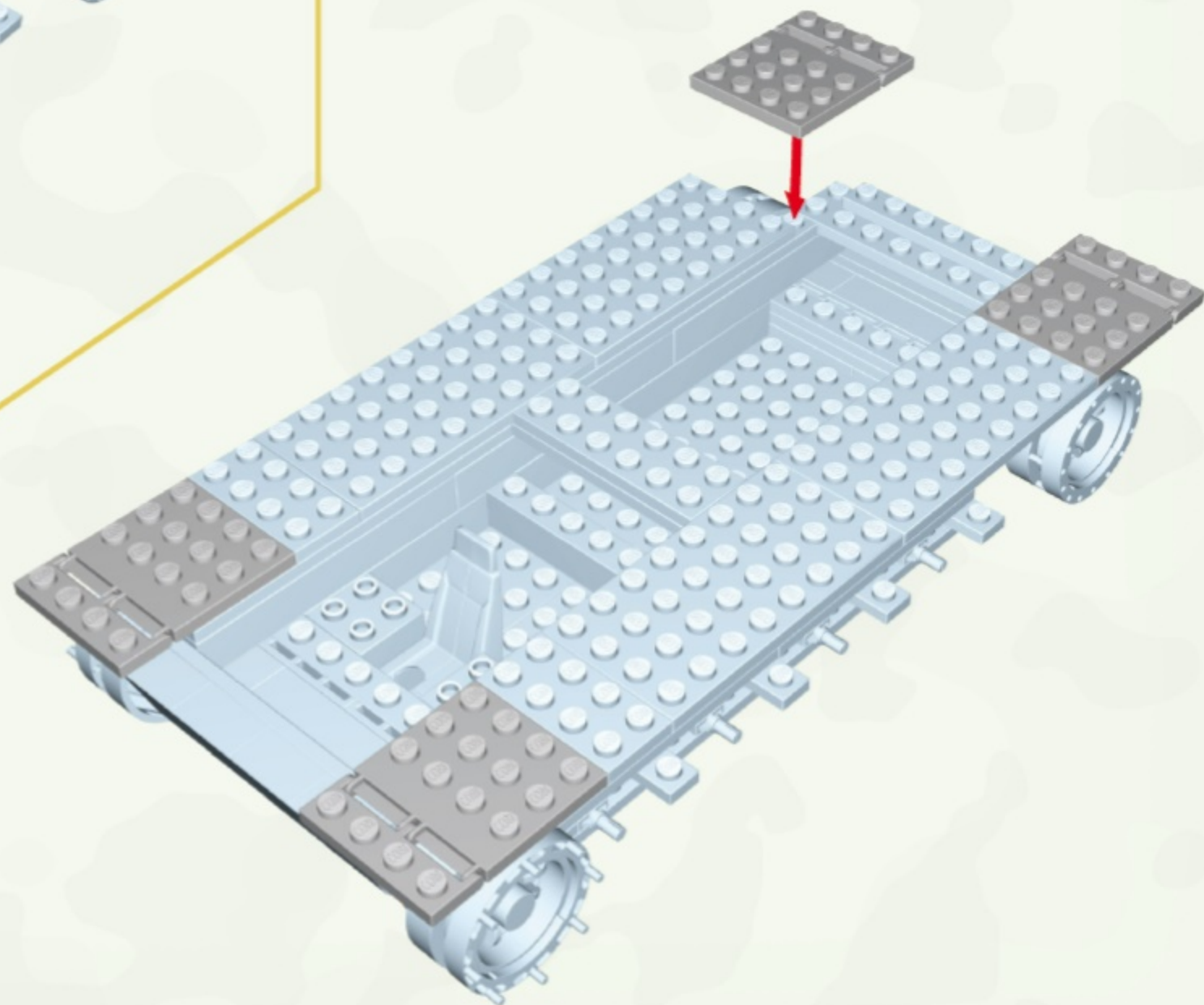
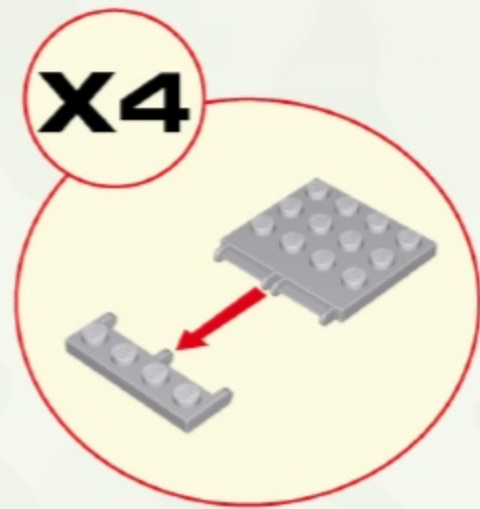
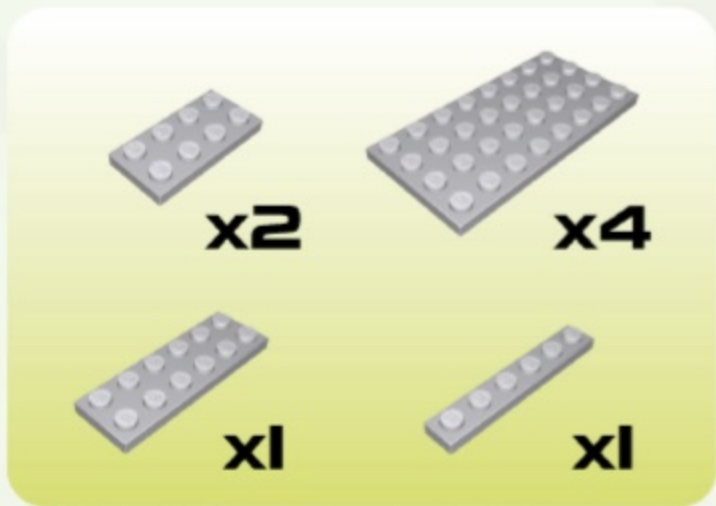
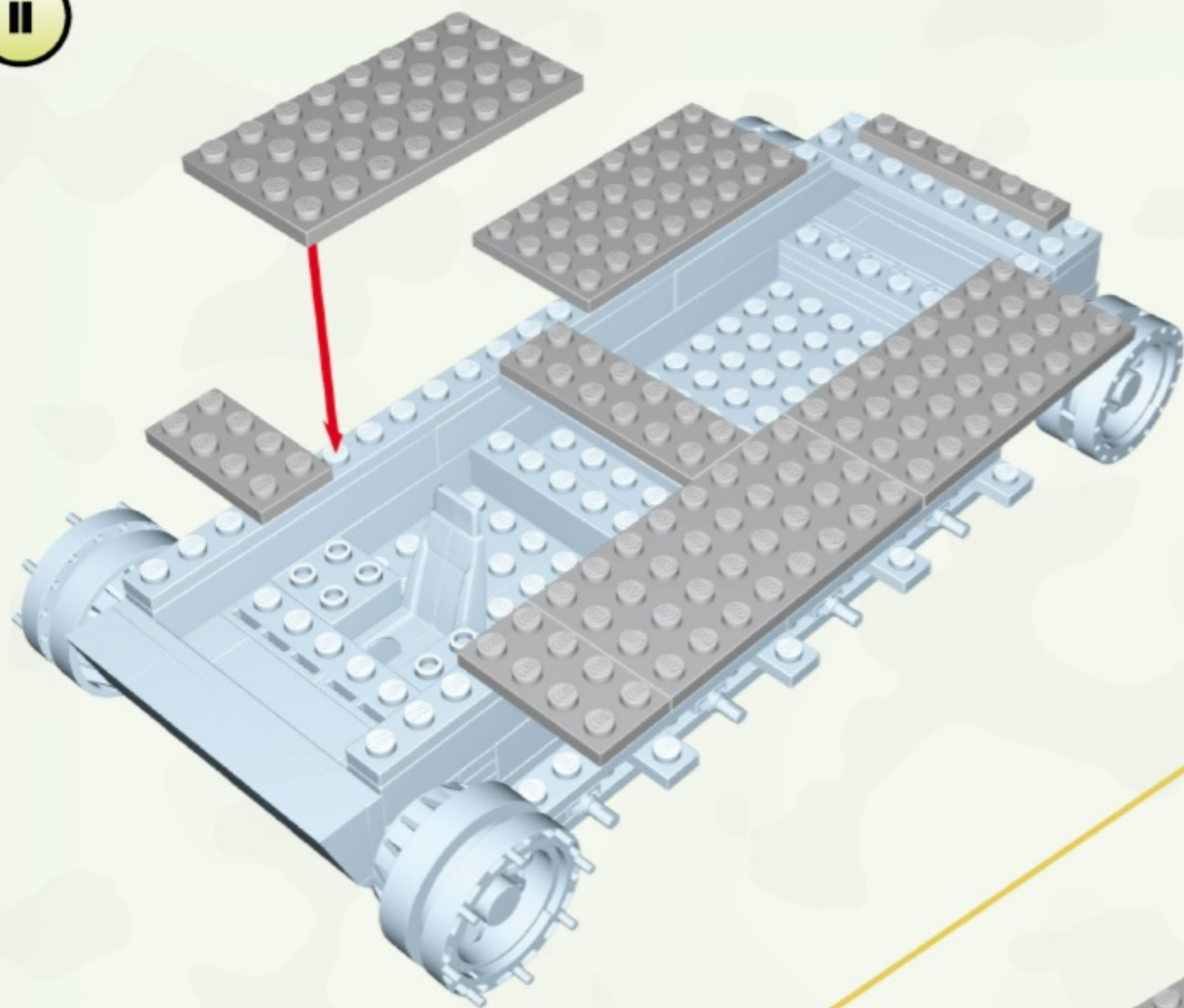



13

X10

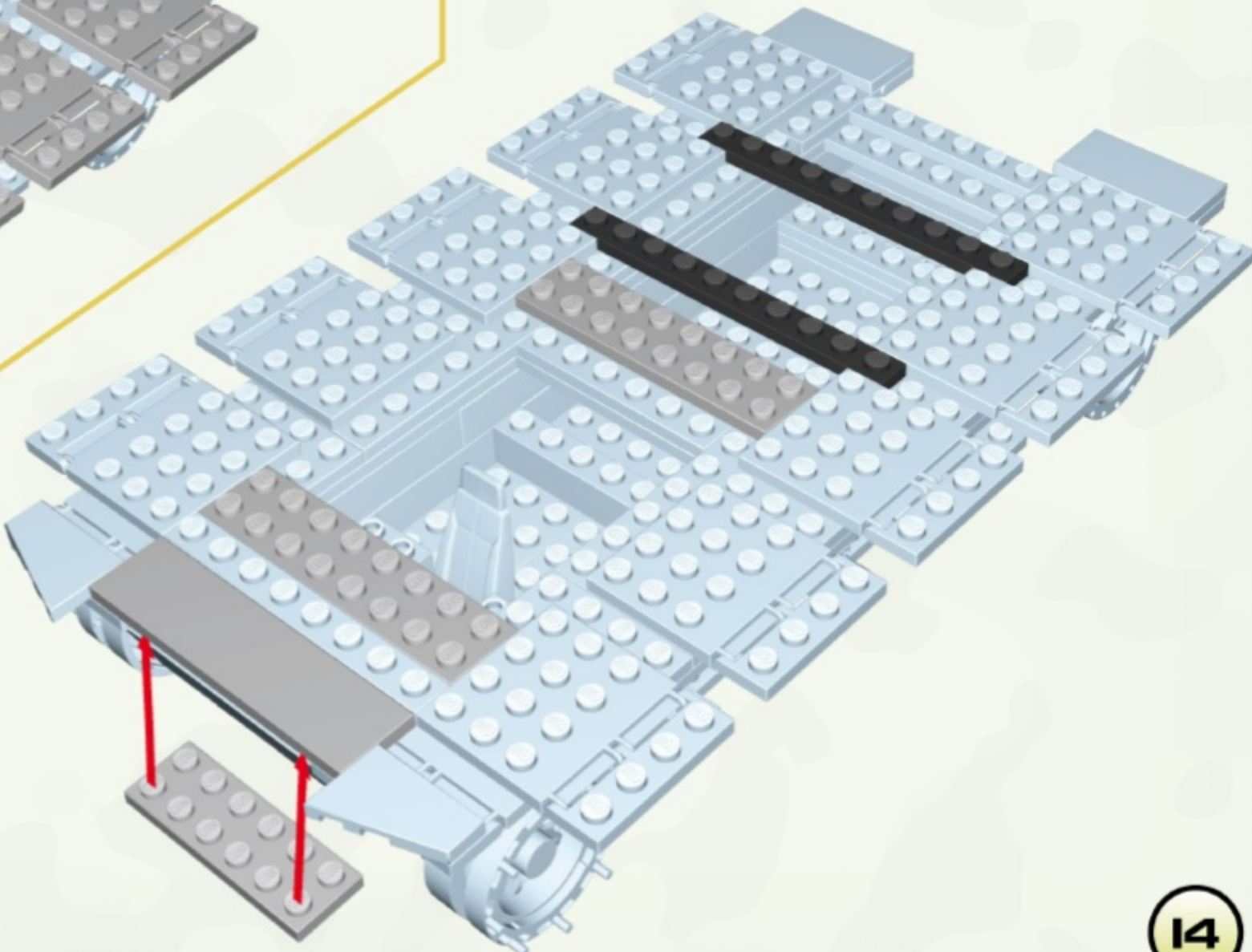
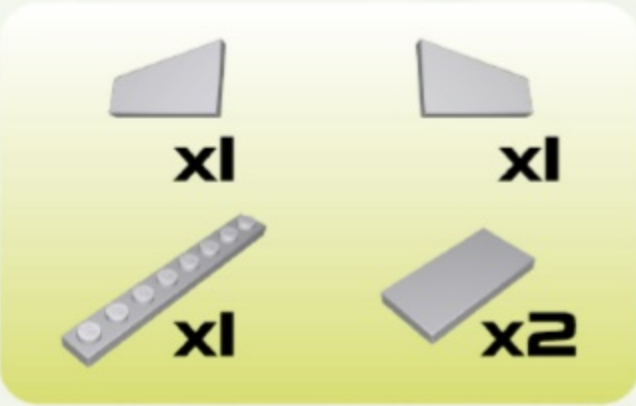
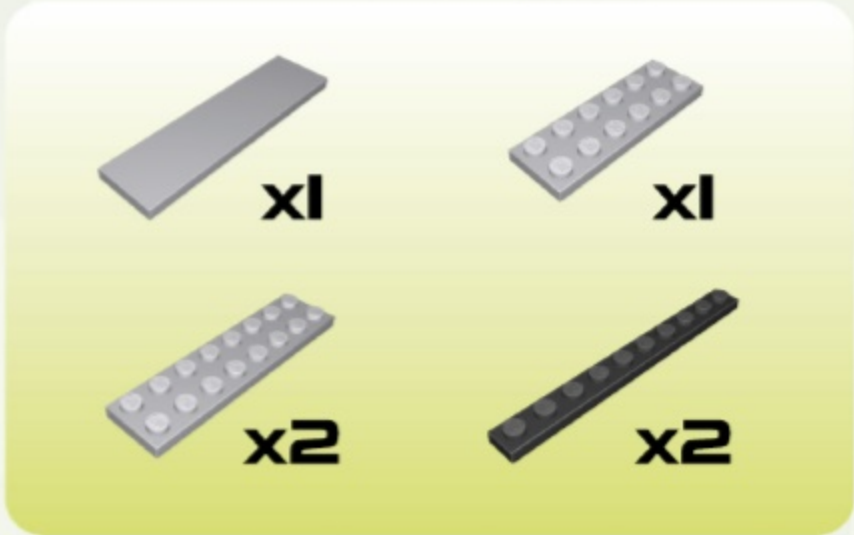
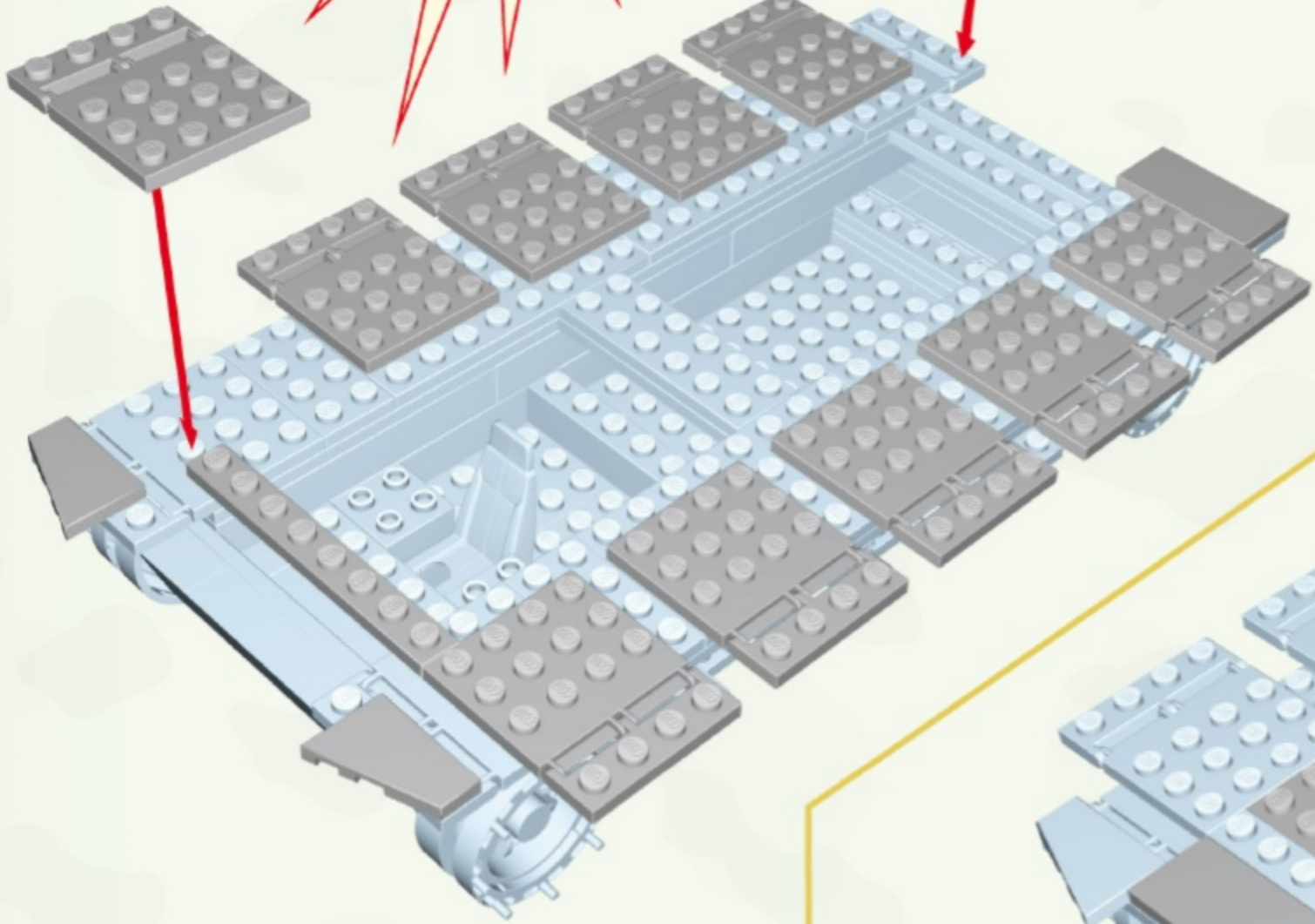

14





17

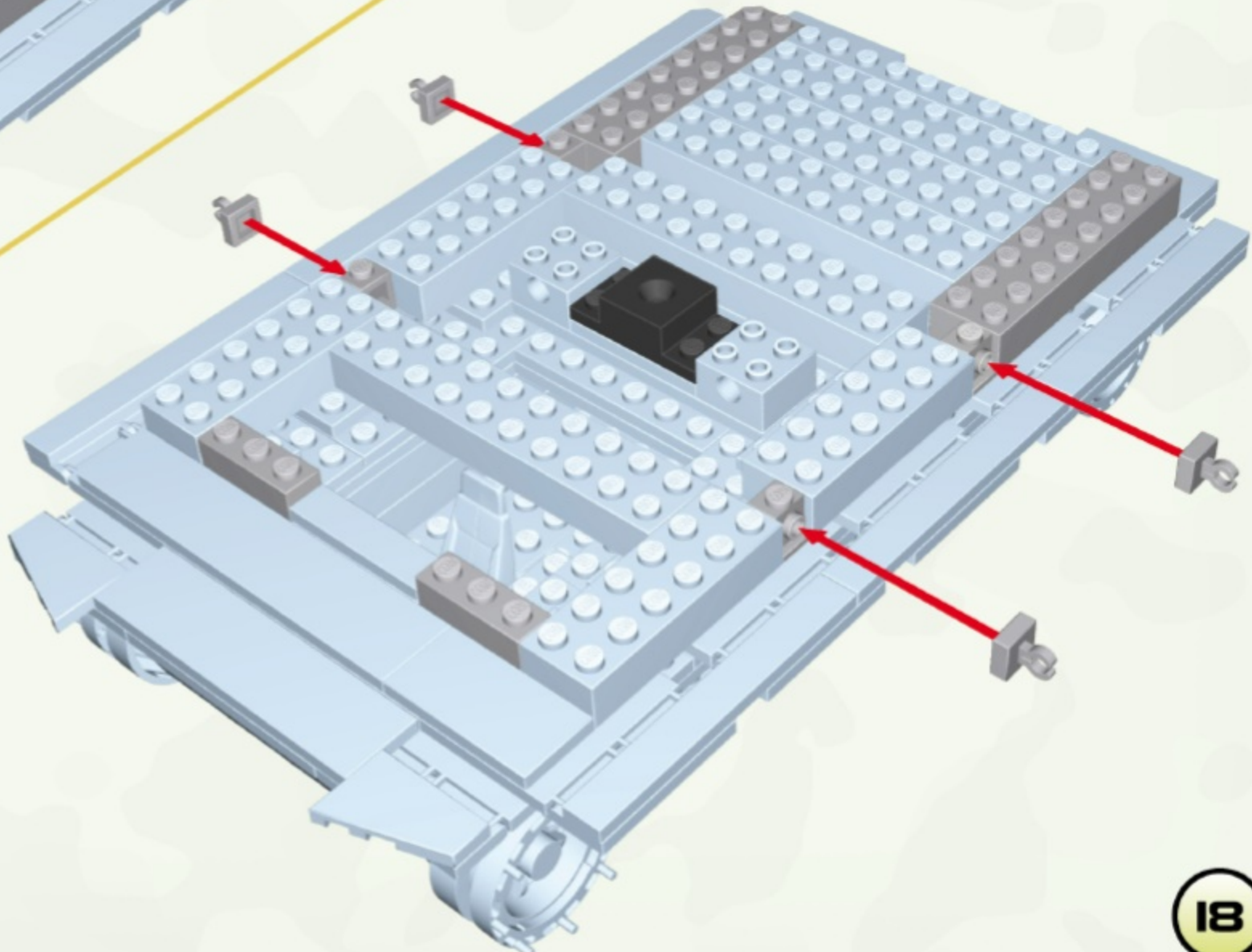
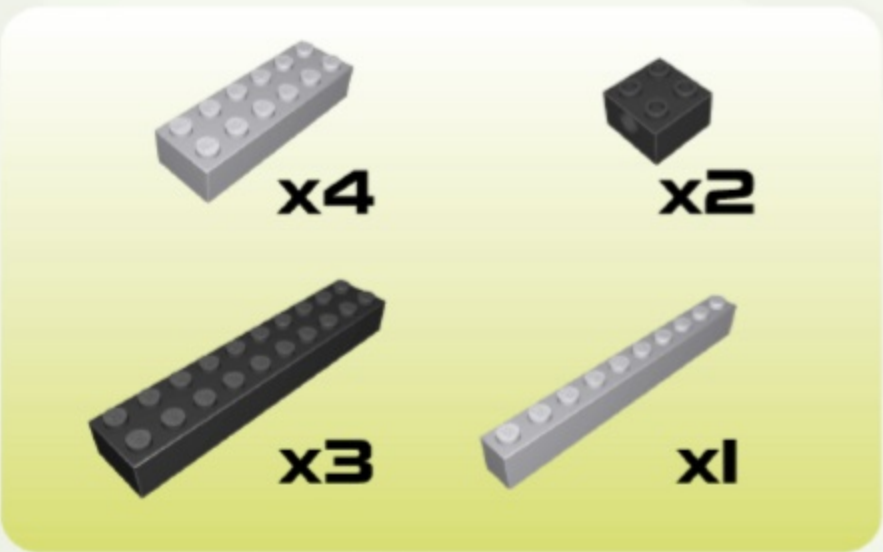
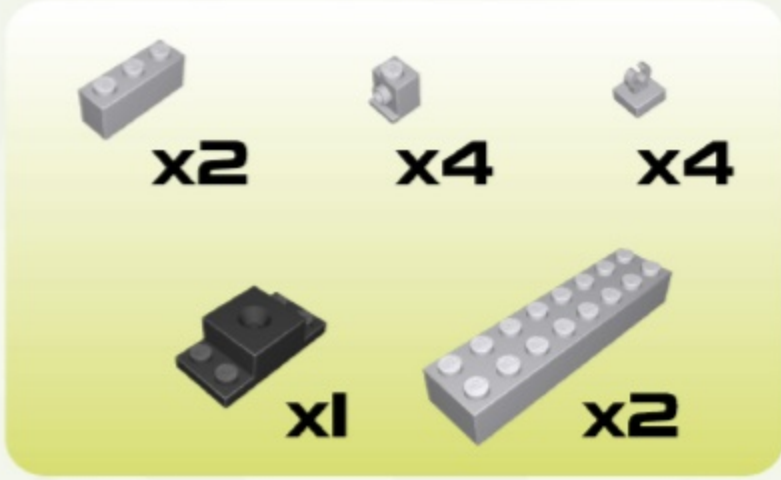
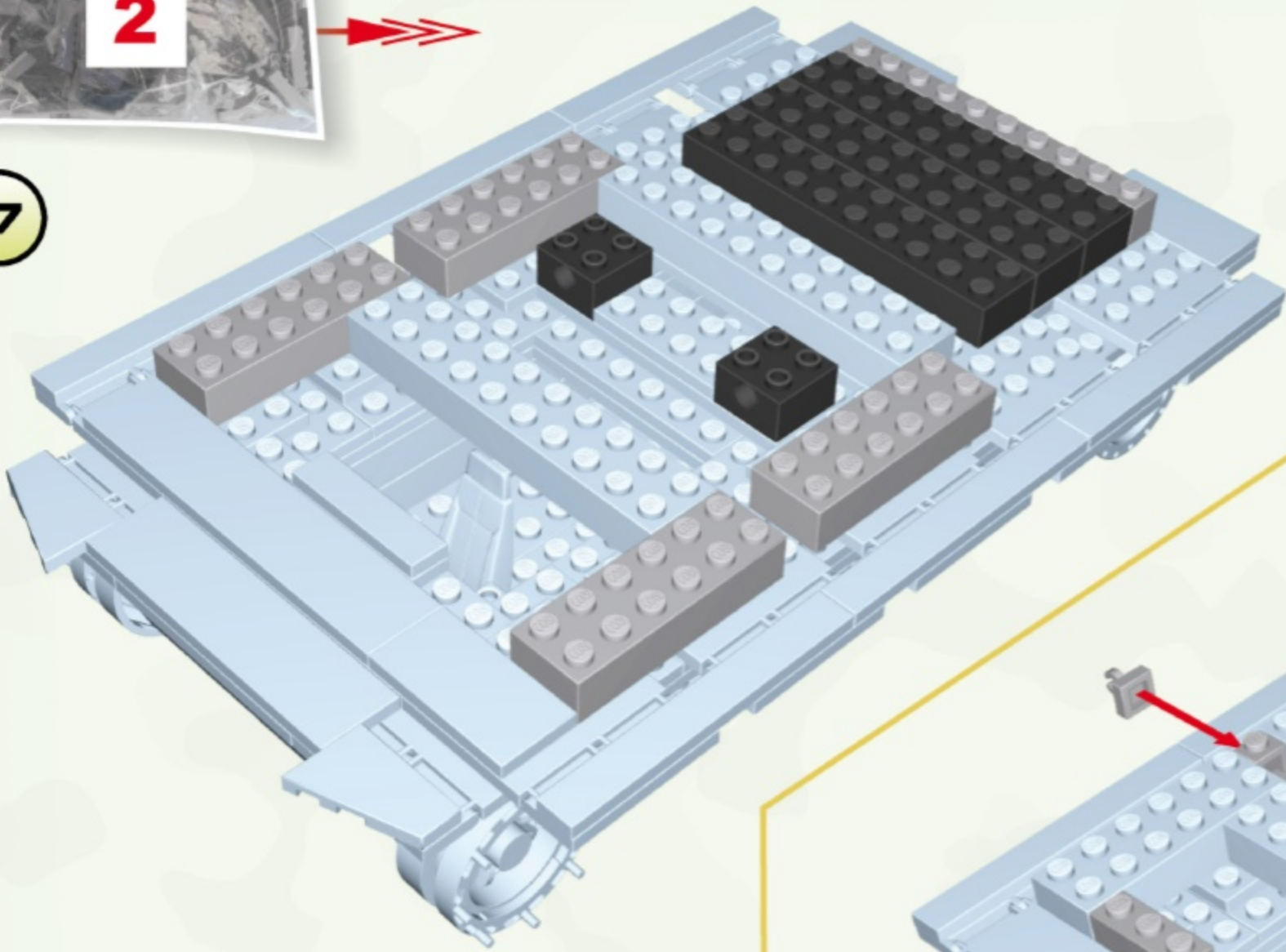

18

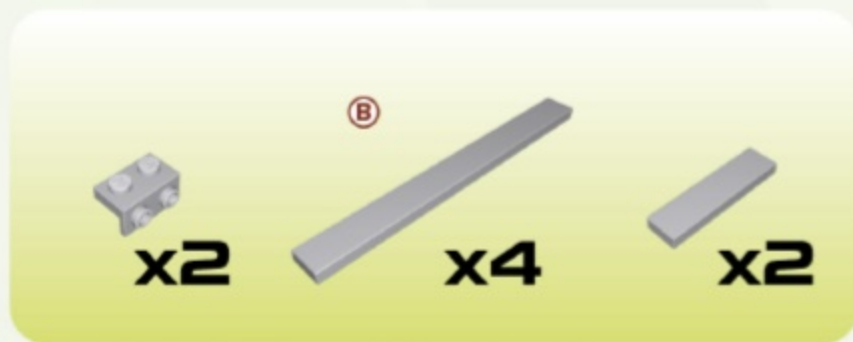
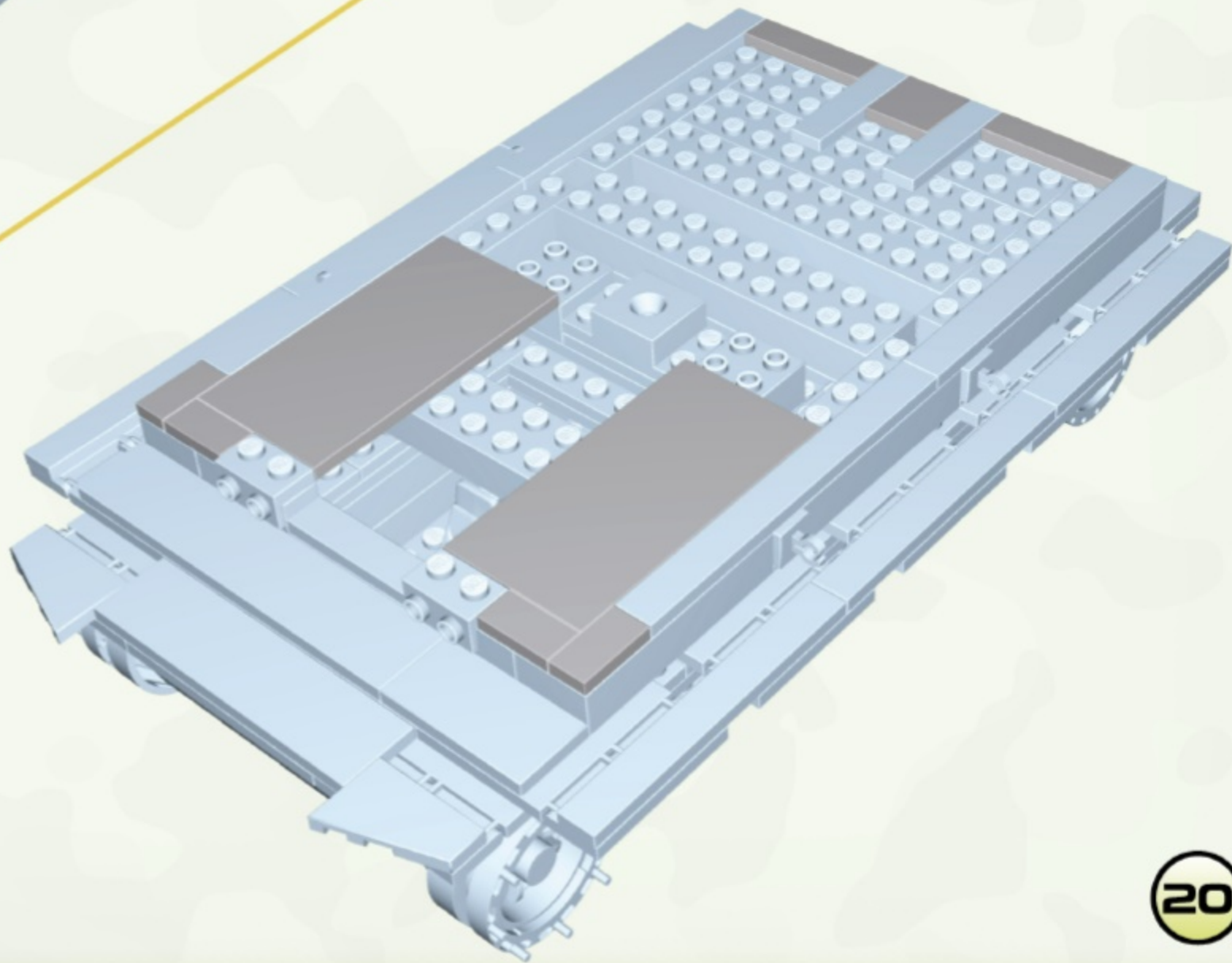
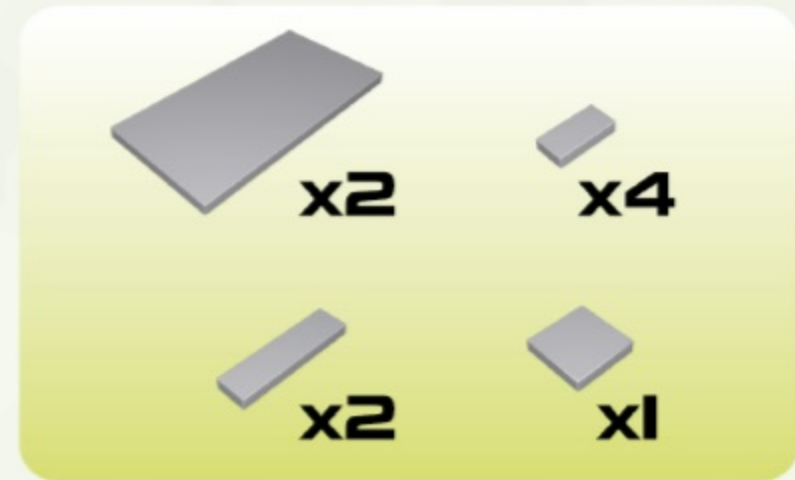
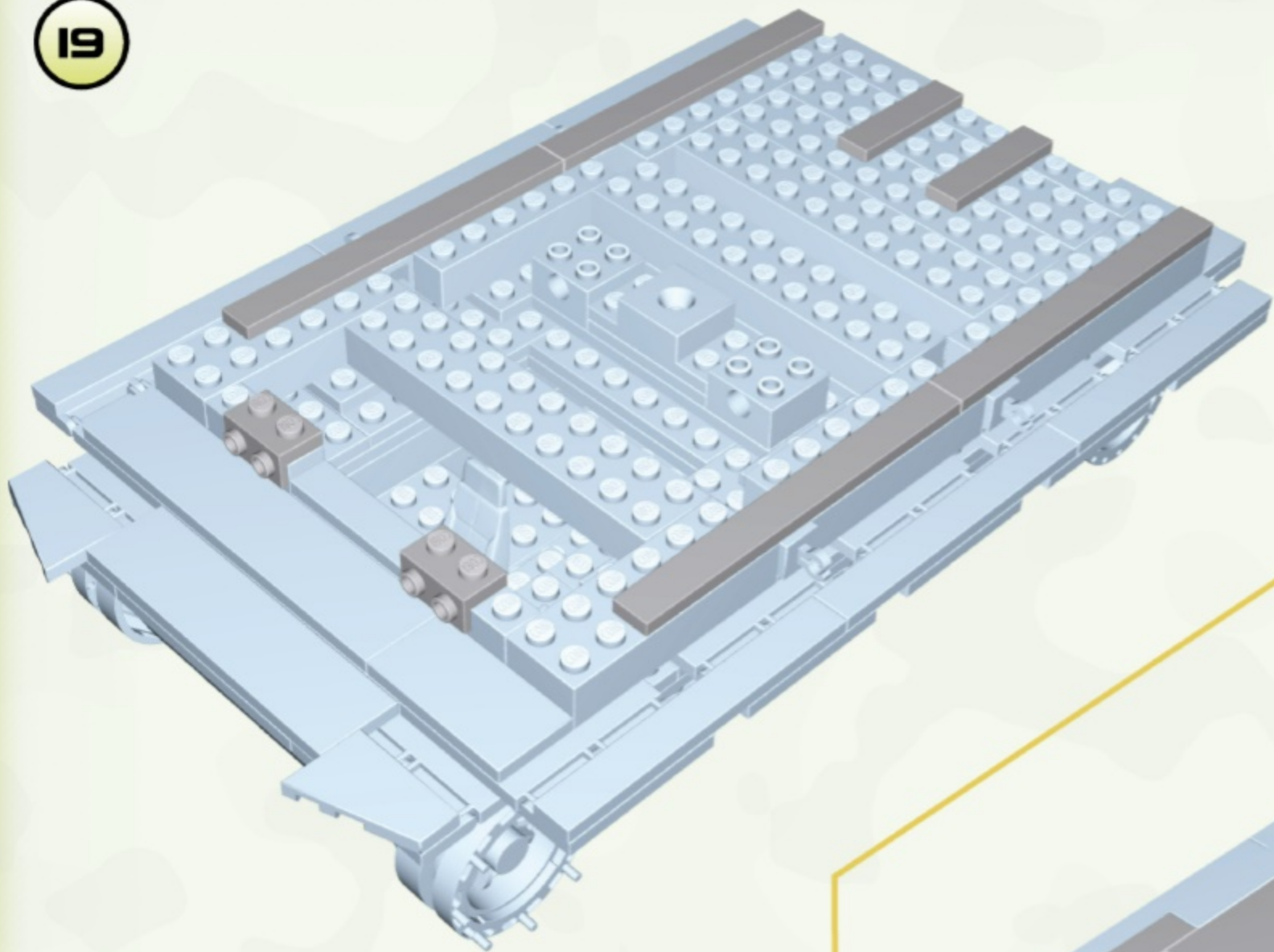

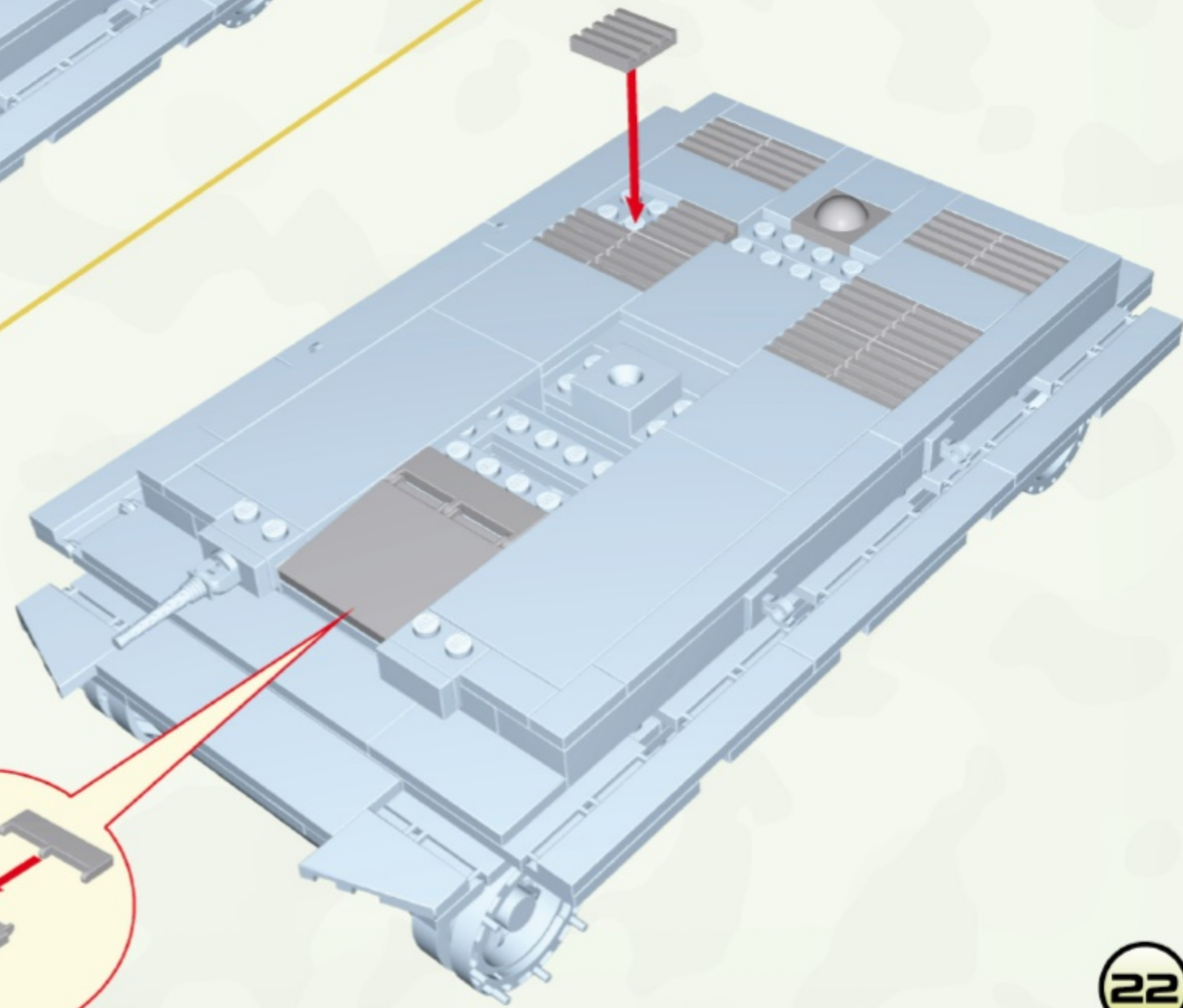
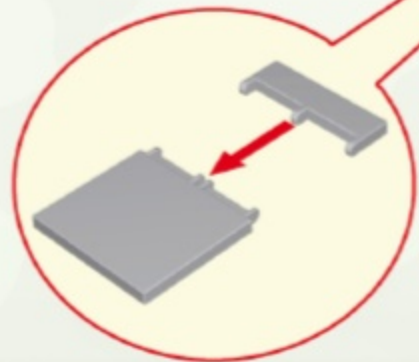
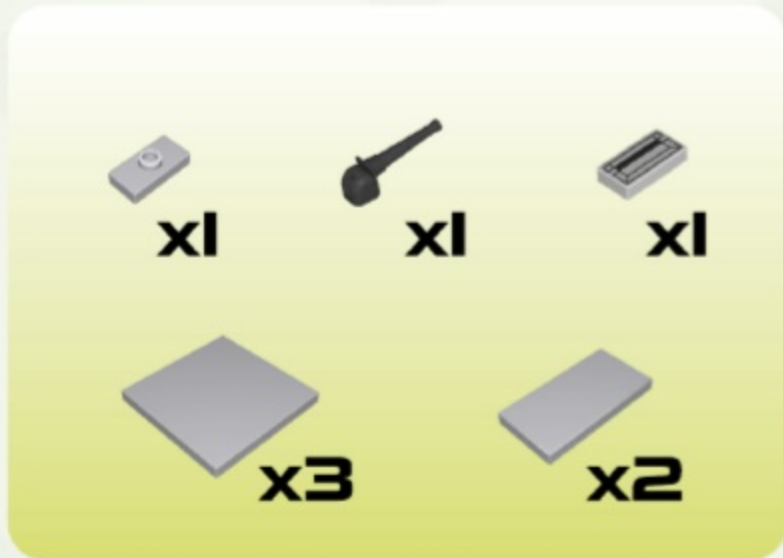
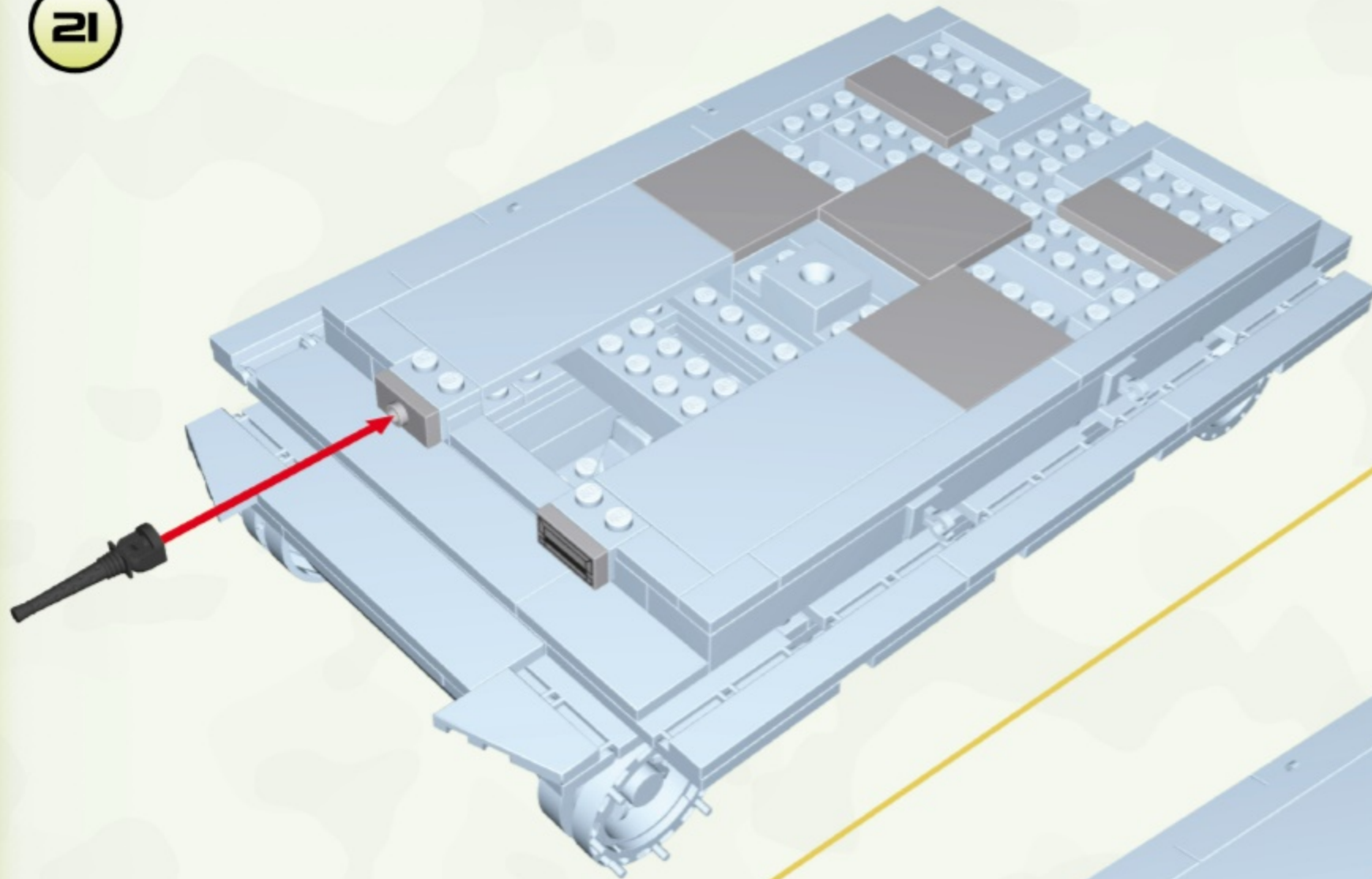

23

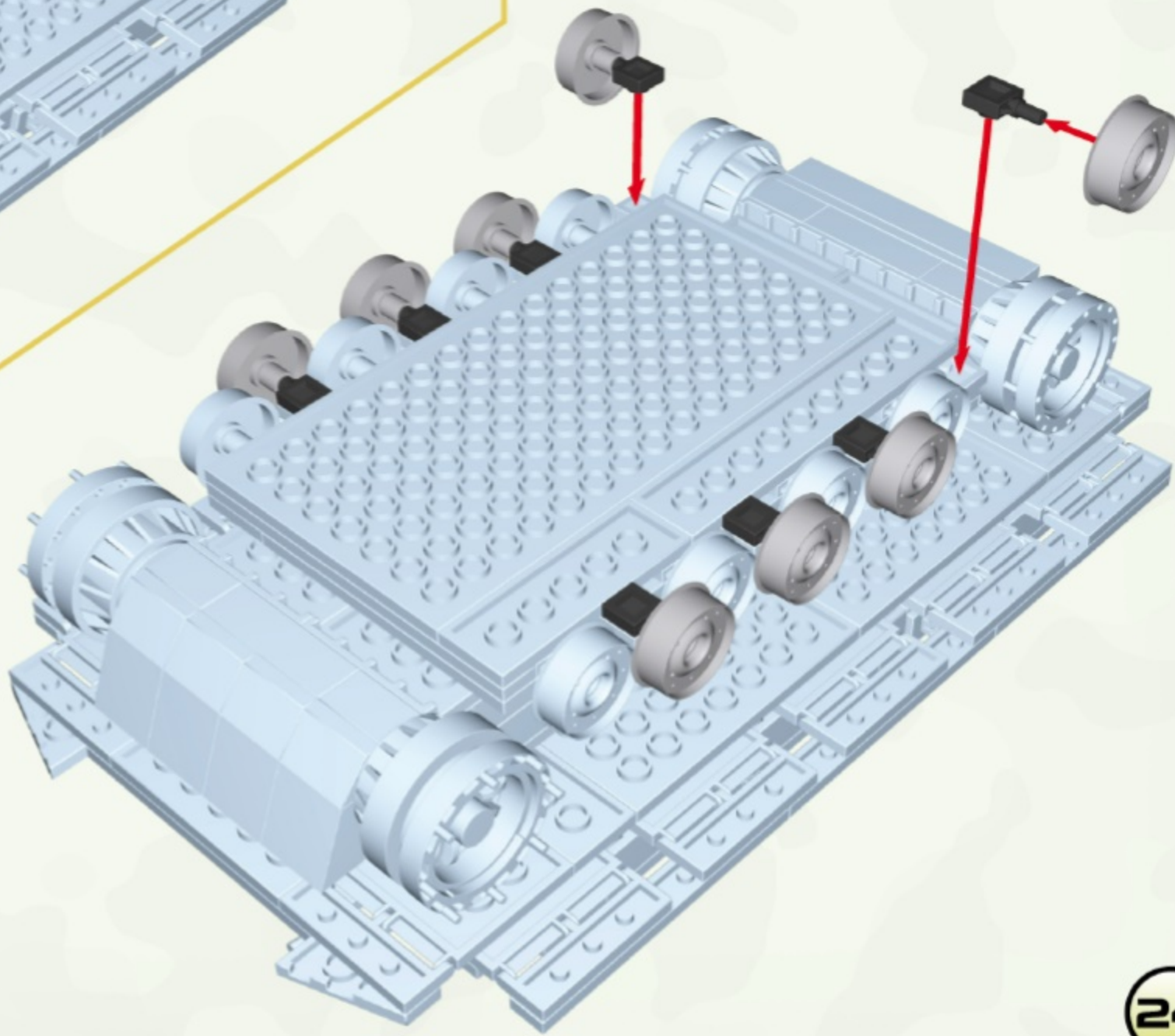
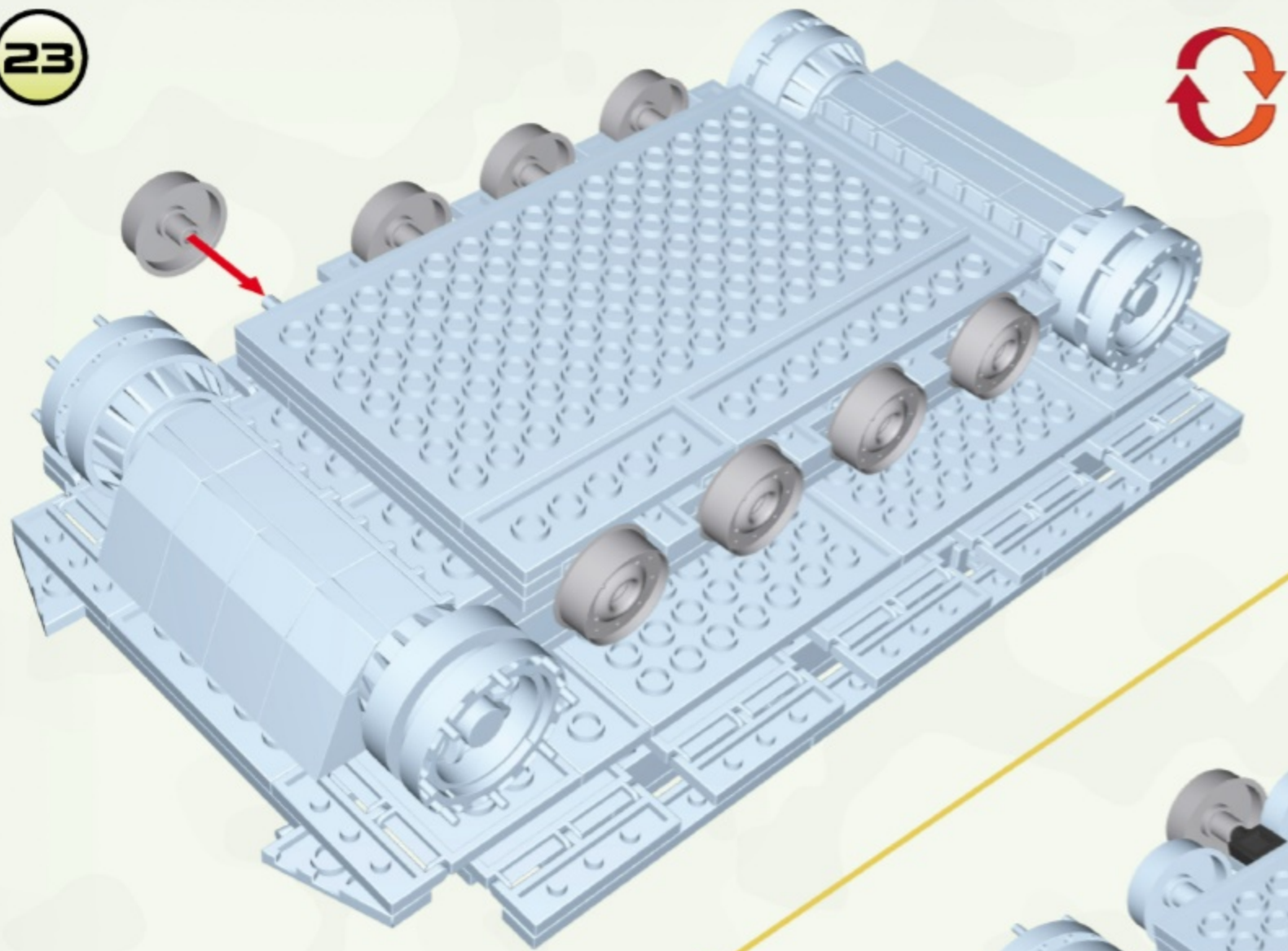

24

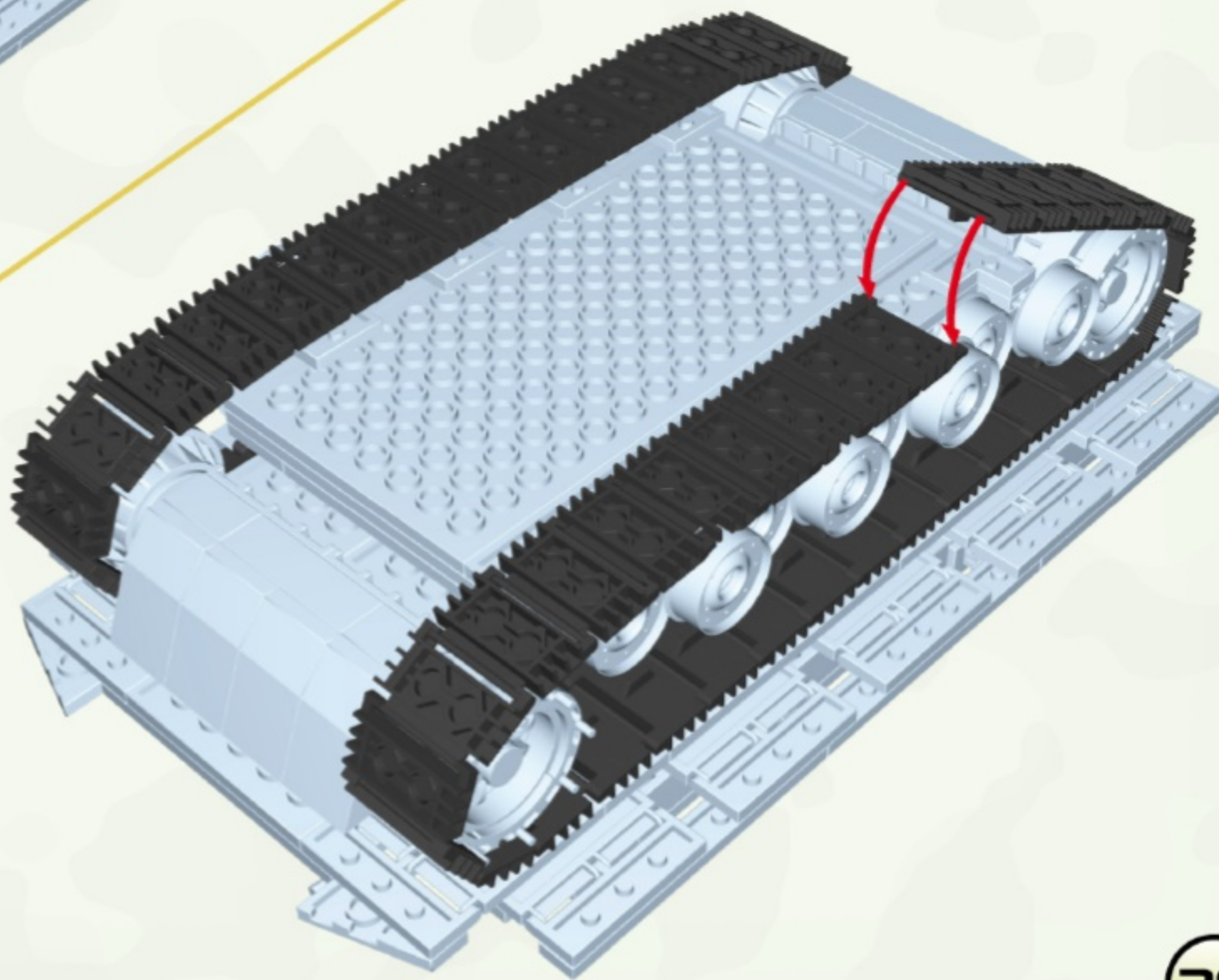
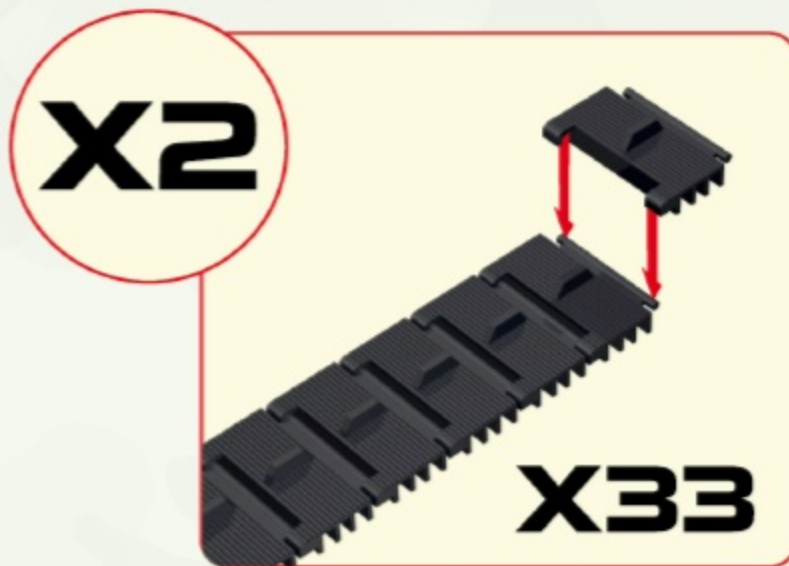
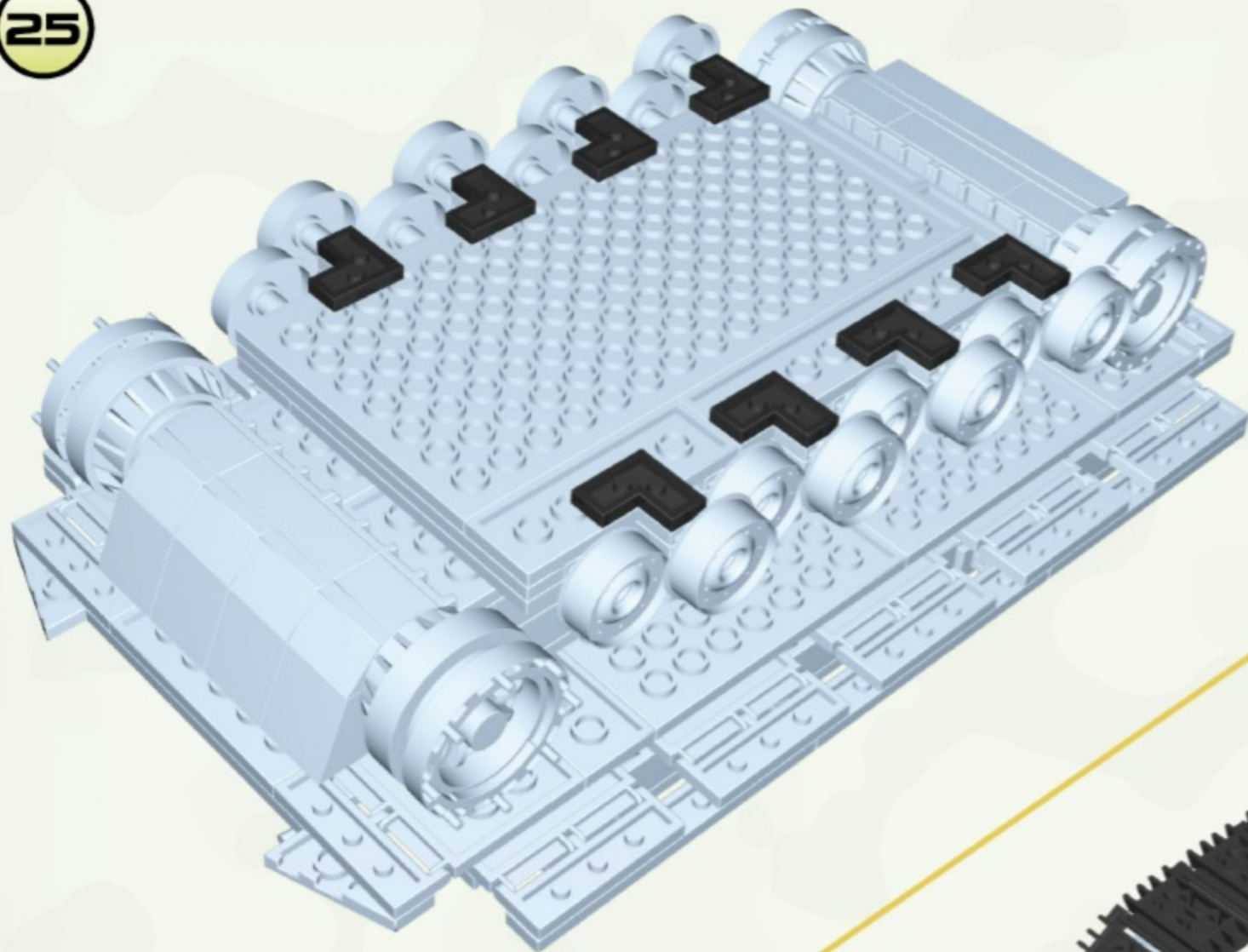



3

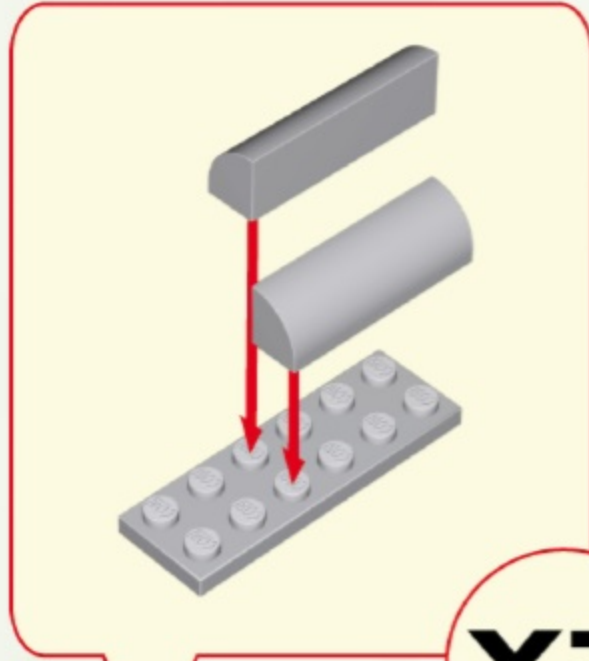
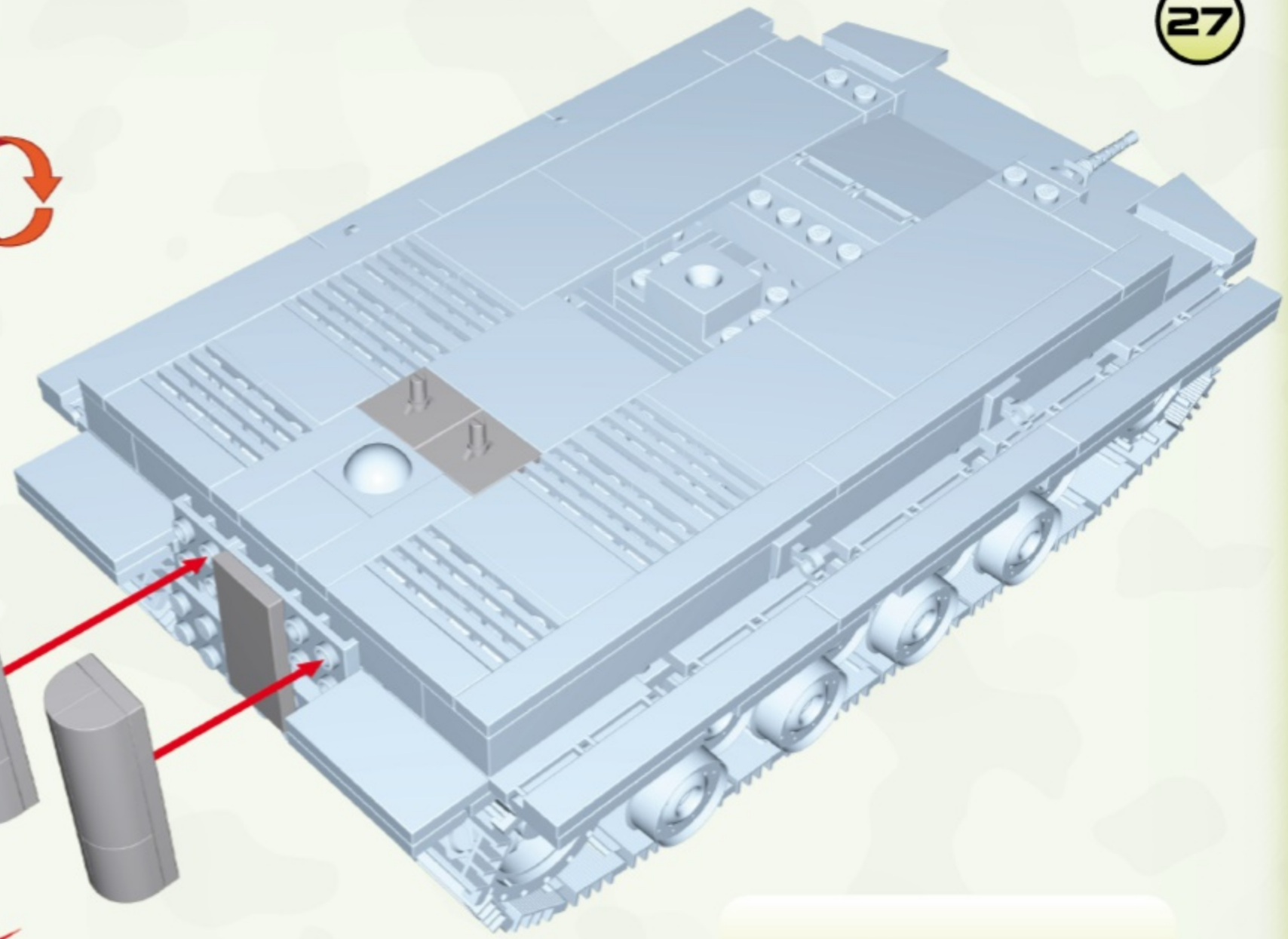

X2

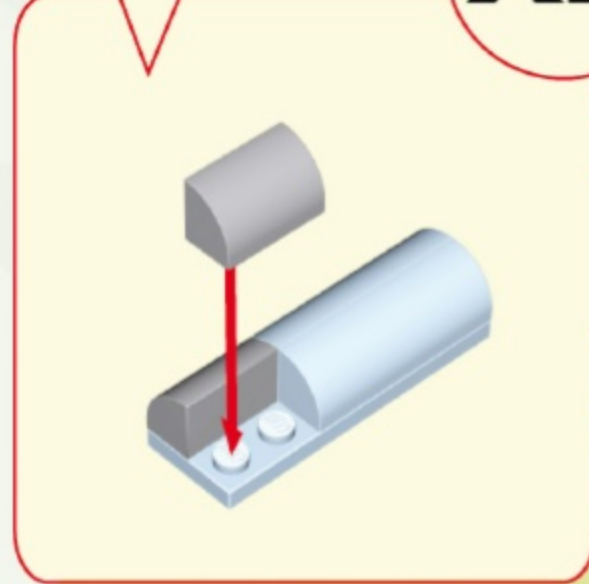



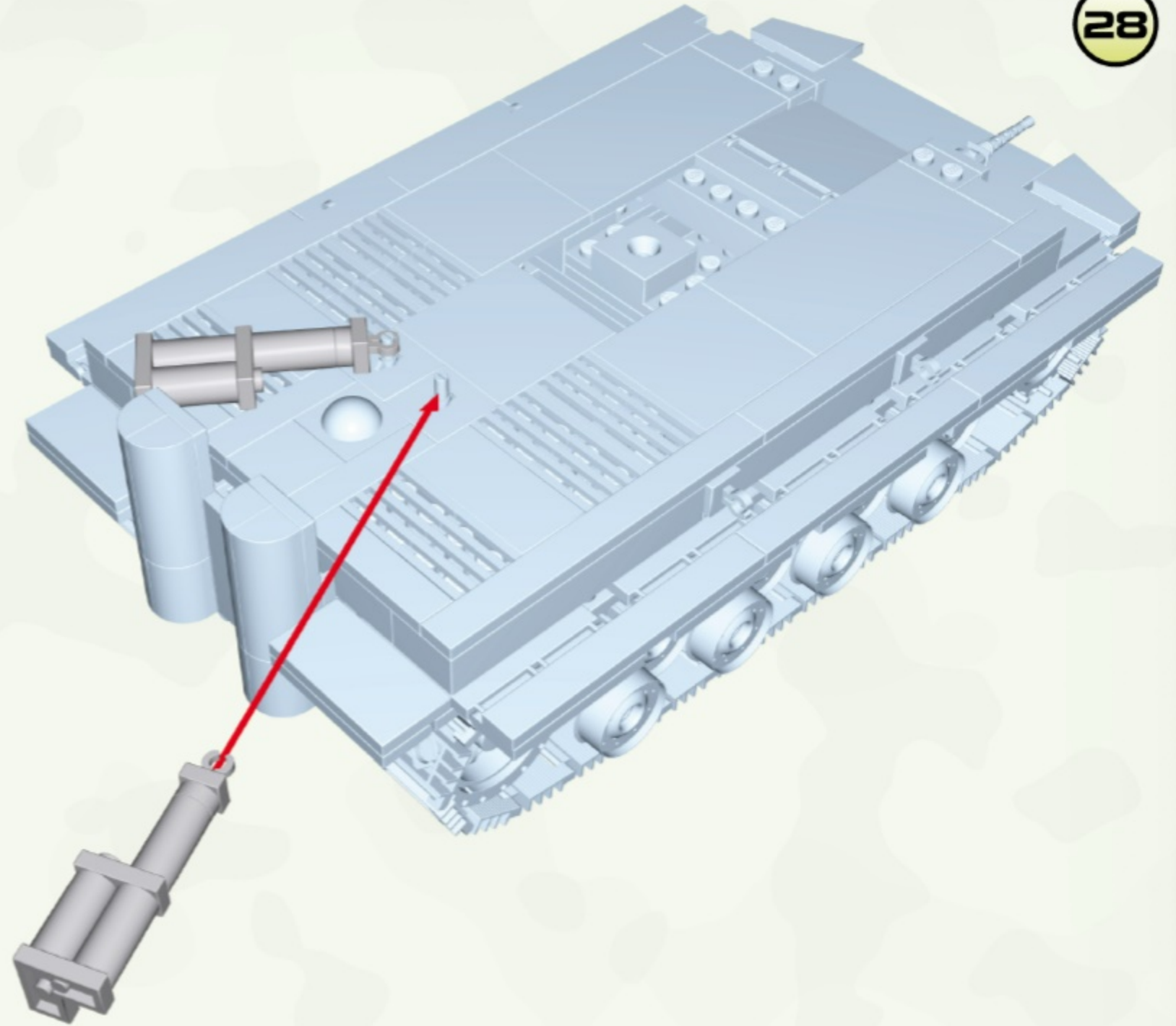
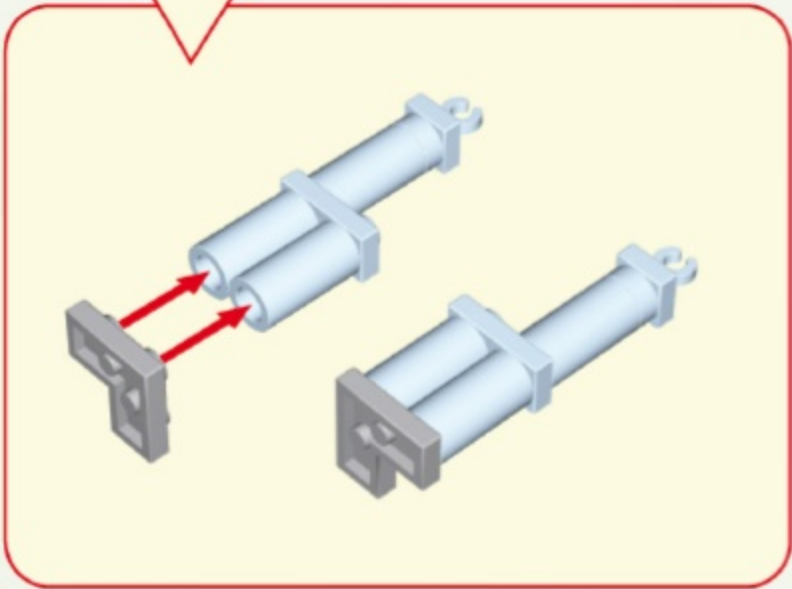
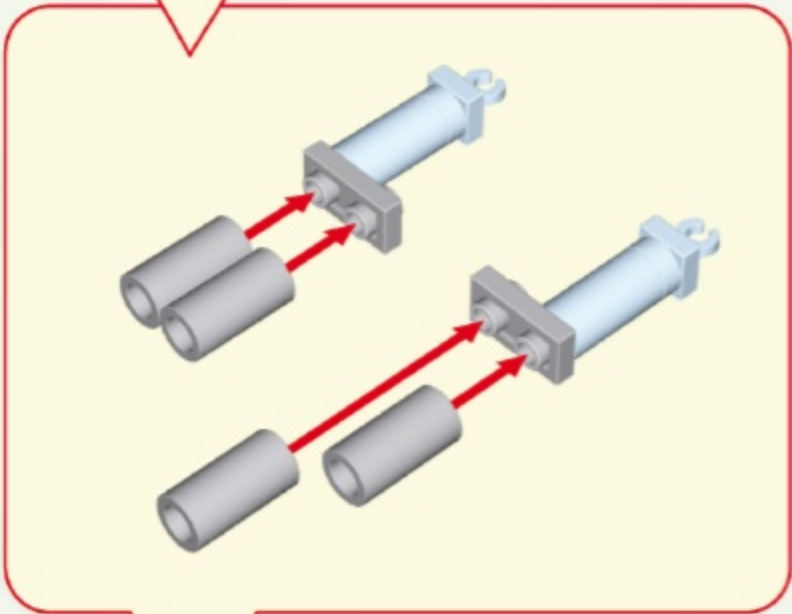
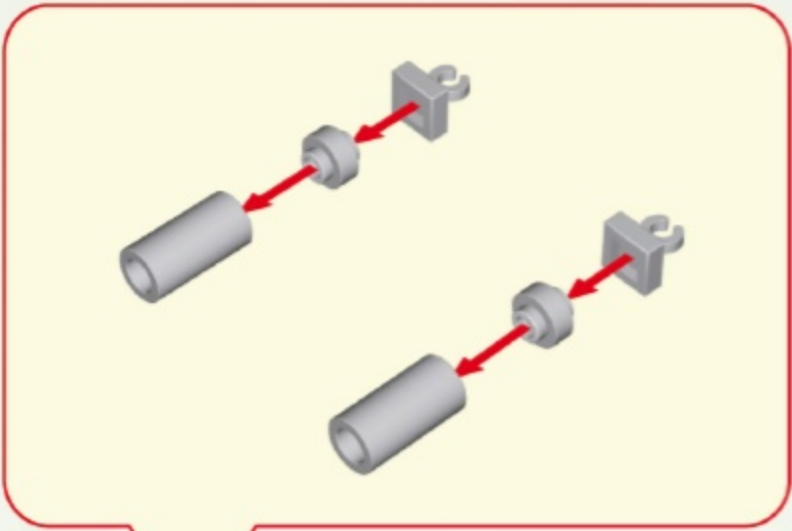

-  x2
-  x2
-  x6
-  x2
-  x2

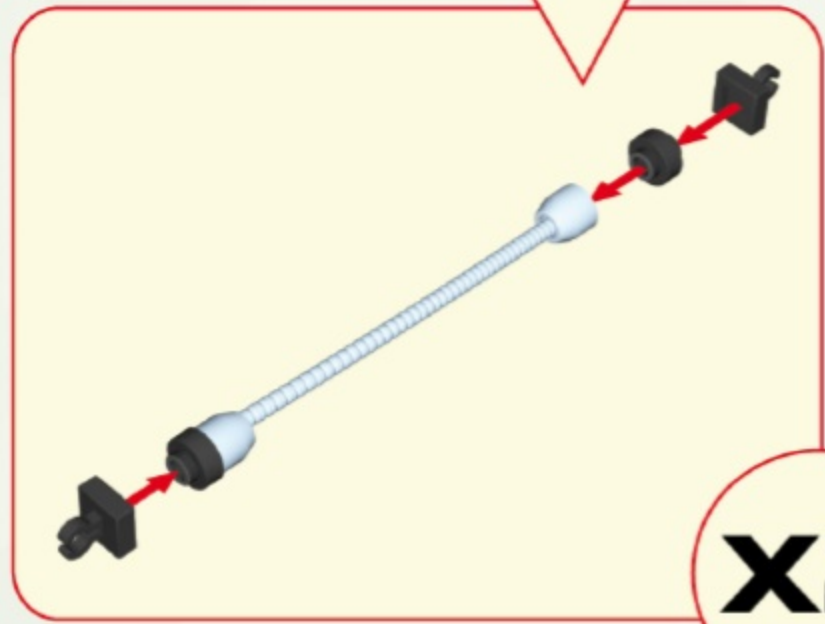
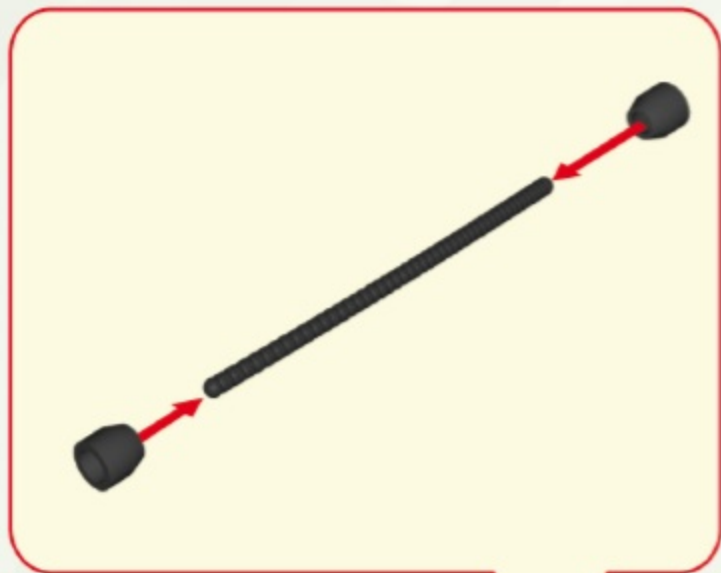

**X2**

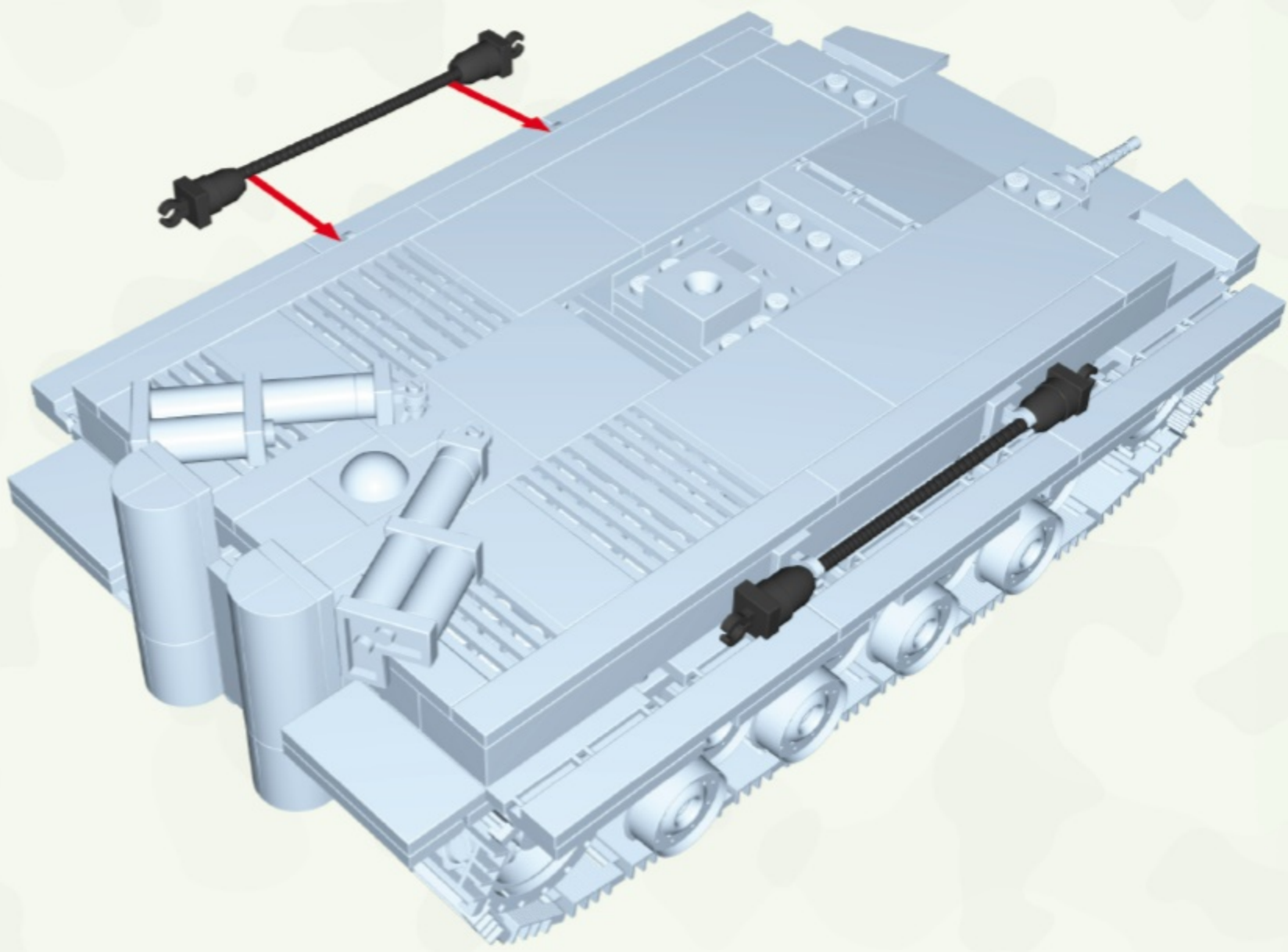

-  **x4**
-  **x2**
-  **x4**
-  **x4**

30

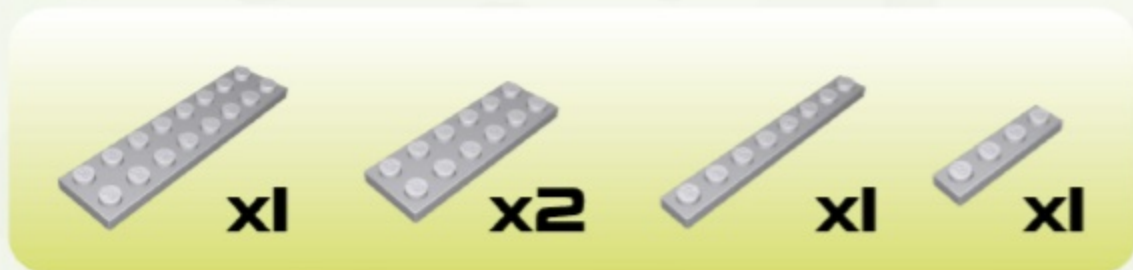
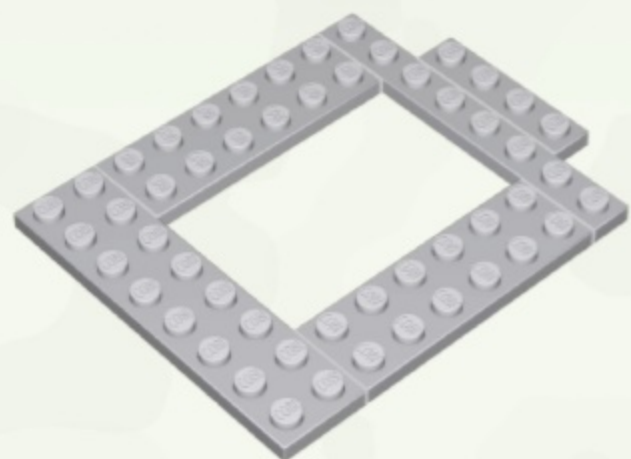

31

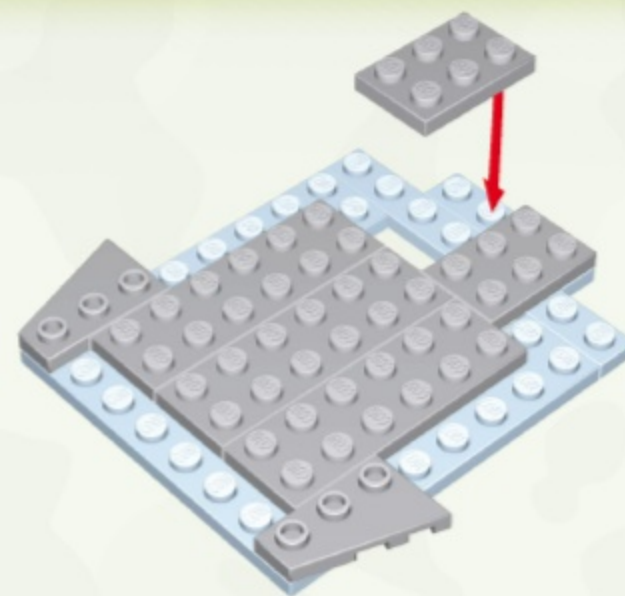

32

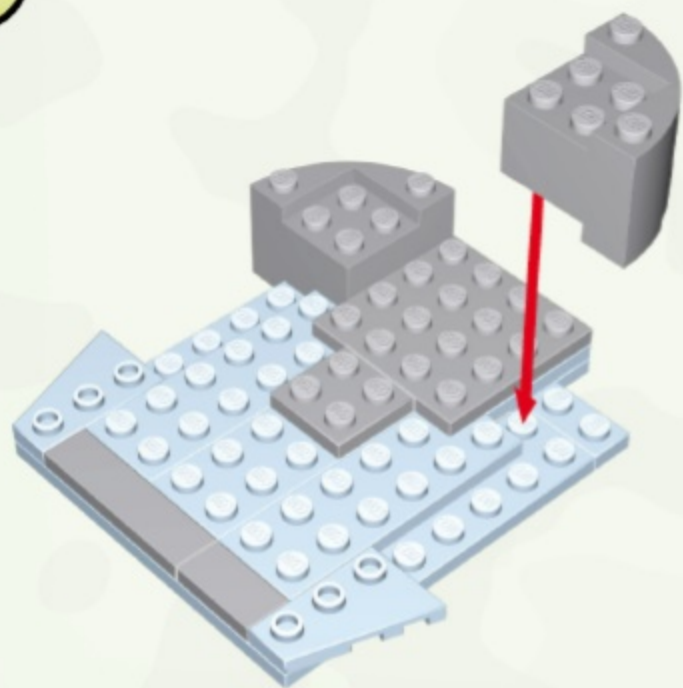

33

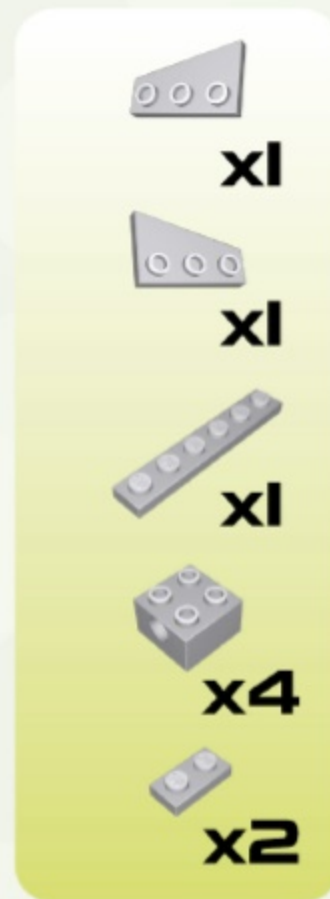
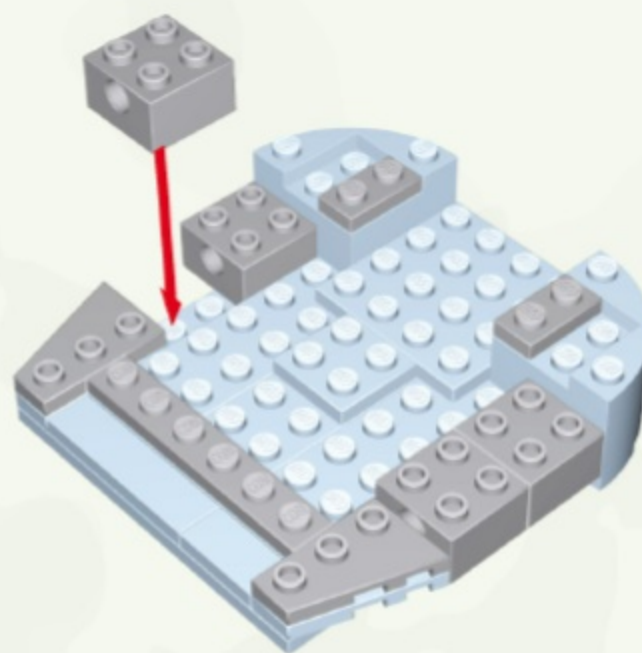

34

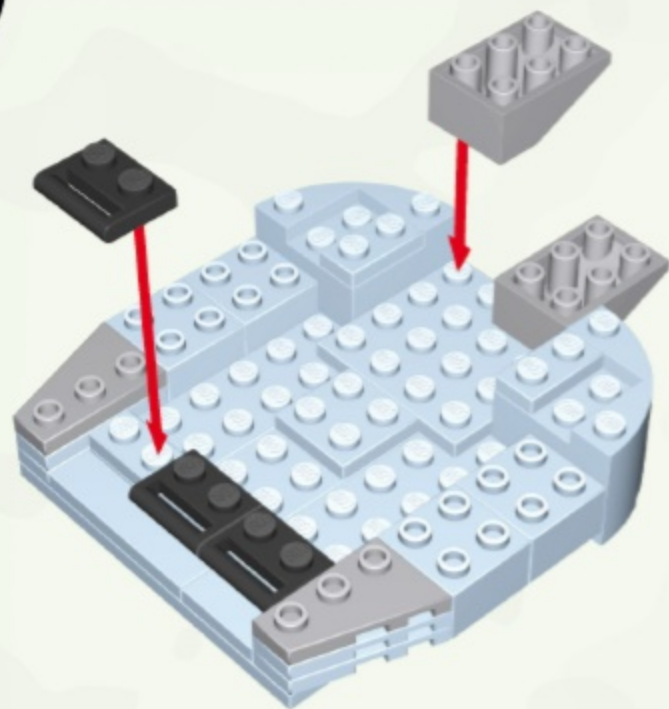

35

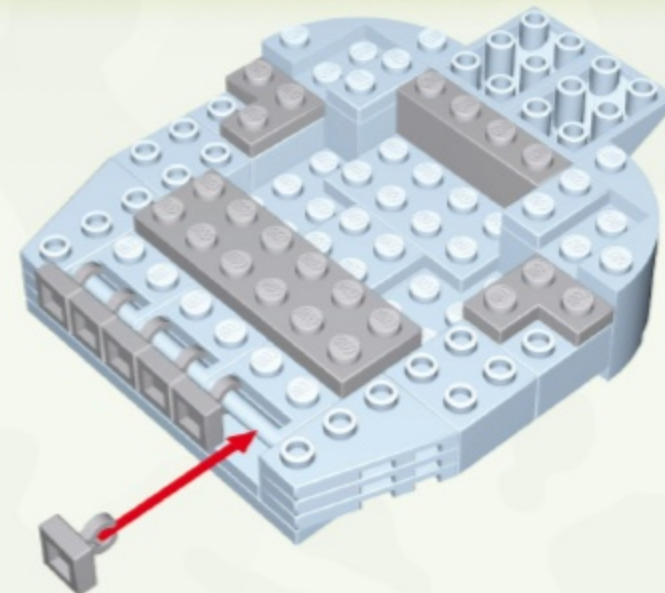

36

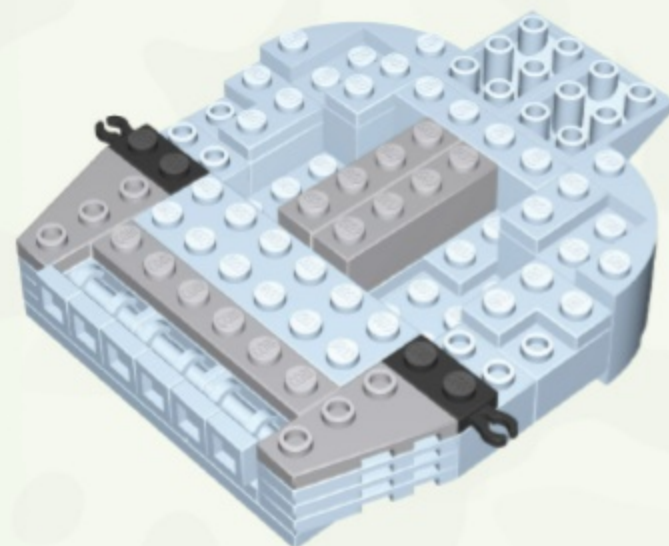

37

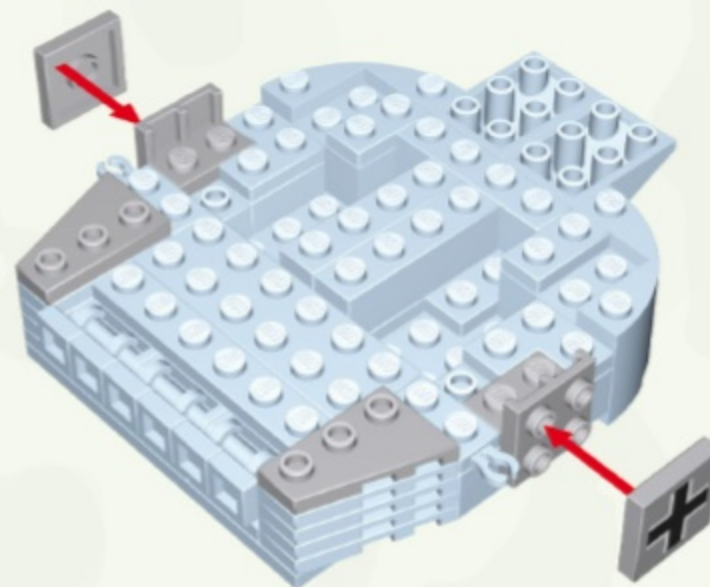

38

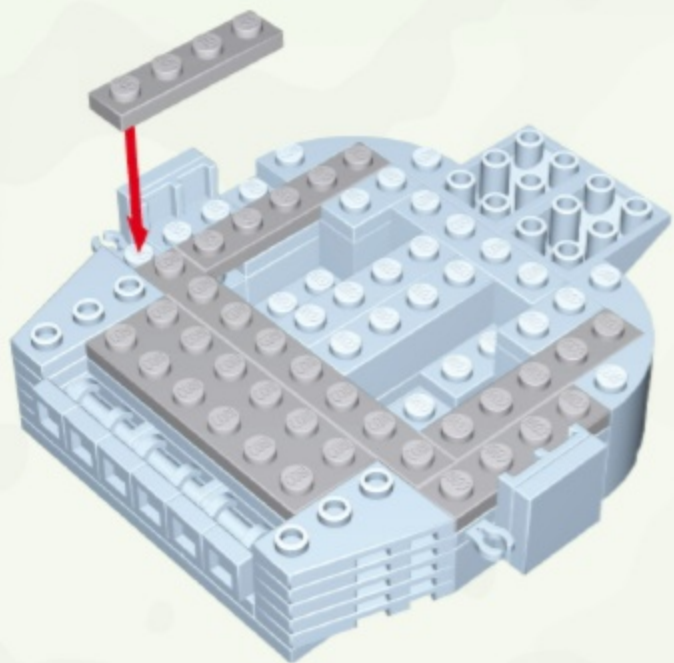

-  x1
-  x1
-  x2
-  x2

39

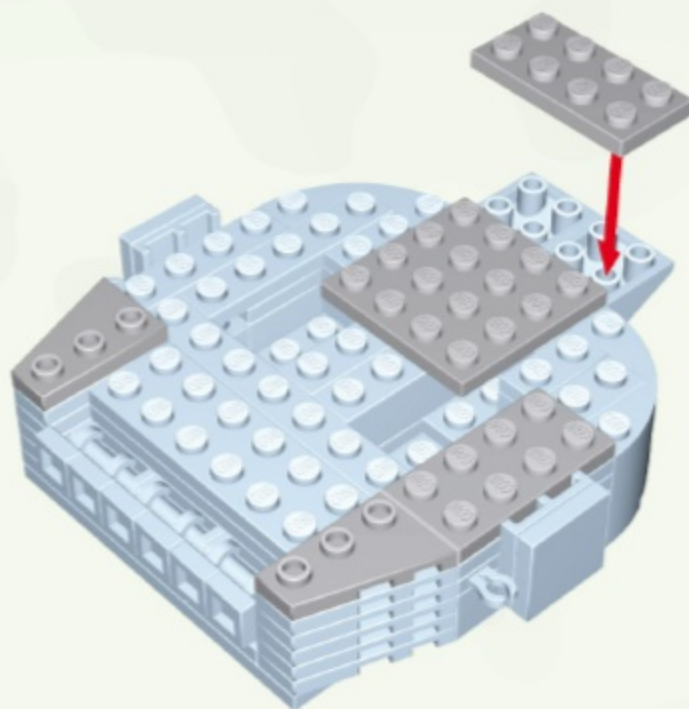

-  x1
-  x1
-  x2
-  x1

40

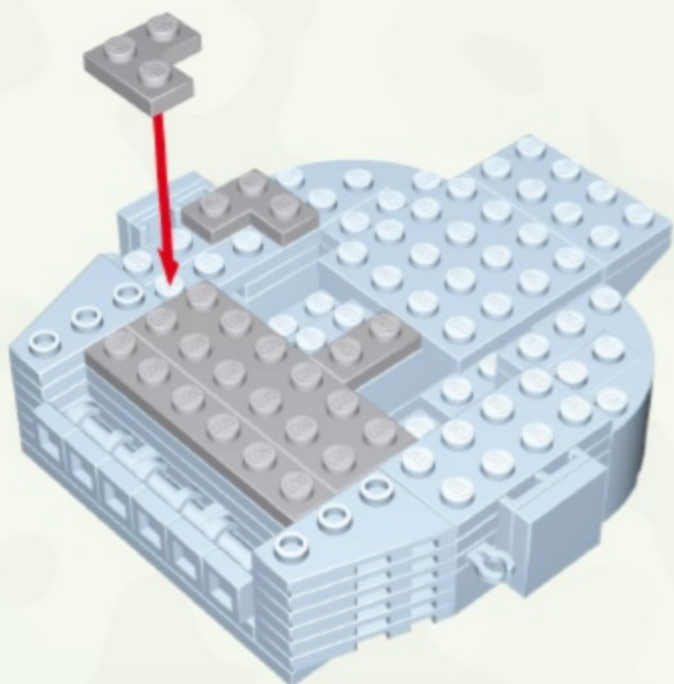

-  x1
-  x1
-  x2
-  x1

41

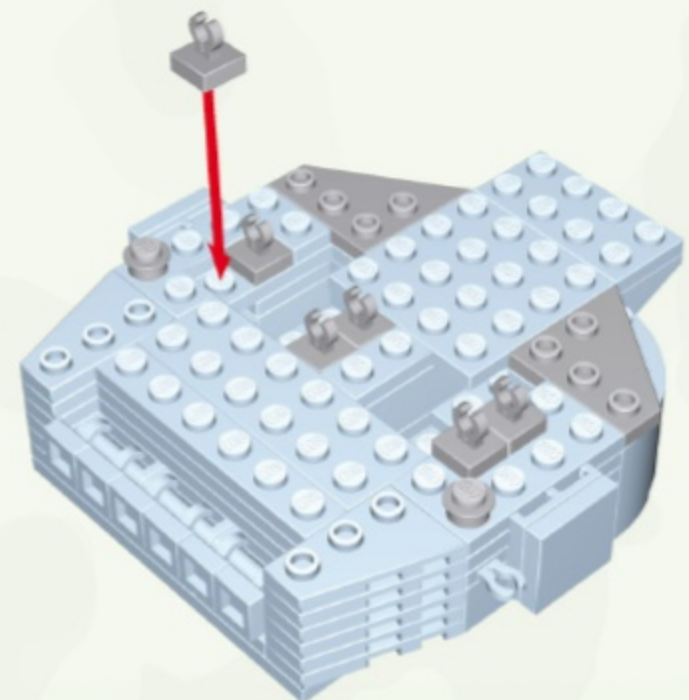

-  x2
-  x6
-  x1
-  x1

42

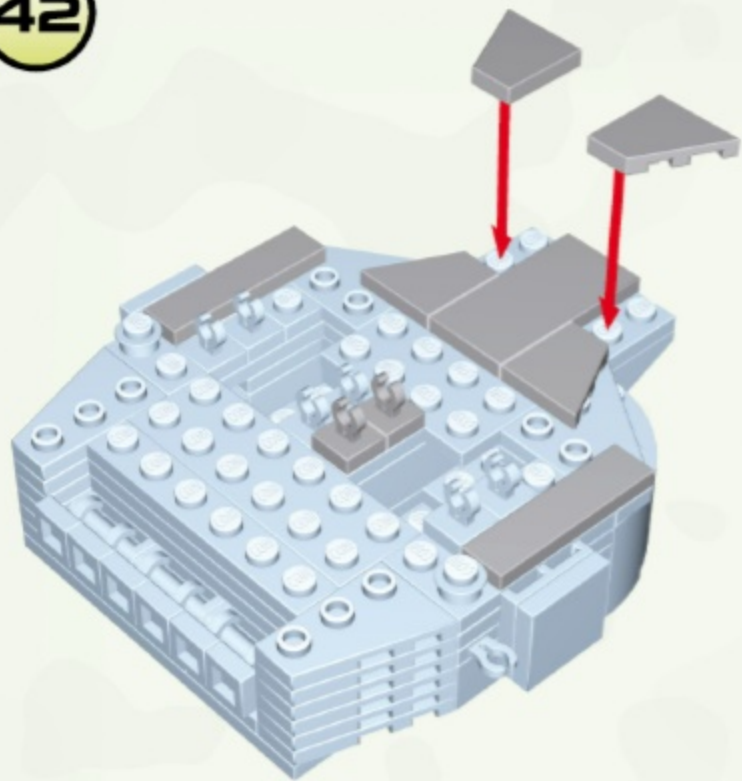

x2

x2

x1

x2

x2

43

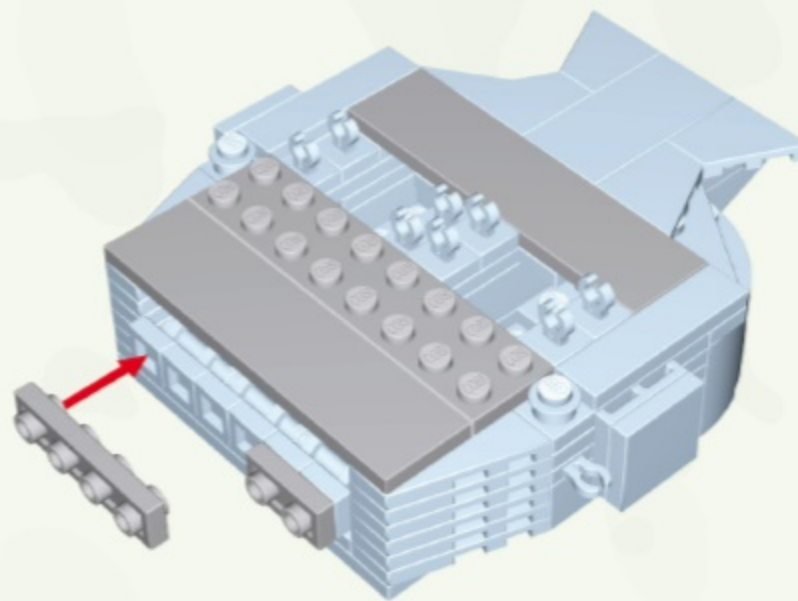

x1

x1

x2

x1

44

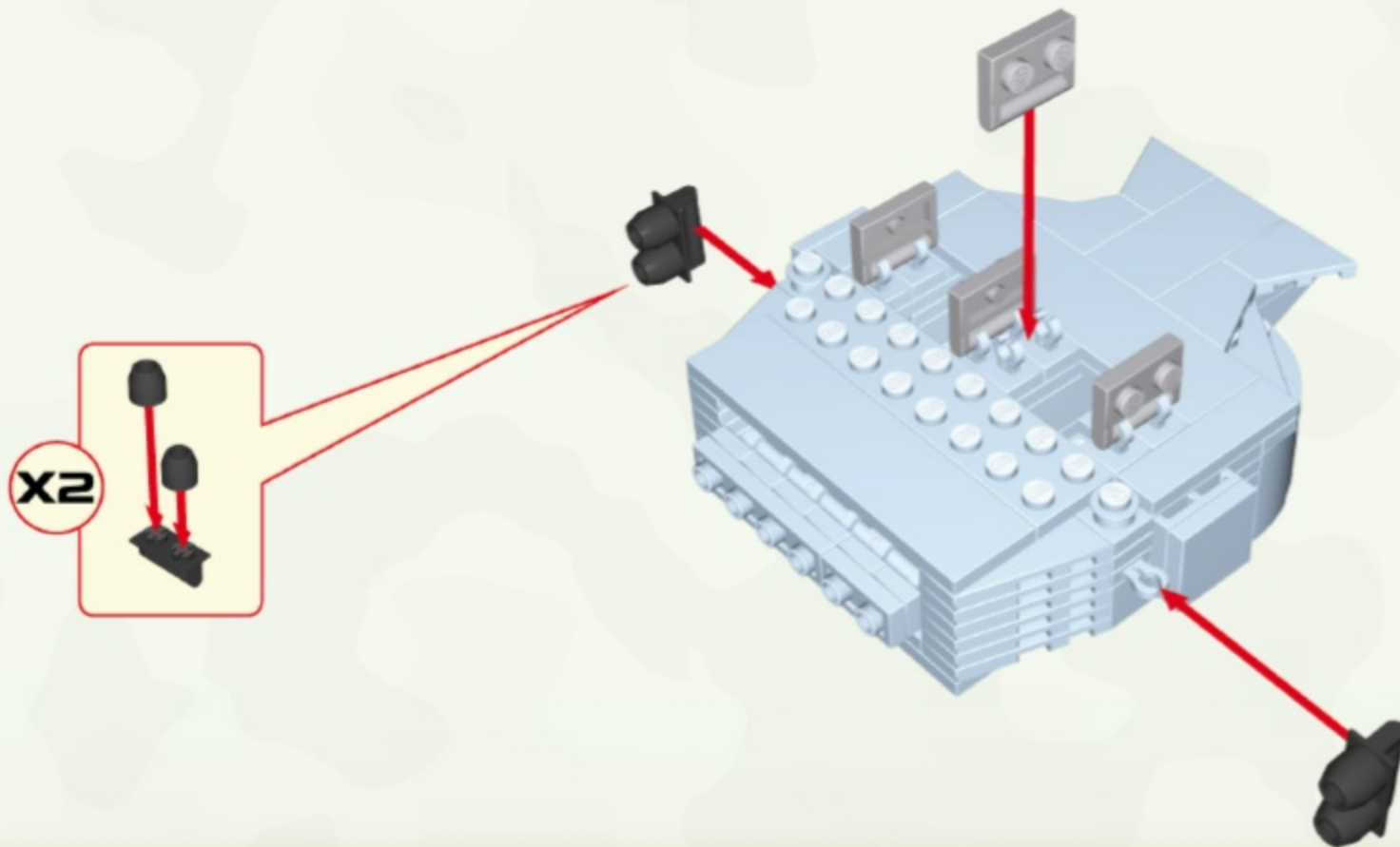

x2



x2

x4

x4

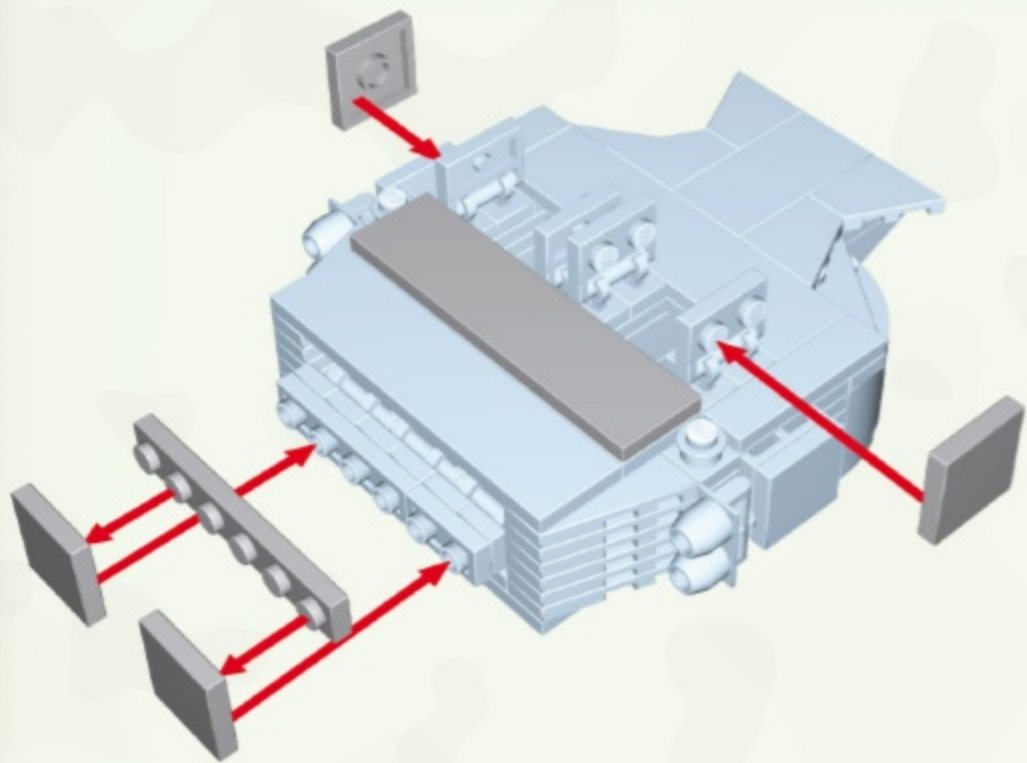

45

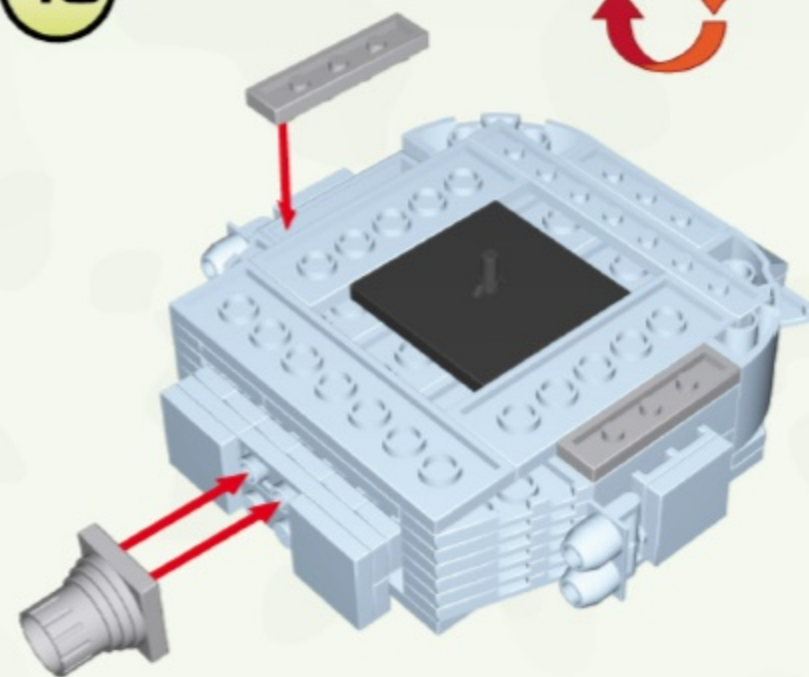

-  x4
-  x1
-  x1

46

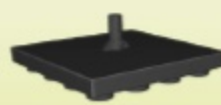

-  x1
-  x1
-  x2

47



-  x2
-  x1
-  x5
-  x4

