



PzK PFW VI TIGER AUSF. E



**WARNING: CHOKING HAZARD-**

Toy contains small parts.  
Not for children under 3 years.

Printed in EU







x1



x1

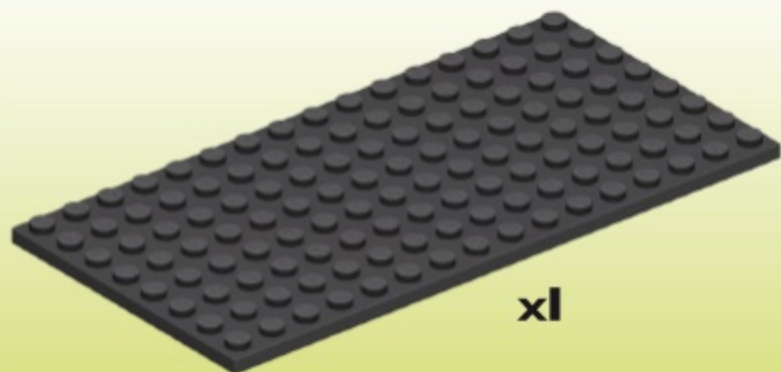

x1

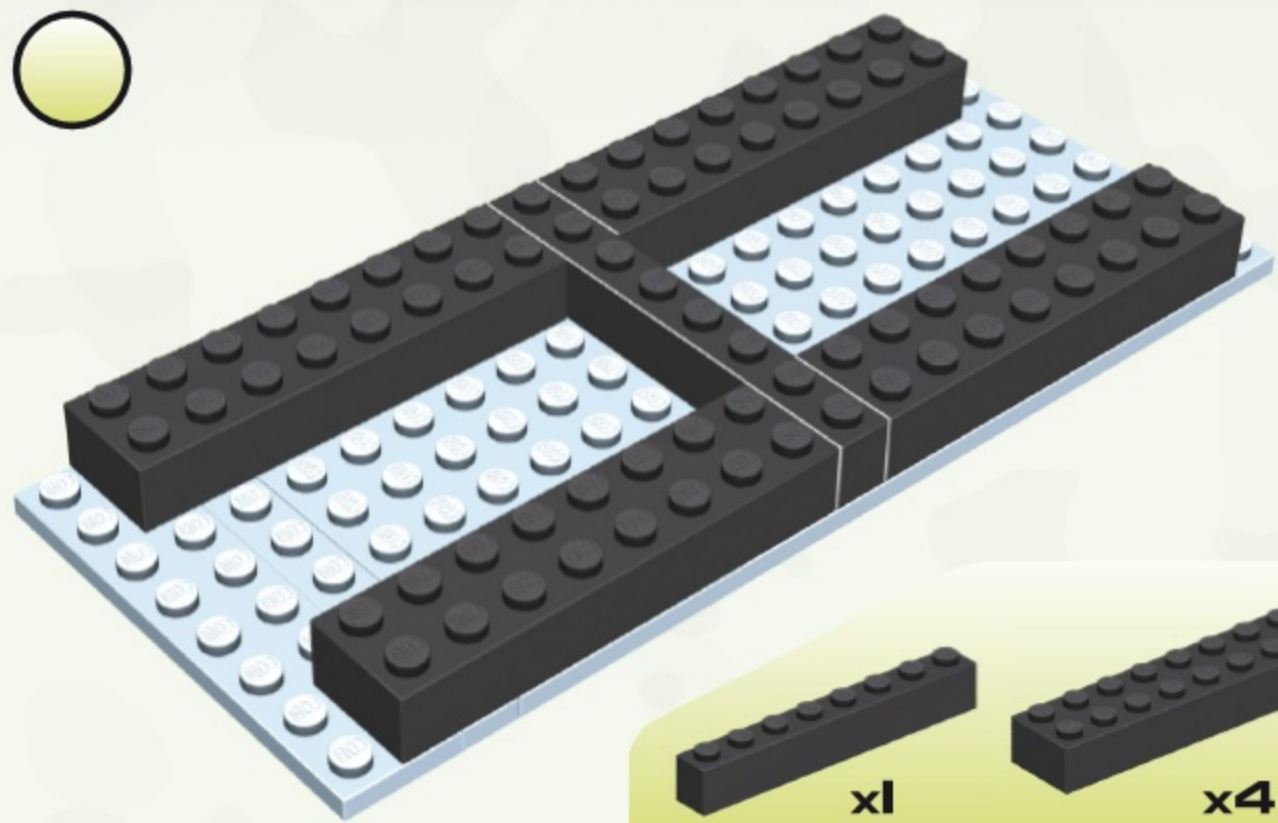

x1



x4

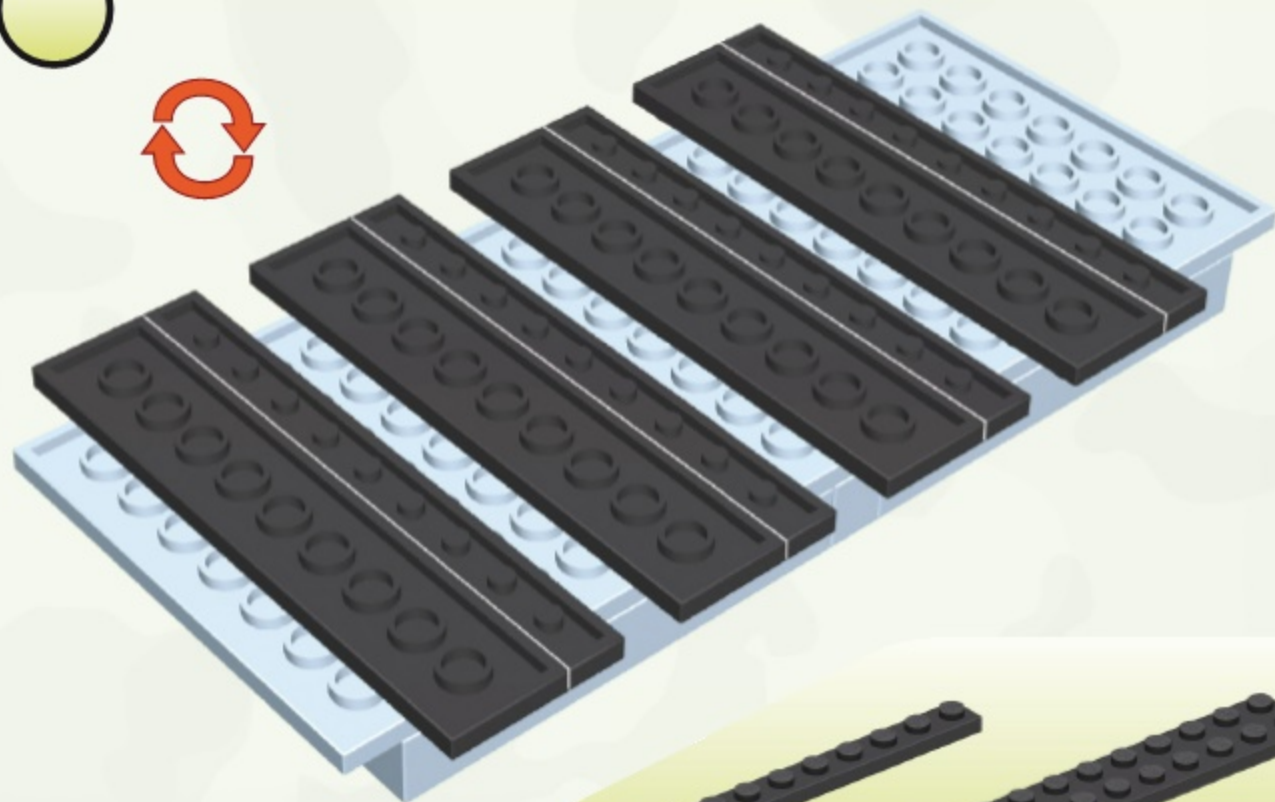

x4



x4



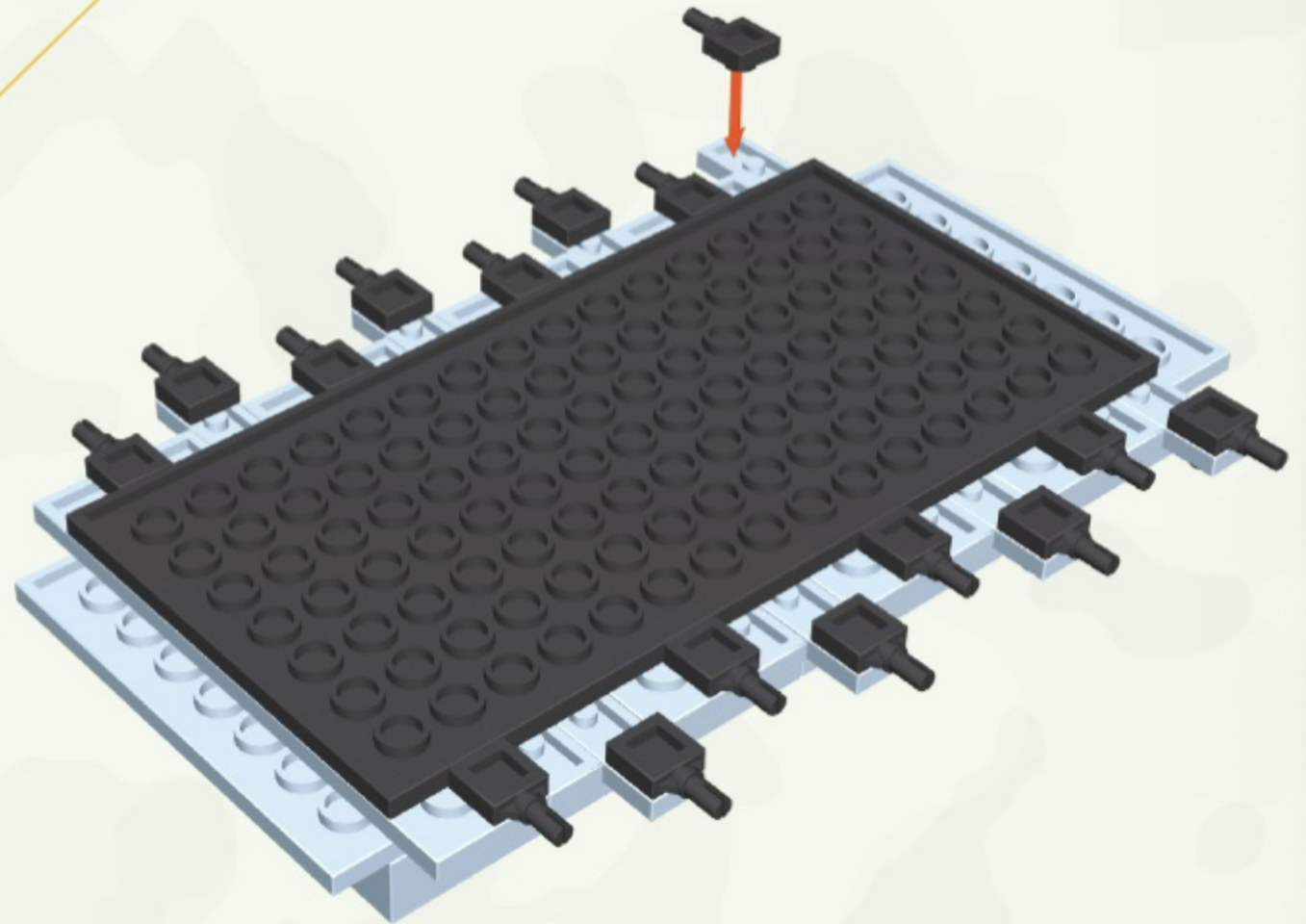
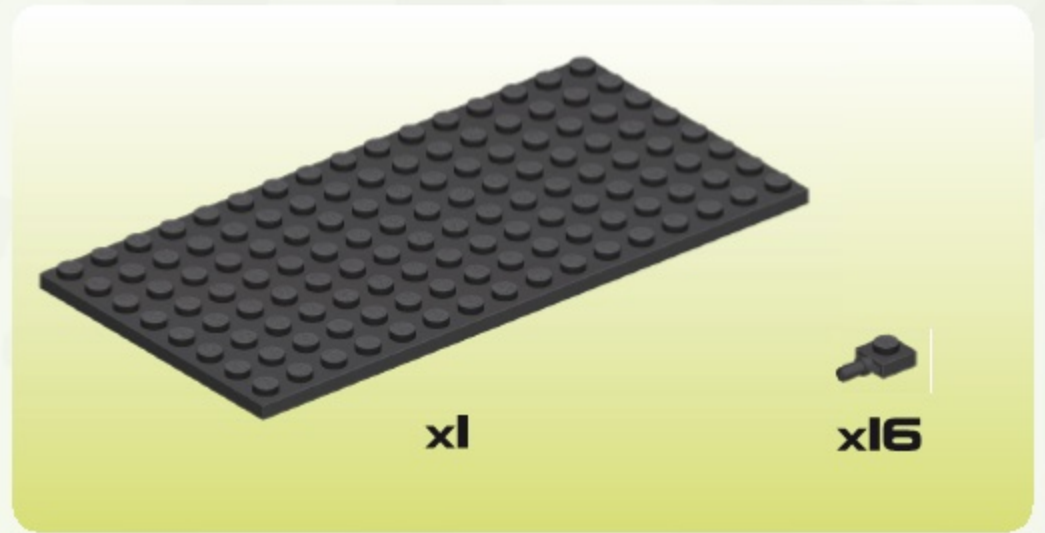
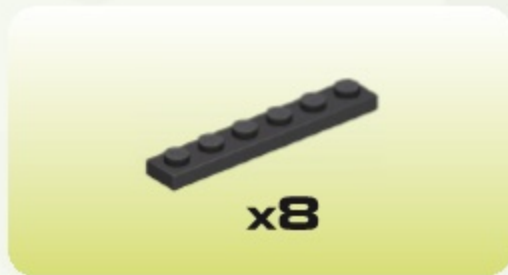
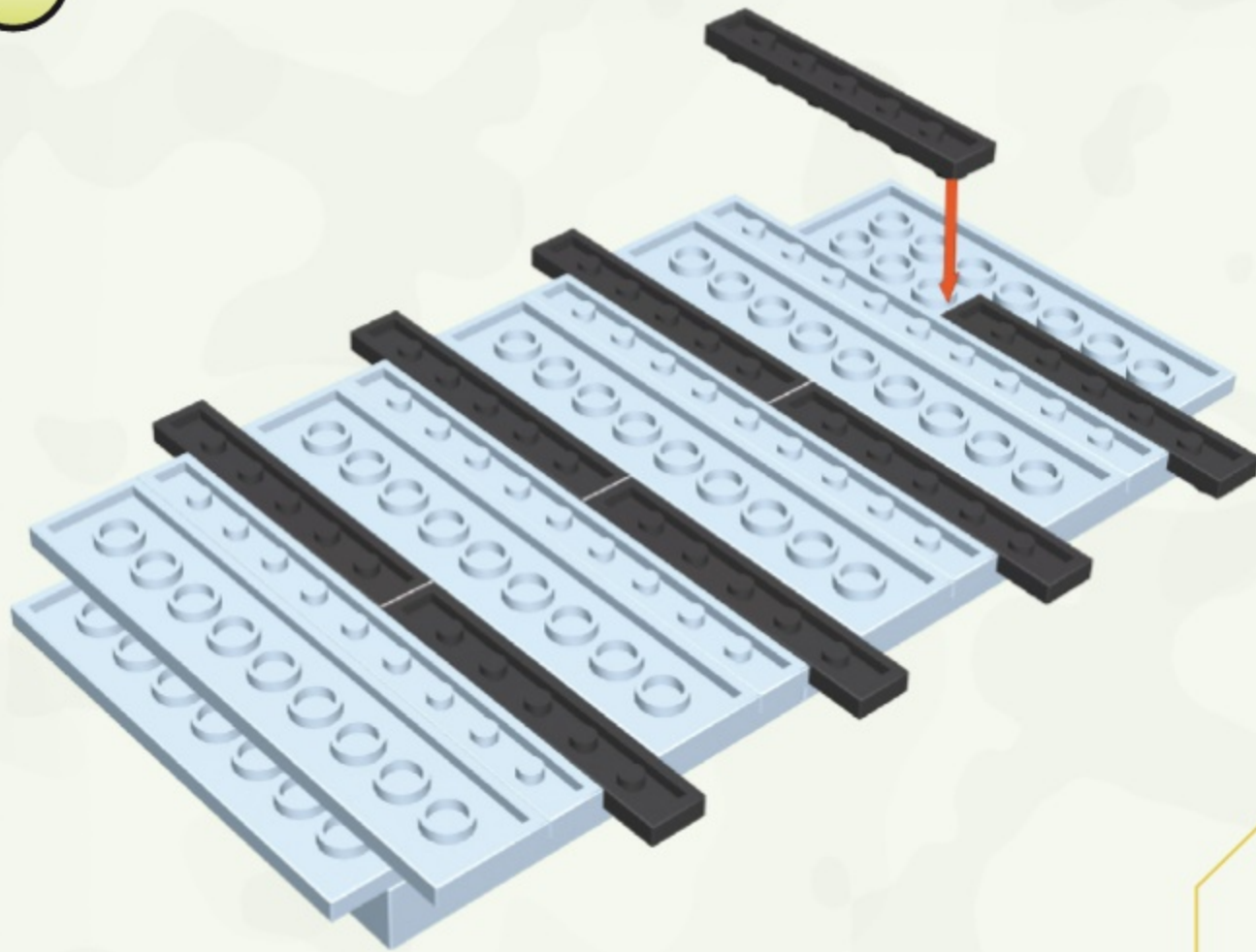



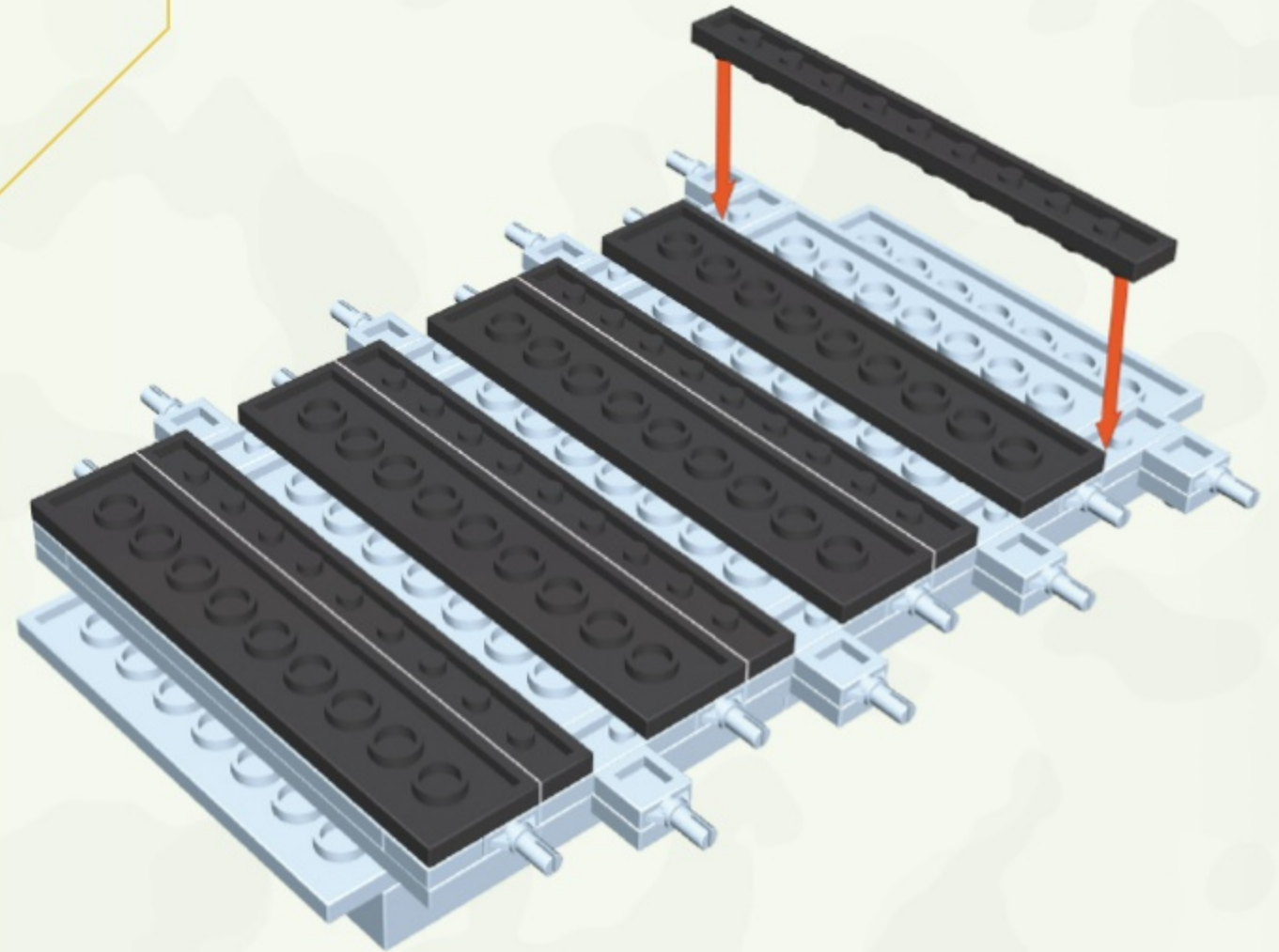
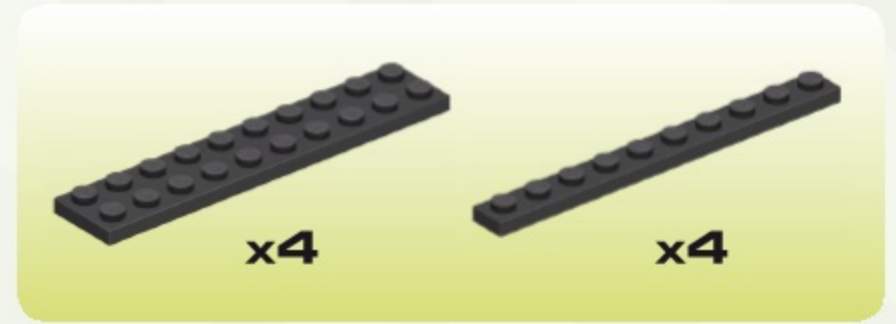
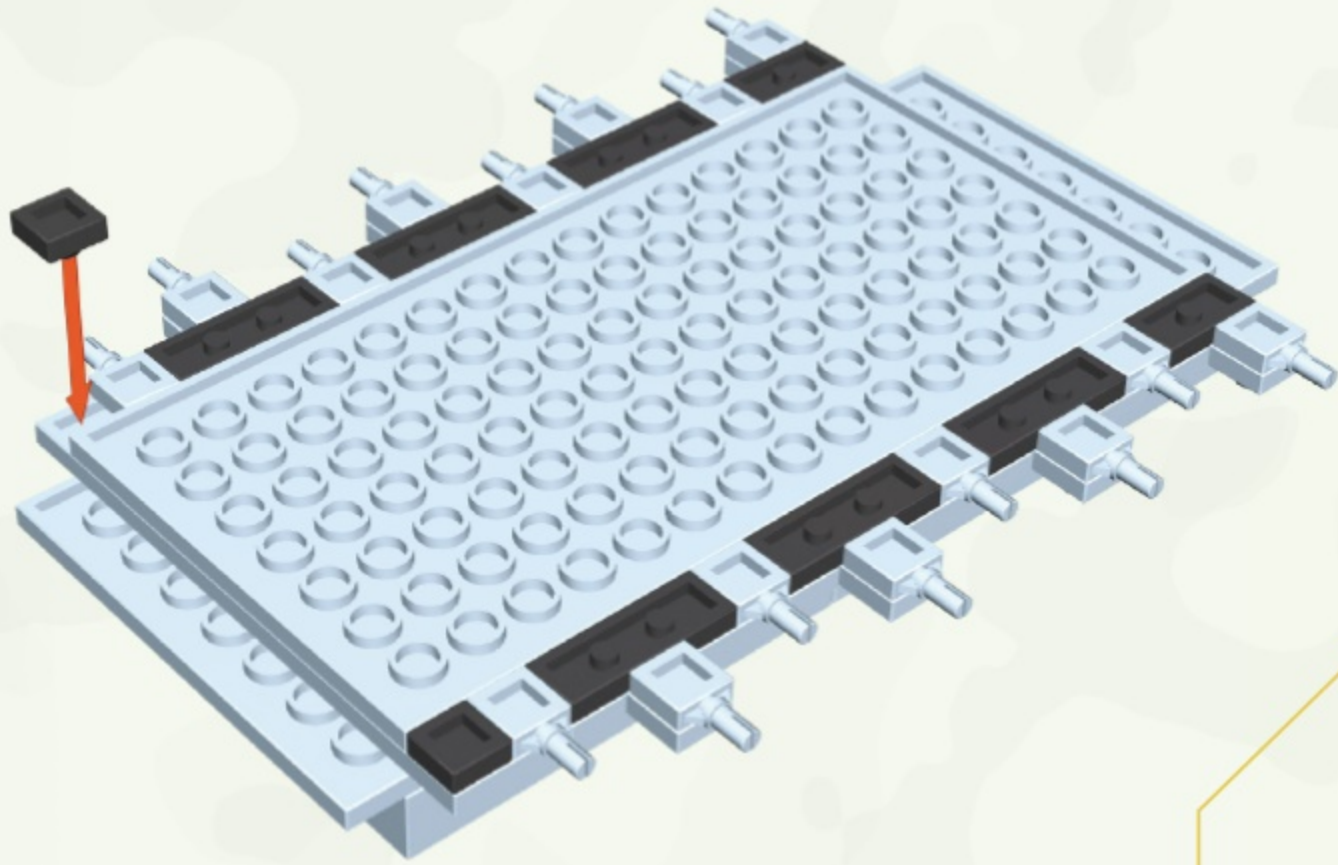



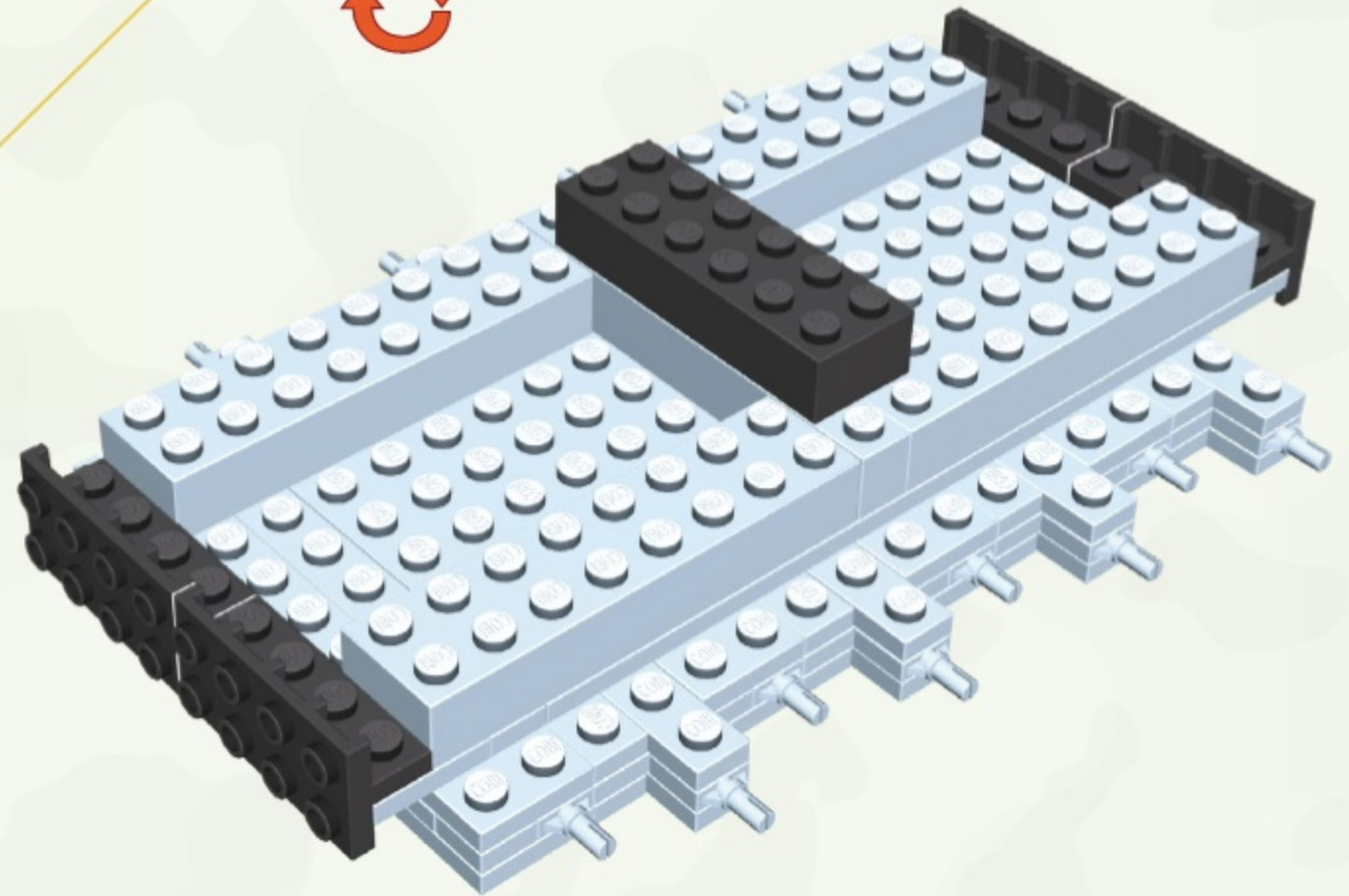
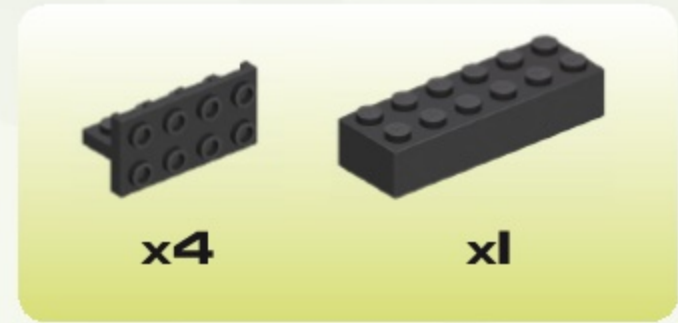
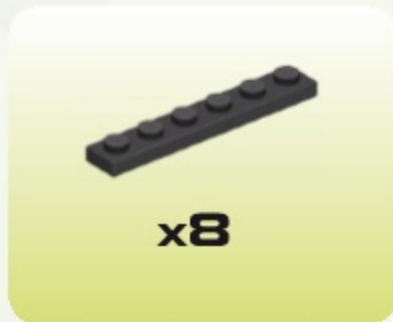
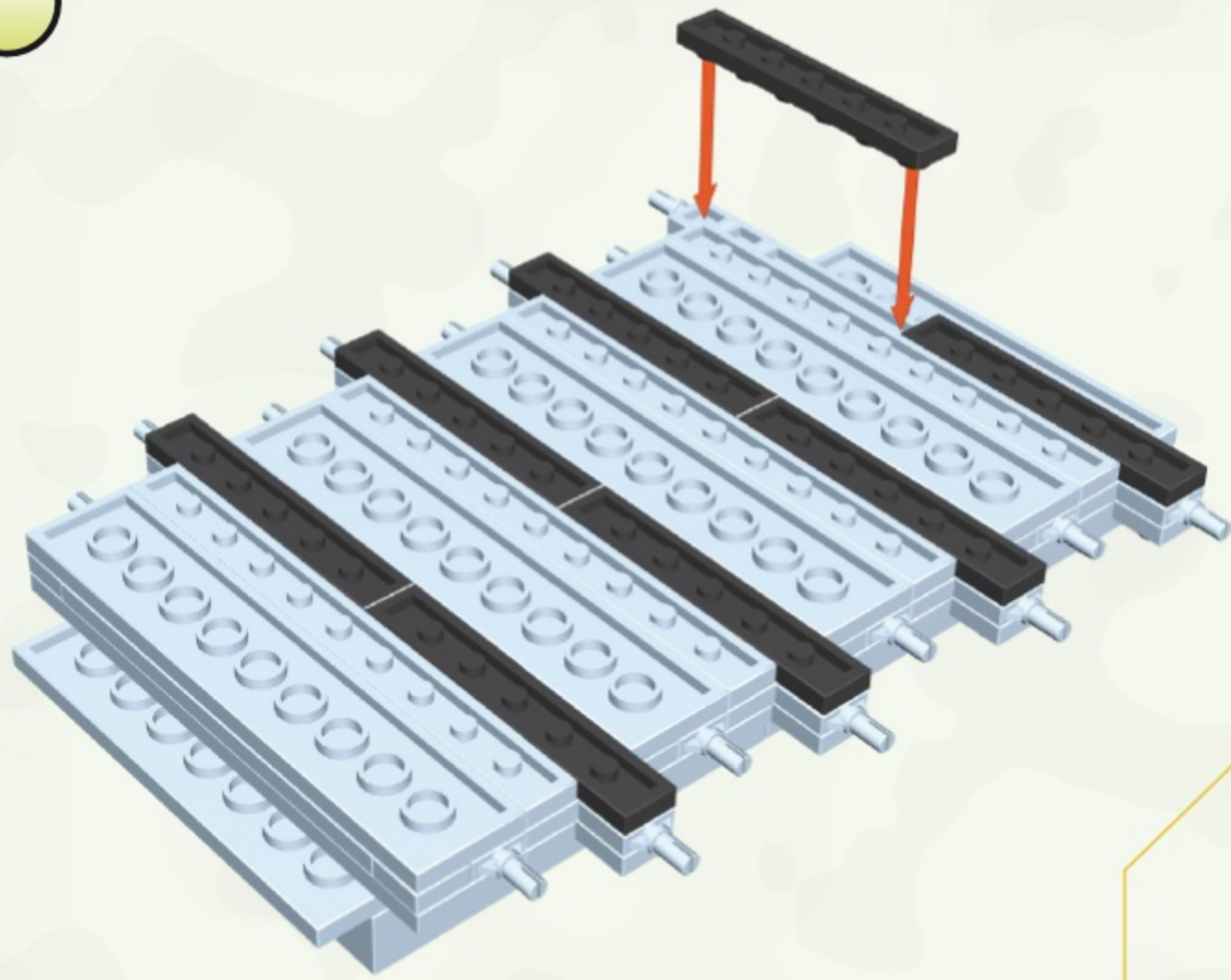



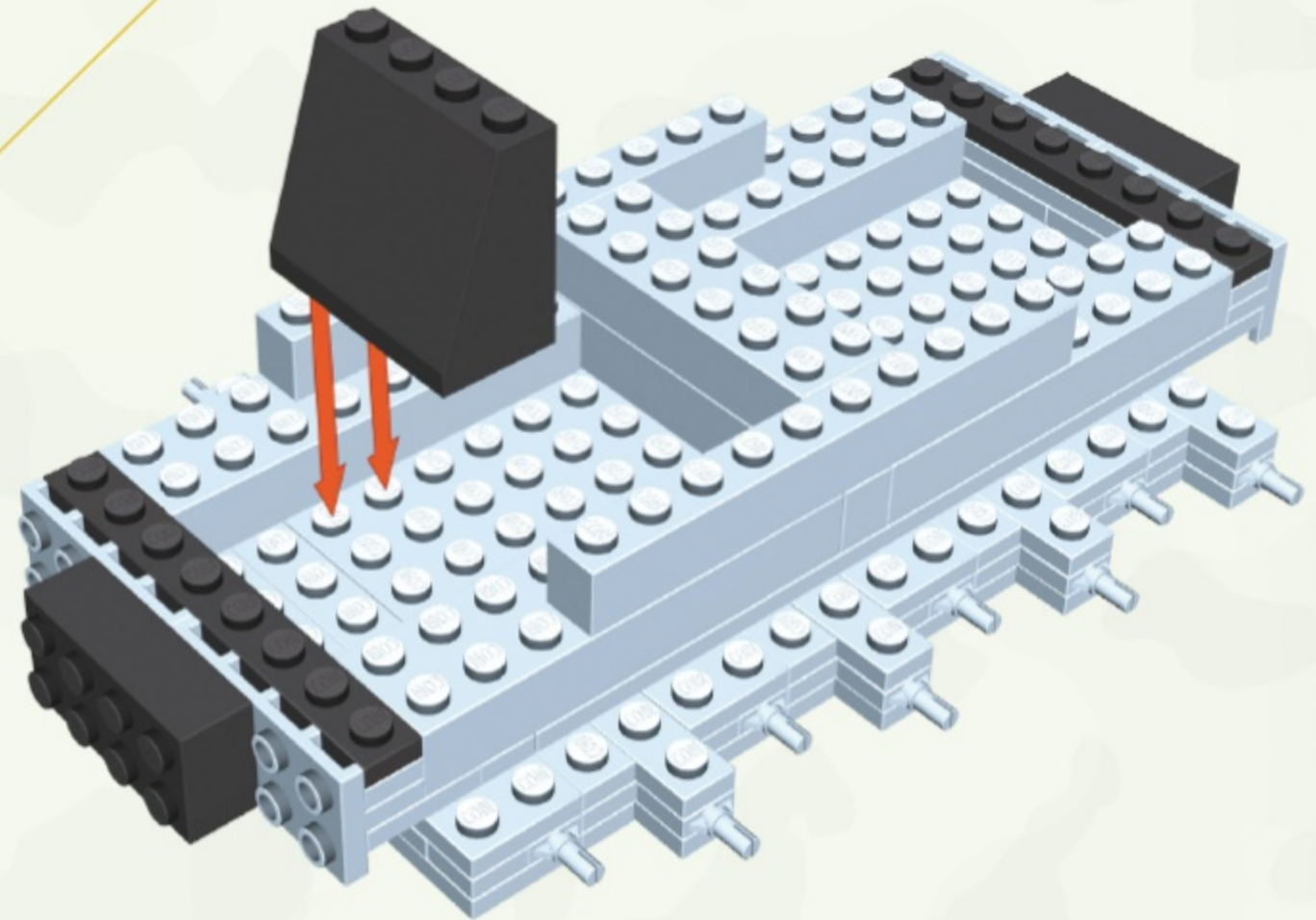
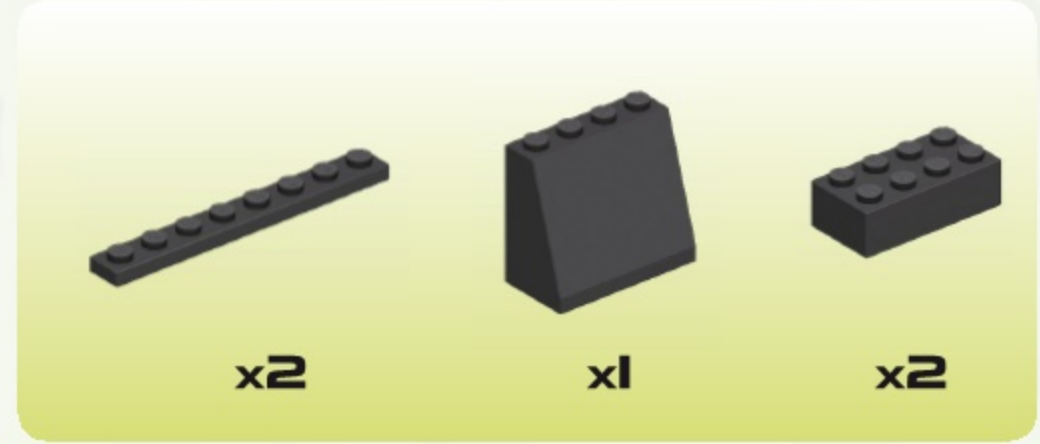
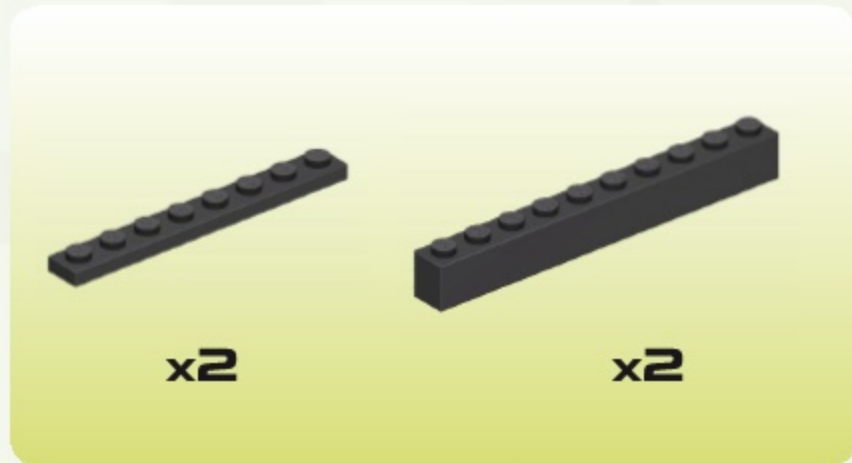
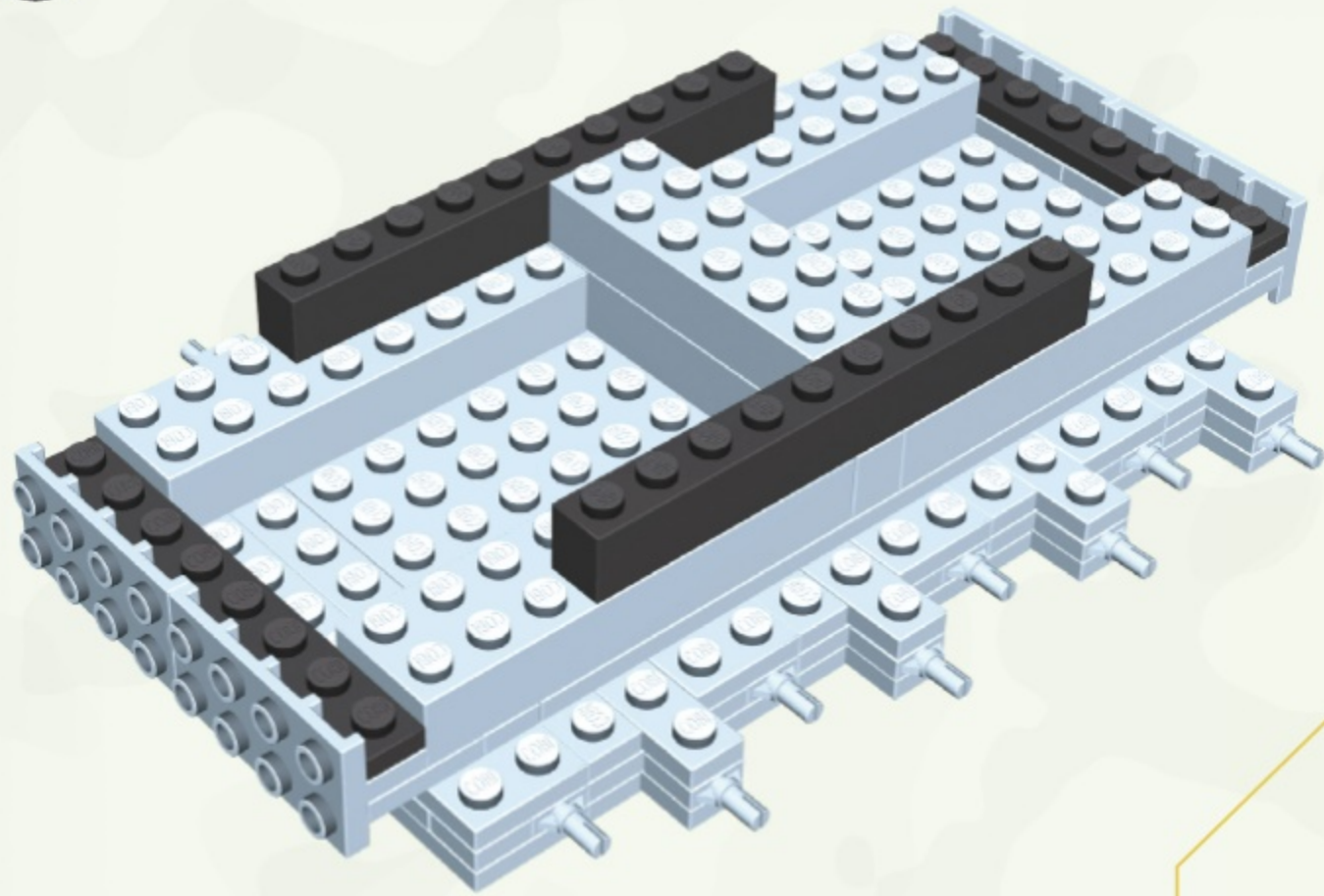



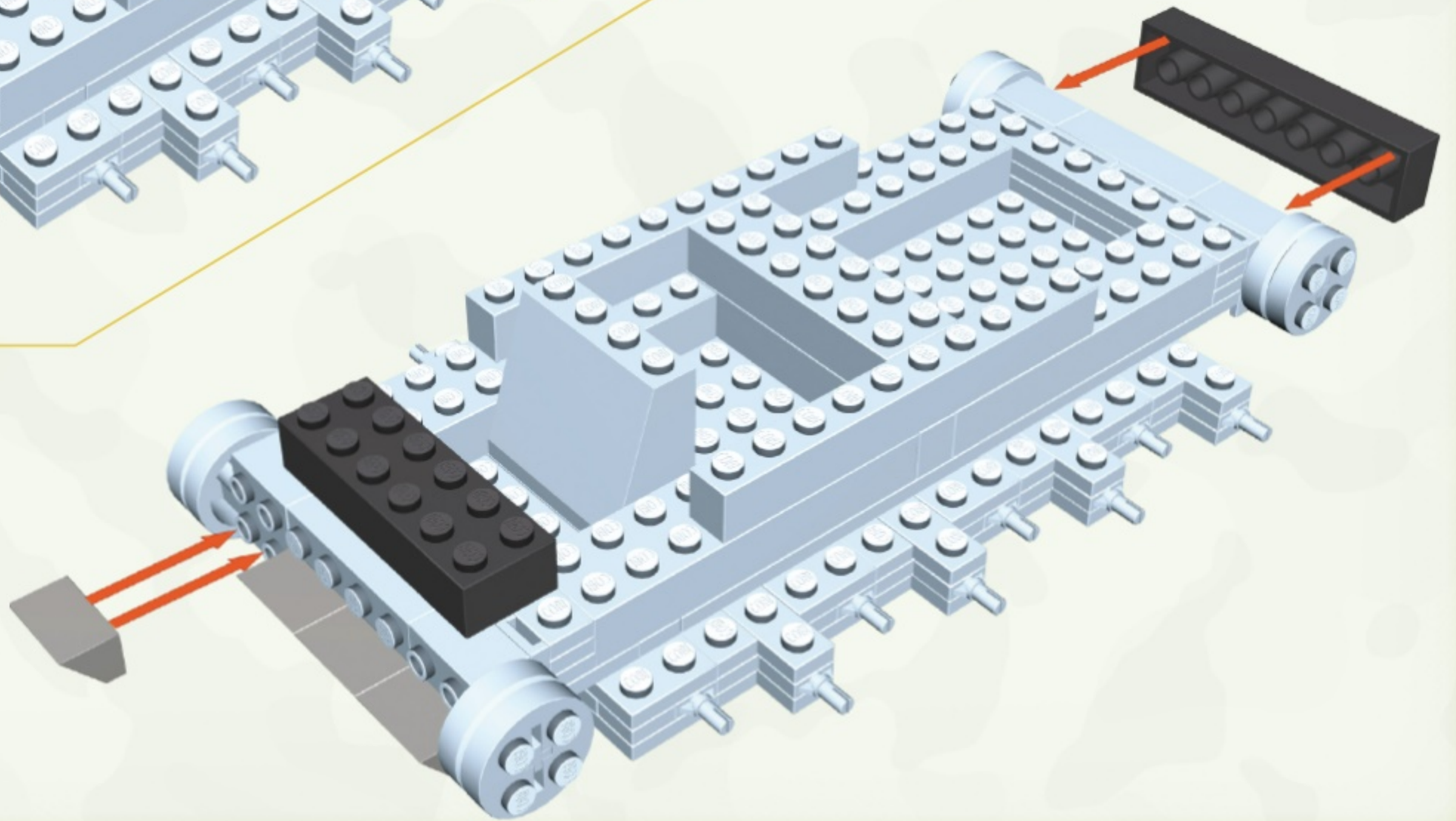
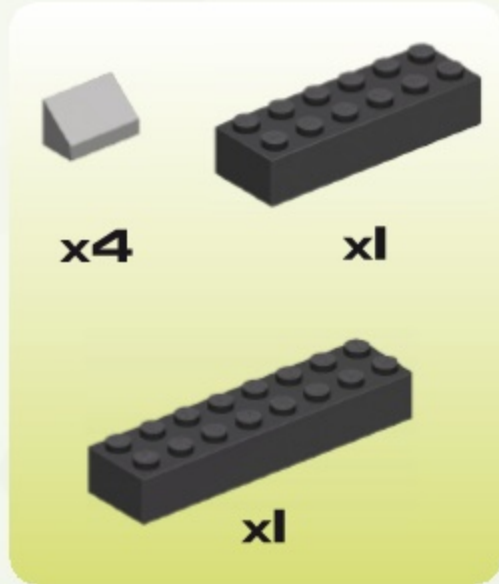
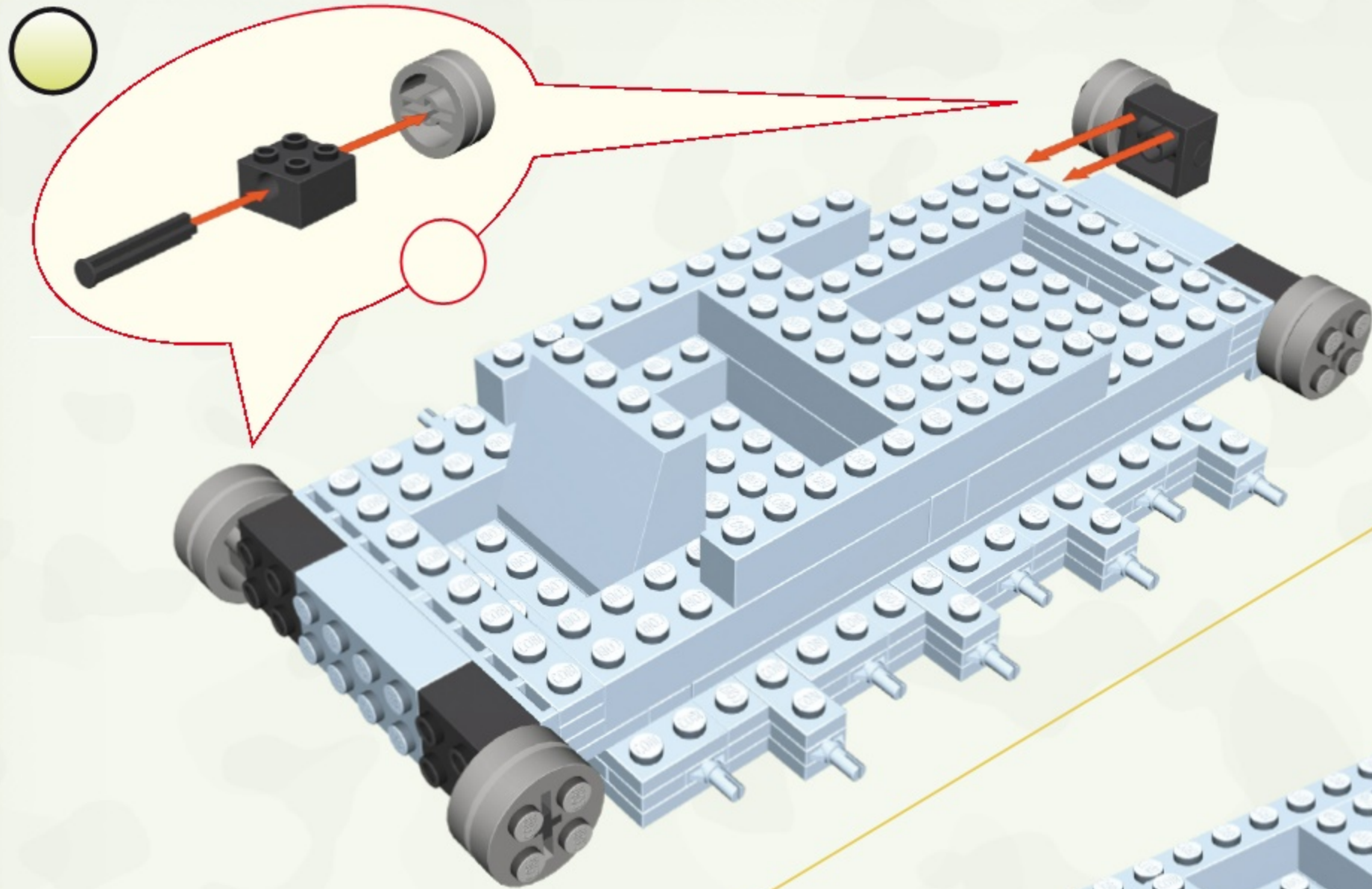



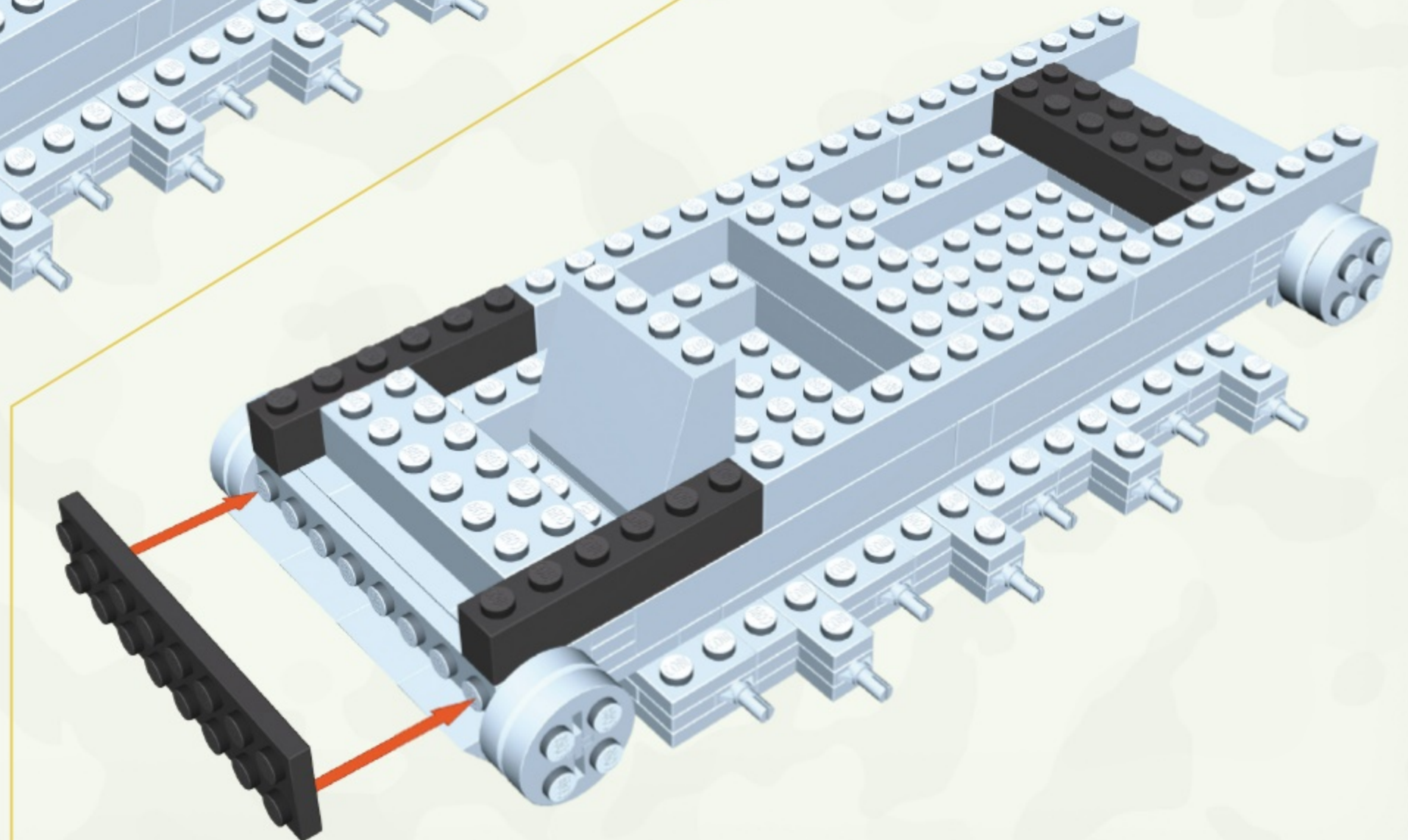
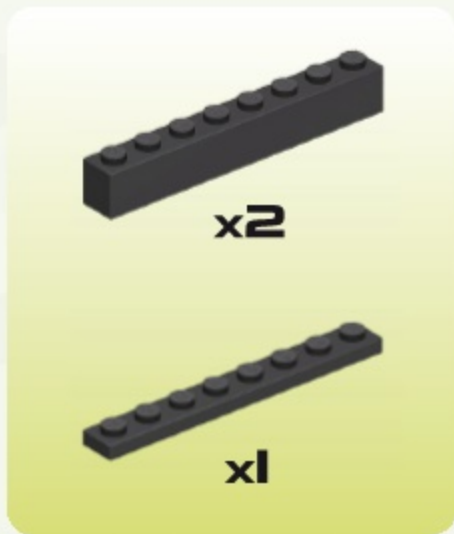
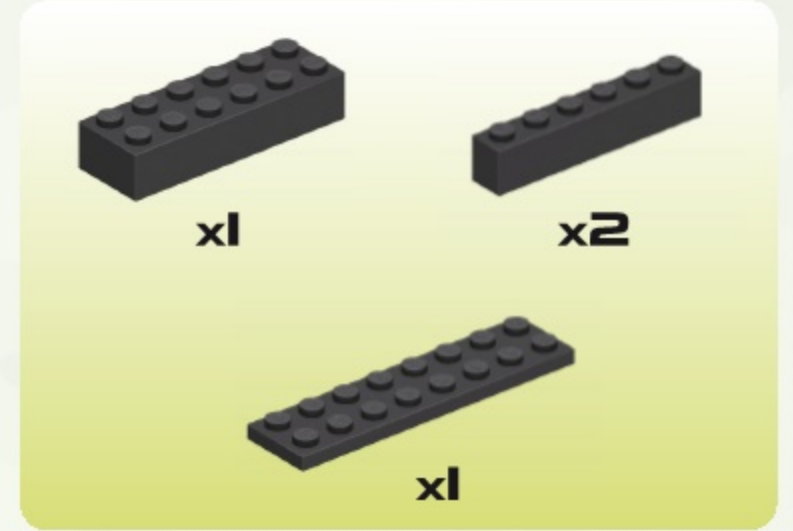
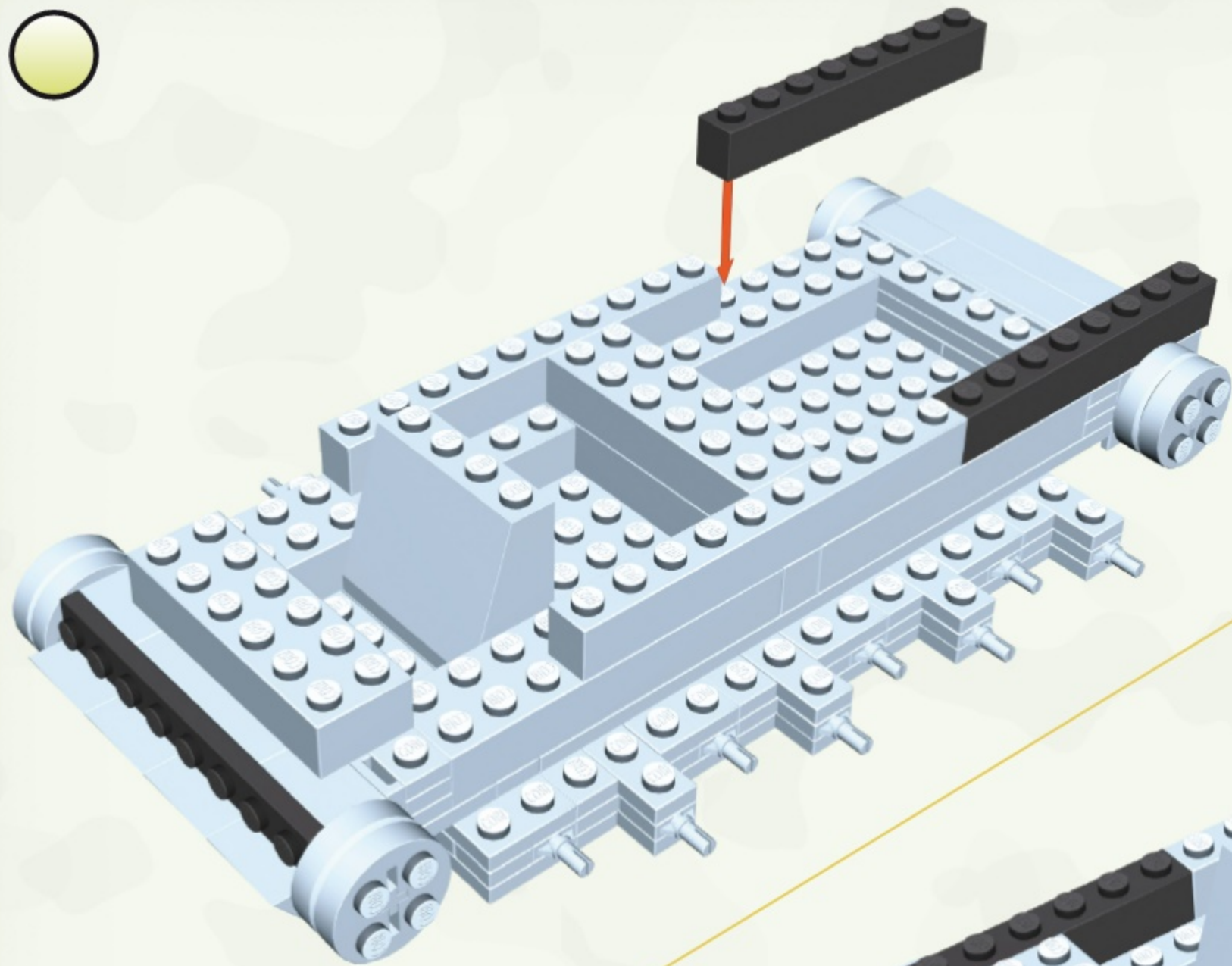



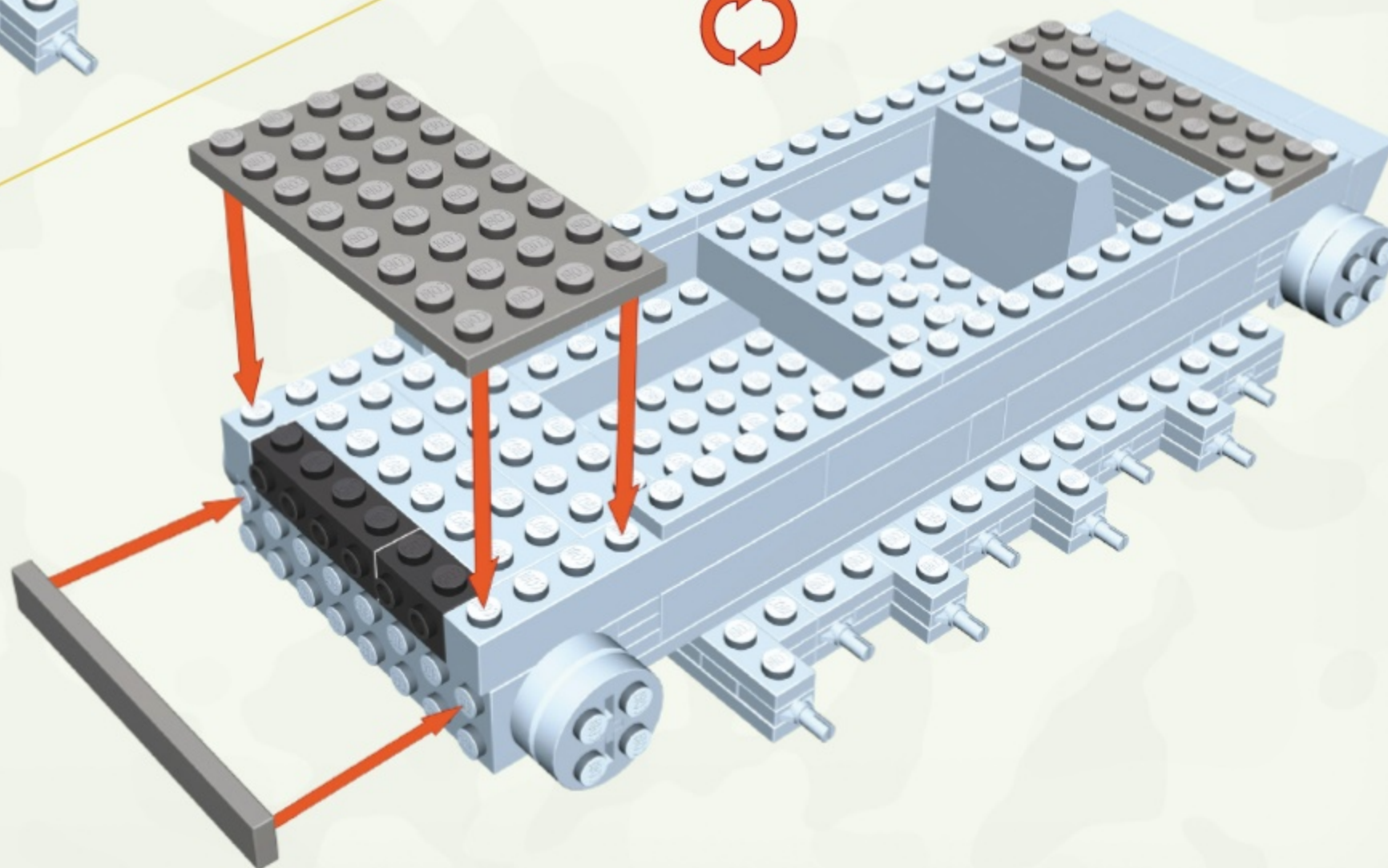
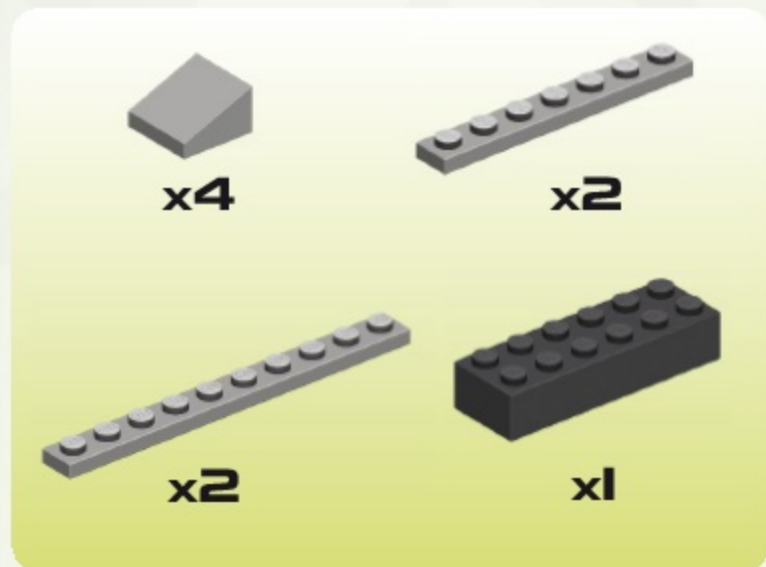
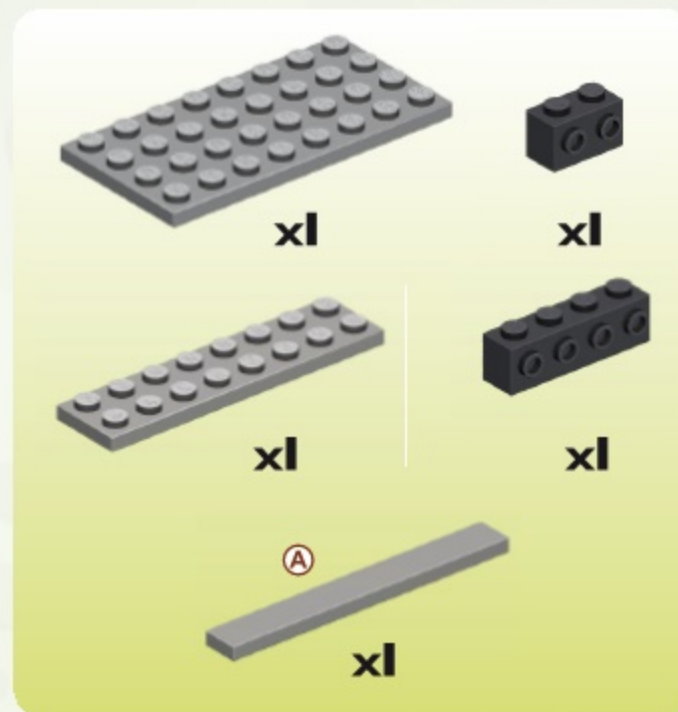
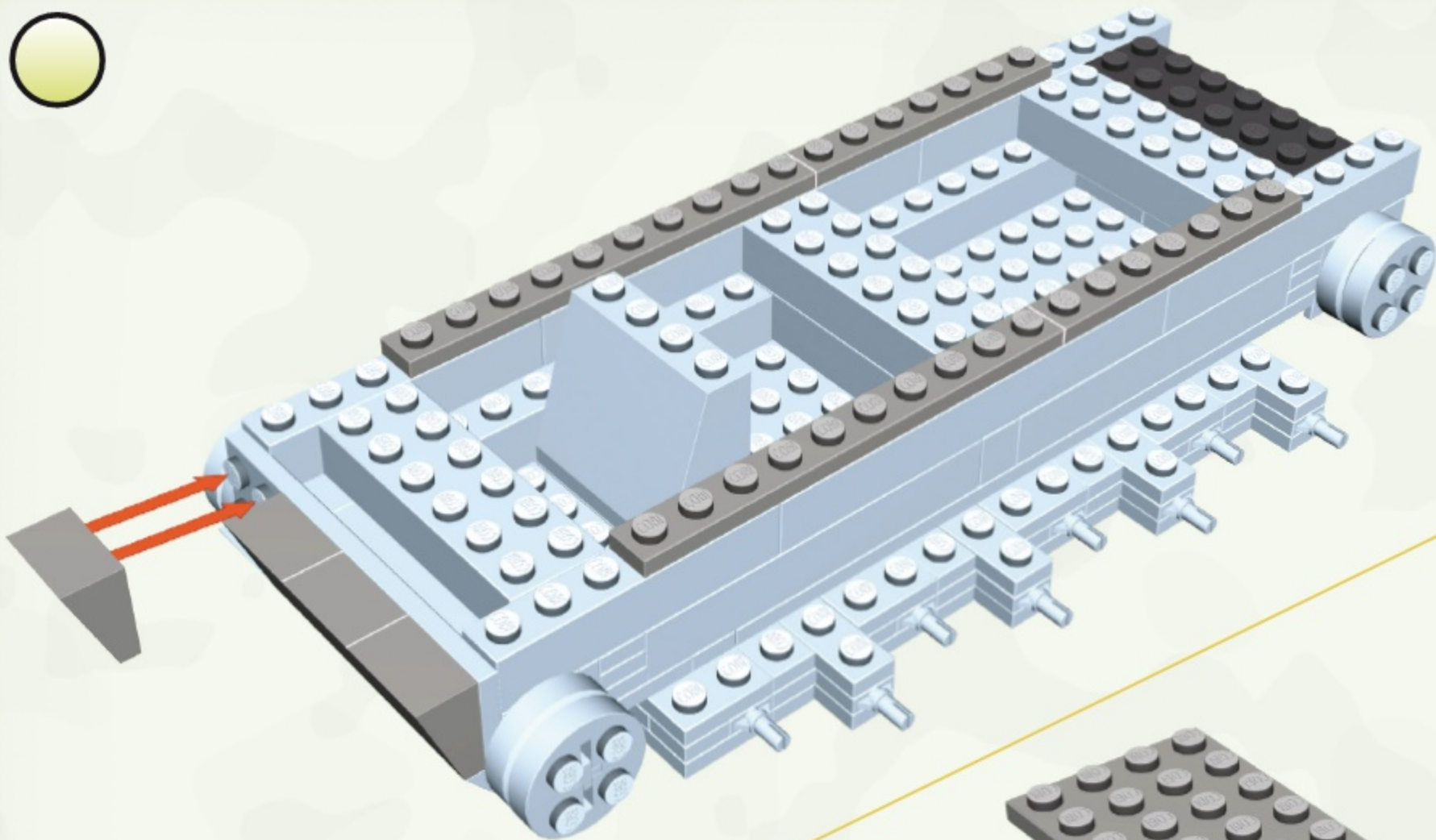



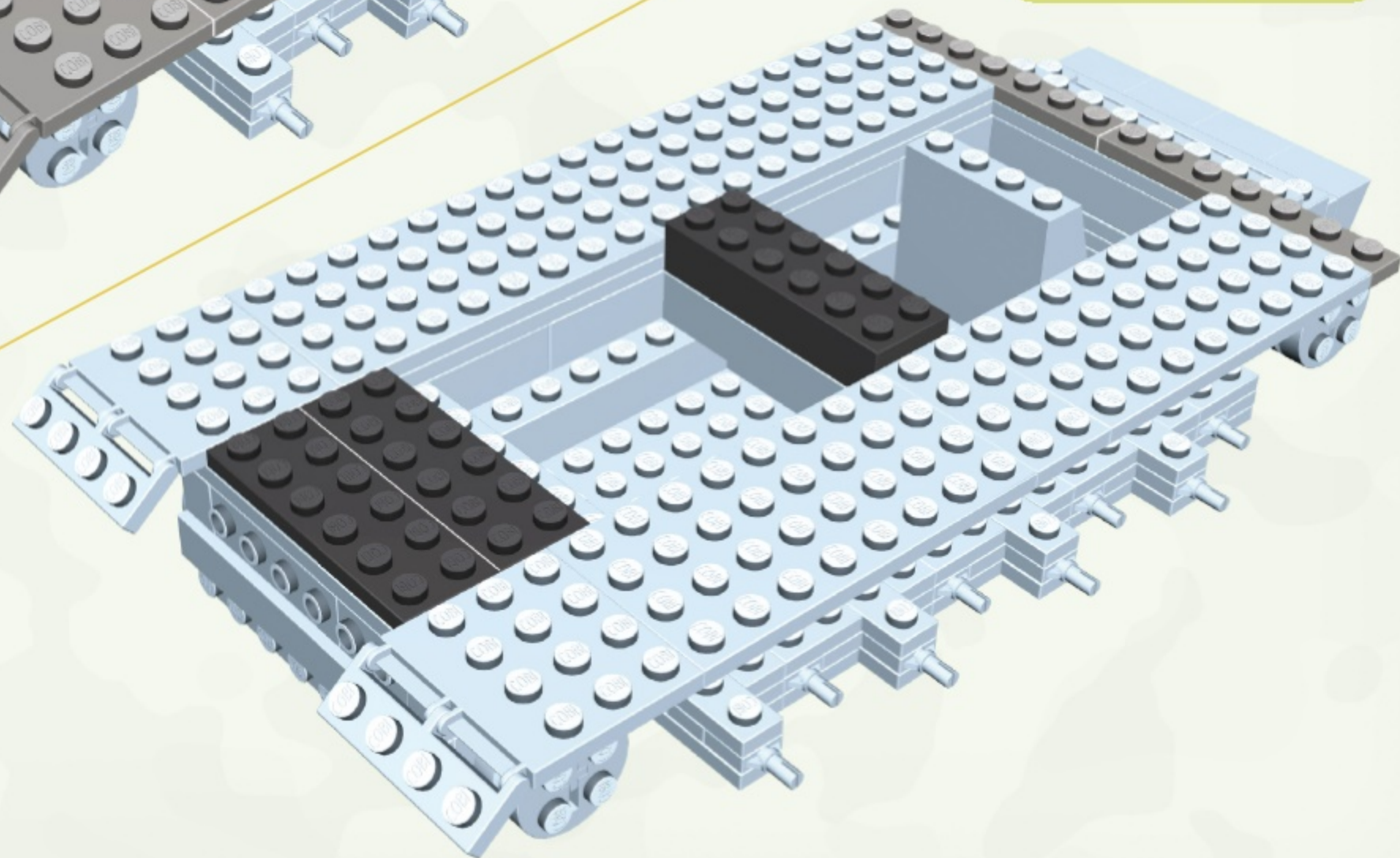
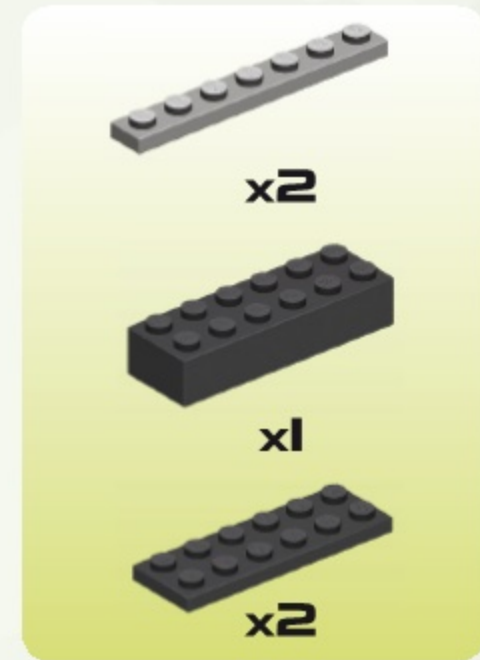
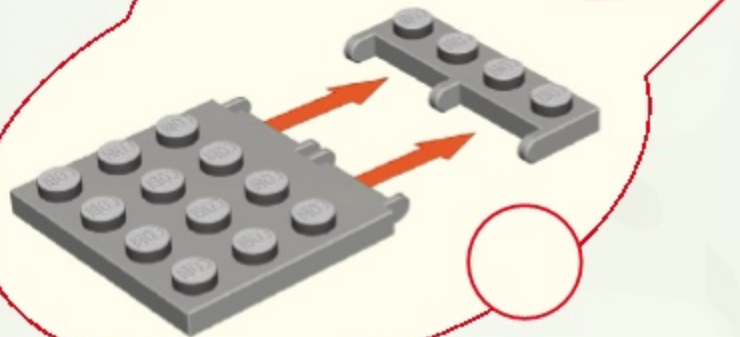
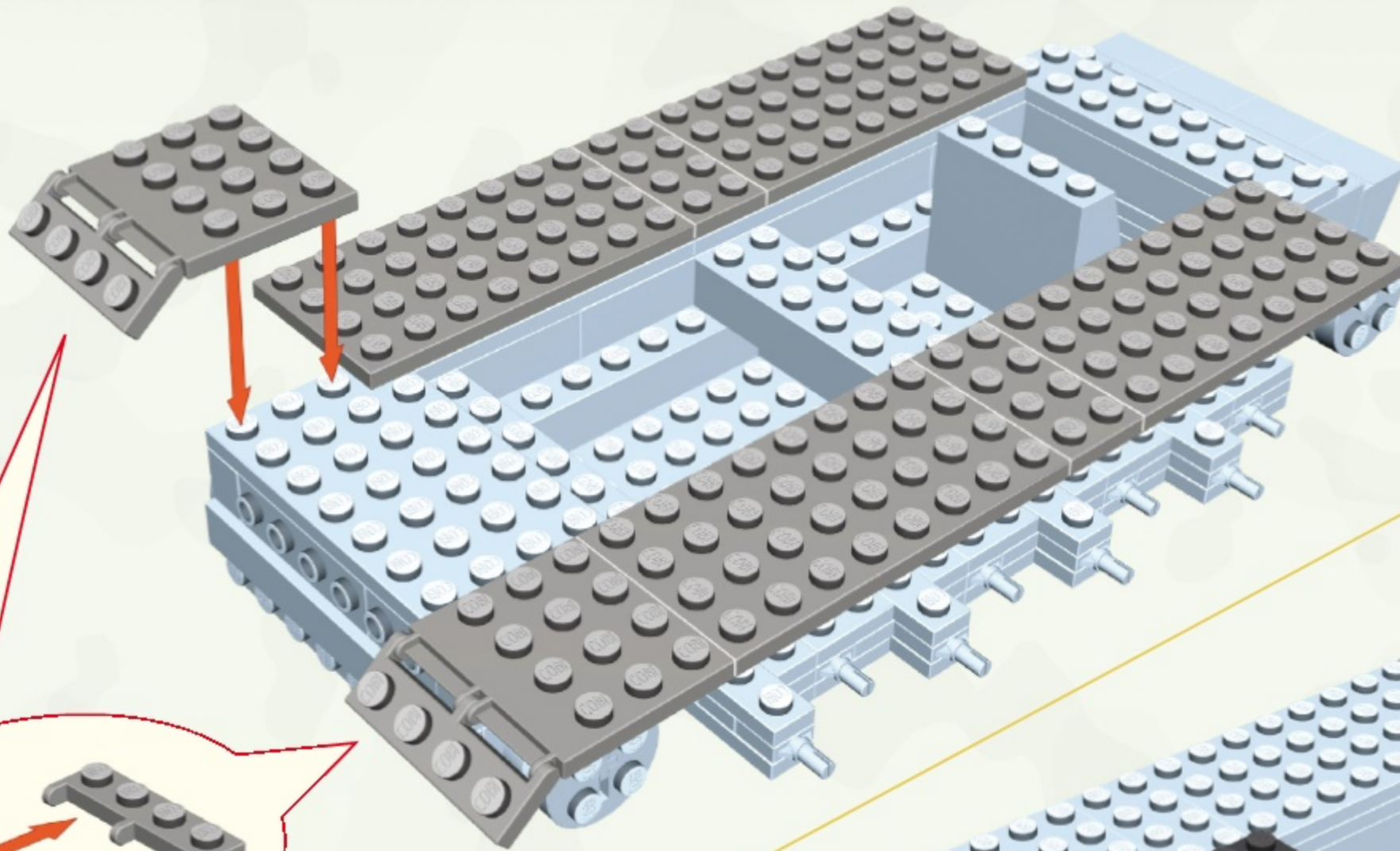

x4



x2



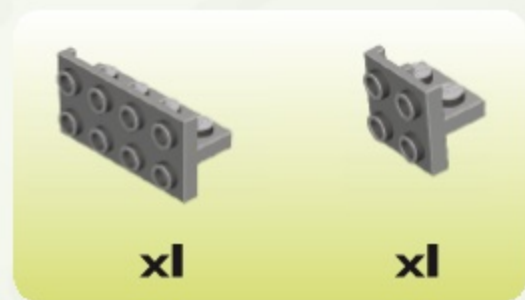
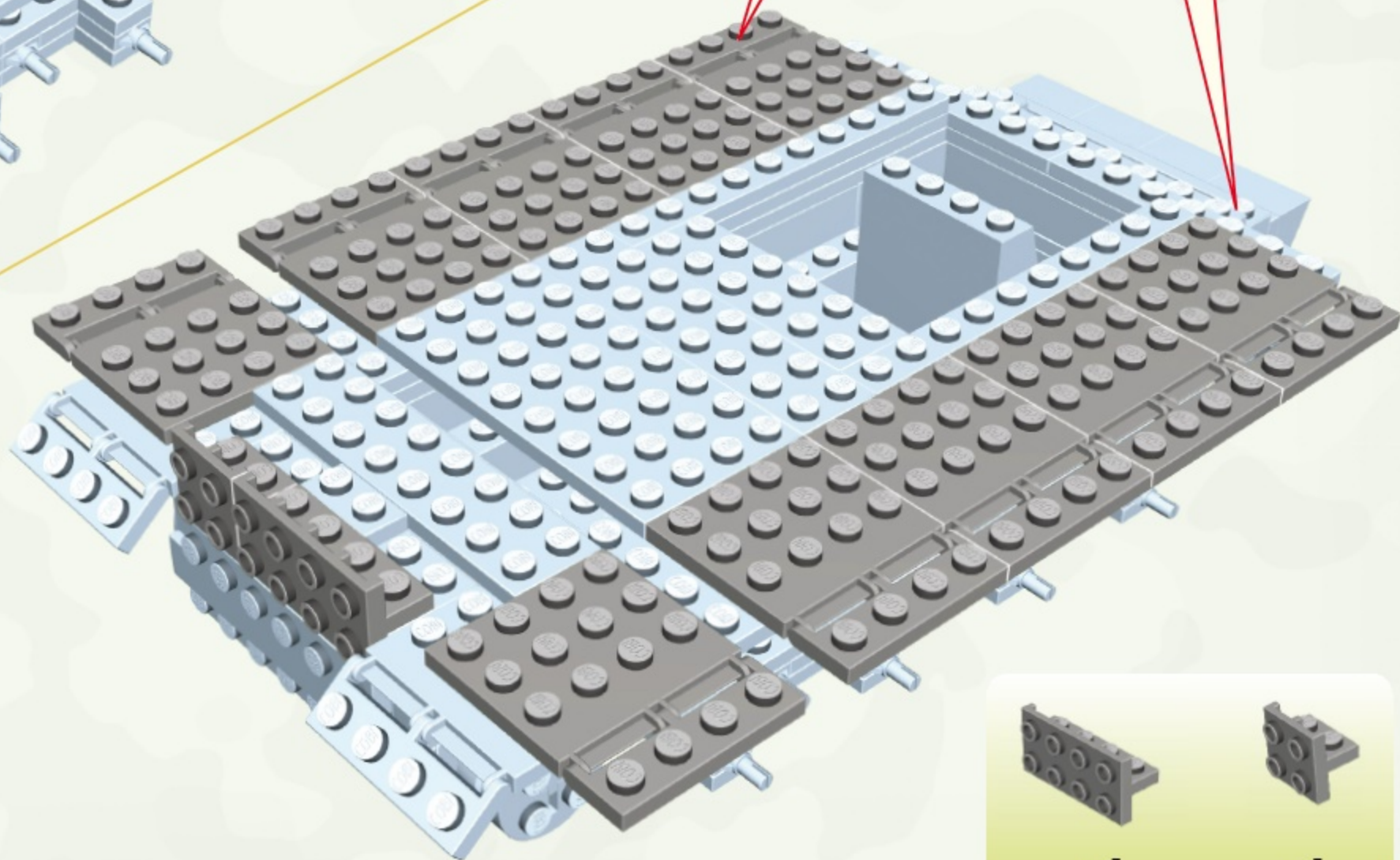
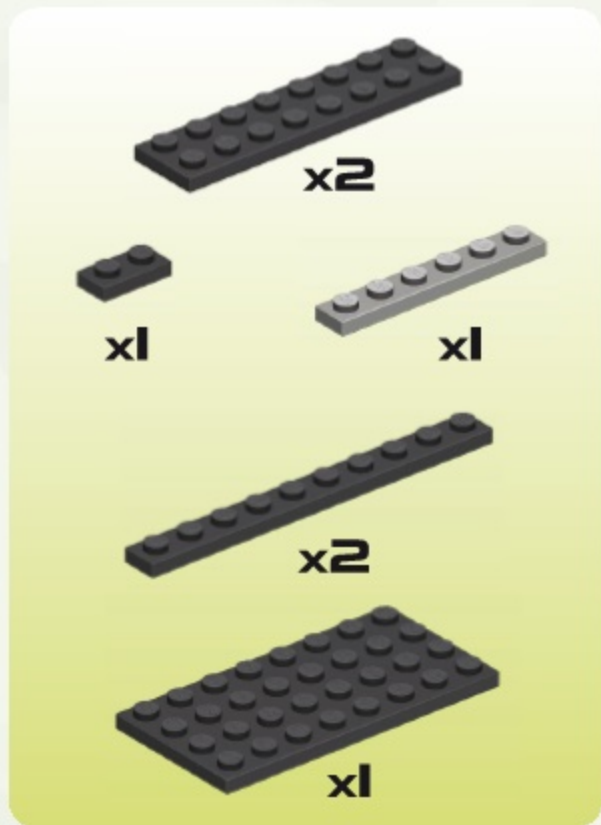
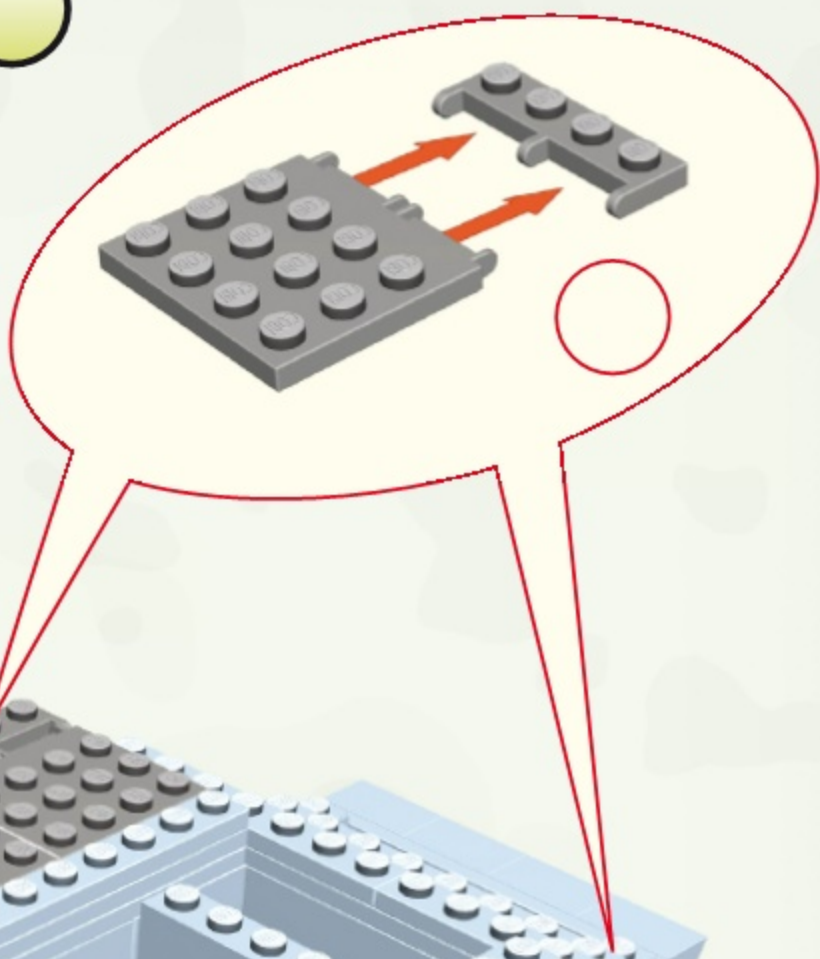
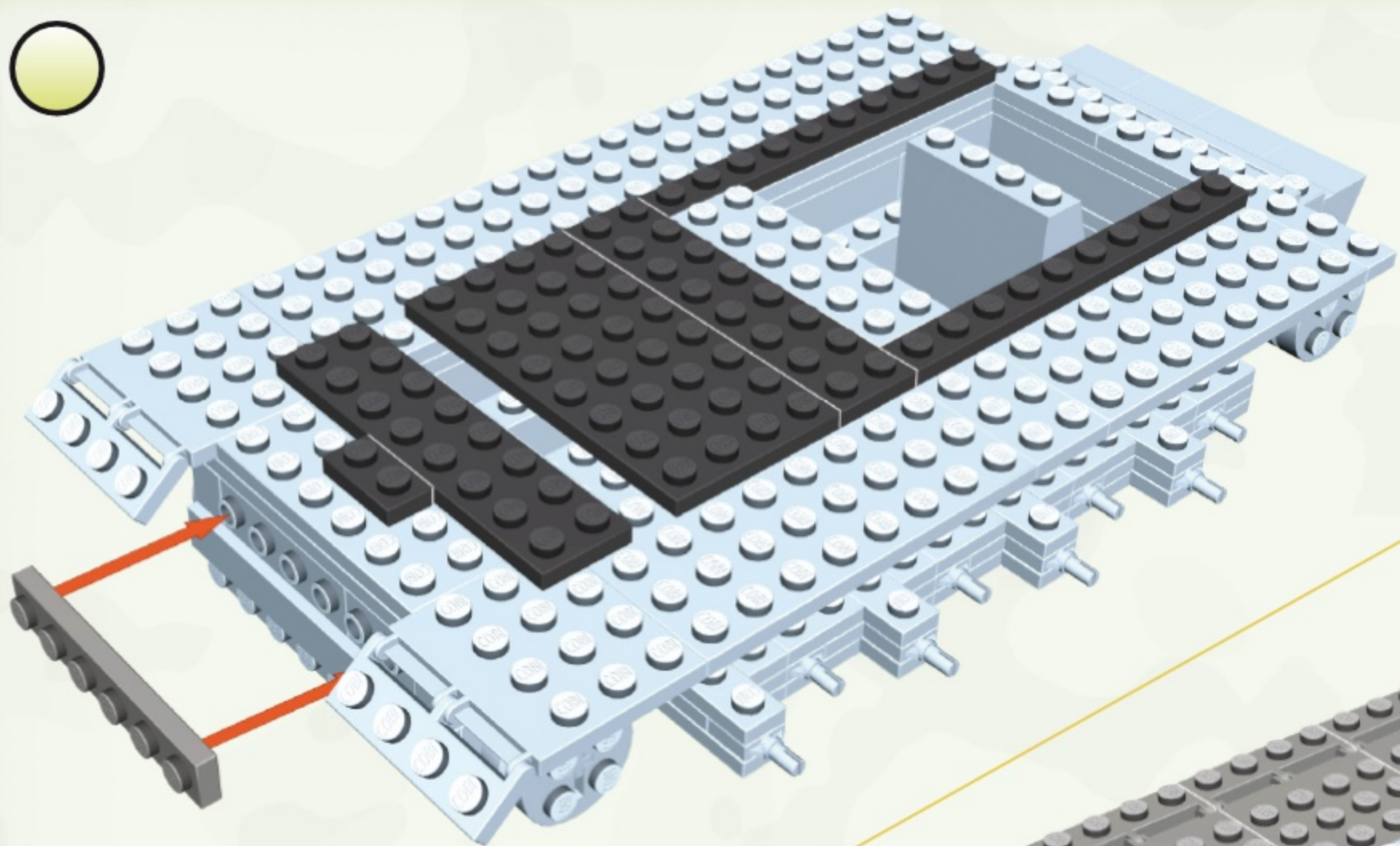



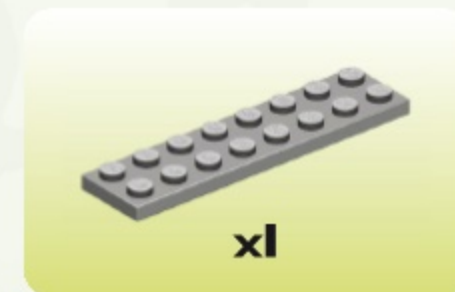
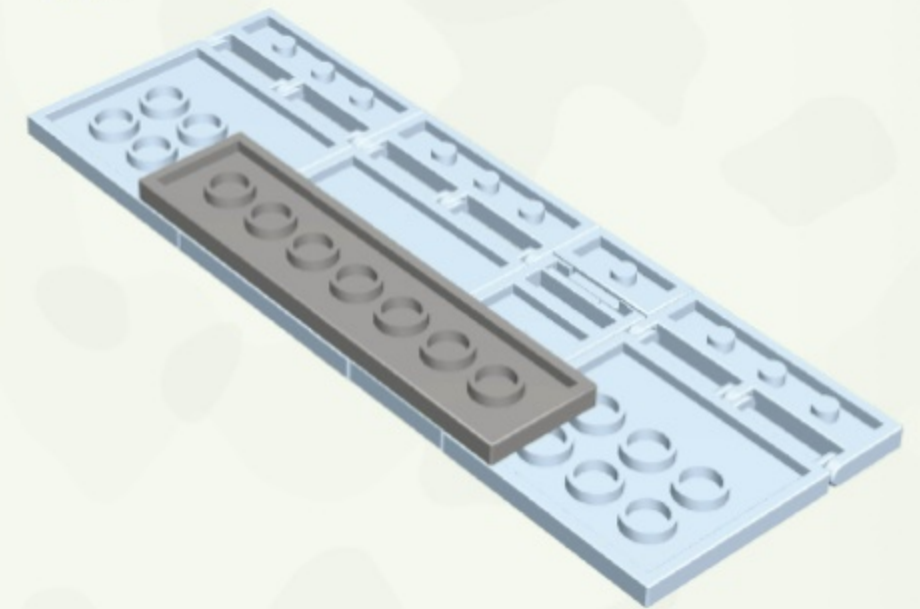
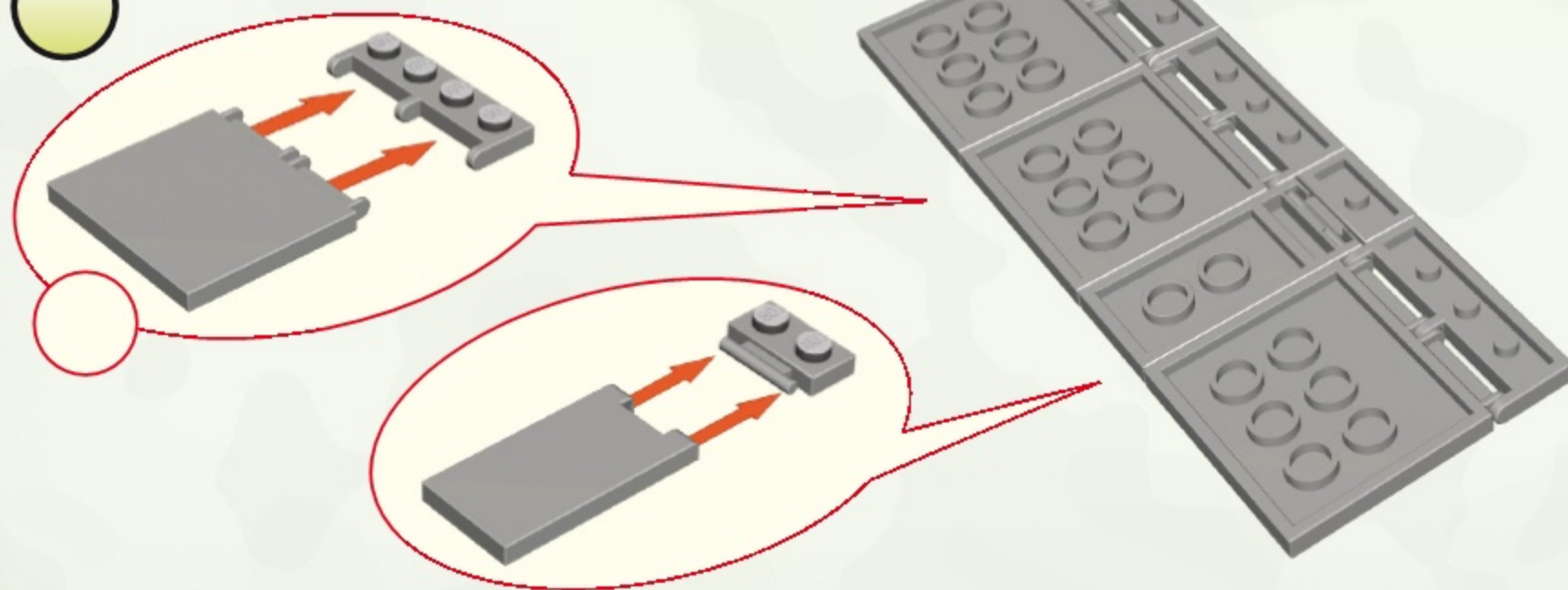
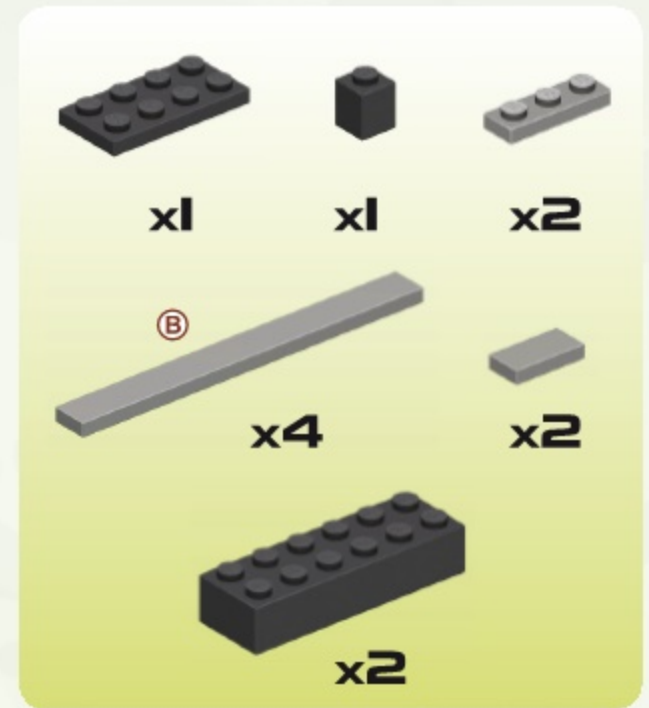
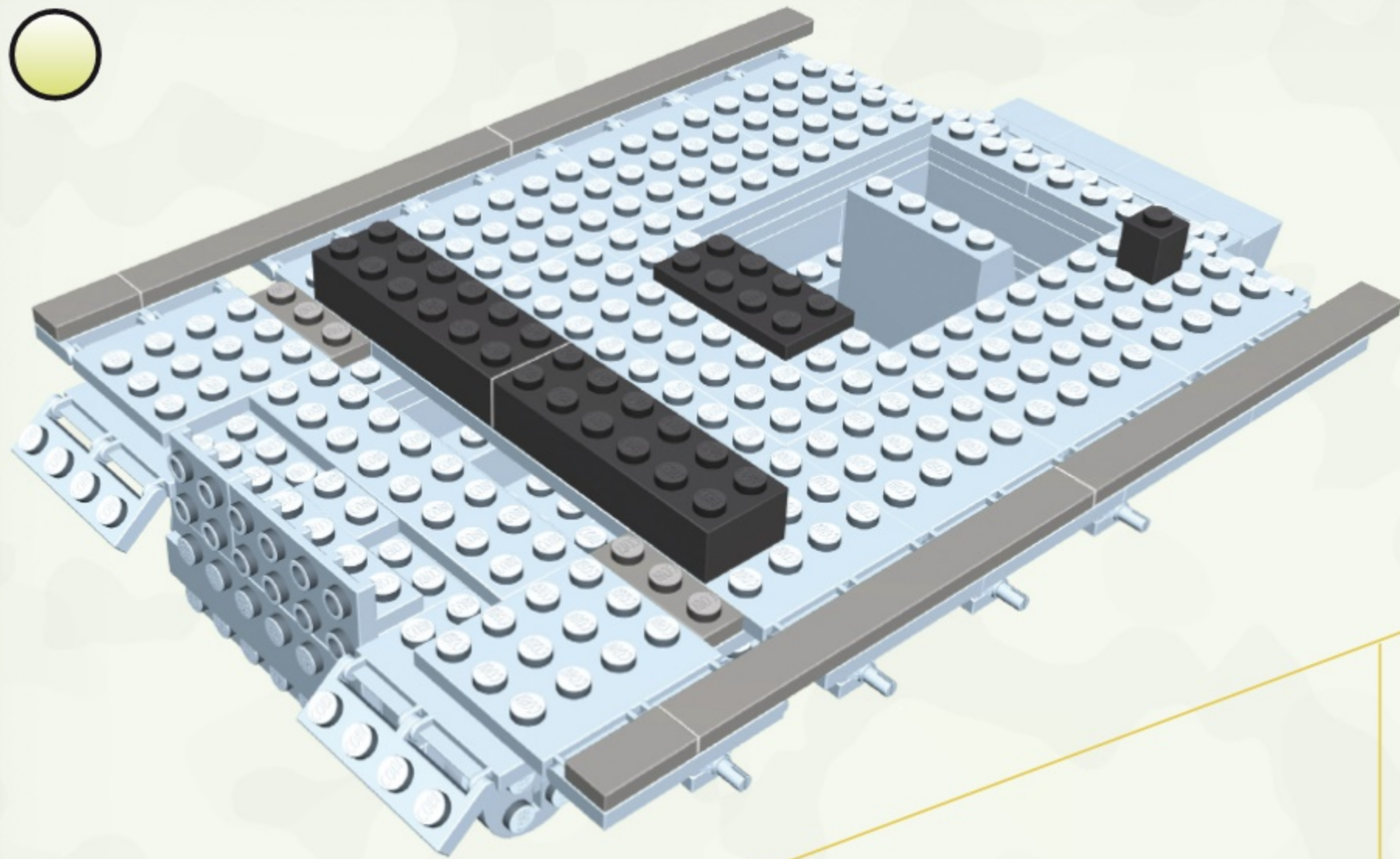



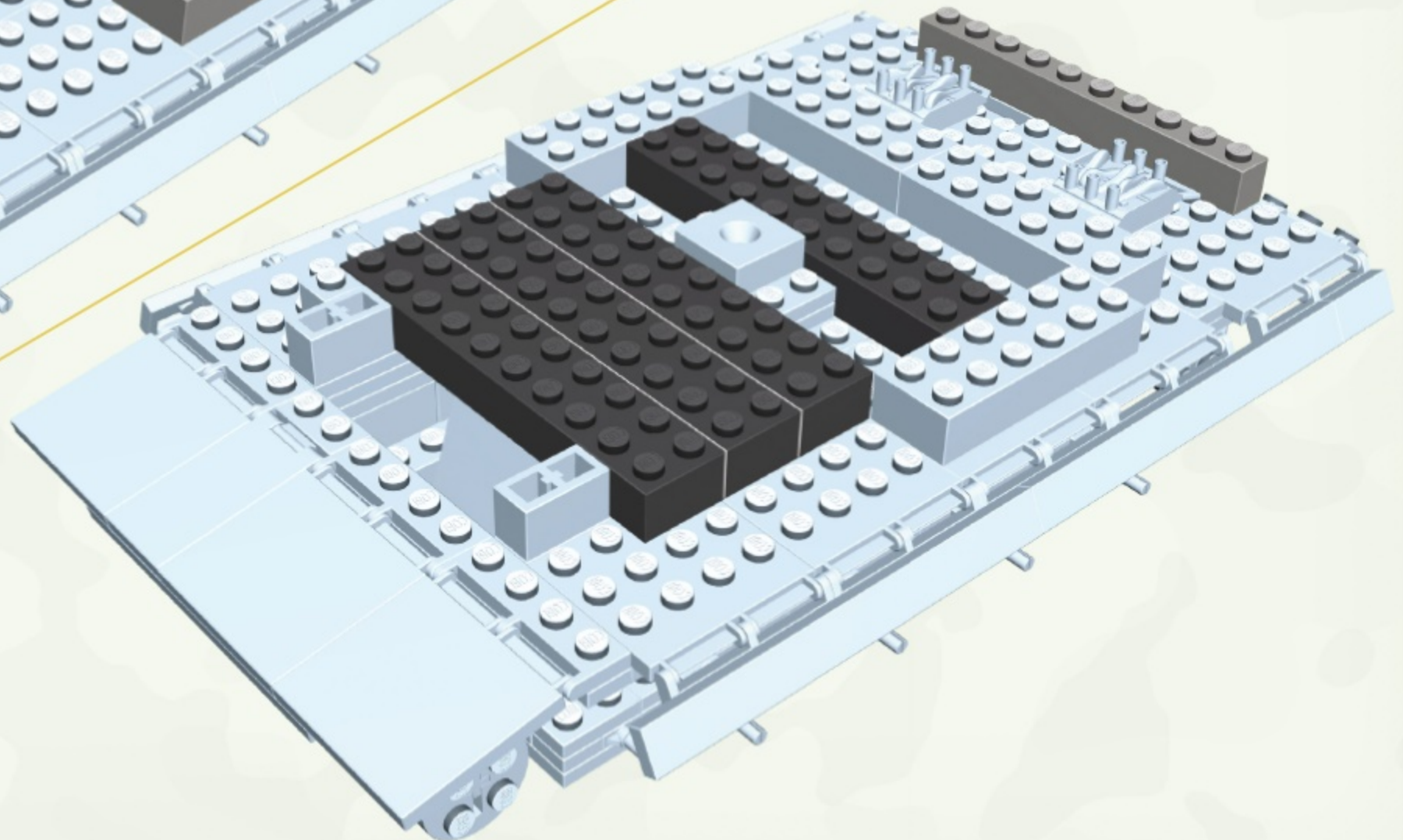
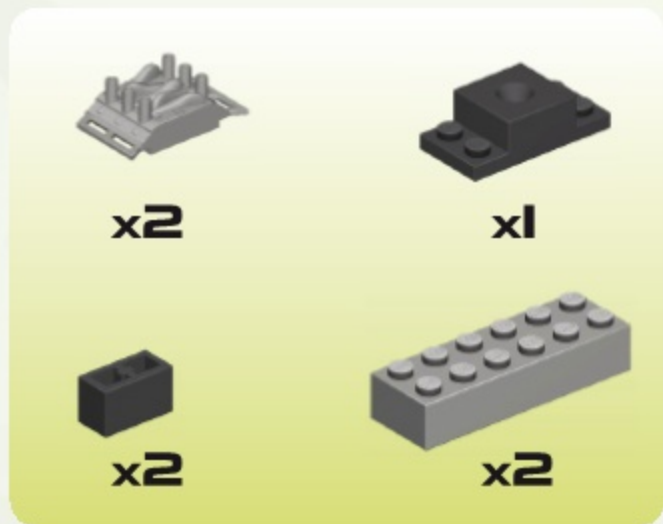
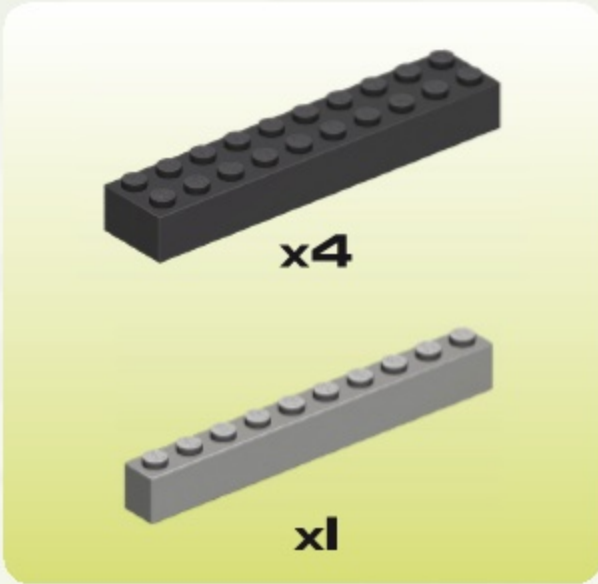
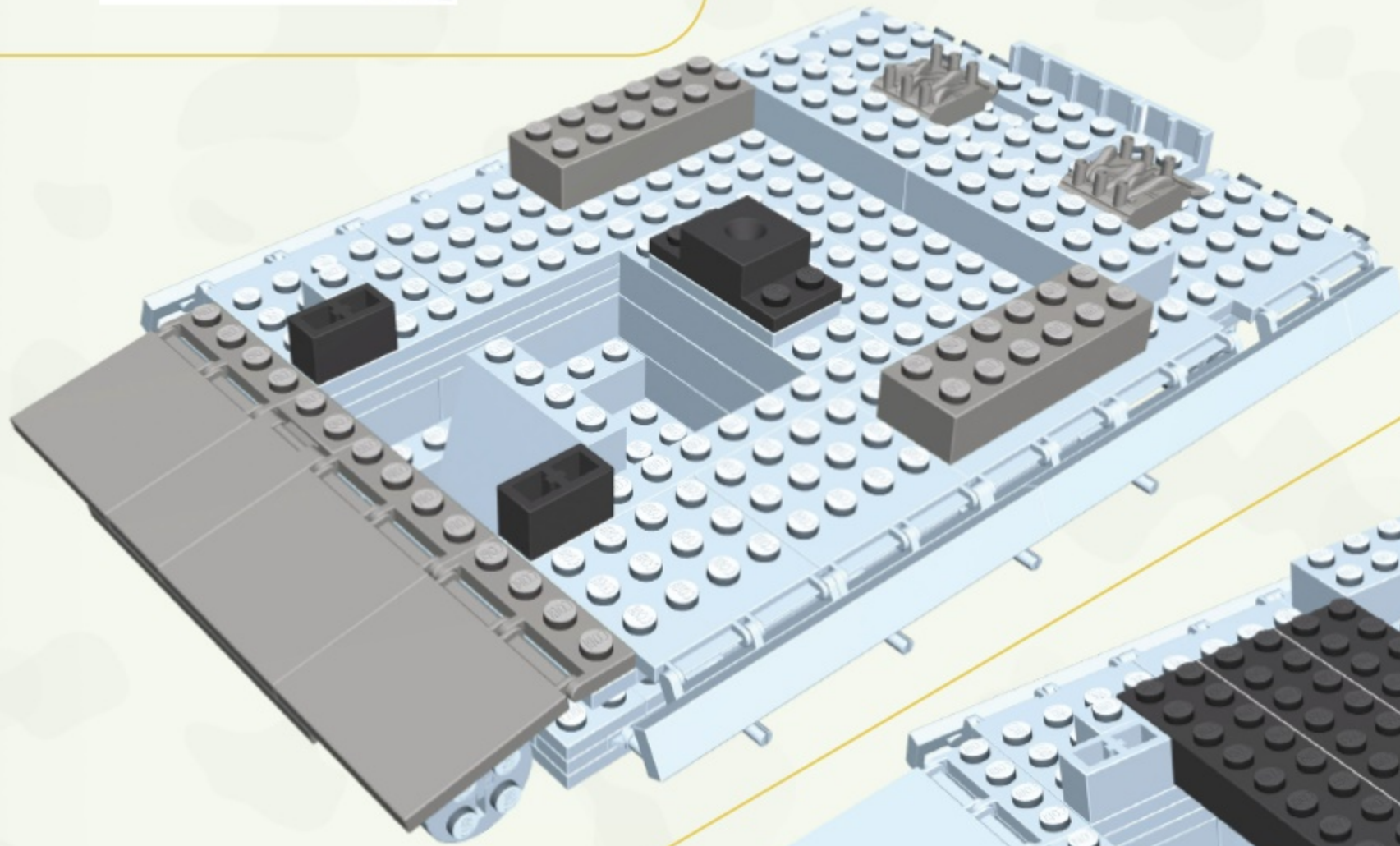



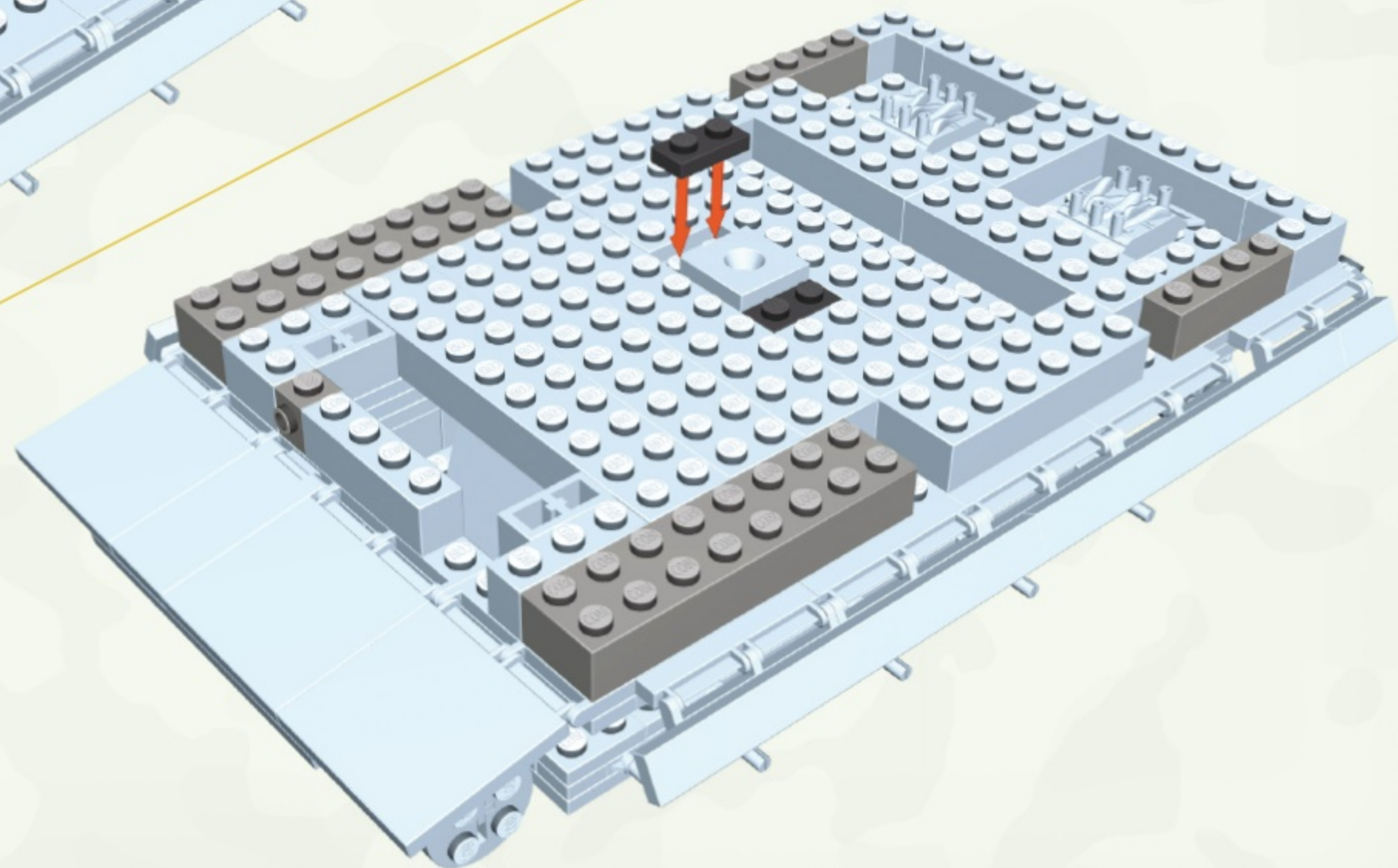
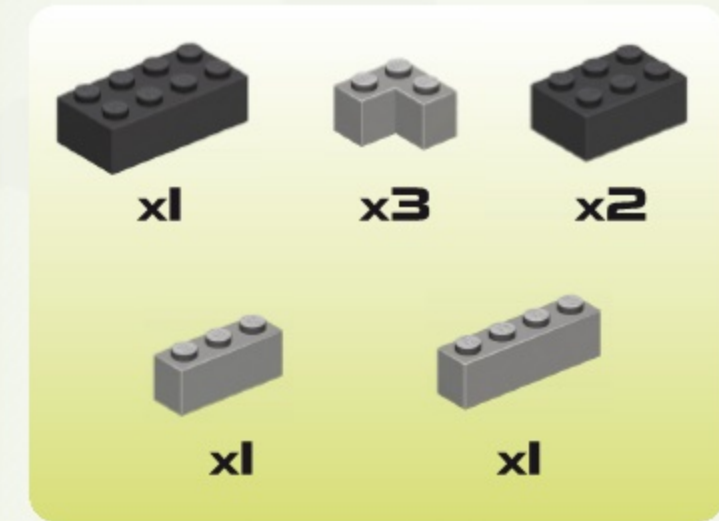
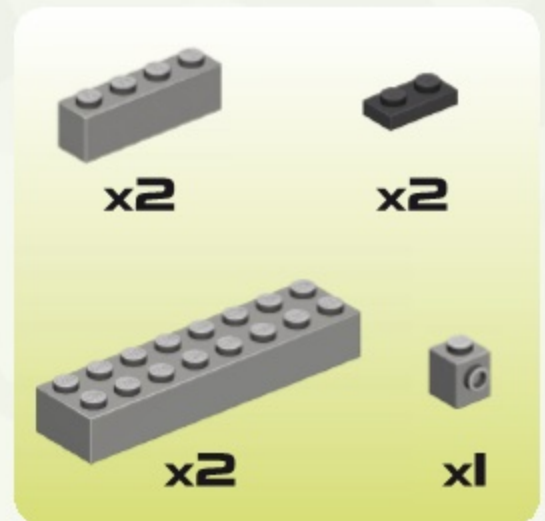
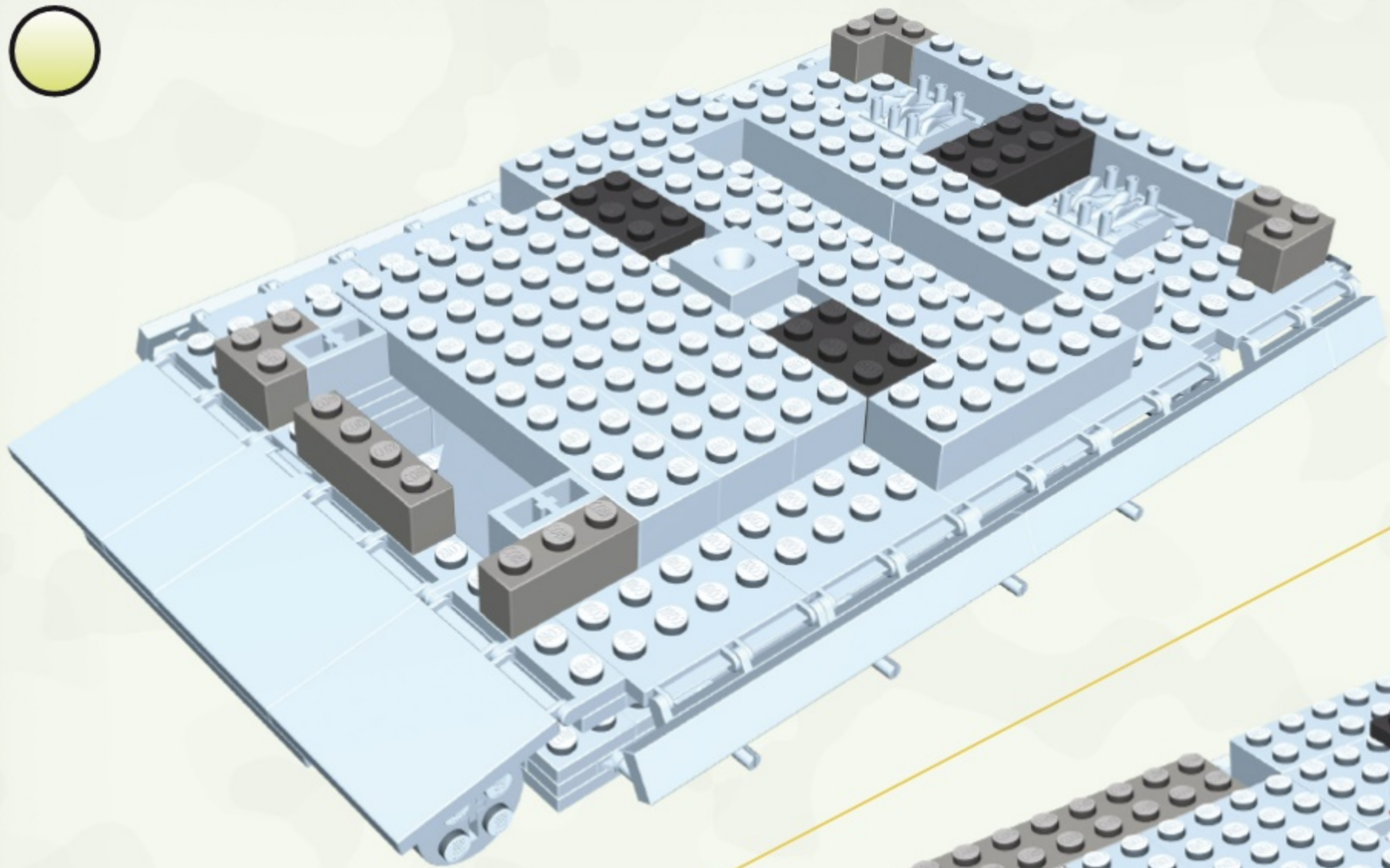



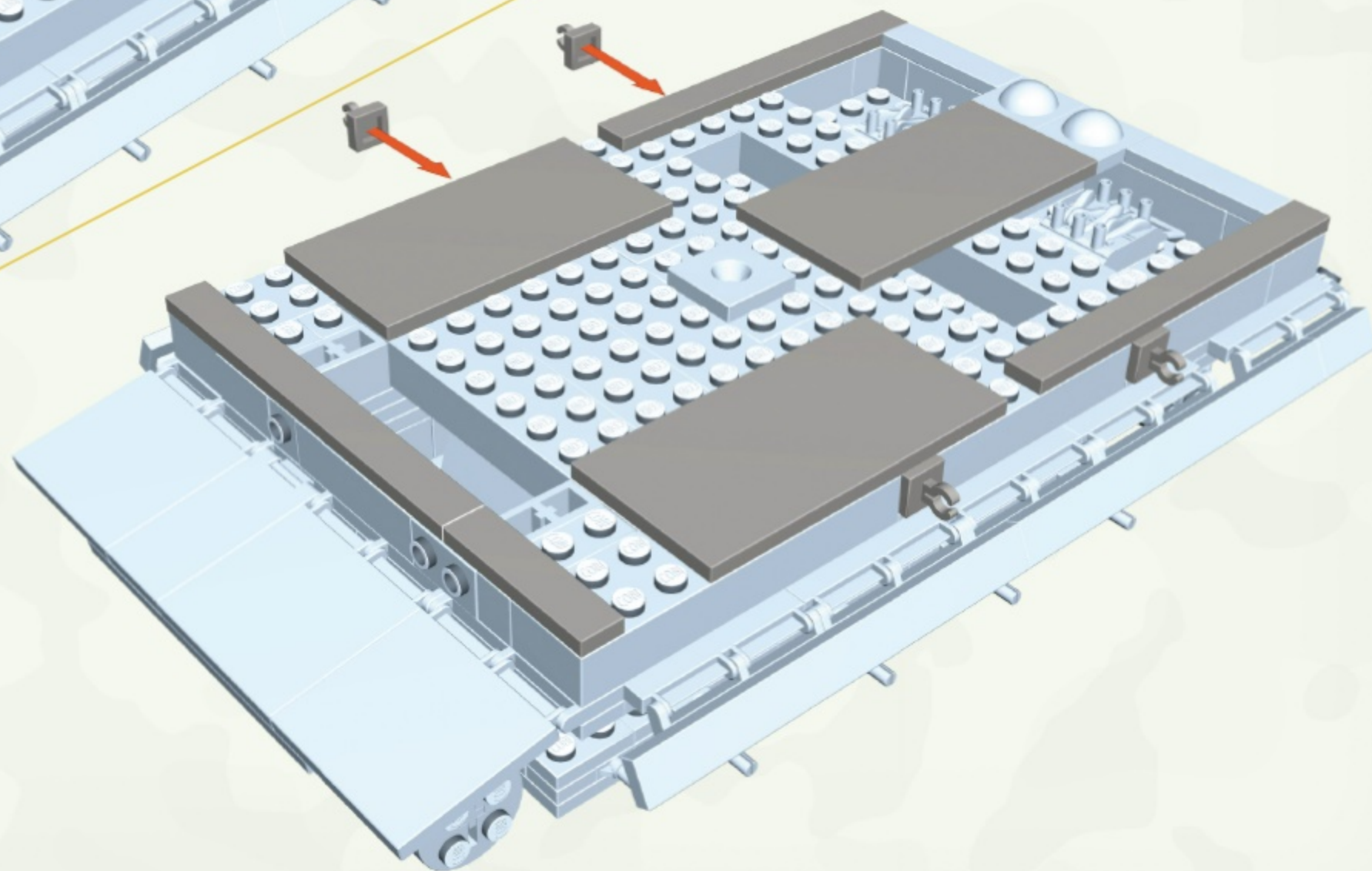
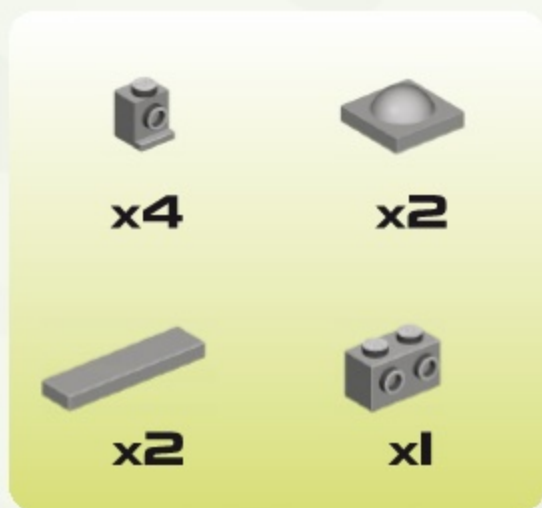
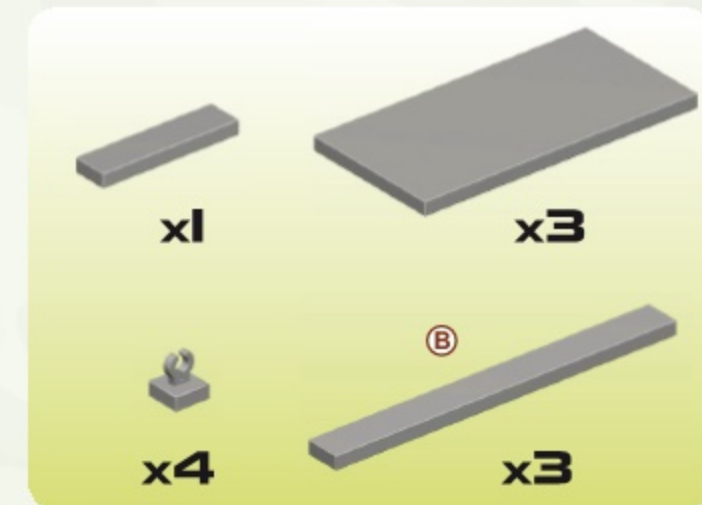
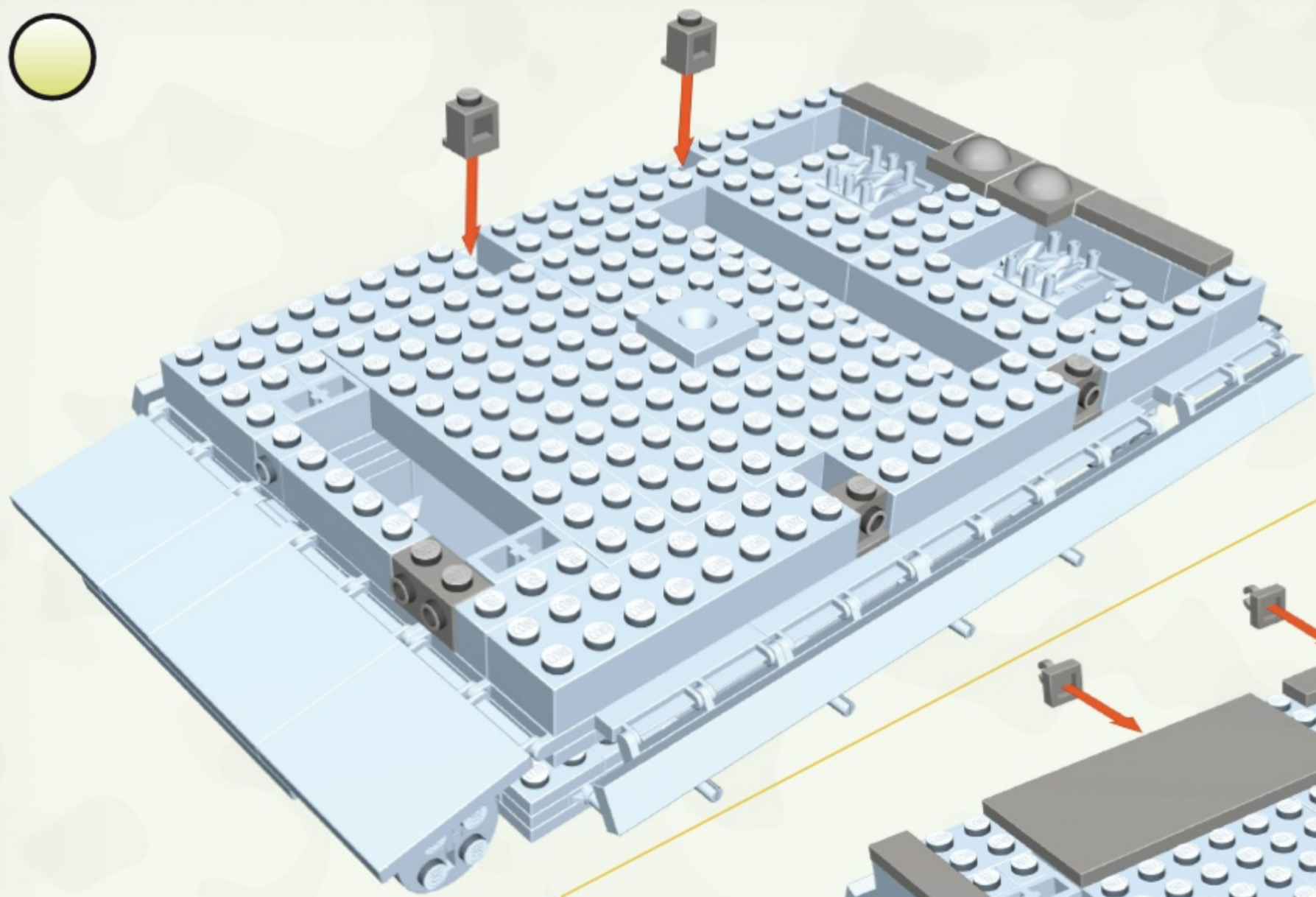



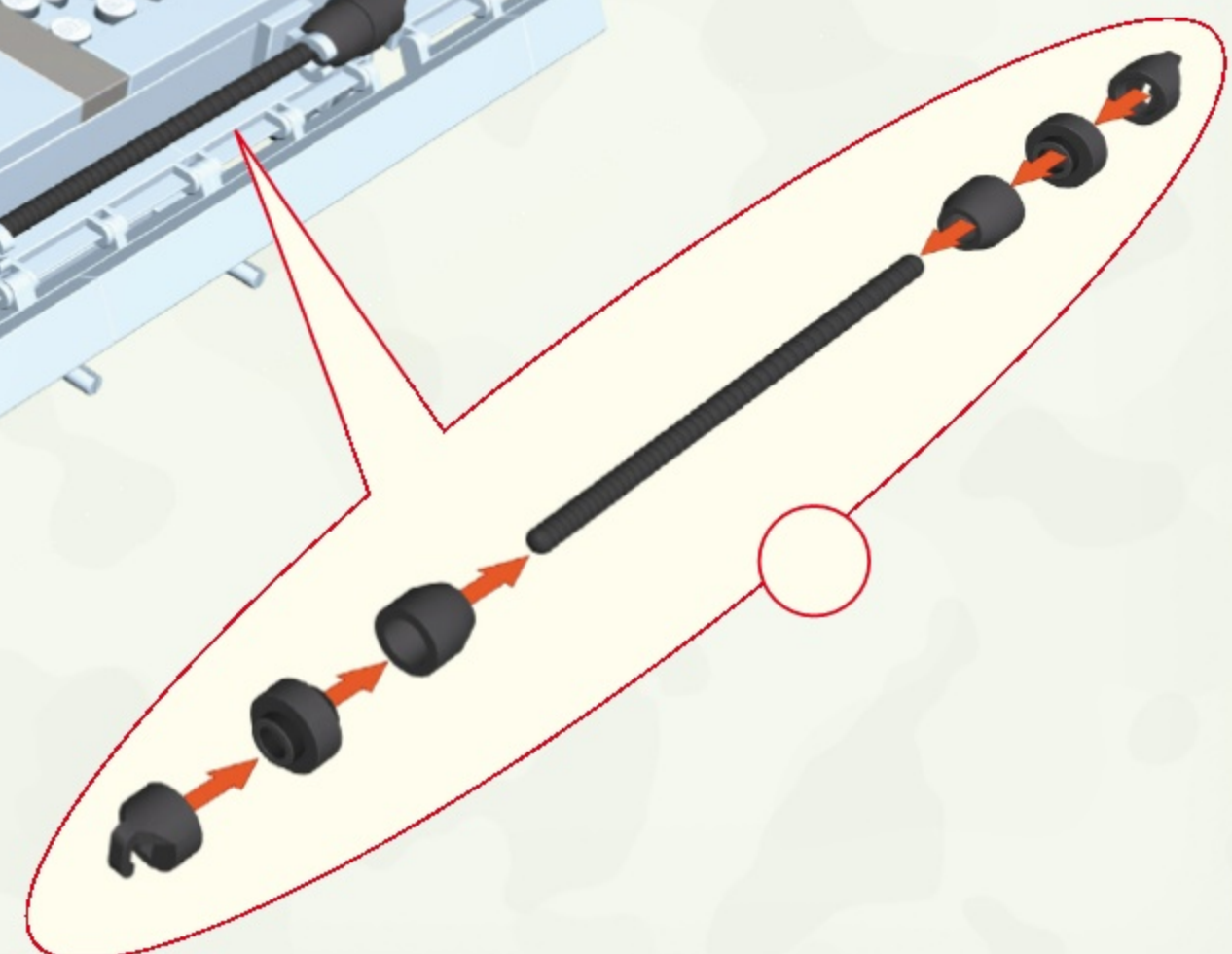
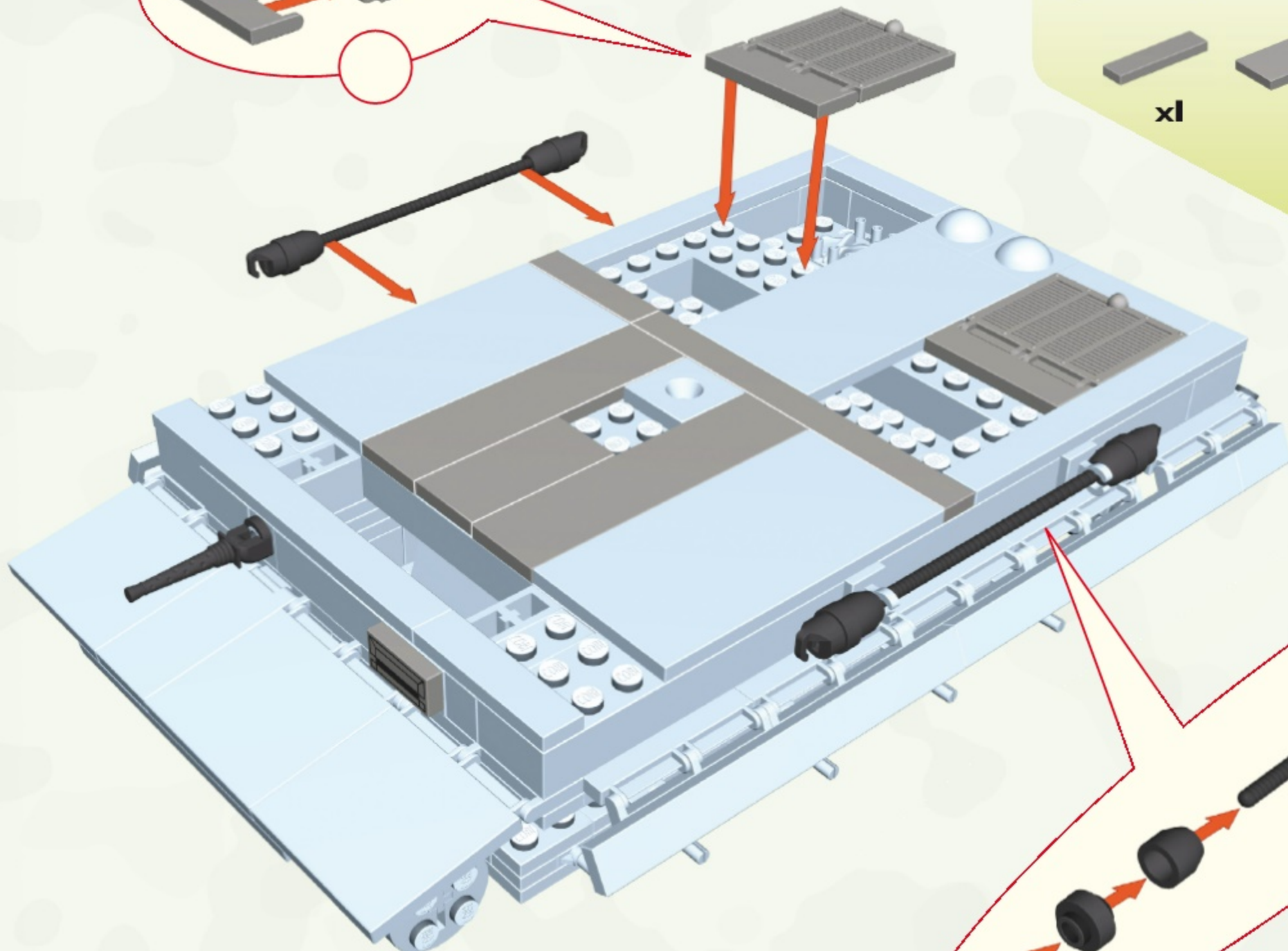
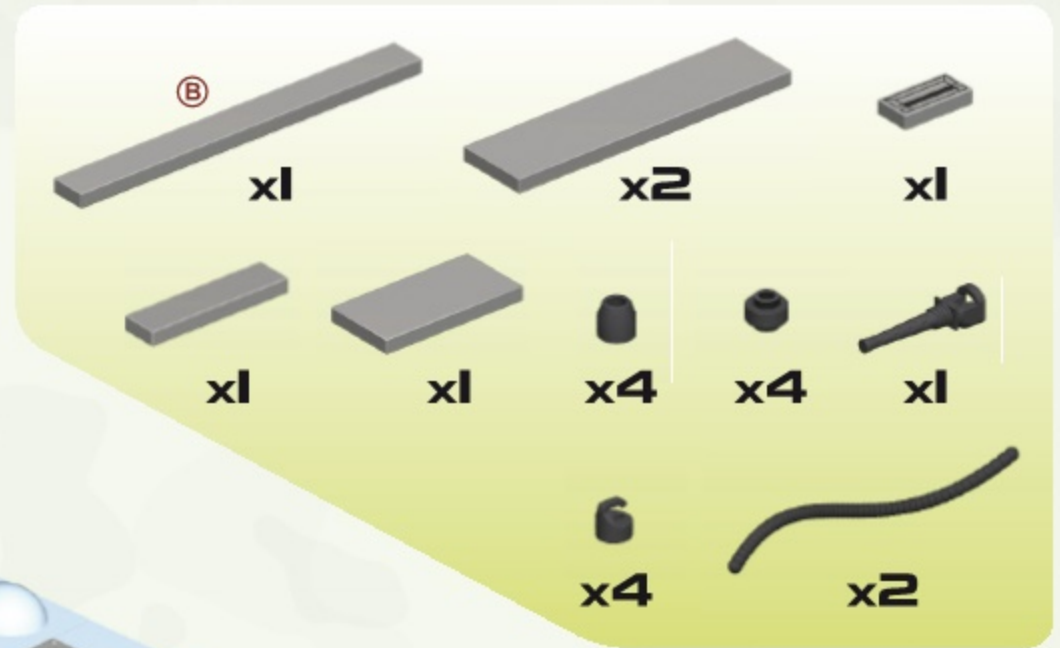
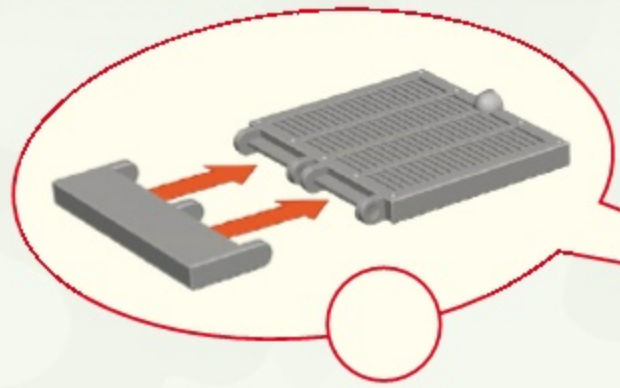



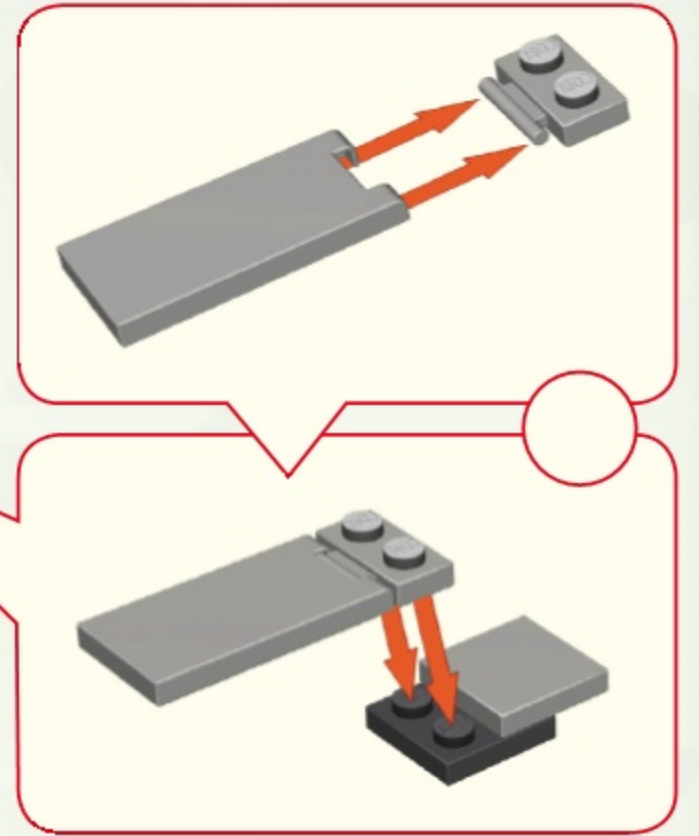
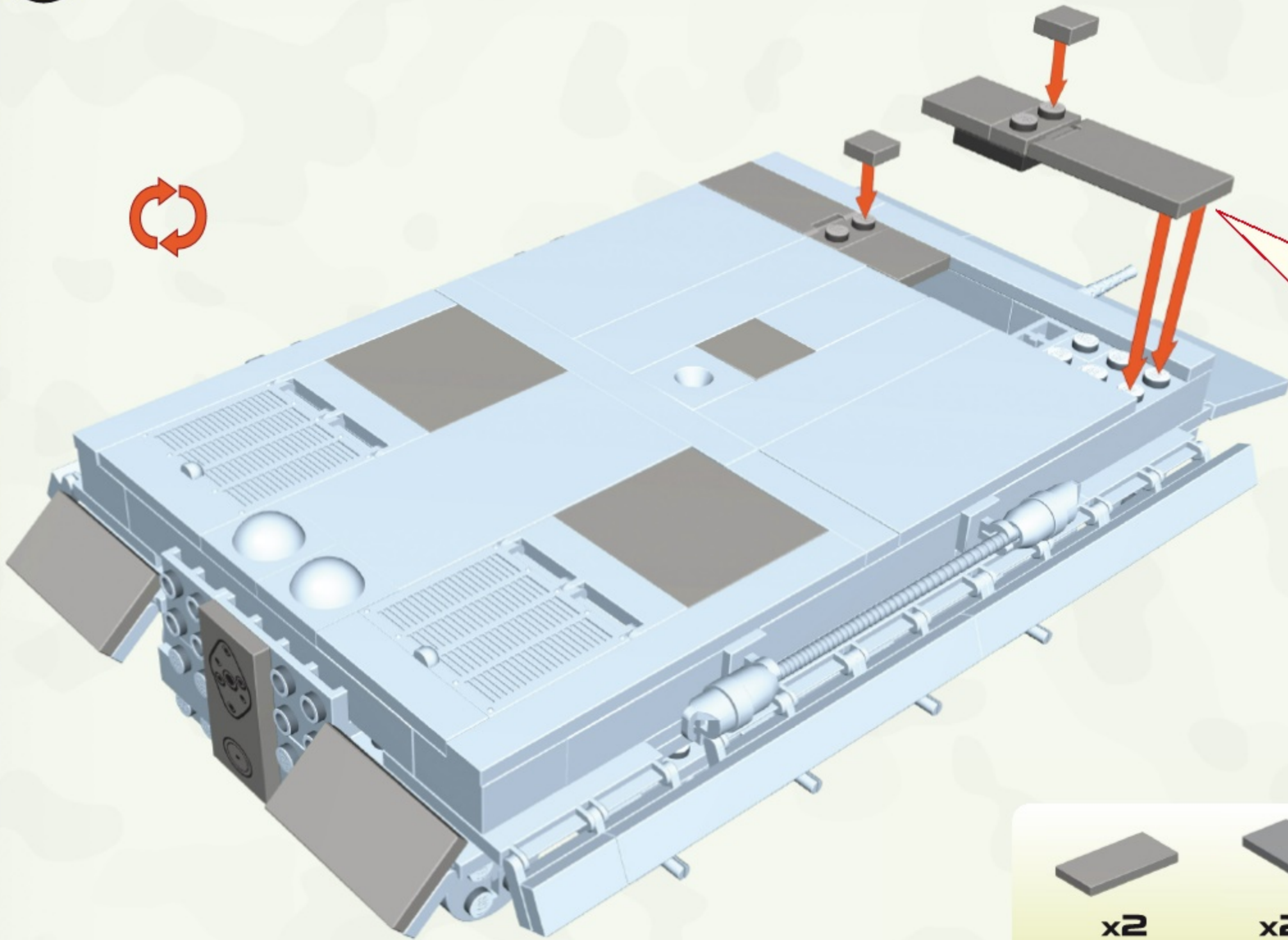







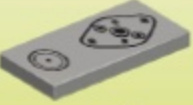

- |  |  |  |  |
|--|--|--|--|
| <br><b>x2</b> | <br><b>x2</b> | <br><b>x2</b> | <br><b>x2</b> |
| <br><b>x2</b> | <br><b>x1</b> | <br><b>x3</b> | <br><b>x2</b> |



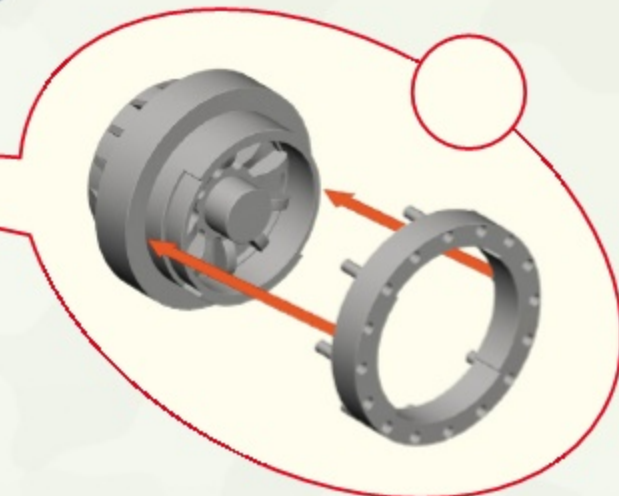
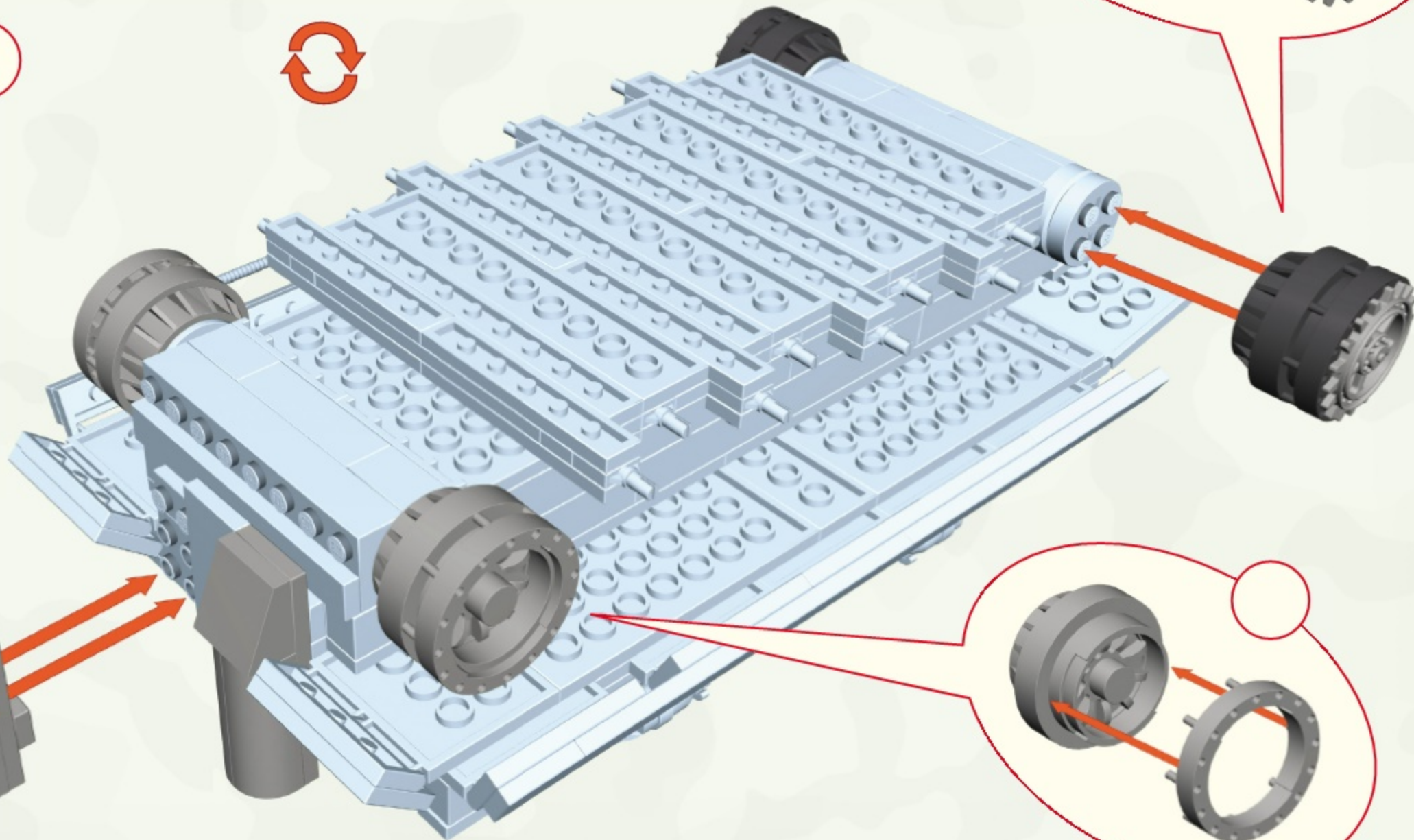
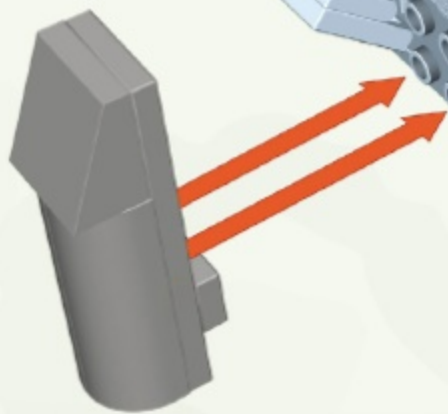
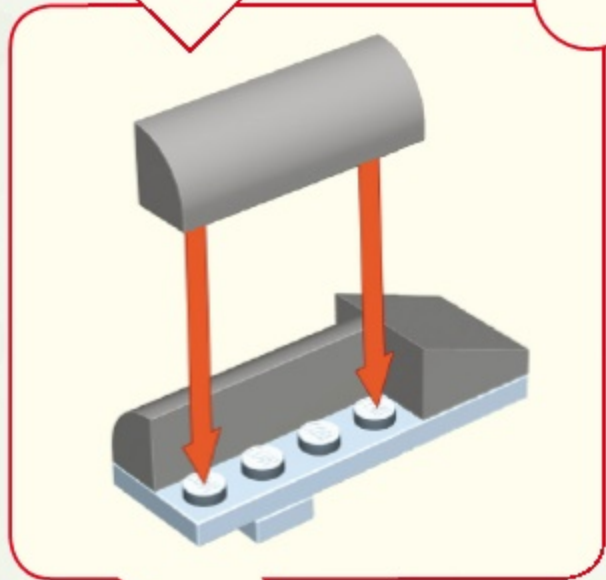
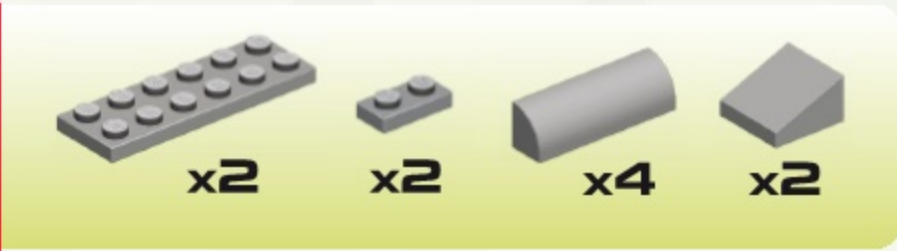
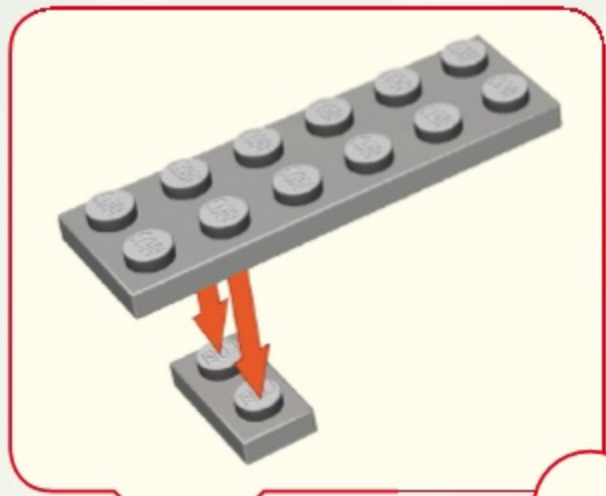



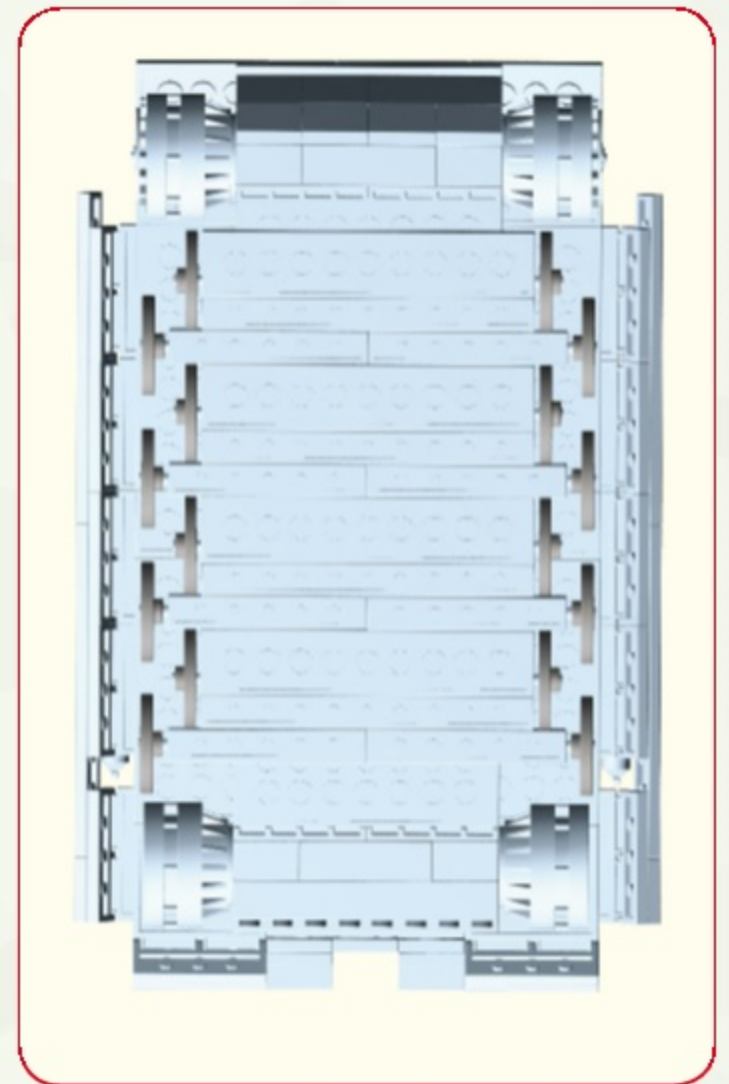
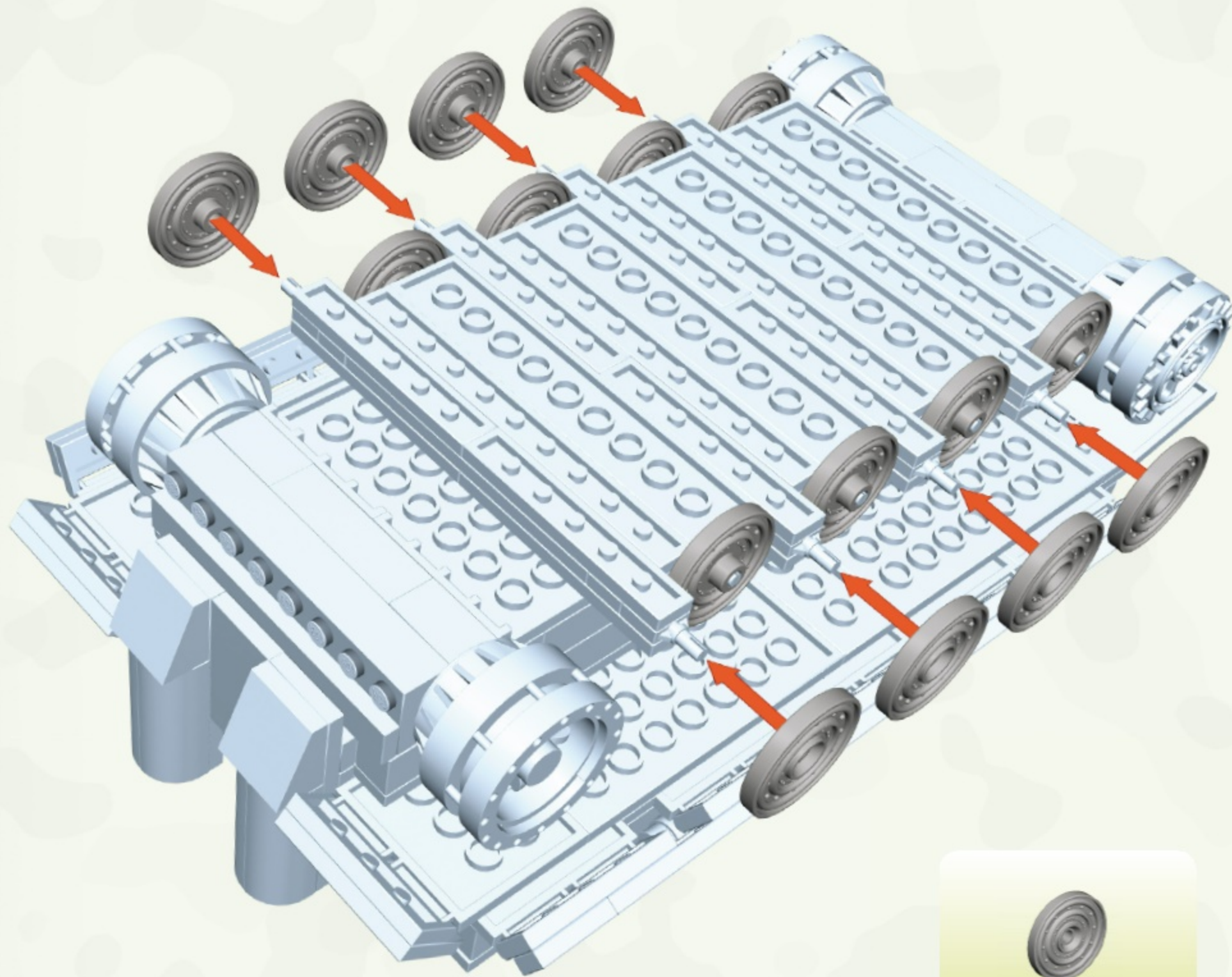



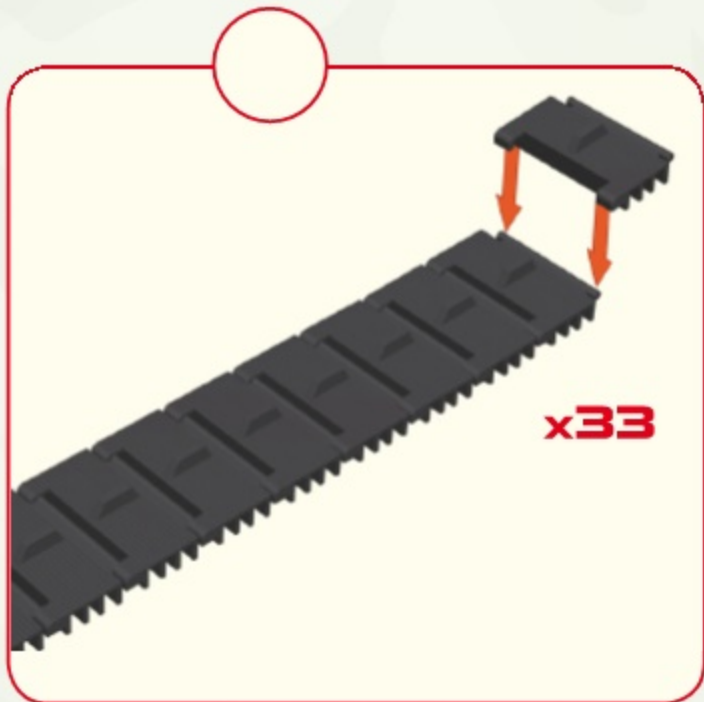
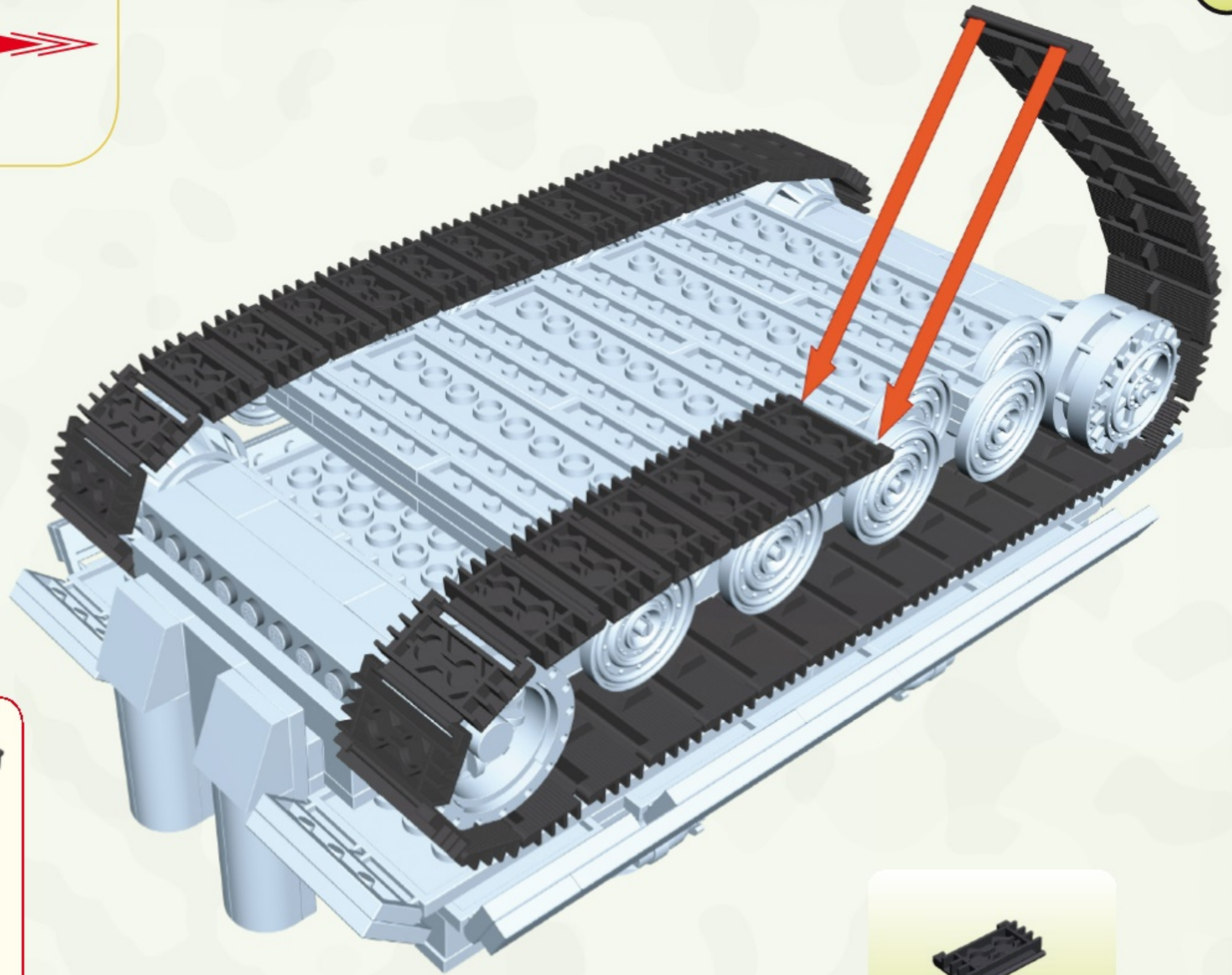

x33



x66





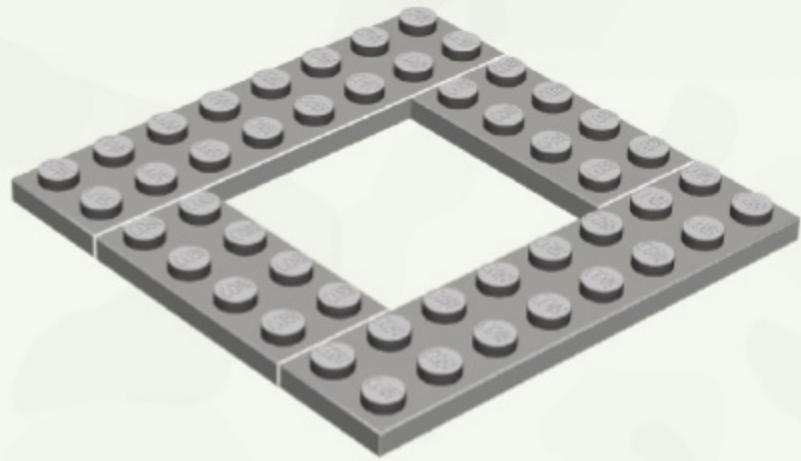

x2



x2

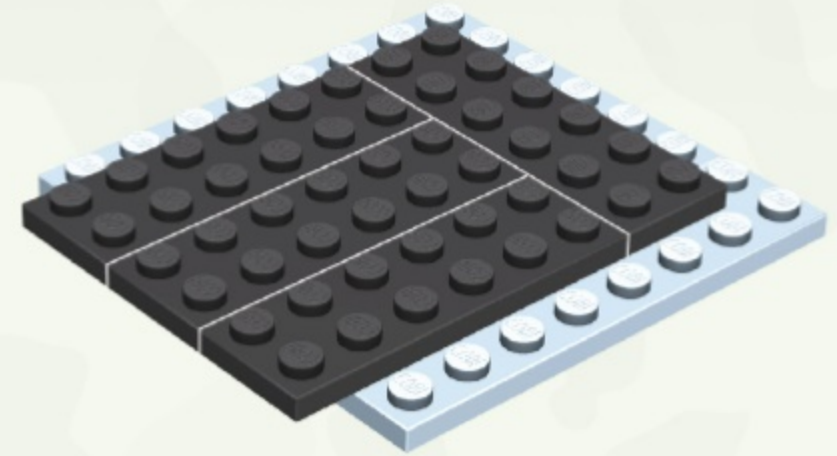

x4



x1



x2



x2



x1



x1

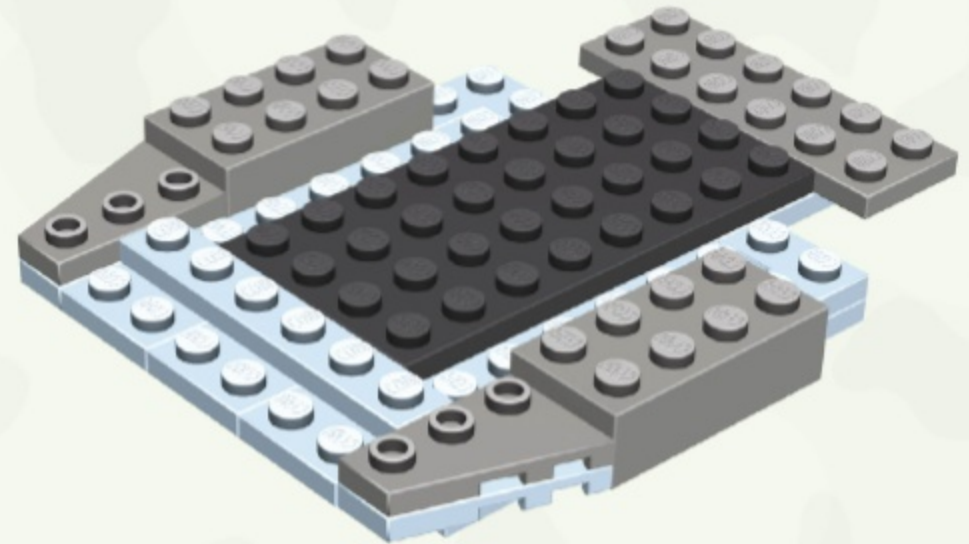

x1



x1



x2



x1



x1



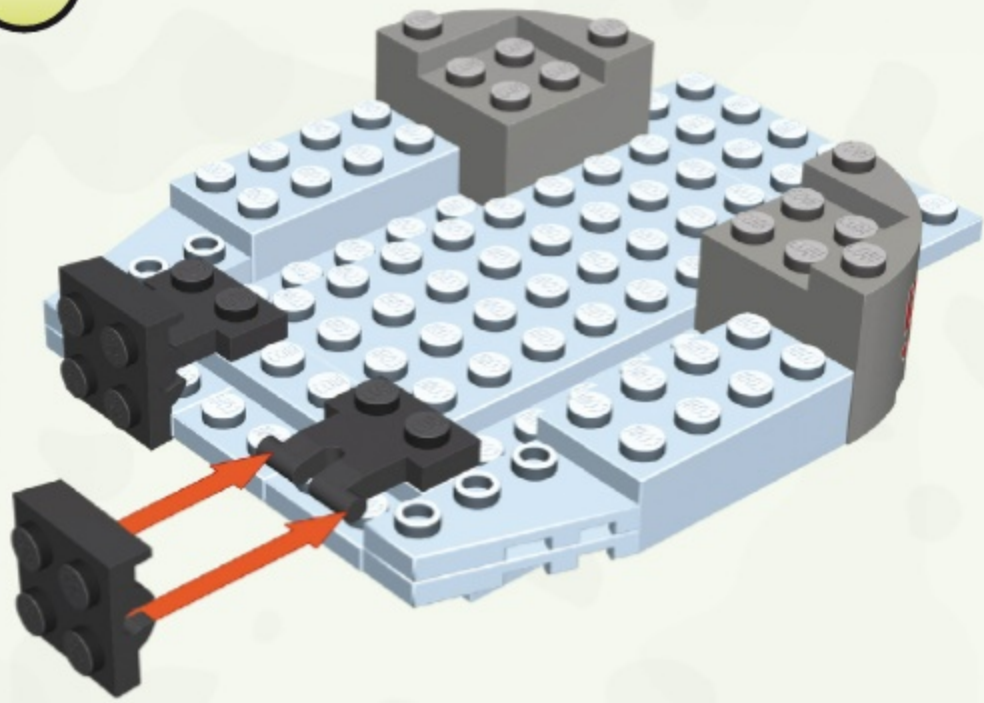

x2



x2



x2

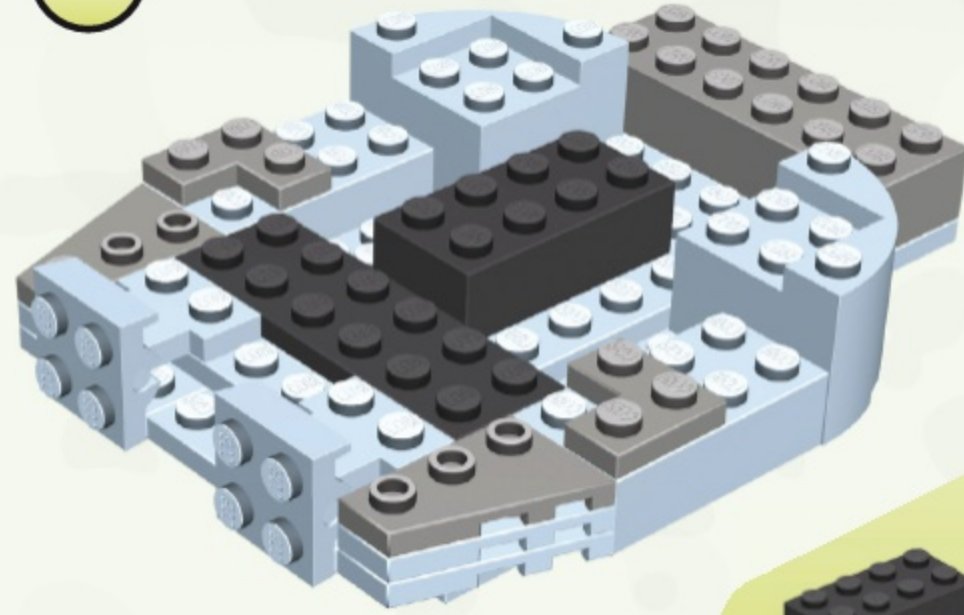

x1



x1



x1



x2



x1



x1

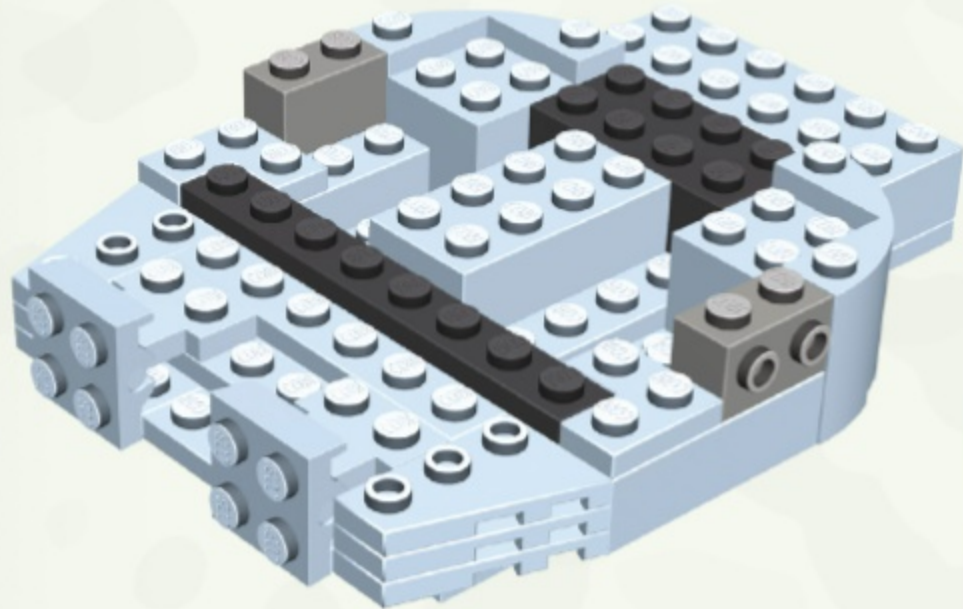

x1



x1



x2

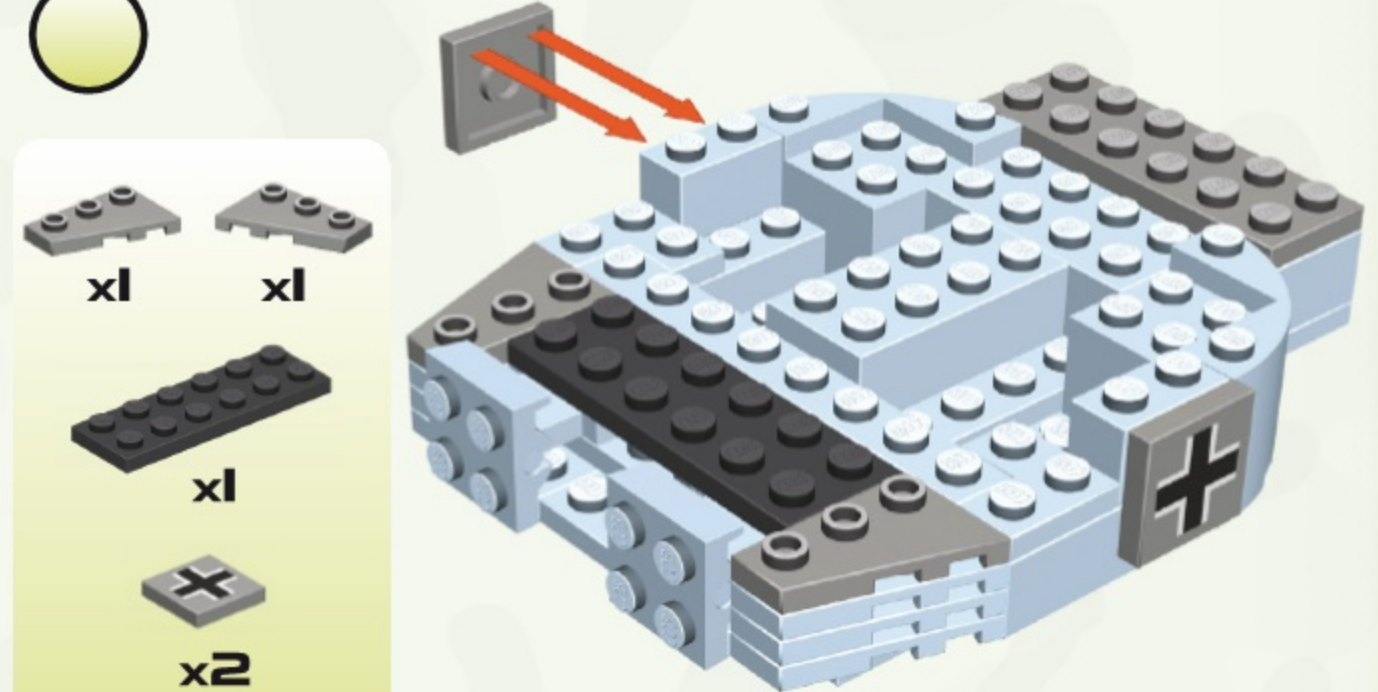

x1



x1



x1



x2



x1



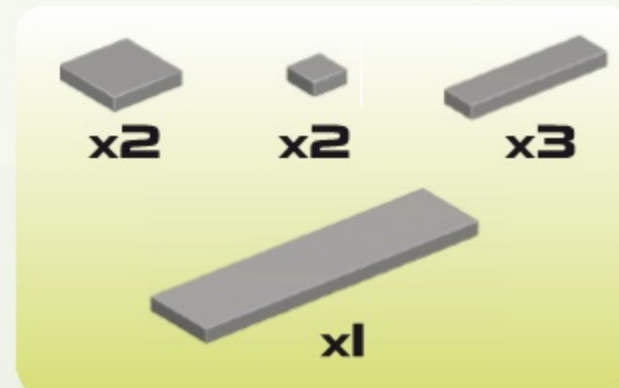
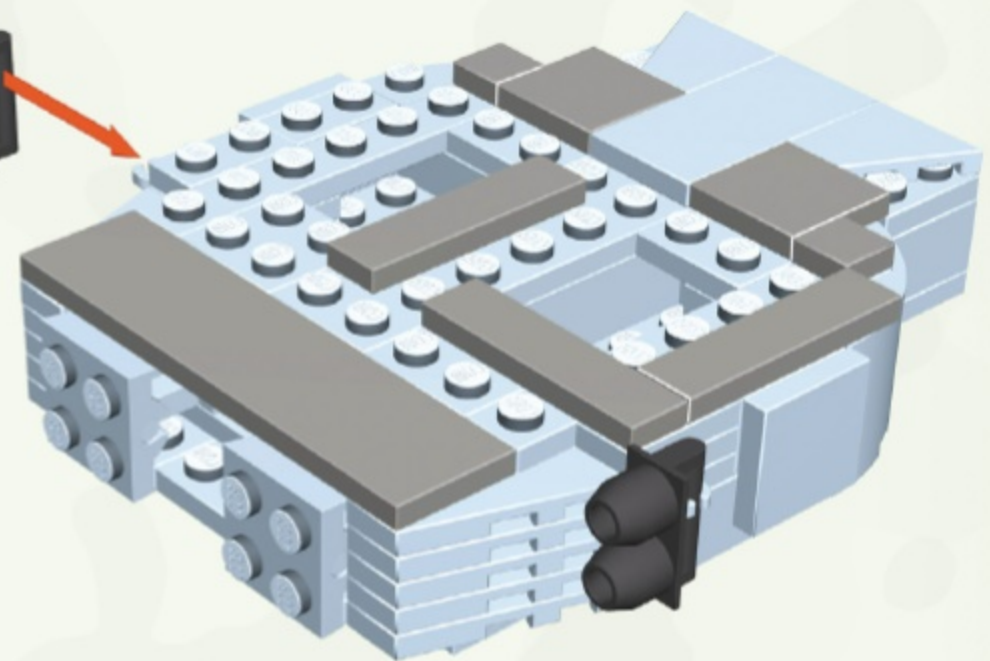
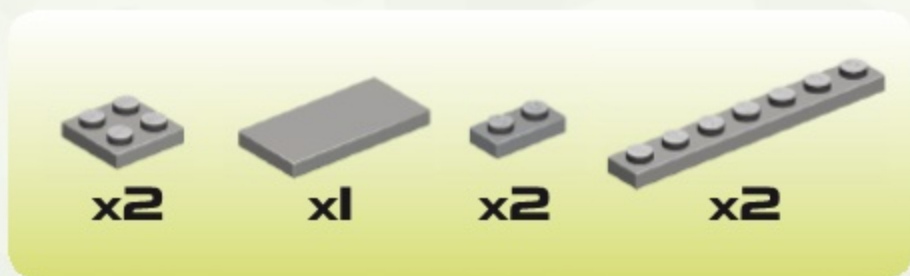
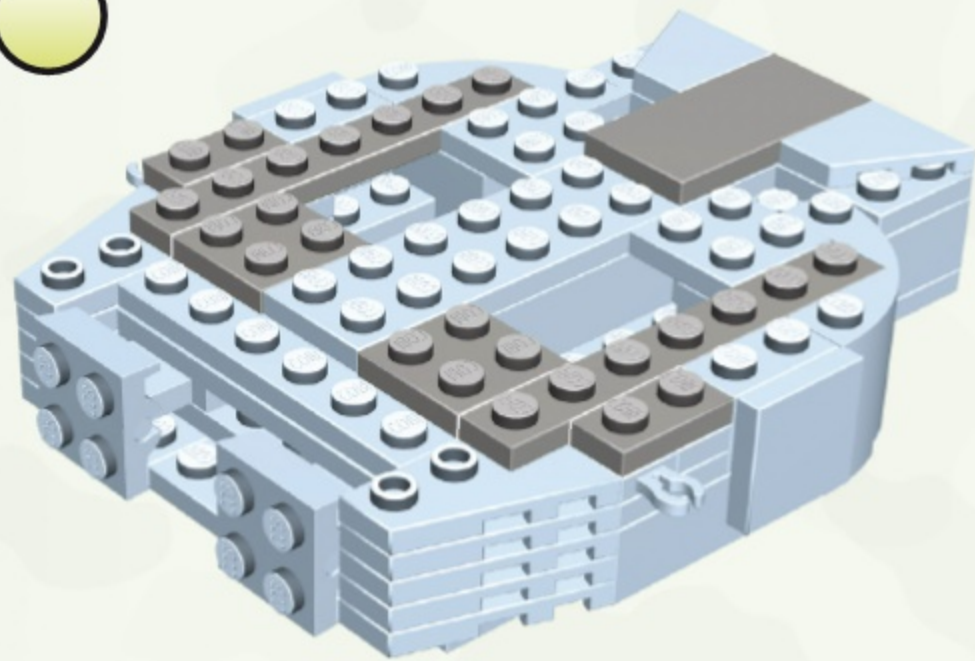
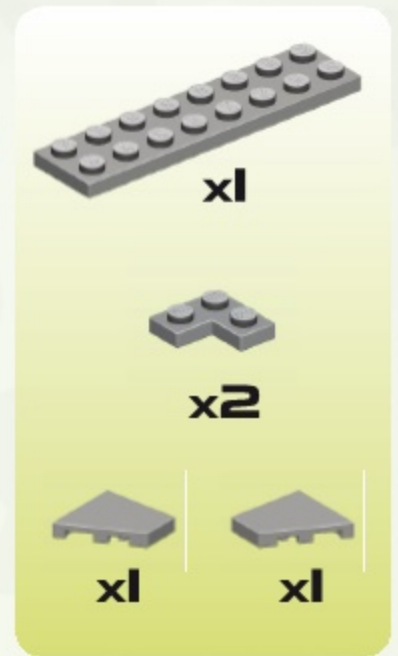
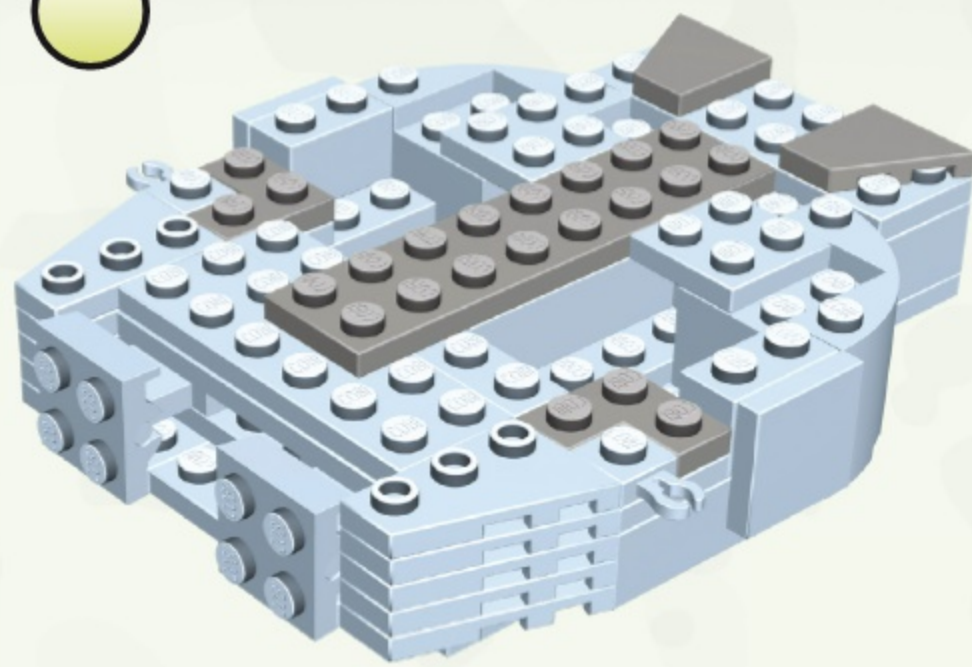
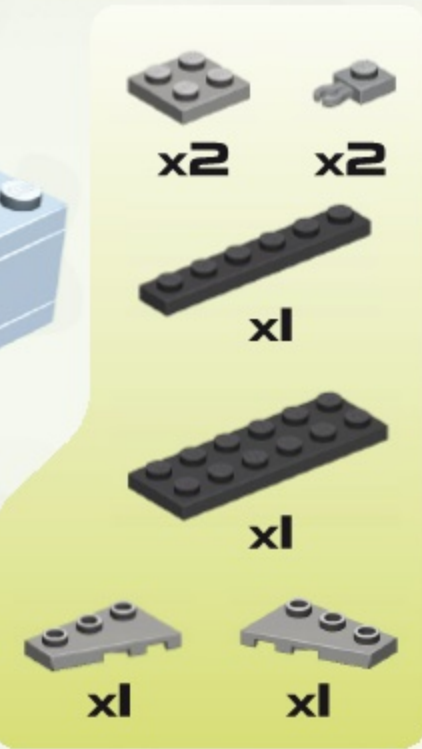
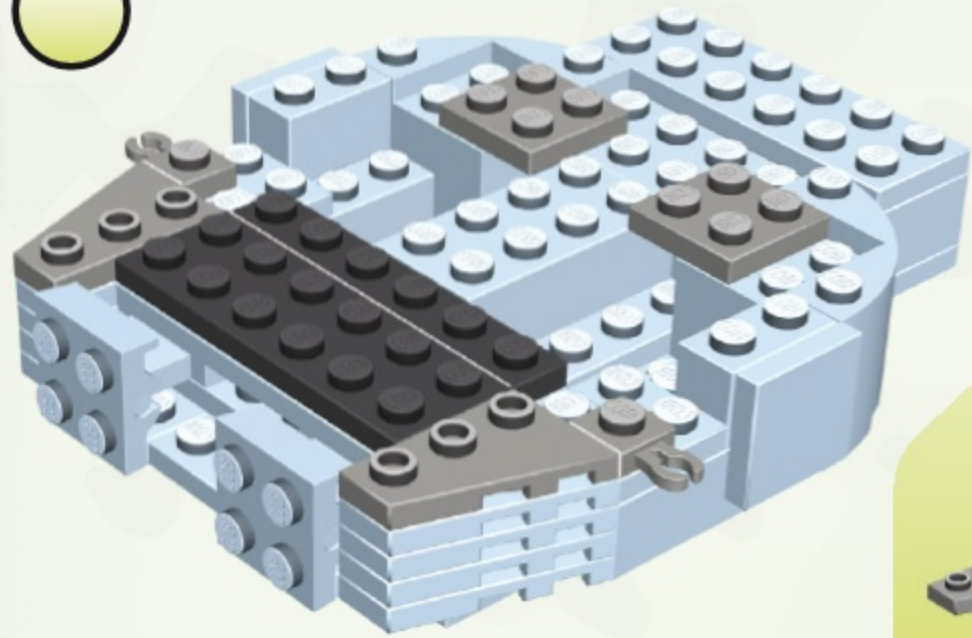



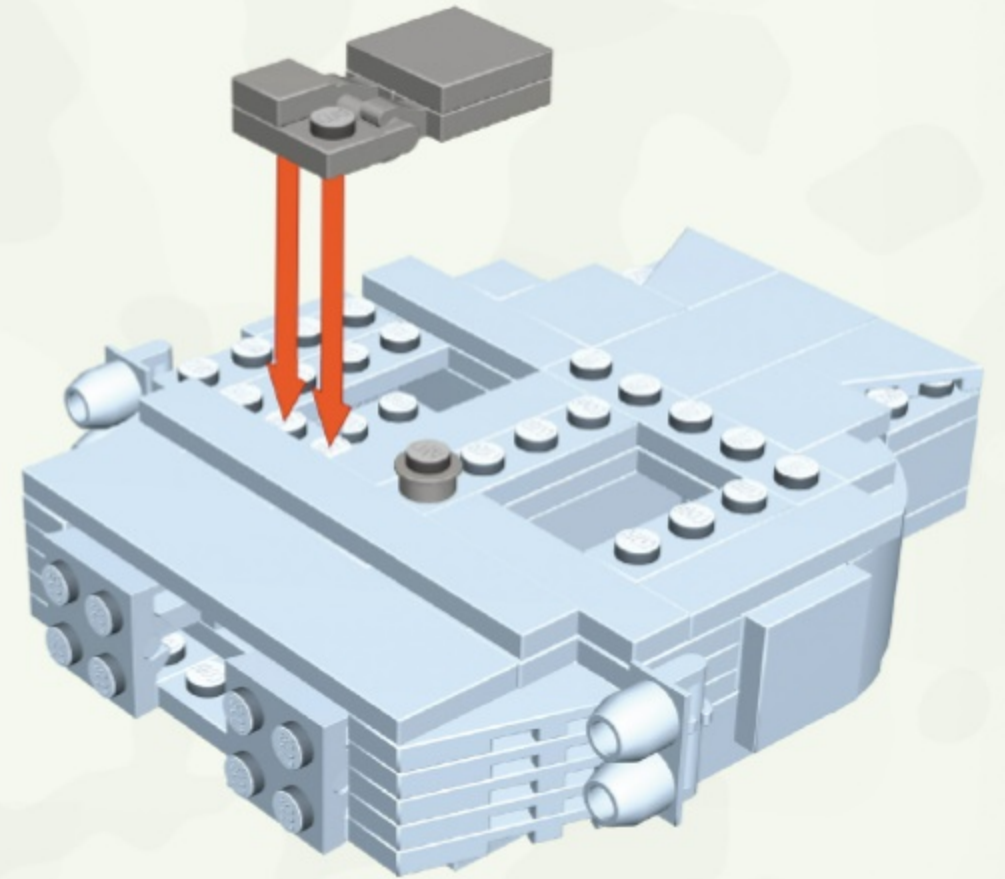
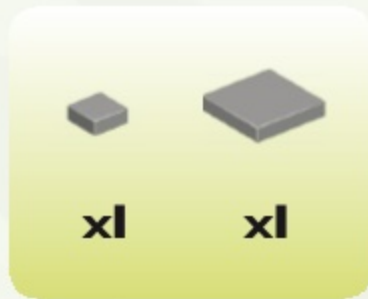
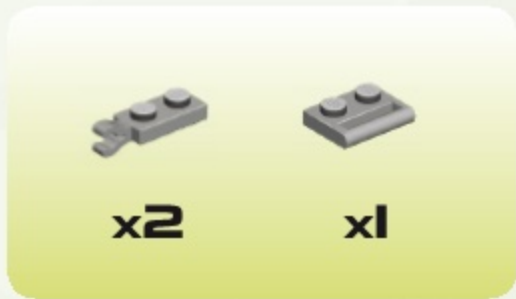
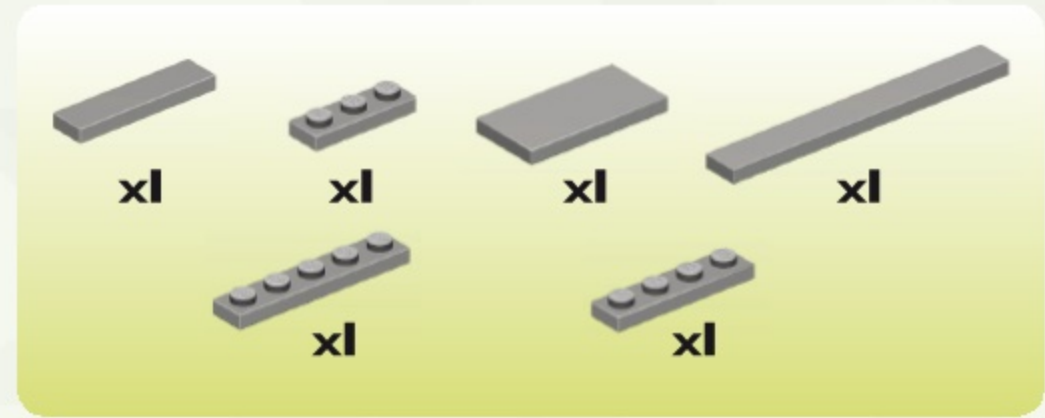
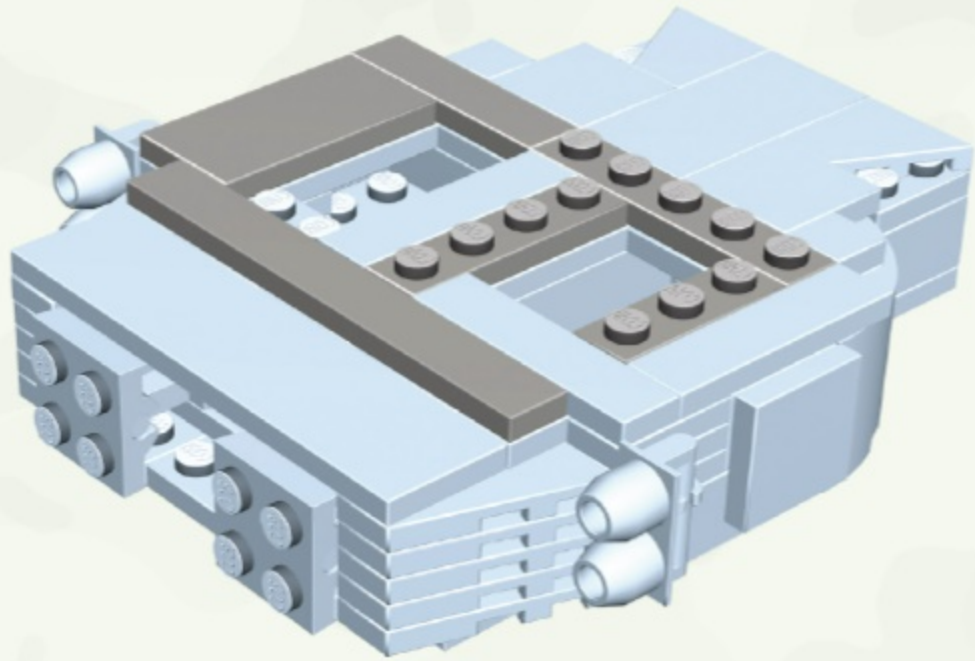



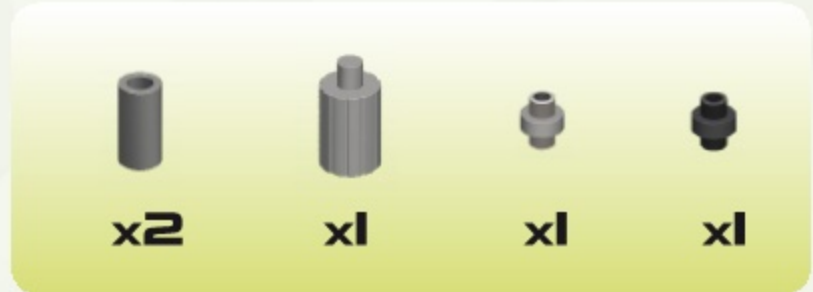
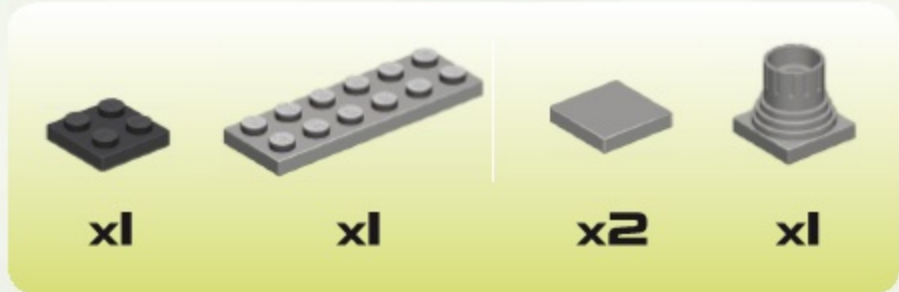
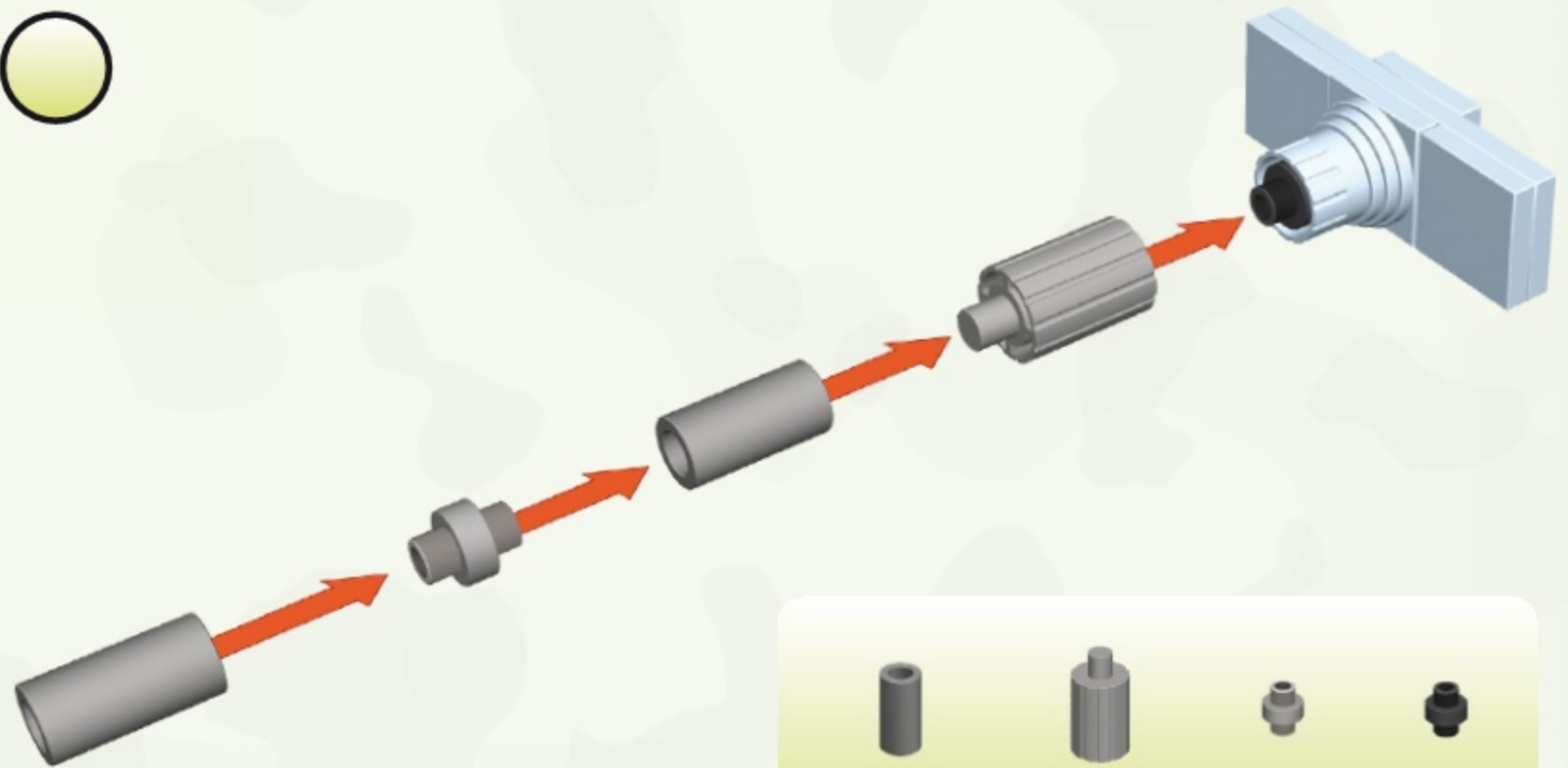
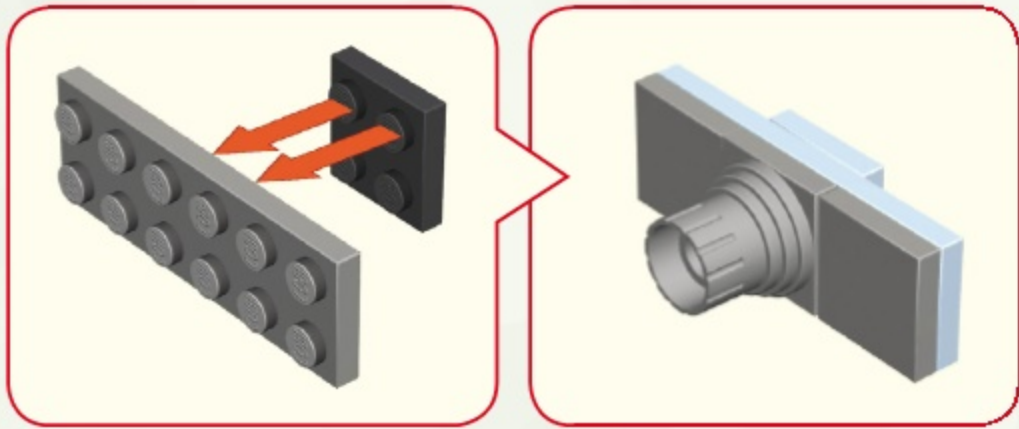
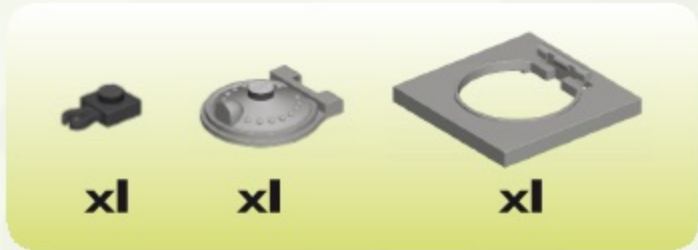
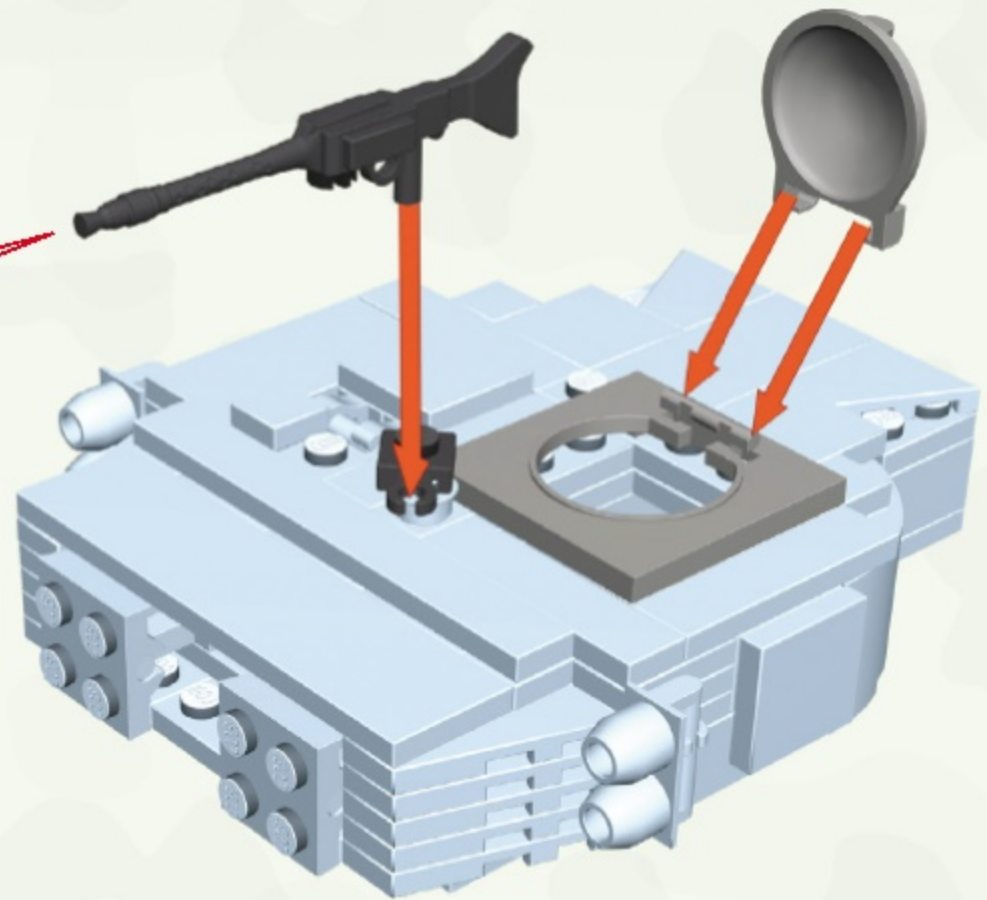



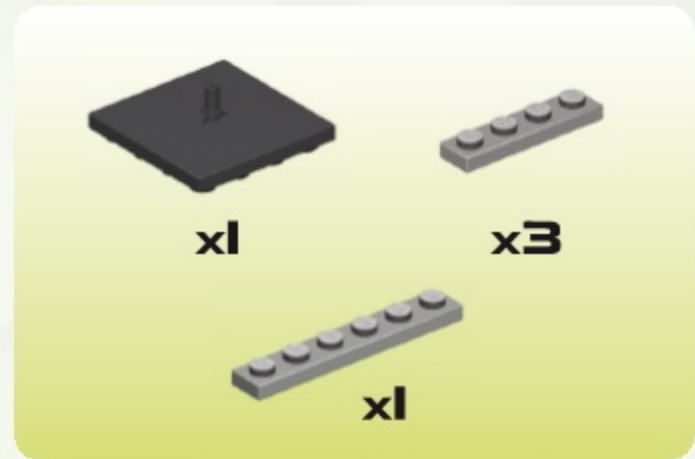
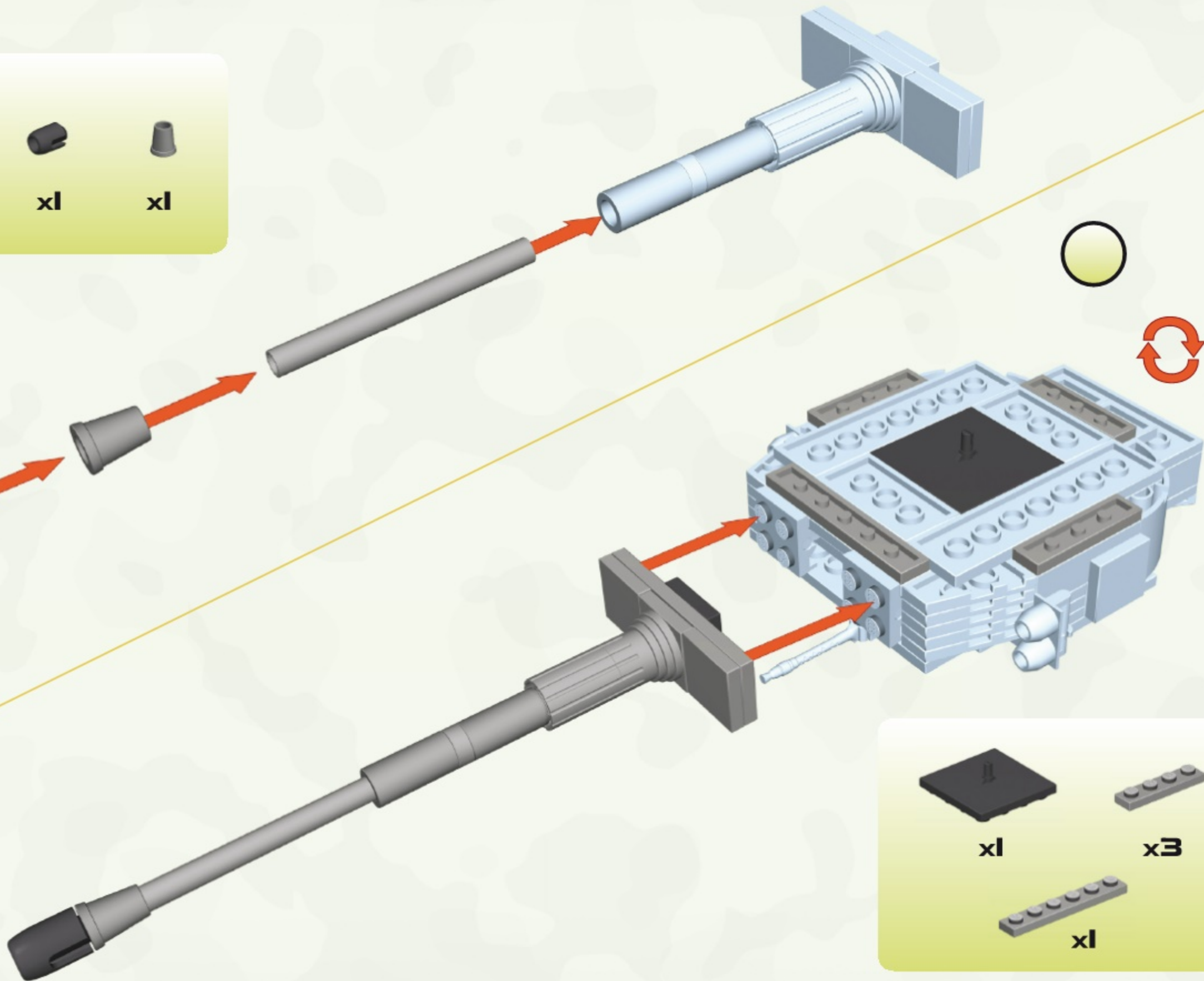
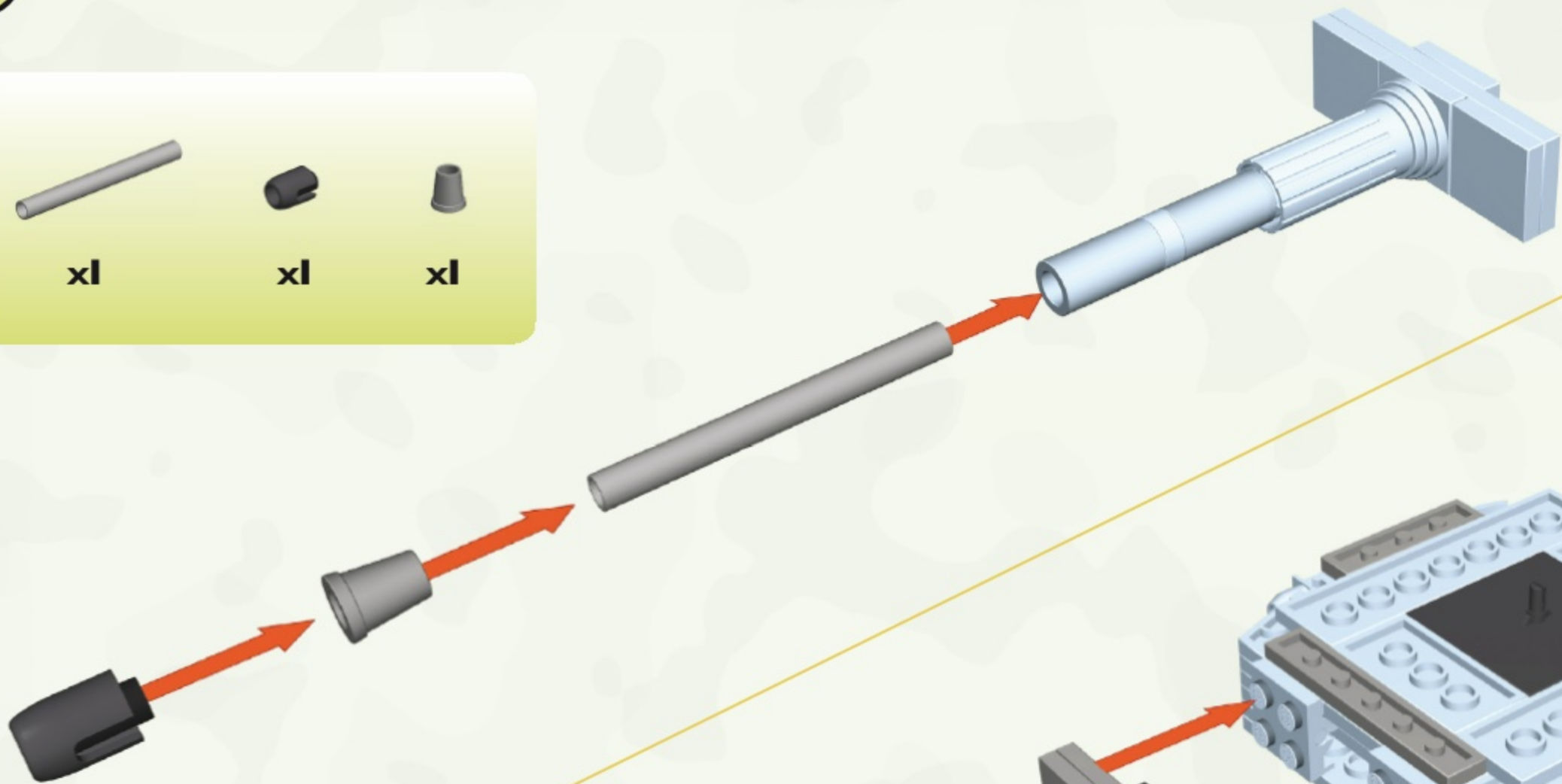
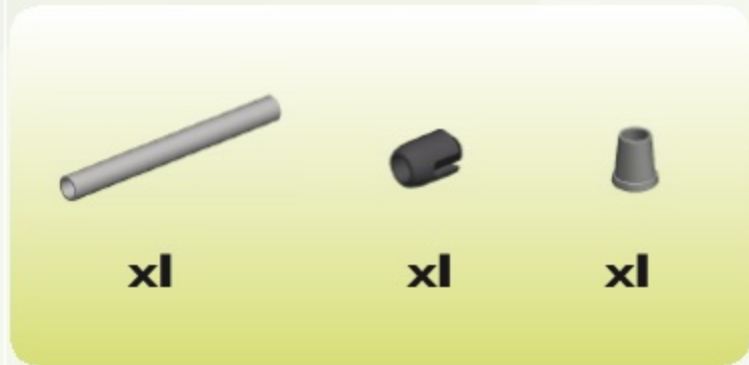



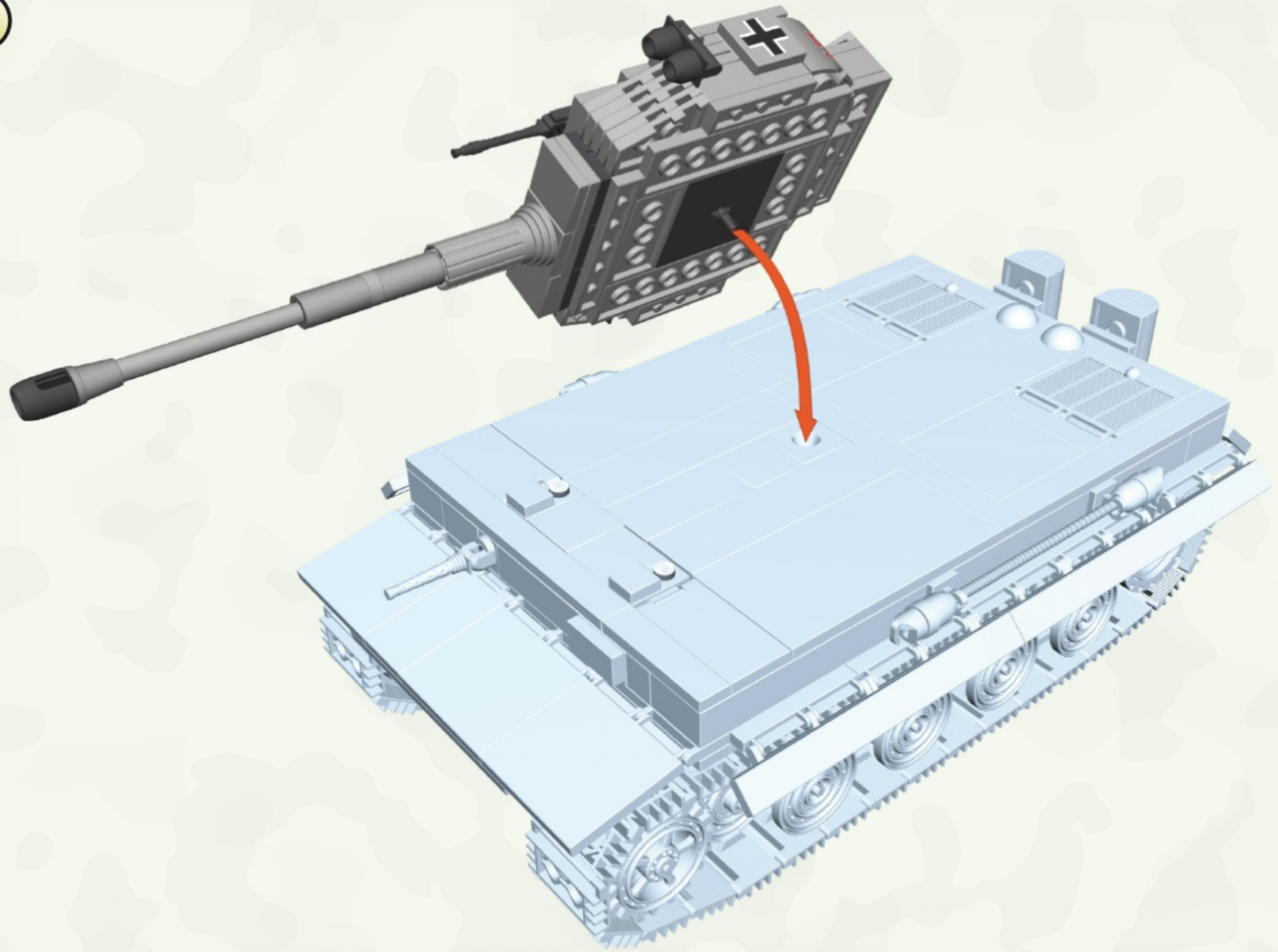





**PANZER III TANK AUSF. J.**  
2451



**KÜBELWAGEN  
TYPE 82**  
2338



**T-34/85**  
2452



**PzKPFW VI TIGER II KÖNIGSTIGER**  
2460



**8,8cm FLAK GUN 36/37**  
2338



**PANTHER TANK**  
2447



**3,7 CM PAK 36**  
2180



**KATYUSHA BM-13N**  
2448



**OPEL BLITZ 3t (4x2)**  
2449