

DREAMWORKS
The PENGUINS
of **MADAGASCAR**
nickelodeon



WARNING: CHOKING HAZARD-

Toy contains small parts.

Not for children under 3 years.

Printed in EU

1

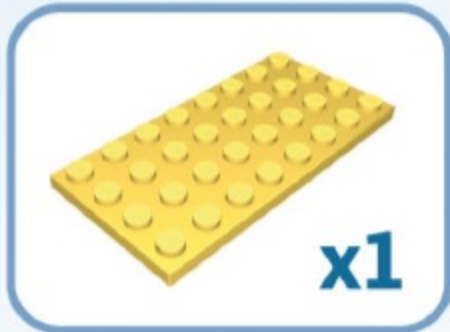

2

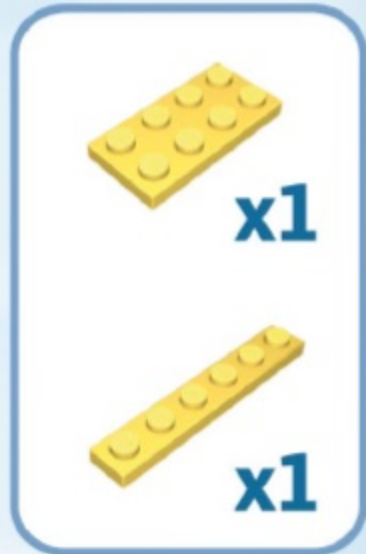

3



4

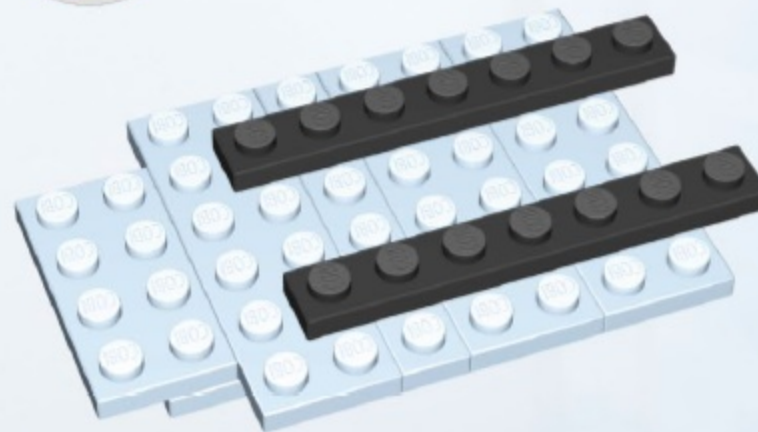

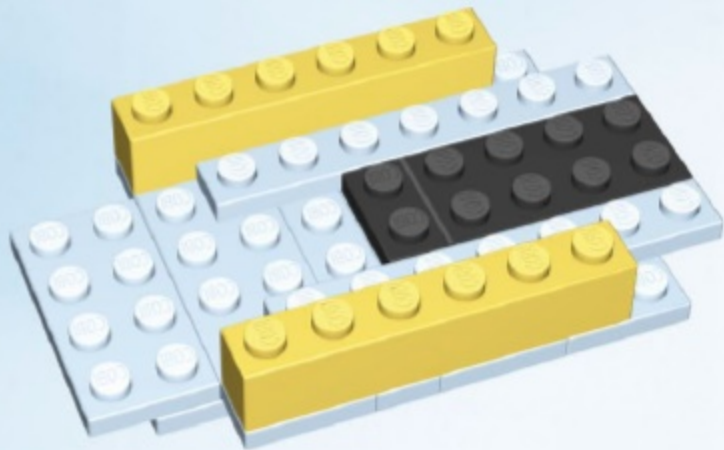

5



-  x1
-  x1
-  x2



6



-  x2
-  x1
-  x2

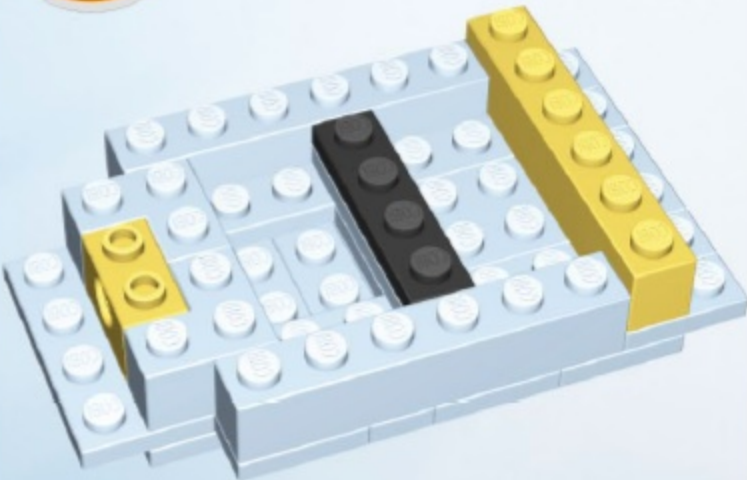

7

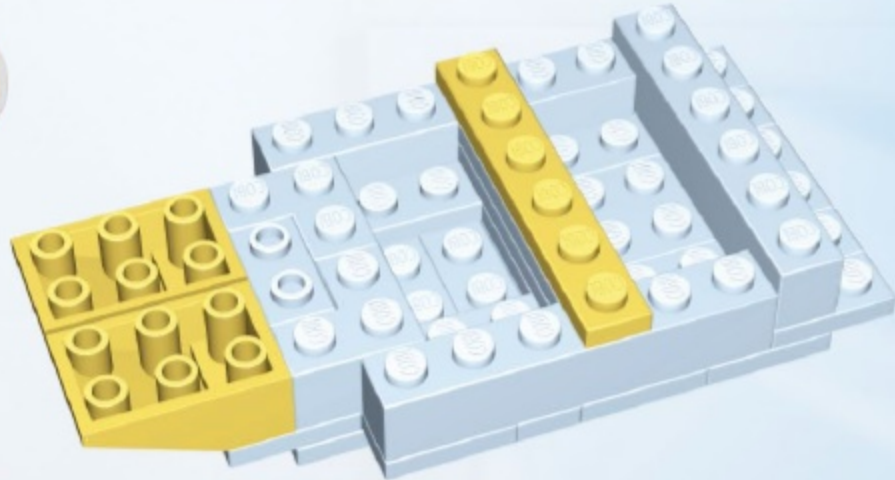

-  x1
-  x1
-  x1

8



-  x2
-  x1

9

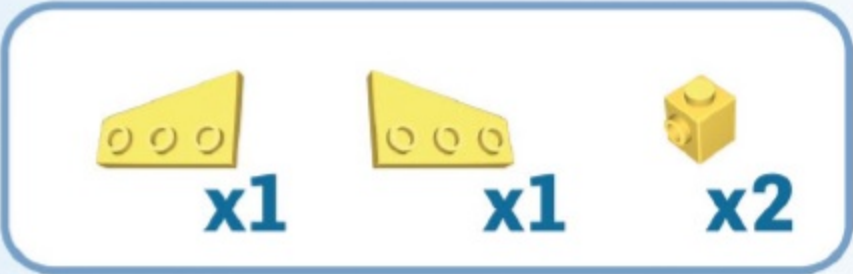

10

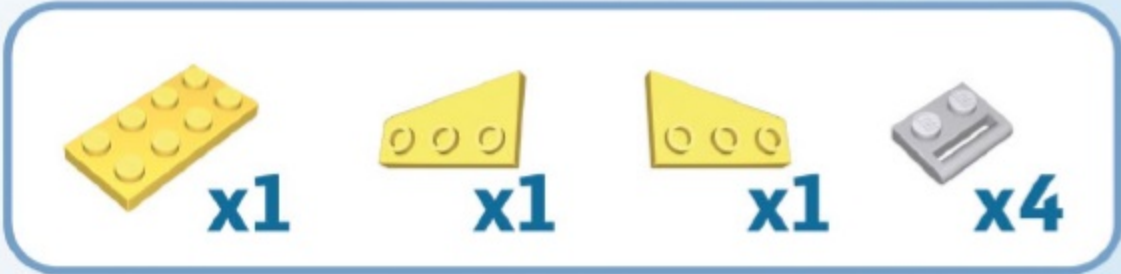
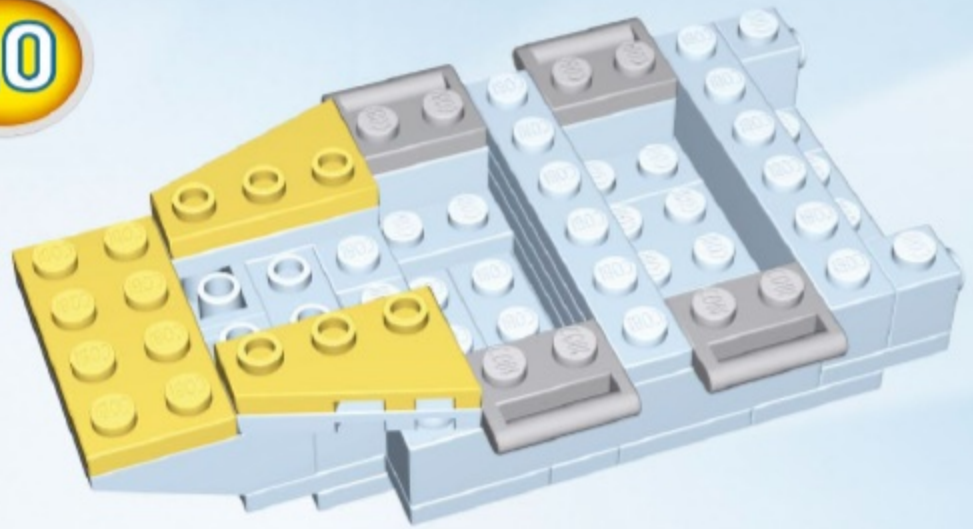

11

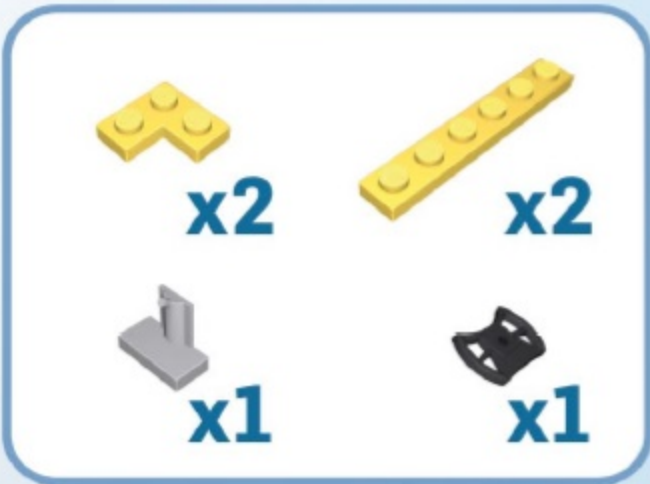
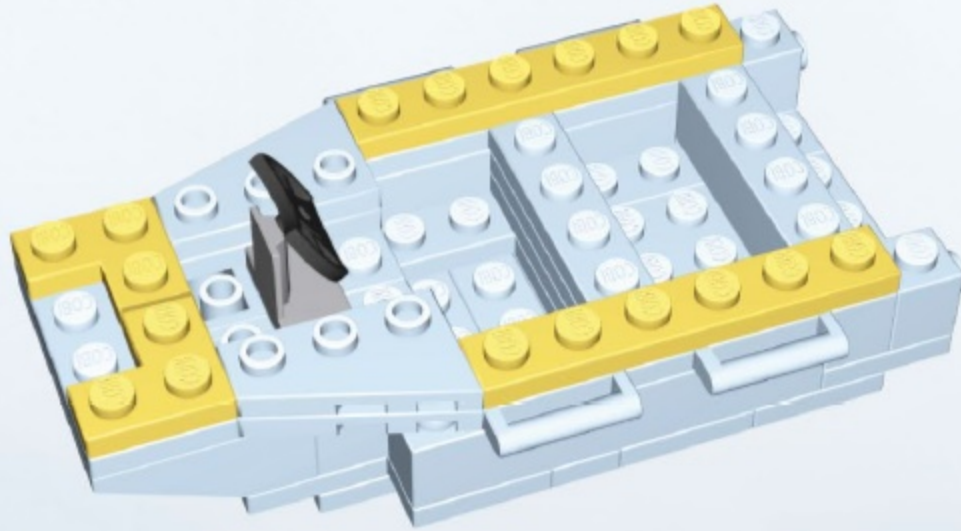
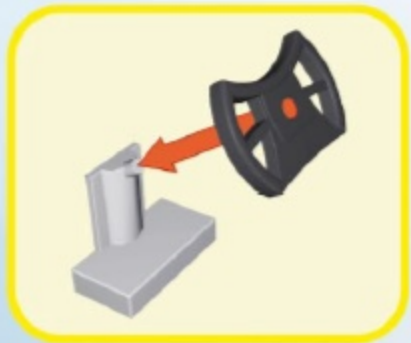

12



13

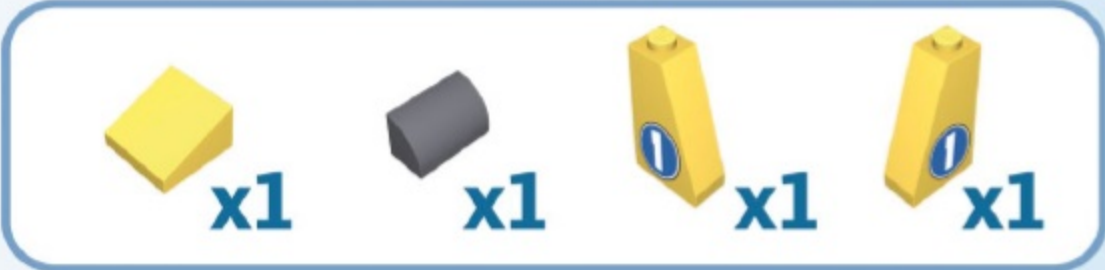
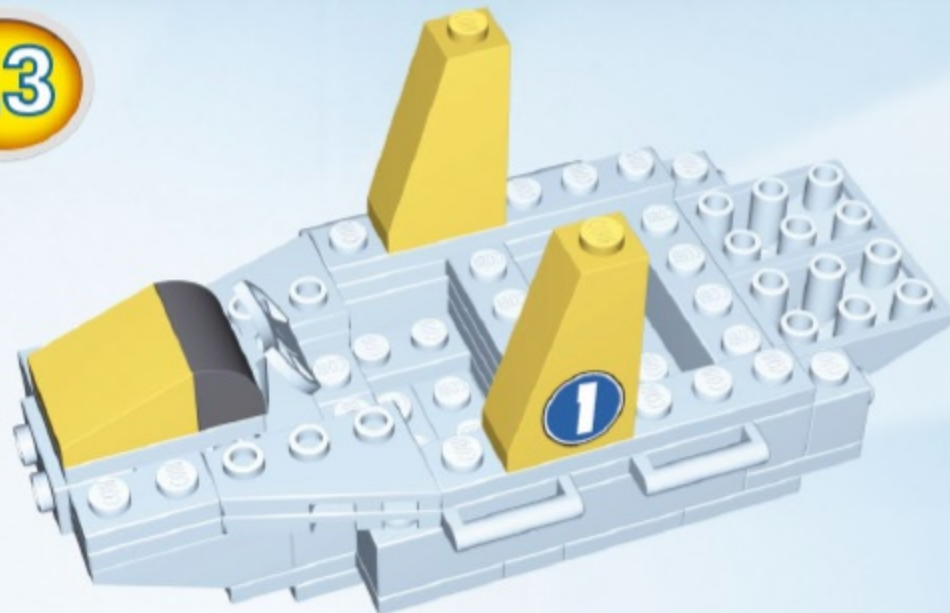

14

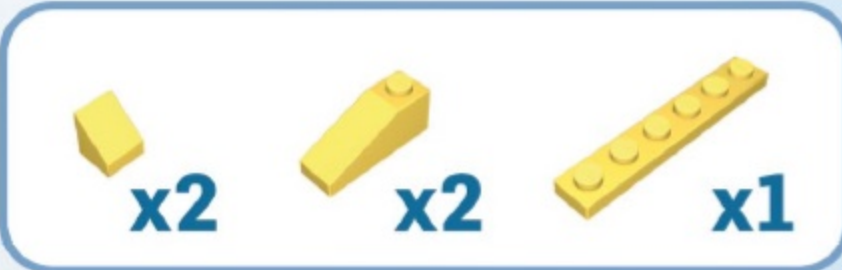

15

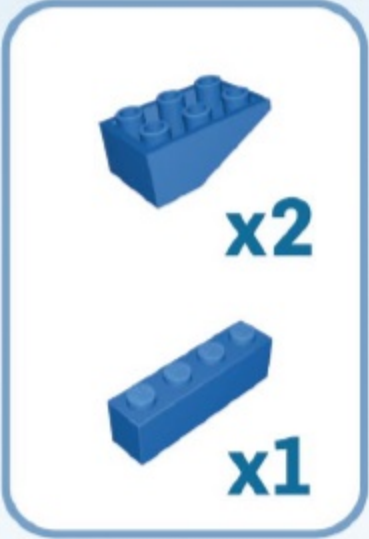
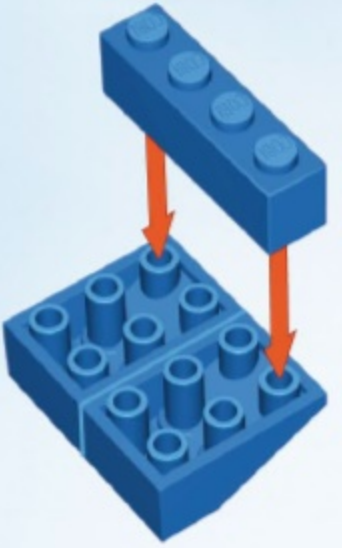

16

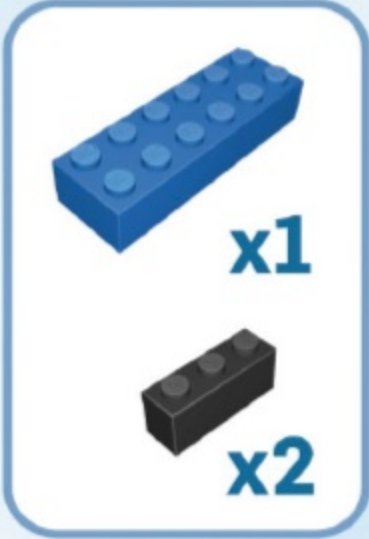
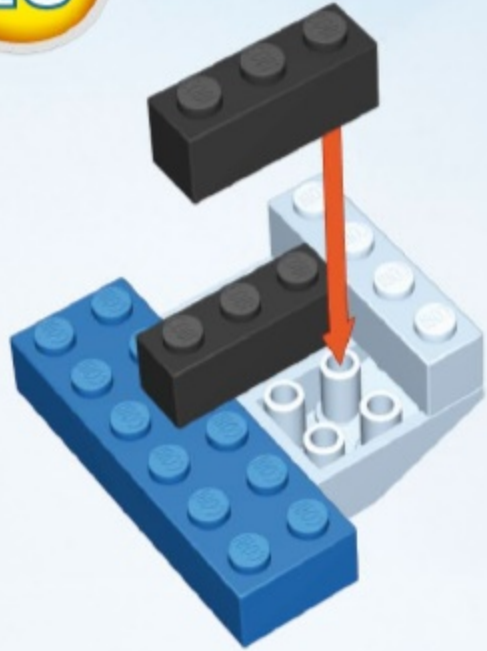

17

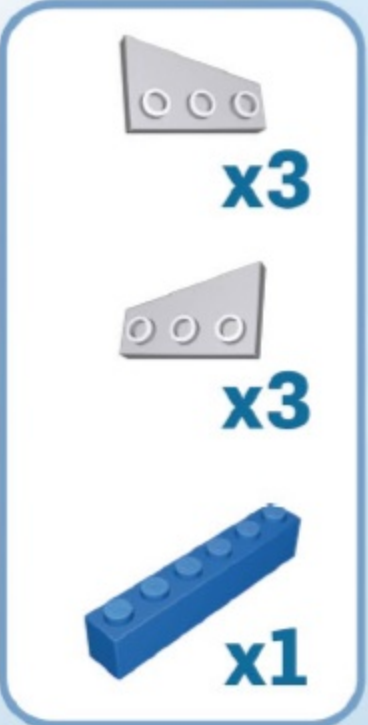
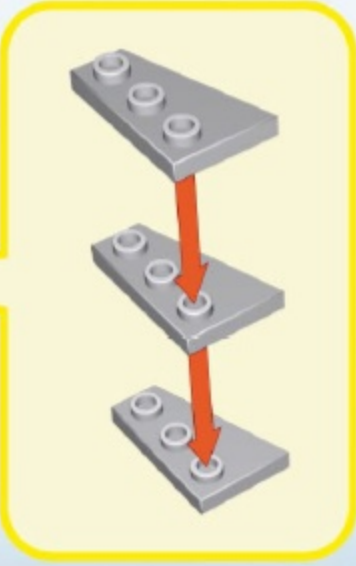
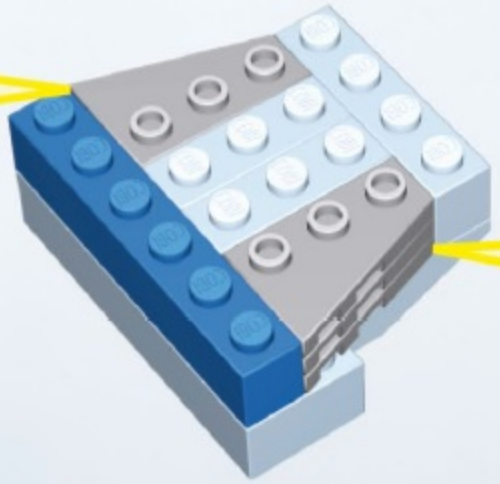
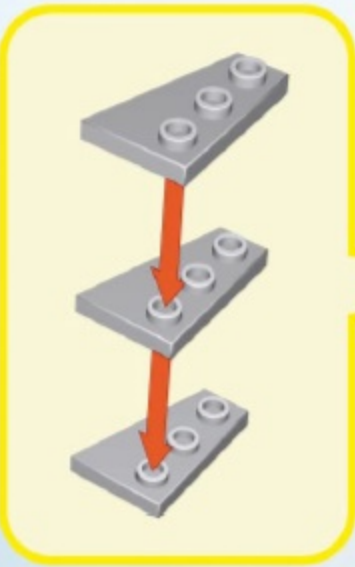

18

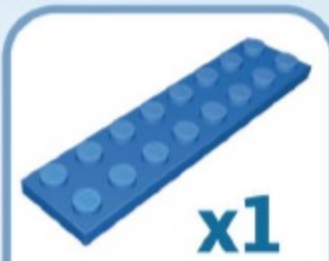
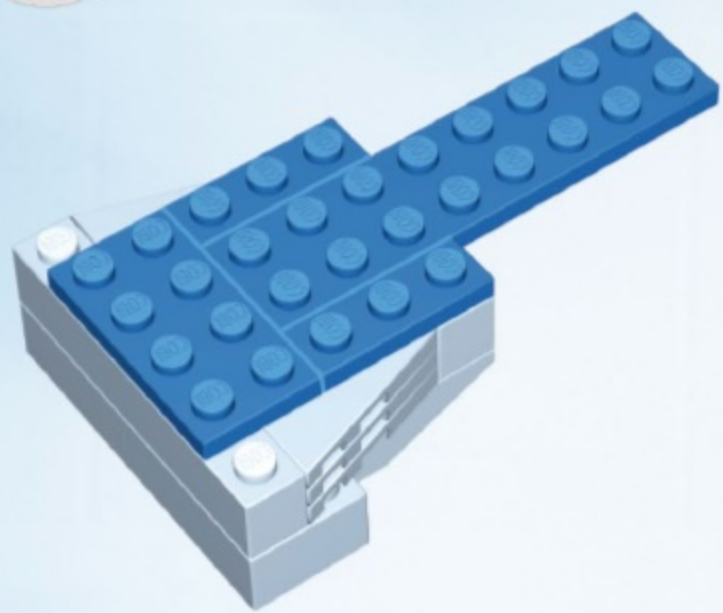

x1



x2



x1

19

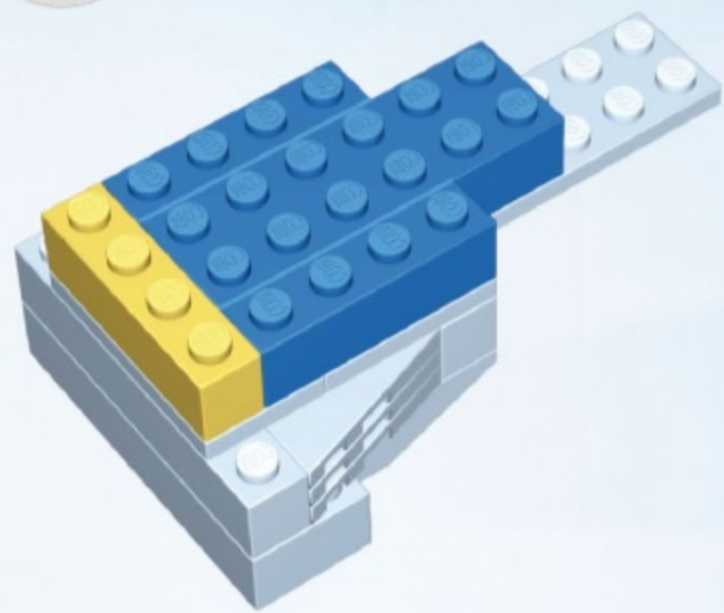

x1



x1



x2

20

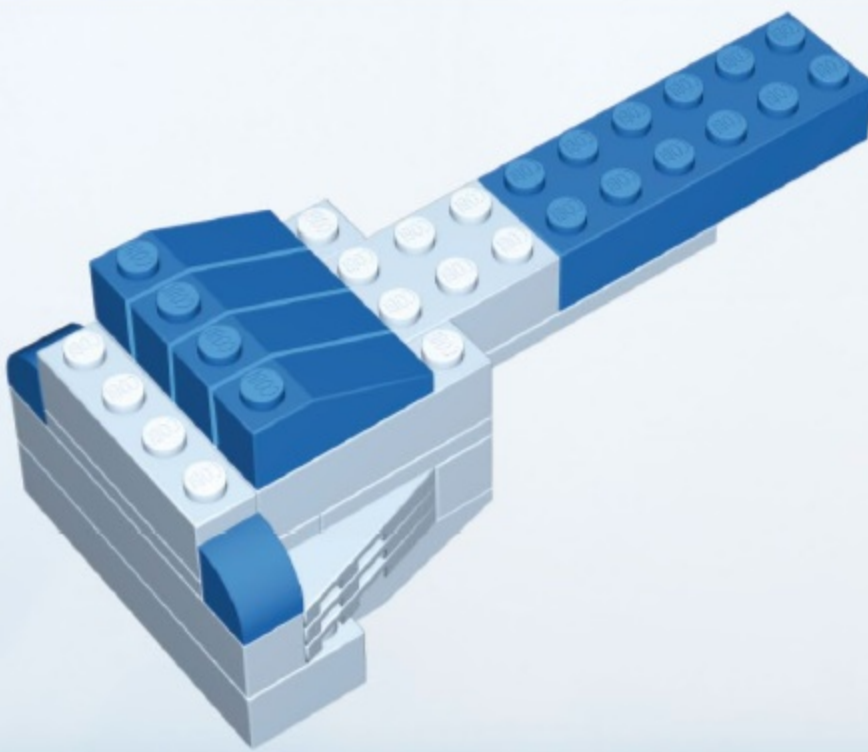

x2





x4



x1

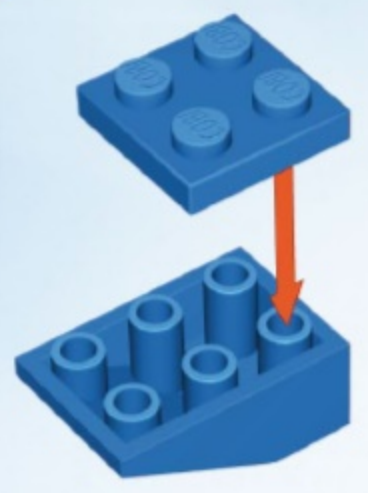

21



-  x1
-  x1

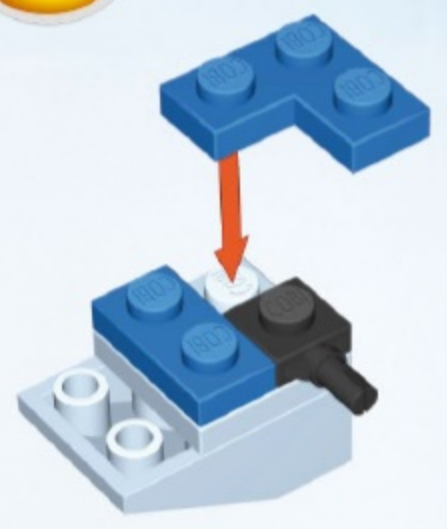

22

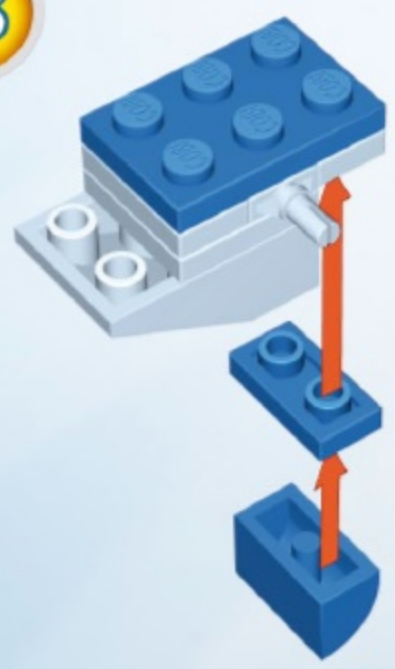

-  x1
-  x1
-  x1

23



-  x1
-  x1
-  x1

24

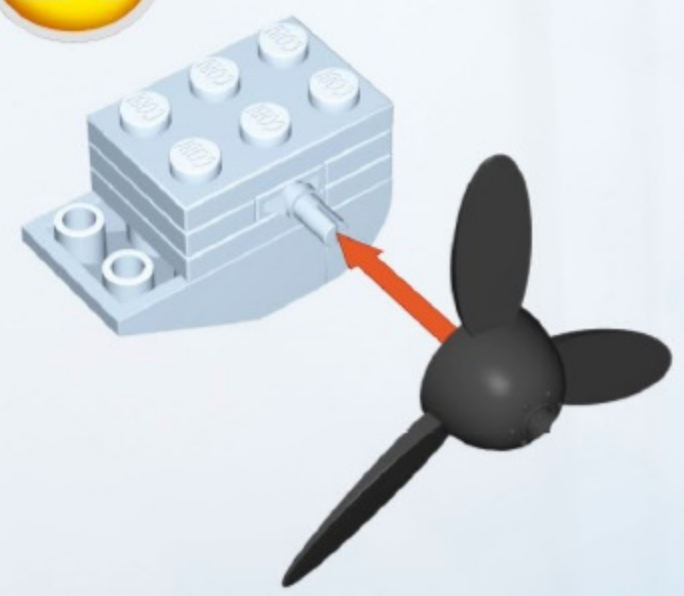

-  x1

25

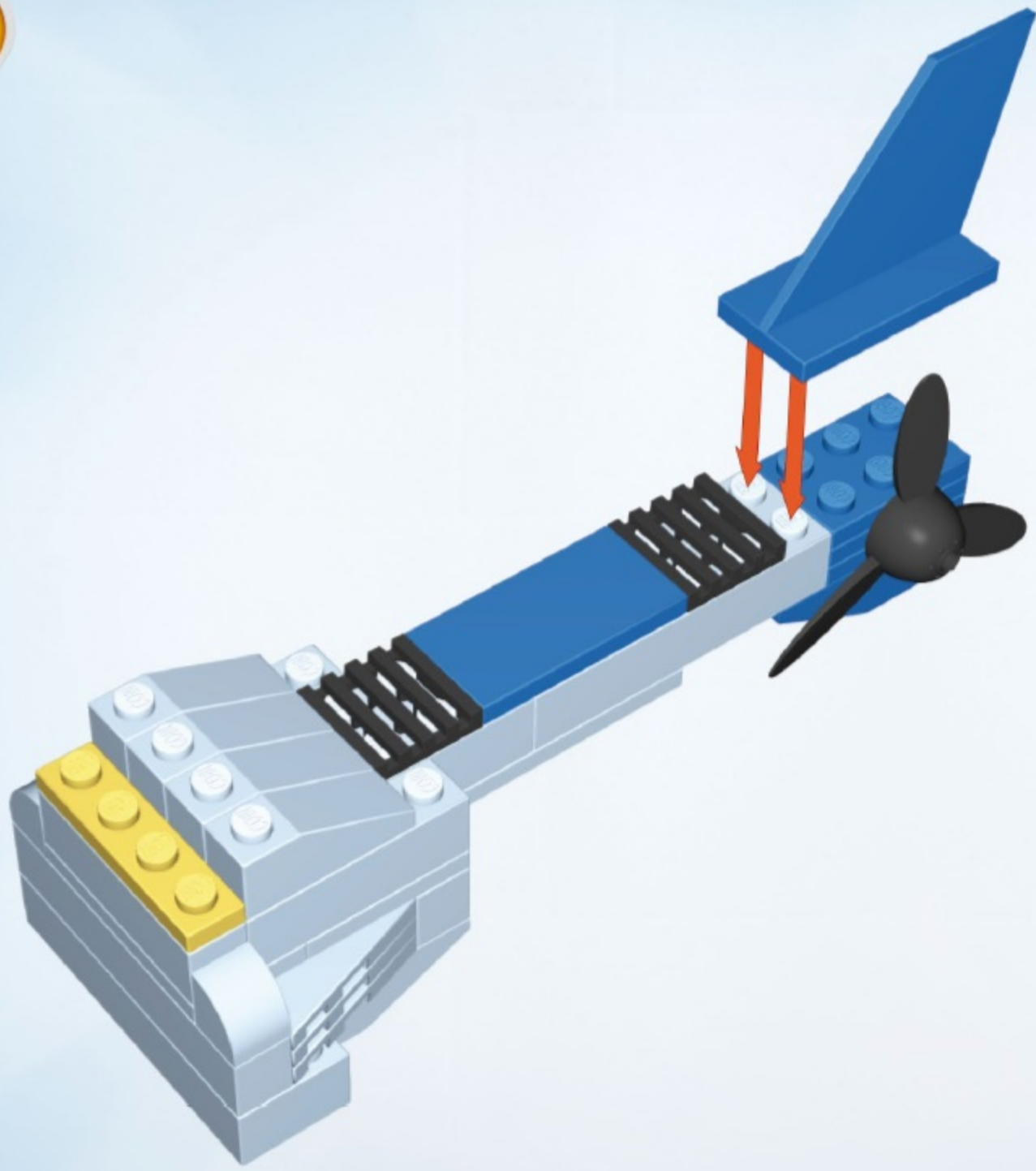

-  x1
-  x1
-  x2
-  x1

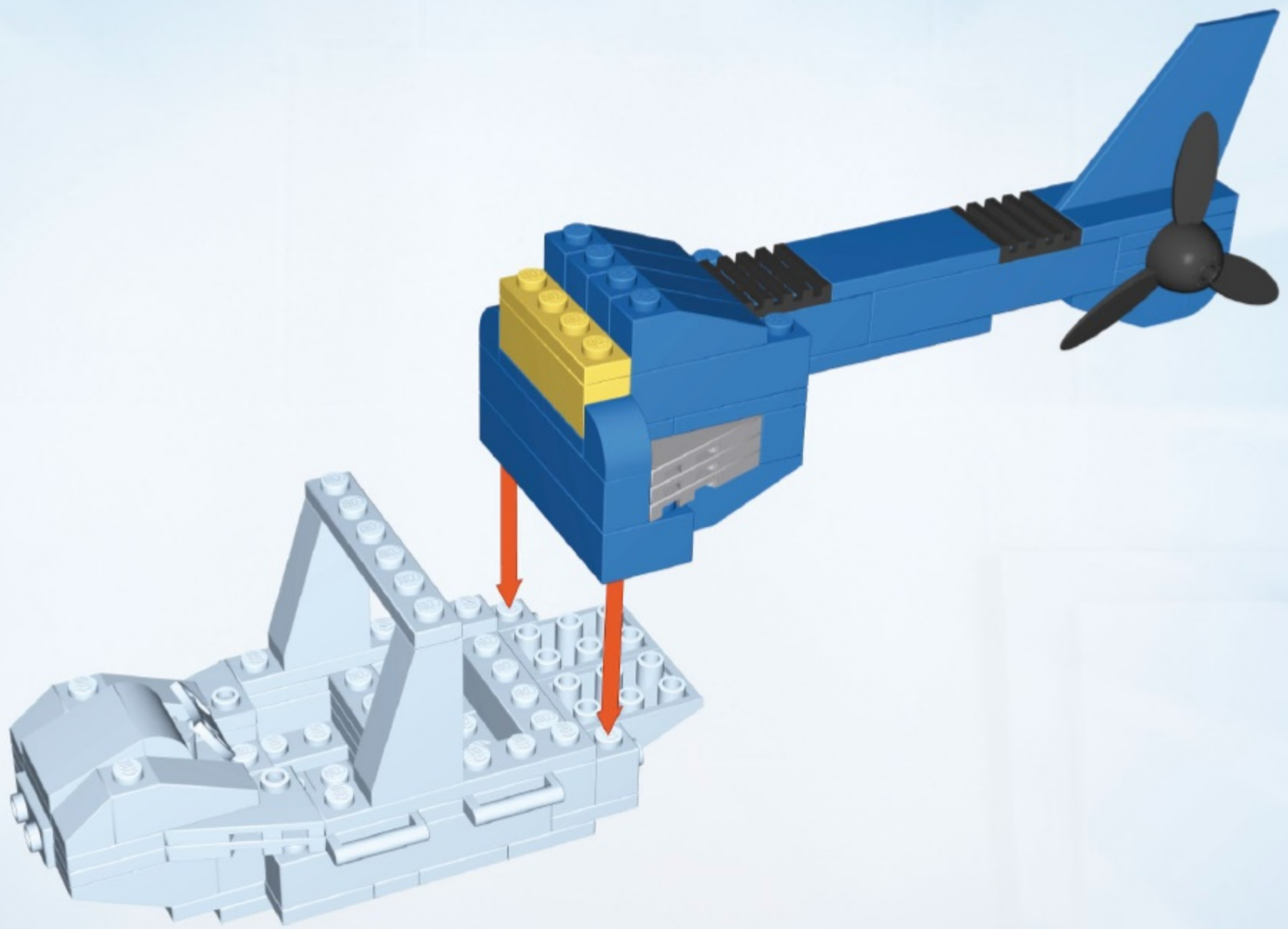

27

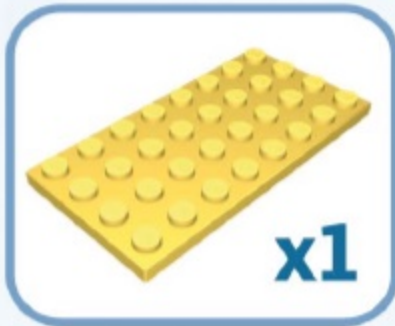
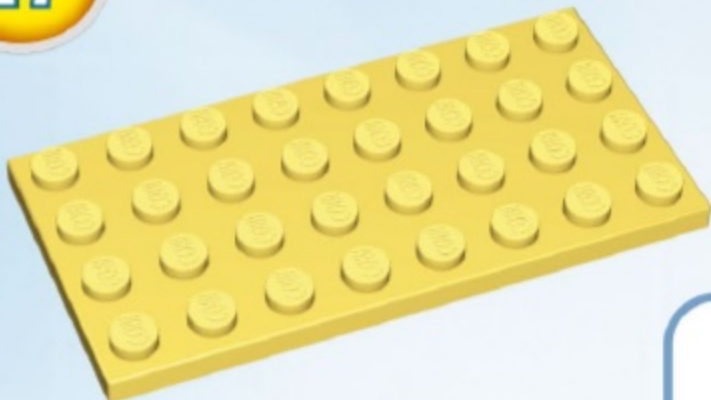

28



29

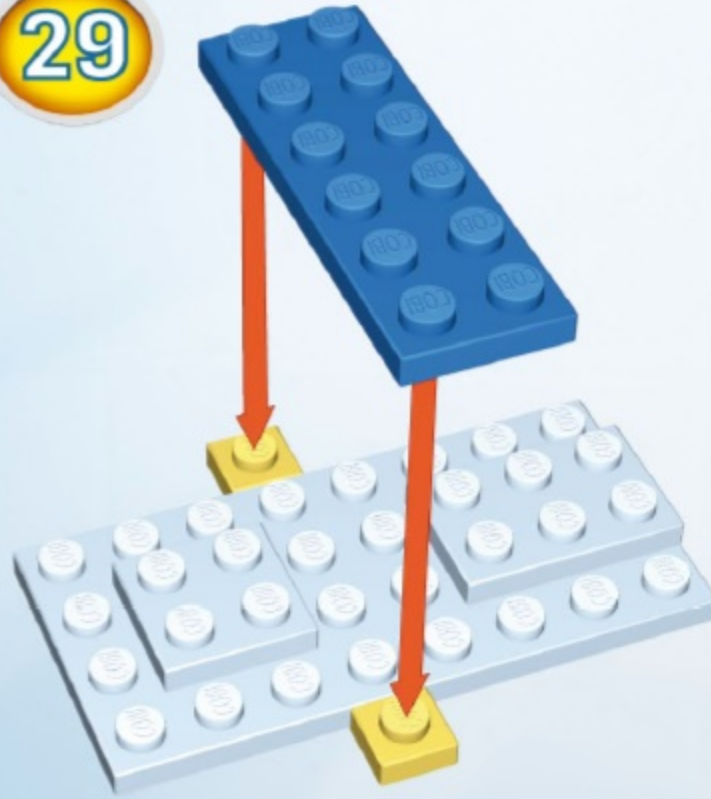

30

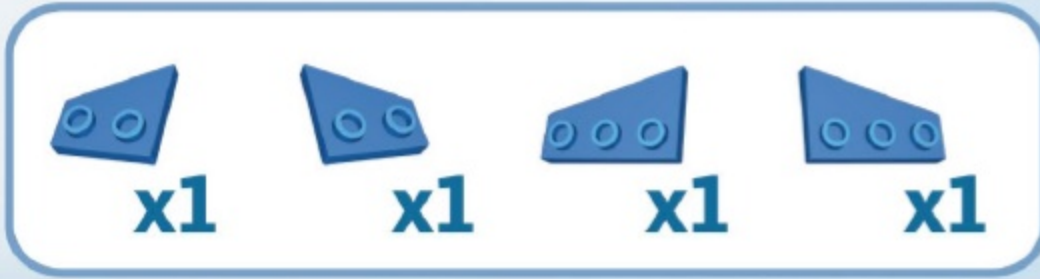

31

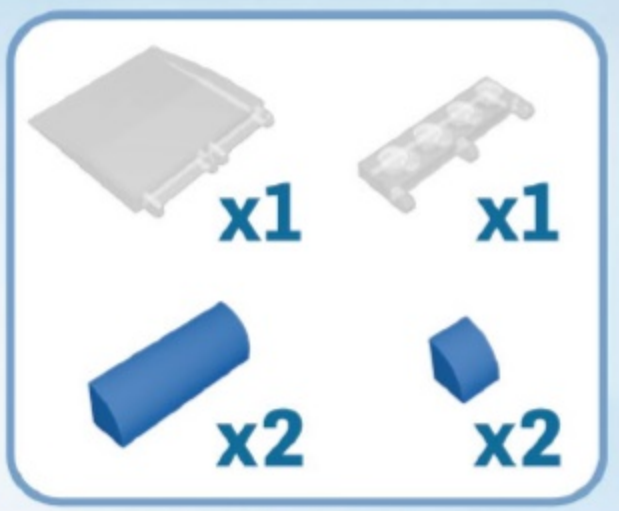
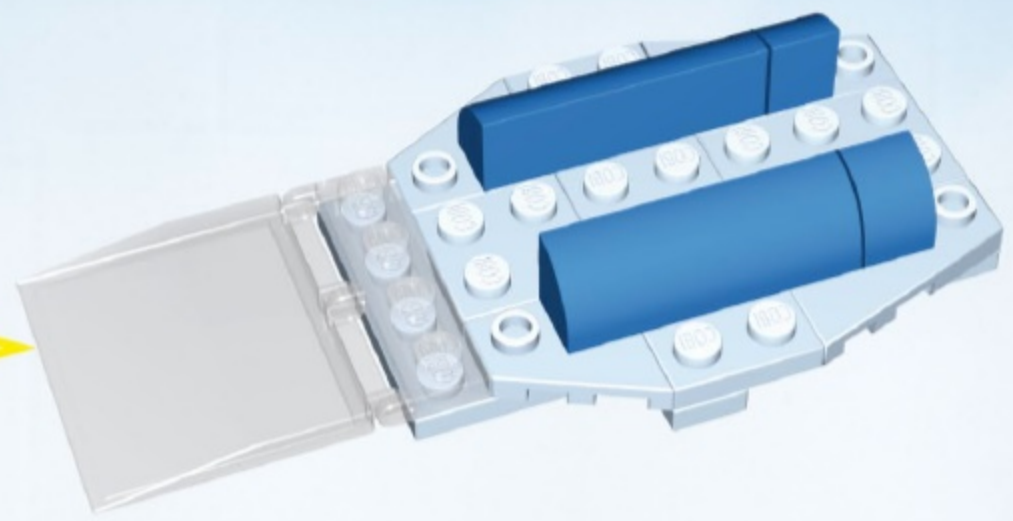
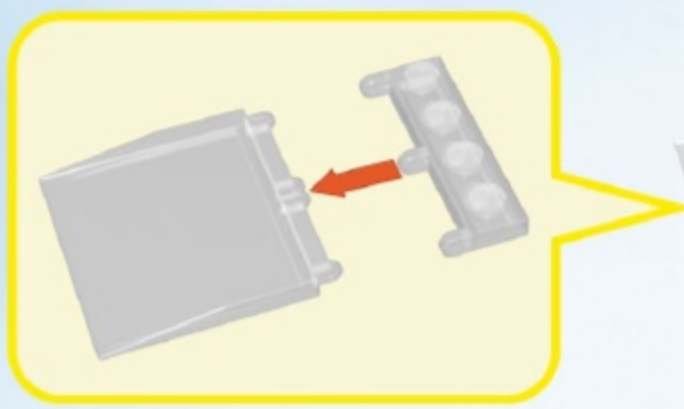

32

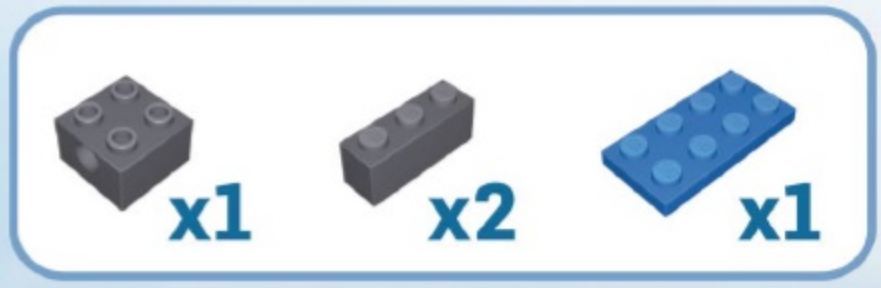
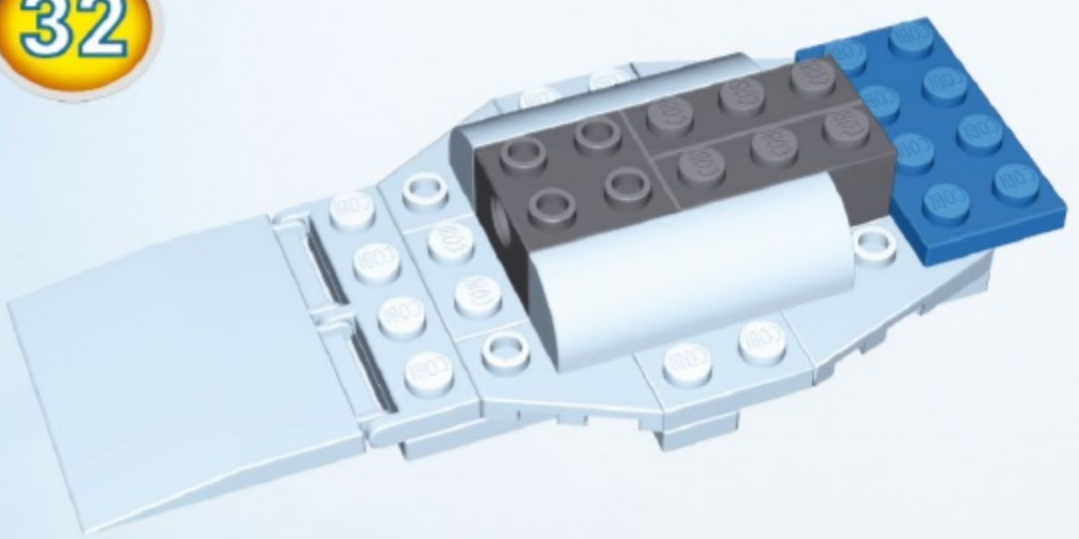

33

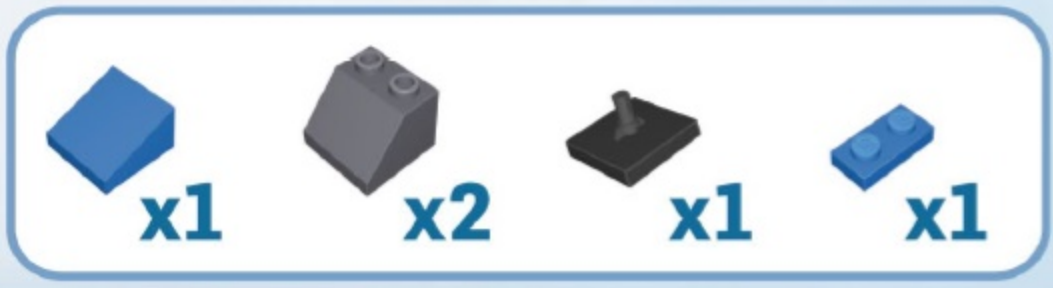
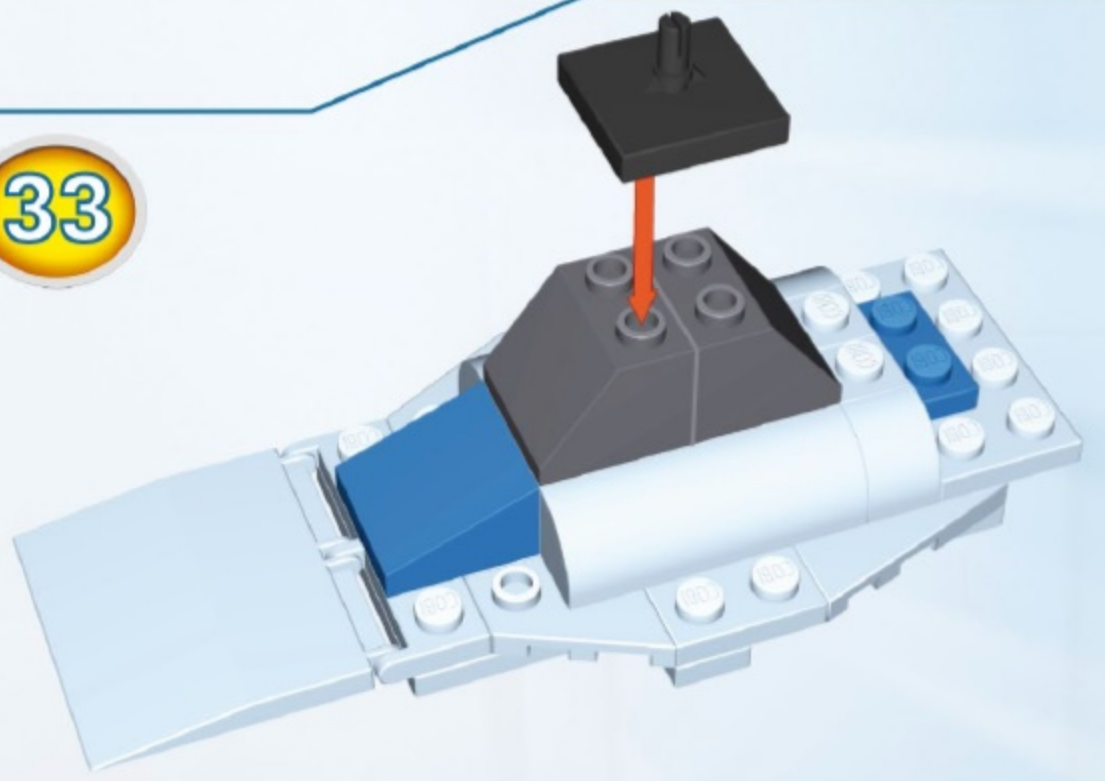

34

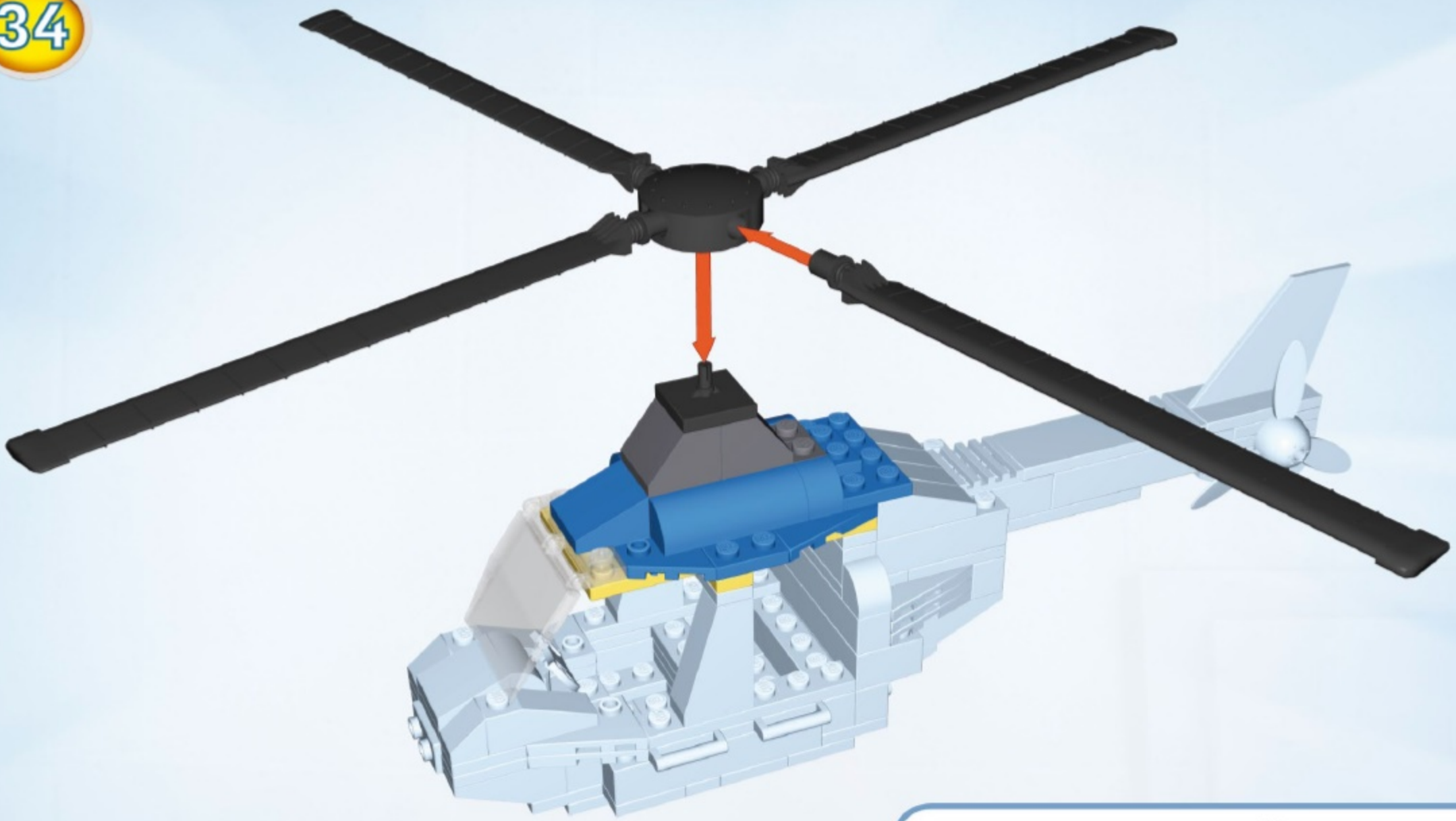

x4 x1

35



36

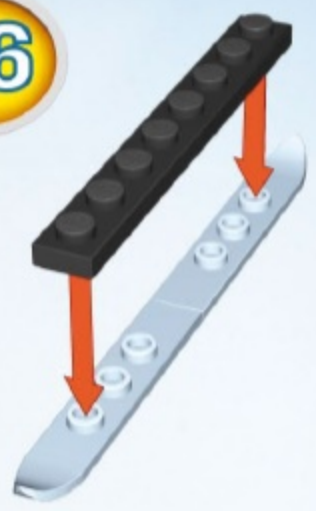

37



38



39





26150

Bi-Plane Bomber



26230

Swing & Smash Crane



26153

TV 1 Helicopter



26171

Fish-E Delivery Truck



26280

The S.T.A.N.K. Mobile



26080

Golf Cart Madness



26081

Grab-A-Fish-Factory



26400

King Julien's ZOO Adventure



26231

Speed Boat Attack



26050

The Dematerializer



26051

Rat King's Revenge



26480

Penguin's Secret Mission HQ

07-26153-136

