

DREAMWORKS
The PENGUINS
of **MADAGASCAR**
nickelodeon



Printed in EU



WARNING: CHOKING HAZARD-
Toy contains small parts.
Not for children under 3 years.

1

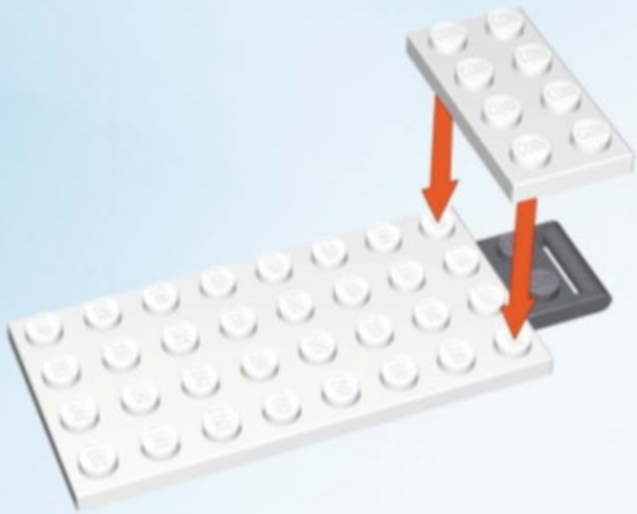

2



3

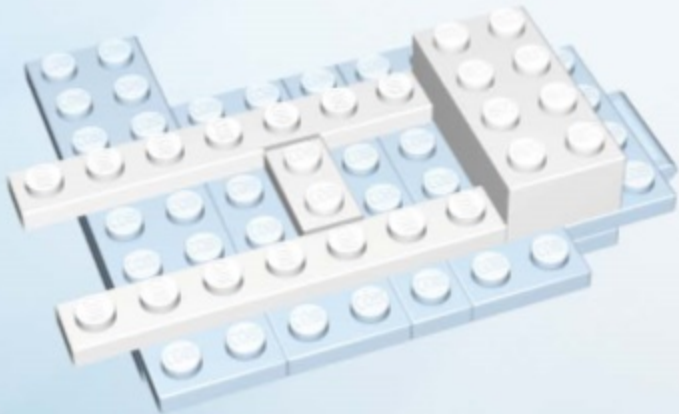

4



5

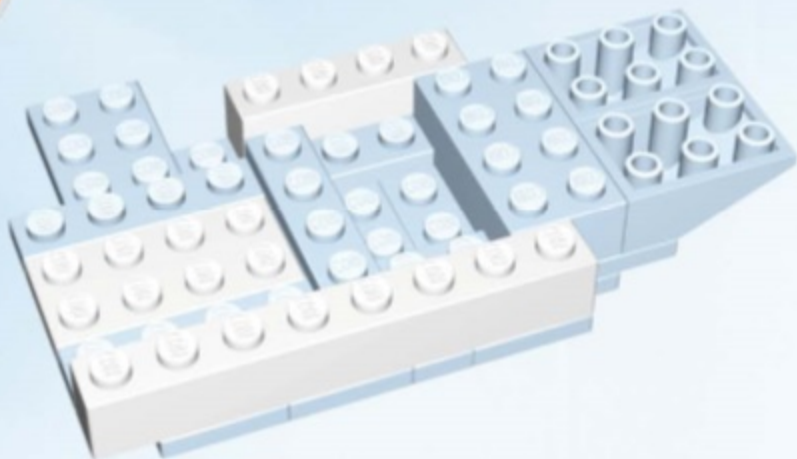

x1



x1



x1

6

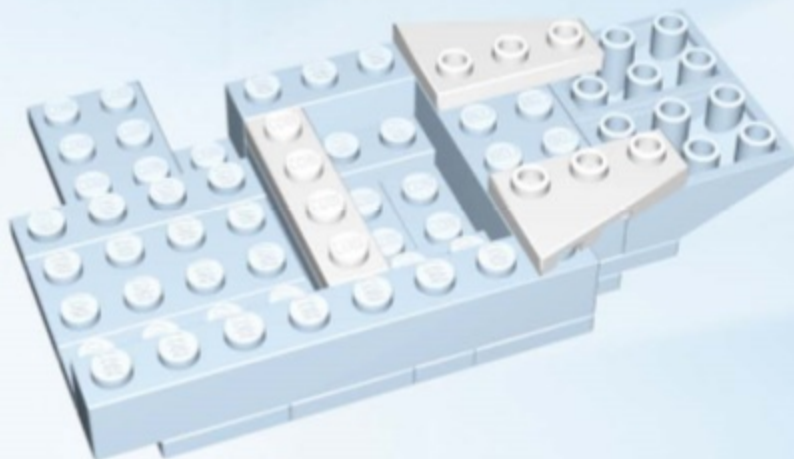

x1



x1



x1

7

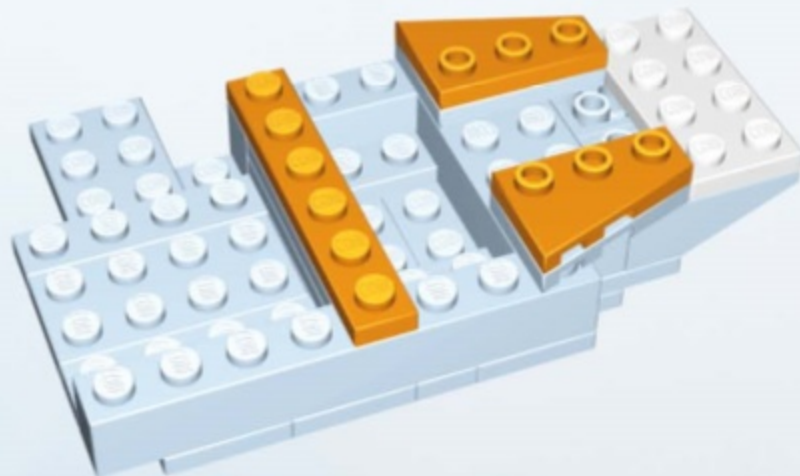

x1



x1



x1



x1

8

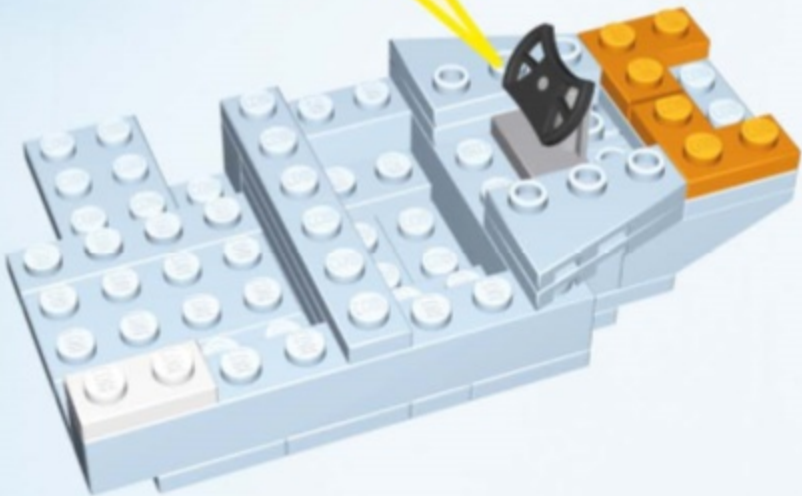

9



10

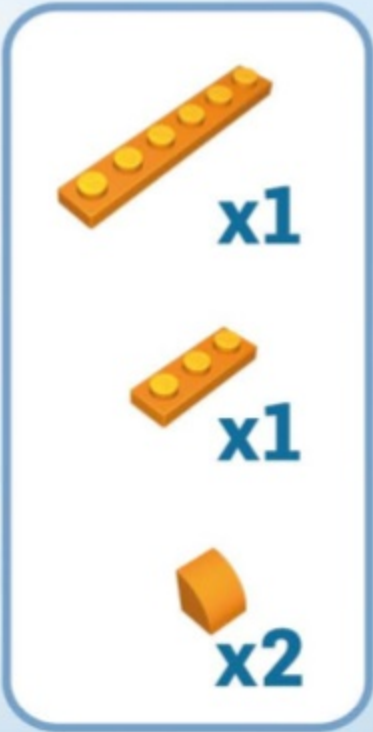

11



12

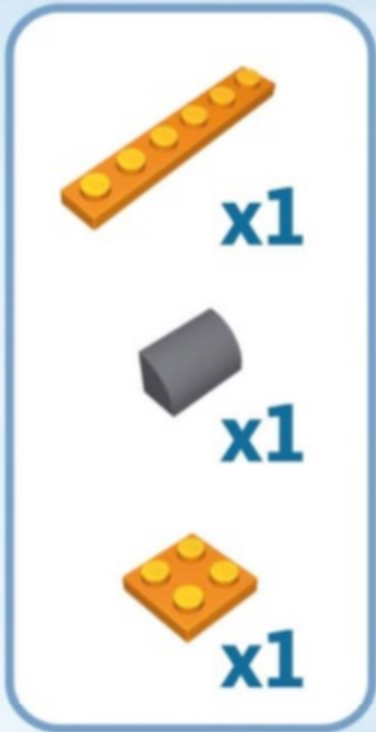

13

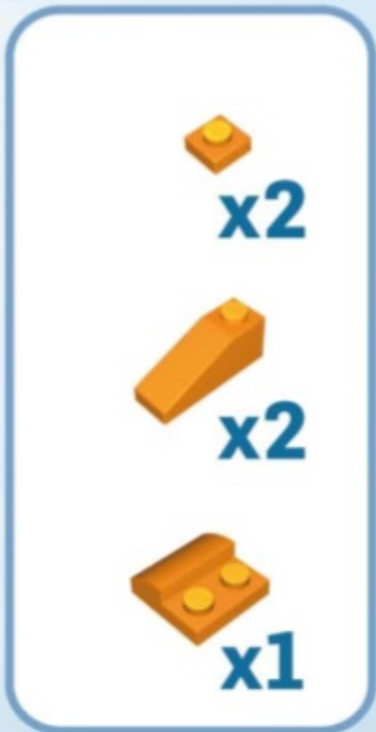
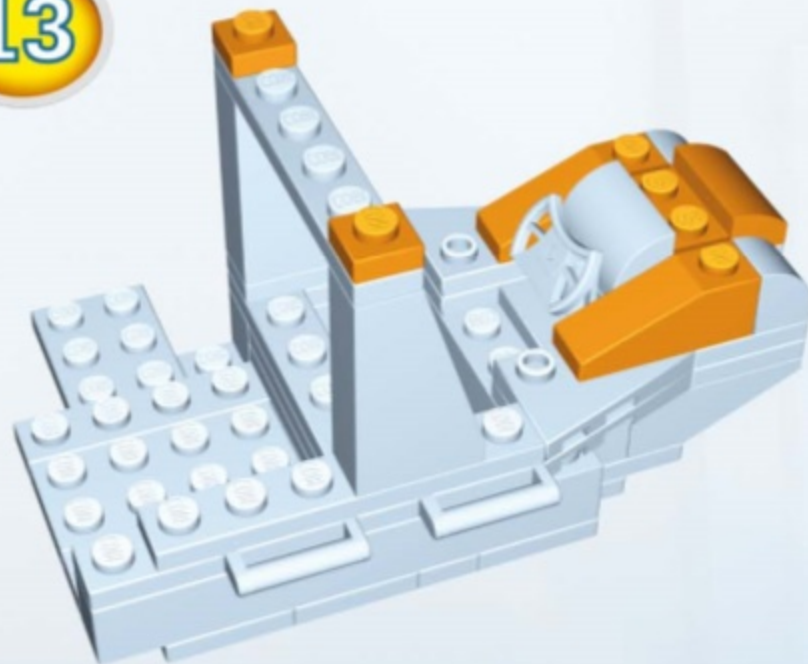

14

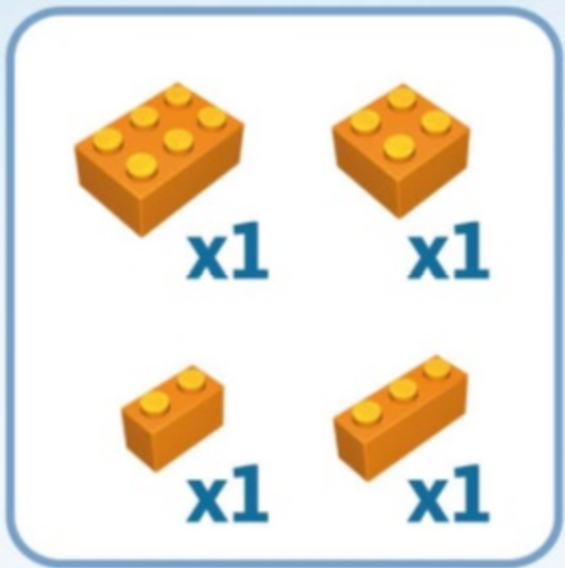
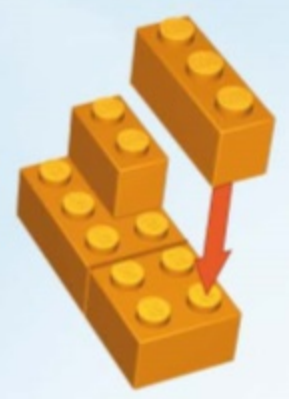

15

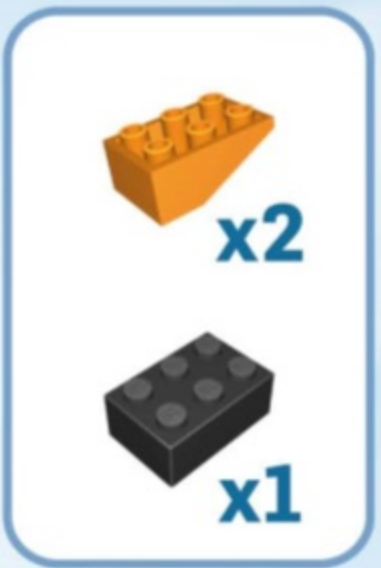
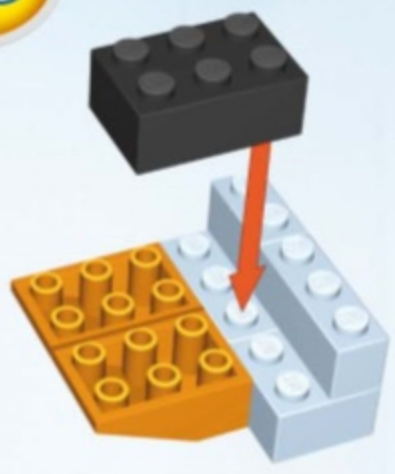

16

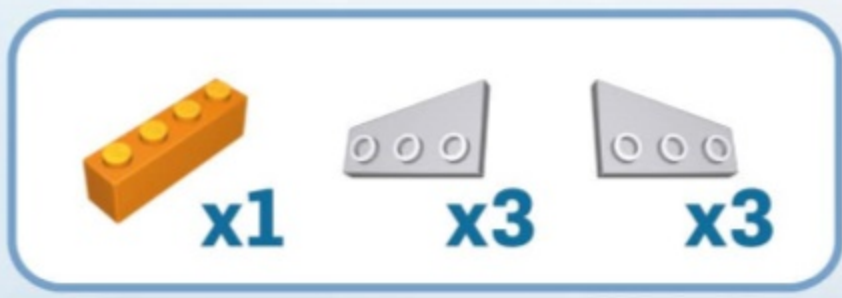
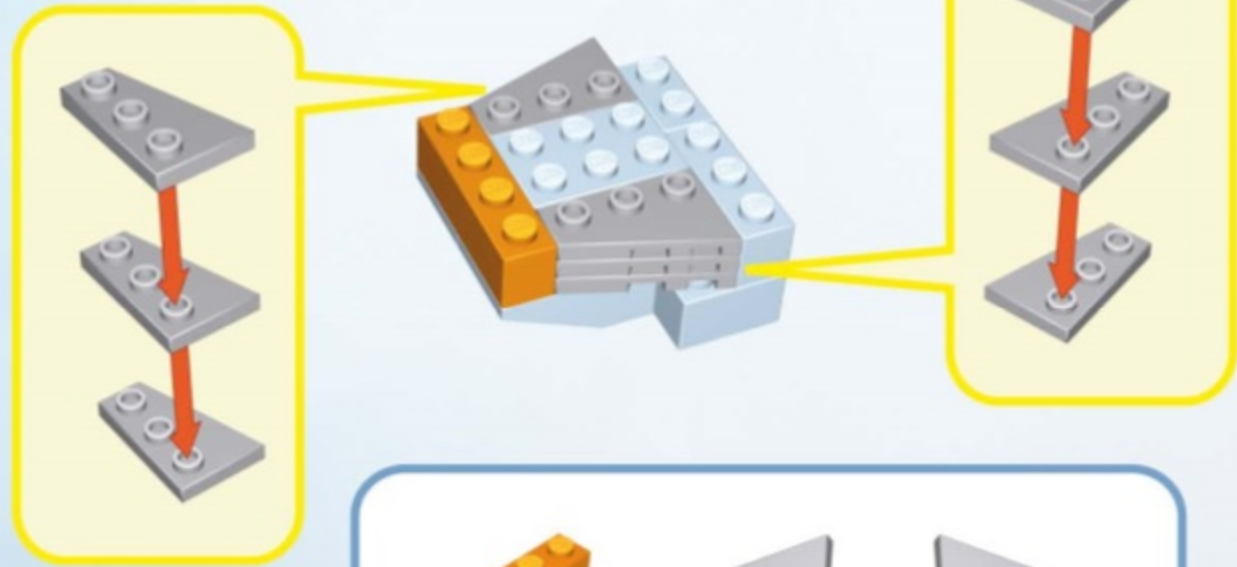

17

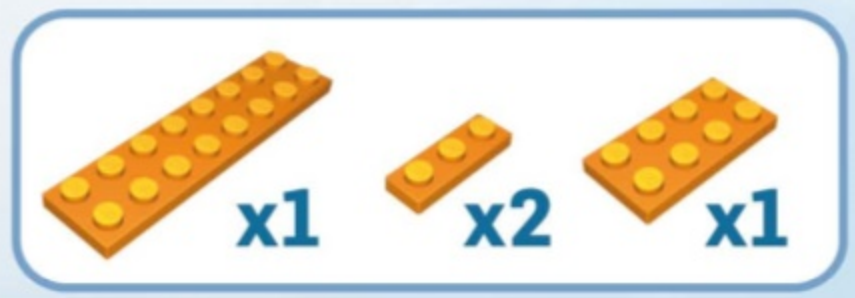

18



- x3
- x1
- x1

19



- x1
- x1
- x1

20



- x1
- x1

21



- x1
- x1
- x1

22



- x1
- x1

23



- x1
- x1

24

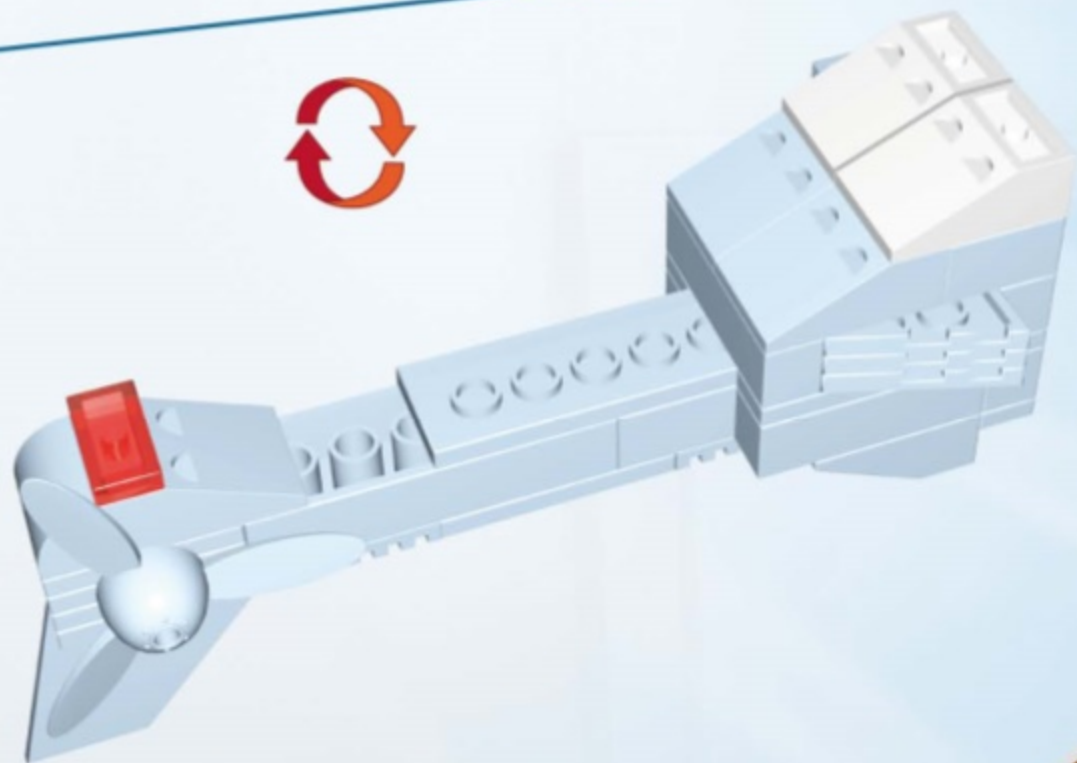
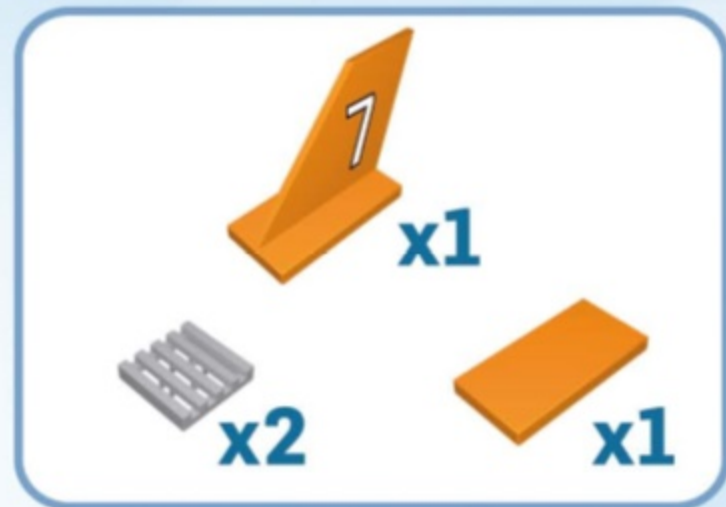
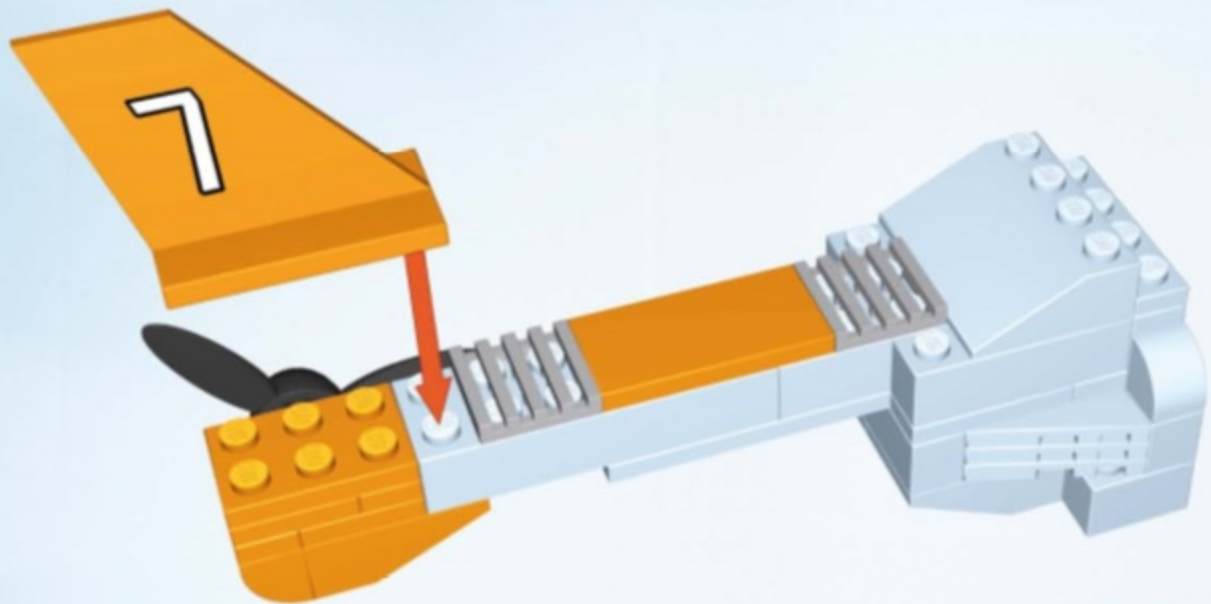

25

26

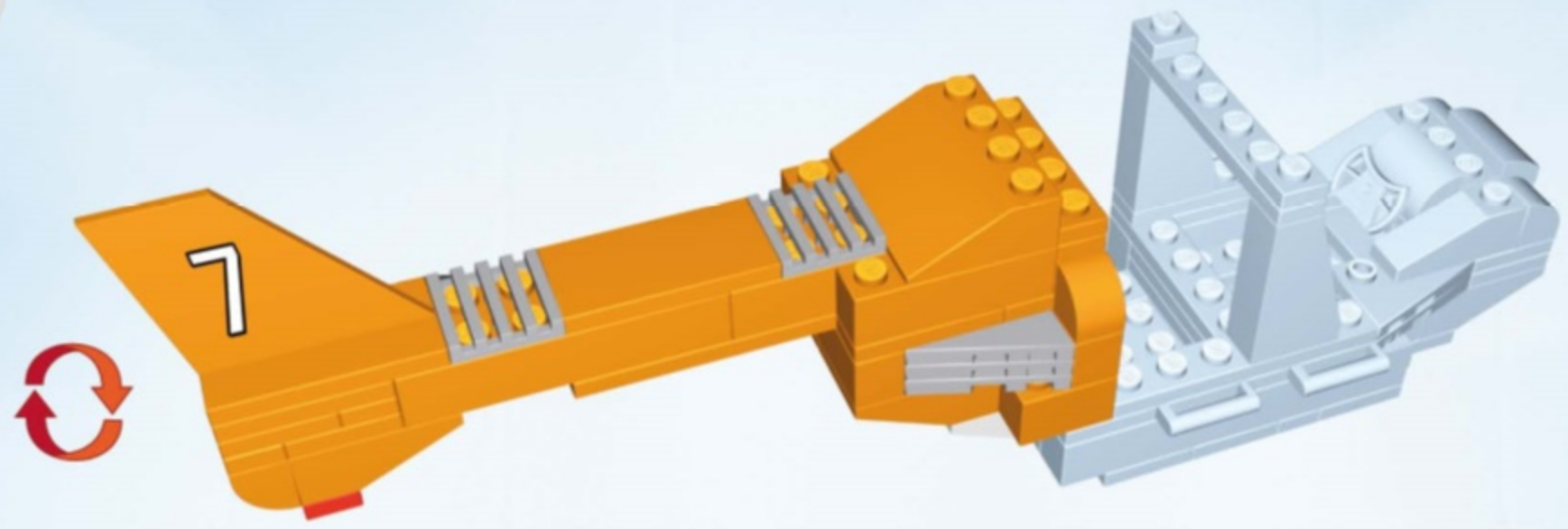

27

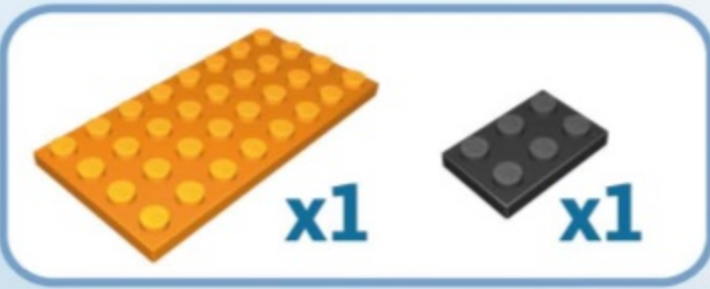

28

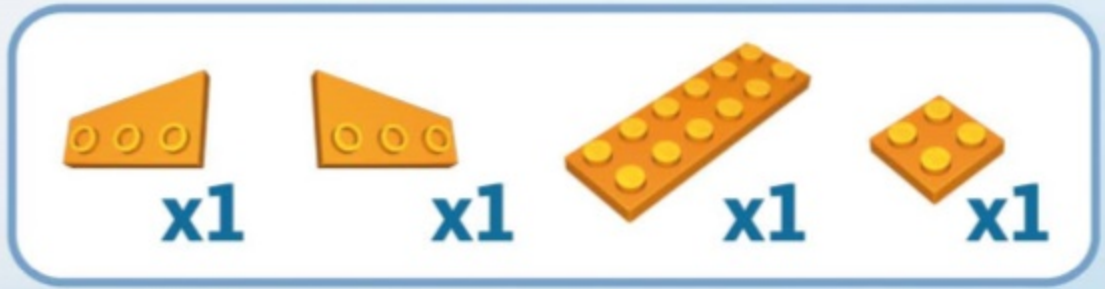

29

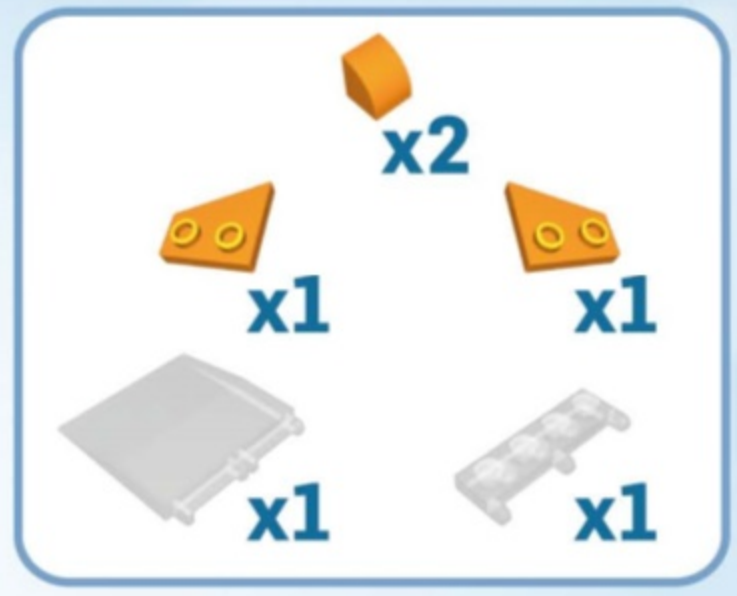
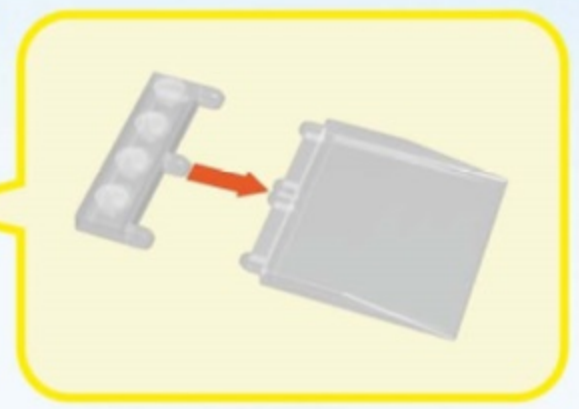

30

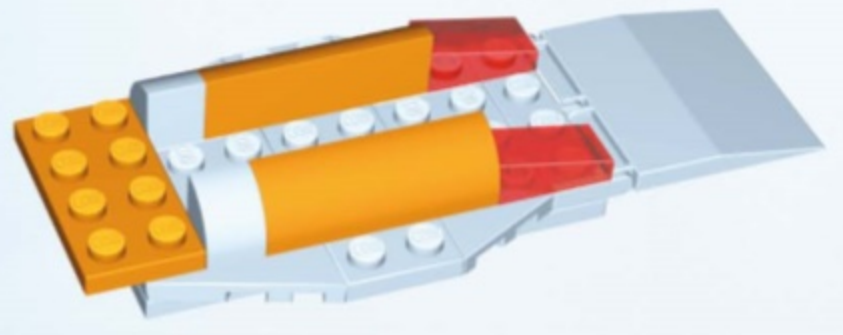

31

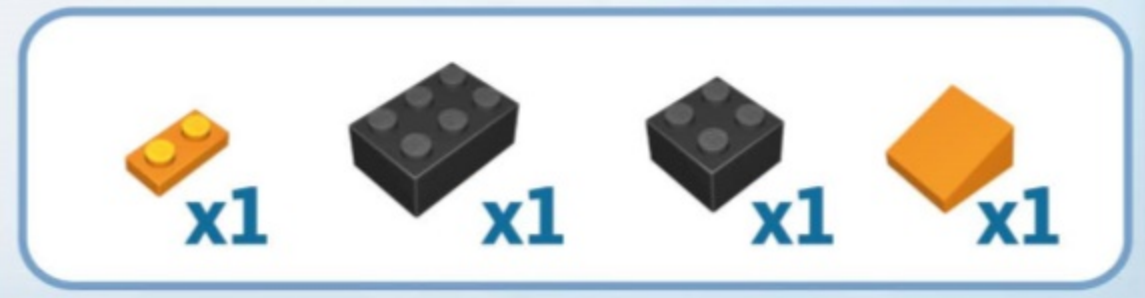
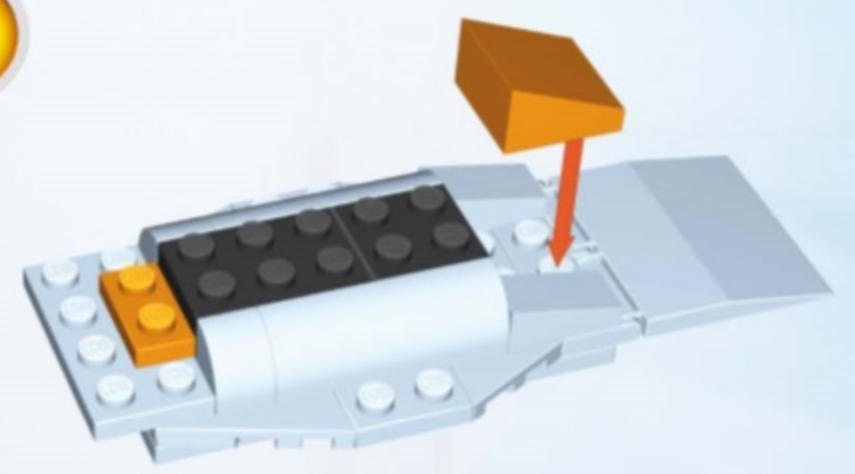

32

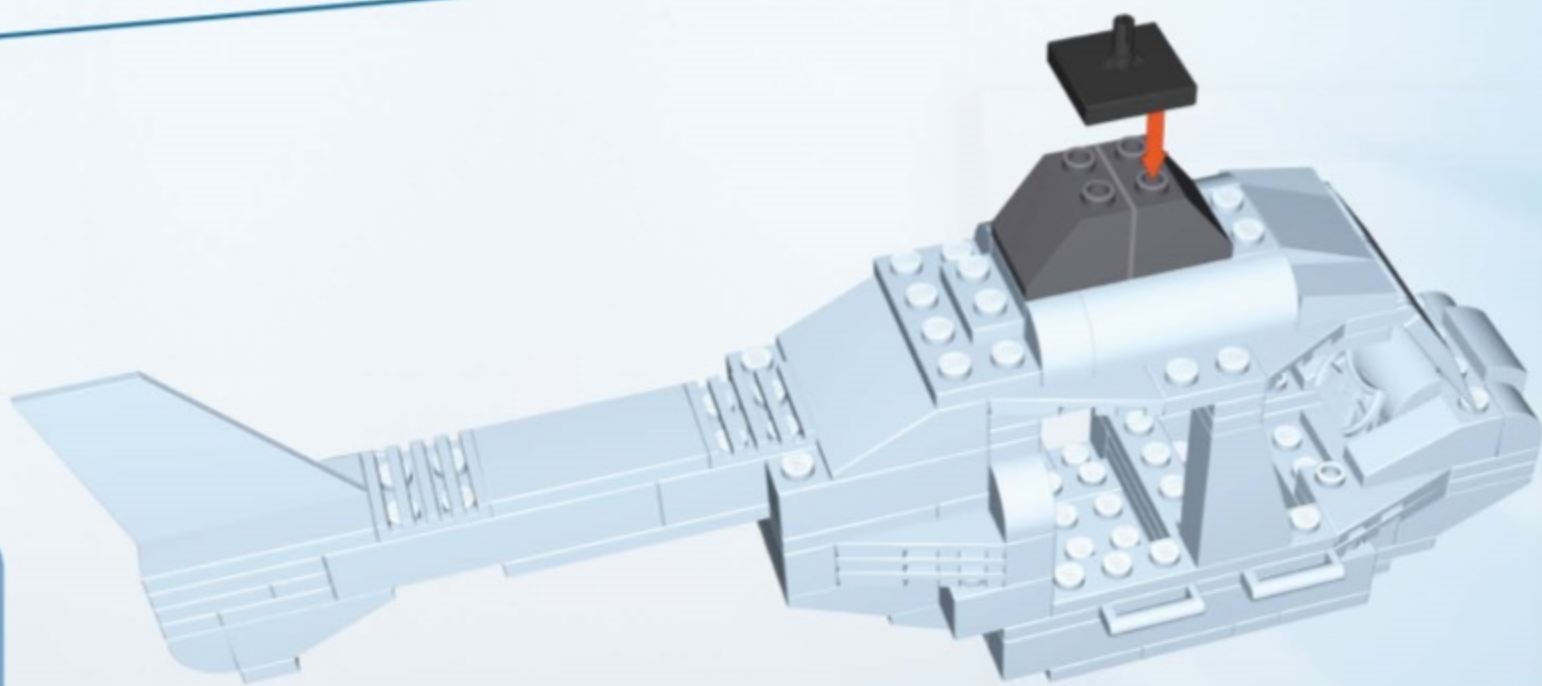
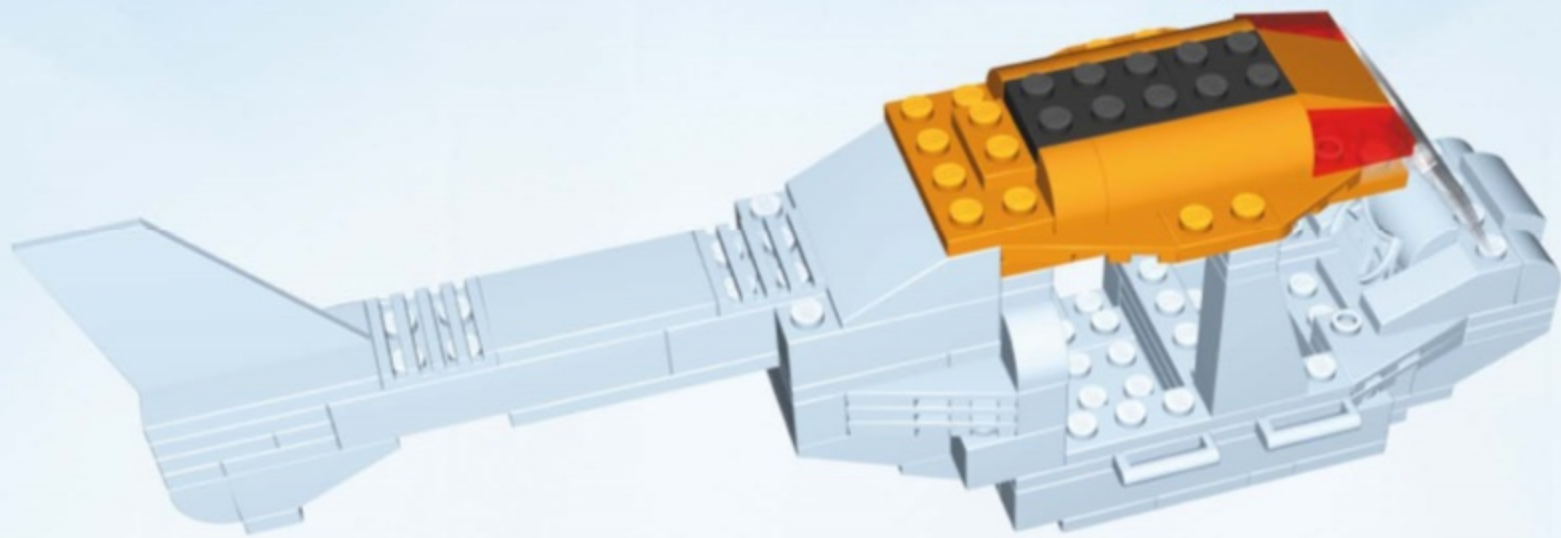

x2



x1

33

34

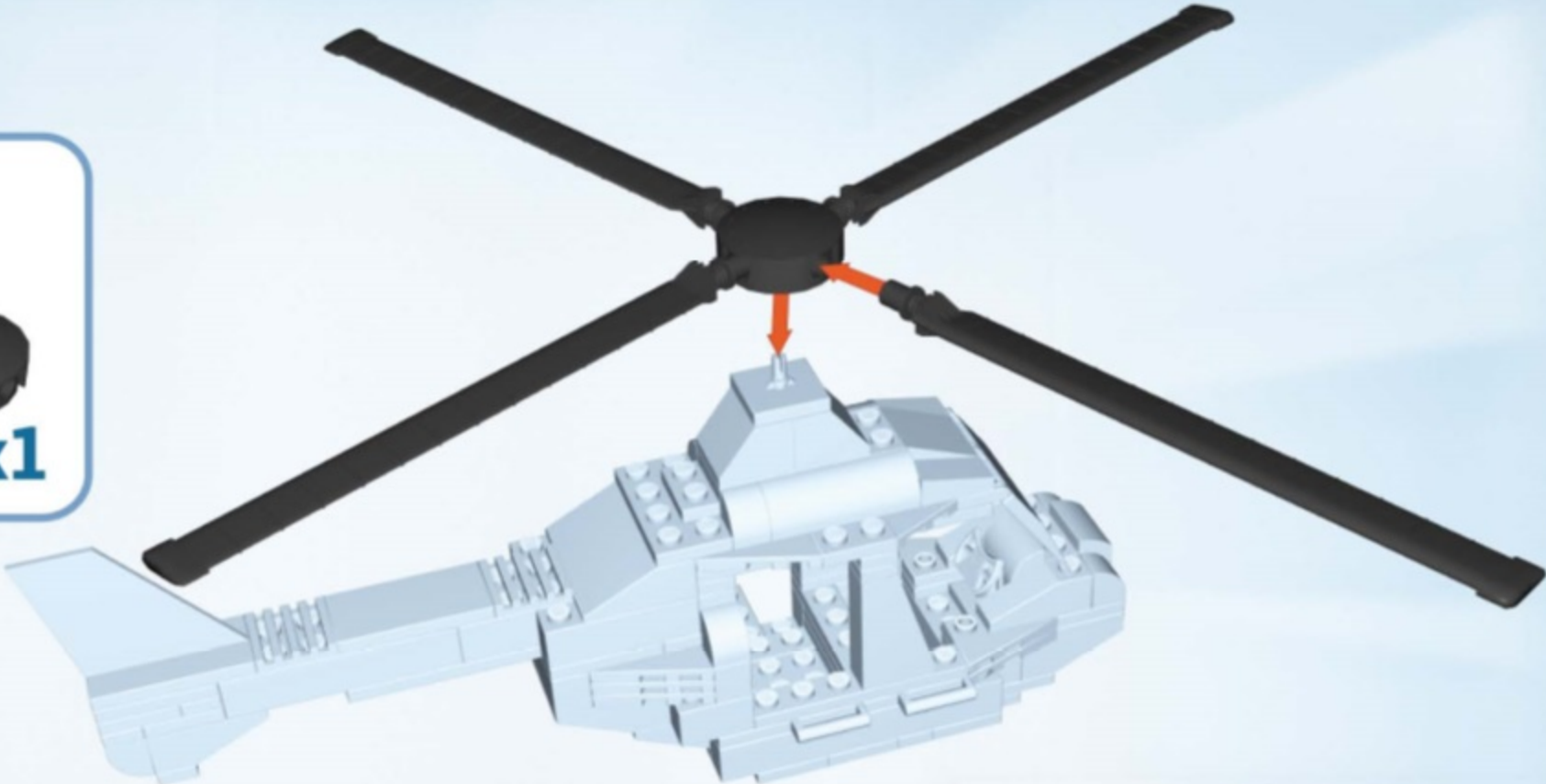

35

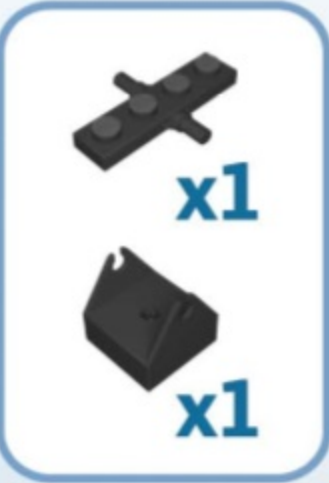

36



37

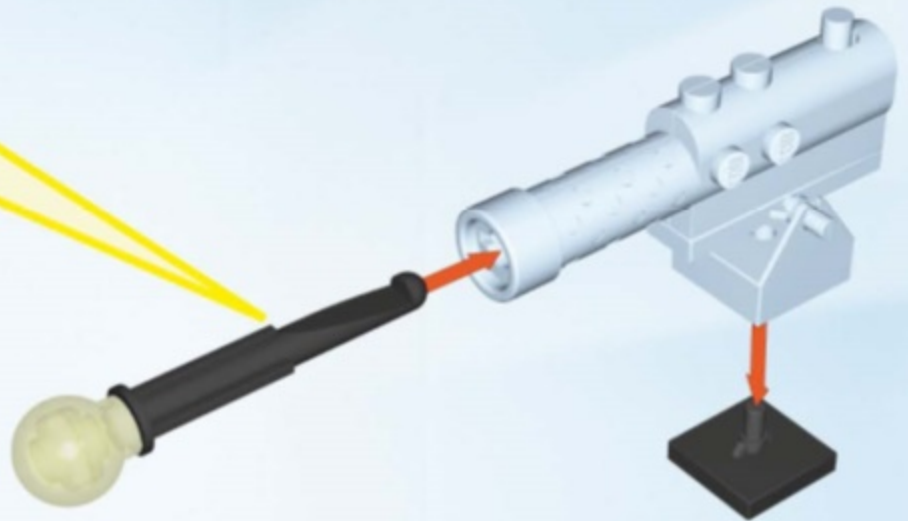
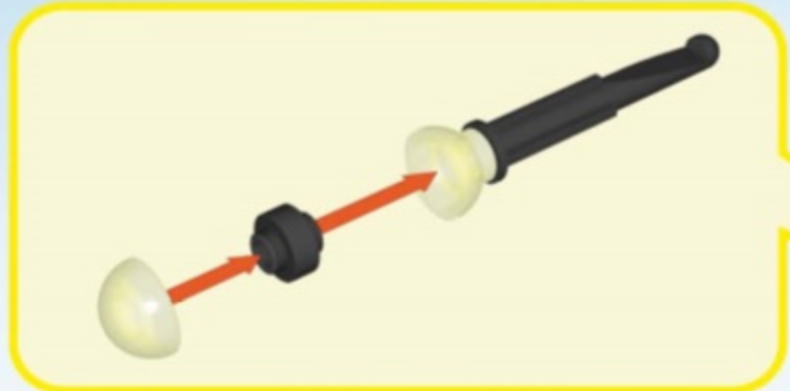

38

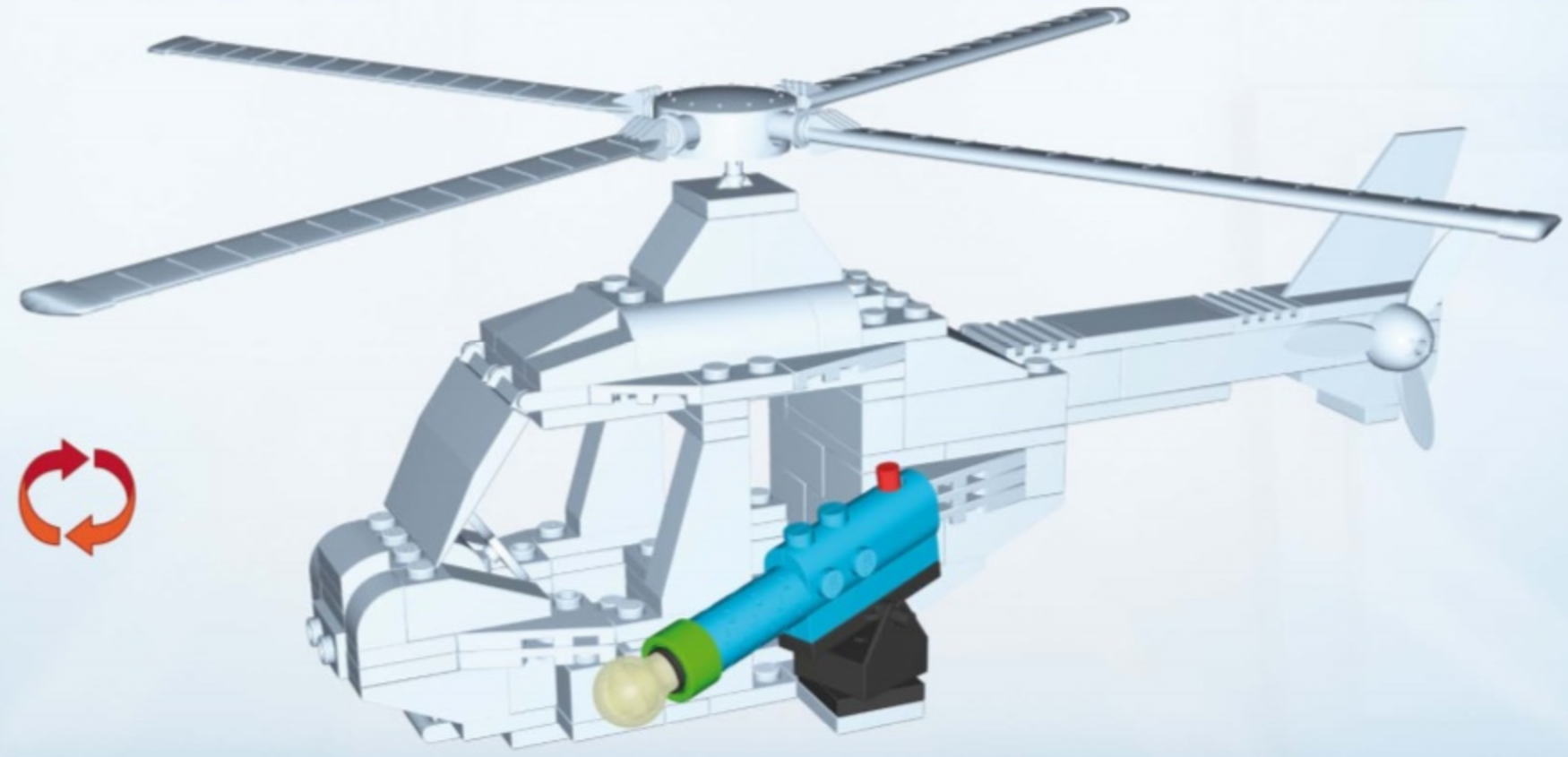

39



40

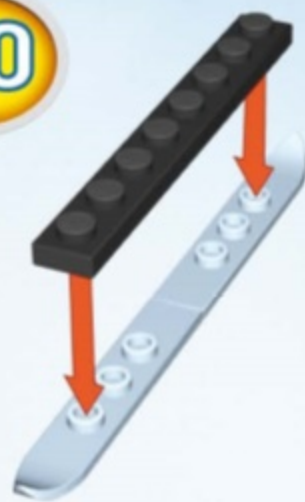

41





42

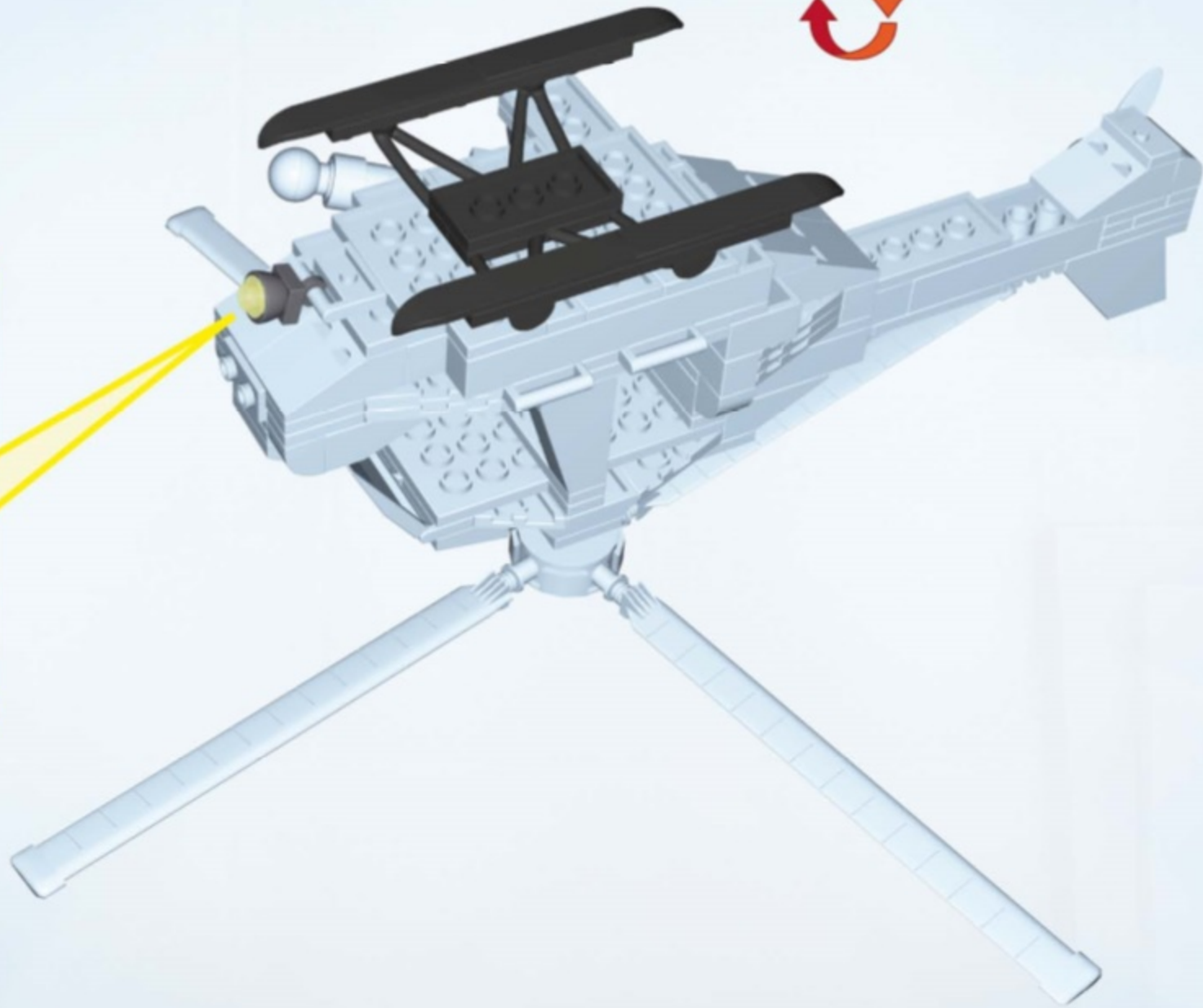
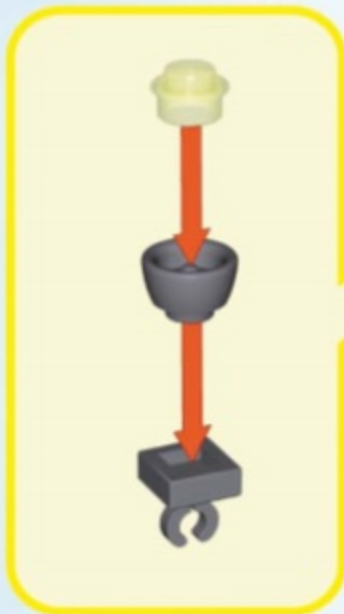

43



-  x1
-  x1
-  x1



26150

Bi-Plane Bomber



26281

The S.T.A.N.K. Mobile

26173



Pest Control

26171



Fish-E Delivery Truck

26230



Swing & Smash Crane

26080



Golf Cart Madness

26081



Grab-A-Fish-Factory

26400



King Julien's ZOO Adventure

26051



Rat King's Revenge

26231



Speed Boat Attack

26050



The Dematerializer

26480



Penguin's Secret Mission HQ

00-26160-140

