



SMALLEST CLASS

„Selbst wenn du noch nicht bereit bist, mit voller Lautstärke zu leben, dreh wenigstens halb auf, denn auch so gelangst du ans Ziel.“

- Bobby Berk

QUEER EYE

MORE THAN A MAKEOVER

In vielen Reality-Shows im Fernsehen geht es nur darum, Menschen herabzusetzen. Im Gegensatz dazu will *Queer Eye* Menschen aufbauen. Die Fab Five greifen auf ihre persönlichen positiven und negativen Erfahrungen zurück, um jeden Menschen oder Helden (so nennen die Fab 5 ihre Gäste), dem sie begegnen, wirksam und nachhaltig zu verwandeln.

Besuche die Minifigur-Versionen der Fab Five in der LEGO® Nachbildung des Original-Lofts in Atlanta. Alle sind da: der Modedesigner Tan France, der Kulturexperte Karamo Brown, der Experte für Essen und Wein Antoni Porowski, der Designfachmann Bobby Berk und Jonathan Van Ness, der Spezialist für Körperpflege. Sie brauchen deine Hilfe bei ihrem nächsten Umstyling. Viel Spaß!





*„Als Stylist möchte ich den Menschen helfen,
die beste Version ihres Selbst zu sein.“*

- Tan France



TAN FRANCE

MODE



Tan France kam in Doncaster (England) zur Welt. Seit 2008 arbeitet der Sohn pakistanischer Eltern in den USA. Heute lebt er in Salt Lake City, Utah. Als Modedesigner und Fashionexperte gibt Tan den Menschen ihr Selbstvertrauen zurück. Er hilft ihnen dabei, sich in den Sachen, die sie tragen, wohlfühlen. Fast jede magische Verwandlung vollendet er mit seinem typischen French Tuck!



*„Essen kann einen Moment
purer emotionaler Freude in
einer ansonsten harten und
schwierigen Welt bieten.“*

– Antoni Porowski

ANTONI POROWSKI

ESSEN & WEIN



Der Sohn polnischer Einwanderer wuchs in Montreal (Kanada) auf und spricht Polnisch, Englisch und Französisch. Nach seinem Umzug in die USA studierte er zunächst Psychologie und Schauspiel. Später wandte er sich der Kochkunst zu. Bevor er sich den Fab Five anschloss und die Leute ermutigte, für sich selbst zu kochen, arbeitete er für Ted Allen, den Ernährungsexperten aus der Originalserie *Queer Eye*, die in den frühen 2000er-Jahren lief.



KARAMO BROWN

KULTUR

Karamo Brown ist der Life-Coach und Therapeut der Gruppe. Er hilft den Helden der Show, sich selbst besser zu verstehen, und ermutigt sie, den Widrigkeiten zu trotzen, die sie aus der Bahn geworfen haben. Karamo ist jamaikanisch-kubanischer Abstammung und wurde in Houston (Texas) geboren. Heute lebt er mit seinen beiden Söhnen in Los Angeles und engagiert sich aktiv für die schwarze LGBT Community.



„Das Leben passiert dir nicht. Das Leben reagiert auf dich.“

– Karamo Brown





„Wenn du zu Hause glücklich bist, überträgt sich das auf jeden anderen Bereich deines Lebens.“

- Bobby Berk



BOBBY BERK

DESIGN

Bobby wuchs in einer Kleinstadt in Missouri auf. 2003 zog er mit nur 100 Dollar in der Tasche nach New York. In einem Einrichtungsunternehmen arbeitete er sich bis zum Kreativdirektor hoch, bevor er seinen eigenen Online-Shop gründete. In der Netflix-Show *Queer Eye* peppt Bobby die Wohnräume der Helden auf, um ihnen dabei zu helfen, ihr Leben umzukrempeln.

„Die Welt nimmt dich so
wahr, wie du auf dich
selbst achtest.“

- Jonathan Van Ness



JONATHAN VAN NESS

STYLING

Als Cheerleader der Fab Five ermutigt Jonathan die Helden der Show dazu, sich Zeit für sich selbst zu nehmen und sich ganz bewusst mit ihrer Körperpflege und ihrem Styling zu befassen. Wenn Jonathan nicht gerade in *Queer Eye* Haare neu frisiert, arbeitet er als überschwänglicher Moderator diverser preisgekrönter Podcasts. Außerdem schwärmt er für Gymnastik und Eiskunstlauf – es wird sogar gemunkelt, dass Jonathan sowohl den Toeloop als auch den Axel beherrscht!





JEDER GAST IST EIN HELD

Jeder Held in *Queer Eye* kann eine besondere Geschichte erzählen. Manche mussten den Verlust eines geliebten Menschen verschmerzen, eine schwere Krankheit überstehen oder die Abkehr ihrer Familie verkraften. Andere haben sich so sehr um ihre Mitmenschen gekümmert, dass ihnen keine Zeit blieb, um auf sich selbst zu achten. In den Augen der Fab Five sind all diese Menschen Helden, die eine Verwandlung verdient haben, die ihr Leben einfacher, gesünder und glücklicher machen wird.



Bruley war die liebenswerte französische Bulldogge aus den Staffeln 3 und 4. Er starb 2019, wurde jetzt aber in LEGO® Form verewigt.



GAST DER WOCHE

Es wäre kein richtiges *Queer Eye* LEGO® Set, wenn niemand einer magischen Verwandlung unterzogen würde! Das ist Kathi Dooley, eine engagierte Lehrerin, die eine besondere Rolle in Jonathans

Kindheit gespielt und ihn mit ihrer verständnisvollen und freundlichen Art unterstützt hat. Jetzt werden sich Jonathan und seine Freunde dafür erkenntlich zeigen ...

Kathi Dooleys
LEGO Umstyling



Vorher

Nachher

Bobbys Talent für Design zeigte sich schon früh ...
mit einem LEGO® Set!



MEHR ALS EIN UMSTYLING

EINE ECHTE ZUSAMMENARBEIT!

Dieses *Queer Eye* LEGO® Set ist das Ergebnis der Zusammenarbeit zwischen dem LEGO Design-Team und Bobby Berk, dem Design-Guru der TV-Serie – ganz nach Art der Fab Five. Für Bobby wurde das Projekt schnell zu einer Herzensangelegenheit: „LEGO hat in meiner Kindheit eine ganz wichtige Rolle gespielt. Beim Zusammenstecken der kleinen Steine wurden meine Fantasie und Kreativität geweckt.“ Matthew Ashton, LEGO Vice President of Design, betrachtete die Zusammenarbeit als perfekte Partnerschaft: „Wir haben so viele gemeinsame Werte wie Fürsorge, Lernen, Kreativität und Spaß. Während die Fab Five das Leben der Menschen wieder aufbauen, wollen wir Kinder und Erwachsene inspirieren, kreativ zu werden und sich daran zu beteiligen, wieder eine positivere Welt aufzubauen.“

Als Erstes mussten wir entscheiden, was das Set darstellen sollte. Das Team einigte sich rasch auf die ursprüngliche Loft-Kulisse aus der ersten Staffel und legte dann die Raumaufteilung und den Grundriss des Modells fest. Matthew war es wichtig, möglichst viele Details darzustellen: „Wir wollten die Möbel nachbilden und kultverdächtige Details wie das Schild mit der Aufschrift „STYLE, TASTE, CLASS“ unterbringen. Außerdem sollte für jeden der Jungs eine eigene Zone eingerichtet werden, die die einzigartigen Fähigkeiten der Fab Five und deren Beiträge zum Team widerspiegelt.“

„Durch die Zusammenarbeit mit dem LEGO Team ist ein echter Traum für mich wahr geworden! Dieser Traum jedes Kindes ist jetzt meine Wirklichkeit.“

- Bobby Berk



Bobby und Matthew in der Anfangsphase des Designprozesses.



ALLES FÜGT SICH ZUSAMMEN

Genau wie bei den Fab Five ist auch bei der Entwicklung eines tollen LEGO® Sets das Teamwork ganz entscheidend. Zu Matthews LEGO Dream-Team zählten auch noch der Leitende Grafikdesigner Diego Sancho und die Leitende Elementdesignerin Ruth Kelly.

Diego hatte die wichtige Aufgabe, die Fab 5 als originalgetreue LEGO Minifiguren darzustellen und die Dekorationen und Aufkleber zu entwerfen, die das Loft zum Leben zu erwecken: „Ich hatte die Chance, den Kunstwerken im Loft meine persönliche Note zu verleihen und einige coole Überraschungen für die Fans zu verstecken! Als Hommage an die LGBTQ+ Community habe ich die Grafik „Yaaas Queen“ (Ausdruck größter Zustimmung) für die Küche entworfen. Bei näherer Betrachtung entdeckt man in dem Pinselstrich-Kunstwerk den Schriftzug „FAB 5“!

Ruth sah sich dagegen mit einer ganz anderen Herausforderung konfrontiert: „Wir hatten einfach keine Perücken, die Tans voluminöser Haarpracht entsprachen. Deshalb musste ich eine neue Perücke gestalten. Wir beschlossen, die Perücke aus schimmerndem silbernem Kunststoff zu formen, um Tans Look die richtige Höhe zu verleihen!“

Matthew ist stolz auf das fertige Set – und darauf, wofür diese Partnerschaft steht: „Die Fab Five haben das Leben so vieler Menschen positiv beeinflusst. Freundlichkeit sollte gefeiert werden. Diese Zusammenarbeit war die perfekte Möglichkeit, genau das darzustellen.“



Von links nach rechts:
Ruth Kelly, Leitende Elementdesignerin
Matthew Ashton, Vice President of Design
Diego Sancho, Leitender Grafikdesigner



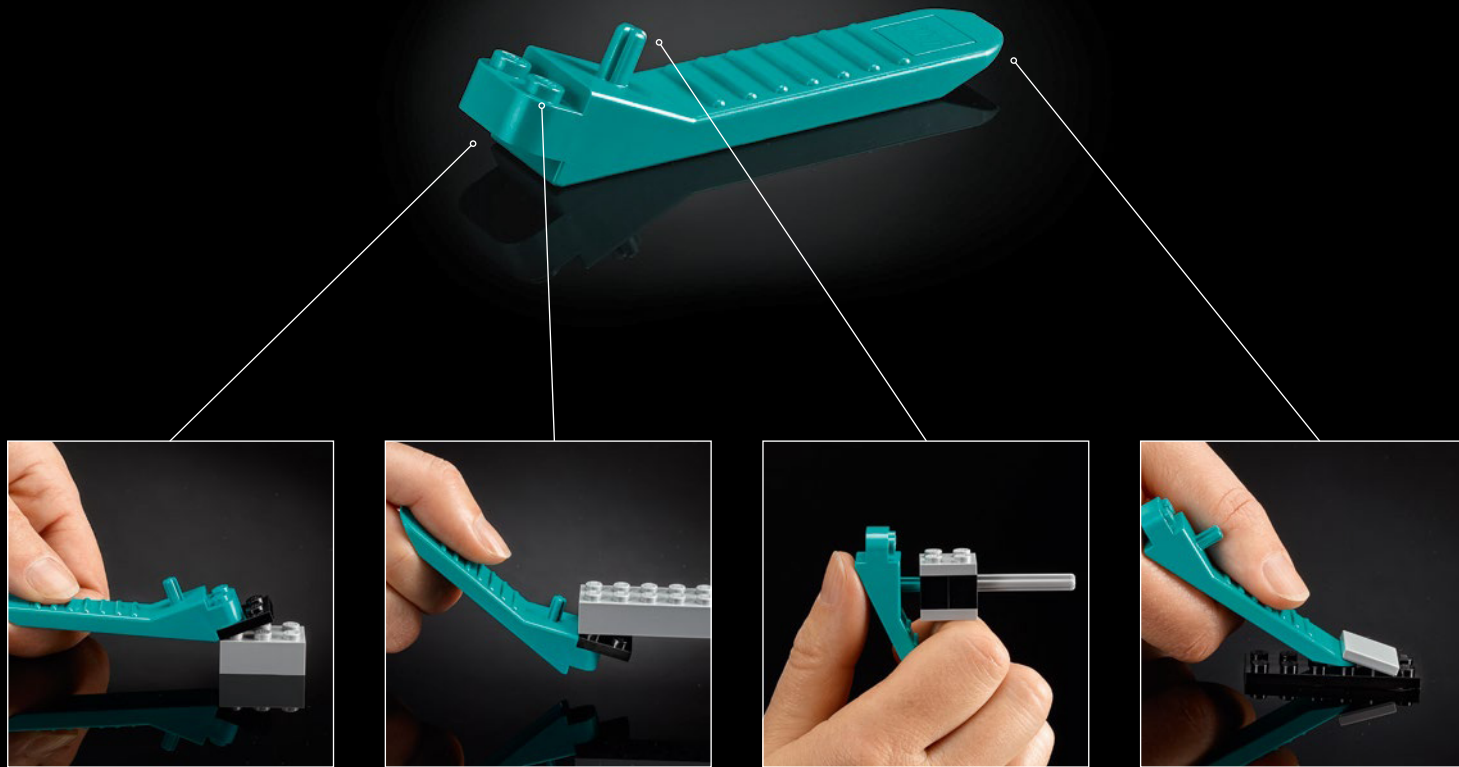

[LEGO.com/brickseparator](https://www.lego.com/brickseparator)

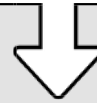
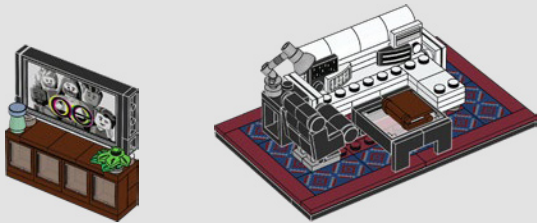
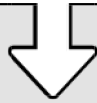

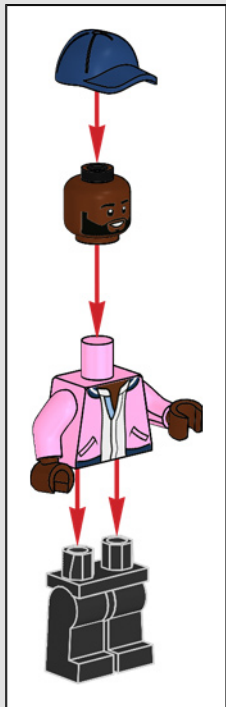
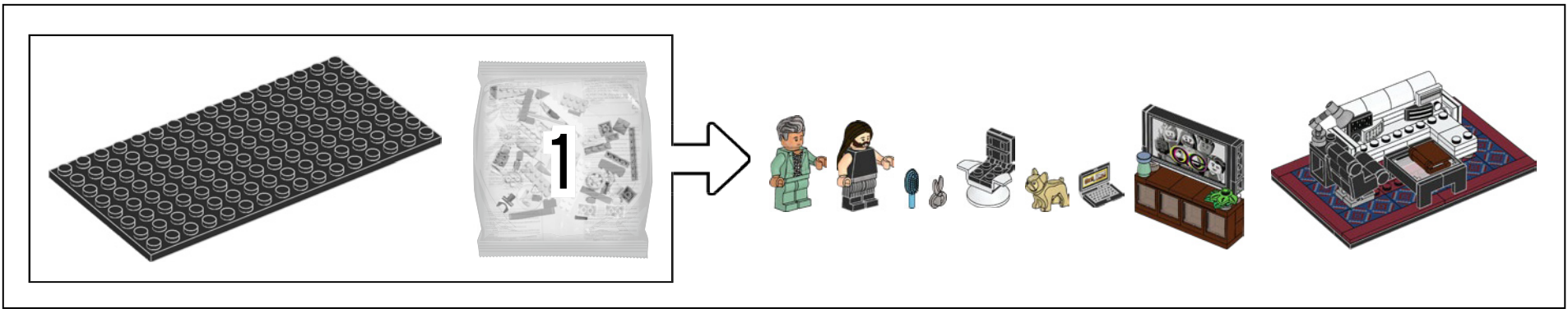

Karamo Brown

„Bin ich froh, dass sie mich meine typische Karamo-Bomberjacke tragen lassen. Und das Basecap bedeckt diese unschöne Beule auf meinem Kopf! Ha!“

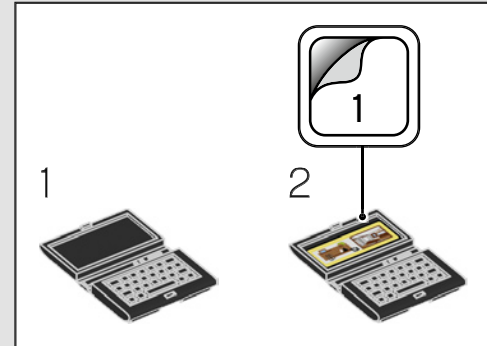

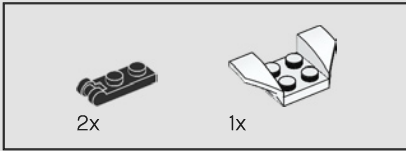
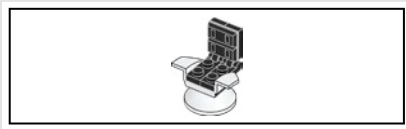

1

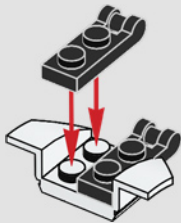

2

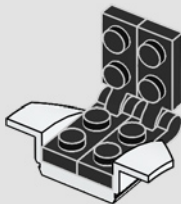

3

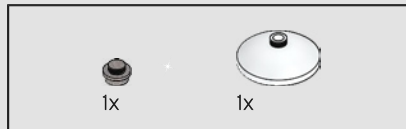
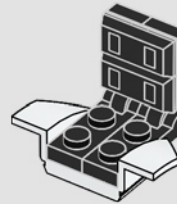

4

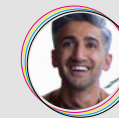
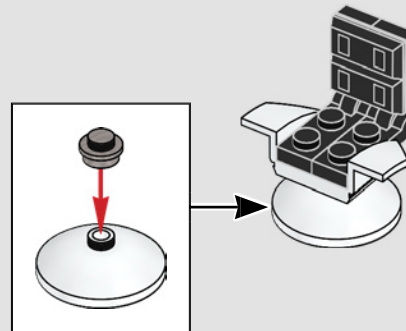

Tan France

„Ha! Diese kleine LEGO® Perücke ist pure Perfektion! Sie bewegt sich keinen Zentimeter, genau wie mein echtes Haar, sobald ich es mit Spray fixiert habe!“



Jonathan Van Ness

„Könnten wir als LEGO Figuren noch niedlicher aussehen?!“

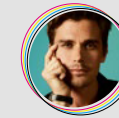

Antoni Porowski

„Es ist so süß, dass Bruley auch dabei ist! Ich vermisse den kleinen Kläffer!“

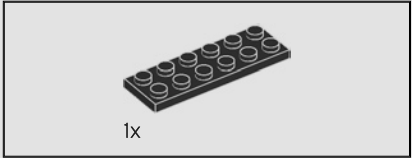
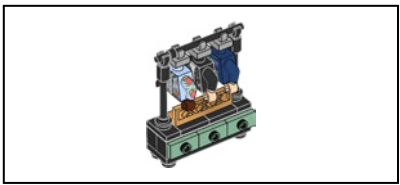

1

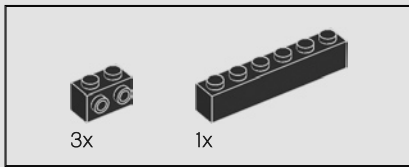
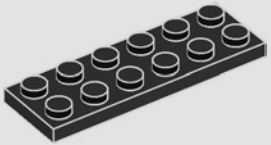

2

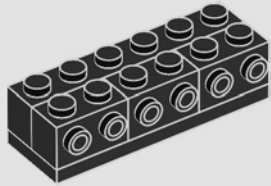

3

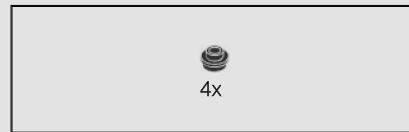
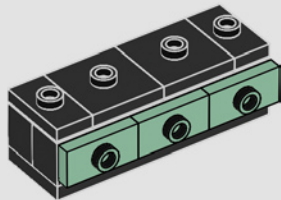

4

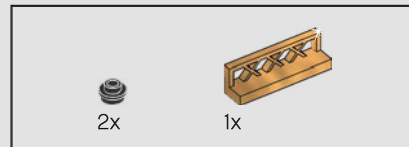
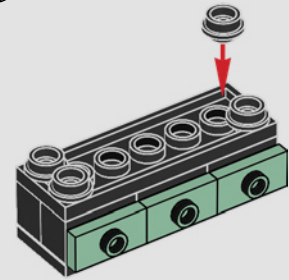
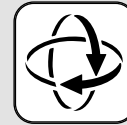

5

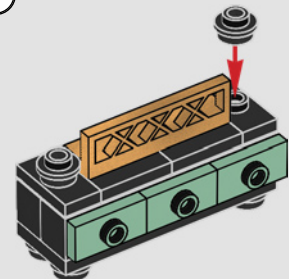
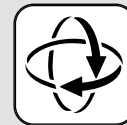



6

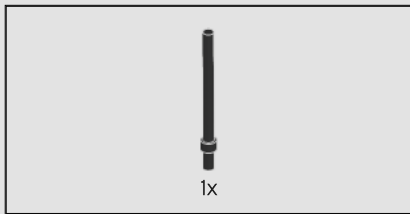
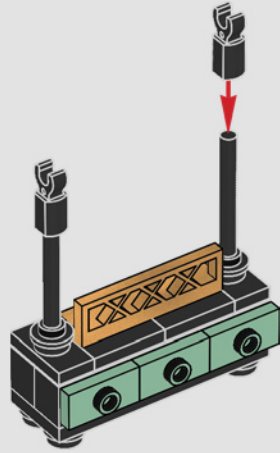

7

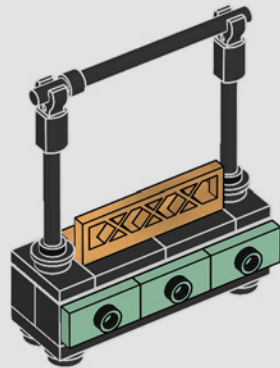

8

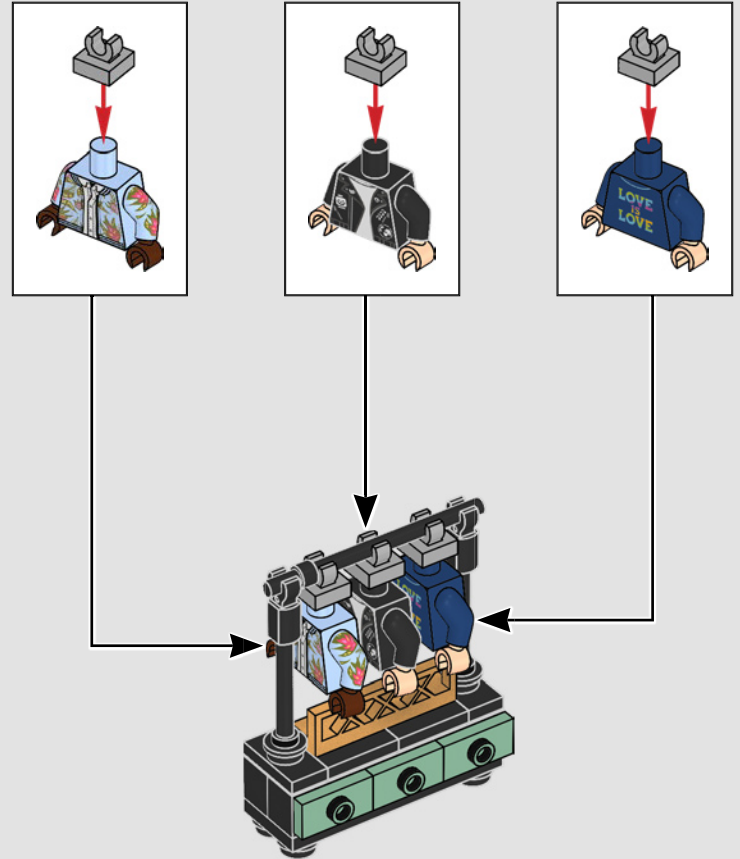

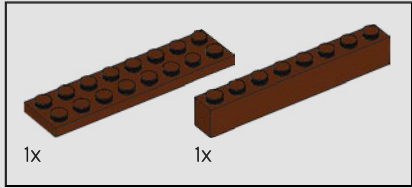

1

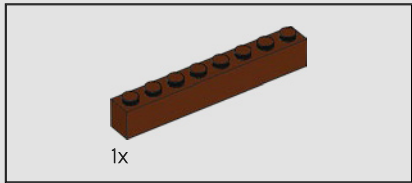
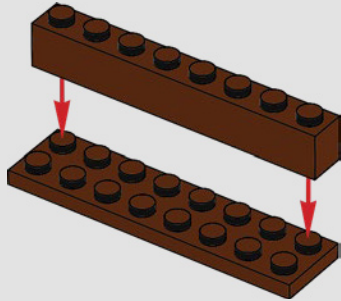

2

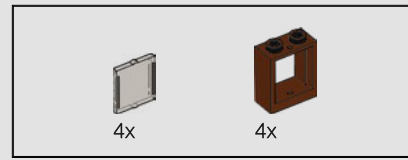
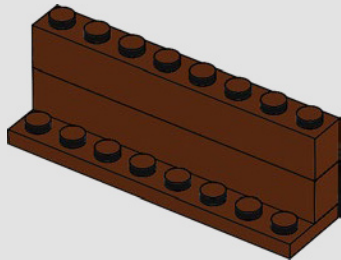

3

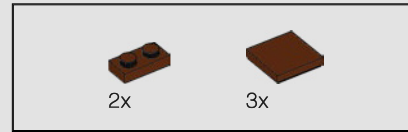
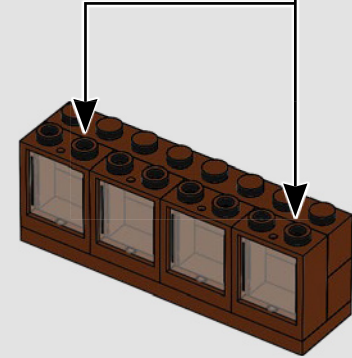
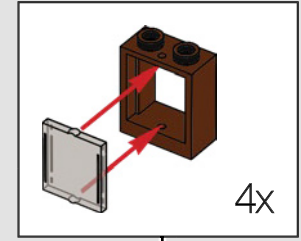

4

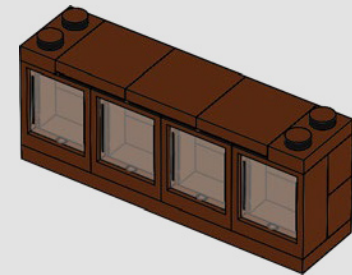



5

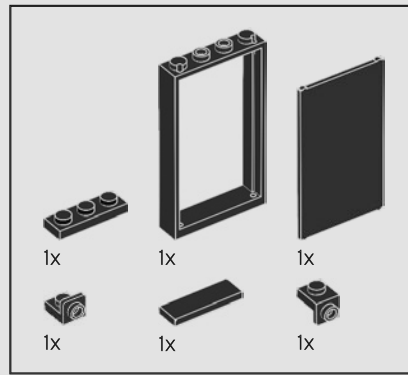
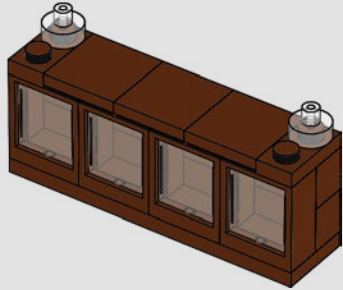

6

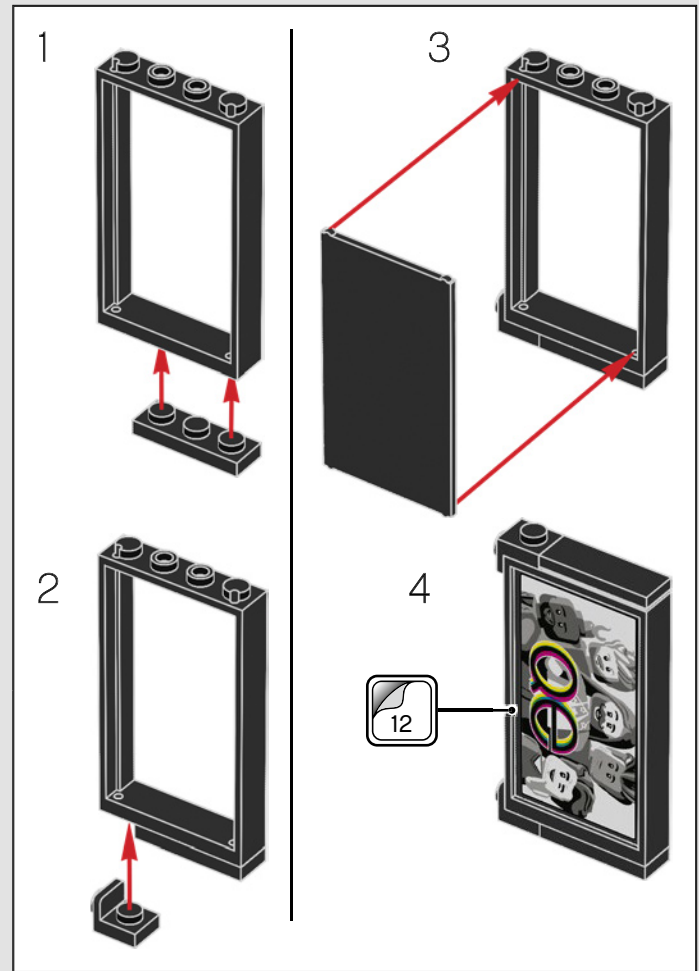
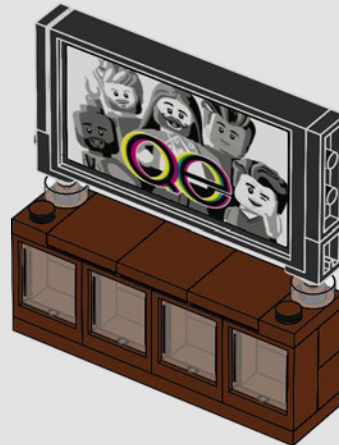



7



Jonathan Van Ness

„Es ist so wichtig, dass für die Leute Inklusion und Kreativität zusammengehören. Dass die LEGO Company Themen wie die Inklusion der LGBTQ Community unterstützt, ist absolut notwendig. Toll, dass das jetzt geschieht.“

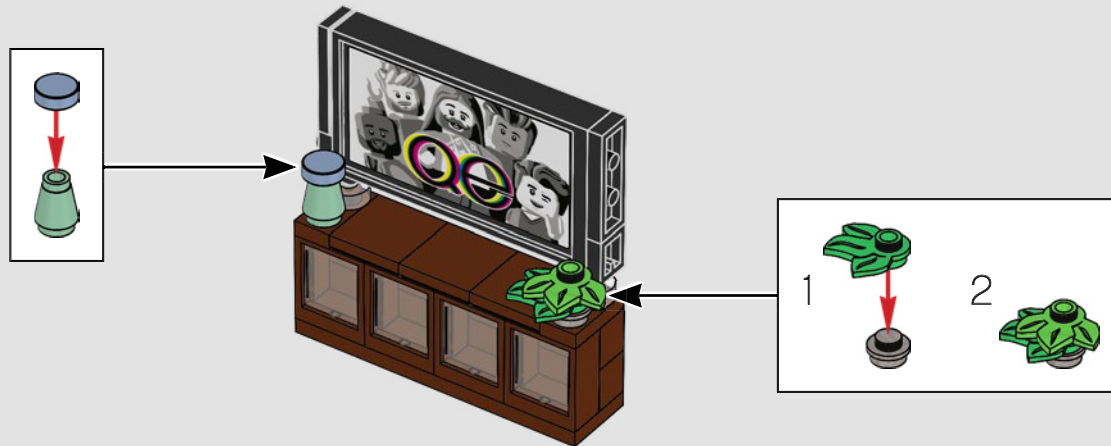

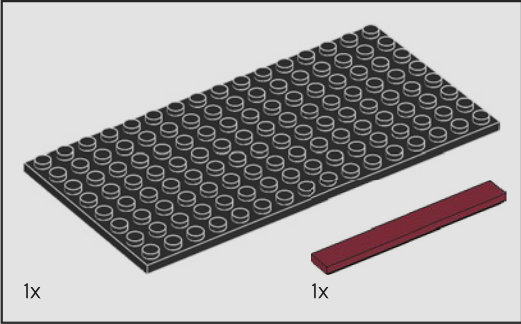
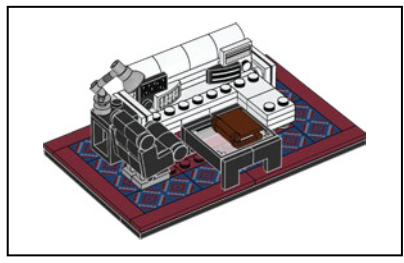

1

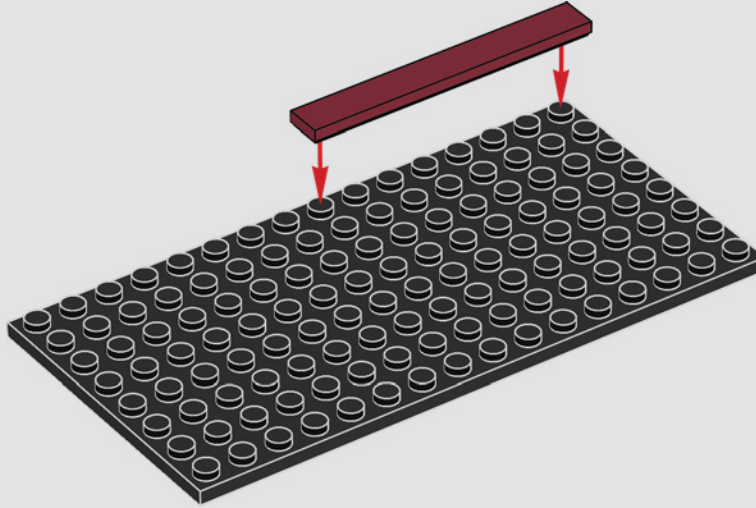

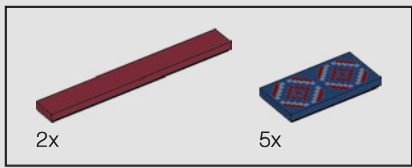

2

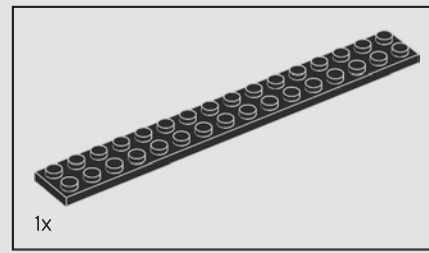
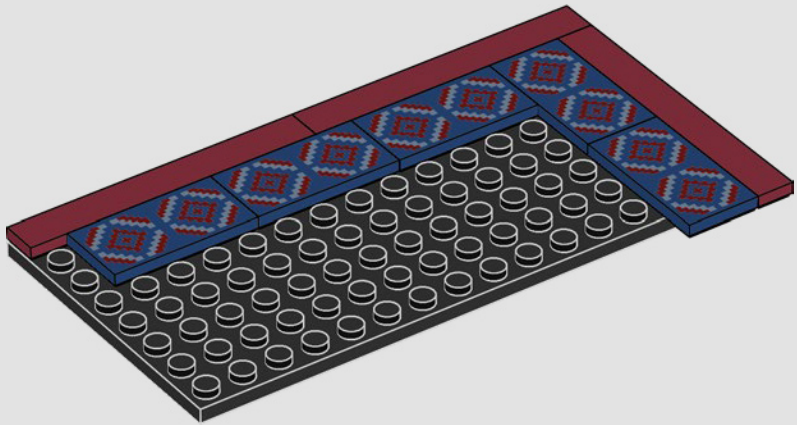

3

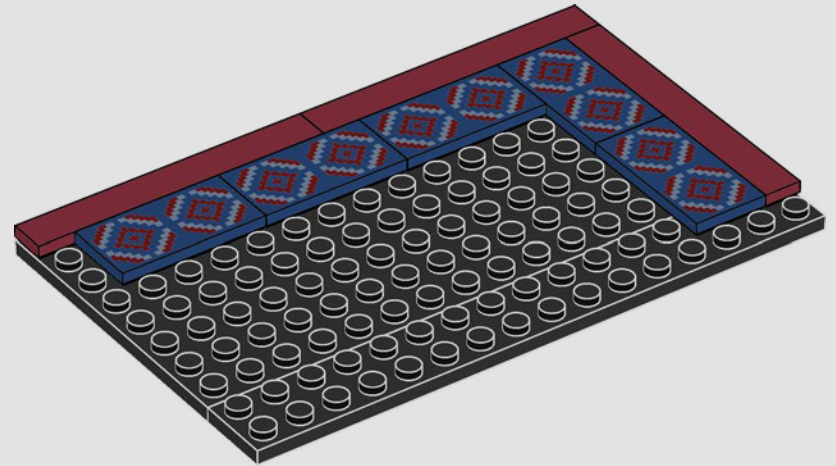

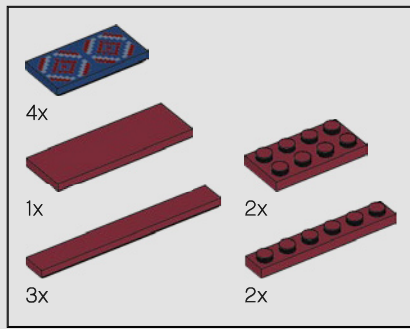

4

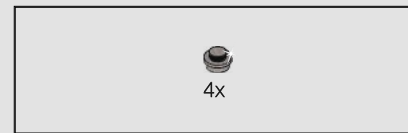
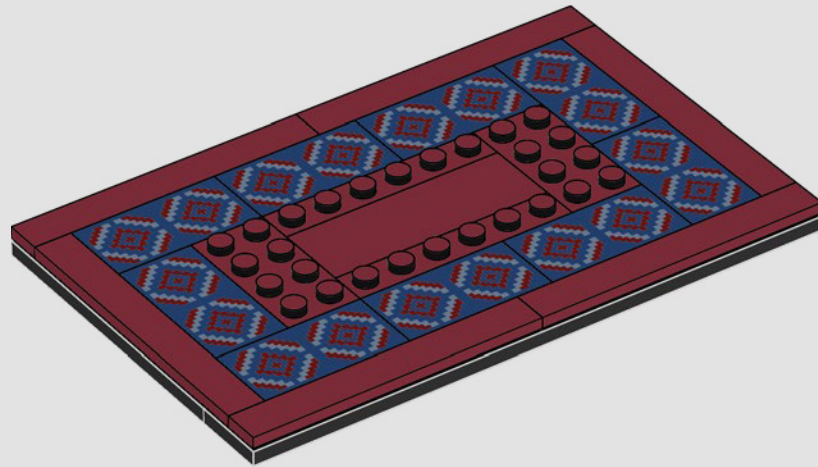

5

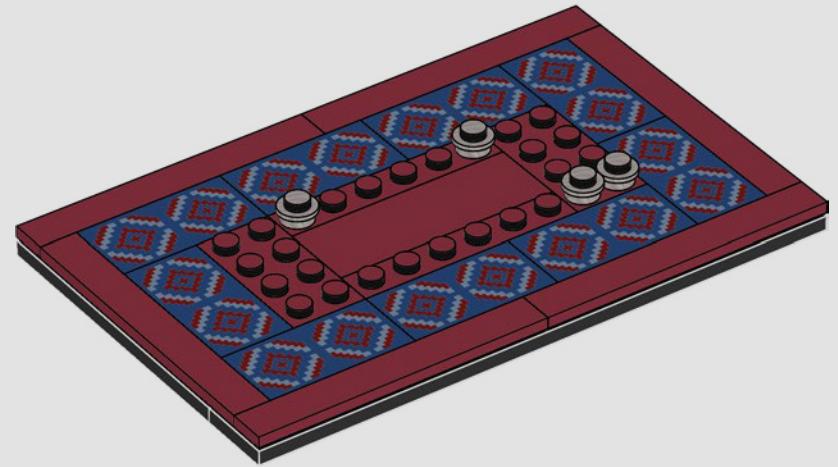

Jonathan Van Ness

„Die Vorstellung, eine bessere Welt zu erschaffen, ist einfach toll. Noch schöner ist es, daran mitzuwirken! Hoffentlich regt diese Zusammenarbeit die Fantasie vieler Menschen an.“

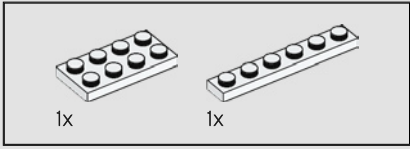
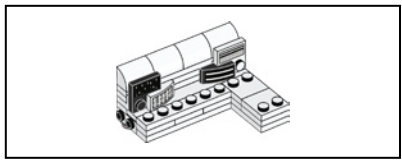

6

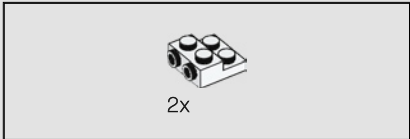
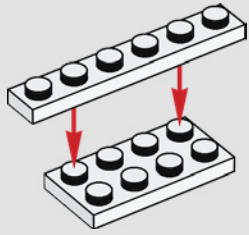

7

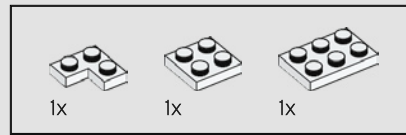
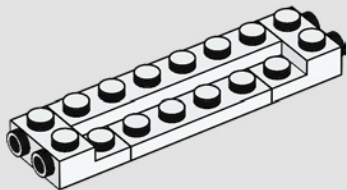

8

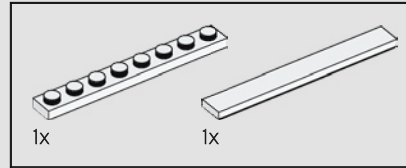
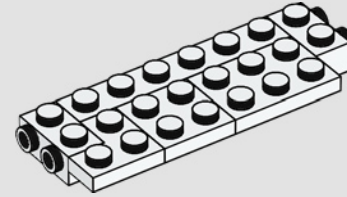

9

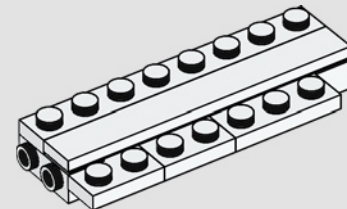

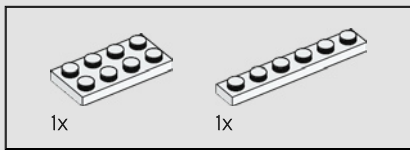

10

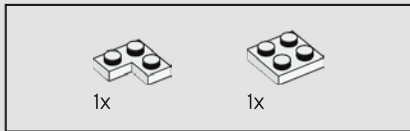
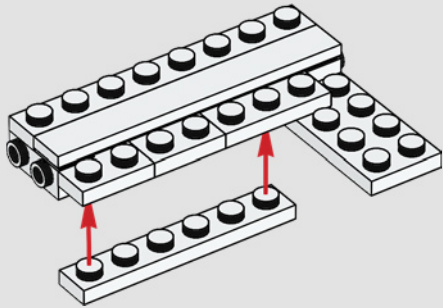

11

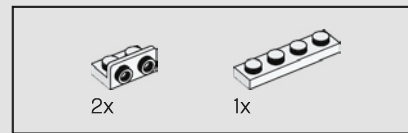
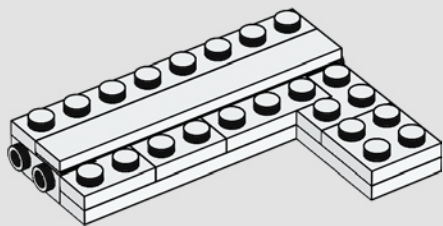

12

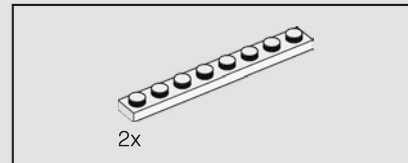
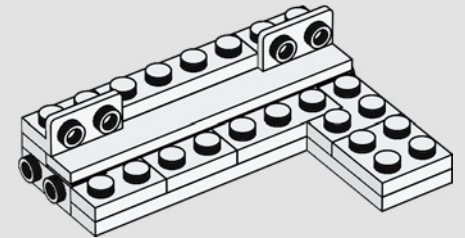

13

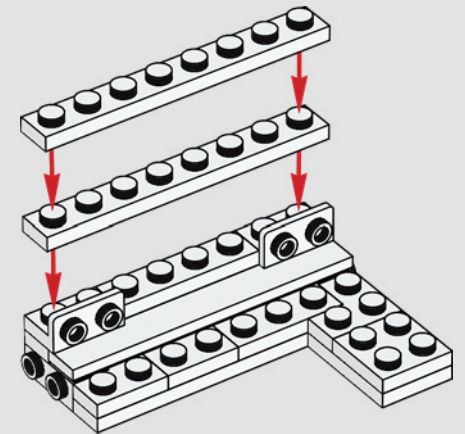

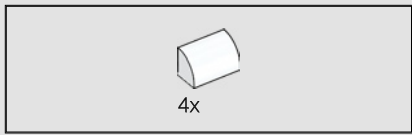

14

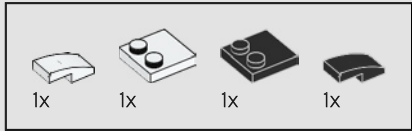
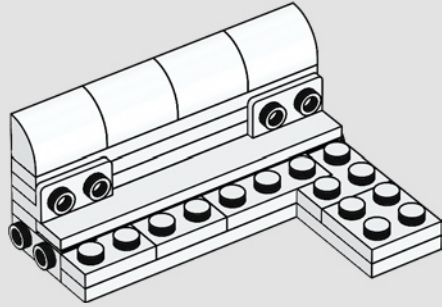

15

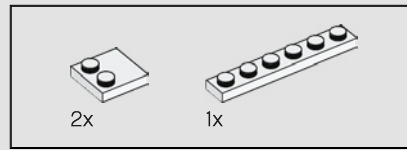
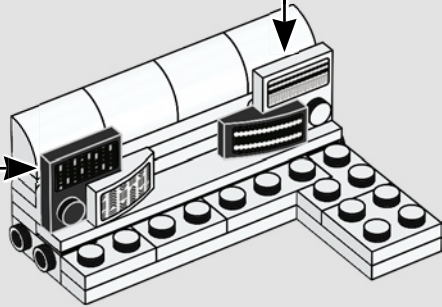
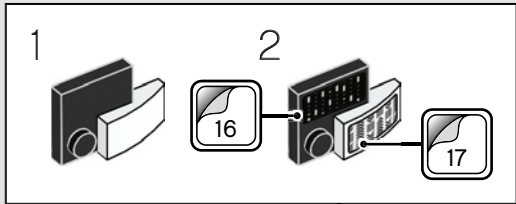
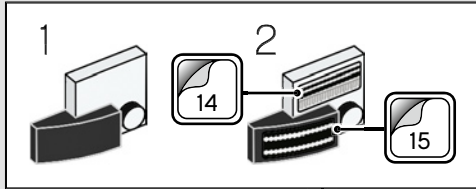

16

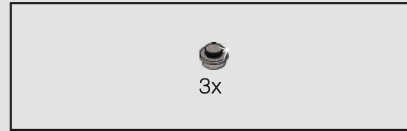
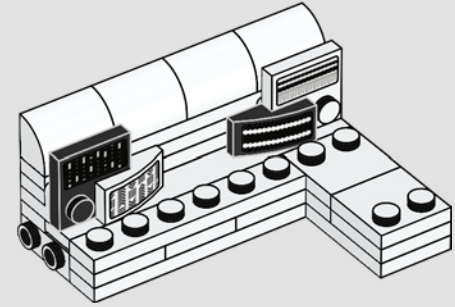

17

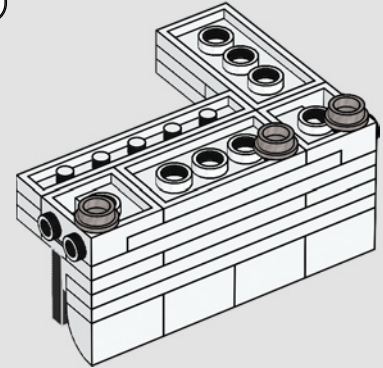
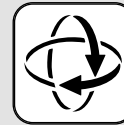

18

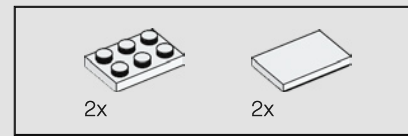
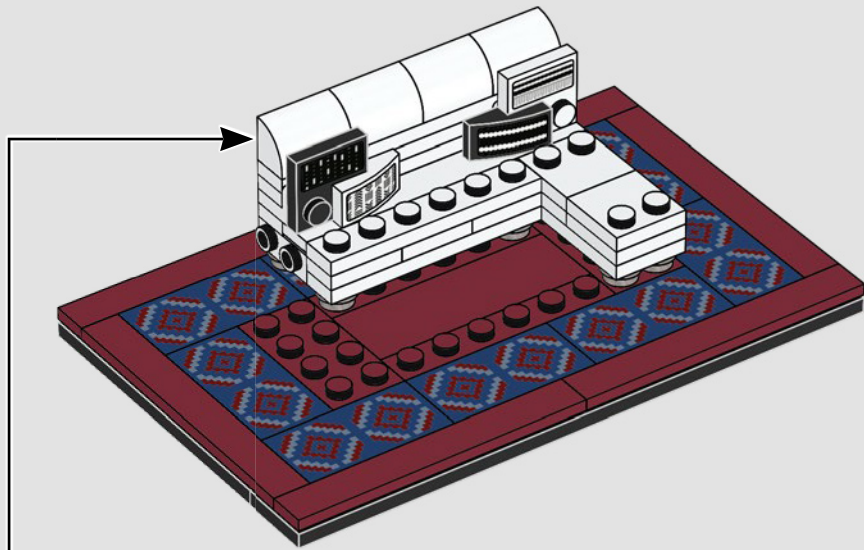

19

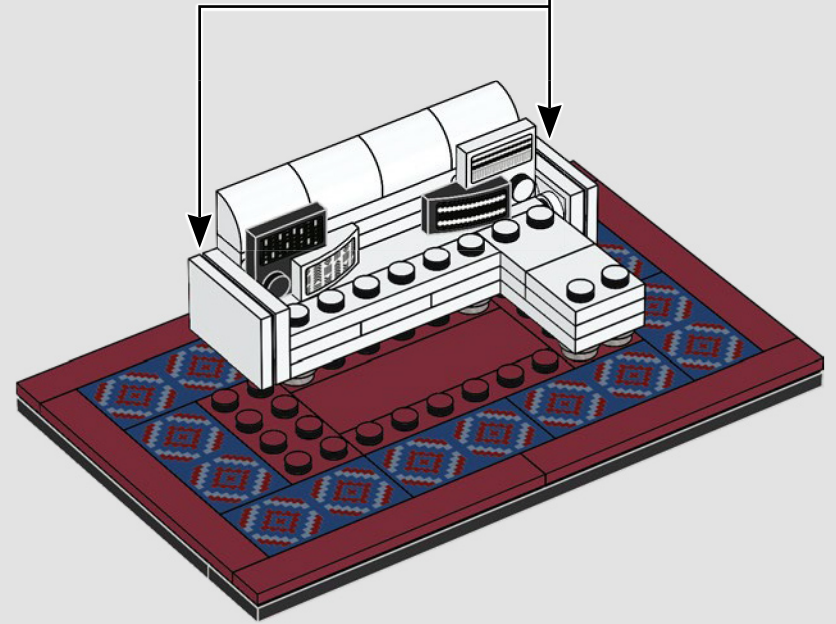
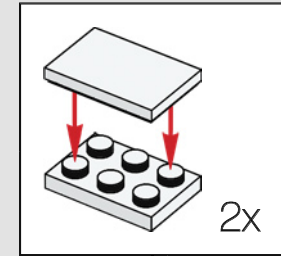

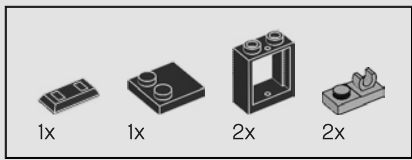

20

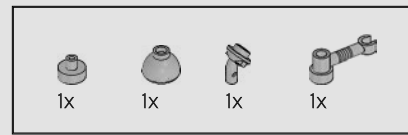
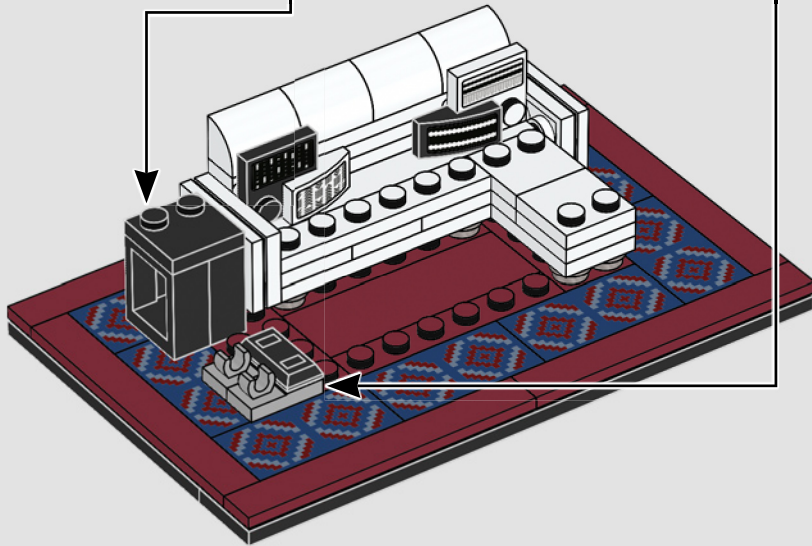
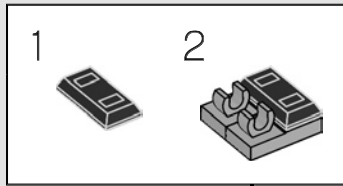
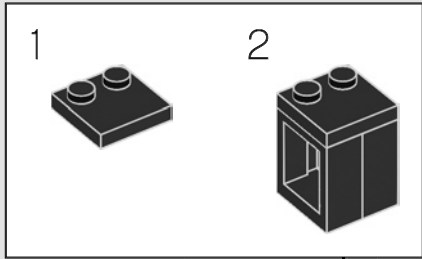

21

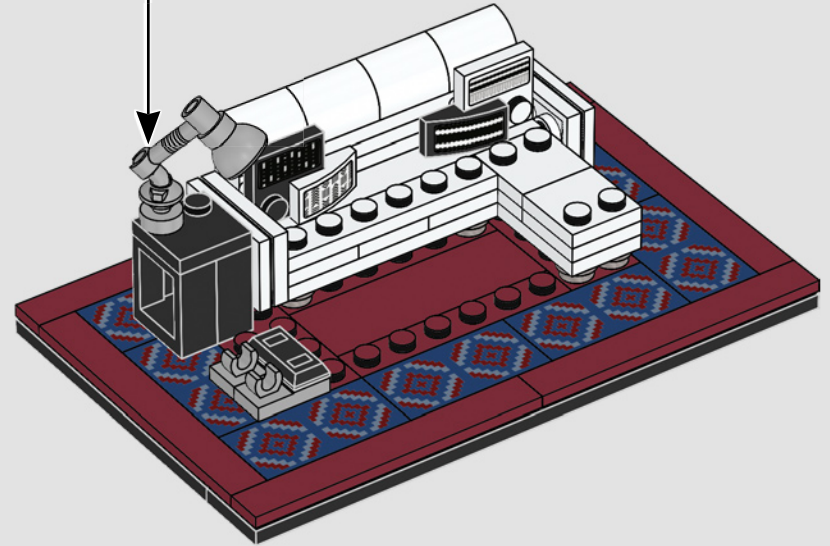
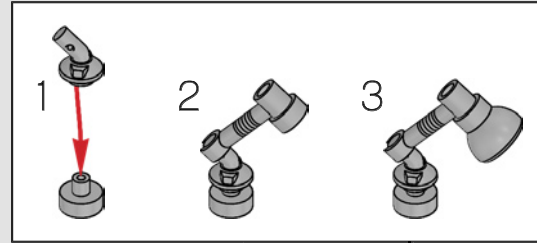

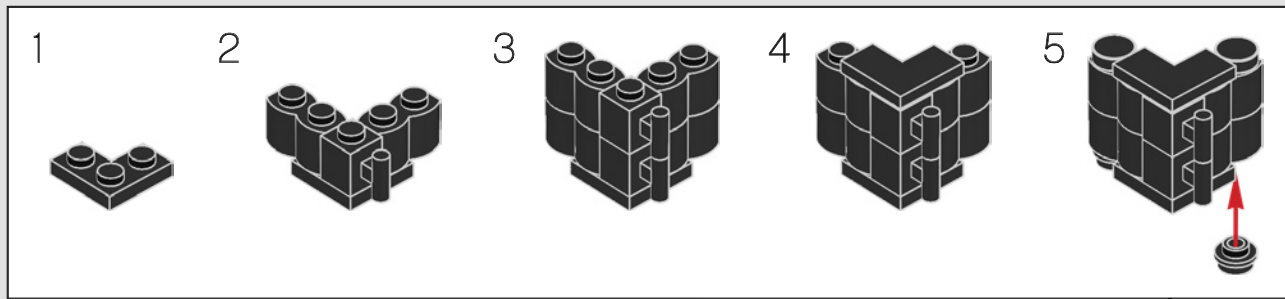
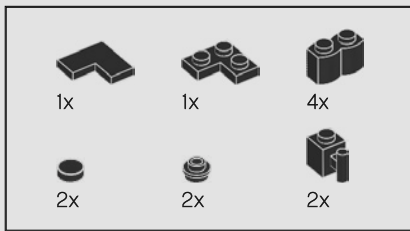

22

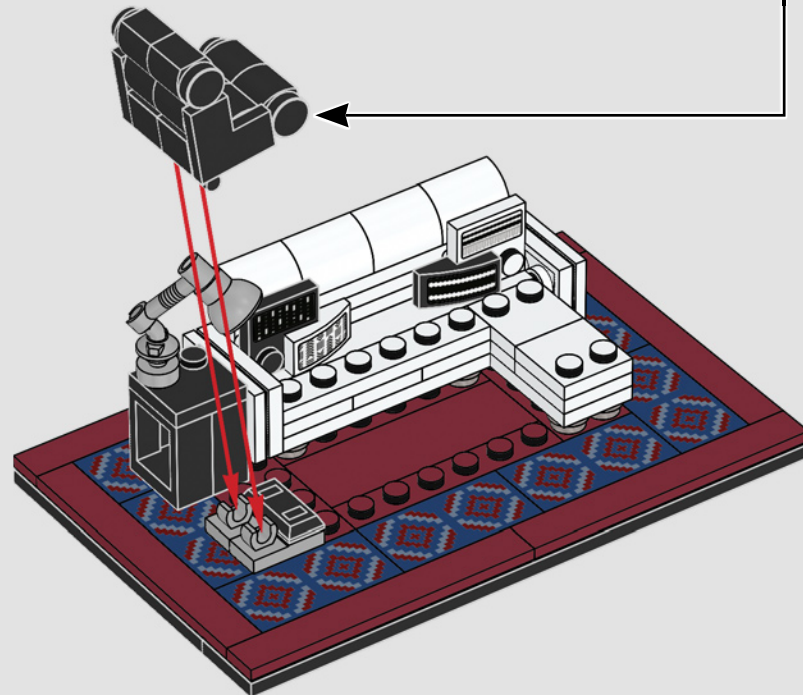

Tan France

„Ich liebe kreative Prozesse. LEGO® Sets sind perfekt, um diese Kreativität zu entfesseln, denn man kann alles bauen, was man will. Und das im eigenen Stil.“

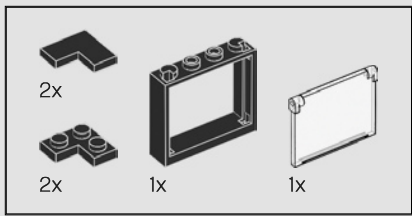

23

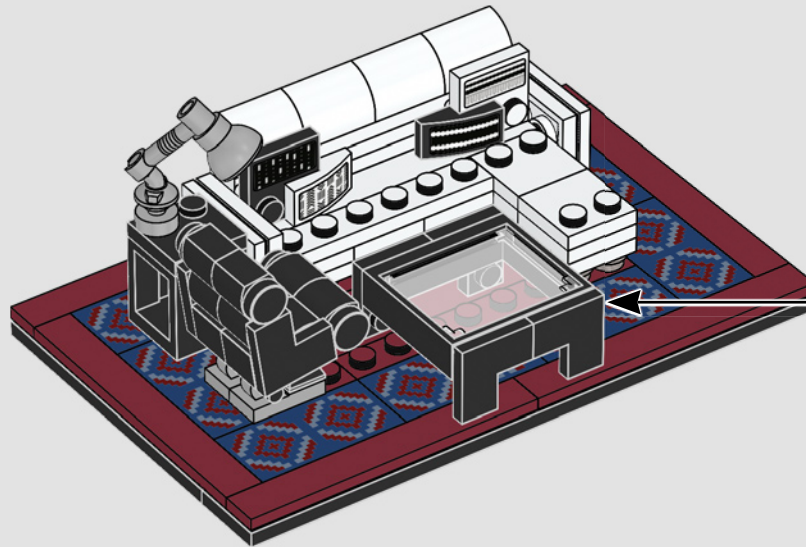
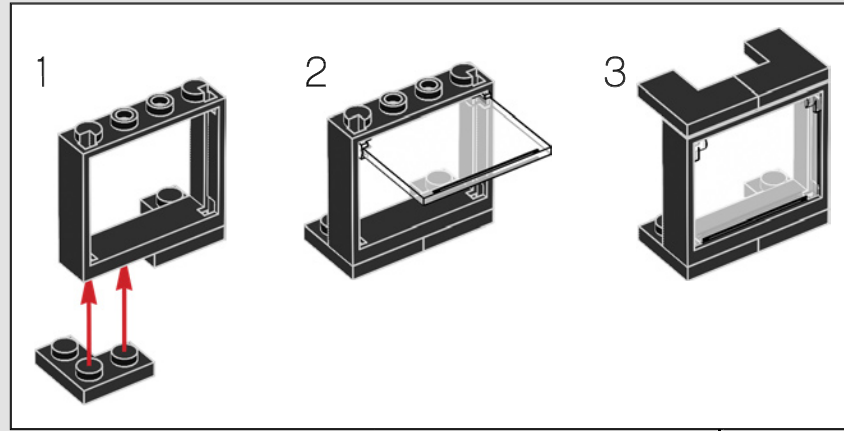

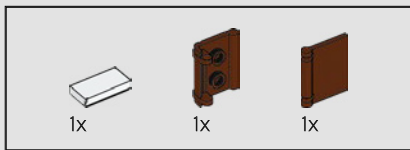

24



Karamo Brown

„Dieses Set weckt so viele glückliche Erinnerungen. Es ist so, als wäre ich geschrumpft und könnte nun im Minifigur-Maßstab noch einmal die ganze Serie erleben!“

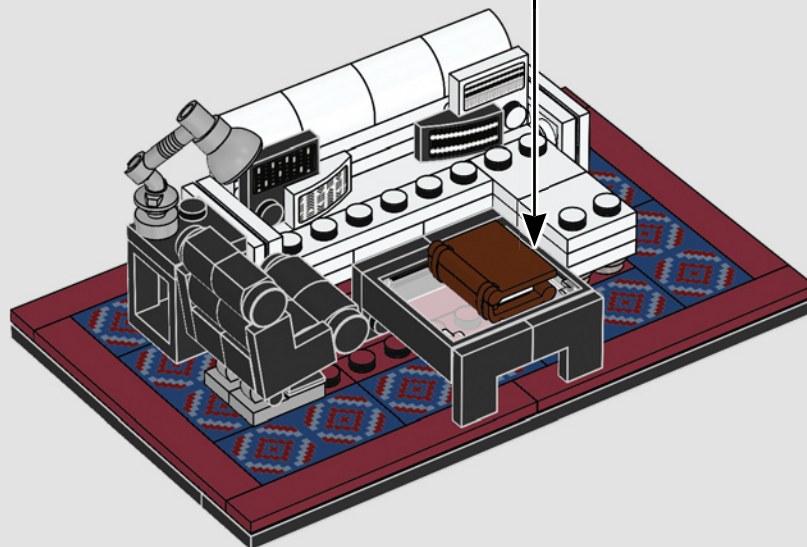
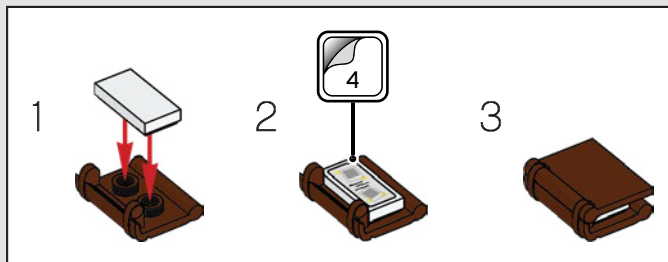

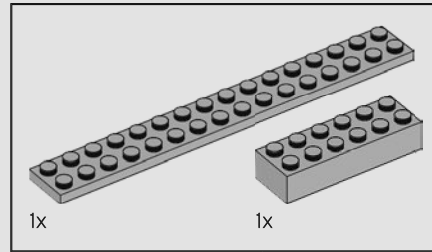
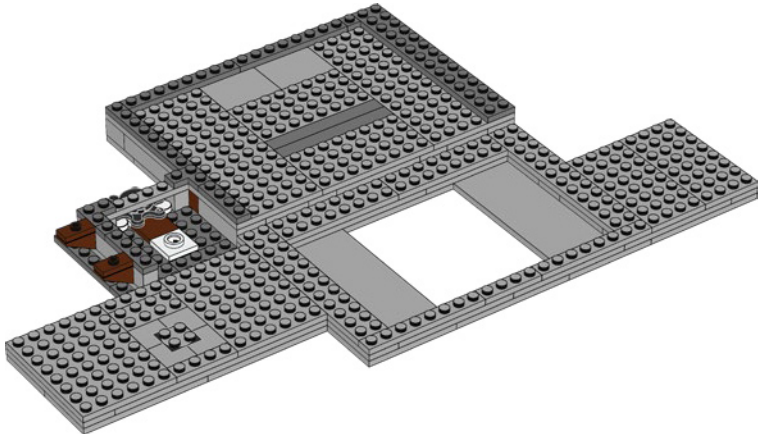
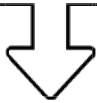

1

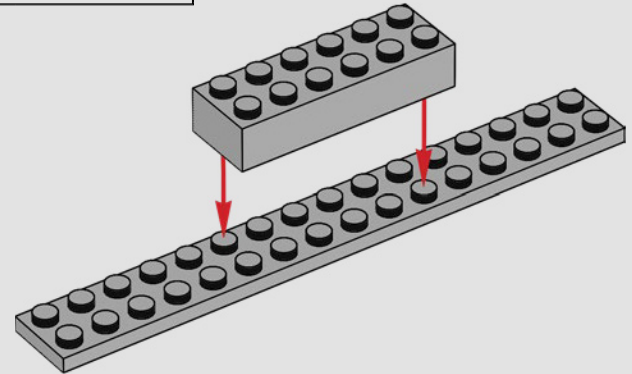

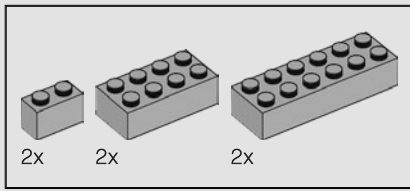

2

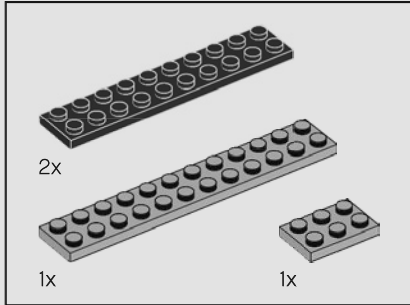
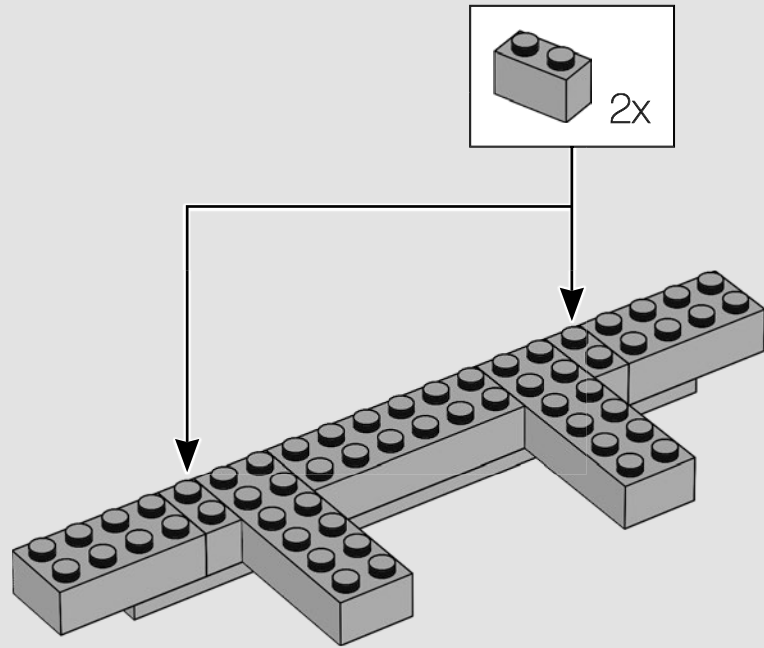

3

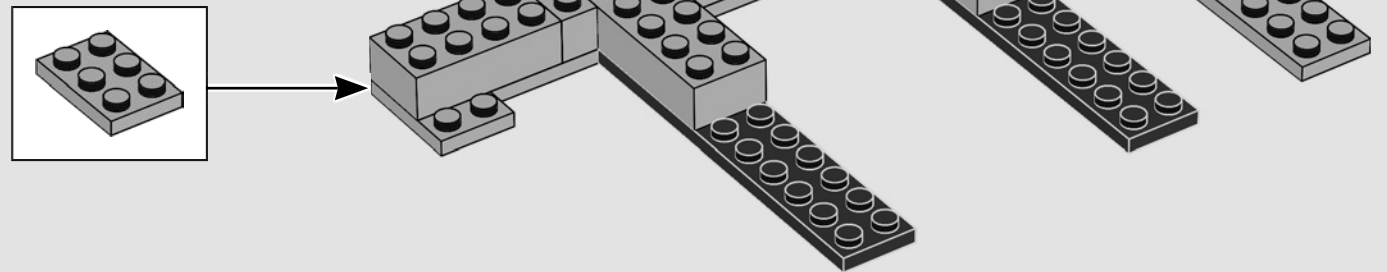

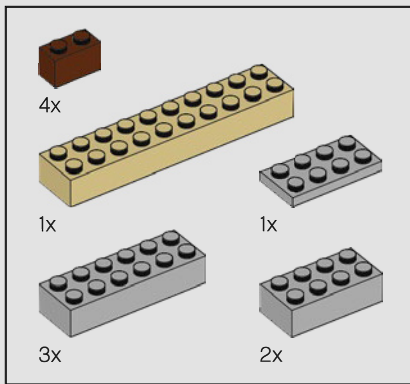

4

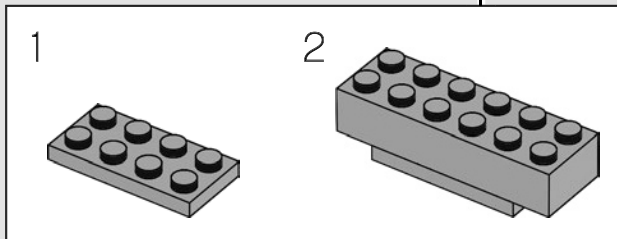
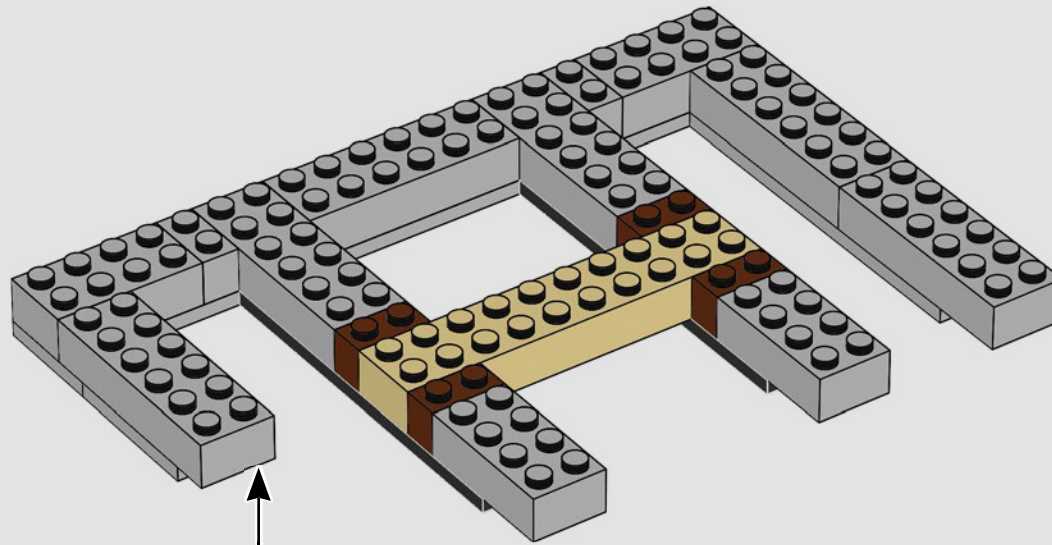

Karamo Brown

„Queer Eye ist wegen der Menschen so besonders: die fantastischen Leute, mit denen ich jeden Tag arbeite, und die wunderbaren Lebensweisen, mit denen ich in der Serie in Kontakt komme und die ich mit der ganzen Welt teile.“

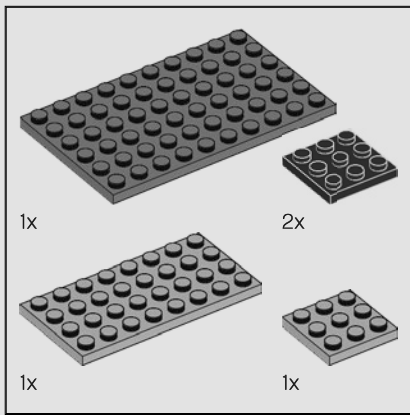

5

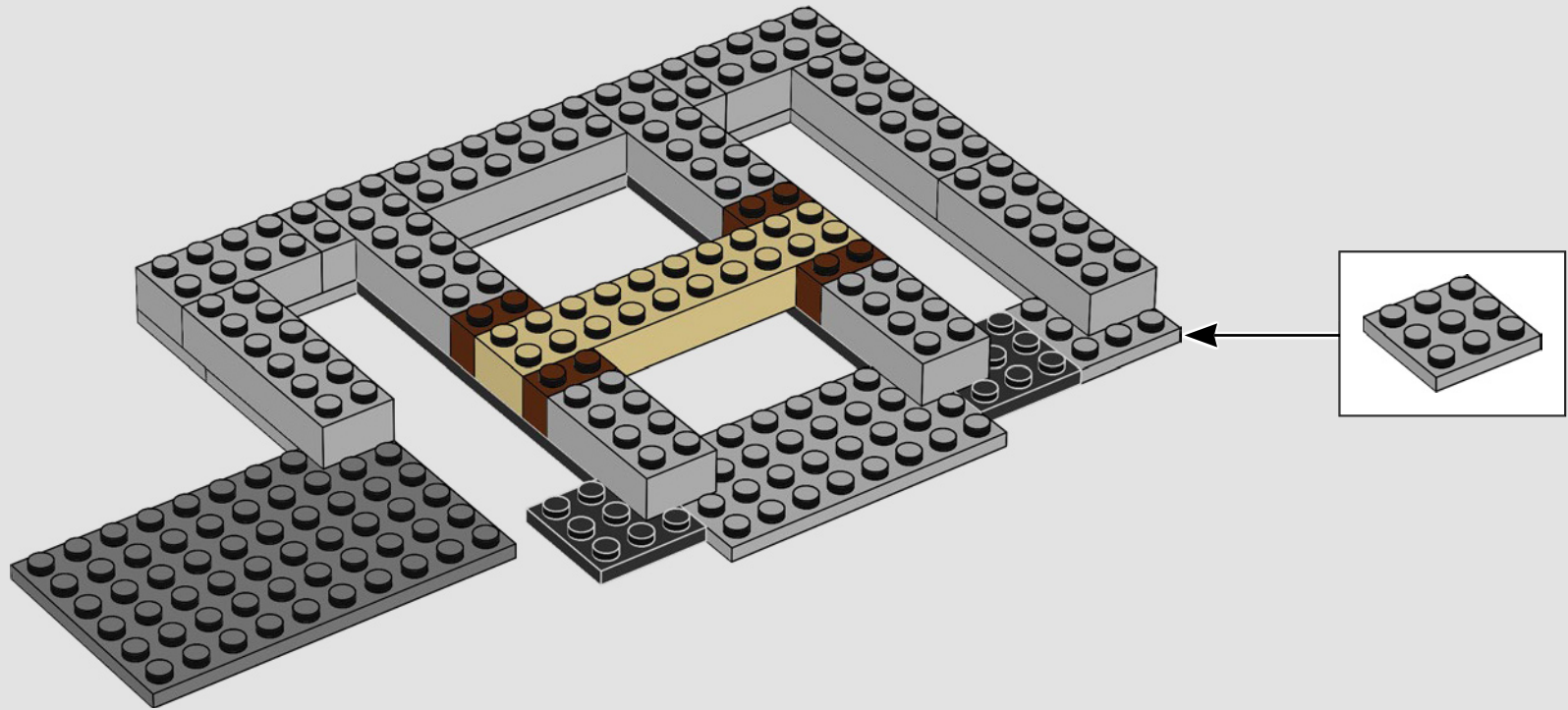

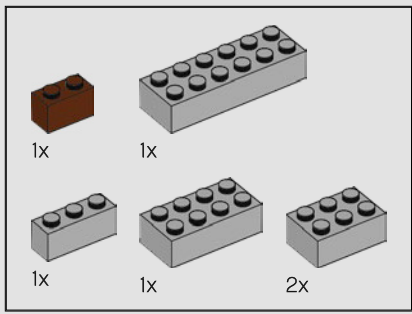

6

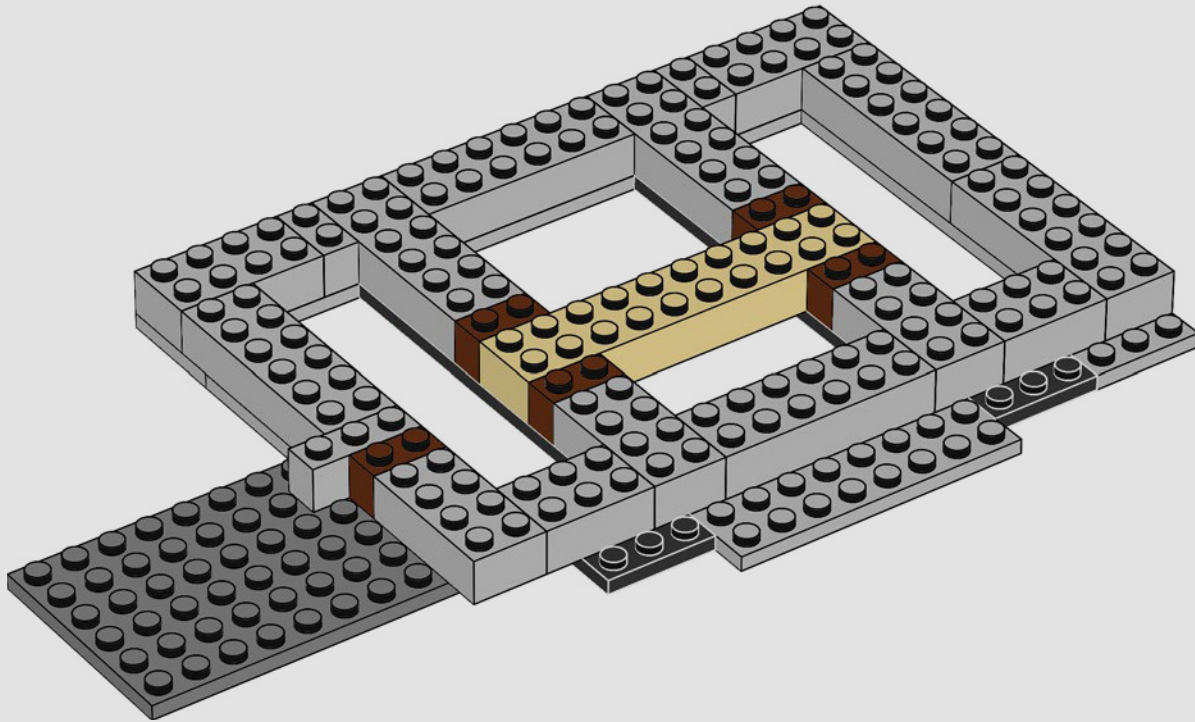

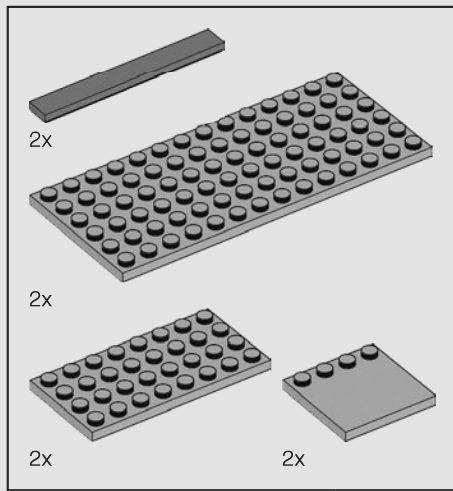

7

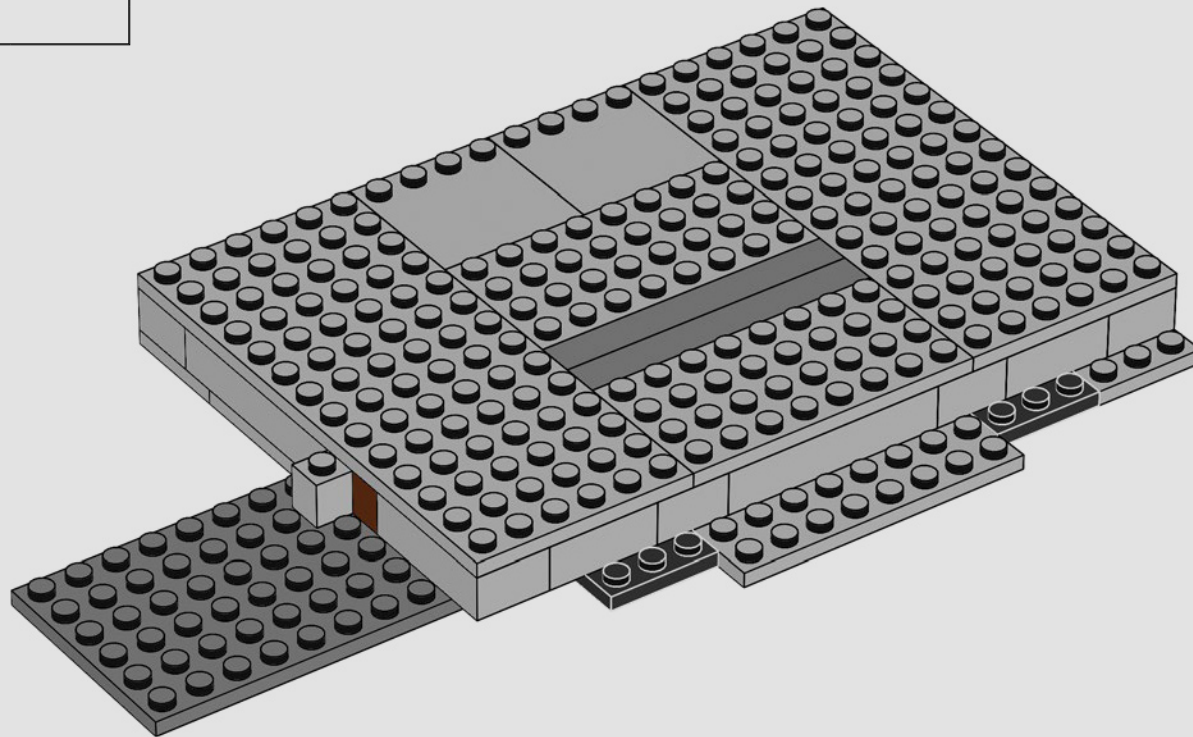

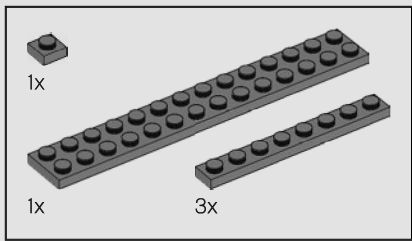

8

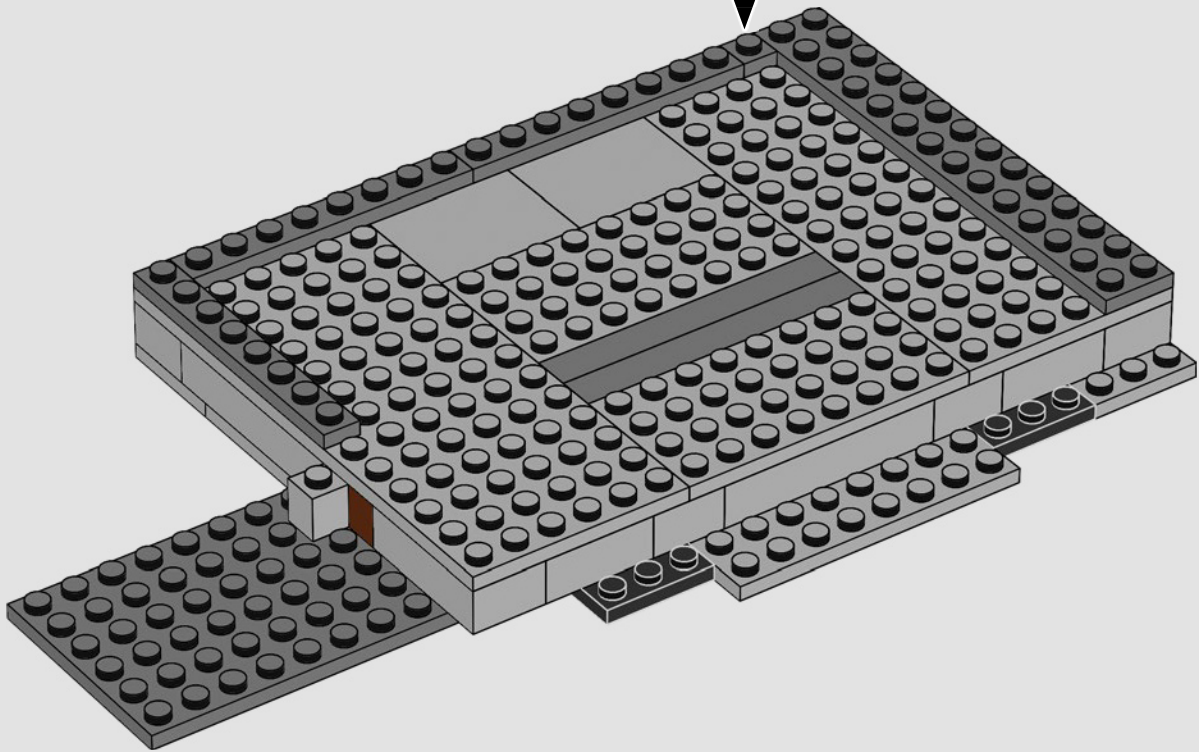
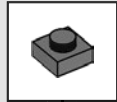

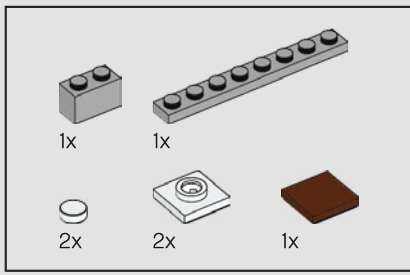

9

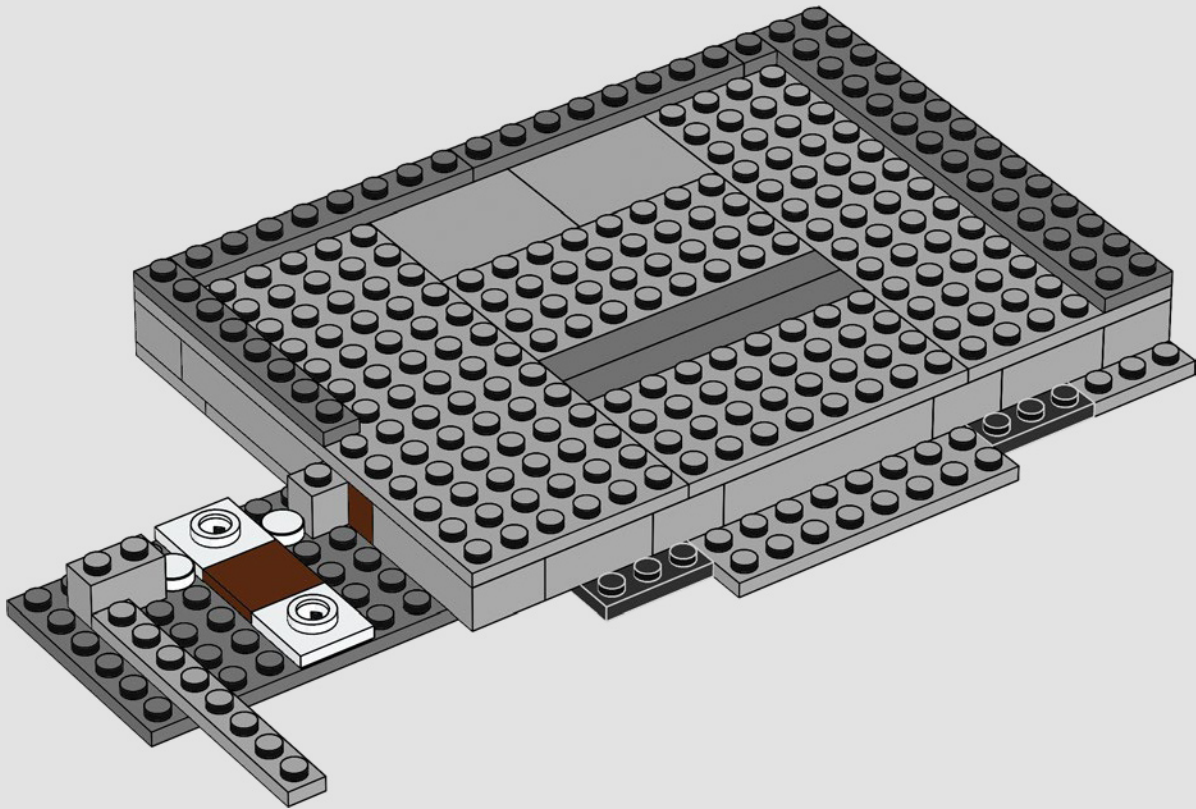

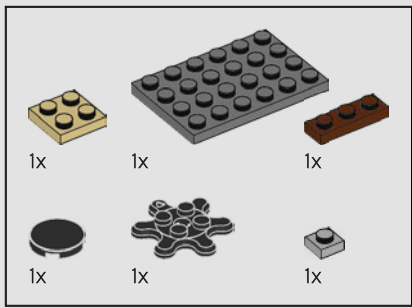

10

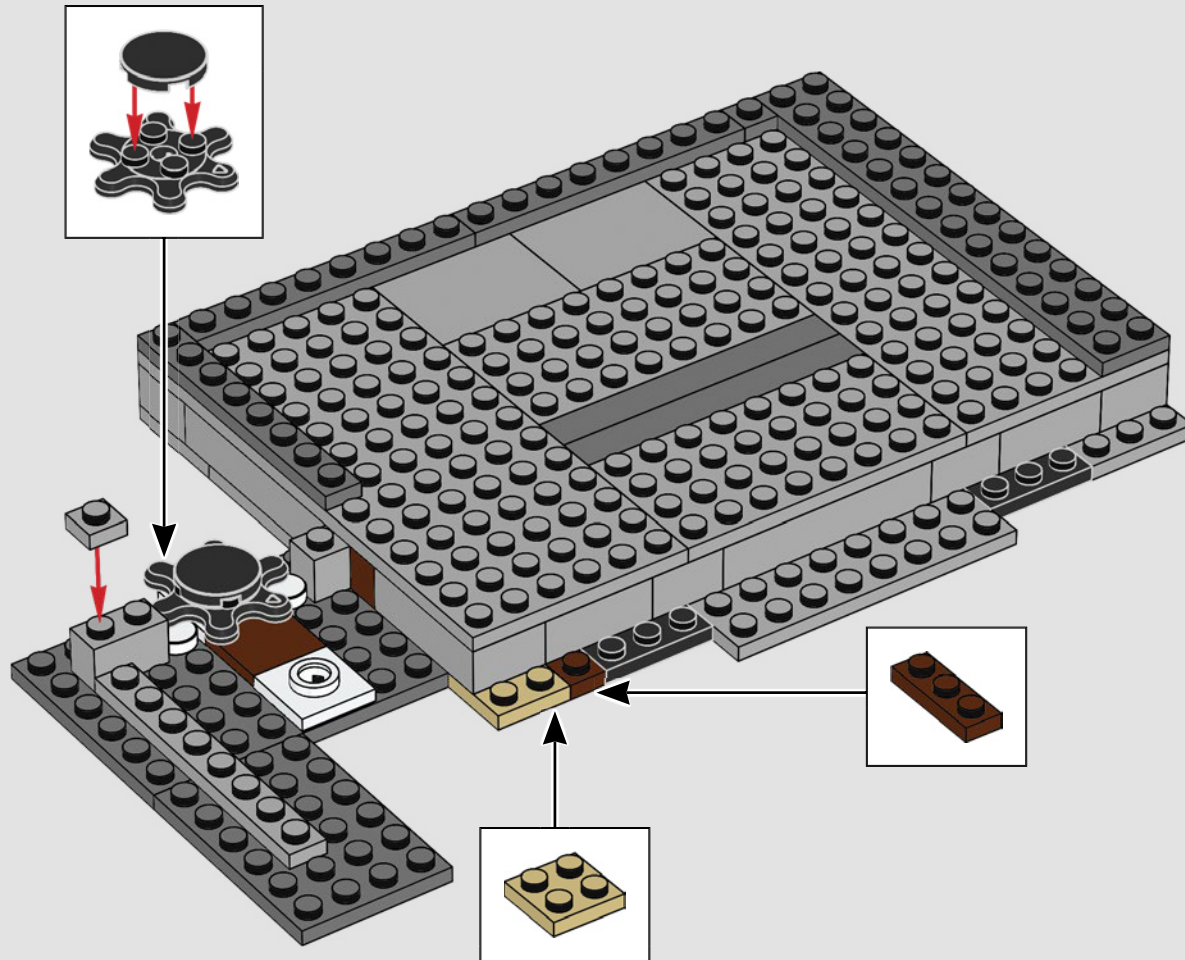

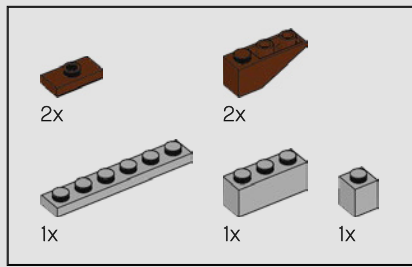

11

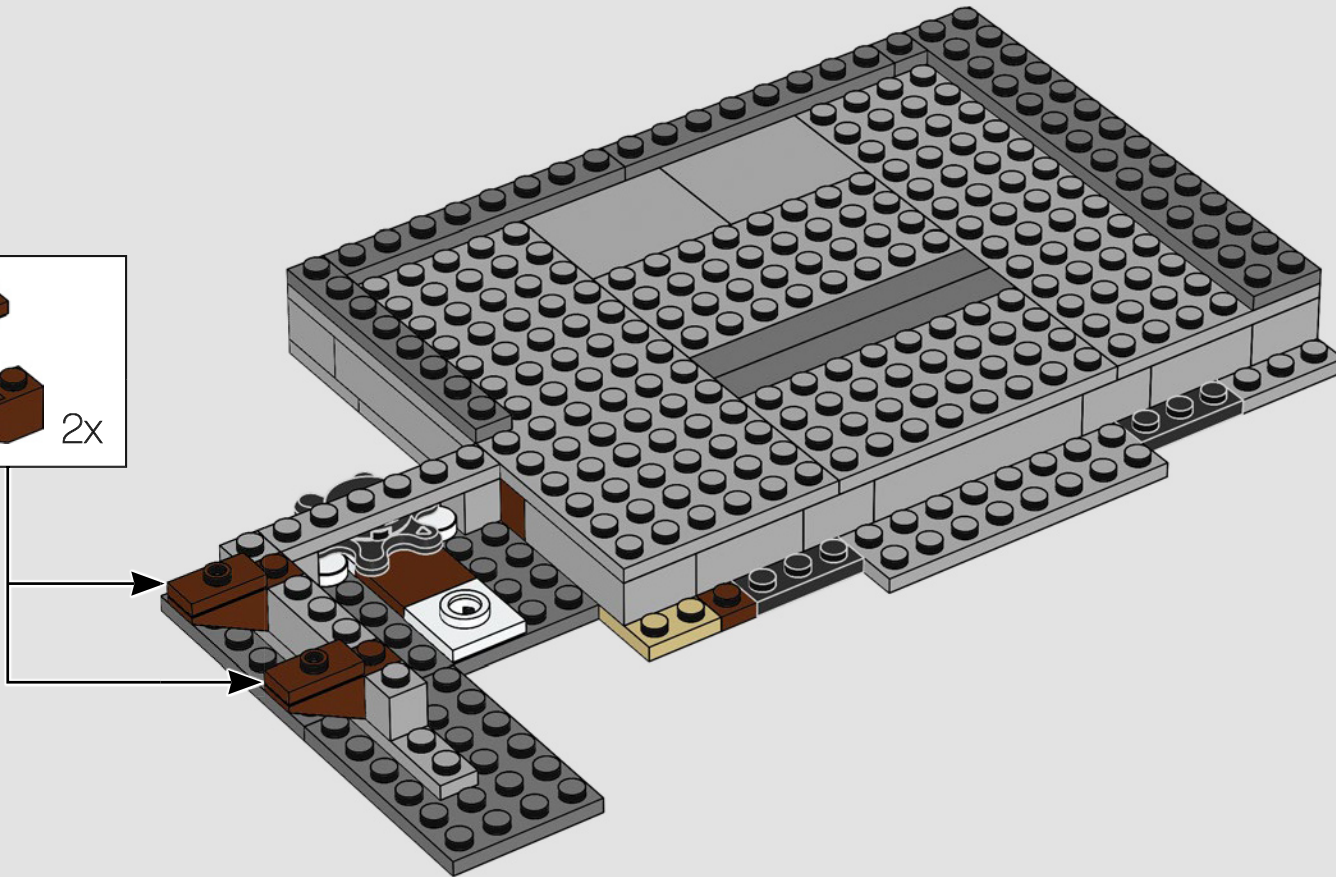
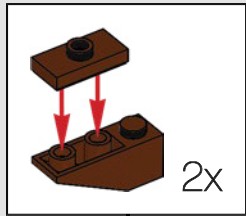

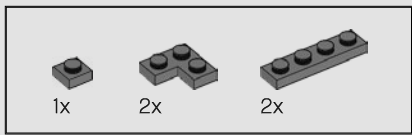

12

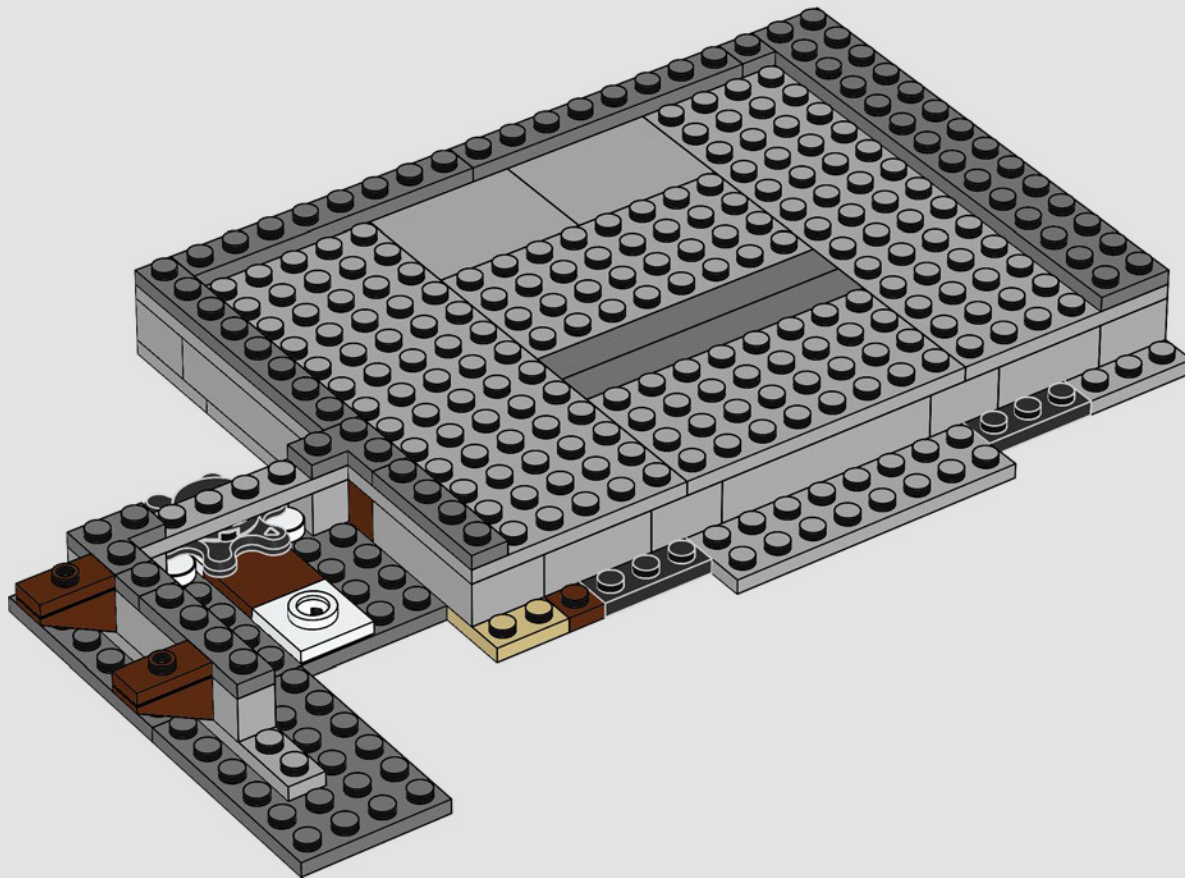

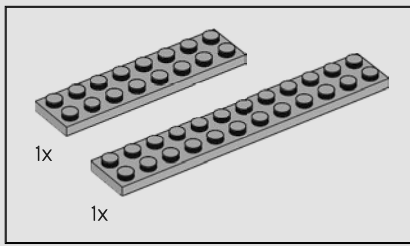

13

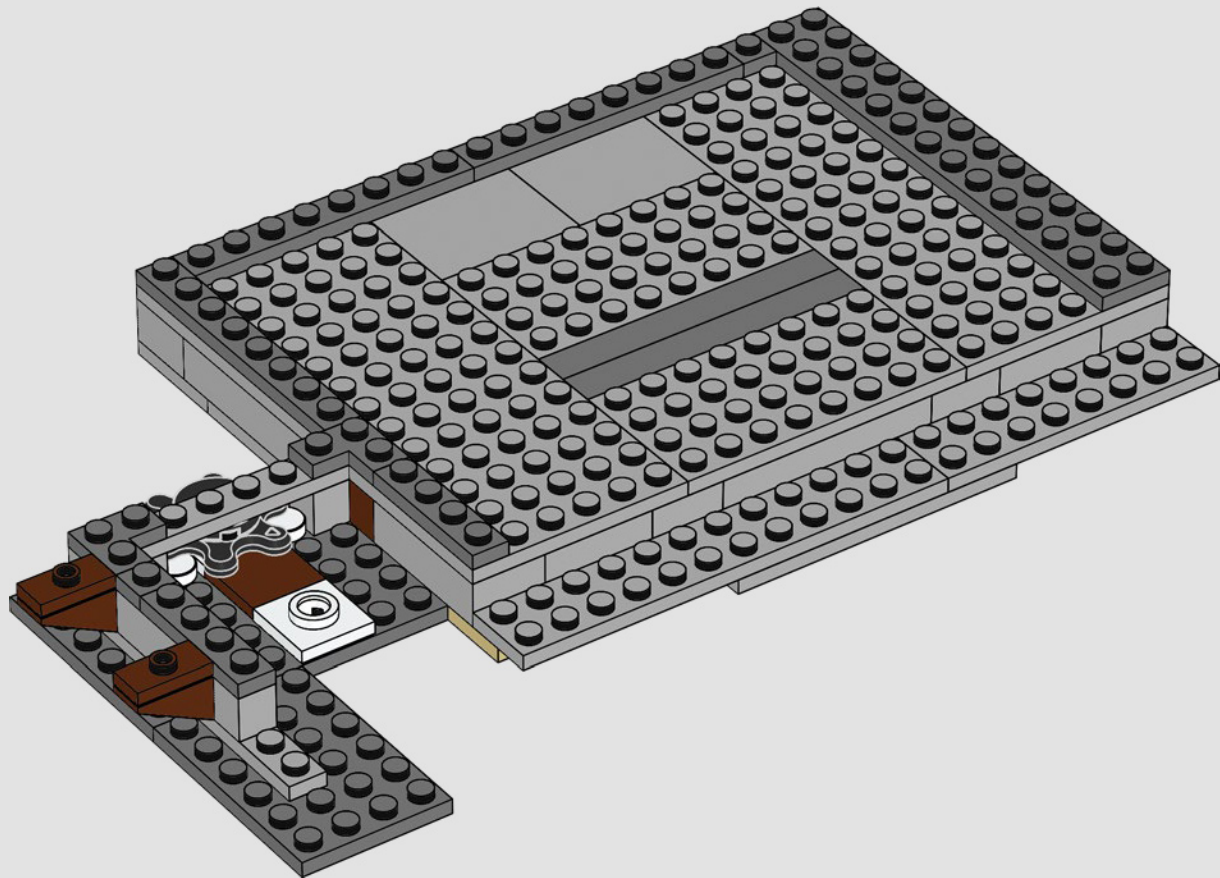

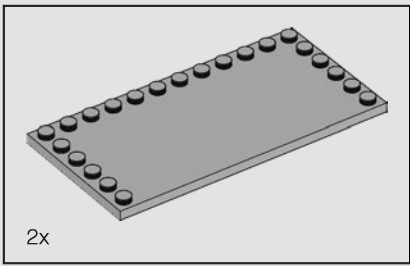

14

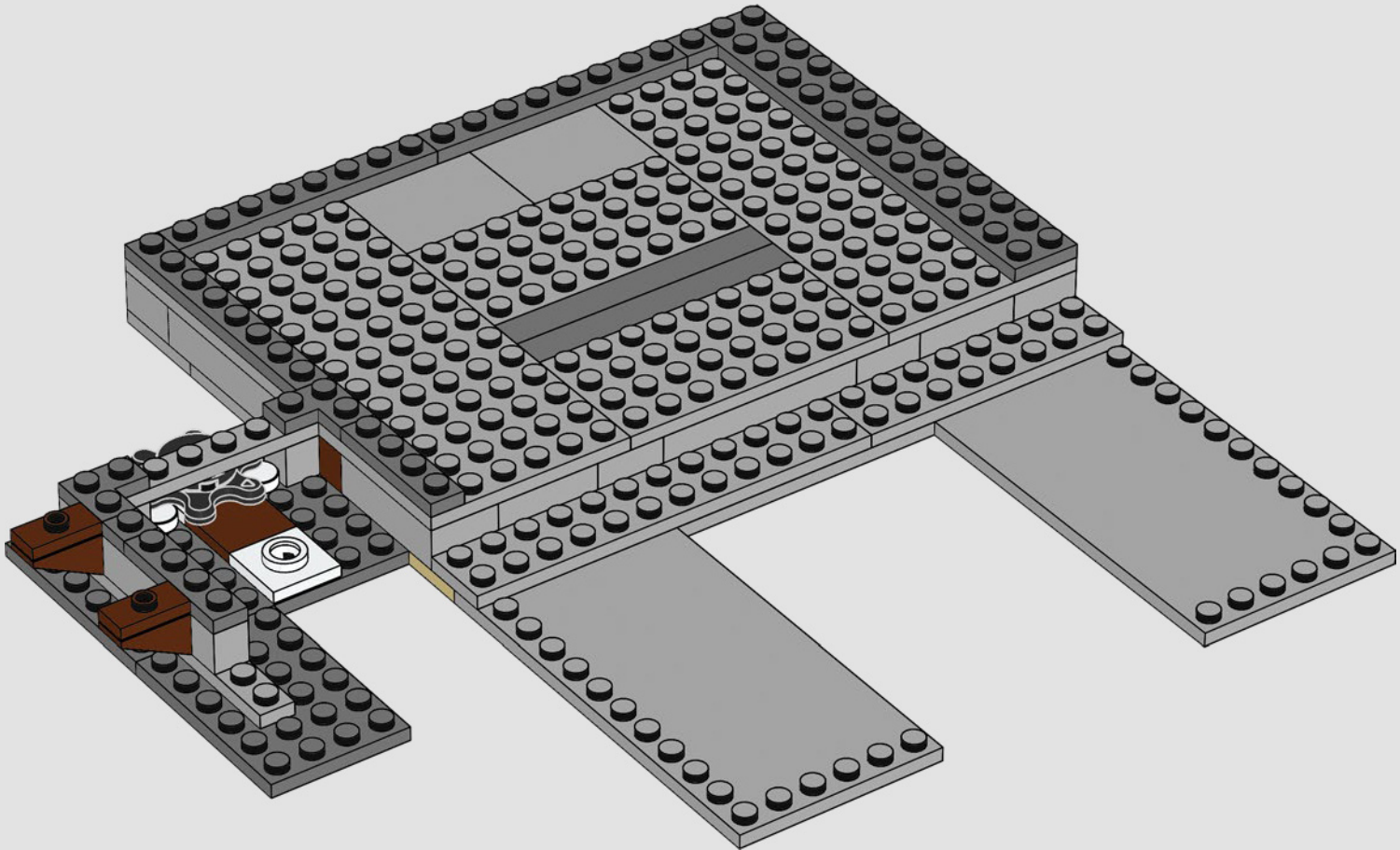

Jonathan Van Ness

„Mit Queer Eye möchte ich ein Vermächtnis des Zusammenhalts und des Verständnisses erschaffen, das sich nicht nur auf die Menschen in unserem näherem Umfeld beschränkt, sondern auch dazu beiträgt, dass wir uns selbst verstehen und akzeptieren.“

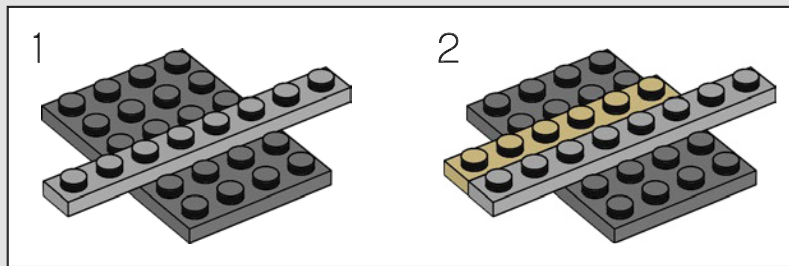
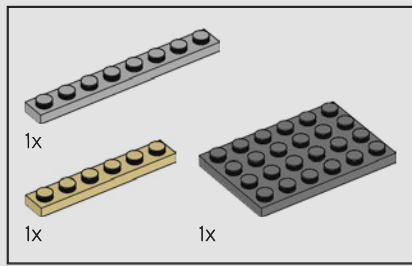

15

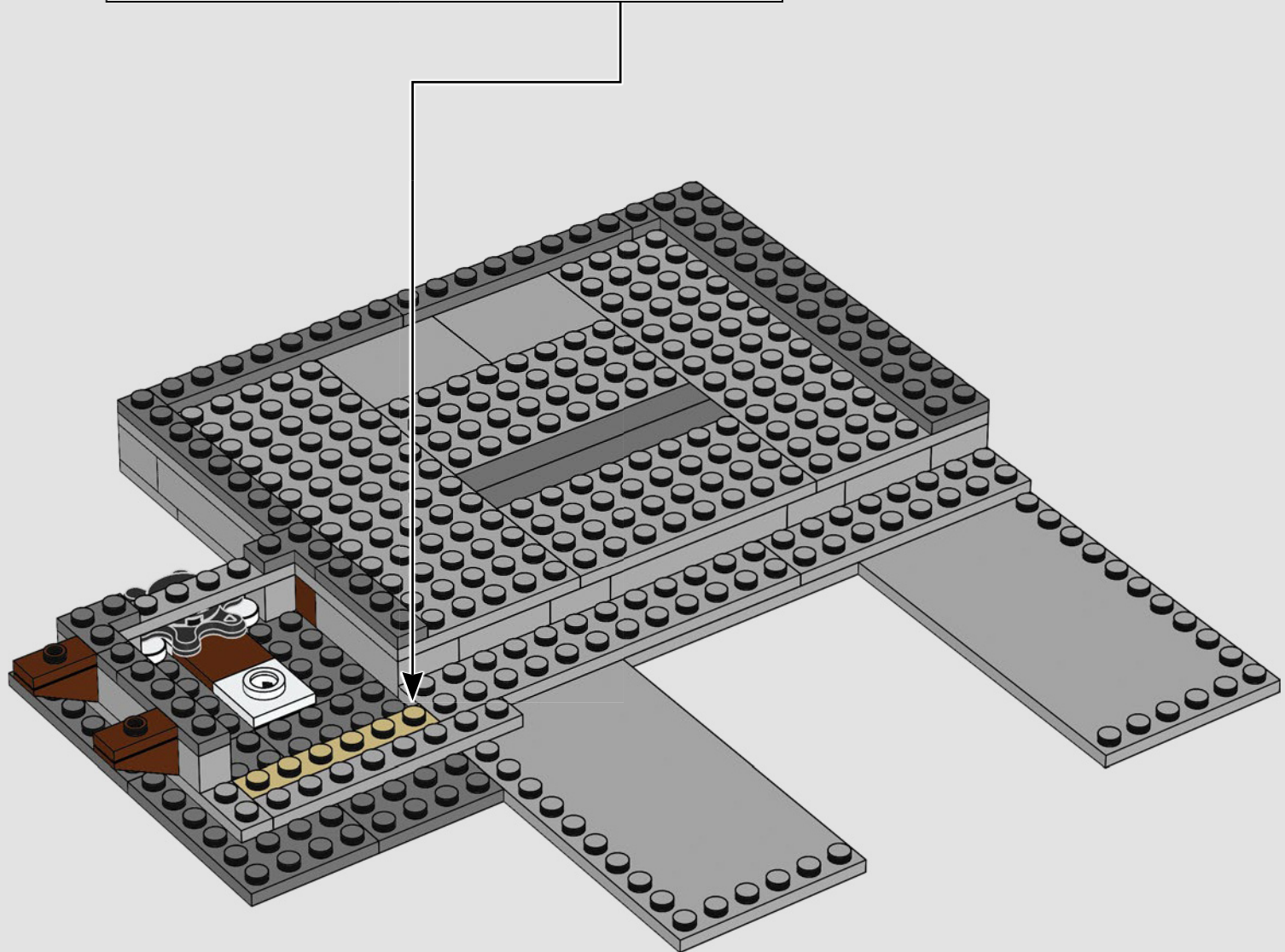

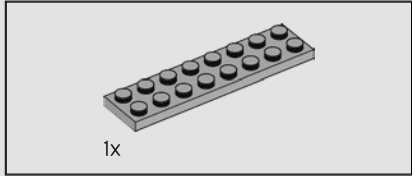
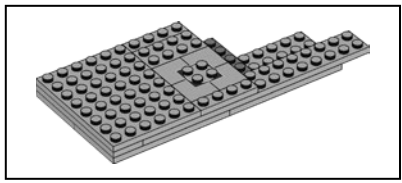

16

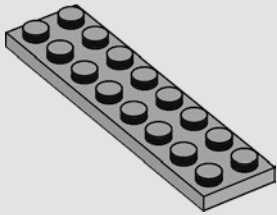

17

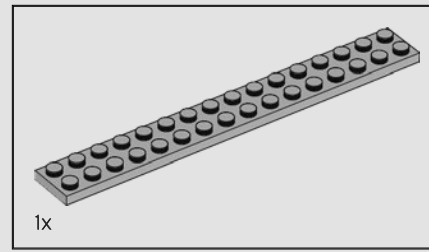
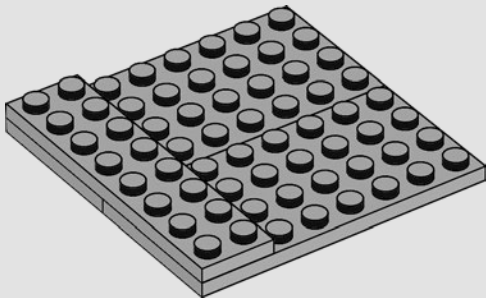

18

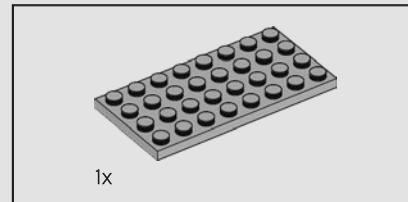
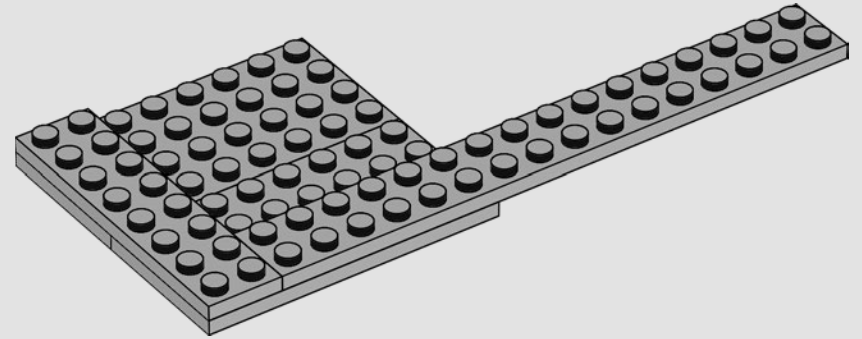

19

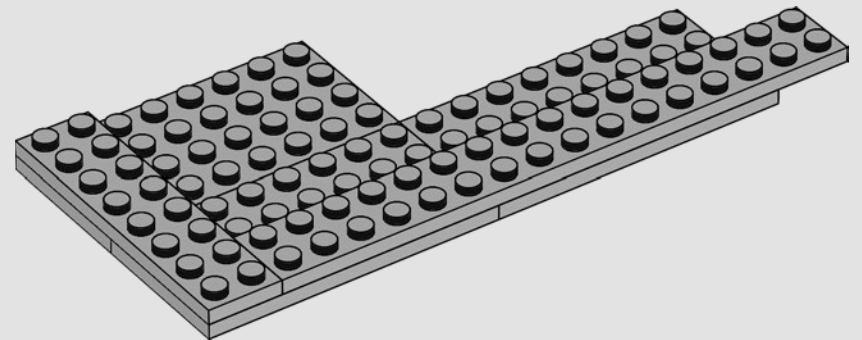

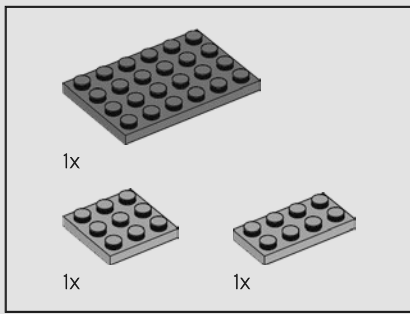

20

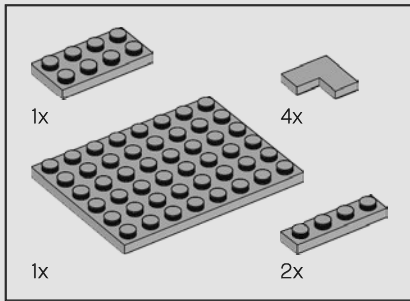
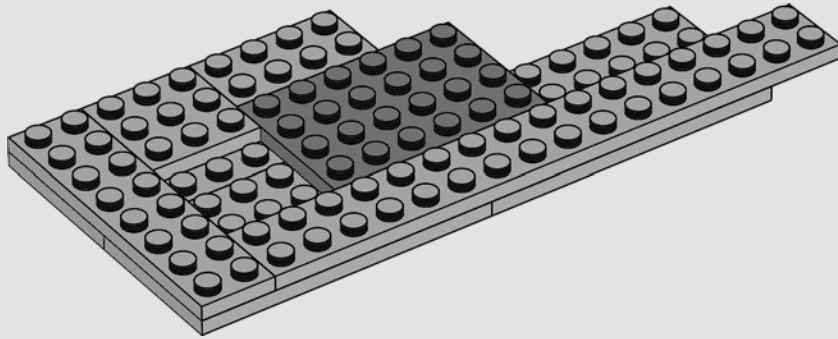

21

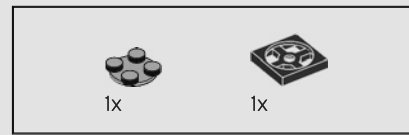
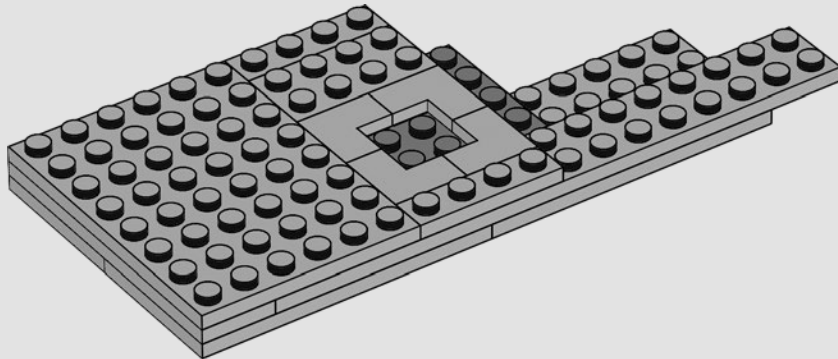

22

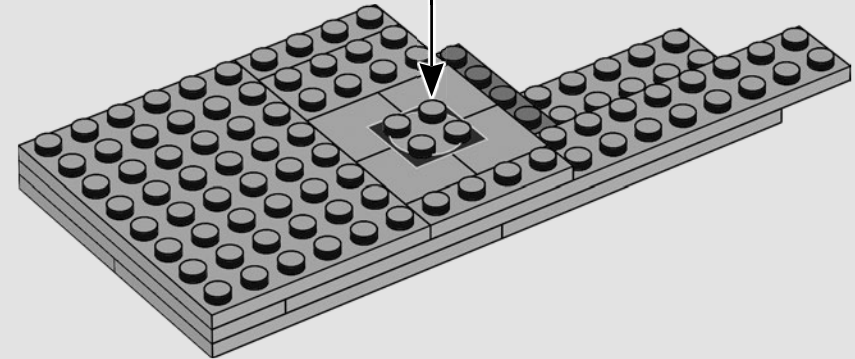
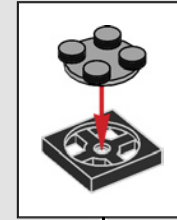



Karamo Brown

„LEGO® Sets sind für mich und meine Familie etwas ganz Besonderes. Die LEGO Sets haben meine Jungs nicht nur stundenlang beschäftigt, sondern mich auch eine noch engere Verbindung zu ihnen aufbauen lassen.“

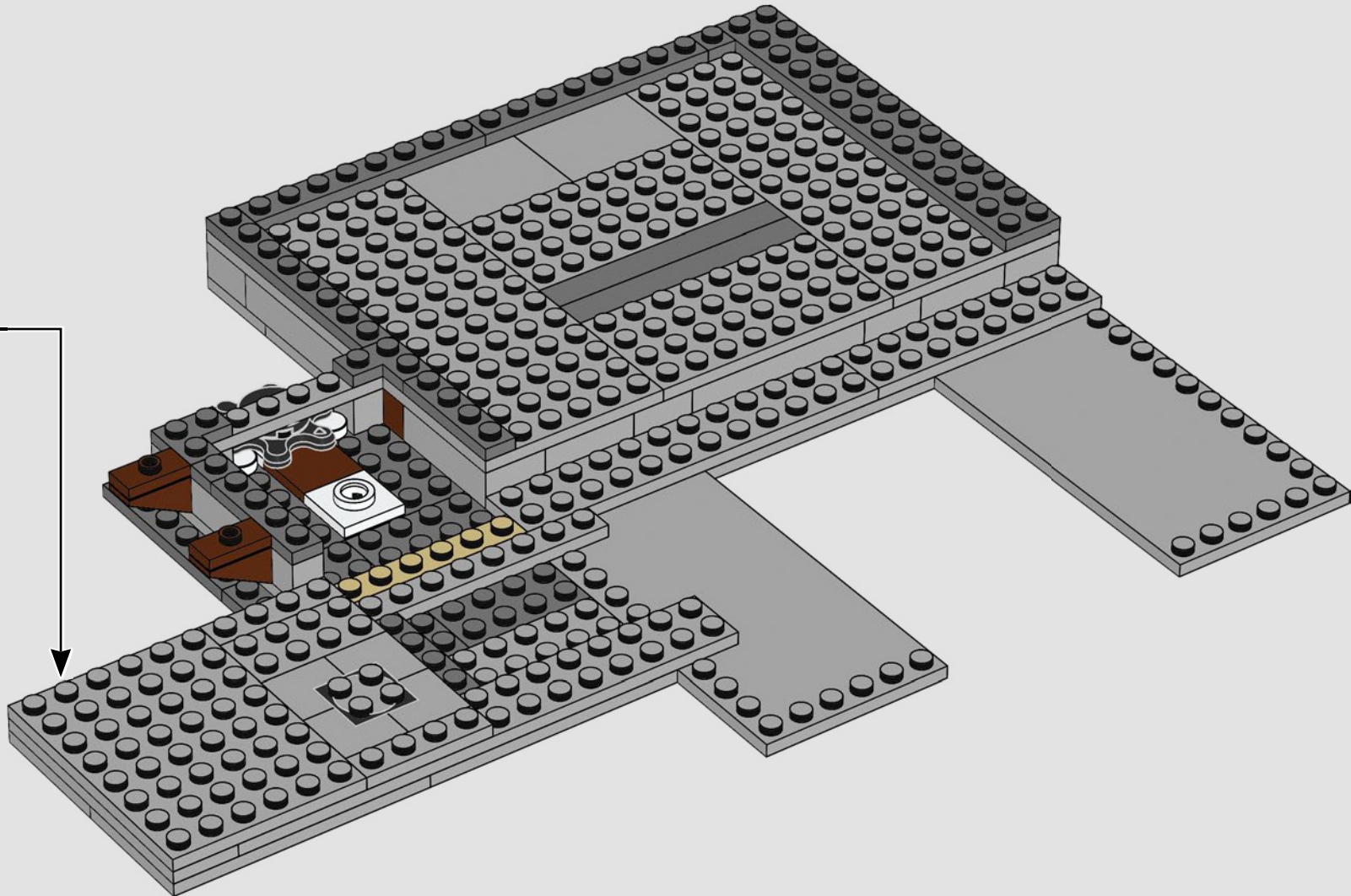

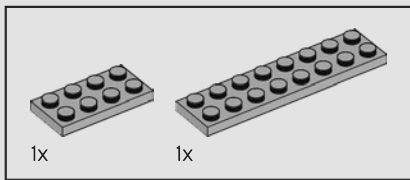

24

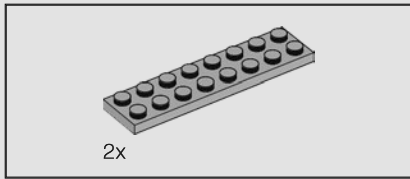
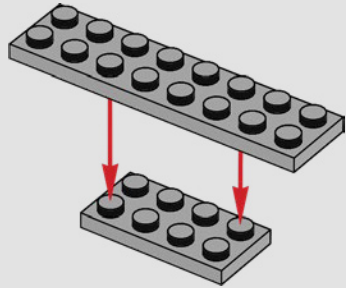

25

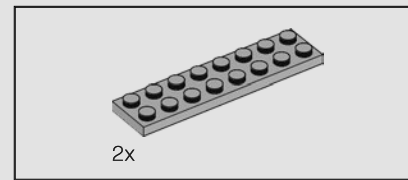
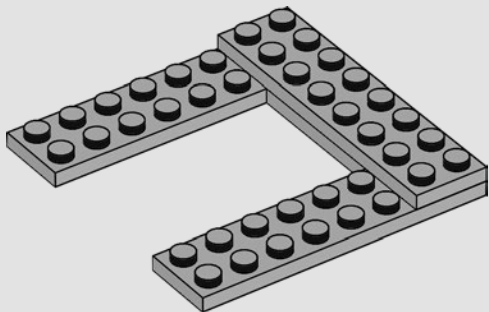

26

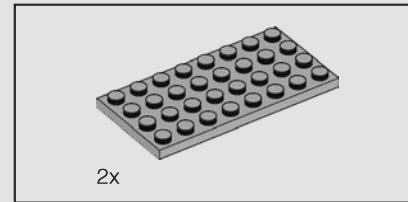
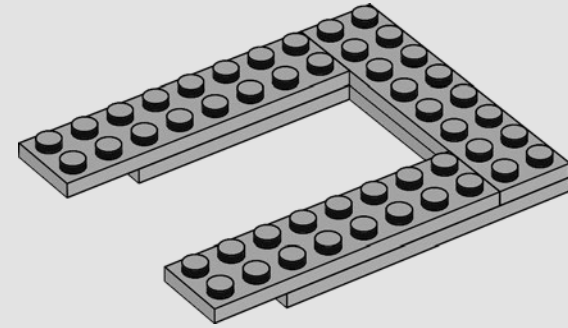

27

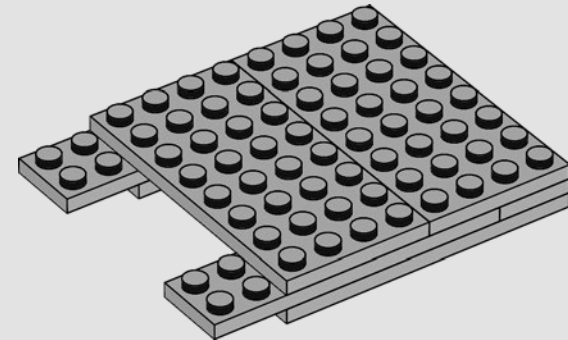

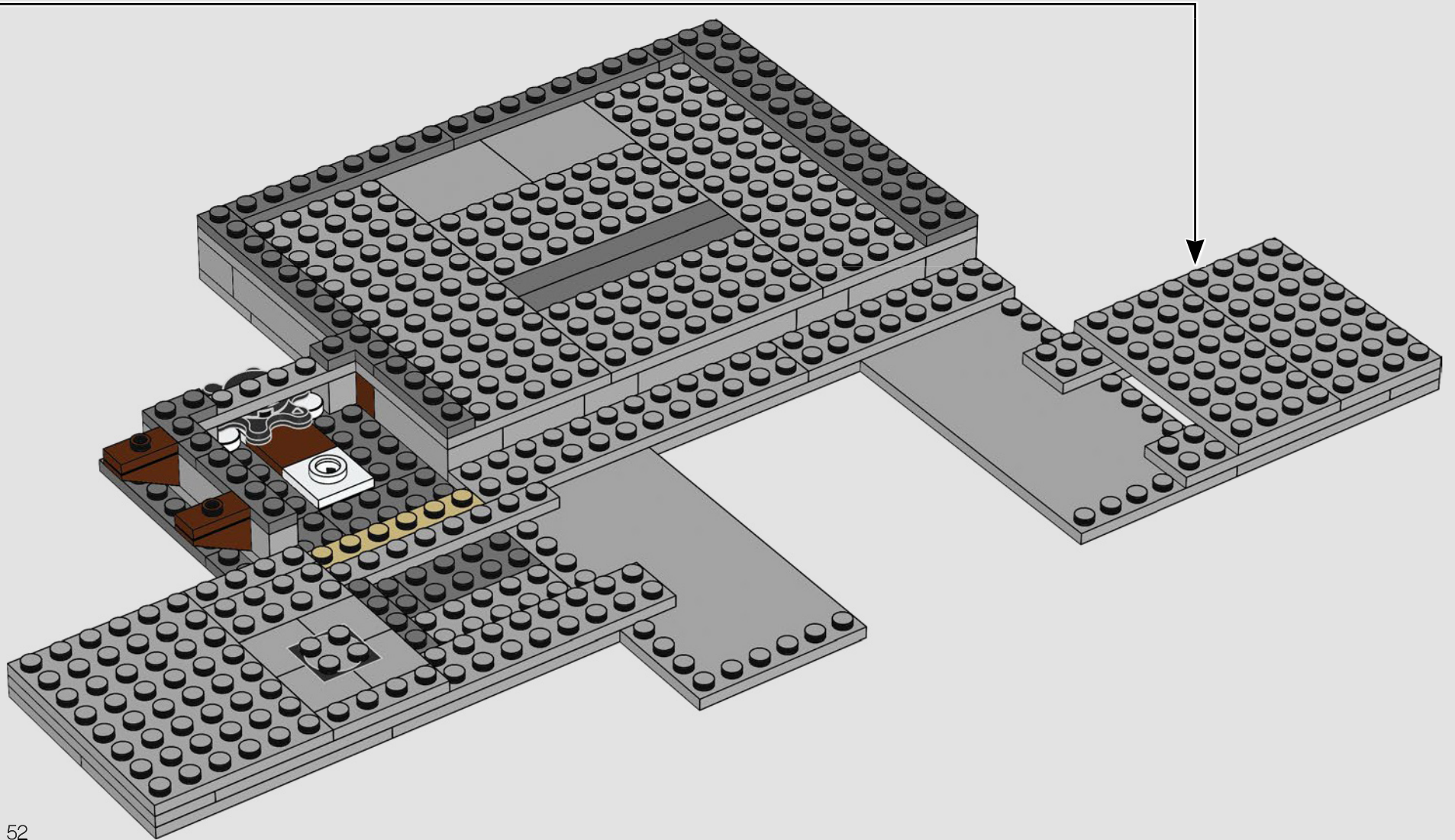

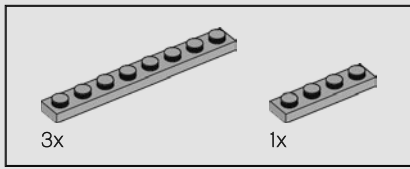

29

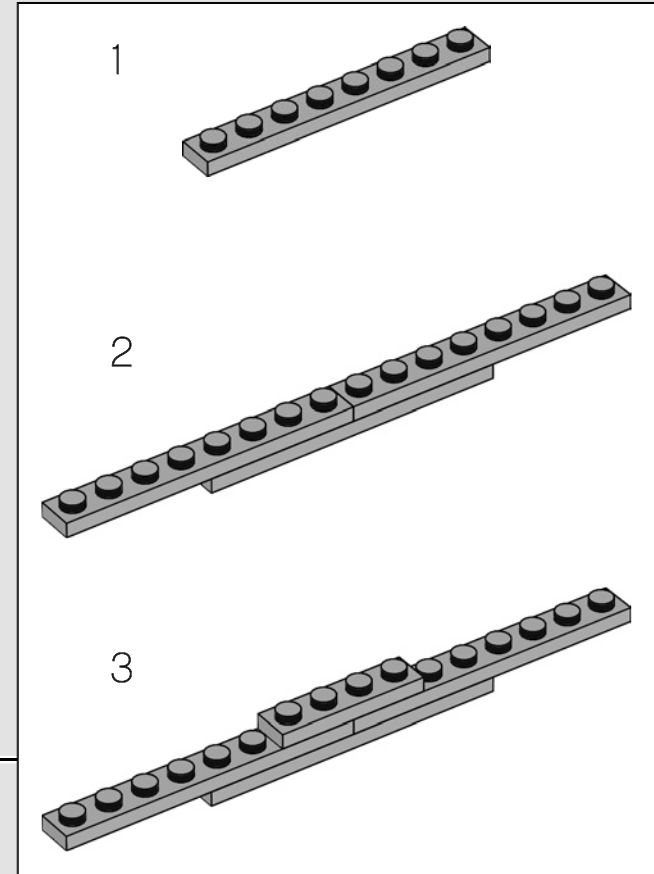
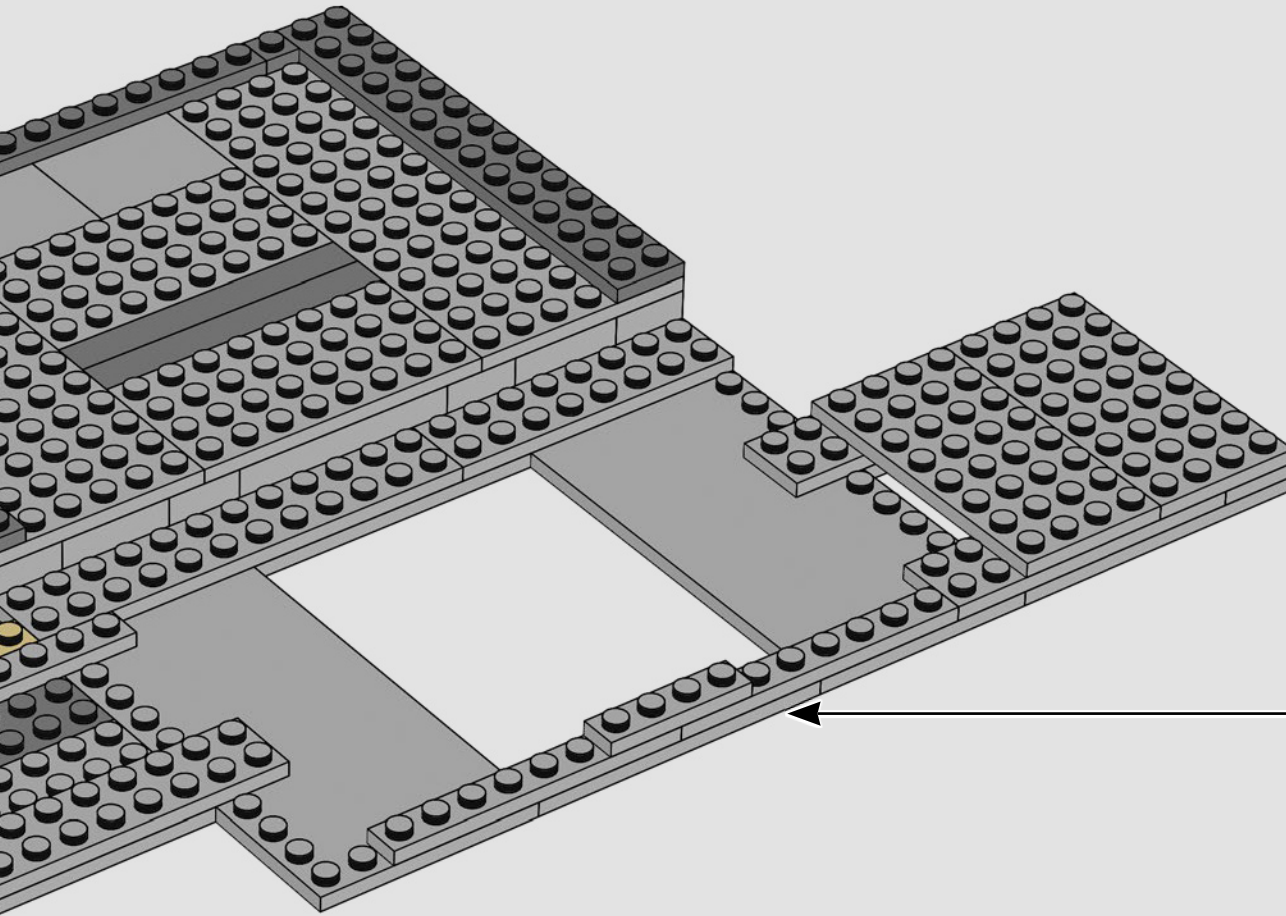

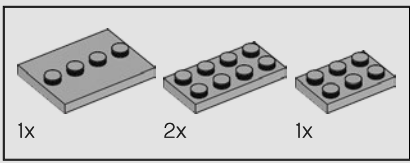

30

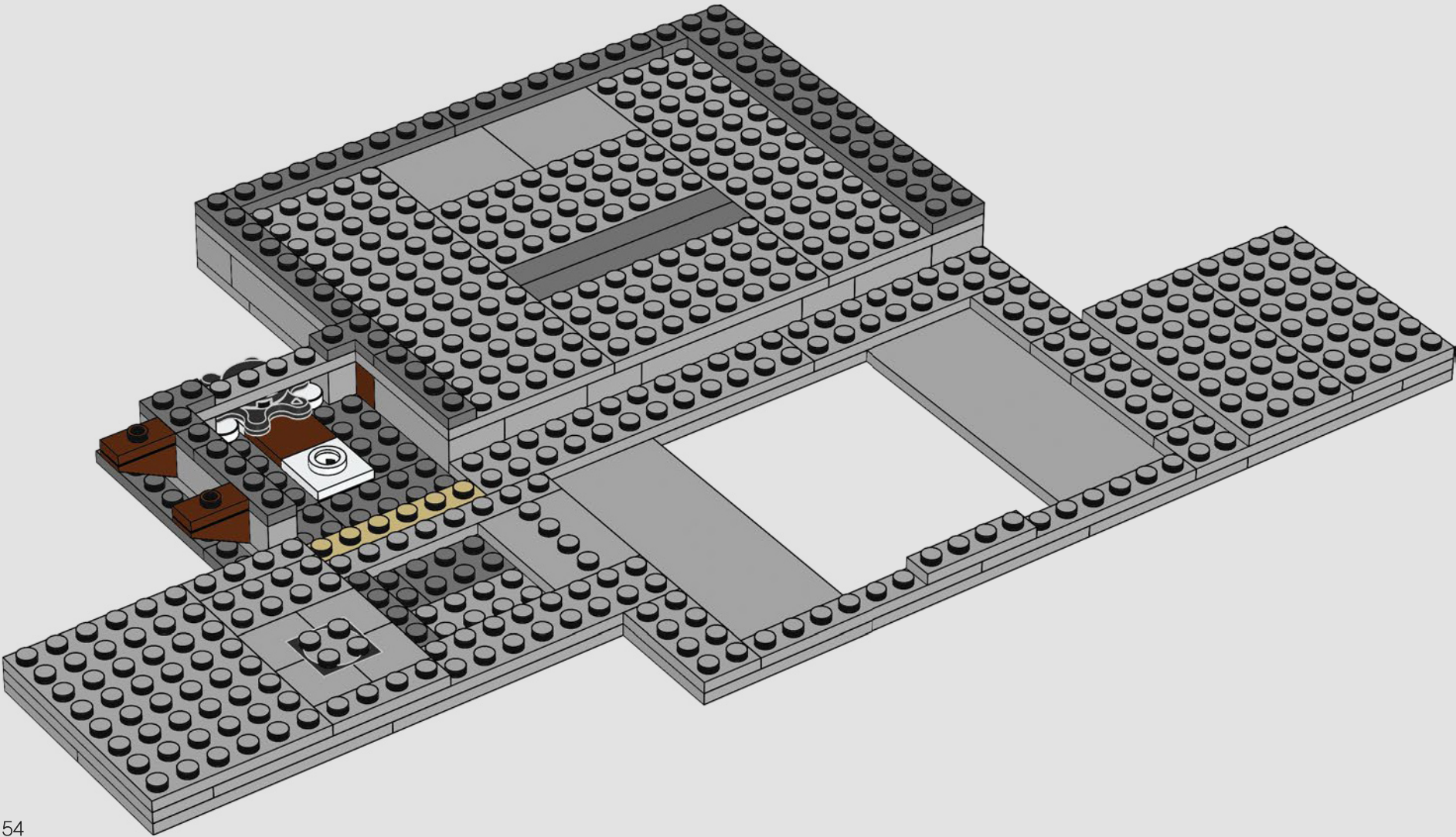

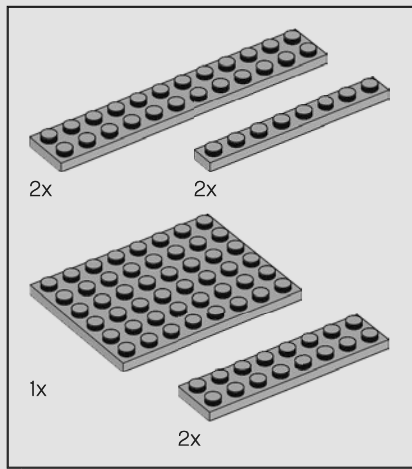

31

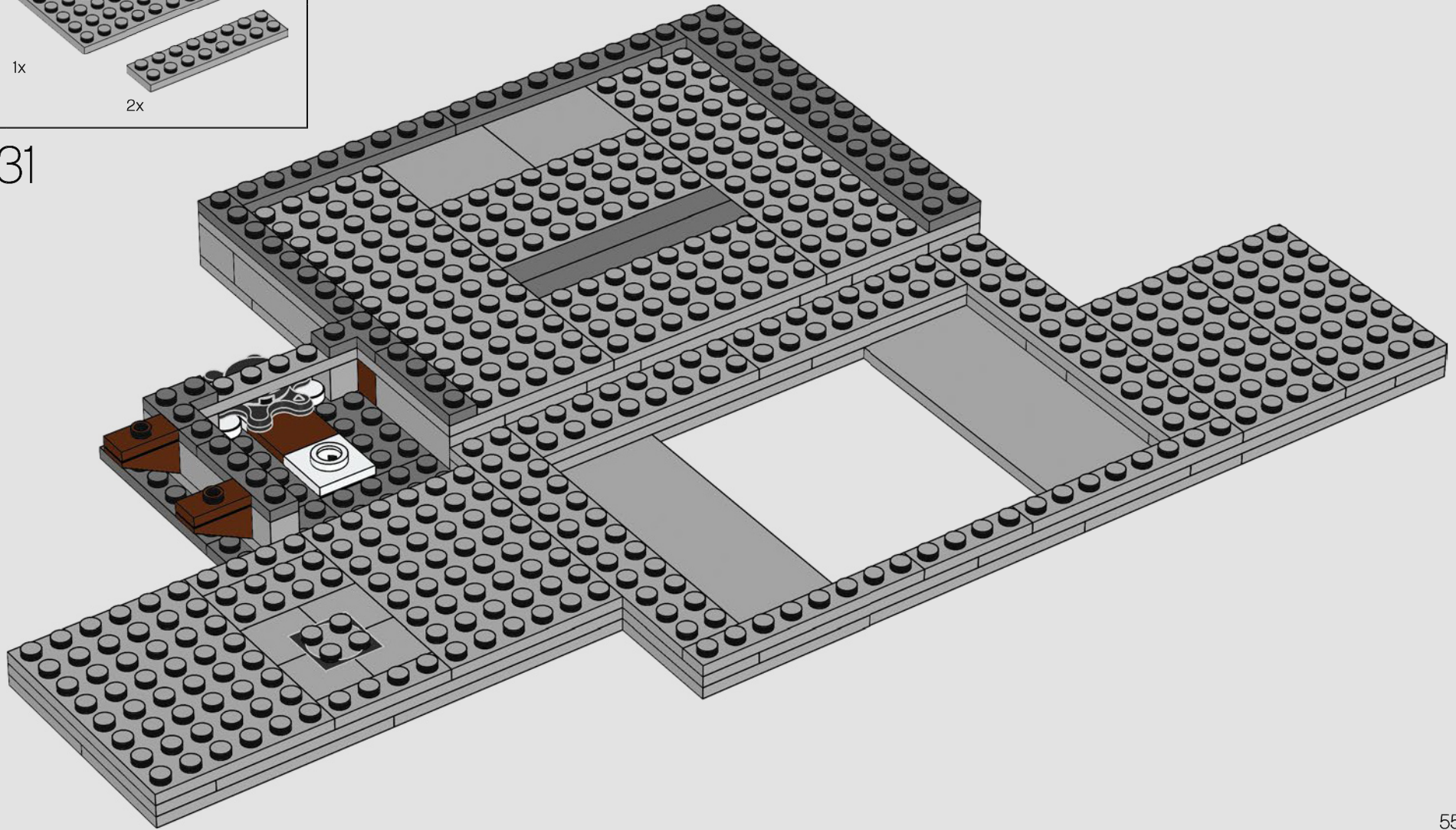

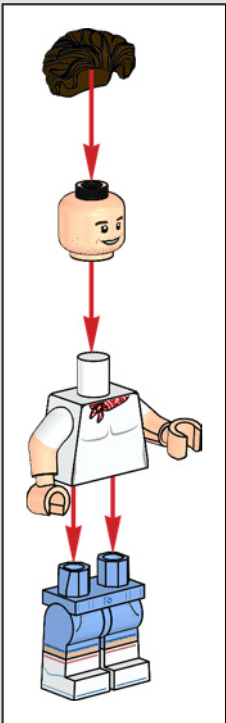
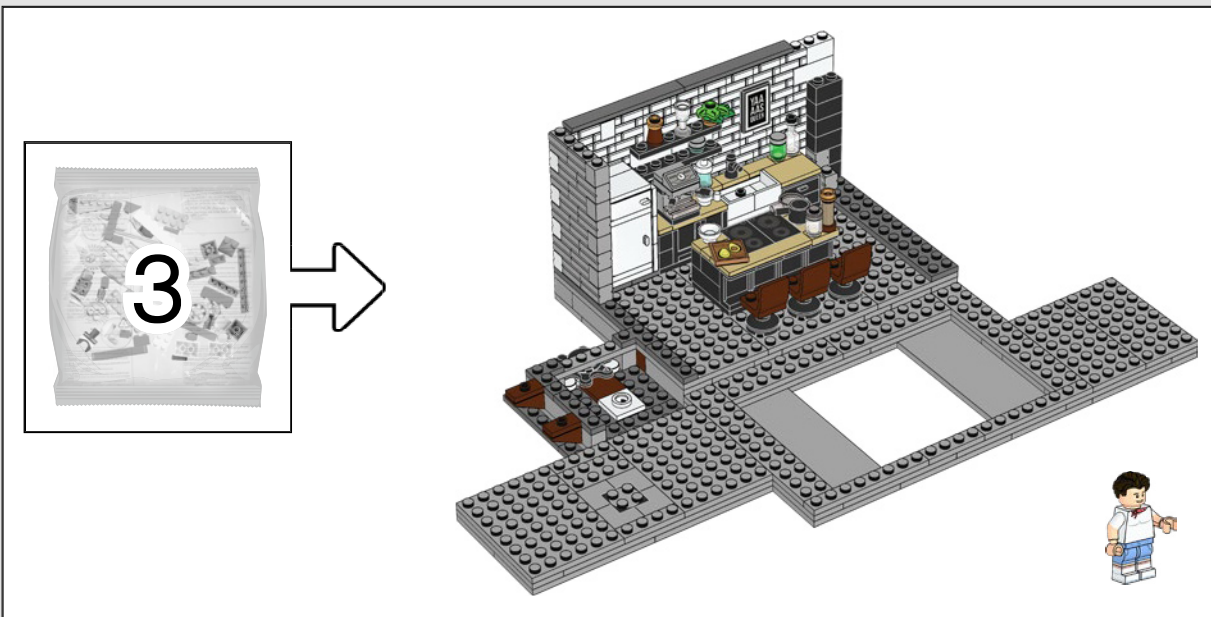

Antoni Porowski

„Mir gefällt das kleine Halstuch. Und als LEGO® Zubehör durfte das winzige Schneidebrett mit Avocados nicht fehlen.“

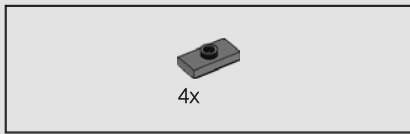

32

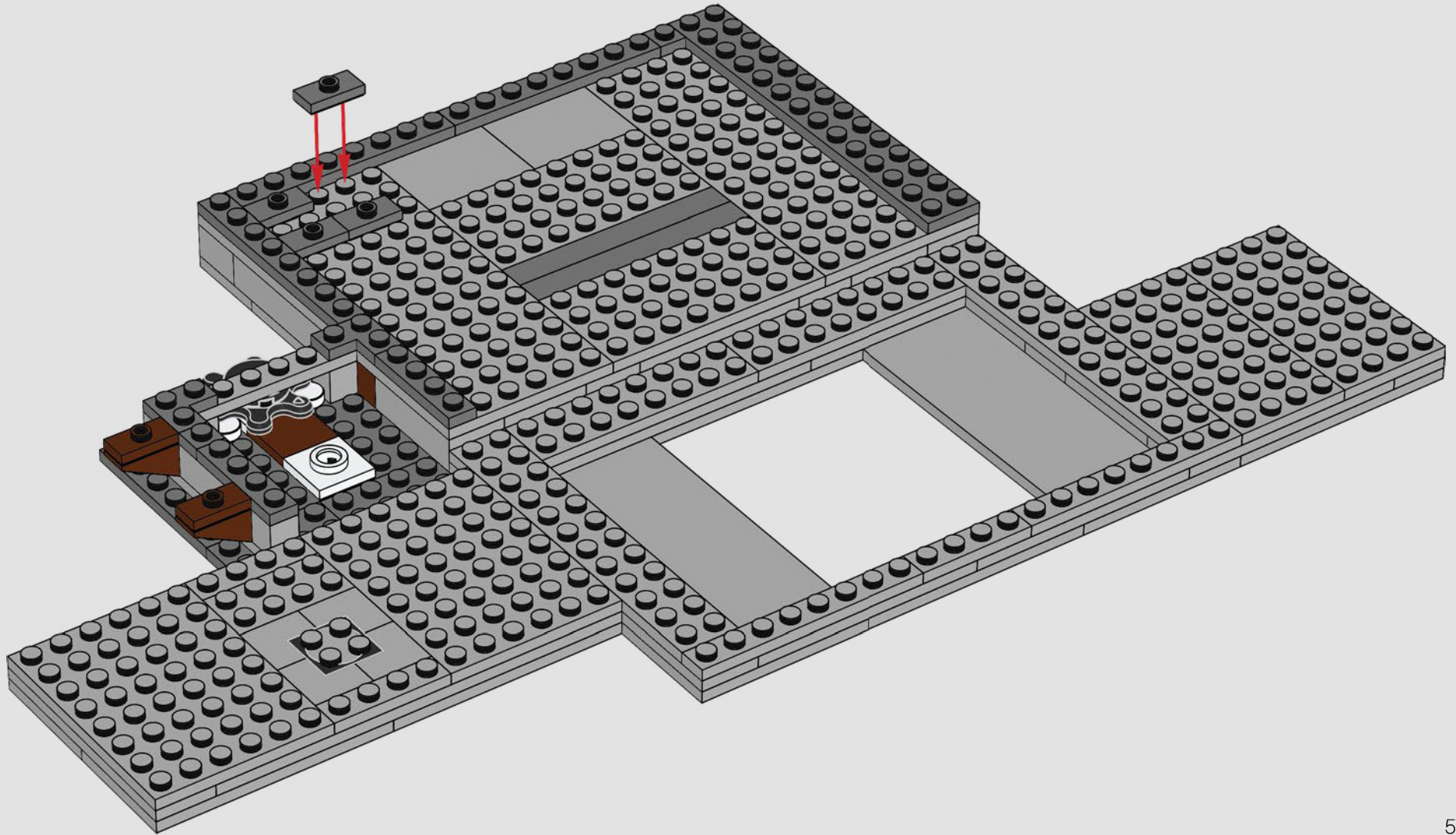

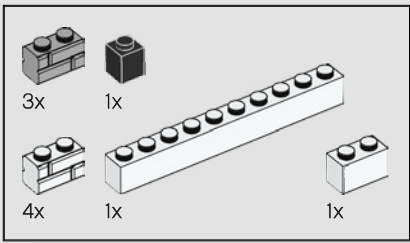

33



Bobby Berk

„Als Kind haben LEGO® Sets die Kreativität in mir geweckt. Die Steine gaben mir das Gefühl, das Leben würde unendlich viele Möglichkeiten bieten, genau wie die Dinge, die ich bauen konnte.“

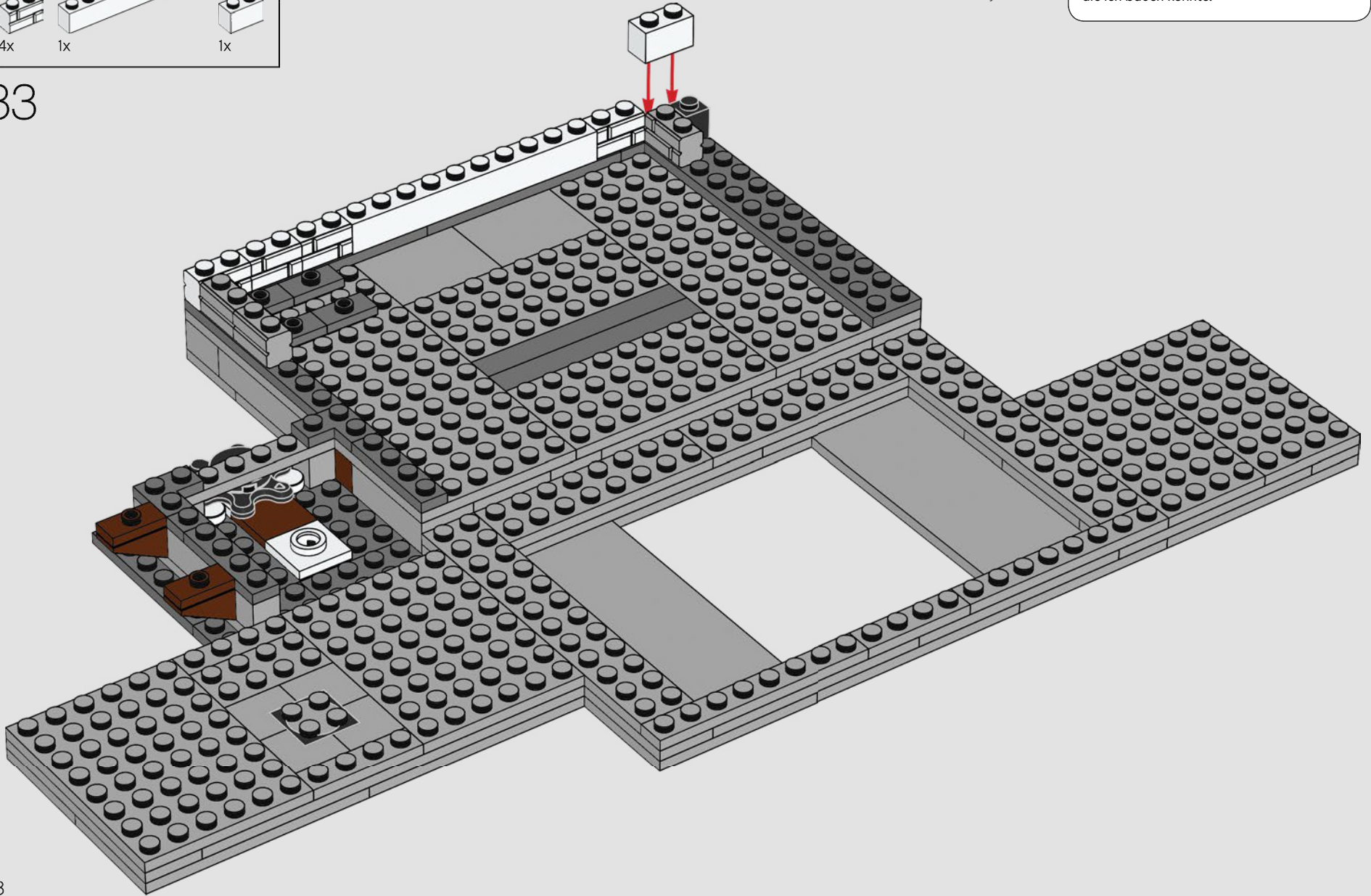

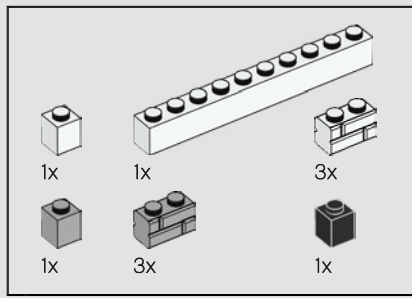

34

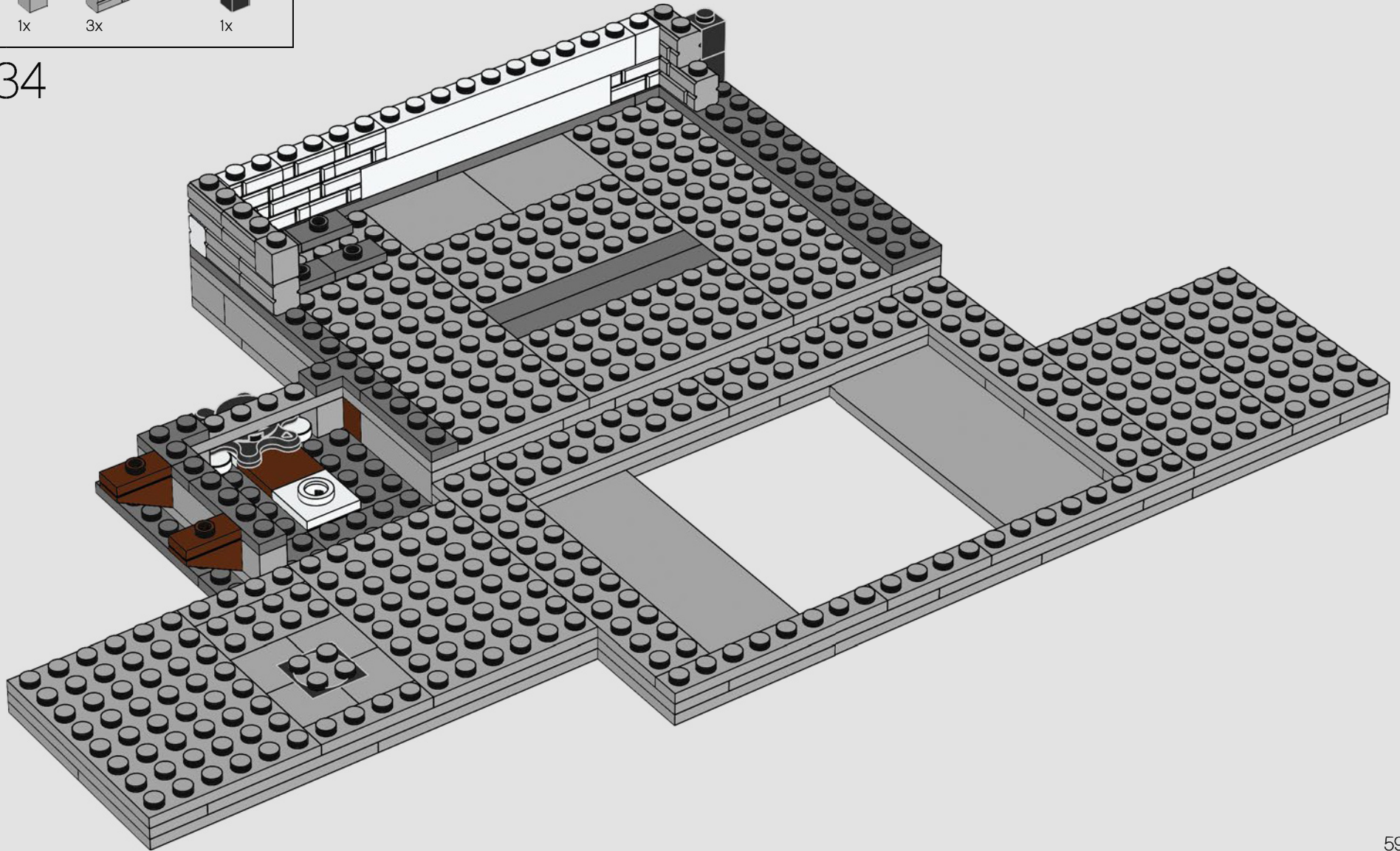

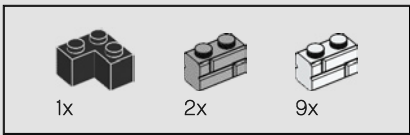

35

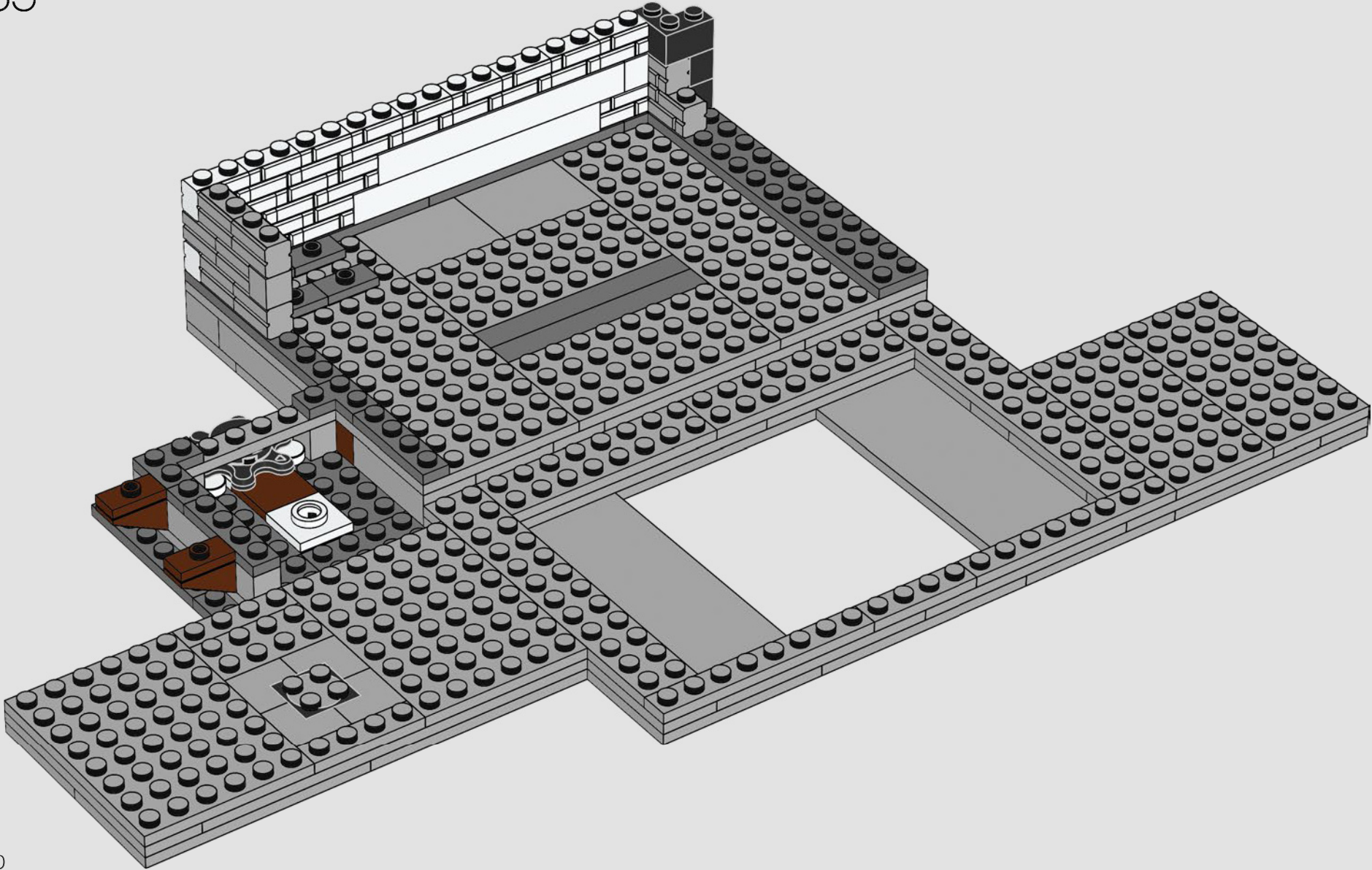

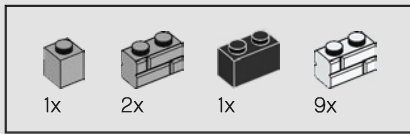

36

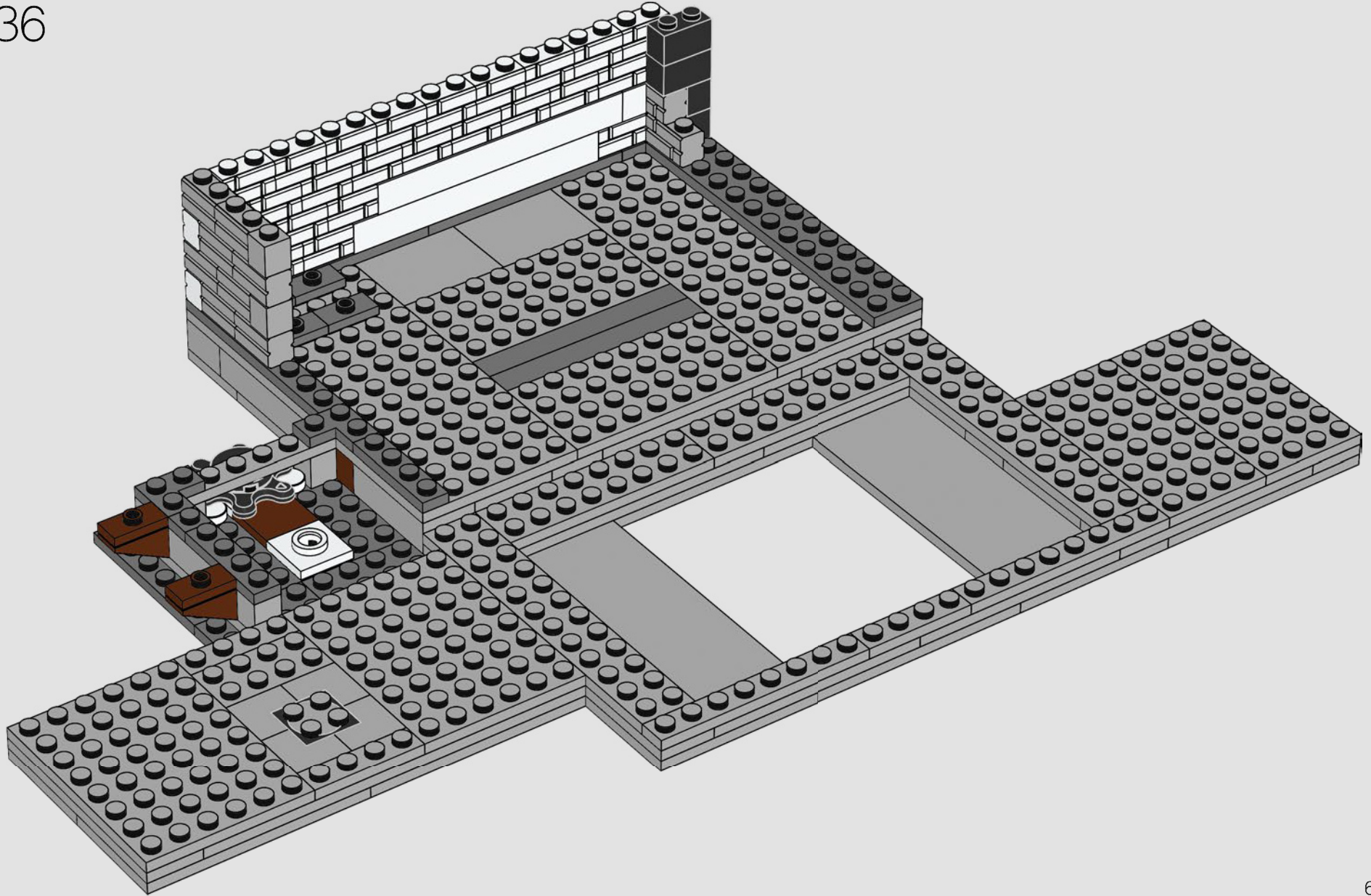

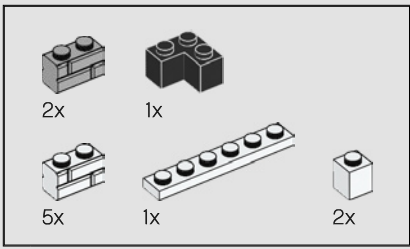

37



Bobby Berk

„Eine Serie zu produzieren, die nicht nur erfolgreich ist, sondern auch zig Millionen Menschen helfen kann, sich selbst und andere mehr zu lieben, ist die größte Ehre meines Lebens.“

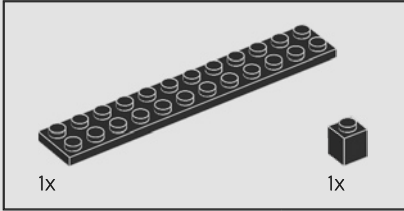
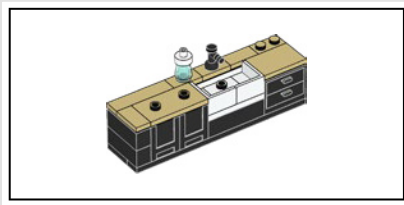

38

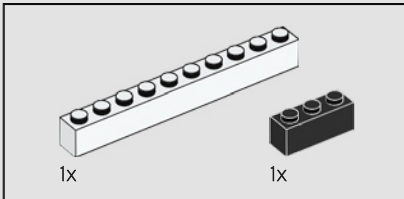
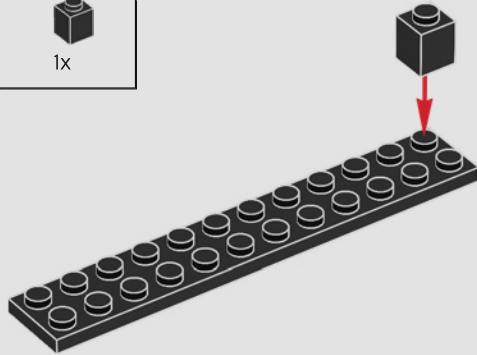

39

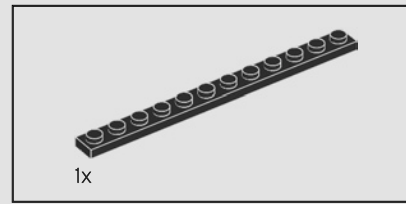
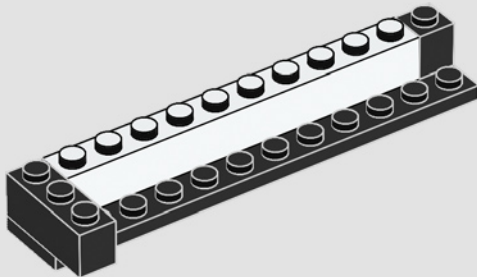

40

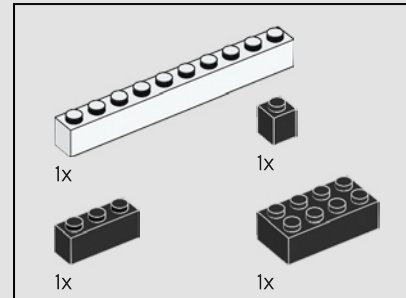
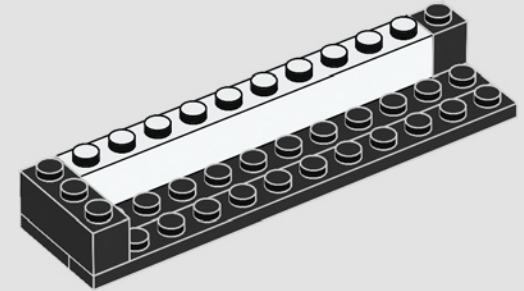

41

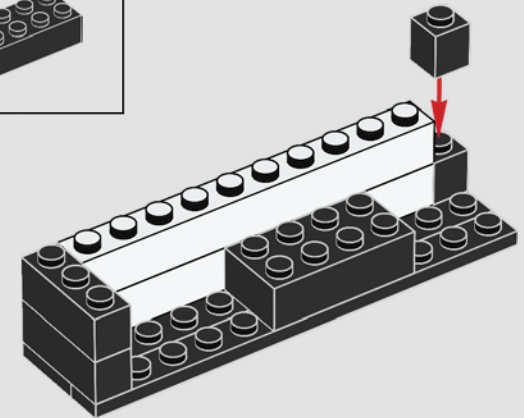



42

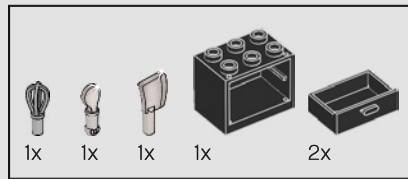
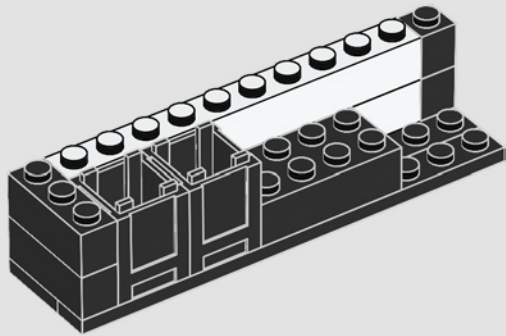

43

1

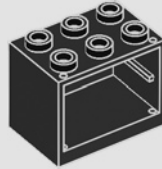

2

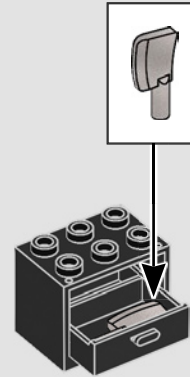

3

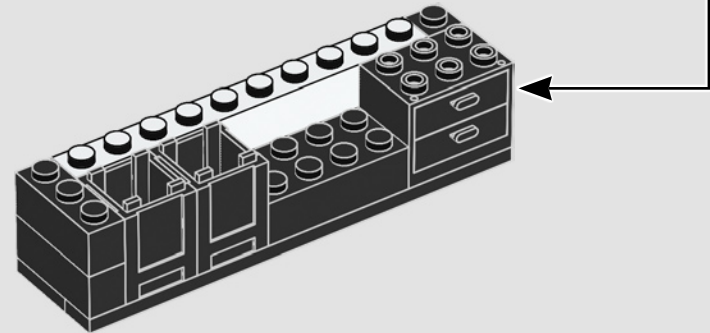
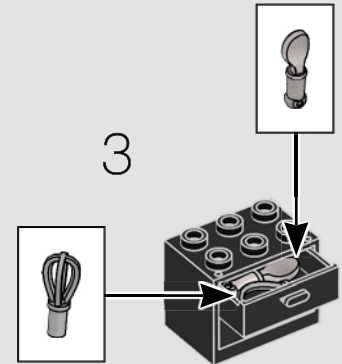

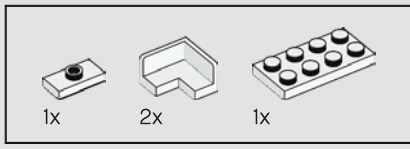

44

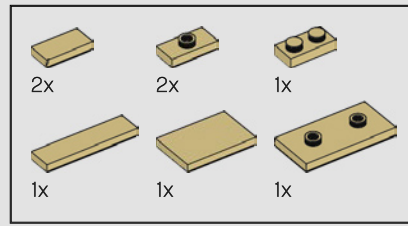
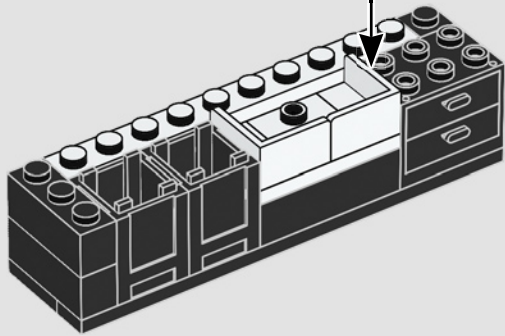
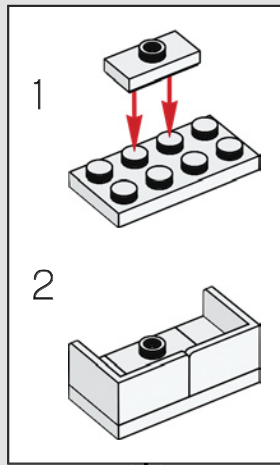

45

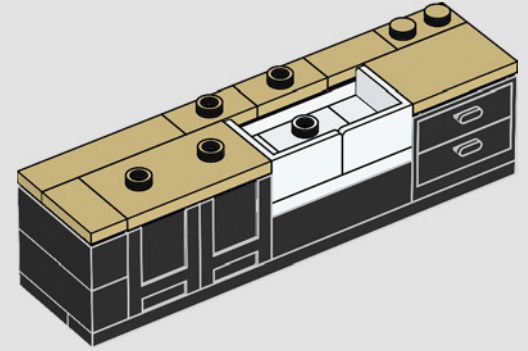

46

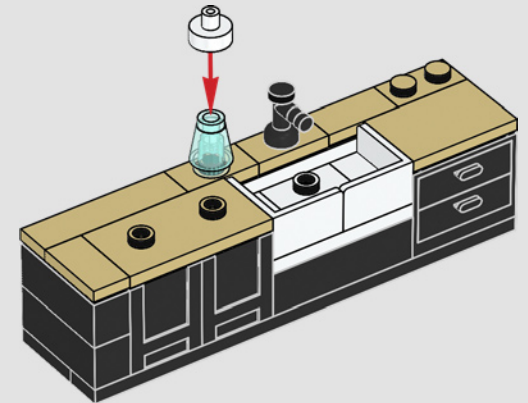

47

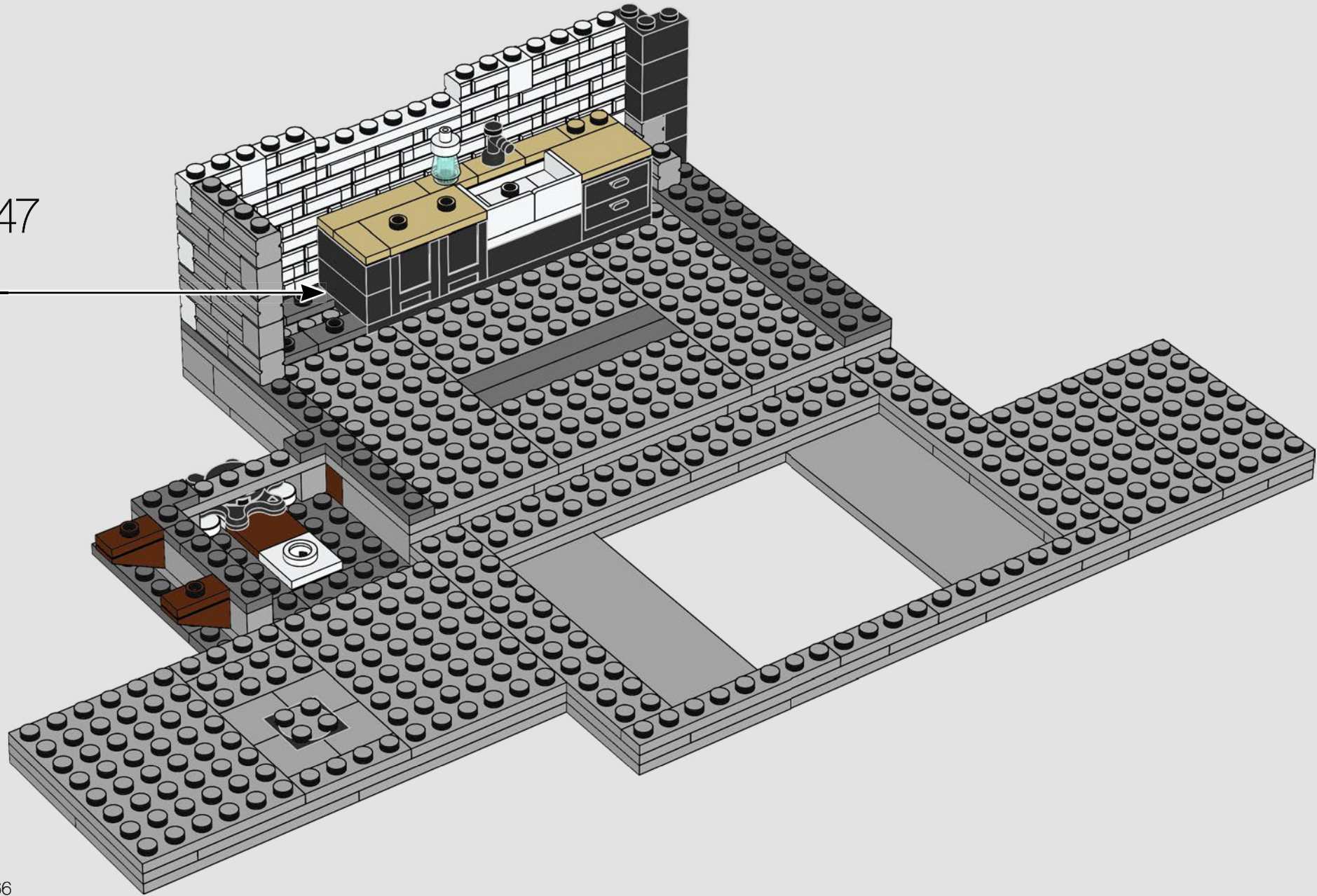

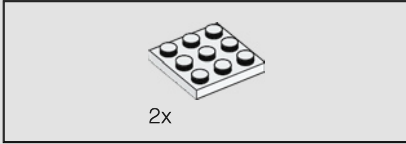
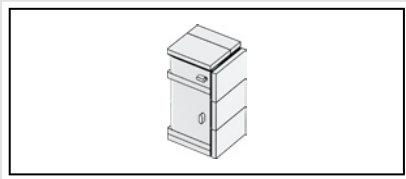

48

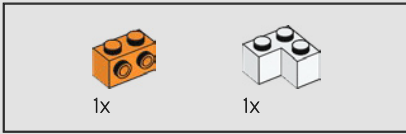
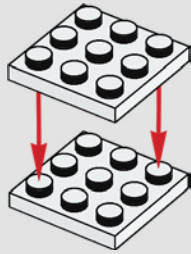

49

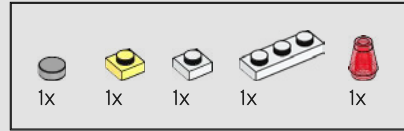
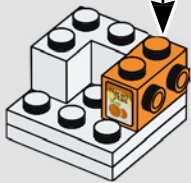
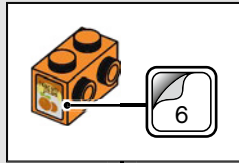

50

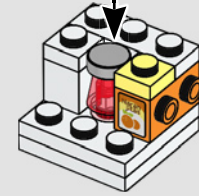
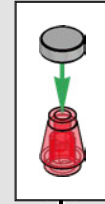

51

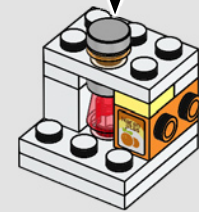
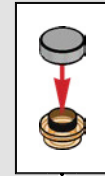

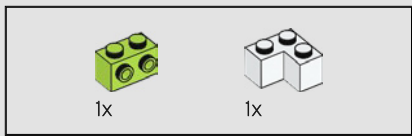

52

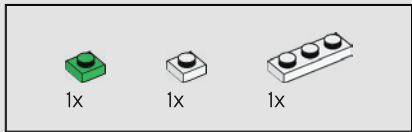
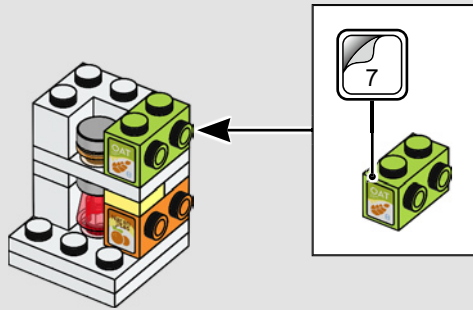

53

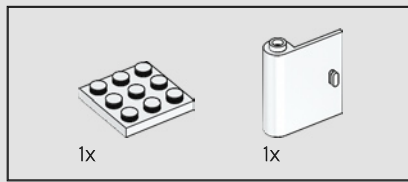

54

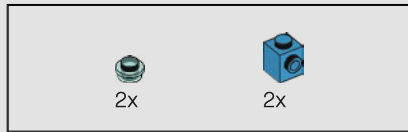
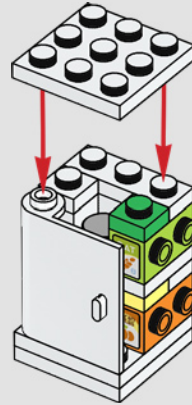

55

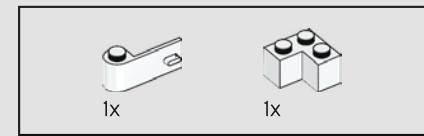
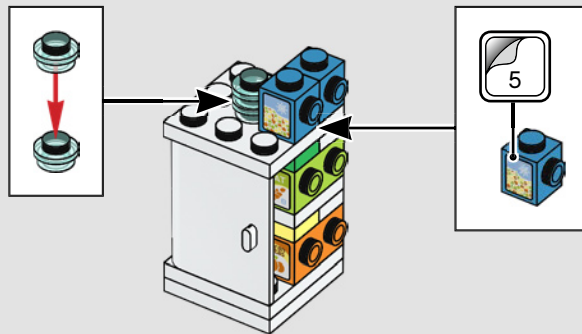

56

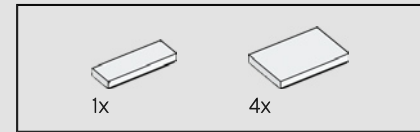

57

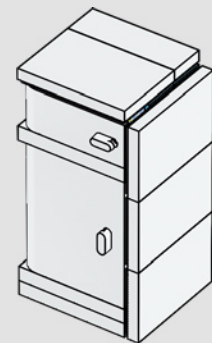



Antoni Porowski

„Das Bauen mit LEGO® Steinen ist gewissermaßen mit der Zubereitung einer Mahlzeit vergleichbar. Natürlich kann man dem Rezept folgen, um das perfekte „bewährte“ Endergebnis zu erzielen. Man kann aber auch experimentieren und etwas Eigenes erschaffen.“



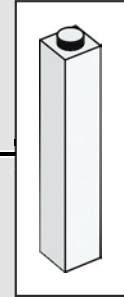
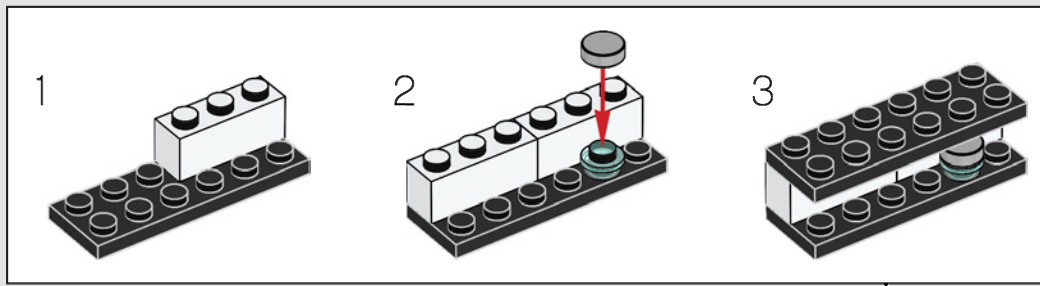
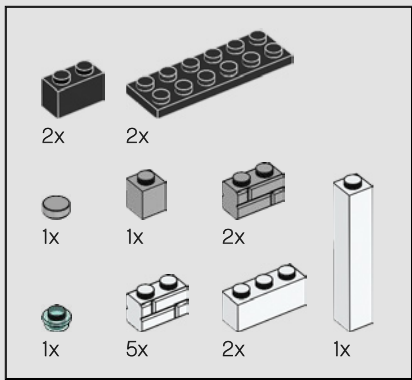

59

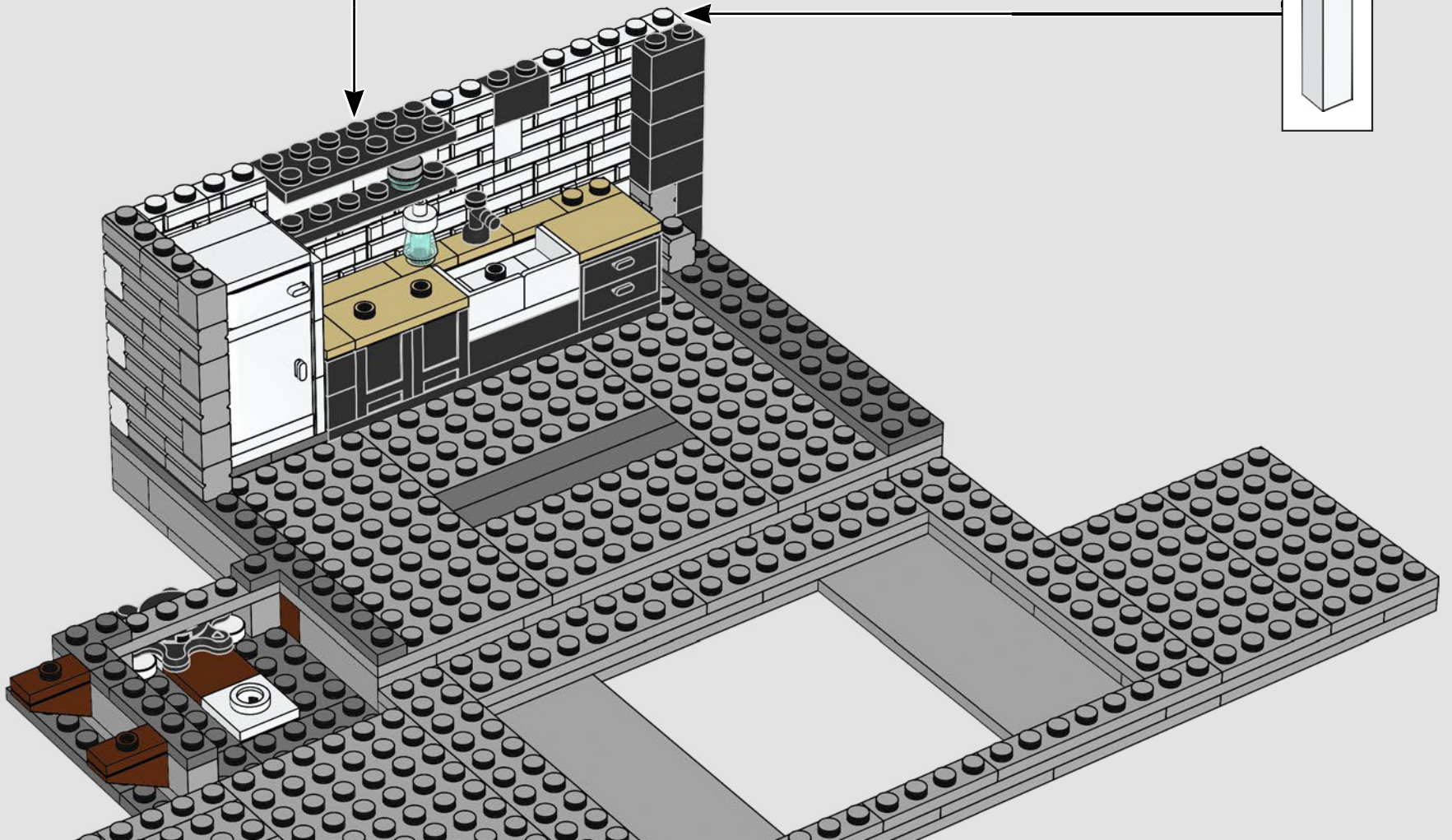

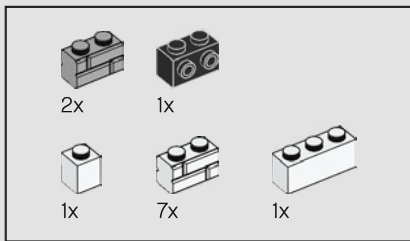

60

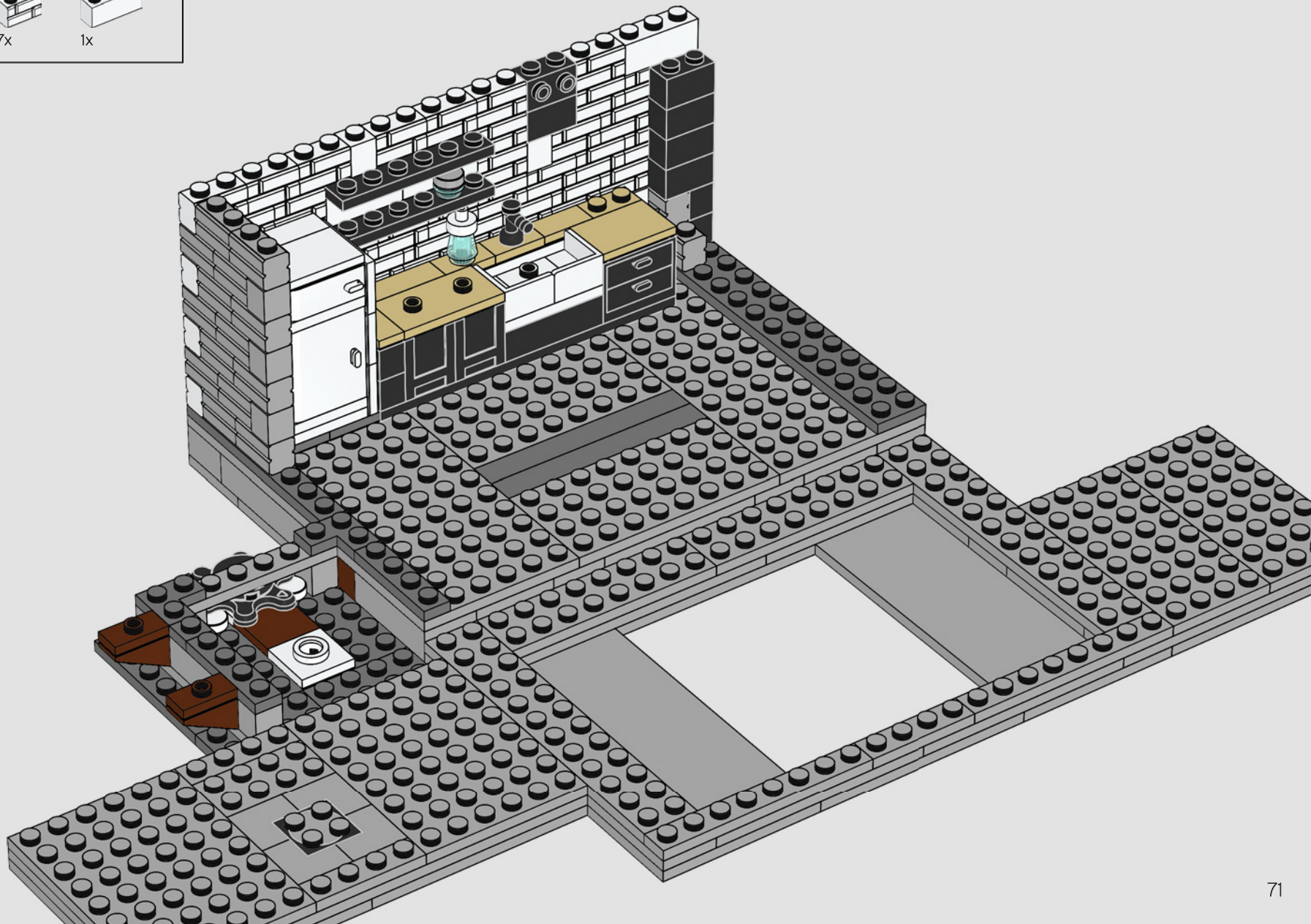

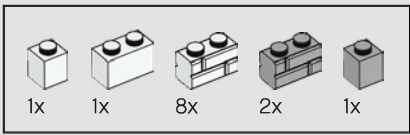

61



Bobby Berk

„In Queer Eye geht es um einen Neuanfang, um einen Wiederaufbau und darum, das Beste aus dir herauszuholen. Welches Spielzeug wäre eine bessere Hommage an diese Idee als ein LEGO® Set?“



62

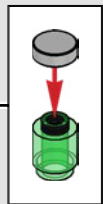
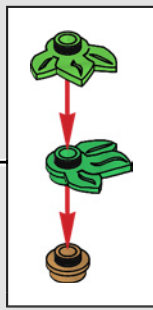
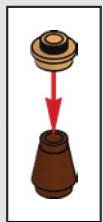
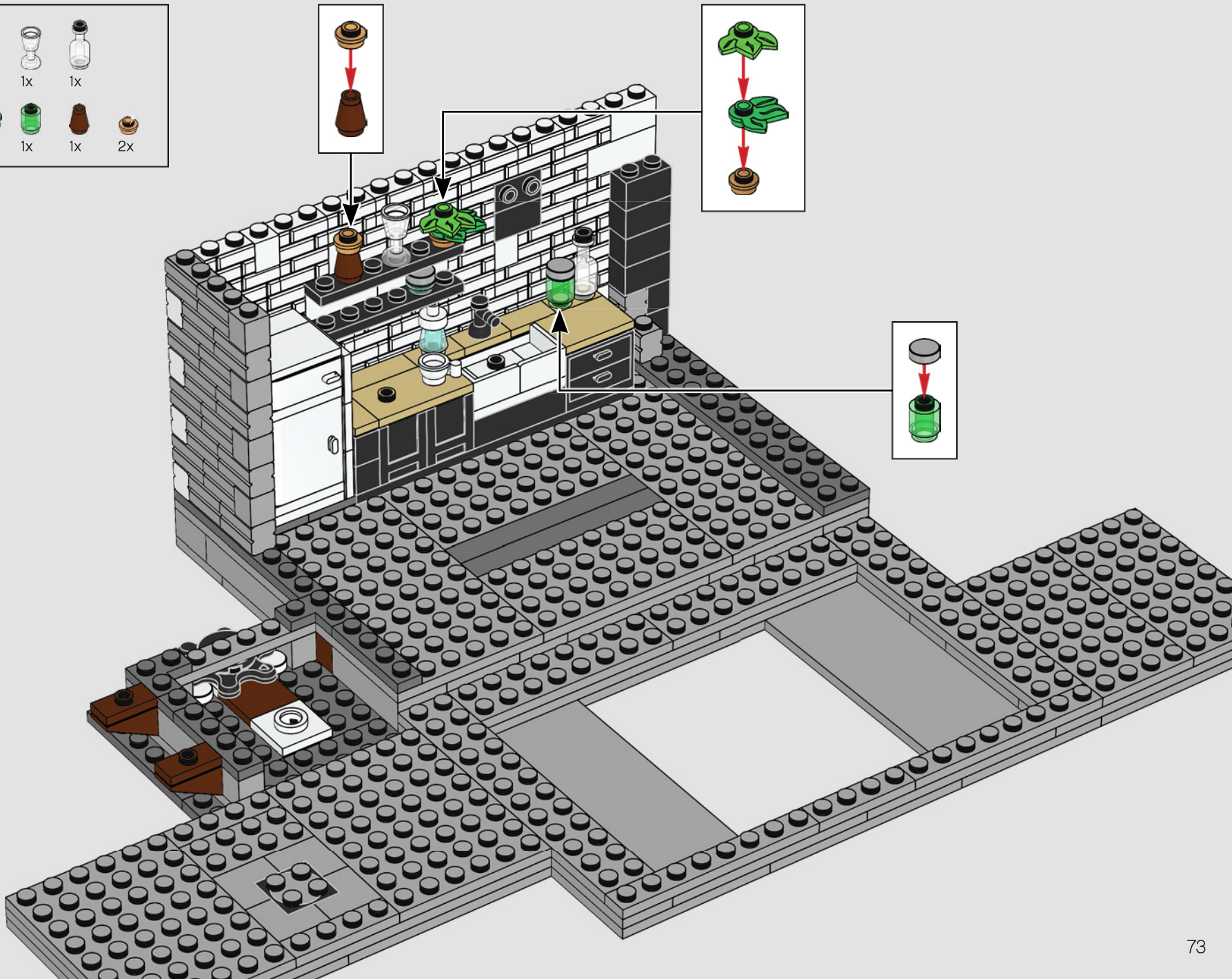

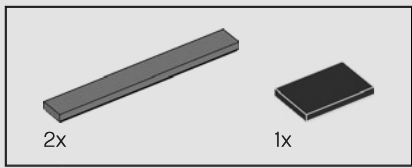

63

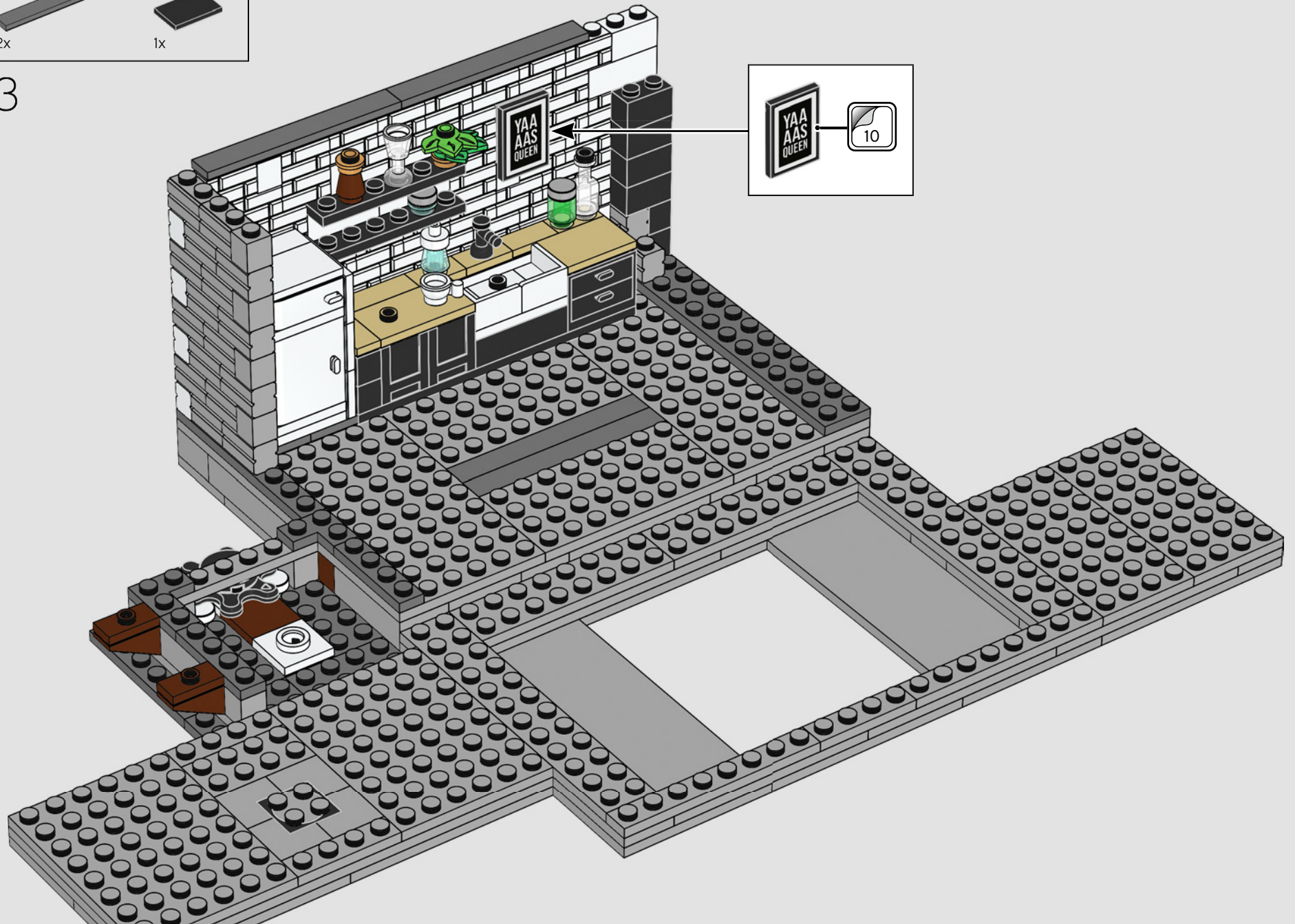

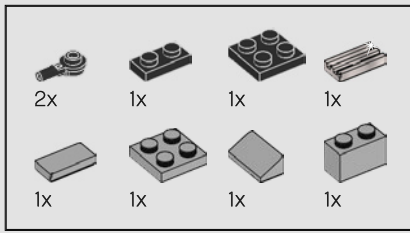

64

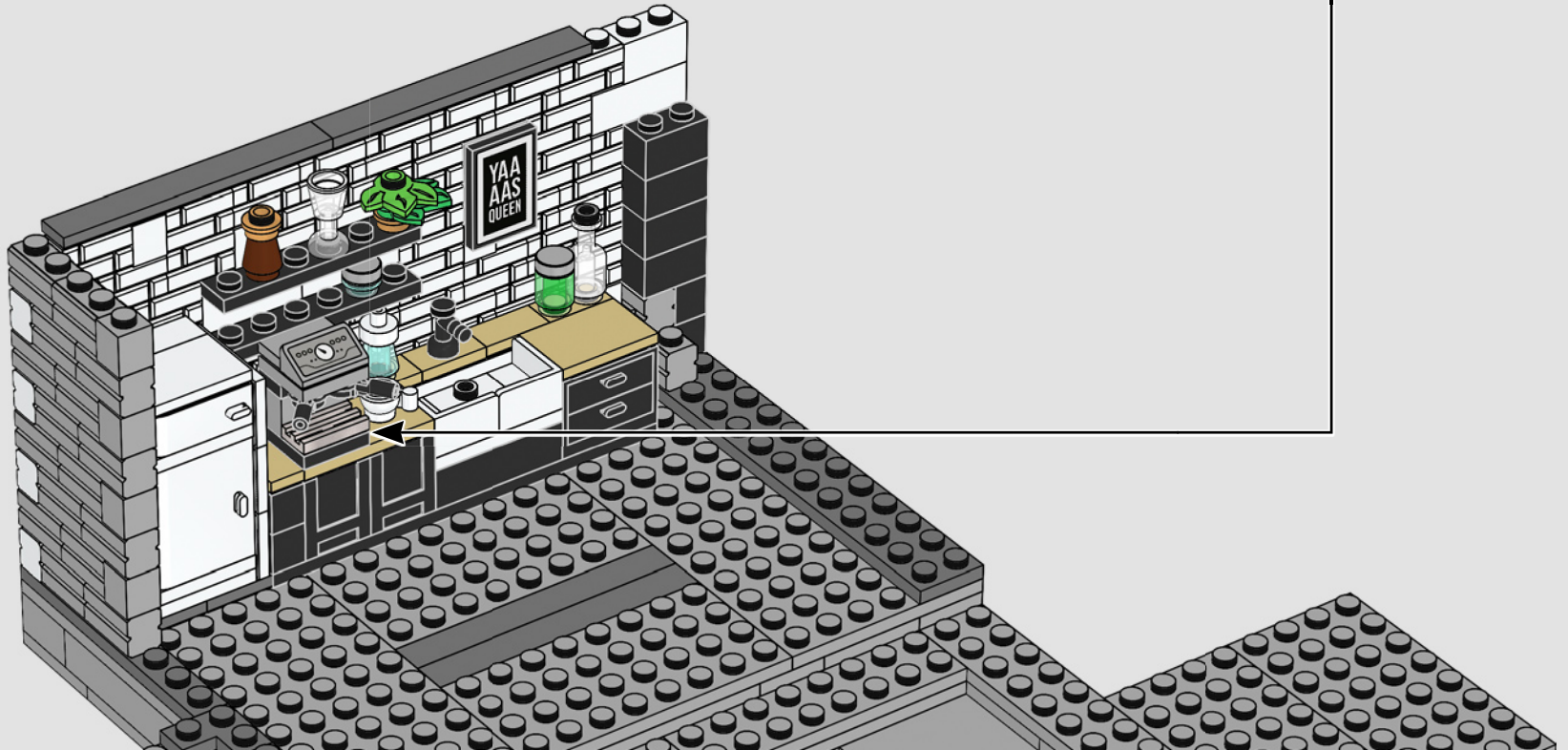
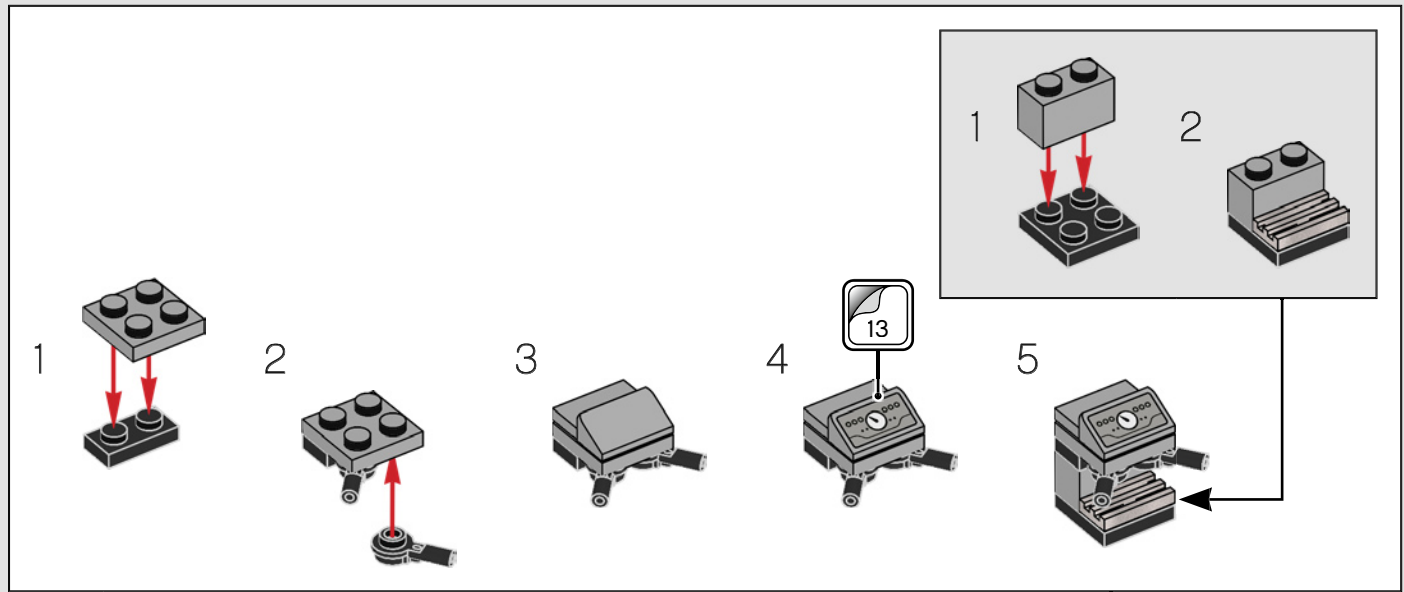

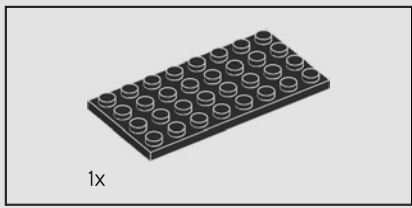

65

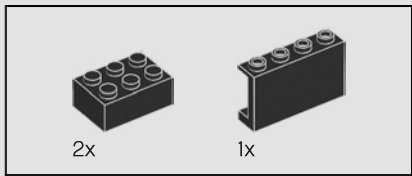
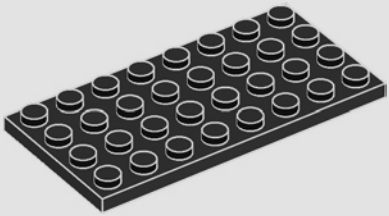

66

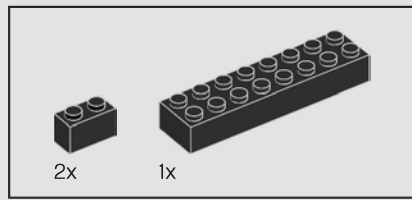
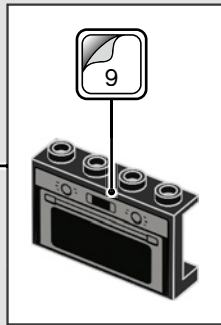
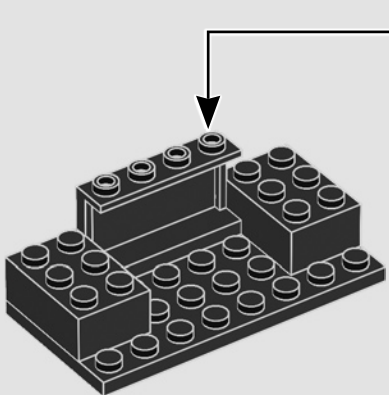

67

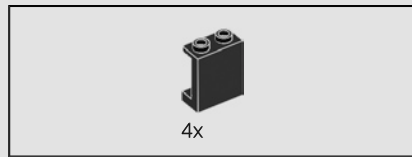
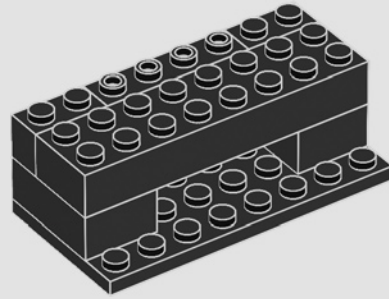

68

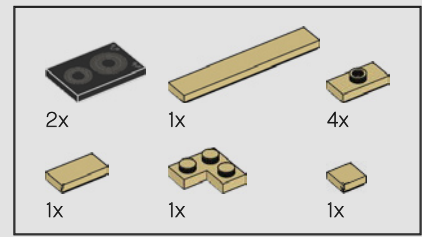
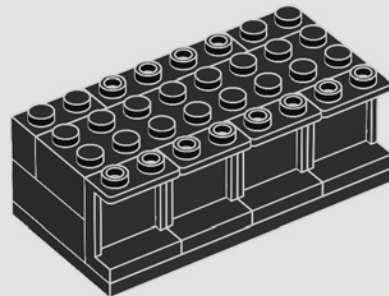

69

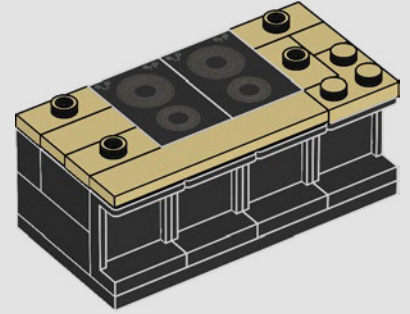

70

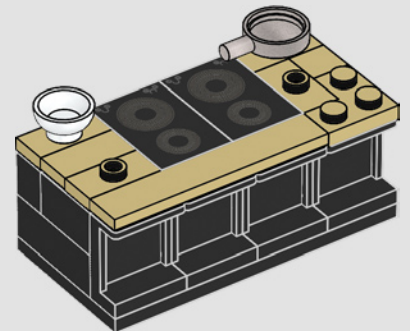

71

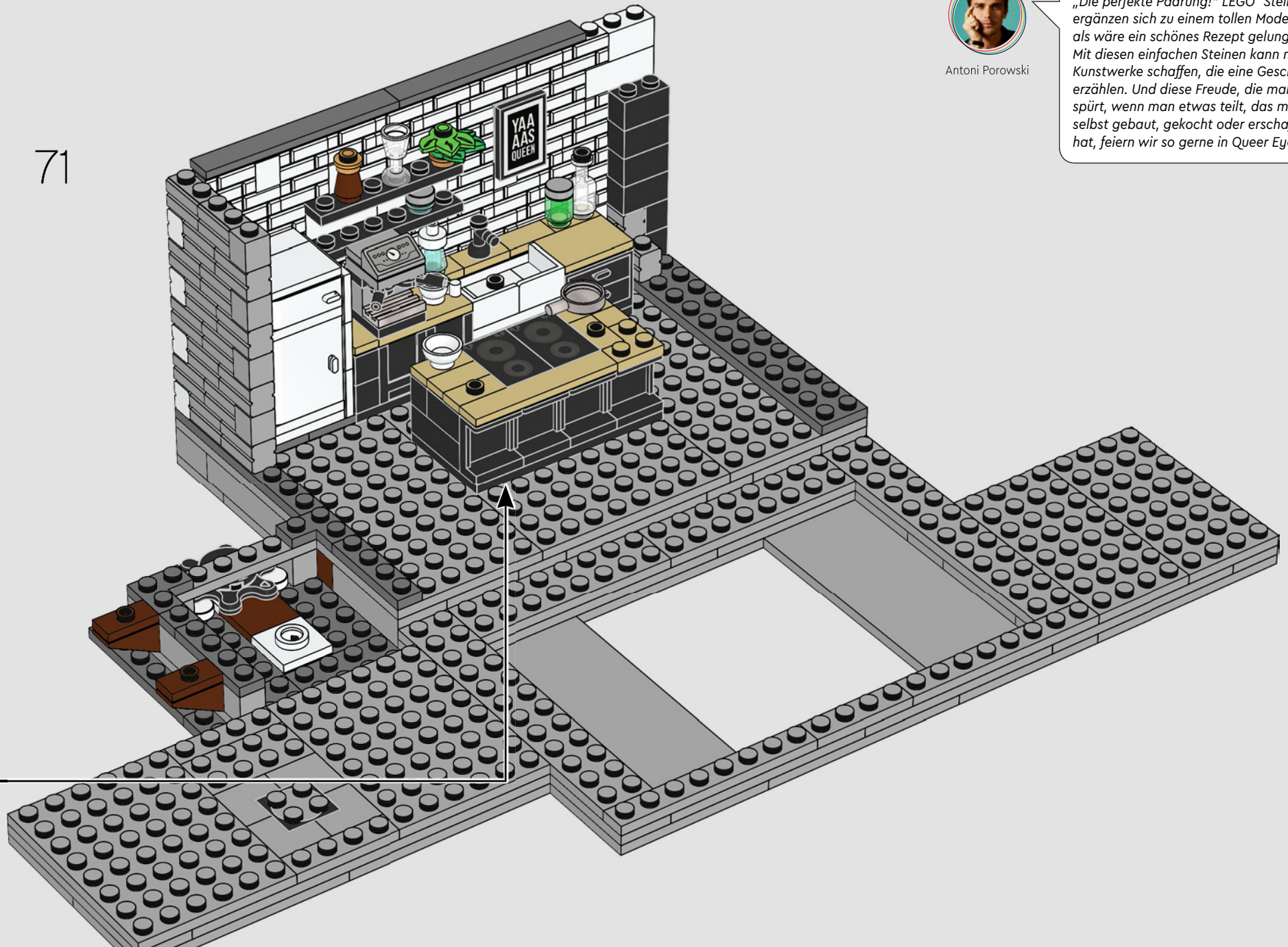

Antoni Porowski

„Die perfekte Paarung!“ LEGO® Steine ergänzen sich zu einem tollen Modell, als wäre ein schönes Rezept gelungen. Mit diesen einfachen Steinen kann man Kunstwerke schaffen, die eine Geschichte erzählen. Und diese Freude, die man spürt, wenn man etwas teilt, das man selbst gebaut, gekocht oder erschaffen hat, feiern wir so gerne in Queer Eye.“

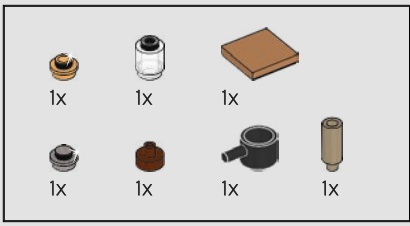

72

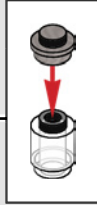
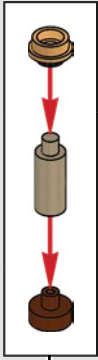
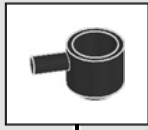
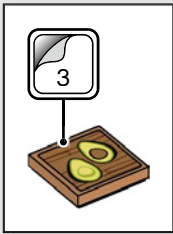

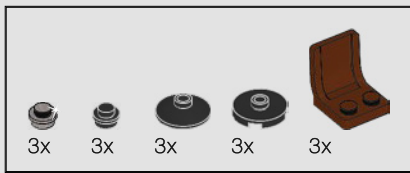

73

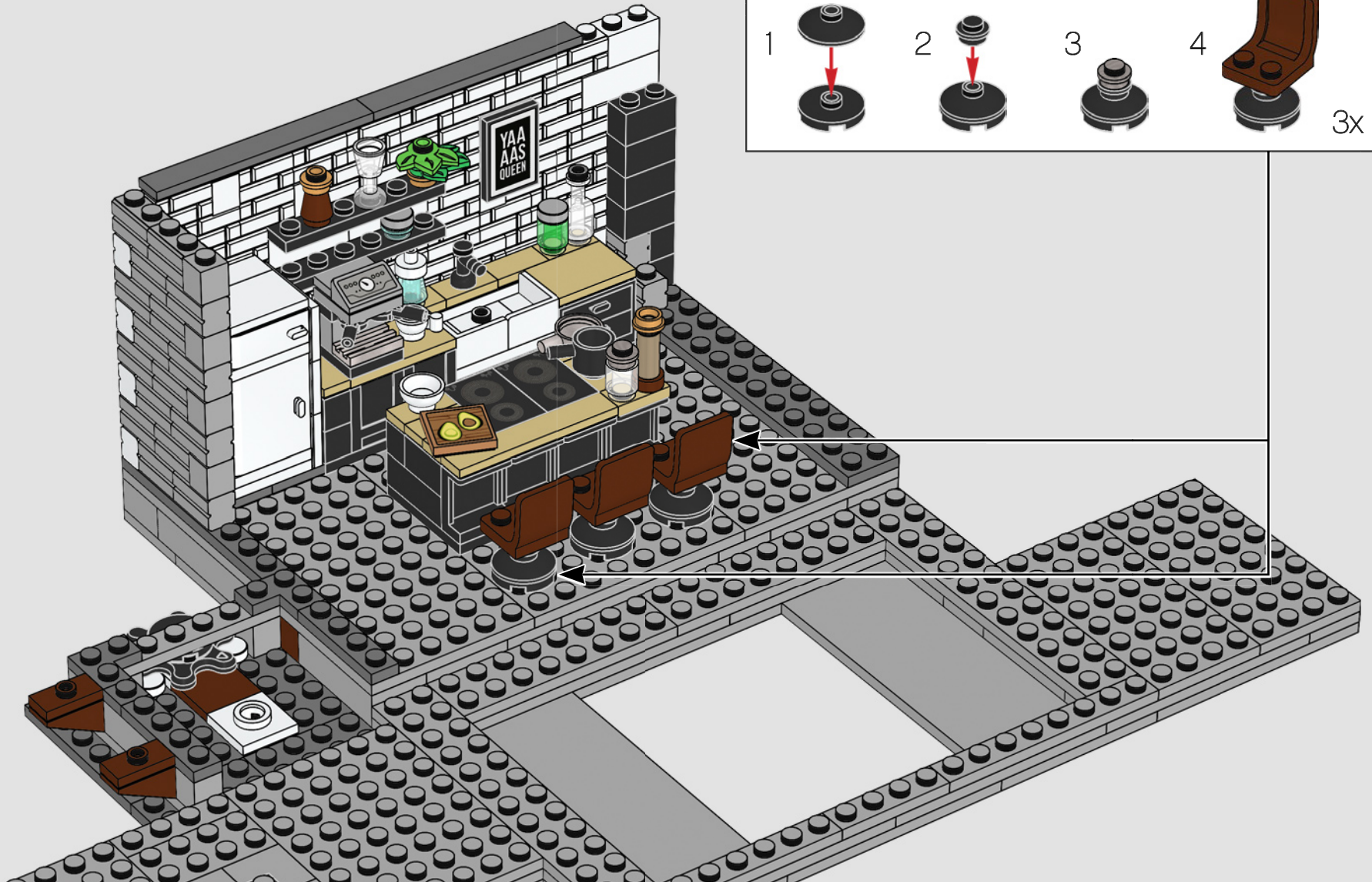
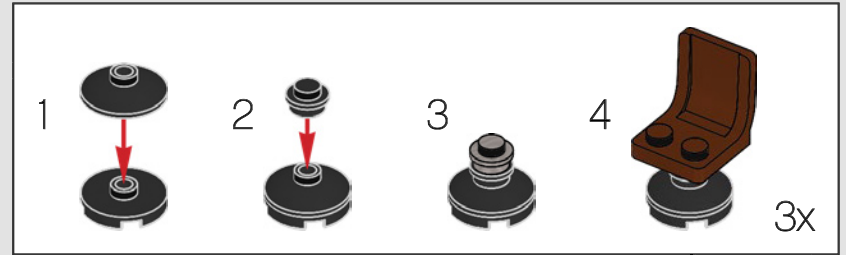

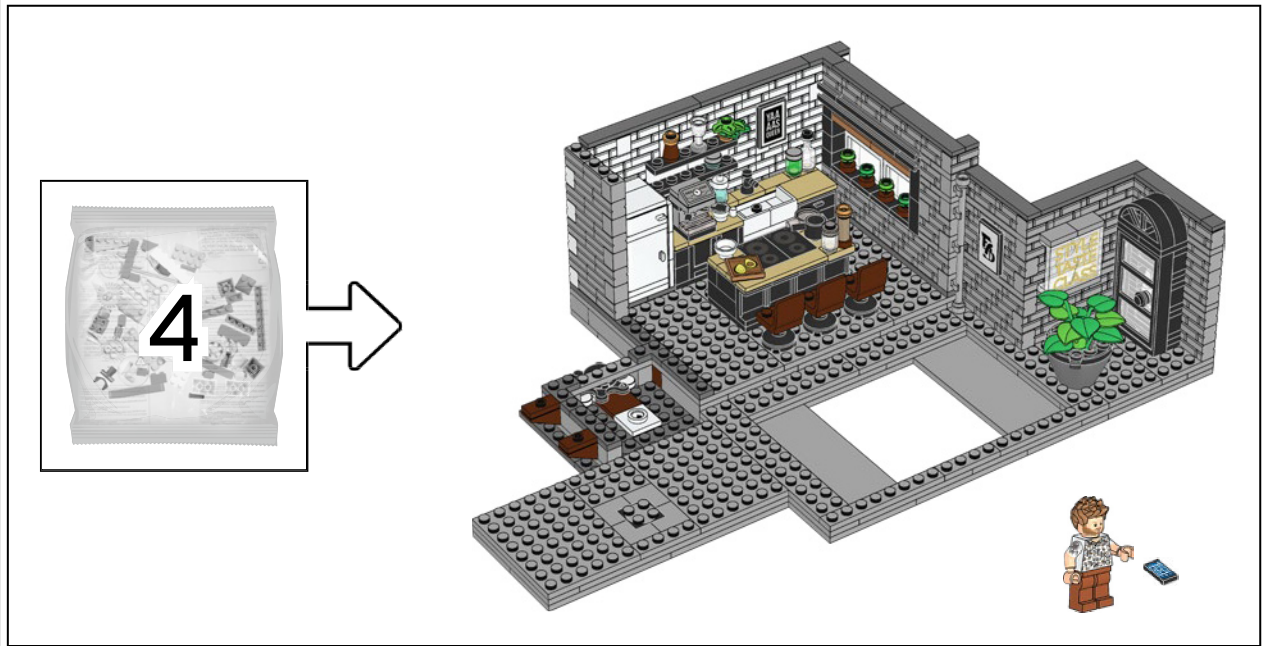

Bobby Berk

„Es ist surreal, mich als LEGO® Minifigur zu sehen. Mein 7-jähriges Ich wäre völlig aus dem Häuschen, wenn es das wüsste!“



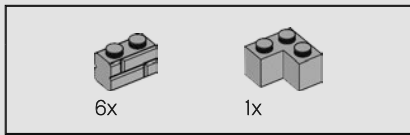

74



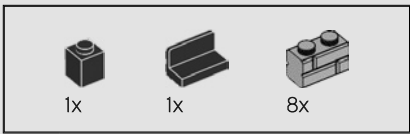

75

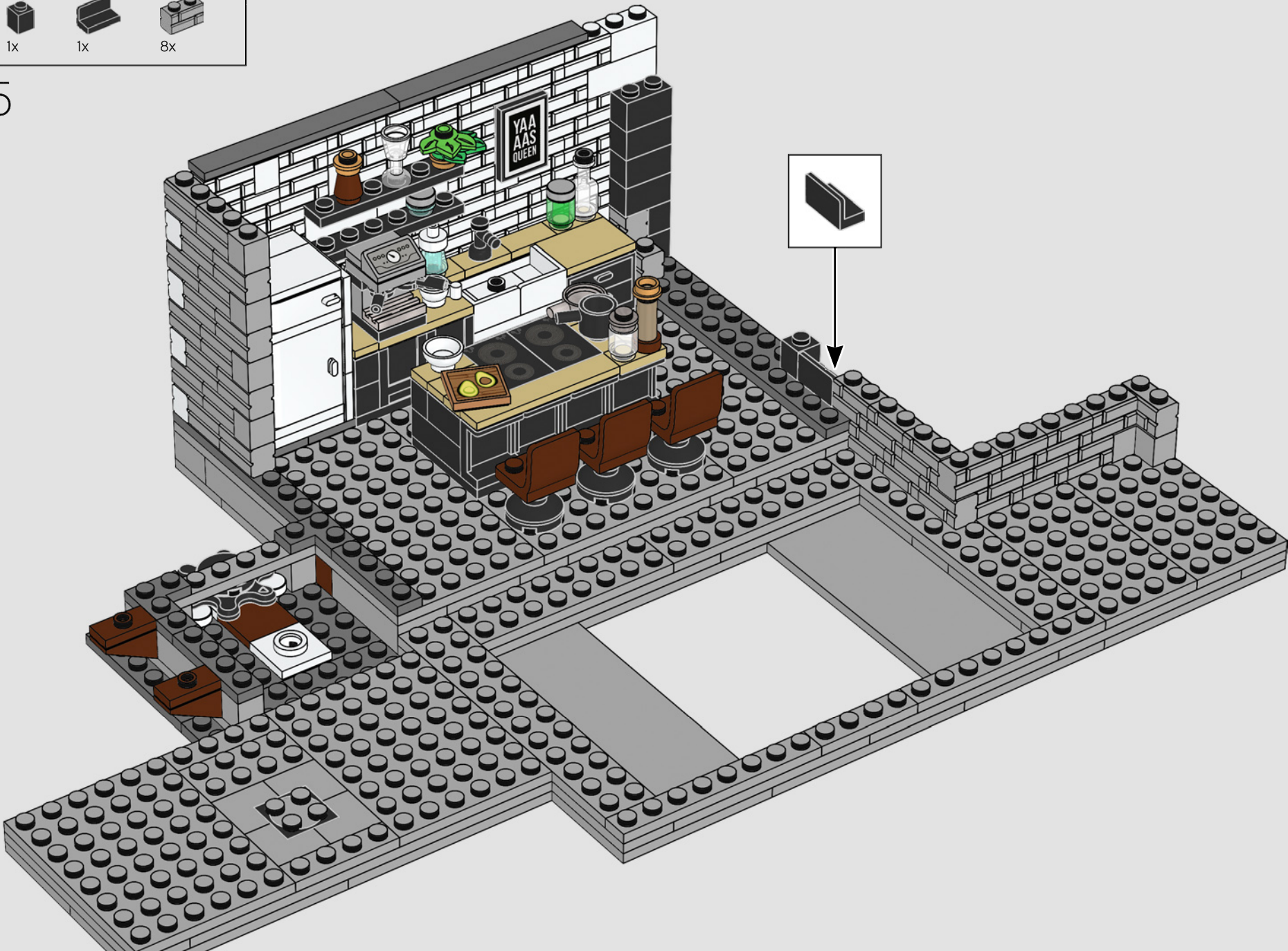

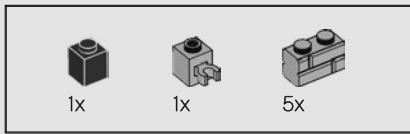

76

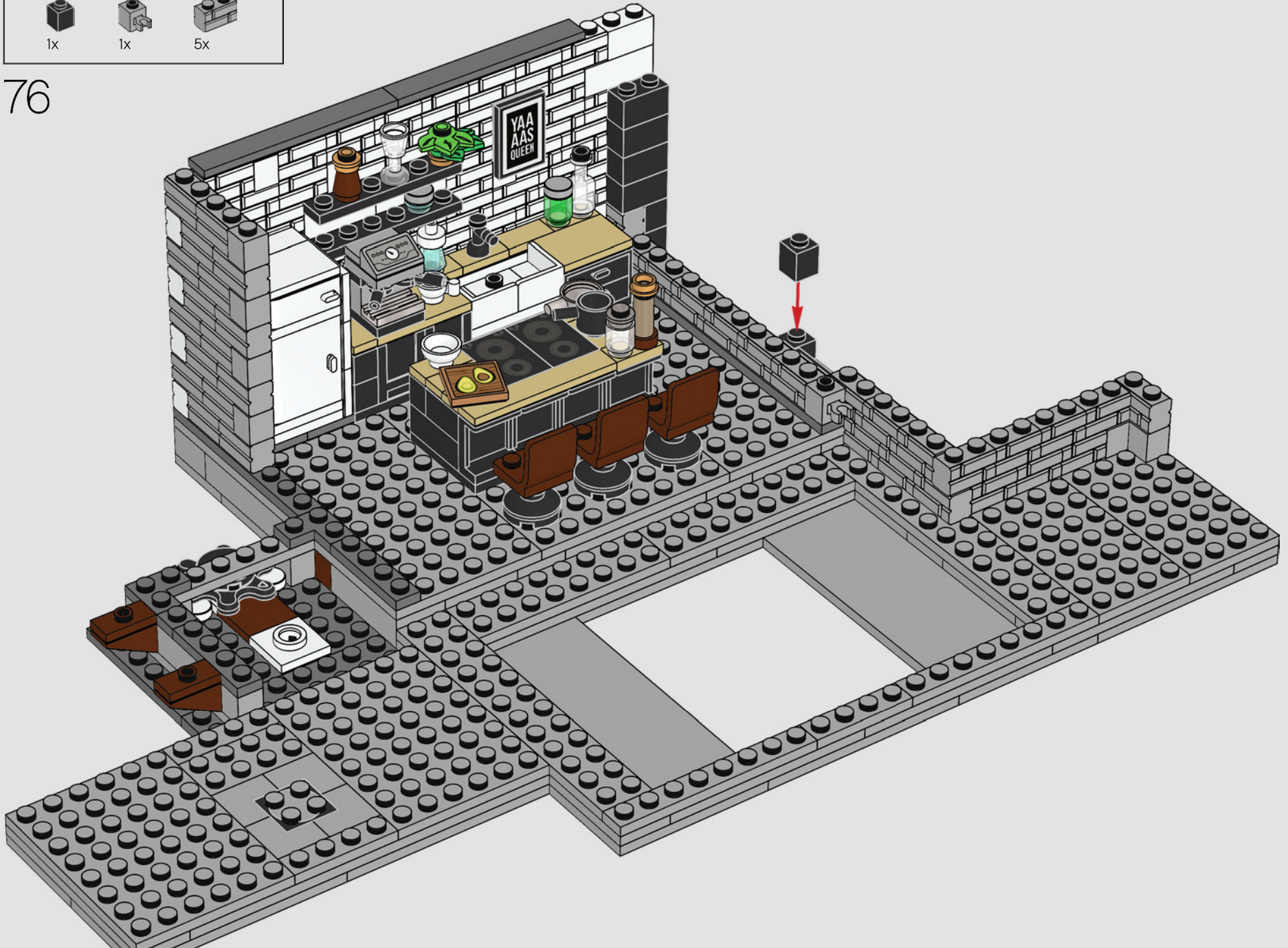

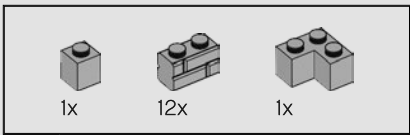

77

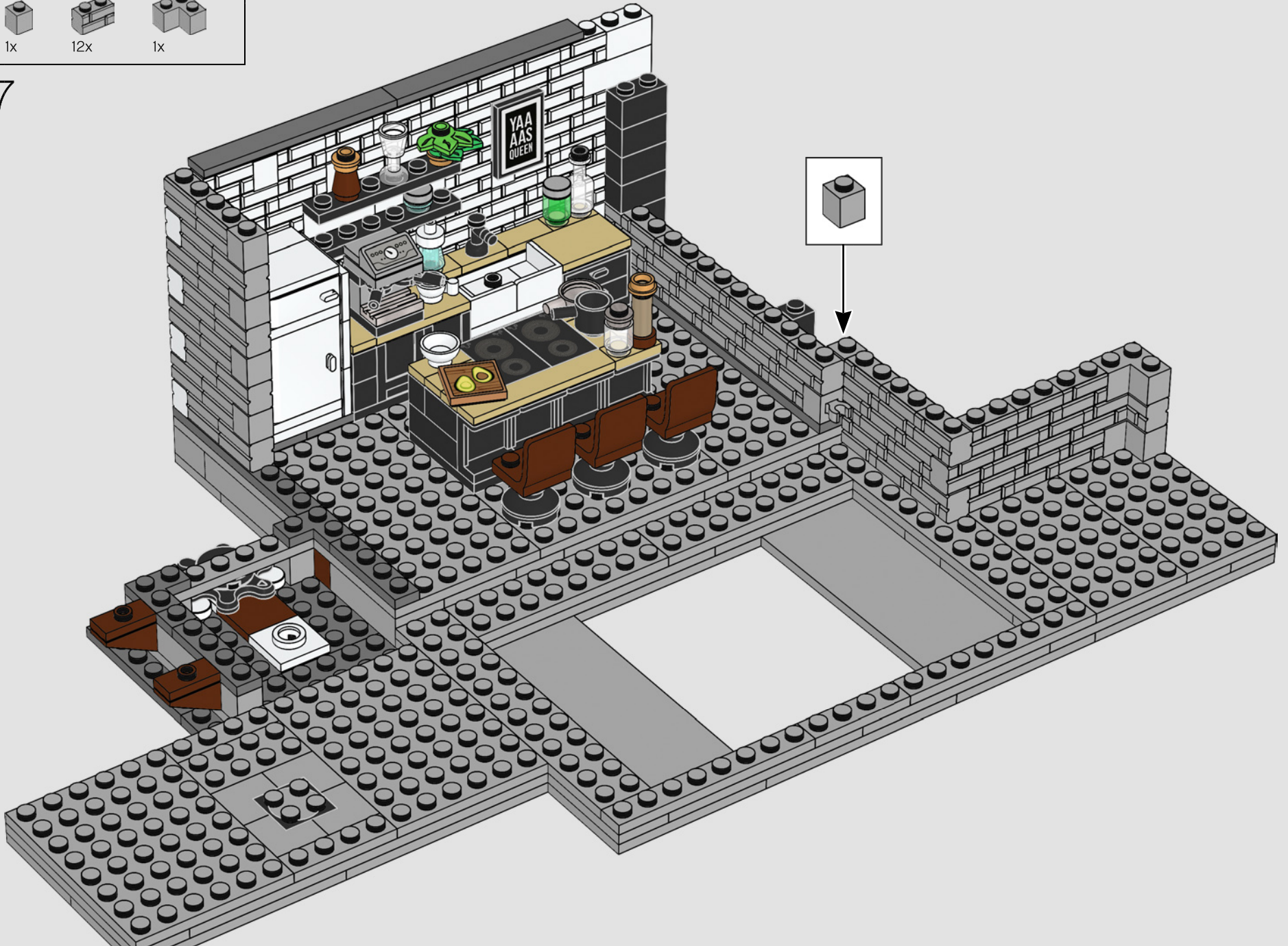



78

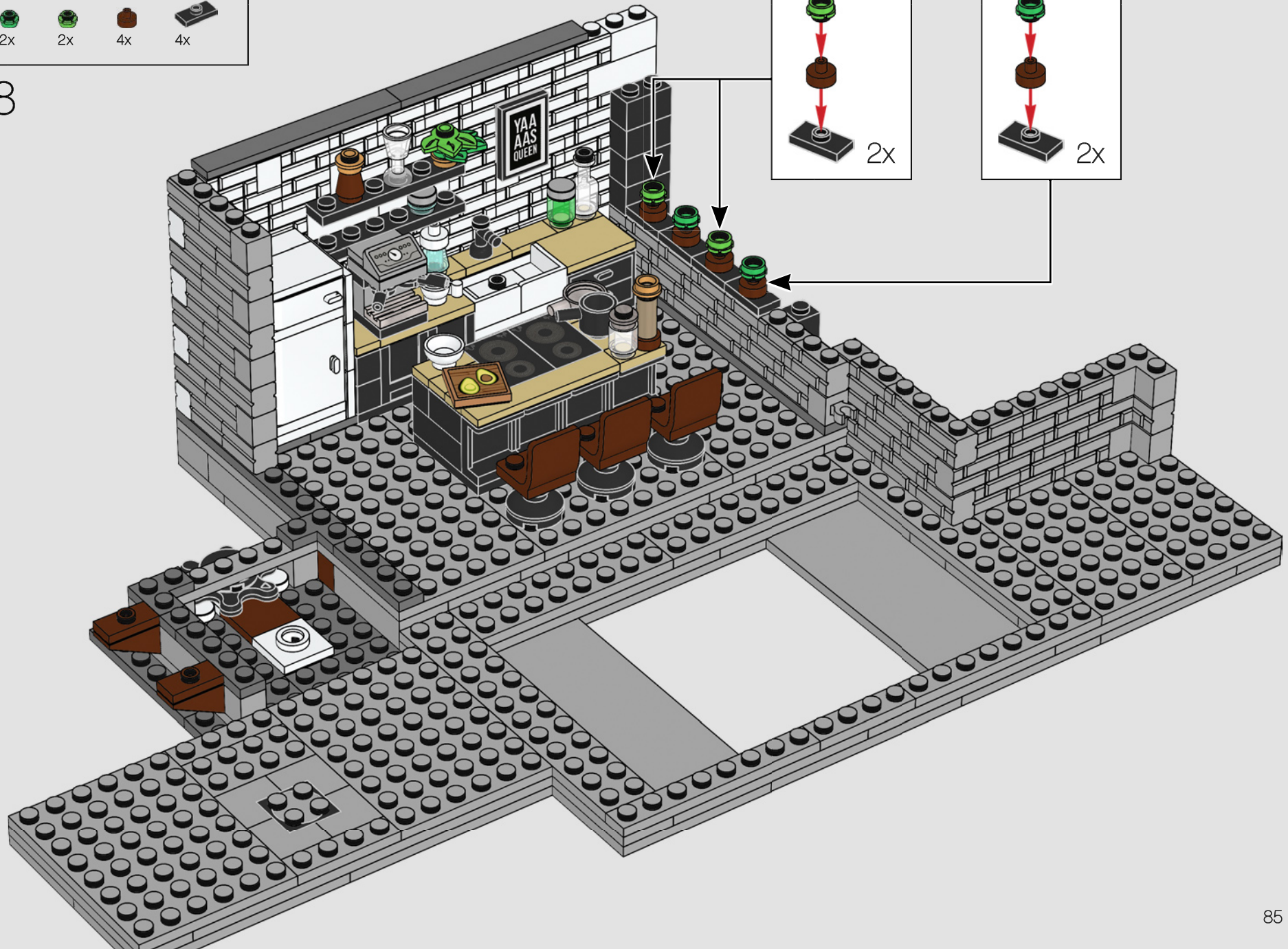
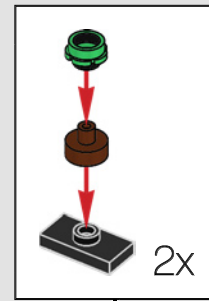
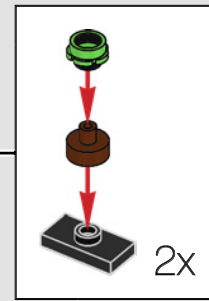

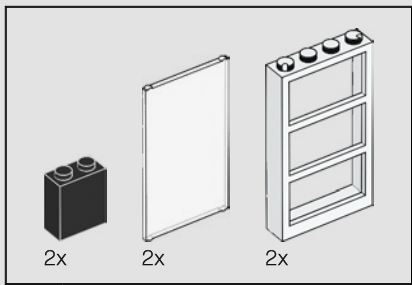

79

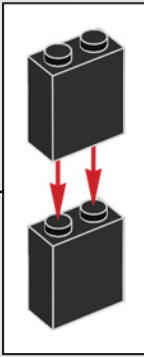
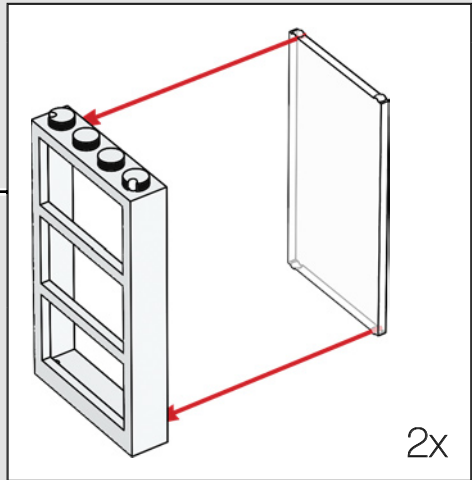
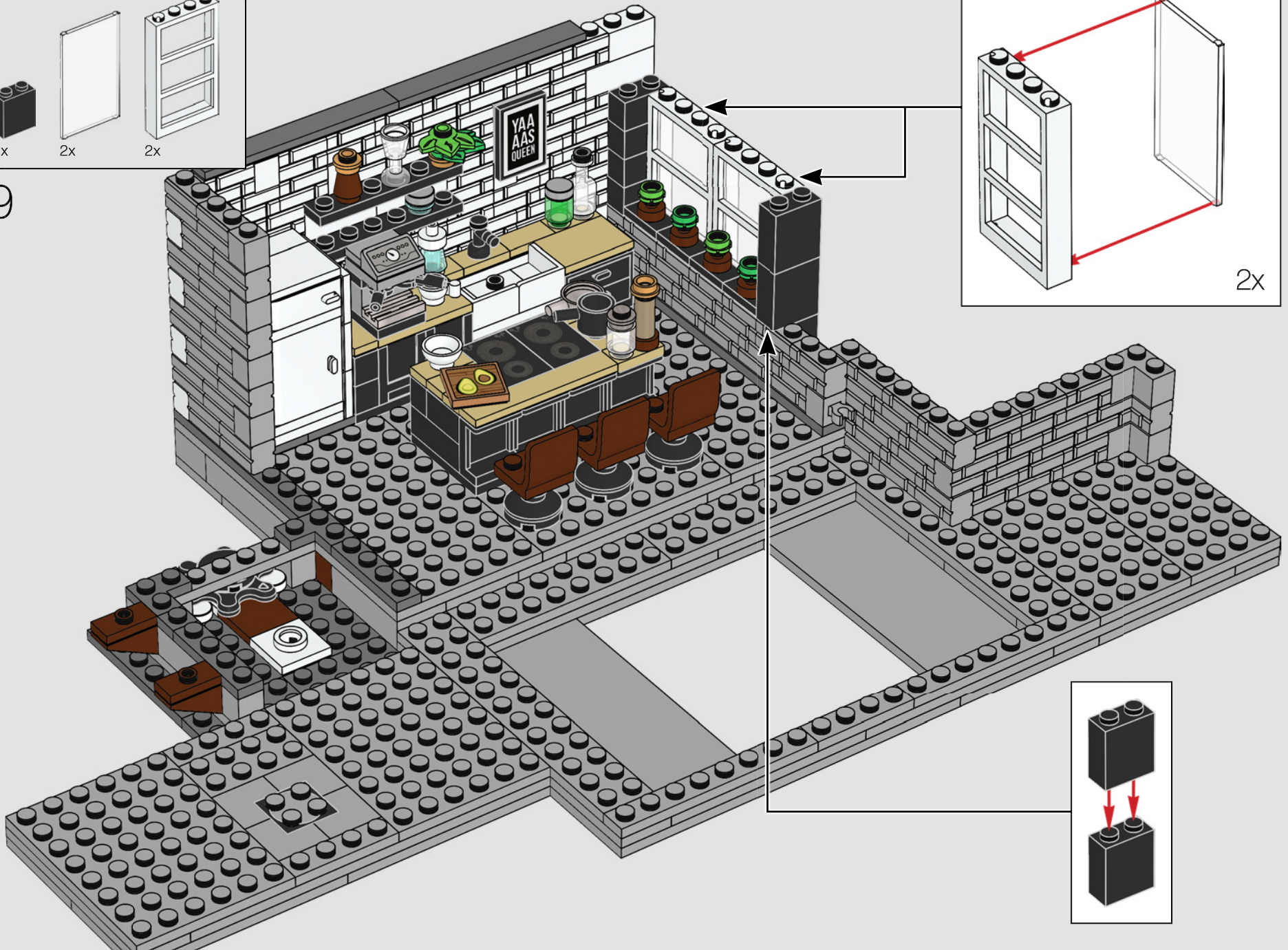

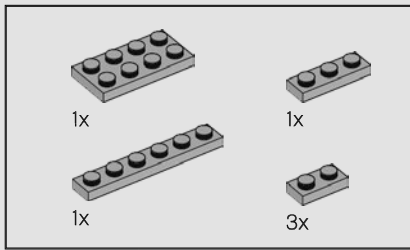

80

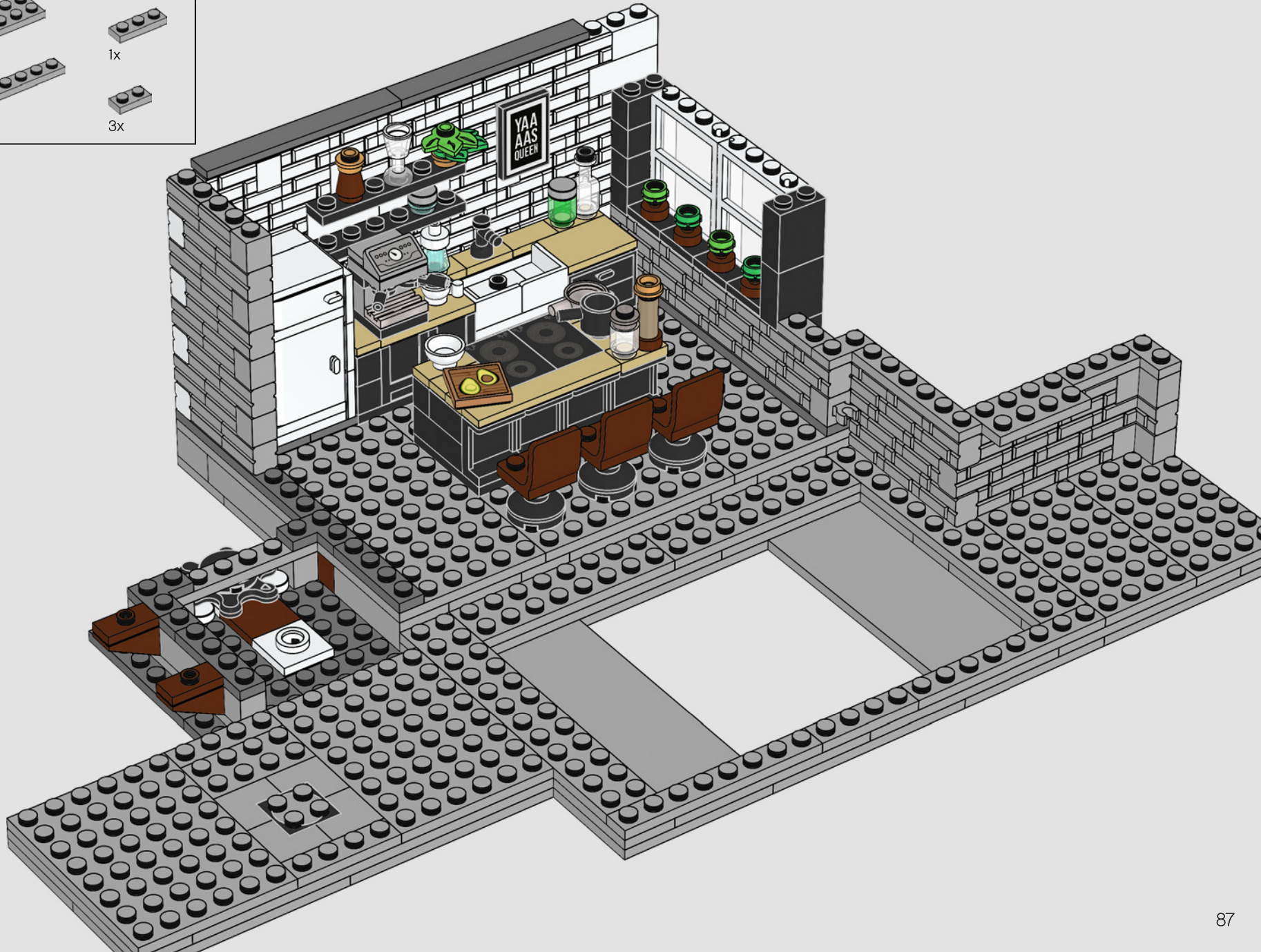

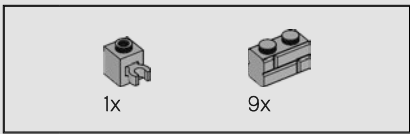

81



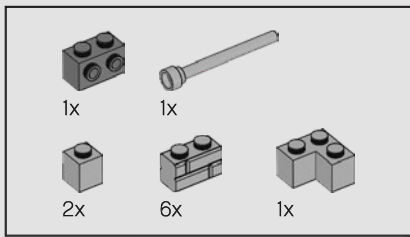

82

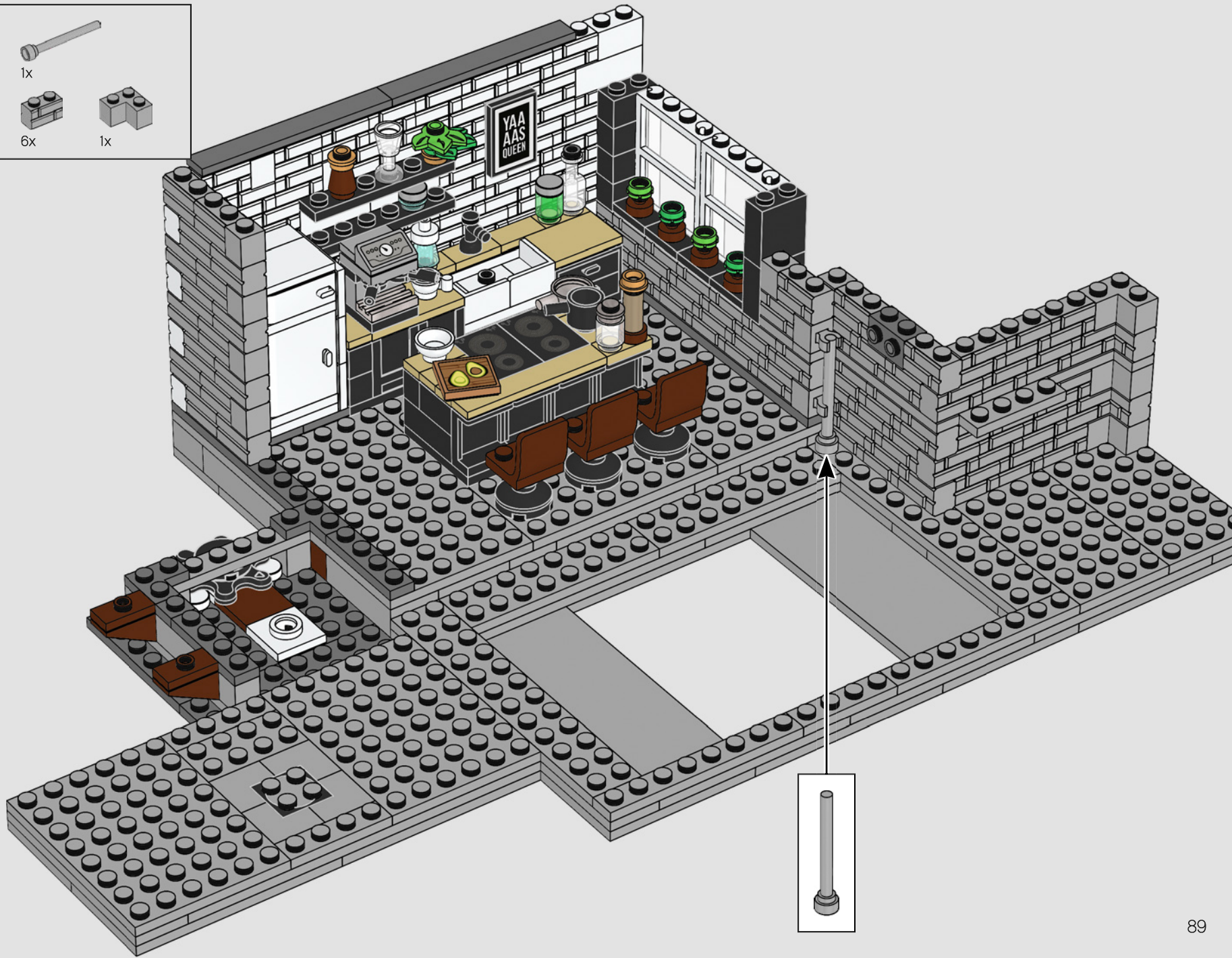

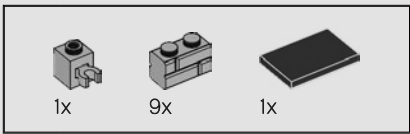

83

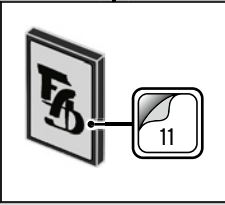
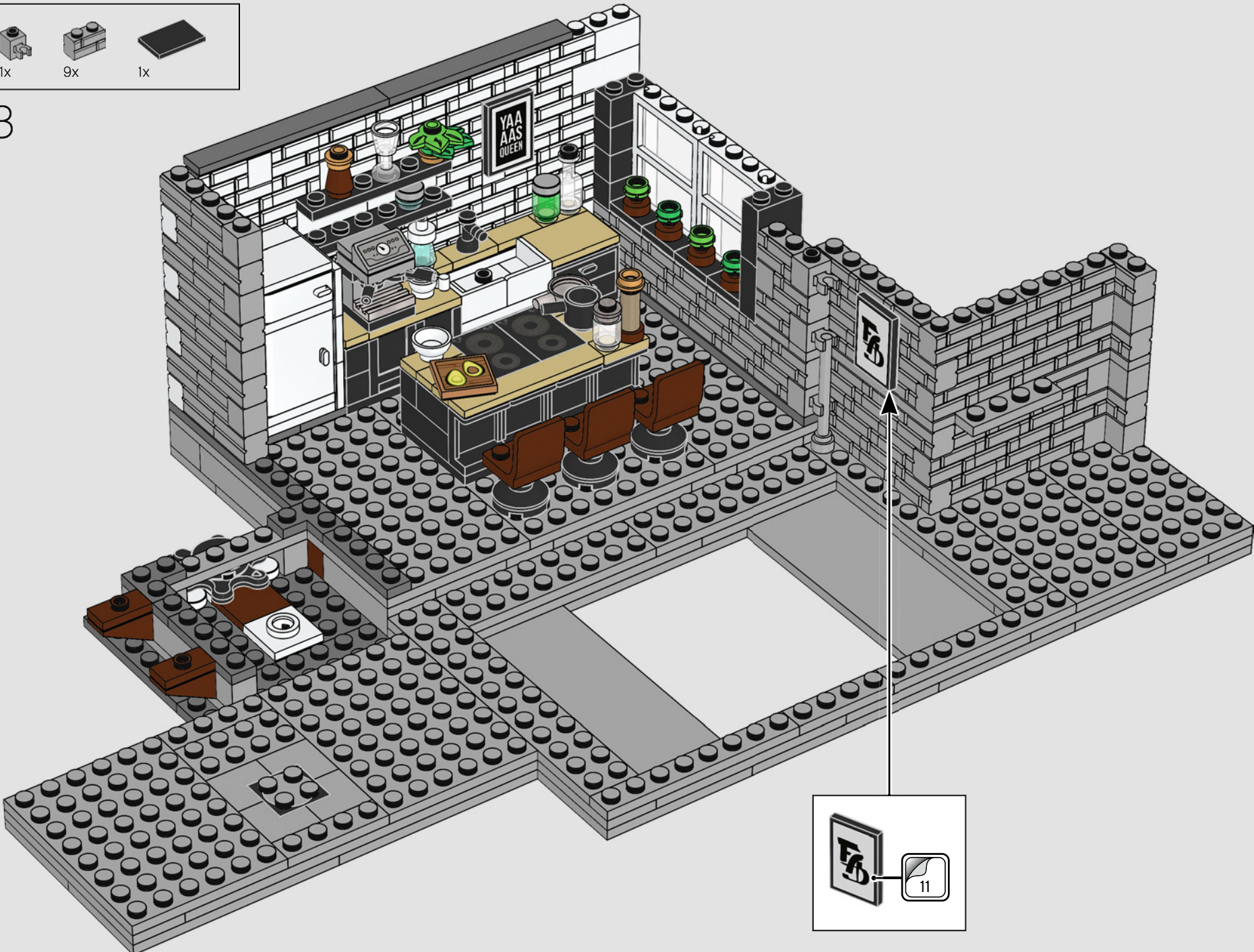

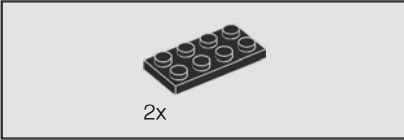
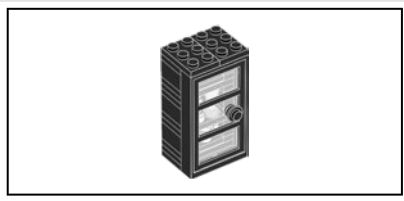

2x

84

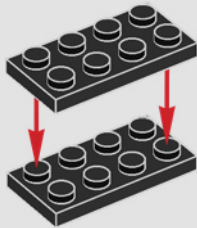

1x

2x

85

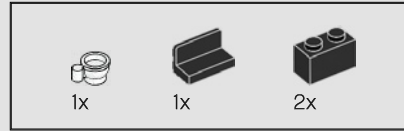
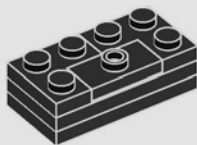

1x

1x

2x

86

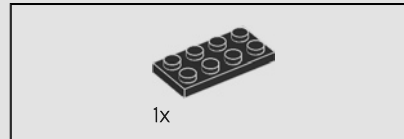
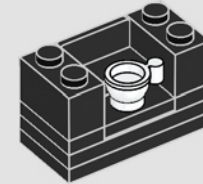

1x

87

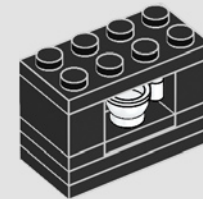



88

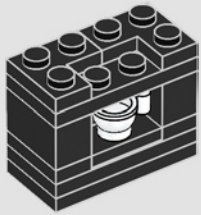

89



90

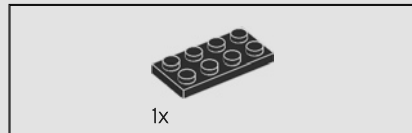

91

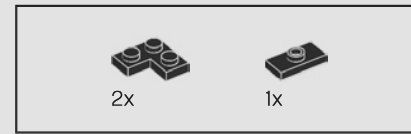

92

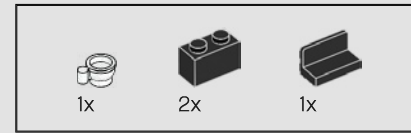

93



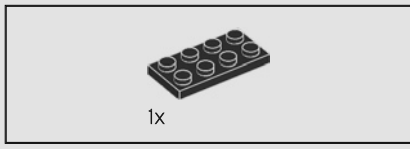

94

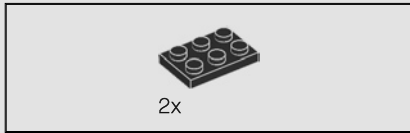

95

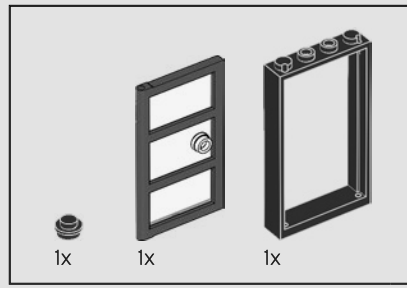
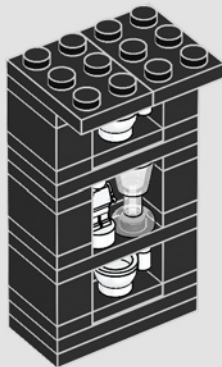

96

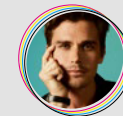
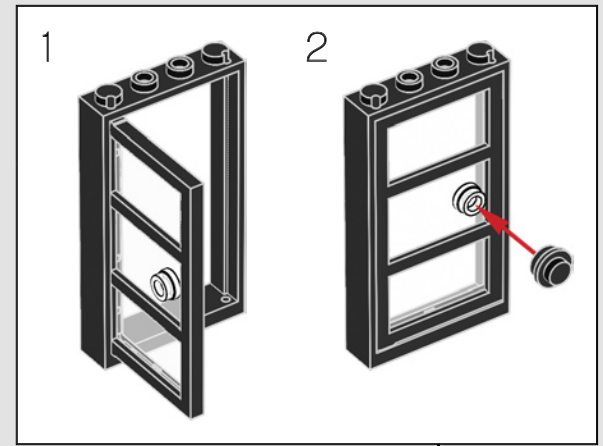
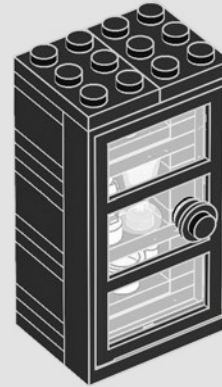

Antoni Porowski

„Als Kind waren LEGO® Sets meine Lieblingsspielzeuge. Ich baute damals Städte und Piratenschiffe, zerlegte sie dann und fing wieder von vorne an. Es ist einfach unglaublich, dass junge Kinder jetzt LGBTQ+ Optionen zum Bauen und Spielen haben. Es ist mir eine Ehre, an dieser besonderen Partnerschaft beteiligt zu sein. Der zehnjährige Antoni könnte schreien vor Glück.“

97

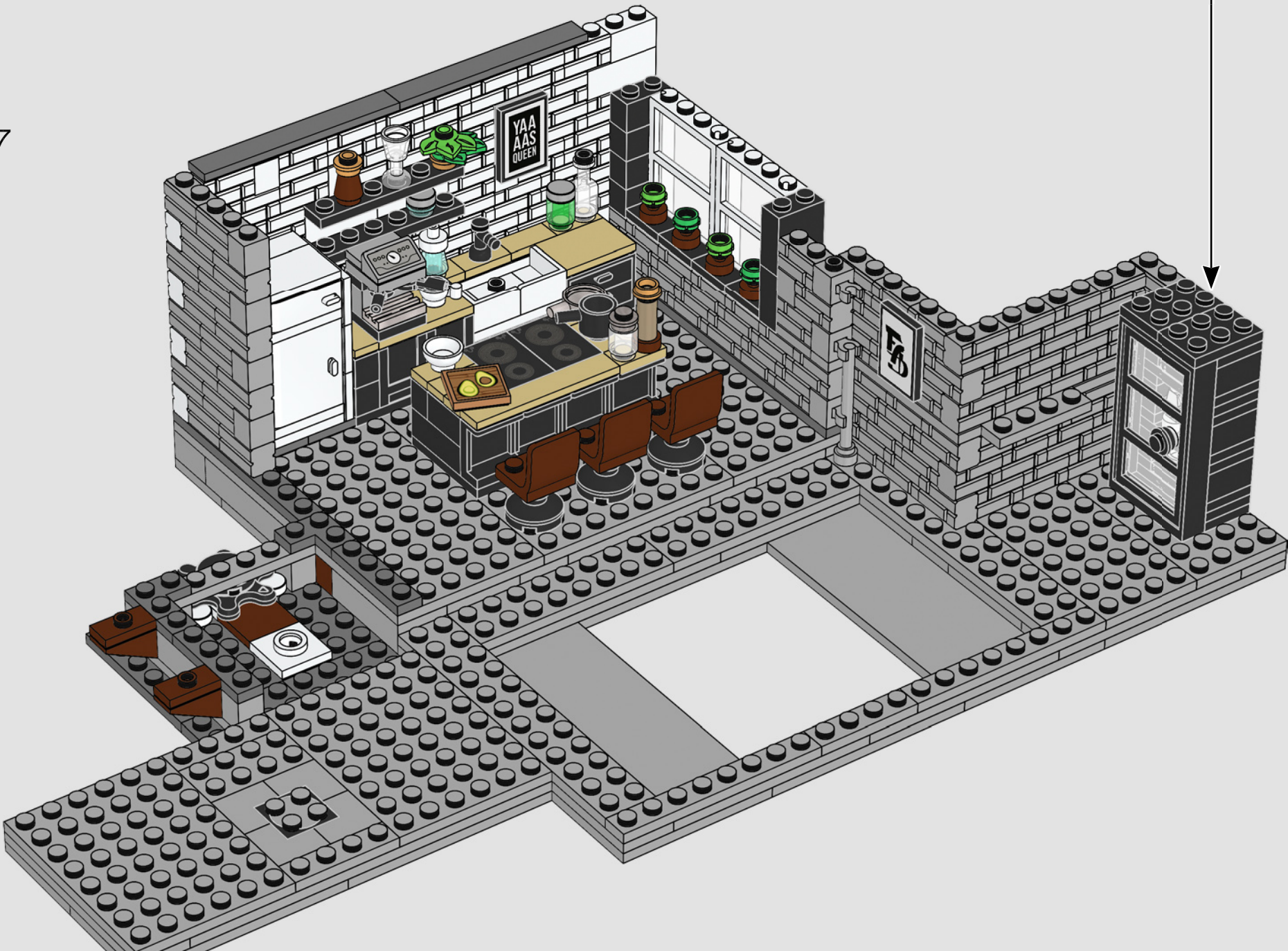

94

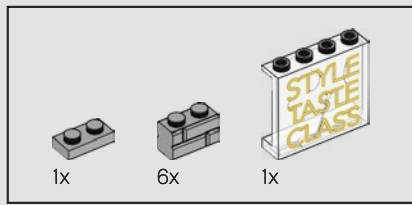

98

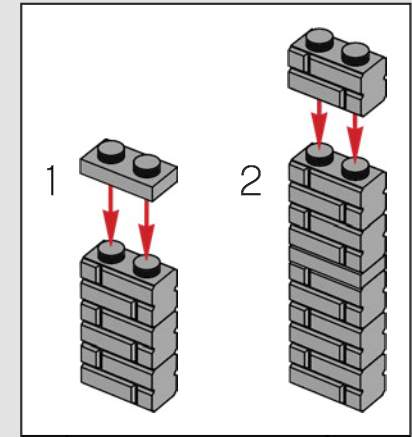
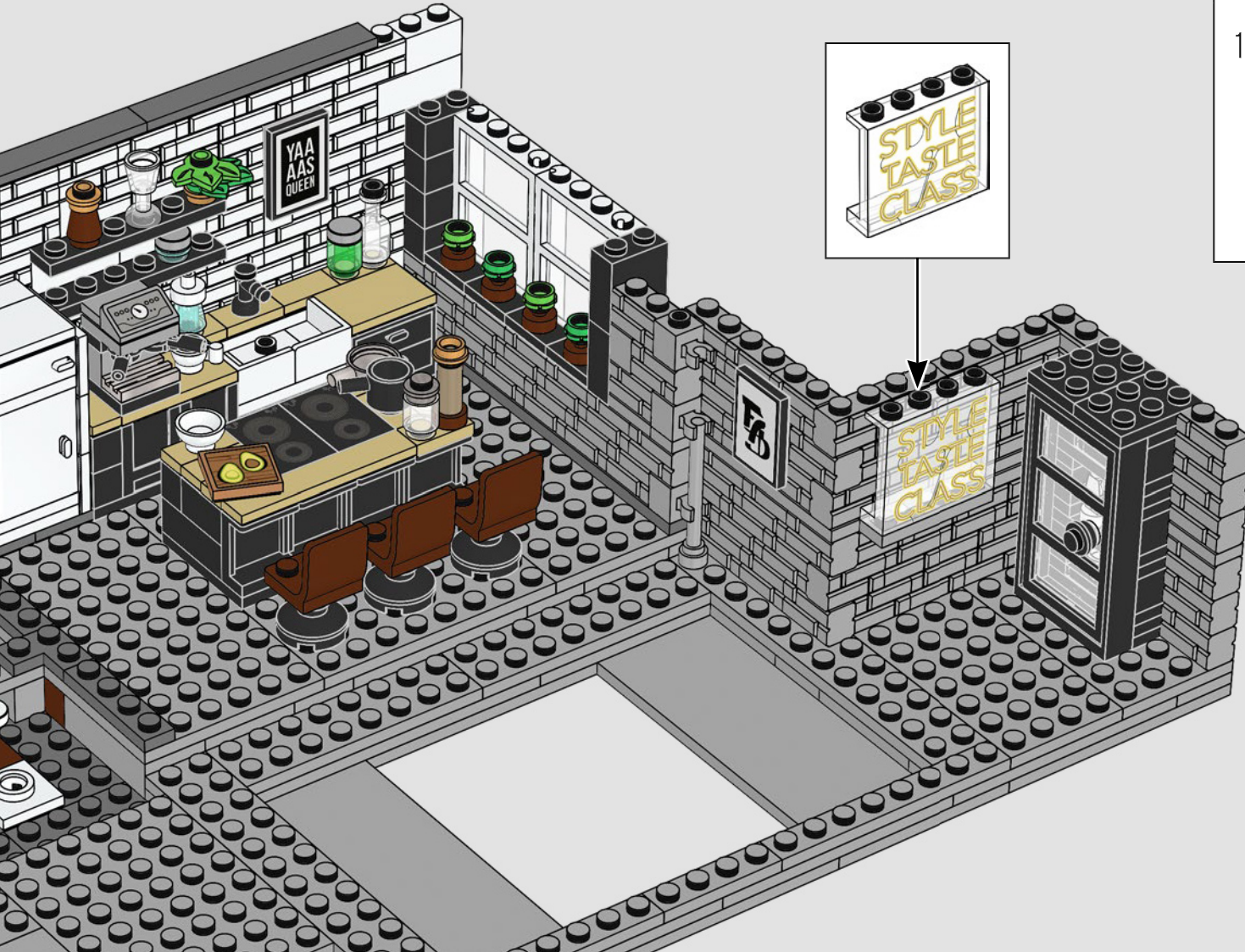

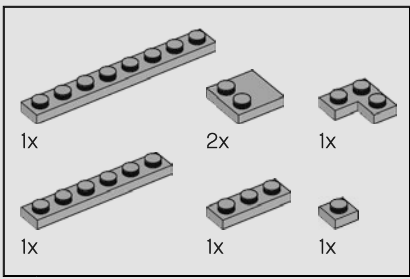

99



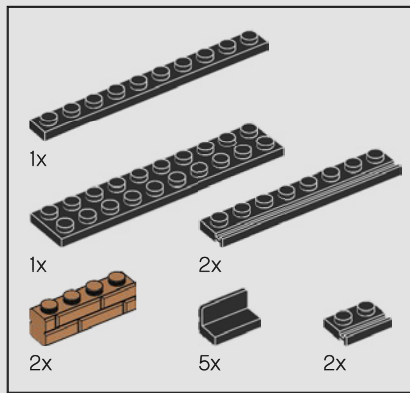

Tan France

„Im Herzen sind wir, die Fab Five, immer noch Kinder. Was wir in *Queer Eye* machen, fühlt sich für uns viel mehr nach Spielen als nach Arbeit an. Es passt einfach zu uns, dass wir an diesem LEGO® Set mitwirken, einem Spielzeug für Kinder jeden Alters!“

100

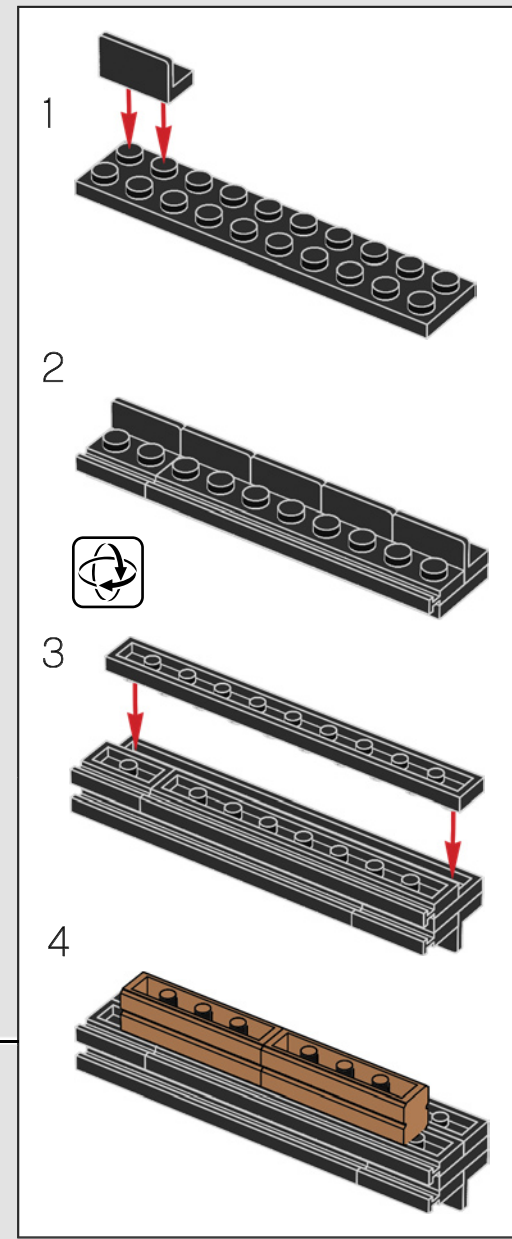

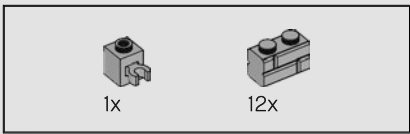

101



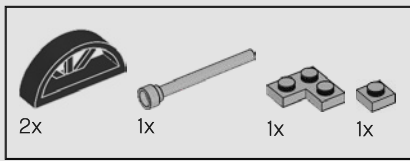

102

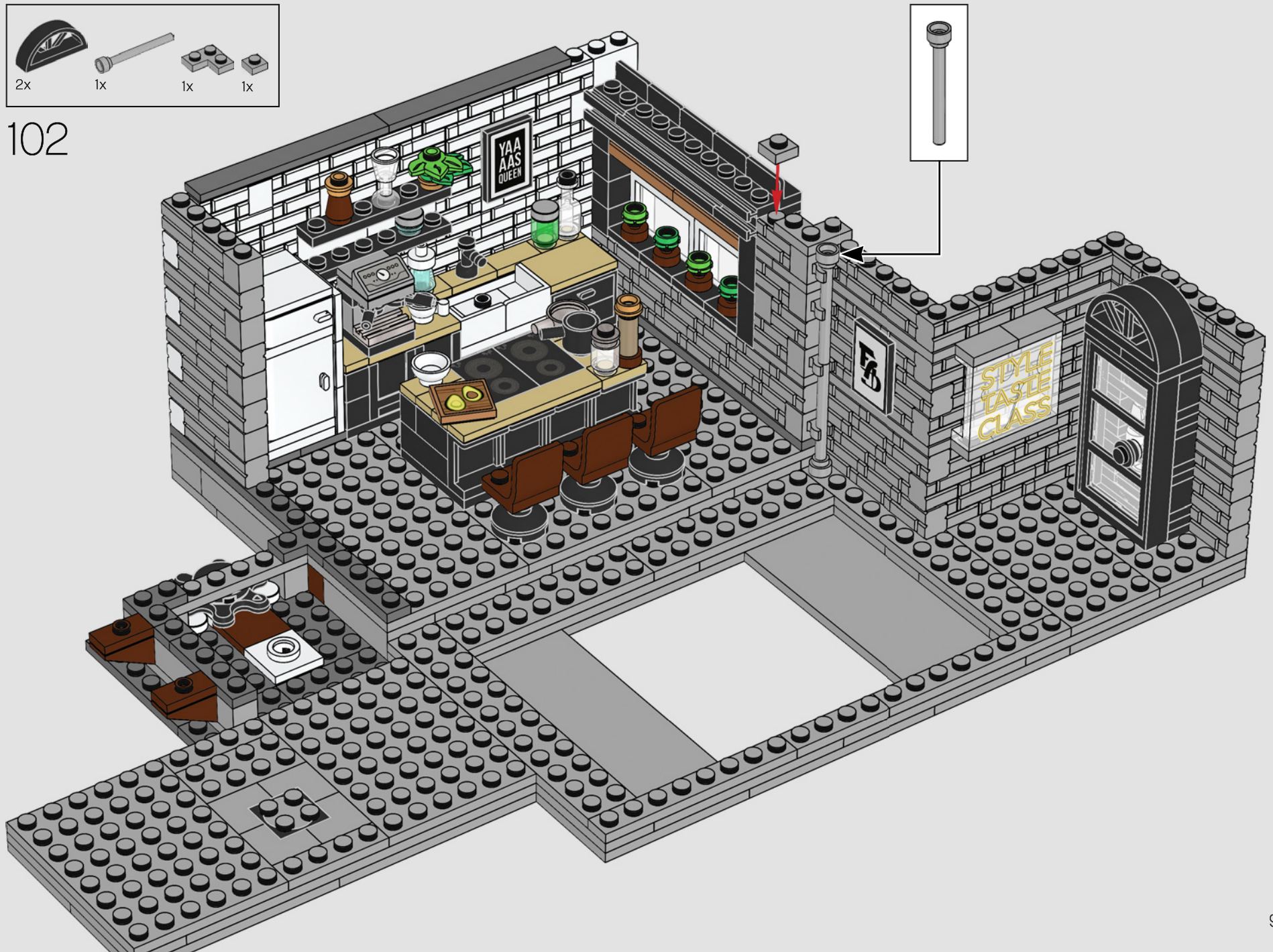



7x

103

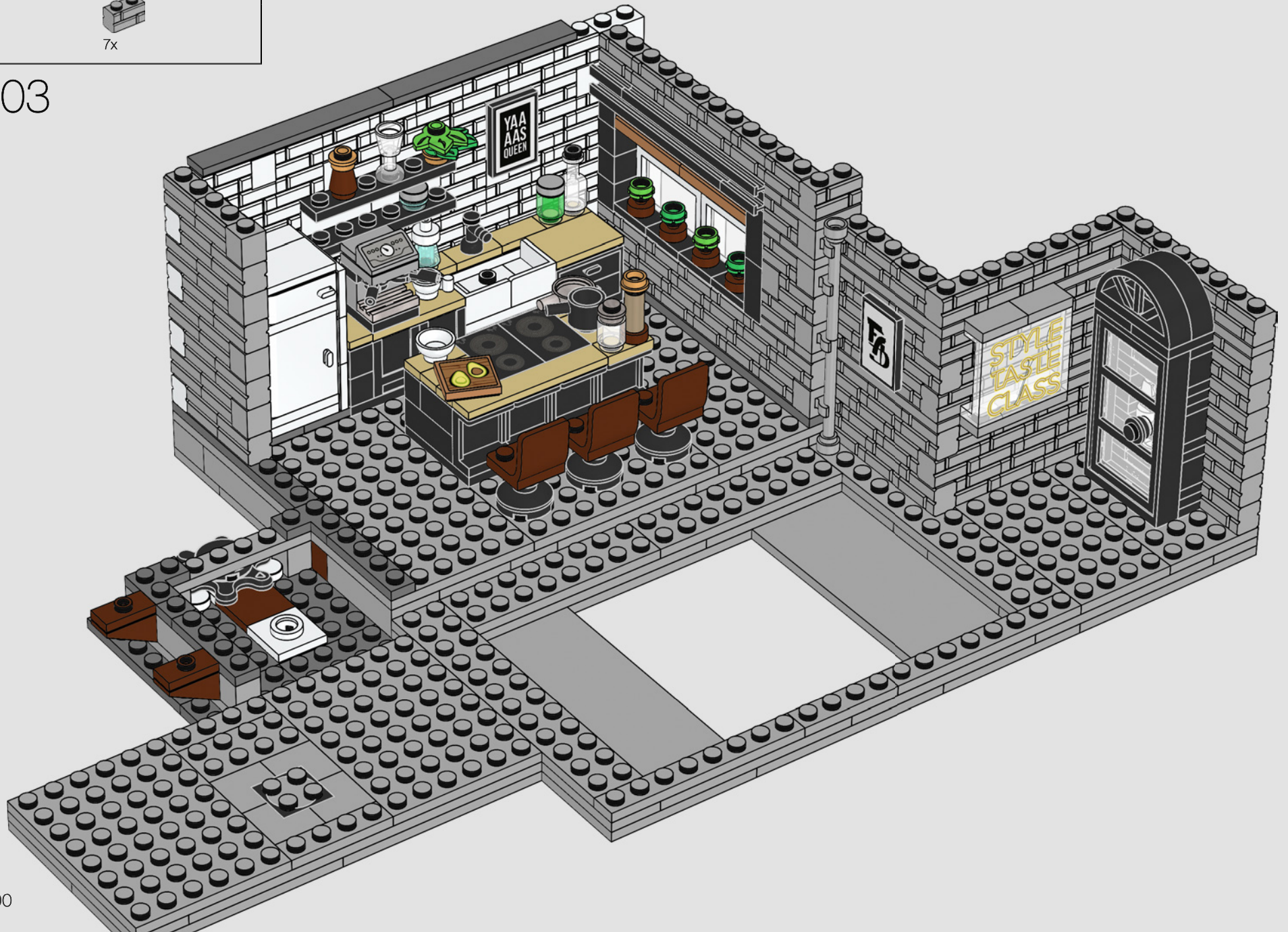

100

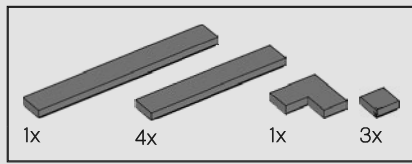

104



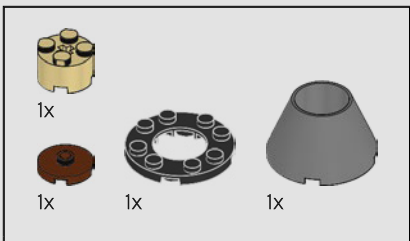

105

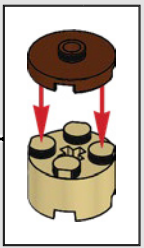
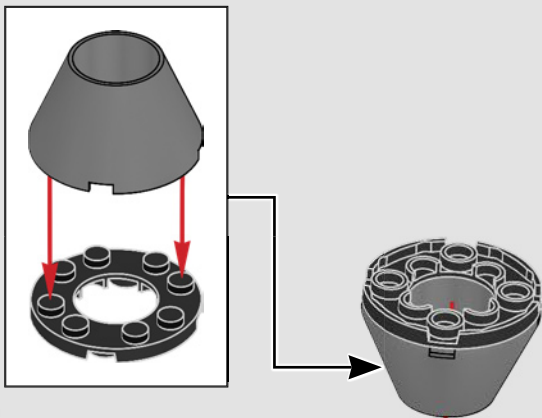

102

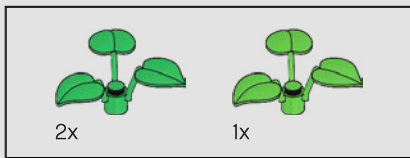

106

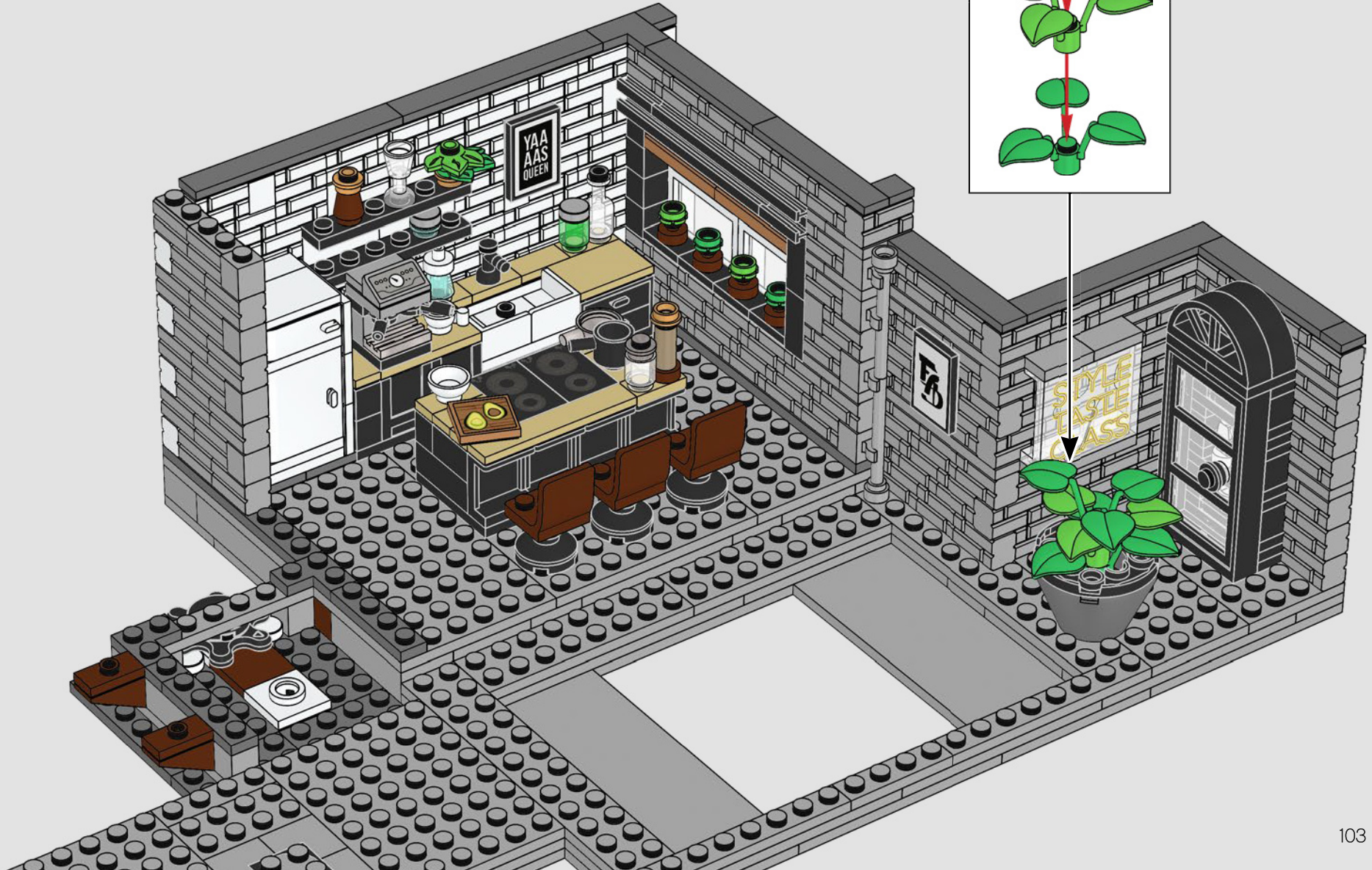

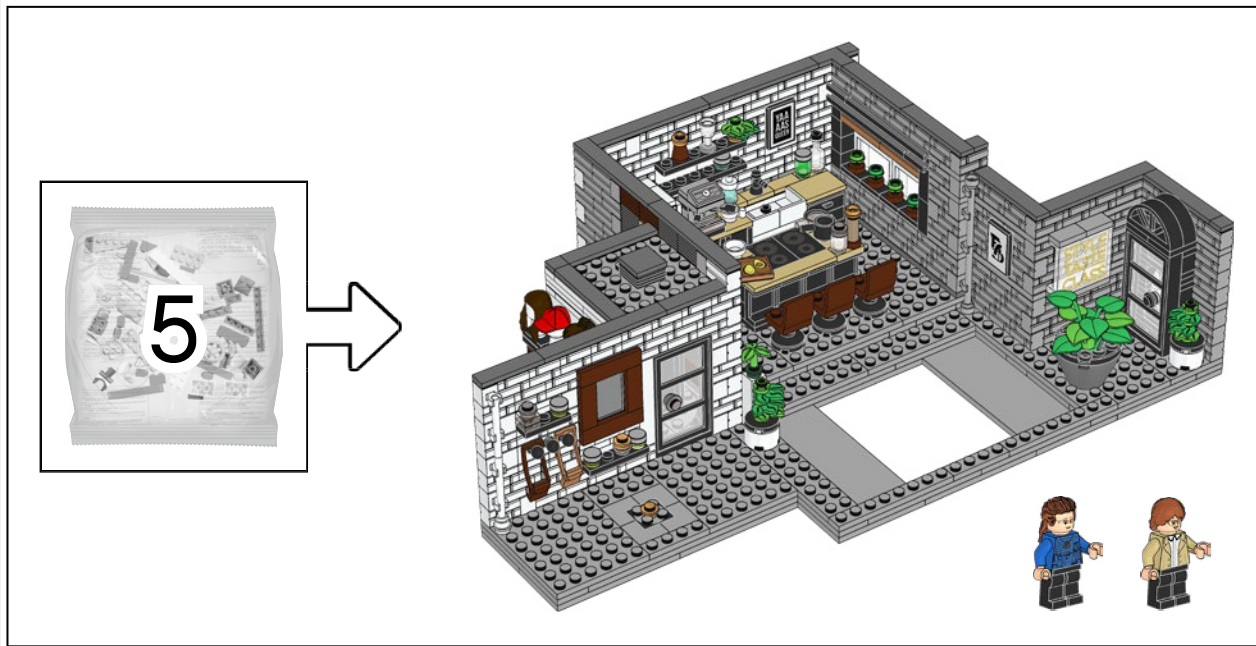

Jonathan Van Ness

„Es freut mich riesig, dass auch Kathi Dooley in diesem Set dargestellt ist! Sie ist die Heldin meiner Kindheit und bedeutet mir sehr viel. Außerdem kann ich ihr jetzt die Mähne abschneiden, und zwar so oft ich will.“



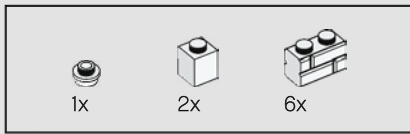

107



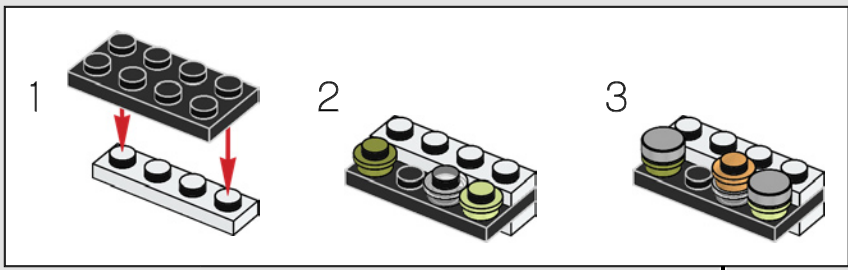
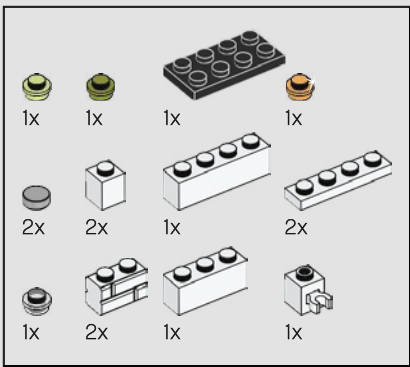

108



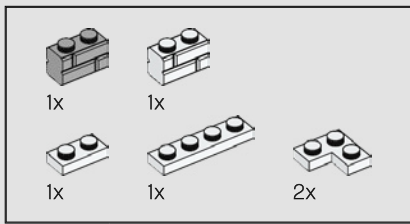

109



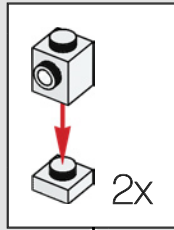
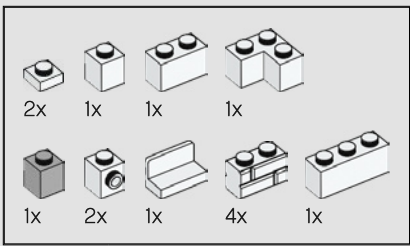

110



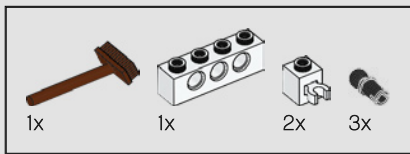

111

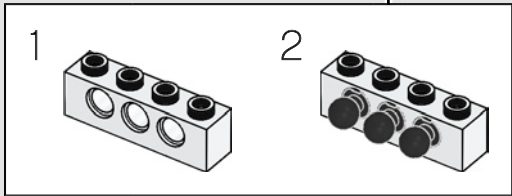
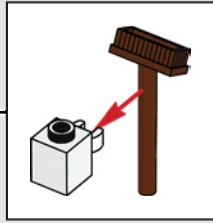

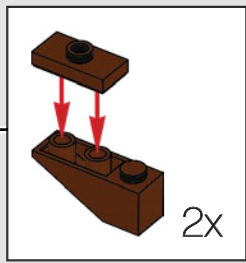
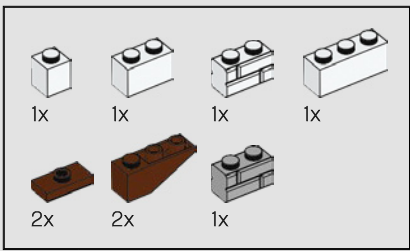

112



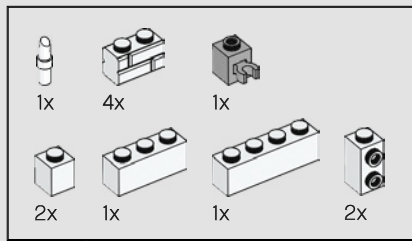

113

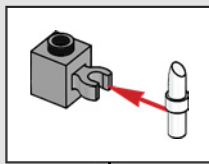

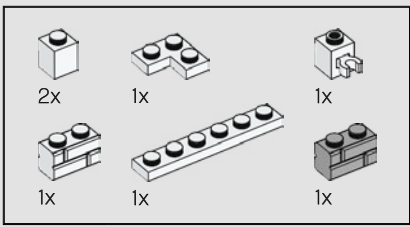

114



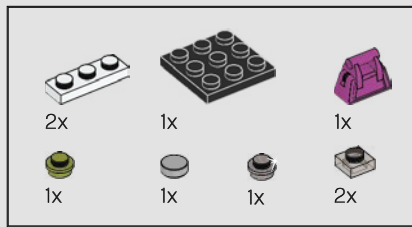

115

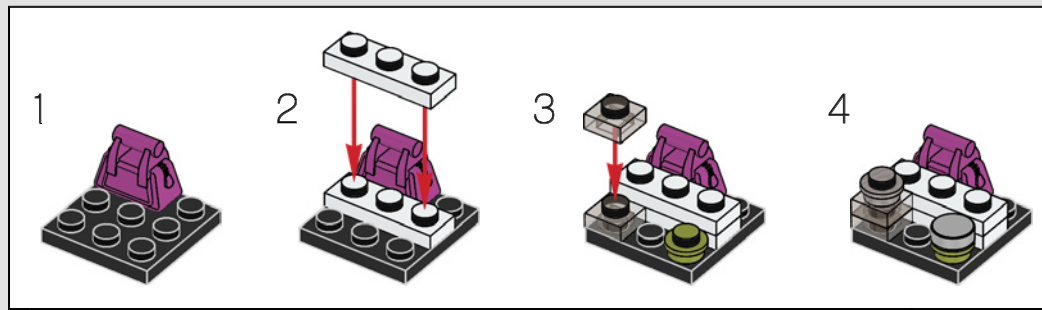

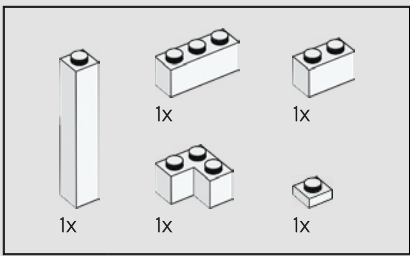

116



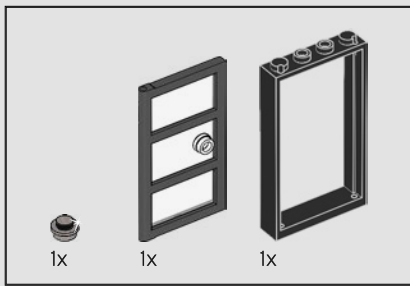

117

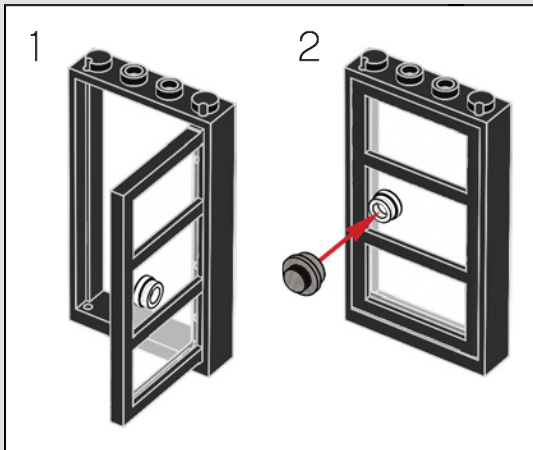

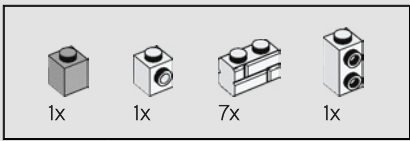

118



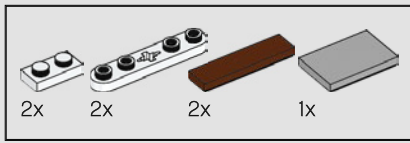

119

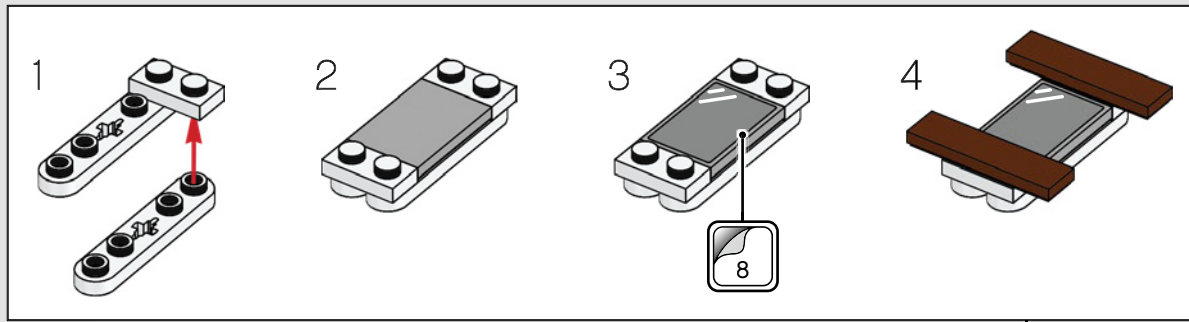

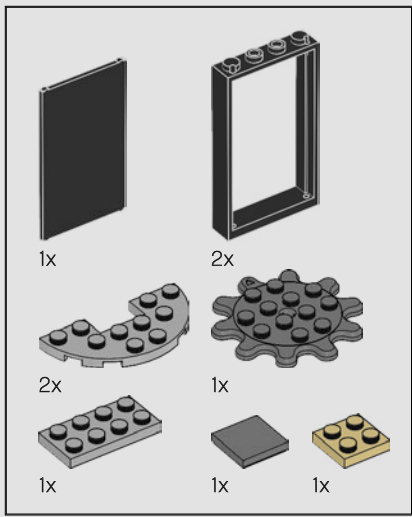

120

1

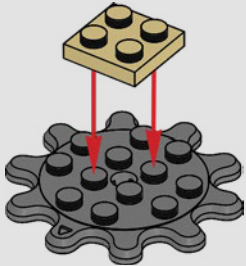

2

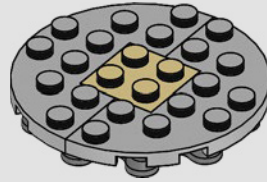

3

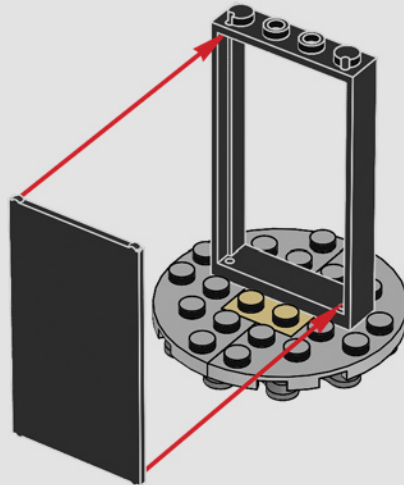

4

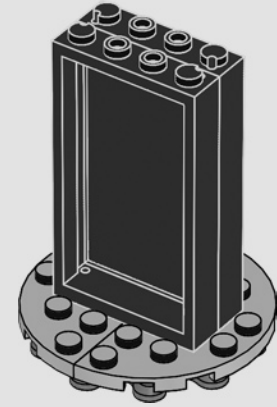

5

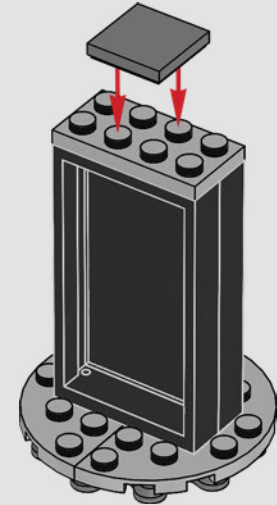

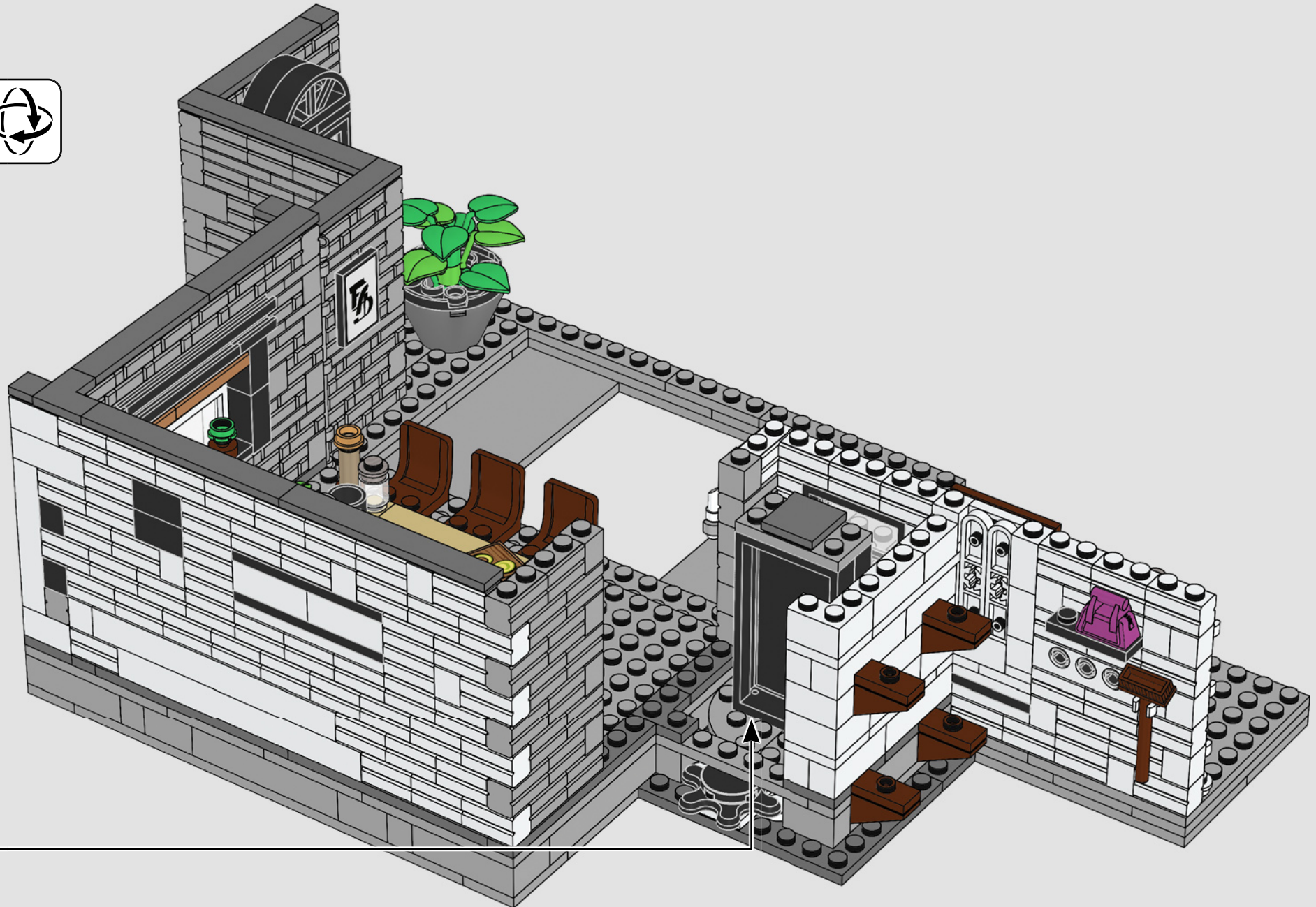

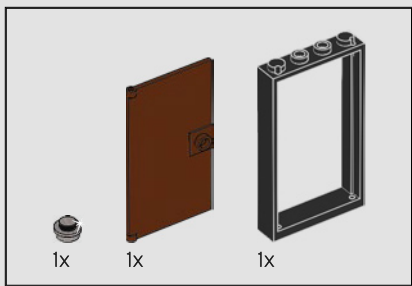

121

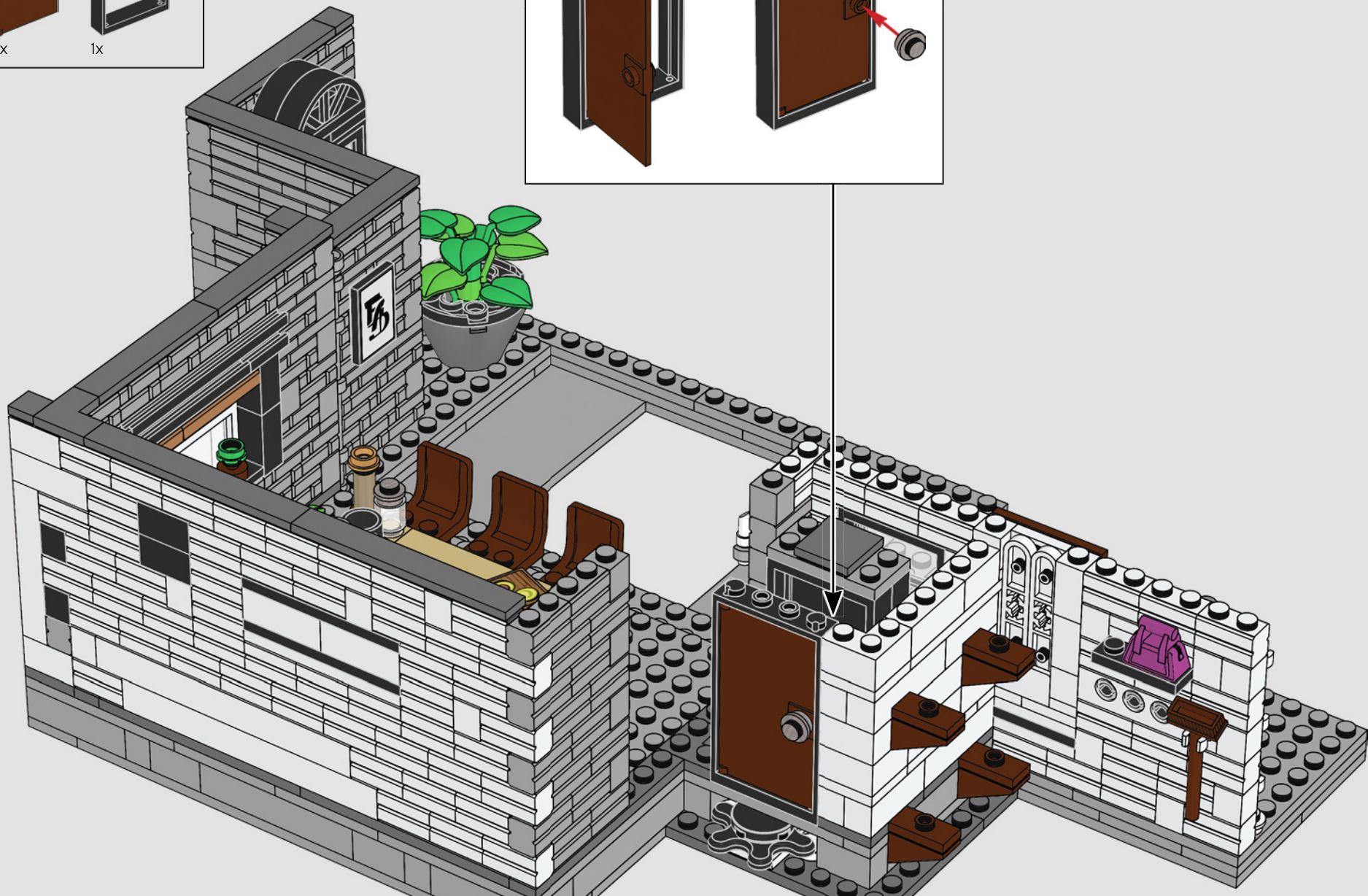
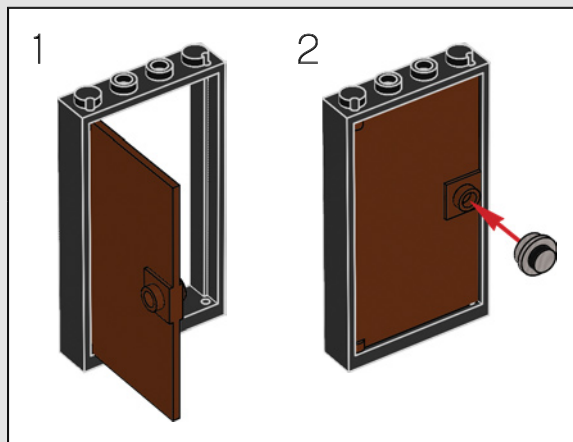

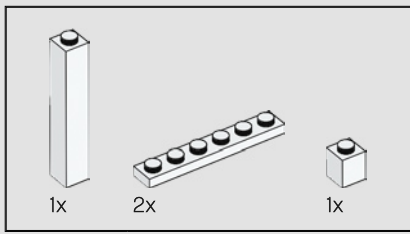

122

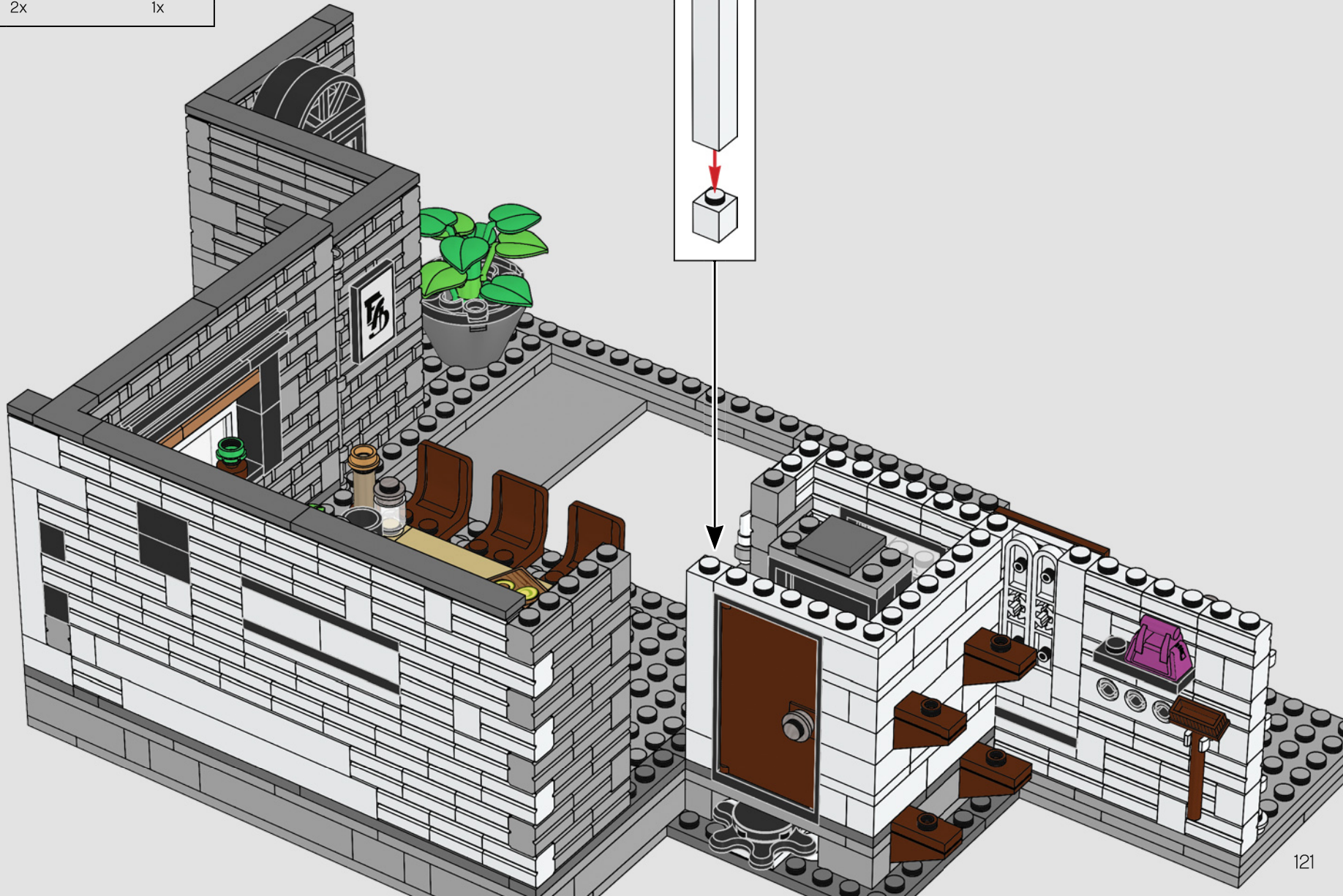

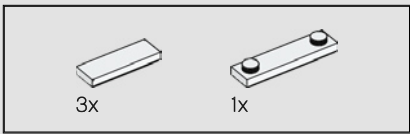

123



Tan France

„Ich liebe es, einer der Fab 5 zu sein. Queer Eye bietet mir die Möglichkeit, die tolle Vielfalt in unserer Gesellschaft ins Rampenlicht zu rücken. Das war meine größte Hoffnung, als ich für die Serie vorsprach, und ich bin so dankbar, jetzt diese Chance zu haben.“

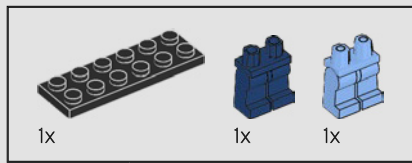

124

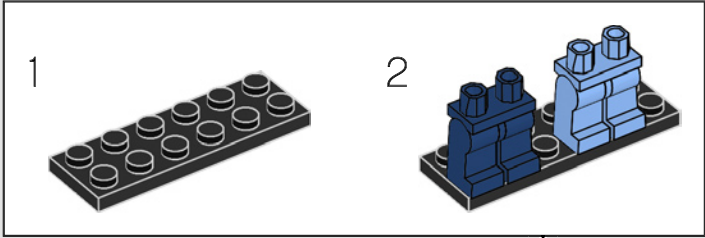
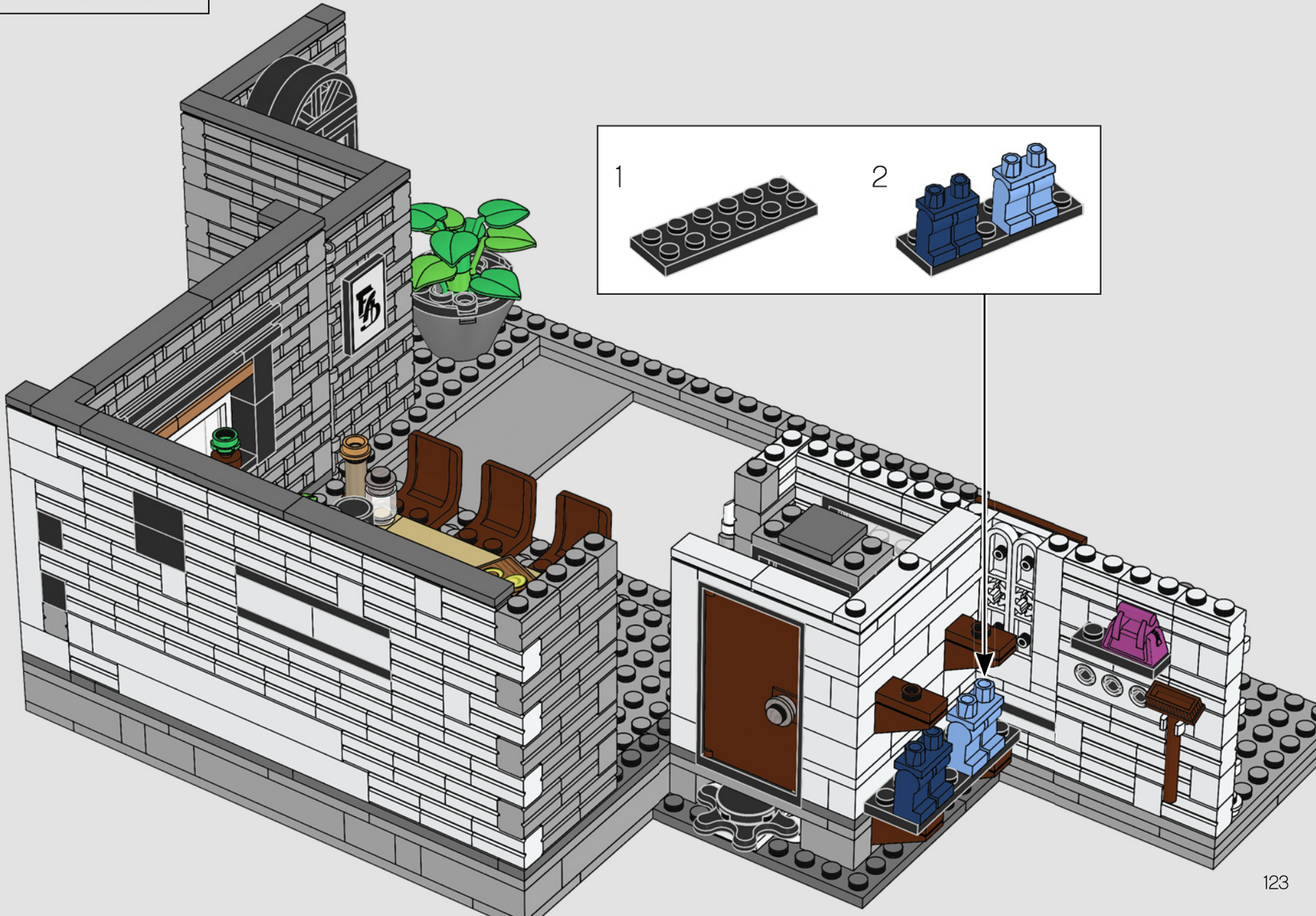

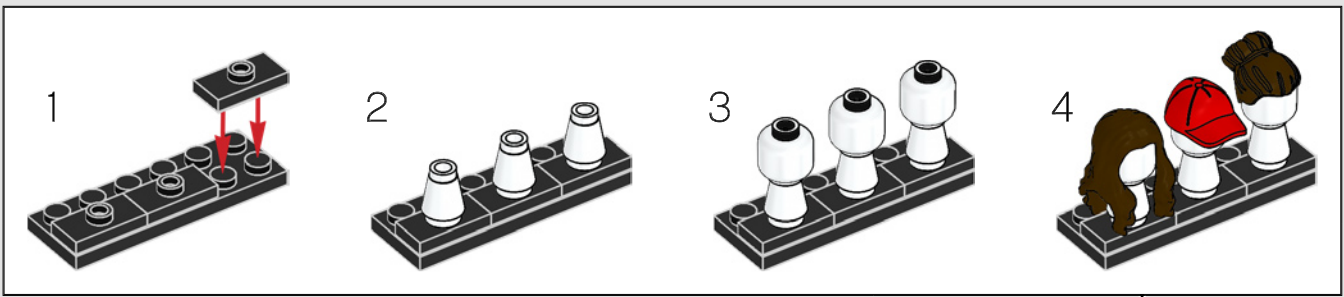
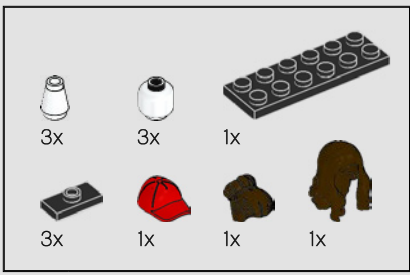

125



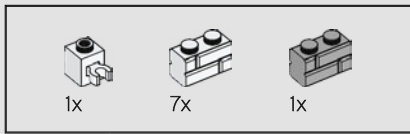

126



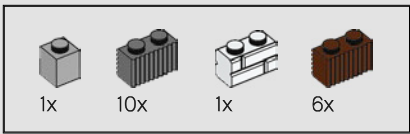

127

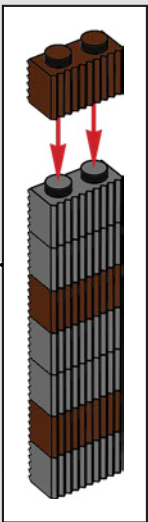
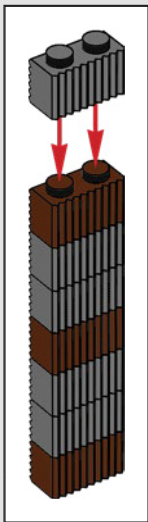

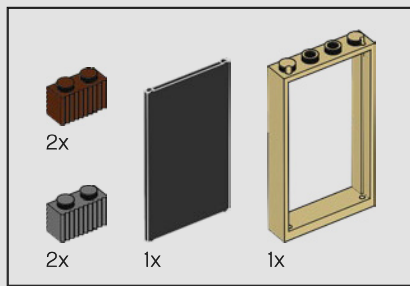

128

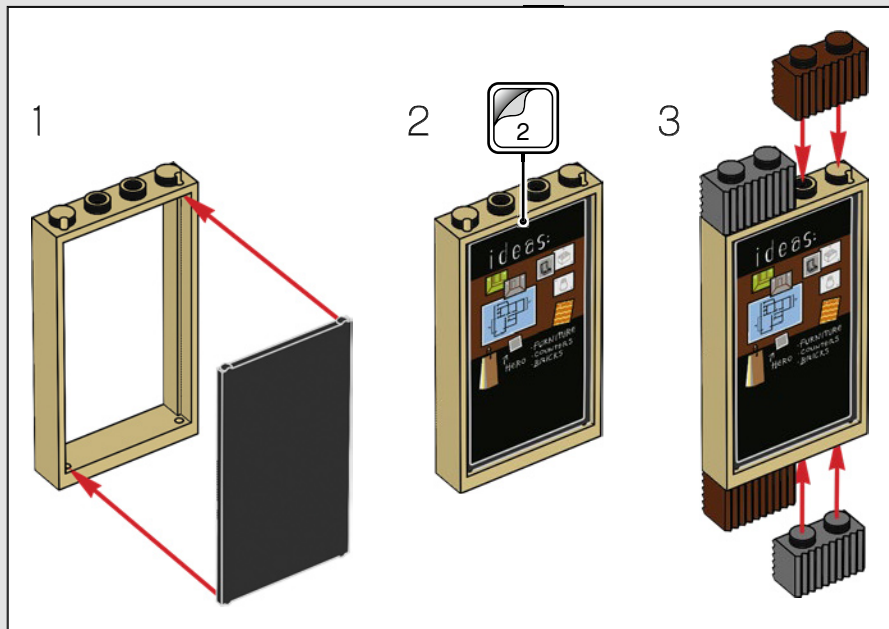

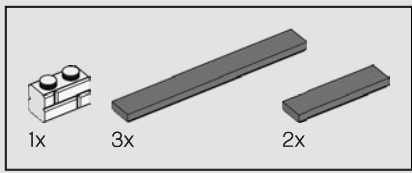

129

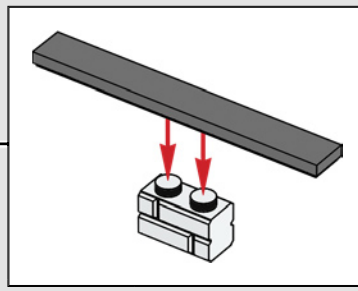

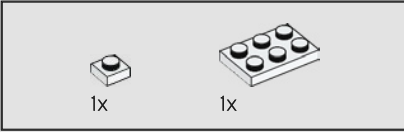
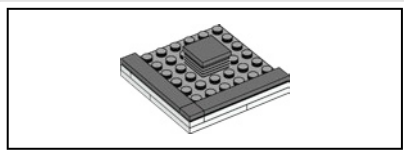

130

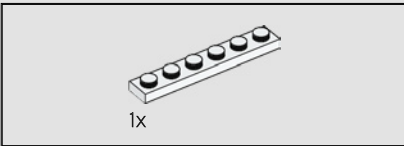
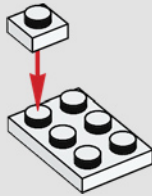

131

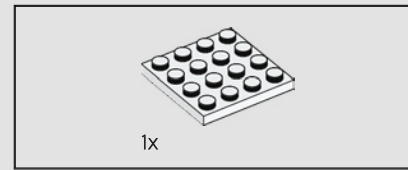
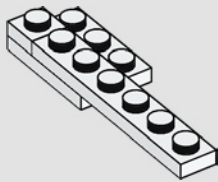

132

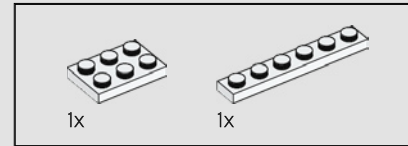
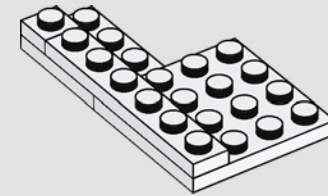

133

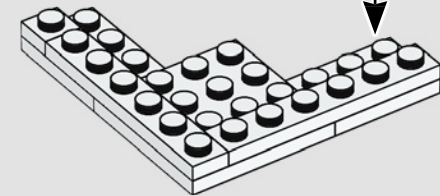
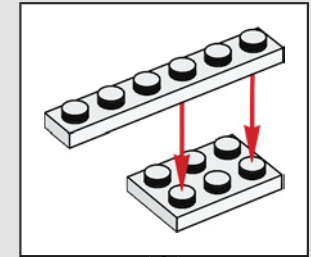

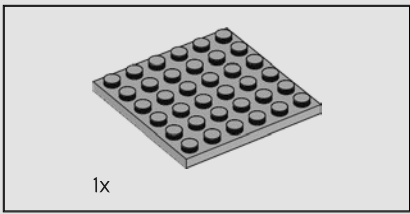

134

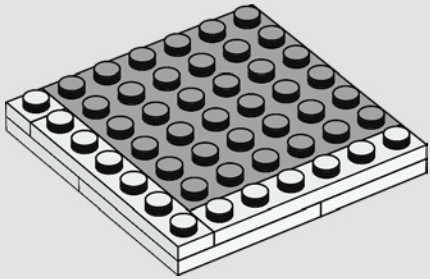

135

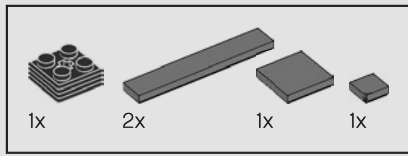
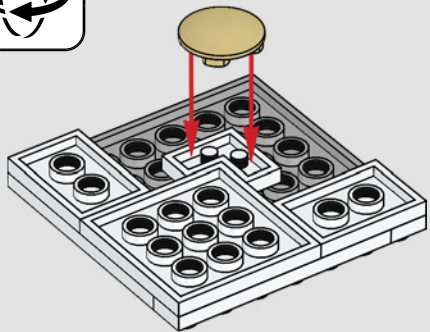

136

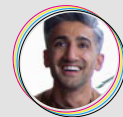
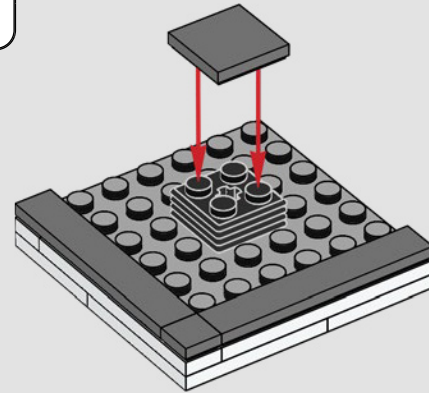
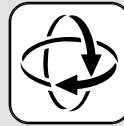

Tan France

„Dieser Verwandlungsraum ist genial! Einmal umdrehen und „Ta-daaa!“ - die große Enthüllung!“

137



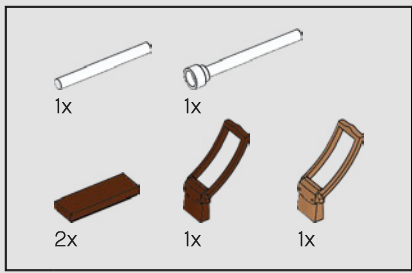

138



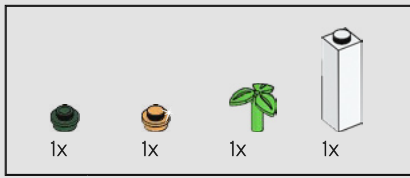

139

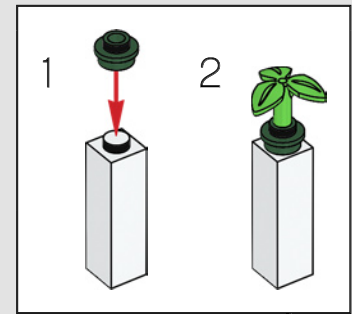

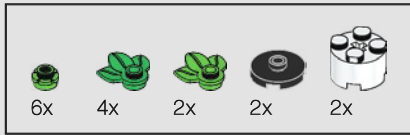

140



Karamo Brown

„Für Erwachsene sind kreative Prozesse eine Möglichkeit, sich zu fokussieren und den Kopf für ganz neue Ideen freizubekommen. Das Bauen mit LEGO® Steinen lässt dich wunderbar entspannen und abschalten. Und jedes fertige Modell vermittelt dir ein echtes Erfolgsgefühl. Genau wie unsere Serie können LEGO Steine den Menschen helfen, ihr Leben wieder ein kleines bisschen zusammenzufügen. Das ist die perfekte Partnerschaft.“

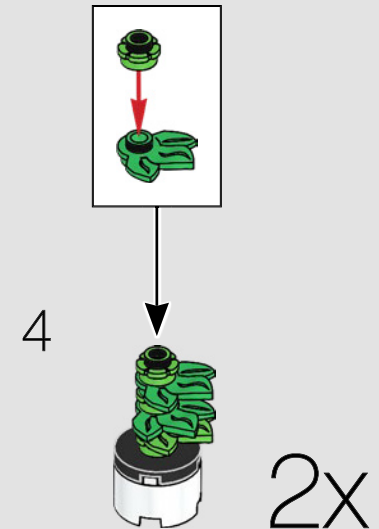
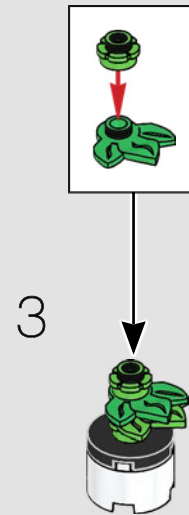
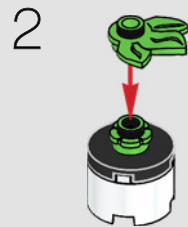
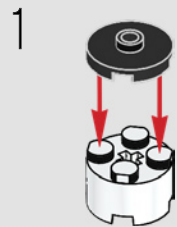





Bobby Berk

„Mir gefällt das fertige Set sehr. Wir haben es wirklich geschafft, alles Wesentliche aus unserem Original-Loft darzustellen!“





FEEDBACK AND WIN



FEEDBACK AND WIN

Your feedback will help shape the future development of this product series.

Please visit:

FEEDBACK UND GEWINNEN

Dein Feedback trägt zur Weiterentwicklung dieser Produktreihe bei.

Geh auf:

COMMENTEZ ET GAGNEZ

Vos commentaires nous aideront à concevoir les futurs produits de cette gamme.

Rendez-vous sur :

COMENTA Y GANA

Tu opinión nos ayudará a dar forma al desarrollo de esta serie de productos en el futuro.

Visita:

反馈有奖

您的反馈将有助于我们在今后改进本系列产品。

请访问：

[LEGO.com/productfeedback](https://www.lego.com/productfeedback)

By completing, you will automatically enter a drawing to win a LEGO® set.

Terms & Conditions apply.

Durch Ausfüllen nimmst du automatisch an der Verlosung eines LEGO® Preises teil.

Es gelten die Teilnahmebedingungen.

En envoyant vos commentaires, vous serez automatiquement inscrit(e) à un tirage au sort qui vous permettra de remporter un prix LEGO®.

Offre soumise à conditions.

Al contestar, participarás automáticamente en el sorteo y podrás ganar un set LEGO®.

Sujeto a Términos y Condiciones.

完成我们的反馈调查，即可自动进入抽奖环节，赢取乐高®套装。

适用《条款和条件》。

1x 6189137	5x 6321349	2x 6181753	3x 362601	1x 306901	3x 4114026	6x 300526	1x 459926	11x 6092585	11x 242026	2x 300226	1x 447726	1x 6345181
1x 6299492	2x 614301	2x 6046979	1x 370101	1x 395701	6x 6092587	2x 6315887	2x 6315887	8x 6146220	2x 235726	1x 6138479	1x 303526	1x 6352842
2x 6284572	85x 6152409	1x 4527637	1x 370101	1x 370101	1x 4113917	1x 6170421	3x 6344752	1x 6329698	2x 4515368	1x 6138479	1x 303526	1x 6032178
3x 4518400	1x 6146215	1x 4519346	1x 4519346	3x 346001	1x 4113917	2x 6284070	2x 6170566	2x 4618852	2x 362226	1x 300926	1x 303526	1x 6032178
1x 6168642	4x 371001	1x 4179580	1x 4549393	2x 301001	1x 416201	8x 6168646	1x 6234695	1x 302326	1x 362326	2x 6177083	3x 383226	8x 6206150
1x 6186681	3x 302301	8x 362201	2x 6271168	4x 611101	4x 611101	4x 614126	4x 6138173	2x 4107761	1x 4558170	2x 6177083	1x 4514845	2x 6135287
3x 6235083	1x 6034044	4x 362301	2x 6271168	1x 4125253	1x 4550324	12x 300426	3x 6156991	2x 6336989	3x 6256051	1x 611517	1x 244526	1x 302428
6x 302401	5x 300401	4x 4558168	3x 6104805	1x 4278422	1x 6294227	1x 6299338	2x 4521439	1x 6325254	1x 6346248	1x 611517	1x 244526	6x 6229130
3x 4558952	4x 6248827	1x 6353707	3x 302001	1x 4278422	1x 4124067	1x 6299338	2x 6196548	1x 302226	2x 6346248	1x 4530589	1x 428226	2x 6269046
3x 245301	2x 6070698	1x 6353707	3x 302001	1x 4278422	1x 4124067	2x 6196548	1x 452926	1x 452926	1x 6116604	1x 4530589	1x 428226	1x 6269046
1x 6198979	2x 302201	1x 6353627	9x 366601	1x 4278422	1x 4157277	1x 6070695	1x 6070695	1x 302226	2x 6116604	1x 4530589	1x 428226	2x 6269046
3x 6218841	3x 6218822	1x 6116602	3x 6104805	1x 4278422	1x 4157277	2x 6196548	2x 6196548	1x 302226	2x 6162892	6x 6337273	1x 6094066	1x 6235080
1x 6055541	2x 6238334	6x 6156667	1x 4243812	2x 4114084	2x 4286009	3x 474026	3x 474026	2x 6192346	2x 6162892	1x 6167800	1x 6094066	4x 6182261
16x 300501	5x 235701	6x 302101	1x 6051511	1x 4114077	2x 4286009	4x 4644456	5x 6195325	2x 6192346	2x 6162892	6x 6337273	1x 6198992	1x 6269048
1x 6055541	6x 242001	1x 6249091	2x 6280386	1x 6175367	1x 6037390	3x 9339	2x 4565323	2x 6346247	1x 6167800	1x 300126	1x 6125719	1x 6223655
1x 6055541	6x 242001	1x 6249091	2x 6280386	1x 6175367	5x 379526	1x 6047276	2x 302126	3x 6133722	1x 6087083	6x 302026	1x 6254100	2x 6166107
1x 6055541	6x 242001	1x 6249091	2x 6280386	1x 6175367	5x 379526	4x 4593678	1x 6306064	2x 6345177	3x 6174917	6x 302026	1x 6254100	2x 6166107



Customer Service
 Kundenservice
 Service Consommateurs
 Servicio Al Consumidor
 LEGO.com/service or dial





LEGO and the LEGO logo are trademarks of the LEGO Group. ©2021 The LEGO Group.

©2021, Scout Productions, Inc. and the Queer Eye logo are trademarks or registered trademarks of Scout Productions, in the United States of America and elsewhere. All rights reserved.