

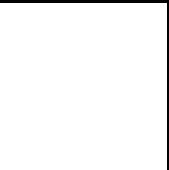

Booklet available in English on
Livret disponible en français sur
Folleto disponible en español en





WELCOME

What started as a nights and weekends passion project for our designers in 2007 has now grown into a vibrant downtown filled with beautiful architecture, rich interiors, clever brick usage and an impressive population of happy minifigures. And what better way to celebrate 15 years of Modular Building than by creating one of the models most-often requested by fans.

BIENVENUE

Ce qui n'était au départ qu'un projet personnel hors travail pour nos concepteurs en 2007 est devenu un centre-ville dynamique, doté d'une superbe architecture et de riches décors intérieurs, qui fait montre d'une utilisation intelligente des briques et accueille une impressionnante population de joyeuses figurines. Et quelle meilleure façon de célébrer les 15 ans des bâtiments modulaires qu'en créant l'un des modèles les plus souvent demandés par les amateurs ?

BIENVENIDOS

Lo que comenzó como un proyecto personal que ocupaba las noches y fines de semana de nuestros diseñadores en 2007 ha crecido hasta convertirse en un vibrante centro urbano lleno de hermosa arquitectura, ricos interiores, un astuto uso de los bricks y una impresionante población de alegres minifiguras. Y qué mejor manera de celebrar estos 15 años de la serie Modular Buildings que creando uno de los modelos más solicitados por los fans.

Welcome to the beautiful, historic **Boutique Hotel**! Inspired by turn-of-the-century European architecture, the unique wedge-shaped structure showcases a myriad of elegant forms and delicate details. It's also packed with small stories and subtle references to earlier models in the Modular Building range. See how many you can spot!

Bienvenue au magnifique et historique **hôtel-boutique** ! Inspirée de l'architecture européenne du début du siècle dernier, la structure unique en forme de coin présente une myriade de formes élégantes et de détails délicats. Le modèle regorge également de petites histoires et de subtiles références aux modèles antérieurs de la gamme de bâtiments modulaires. Combien pourrez-vous en repérer ?

¡Les damos la bienvenida al precioso y mítico **Hotel Boutique**! Inspirada en la arquitectura europea de principios del siglo XX, la singular estructura en cuña luce un sinfín de elegantes formas y delicados detalles. También está repleta de pequeñas historias y sutiles referencias a los anteriores modelos de la serie Modular Buildings. ¡Veamos cuántas pueden descubrir!





*From left to right:
De gauche à droite :
De izquierda a derecha:*

Michael Psiaki
Astrid Graabæk
Wesley Alan Talbott
Torben Kidde Skov
Anderson Ward Grubb
Chris McVeigh
Jamie Berard

It's been an exciting 15 years of Modular Building! Here are all the models and many of the designers who made it happen.

Les 15 années de la gamme de bâtiments modulaires ont été passionnantes ! Voici tous les modèles ainsi que plusieurs des créateurs qui les ont réalisés.

¡Han sido 15 emocionantísimos años de Modular Buildings! Aquí están todos los modelos y muchos de los diseñadores que los hicieron realidad.



Anderson Ward Grubb
Designer of the 10297 Boutique Hotel
Concepteur du modèle 10297 L'hôtel-boutique
Diseñador del Hotel Boutique (10297)



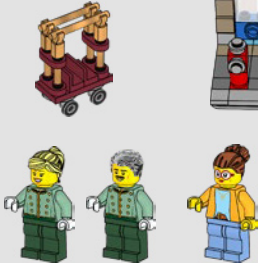
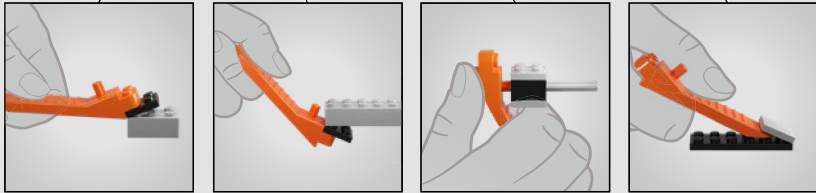
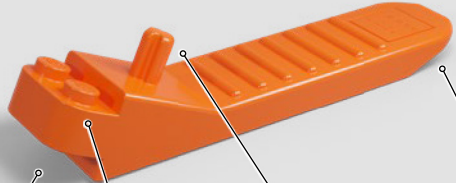
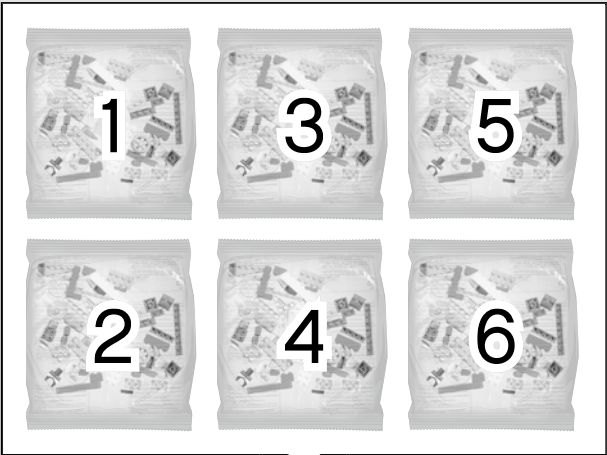

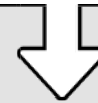
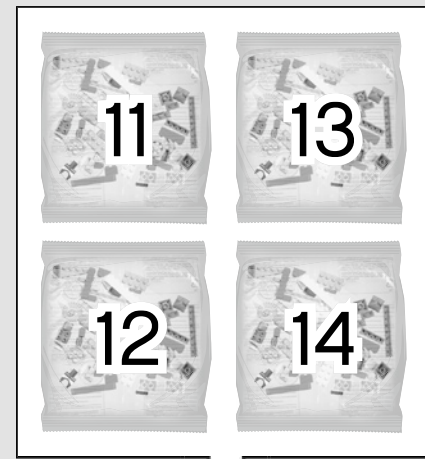
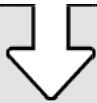
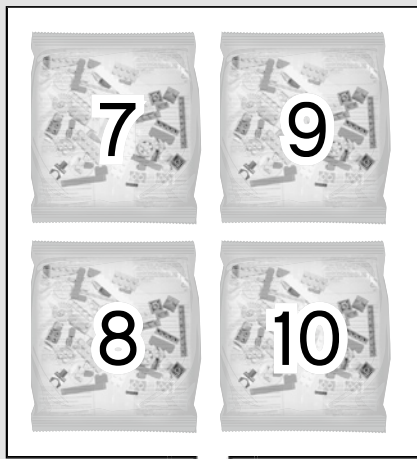

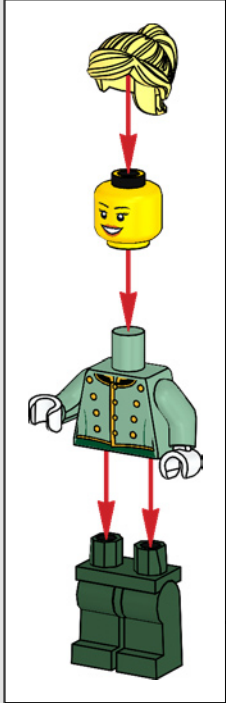
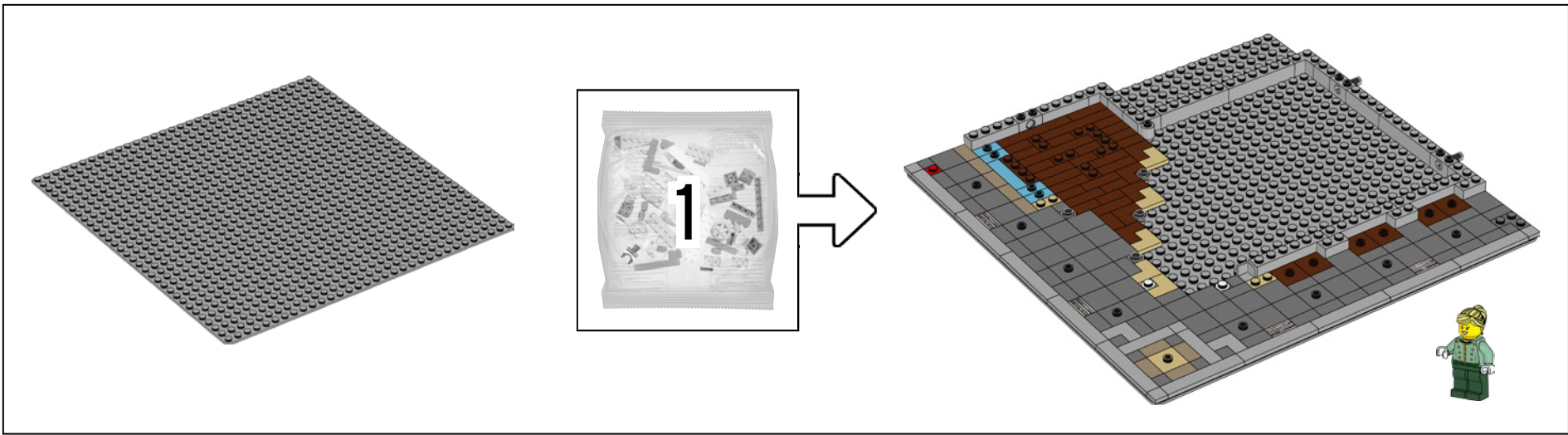

Looking for things to do during your stay? Just ask the Receptionist about her favorite shop within the 10211 Grand Emporium set, or the best meal at Chez Albert.

Vous cherchez des choses à faire pendant votre séjour ? Demandez à la réceptionniste quelle est sa boutique préférée dans le grand magasin (10211), ou quel est le meilleur repas au restaurant Chez Albert.

¿Buscas algo que hacer durante tu estancia? Pregunta a la recepcionista sobre su tienda favorita en el set Grand Emporium (10211) o la mejor comida de la ciudad en Chez Albert.

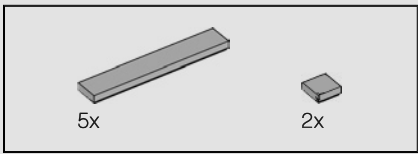

1

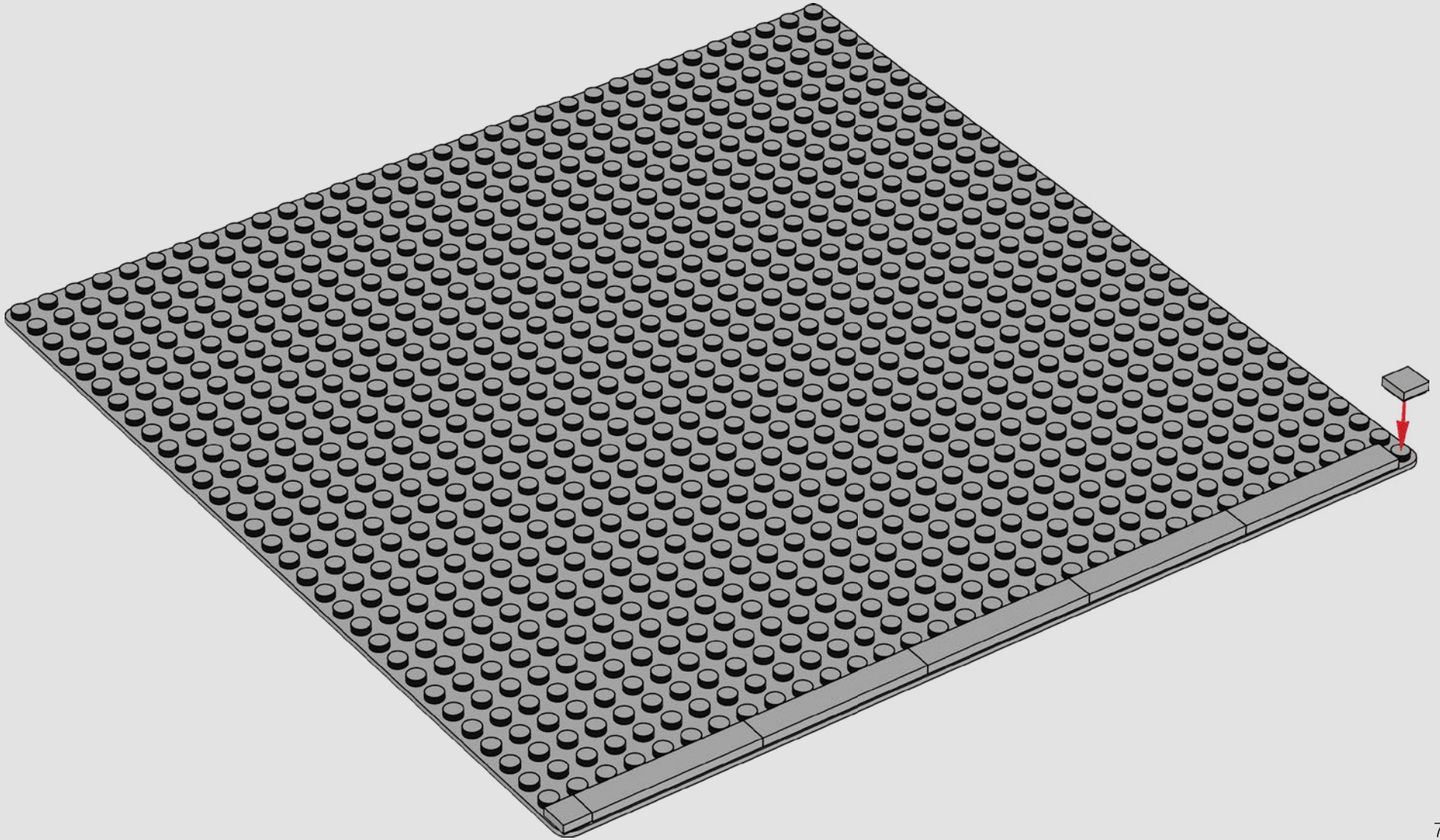

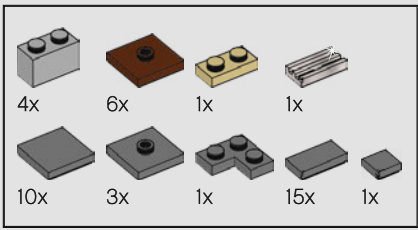

2

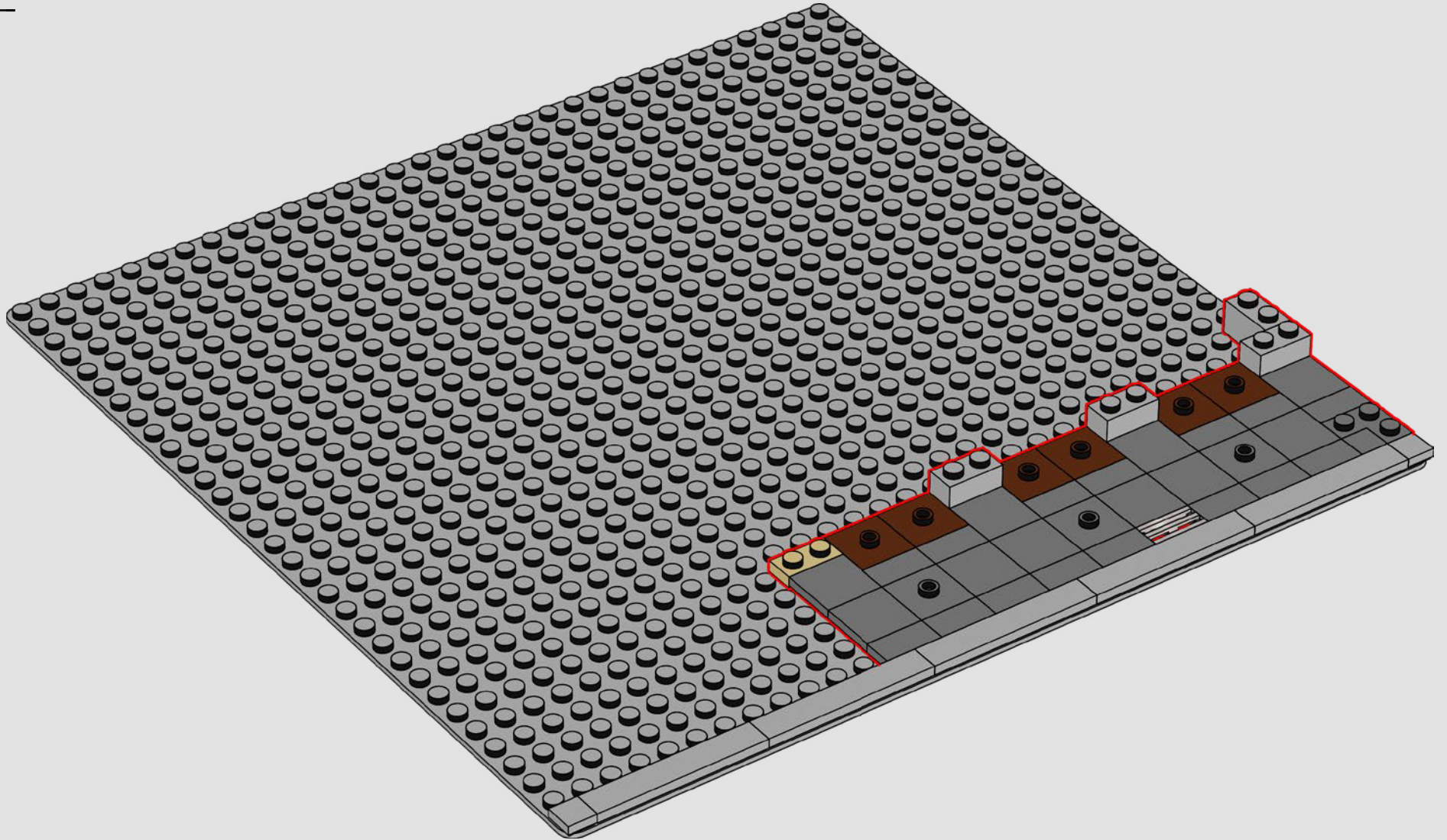

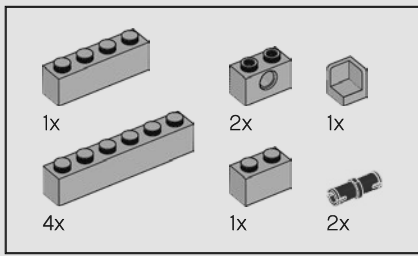

3

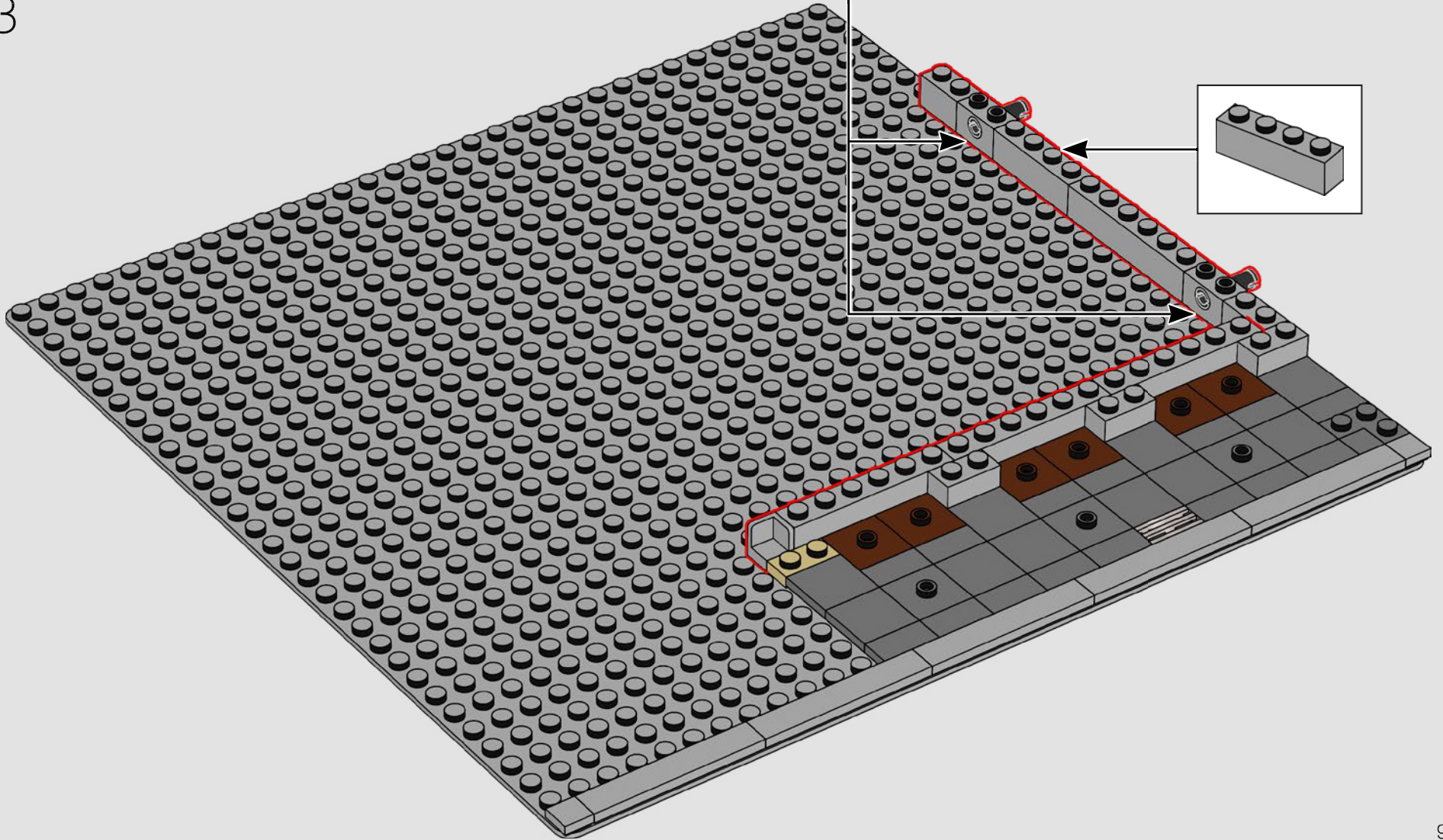
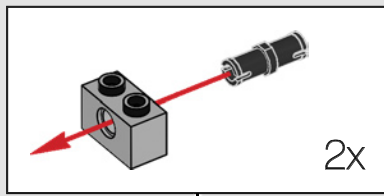

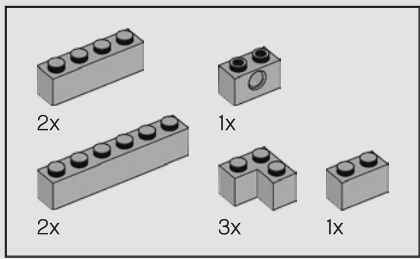

4

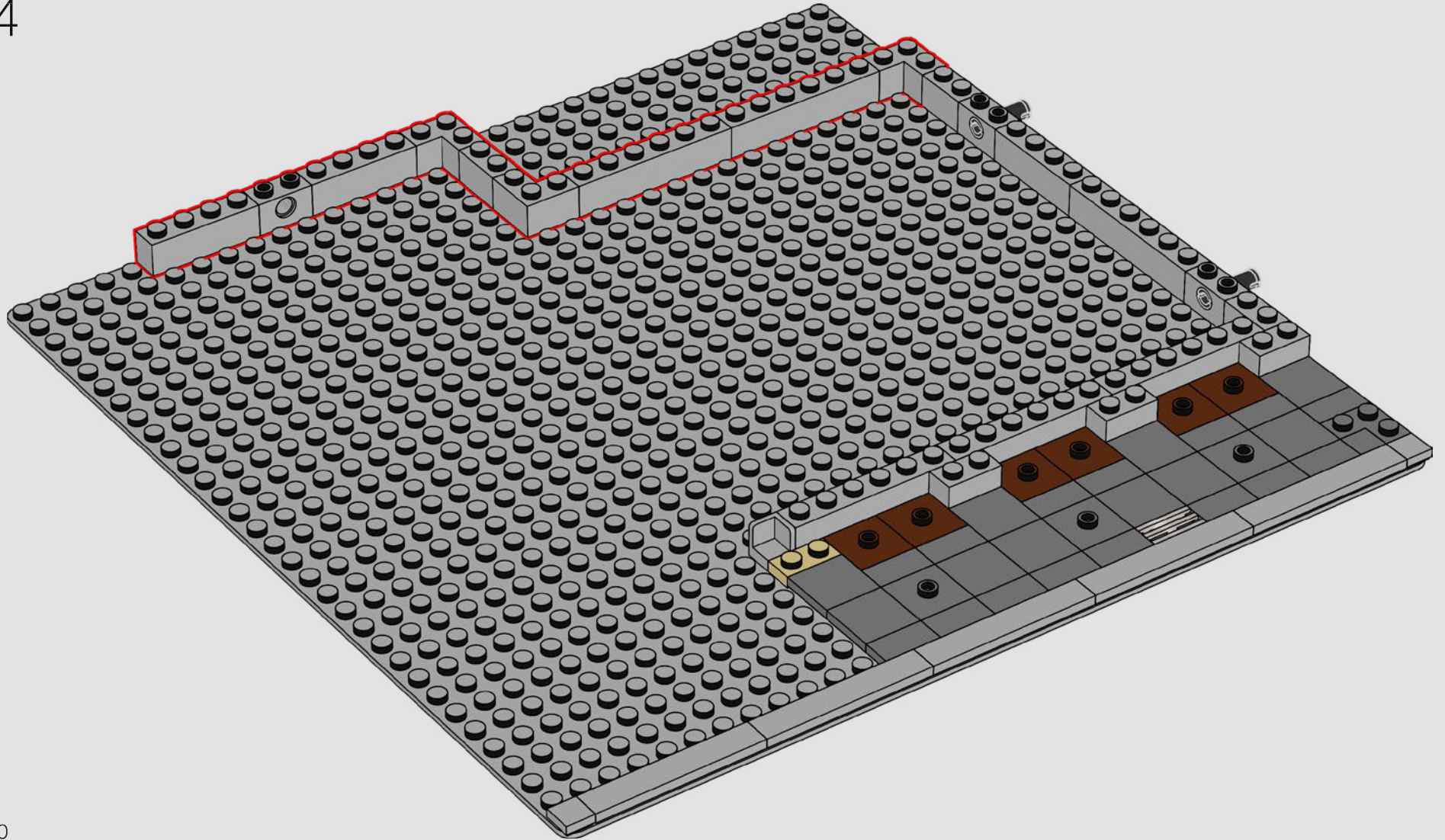

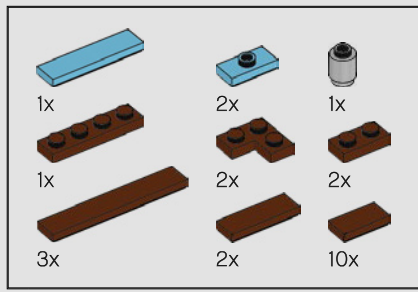

5

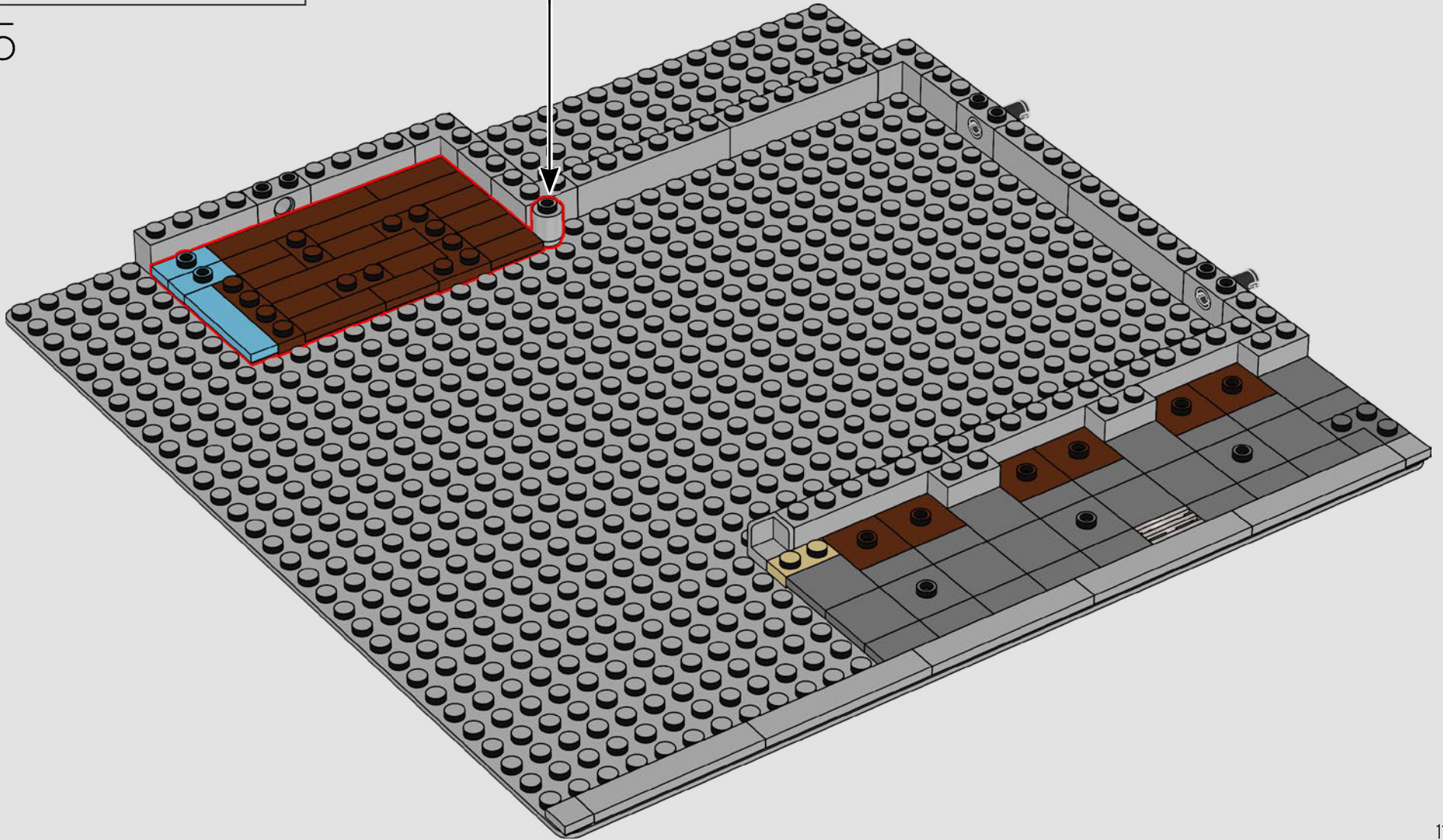
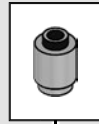

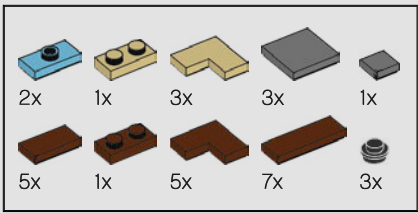

6

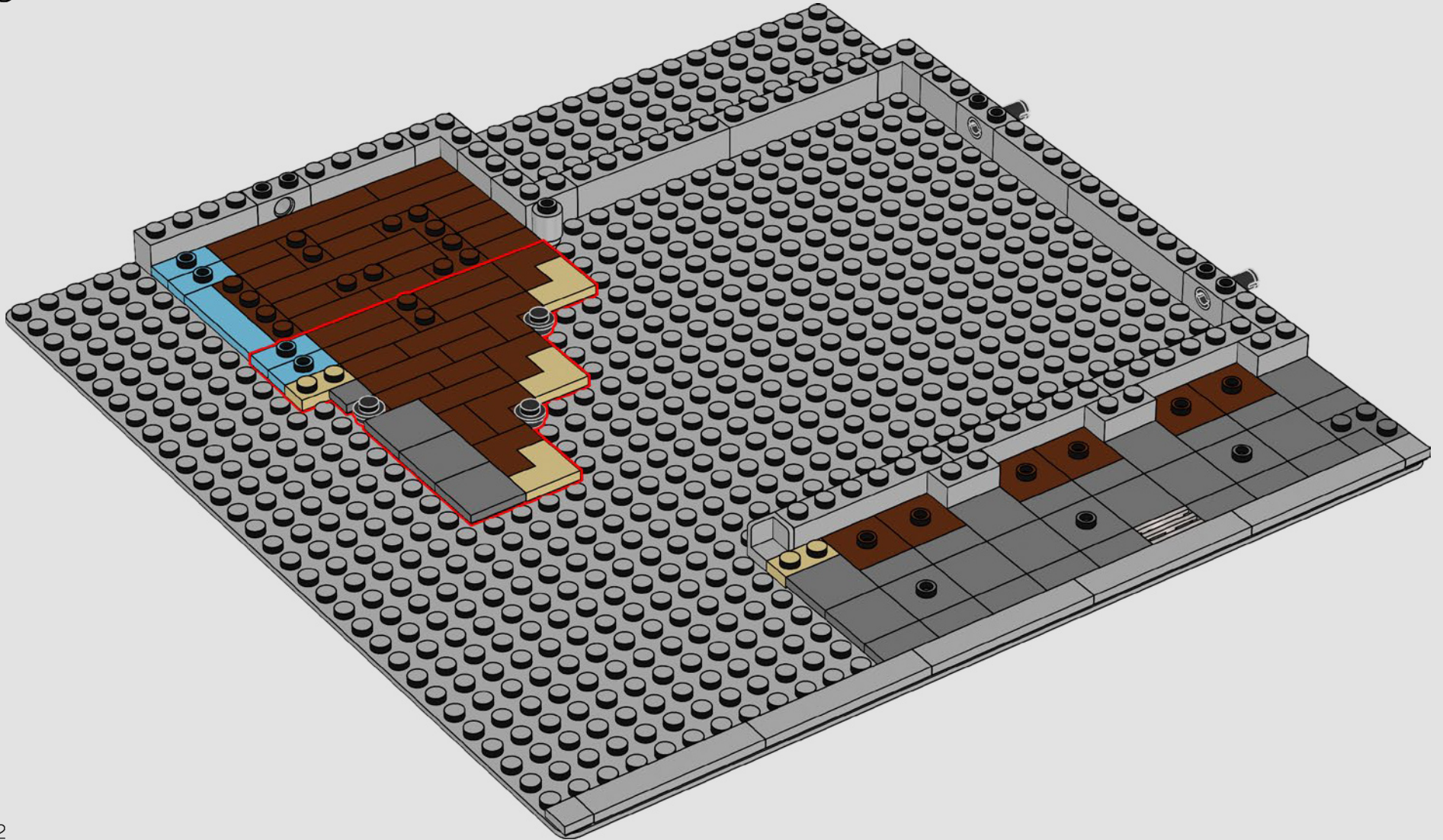

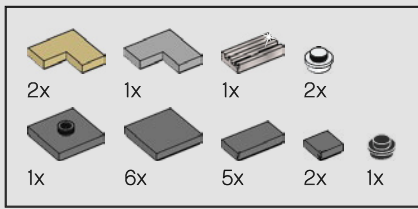

7

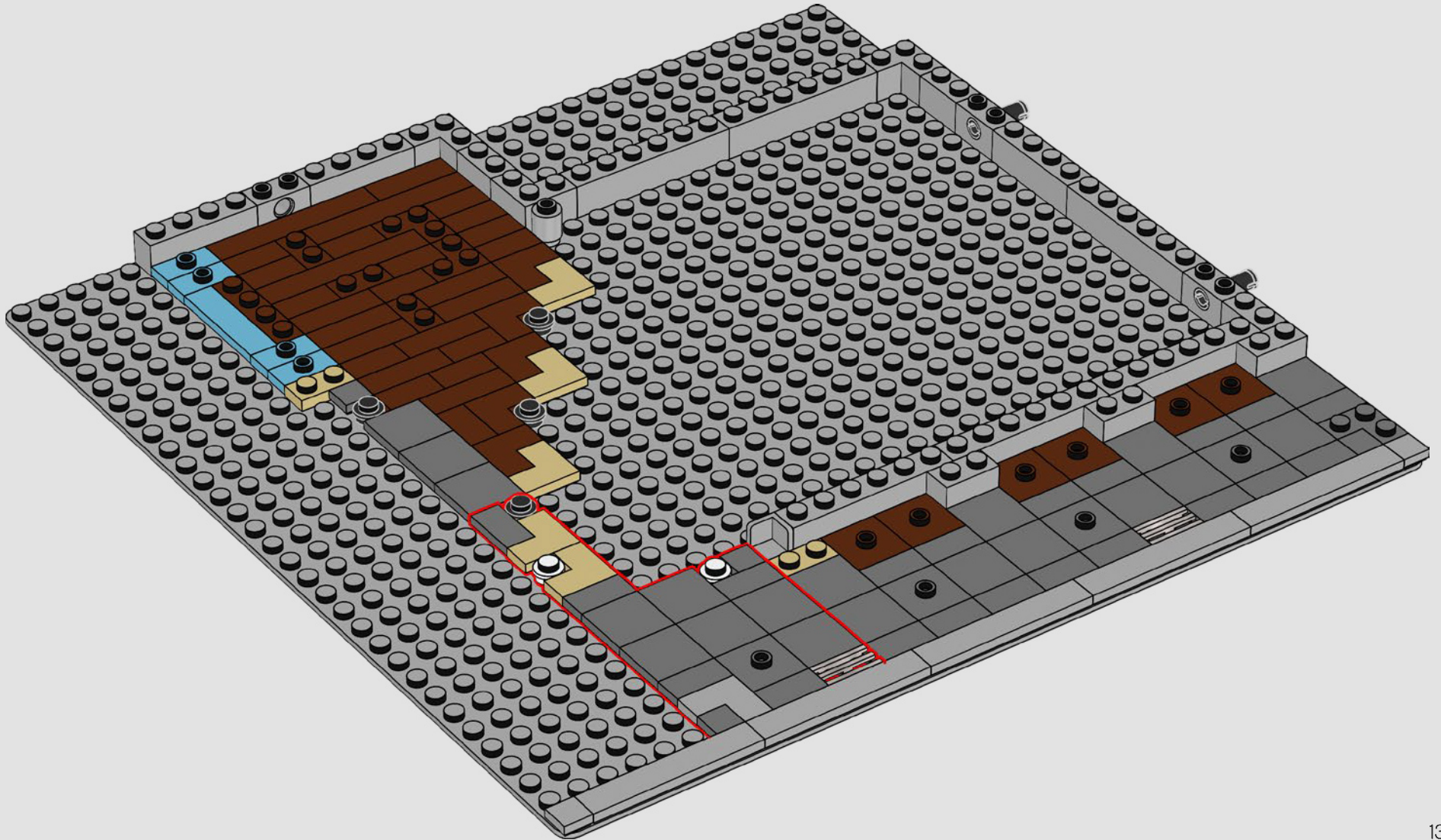

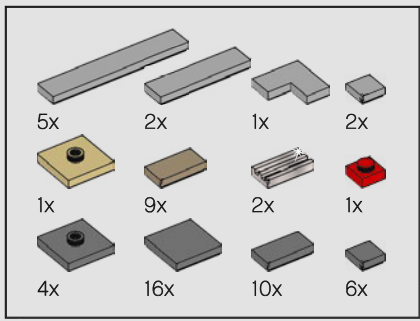

8

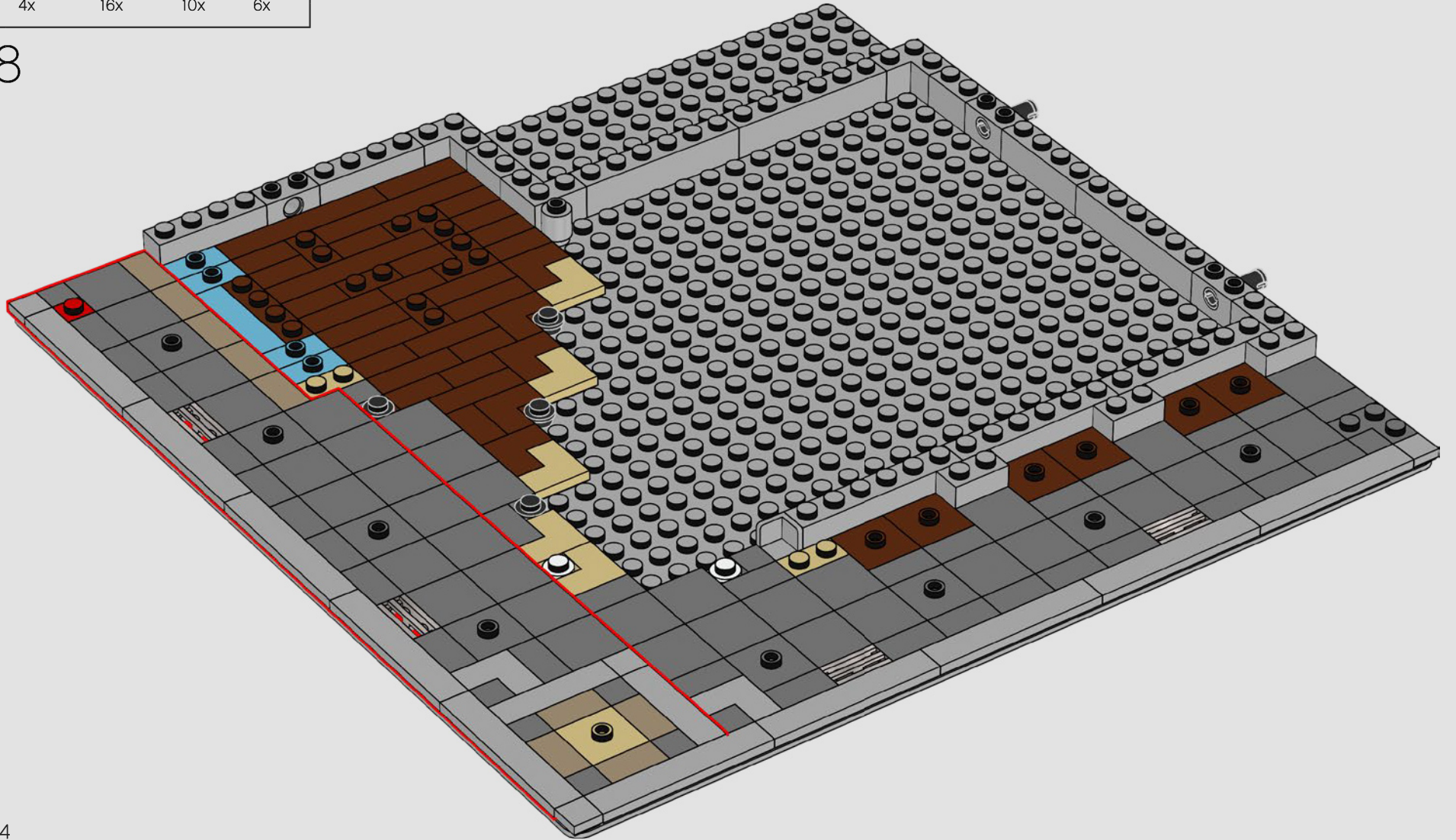

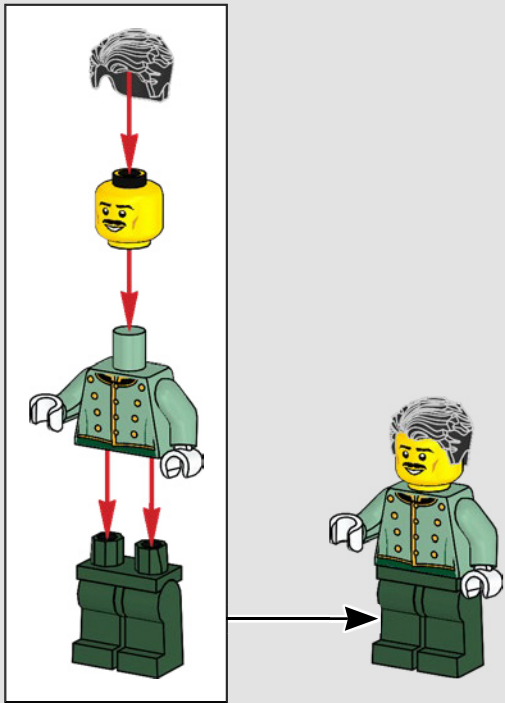
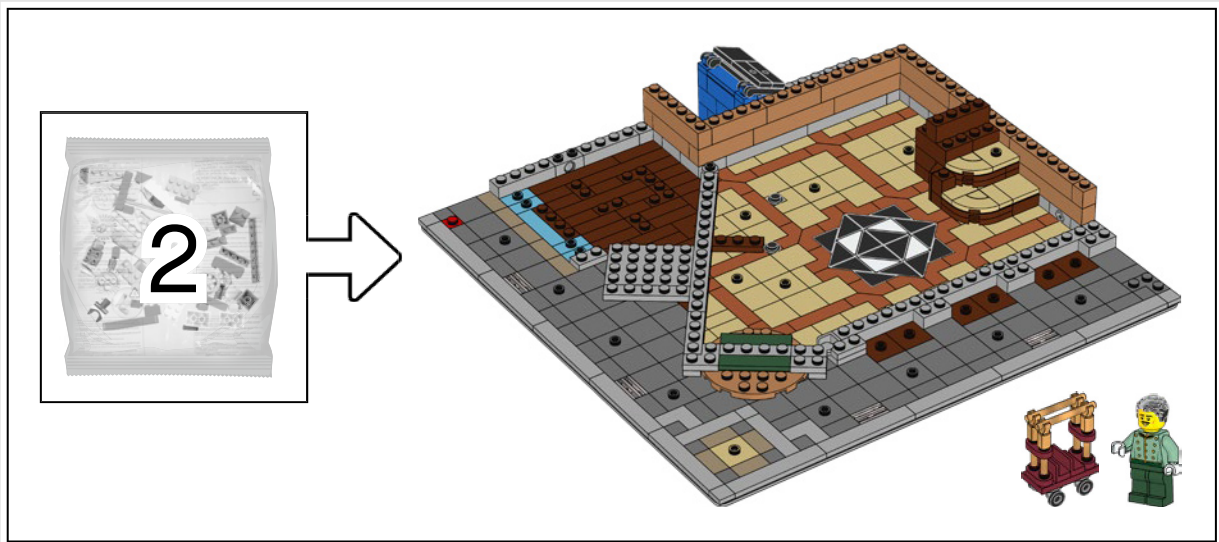

The Bellhop will happily help carry your luggage up the Hotel's stairs to your room. Don't forget to give him a tip!

Le chasseur se fera un plaisir de vous aider à monter vos bagages à votre chambre. N'oubliez pas de lui donner un pourboire !

El botones estará encantado de ayudarte a subir tu equipaje por las escaleras del hotel hasta tu habitación. ¡Acuérdate de darle una propina!

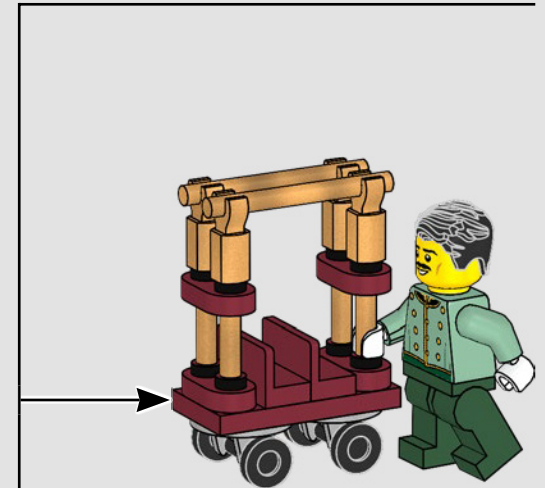
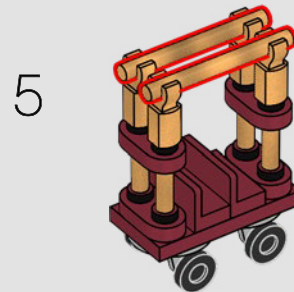
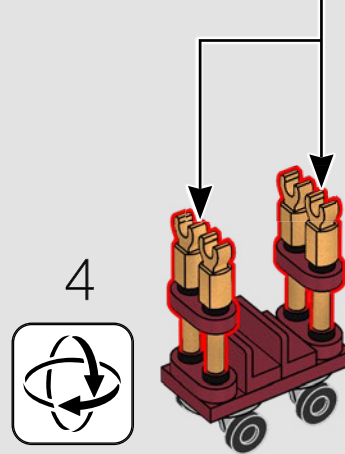
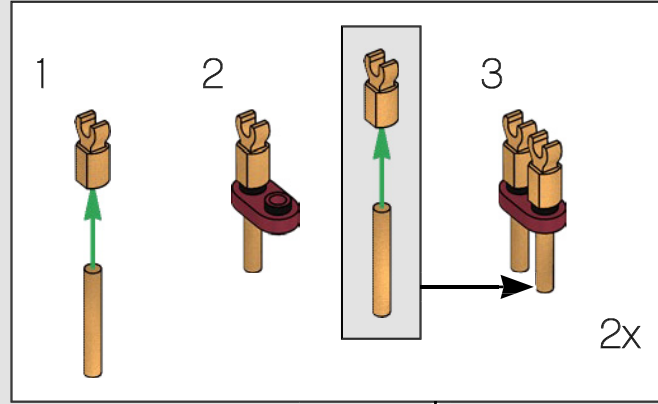
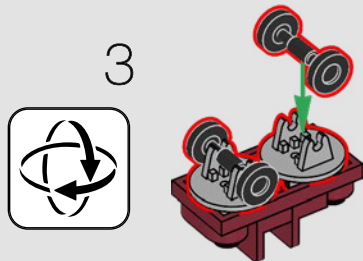
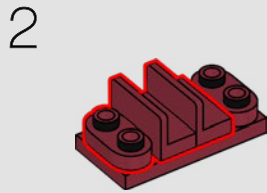
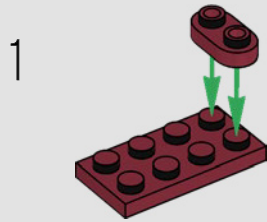
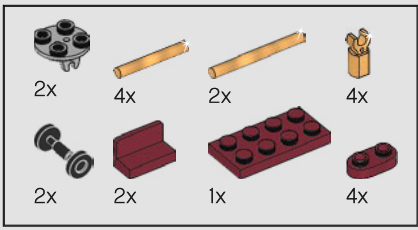

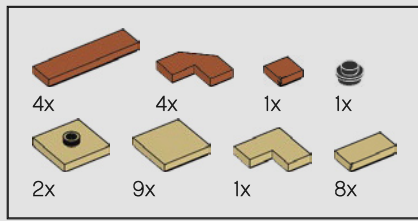

9

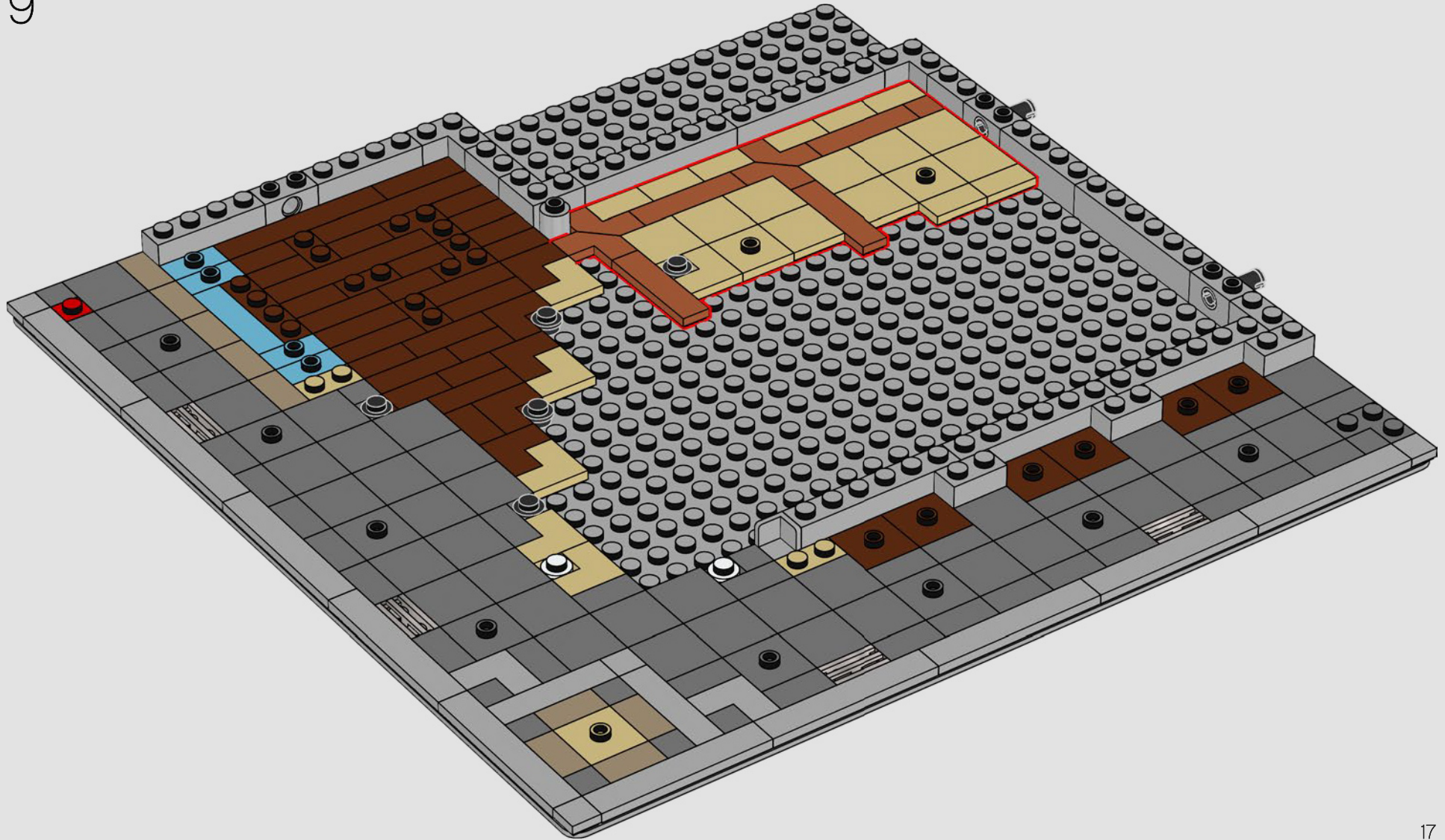

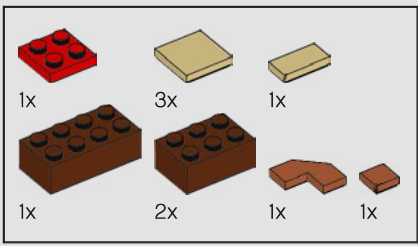

10

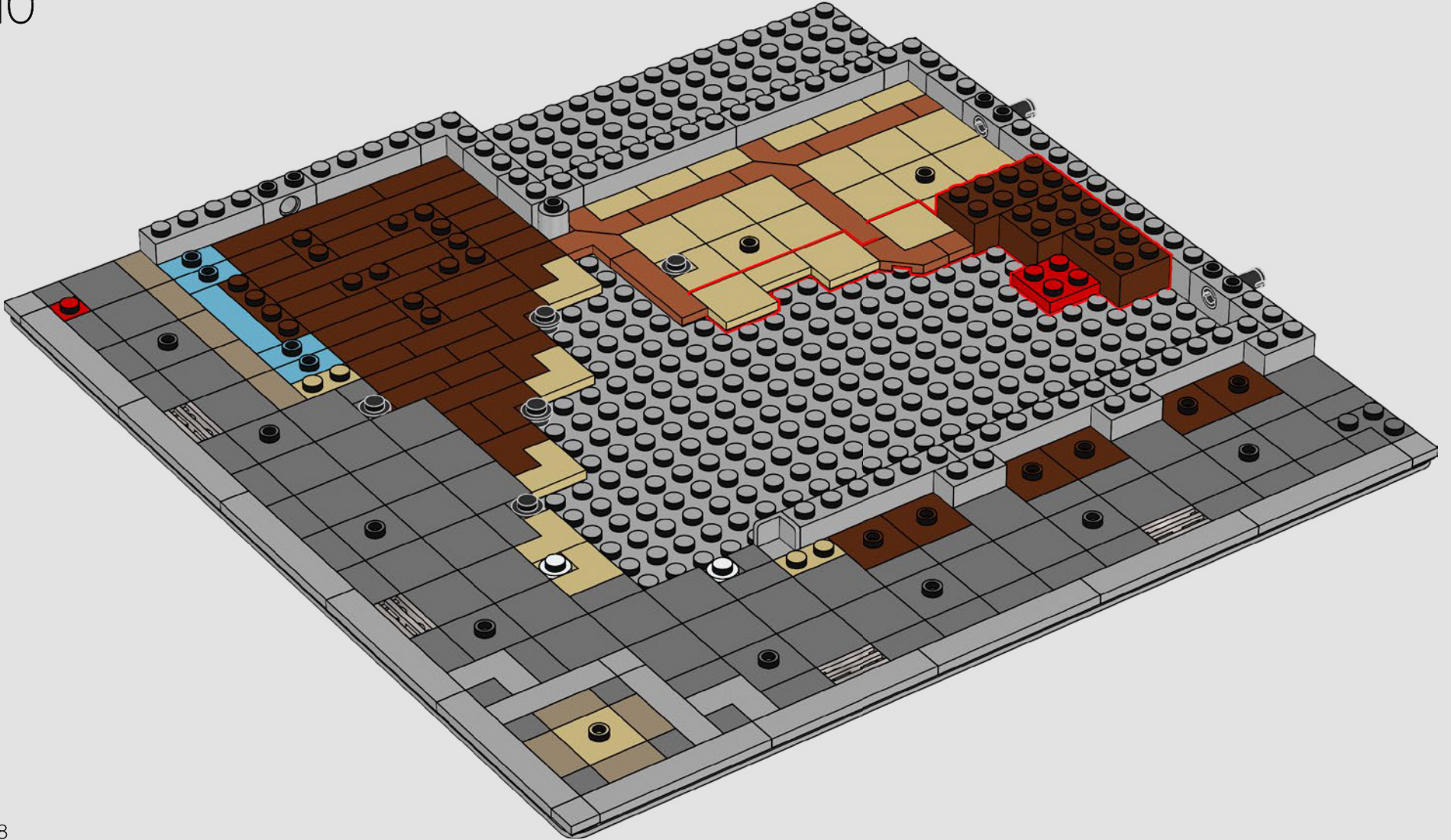

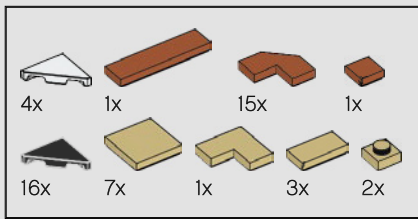

11

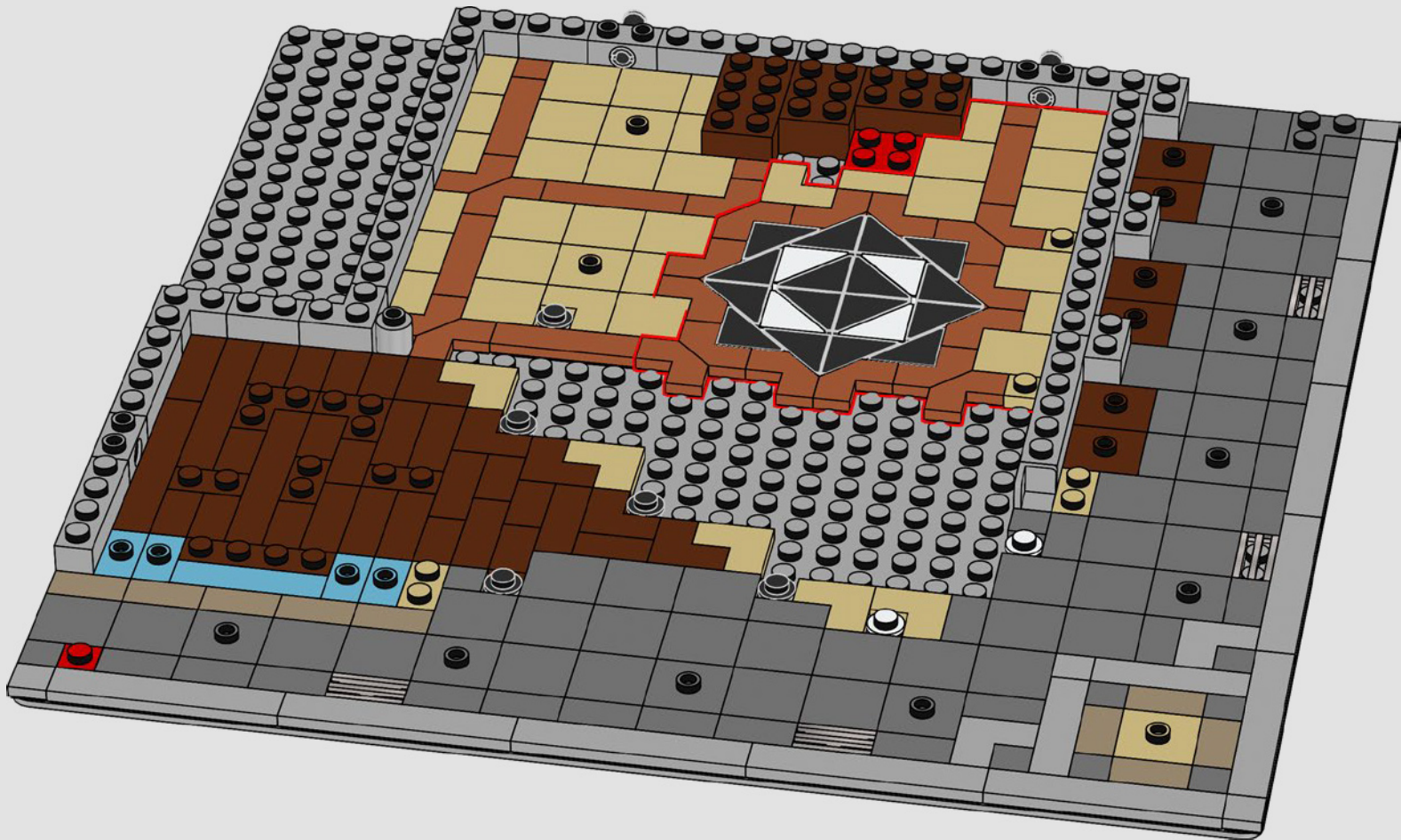

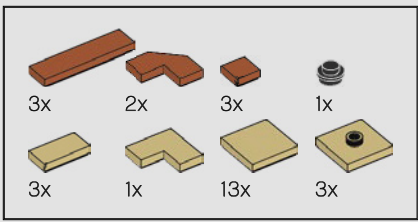

12

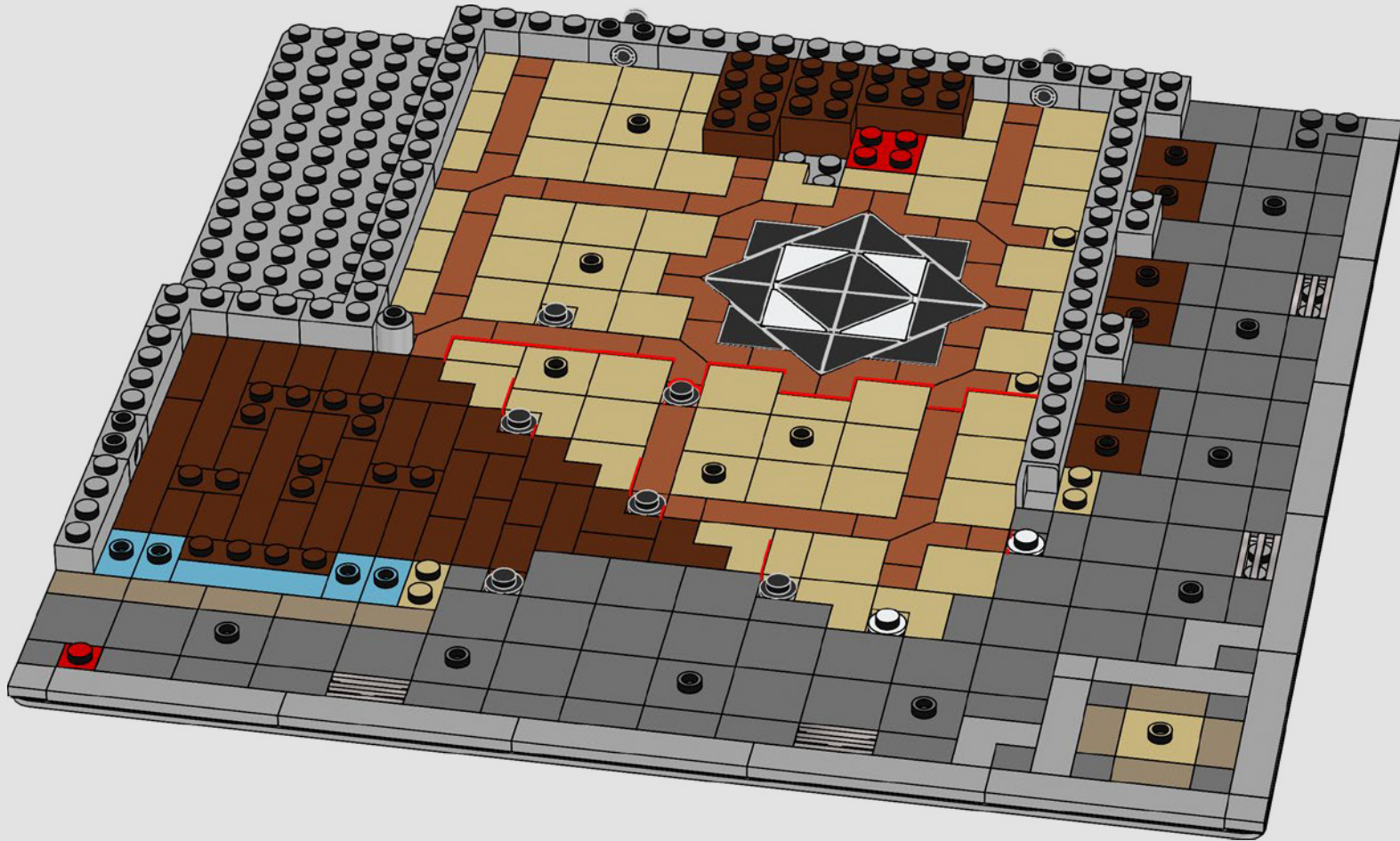

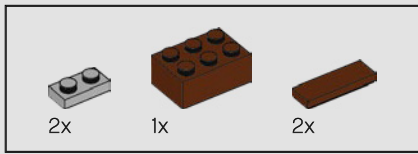

13

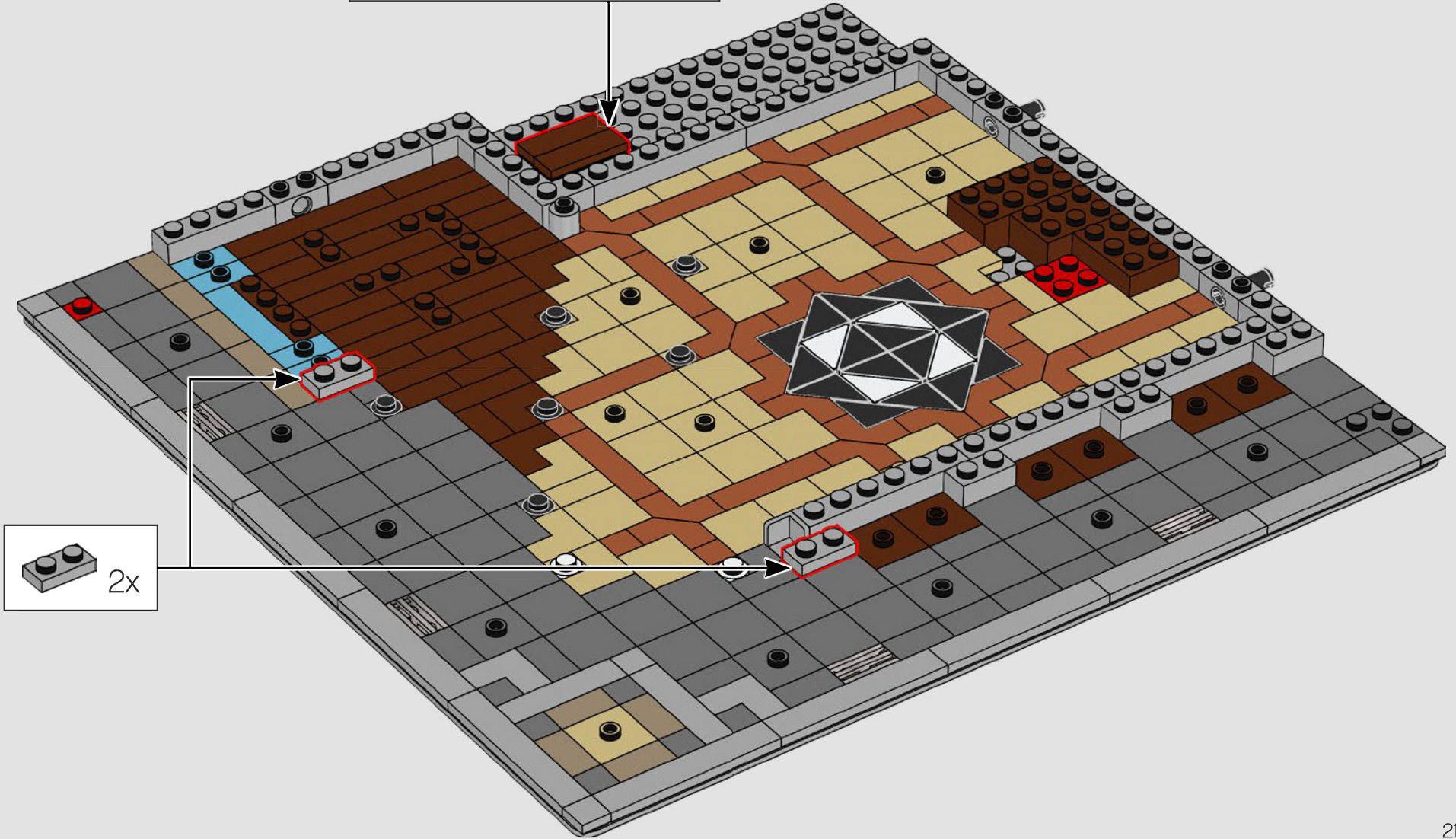
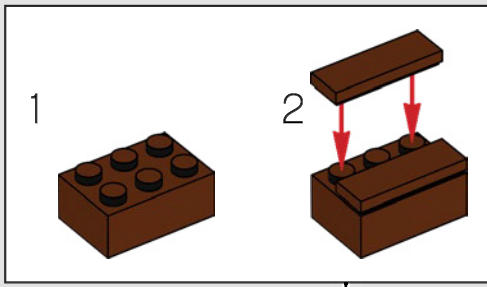

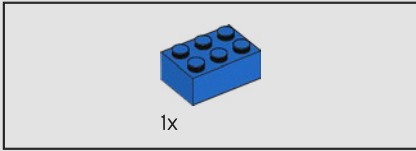
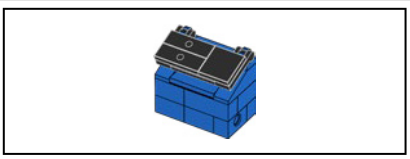

14

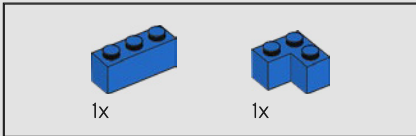
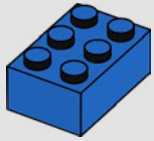

15

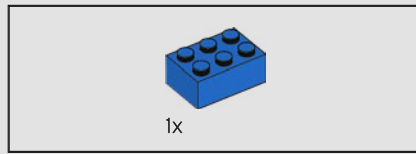
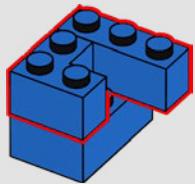

16

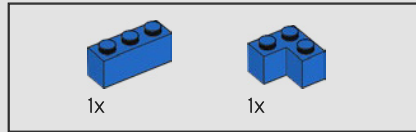
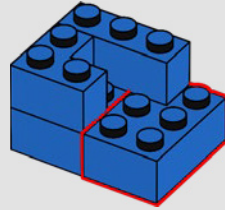

17

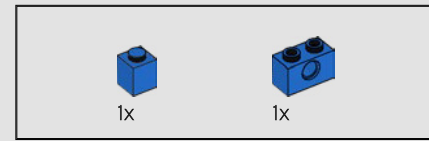
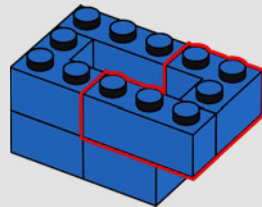

18

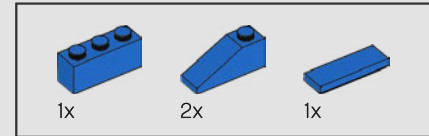
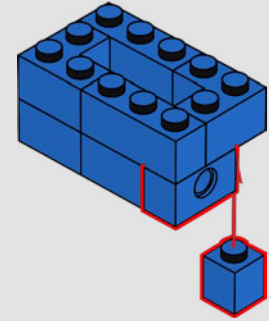

19

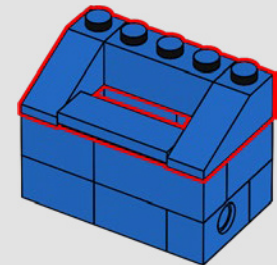

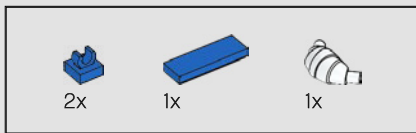

20

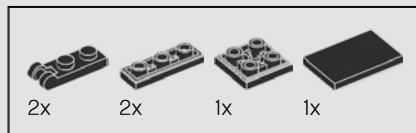
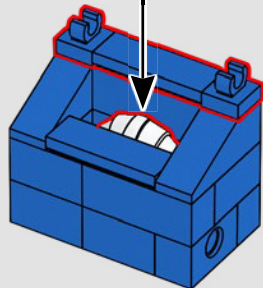

21

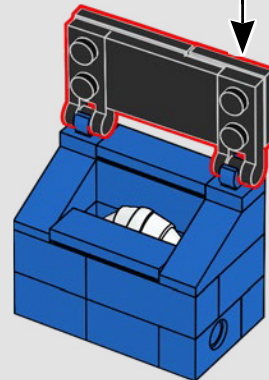
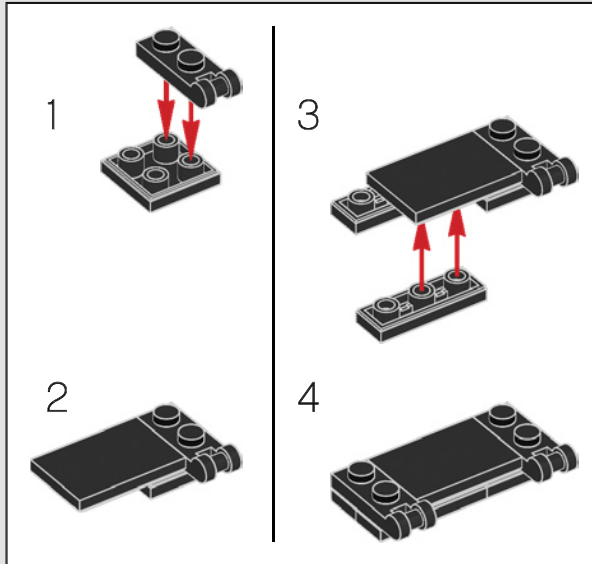

22

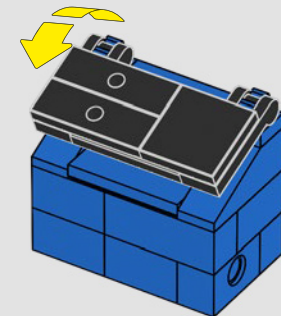

This croissant was found at the Parisian Restaurant in the 10243 set ... but why would anyone want a moldy white croissant?

Ce croissant provient de l'ensemble Le restaurant parisien (10243)... mais qui voudrait d'un roissant blanc moisi ?

Este cuernito aparecía en el set Restaurante Parisino (10243), ¿pero para qué querría alguien un cuernito blanco de yeso?

23

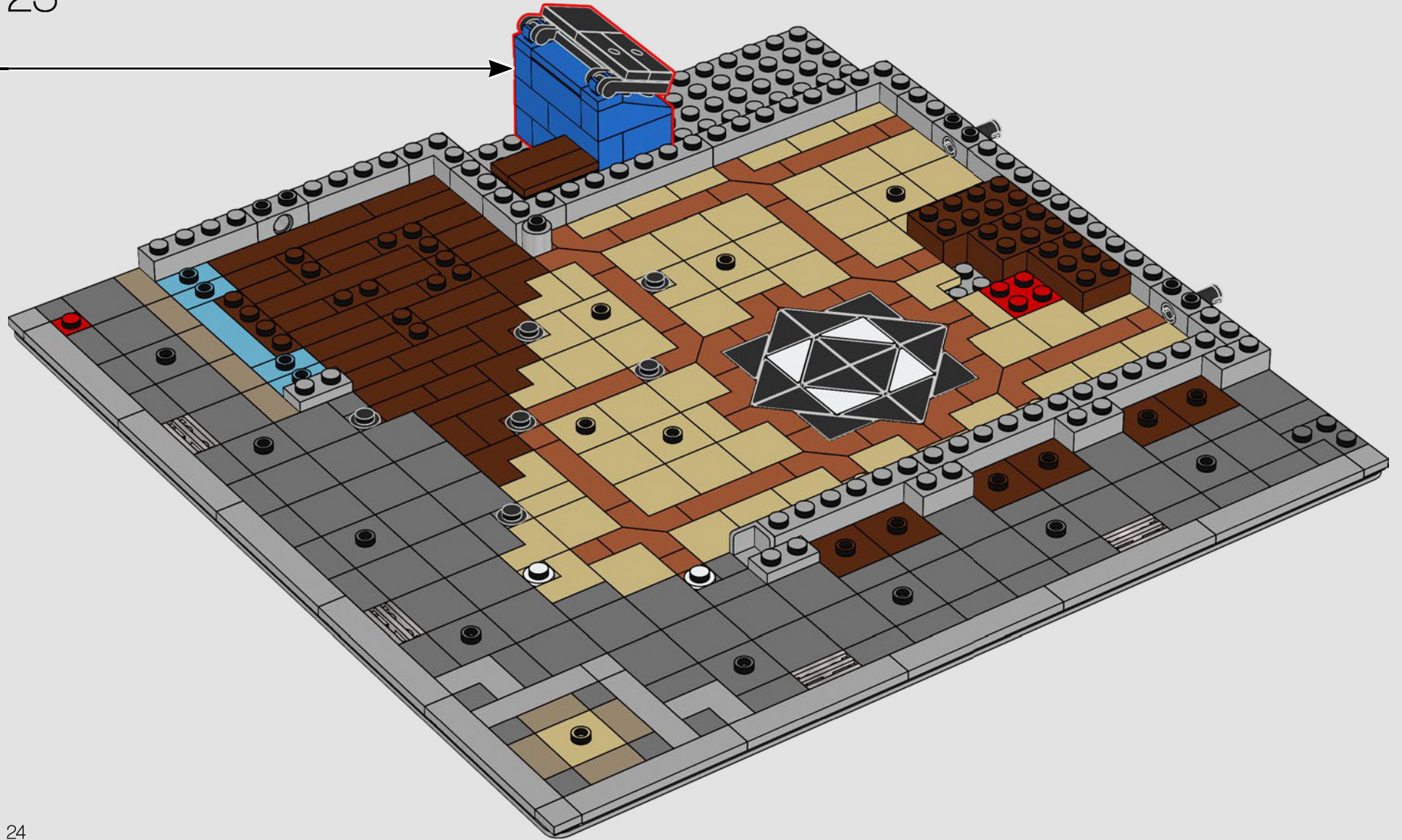

24

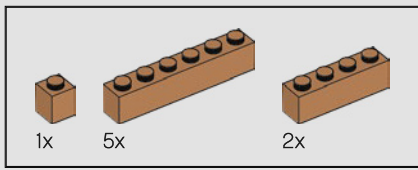

24

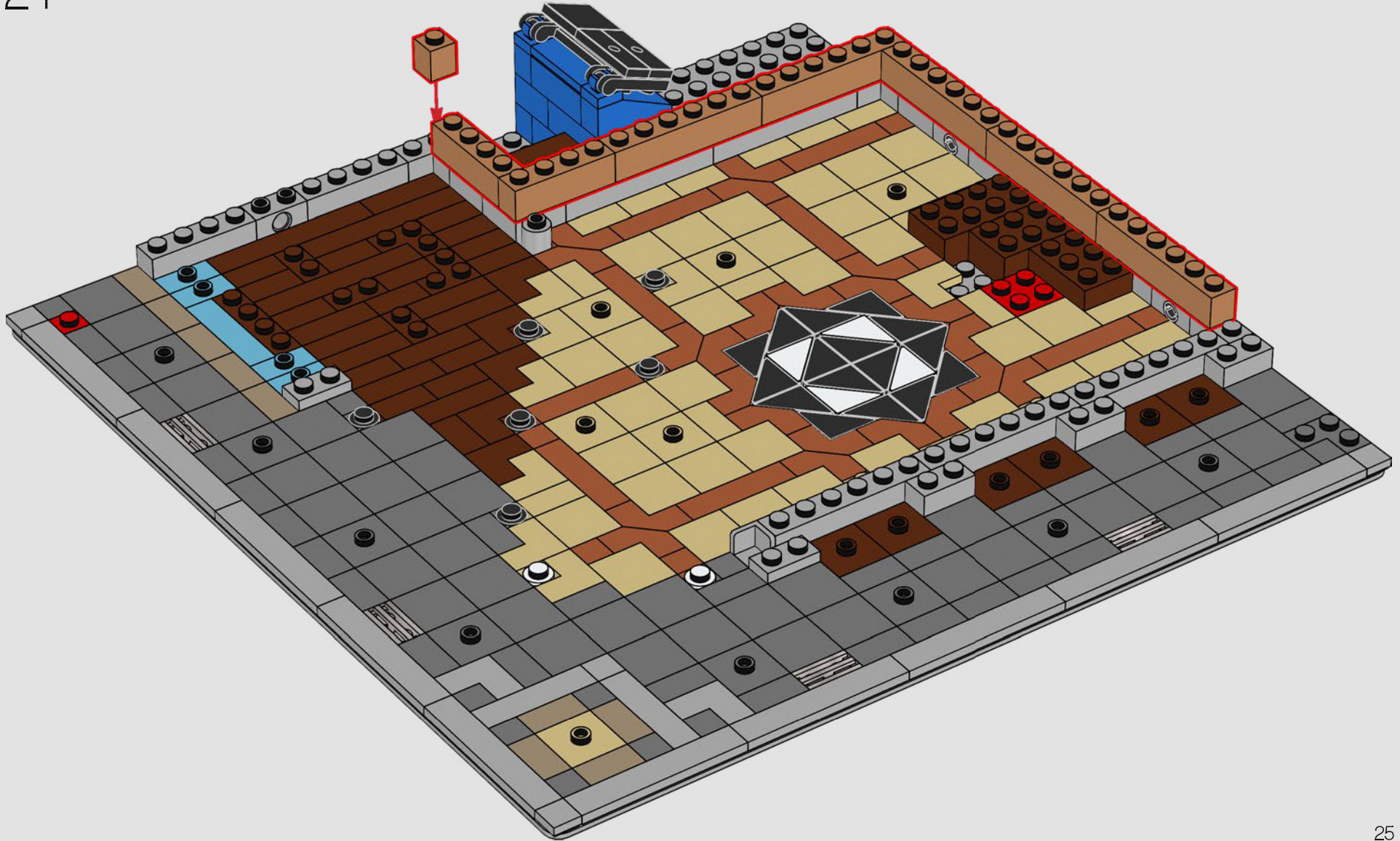

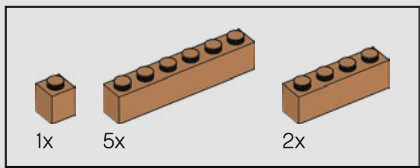

25

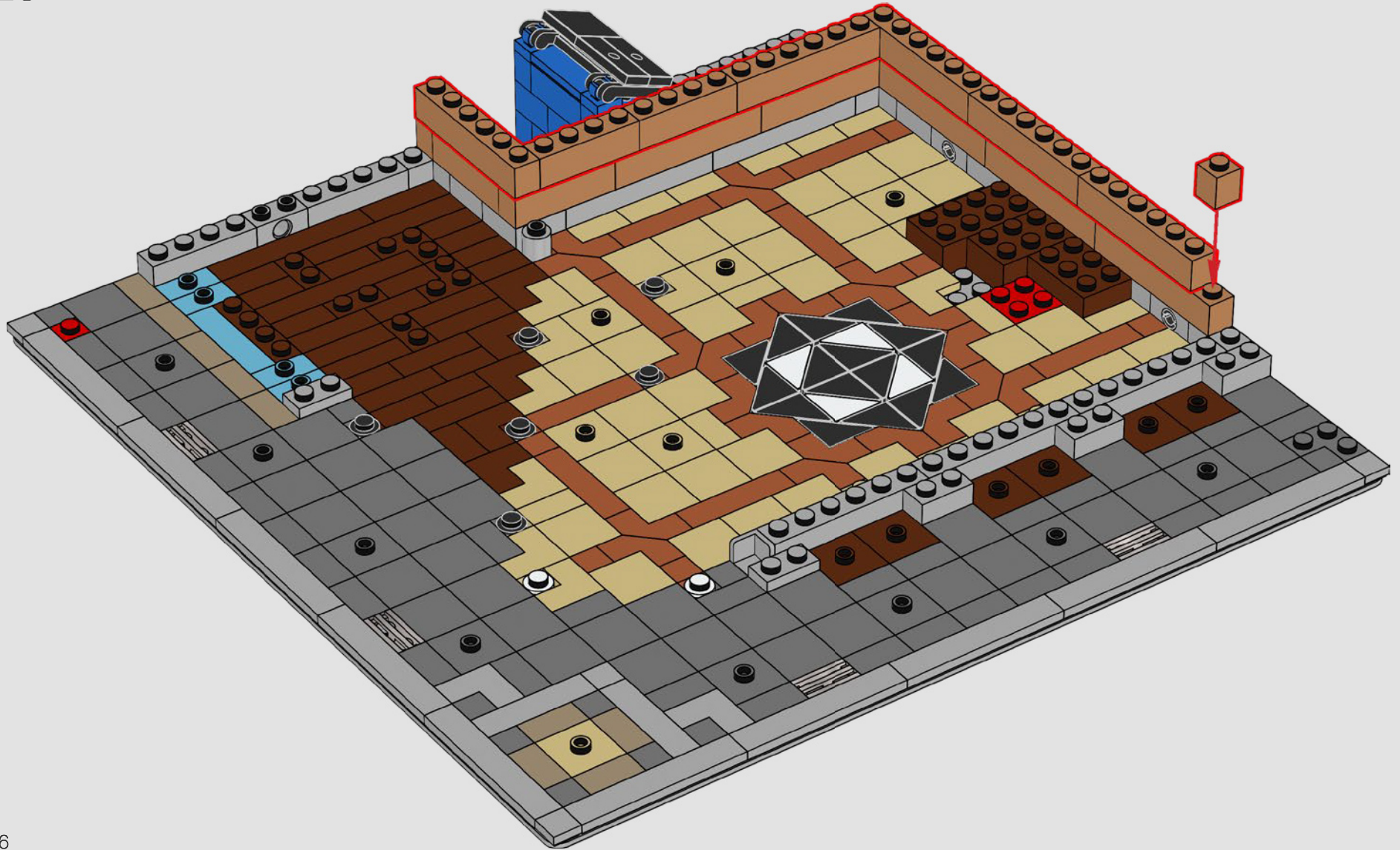

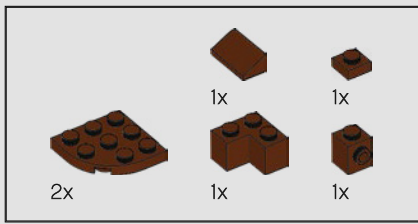

26

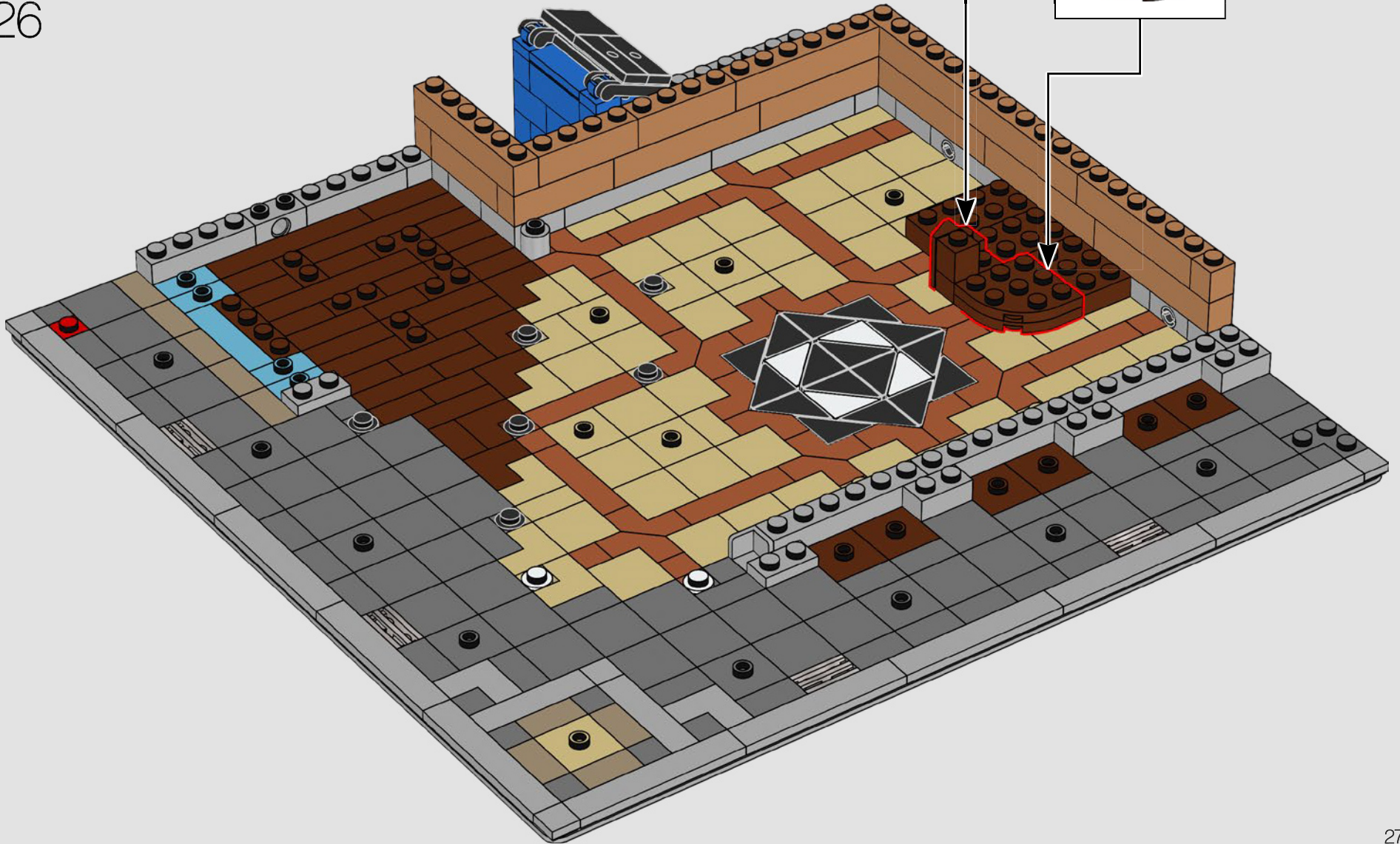
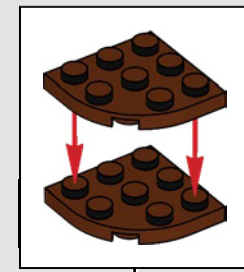
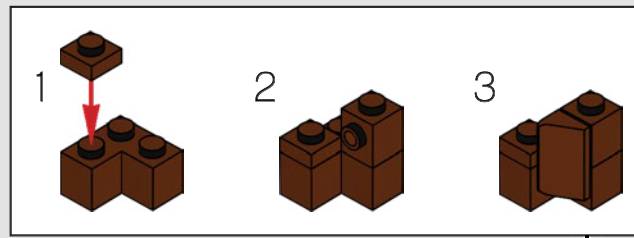

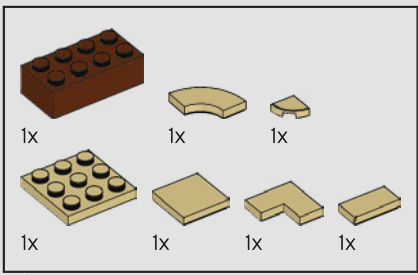

27

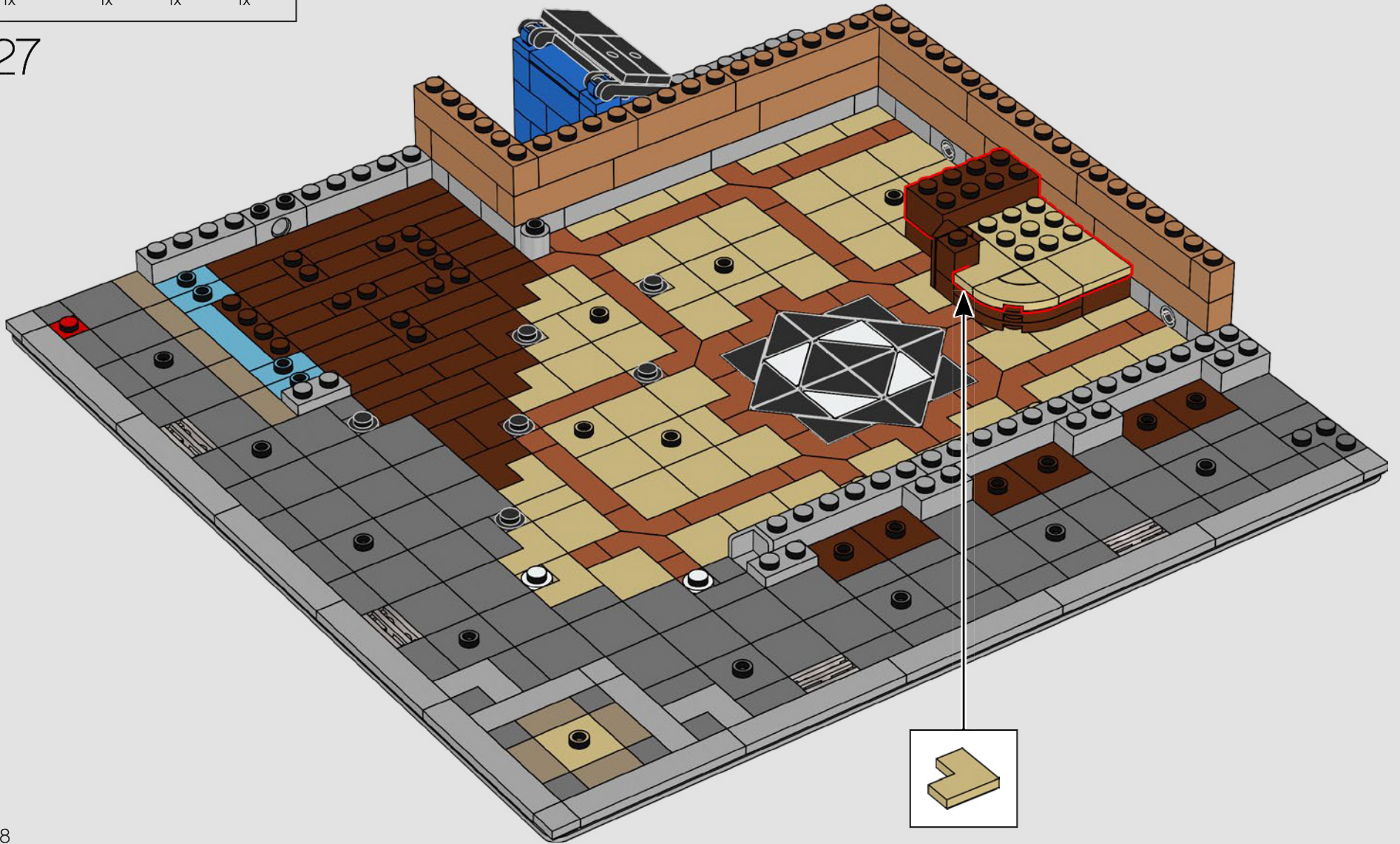

28

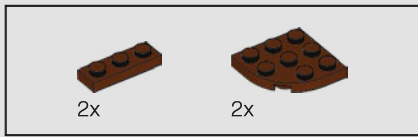

28

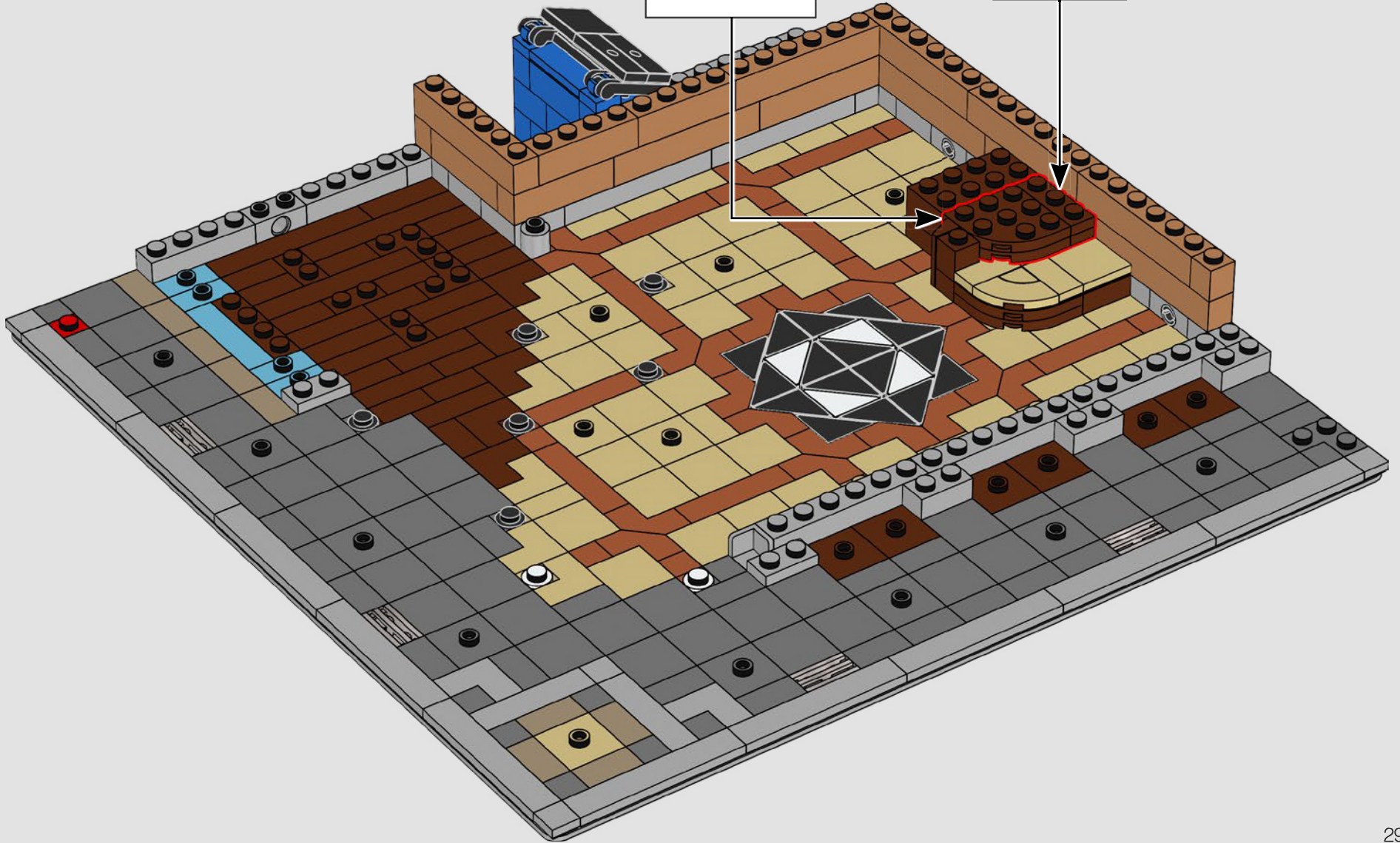
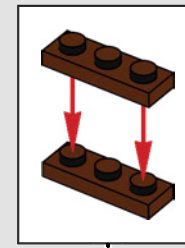
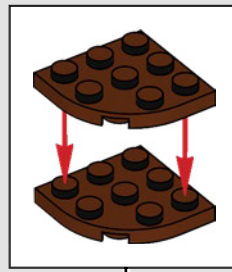

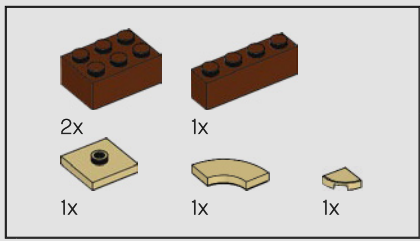

29

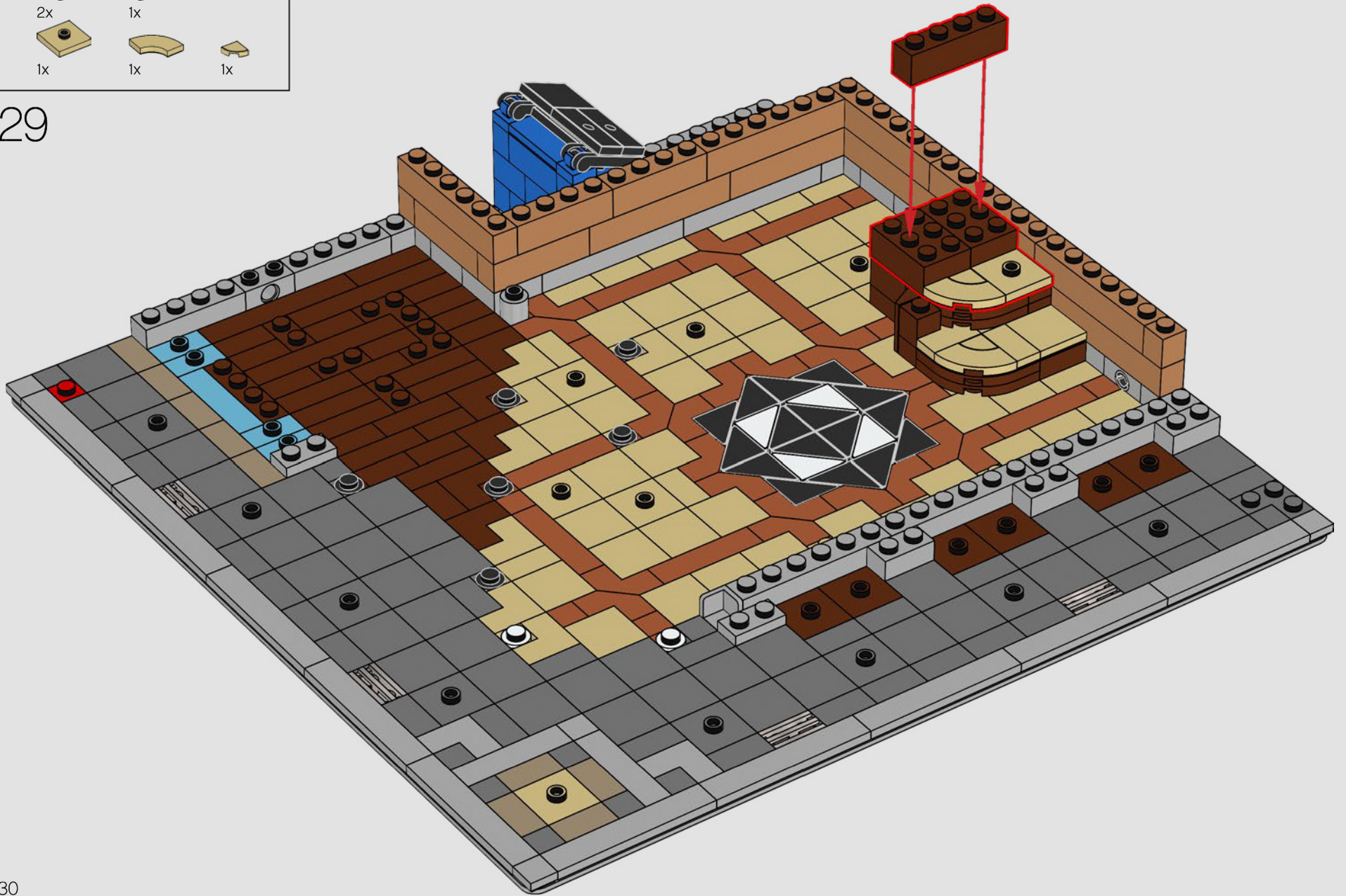

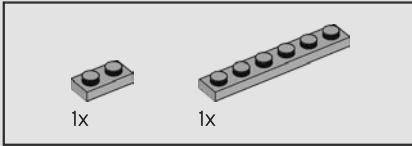
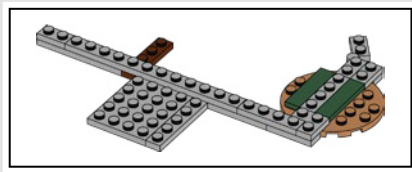

30

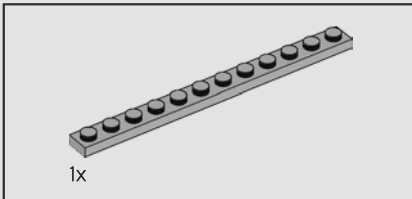
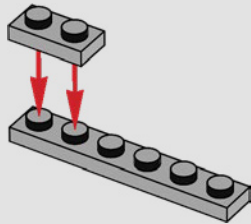

31

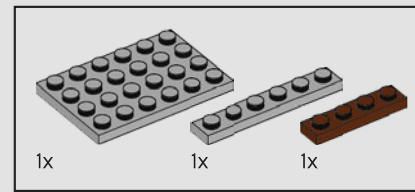
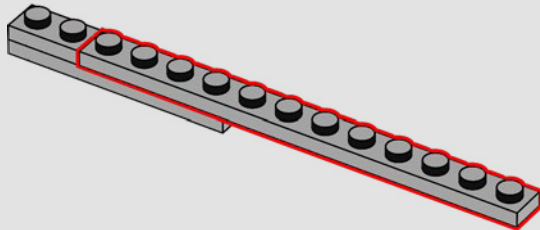

32

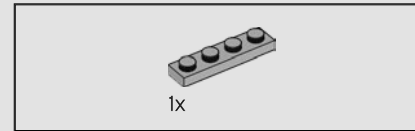
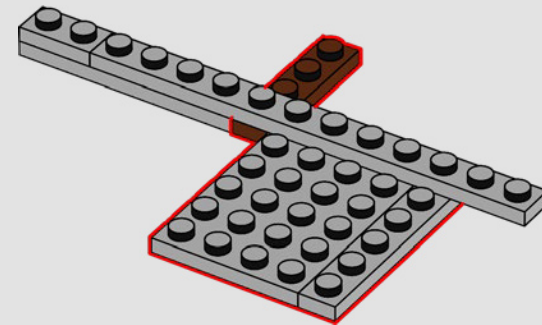

33

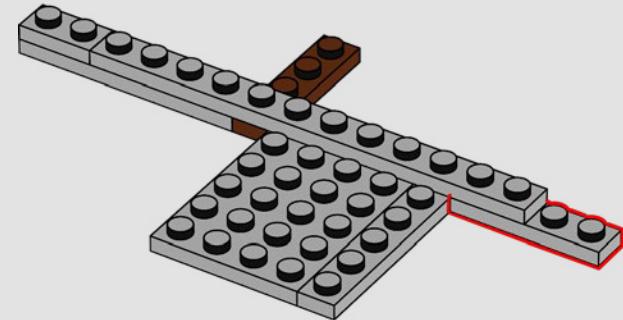

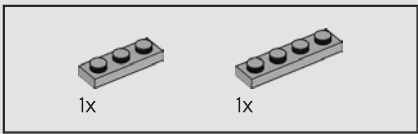

34

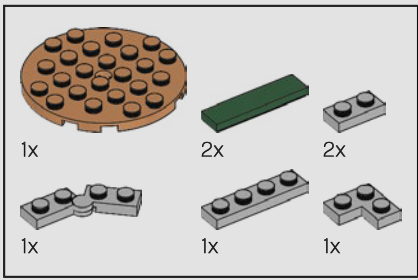
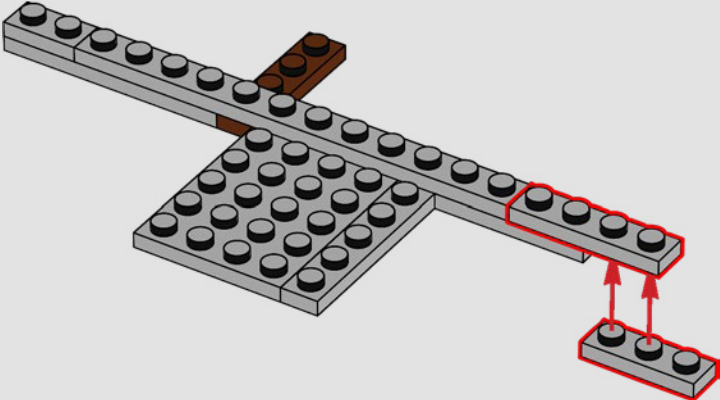

35

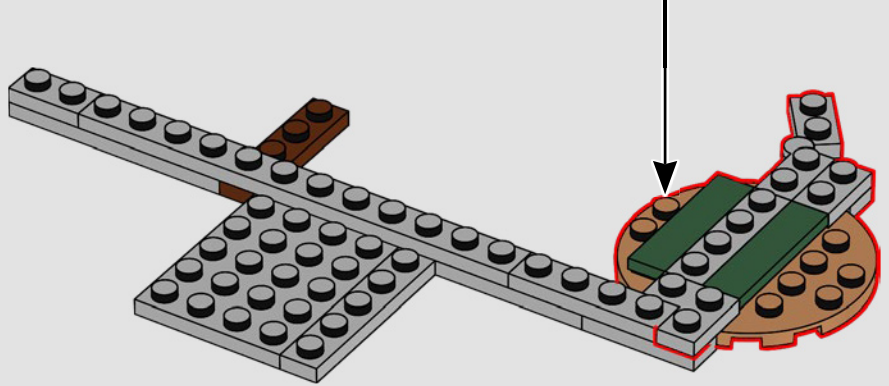
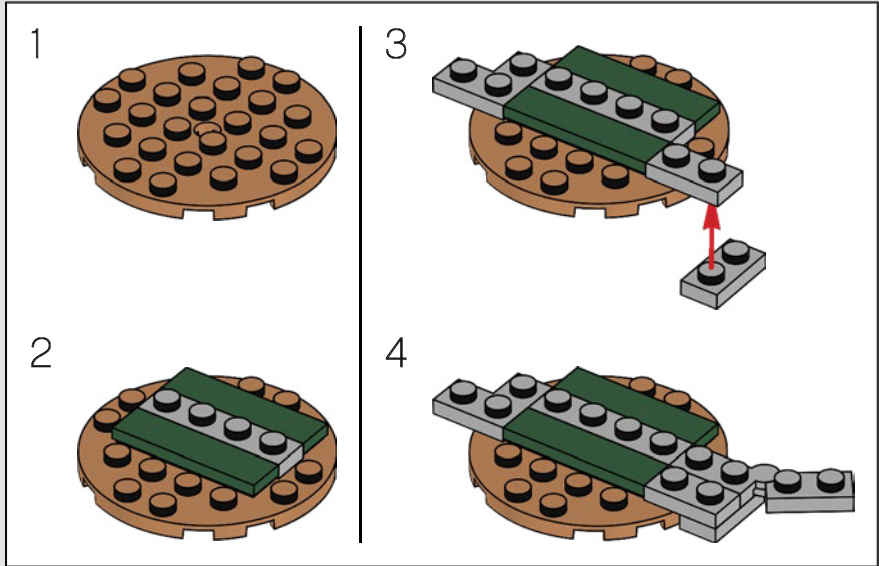

36

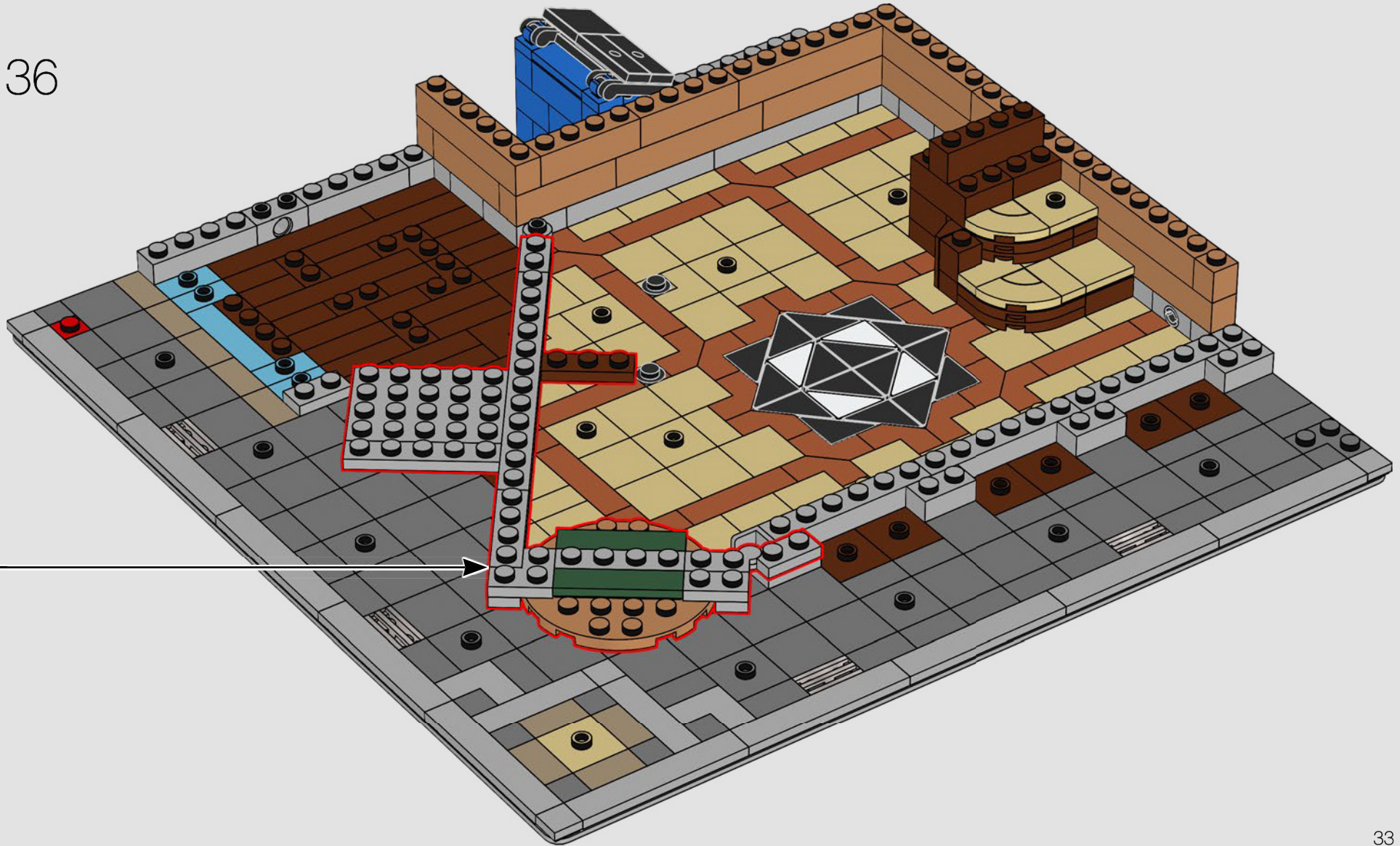

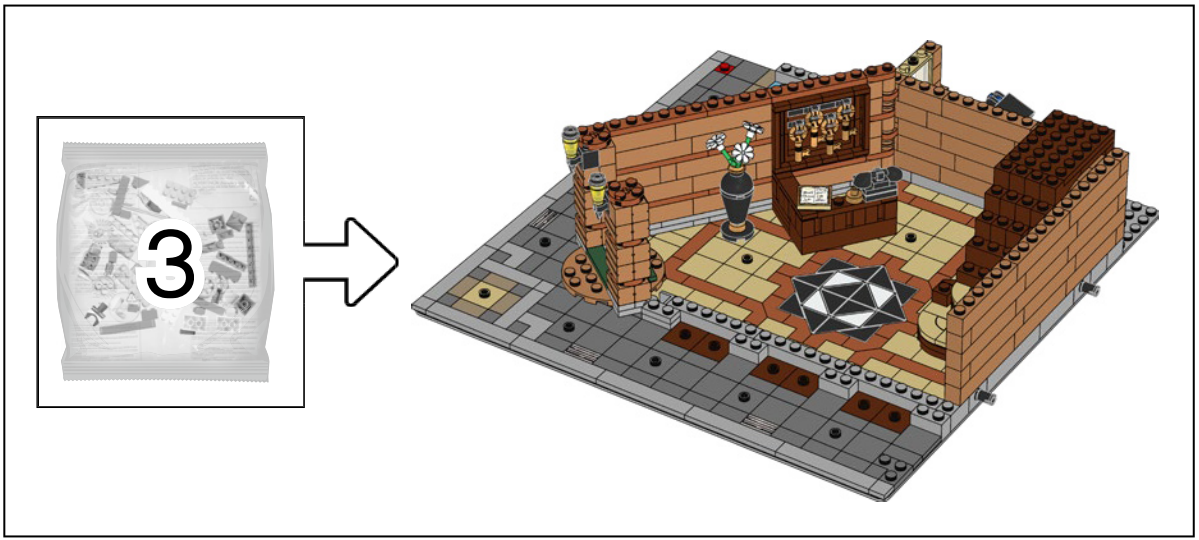

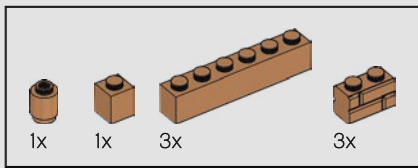

37

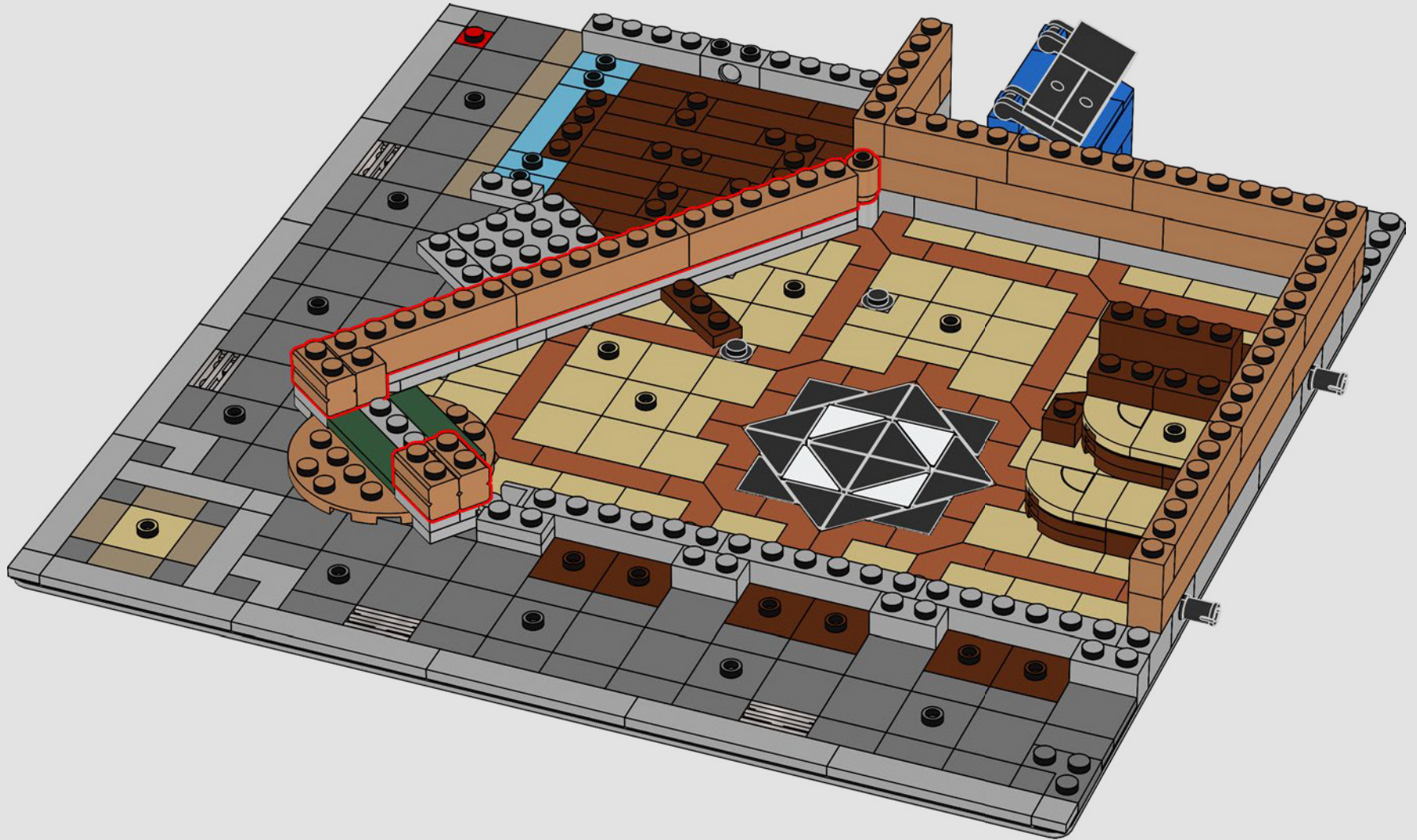

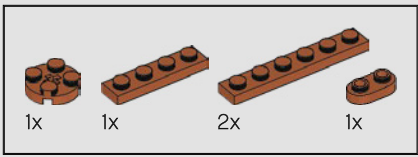

38

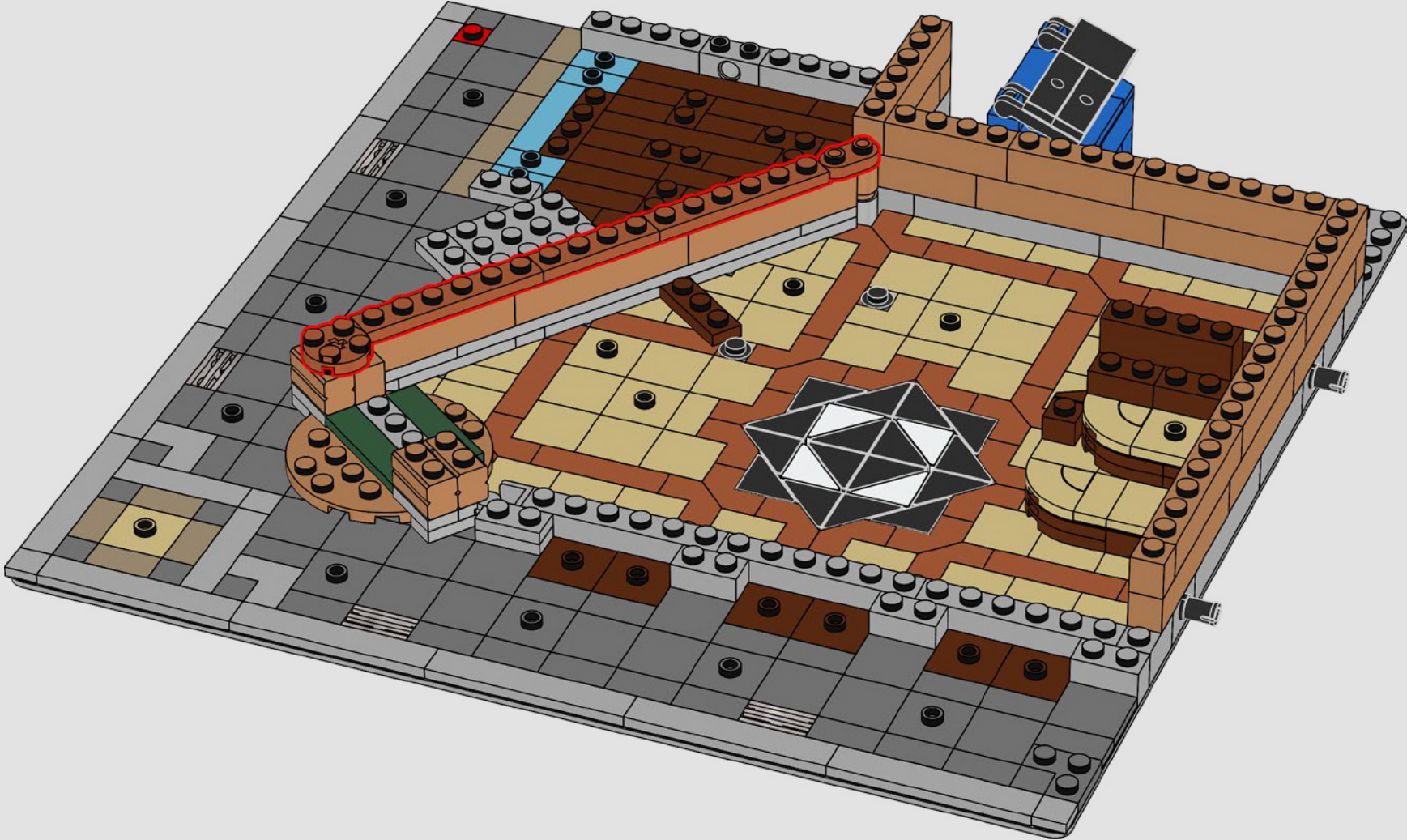

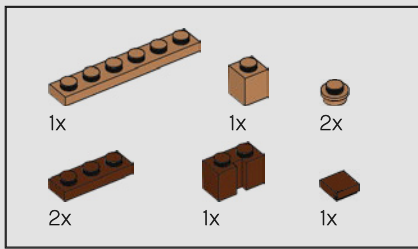

39

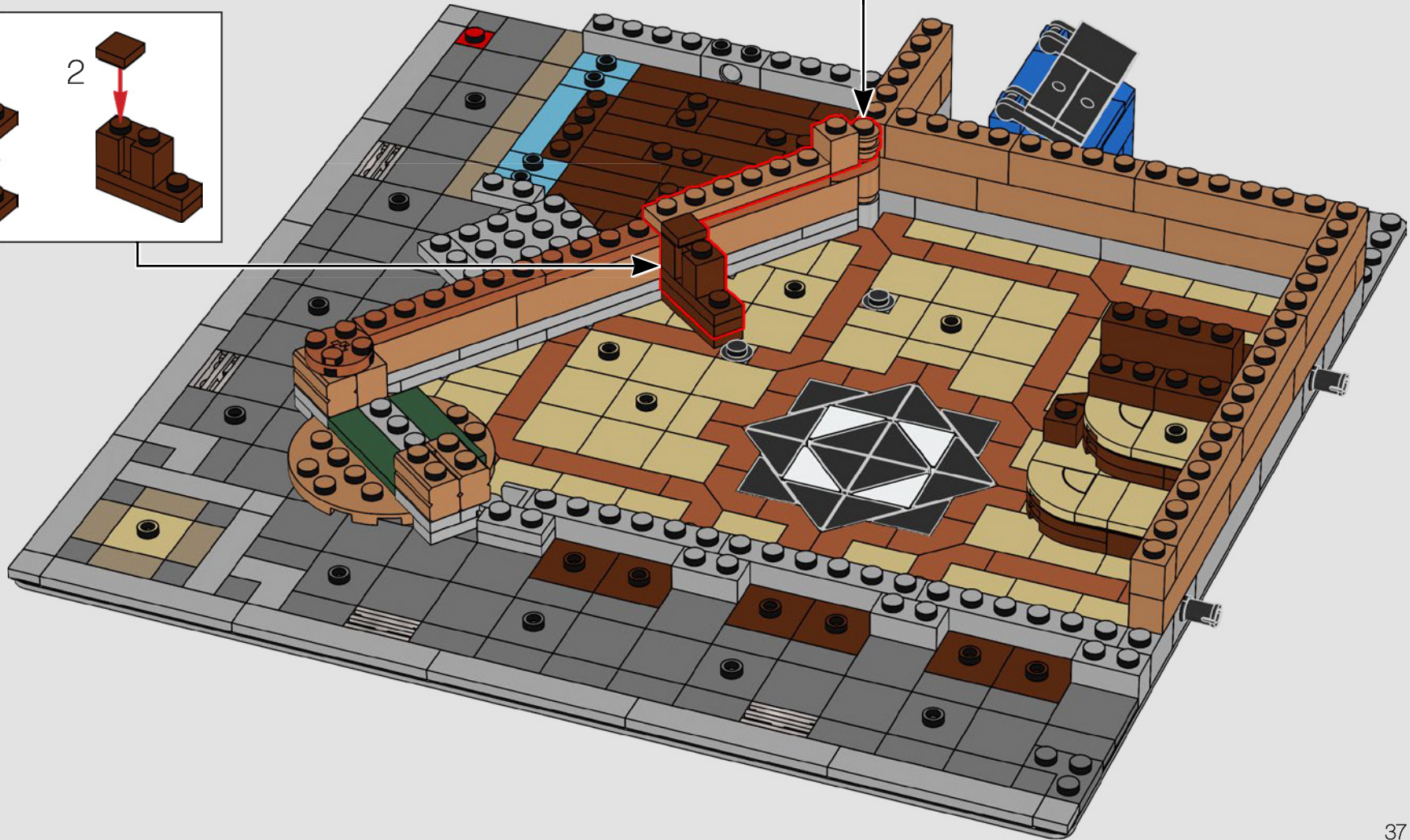
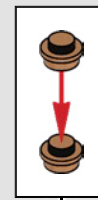
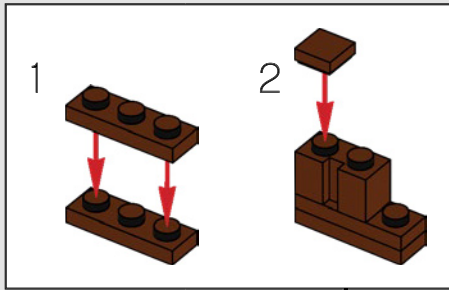

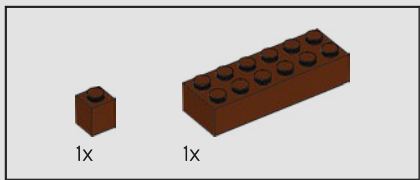

40

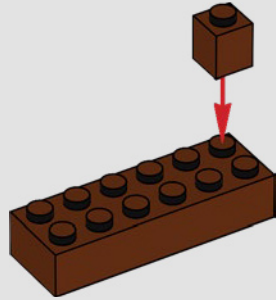

41

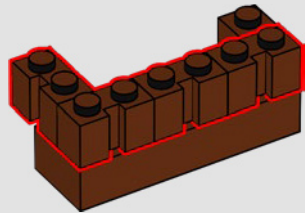

42

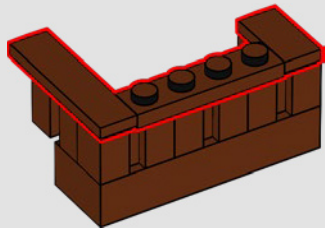

Many of the guests who've stayed in this hotel are residents of earlier Modular sets! Can you identify them?

De nombreux clients ayant séjourné dans cet hôtel sont des résidents des ensembles modulaires antérieurs ! Saurez-vous les identifier ?

¡Muchos de los huéspedes que se han alojado en este hotel son residentes de antiguos sets Modular Buildings! ¿Puedes identificarlos?

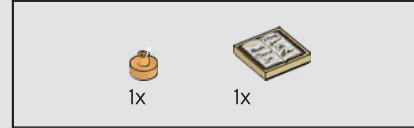

43

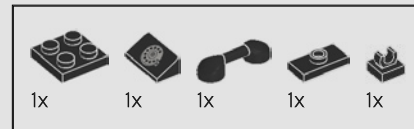
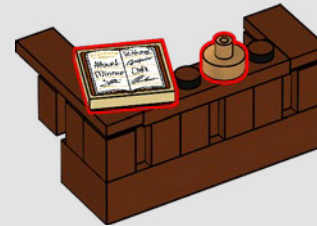

44

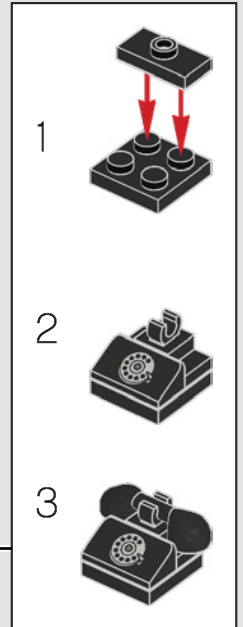
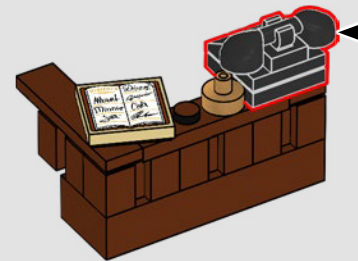

45



The Receptionist enjoys calling her friend the Lieutenant in the 10278 Police Station set on this phone.

La réceptionniste aime utiliser ce téléphone pour appeler son ami, le lieutenant du poste de police (10278).

La recepcionista disfruta llamando a su amiga, la teniente del set Estación de Policía (10278), usando este teléfono.

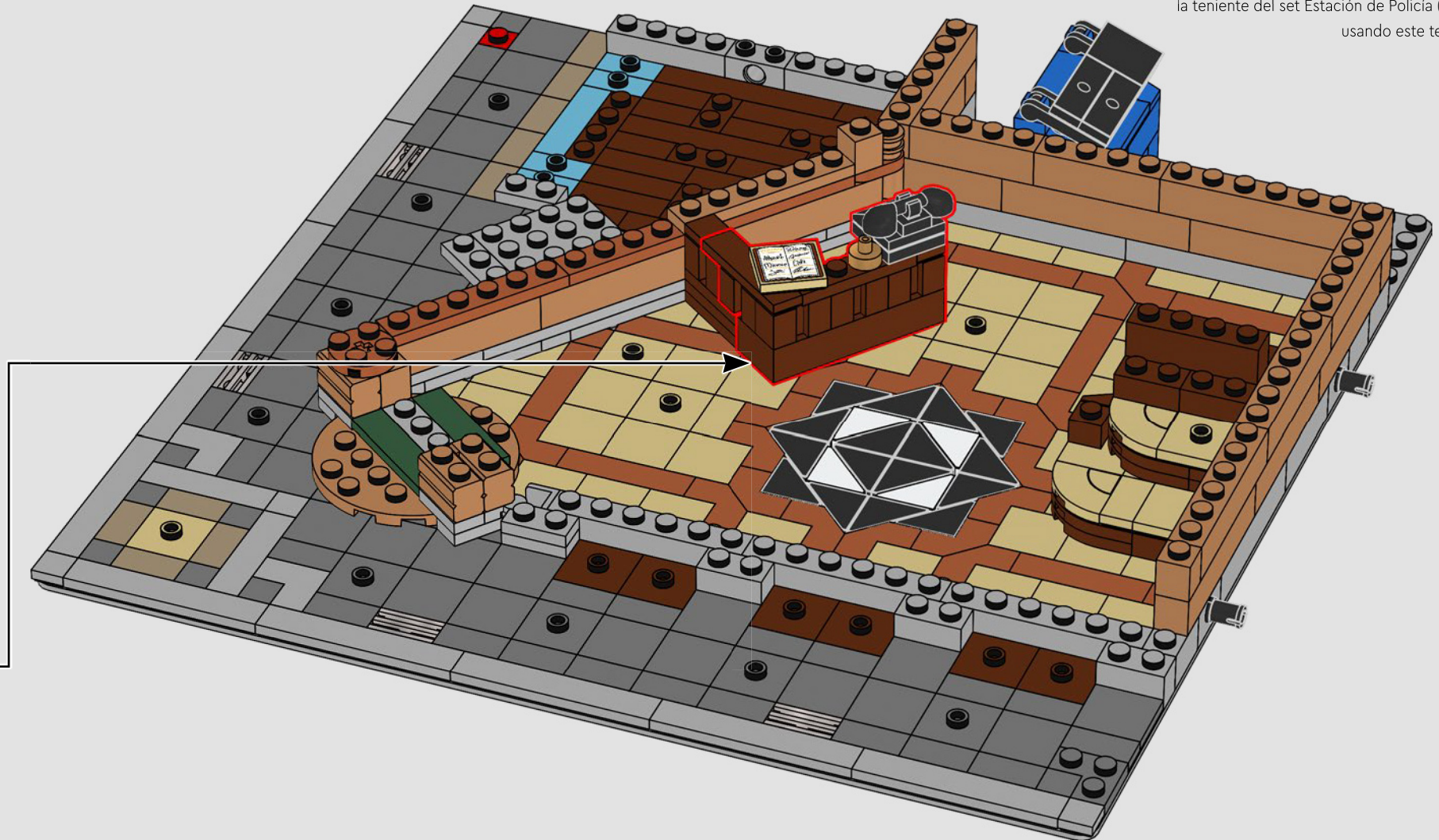

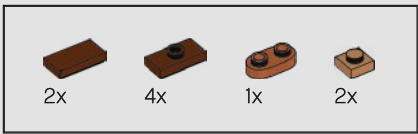

46

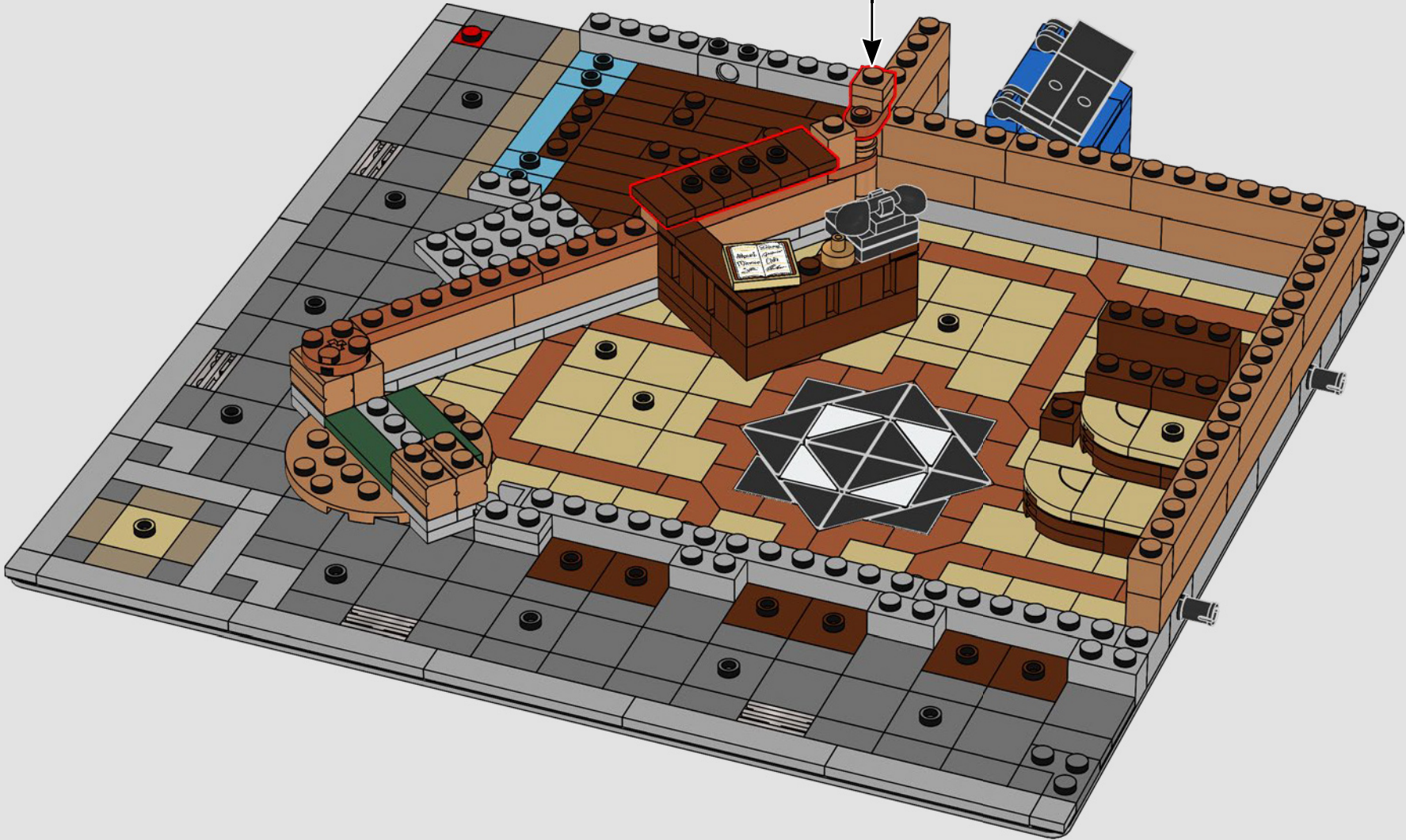
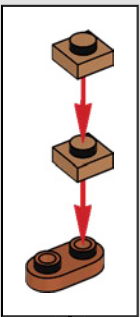

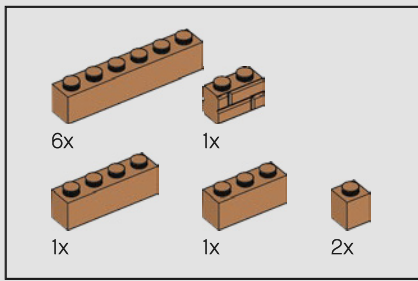

47

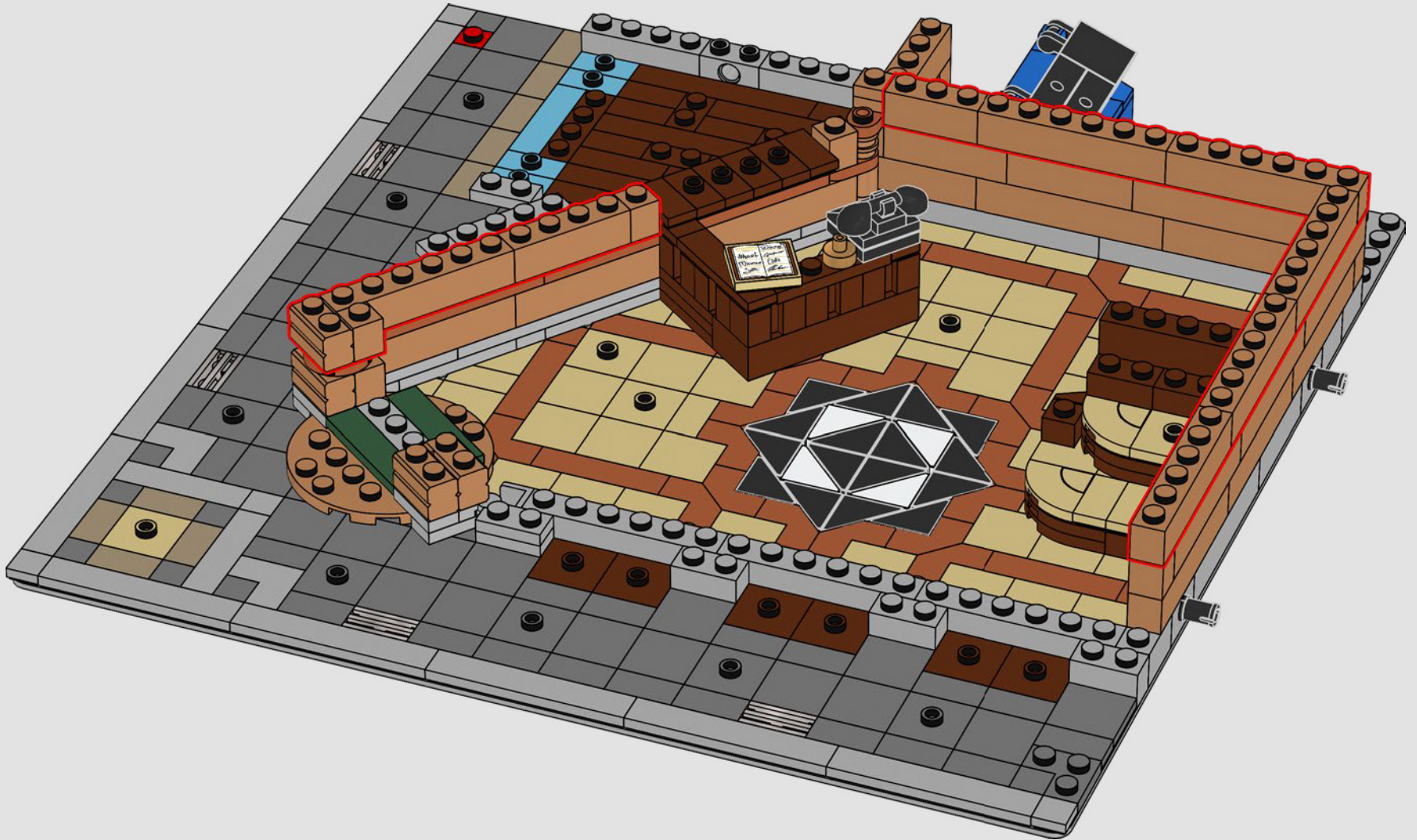

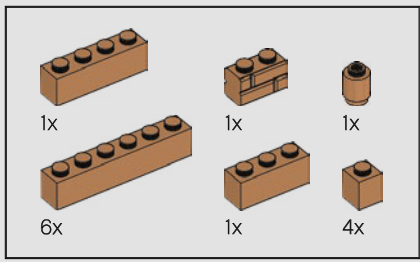

48

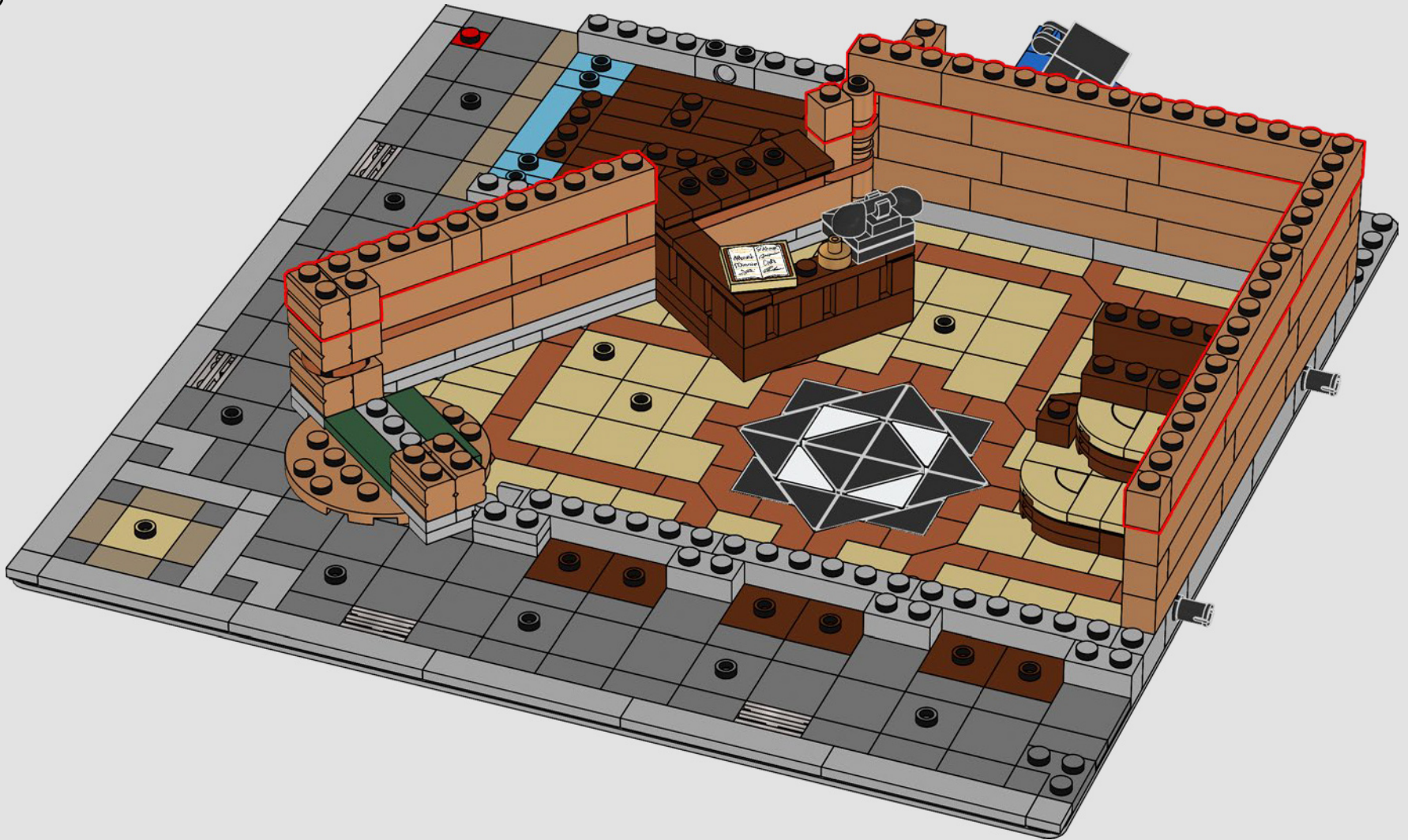

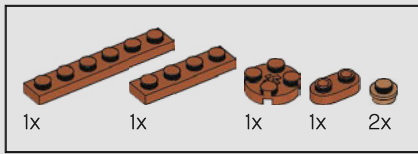

49

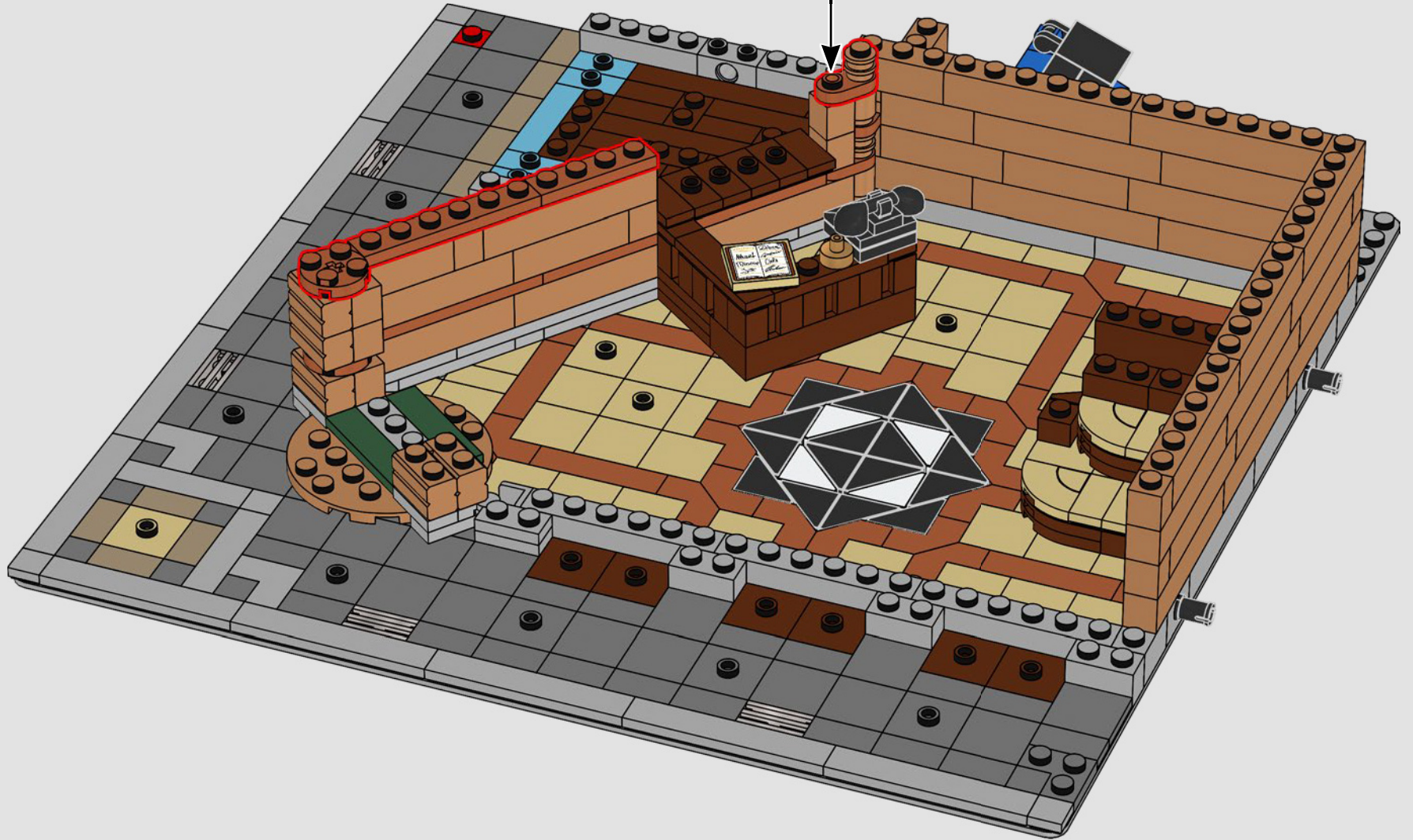
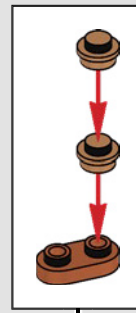

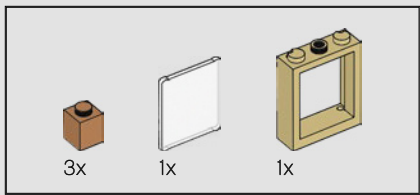

50

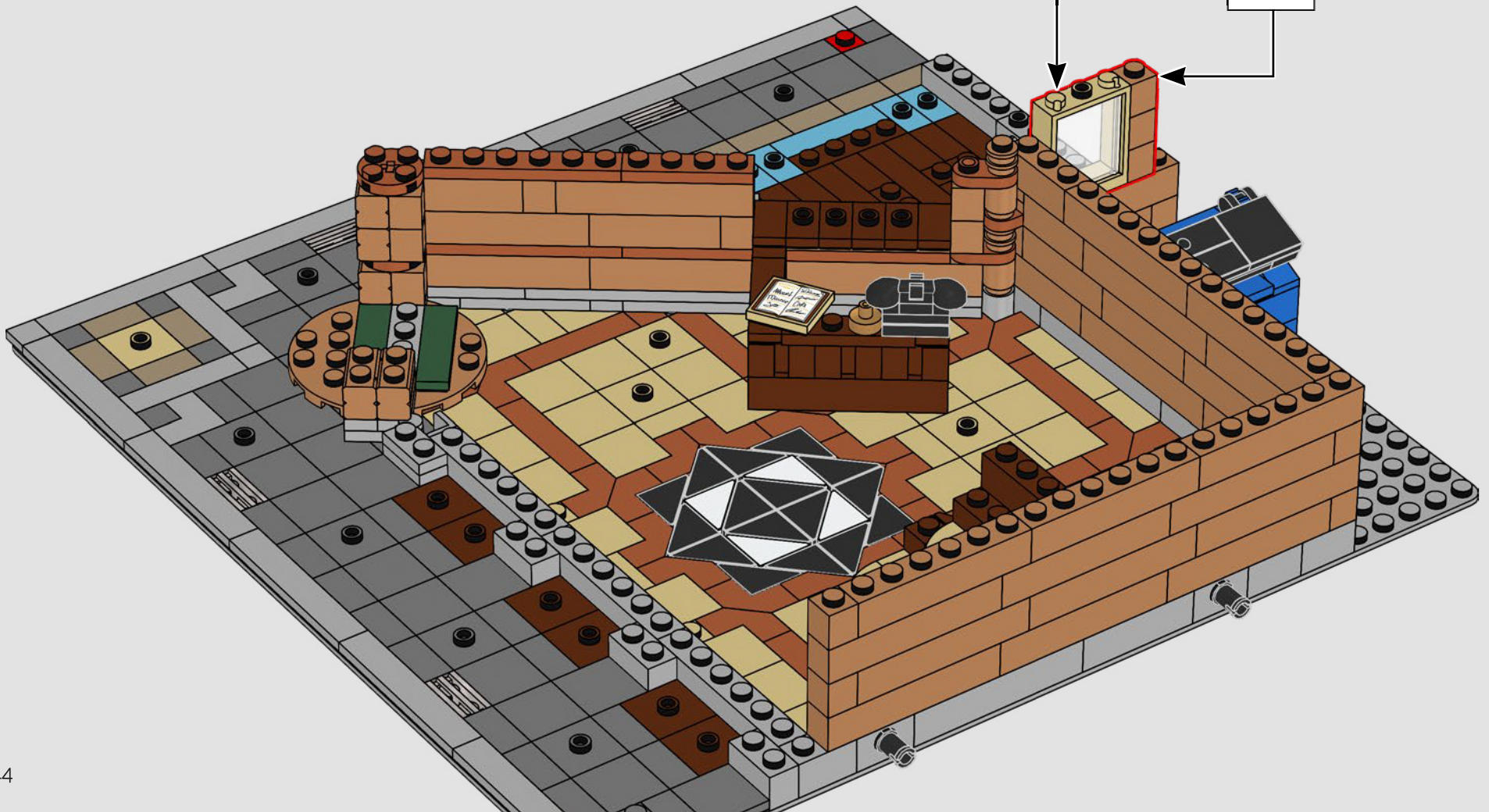
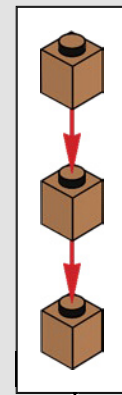
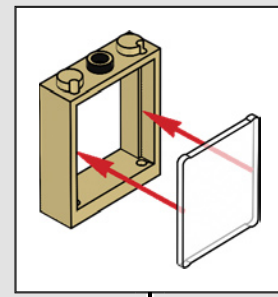

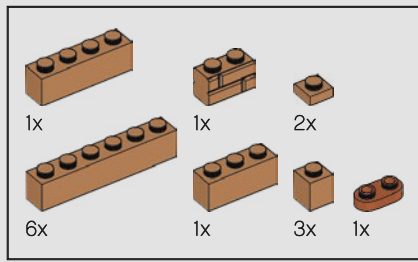

51

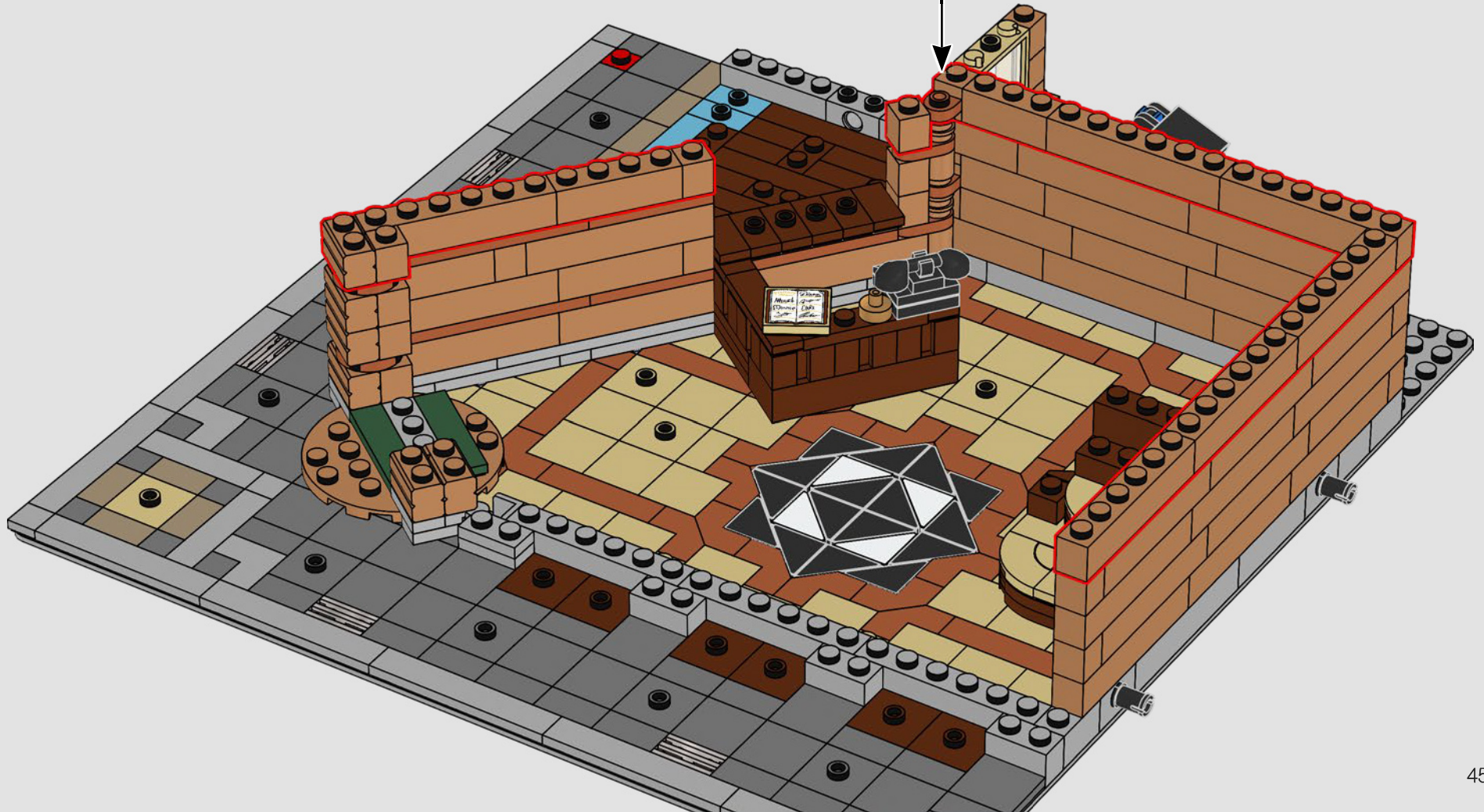
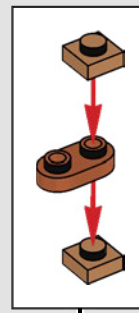

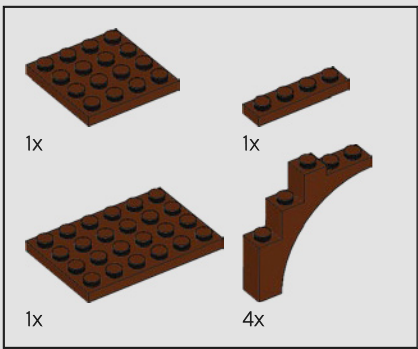

52

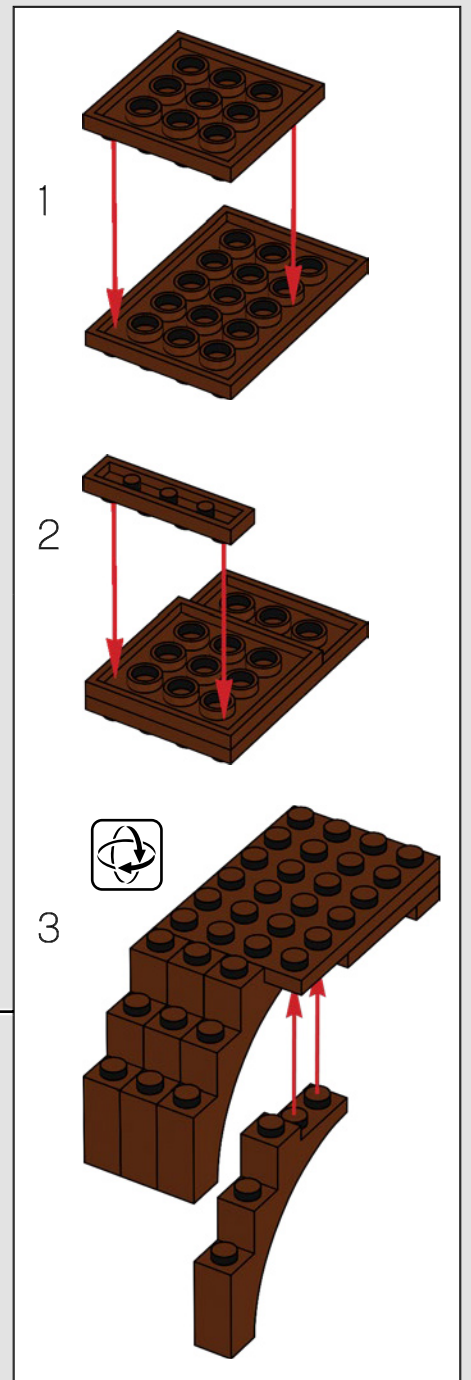
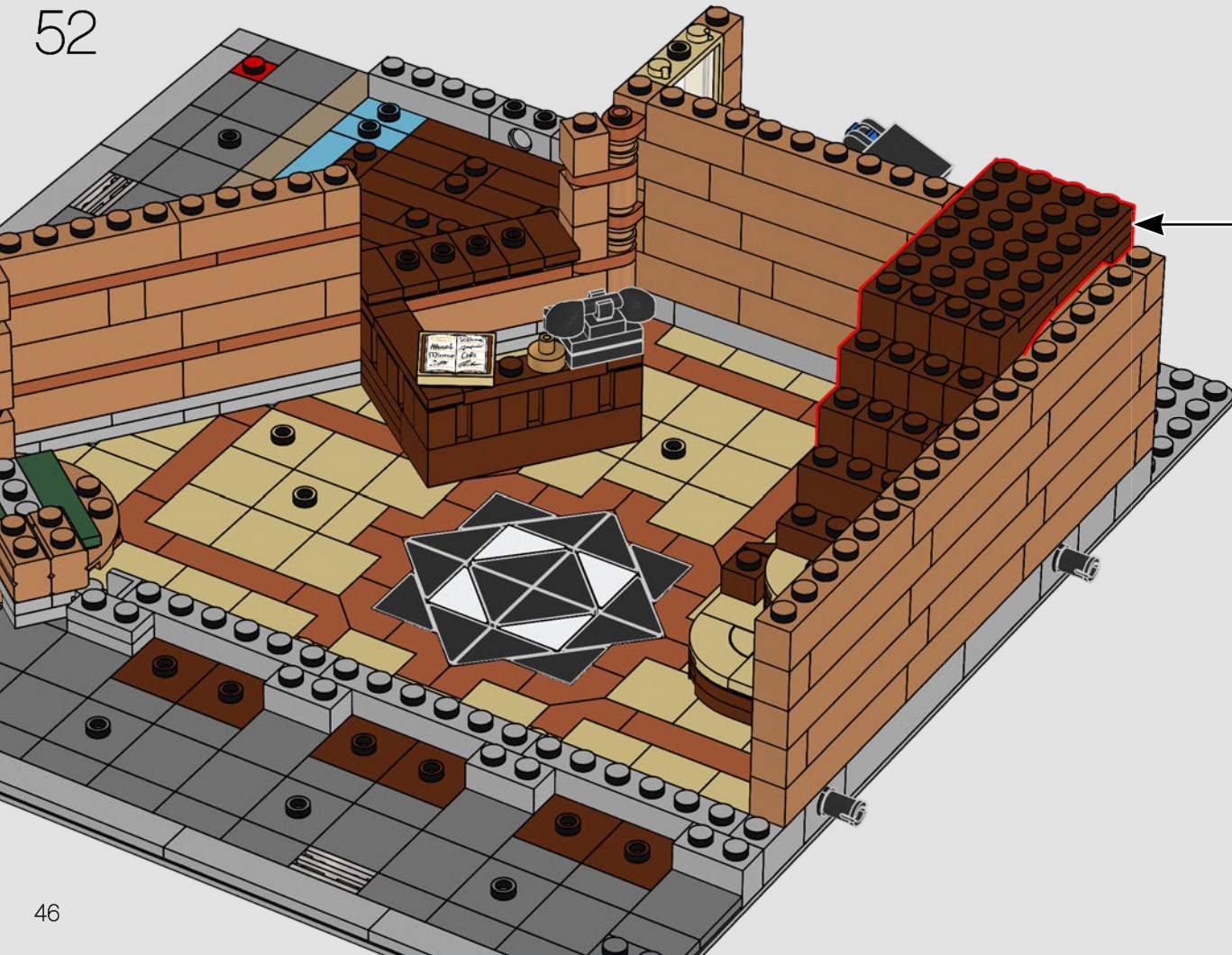

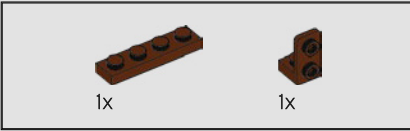

53

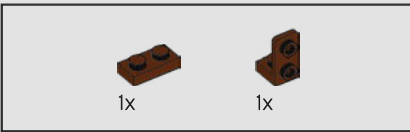
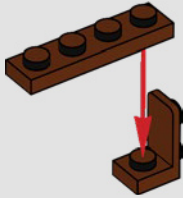

54

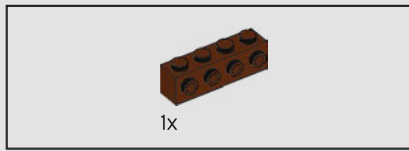
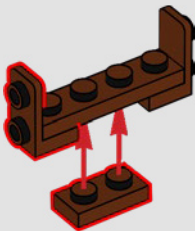

55

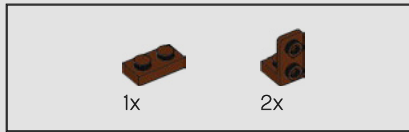
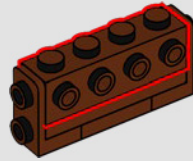

56

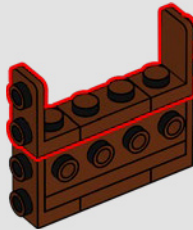

57

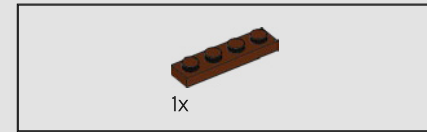
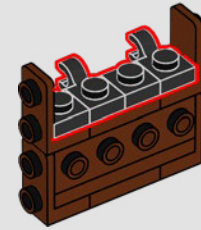

58

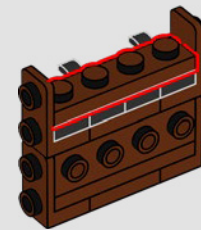



59

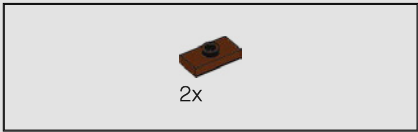
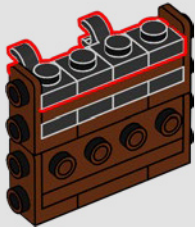

60

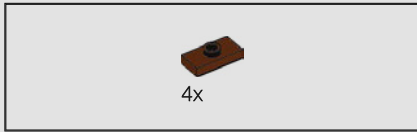
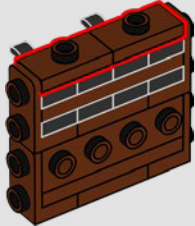

61

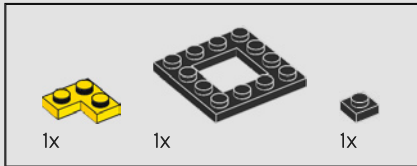
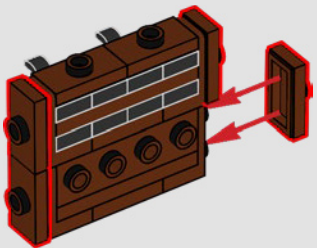

62

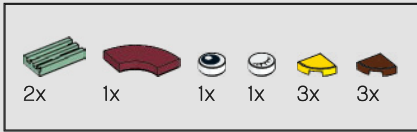
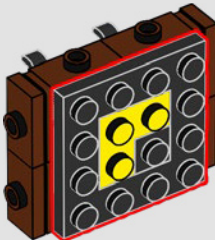

63

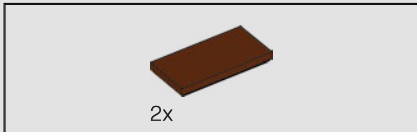
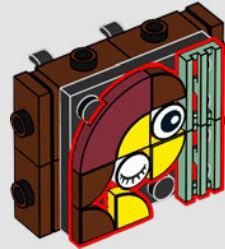

64

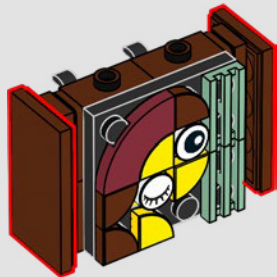

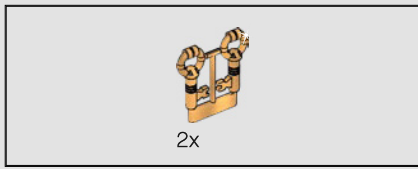

65

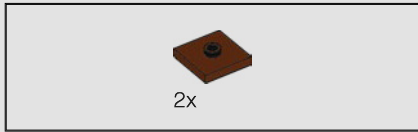
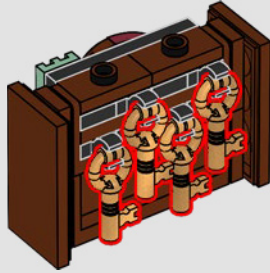

66

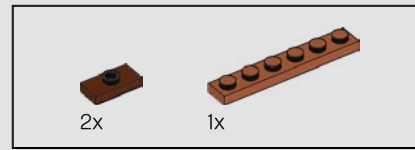
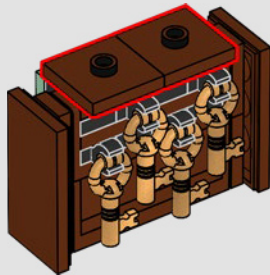

67

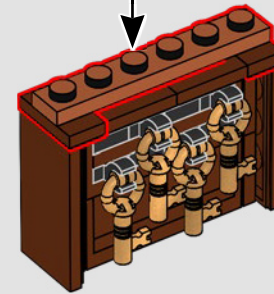
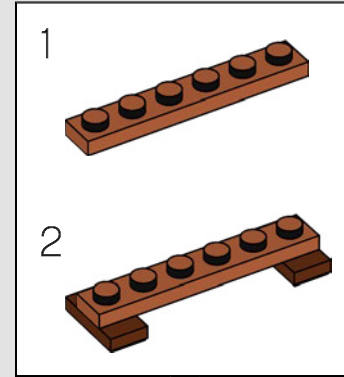

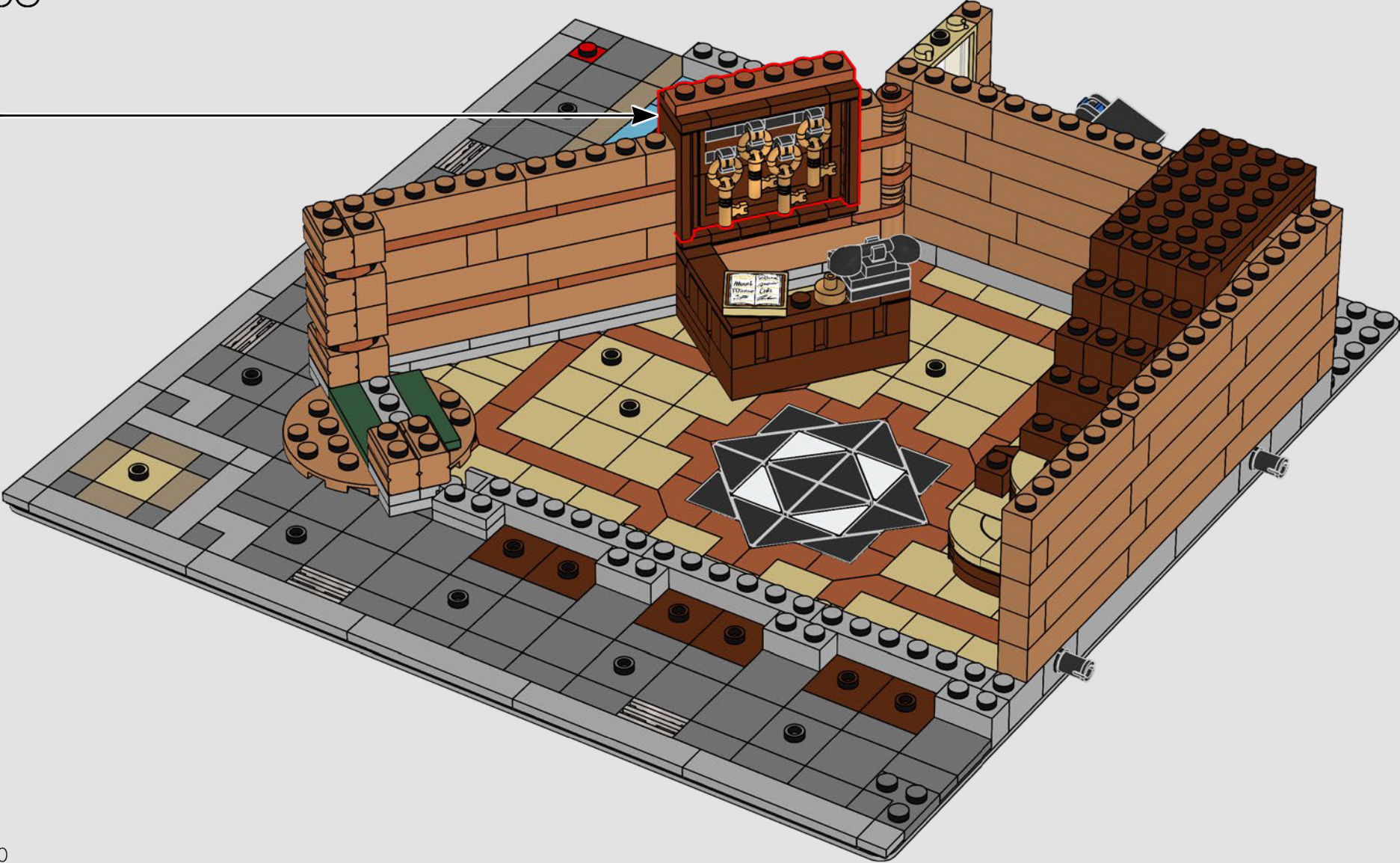

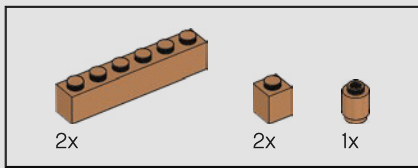

69

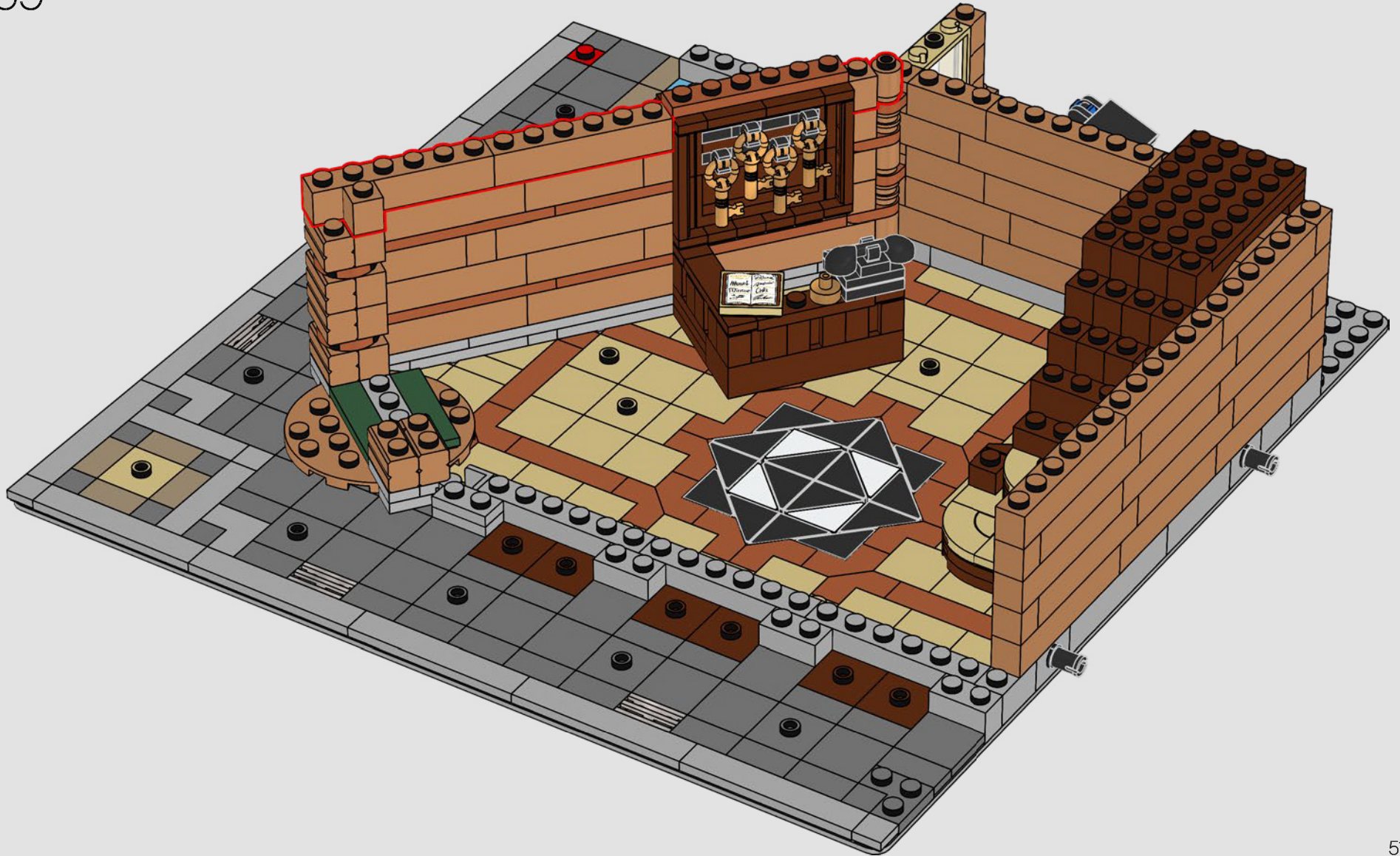

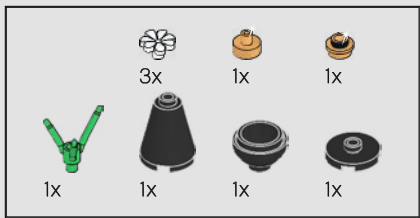

70

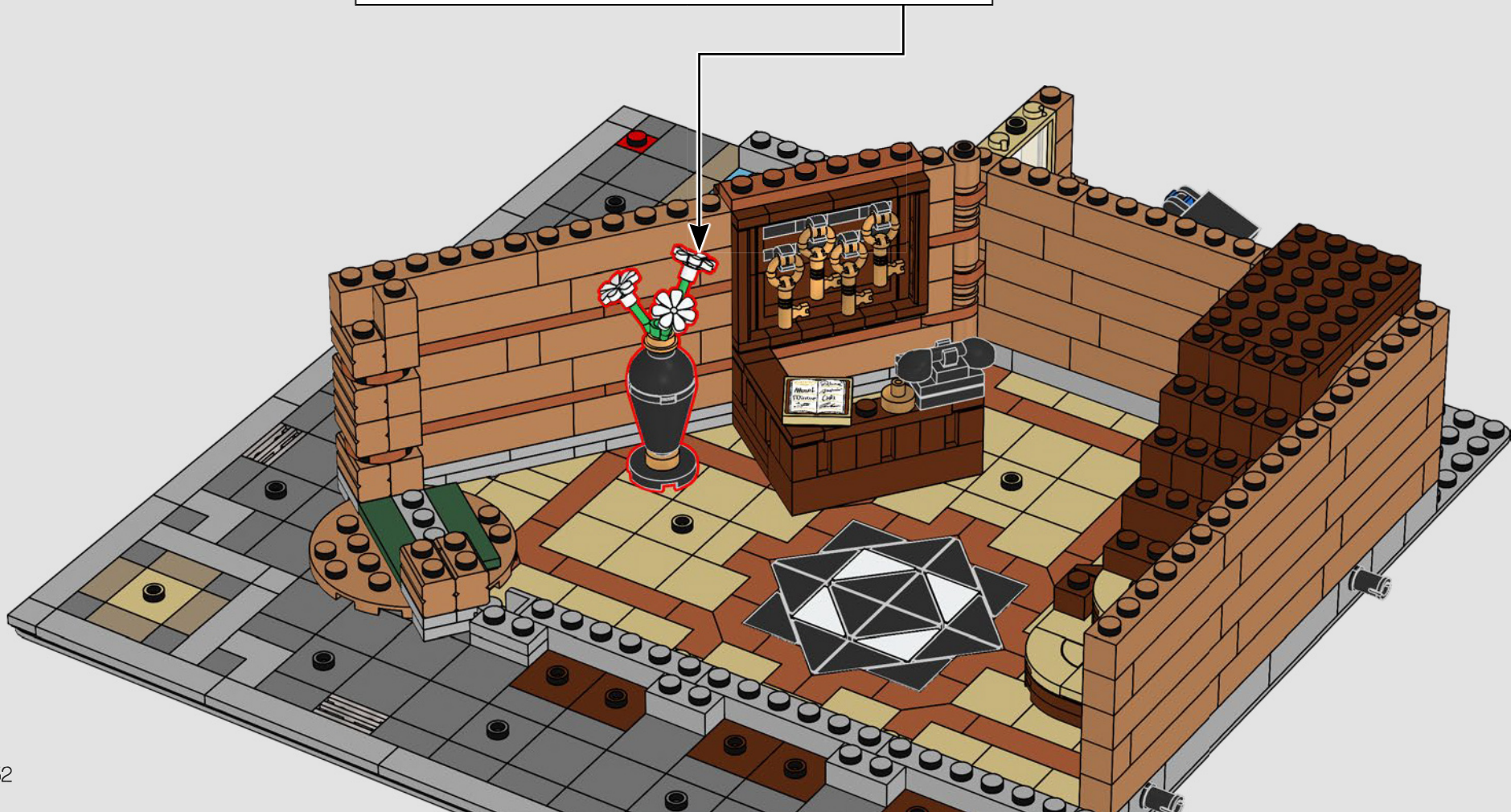
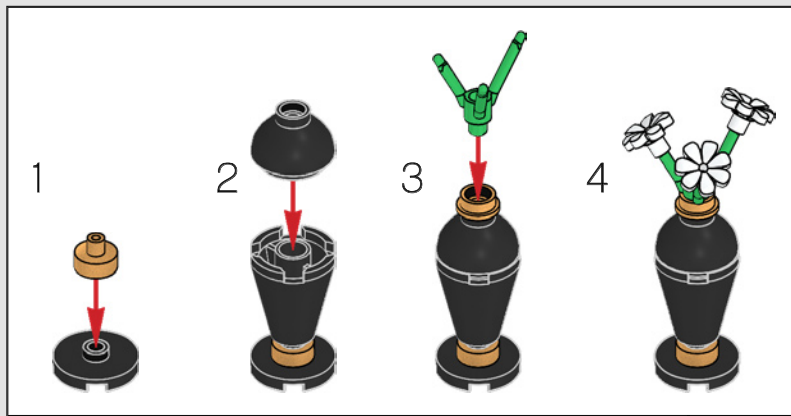

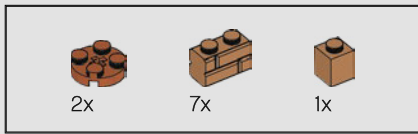

71

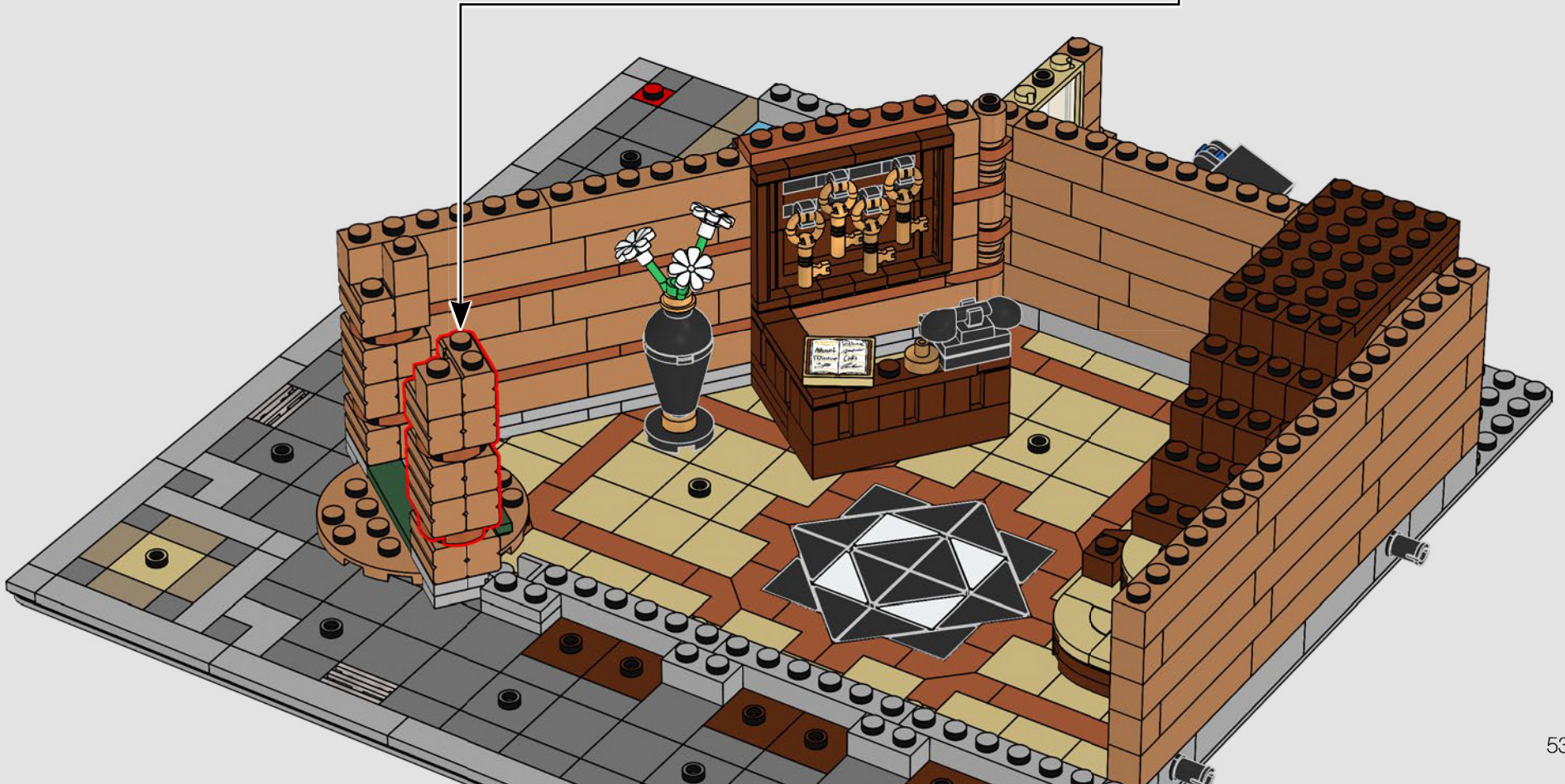
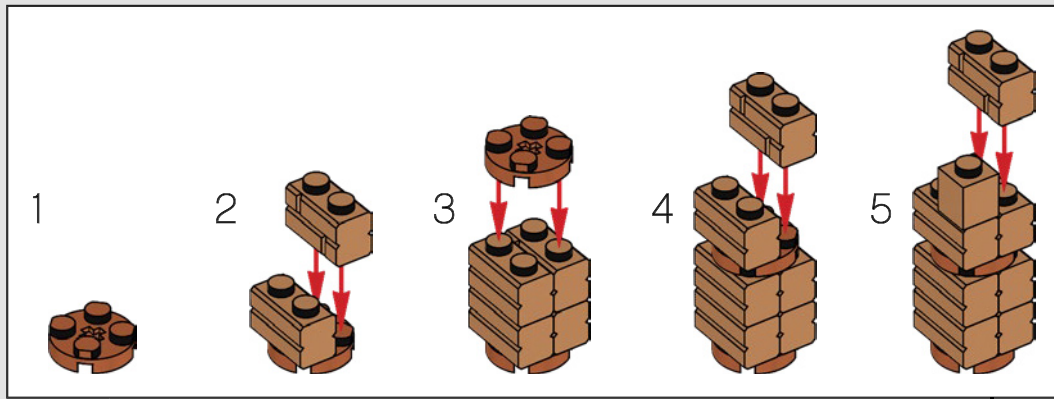

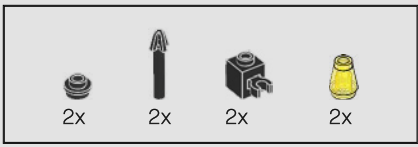

72

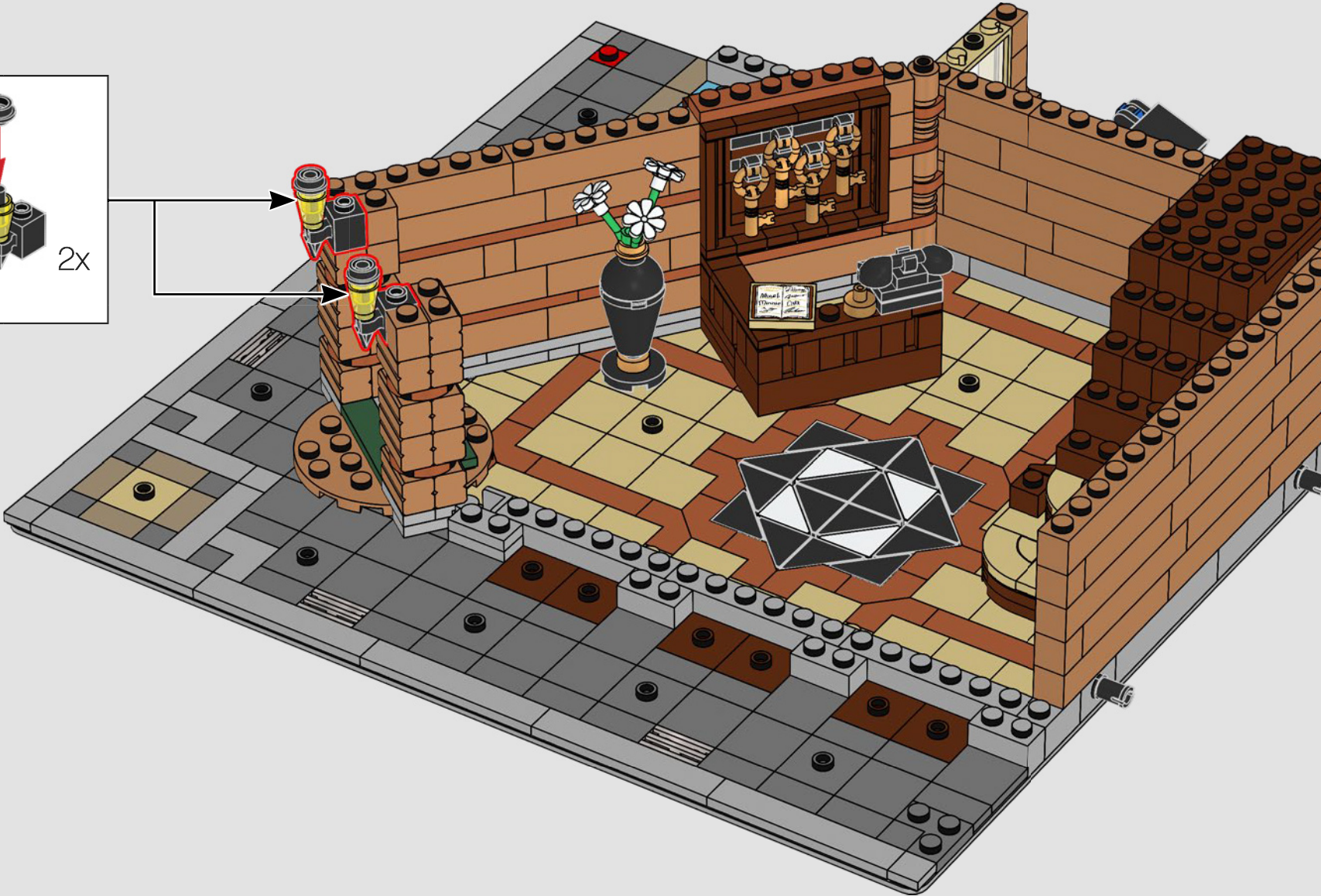
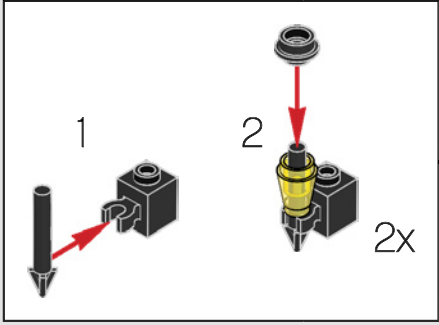

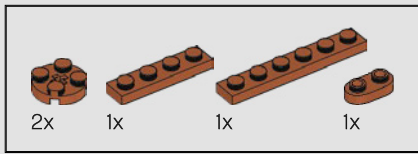

73

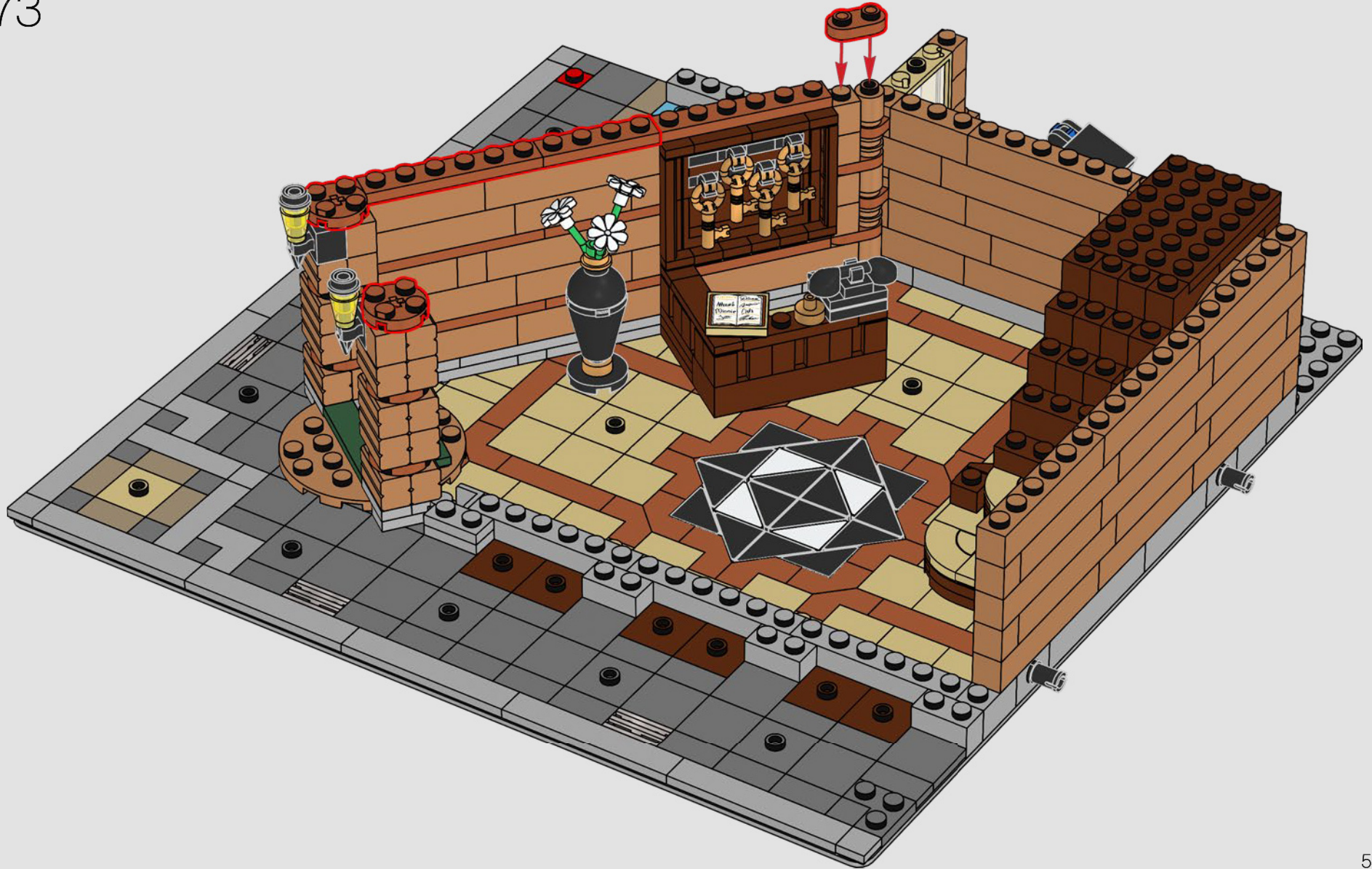

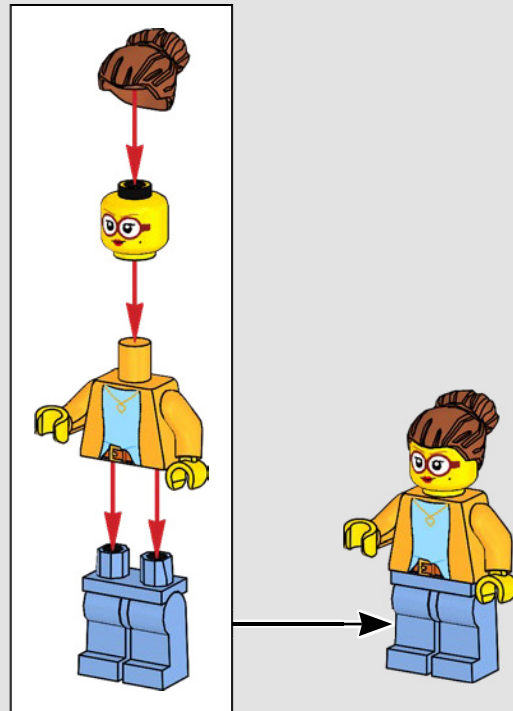

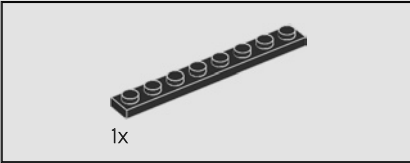
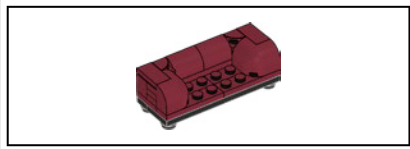

74

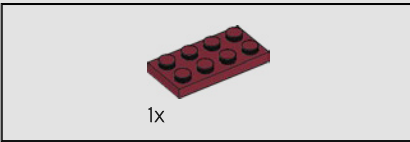
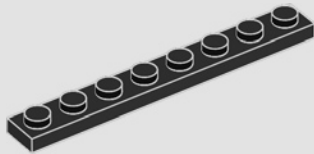

75

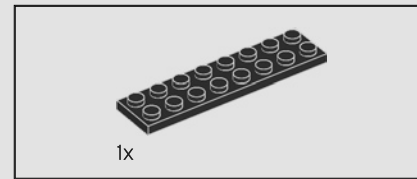
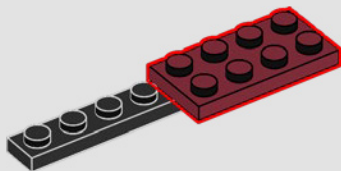

76

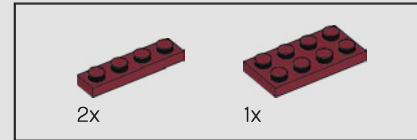
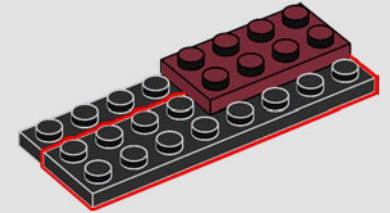

77

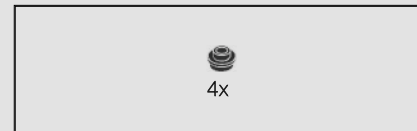
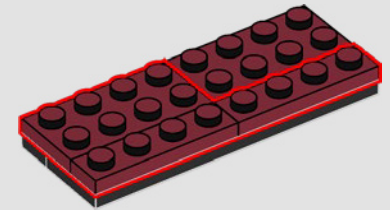

78

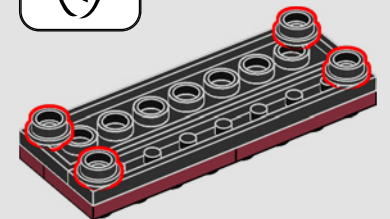
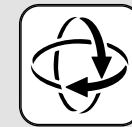

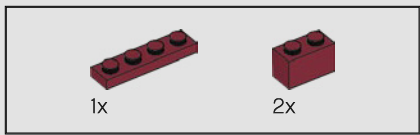

79

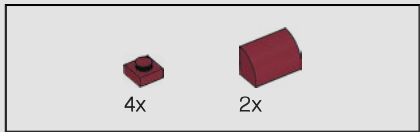
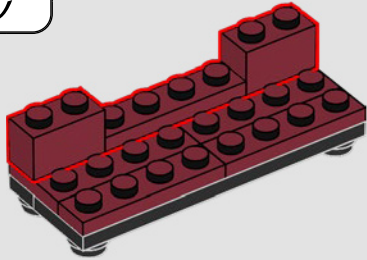

80

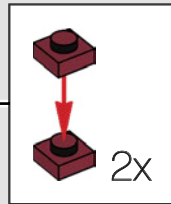
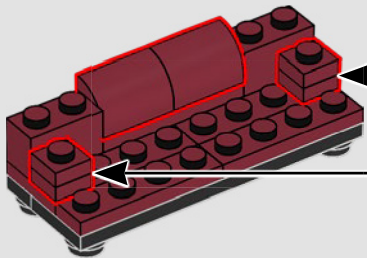

81

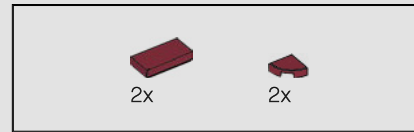
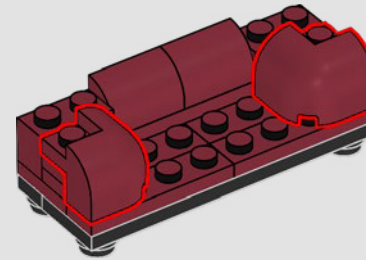

82

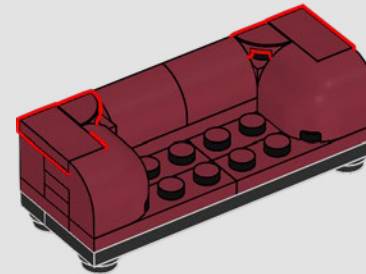



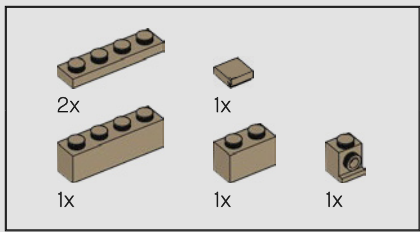

84

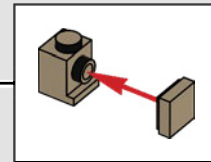
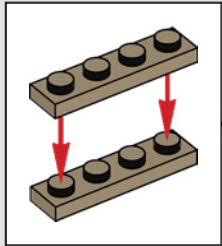
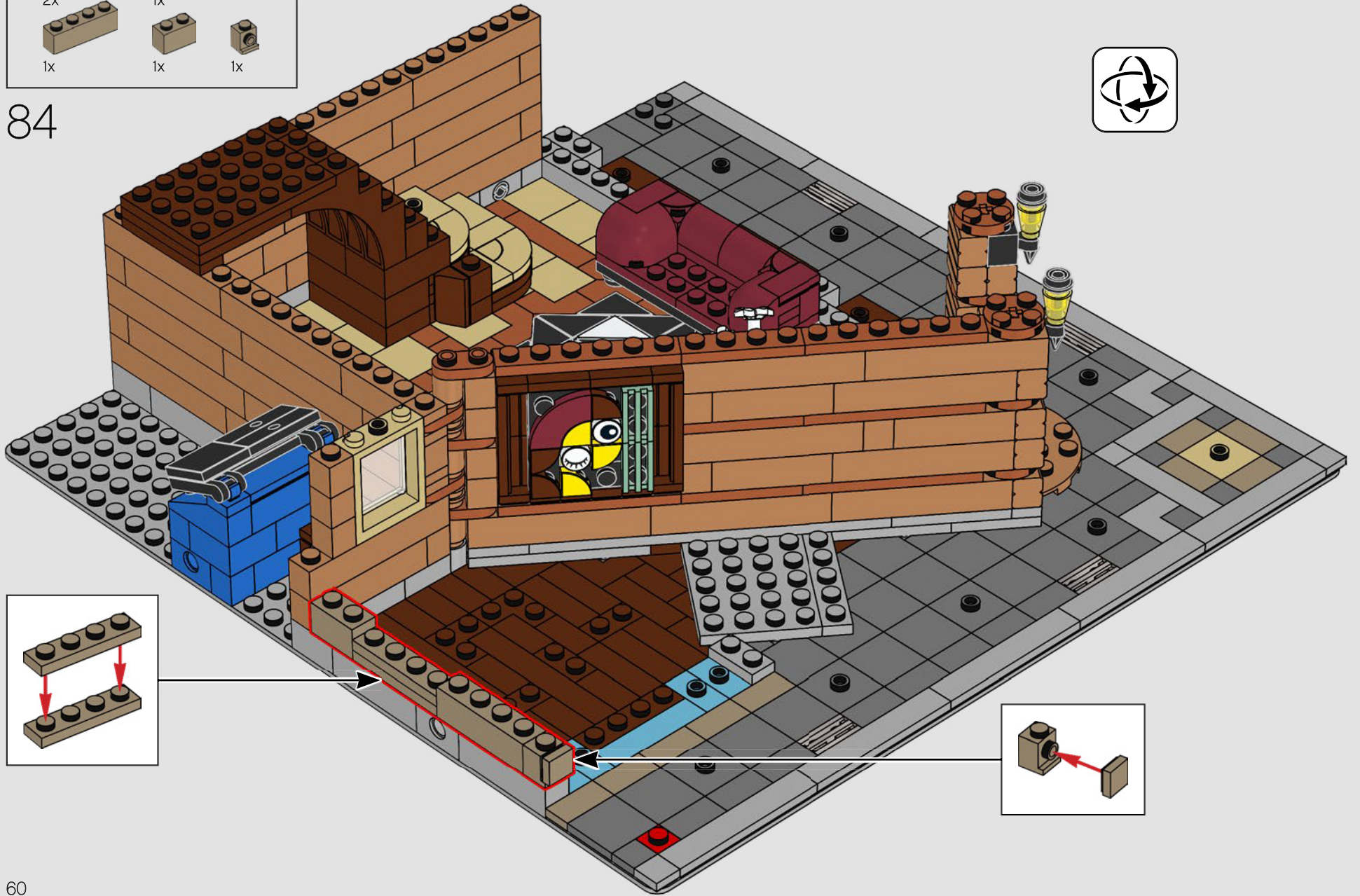
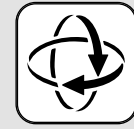

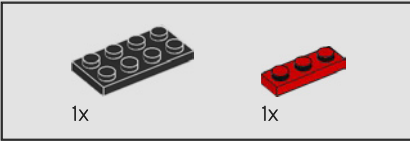

85

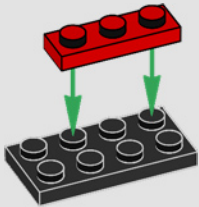

86

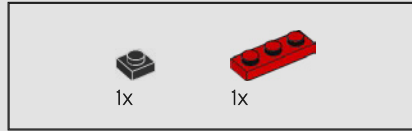
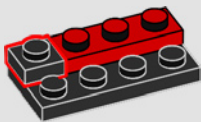

87

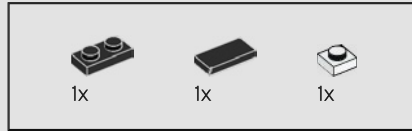
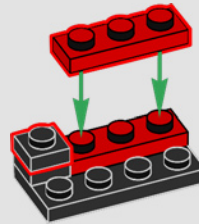

88

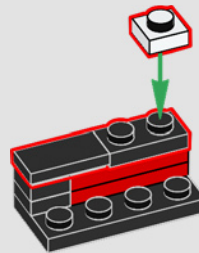

89

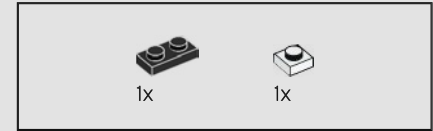
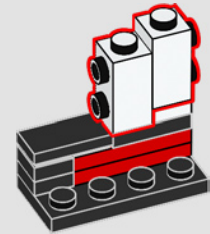

90

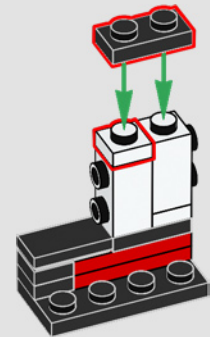



91

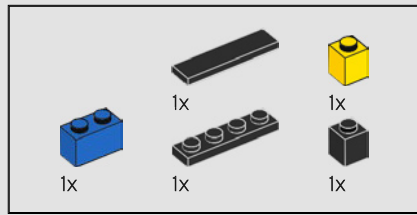
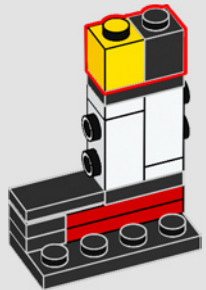

92

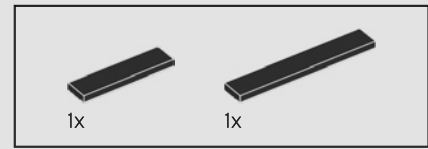
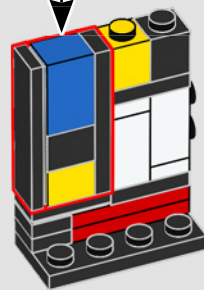
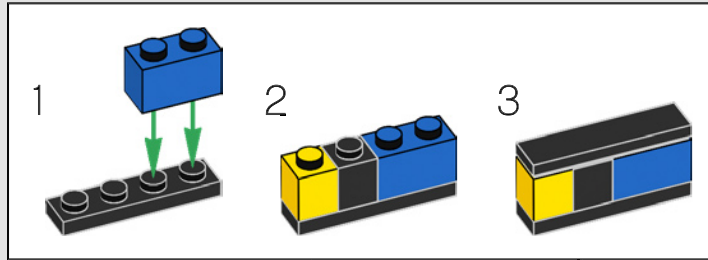

93

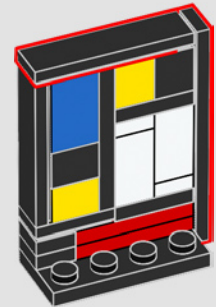

94

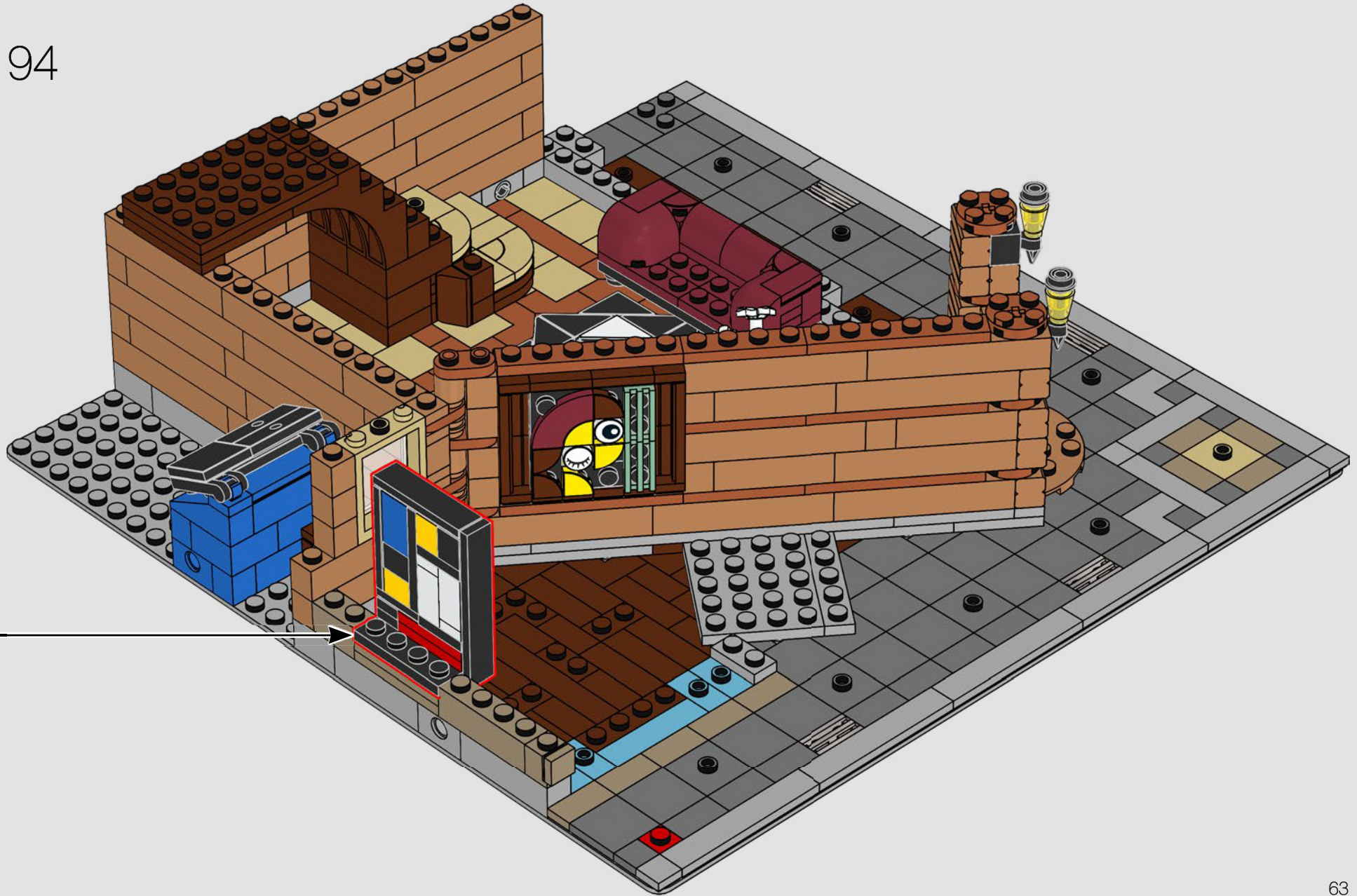

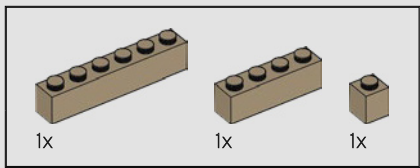

95

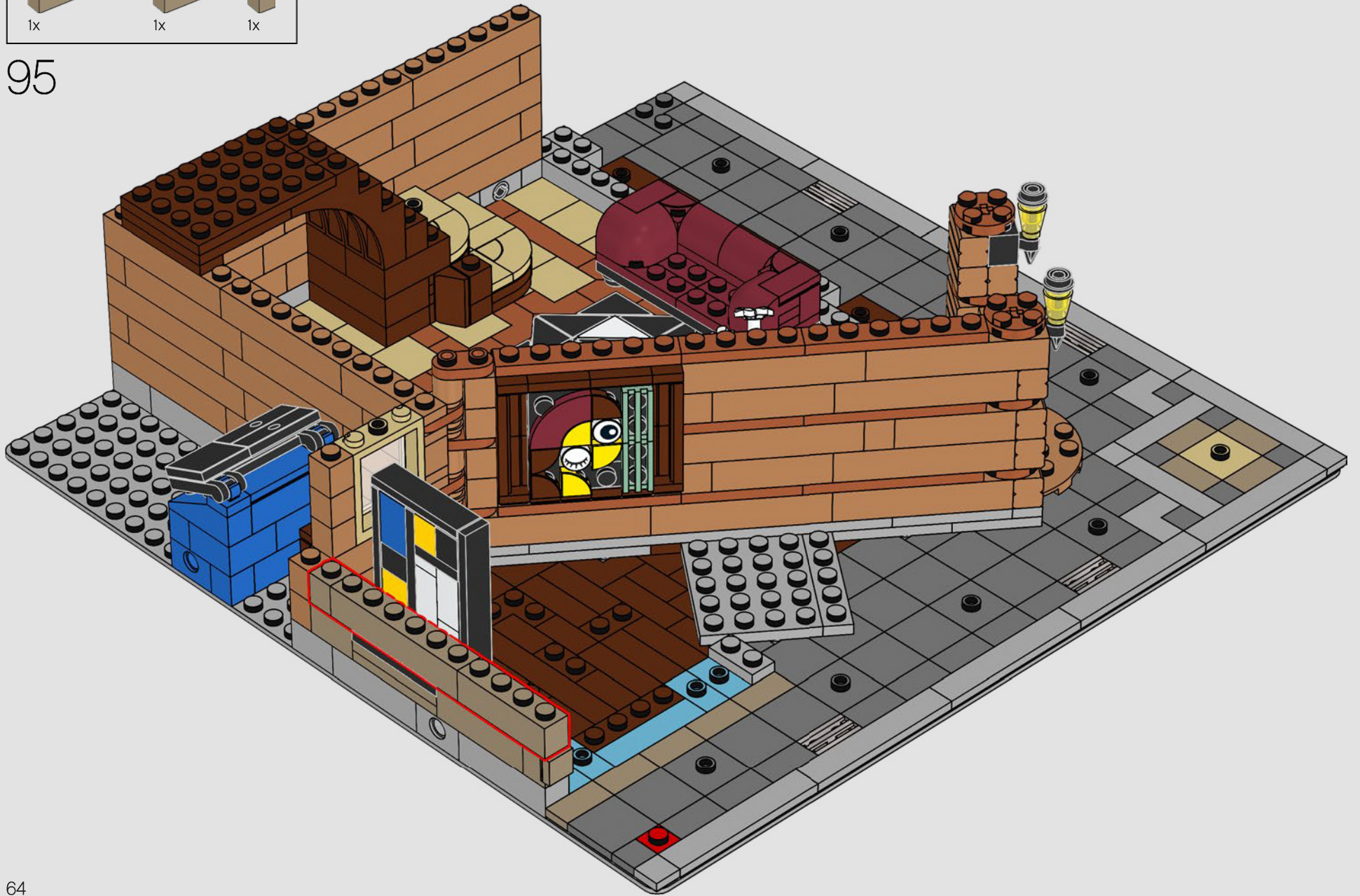

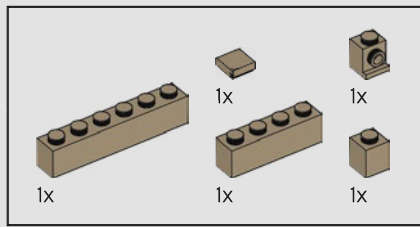

96

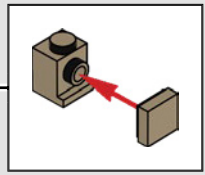
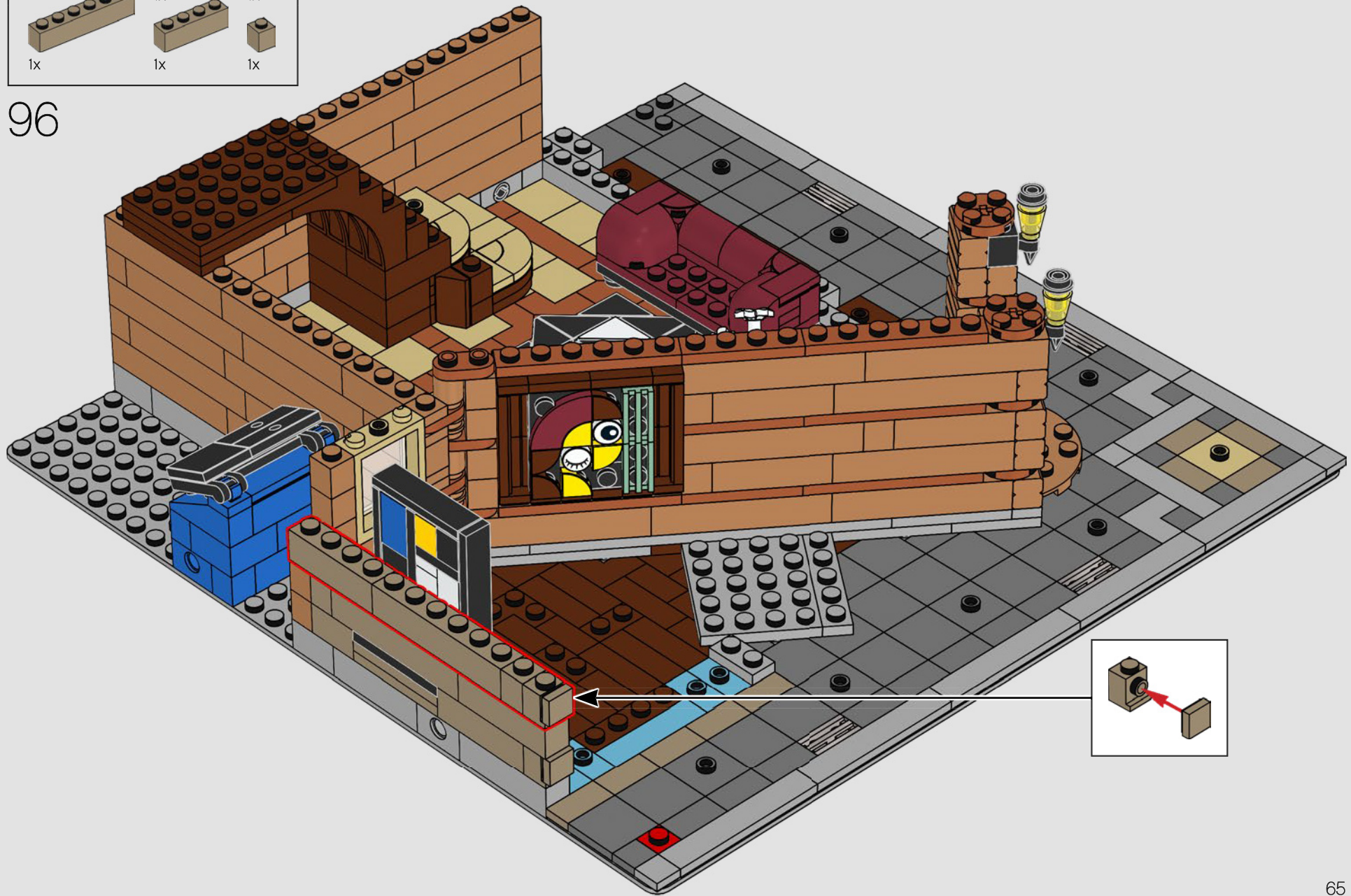

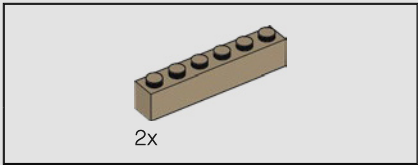

97

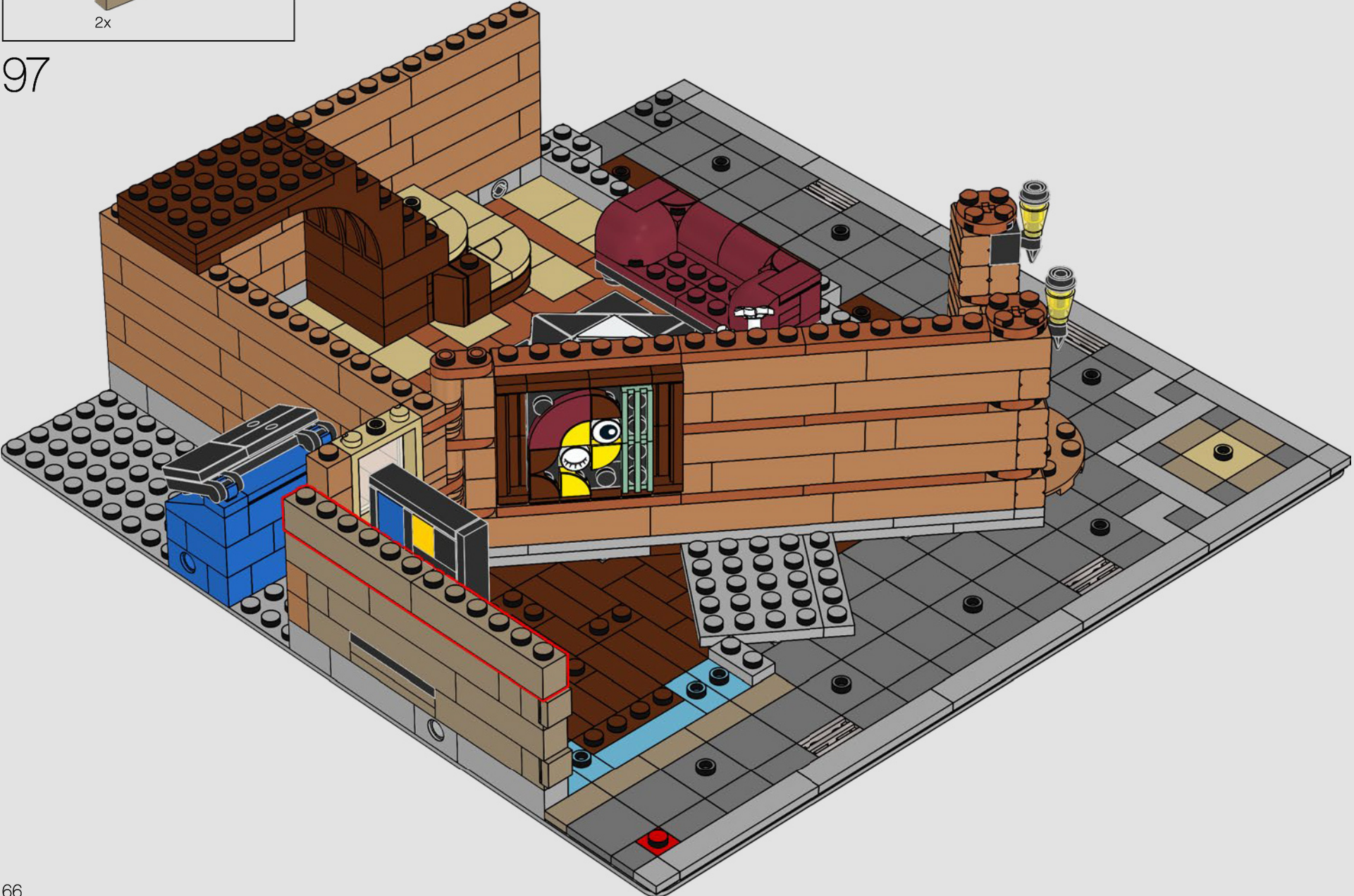

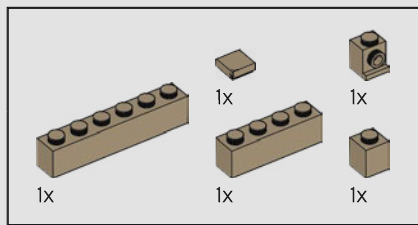

98

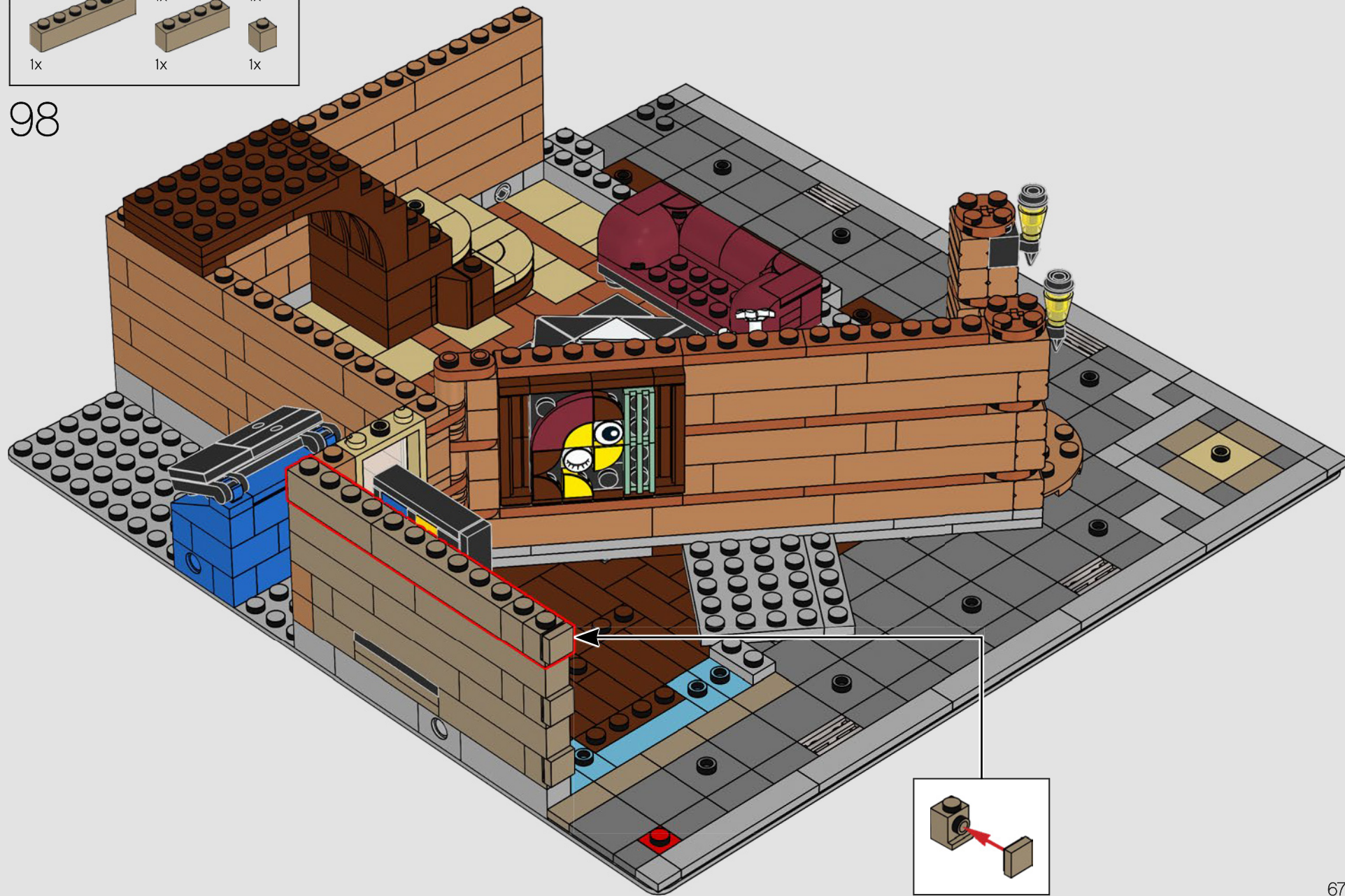

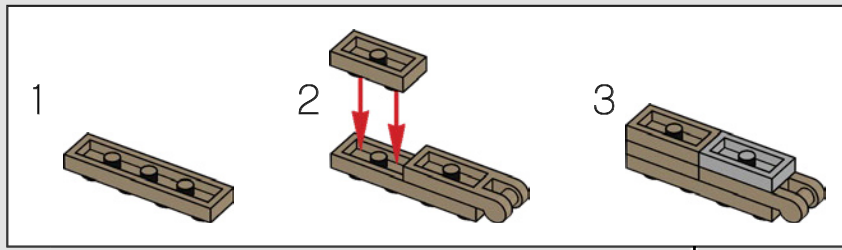
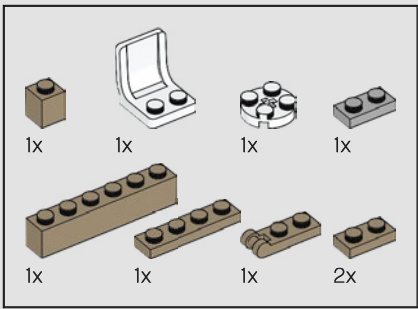

99



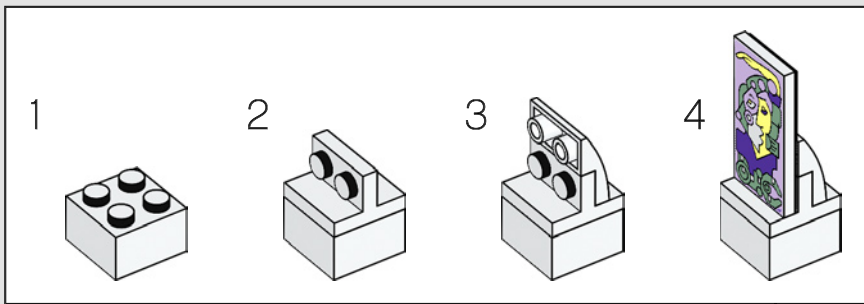
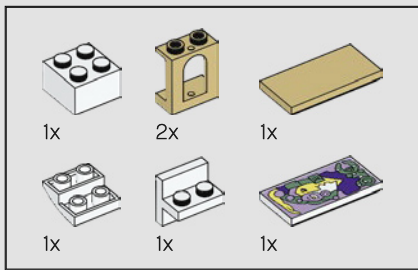

100

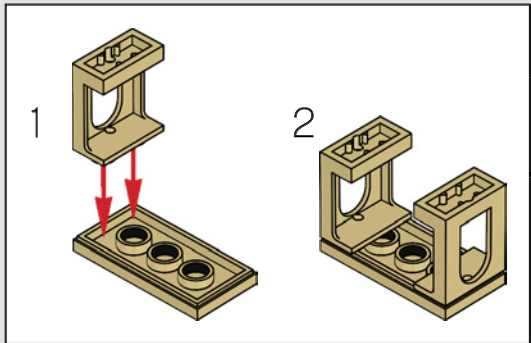

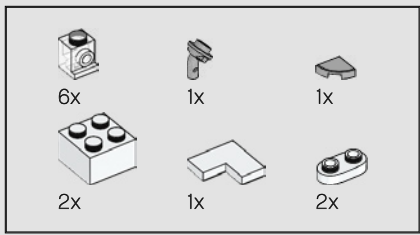

101

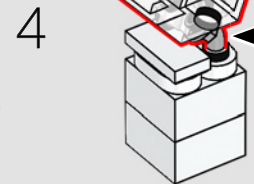
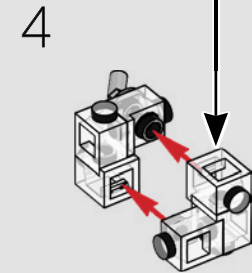
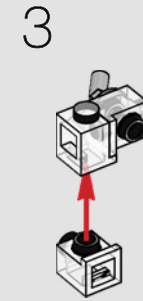
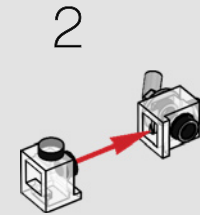
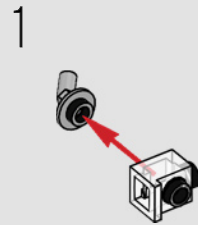
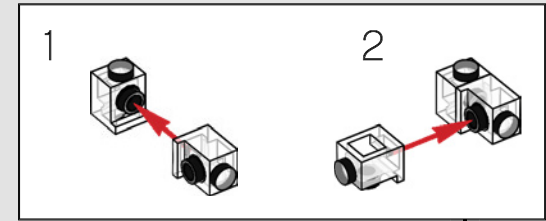
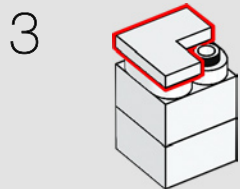
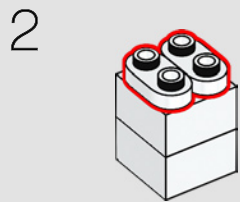
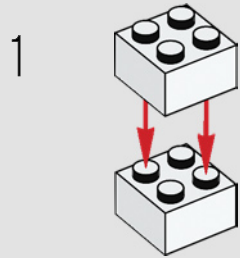

The Gallery Owner is very excited to debut her collection of Cubist Art! Her favorite piece, though, isn't Cubist – it's just an expertly made cube.

La galeriste est très heureuse de présenter sa nouvelle collection d'œuvres cubistes ! Sa pièce préférée, toutefois, n'est pas cubiste – il s'agit simplement d'un cube savamment fabriqué.

¡La propietaria de la galería está entusiasmada con el debut de su colección de arte cubista! Su obra favorita, sin embargo, no es cubista: es simplemente un cubo magistralmente elaborado.

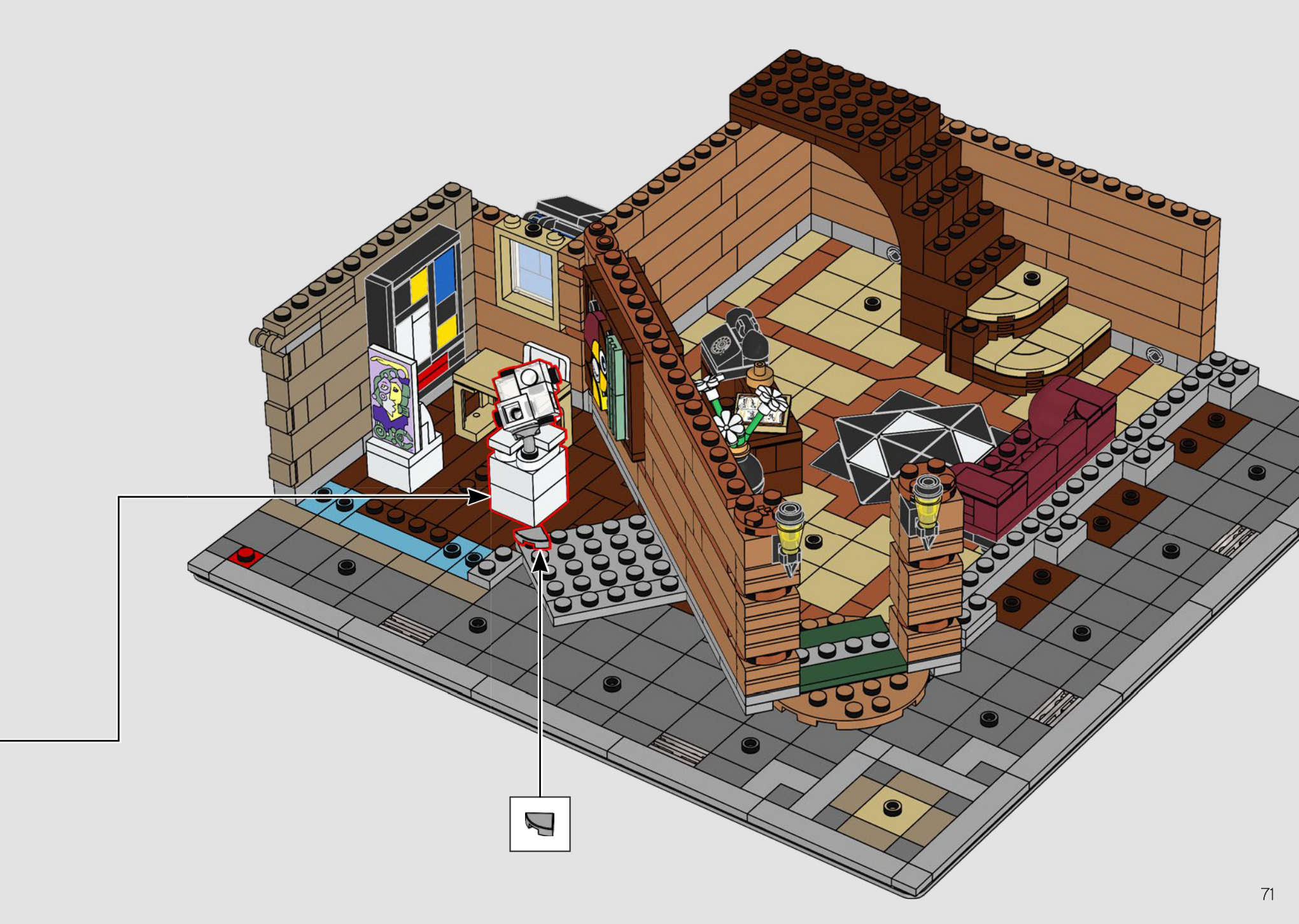

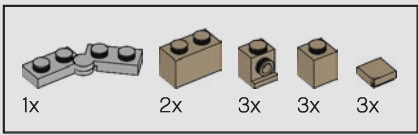

102

1

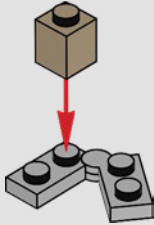

2

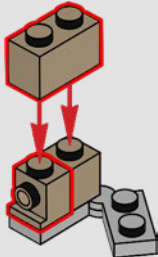

3

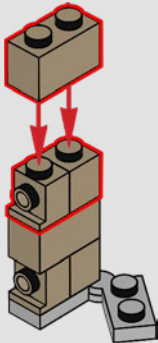

4

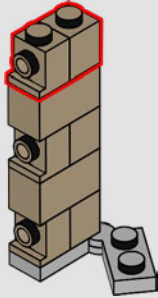

5

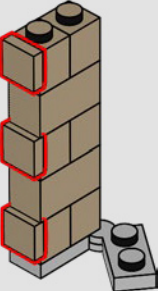

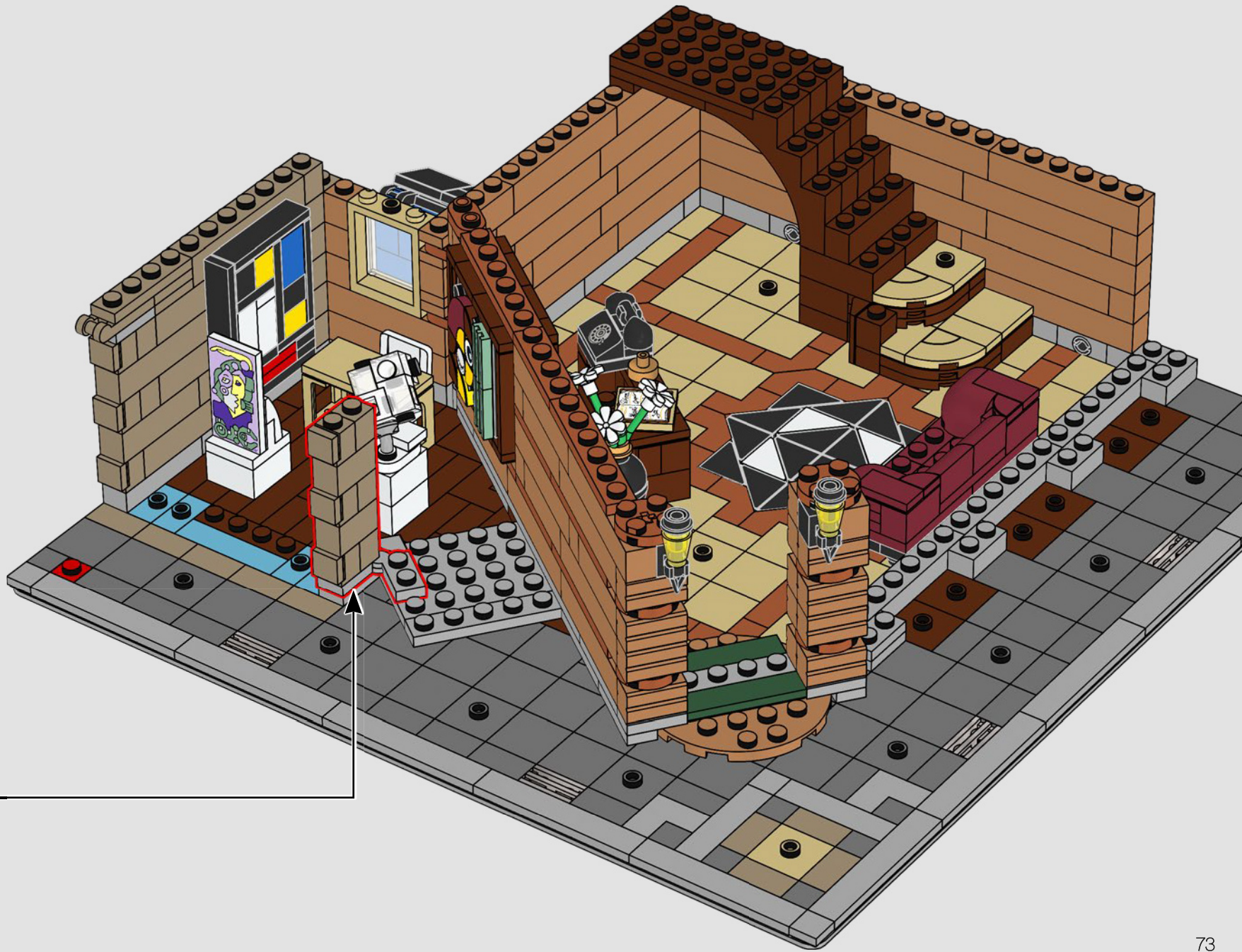

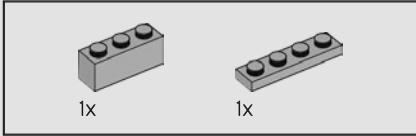
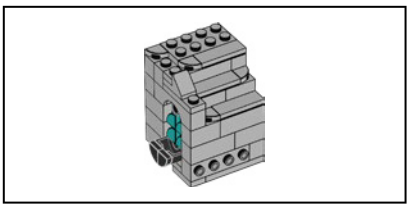

103

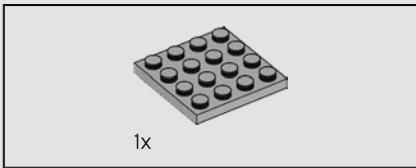
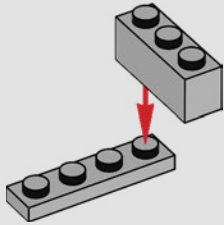

104

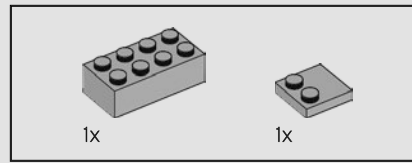
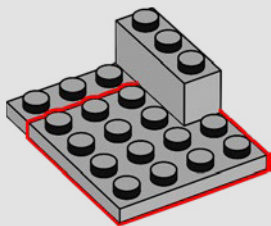

105

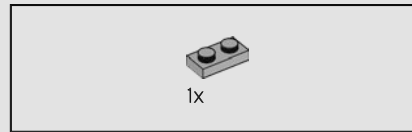
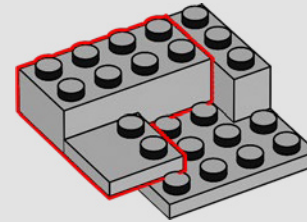

106

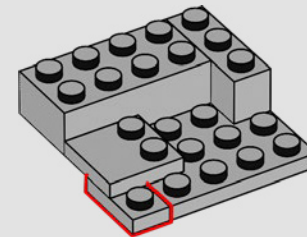

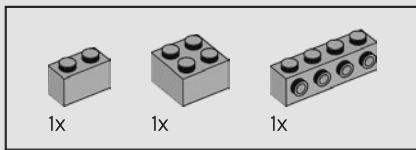

107

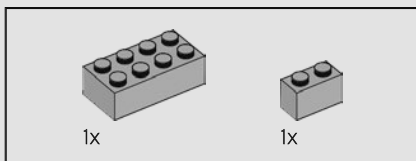
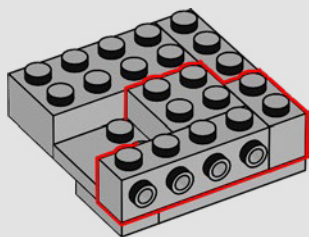

108

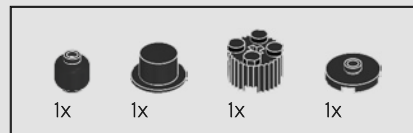
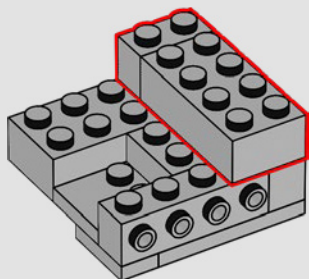

109

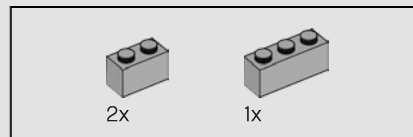
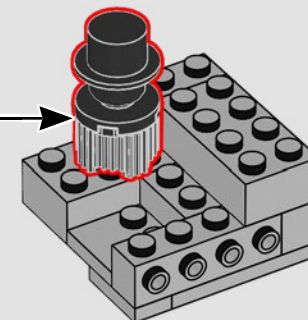
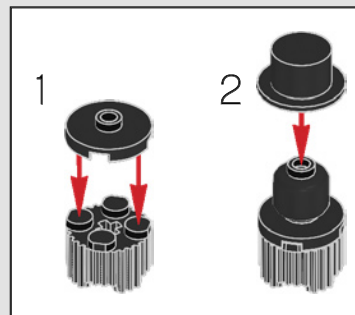

110

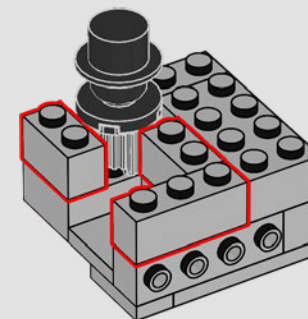

This bust is by the same artist who carved the white bust in the lobby of the 10224 Town Hall set.

Ce buste est l'œuvre du même artiste qui a sculpté le buste blanc se trouvant dans le hall d'entrée de la mairie (10224).

Este busto es del mismo artista que talló el busto blanco del vestíbulo del set Ayuntamiento (10224).

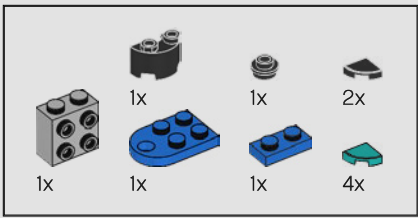

111

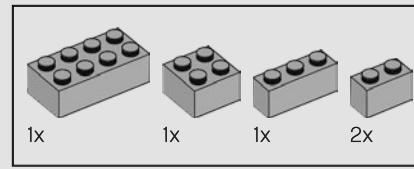
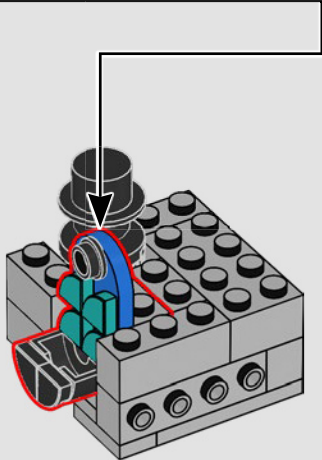
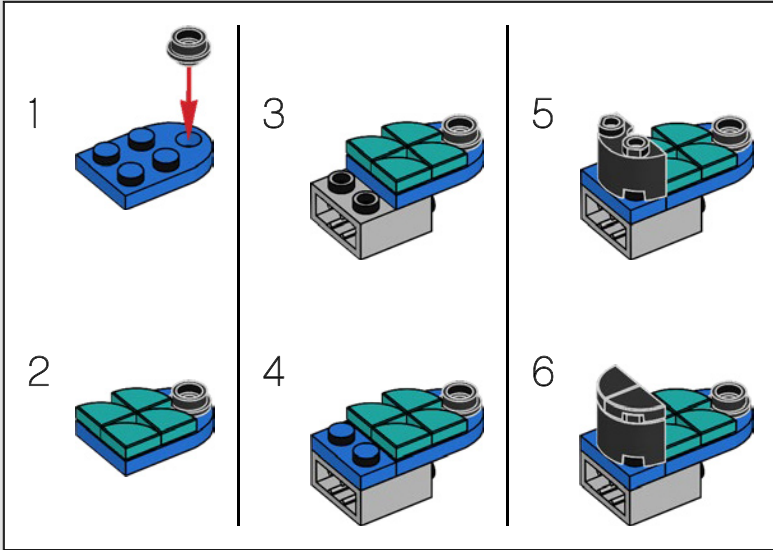

112

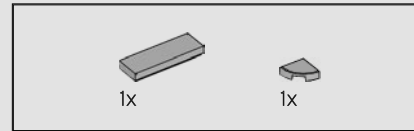
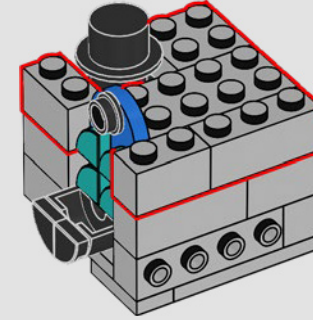

113

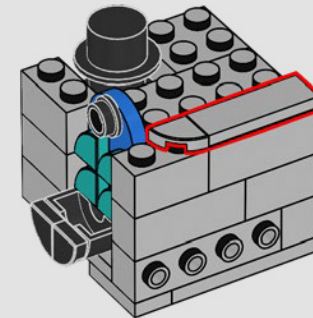

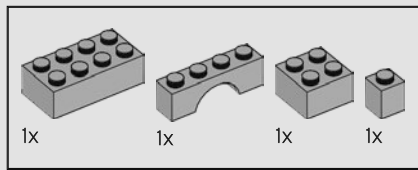

114

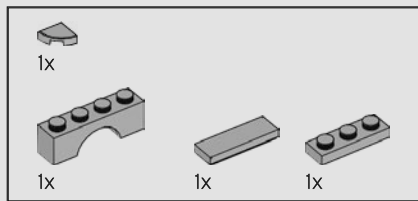
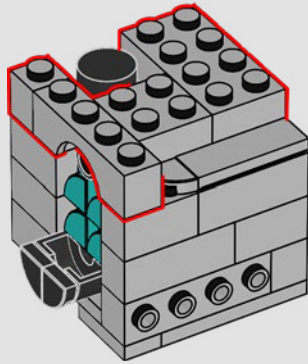

115

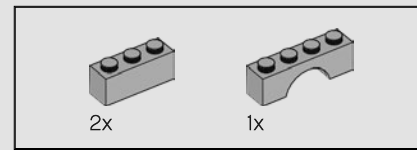
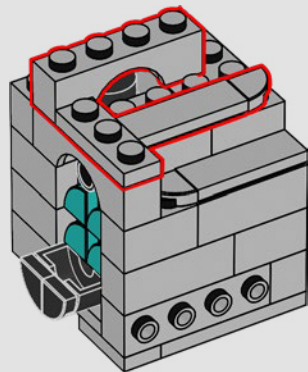

116

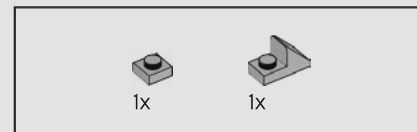
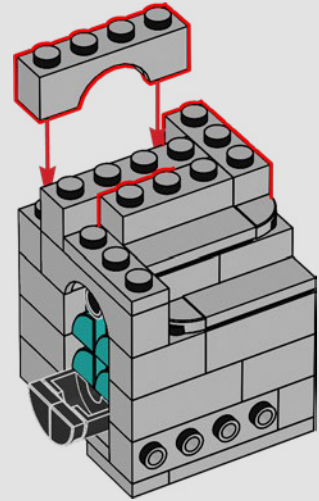

117

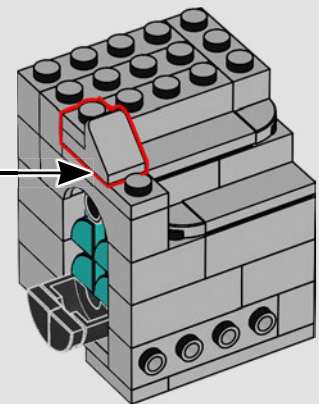
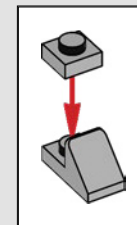

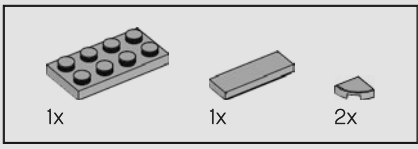

118

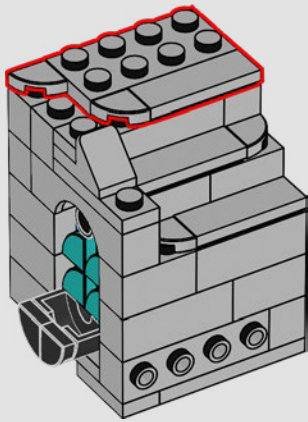

119

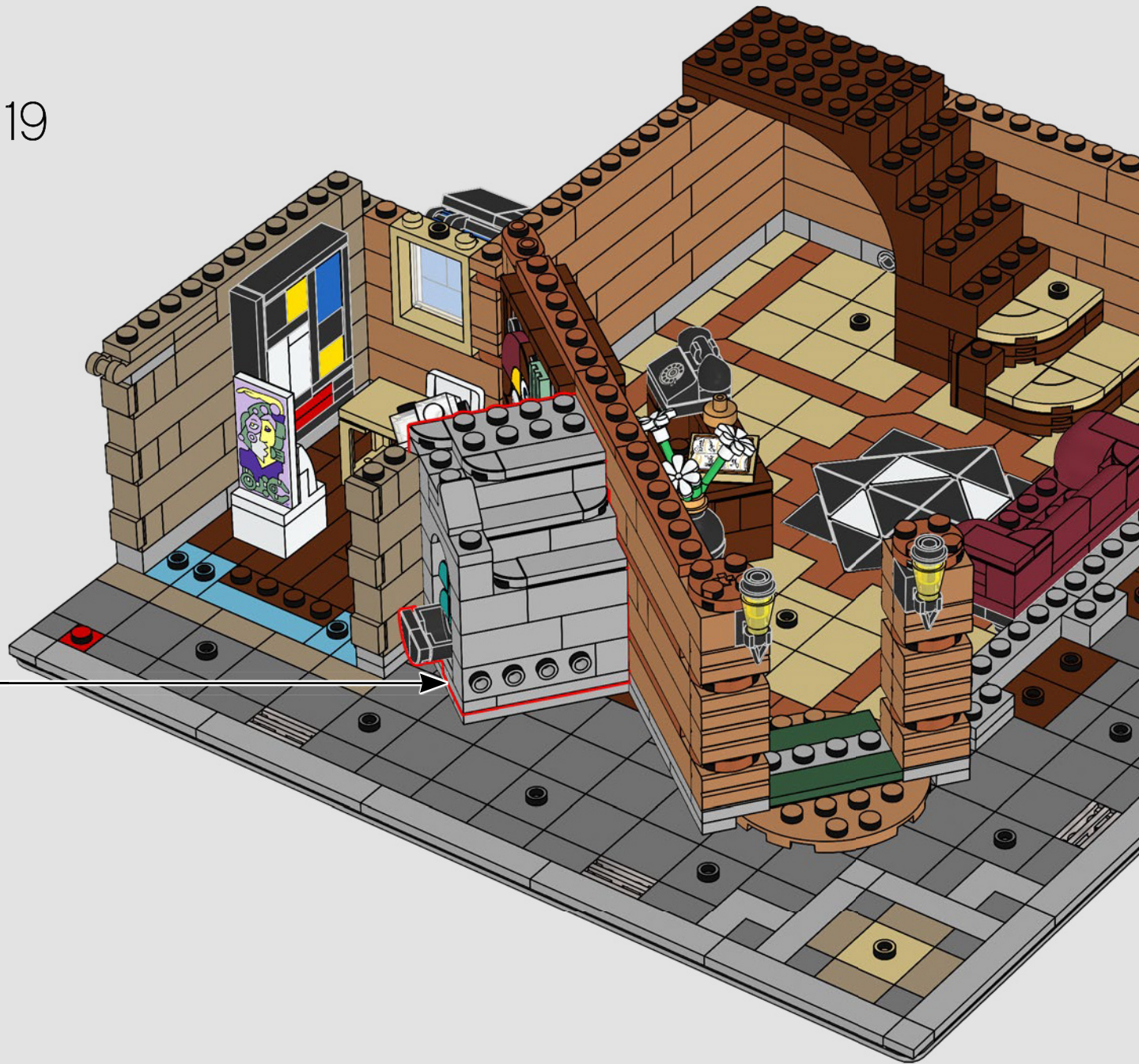

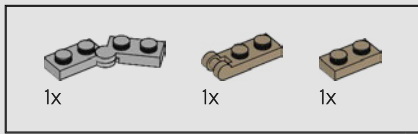

120

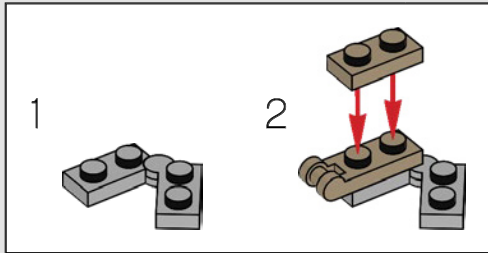

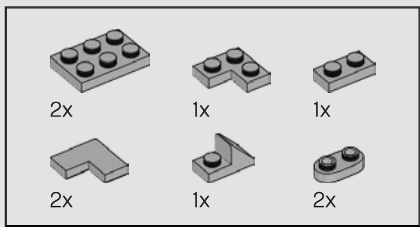

121

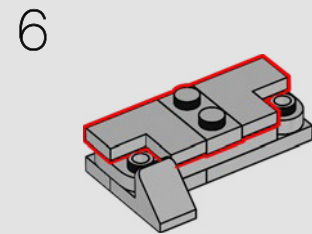
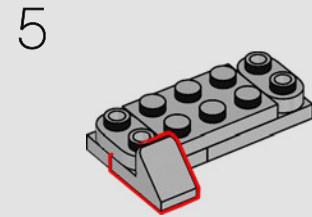
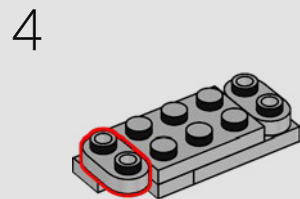
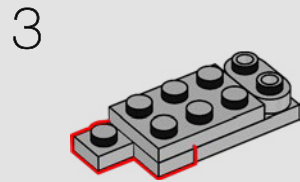
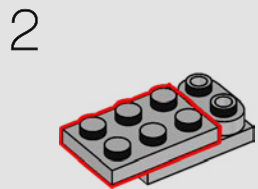
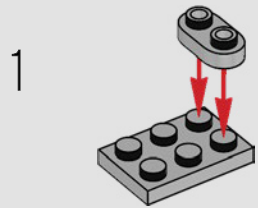



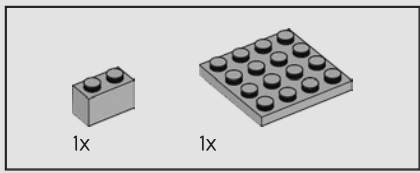

122

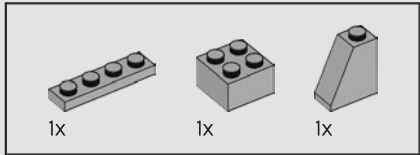
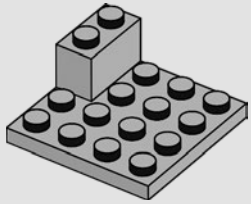

123

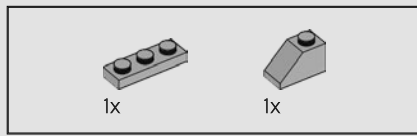
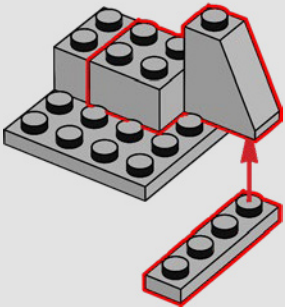

124

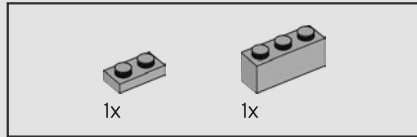
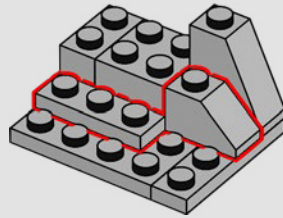

125

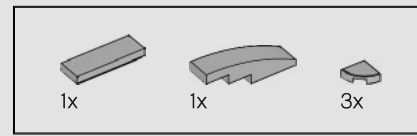
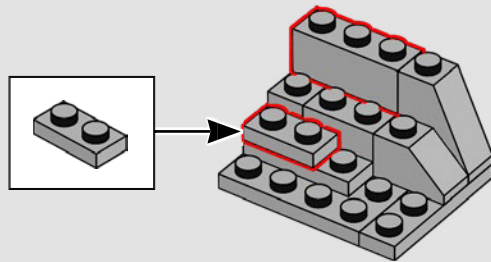

126

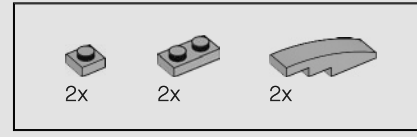
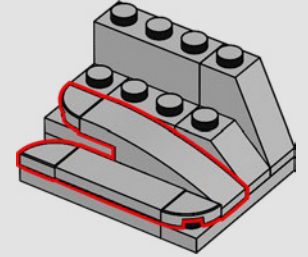

127

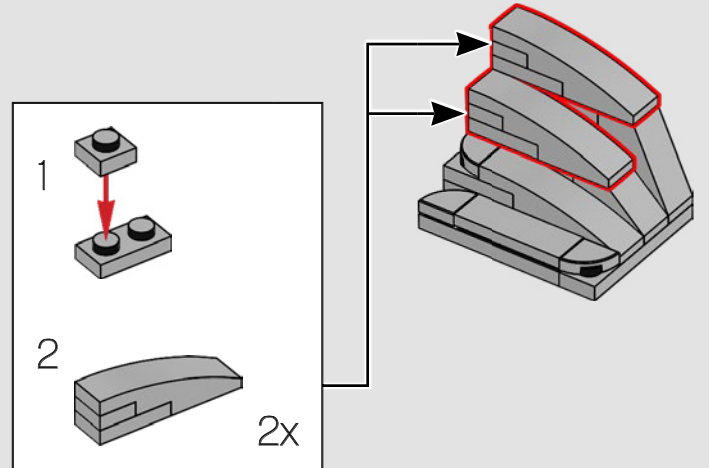

128

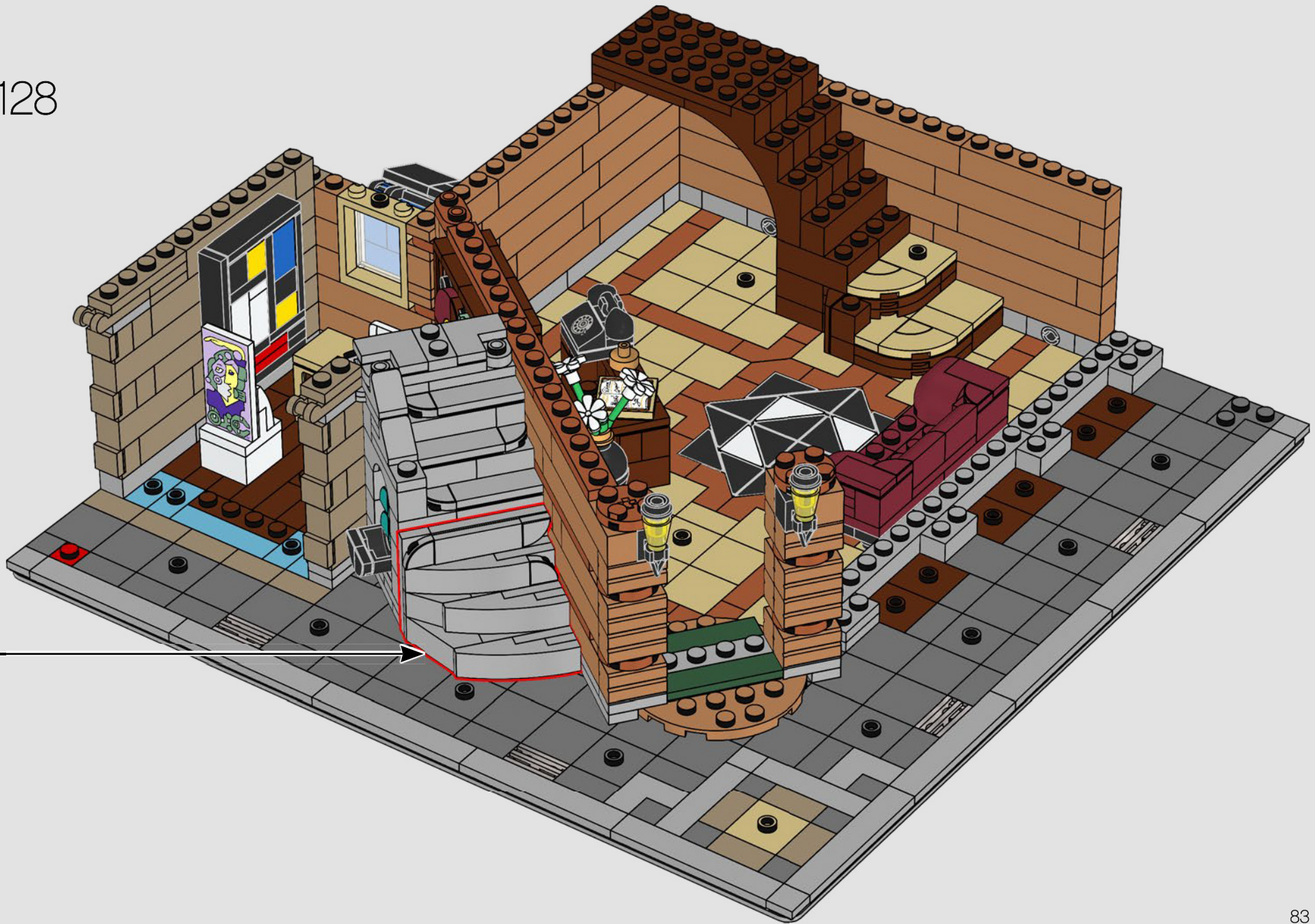

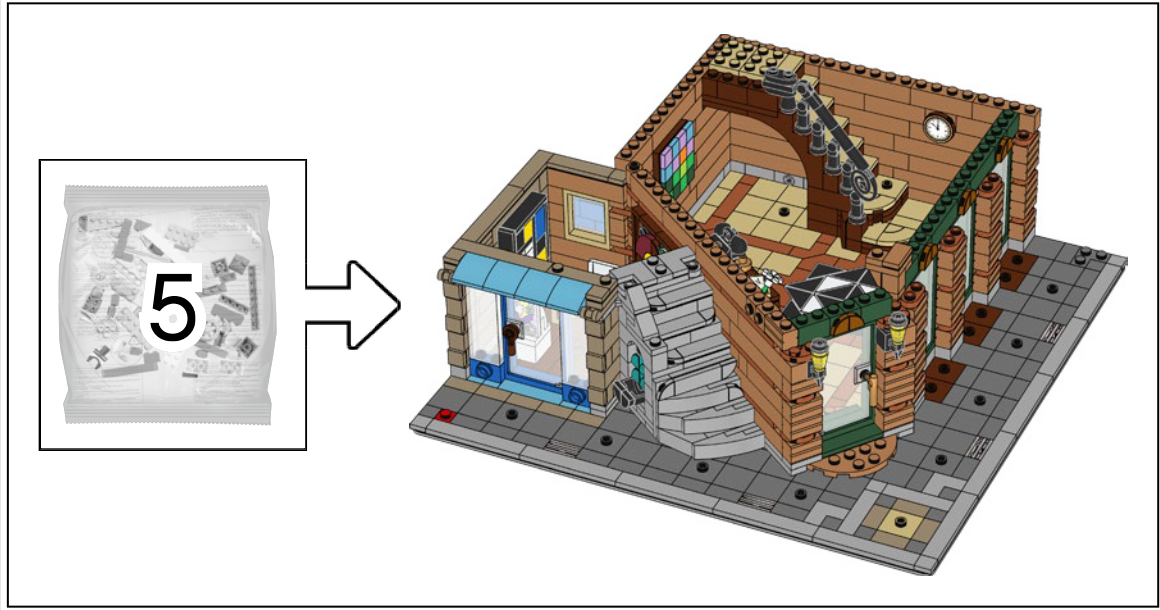

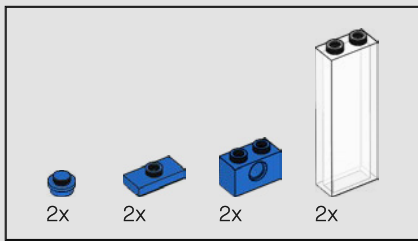

129

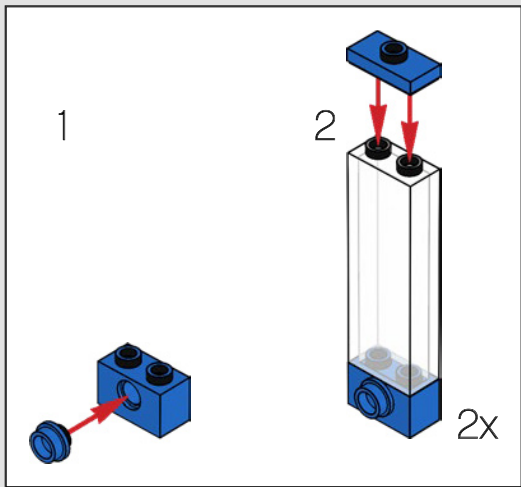

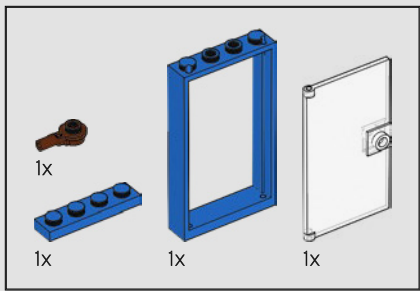

130

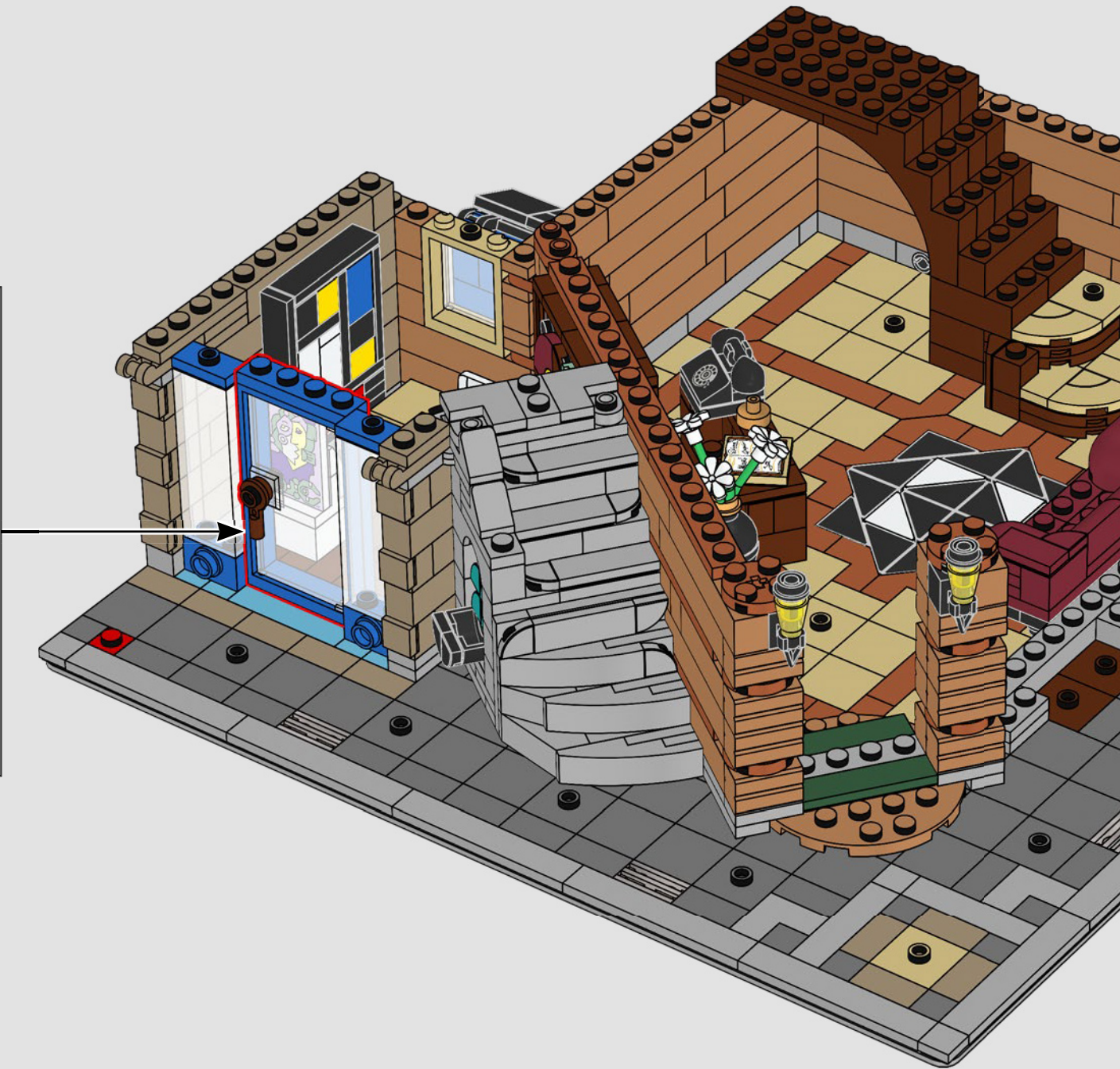
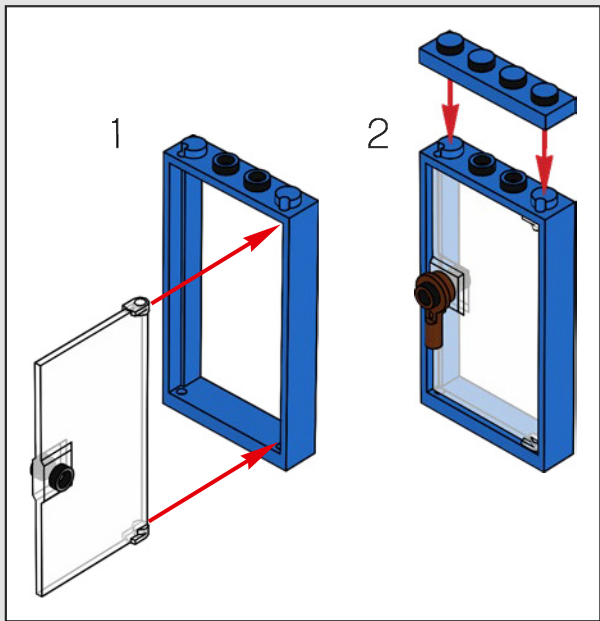

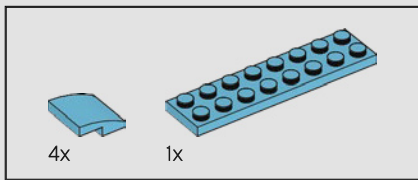

131

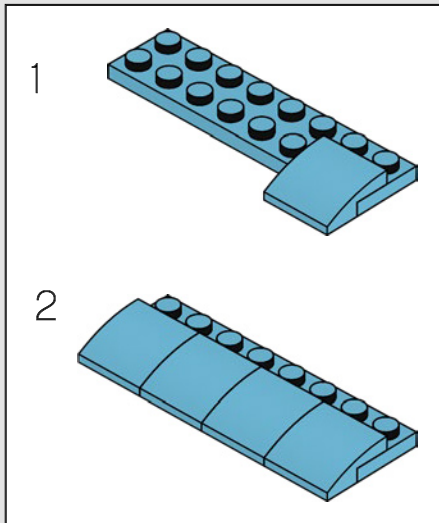

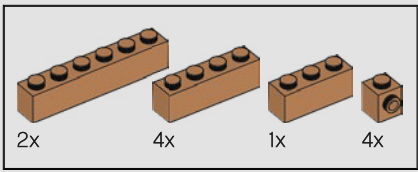

132



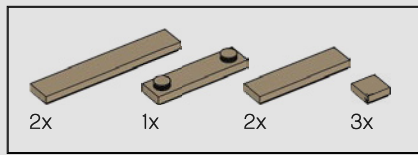

133



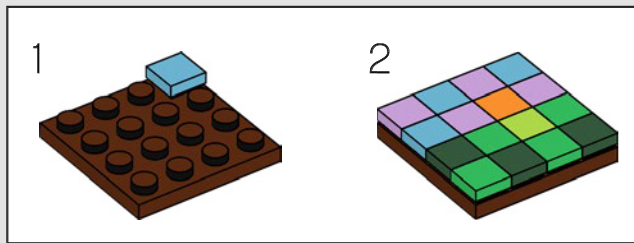
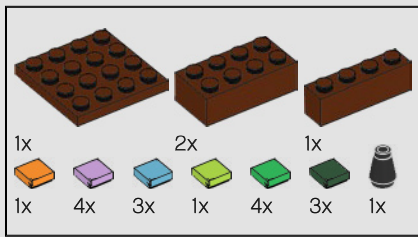

134



This painting is by the Artist whose studio is in the loft of the 10243 Parisian Restaurant set.

Cette peinture a été réalisée par l'artiste dont l'atelier se trouve dans le loft du restaurant parisien (10243).

Este cuadro es obra del artista cuyo estudio está en el ático del set Restaurante Parisino (10243).

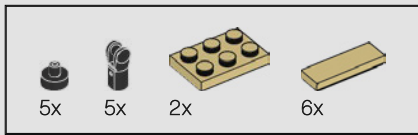

135

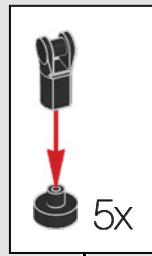



136

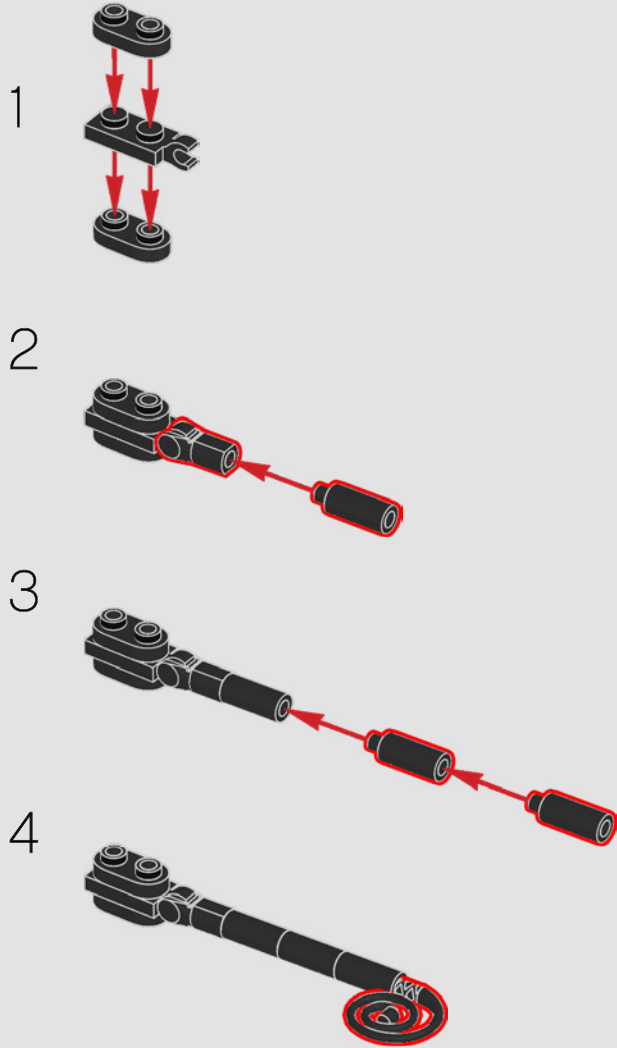

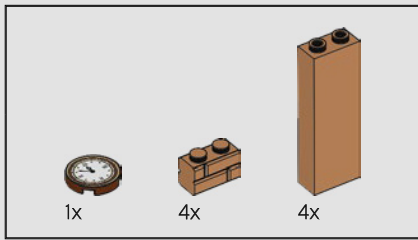

137

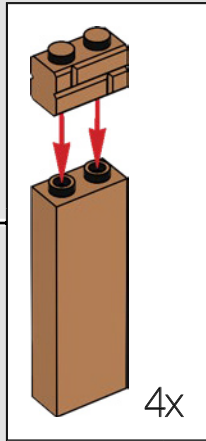

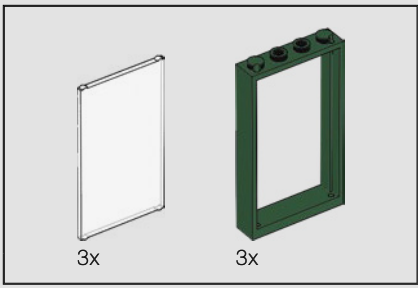

138

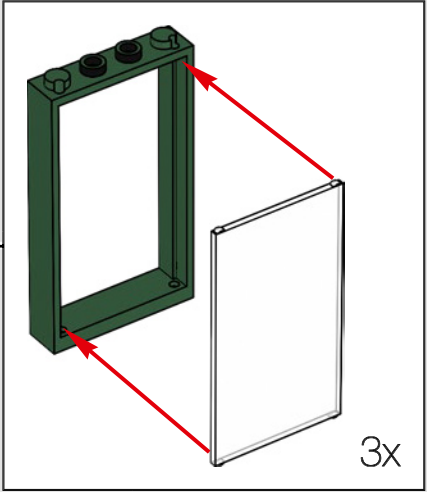

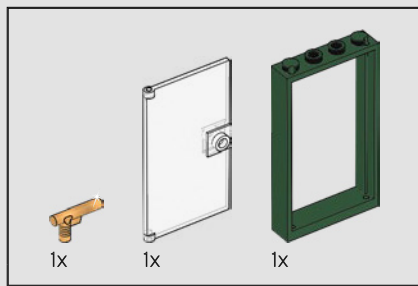

139

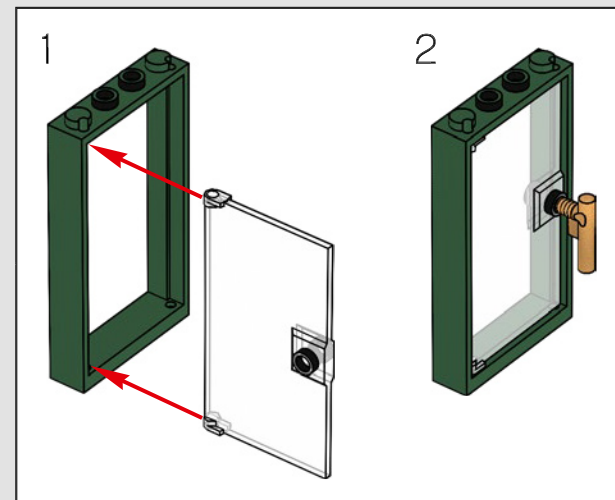

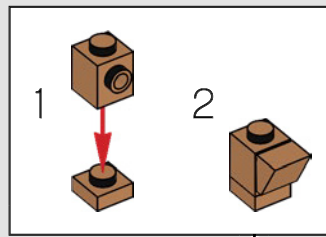
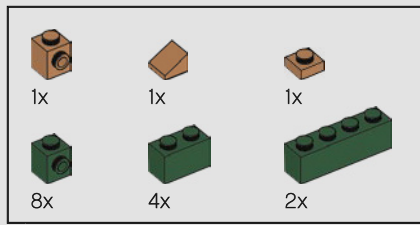

140





141



- 12x 
- 20x 
- 1x 
- 1x 
- 1x 

142

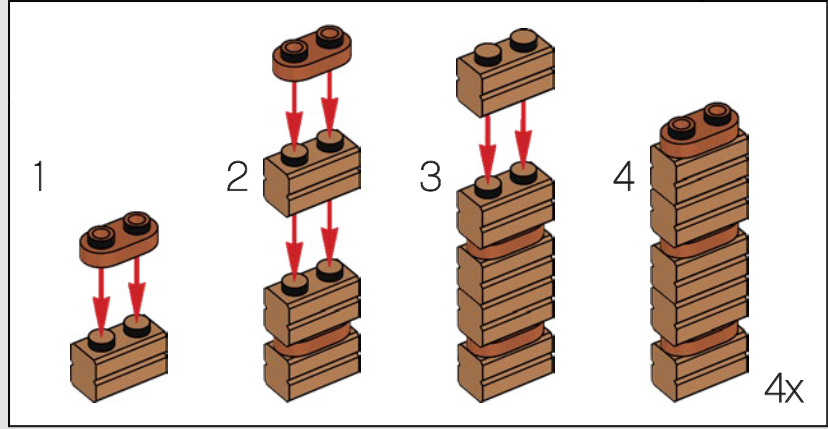
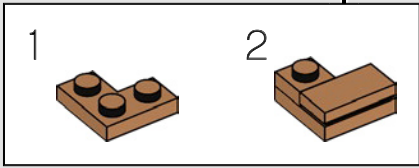

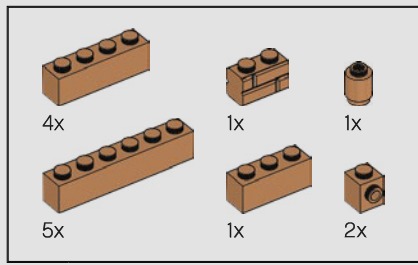

143





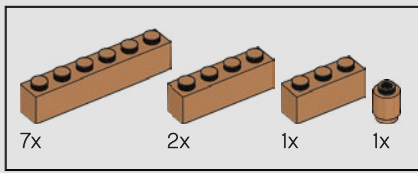

144



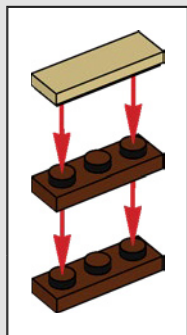
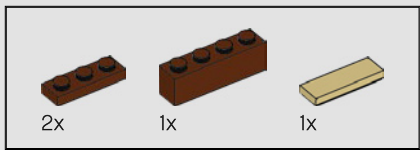

145



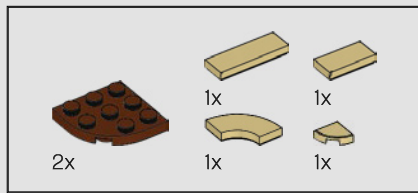

146

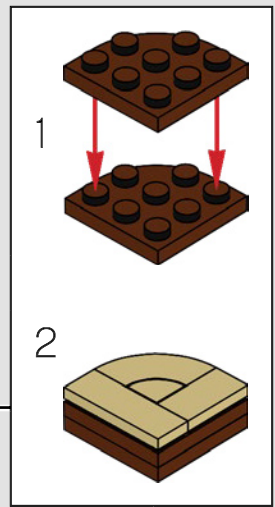

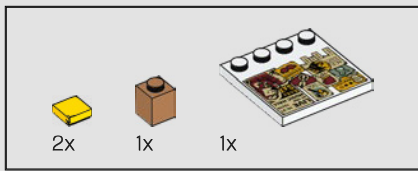

147

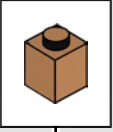
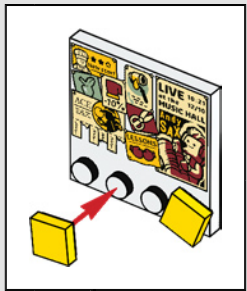

The posts on this Notice Board all advertise goods and services from elsewhere in previous Modular sets. See if you can recognize the references!

Les messages affichés sur ce babillard font la promotion de biens et de services provenant d'ensembles modulaires antérieurs. Saurez-vous reconnaître les références ?

Todos los avisos de este tablero publicitario anuncian bienes y servicios de sets Modular Buildings anteriores. ¡Intenta reconocer las referencias!



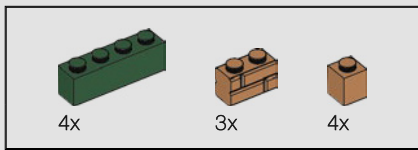

148

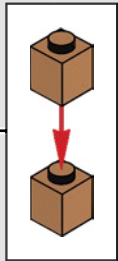

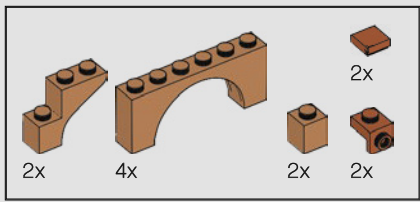

149

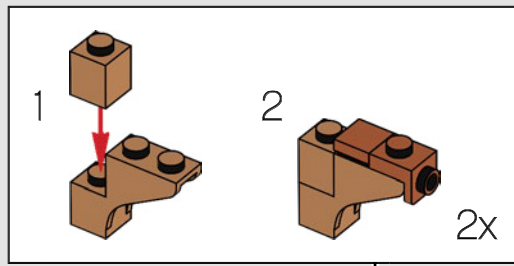

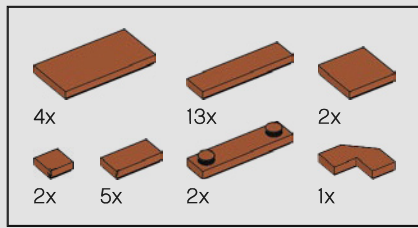

150



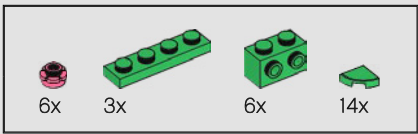

151

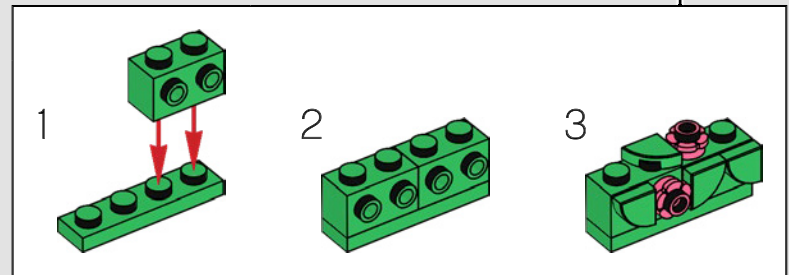
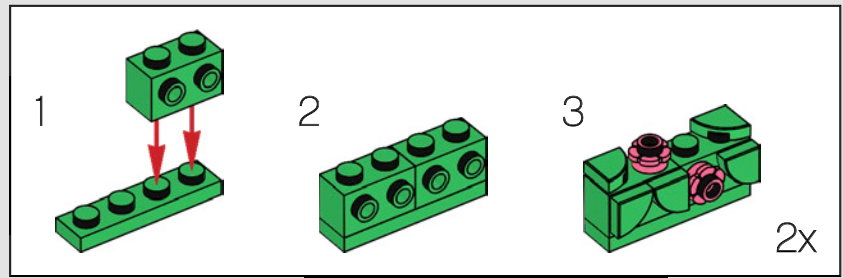

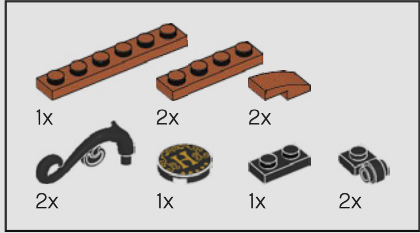
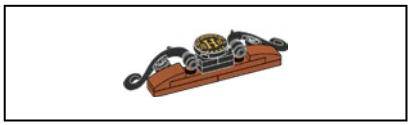

152

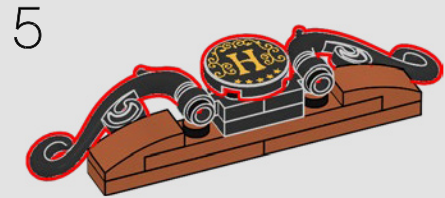
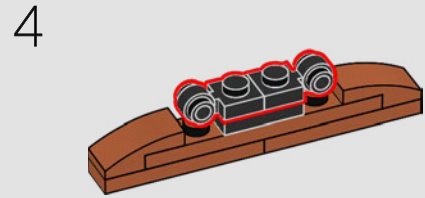
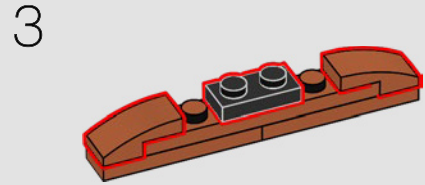
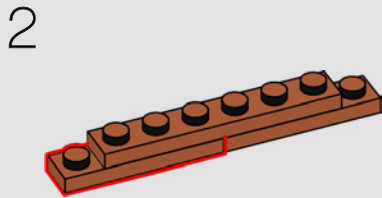
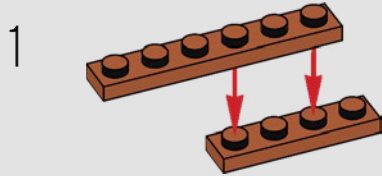



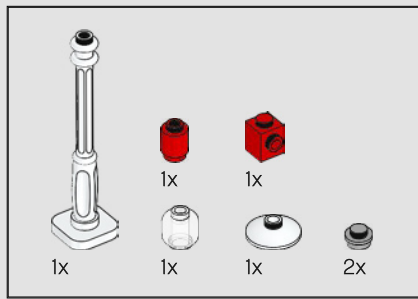

153

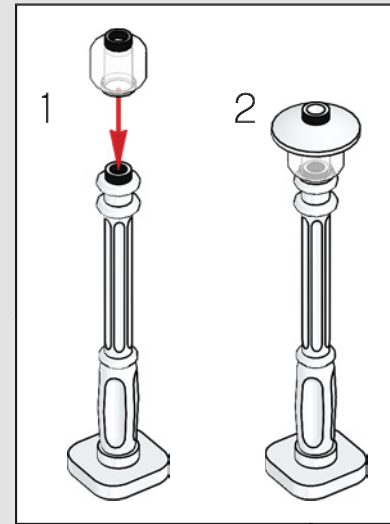
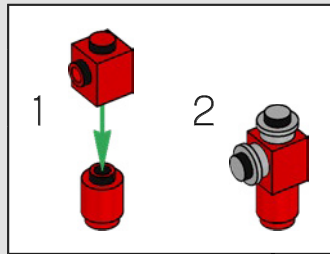

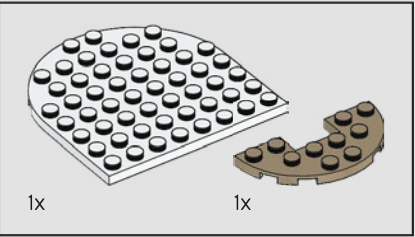
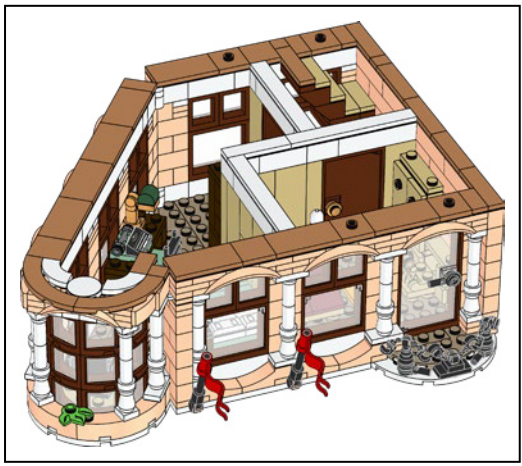
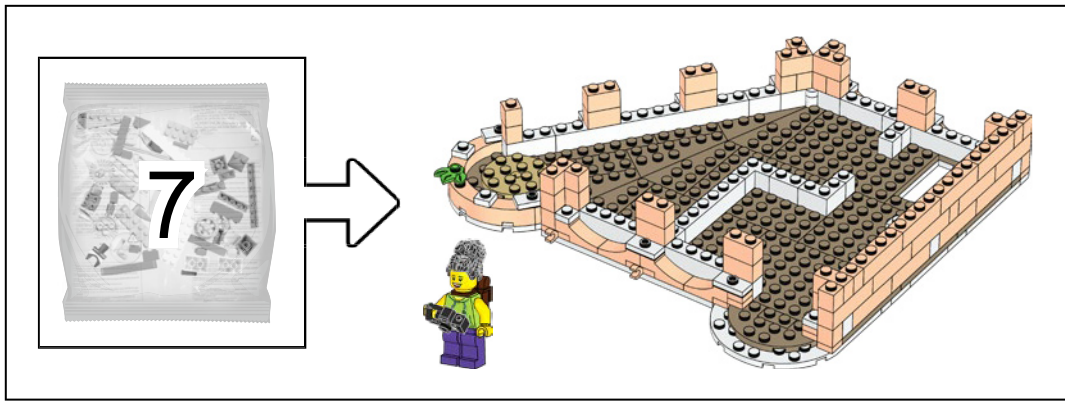

154

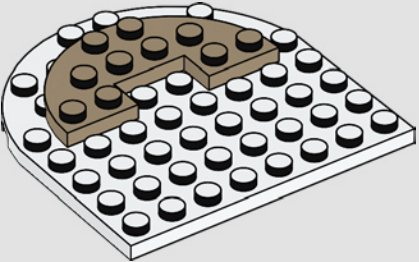

The Backpacker is traveling the world! She's doing it on a budget, so is staying in the Hotel's Economy room.

La randonneuse parcourt le monde ! Compte tenu de son budget limité, elle loge dans une chambre économique de l'hôtel.

¡La mochilera está viajando por el mundo! Tiene que ajustarse al presupuesto, por lo que se aloja en la habitación económica del hotel.

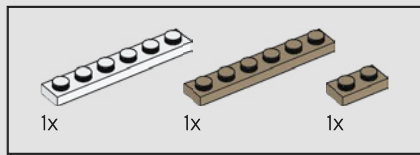

155

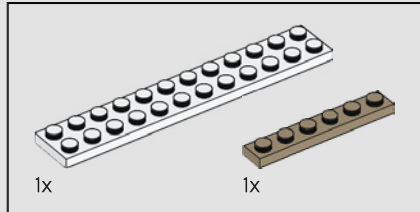
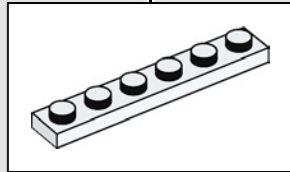
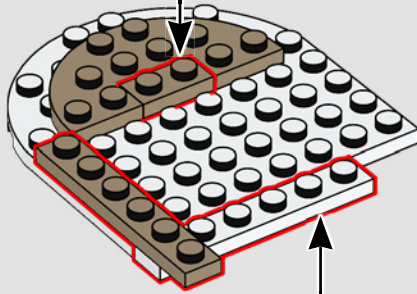
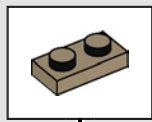

156

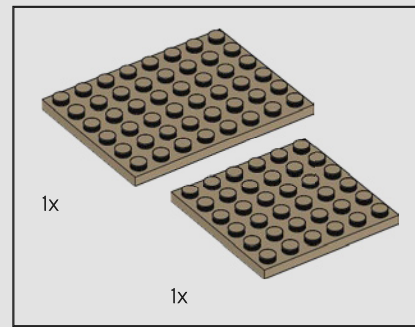
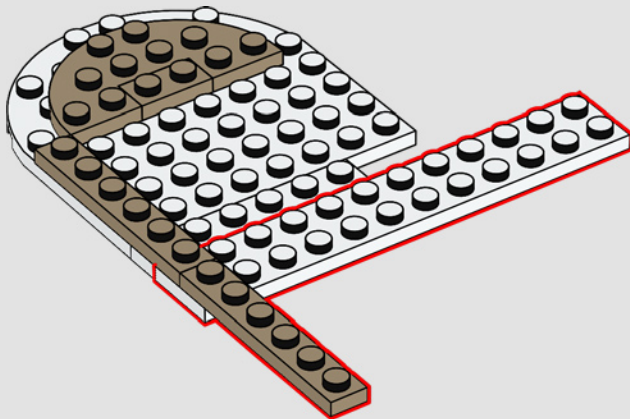

157

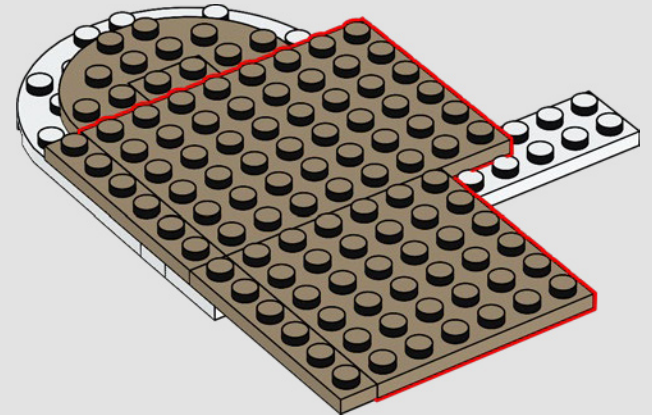

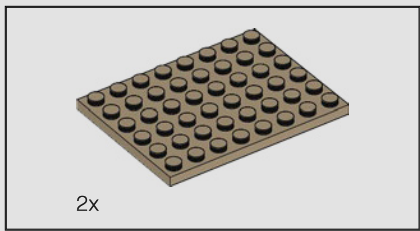

158

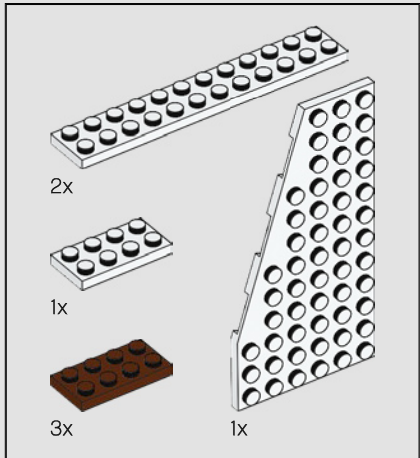
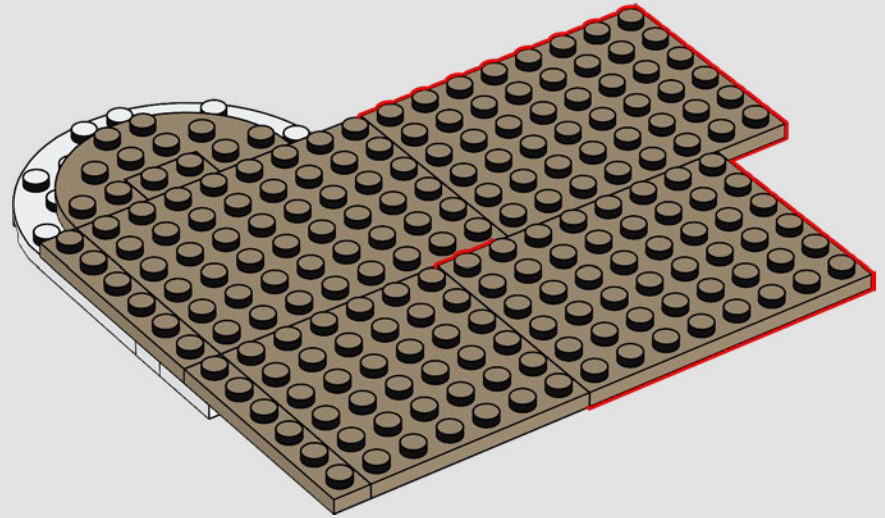

159

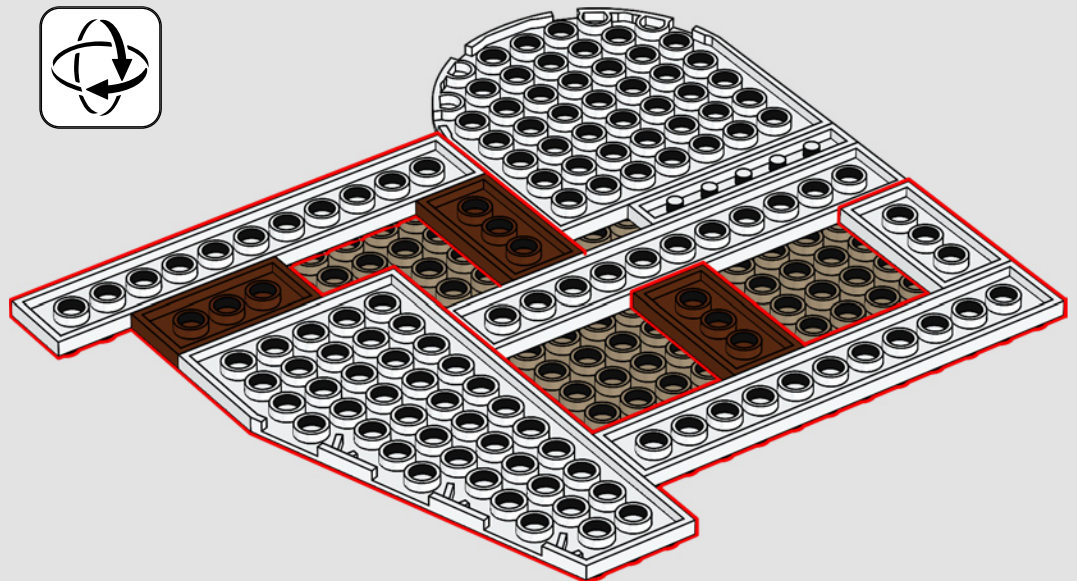

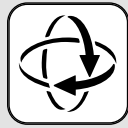
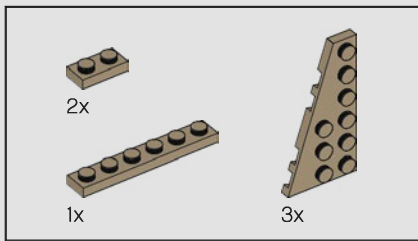

160

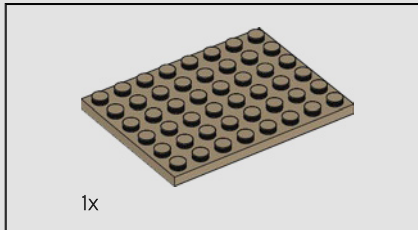
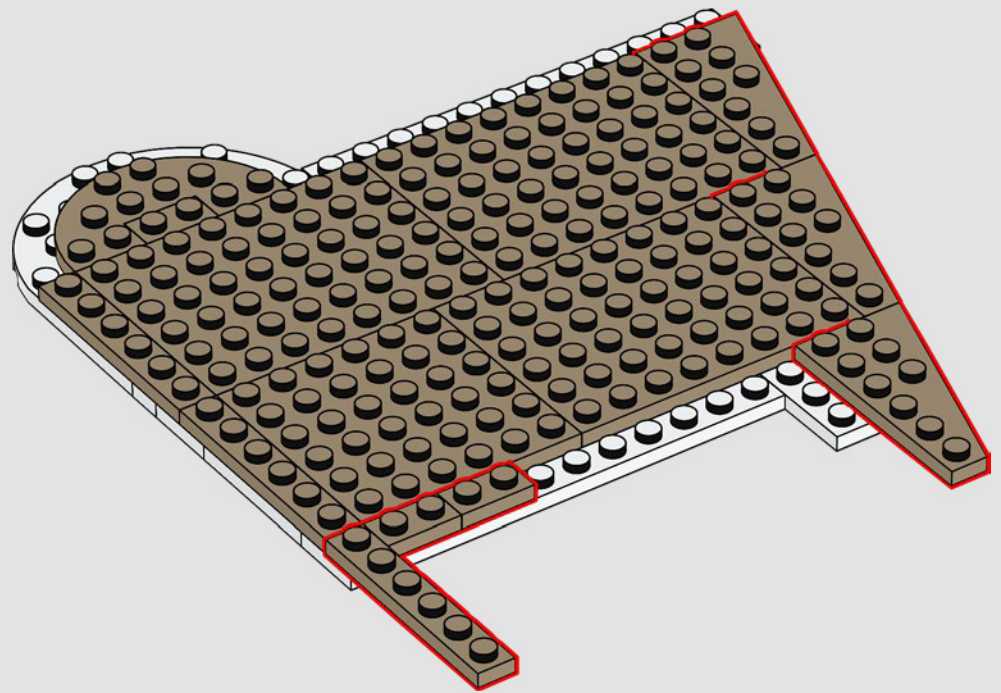

161

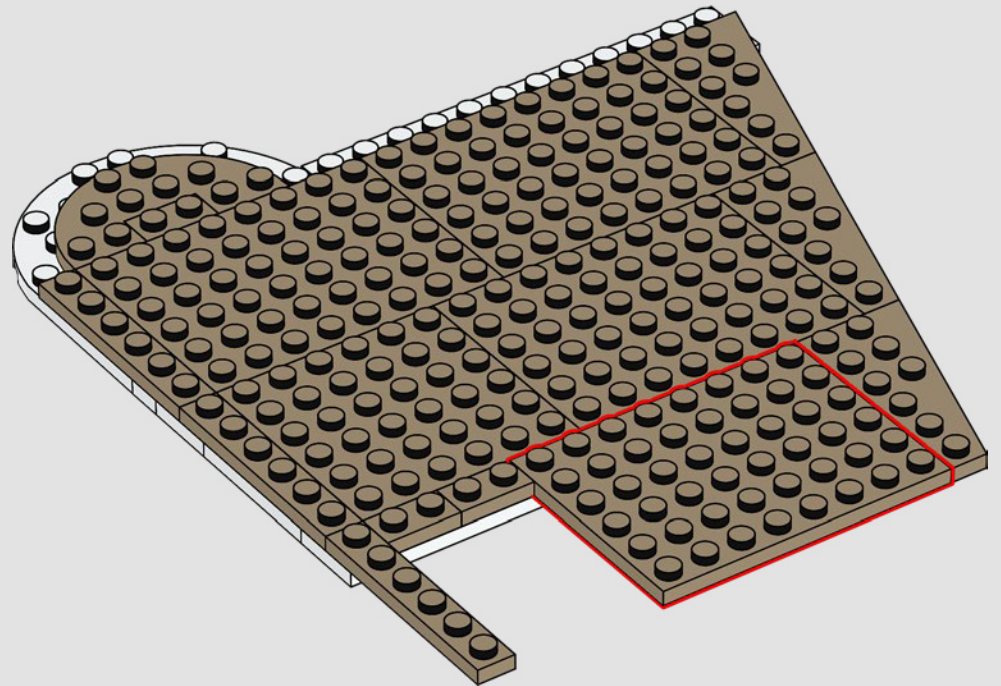

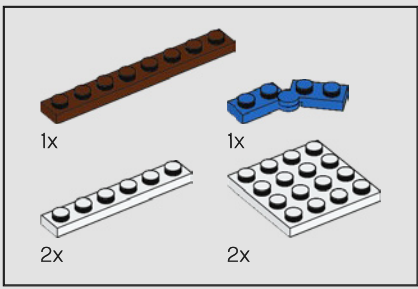

162

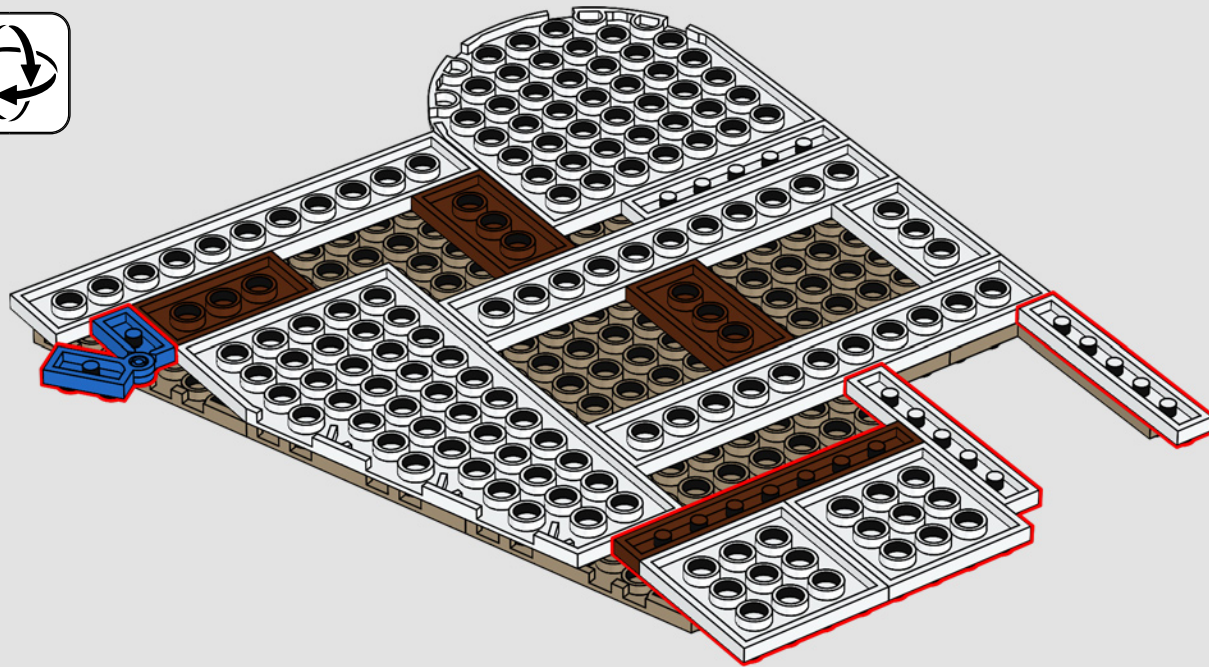

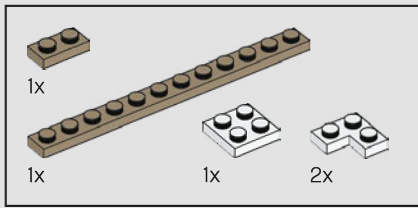

163

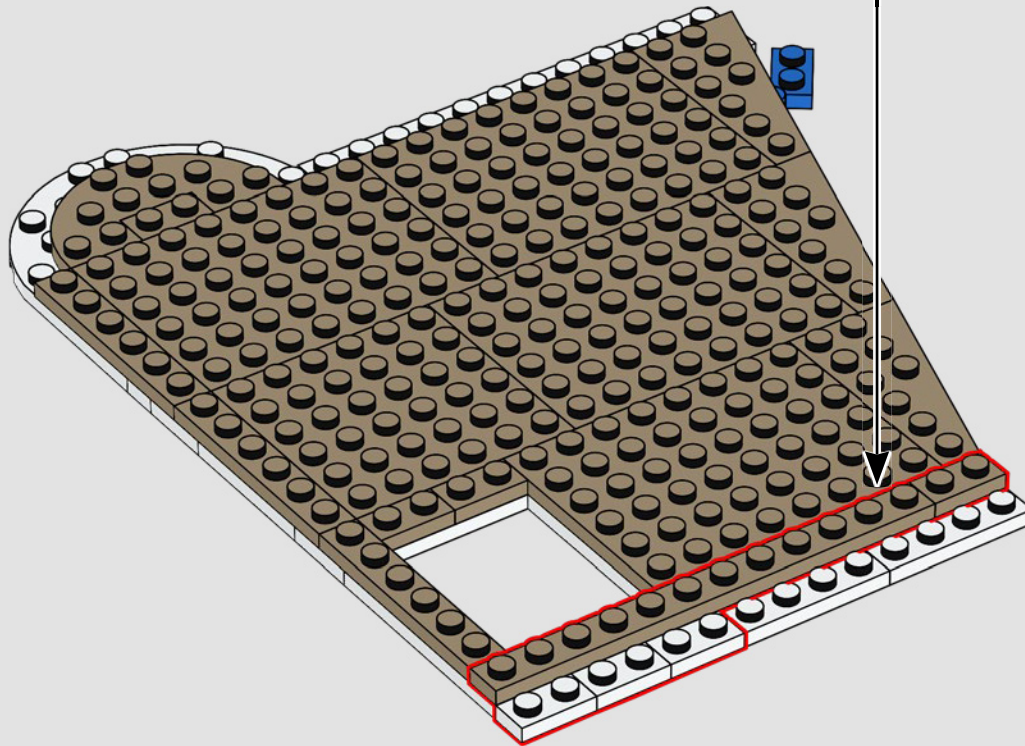
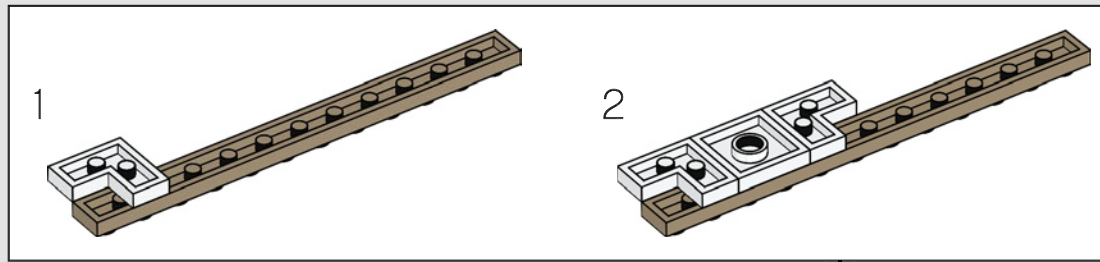

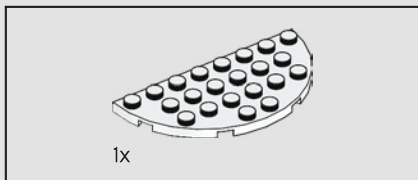

164

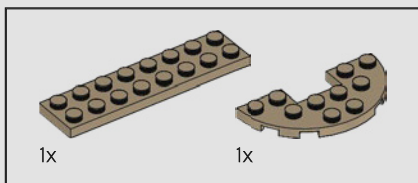
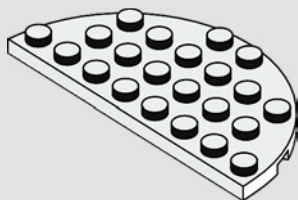

165

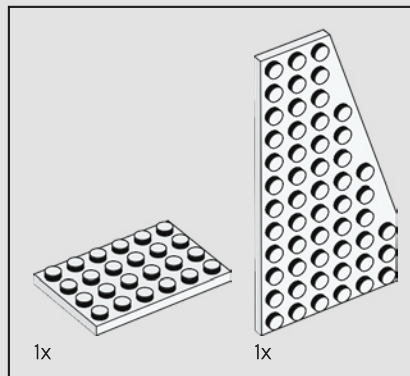
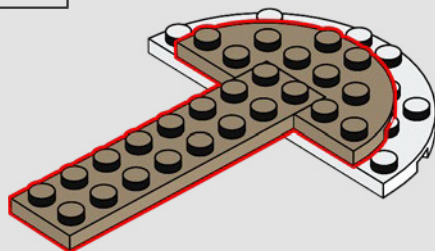

166

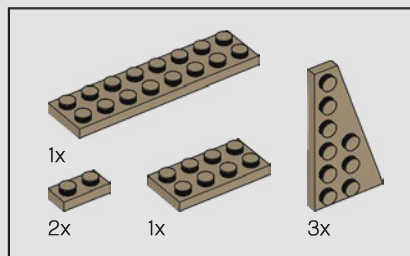
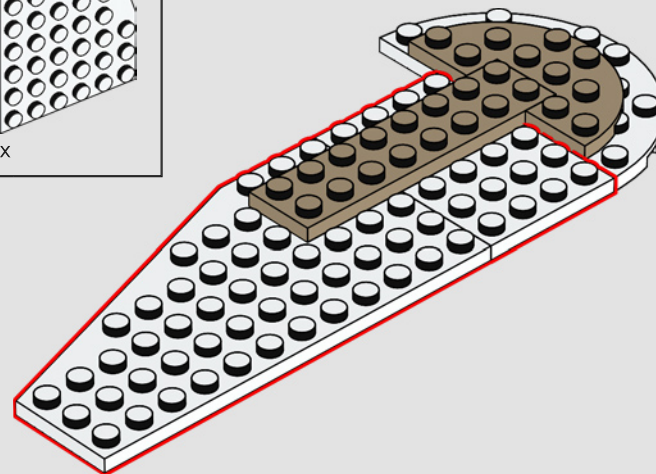

167

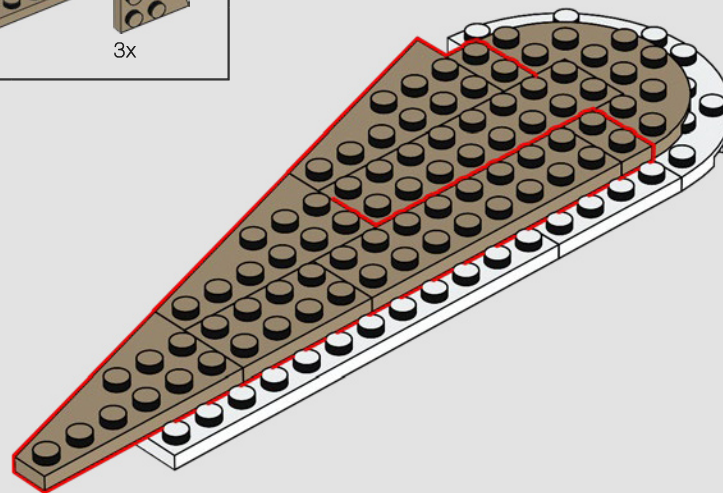

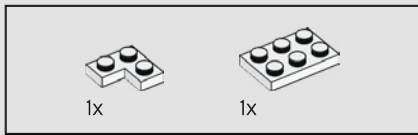

168

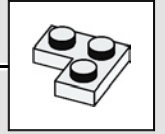
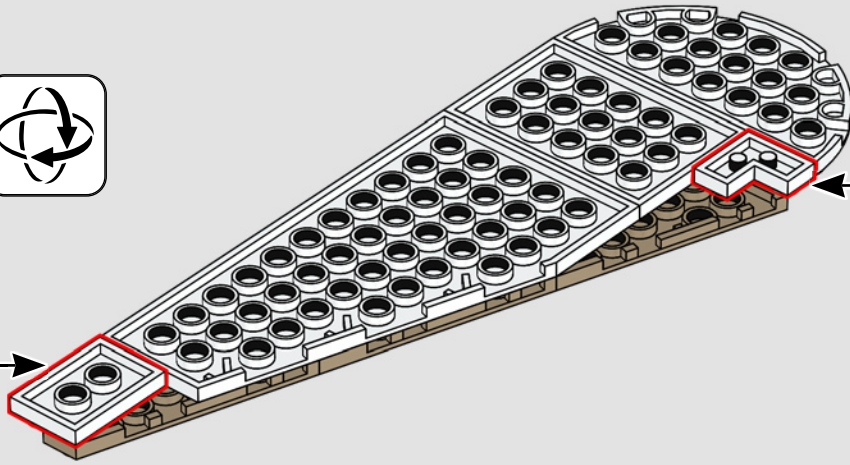
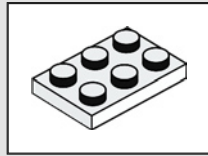

169

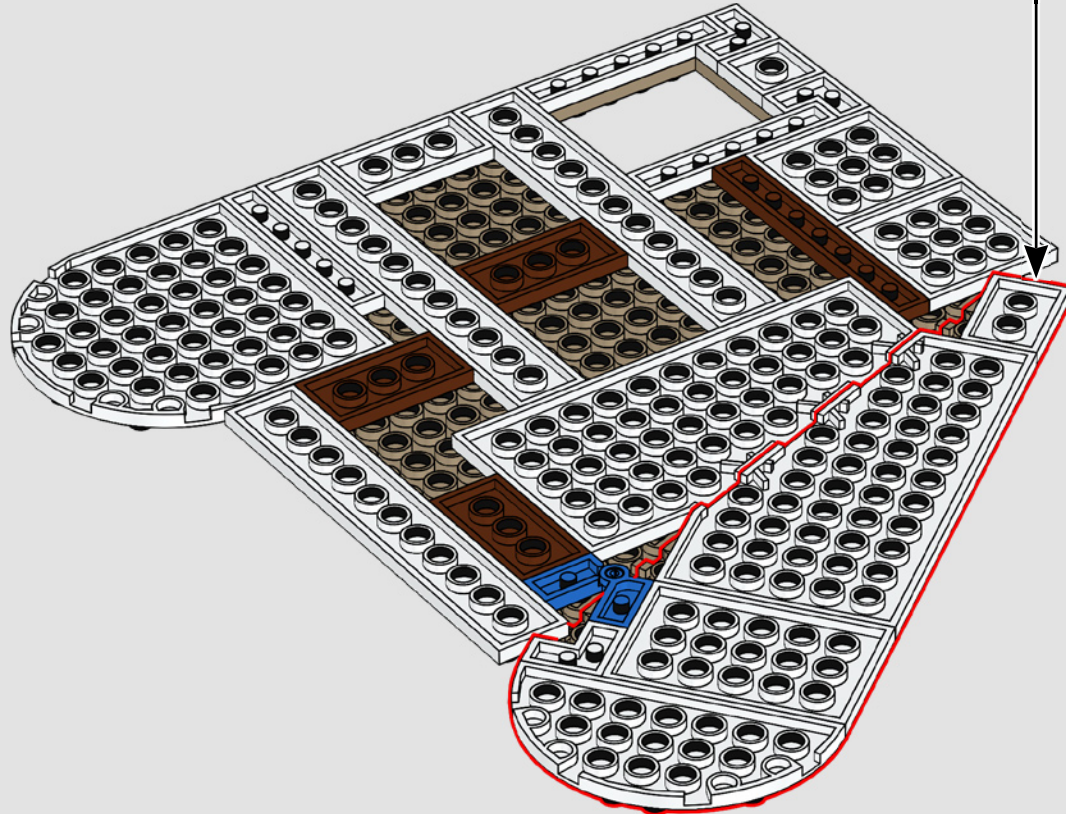

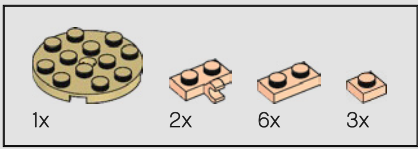

170

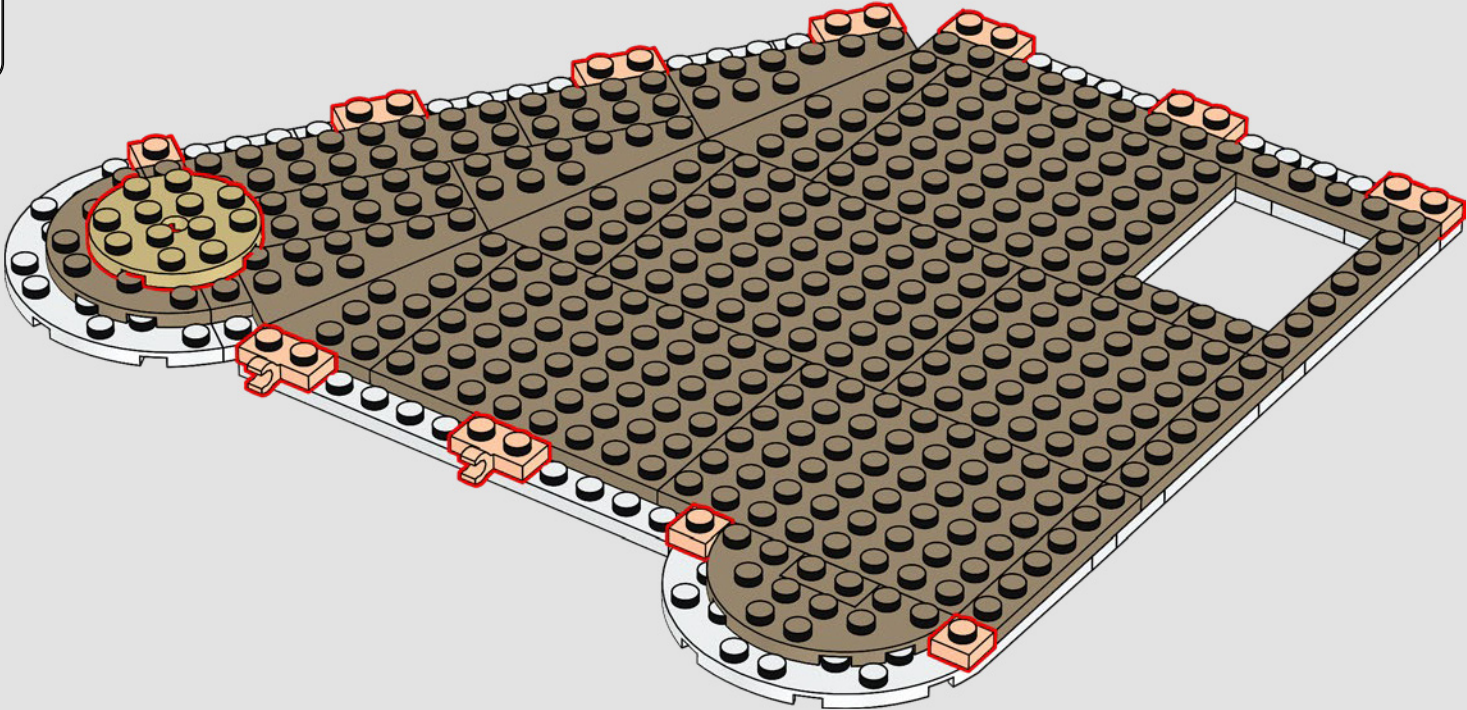

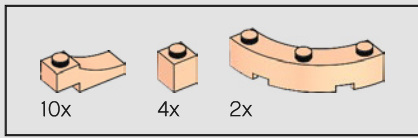

171

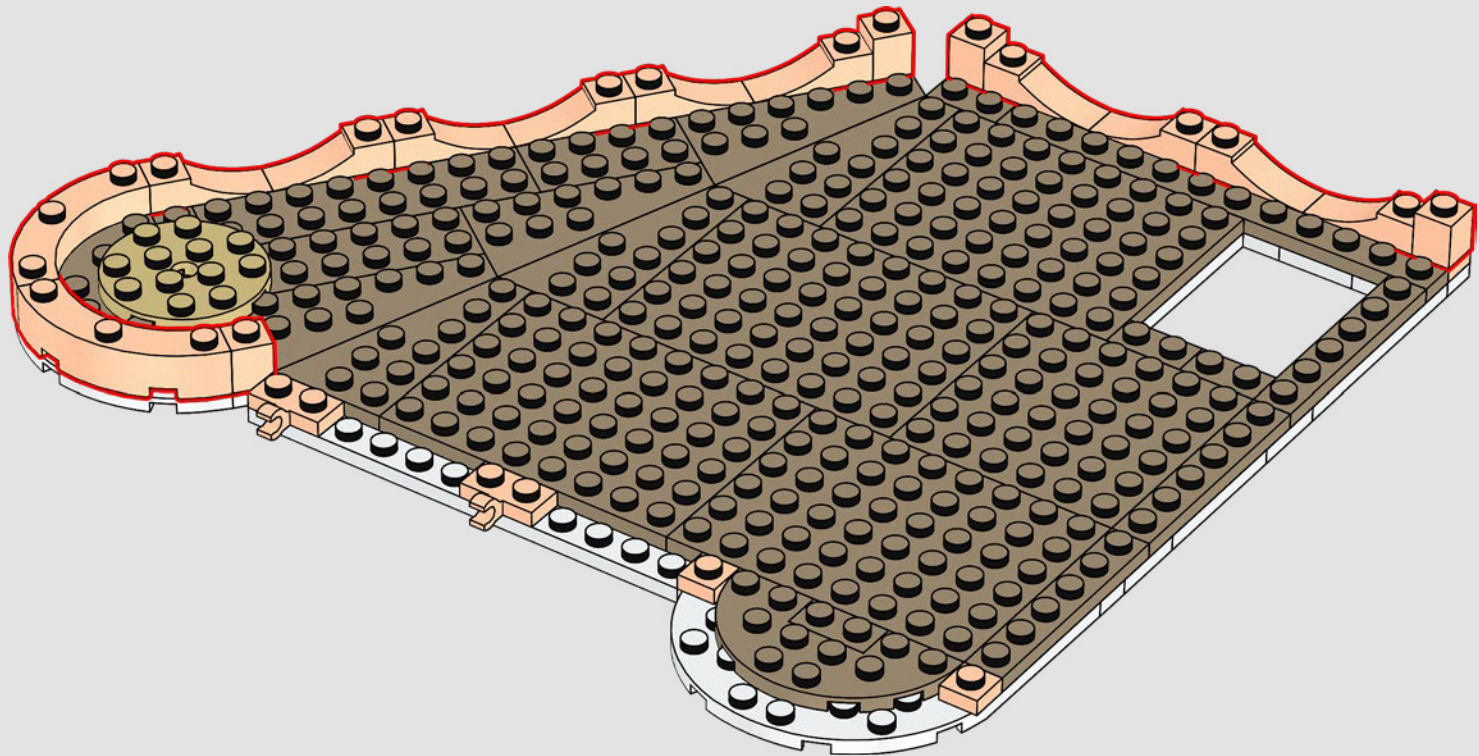

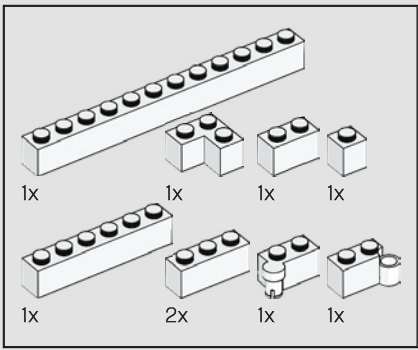

172

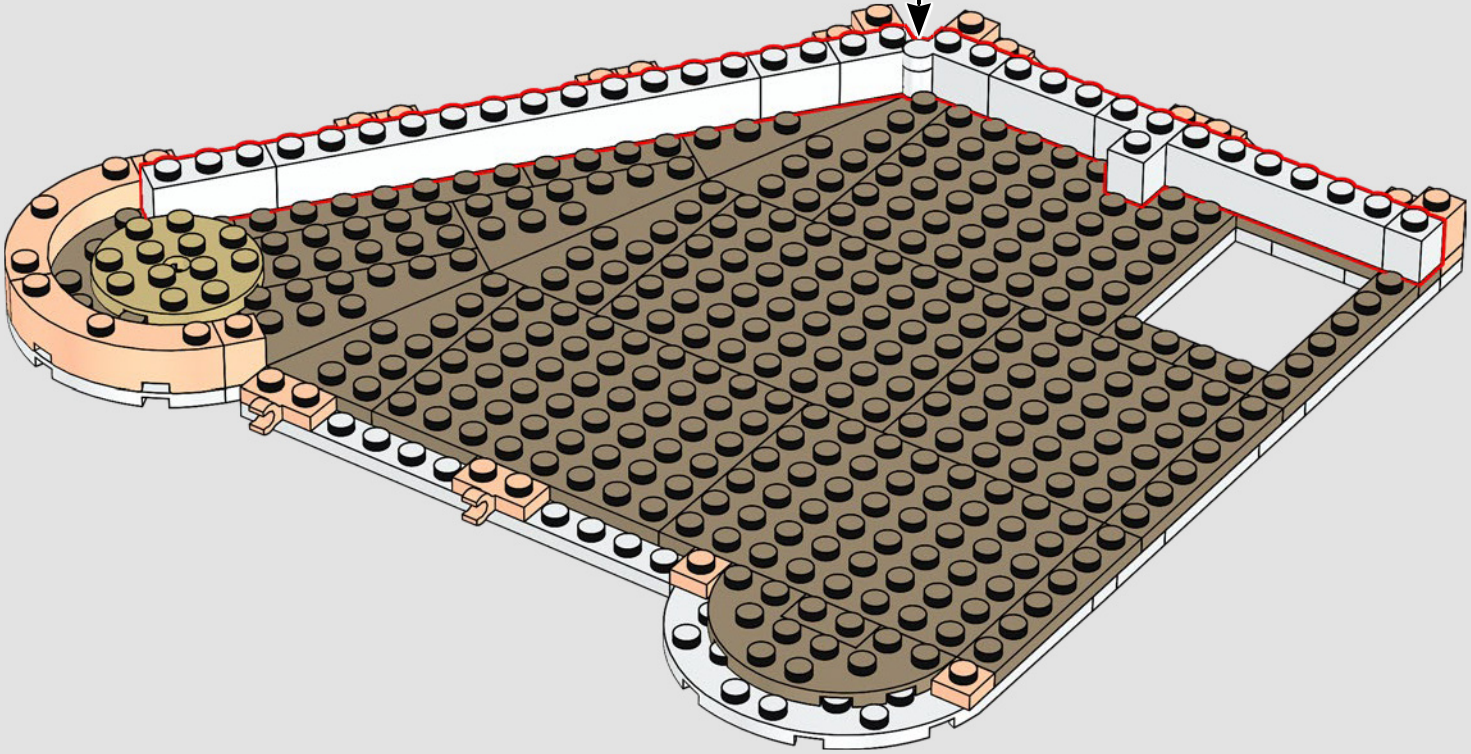
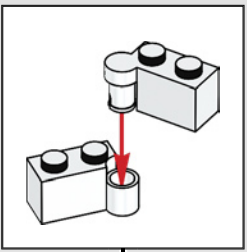

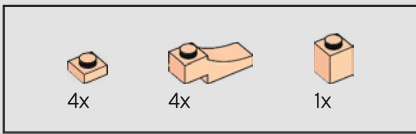

173

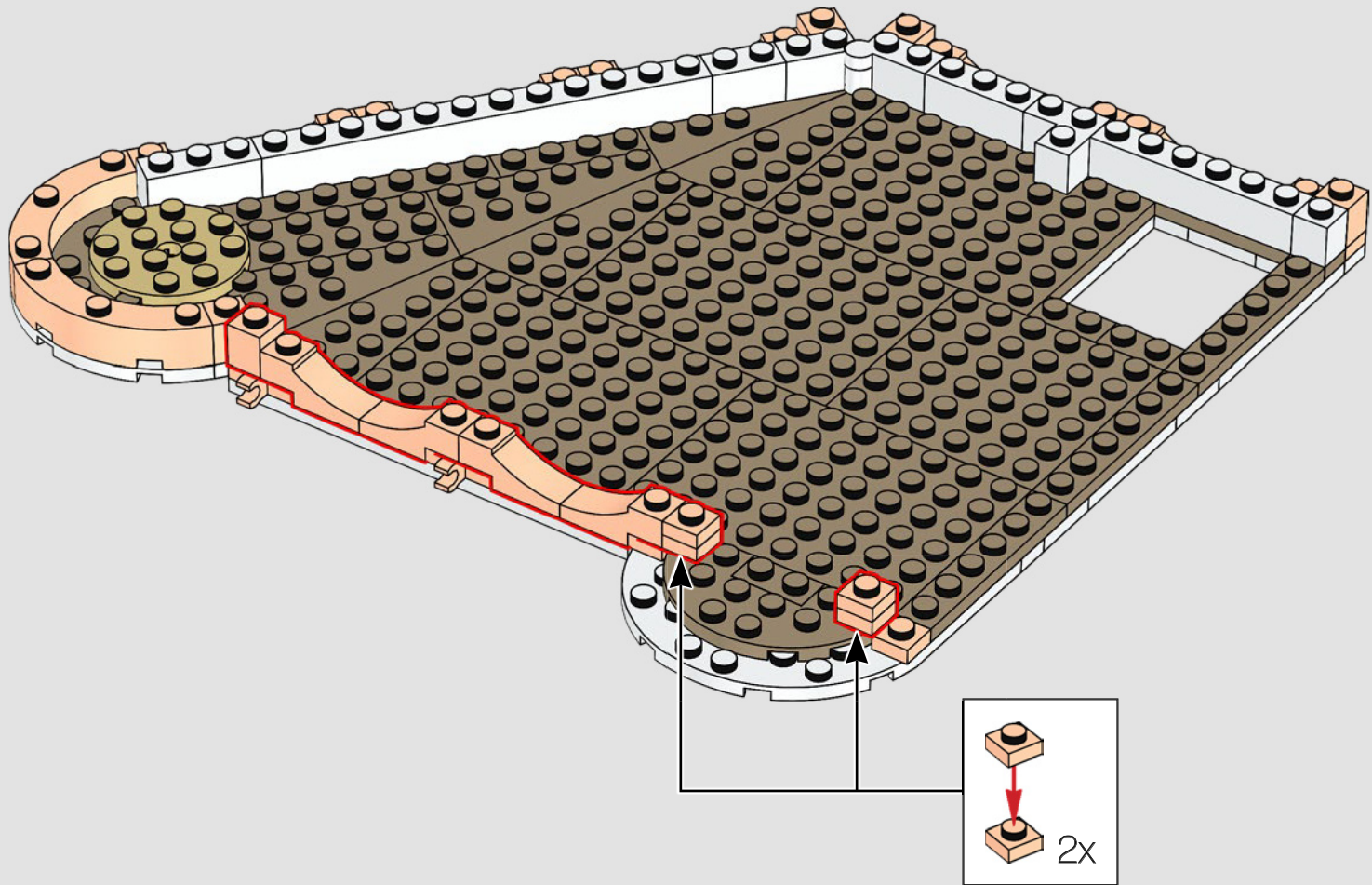

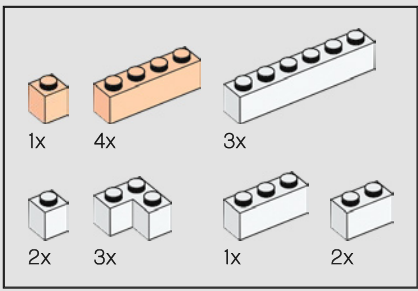

174

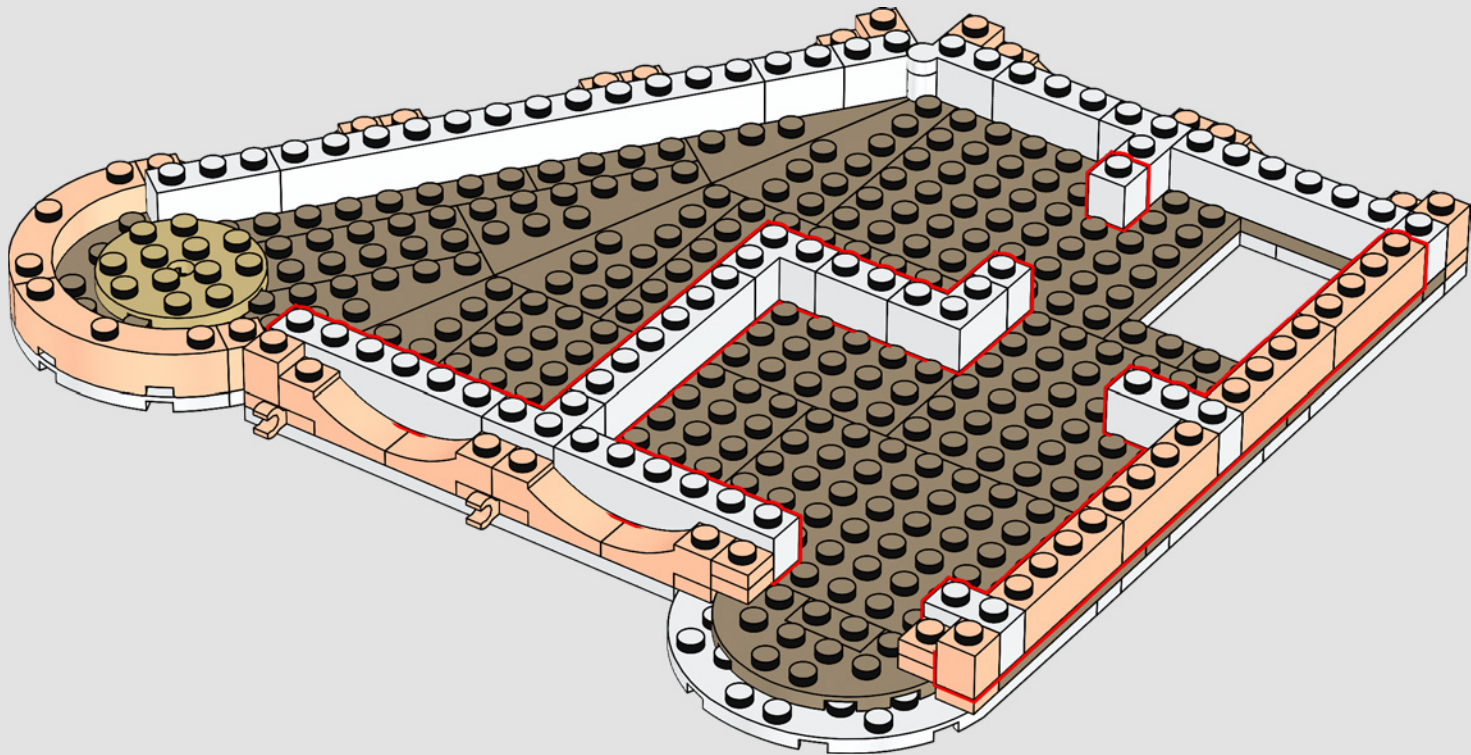

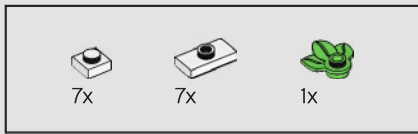

175

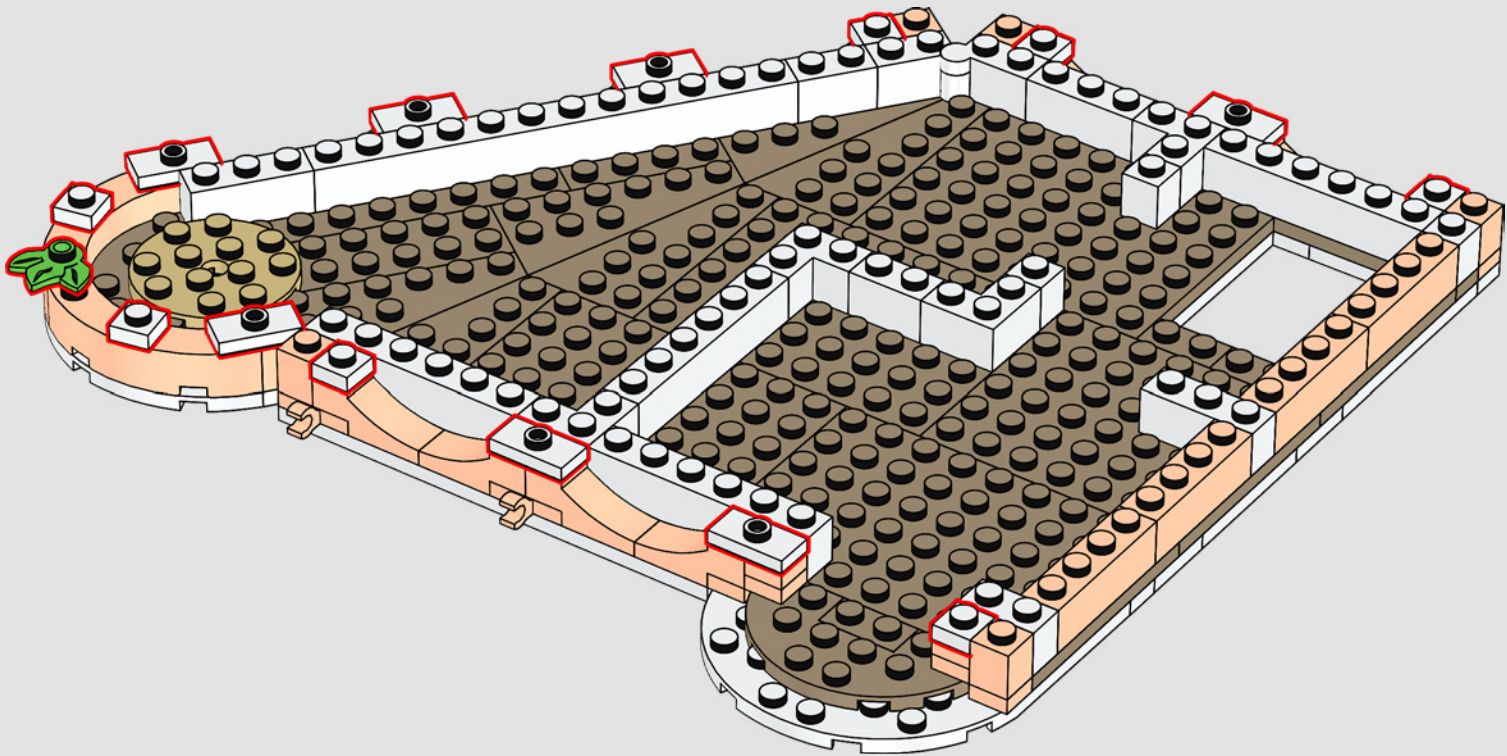

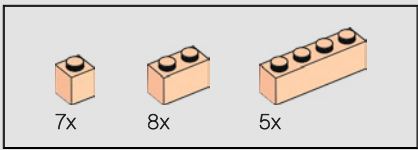

176

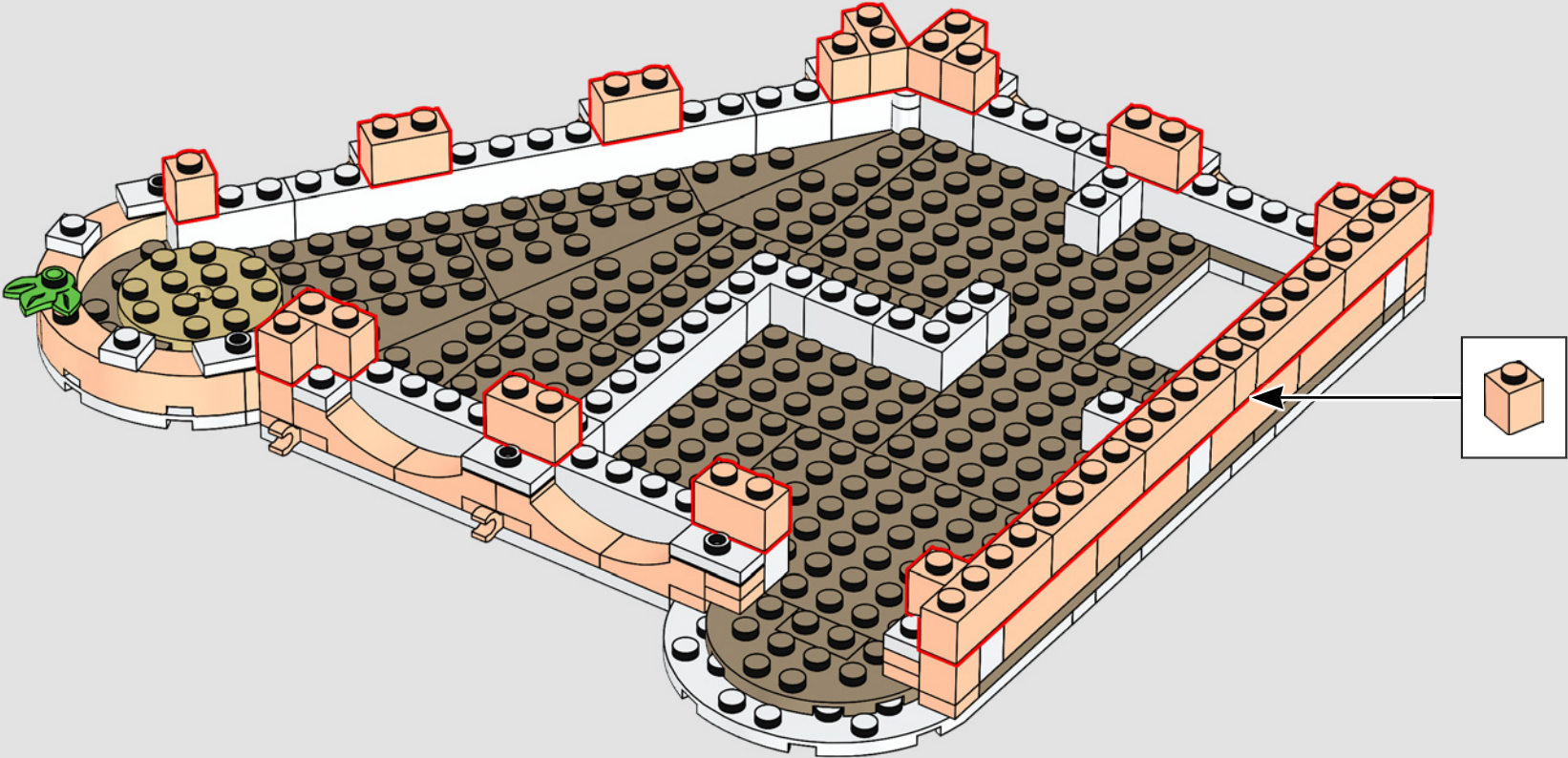

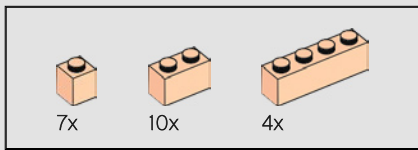

177

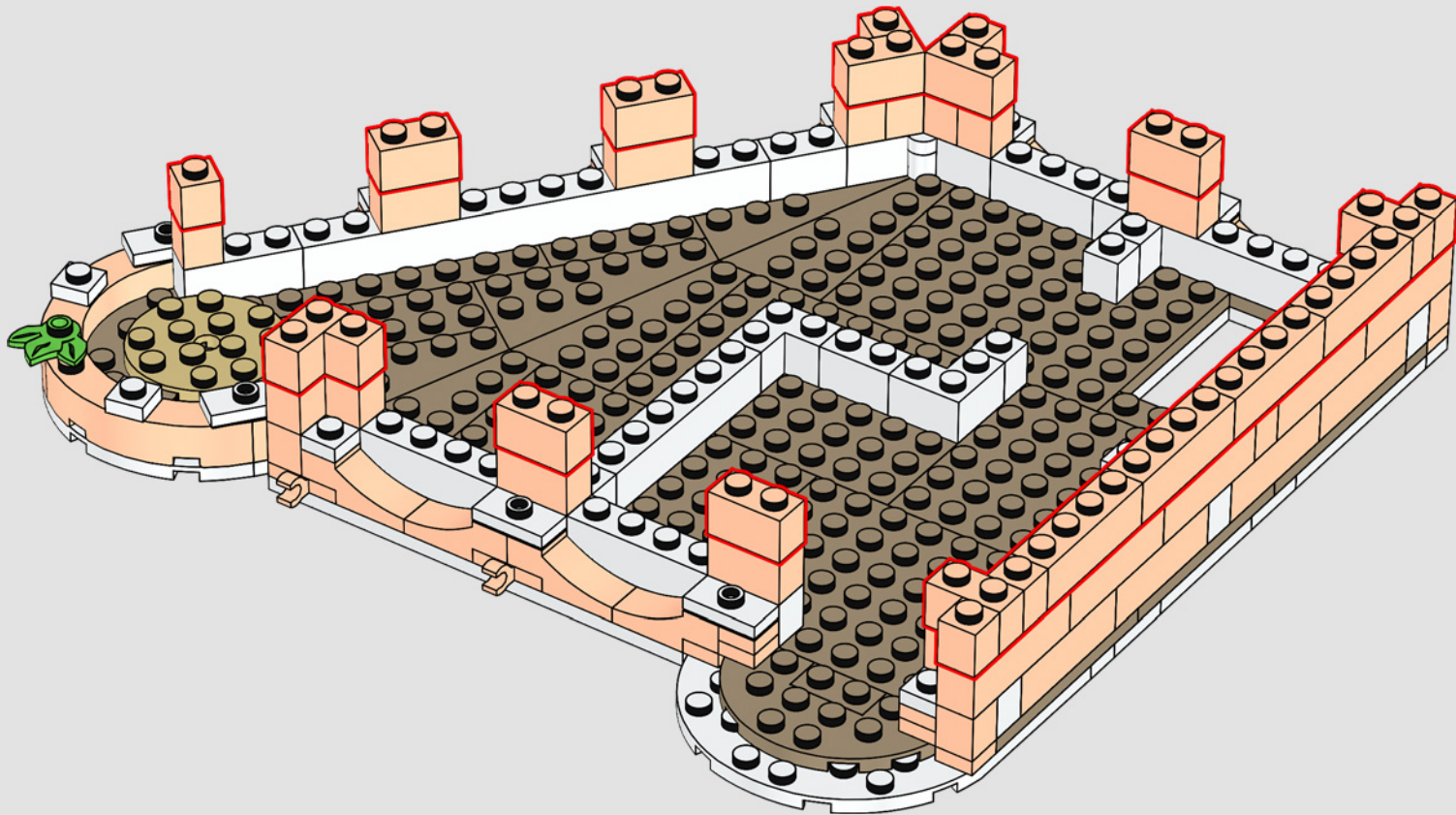

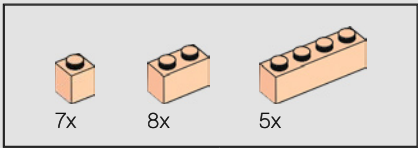
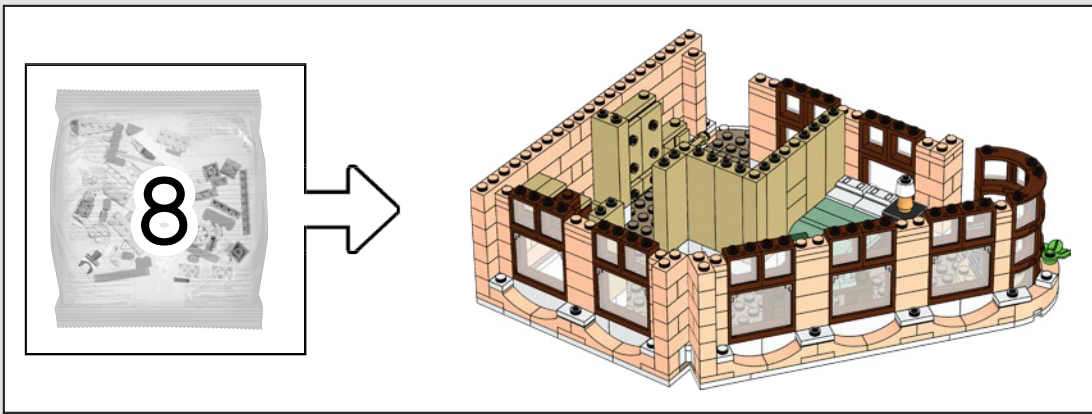

178

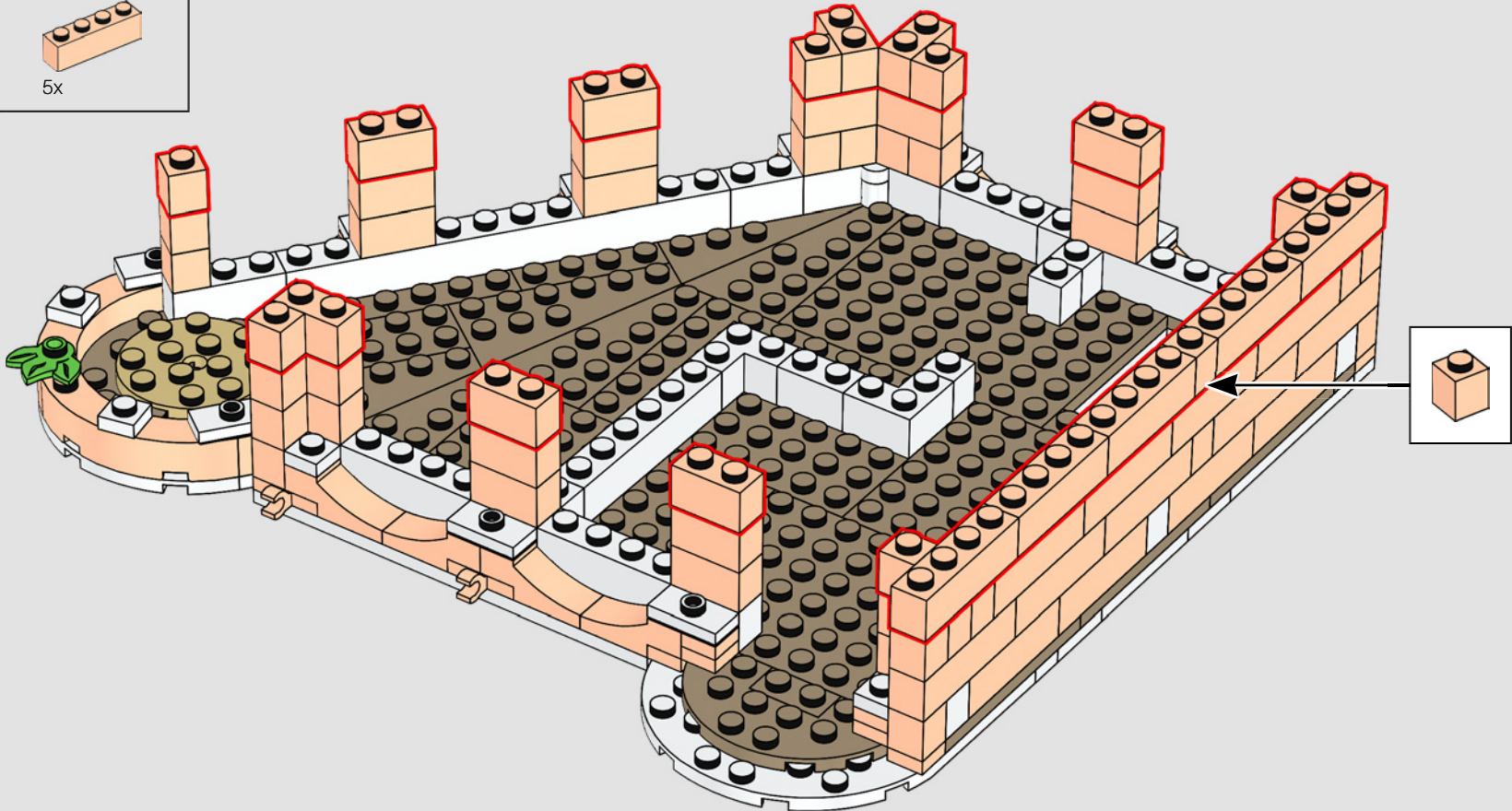

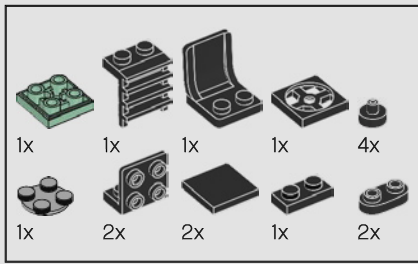

179

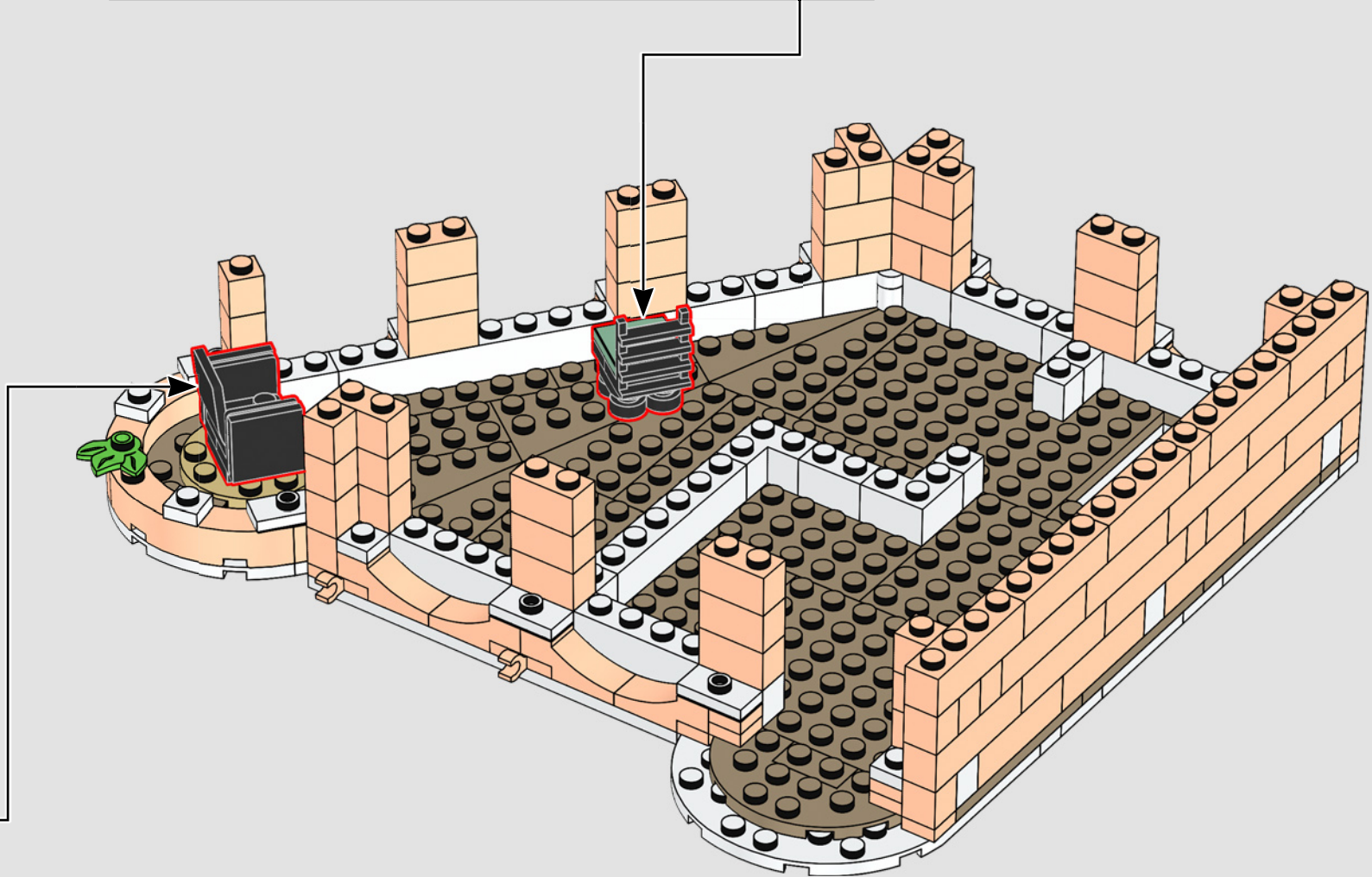
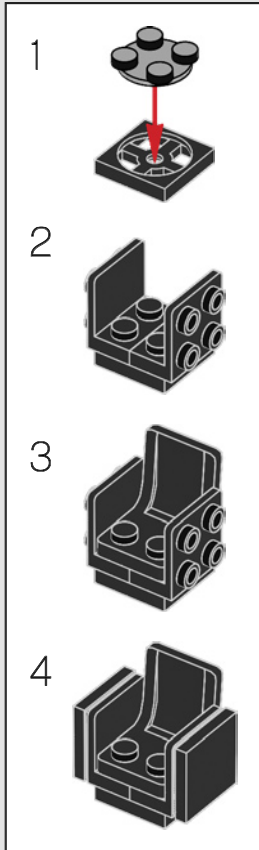
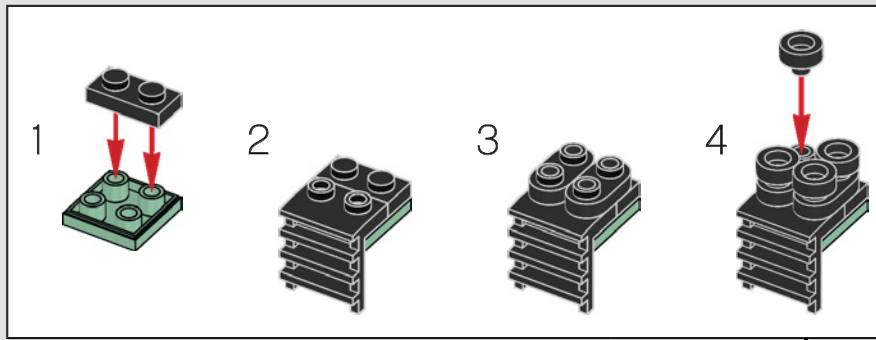

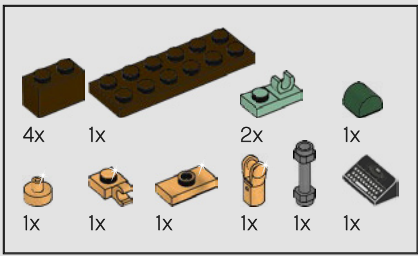

180

1

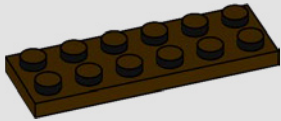

2

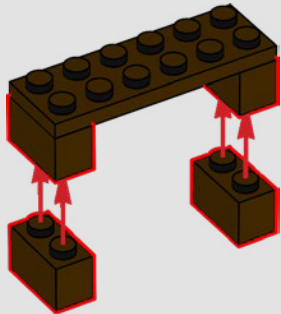

3

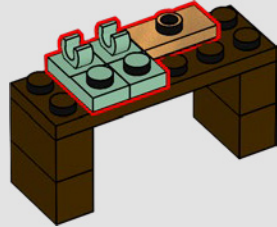

4

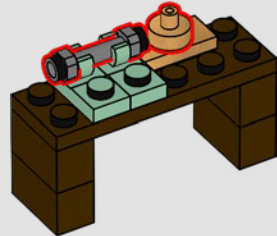

5

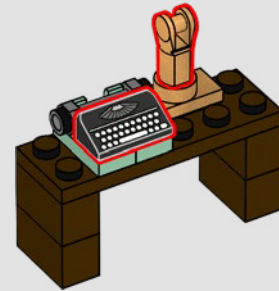

6

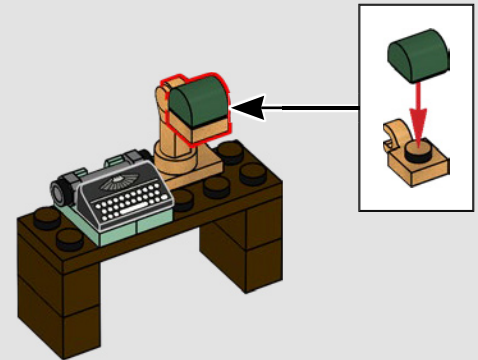

The local typewriter company has recently made sales to both the Hotel and to the 10278 Police Station set.

L'entreprise de machines à écrire locale a récemment effectué des ventes à l'hôtel, ainsi qu'au poste de police (10278).

La empresa local de máquinas de escribir recientemente vendió sus productos tanto al hotel como al set Estación de Policía (10278).

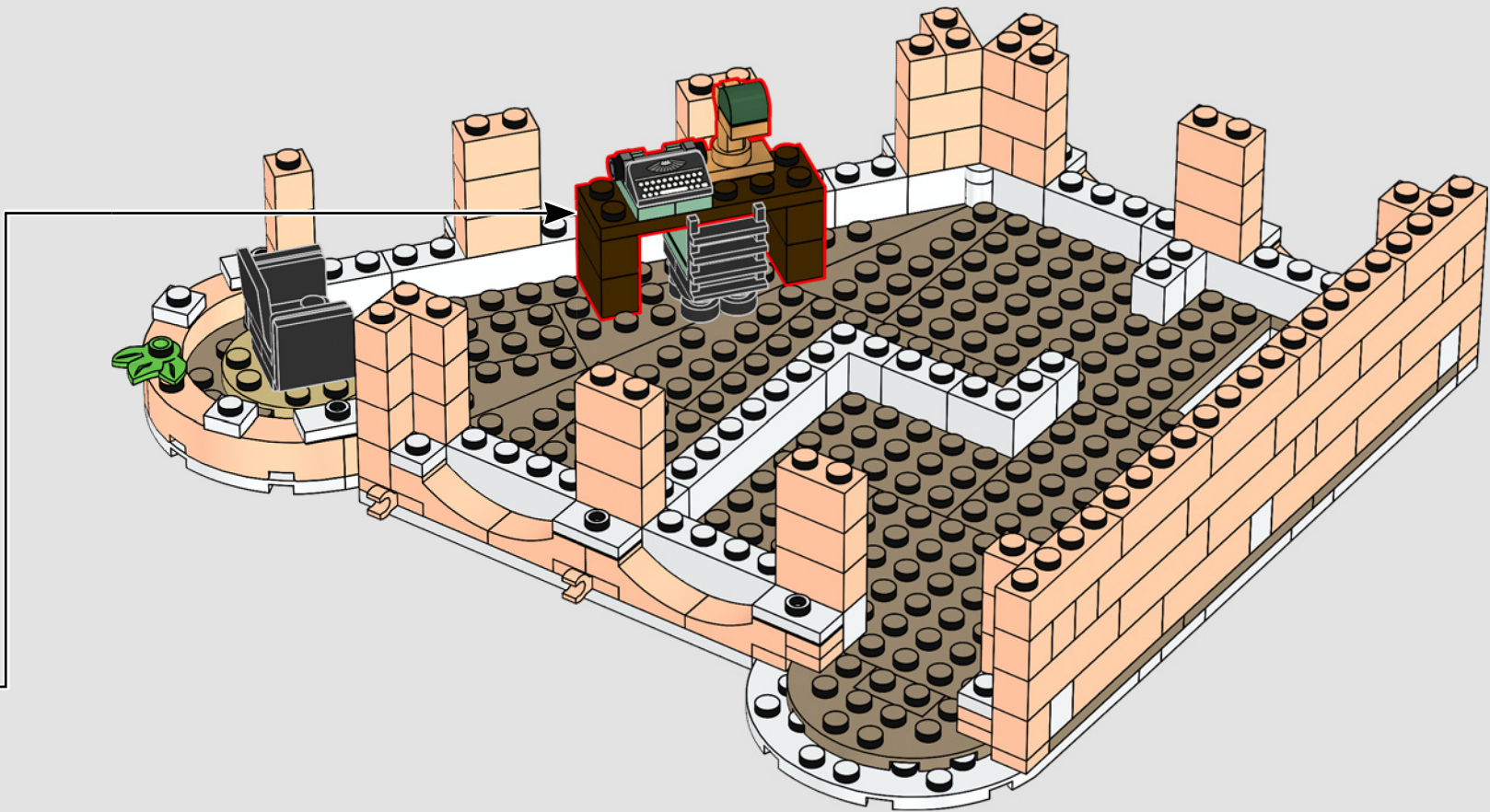

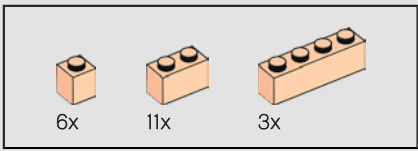

181

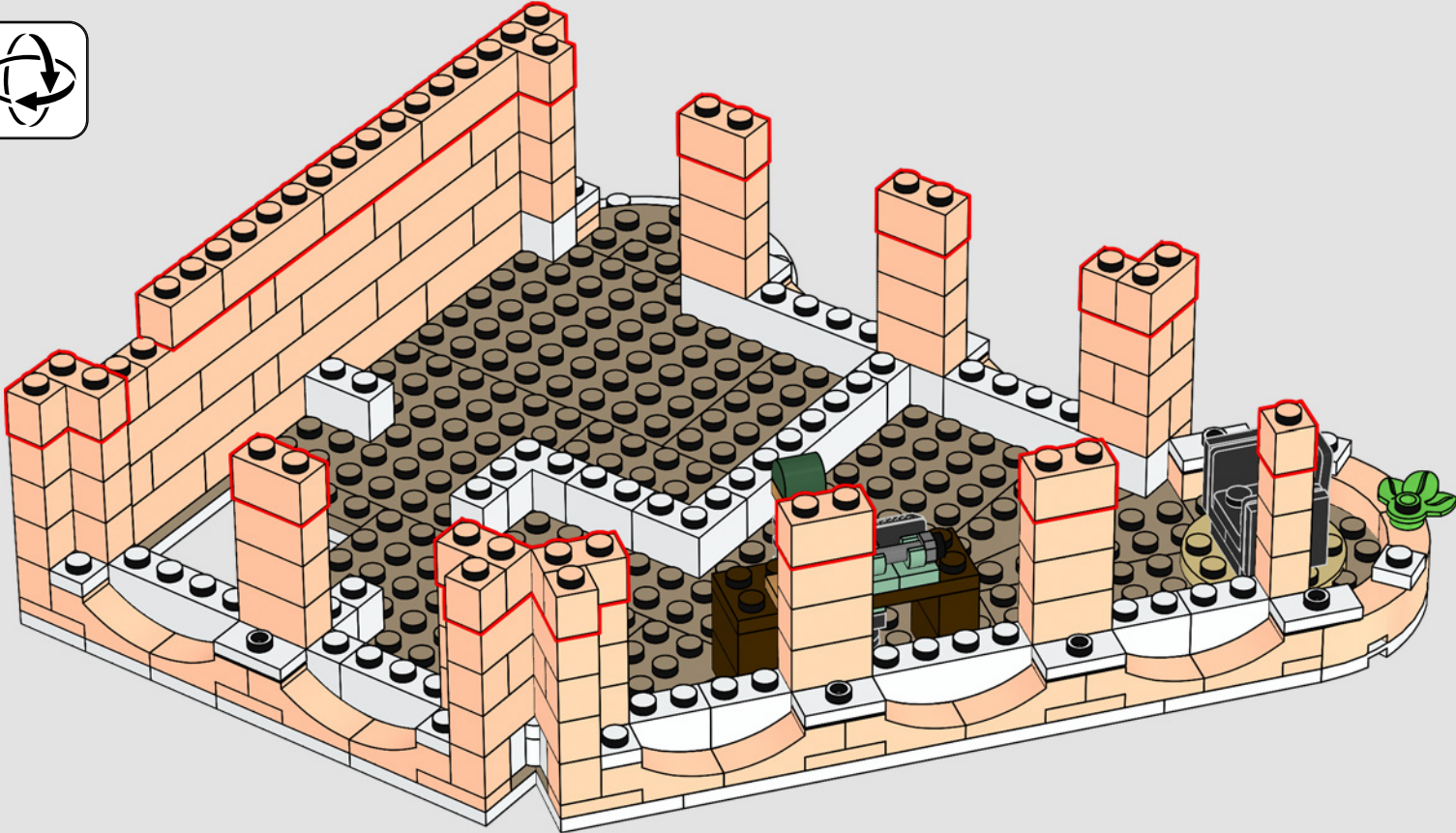

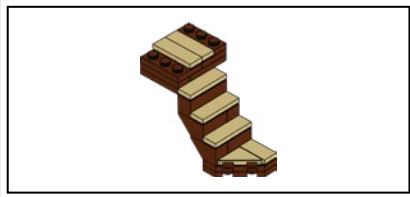

182

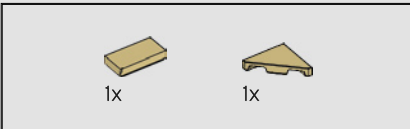
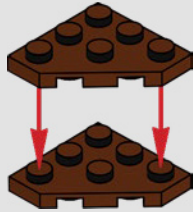

183

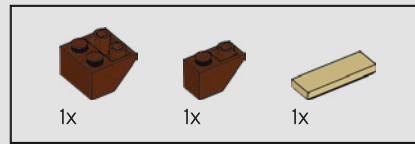

184

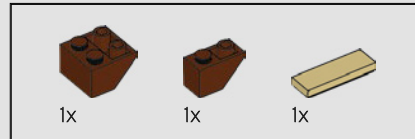
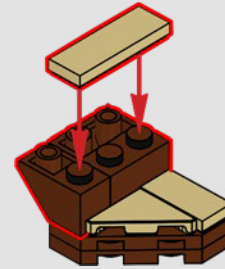

185

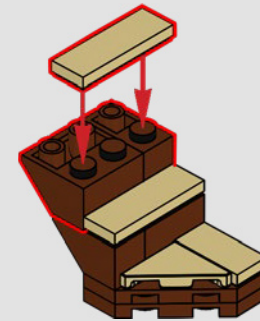

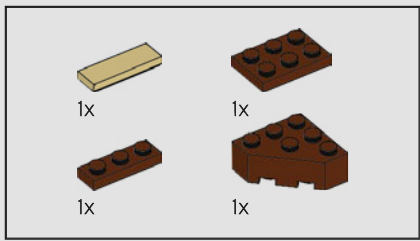

186

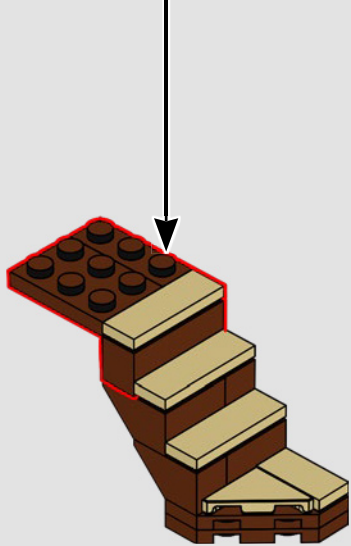
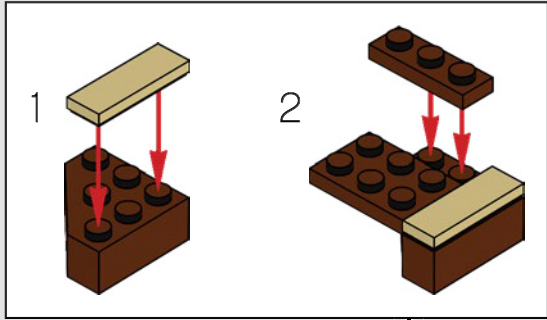

187

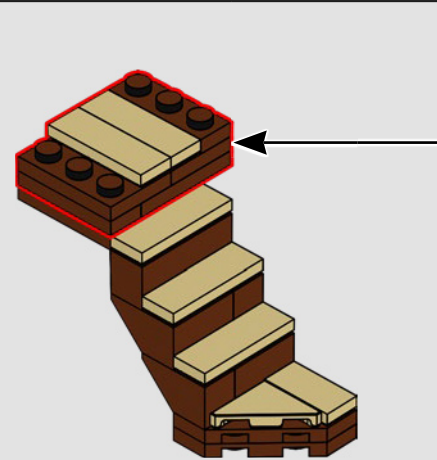
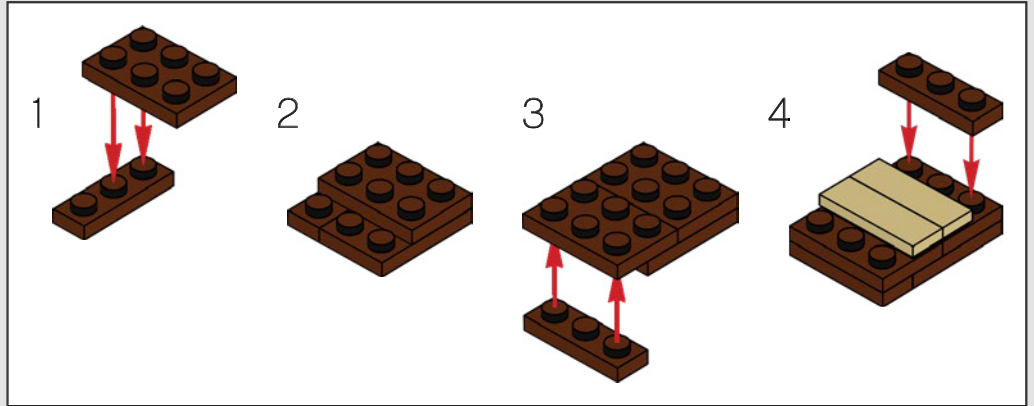

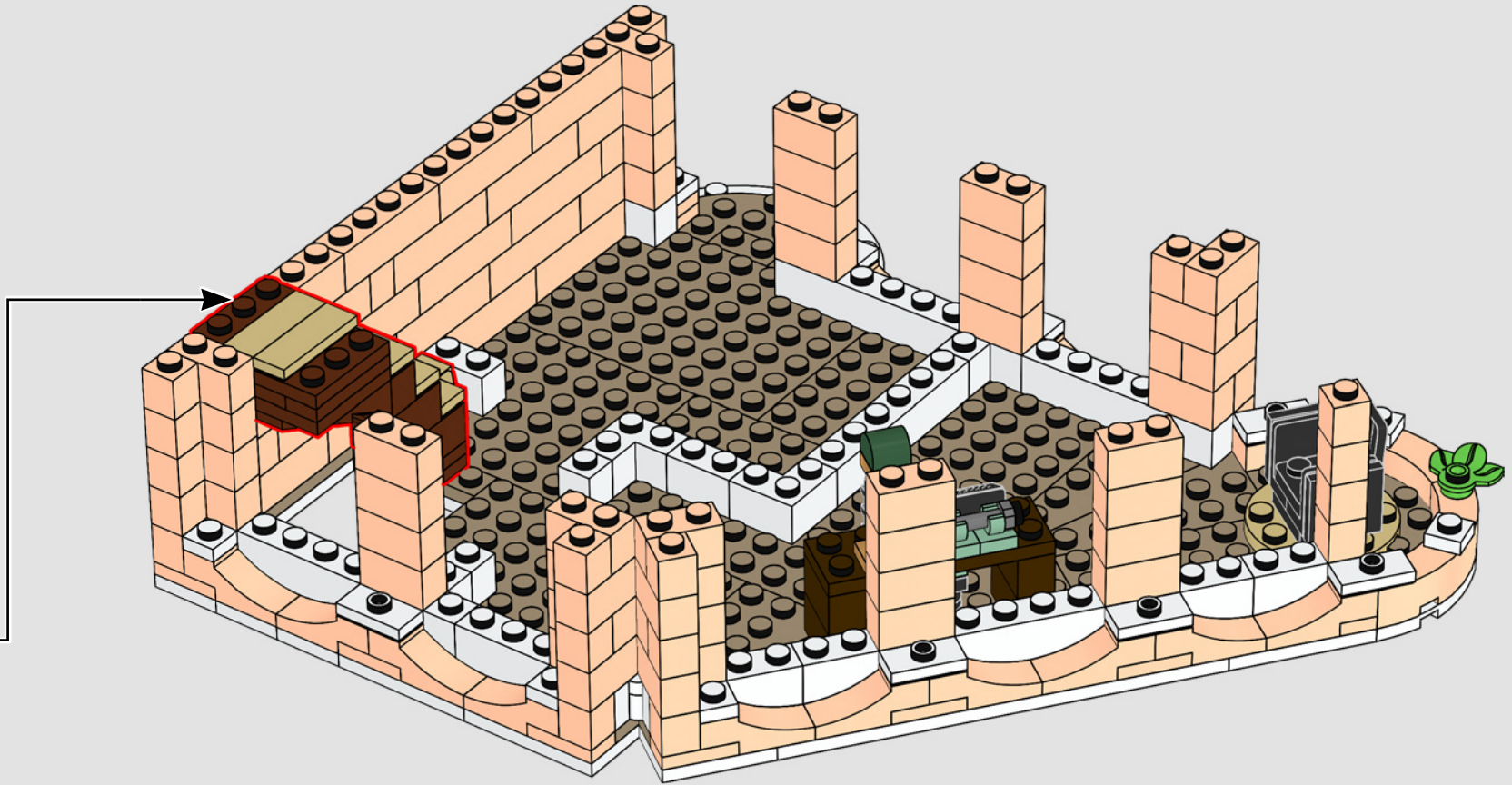

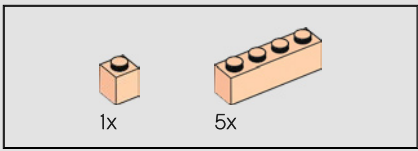

189

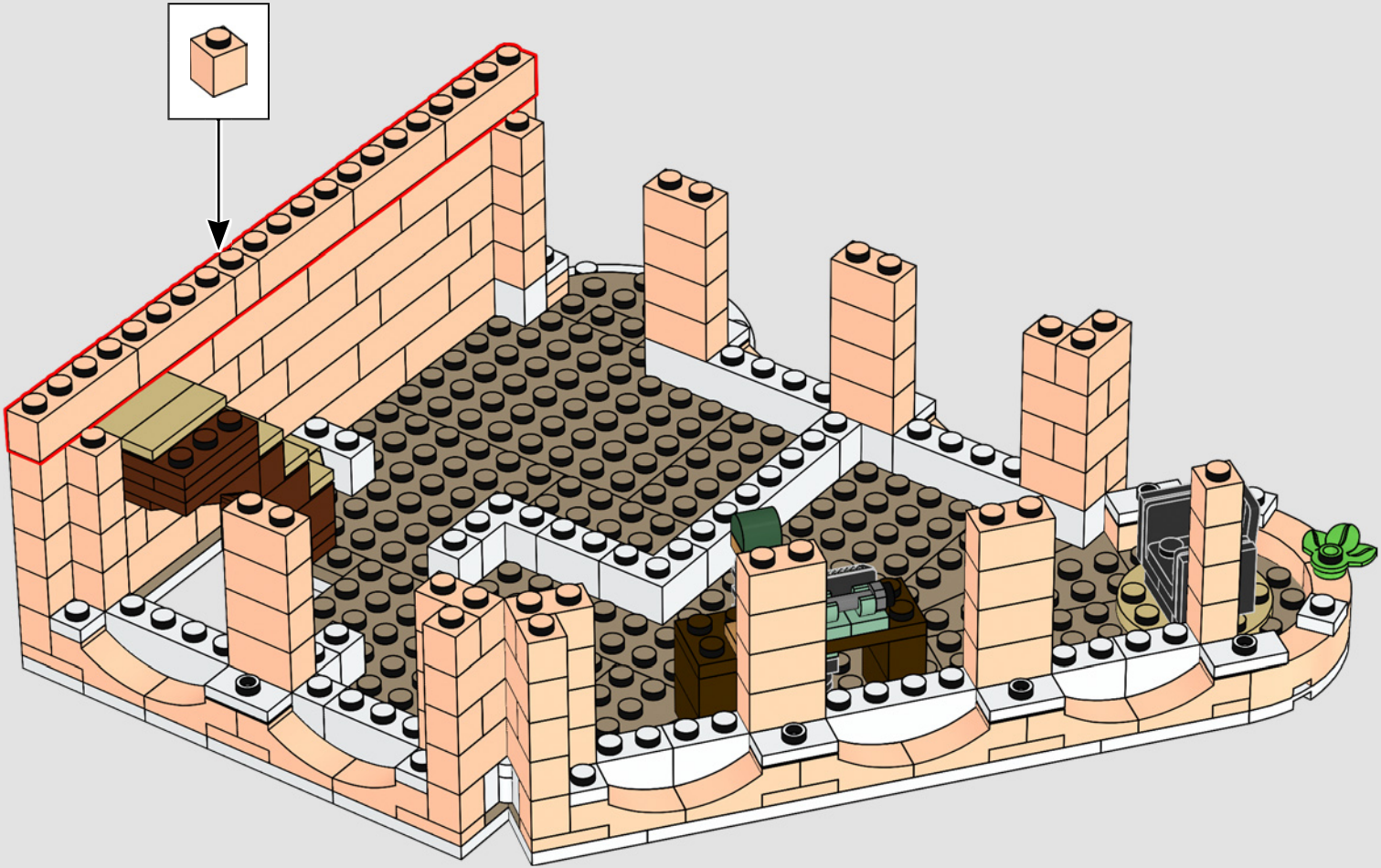

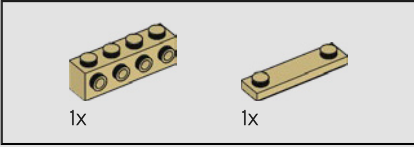
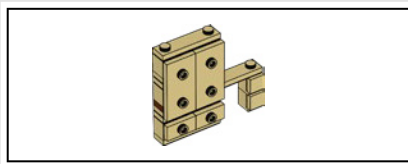

190

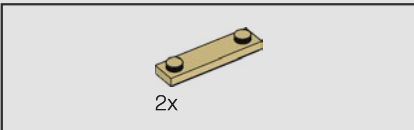
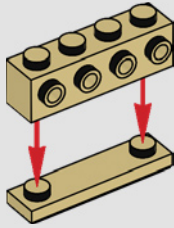

191

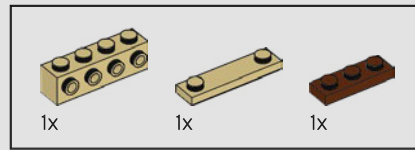
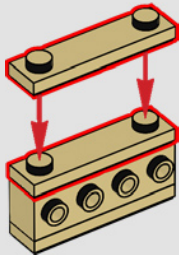

192

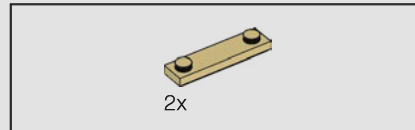
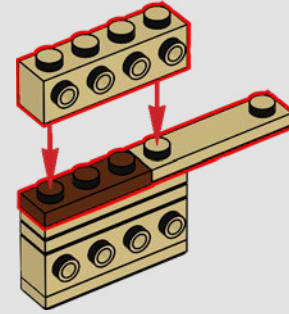

193

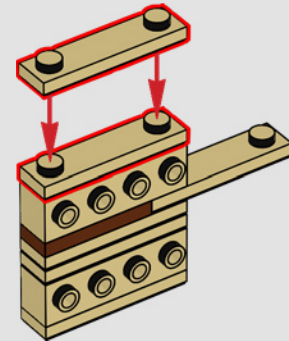

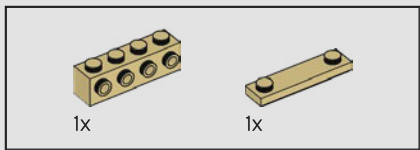

194

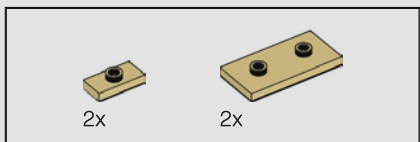
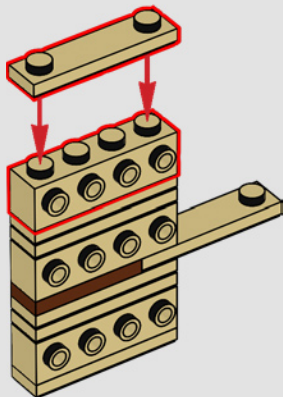

195

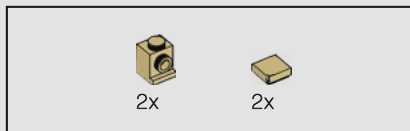
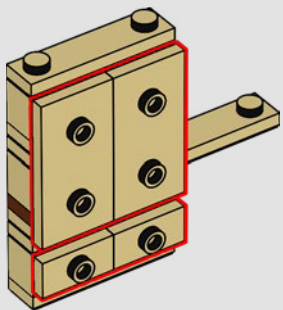

196

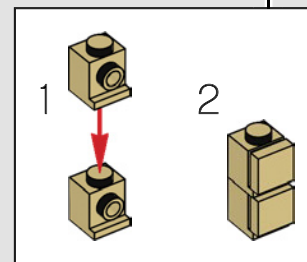
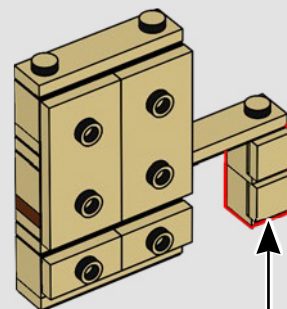

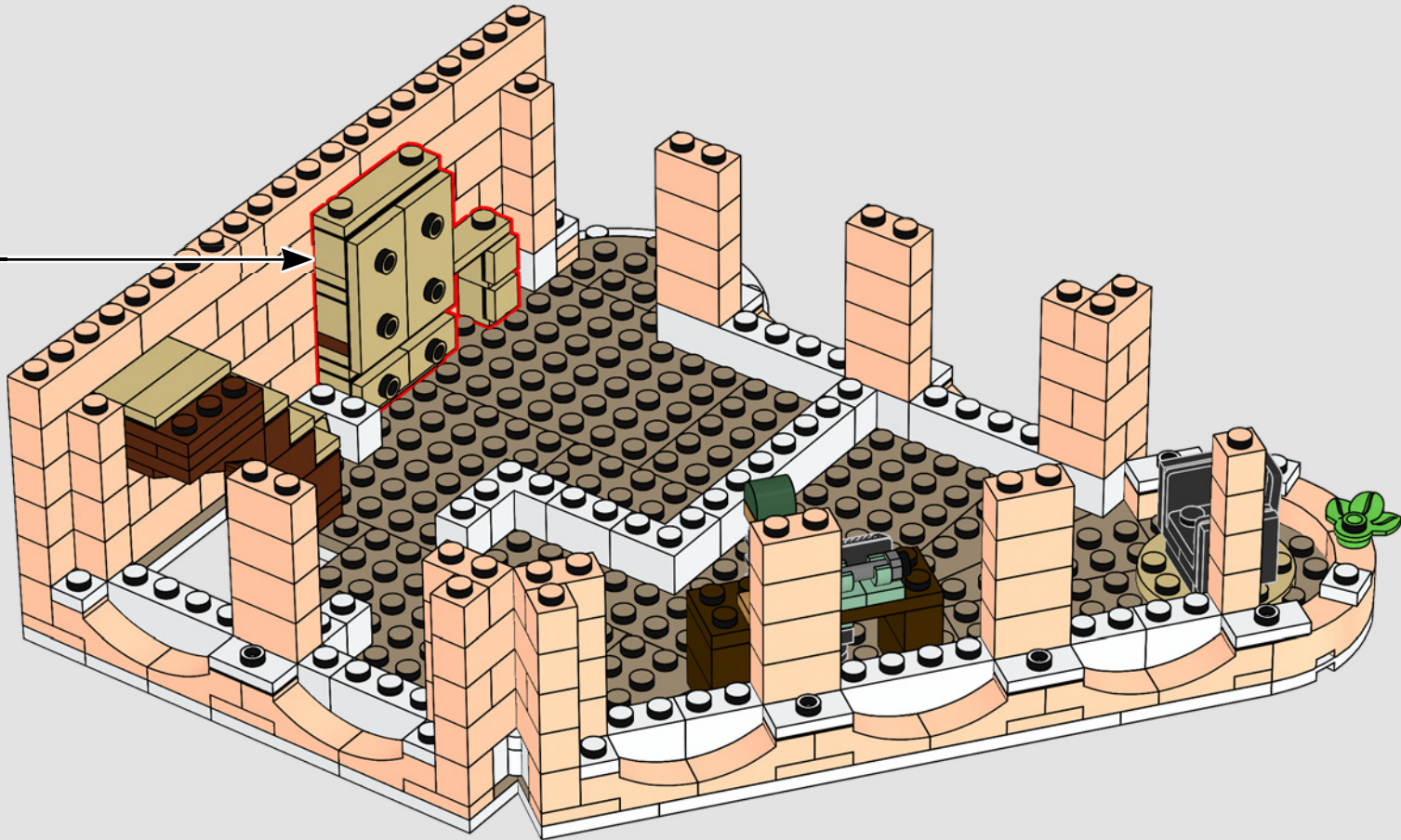

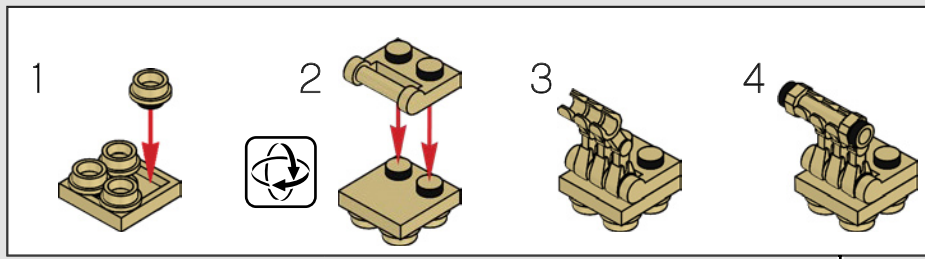
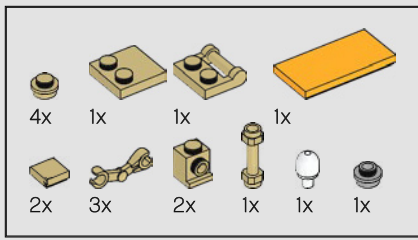

198

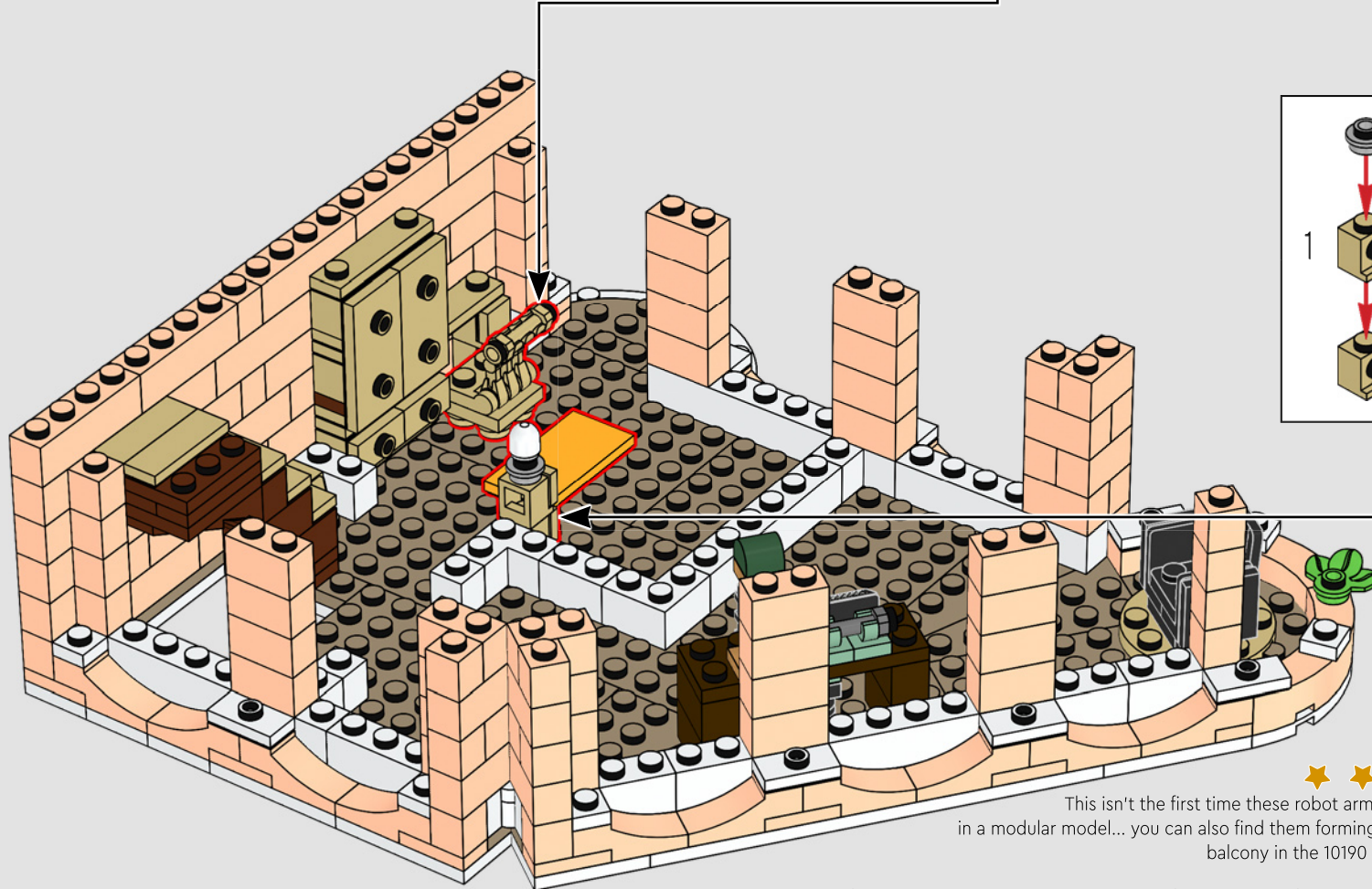

This isn't the first time these robot arms have been used in a modular model... you can also find them forming the railing of the balcony in the 10190 Market Street set.

Ce n'est pas la première fois que ces bras de robot sont utilisés dans un modèle modulaire. Vous pouvez également les voir dans l'ensemble Le marché (10190), où ils forment la balustrade du balcon.

No es la primera vez que se usan estos brazos de robot en un modelo Modular Buildings... También puedes encontrarlos formando el barandal del balcón en el set Calle del Mercado (10190).

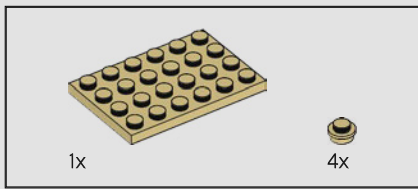

199

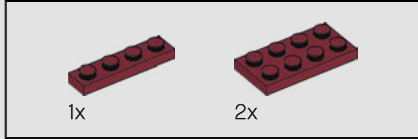
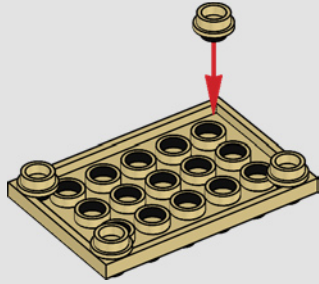

200

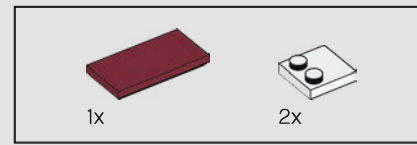
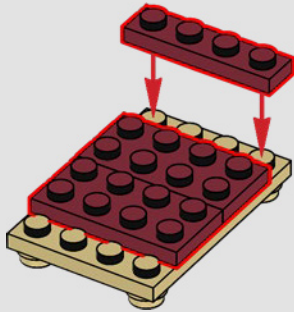

201

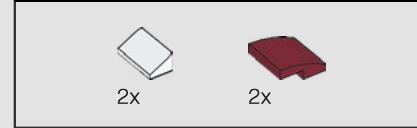
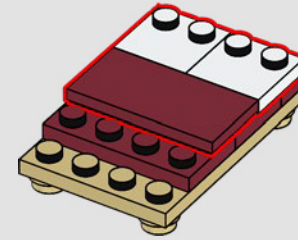

202

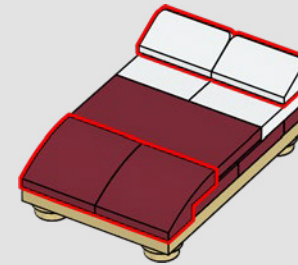

203

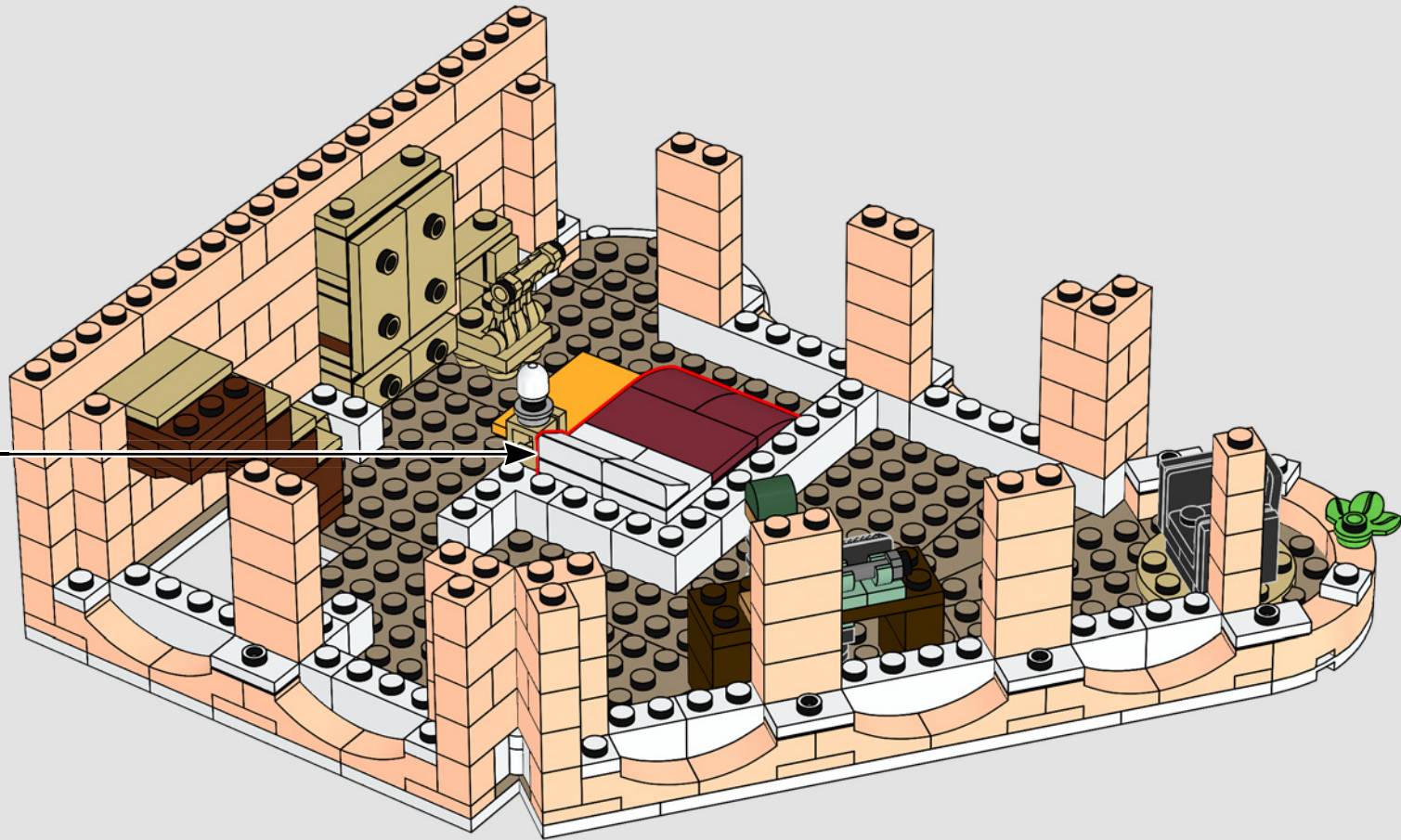

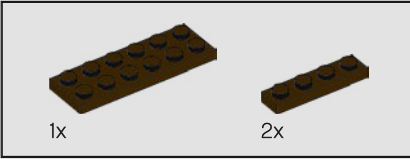
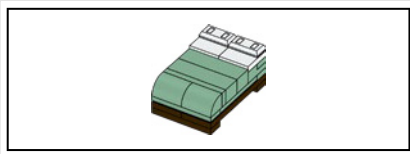

204

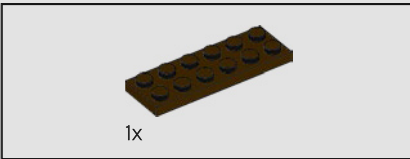
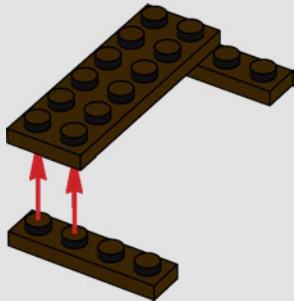

205

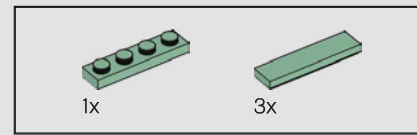
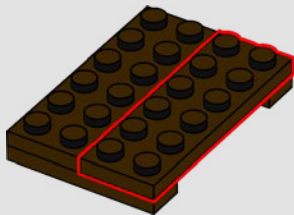

206

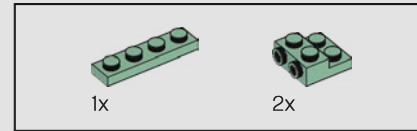
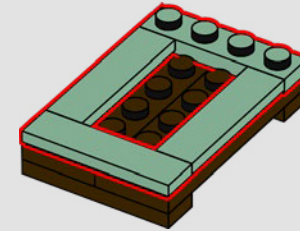

207

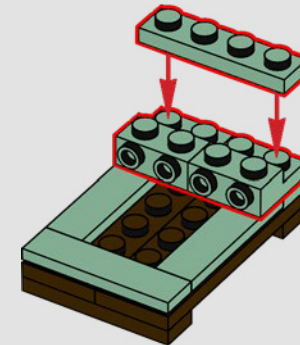

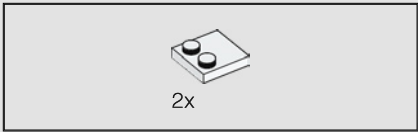

208

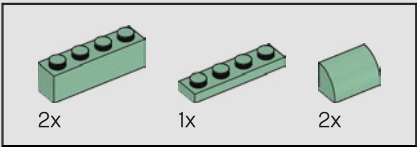
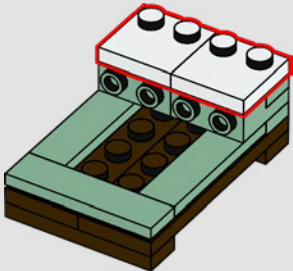

209

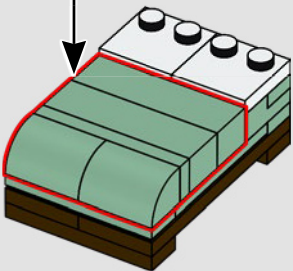
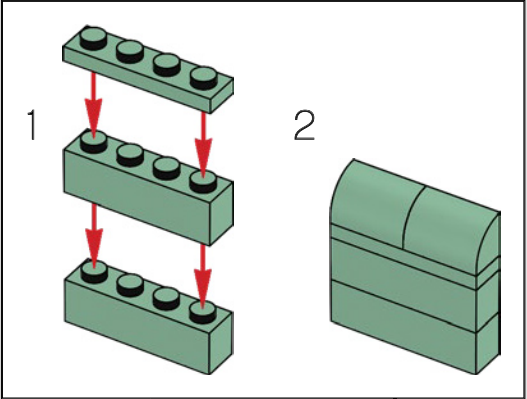

210

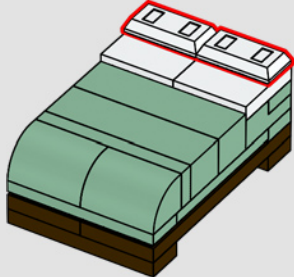

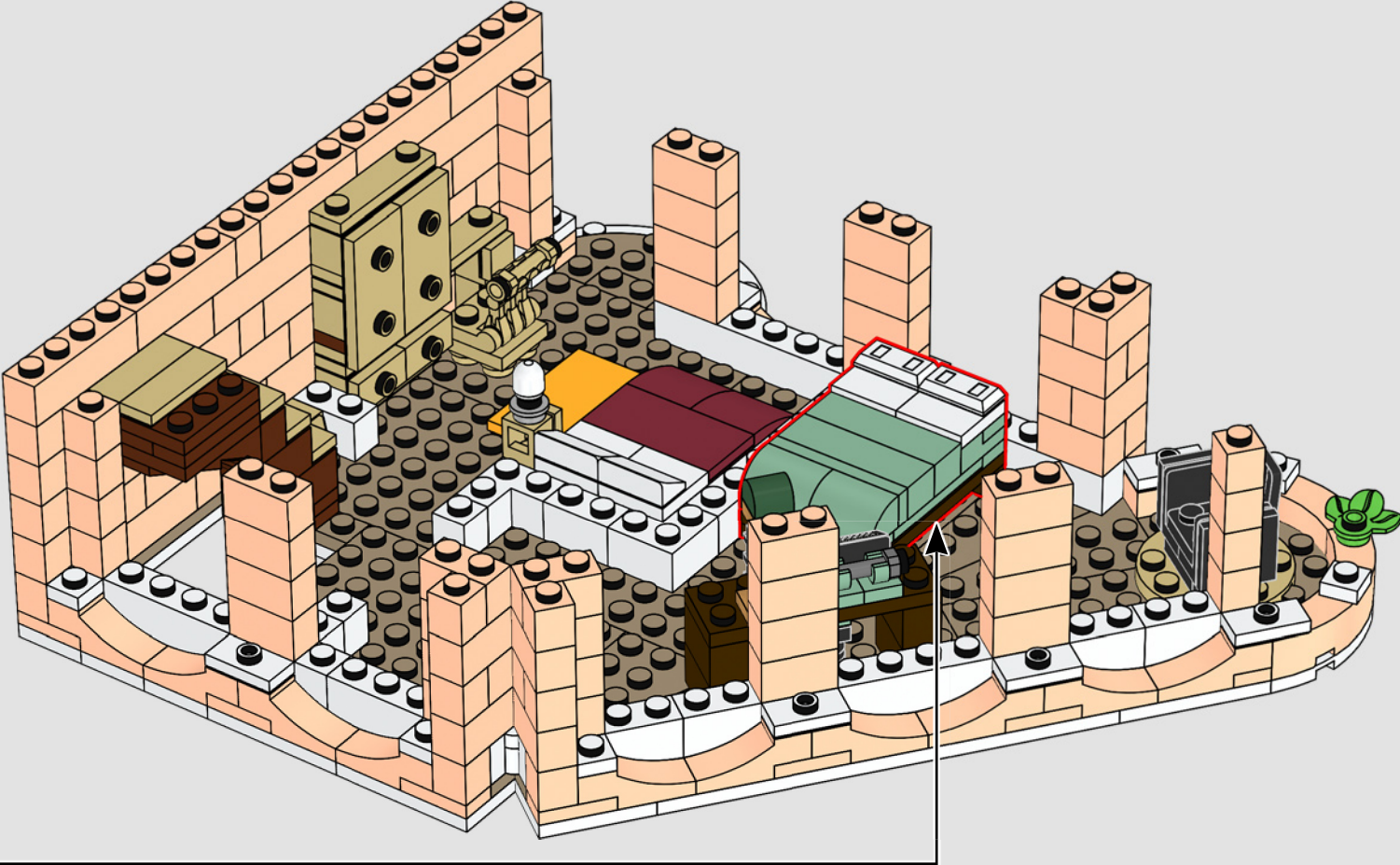

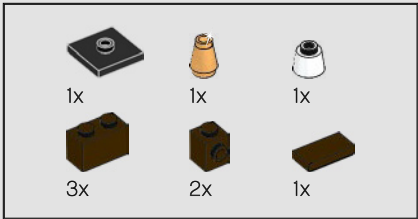

212

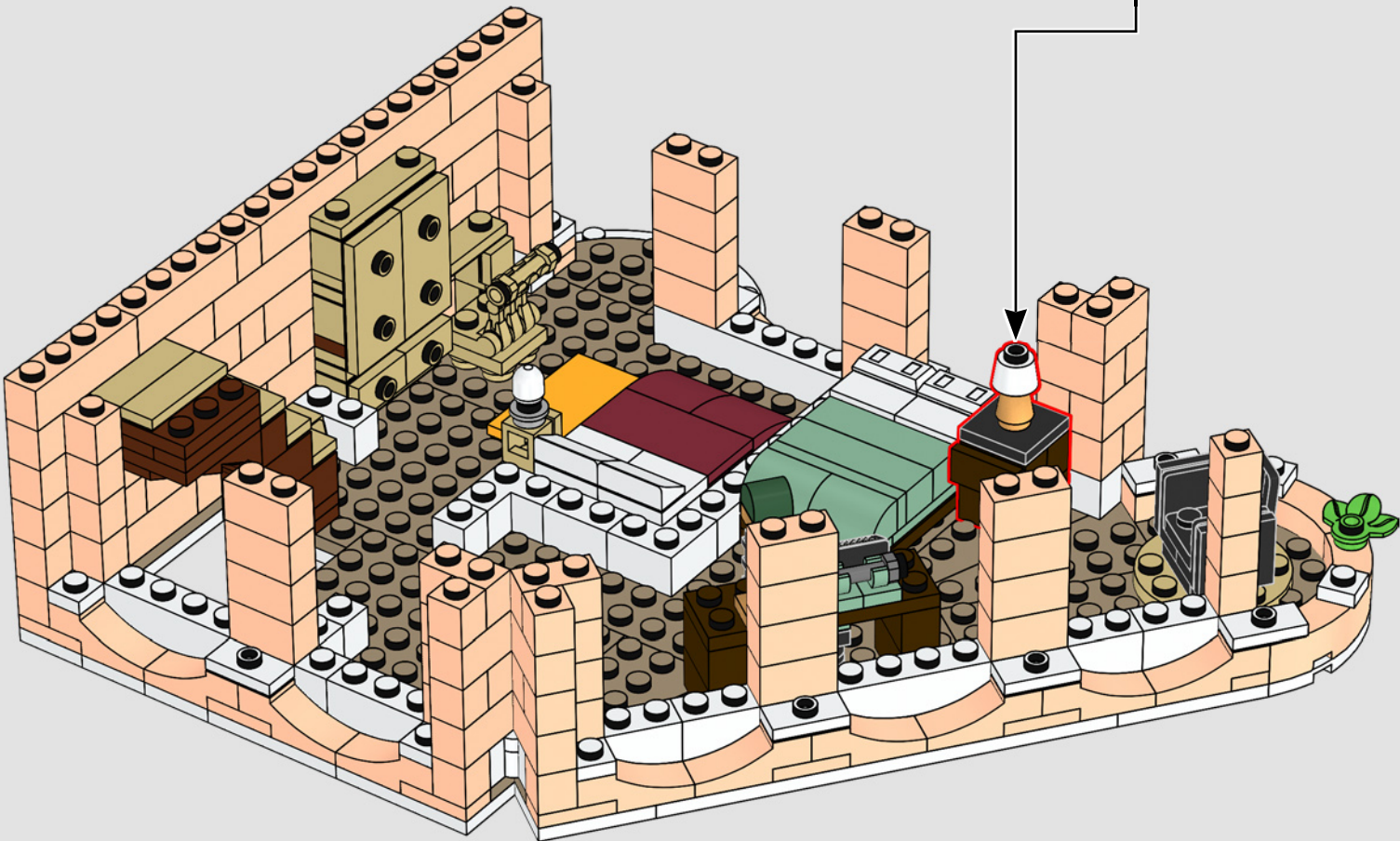
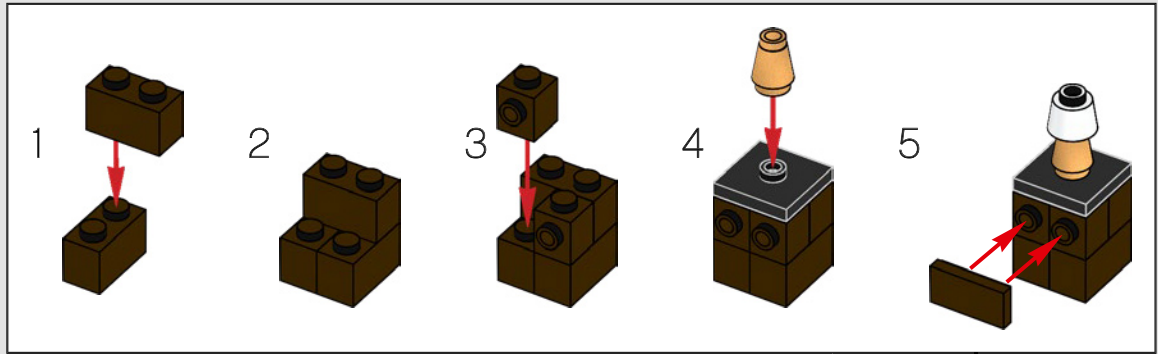

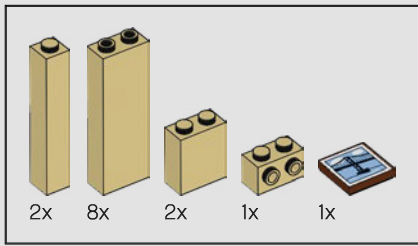

213

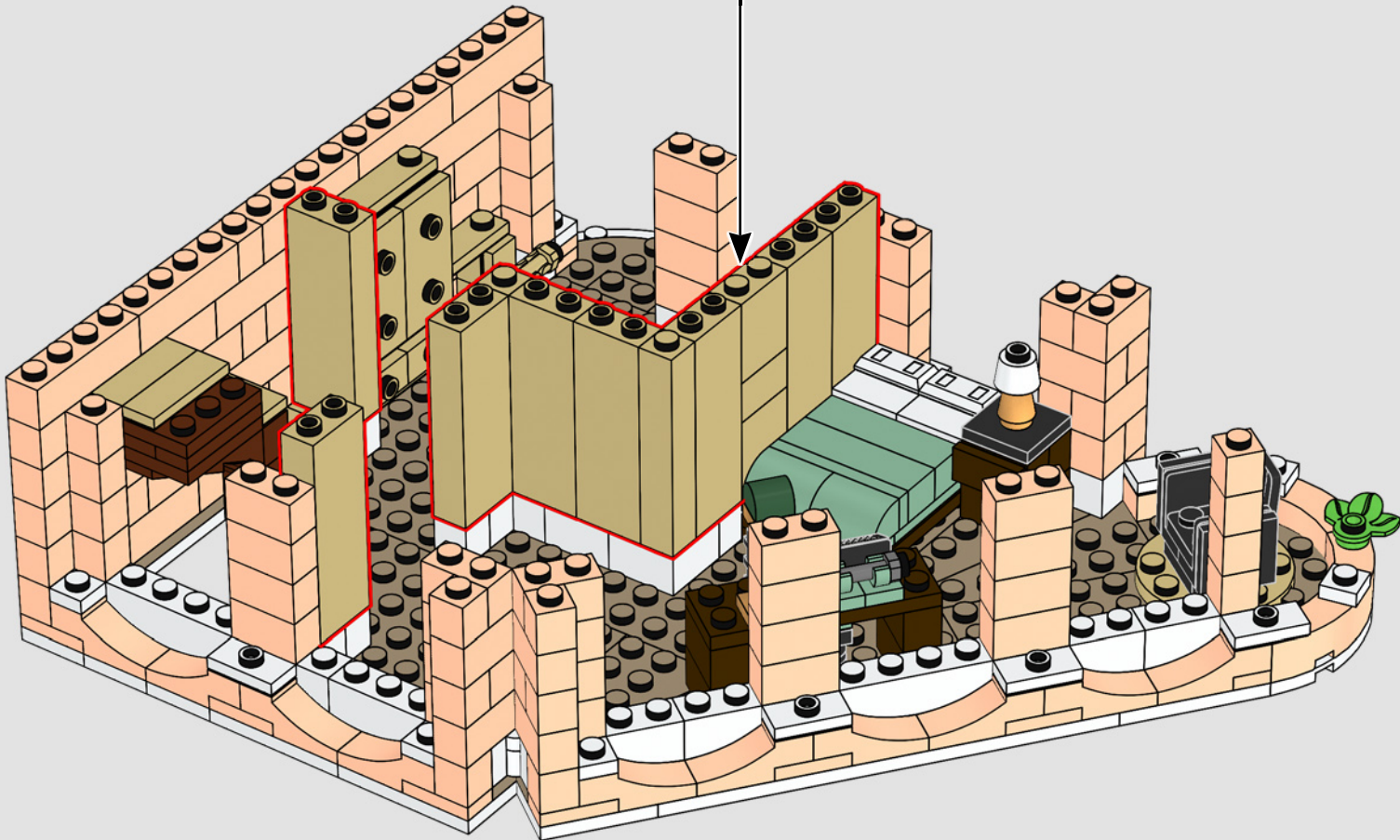
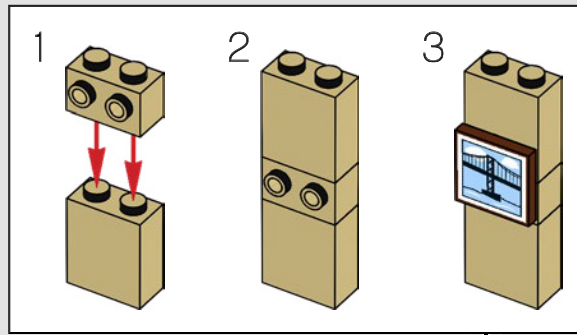

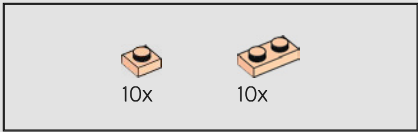

214

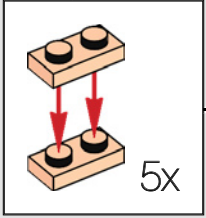
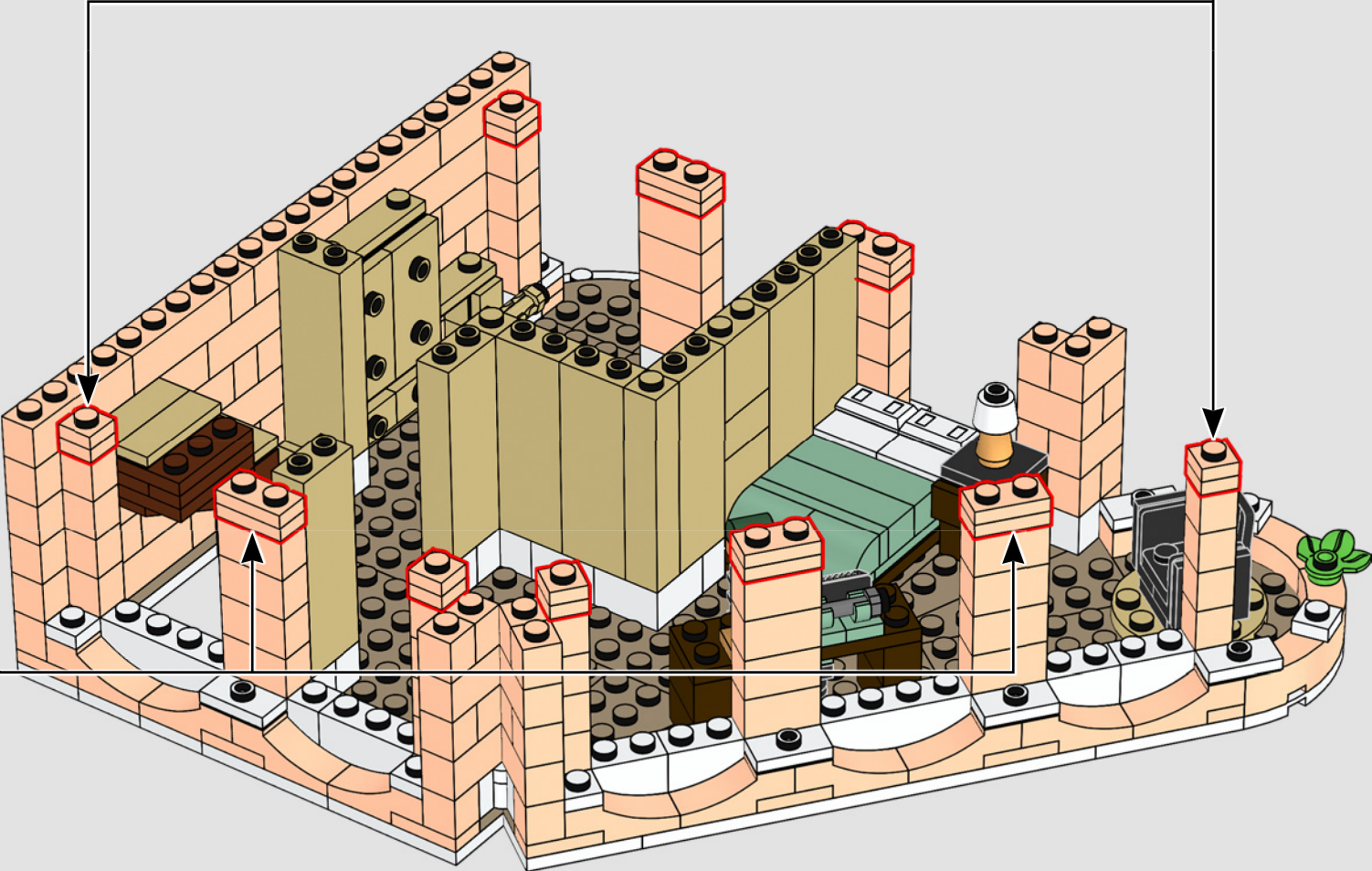
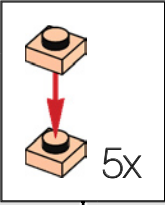

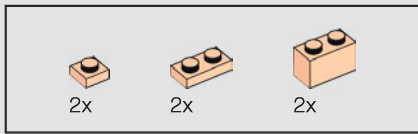

215

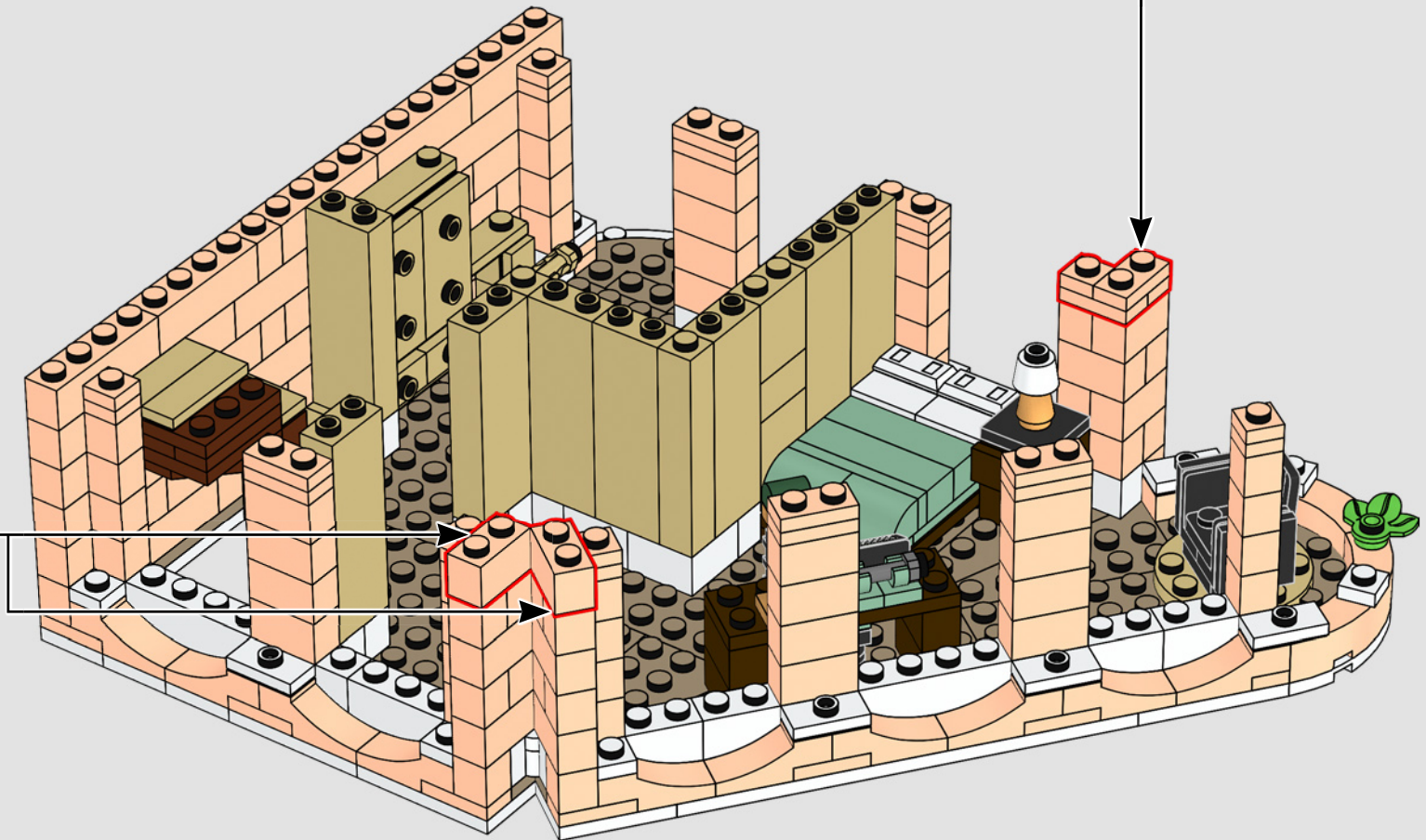
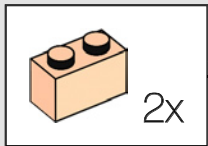
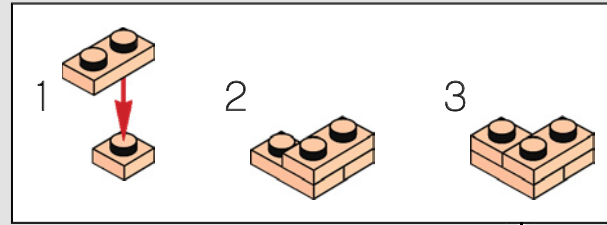

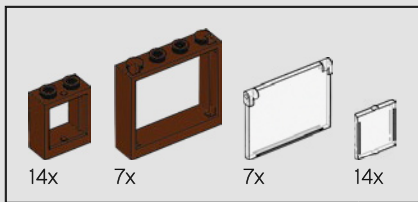

216

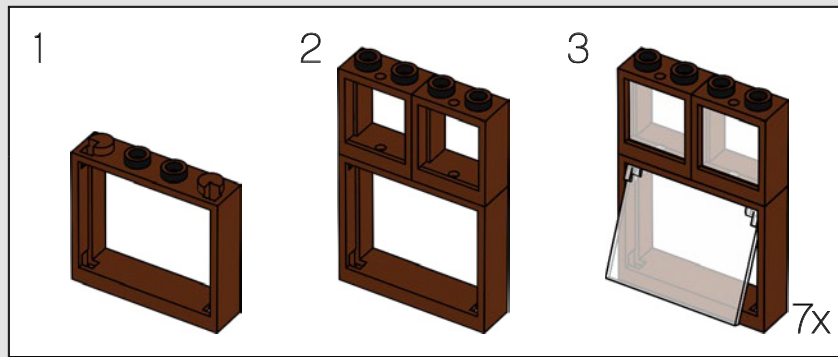

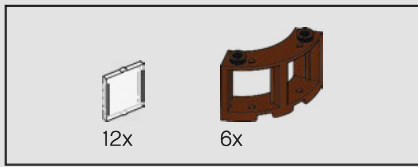

217

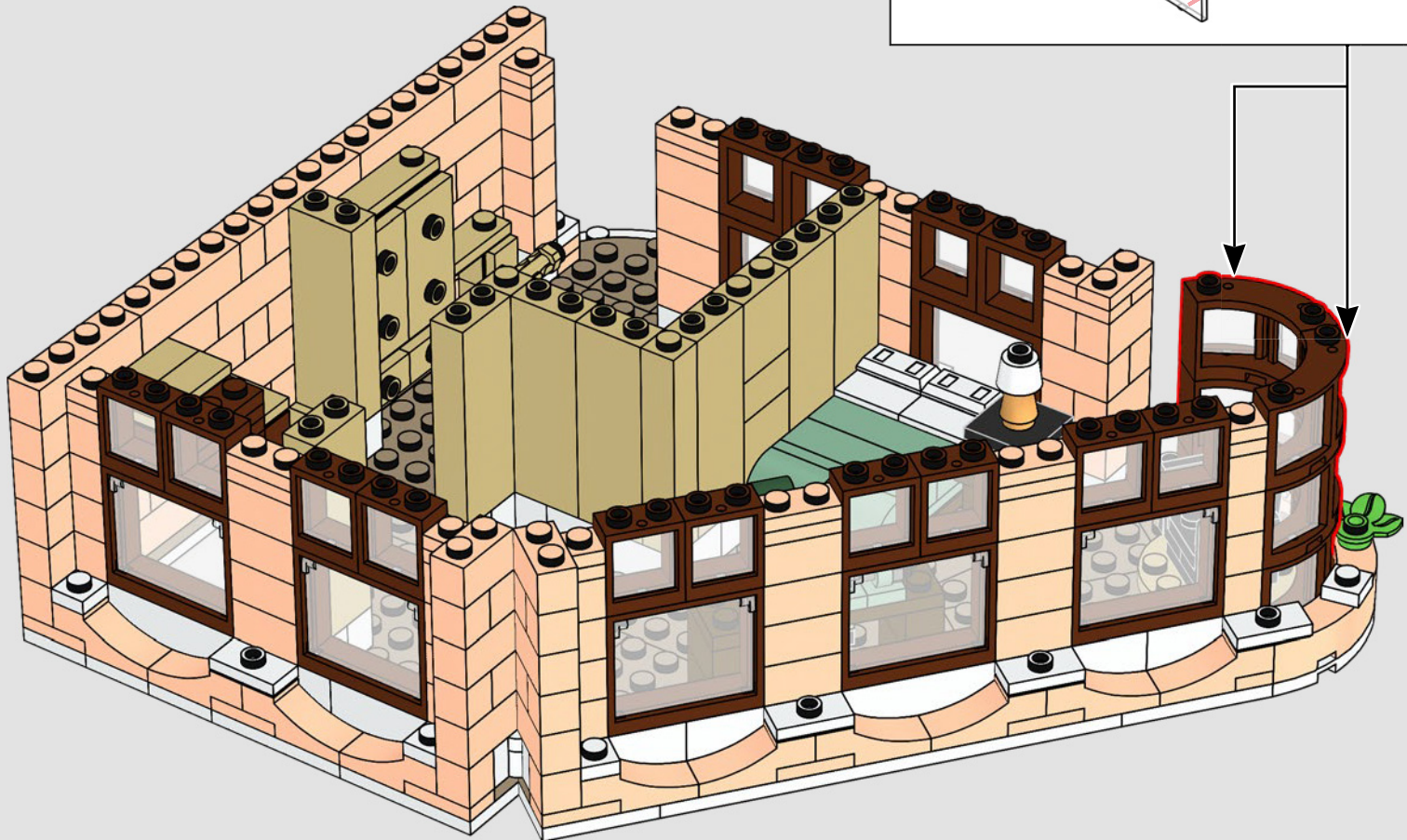
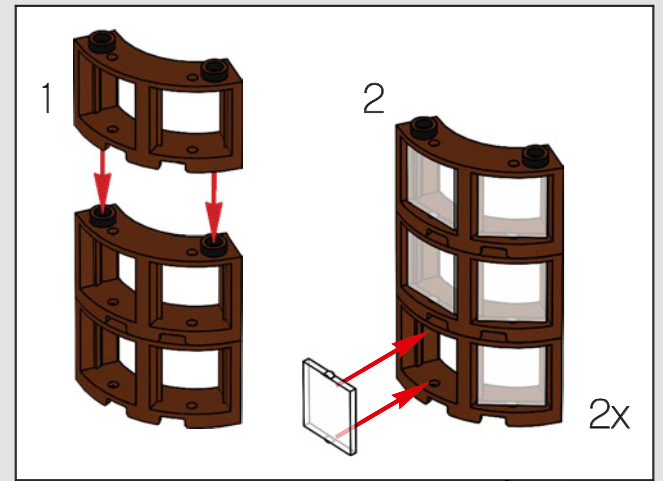

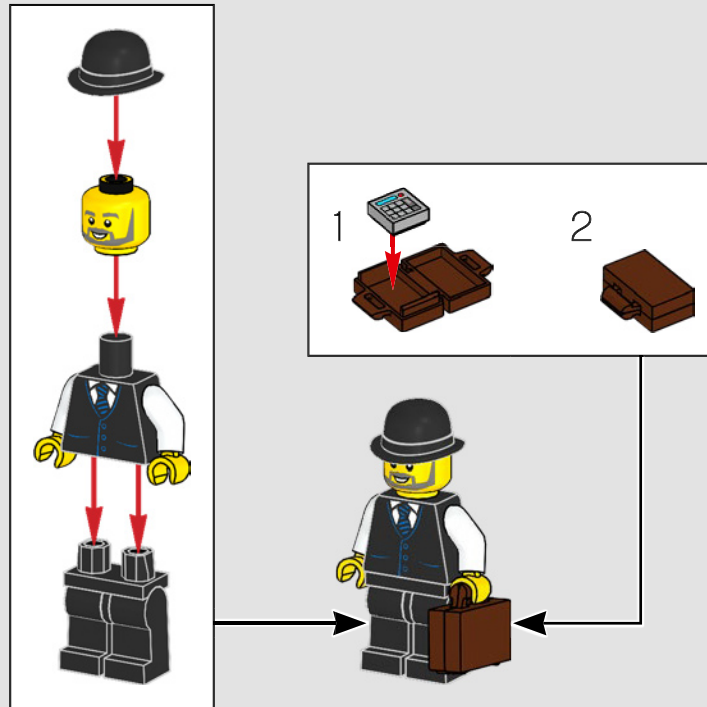
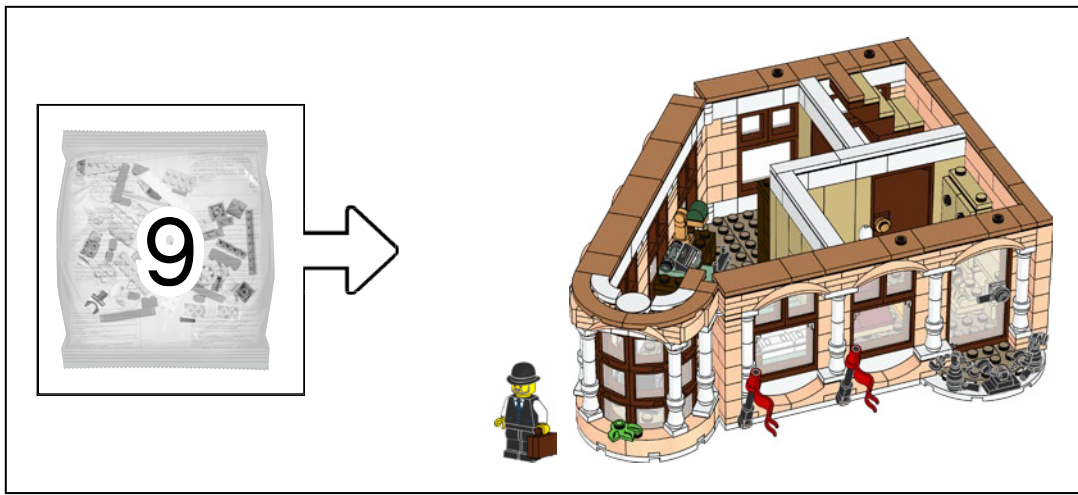

The Accountant is in town to assist with the sale of the Art Gallery's masterpieces. However, he's also been asked to audit the accounts from the 10251 Brick Bank set.

Le comptable est en ville pour aider à la vente des chefs-d'œuvre de la galerie d'art. On lui a également demandé de vérifier les comptes de la Banque Brique (10251).

El contador está en la ciudad para ayudar con la venta de las obras maestras de la galería de arte. No obstante, también le pidieron que auditara las cuentas del set Brick Bank (10251).

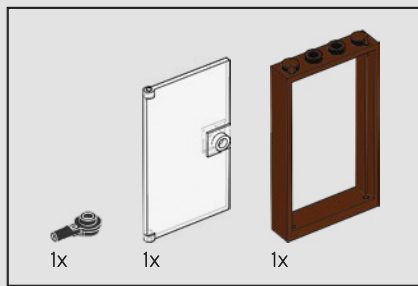

218

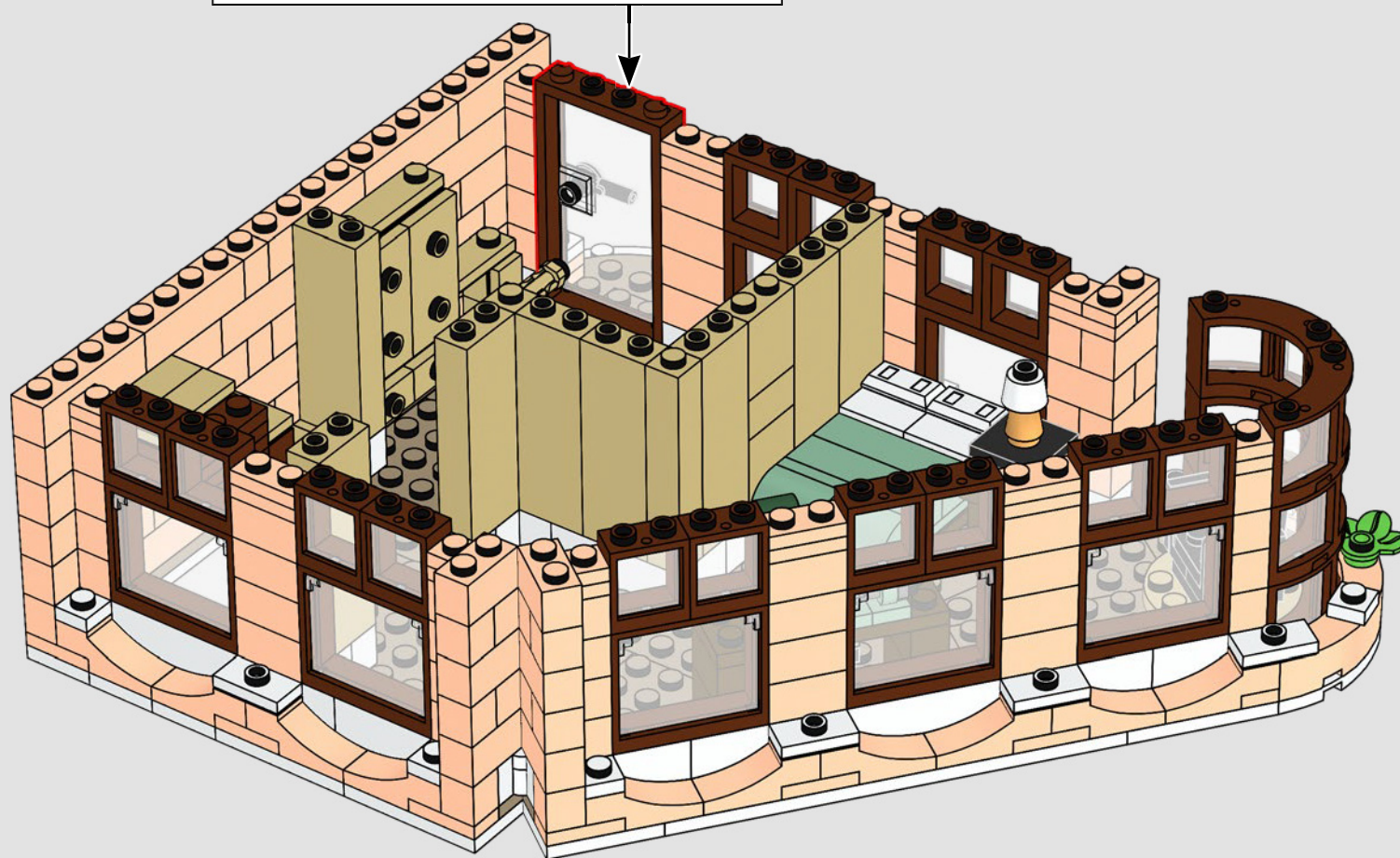
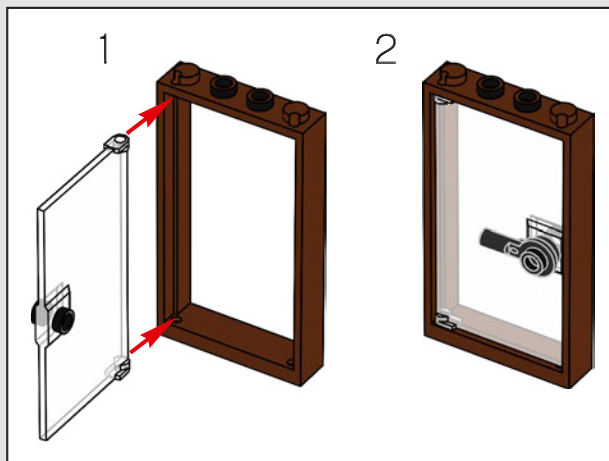

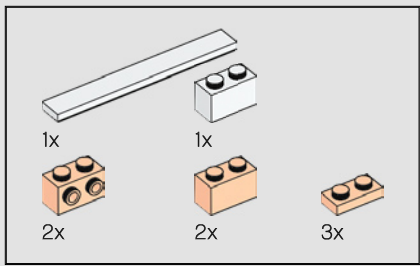

219

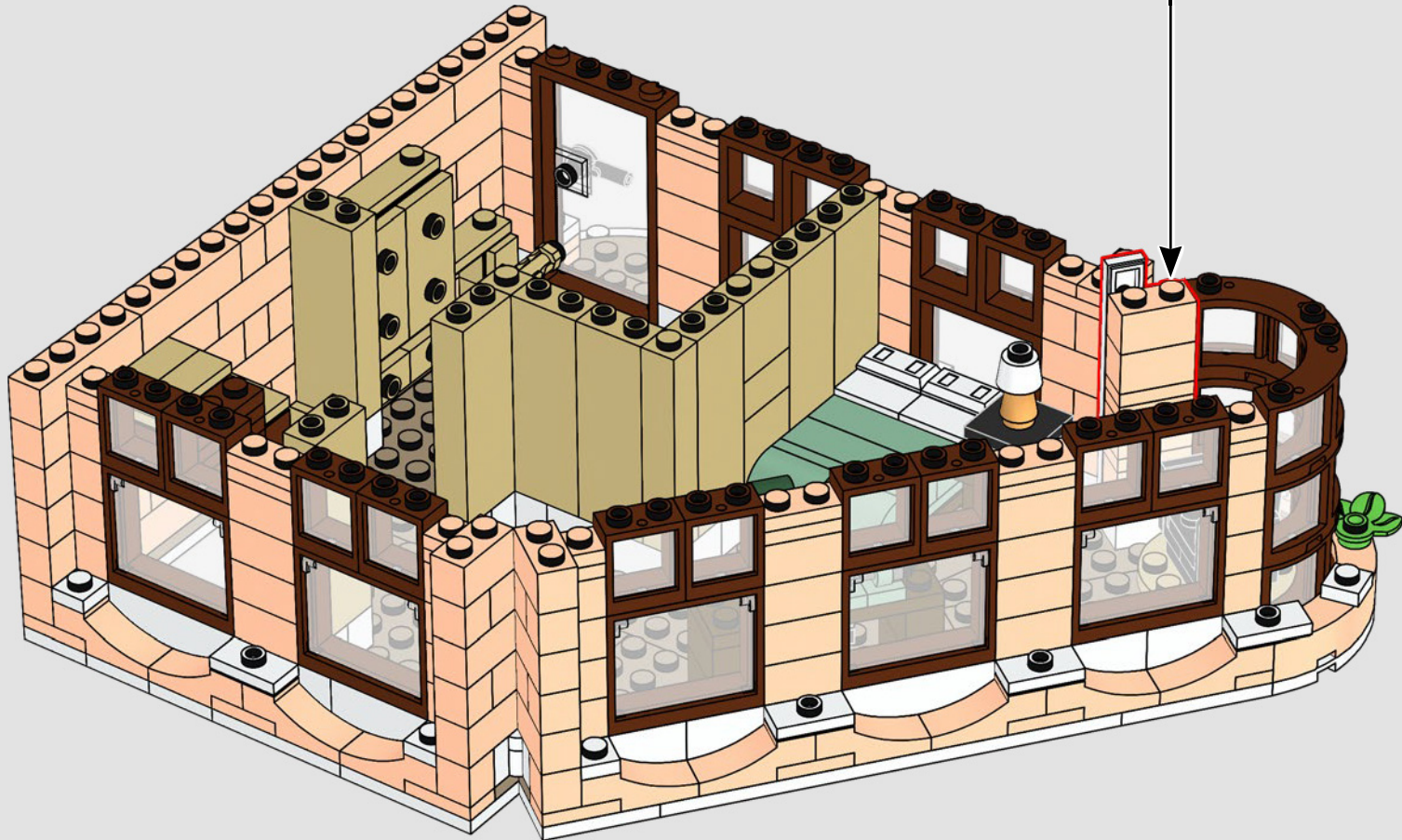
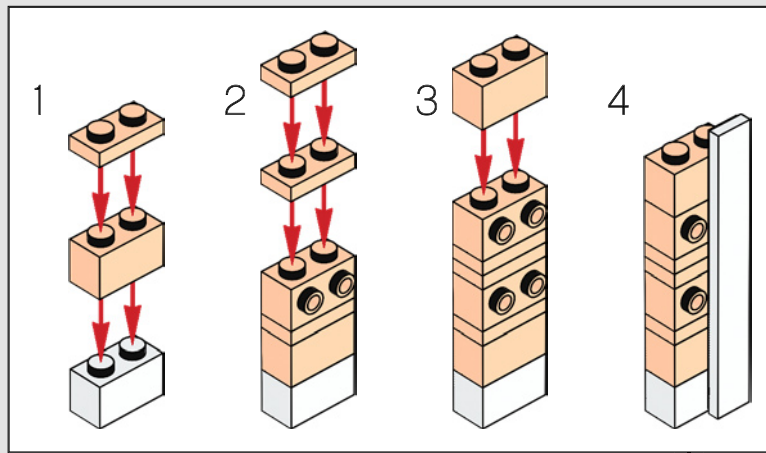

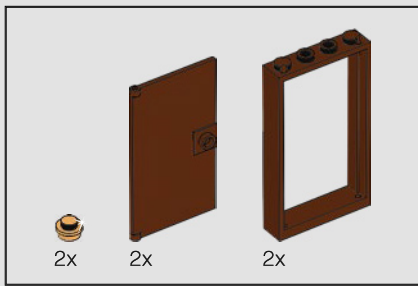

220

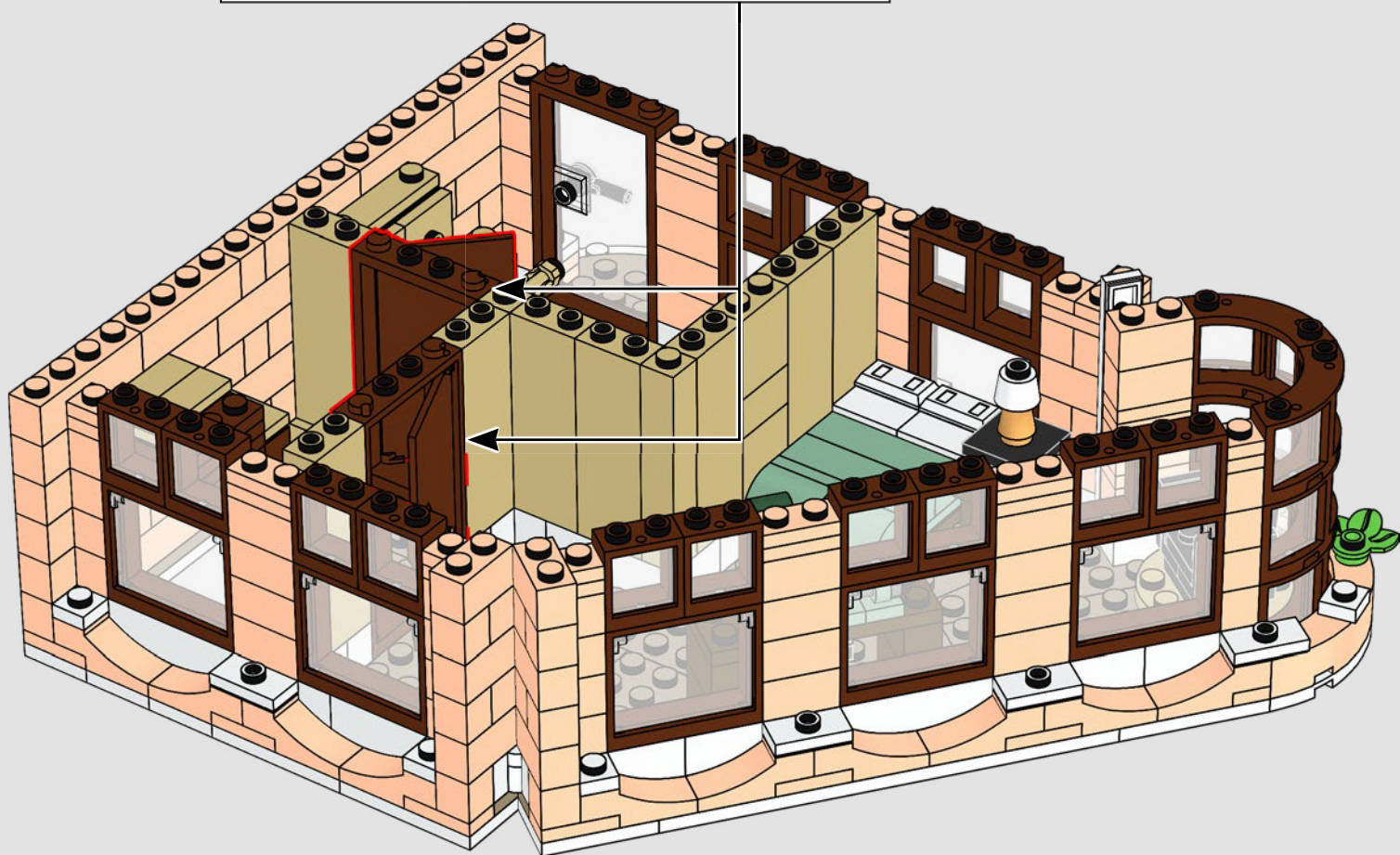
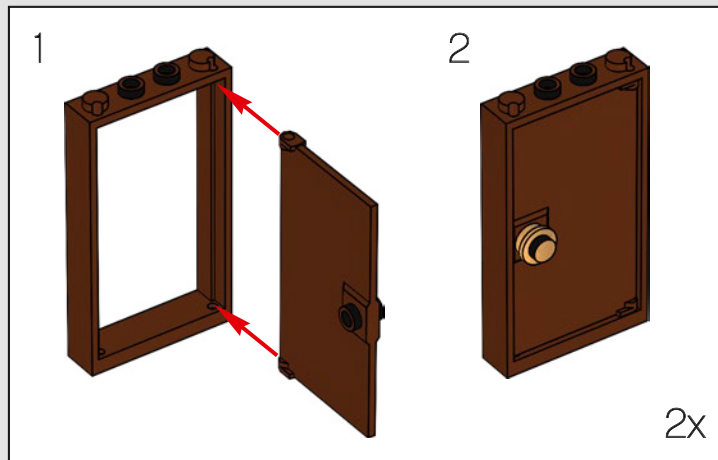

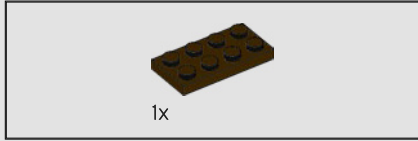
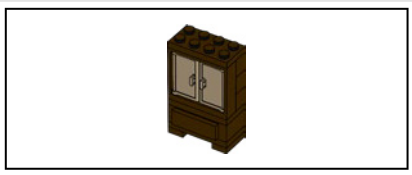

221

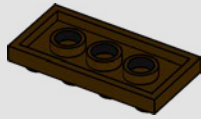

222

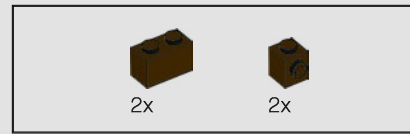
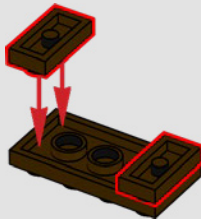

223

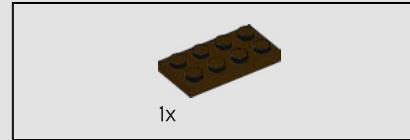
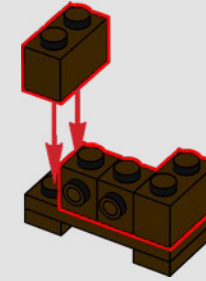
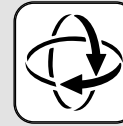

224

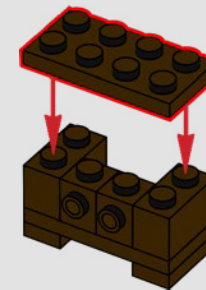

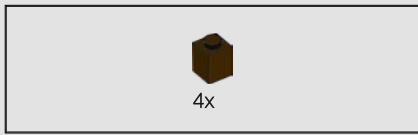

225

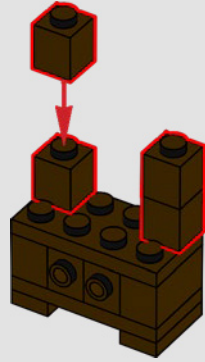

226

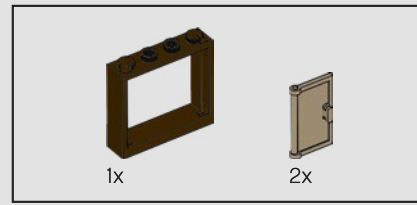
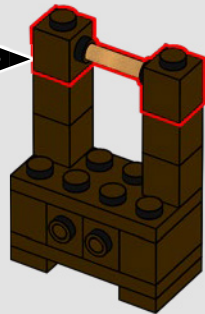
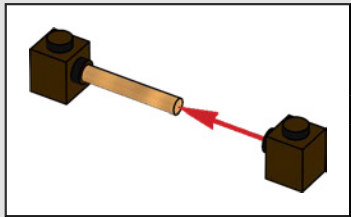

227

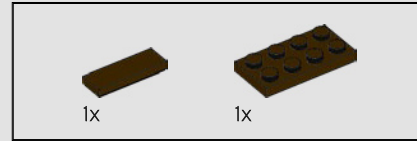
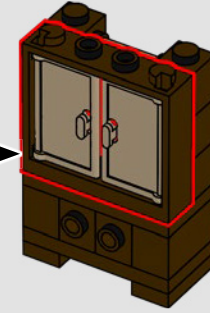
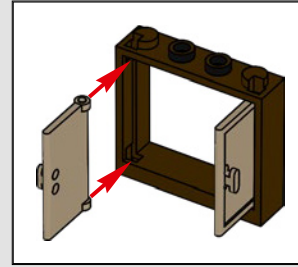

228

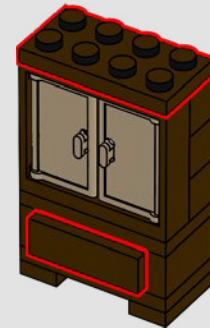

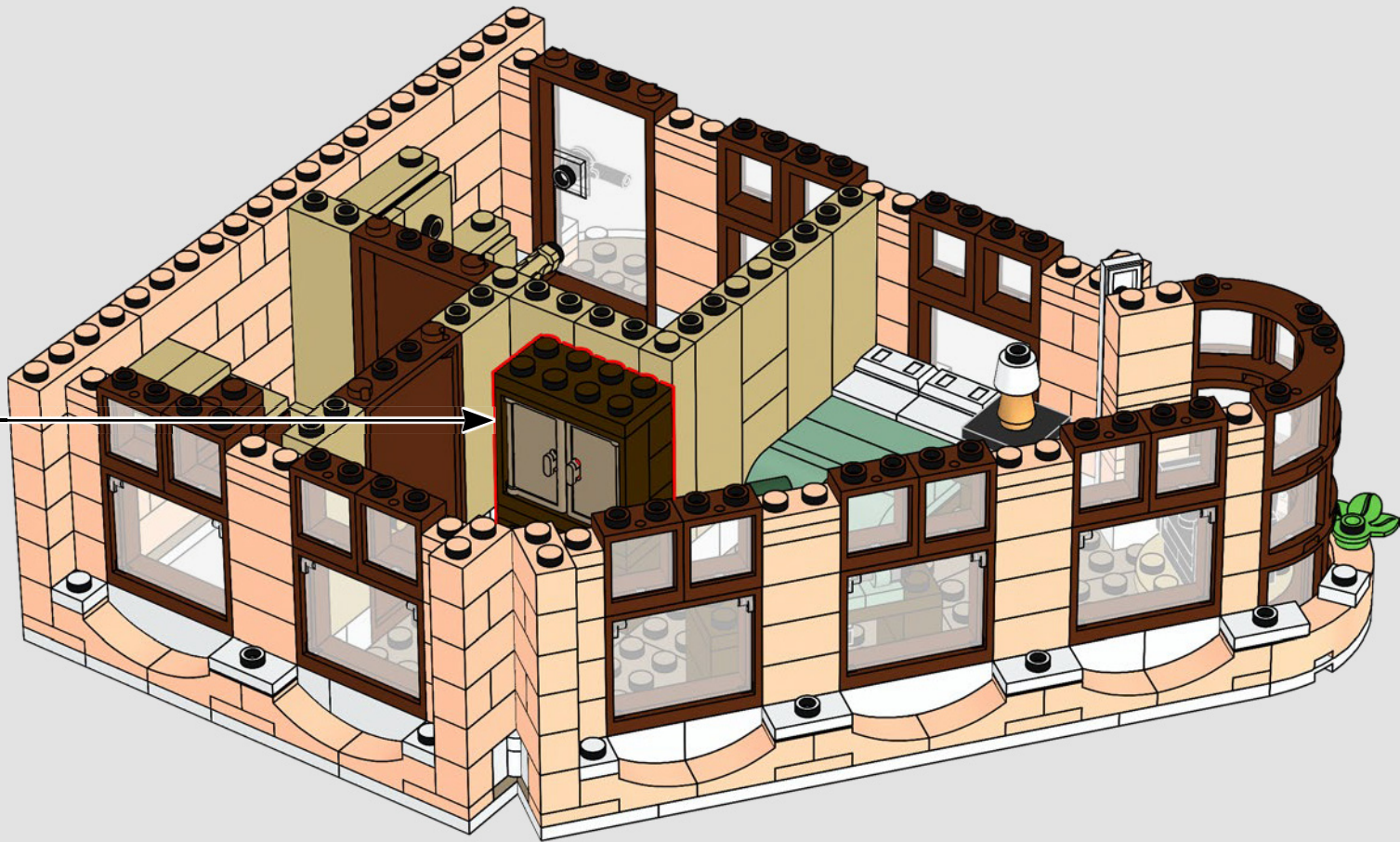

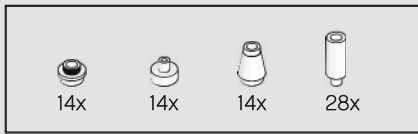

230

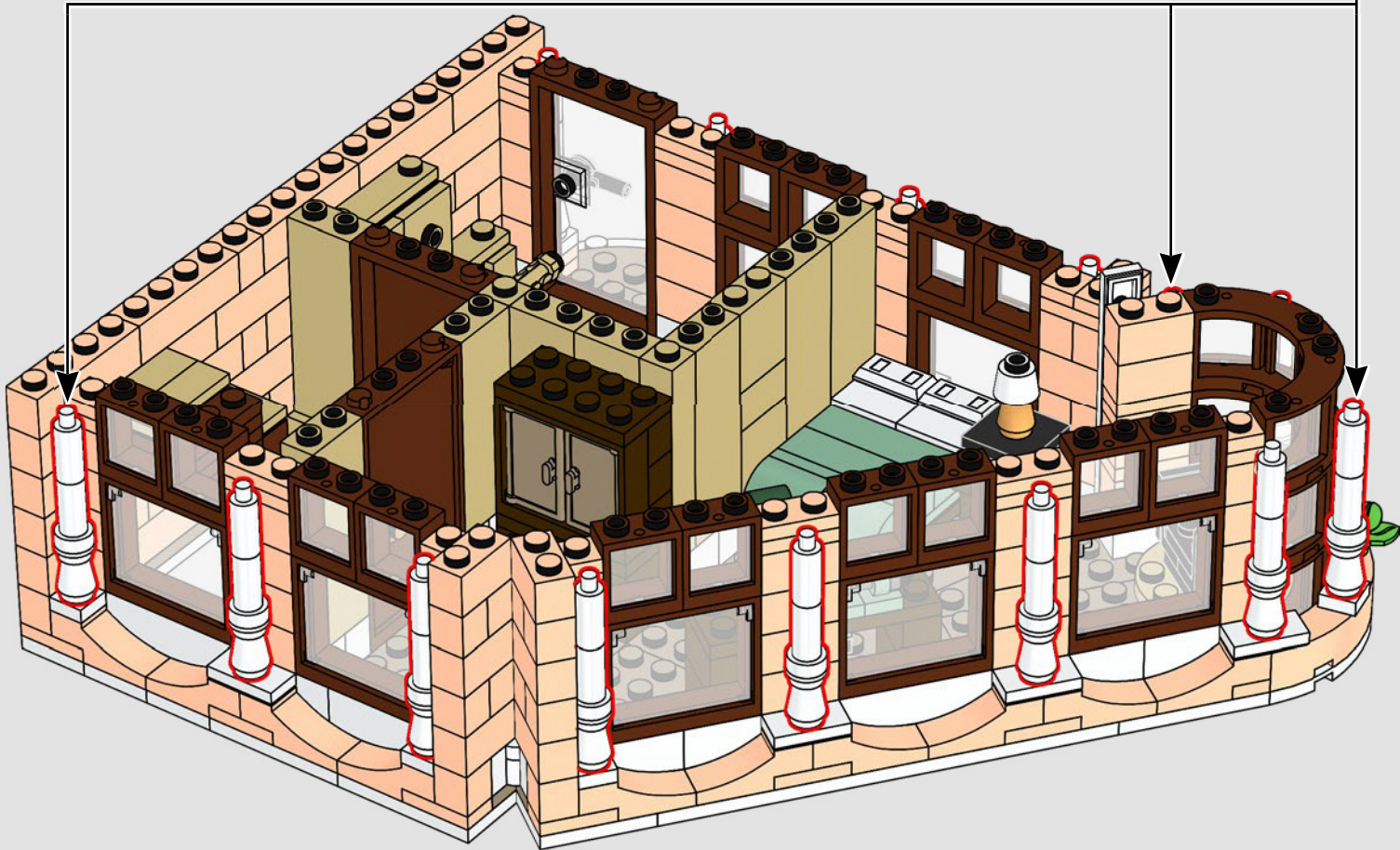
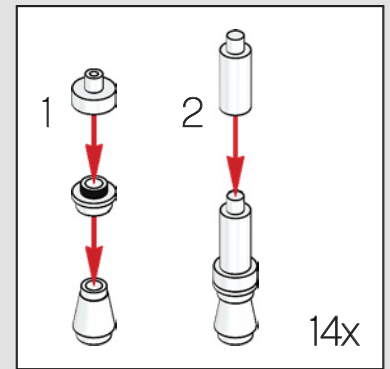

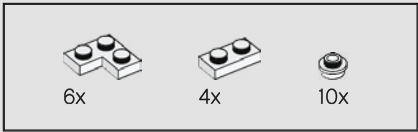

231

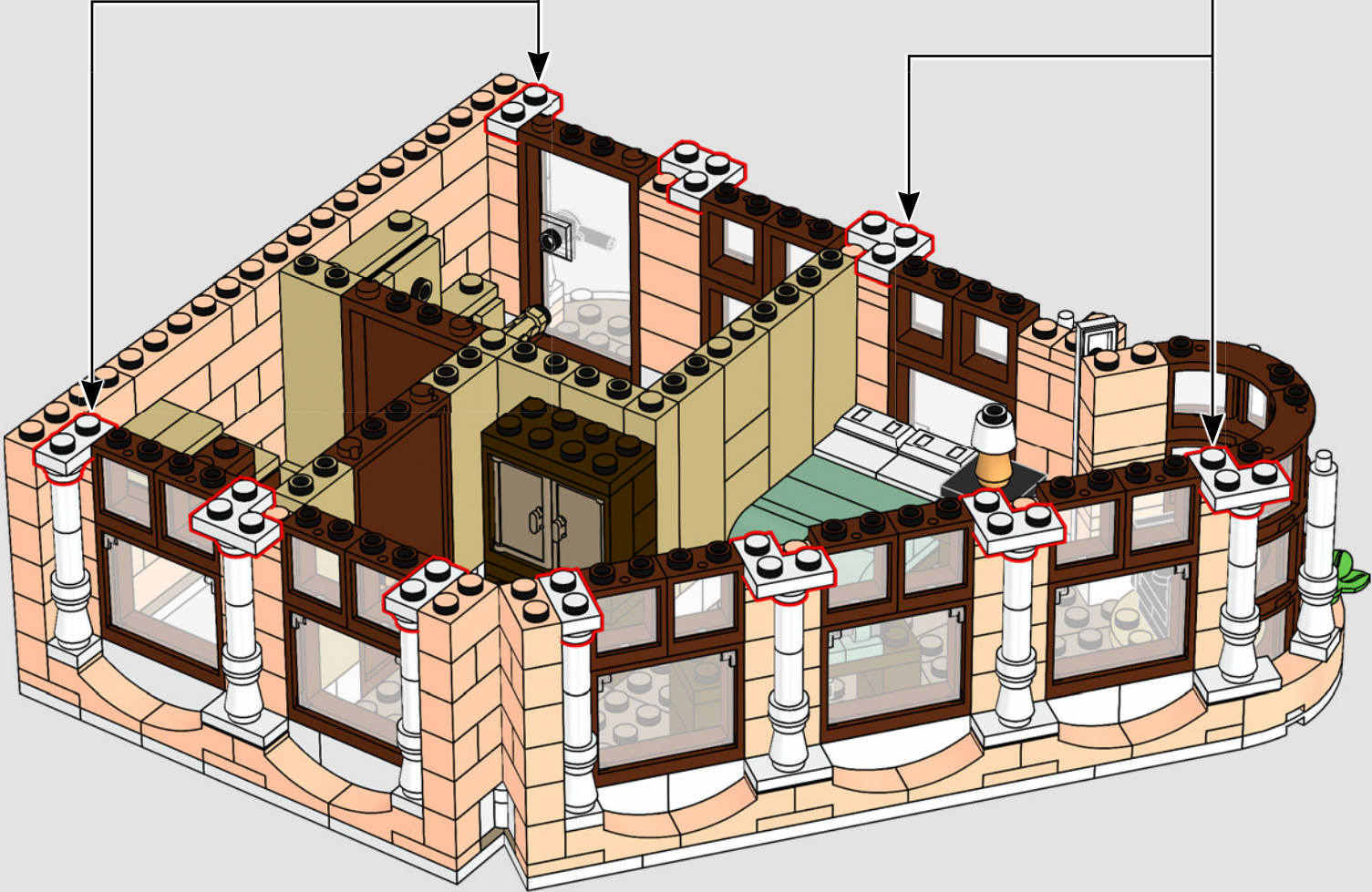
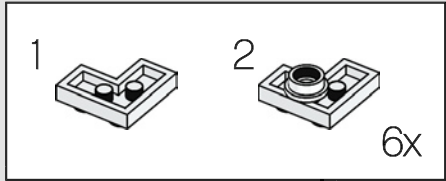
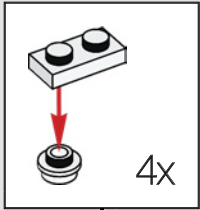

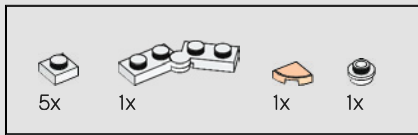

232

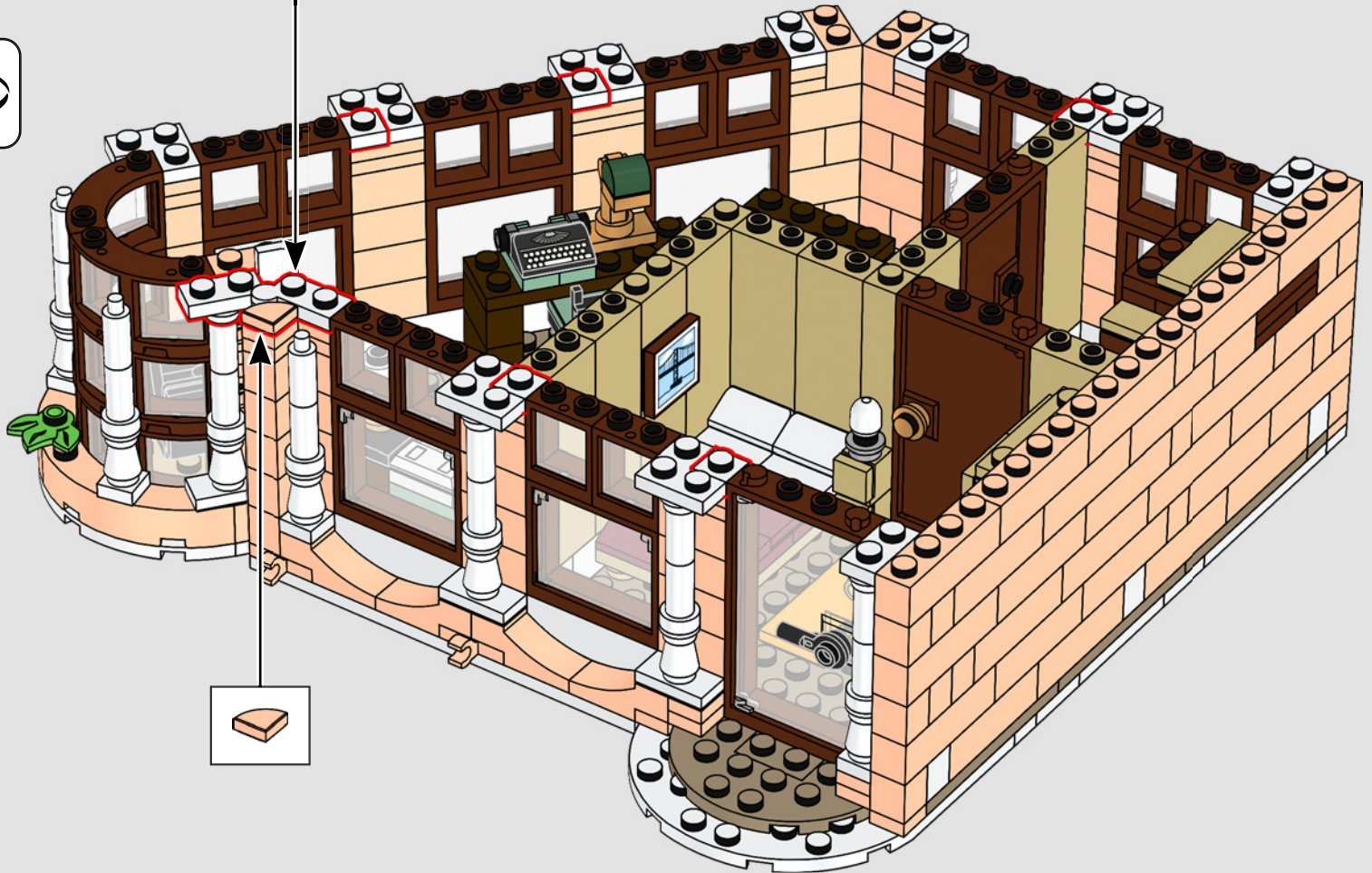
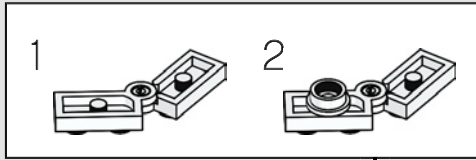

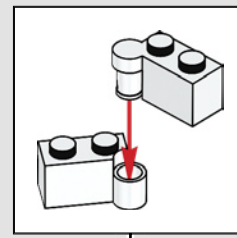
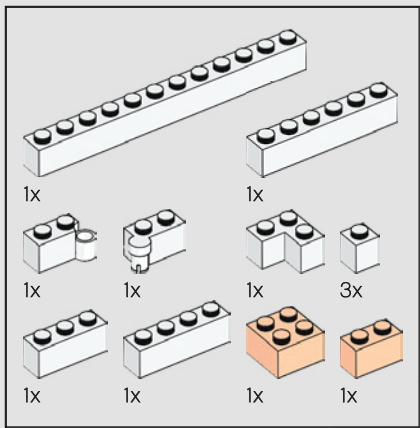

233

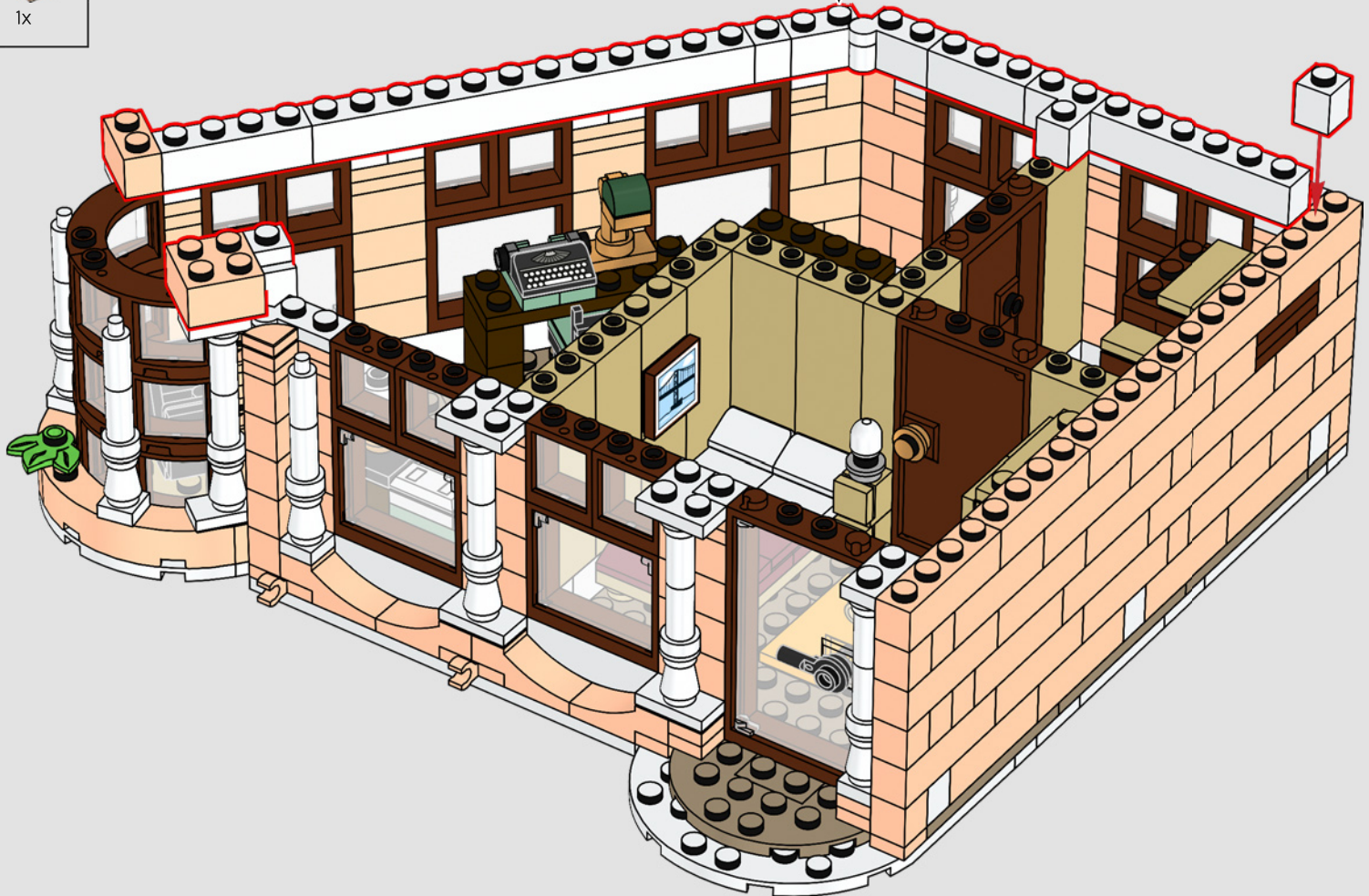

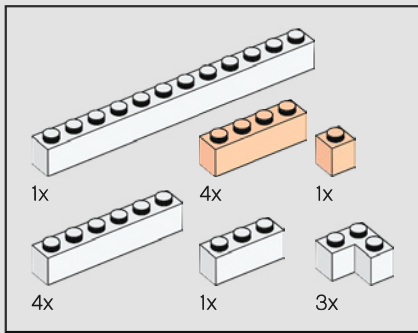

234



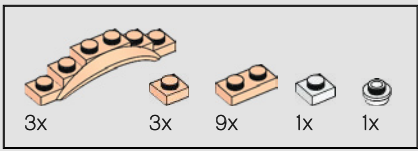

235

1

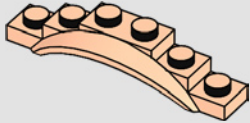

2

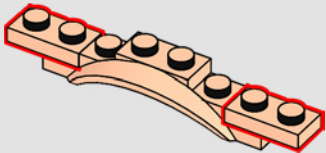

3

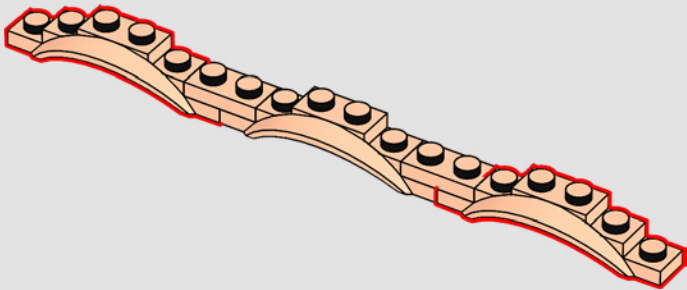

4

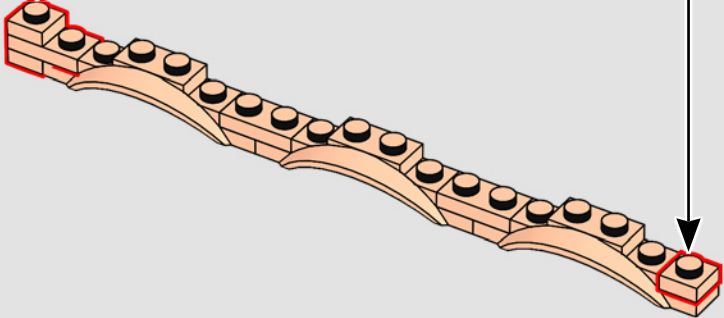
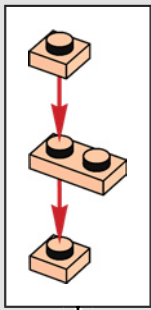

5

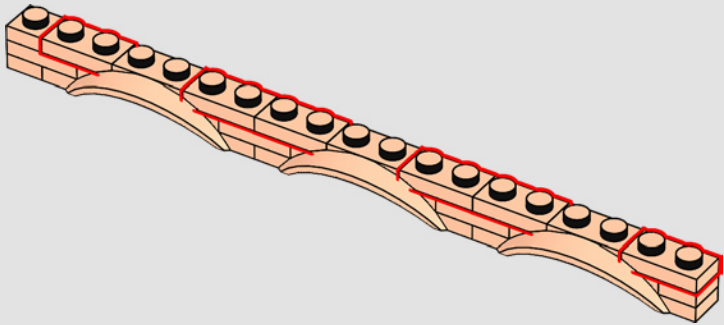

6

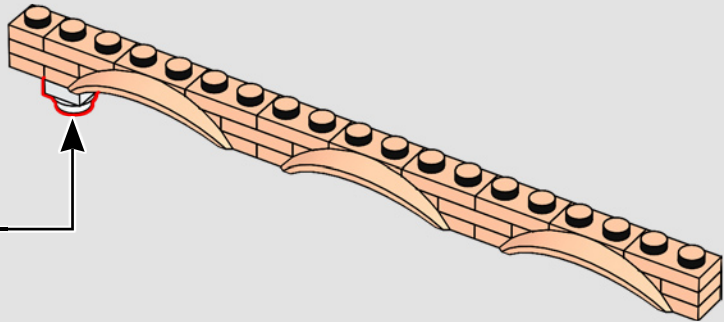
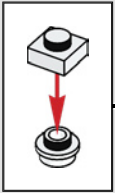



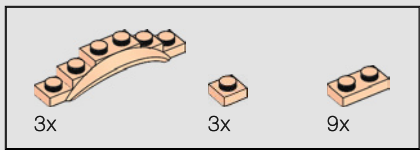

236

1

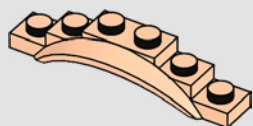

2

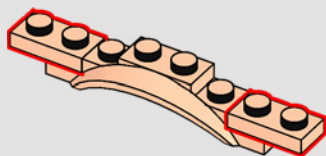

3

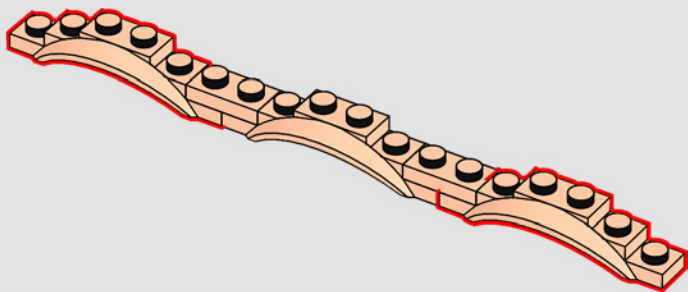

4

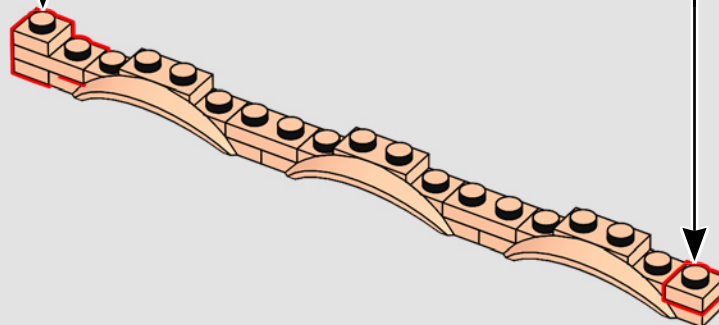
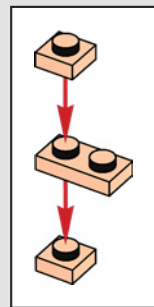

5

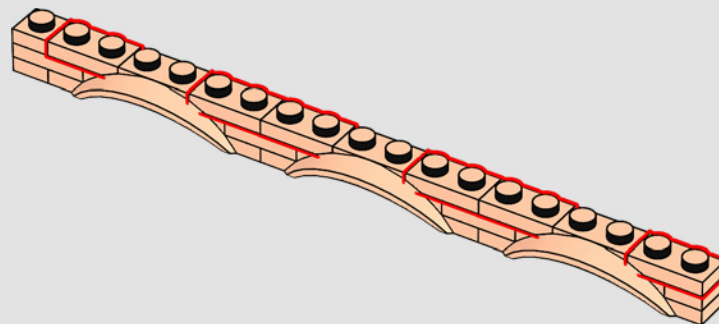

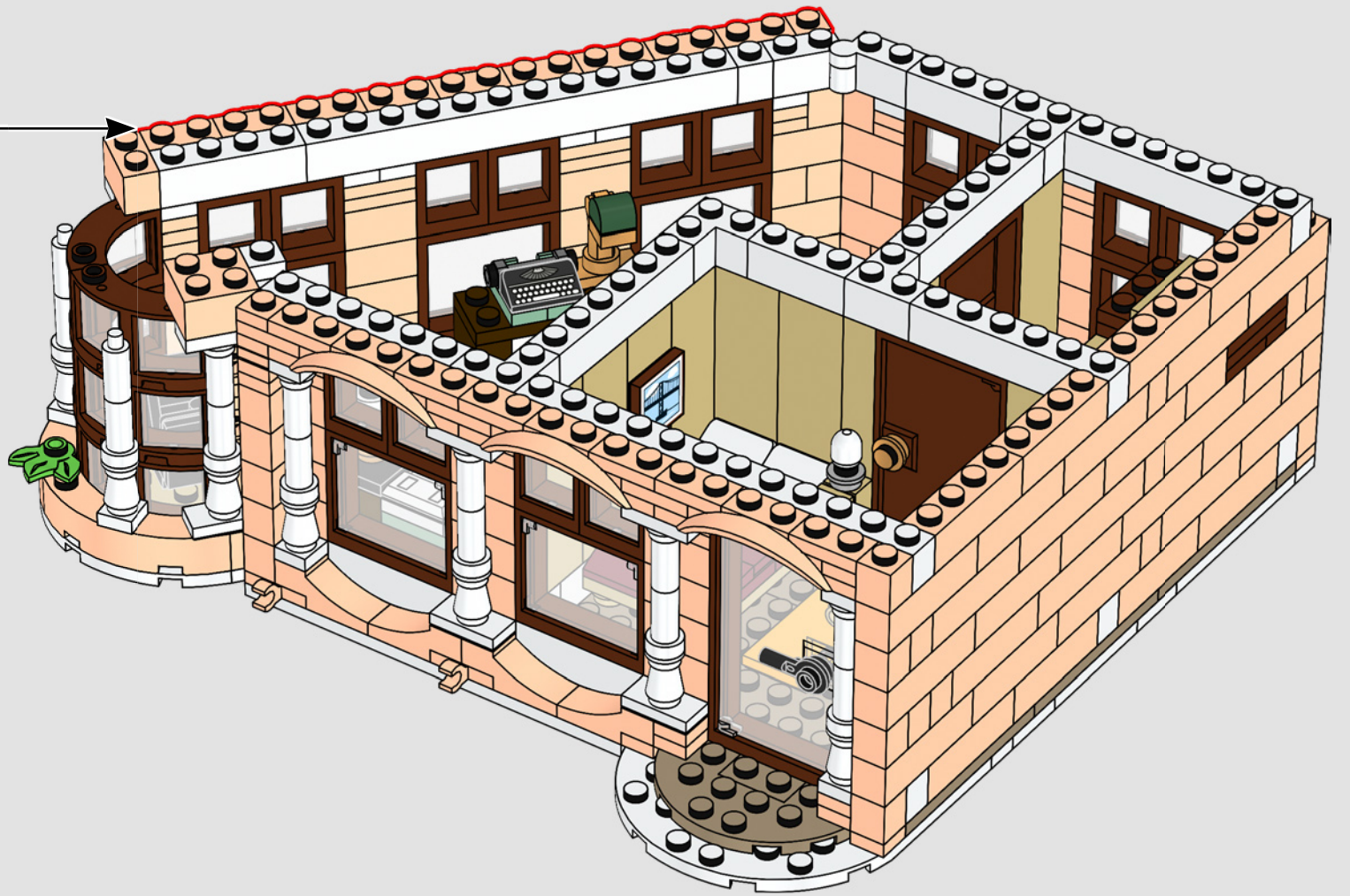

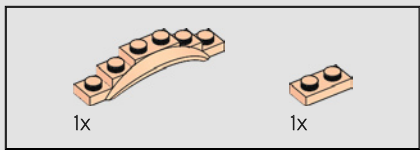

237

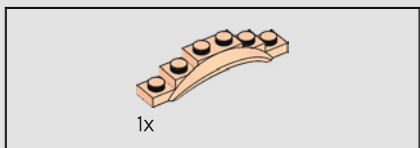
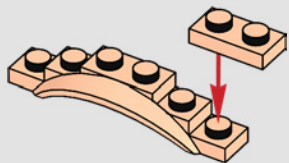

238

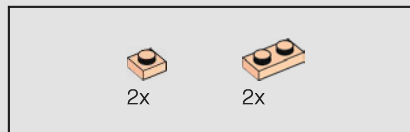
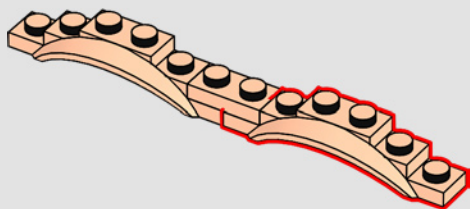

239

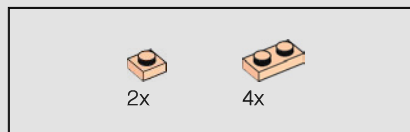
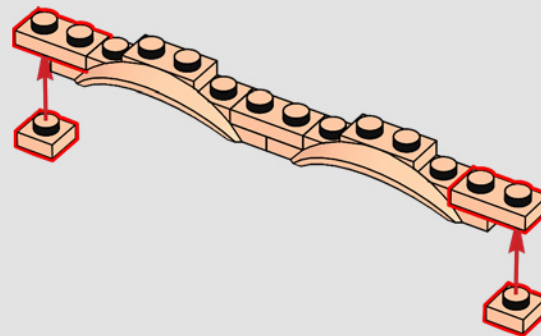

240

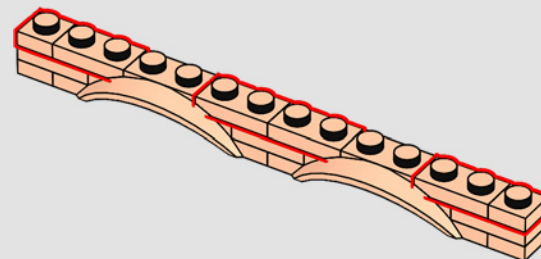

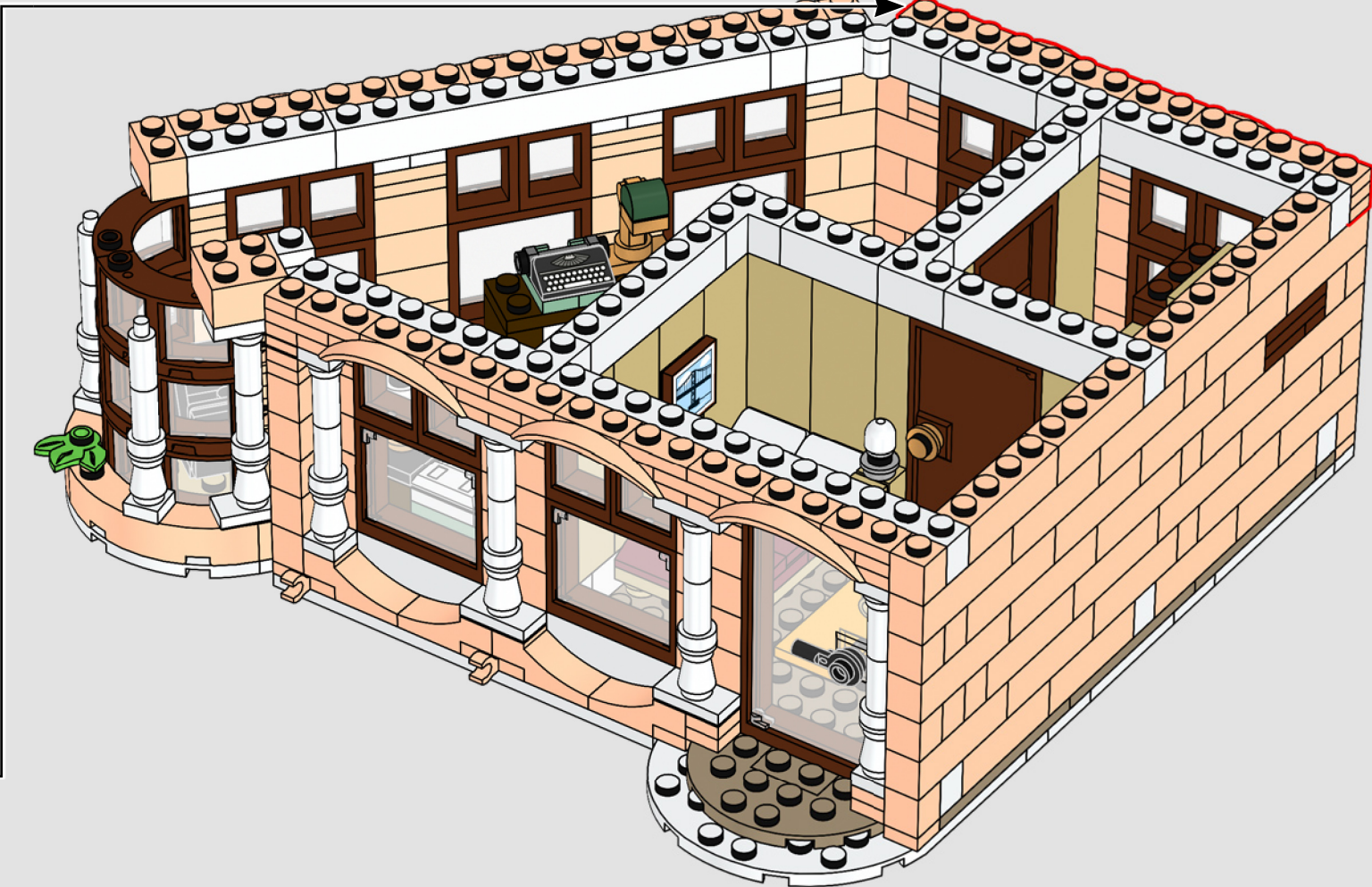

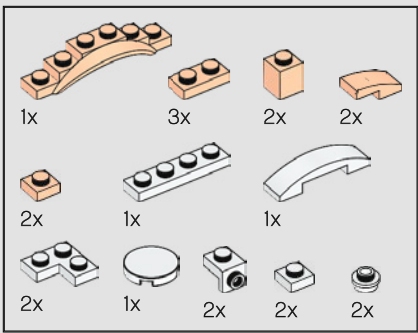

242

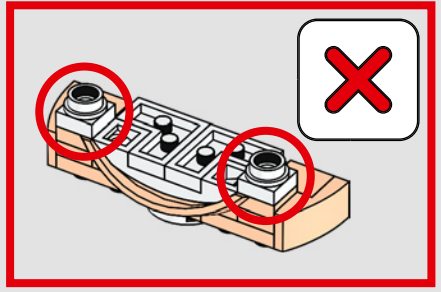
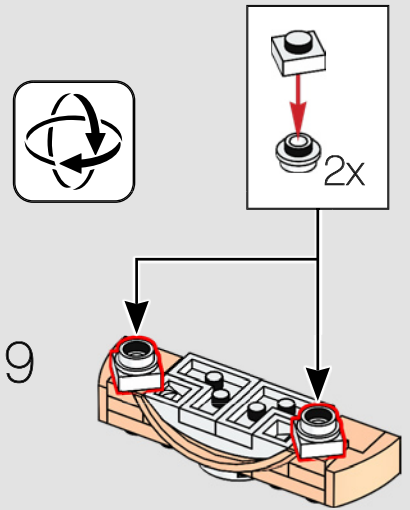
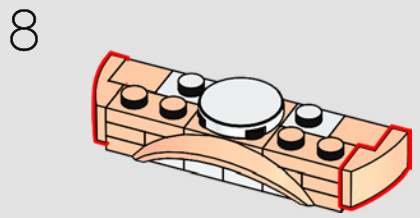
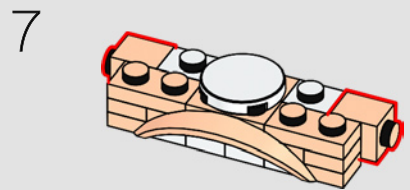
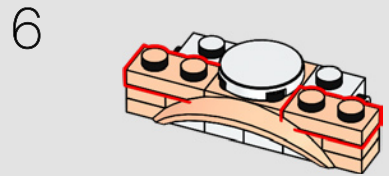
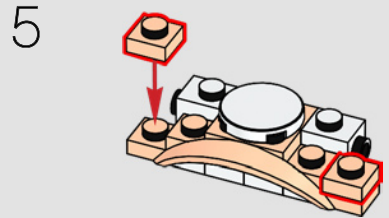
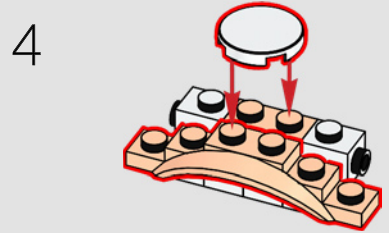
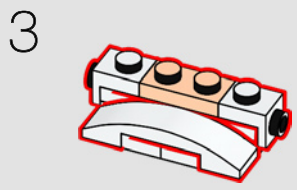
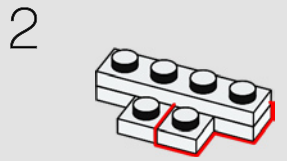
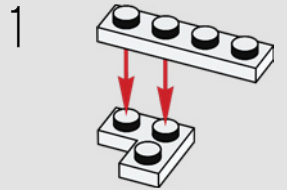

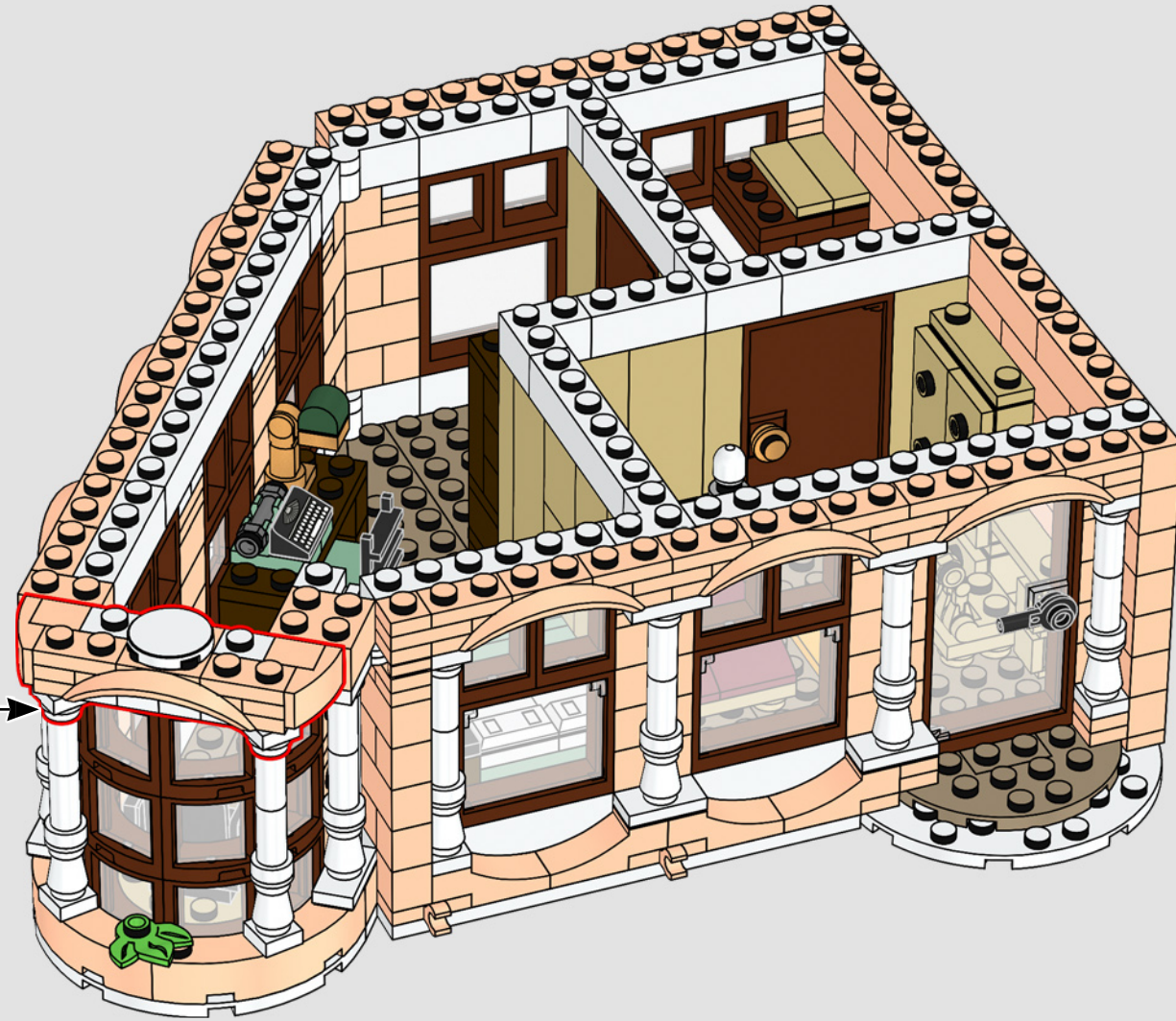

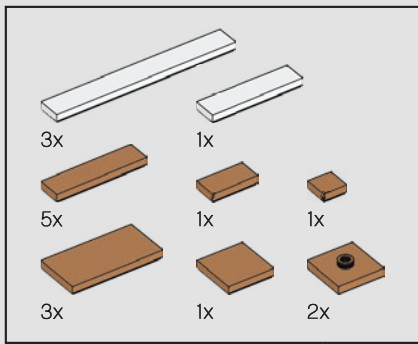

243



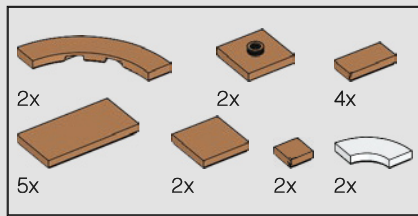

244

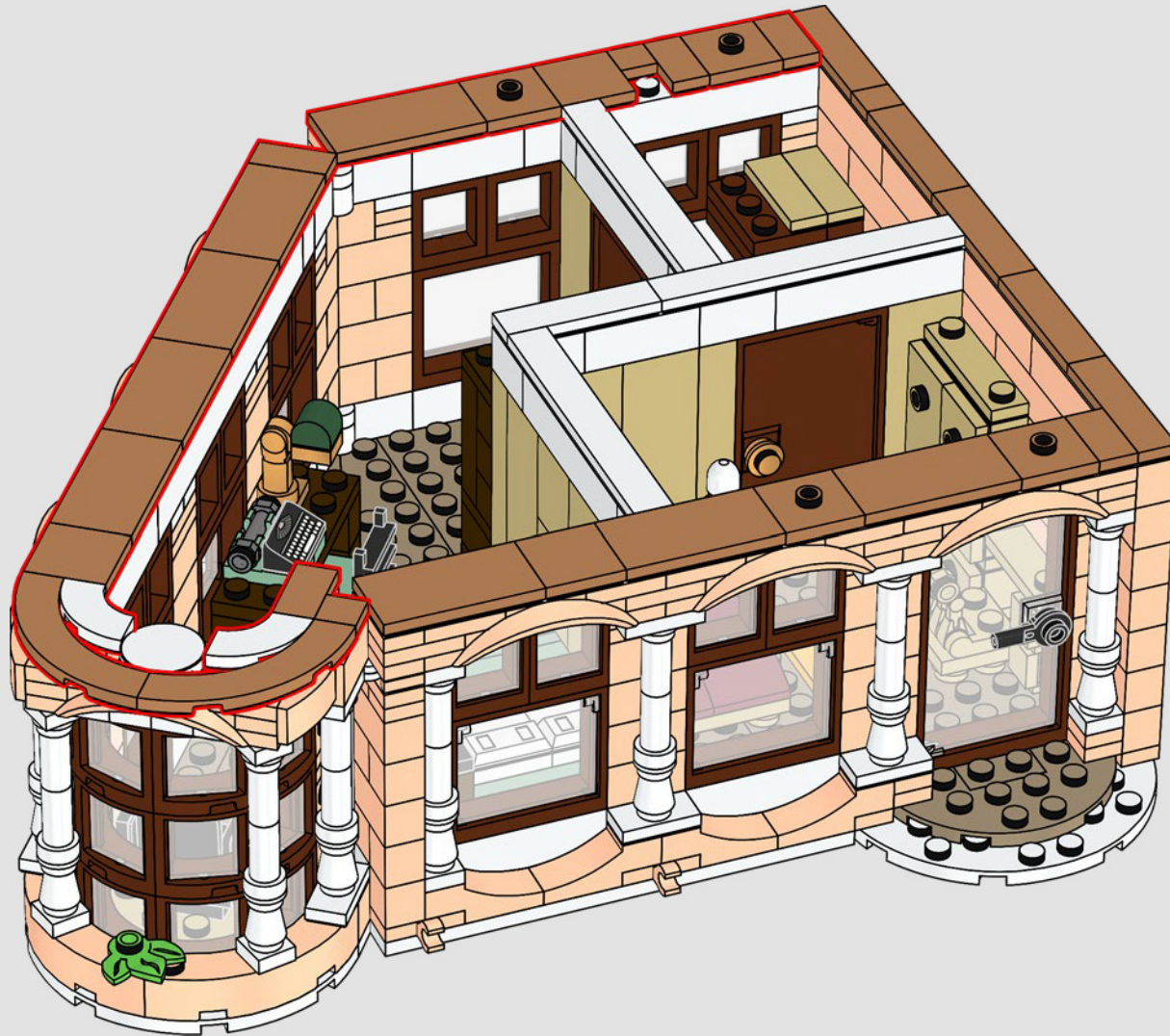

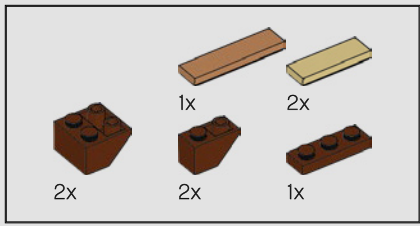

245

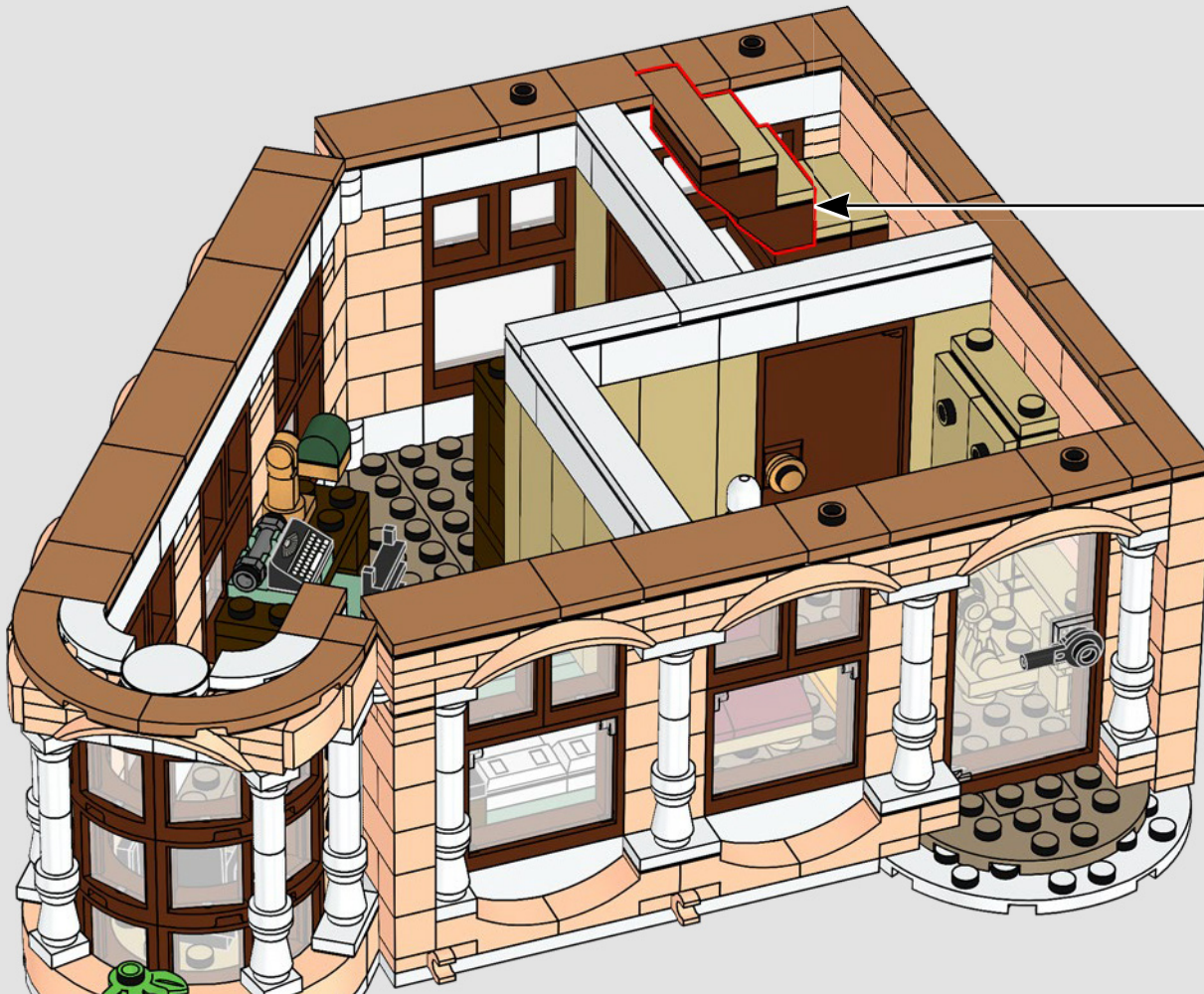
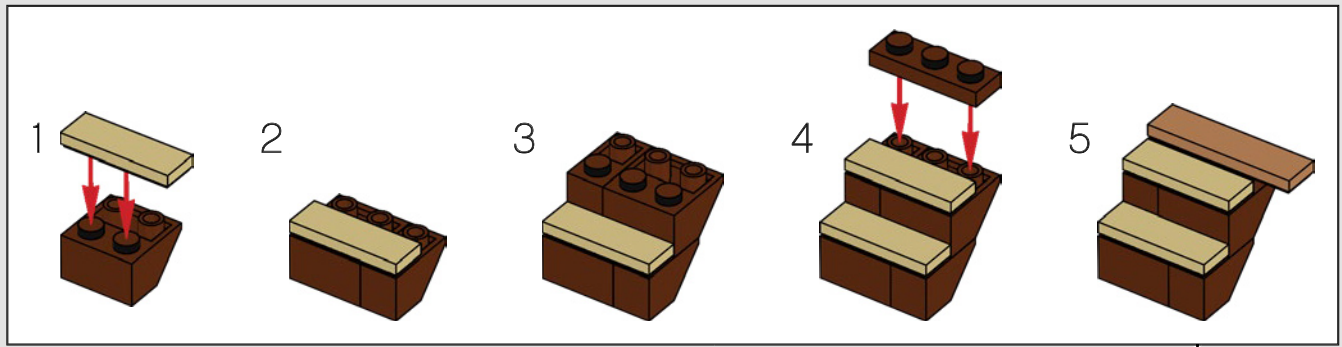

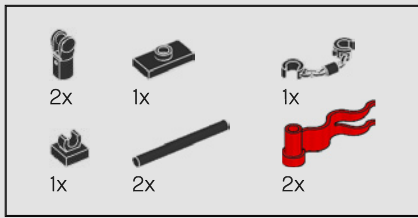

246

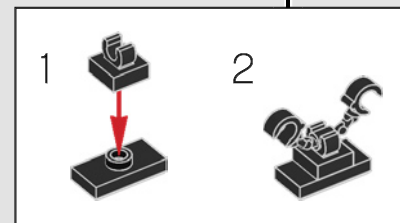
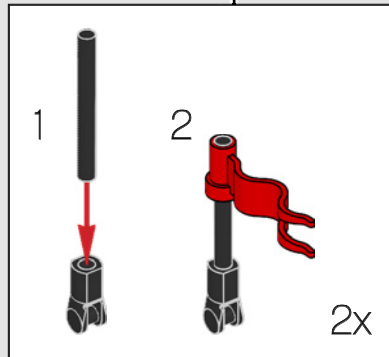



247



Minifigure skeleton legs were first used as a balcony detail in the 10185 Greengrocer set.

Les jambes de squelettes ont été utilisées pour la première fois pour l'ornementation du balcon dans l'ensemble L'épicerie (10185).

Las piernas de minifiguras de esqueleto se usaron por primera vez como detalle en el balcón del set Tienda de Verduras (10185).

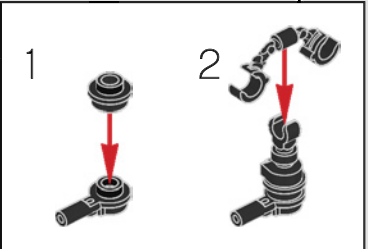
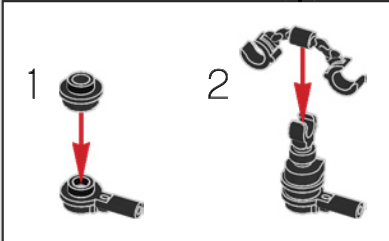



10

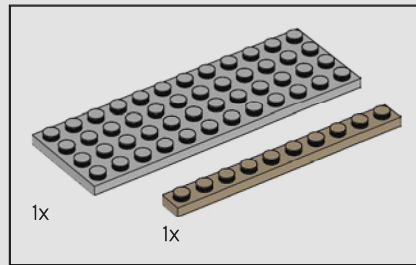
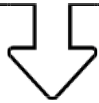

249

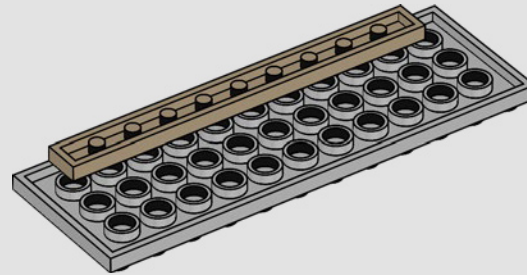

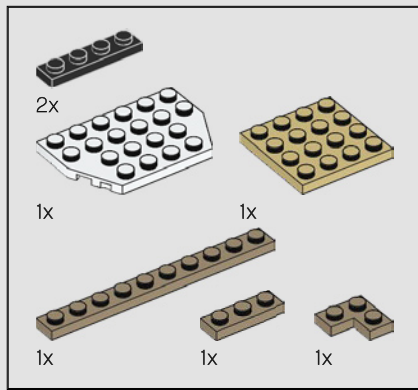

250

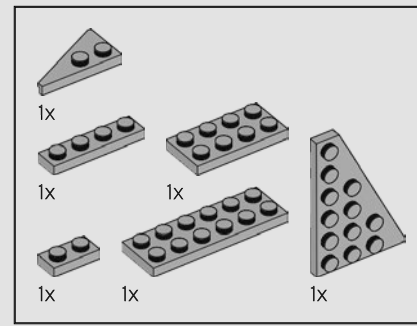
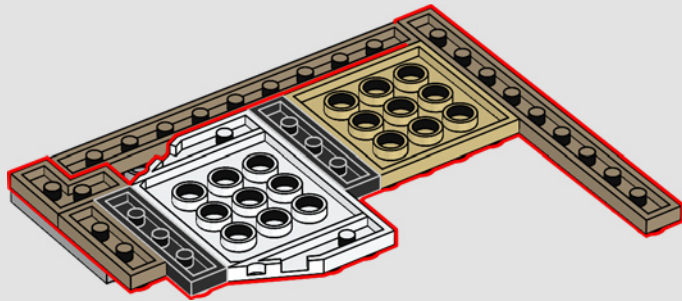

251

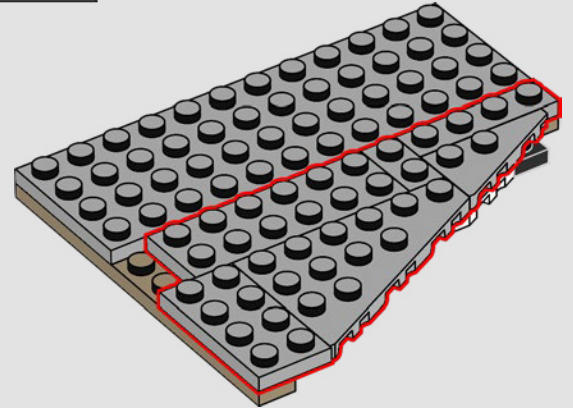
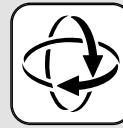

252

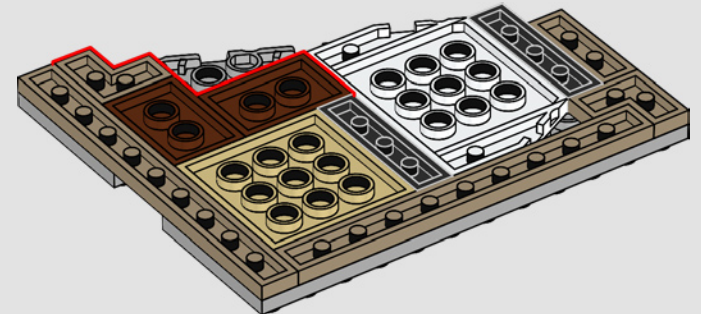
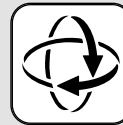

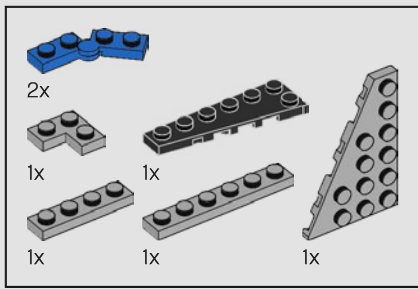

253

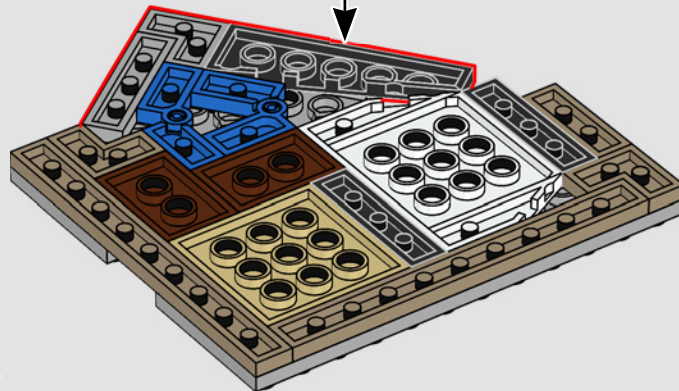
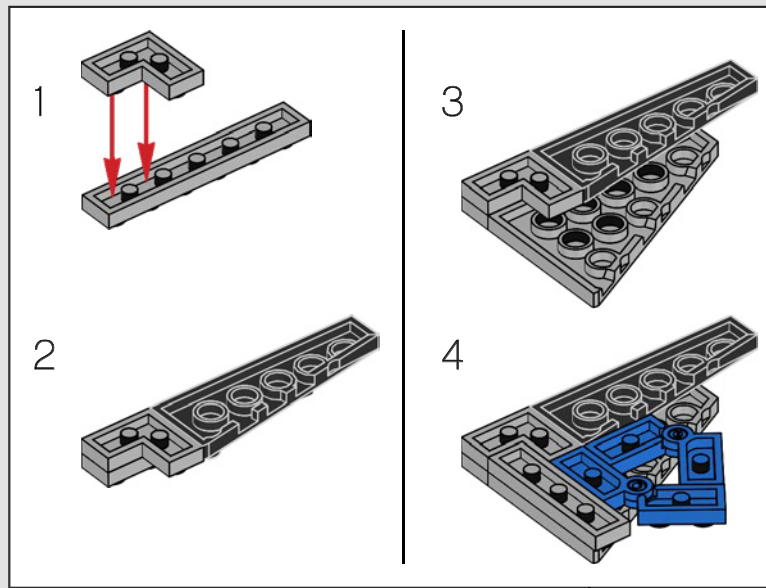

The terrace is built using reflected triangle geometry. Combined with the Hotel building itself, this creates Pythagorean triangles that align perfectly with the LEGO® grid system.

La terrasse est construite à l'aide du principe du triangle réfléchi. Avec la structure de l'hôtel, des triangles pythagoriciens se forment et s'alignent parfaitement avec le système de grille LEGO®.

180 La terraza se construye aplicando geometría de triángulos invertidos. En combinación con el propio edificio del hotel, ello da lugar a triángulos pitagóricos que encajan a la perfección con la retícula del sistema LEGO®.

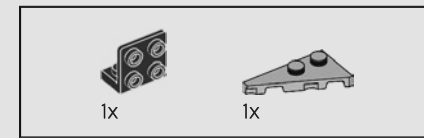

254

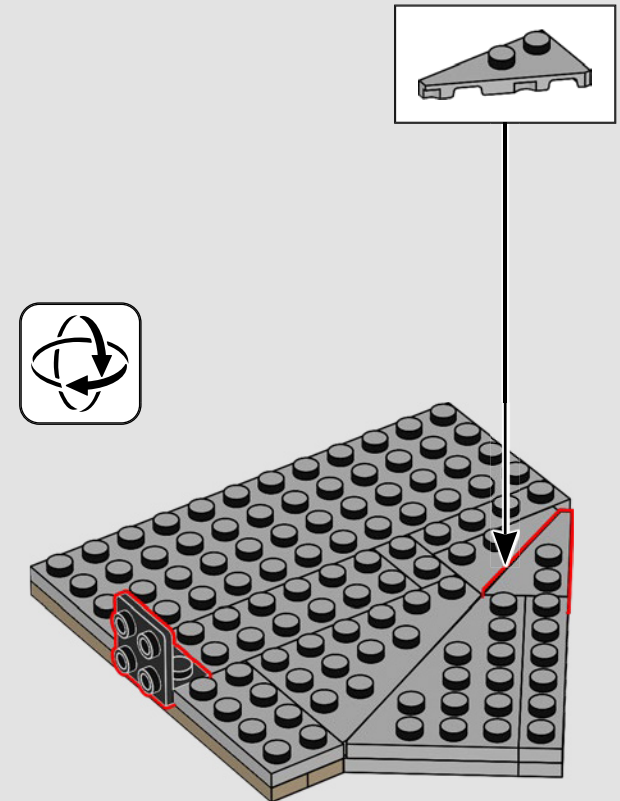

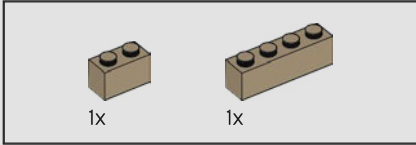

255

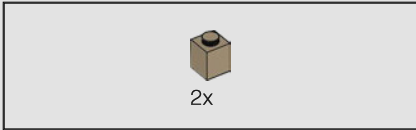
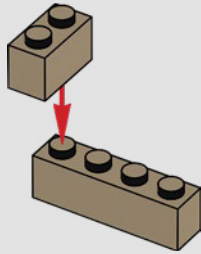

256

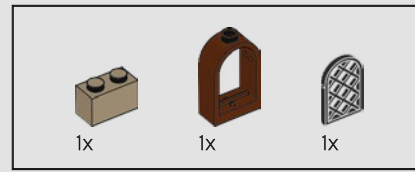
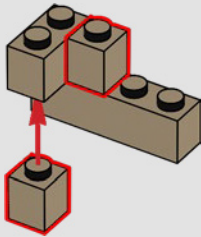

257

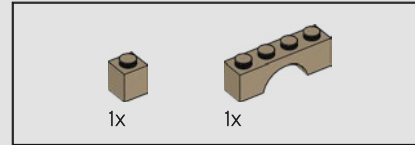
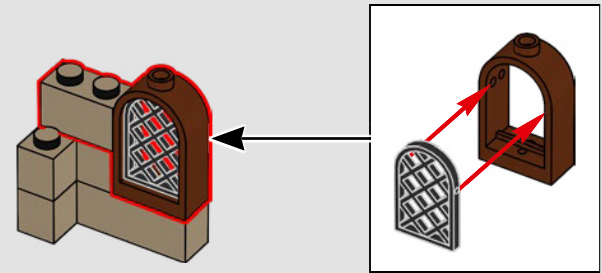

258

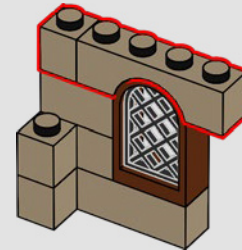

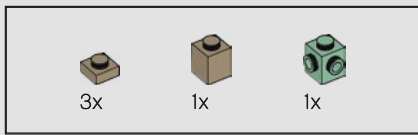

259

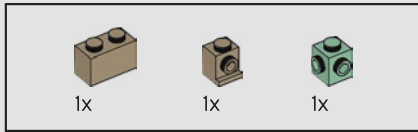
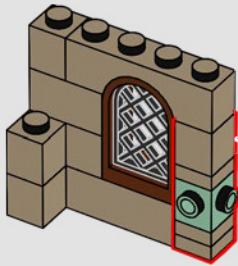
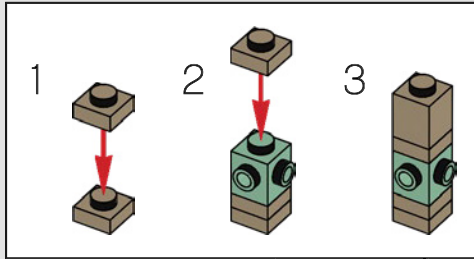

260

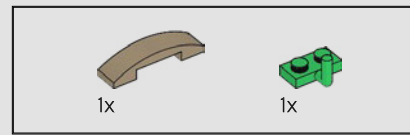
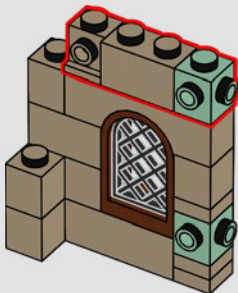

261

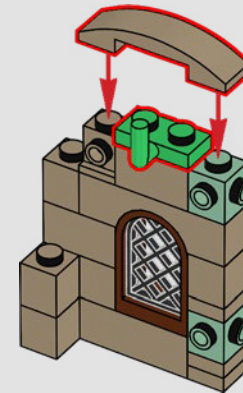

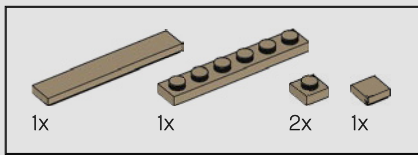

262

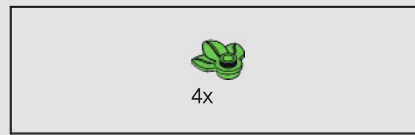
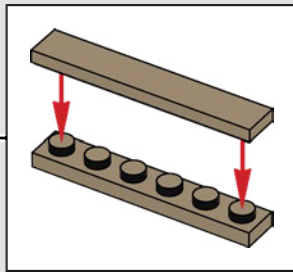
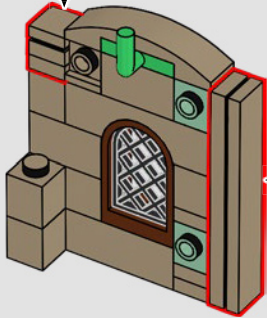
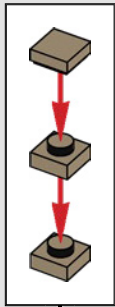

263

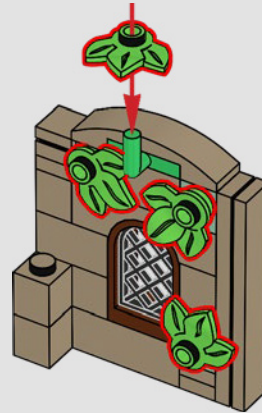

264

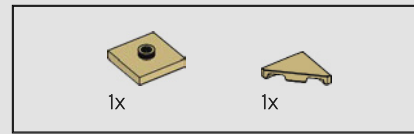
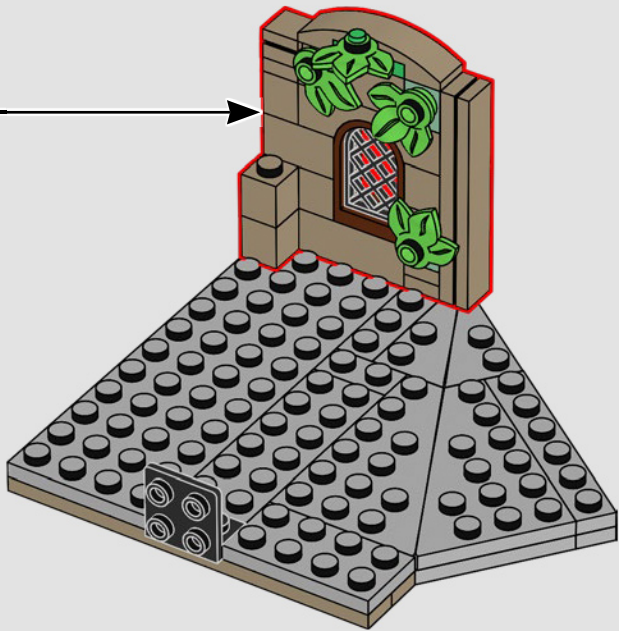

265

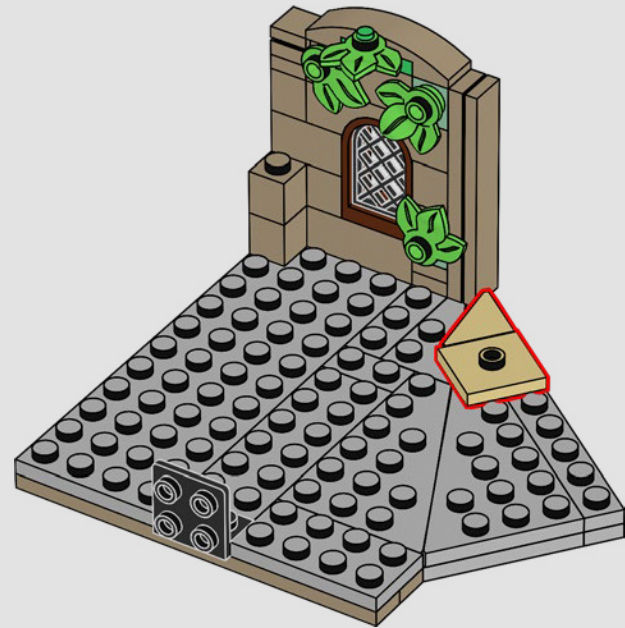

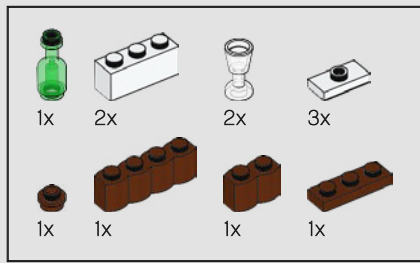

266

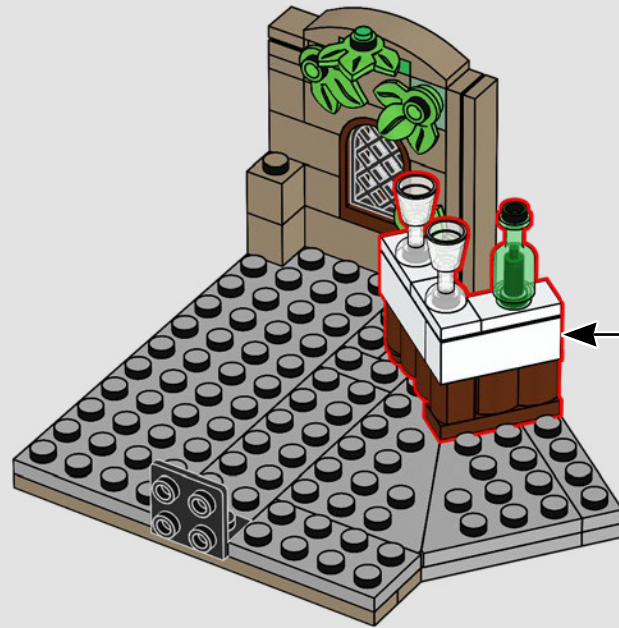
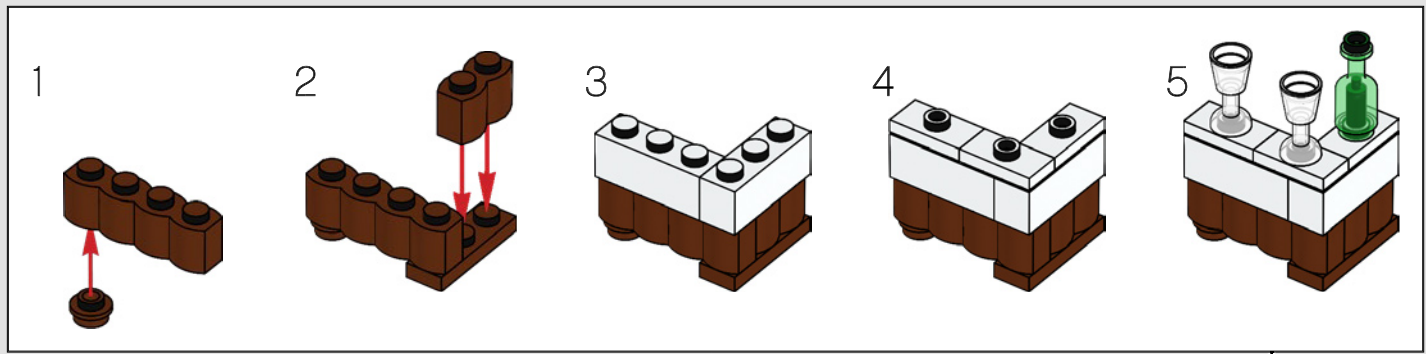

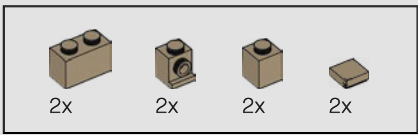

267

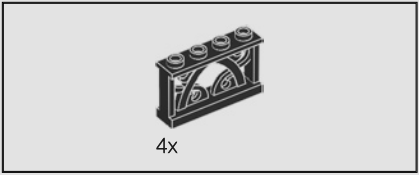
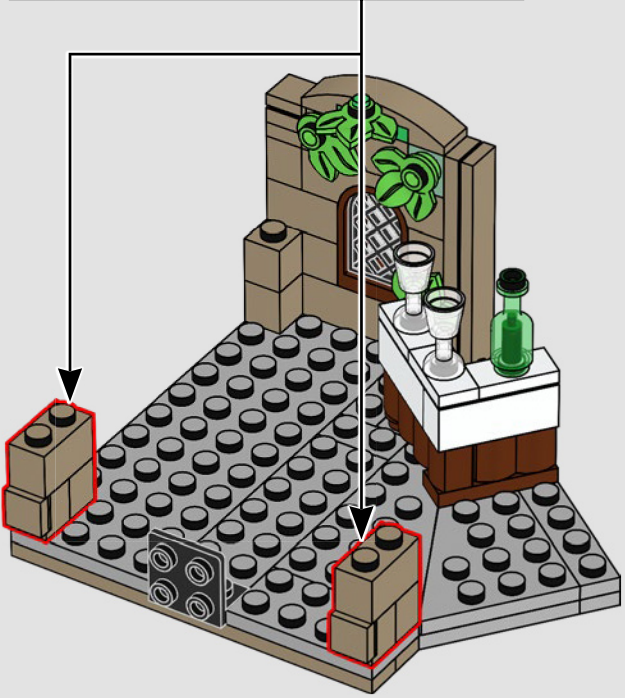
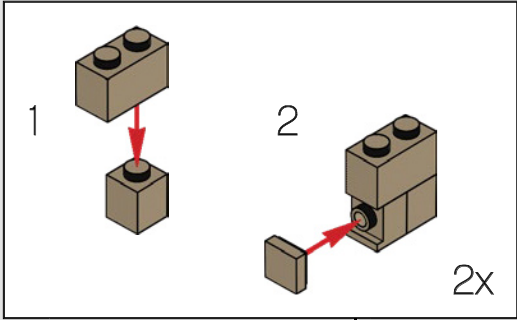

268



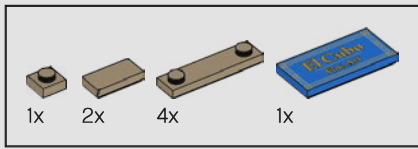

269

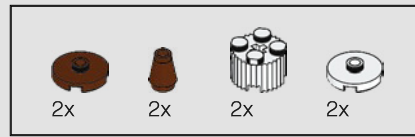
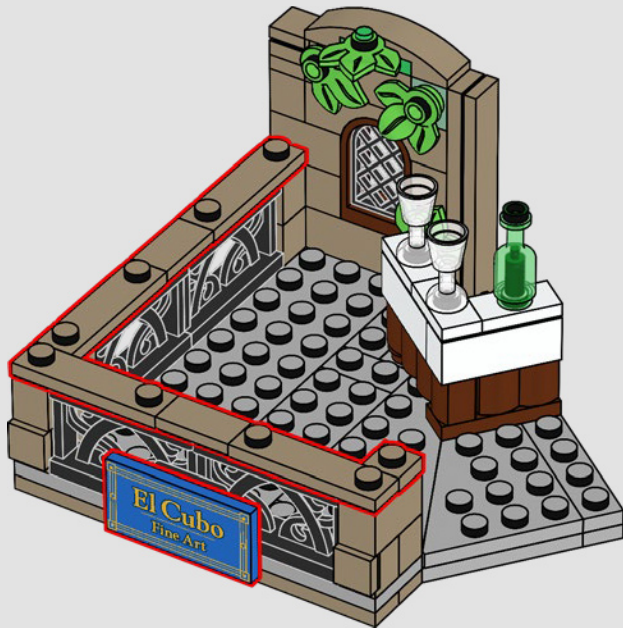

270

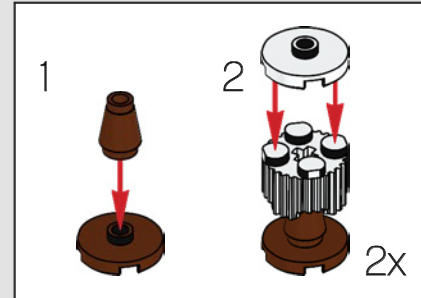

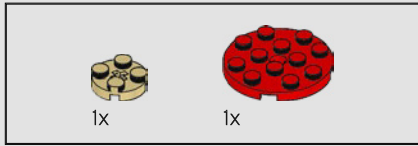

271

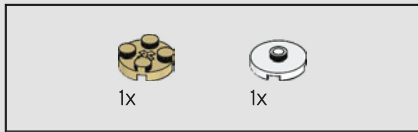

272

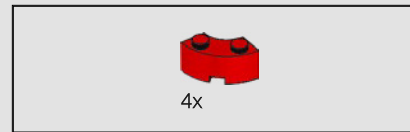
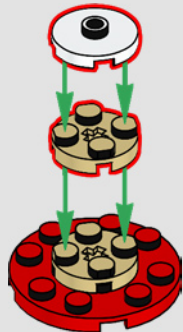

273

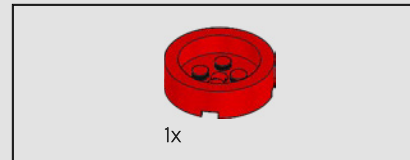
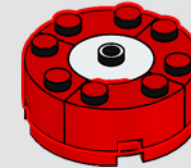

274

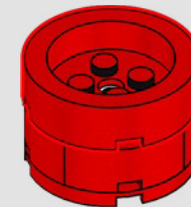

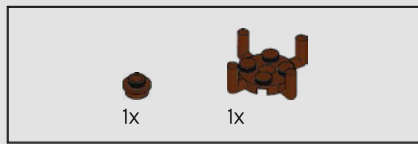

275

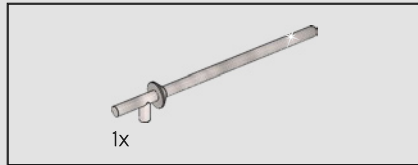
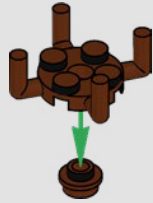

276

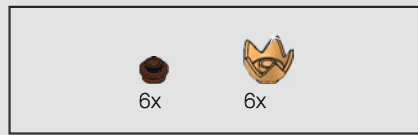
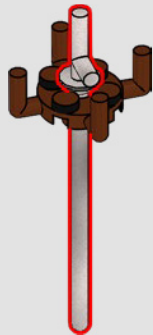

277

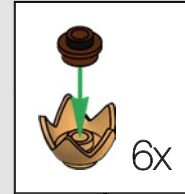

278

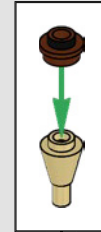

279

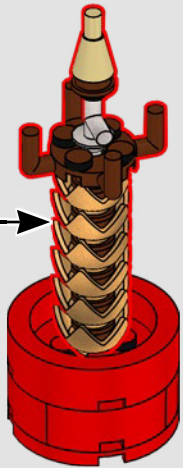

5x

280

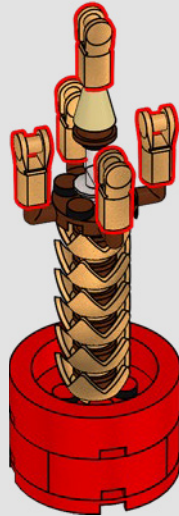

5x

281

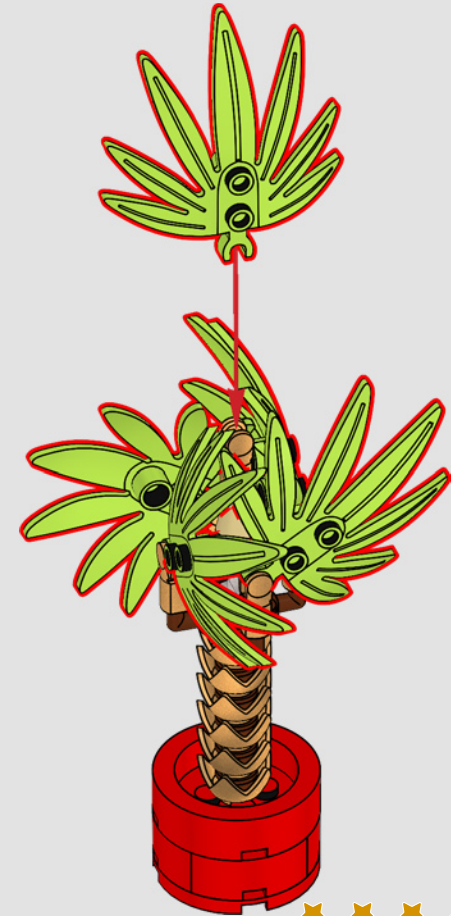

The elements used to make the trunk of the palm tree first appeared as the crown of Queen Watevra Wa'nabe from *The LEGO® Movie 2™*.

Les éléments utilisés pour fabriquer le tronc du palmier sont apparus pour la première fois comme couronne de la reine Jpeuzette Skejai'envie du *Film LEGO® 2*.

Los elementos que se usan para hacer el tronco de la palmera se crearon para representar la corona de la Reina SoyLoQue QuieraSer en *La Gran Aventura LEGO® 2*.

282

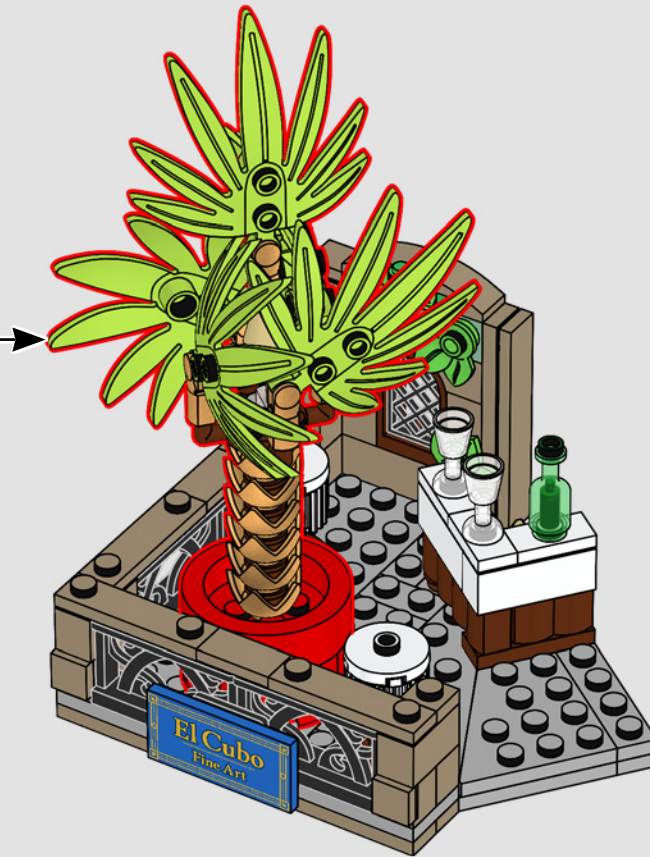

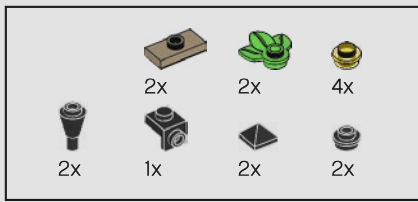

283

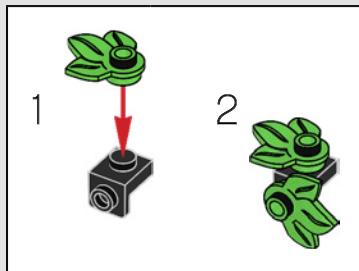
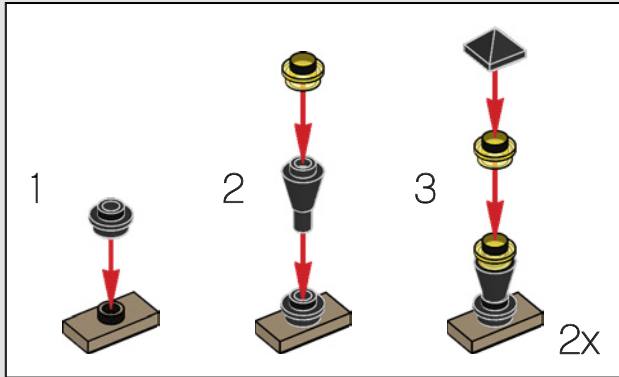

284



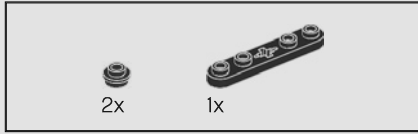
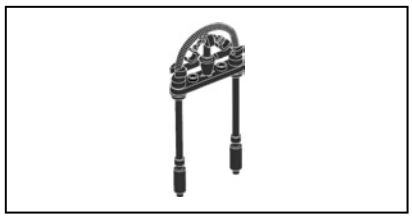

285

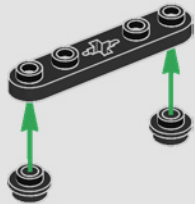

286

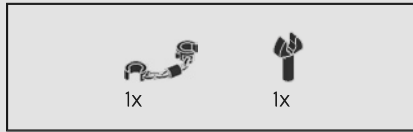
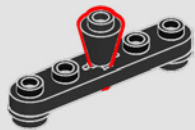

287

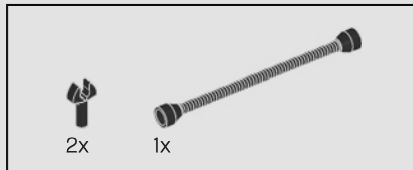
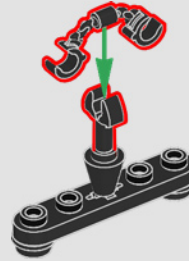

288

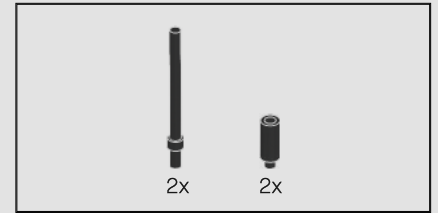
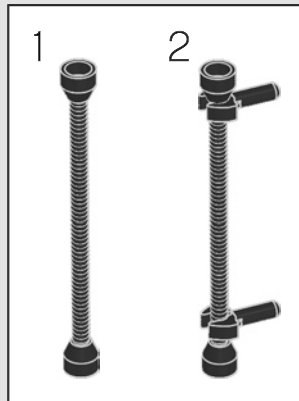

289

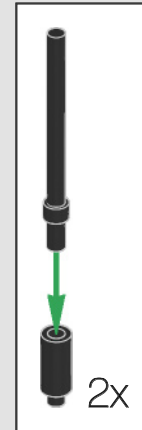
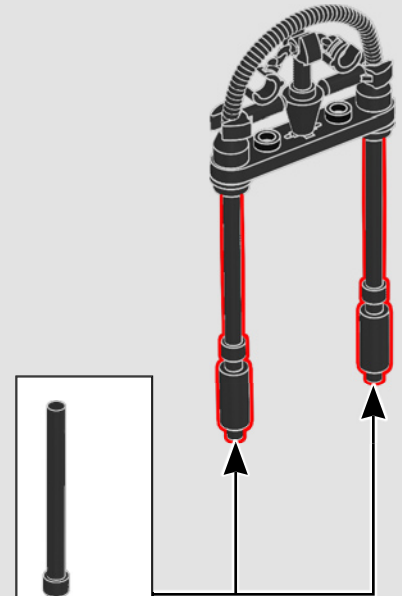

290



A wrought-iron gate first appeared in the 10190 Market Street set. It was notable for its use of minifigure whips to make organic curving details.

La porte en fer forgé est apparue pour la première fois dans l'ensemble Le marché (10190). Elle se distingue par son utilisation de fouets de figurines pour créer des courbes organiques.

El set Calle del Mercado (10190) fue el primero en incluir una puerta de hierro forjado. Aquella destacaba por el uso de látigos de minifigura para crear detalles orgánicos curvados.

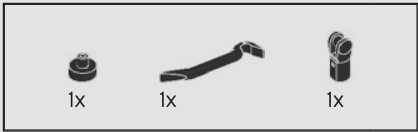

291

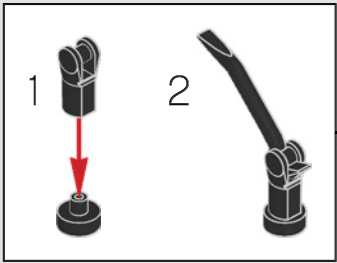

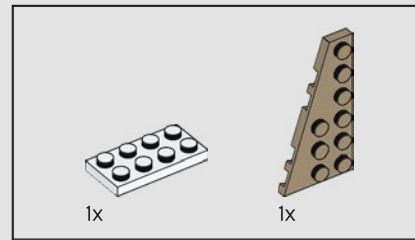
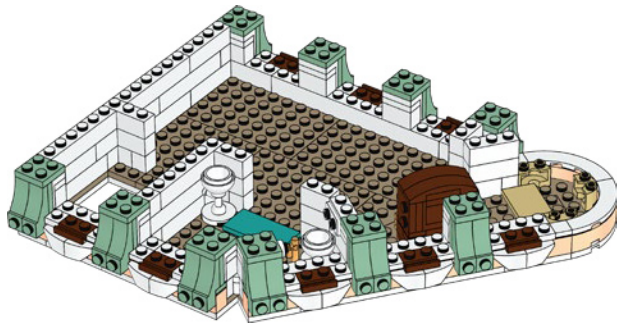
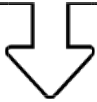

292

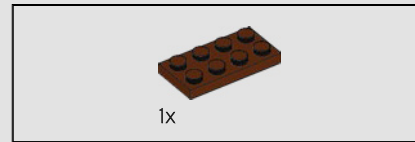
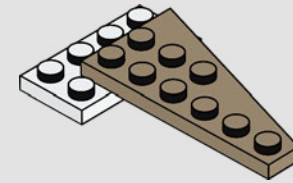

293

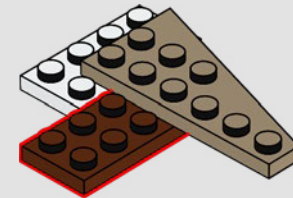

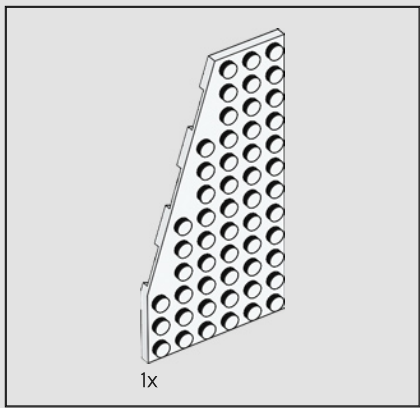

294

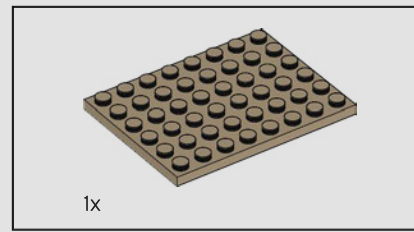
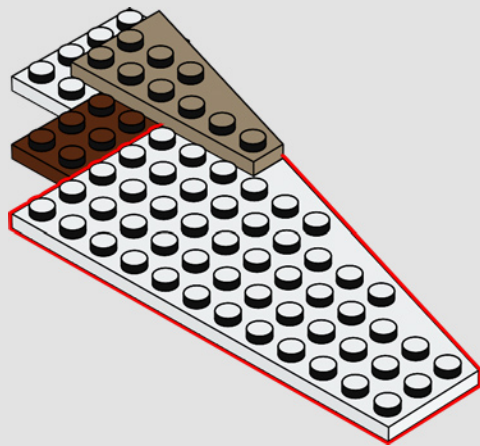

295

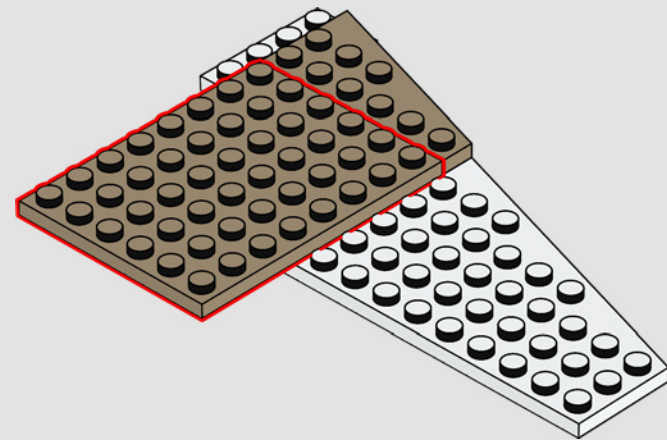

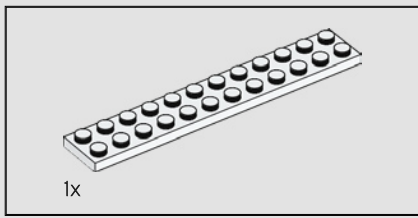

296

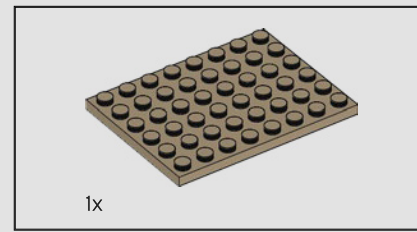
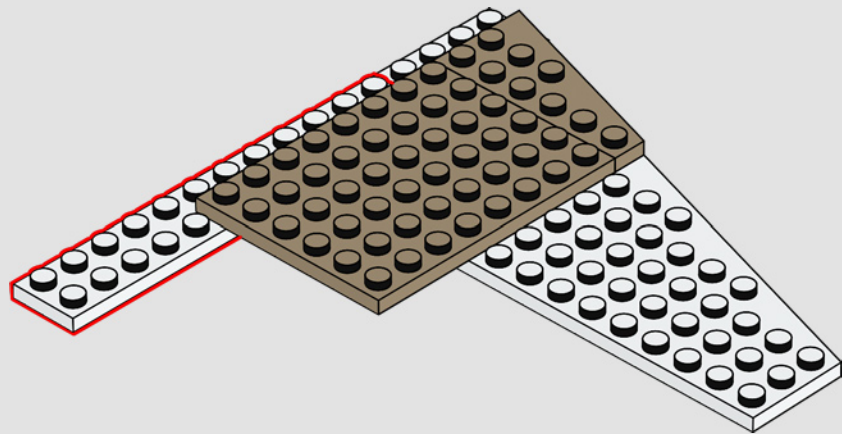

297

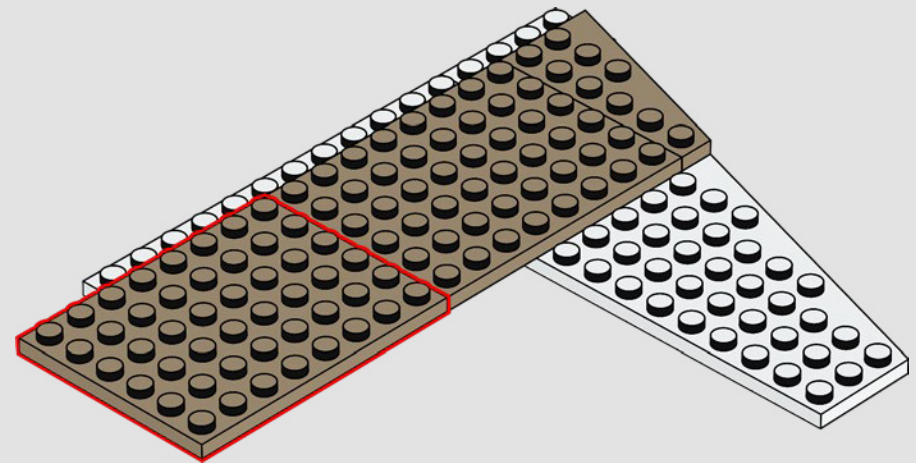

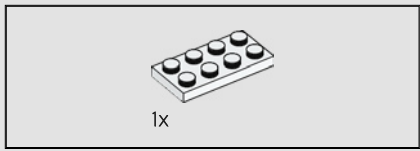

298

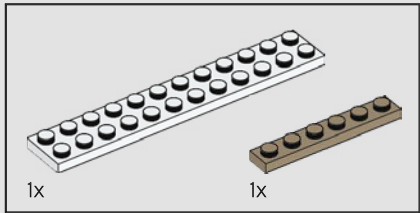
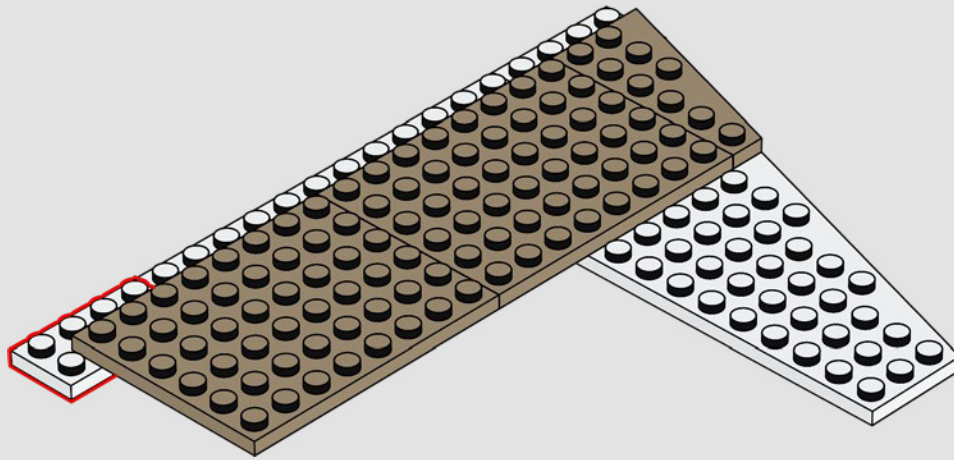

299

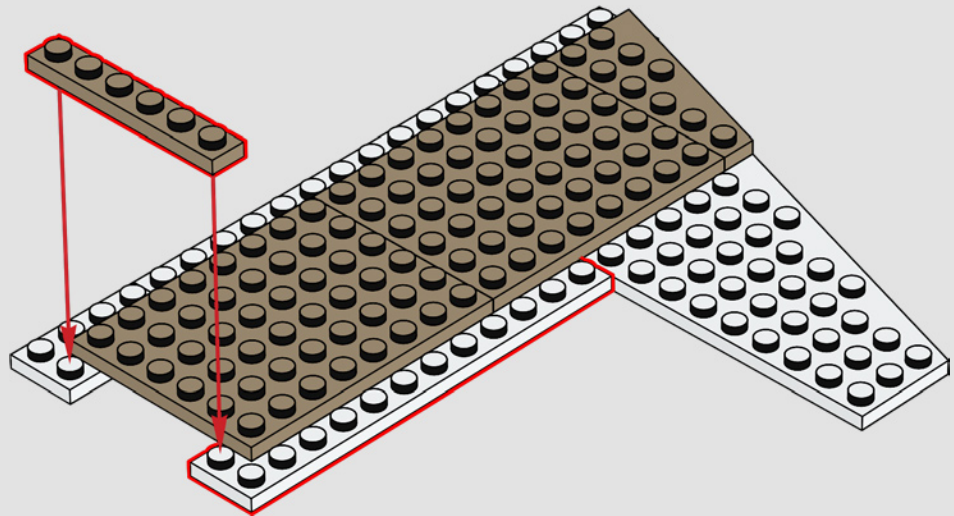

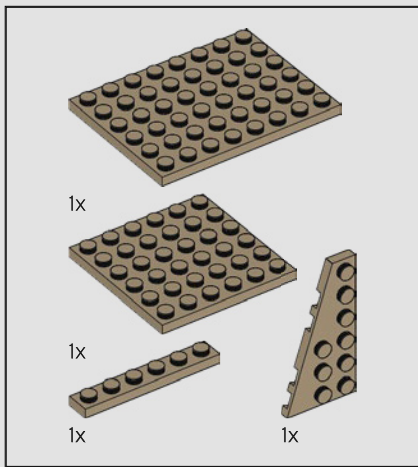

300

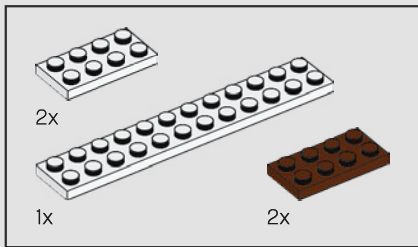
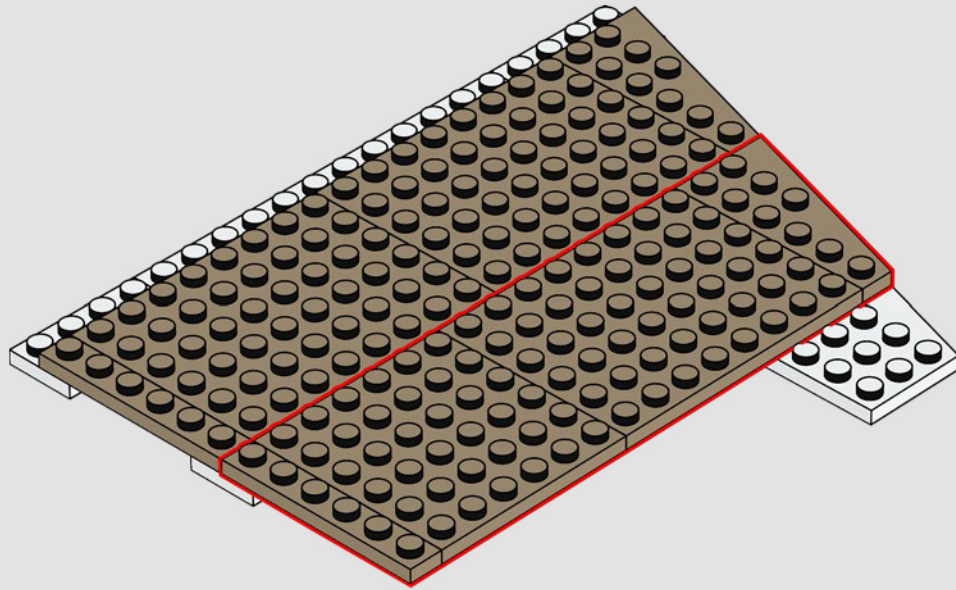

301

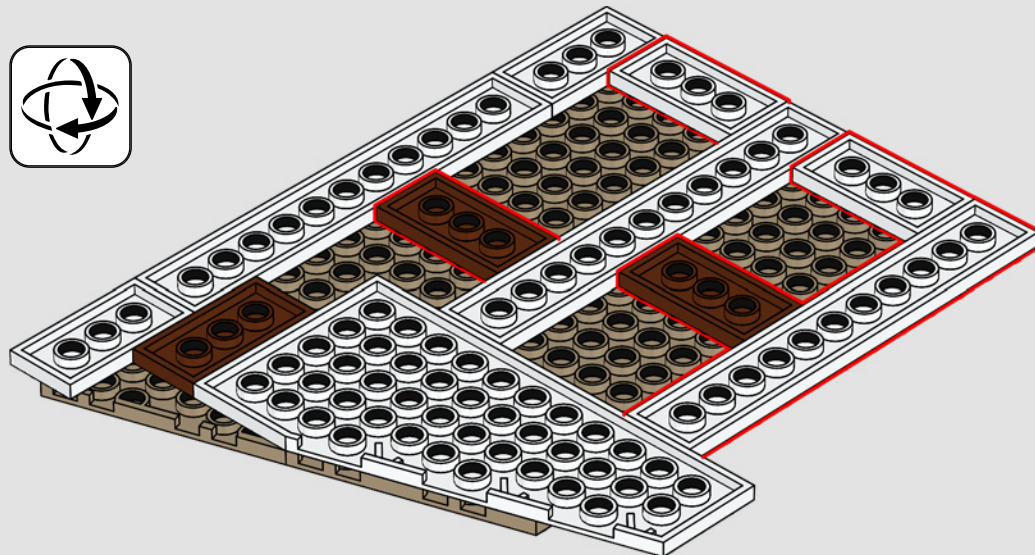
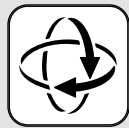

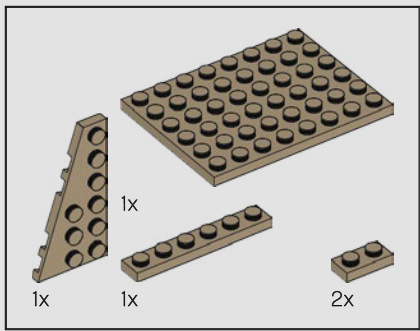

302

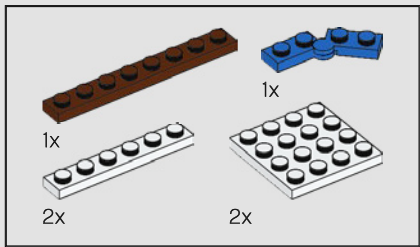
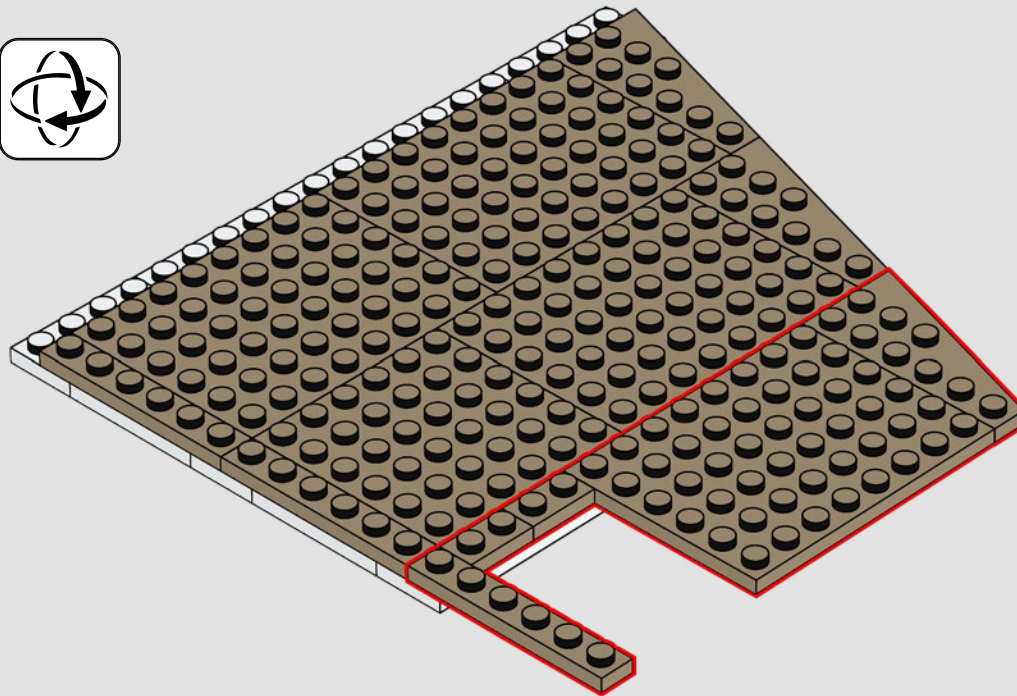

303

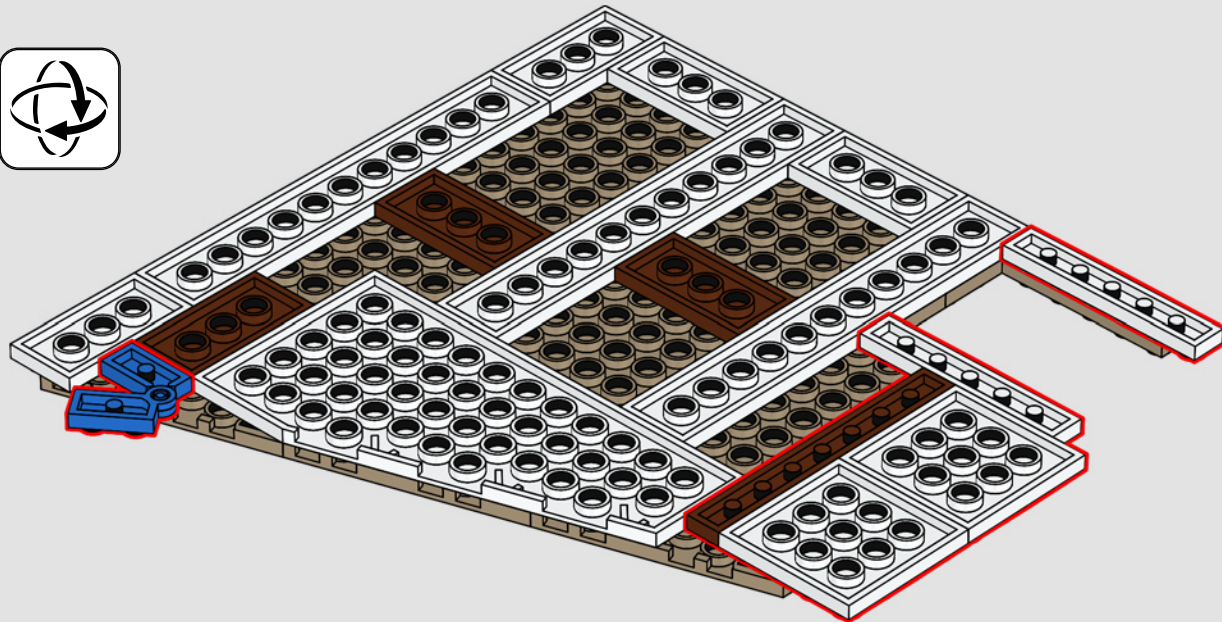
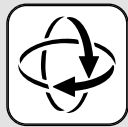

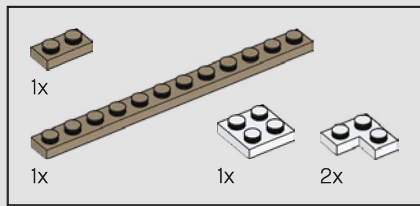

304

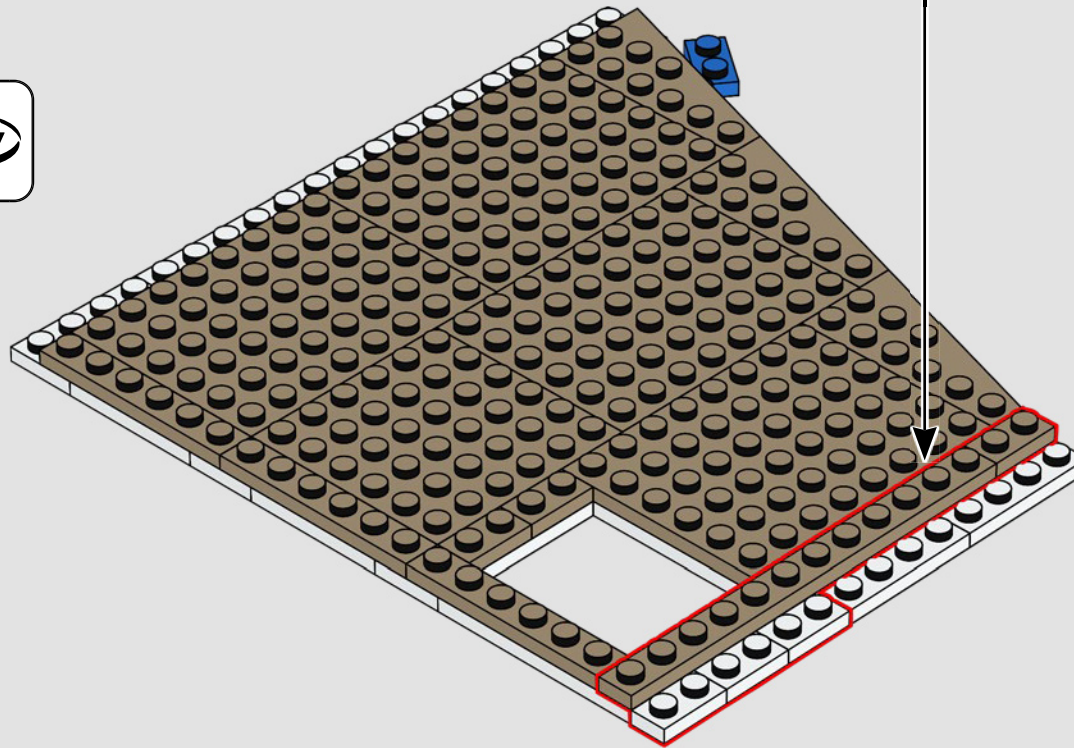
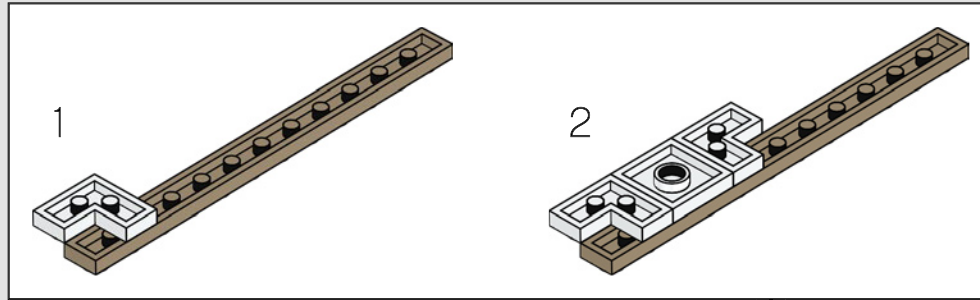

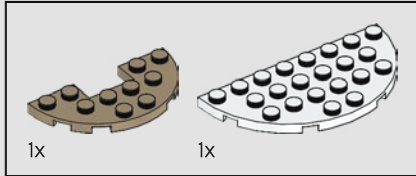
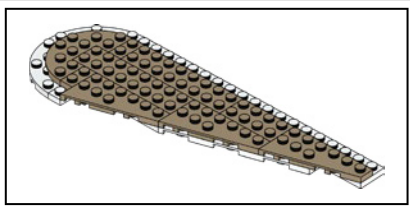

305

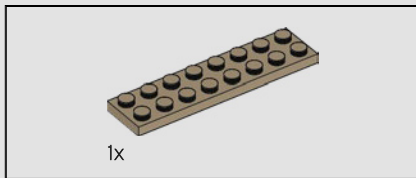
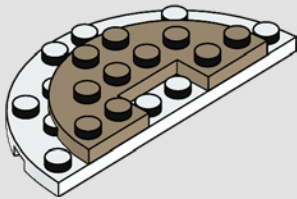

306

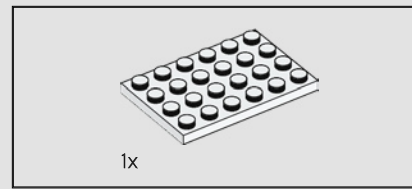
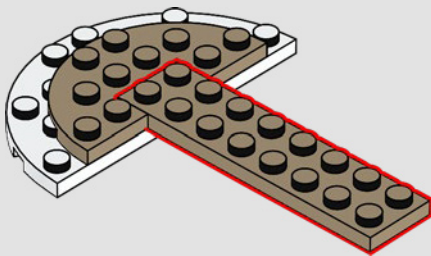

307

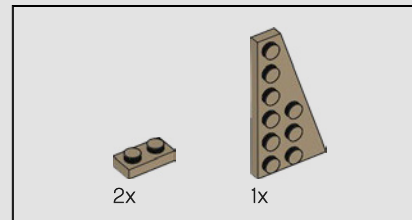
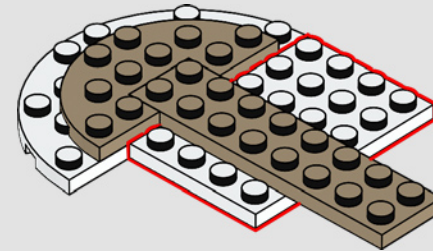

308

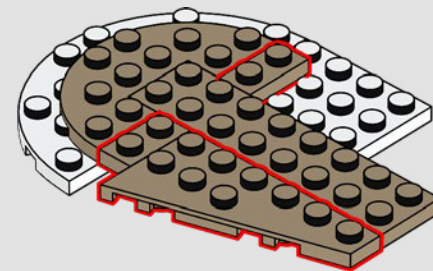

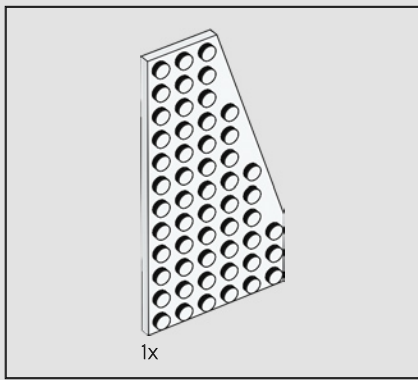

309

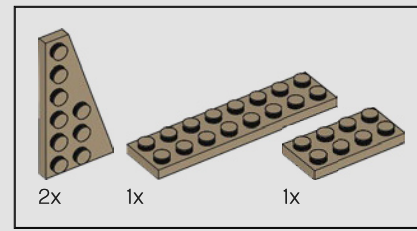
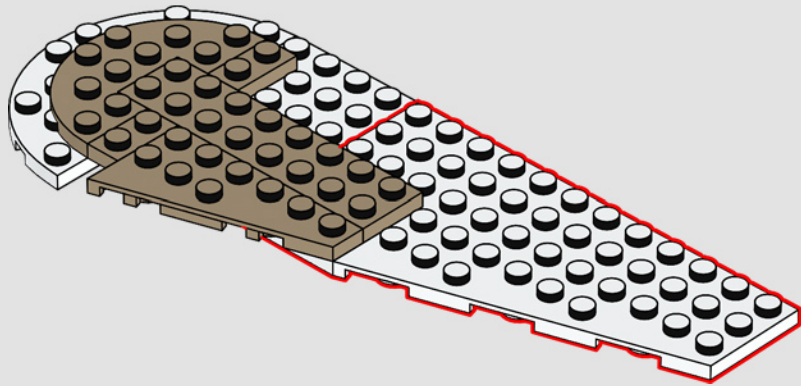

310

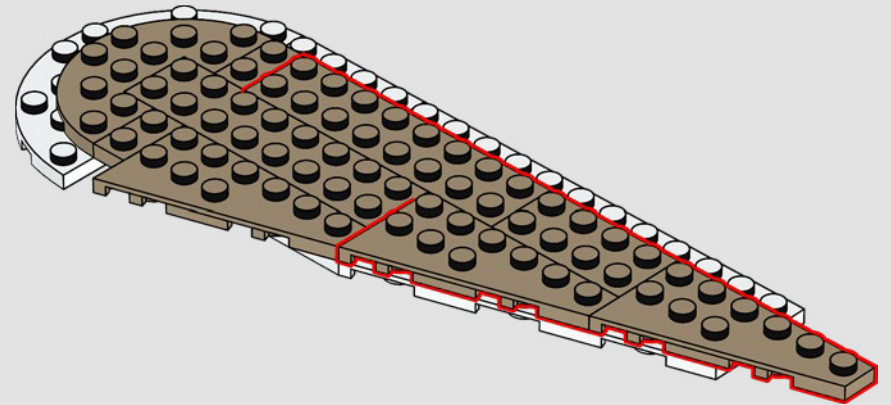

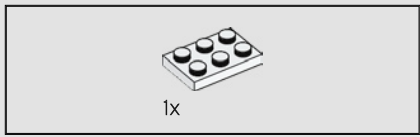

311

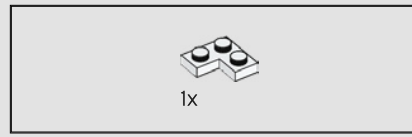
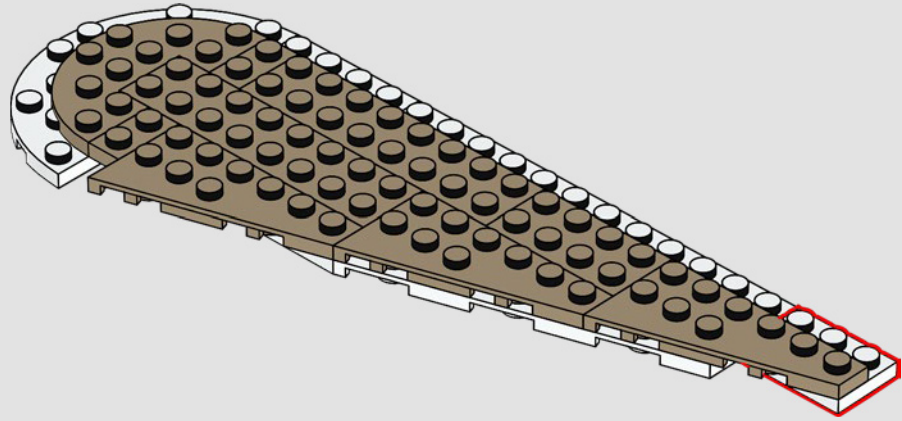

312

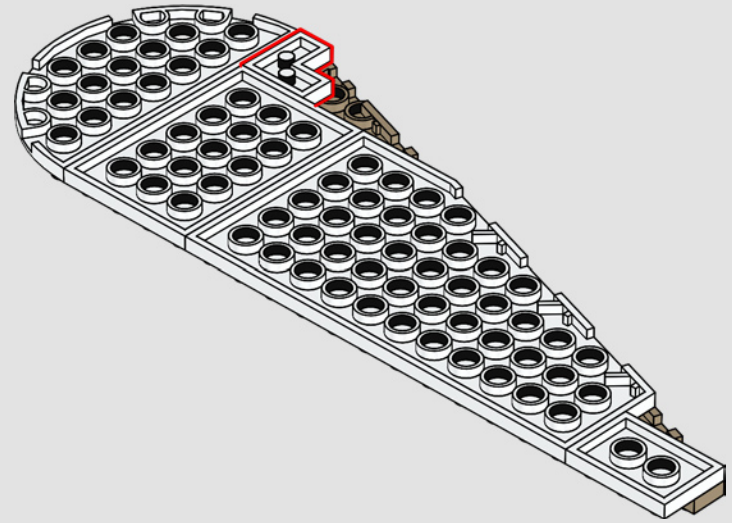
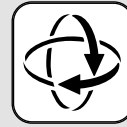

313

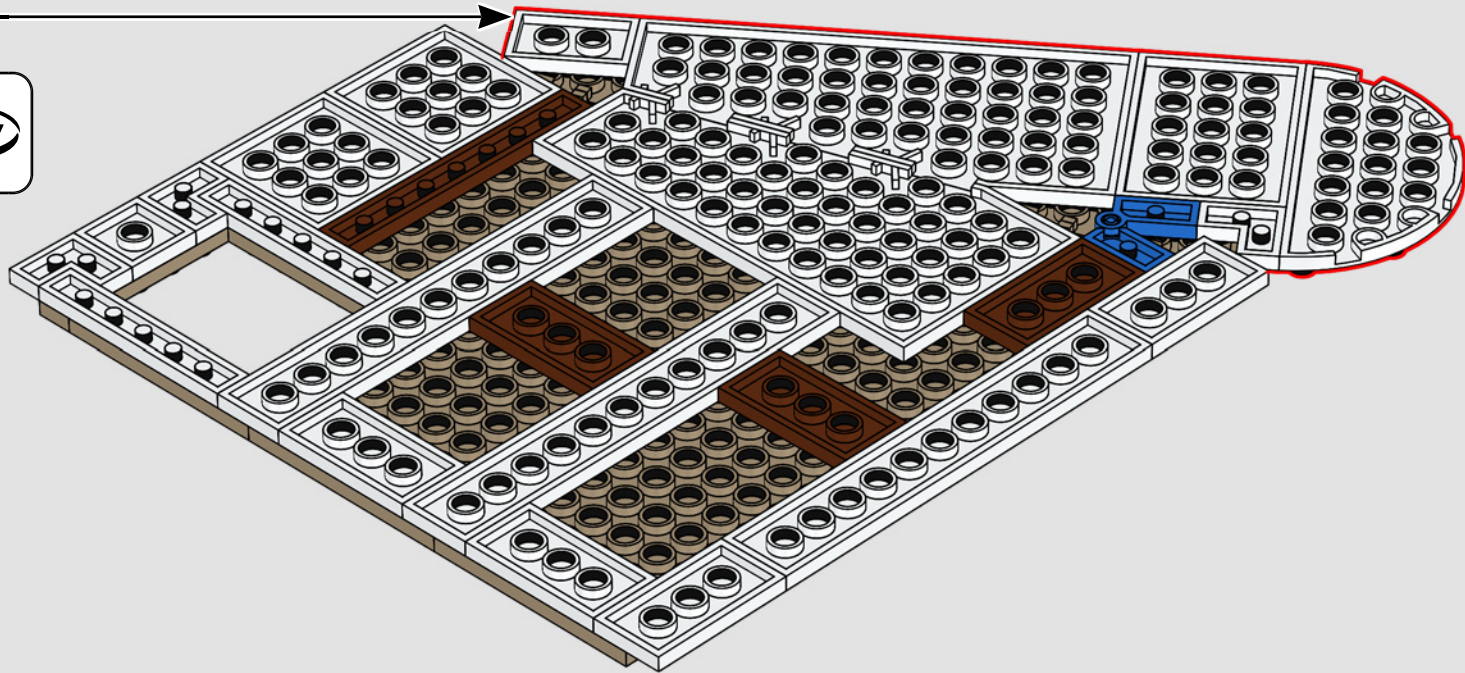

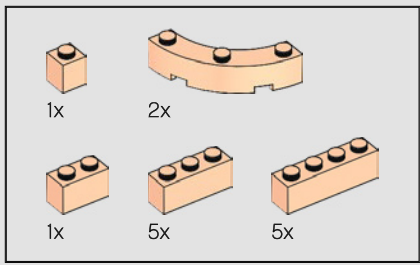

314

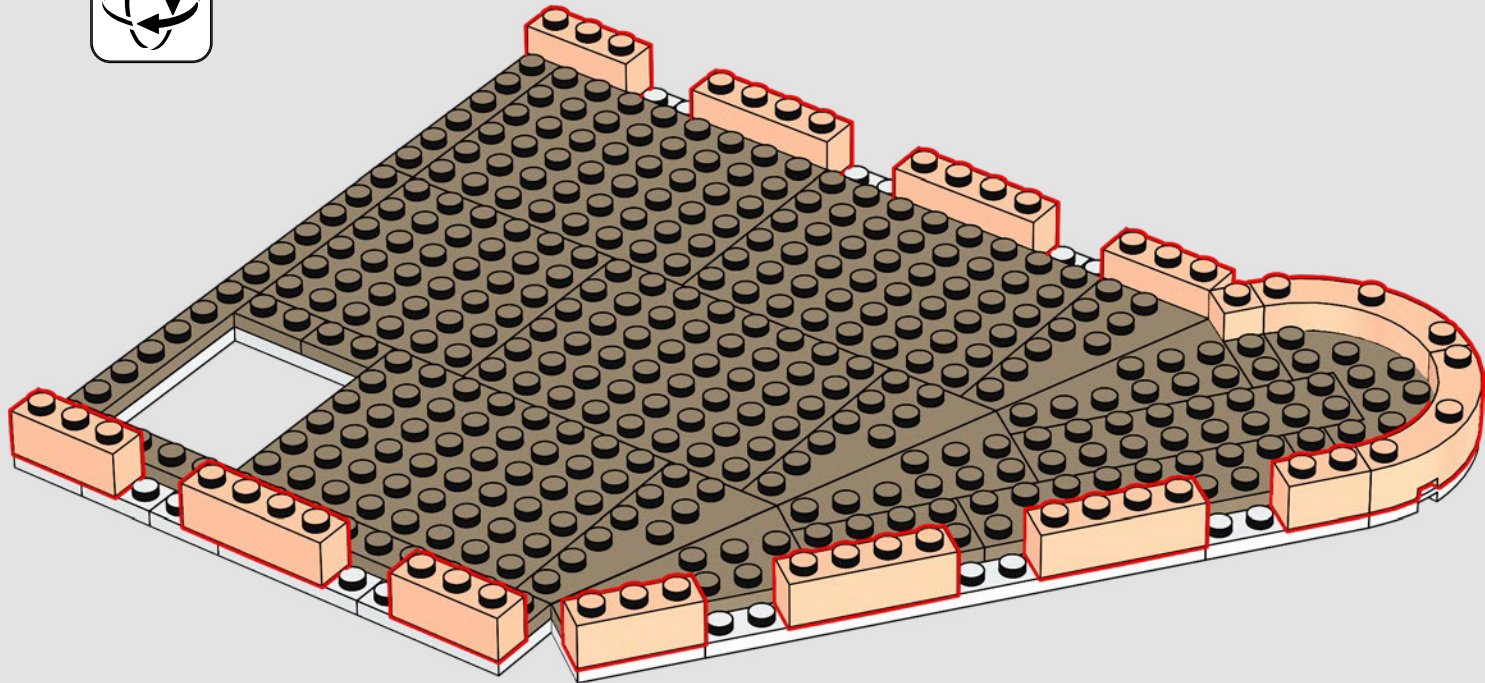

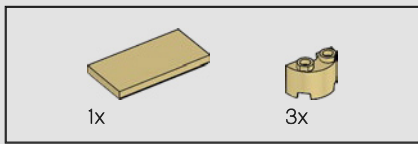

315

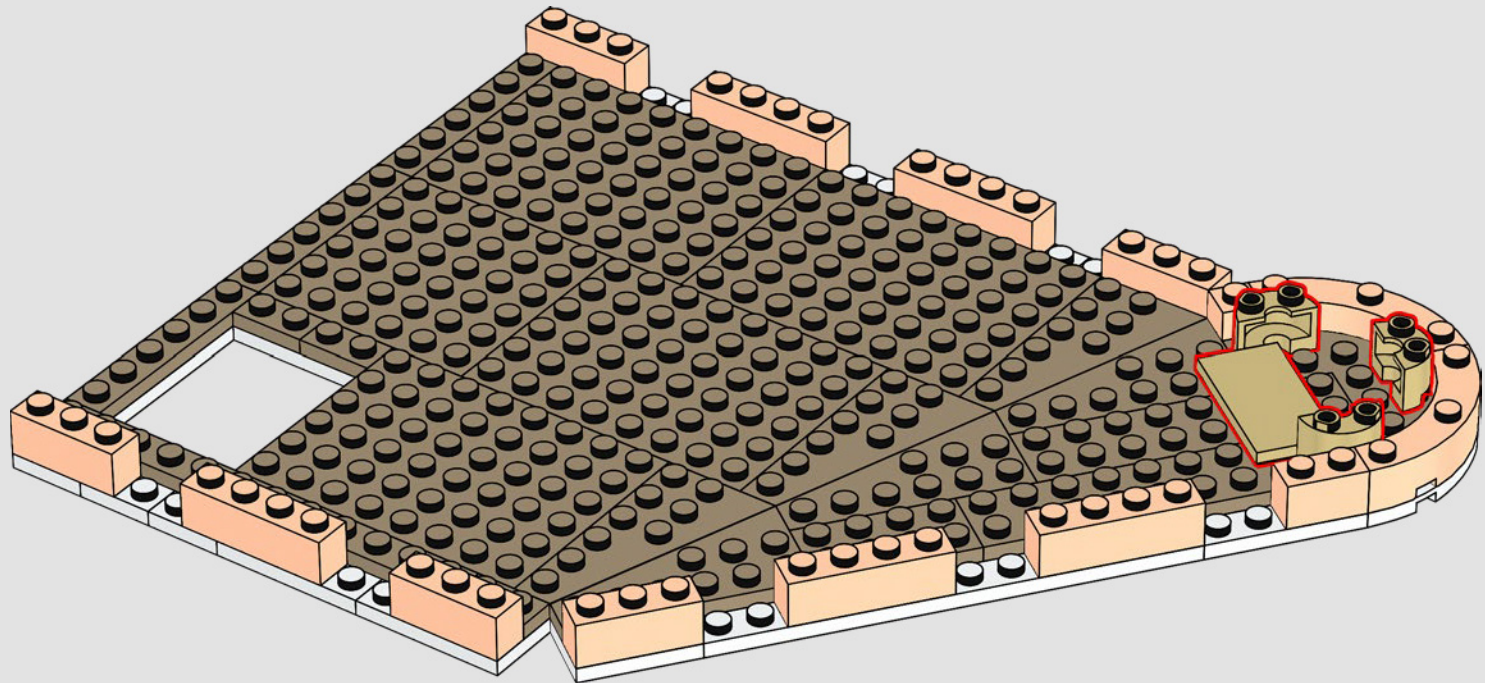

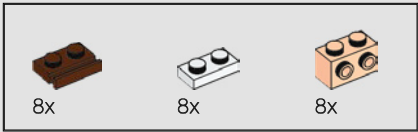

316

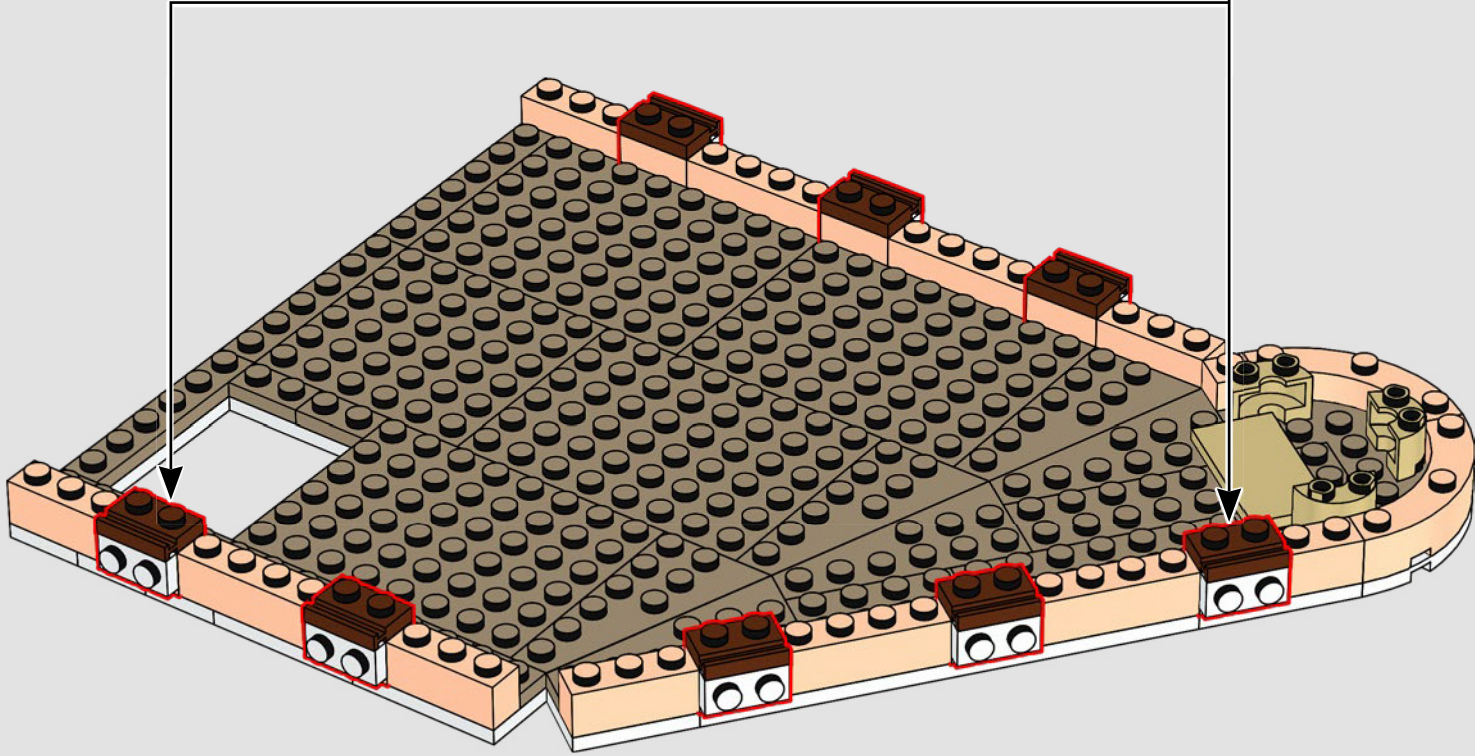
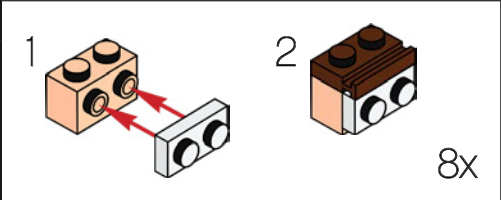

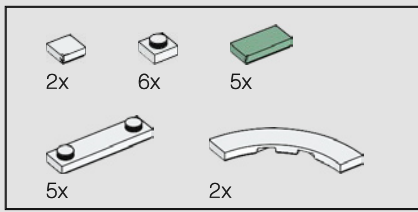

317

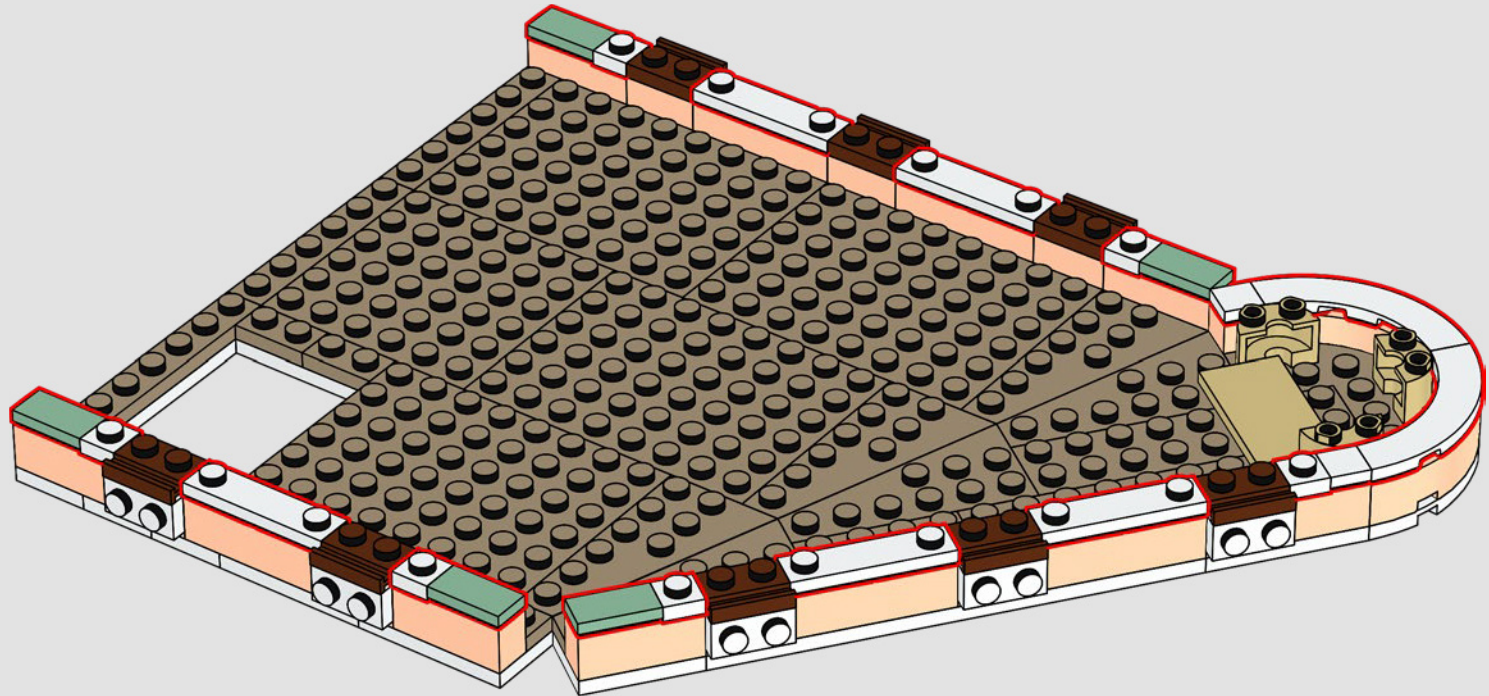

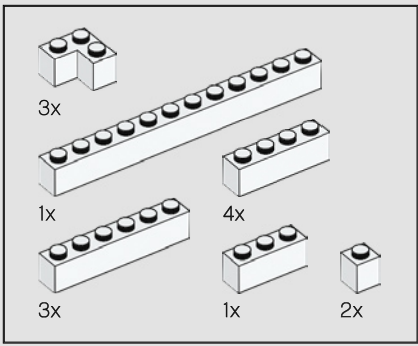

318

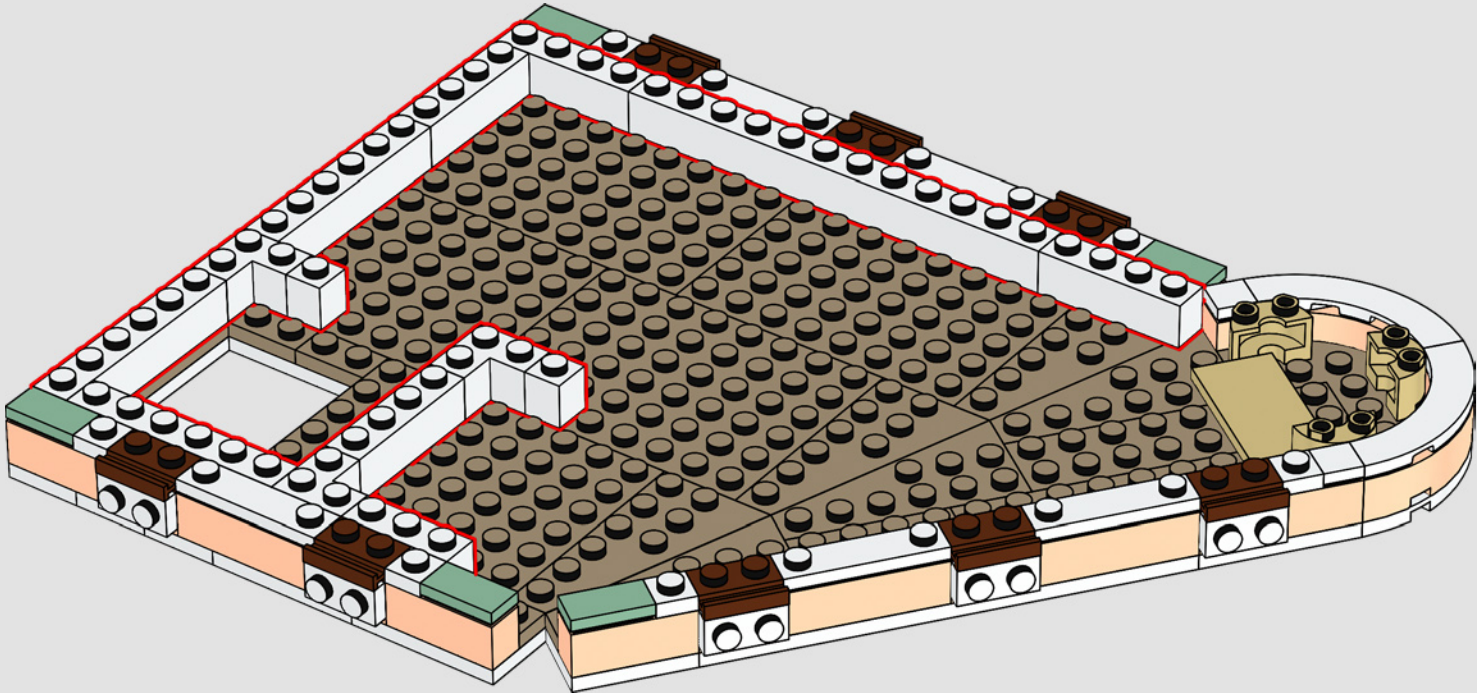

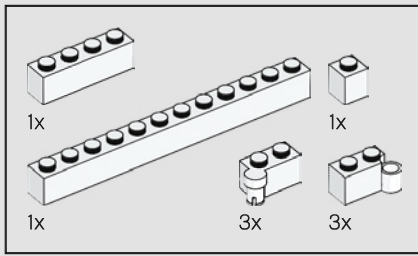

319

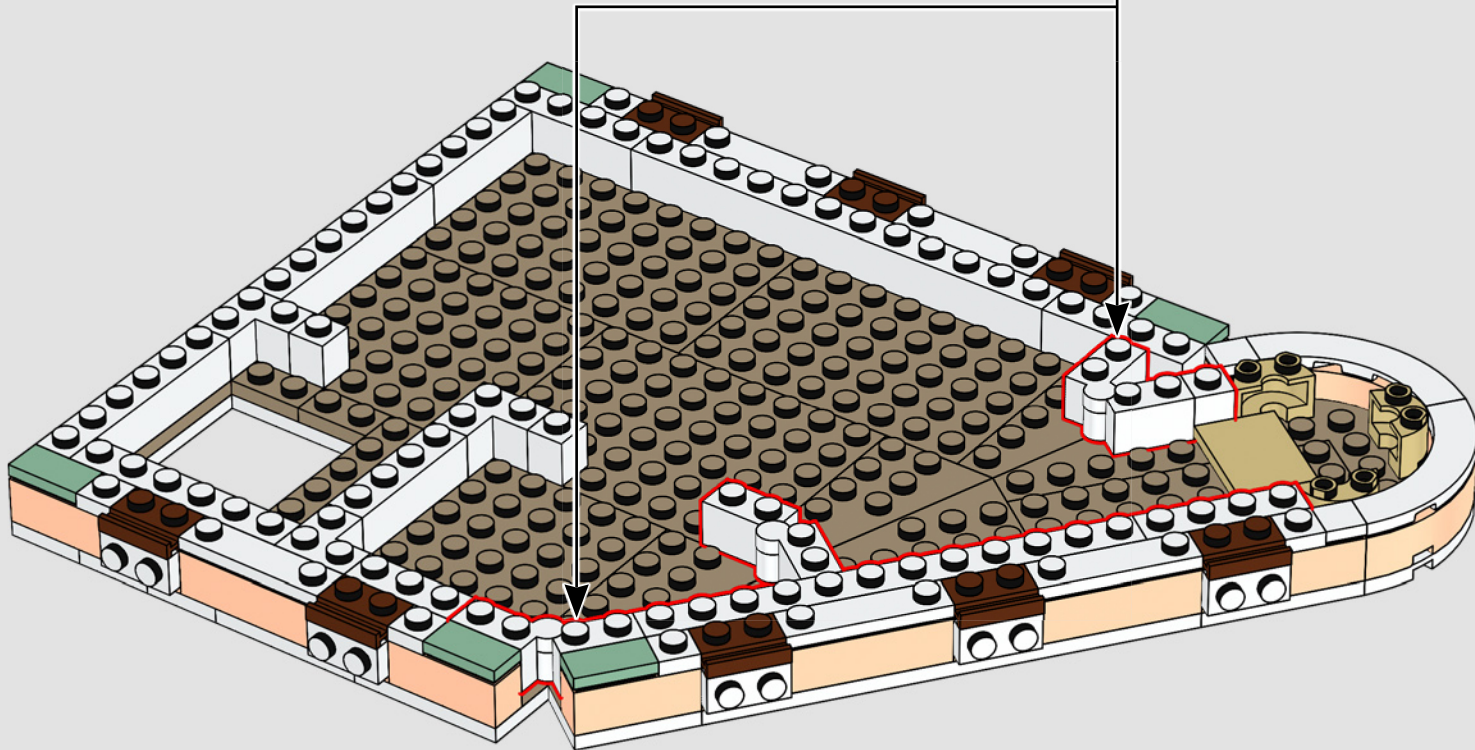
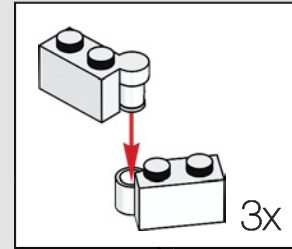

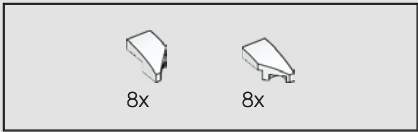

320

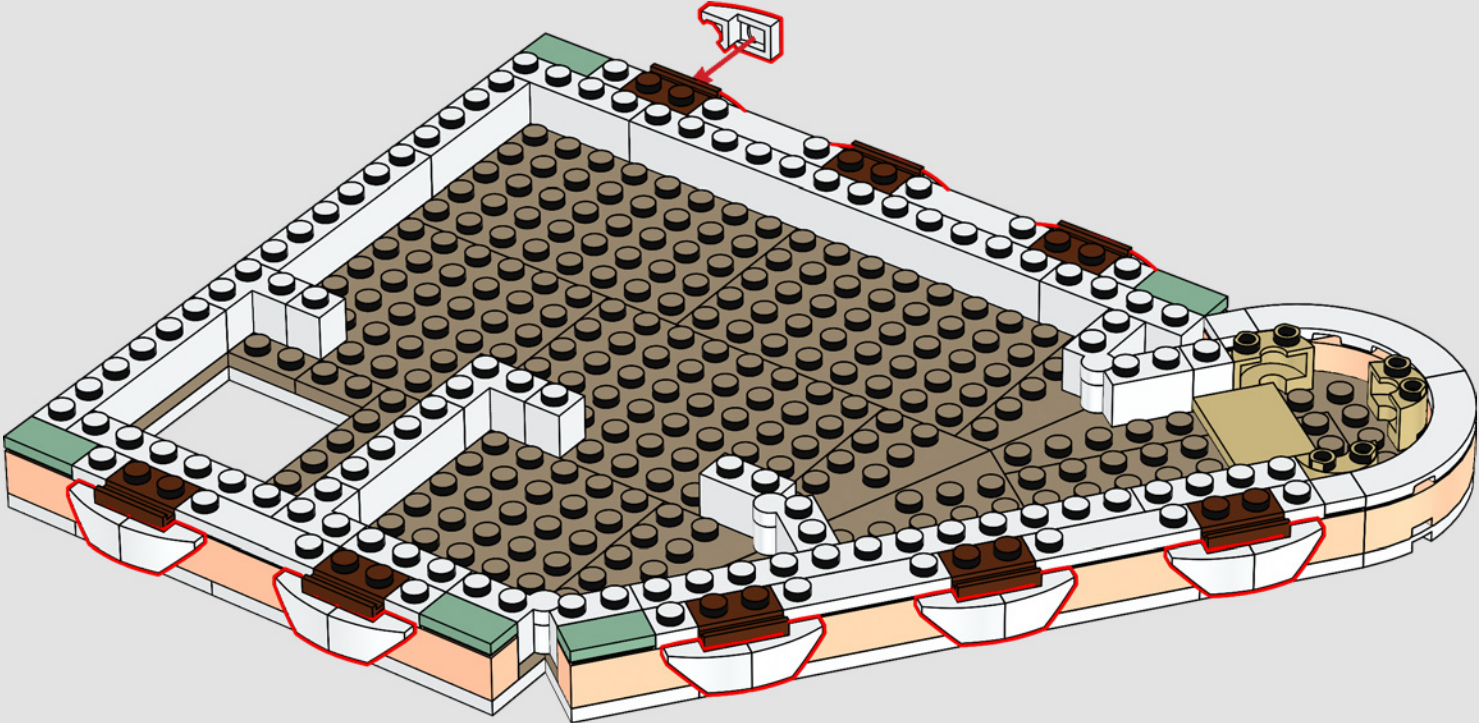

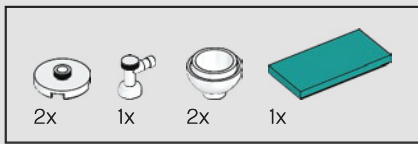

321

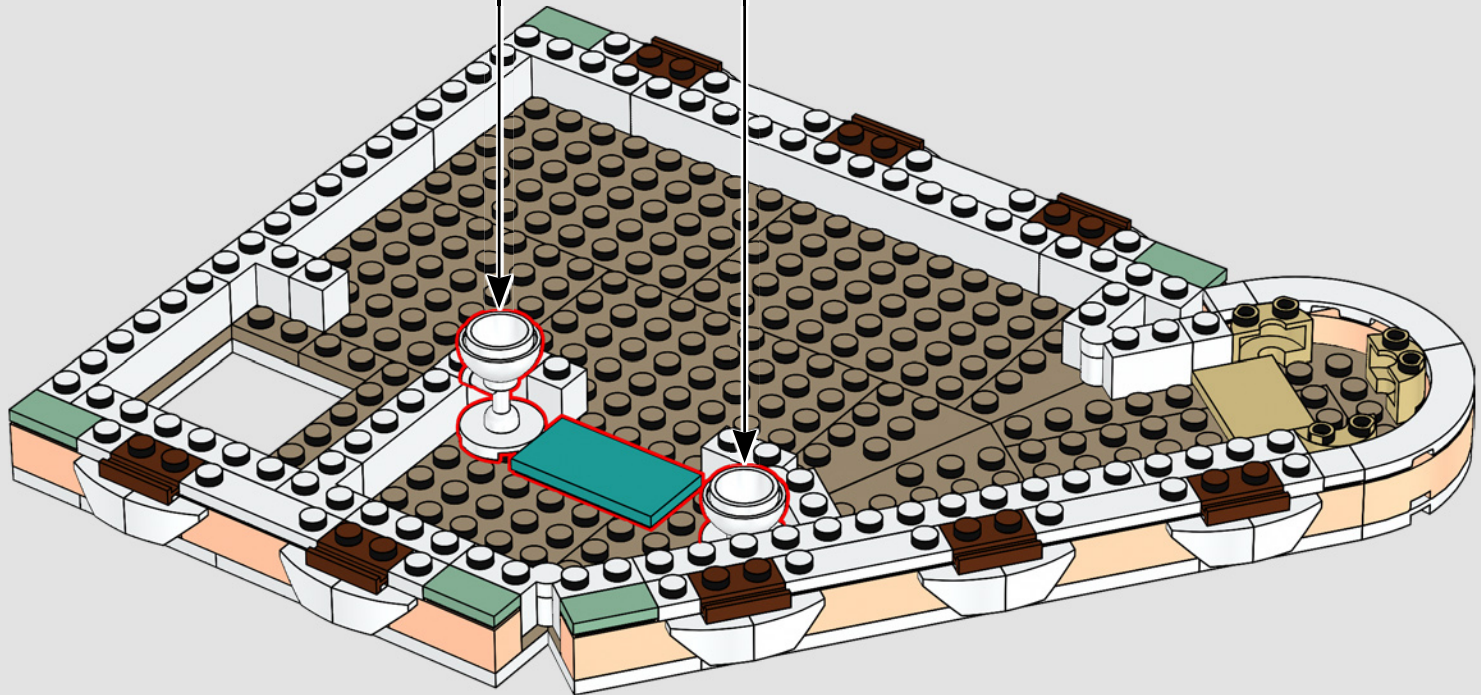
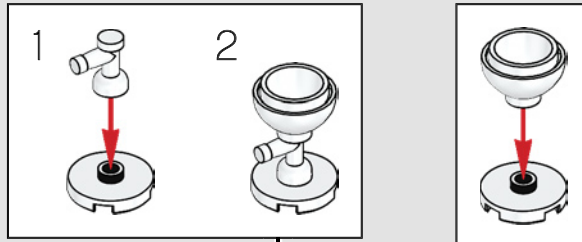

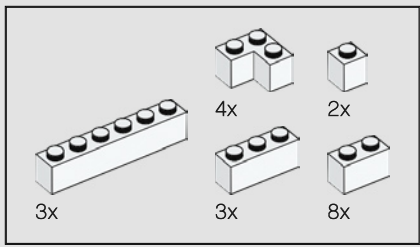

322

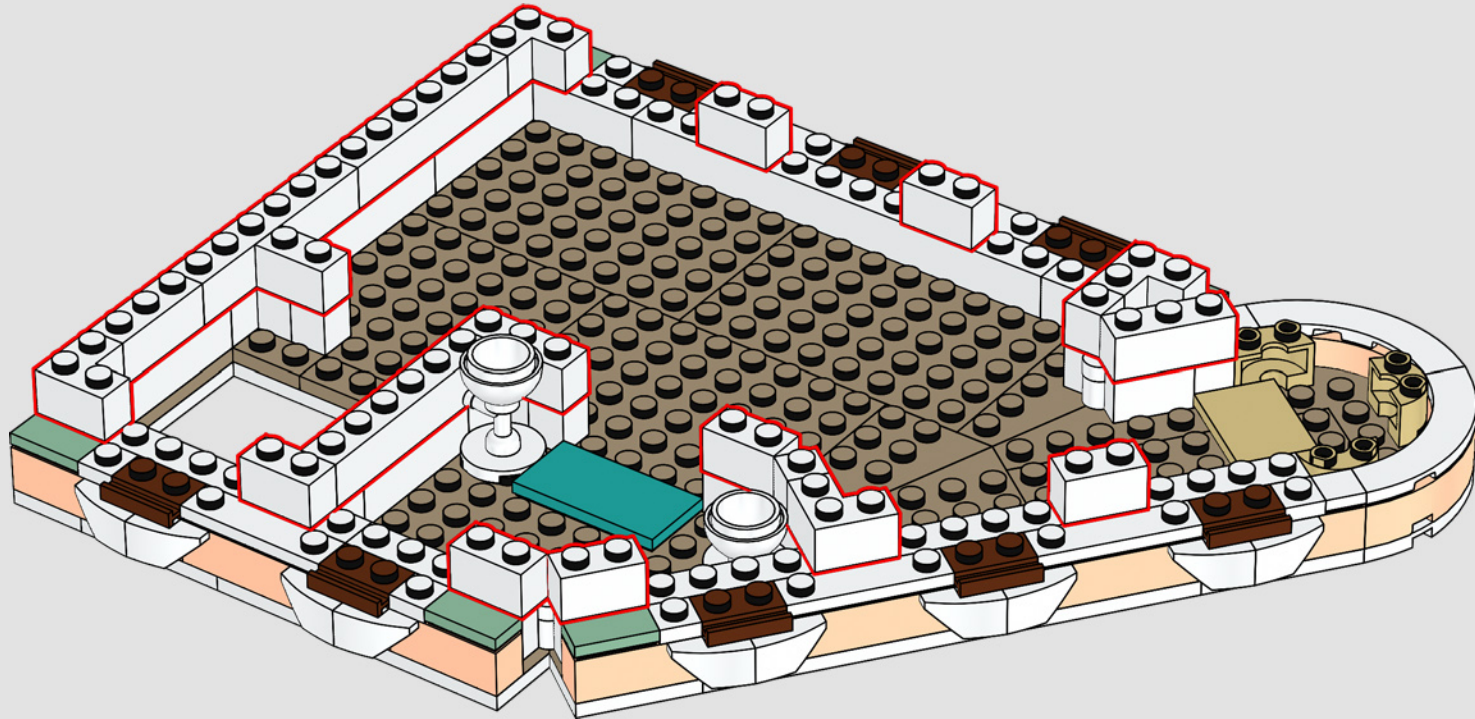

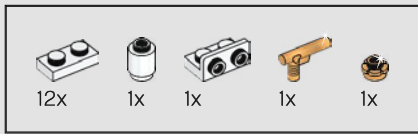

323

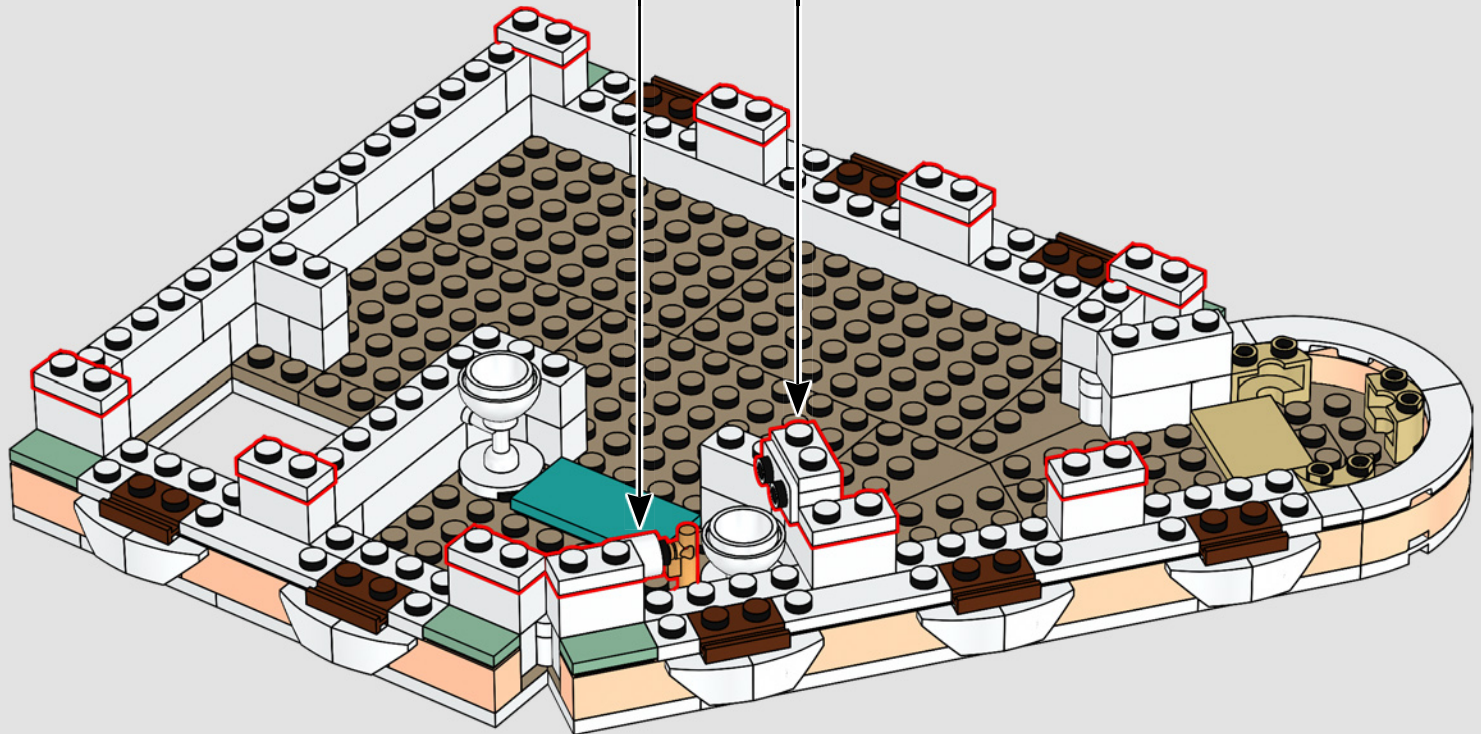
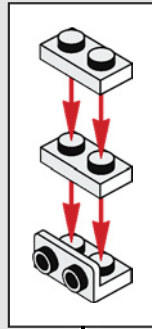
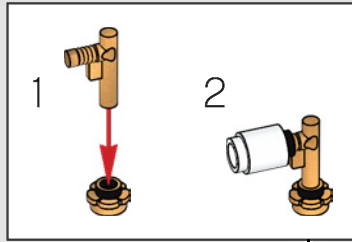

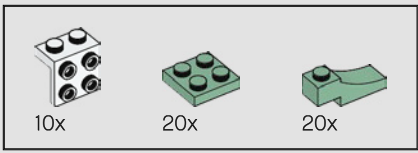

324

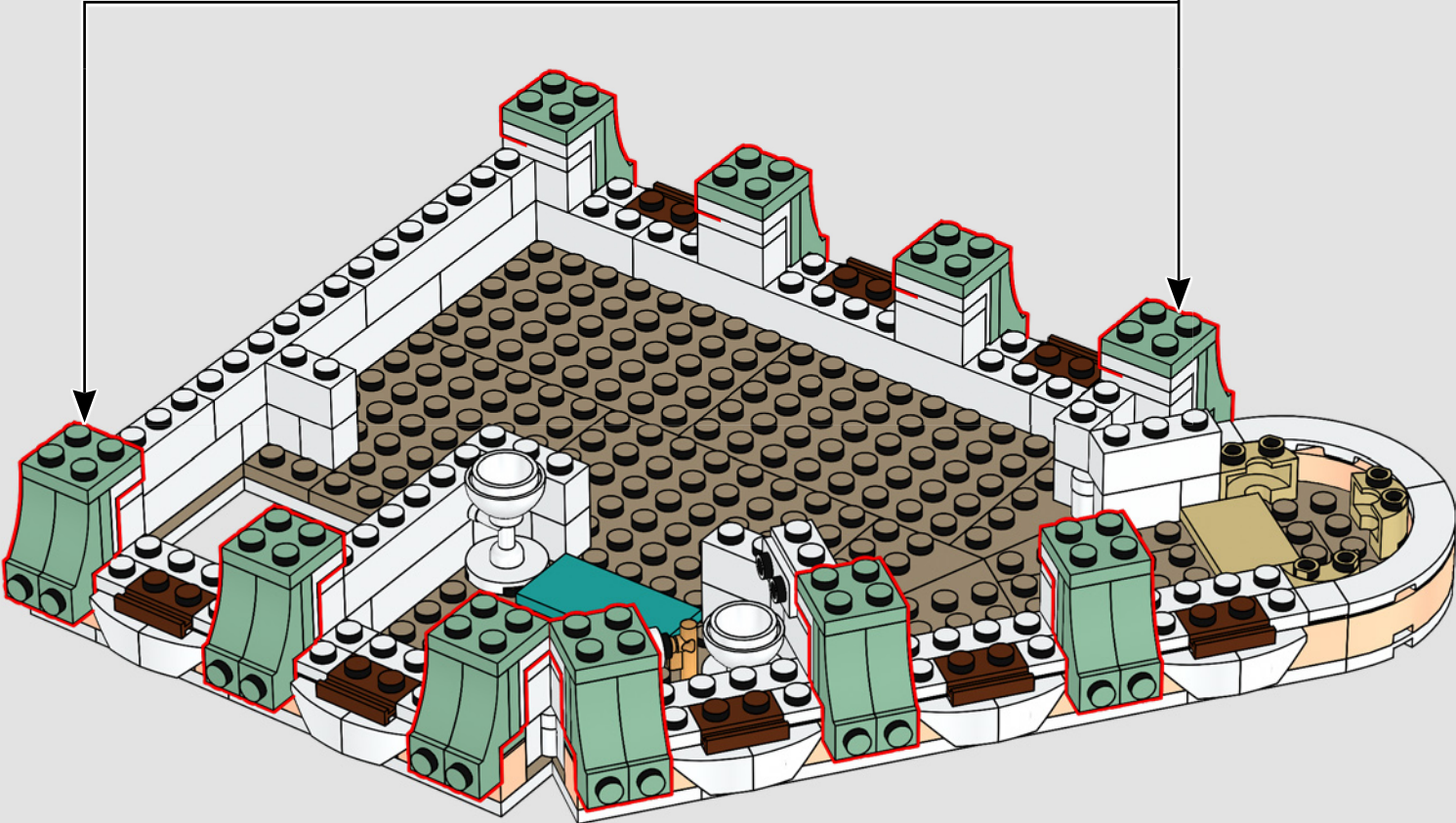
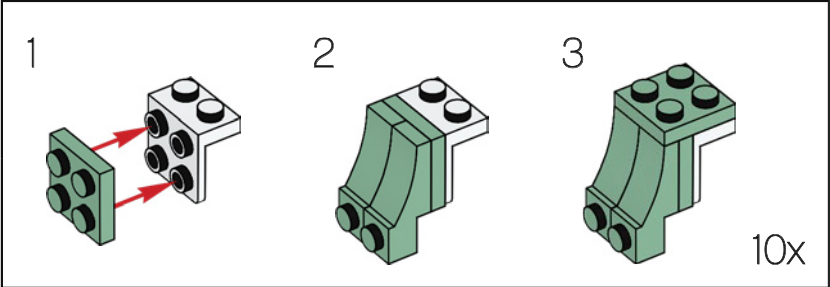

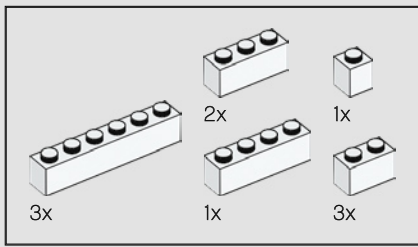

325

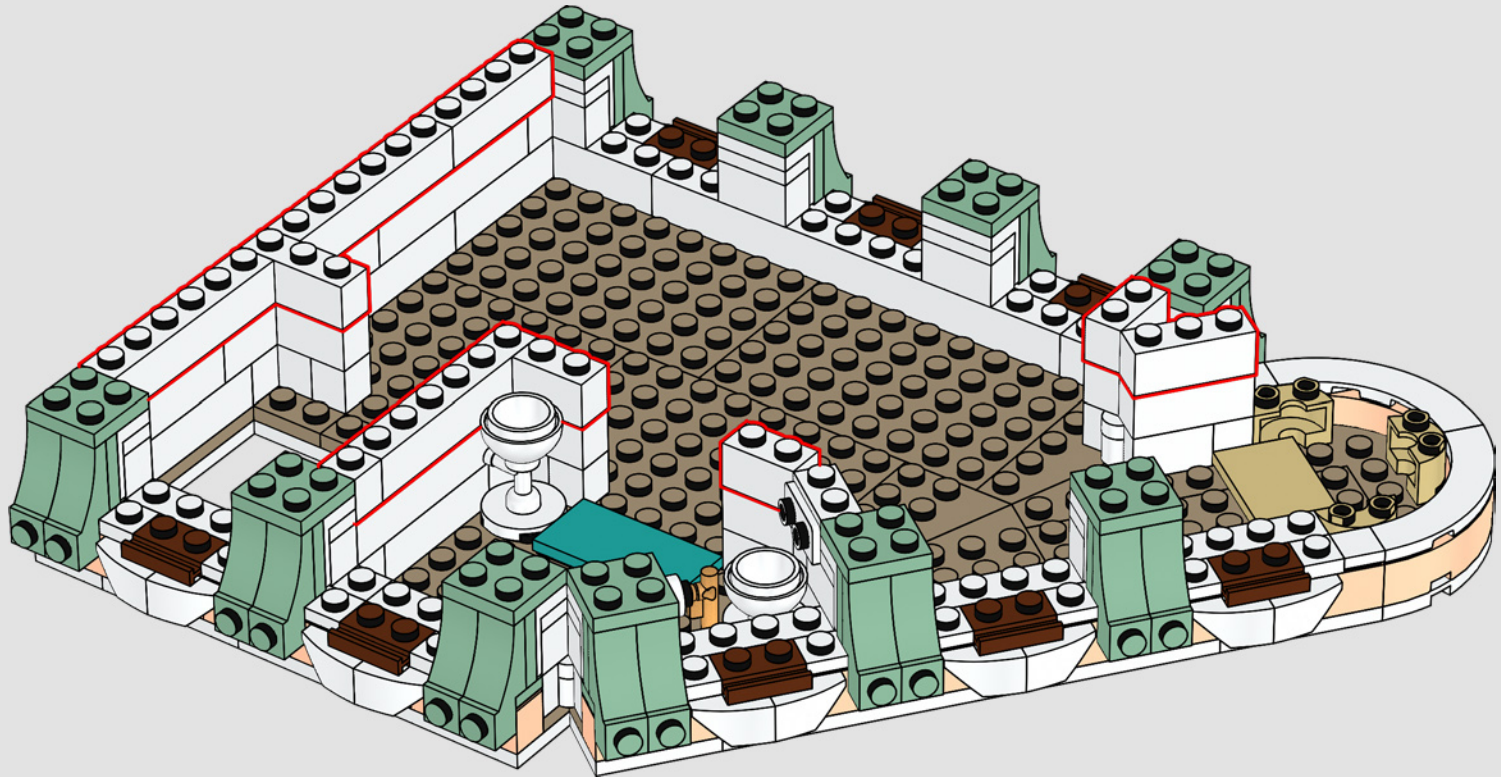

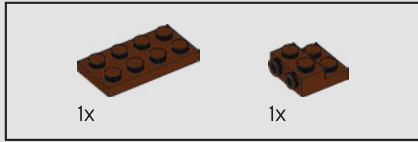

326

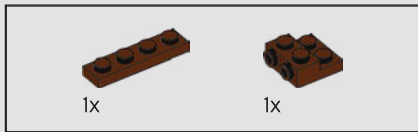
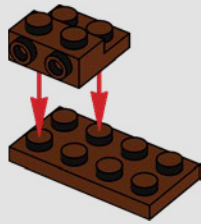

327

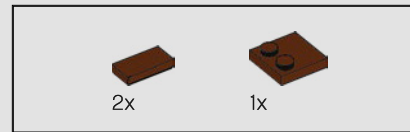
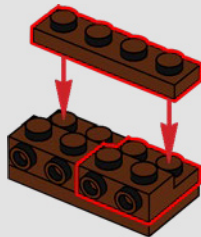

328

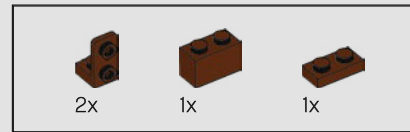
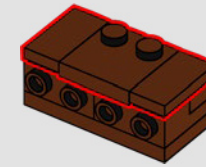

329

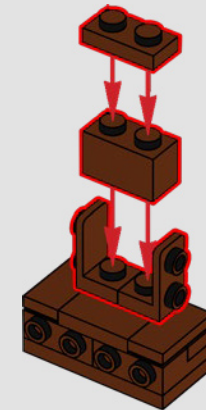

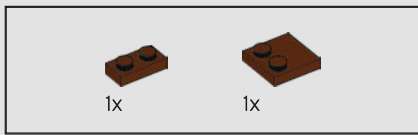

330

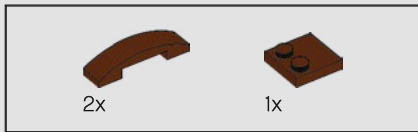
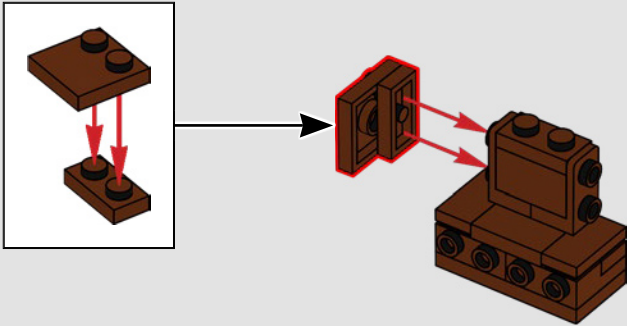

331

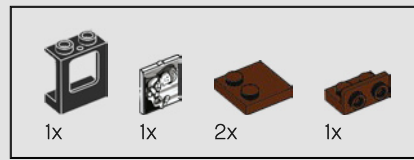
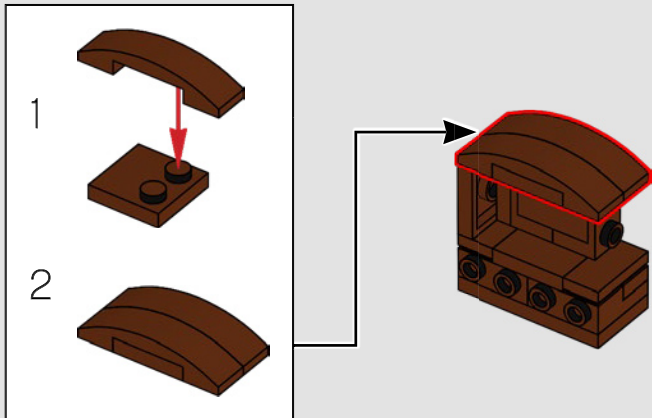

332

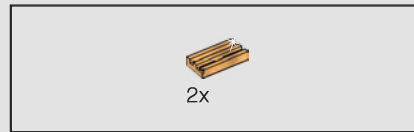
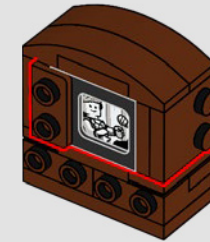
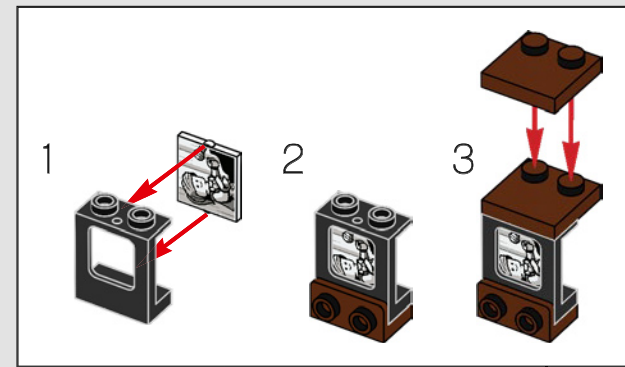

333



334

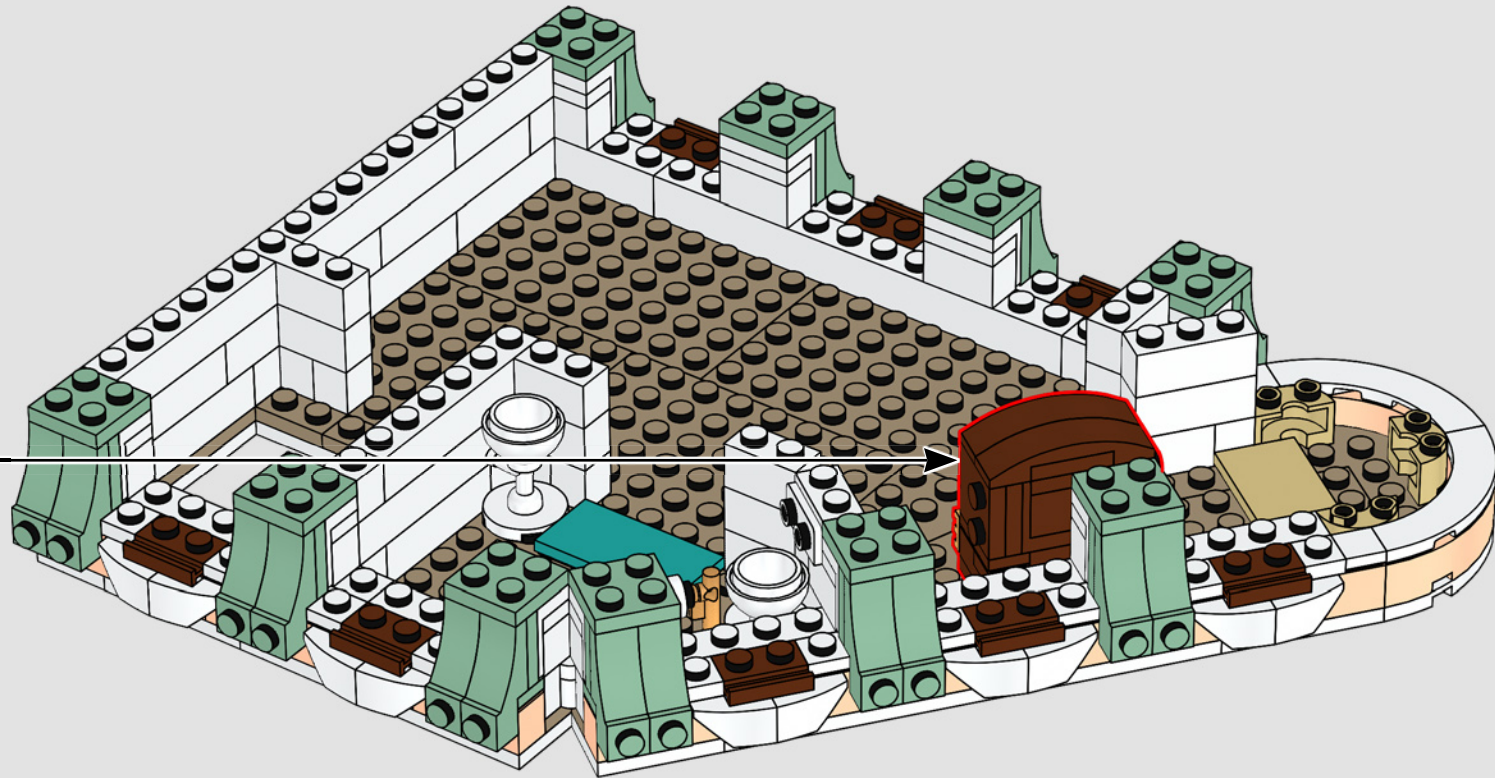

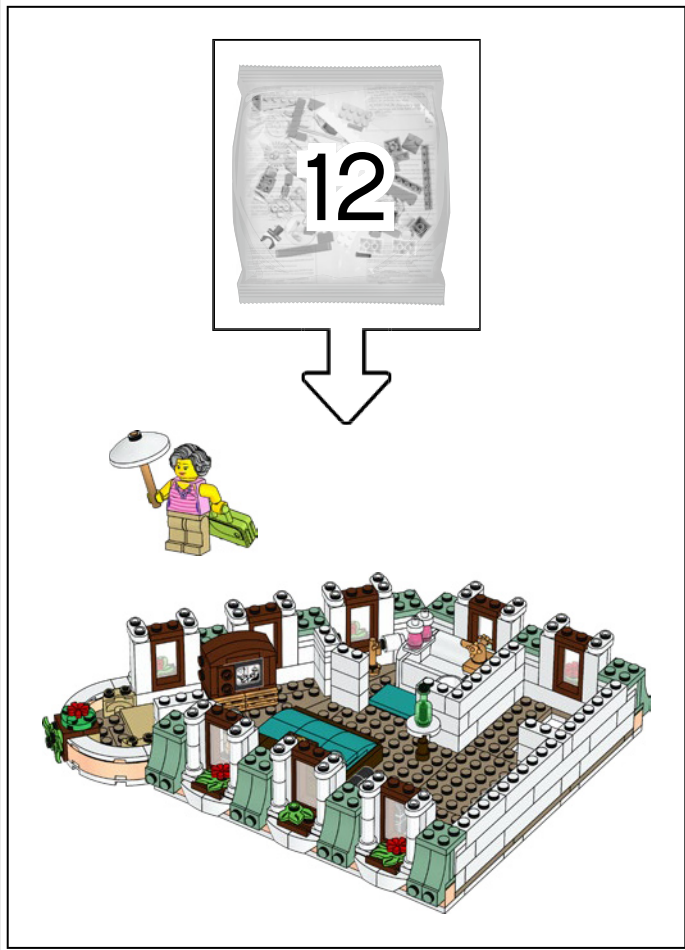

The Globetrotter has been all over the world,
but always loves to come back to the Boutique
Hotel for a relaxing stay.

La globe-trotteuse a parcouru le monde entier,
mais elle aime toujours revenir passer un séjour
relaxant à l'hôtel-boutique.

La trotamundos ha recorrido todo el planeta,
pero adora regresar al Hotel Boutique para
disfrutar de una relajante estancia.

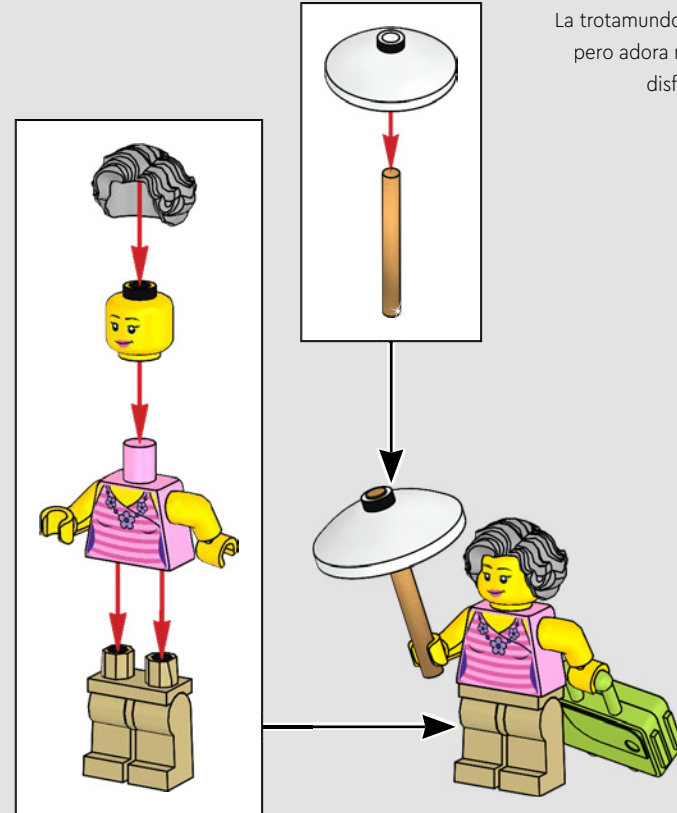

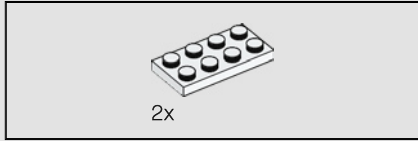
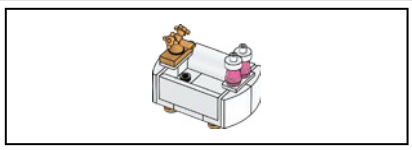

335

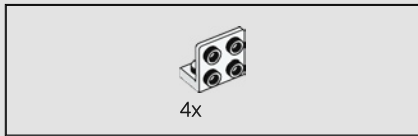
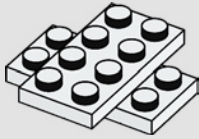

336

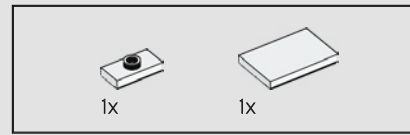
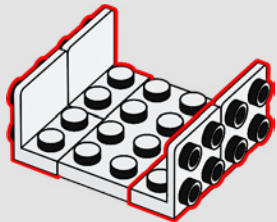

337

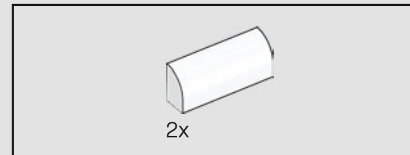
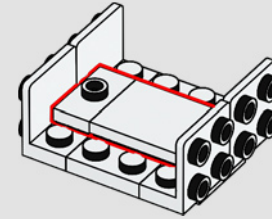

338

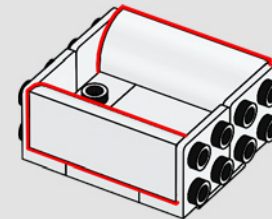

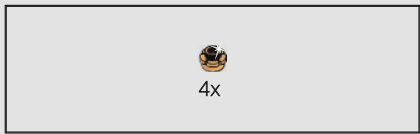

339

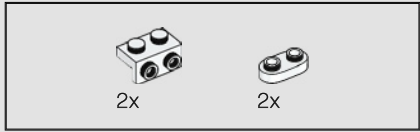
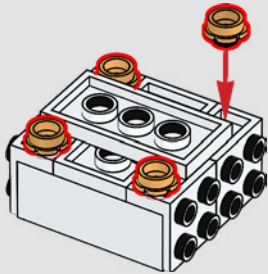

340

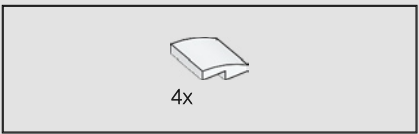
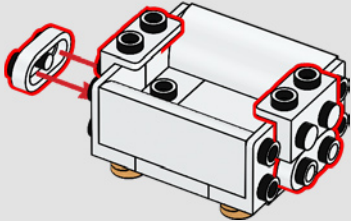

341

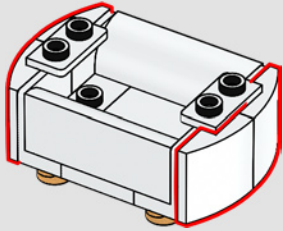

342

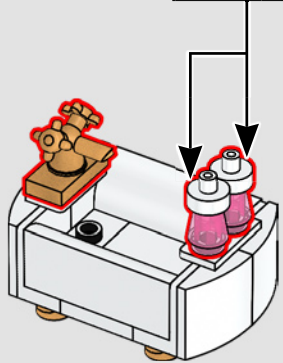
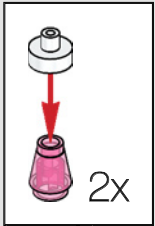

343

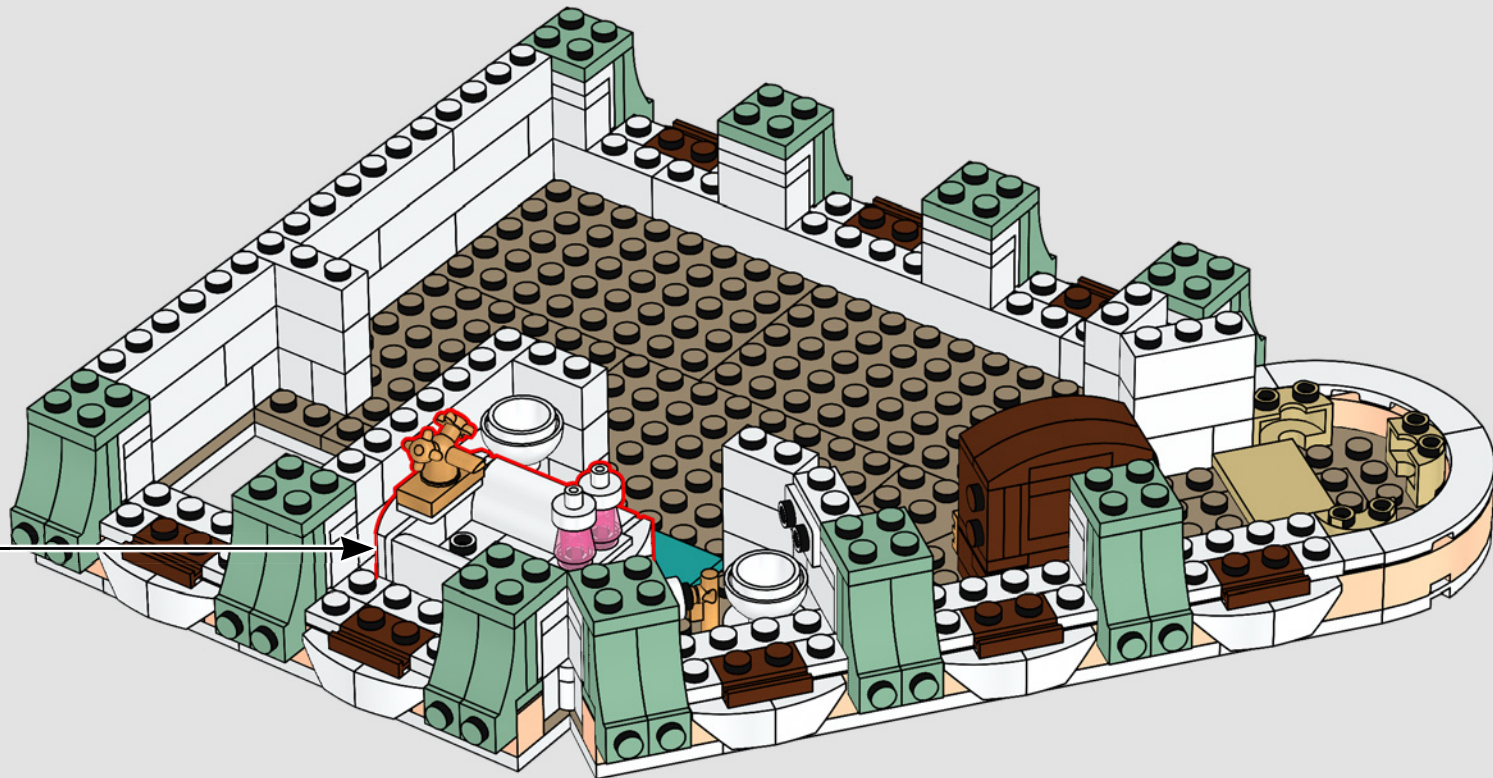

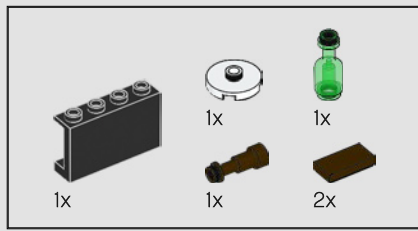

344

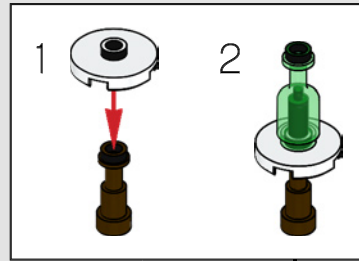

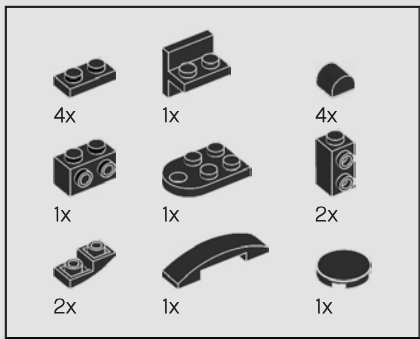

345

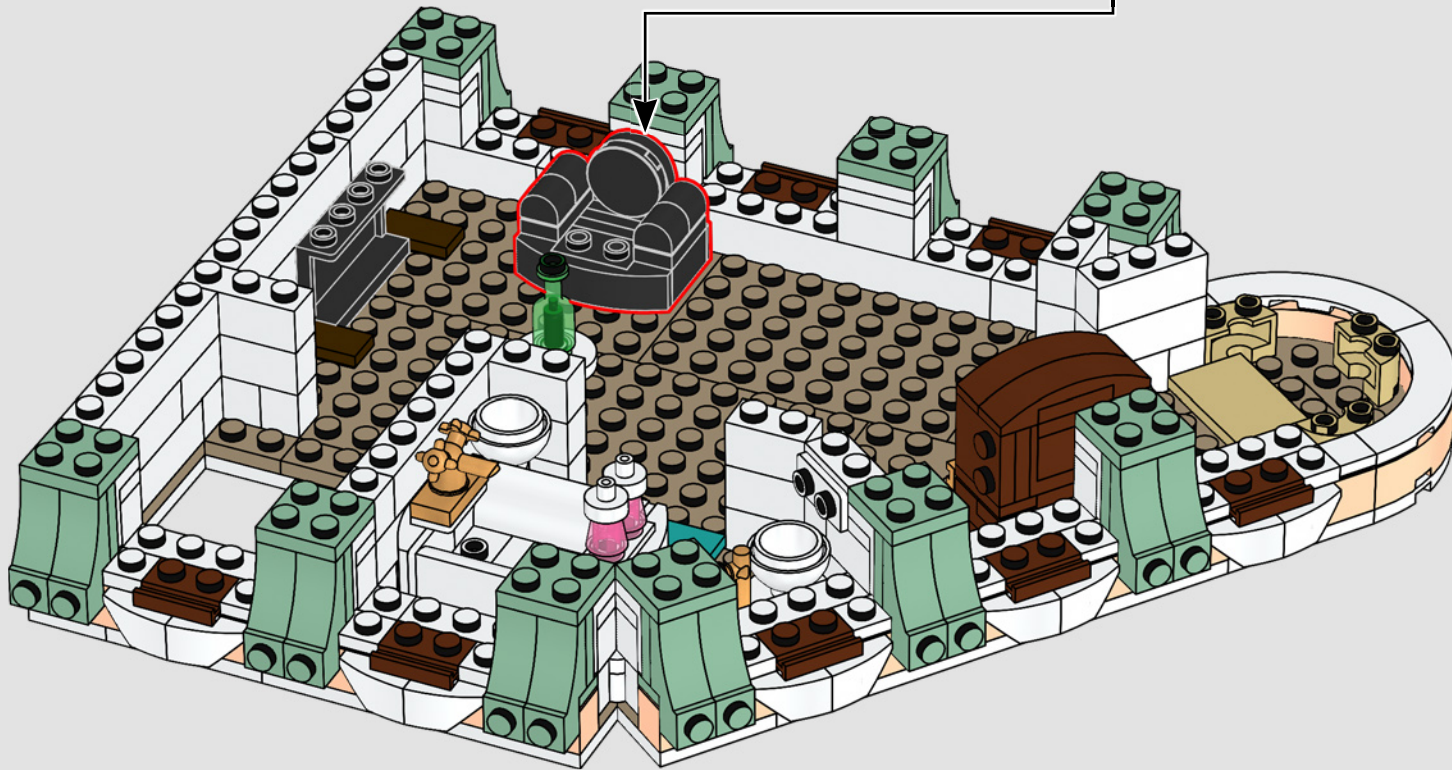
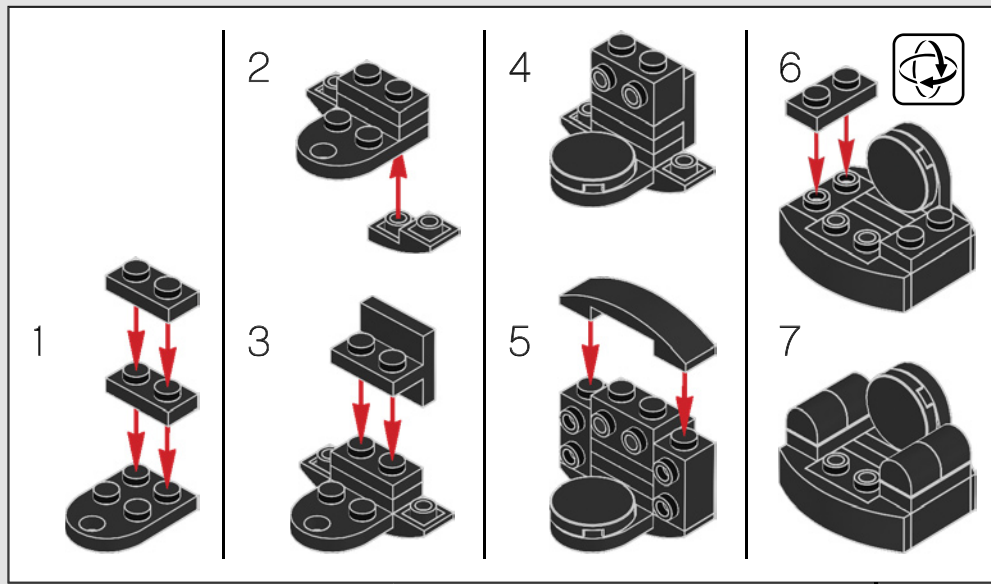

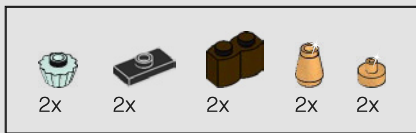

346



The lampshade element here is actually a cupcake element from LEGO® Friends.

Les abat-jour sont en fait des éléments de petit gâteau de LEGO® Friends.

Esta pantalla de aquí es, en realidad, un elemento LEGO® Friends que se usa como cupcake.

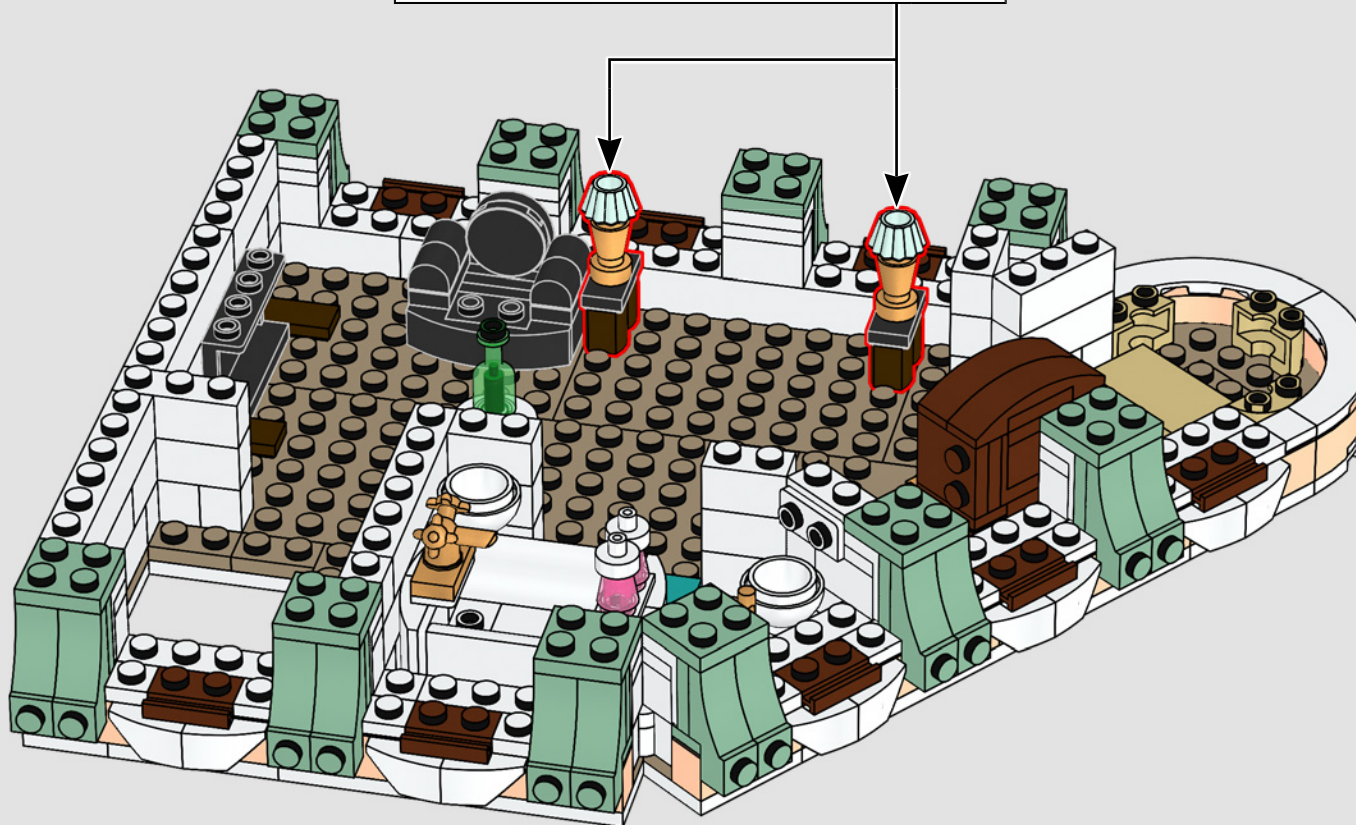
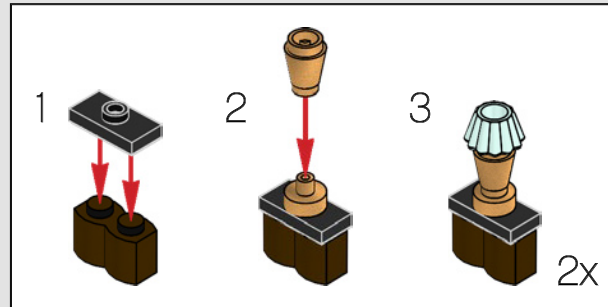

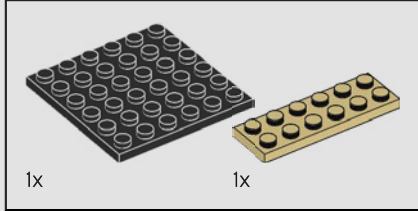
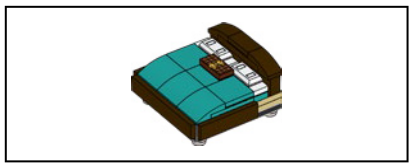

347

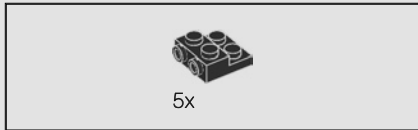
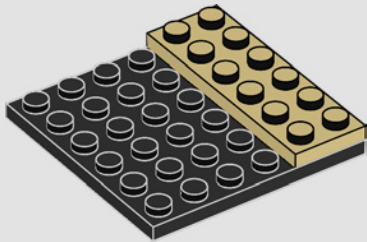

348

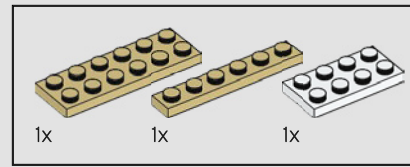
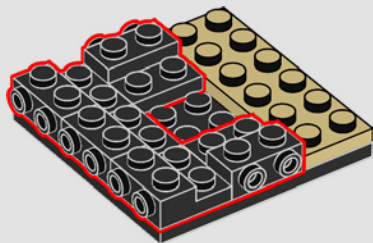

349

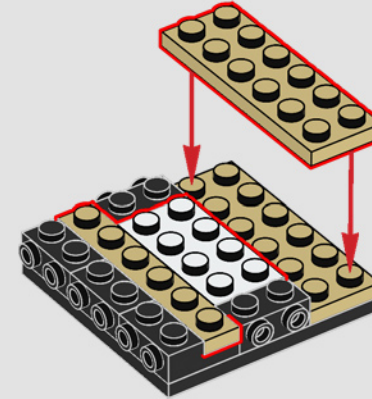

350

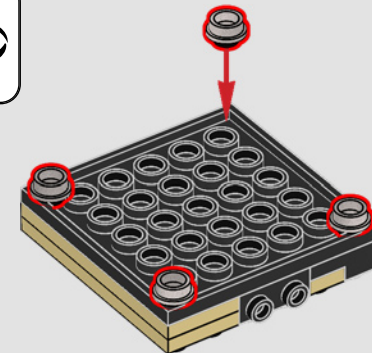
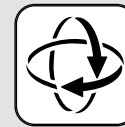

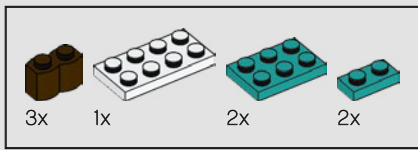

351

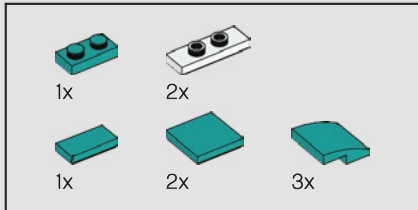
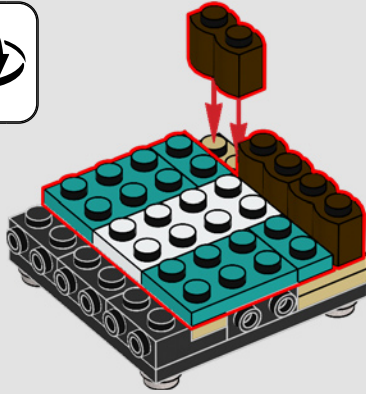

352

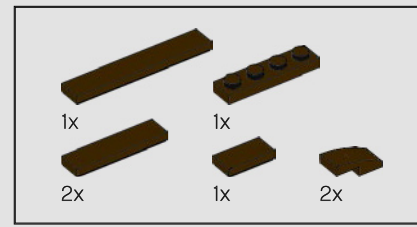
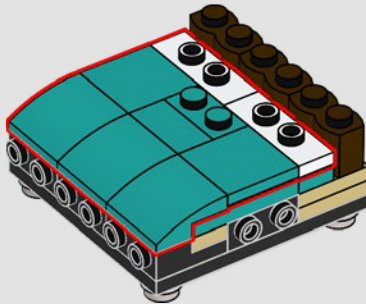

353

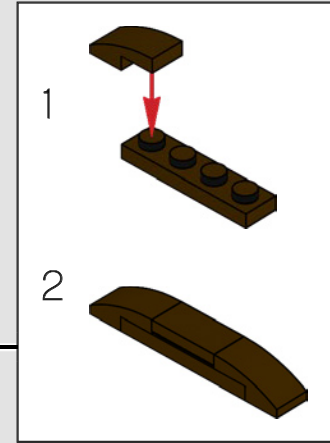
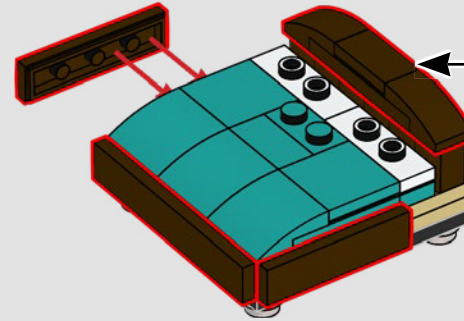

354

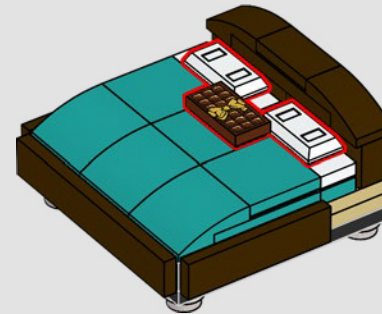

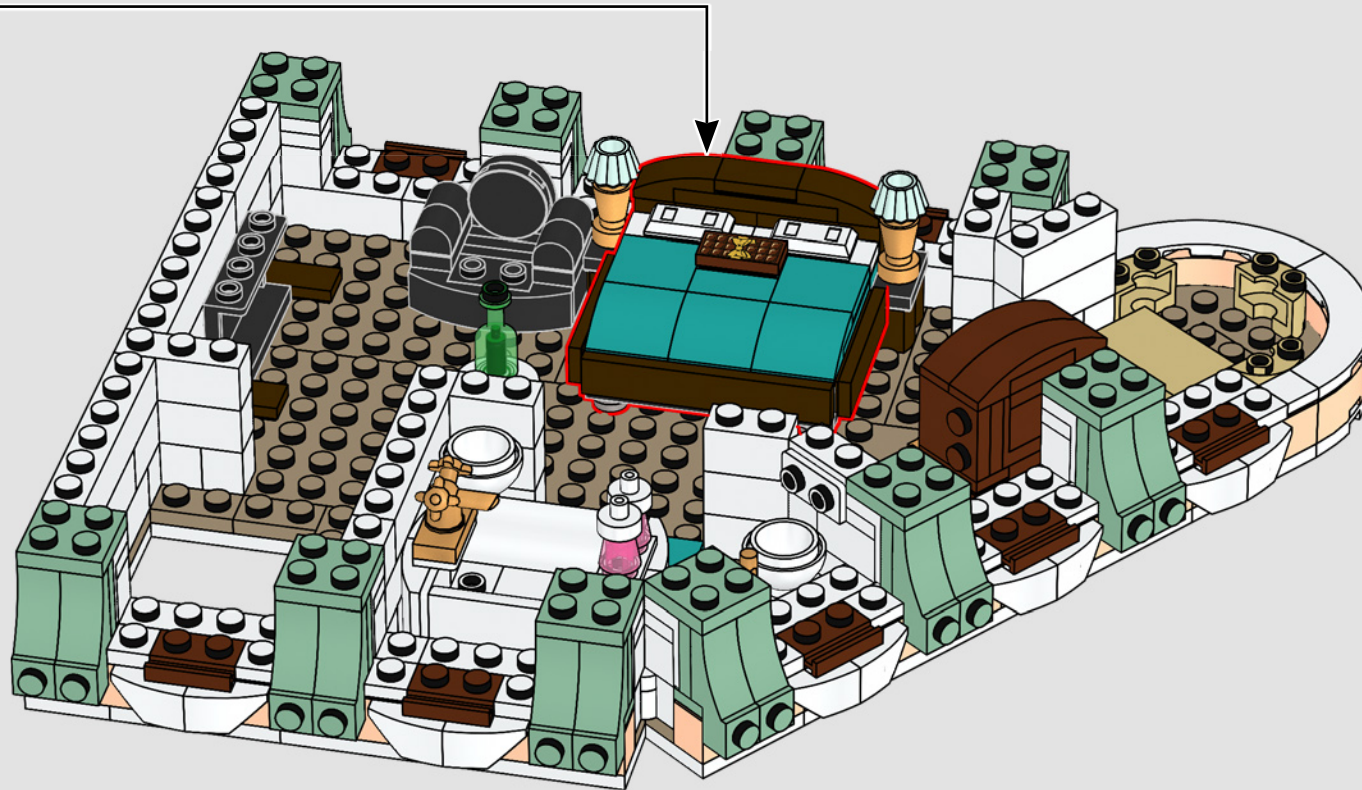

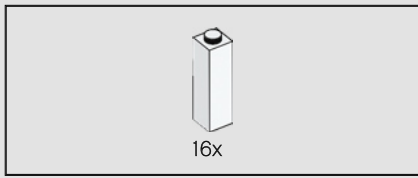

356

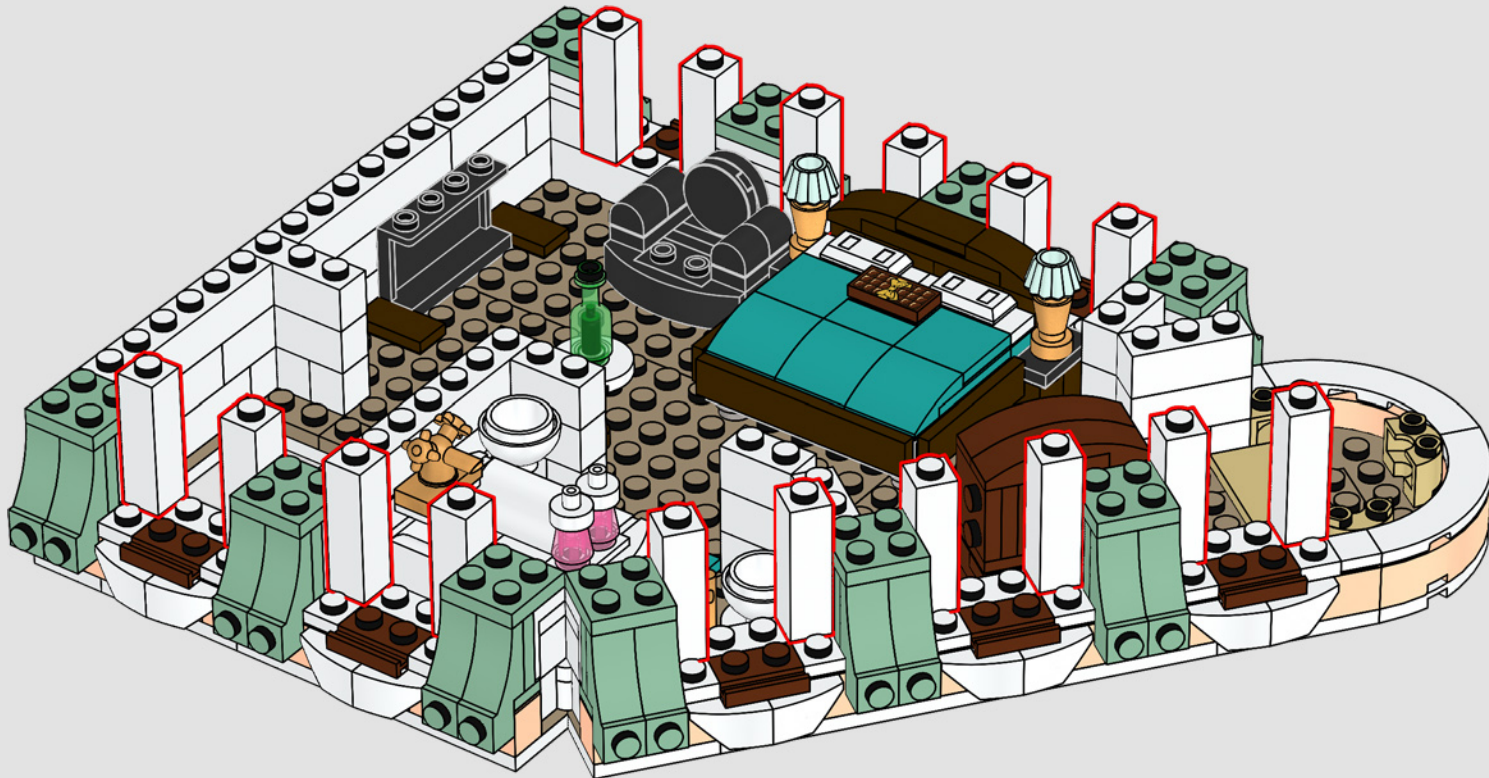

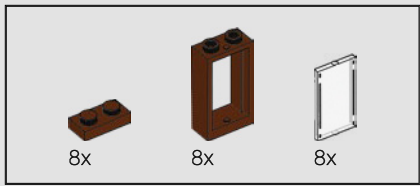

357

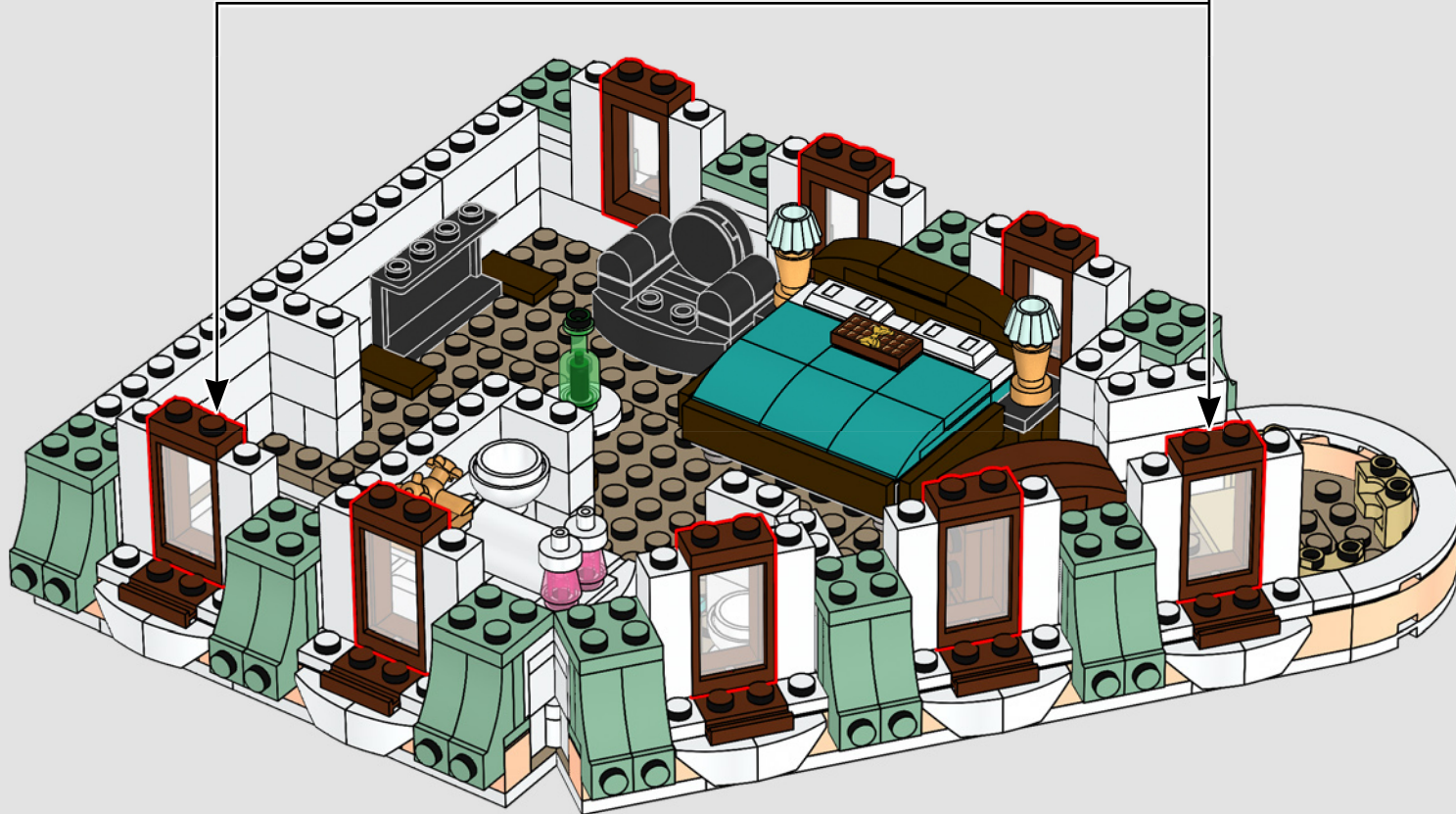
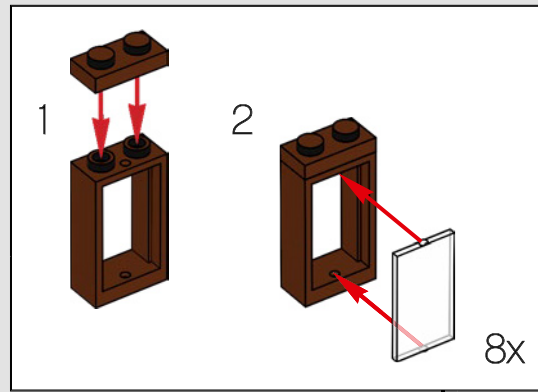

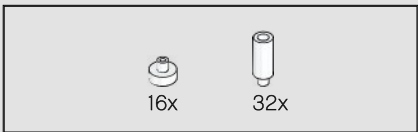

358

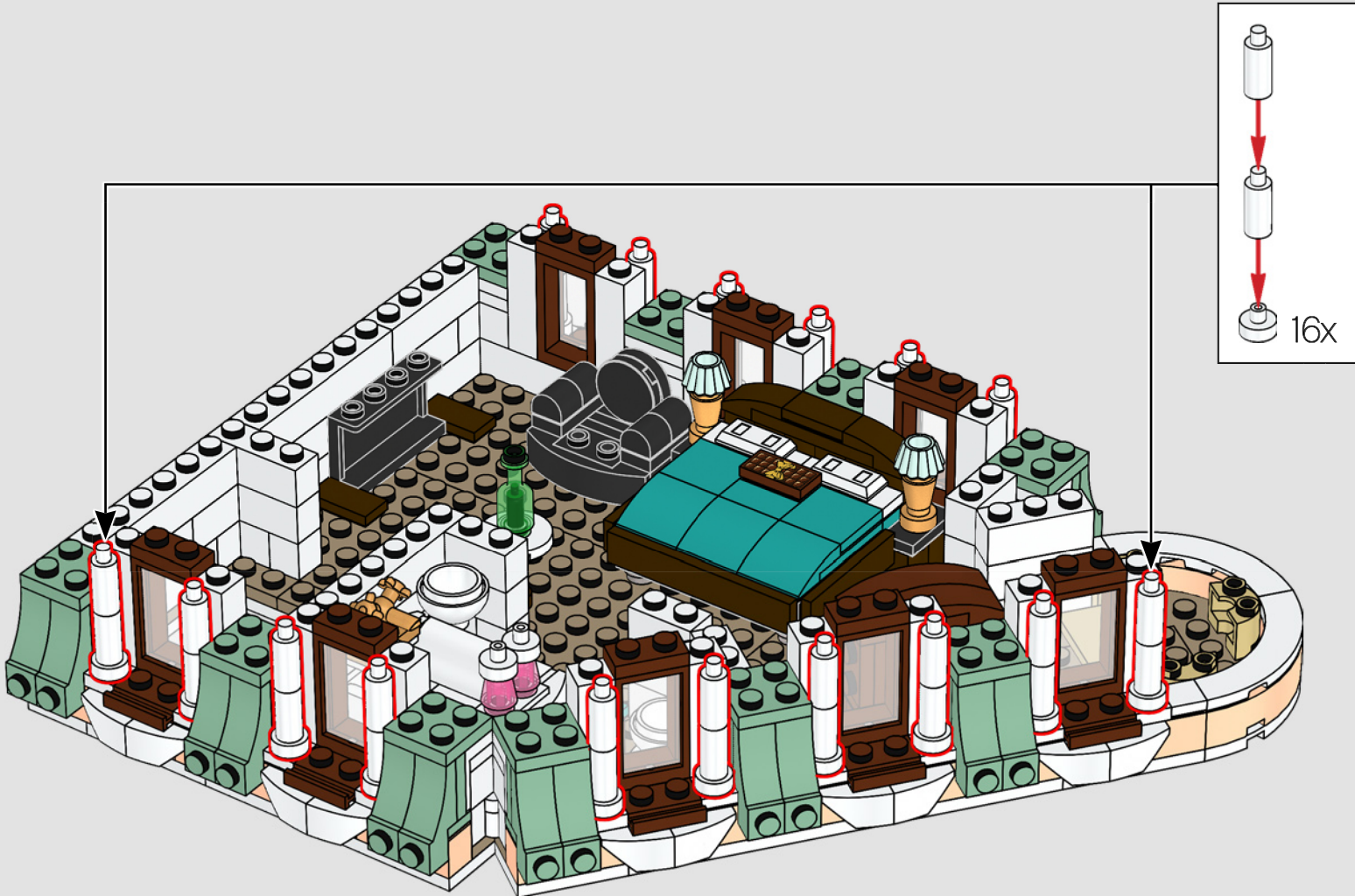



16x

359

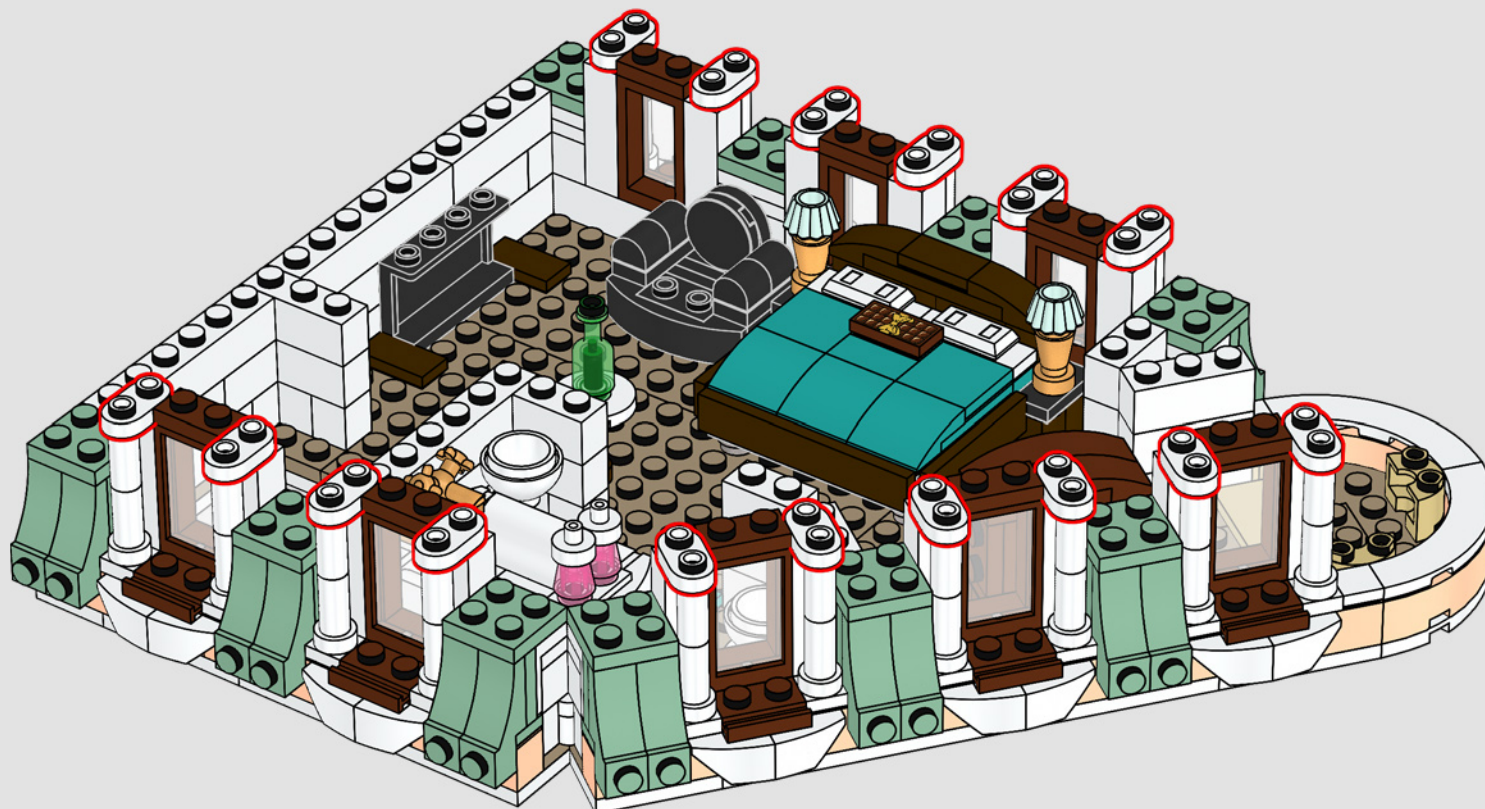

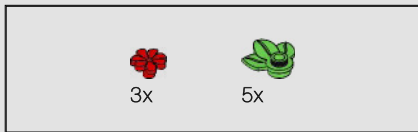

360

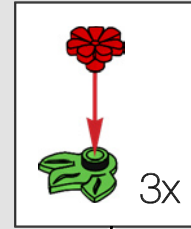

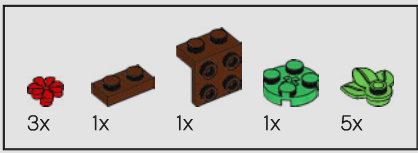

361

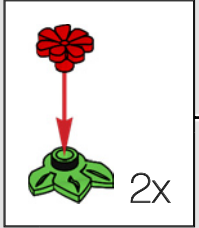
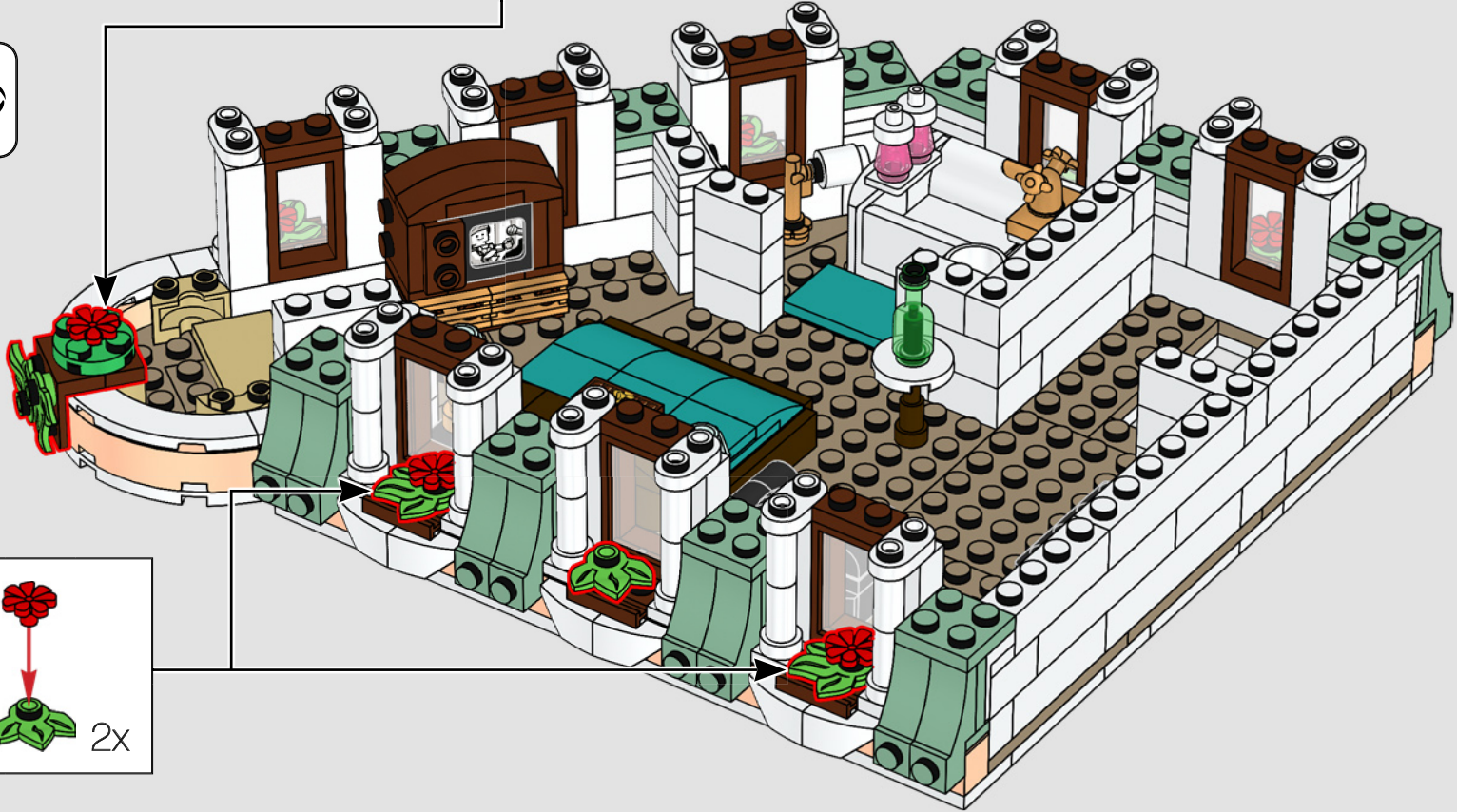
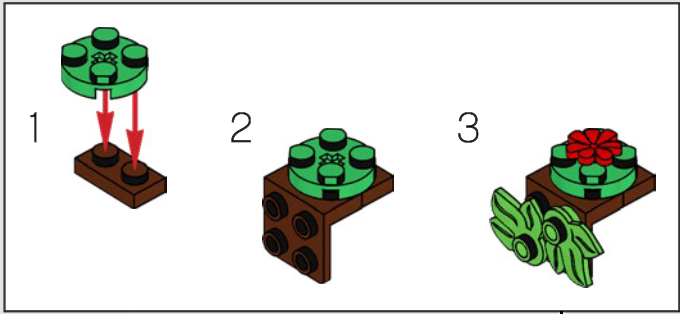

13

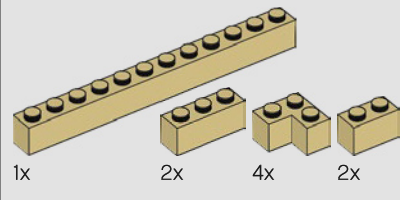
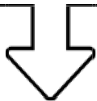

362

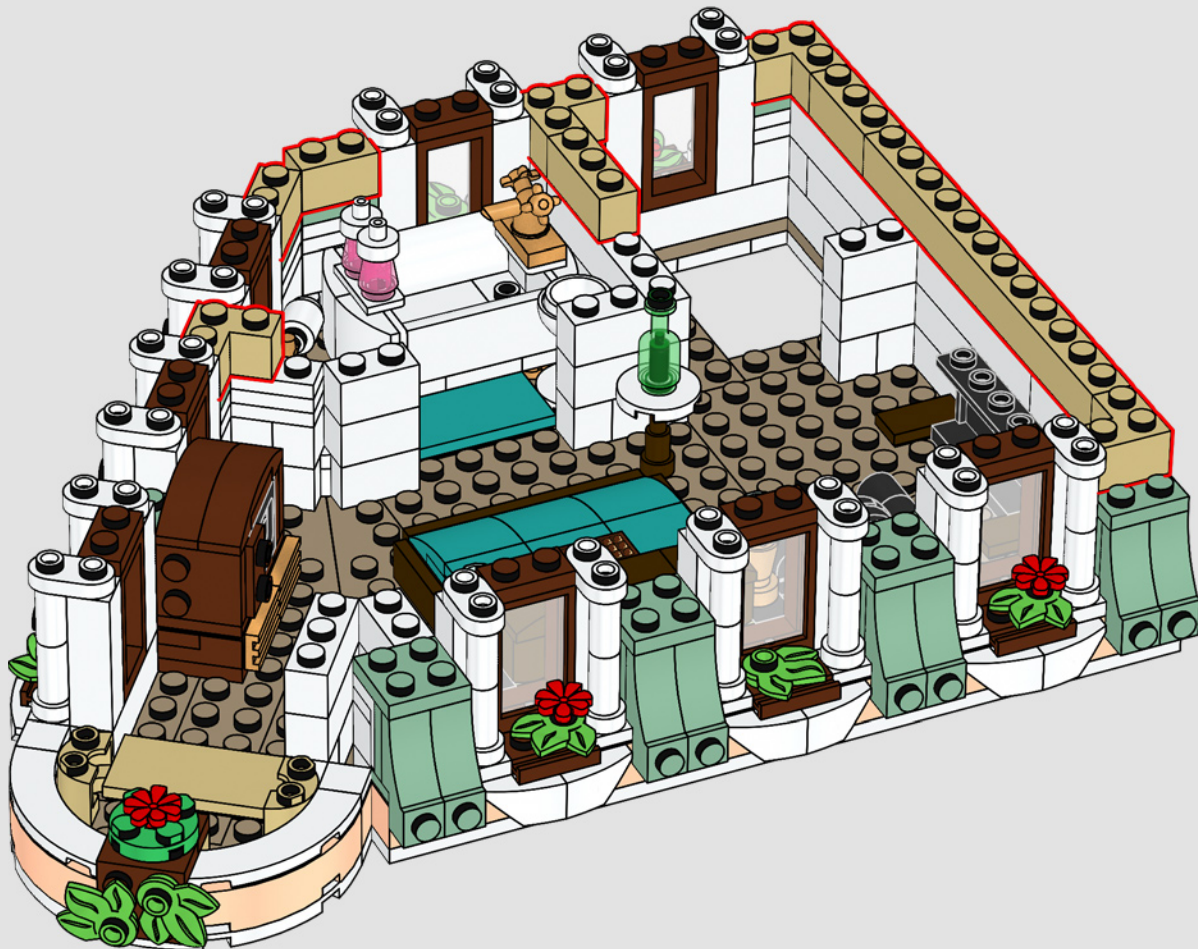

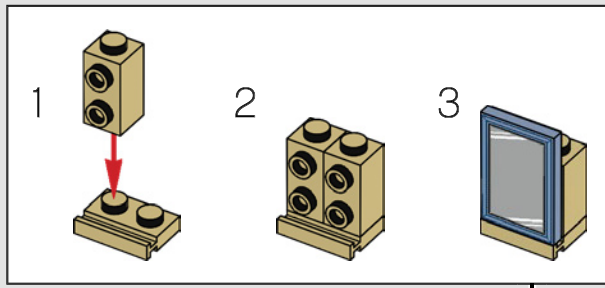
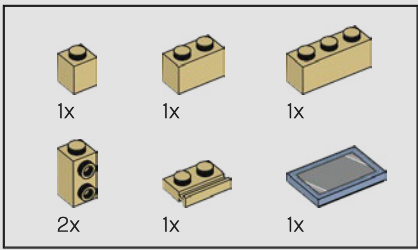

363

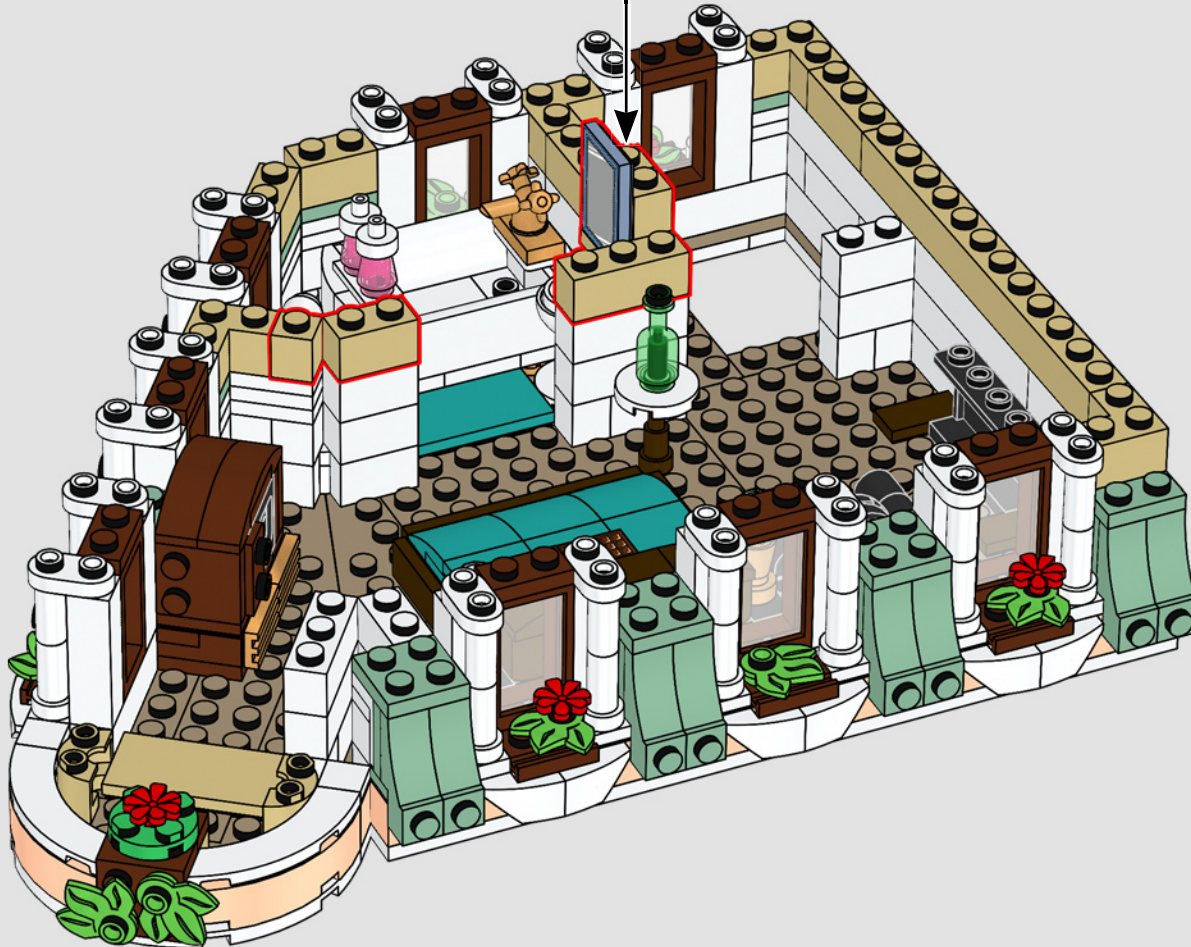

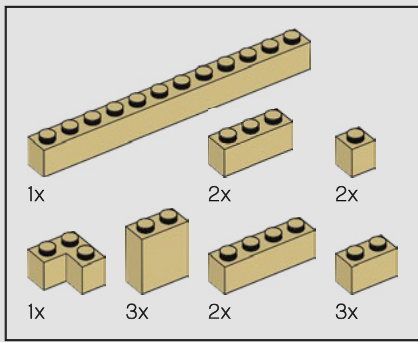

364



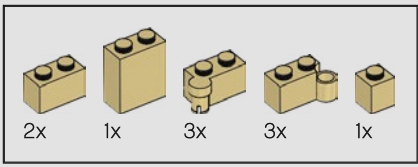

365

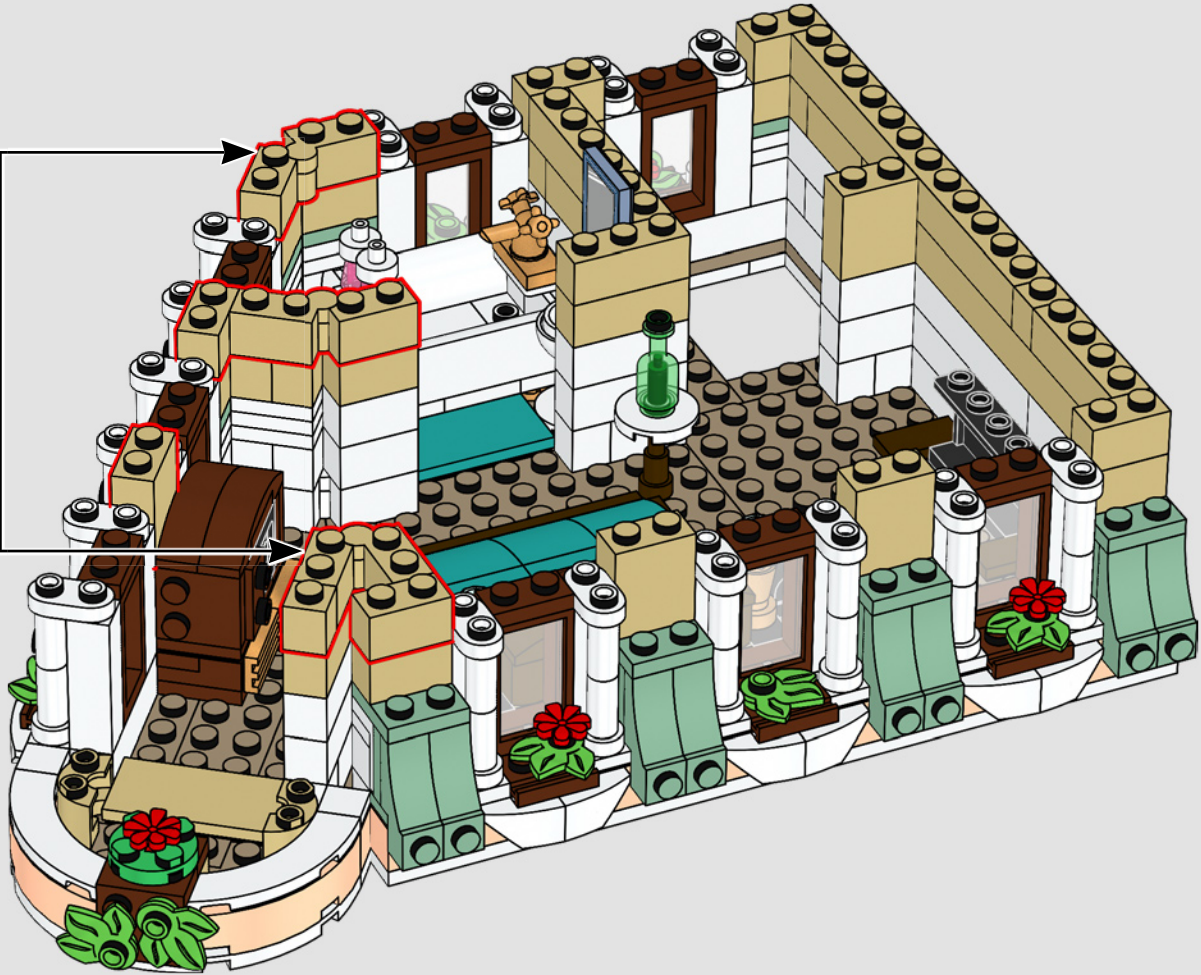
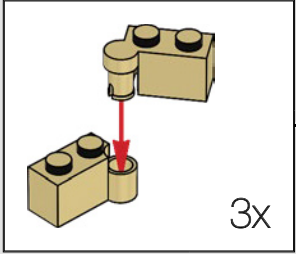

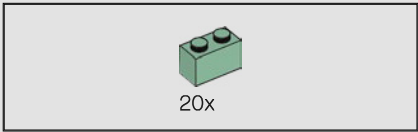

366

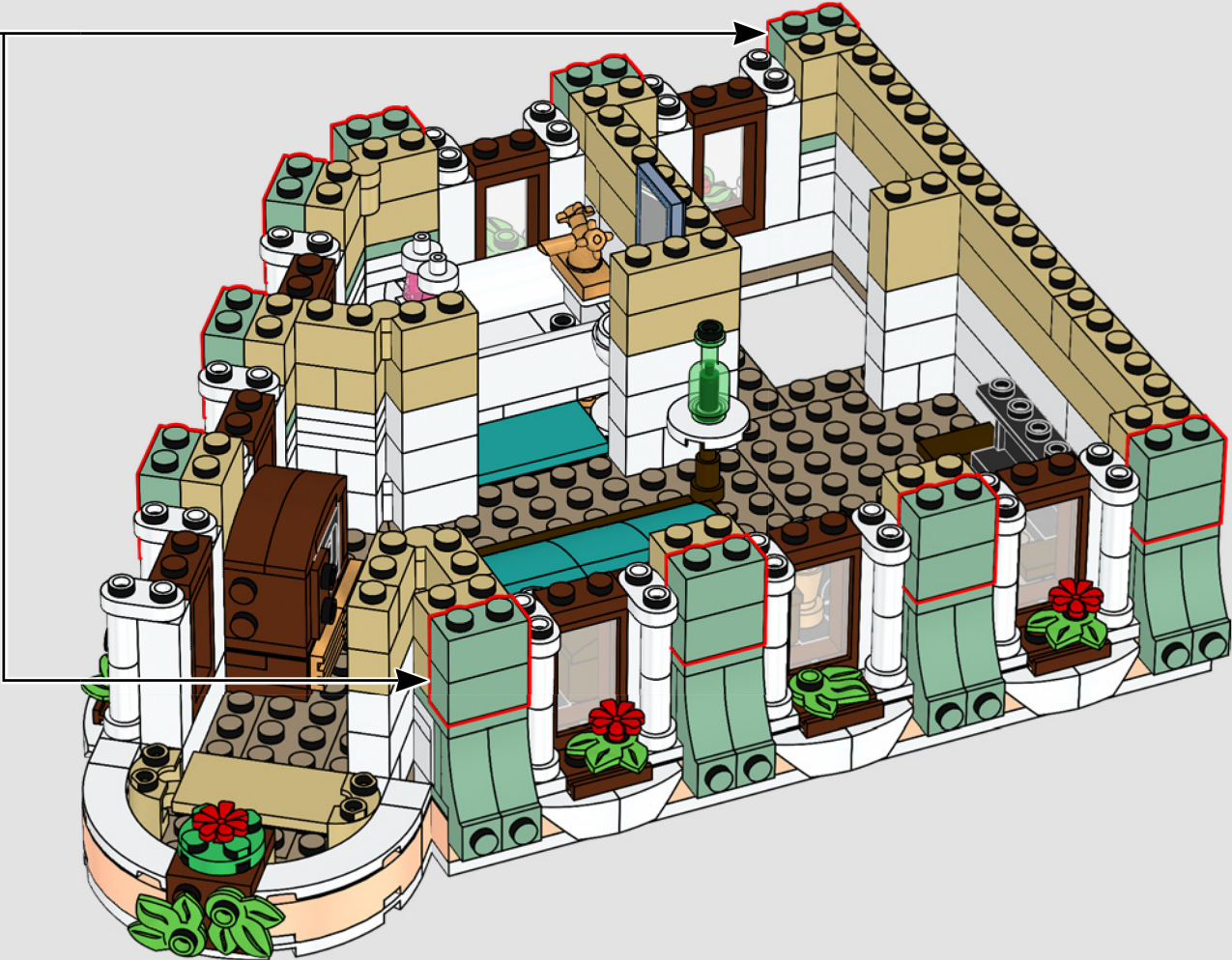
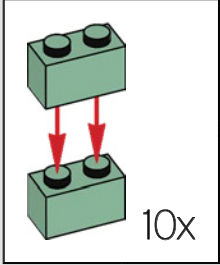

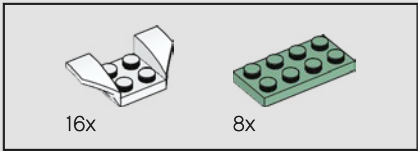

367

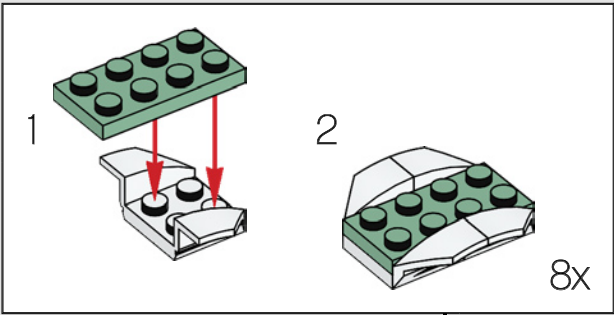

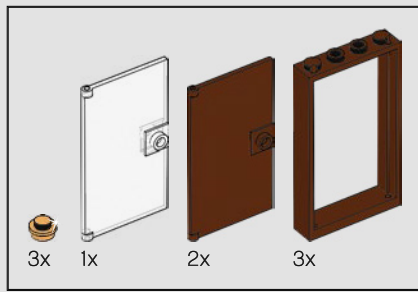

368

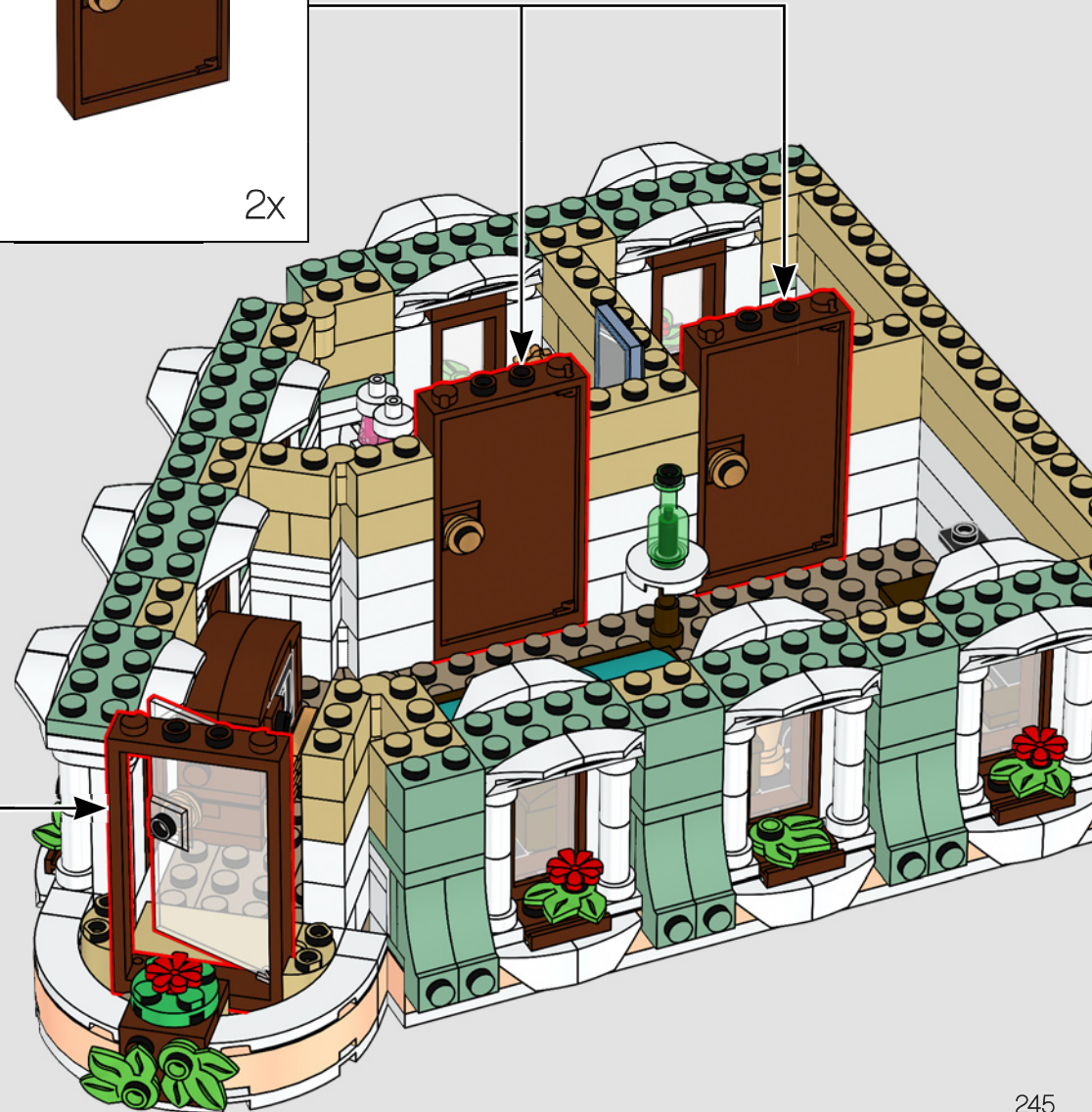
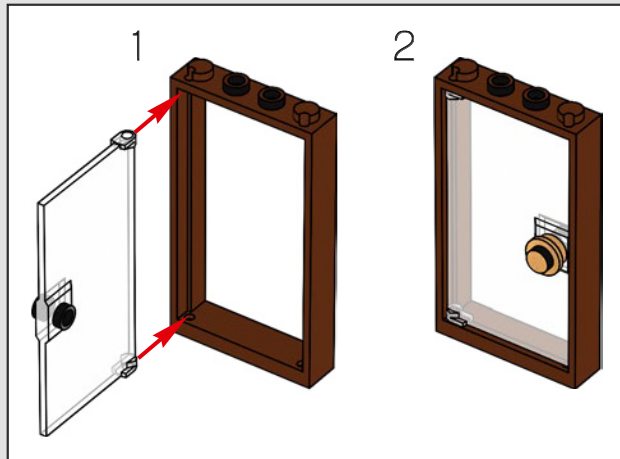
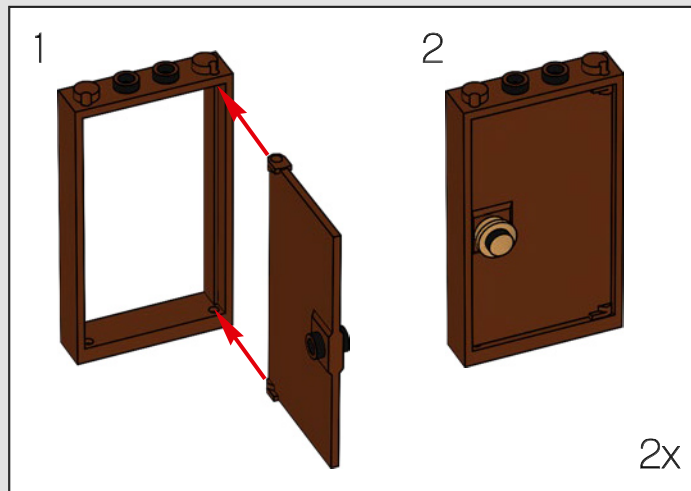

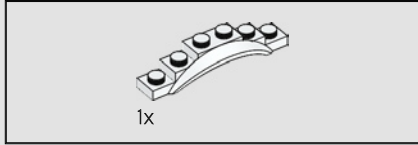
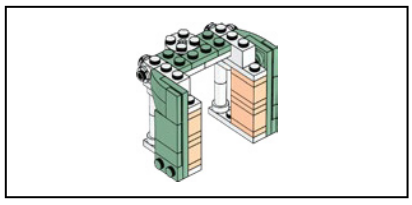

369

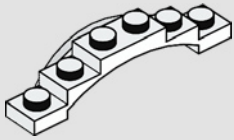

370

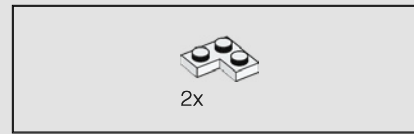
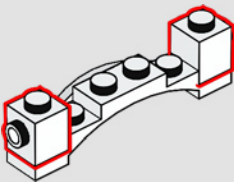

371

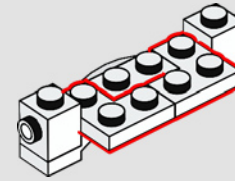

372

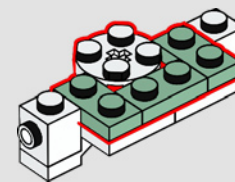



373

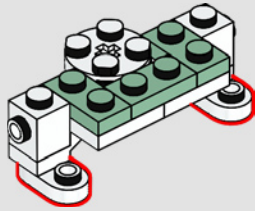

374

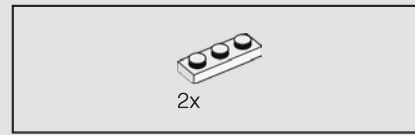
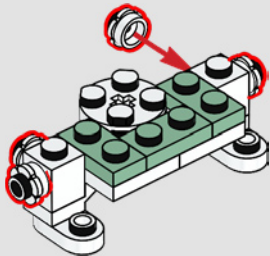

375

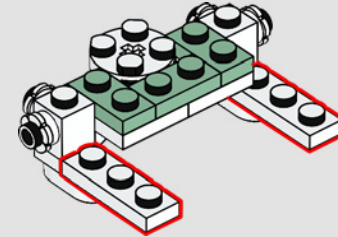

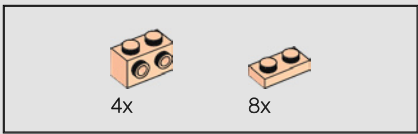

376

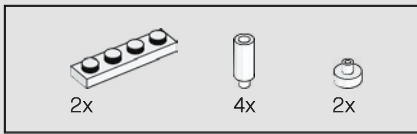
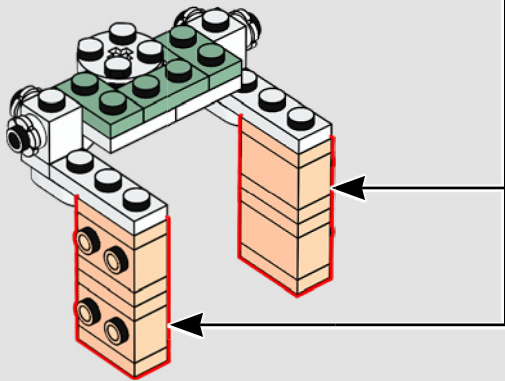
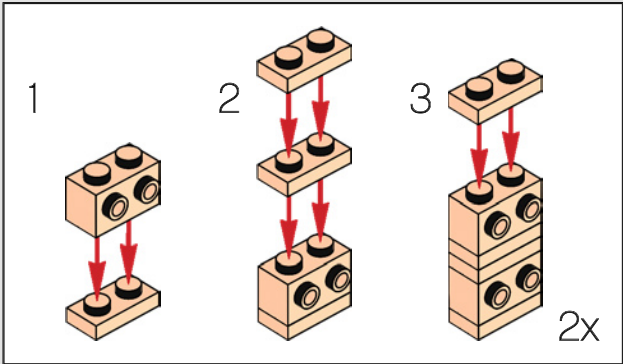

377

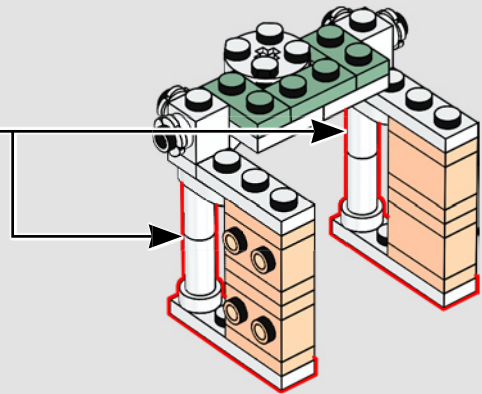
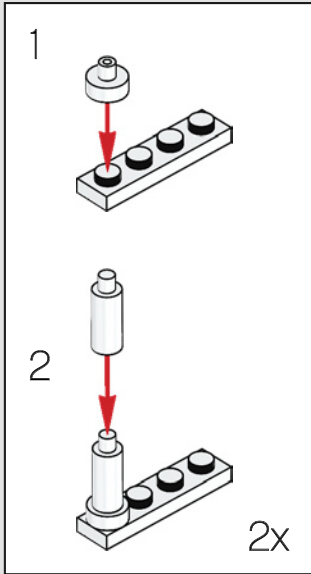

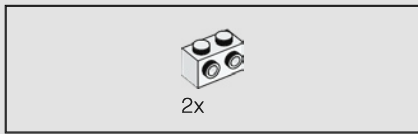

378

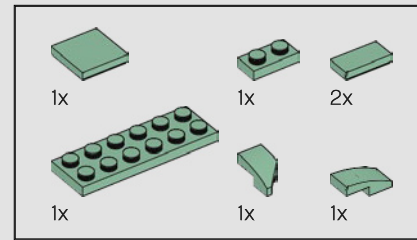
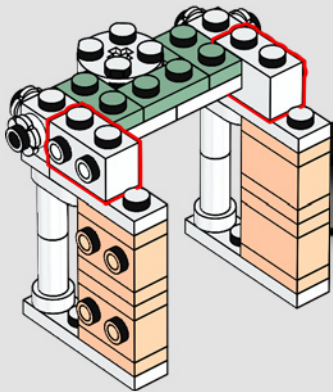

379

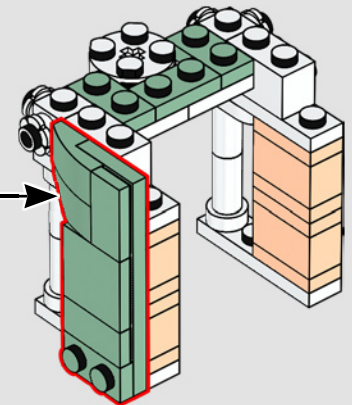
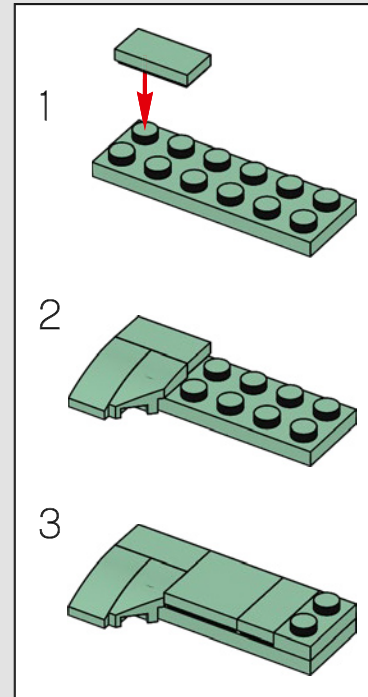

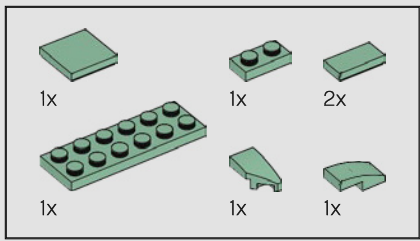

380

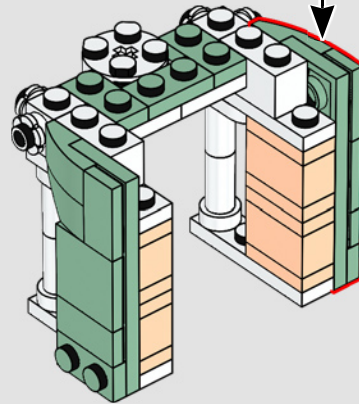
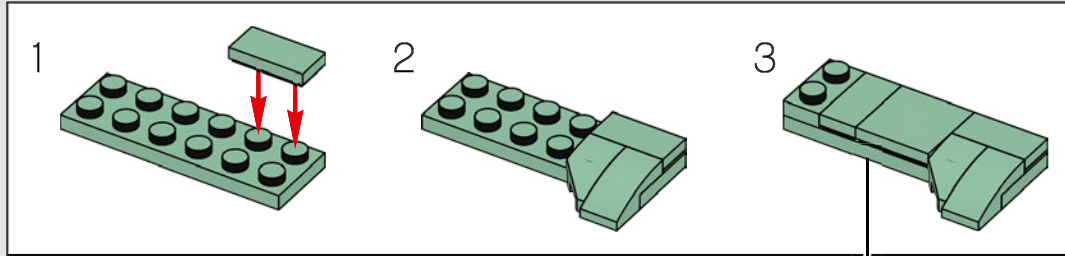

381

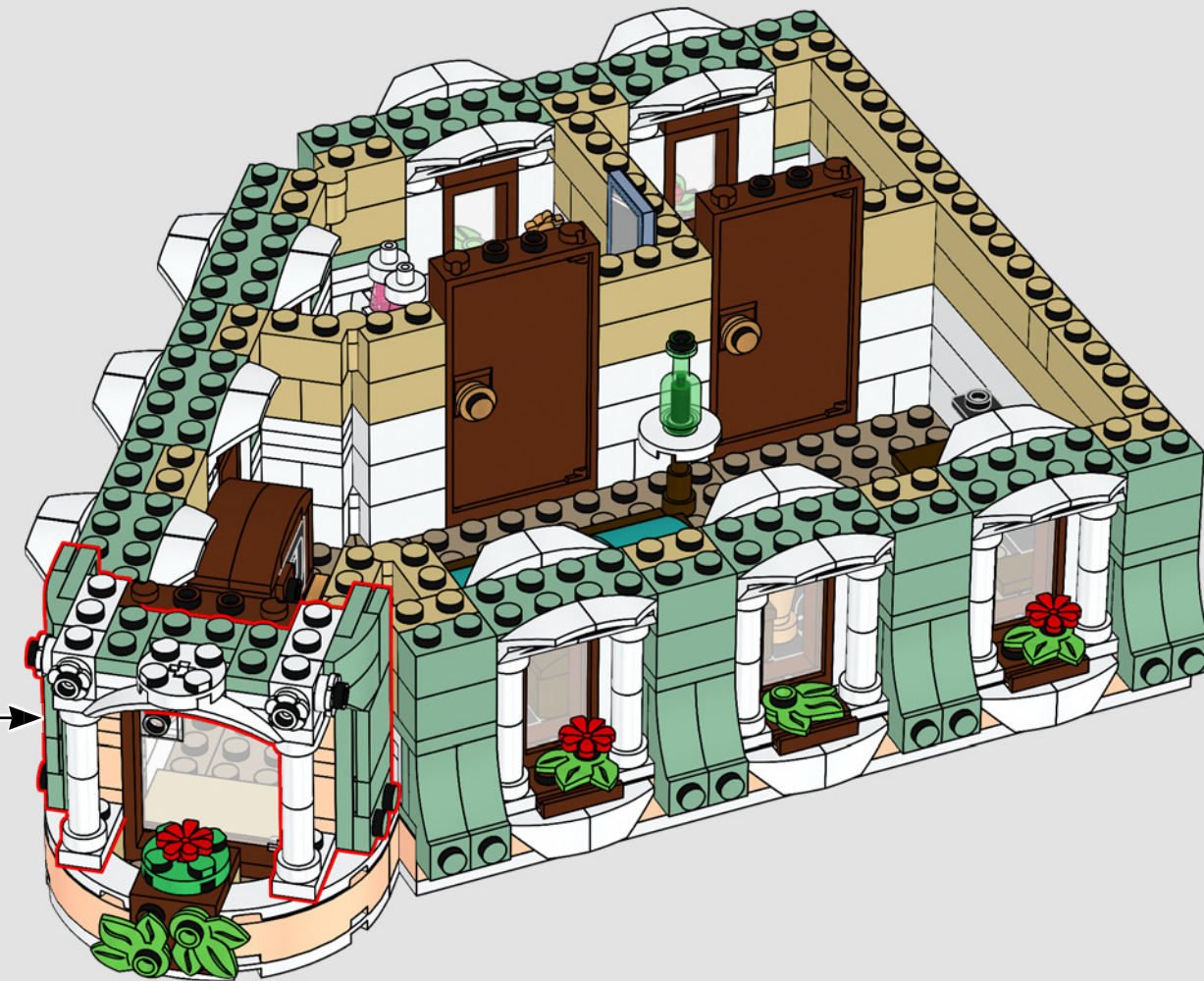

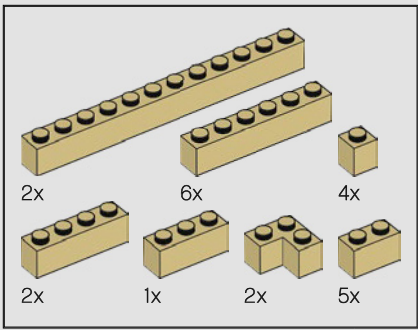

382

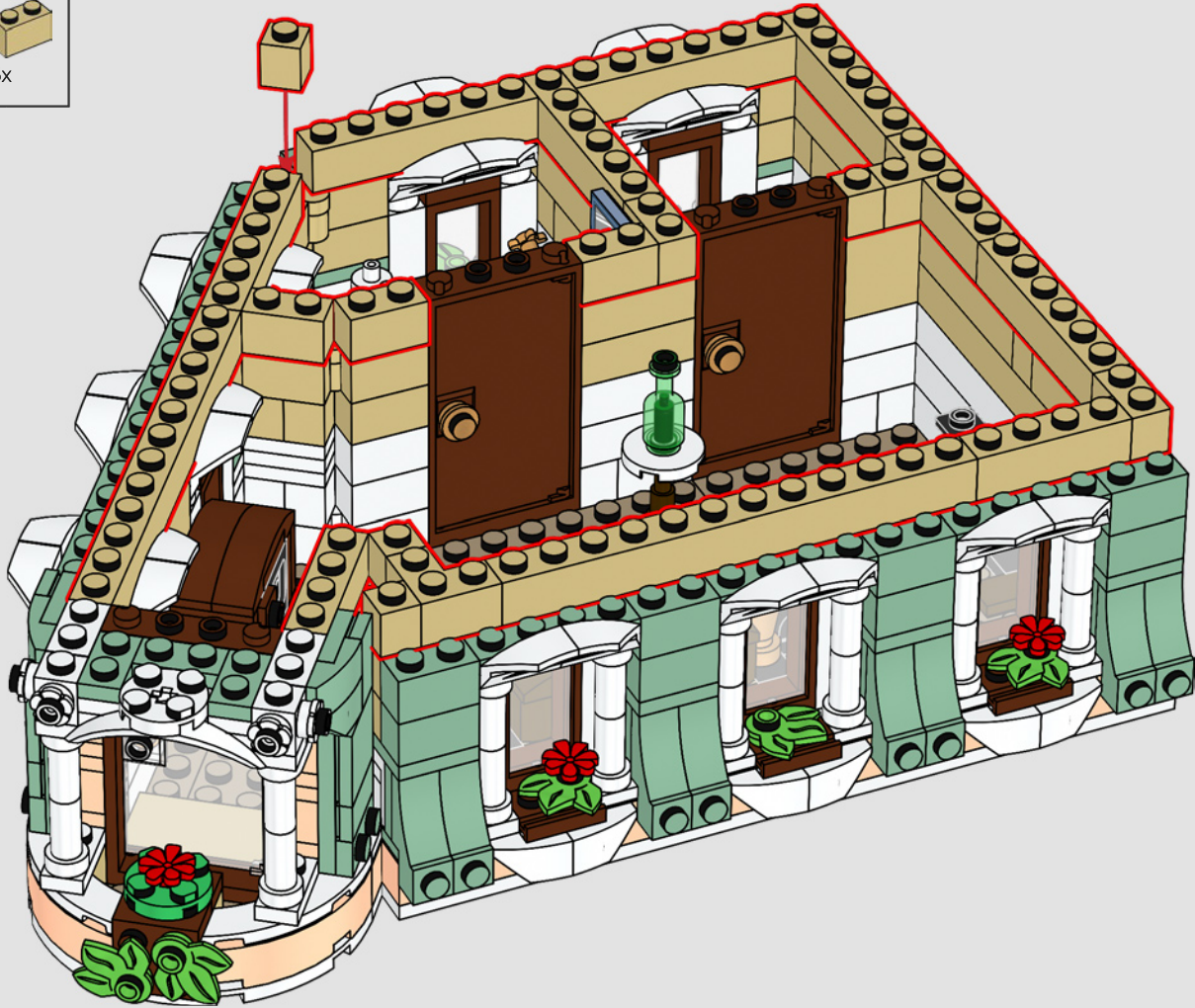

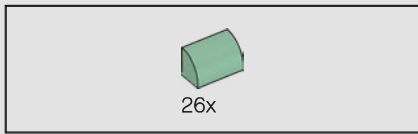

383



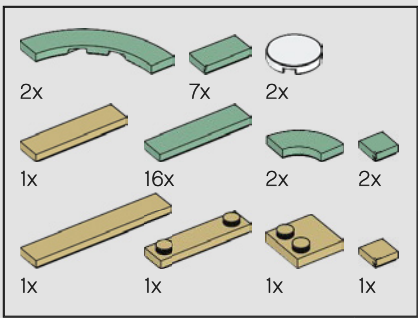

384

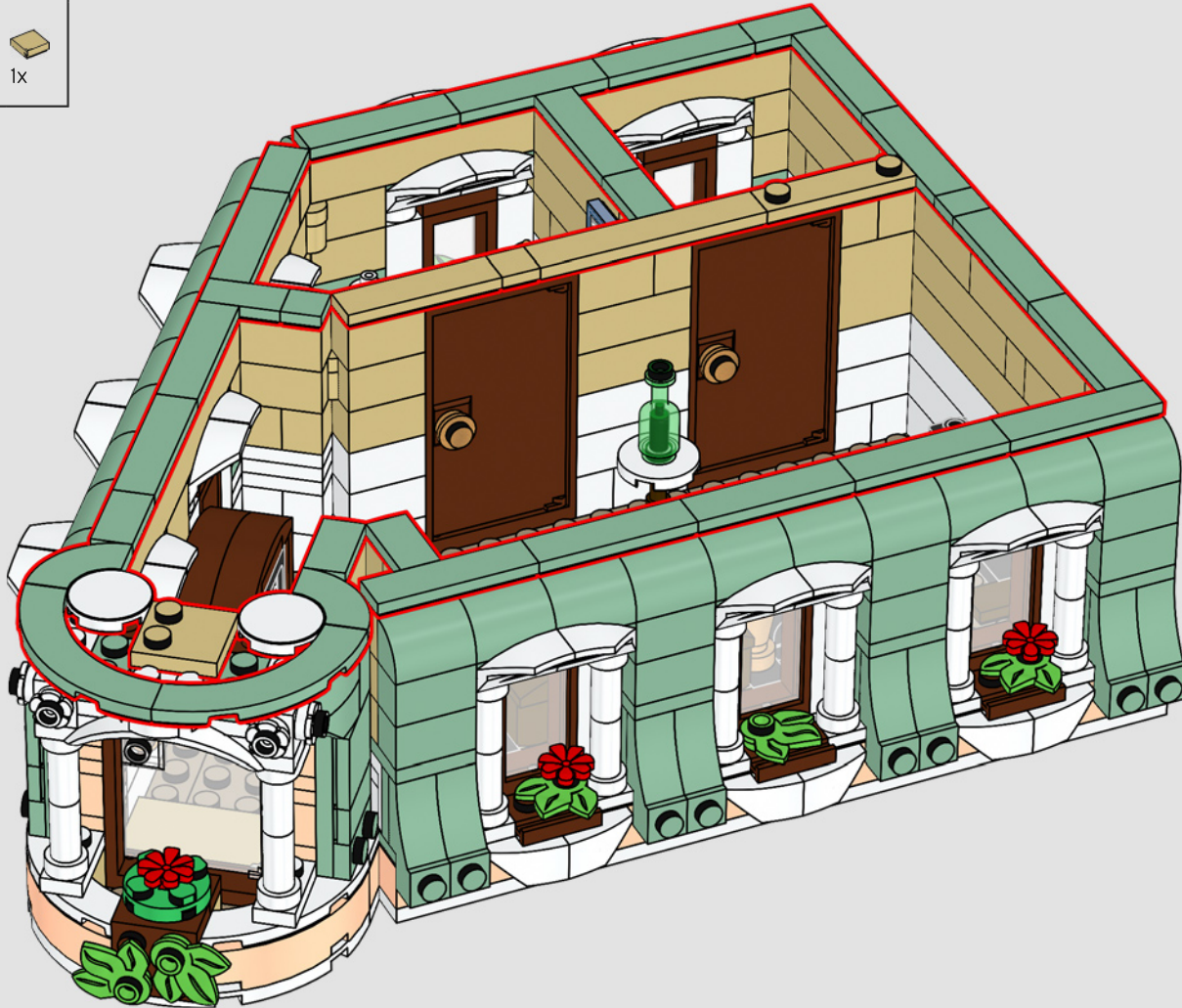

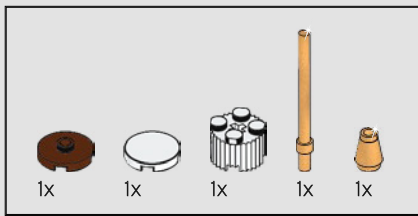

385

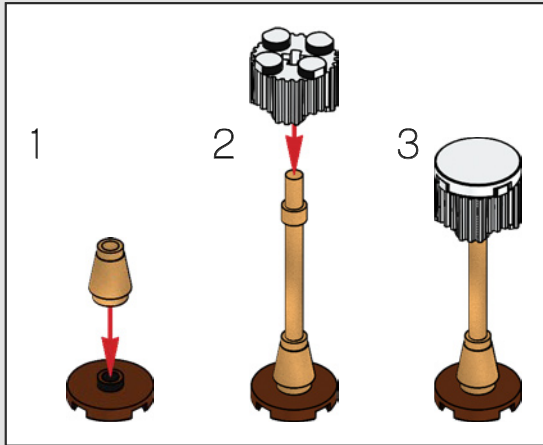

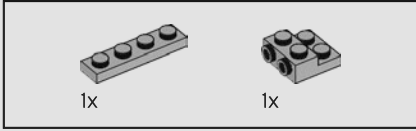
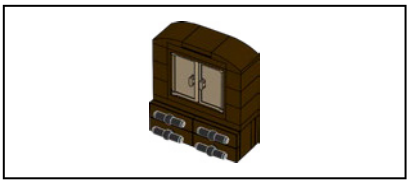

386

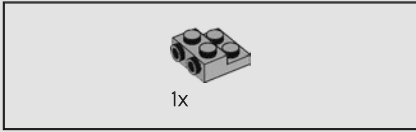
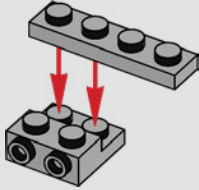

387

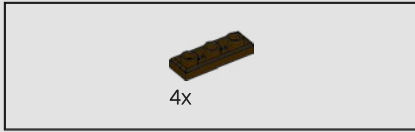
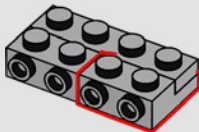

388

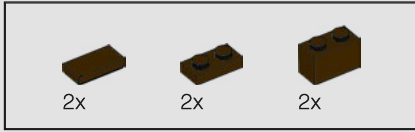
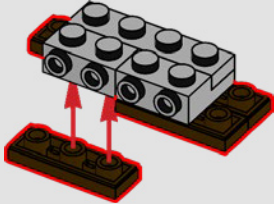

389

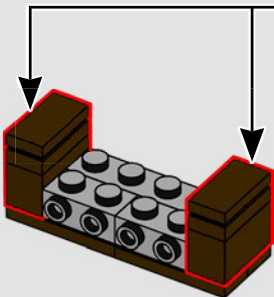
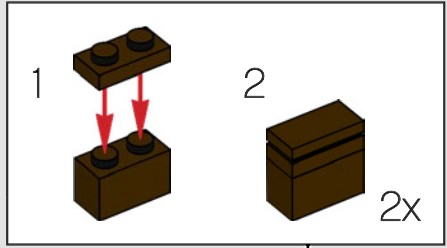

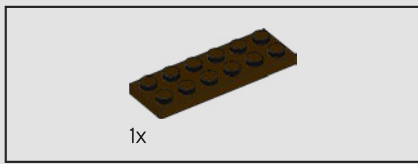

390

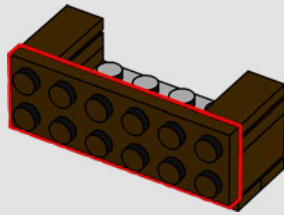

391

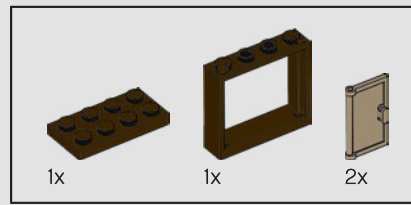
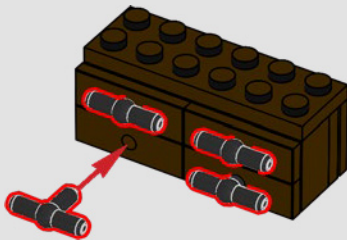

392

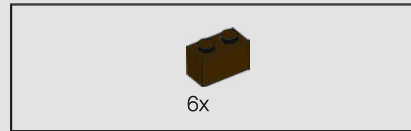
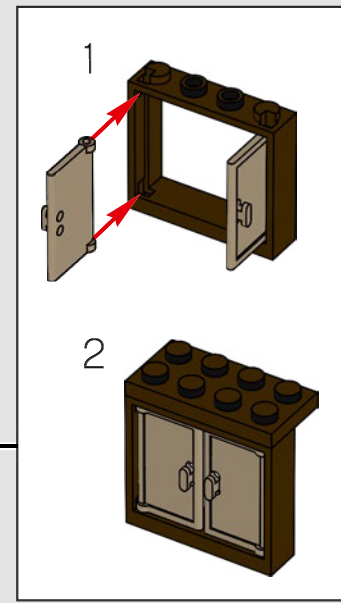
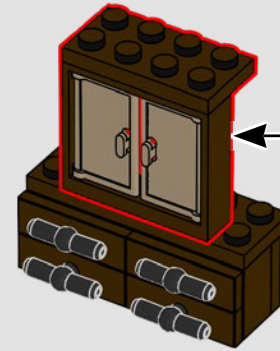

393

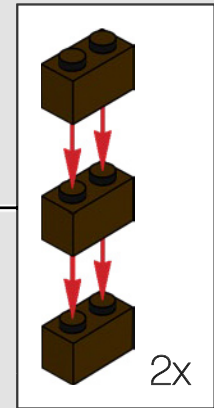
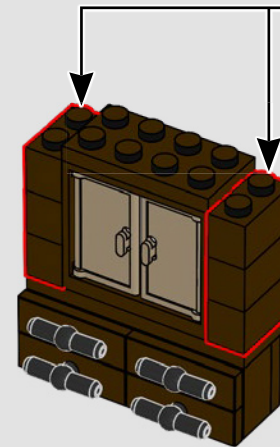

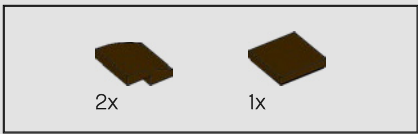

394

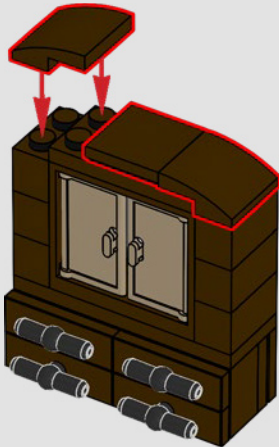

395



396

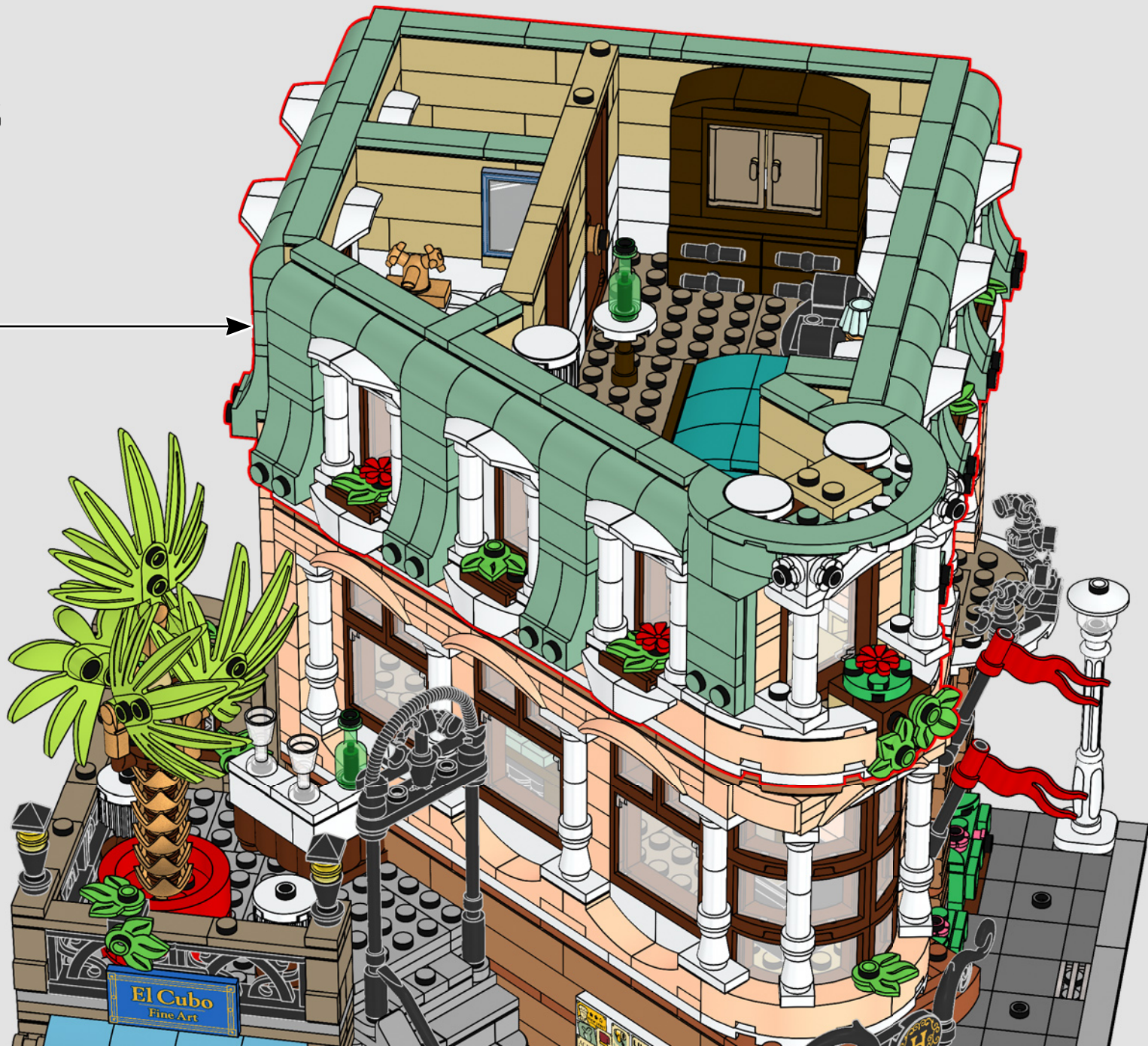

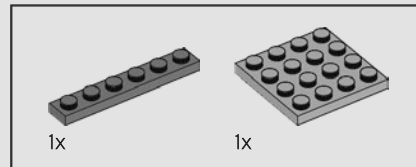
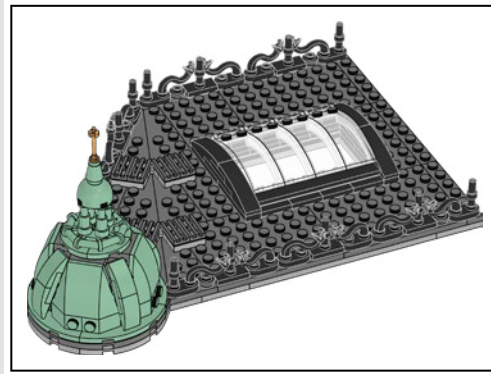
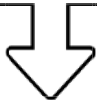

1x

1x

397

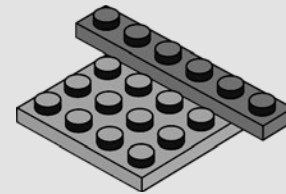

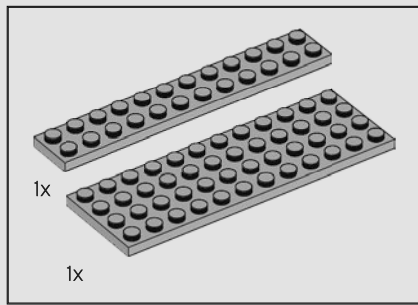

398

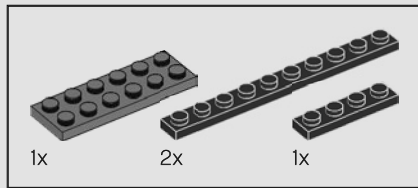
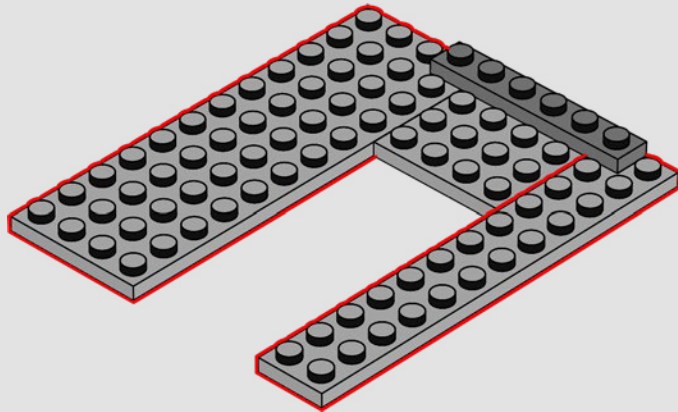

399

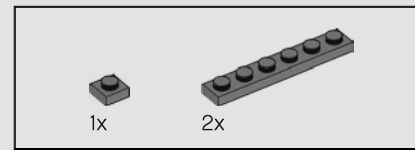
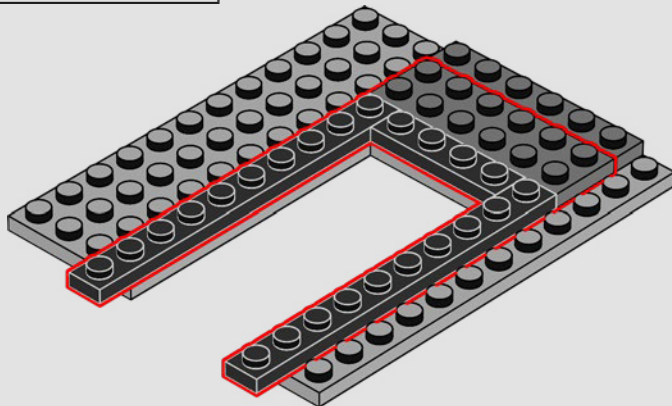

400

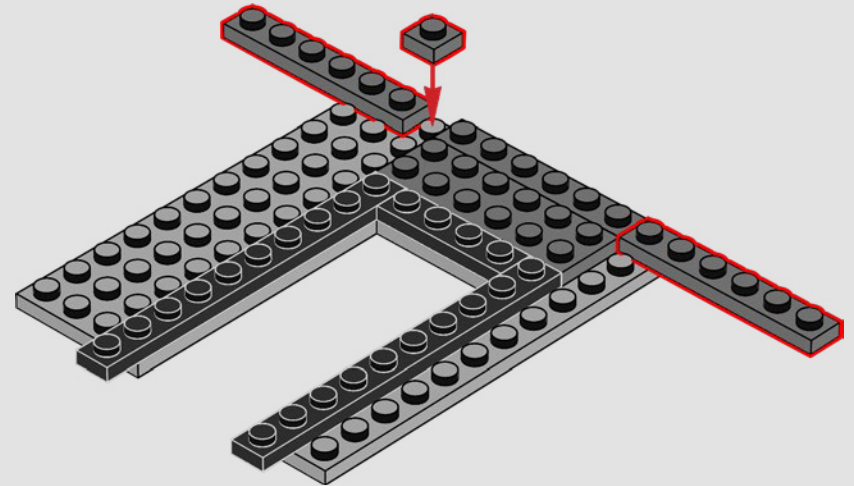

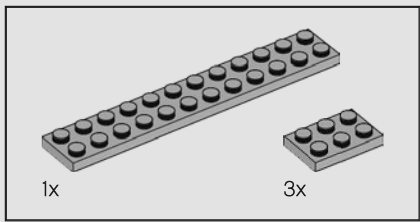

401

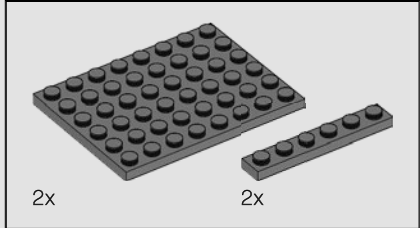
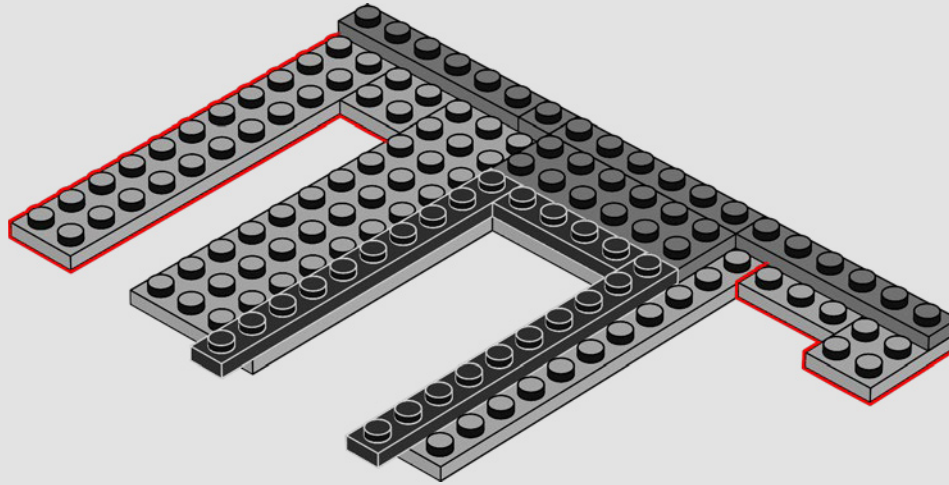

402

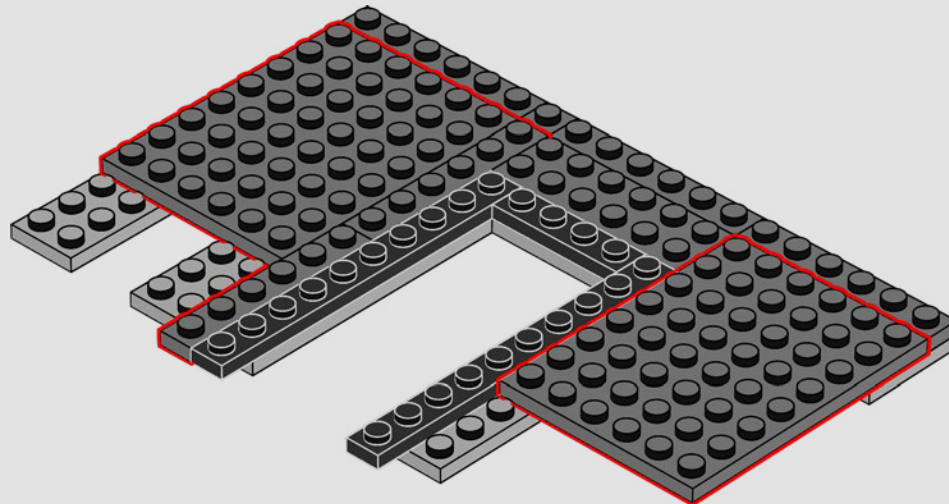

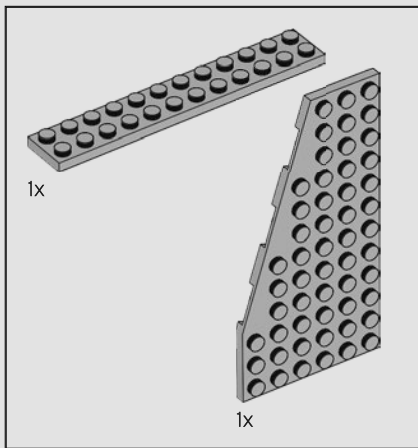

403

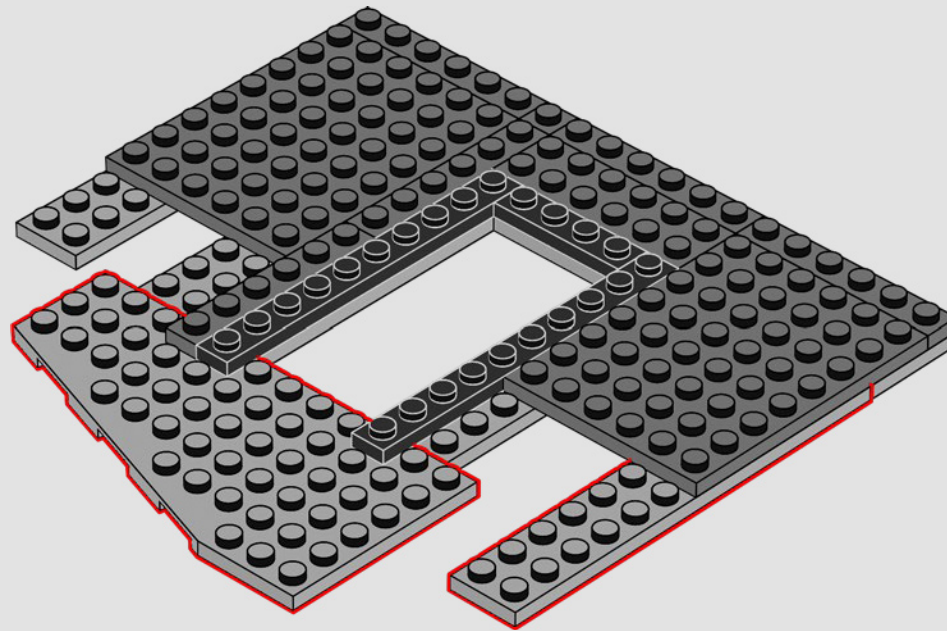

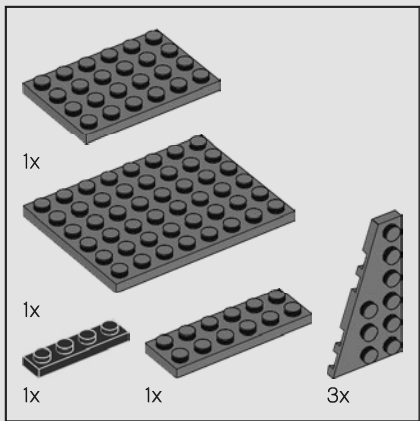

404

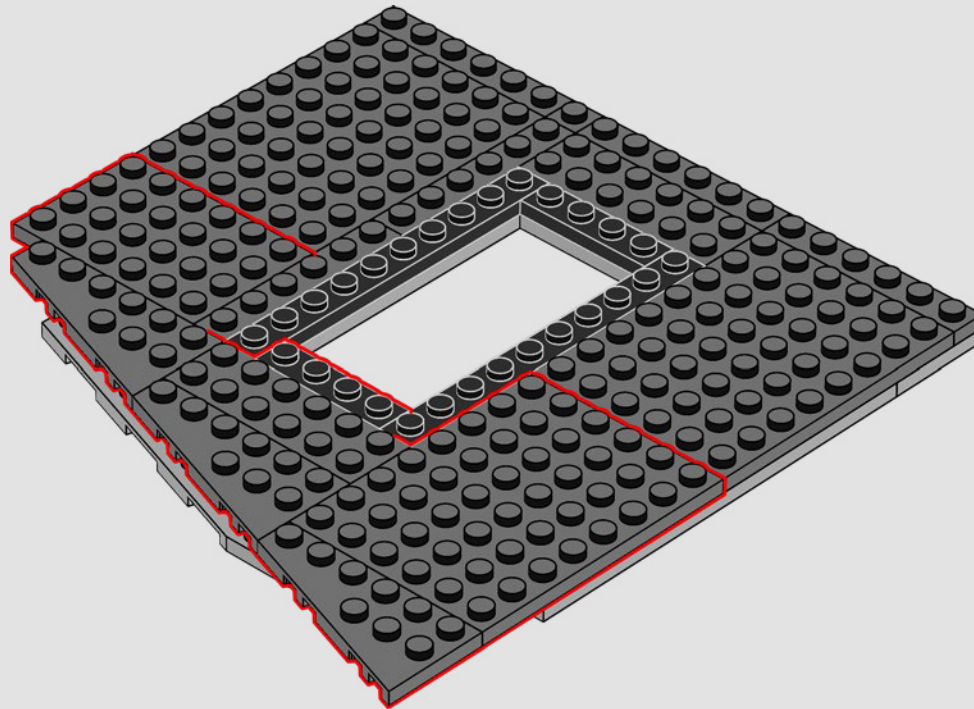

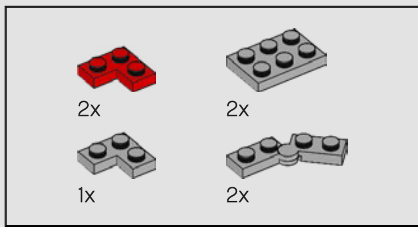

405

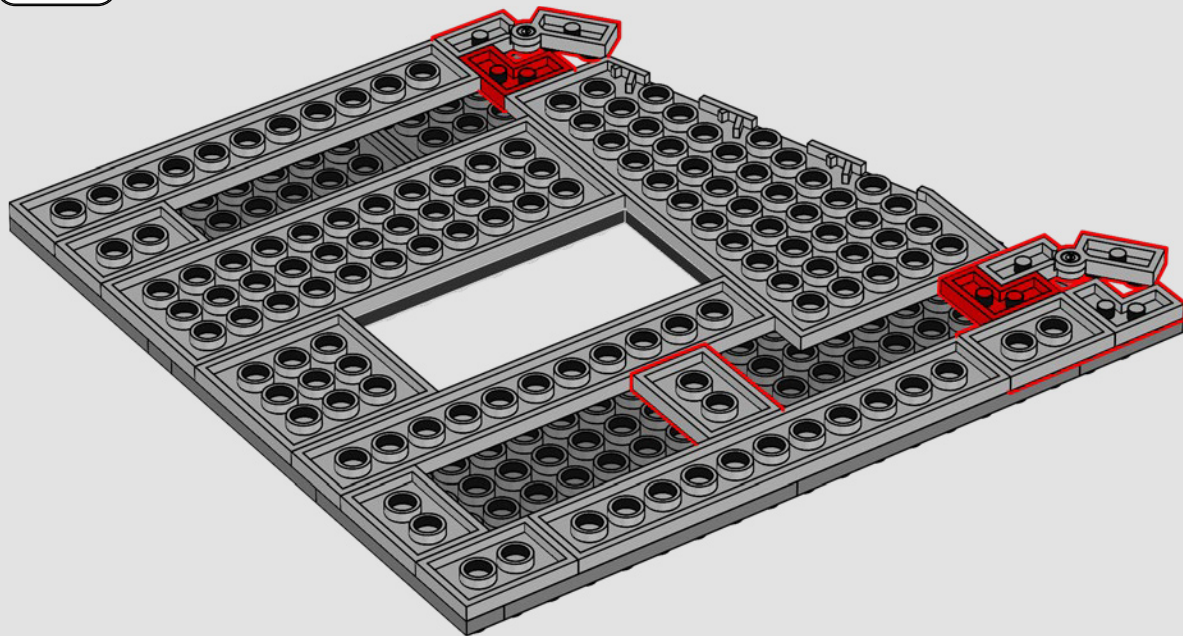



1x

406

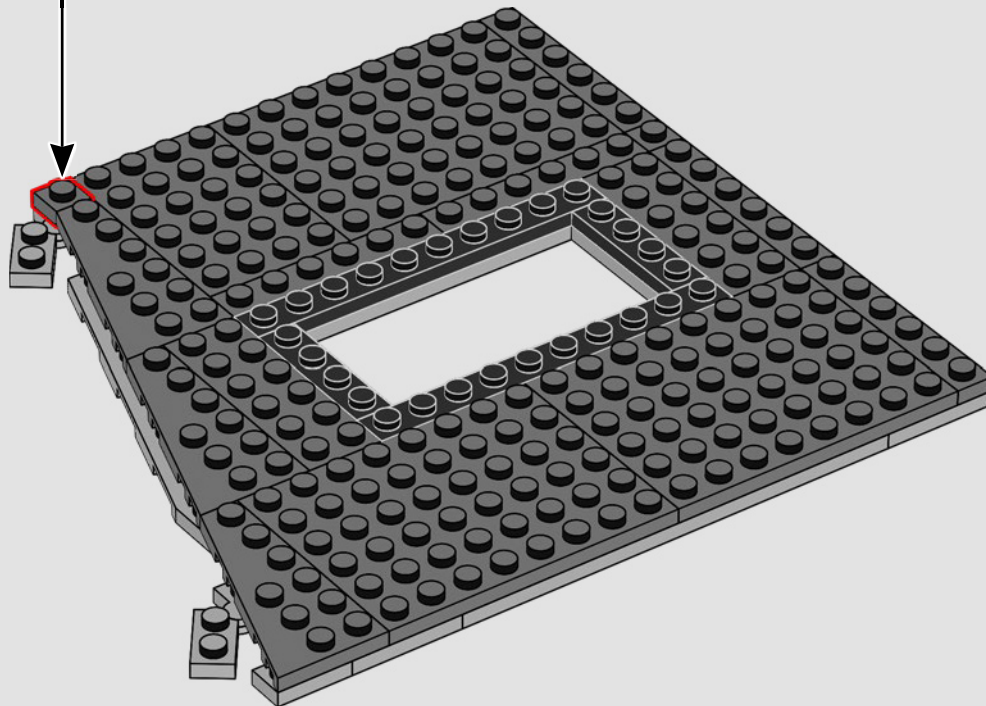
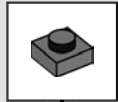

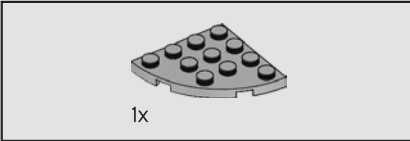
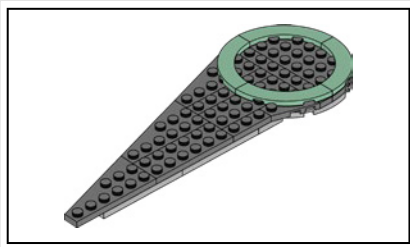

407

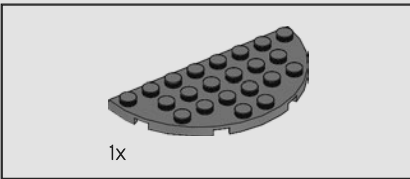
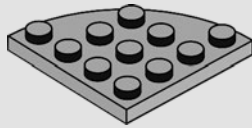

408

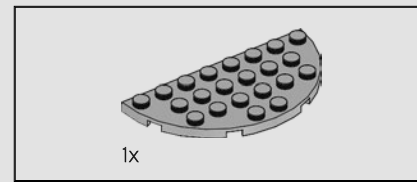
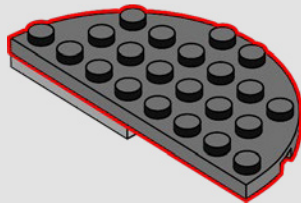

409

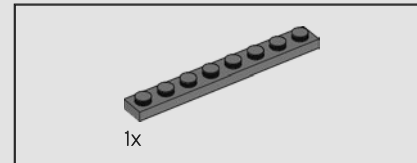
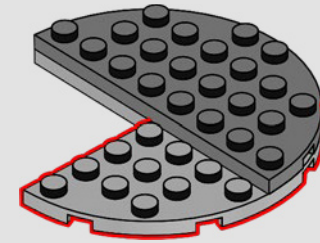

410

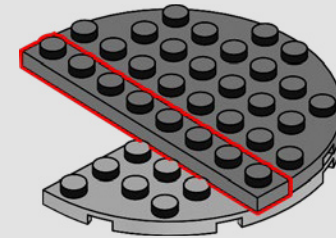

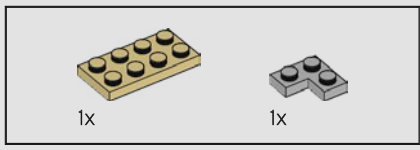

411

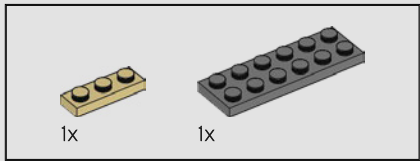
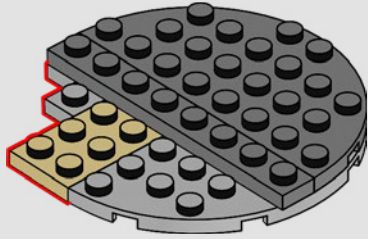

412

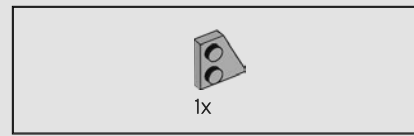
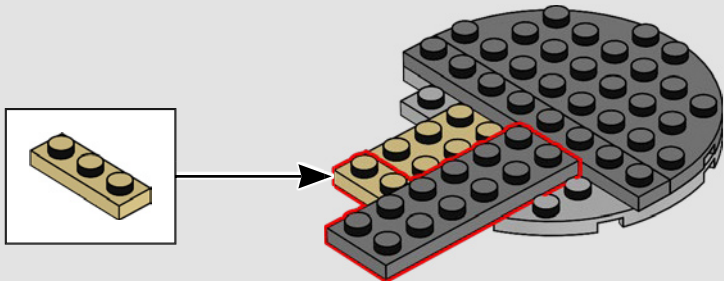

413

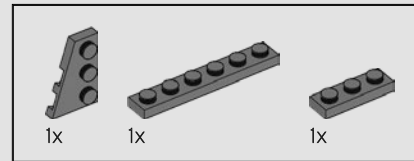
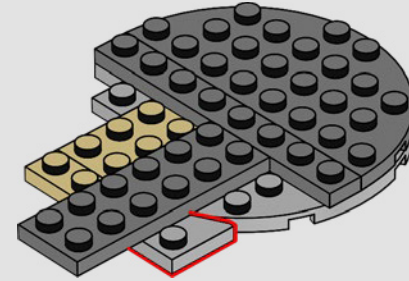

414

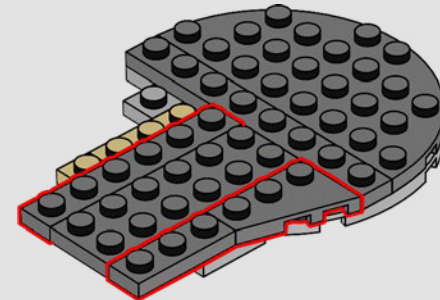

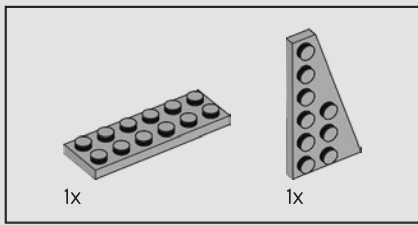

415

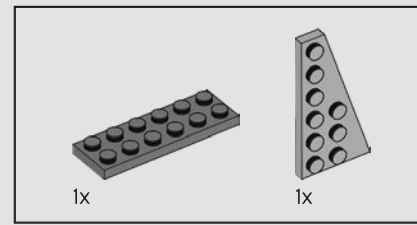
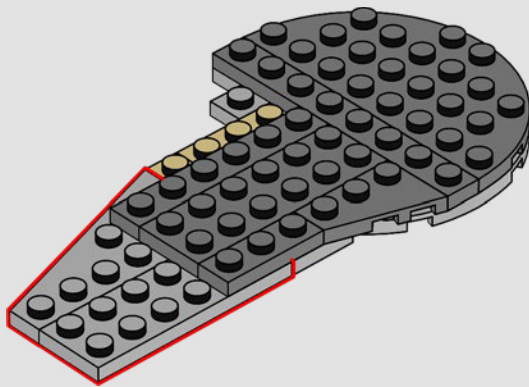

416

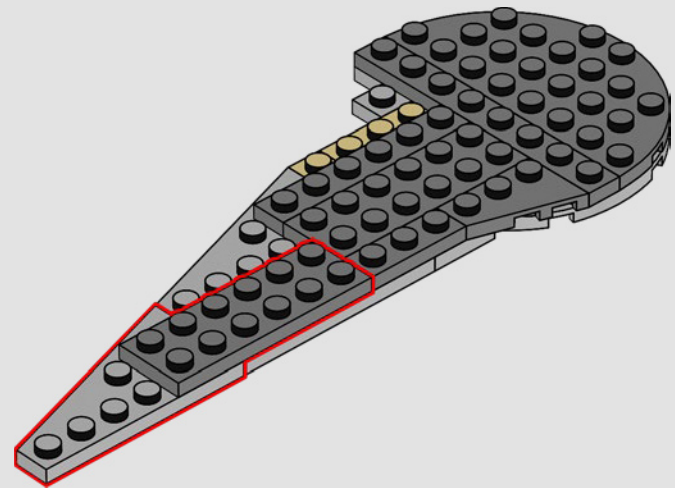

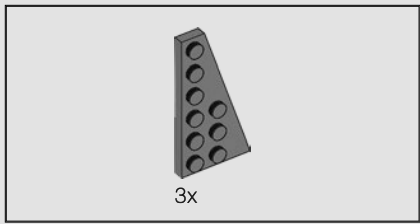

417

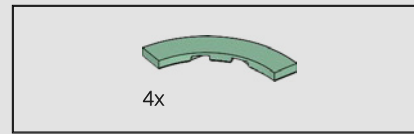
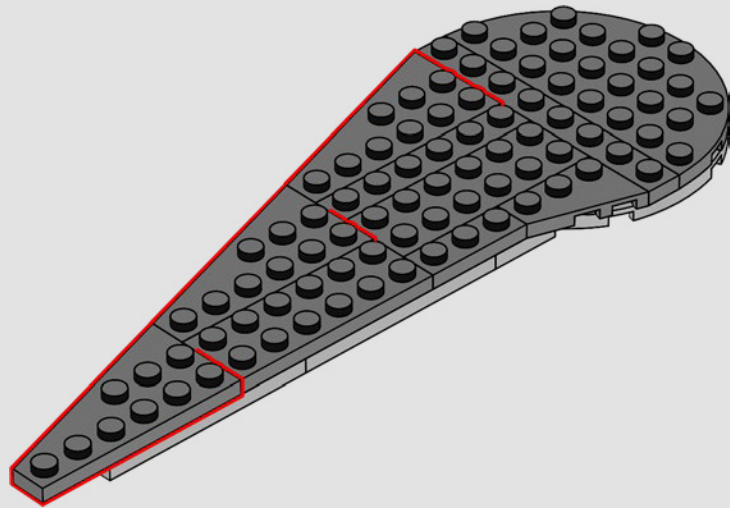

418

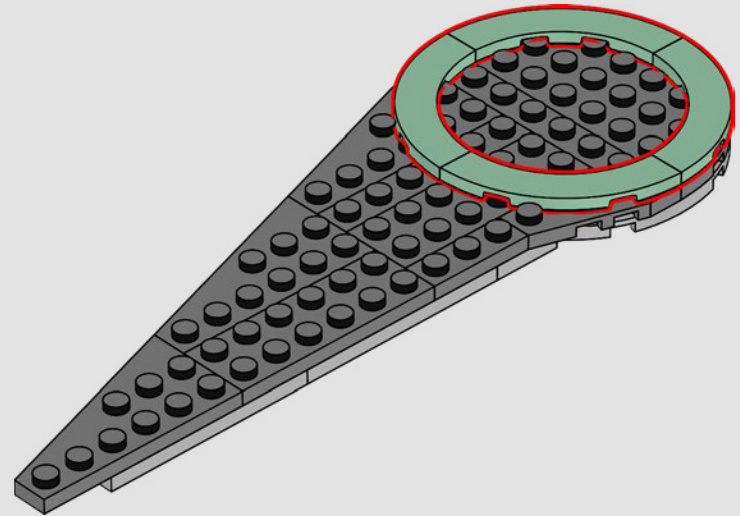

419

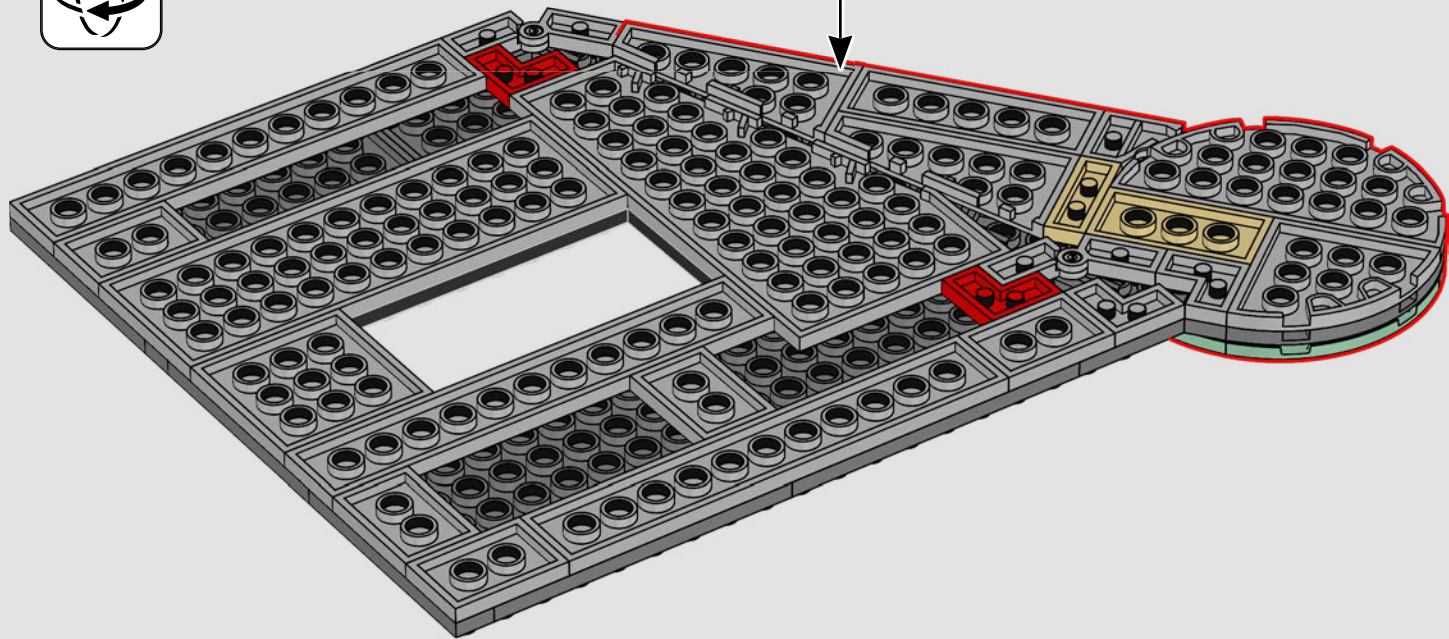



420

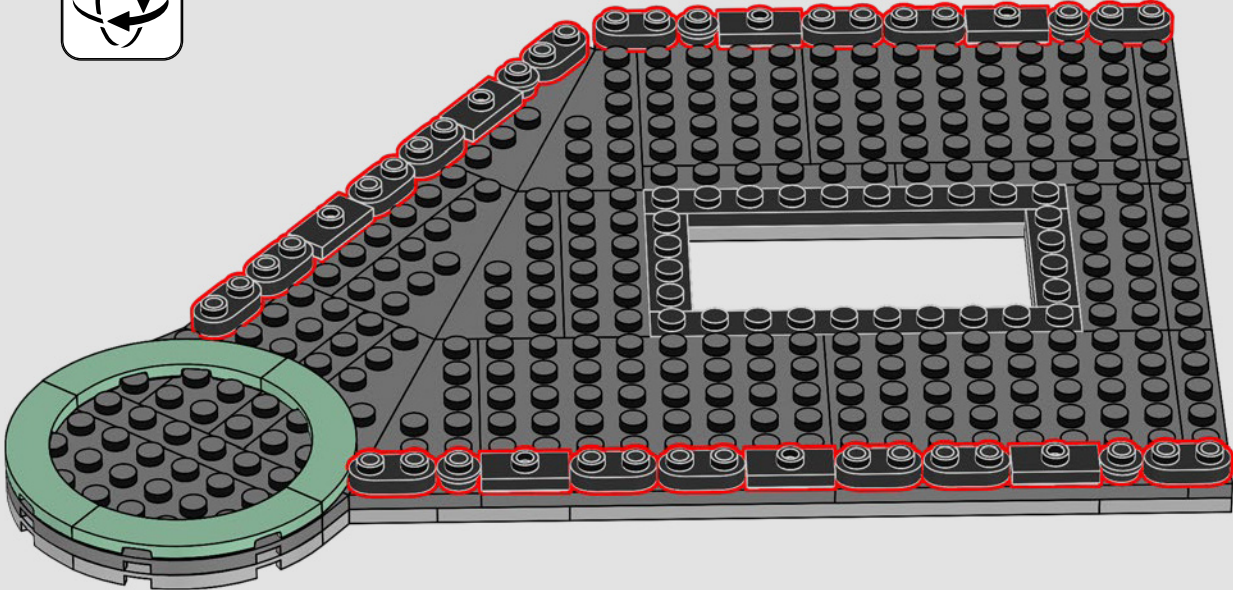

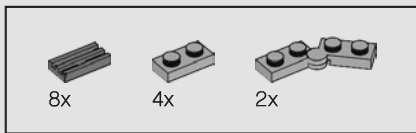

421

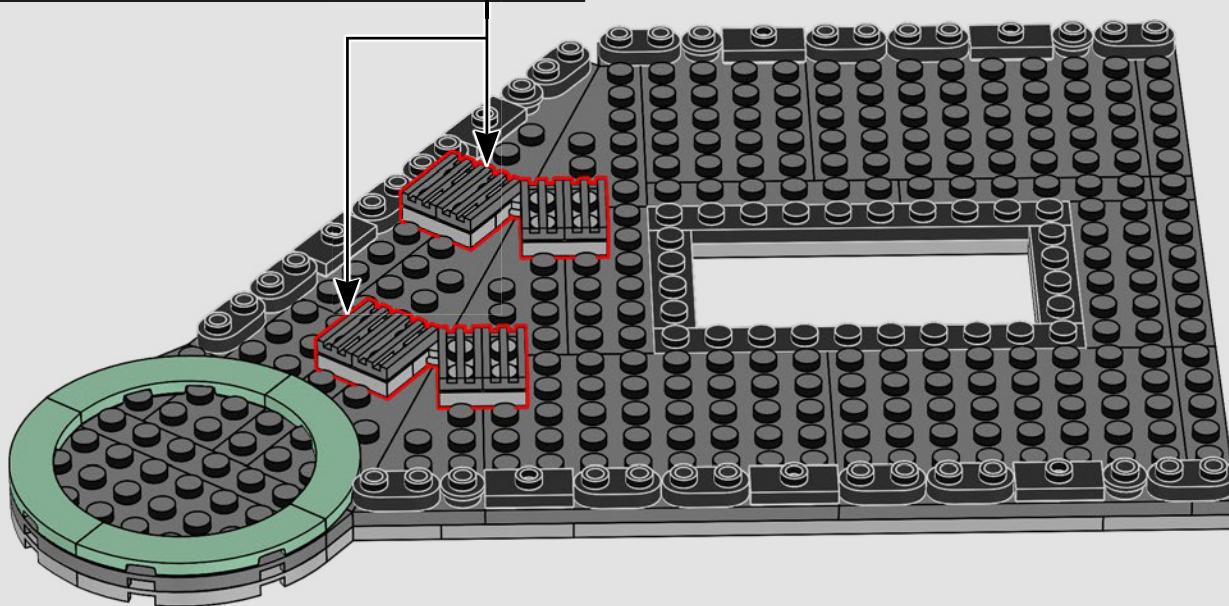
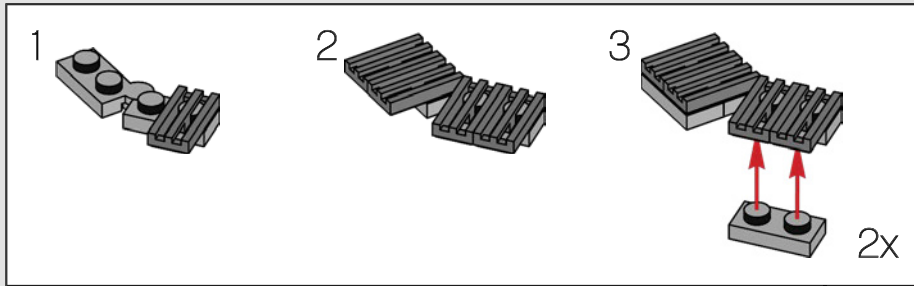



12x

422

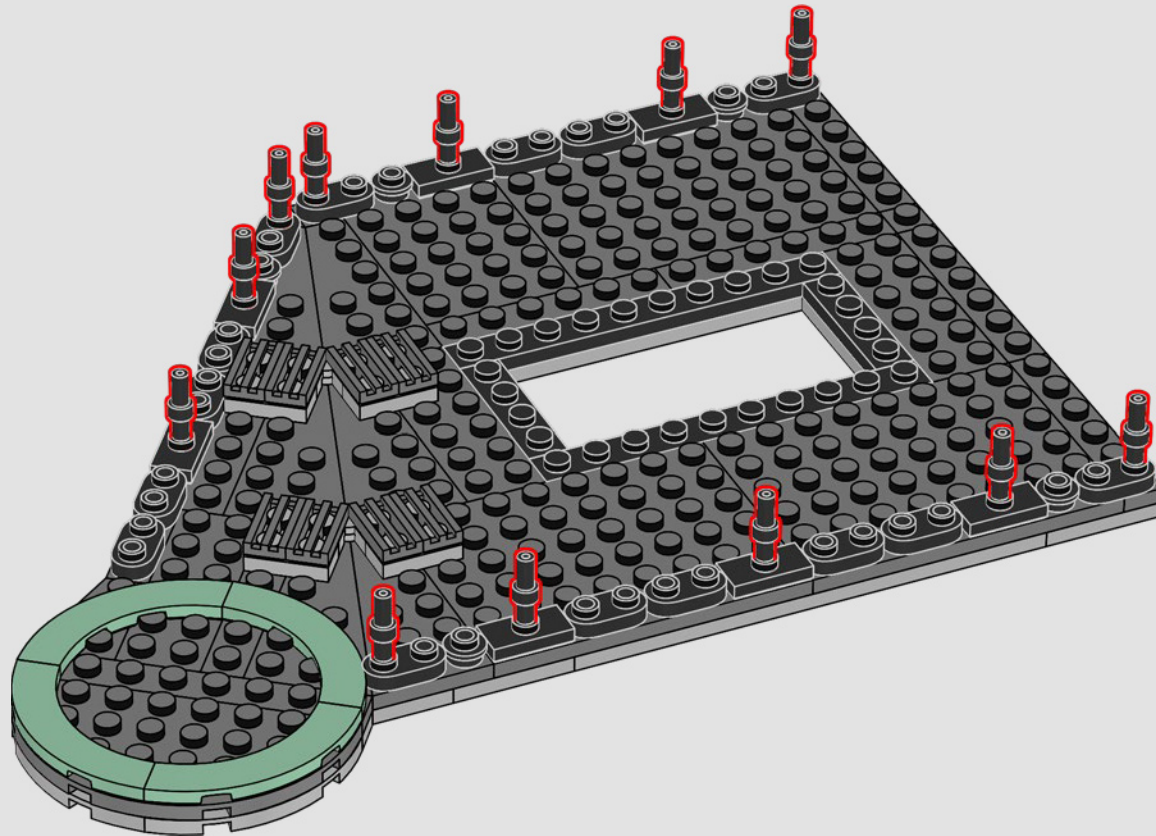



423

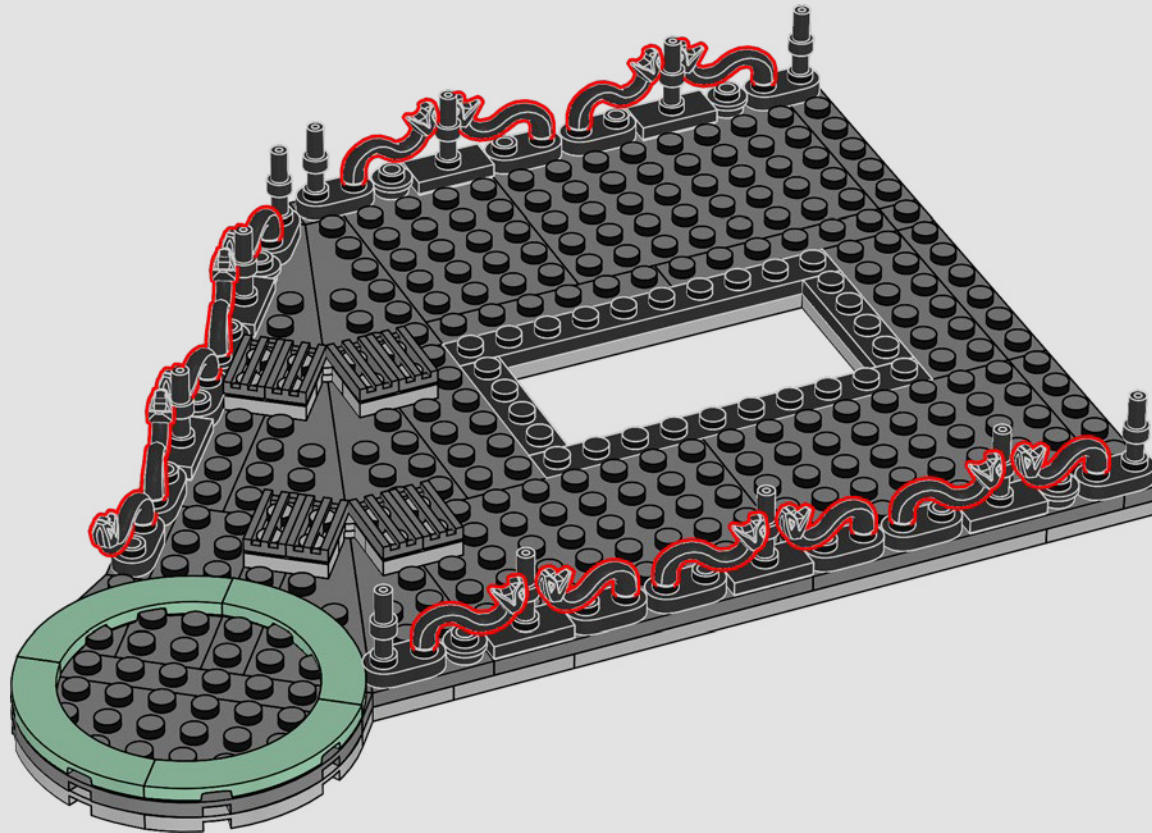

The elements used to make the curves of this wrought-iron detailing first appeared in NINJAGO® sets as a Snake Head.

Les éléments utilisés pour réaliser les courbes en fer forgé sont apparus pour la première fois dans les ensembles NINJAGO® sous forme de tête de serpent.

Los elementos que se usan para crear las curvas de estos detalles de hierro forjado aparecieron por primera vez en los sets NINJAGO®, donde representaban cabezas de serpiente.

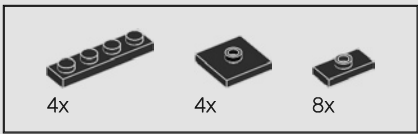

424

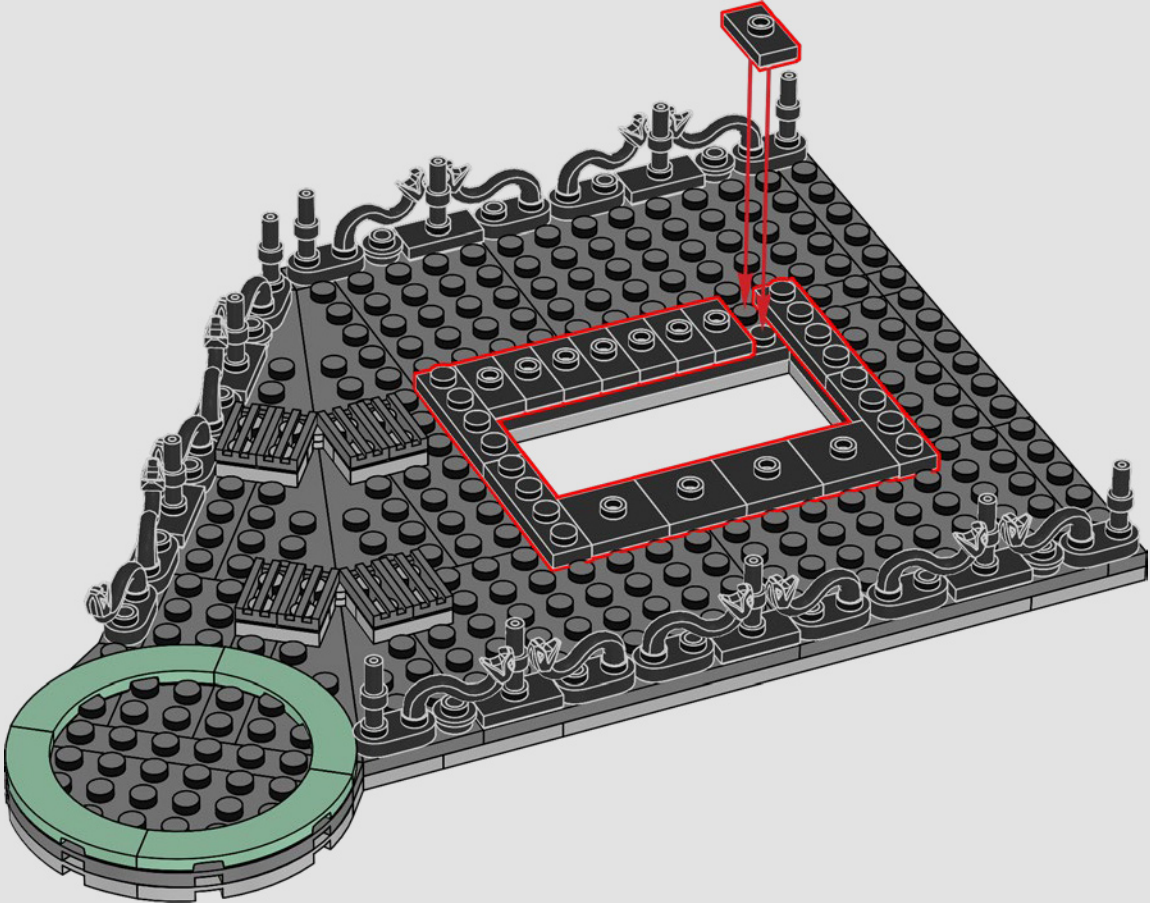

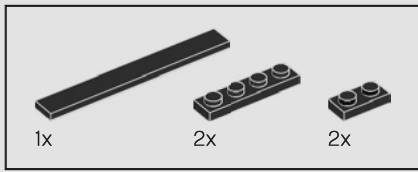

425

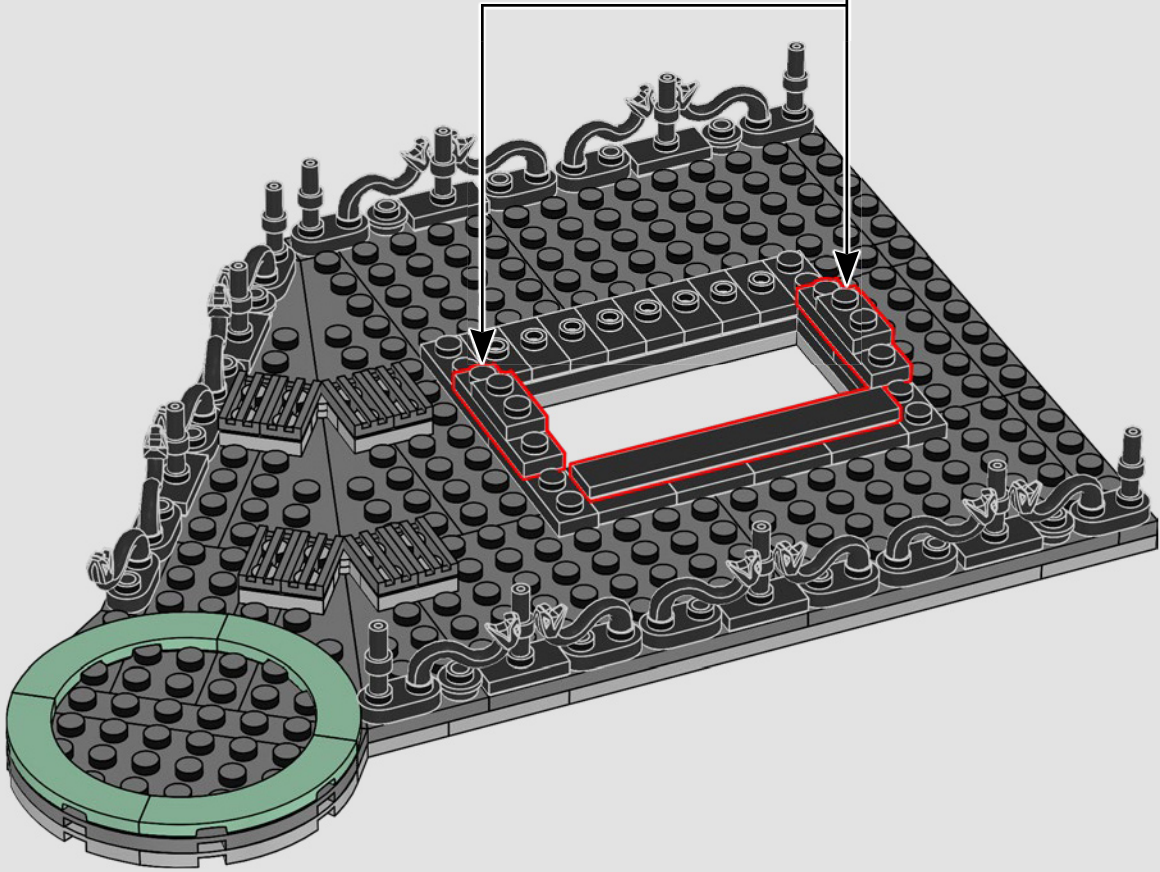
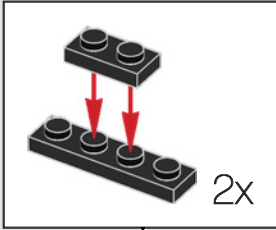



426

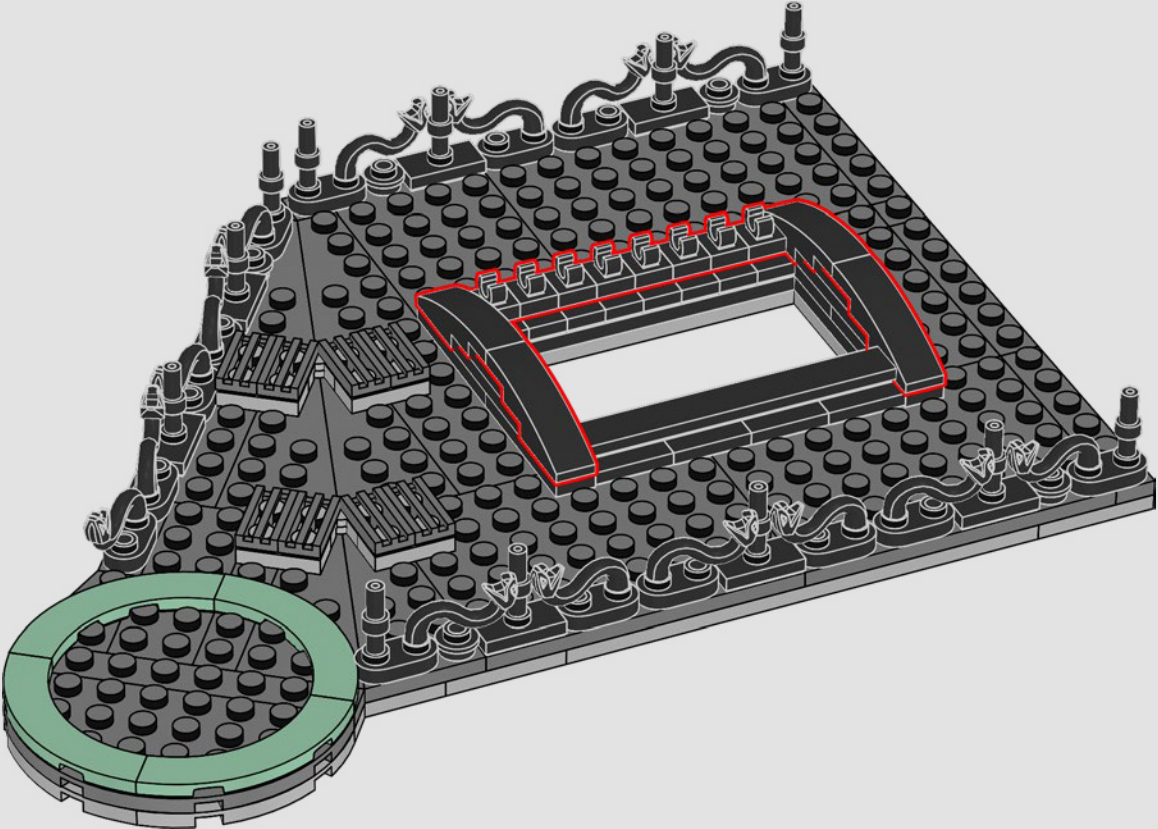

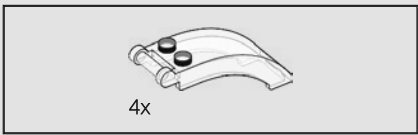

427

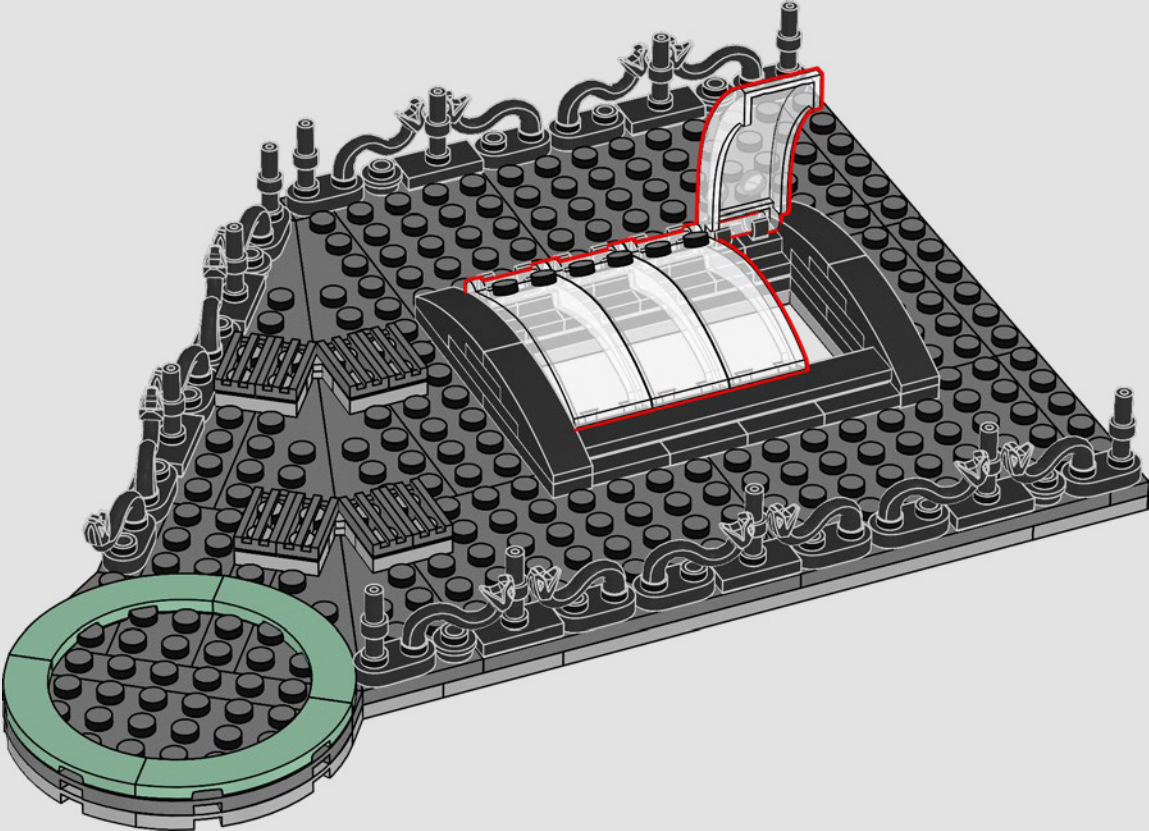

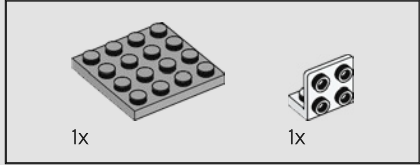
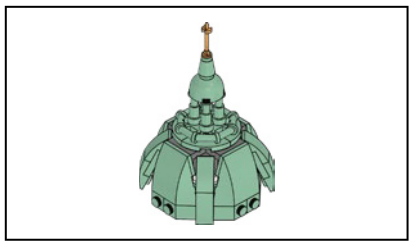

428

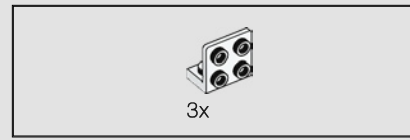
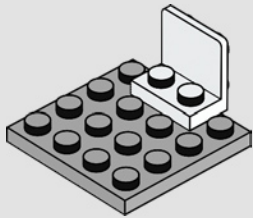

429

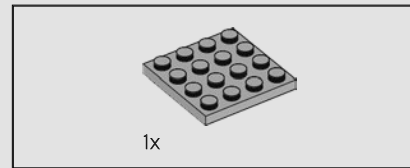
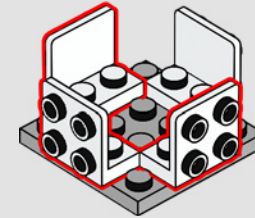

430

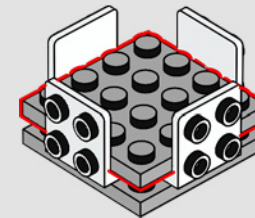

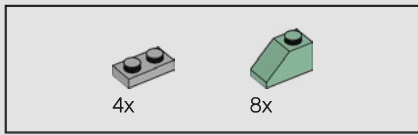

431

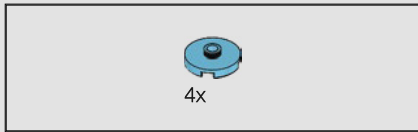
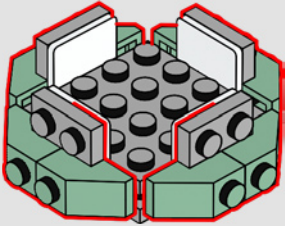

432

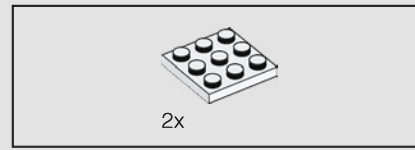
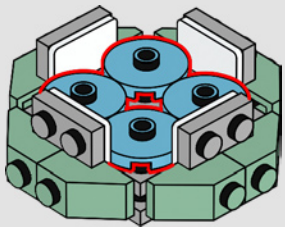

433

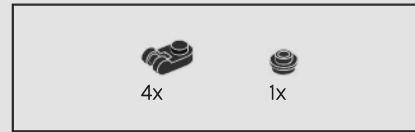
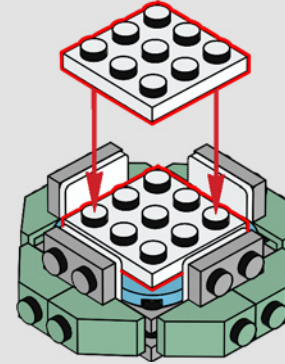

434

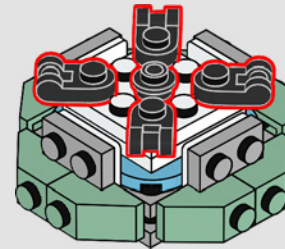

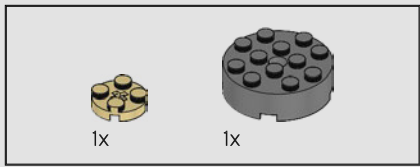

435

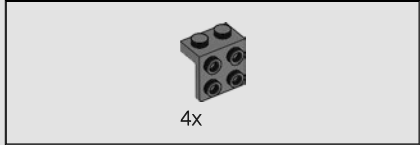
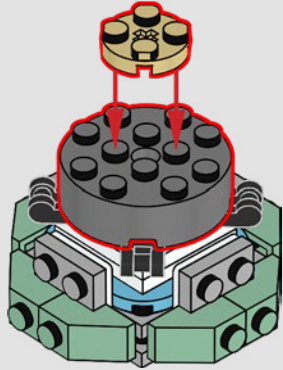

436

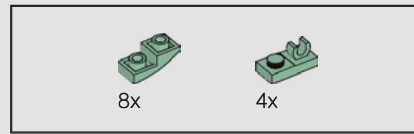
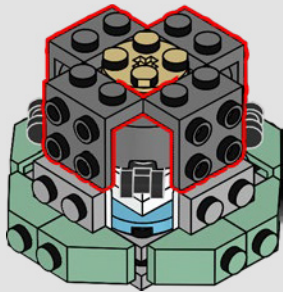

437

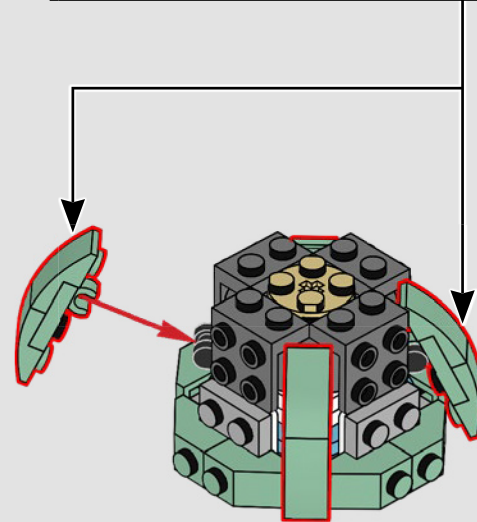
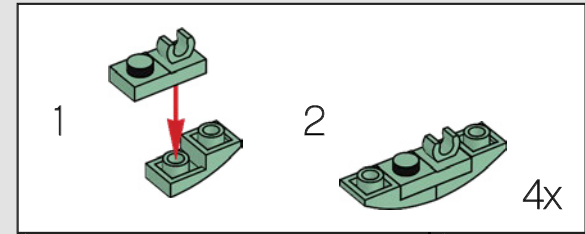

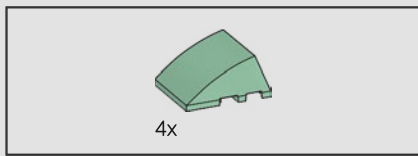

438

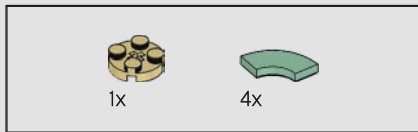
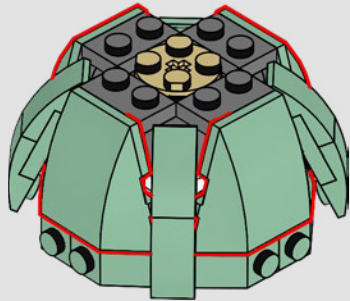

439

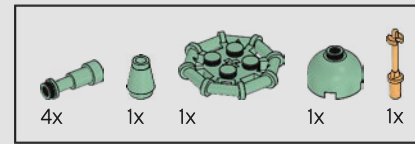
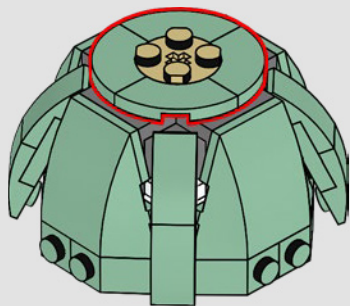

440

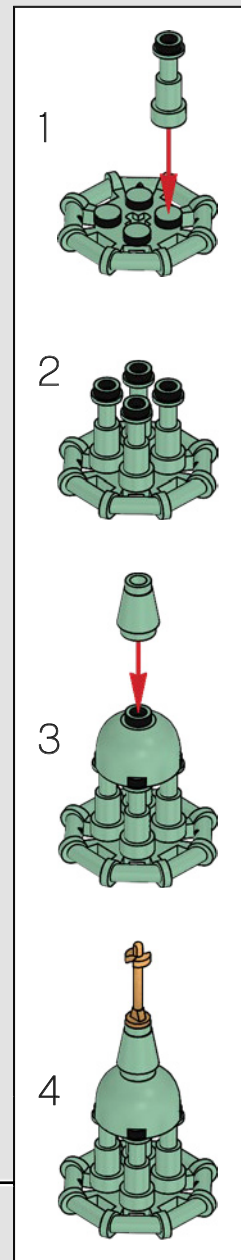
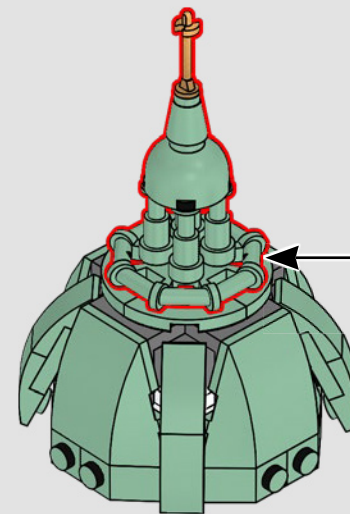

441

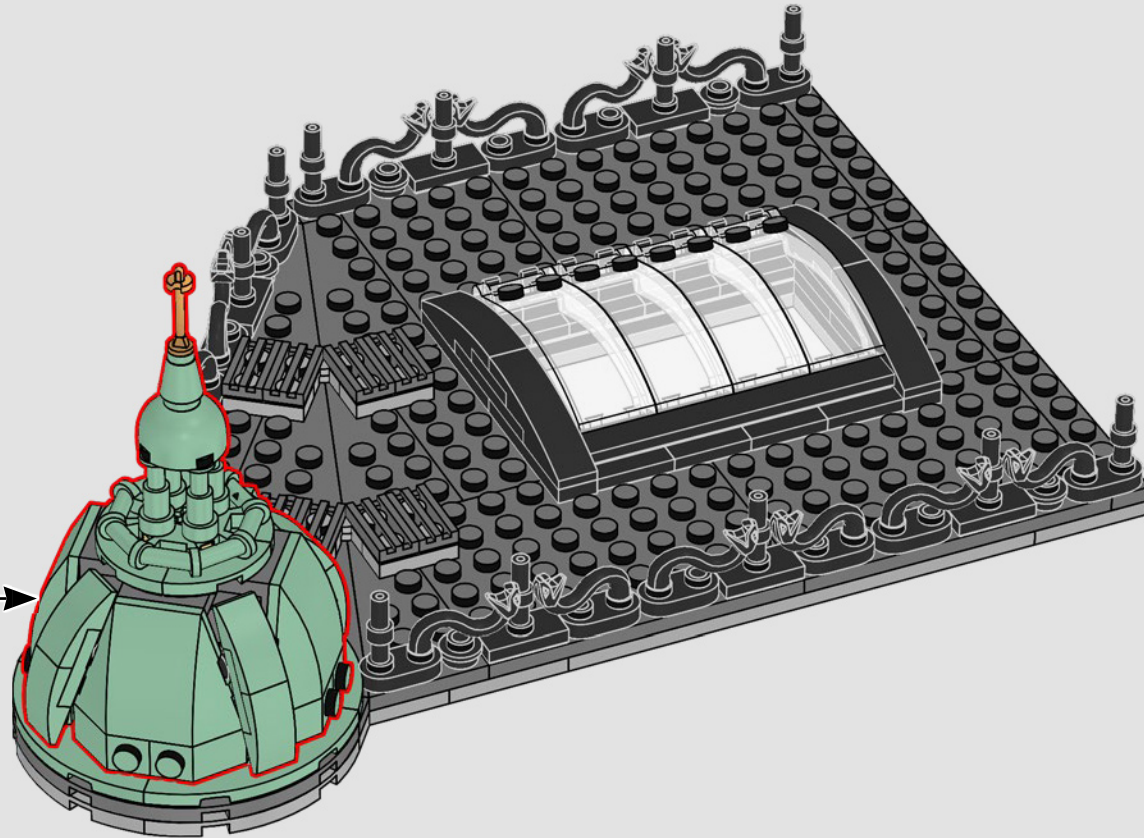

442

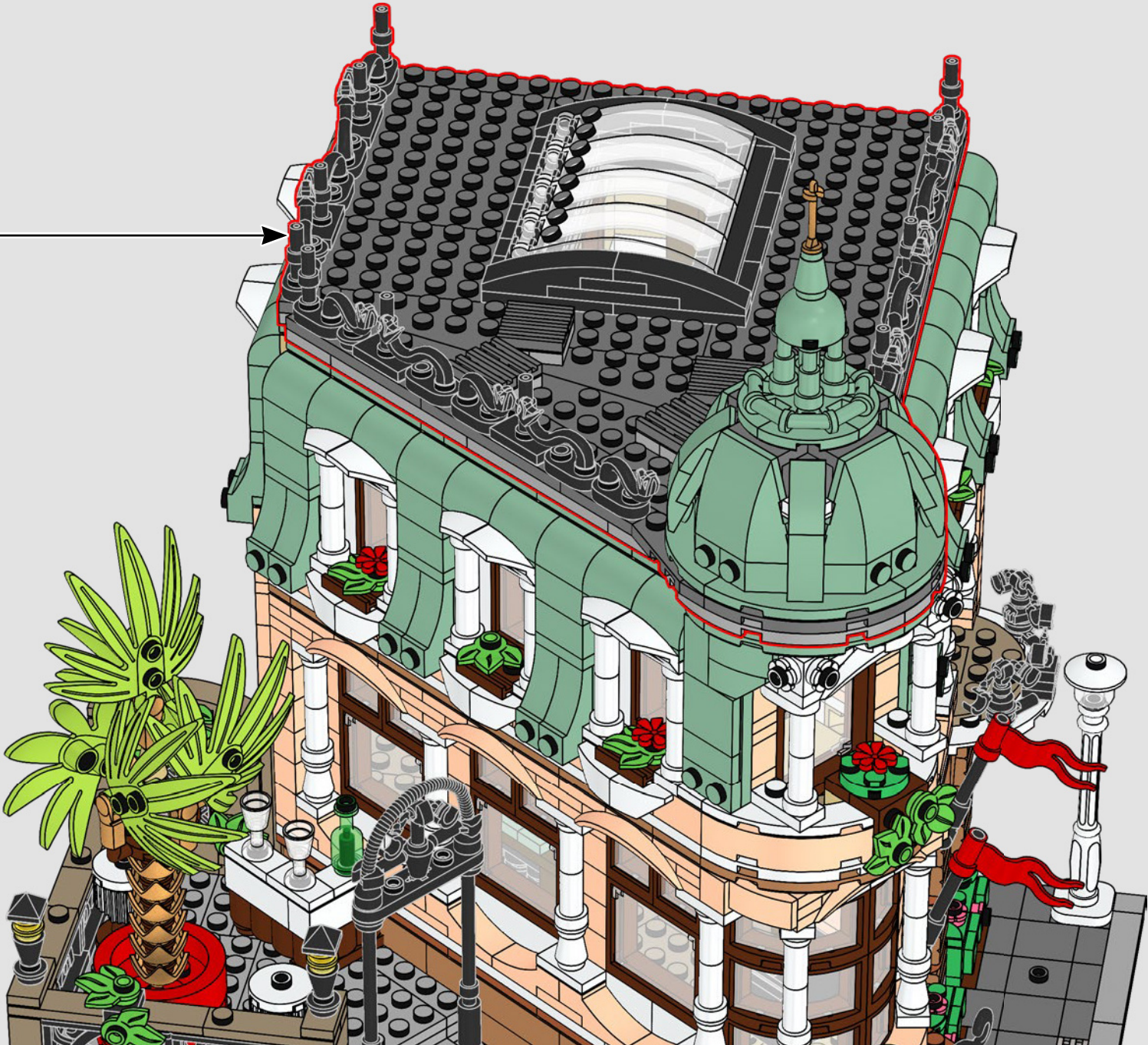

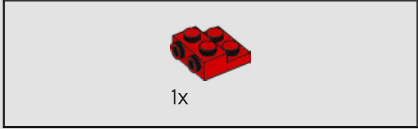

1

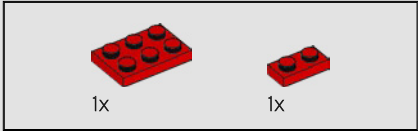
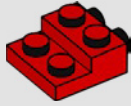

2

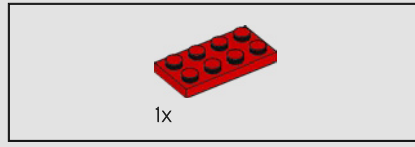
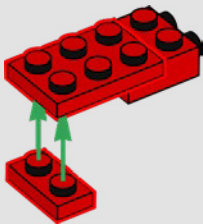

3

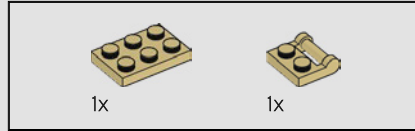
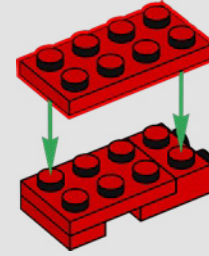

4

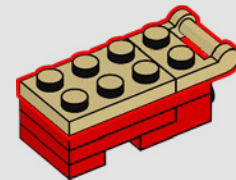



5

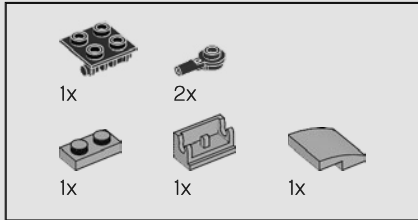
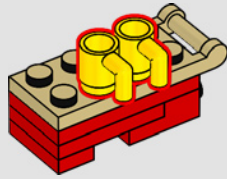

6

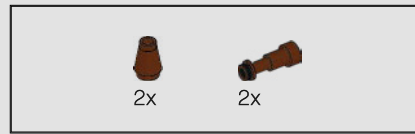
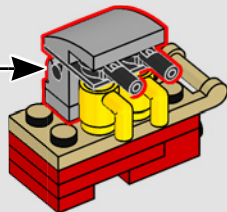
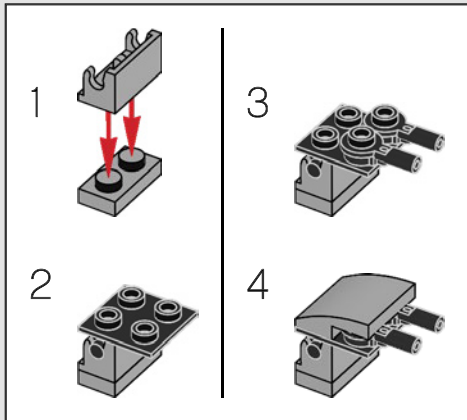

7

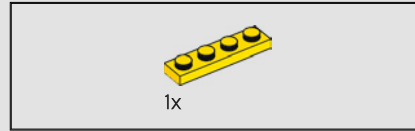
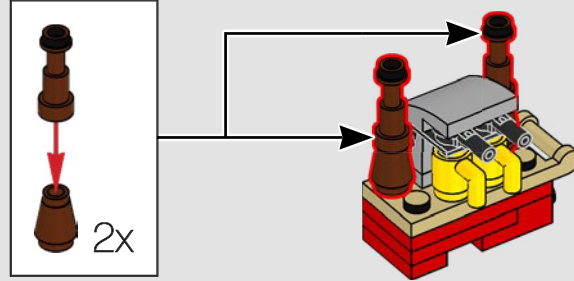

8

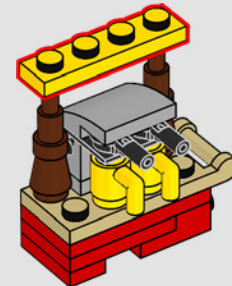

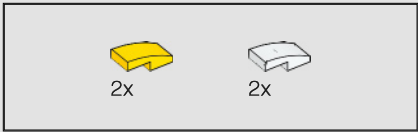

9

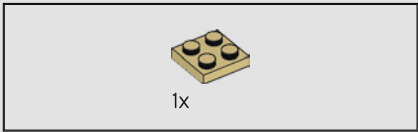
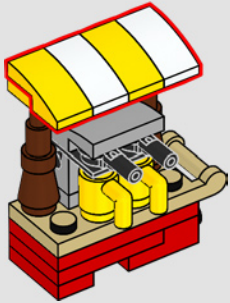

10

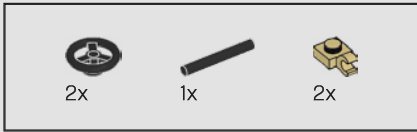
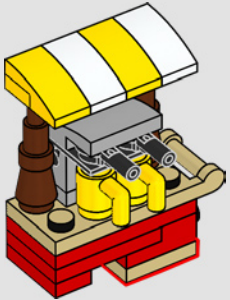

11

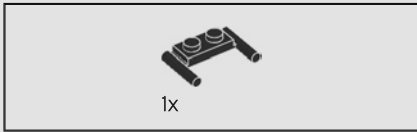
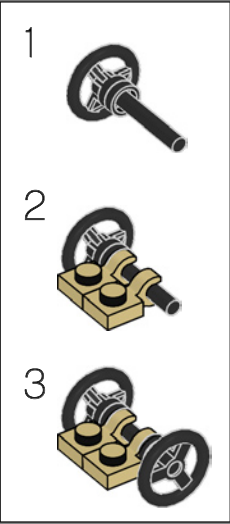
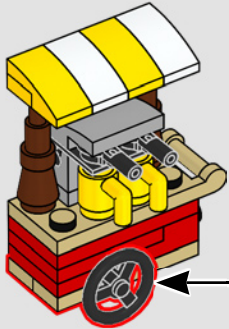

12

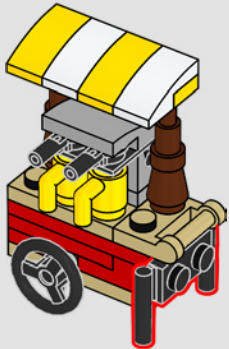

This coffee cart is the mobile extension of the 10182 Café Corner set, the very first Modular Building. Its awning and yellow coffee cups match the ones from the original building.

Ce kiosque de café est une extension mobile de l'ensemble Le café du coin (10182), le tout premier bâtiment modulaire. Son auvent et ses tasses à café jaunes correspondent à ceux du bâtiment d'origine.

Esta cafetería ambulante es una extensión móvil del set Esquina del Café (10182): el primer modelo Modular Buildings. El toldo y las tazas de café amarillas son como los del edificio original.

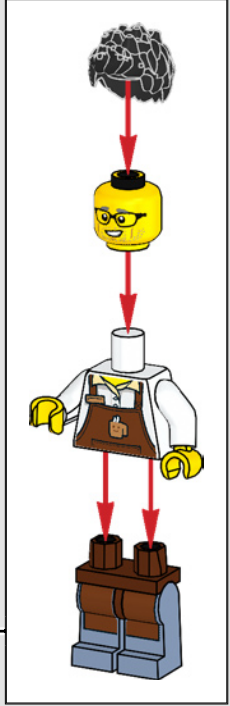





FEEDBACK AND WIN



FEEDBACK AND WIN

Your feedback will help shape the future development of this product series.

Please visit:

FEEDBACK UND GEWINNEN

Dein Feedback trägt zur Weiterentwicklung dieser Produktreihe bei.

Geh auf:

COMMENTEZ ET GAGNEZ

Vos commentaires nous aideront à concevoir les futurs produits de cette gamme.

Rendez-vous sur :

COMENTA Y GANA

Tu opinión nos ayudará a dar forma al desarrollo de esta serie de productos en el futuro.

Visita:

反馈有奖

您的反馈将有助于我们在今后改进本系列产品。

请访问：

[LEGO.com/productfeedback](https://www.lego.com/productfeedback)

By completing, you will automatically enter a drawing to win a LEGO® set.

Terms & Conditions apply.

Durch Ausfüllen nimmst du automatisch an der Verlosung eines LEGO® Preises teil.

Es gelten die Teilnahmebedingungen.

En envoyant vos commentaires, vous serez automatiquement inscrit(e) à un tirage au sort qui vous permettra de remporter un prix LEGO®.

Offre soumise à conditions.

Al contestar, participarás automáticamente en el sorteo y podrás ganar un set LEGO®.







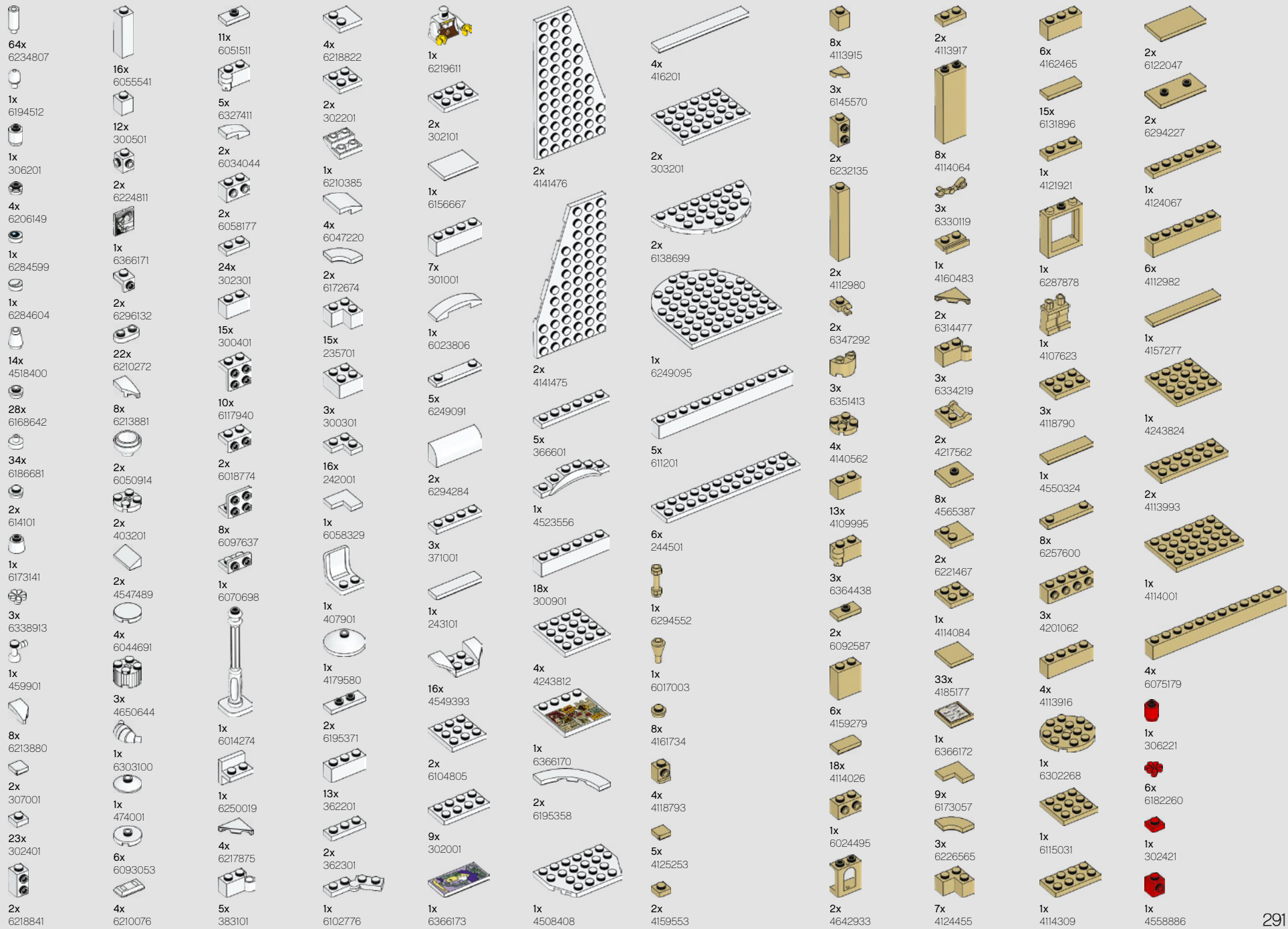



















































































































































Sujeto a Términos y Condiciones.

完成我们的反馈调查，即可自动进入抽奖环节，赢取乐高®套装。

适用《条款和条件》。



1x 302321	2x 6092582	1x 6218235	2x 6210496	1x 6224071	1x 6323420	1x 4539128	5x 4565323	1x 4613153	1x 6327402	1x 6357937	8x 6252258
1x 302221	1x 300423	1x 4651443	9x 6321194	12x 6371584	1x 6323421	19x 6092585	1x 368026	11x 371026	1x 303426	6x 4616027	26x 6254552
2x 242021	1x 302323	1x 6116616	2x 6240496	1x 6173105	1x 6024730	1x 6138173	1x 6013867	4x 6037746	1x 303426	5x 4614158	1x 6278710
4x 4567445	2x 4558606	1x 6103171	1x 4529236	1x 6299338	1x 6024730	1x 306926	1x 4124096	2x 243126	1x 395826	2x 6186009	1x 6278710
1x 6061711	3x 362223	1x 6329613	1x 6056234	4x 6308000	1x 6269081	2x 6147050	5x 6052126	1x 611517	2x 447726	2x 6186423	2x 6251285
2x 362321	2x 4587840	1x 6288015	3x 6056234	4x 6308000	1x 6102341	3x 6147050	2x 4515368	4x 6138726	2x 447726	23x 6253425	2x 6251285
2x 6268946	2x 428623	1x 6211710	19x 6168646	15x 6380639	1x 6092664	3x 6000650	1x 4515368	4x 6138726	4x 4558593	2x 6257603	3x 6256058
1x 302121	1x 317623	2x 307024	10x 6186675	1x 6134617	1x 6092664	1x 6250020	1x 407926	1x 6280168	14x 6150607	2x 6257603	3x 6256058
1x 4515348	4x 6102759	2x 300524	6x 614126	2x 6336977	1x 6092664	1x 6250020	2x 6272184	1x 6280168	1x 403228	5x 6074892	4x 6247362
1x 6313597	2x 300223	3x 6195183	3x 6278152	4x 6104209	2x 6057397	1x 6285241	1x 6219624	1x 302026	1x 6269971	21x 6074893	4x 6247362
1x 302021	1x 371023	2x 389924	1x 362626	2x 6281993	1x 4105175	16x 6214807	1x 317626	1x 663626	1x 6261358	4x 6058089	7x 6253734
2x 614123	1x 371023	2x 6029947	2x 6312449	1x 6079896	1x 6366174	4x 6252201	1x 616604	1x 663626	6x 6129807	4x 6058089	4x 6244793
2x 6344028	1x 371023	1x 242024	4x 6273589	19x 6210270	2x 6195325	1x 6336989	2x 6116604	1x 6058118	3x 371028	6x 6253418	4x 6244793
1x 300523	1x 6262960	7x 302426	2x 6312449	1x 6308032	1x 4106552	1x 6151289	1x 6162892	1x 6344427	17x 6182261	2x 6166107	4x 6240216
1x 370023	1x 6262960	10x 6335388	4x 6273589	4x 6157554	2x 249626	1x 6093525	2x 6286835	1x 346026	10x 6143431	1x 6168665	2x 6337597
3x 370023	1x 6366175	2x 6172383	2x 300526	5x 6196548	1x 9339	1x 6093525	1x 383926	1x 416226	17x 6369194	1x 6168665	2x 6337597
292		5x 6290456	2x 6170421	1x 6210307	10x 302326	1x 302226	1x 6186698	1x 416226	2x 6248949	6x 6244796	2x 6247364

-  1x 6047056
-  1x 4558595
-  4x 6240467
-  1x 6213779
-  3x 6213777
-  3x 6223665
-  2x 6273853
-  2x 6249417
-  1x 6223065
-  2x 6337637
-  1x 4537251
-  1x 6192789
-  1x 6226630
-  5x 6313098
-  1x 6366169
-  12x 6055172
-  9x 6273590
-  6x 4549436
-  13x 6001824
-  4x 6334209
-  2x 6092591
-  8x 4521914
-  11x 4496699
-  14x 4528604
-  6x 6002849
-  6x 6002851
-  2x 4550168
-  2x 6135607
-  1x 6132768
-  1x 6167936
-  5x 6001822
-  1x 6310832
-  2x 6175927
-  5x 6257599
-  3x 4626904
-  2x 4267874
-  3x 6096108
-  3x 4507047
-  7x 6015424
-  6x 4247151
-  4x 4246957
-  2x 4530712
-  2x 6232137
-  8x 4251796
-  2x 6275088
-  1x 6312450
-  3x 6055171
-  8x 6055222
-  4x 4245570
-  2x 4223126
-  8x 6278553
-  5x 4655080
-  2x 6194726
-  6x 6177823
-  2x 6196591
-  1x 6134280
-  2x 6223913
-  1x 6221730
-  2x 6223225
-  1x 6221729
-  1x 6278544
-  16x 4616578
-  20x 4616581
-  6x 6360075
-  28x 6278541
-  2x 6223126
-  8x 6278553
-  5x 4655080
-  2x 6194726
-  6x 6177823
- 2x 6196591
-  8x 6083976
-  4x 4649065
-  2x 6133896
-  20x 6186823
-  1x 6186828
-  6x 6299637
-  2x 6223171
-  20x 6369375
-  2x 6385228
-  1x 6223219
-  3x 6100234
-  19x 6192923
-  2x 4521947
-  4x 6284414
-  8x 6249817
-  4x 4539114
-  2x 6311890
-  4x 6212040
-  2x 6341767
-  2x 4539090
-  2x 6274681
-  2x 4539102
-  2x 6107758
-  1x 6172632
-  2x 6359685
-  4x 4539061
-  1x 6186003
-  5x 4539071
-  1x 6335285
-  1x 4621543
-  4x 4529242
-  9x 6215659
-  1x 4211242
-  1x 4221744
-  1x 4211288
-  3x 6149677
-  1x 6062574
-  6x 6341553
-  1x 6306775
-  1x 6035291
-  1x 6268828
-  1x 6157942
-  3x 6102360
- 1x 4211180
-  4x 4211222
-  14x 6382102
-  5x 6103004
-  1x 6139435
-  12x 6092590
-  1x 4542131
-  1x 4211149
-  16x 4211150
-  20x 4211151
-  8x 6058084
-  2x 6310449
-  1x 6117976
-  1x 6174856
-  8x 4645103
-  5x 6196221
-  8x 4565394
-  1x 6122977
-  1x 4211200
-  4x 4211221
-  5x 6221608
-  2x 4211257
-  2x 6146301
-  1x 6313506
-  11x 6100769
-  13x 4211152
-  4x 6248918
-  1x 6268857
-  1x 6120224
-  6x 4211189
-  5x 4216668
-  1x 4211181
-  6x 6343651
-  3x 4211225
-  2x 4658005
-  1x 4211194
-  7x 4211190
-  1x 6153594
-  7x 4595889
-  6x 6262952
-  6x 4283660
-  2x 6075207

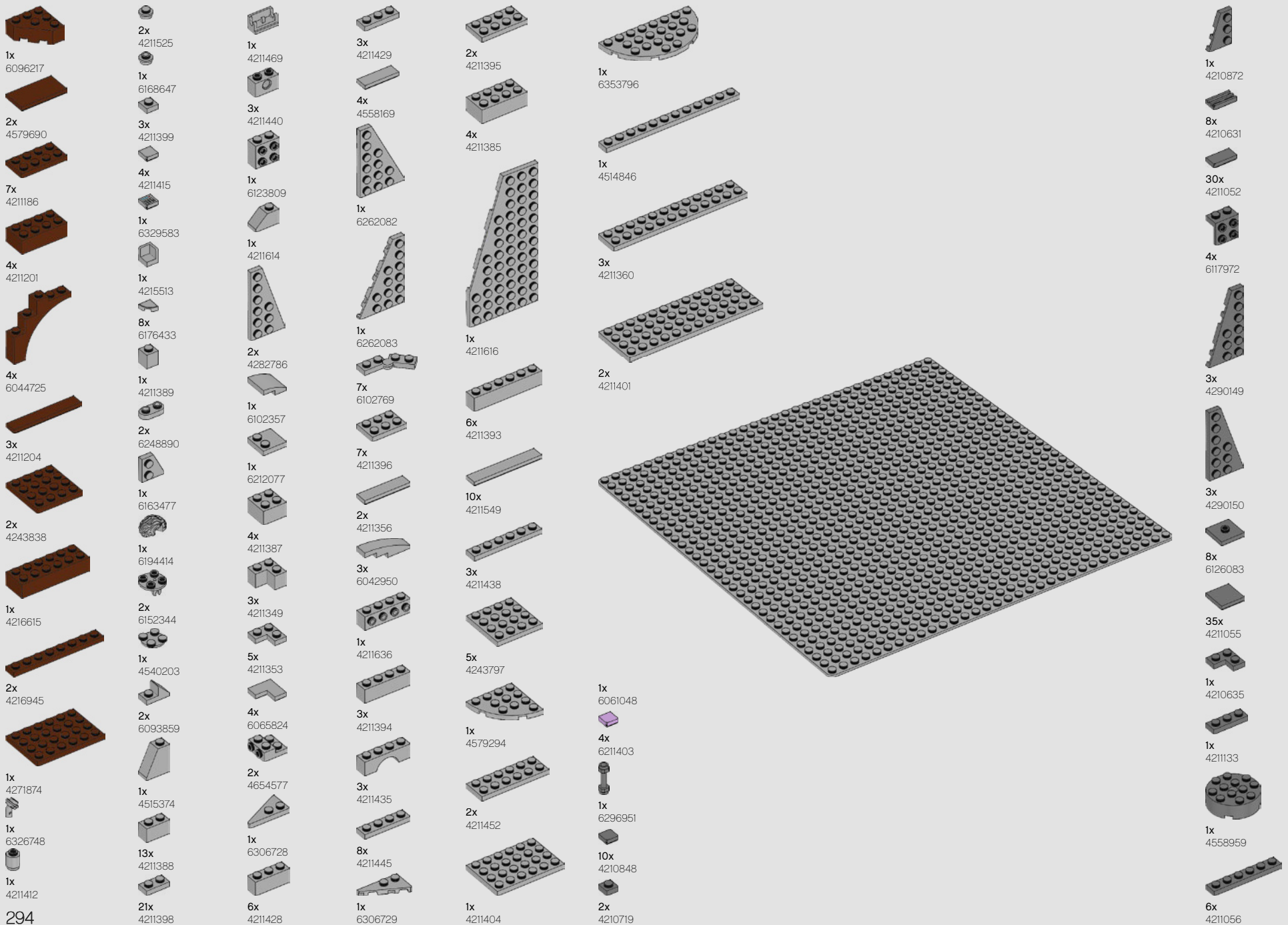

4x
4211002

1x
4210998

1x
4211115

1x
6141856

3x
4210794

1x
6107399

1x
6092833

1x
4586410

38x
6369191

31x
6357797

1x
6275872

57x
6369188

43x
6369189

2x
6357796

2x
6343511

14x
6325881

1x
6297283

5x
6357794

14x
6369190

35x
6378419

9x
6369187

4x
6369192

1x
6170470

1x
6292254

4x
6252838

6x
6296657

5x
6209691

4x
4529247

1x
6190252

5x
6186672

5x
4523159

1x
6284379

6x
6257048

2x
6167585

2x
4490599

1x
6245261

1x
6092594

2x
6022033

5x
6093529

3x
6147169

4x
6226437

6x
6251021

5x
4519970

6x
4566688

2x
6046943

4x
6058221

17x
6058257

1x
4538950

1x
6179803

2x
6047037

4x
6272145

1x
6167928

2x
6313874

3x
6252667

2x
6328181

4x
6226792

1x
6295366

4x
4518687

5x
6300103

4x
6167641

26x
6057986

1x
6167690

7x
6215606

3x
6177146

7x
6314190

41x
4656783

6x
6021997

4x
6186400

2x
4568955

17x
6223183

6x
6102998

8x
6218359

47x
6099341

1x
6295464

4x
6106193

2x
6387478

1x
6345302

3x
6102990

4x
6102994

1x
6177535

6x
6192922

4x
4633691

4x
4619636

1x
4611884

3x
4655243

4x
6136419

4x
6331949

4x
6119126

1x
4624705

1x
6253666

2x
6361352

8x
6251591

6x
6295242

1x
6240515

Customer Service
Kundenservice
Service Client
Assistenza clienti
Atención al cliente
Serviço de Apoio ao Consumidor
Ügyfélszolgálat
Klientu apkalpošanas dienests
Serviciul pentru clienț
客户服务
コンシューマーサービス
고객 서비스
LEGO.com/service



10278

10297

10270