

# libretto 2

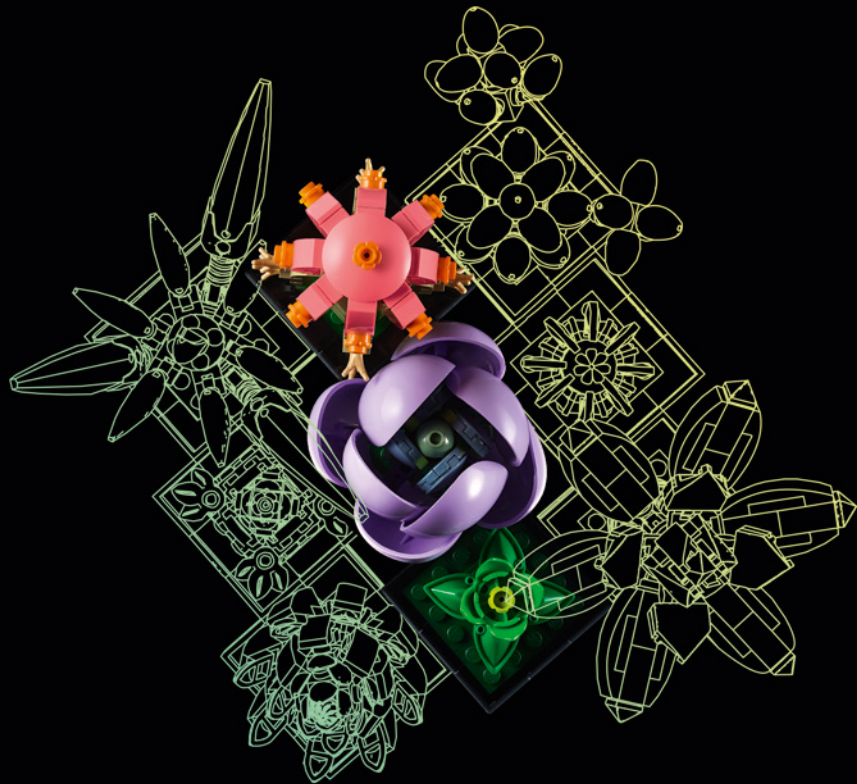

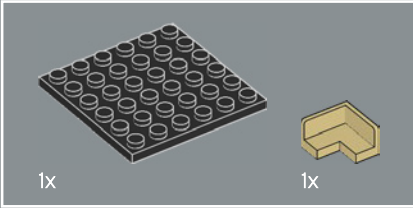

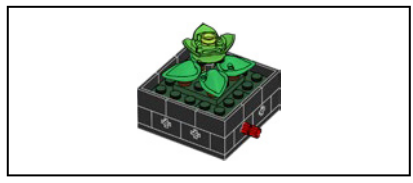

1

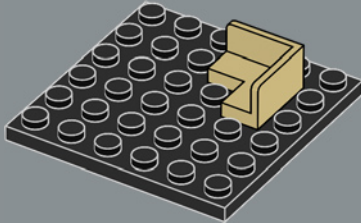

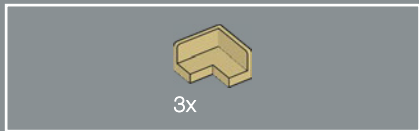

2

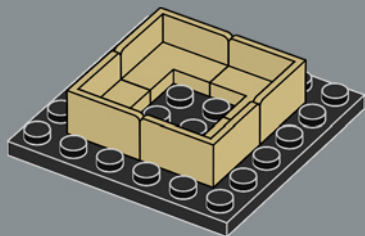

4

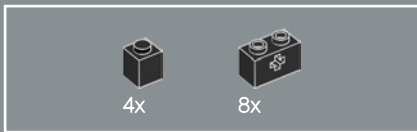

3

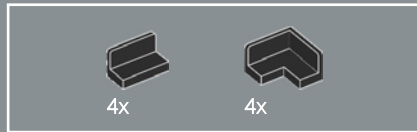
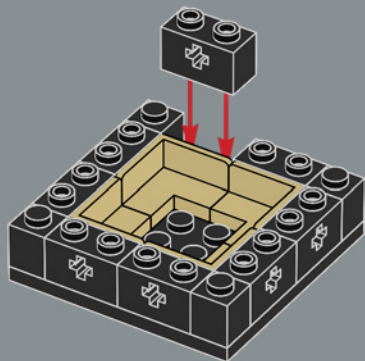

4

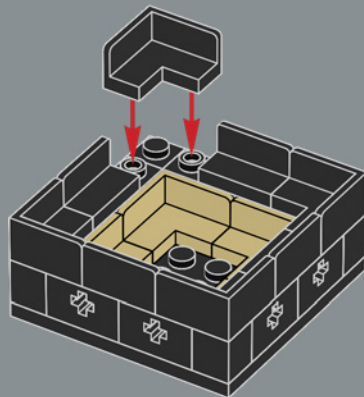

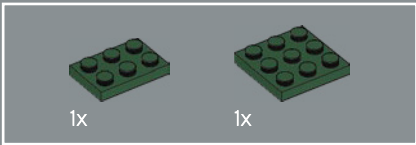

5

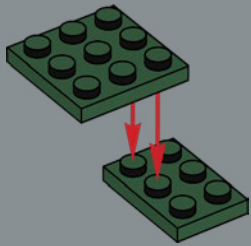

6

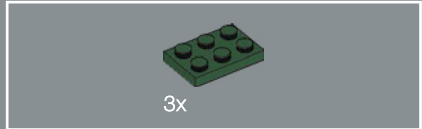

6

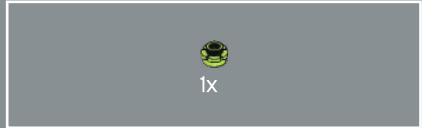
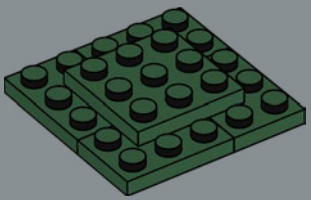

7

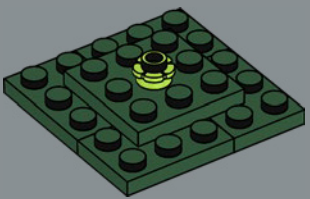

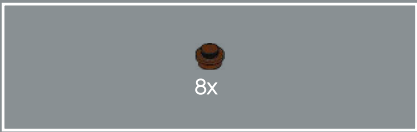

8

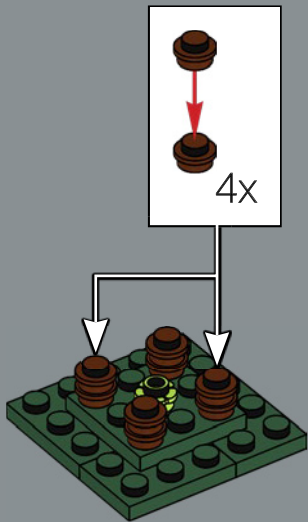

9

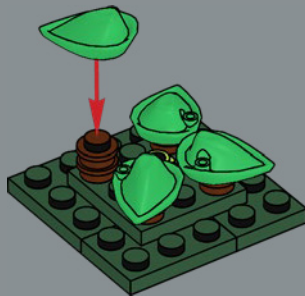



10

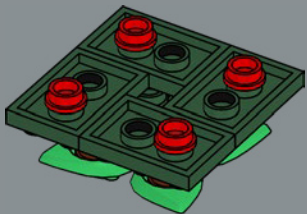

11

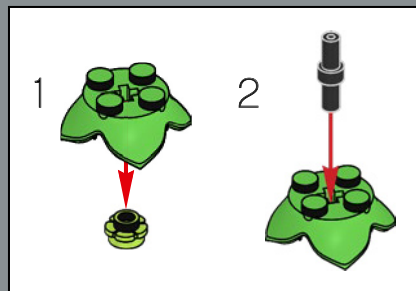



12

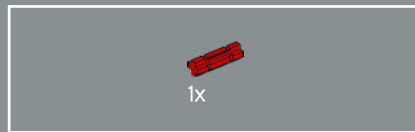
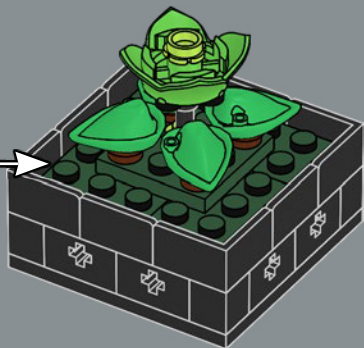

13

Vi sono circa 10.000 tipi di piante grasse coltivabili. Le affascinanti Piante grasse LEGO® sono un ottimo modo per avviare la tua collezione.

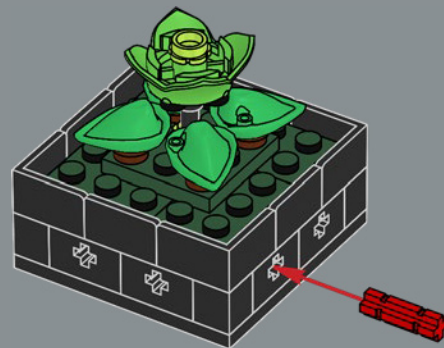

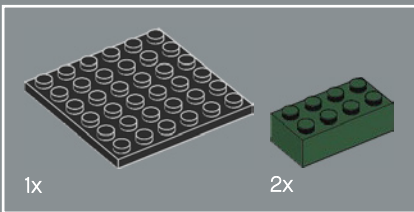
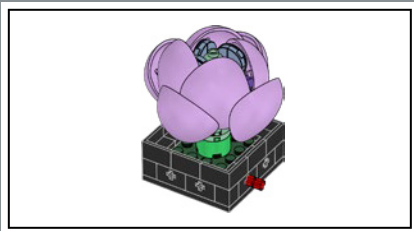

1

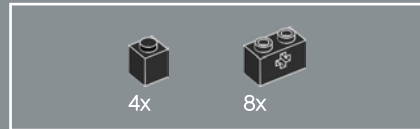
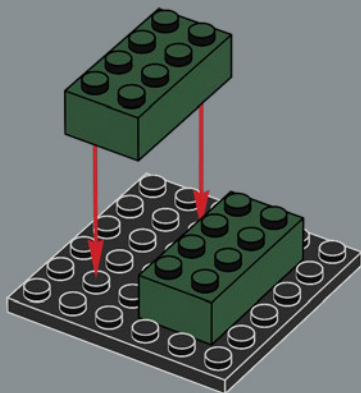

2

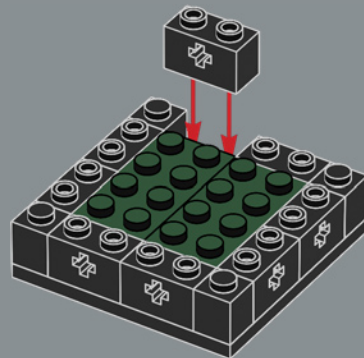

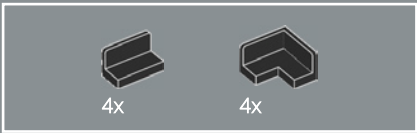

3

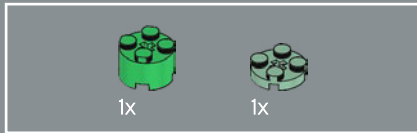
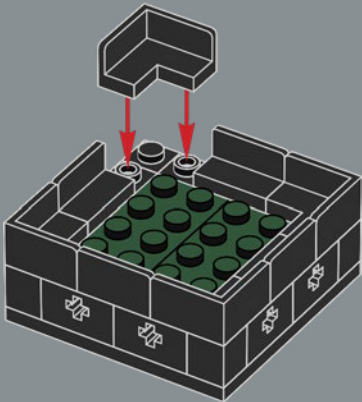

4

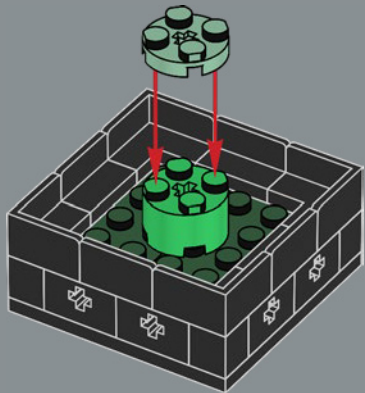

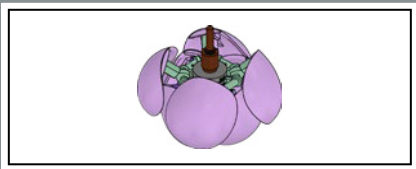

5

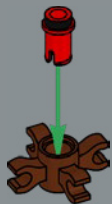

12

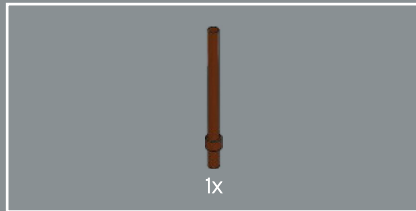

6

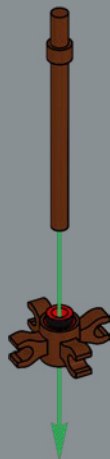

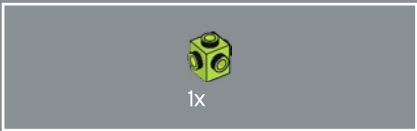

7

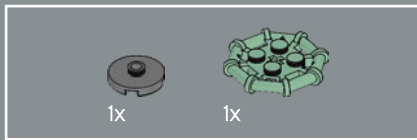

8

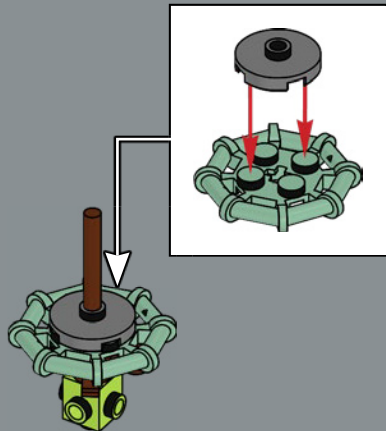



9

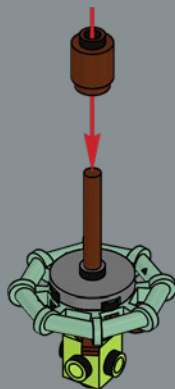

14



10

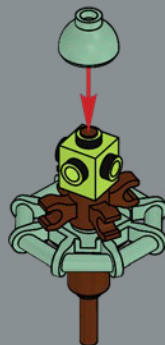



11

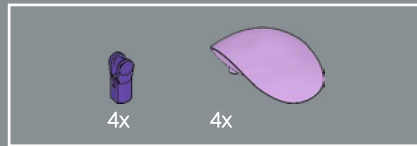
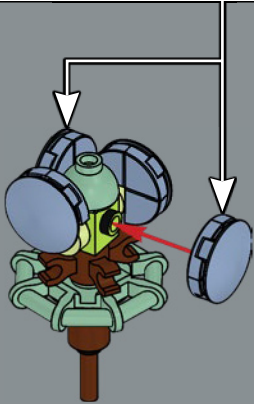
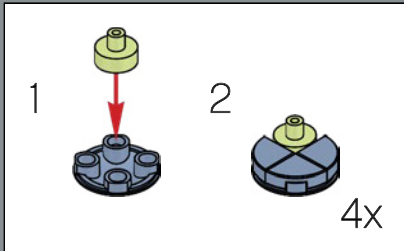

12

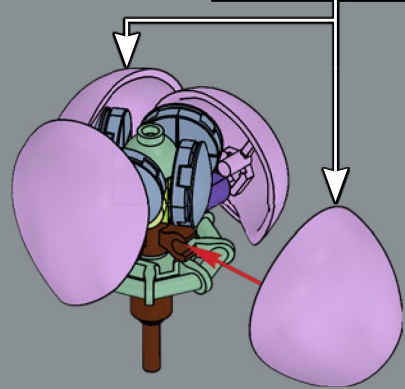
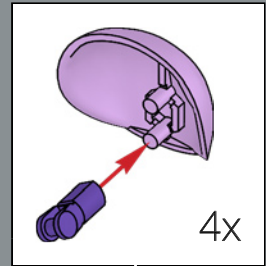

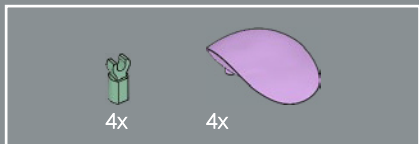

13

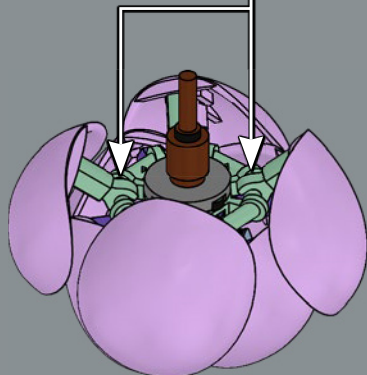
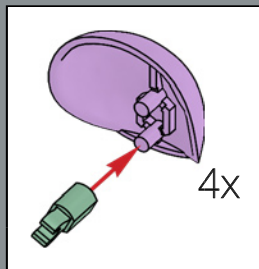

*Echeveria lilacina*  
L'*Echeveria lilacina* è così chiamata perché presenta splendide foglie color lilla. Altri ibridi di questa pianta sono l'*Echeveria Lola*, l'*Echeveria Moondust* e l'*Echeveria Orion*.



14

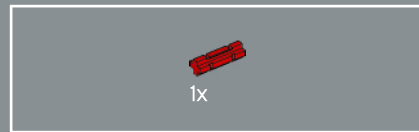
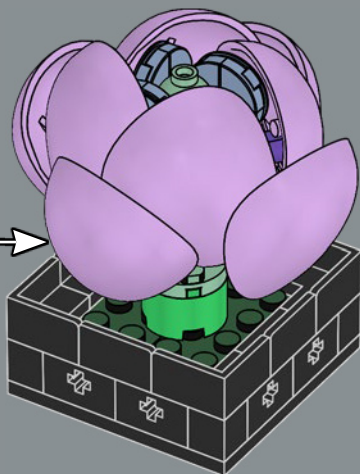

15

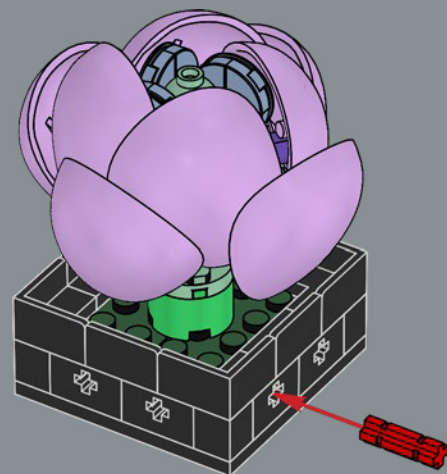

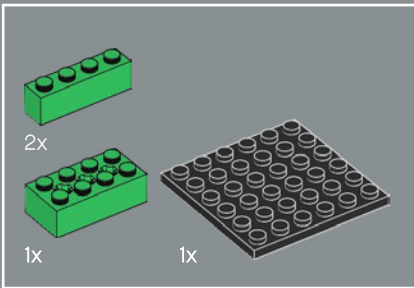
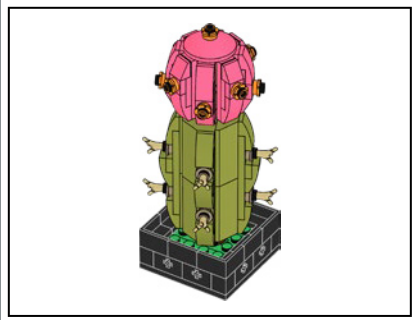

1

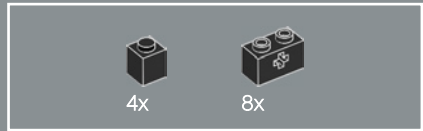
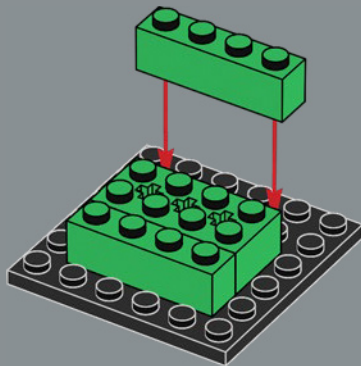

2

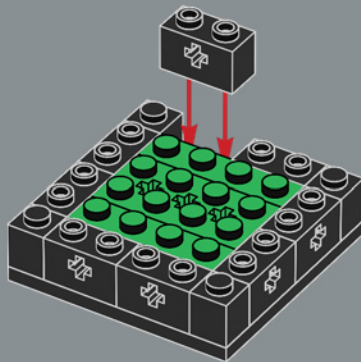

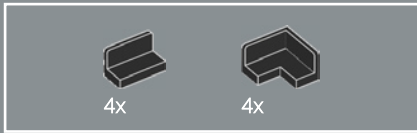

3

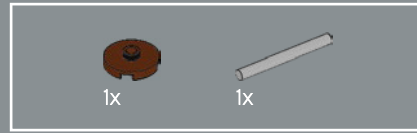
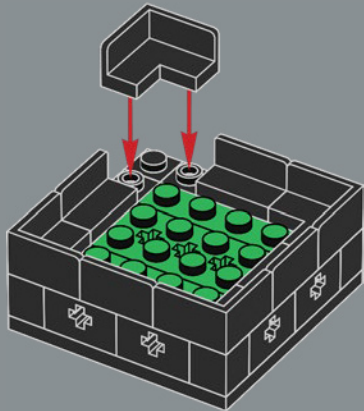

4

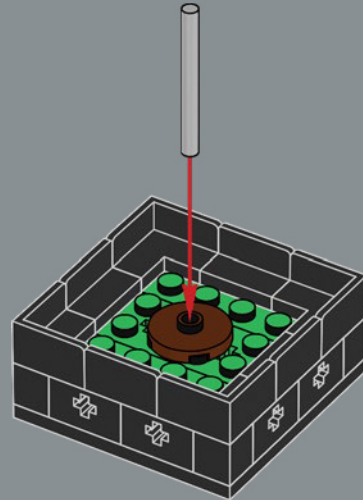

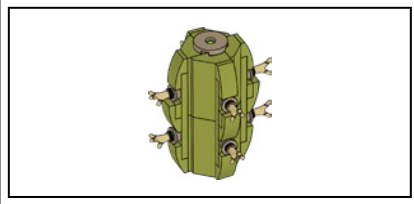

1x

1x

5

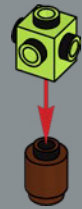

2x

6

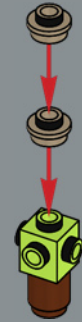



7



8



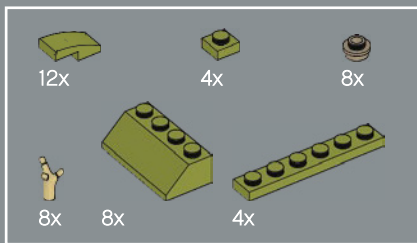
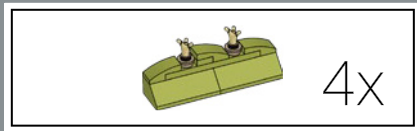

9

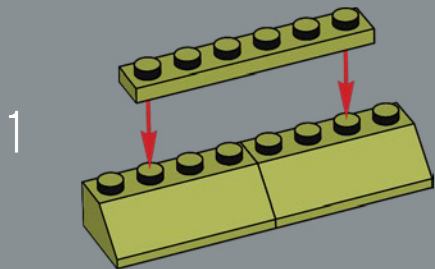

22

2

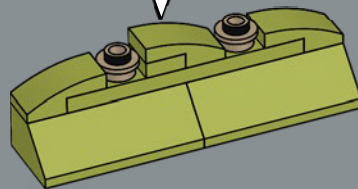

3

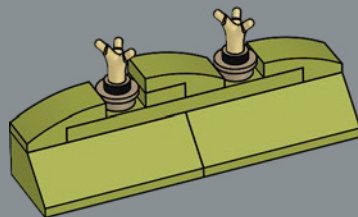

4x

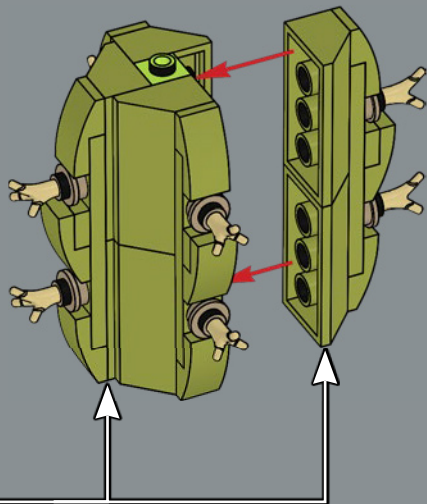

10

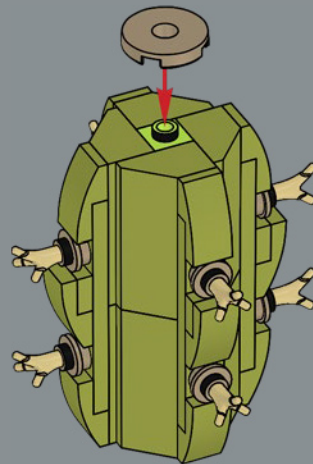

11

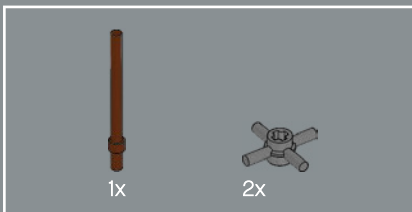
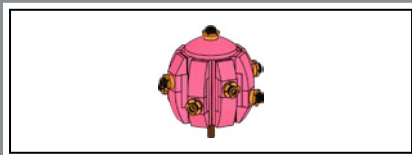
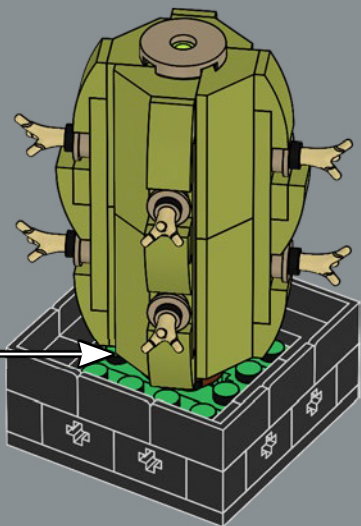

12

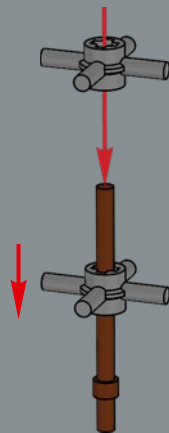





13

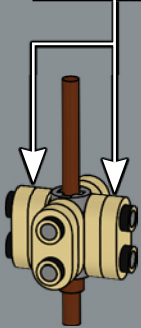
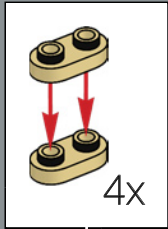

14

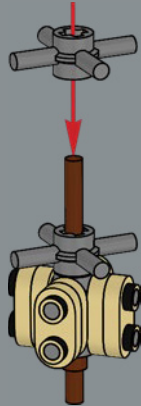

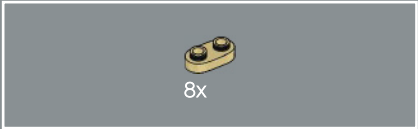

15

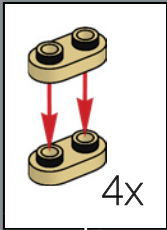

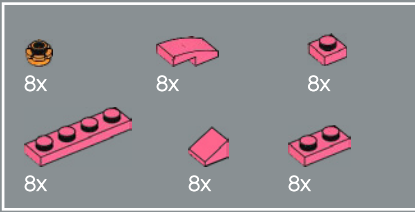

16

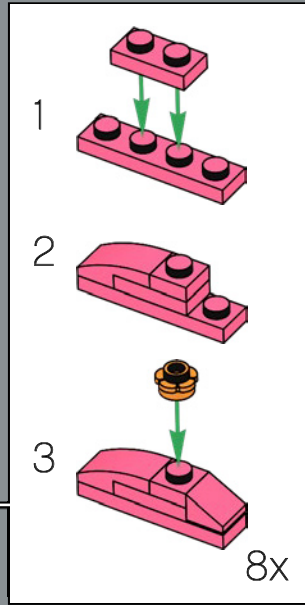
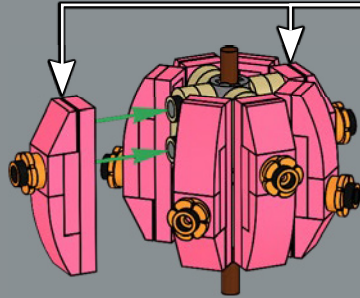



17

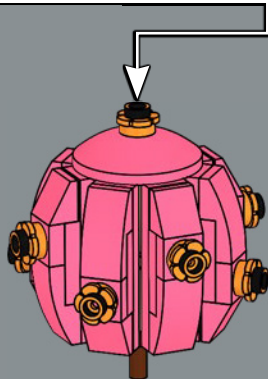
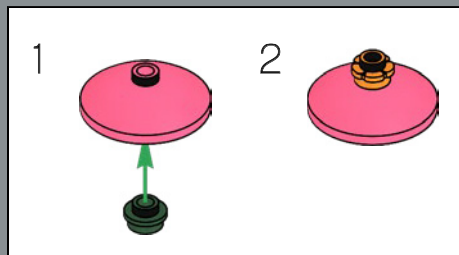

Il *Cactus Hibotan* è di colore rosso in quanto è privo della clorofilla e deve essere innestato su altri cactus per crescere.

18

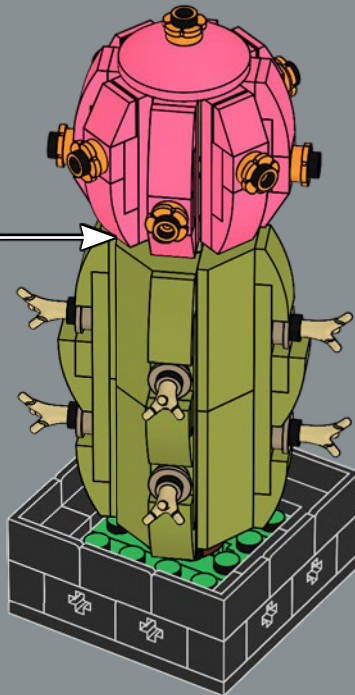

19

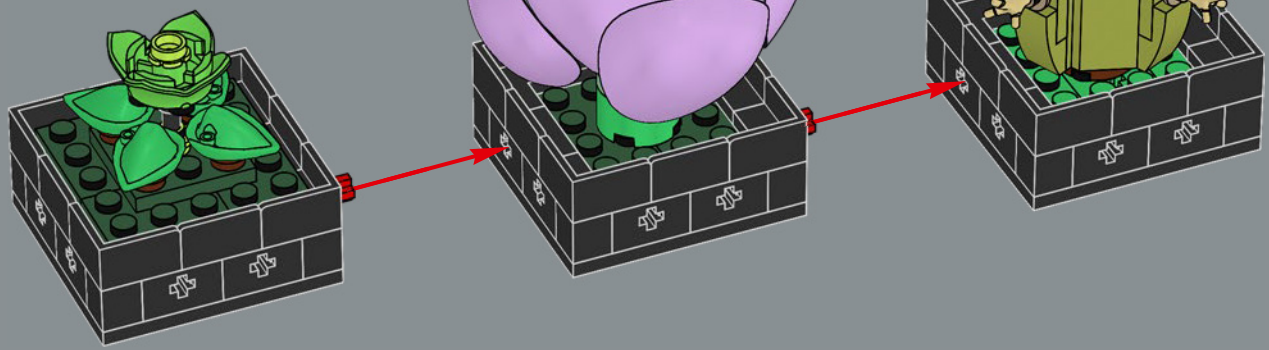



2x

20

