

Book 1

Livre 1

Libro 1



Booklet available in English on
Livret disponible en français sur
Folleto disponible en español en



The LEGO® Succulents

Some are prickly and still somehow adorable. Others are plump and still look so chic. Home design gurus say they can easily perk up any corner of your room. And they are the perfect houseplants that make even a newbie plant parent look like a pro. Meet the LEGO® Succulents.

Les succulentes LEGO®

Certaines sont épineuses, mais n'en restent pas moins adorables. Certaines sont dodues, mais n'en restent pas moins coquettes. Les gourous de la décoration intérieure jurent qu'elles peuvent rehausser n'importe quel coin d'une pièce. Ce sont également les plantes d'intérieur idéales pour donner l'impression d'avoir le pouce vert. Voici les succulentes LEGO®.

Las Suculentas LEGO®

Algunas tienen espinas, y aun así son adorables. Otras son rechonchas, y no por ello menos elegantes. Los gurús del diseño de interiores dicen que tienen la capacidad de realzar cualquier rincón de tu espacio. También son las plantas ideales para tener en casa porque hacen que incluso el cuidador de plantas más novato parezca todo un profesional. Te presentamos las Suculentas LEGO®.

● Succulents make fabulous table centerpieces, can dress up windowsills, and make any space instantly, insta-worthy.

● Les succulentes font de fabuleux centres de table et décorations de rebords de fenêtres et rendent n'importe quel espace digne d'apparaître dans un magazine.

● Las suculentas son fantásticas como centros de mesa, pueden adornar bases de ventanas como ninguna otra cosa y dan vida al instante a cualquier espacio...



They say having succulents in a room helps you focus, and building this set is likely to give you the same feeling. On the plus side, you don't have to water them!

On dit qu'avoir des succulentes dans une pièce aide à se concentrer, et la construction de cet ensemble devrait vous procurer le même effet. De plus, celles-ci n'ont pas besoin d'être arrosées!

Dicen que tener suculentas en una habitación te ayuda a concentrarte, es muy probable que construir las de este set te dé los mismos resultados. Y tienen una ventaja adicional: no hay que regarlas!

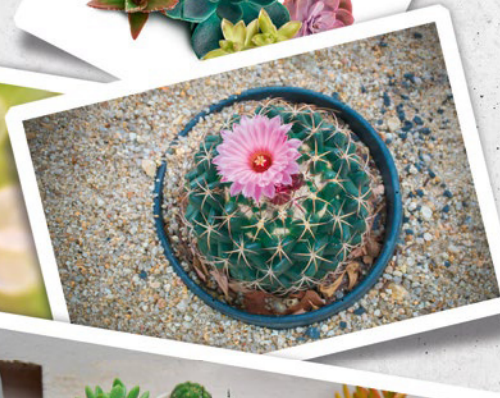



There's a succulent for everyone

Unlike other plants in the LEGO® Botanical Series, each LEGO Succulent can be built in its own individual little pot, which can be either connected to make a beautiful group of succulents or showcased separately. Instructions to build also come in separate booklets so that family and friends can all enjoy the LEGO building experience together.

À chacun sa succulente

Contrairement aux autres plantes de la collection botanique LEGO®, les succulentes LEGO peuvent être construites dans des petits pots individuels et être exposées séparément ou connectées ensemble. Les instructions de construction sont également fournies dans des livrets séparés afin que vous puissiez partager l'expérience de construction LEGO avec votre famille ou vos amis.

Hay una suculenta para cada quien

A diferencia de otras plantas de la serie LEGO® Botanical, cada una de las Suculentas LEGO se puede armar en su propia maceta. A su vez, se conectan para dar forma a un arreglo grupal, o puedes exhibir las especies individualmente si así lo deseas. Además, las instrucciones vienen en folletos separados para que puedas vivir la experiencia de construir con LEGO simultáneamente con tus amigos y familiares.

Build pot by pot, or group them all together. Either way is smile inducing.

Que vous construisiez des pots individuels ou que vous les regroupiez, le sourire est assuré.

Constrúyelas maceta a maceta o crea un arreglo grupal: cualquier opción te hará sonreír.

From the Design Team

Andy comes from Southern California, where succulent gardens thrive and are known for their beauty. "My friends are all expert keepers of these desert jewels while I, on the other hand, never had such luck. So, being able to pay tribute to my home with this LEGO® set was indeed a dream project. No succulent was harmed in the making of this set!" said Andy, which was a happy first for him.

Anderson Ward Grubb, Senior Designer

Un mot de l'équipe de conception

Andy vient du sud de la Californie, où les jardins de succulentes sont abondants et reconnus pour leur beauté. « Mes amis sont tous d'excellents gardiens de ces bijoux du désert alors que moi, je n'ai vraiment pas le pouce vert. Pouvoir rendre hommage à ma patrie avec cet ensemble LEGO® était donc un projet de rêve. Aucune succulente n'a été maltraitée durant la réalisation de cet ensemble ! » affirme Andy, se réjouissant de cette première pour lui.

Anderson Ward Grubb, concepteur principal

Impresiones del equipo de diseño

Andy es originario del sur de California, donde los jardines de suculentas abundan y son reconocidos por su belleza. "Todos mis amigos son expertos cultivadores de estas joyas del desierto. A diferencia de ellos, yo nunca he tenido éxito cuidando plantas. Por eso, tener la posibilidad de mostrar gratitud hacia mi hogar con este set LEGO® es un sueño hecho realidad. ¡Ninguna suculenta resultó lastimada con la construcción de este set!", asegura Andy, para quien la realización de este proyecto representa una feliz primera vez.

Anderson Ward Grubb, Diseñador sénior



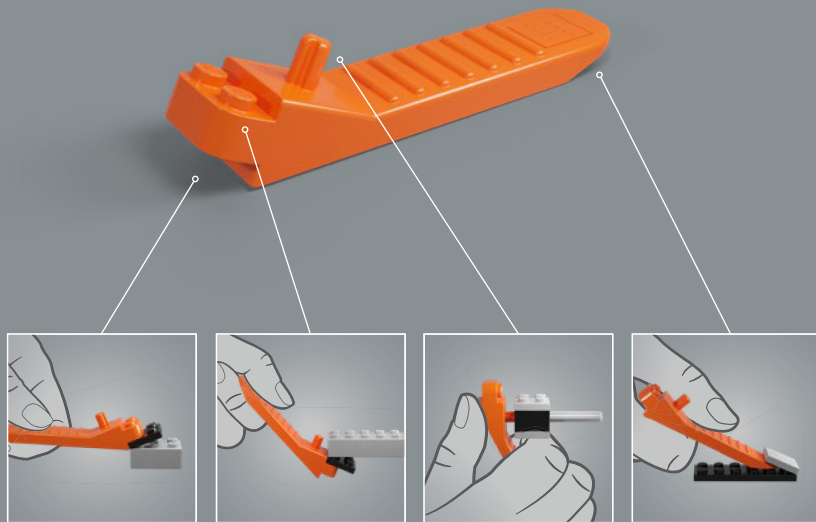



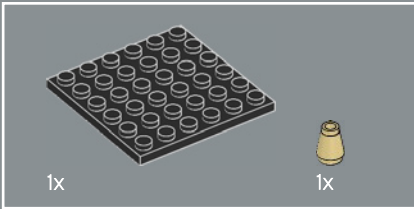
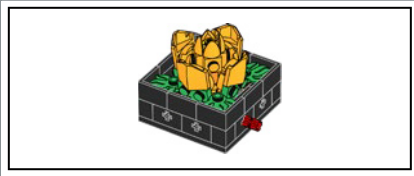

1

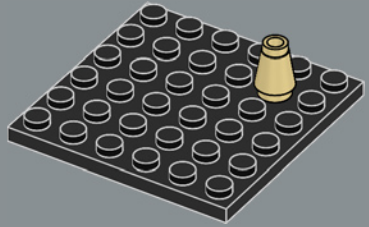

2

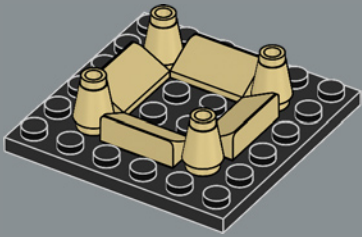

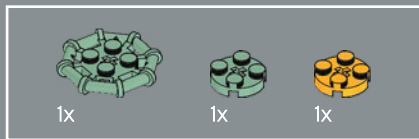

3

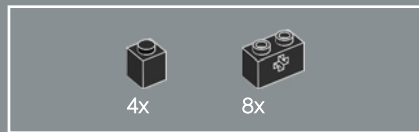
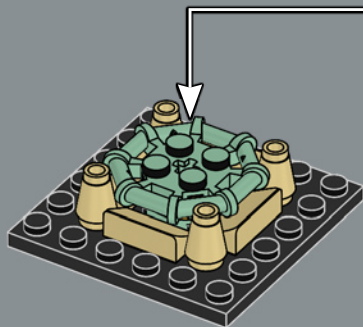
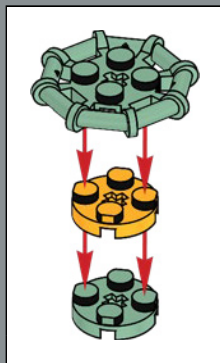

4

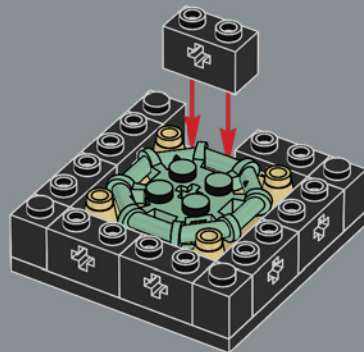

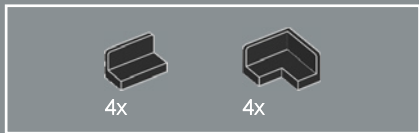

5

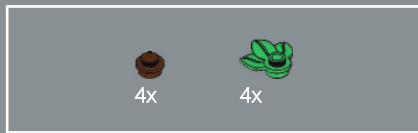
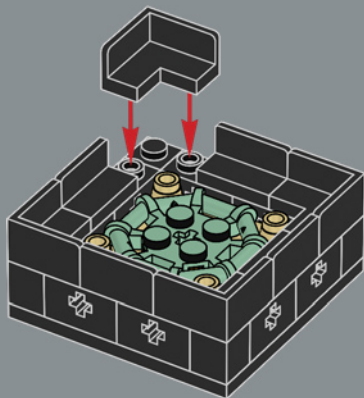

6

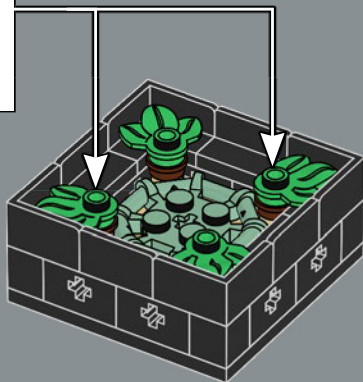
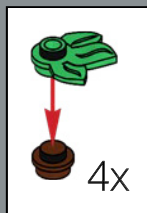

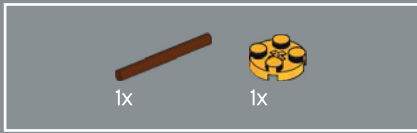

7

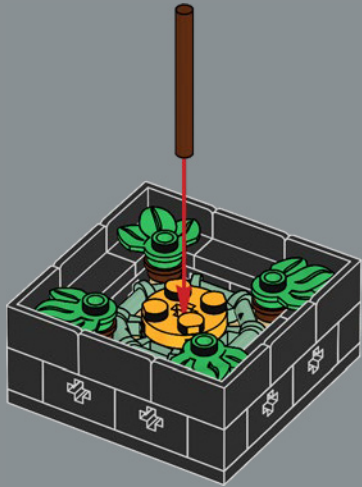

8

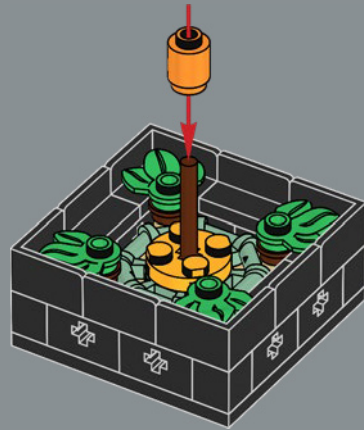



9

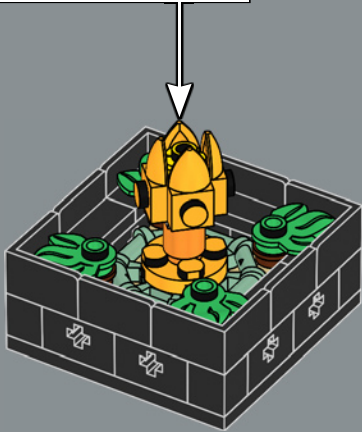
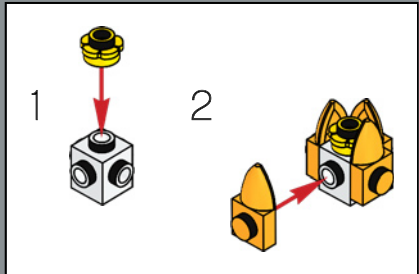

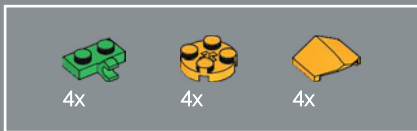

10

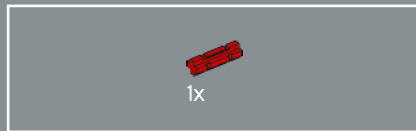
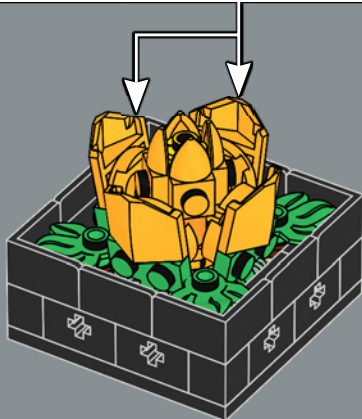
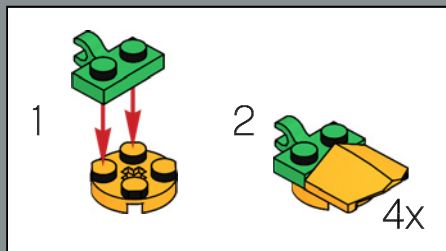

11

Orange Echeveria
Also known as the Orange Monroe, this succulent boasts adorable rosettes in varying shades of green and orange.

L'echeveria orange
Aussi connue sous le nom d'Orange Monroe, cette succulente présente d'adorables rosettes dans différentes nuances de vert et d'orange.

Echeveria naranja
También conocida como *echeveria Monroe*, esta suculenta tiene adorables flores en una variedad de tonos verdes y naranjas.

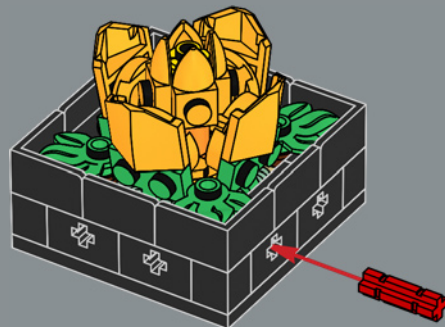

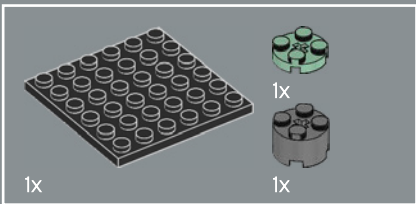
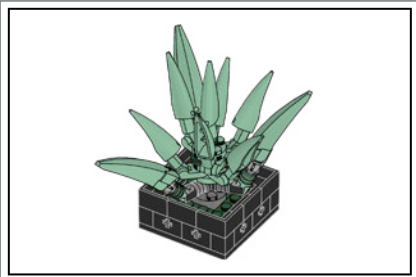

1

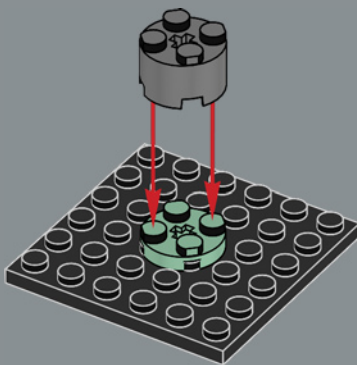

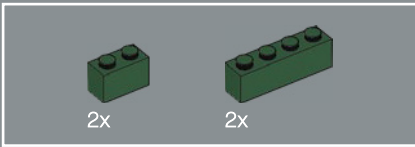

2

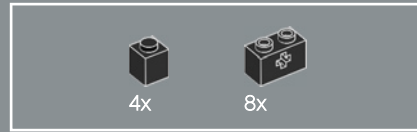
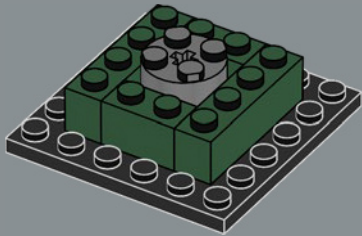

3

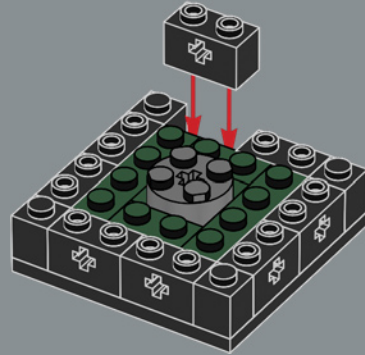

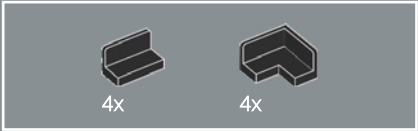

4

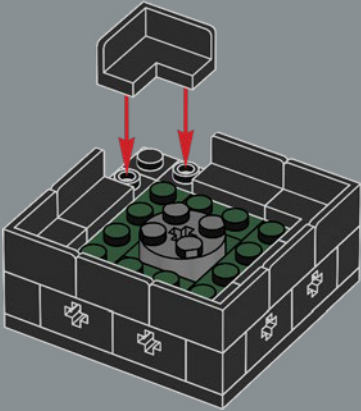



5

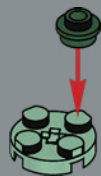

6



7

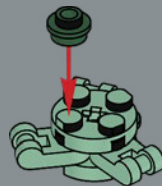



8



9



18

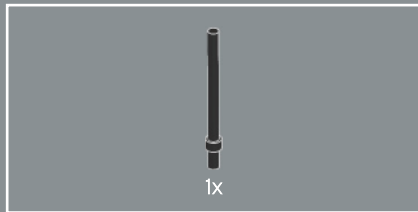

10

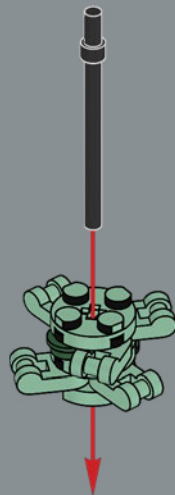

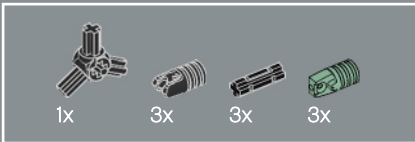

11

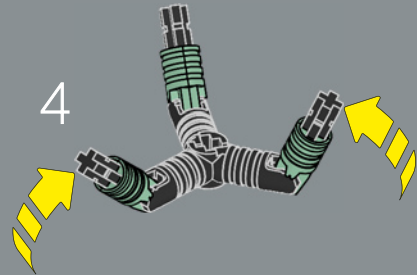
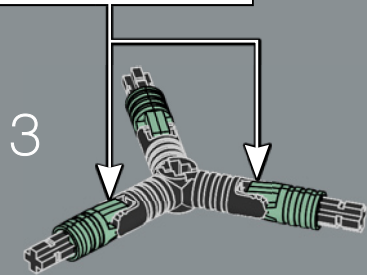
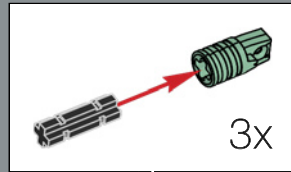
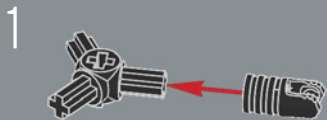

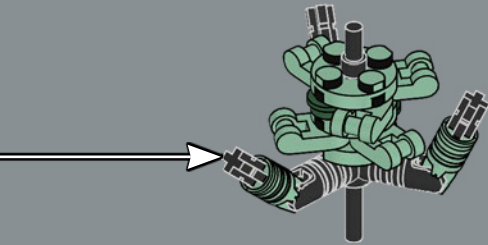

12

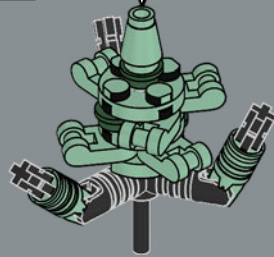
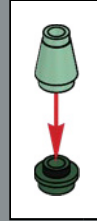

13

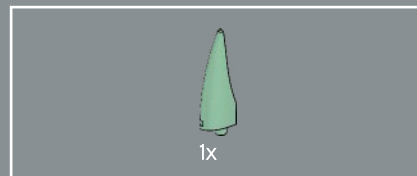
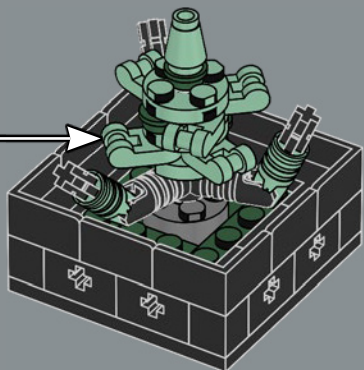

14

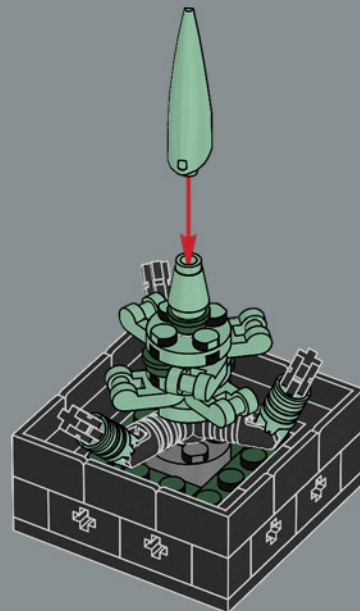

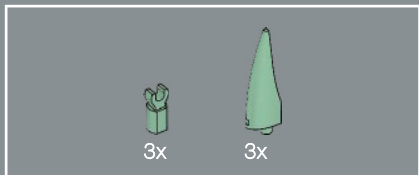

15

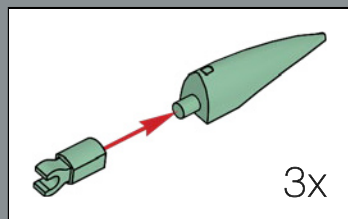

From claw-like to succulents we like
LEGO® claw elements from fantastic creatures make up
the spikey Aloe.

Toutes griffes dehors
L'aloès piquant est composé d'éléments de griffes LEGO®
provenant de créatures fantastiques.

De garras a nuestras suculentas favoritas
Las múltiples puntas de la sábila tienen su origen en
piezas de garras de fantásticas criaturas LEGO®.

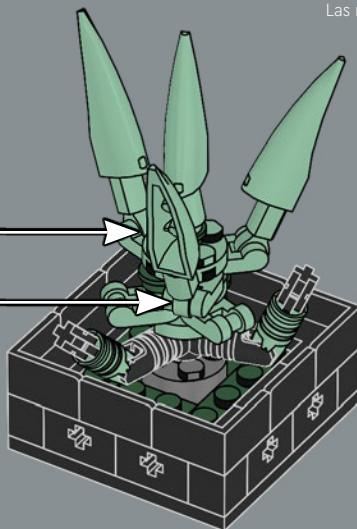

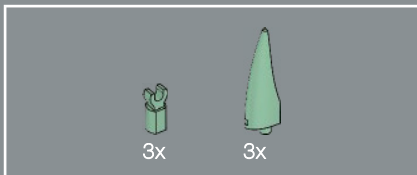

16

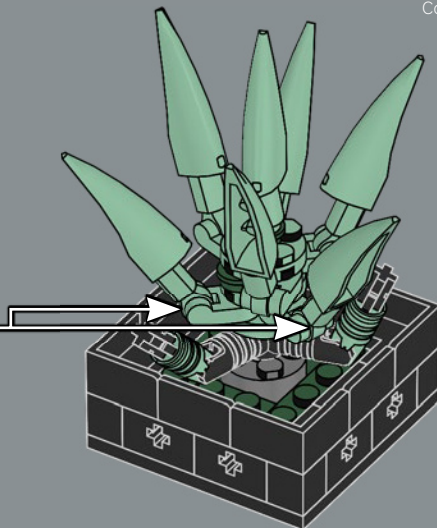
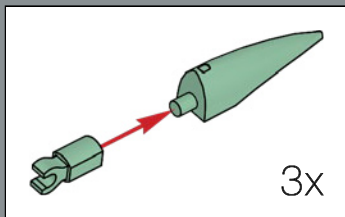

Aloe Plant
Cleopatra applied Aloe plant gel to her body as part of
her beauty regimen!

L'aloès
Cléopâtre utilisait du gel d'aloès dans le cadre de son
rituel de soins de beauté !

Planta de sábila
Como parte de su rutina de belleza, ¡Cleopatra se
aplicaba gel de sábila en el cuerpo!

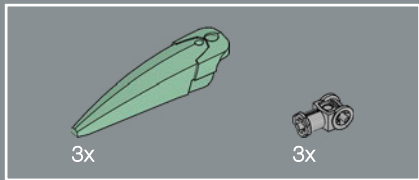

17

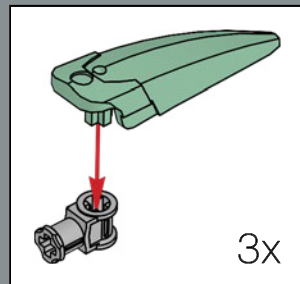
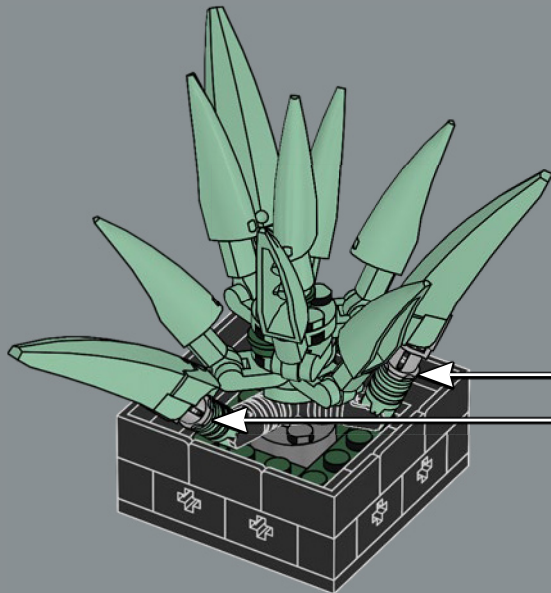

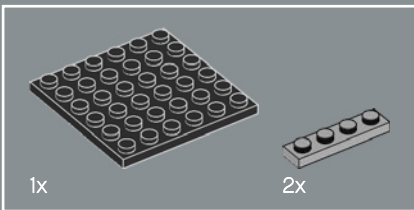
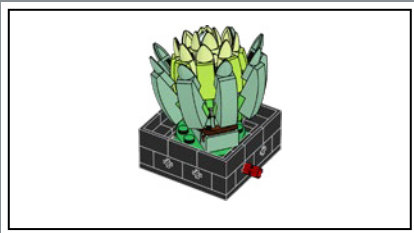

1

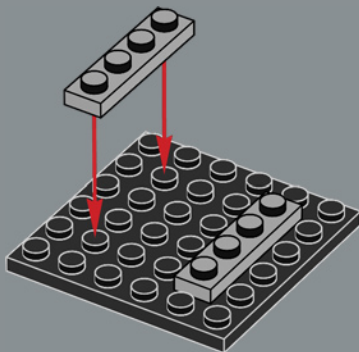

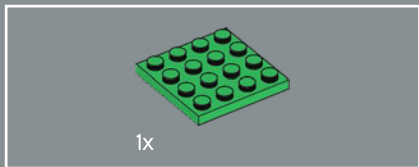

2

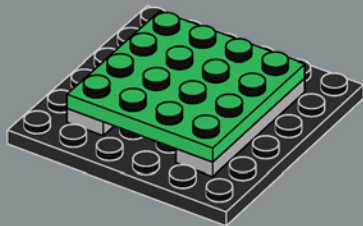

3

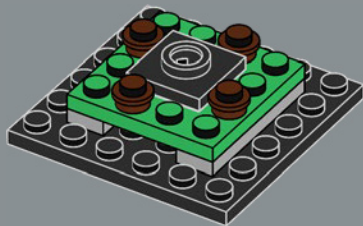

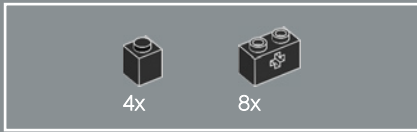

4

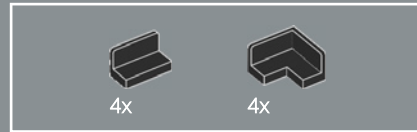
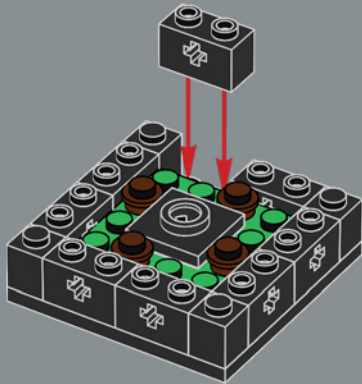

5

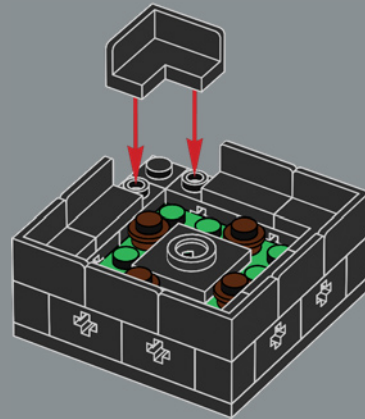

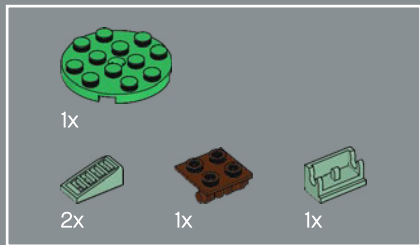

6

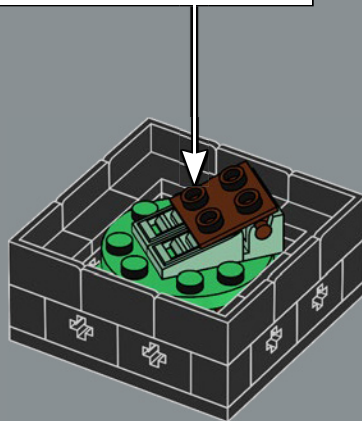
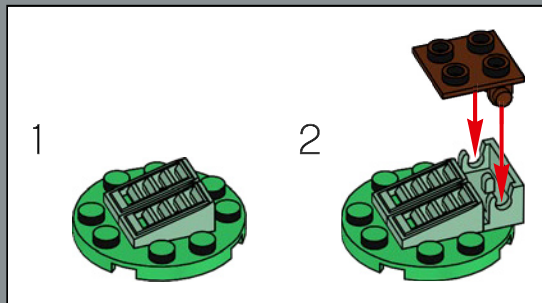

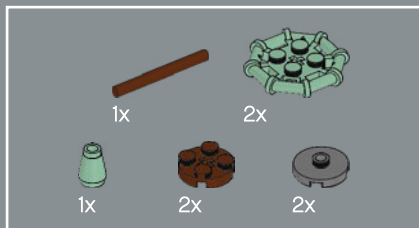

7

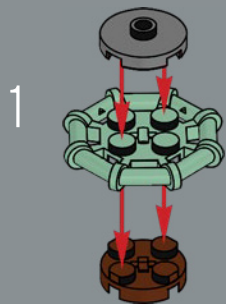

2

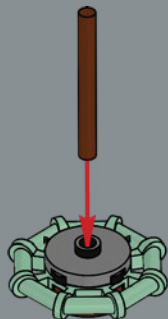

3

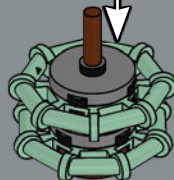

4

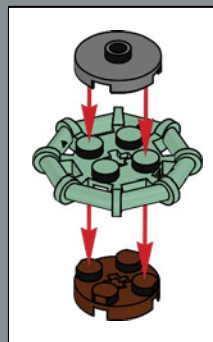
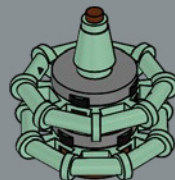

Leaves made from ice cream cones
Inspired by 'Hens and Chicks,' the leaves
arranged in a rosette pattern originate from the
swirl top of an ice cream cone.

Des feuilles en cornets de crème glacée
Inspirées de « la poule et ses poussins », chacune
des feuilles disposées en rosette était à l'origine
un tourbillon de cornet de crème glacée.

Hojas que nacieron como conos de helado
El arreglo a semejanza de los pétalos de una rosa
de las hojas de esta suculenta está conformado
por la retorcida parte superior de un cono de
helado que hay en el centro.

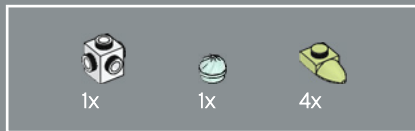
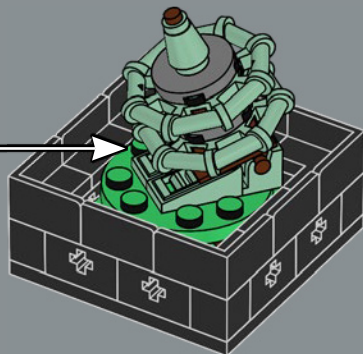

8

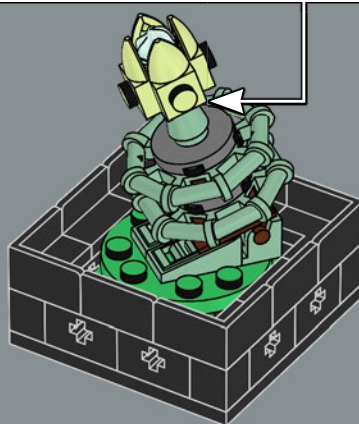
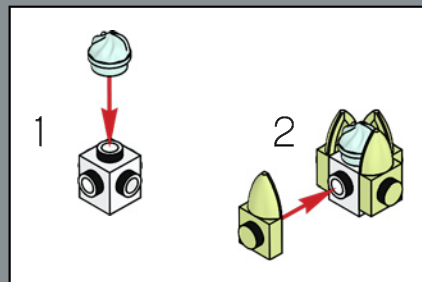



9

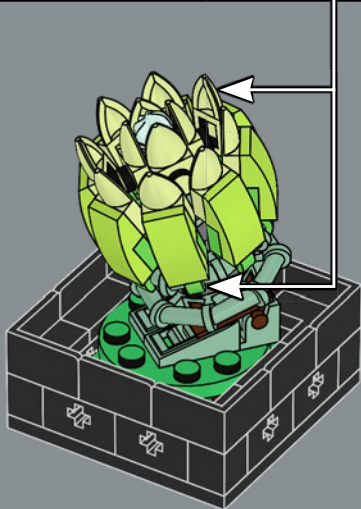
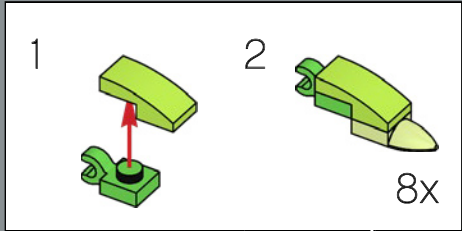

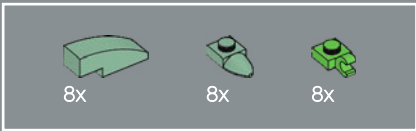

10

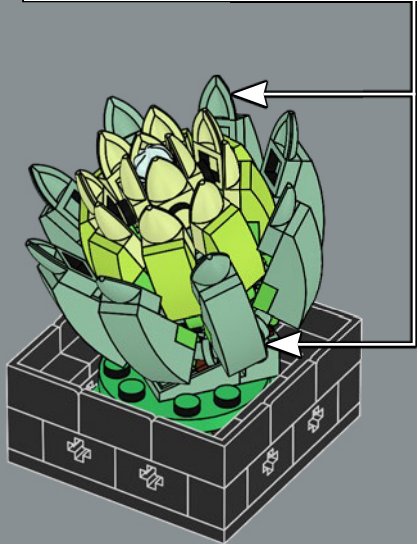
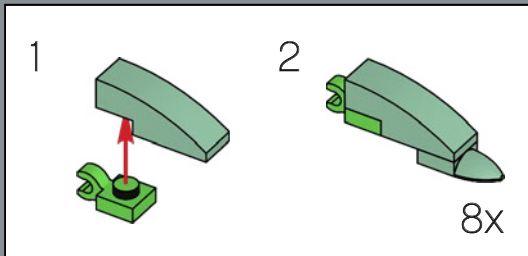

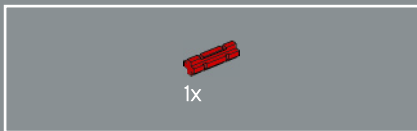

11

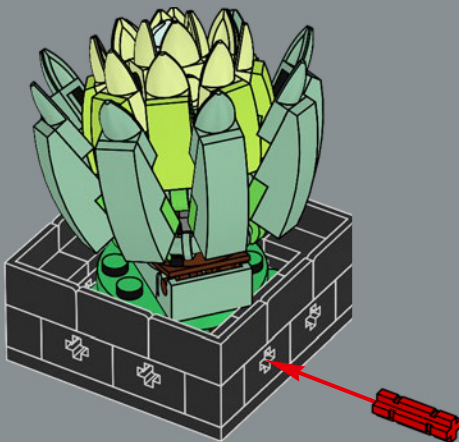

Hens and Chicks
Hens and Chicks plants are called such because they can quickly produce numerous babies.

La poule et ses poussins
La poule et ses poussins doit son nom au fait qu'elle peut produire de nombreuses petites plantes très rapidement.

Siempreviva
En inglés, esta planta es conocida como *hen and chicks* (una expresión que significa *gallina y polluelos*) por su capacidad de producir una gran cantidad de retoños en poco tiempo.

12

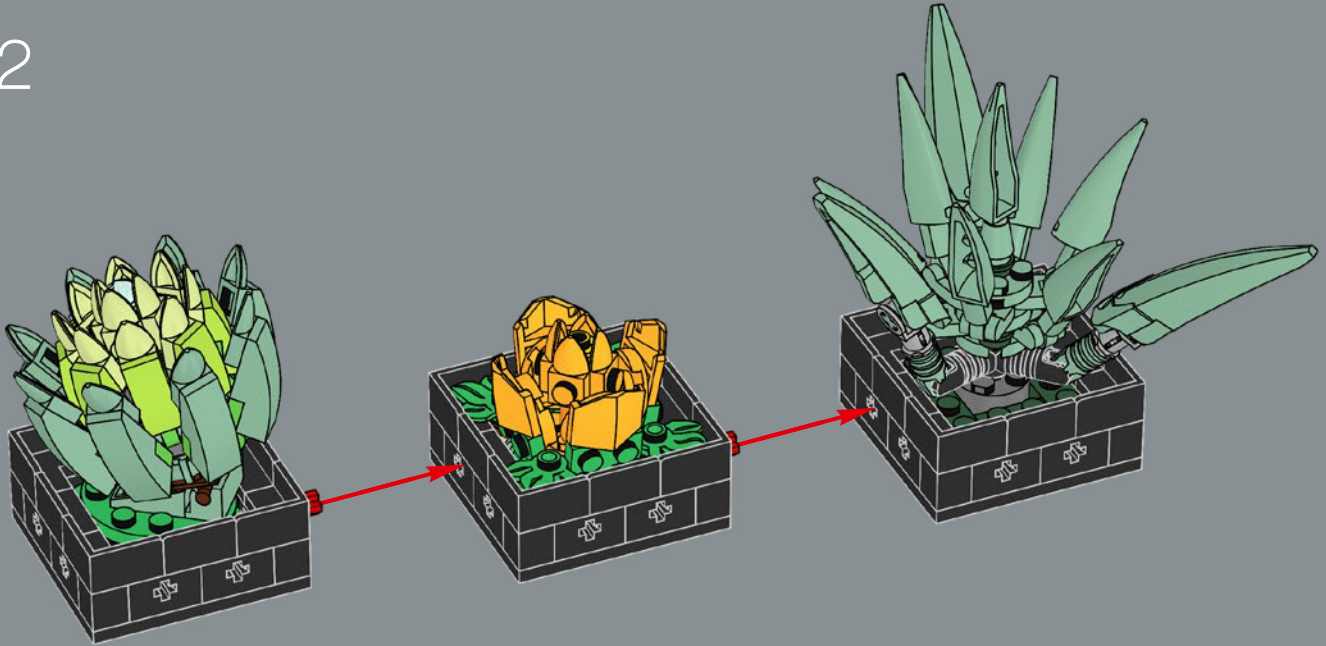

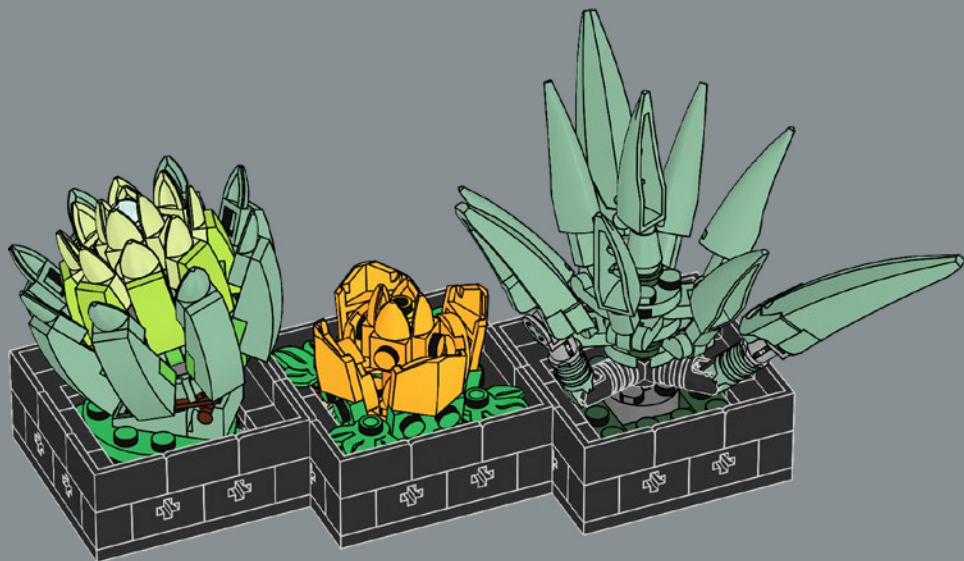

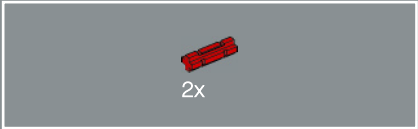

13

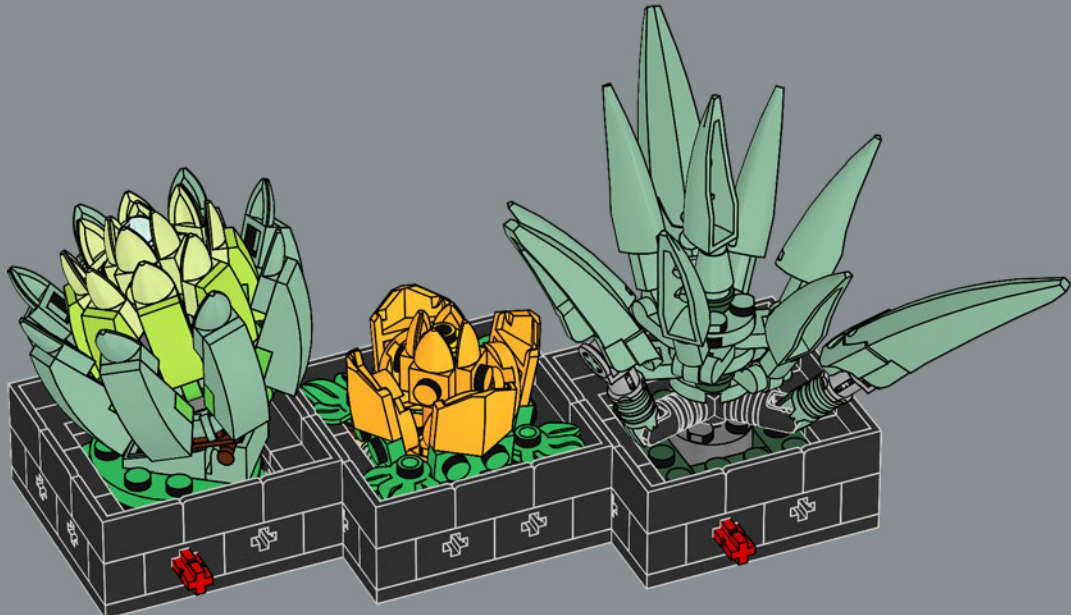

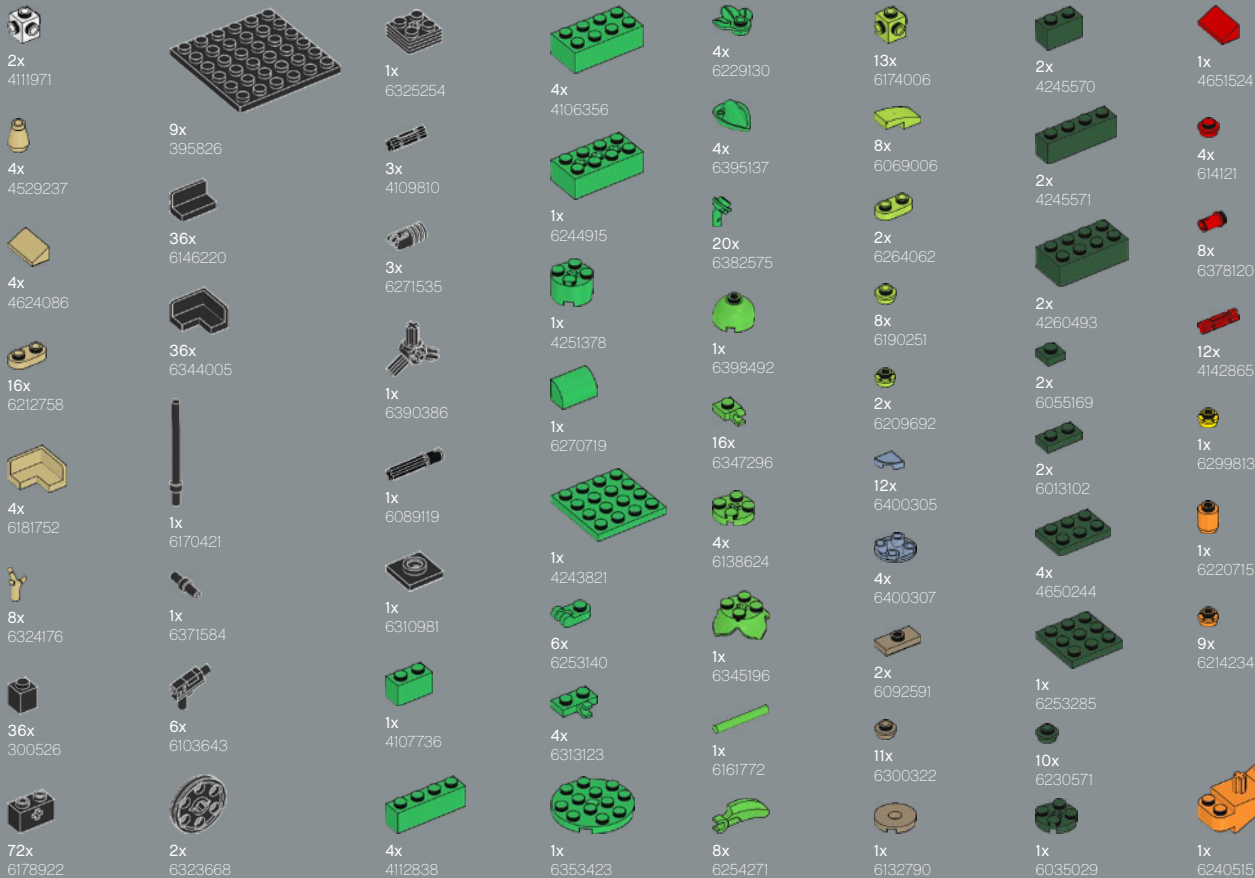

 1x 6349342	 1x 6400309	 10x 6341975	 12x 6000752	 2x 4211159	 2x 4211445	 4x 6347780	 12x 6031787		
 2x 6134280	 3x 6329298	 3x 6348250	 12x 4539097	 2x 6102360	 1x 6116608	 1x 6206151	 4x 6058245		
 8x 6100237	 7x 6398464	 1x 6223234	 4x 6313126	 3x 6170468	 3x 6380605	 1x 6249118	 4x 6278089		
 6x 6278550	 8x 6186079	 12x 6311108	 2x 6219658	 2x 6116613	 1x 4211881	 8x 6398491	 8x 6258091		
 5x 6223219	 2x 6155256	 7x 6398466	 6x 6385485	 1x 6349130	 1x 4249139	 4x 6223506	 8x 6258075		
 6x 6223237	 6x 6312350	 4x 4282860	 1x 6186045	 3x 6115080	 35x 6398468	 8x 6258098	 8x 6258094		
 4x 6400434	 4x 4211183	 1x 6167644	 2x 6278155	 12x 6267420	 8x 6258095	 16x 4216581	 4x 6316692	 8x 6398465	 1x 6398490



Customer Service

Kundenservice

Service Consommateurs

Servicio Al Consumidor

LEGO.com/service or dial



00800 5346 5555 :



1-800-422-5346 :





FEEDBACK AND WIN



FEEDBACK AND WIN

Your feedback will help shape the future development of this product series.

Please visit:

FEEDBACK UND GEWINNEN

Dein Feedback trägt zur Weiterentwicklung dieser Produktreihe bei.

Geh auf:

COMMENTEZ ET GAGNEZ

Vos commentaires nous aideront à concevoir les futurs produits de cette gamme.

Rendez-vous sur :

COMENTA Y GANA

Tu opinión nos ayudará a dar forma al desarrollo de esta serie de productos en el futuro.

Visita:

反馈有奖

您的反馈将有助于我们在今后改进本系列产品。

请访问:

LEGO.com/productfeedback

By completing, you will automatically enter a drawing to win a LEGO® set.

Terms & Conditions apply.

Durch Ausfüllen nimmst du automatisch an der Verlosung eines LEGO® Preises teil.

Es gelten die Teilnahmebedingungen.

En envoyant vos commentaires, vous serez automatiquement inscrit(e) à un tirage au sort qui vous permettra de remporter un prix LEGO®.

Offre soumise à conditions.

Al contestar, participarás automáticamente en el sorteo y podrás ganar un set LEGO®.

Sujeto a Términos y Condiciones.

完成我们的反馈调查,即可自动进入抽奖环节,赢取乐高®套装。

适用《条款和条件》。

