

The LEGO logo, consisting of the word "LEGO" in a bold, white, sans-serif font with a yellow outline, set against a red square background.

Architecture

21043

San Francisco

California, USA

Californie, États-Unis

California, EE. UU.

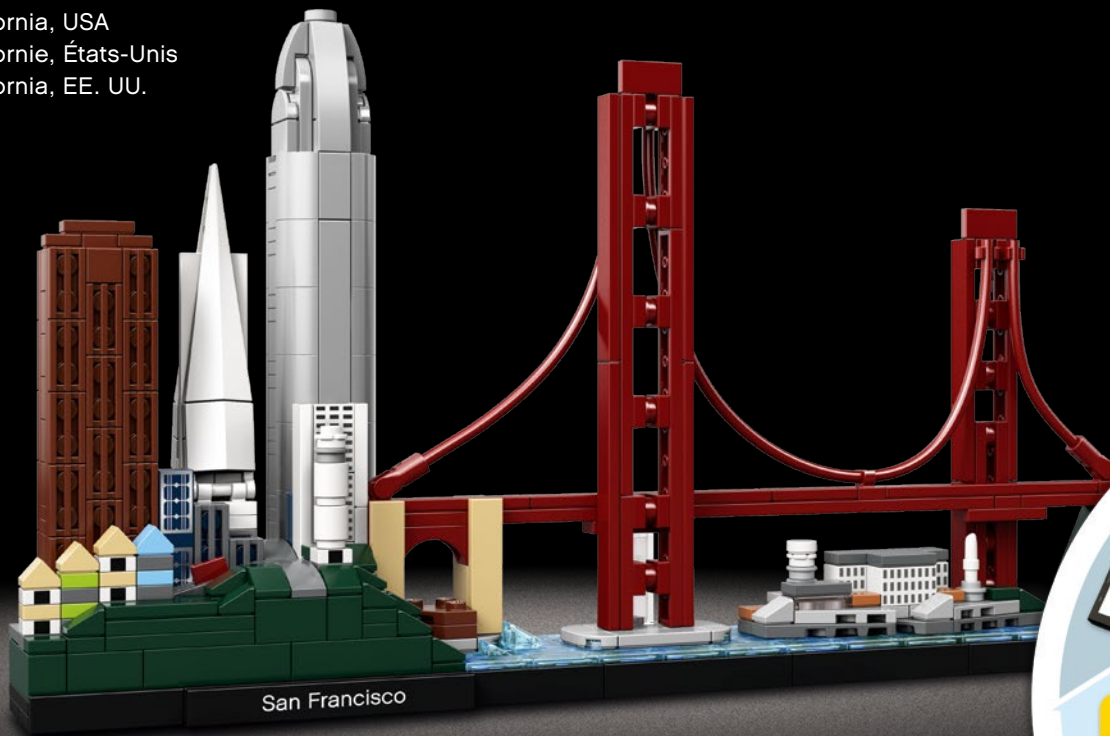

San Francisco

As the fourth largest city in California and the cultural, commercial and financial hub of Northern California, San Francisco's eclectic mix of architecture showcases both its geography and its rich history. It's been more than fifty years since San Francisco enjoyed its revolutionary "Summer of Love" and, having undergone much development since then, this City by the Bay offers a plethora of architectural and cultural delights to its residents and visitors.

Figurant au quatrième rang des plus grandes villes californiennes, San Francisco est le pôle culturel, commercial et financier de la Californie du Nord. Son architecture hétéroclite met en valeur tant sa géographie que sa riche histoire. Il y a plus de 50 ans se déroulait à San Francisco le révolutionnaire « Été de l'amour ». Depuis, la ville au bord de la baie a grandement évolué et offre aux résidents ainsi qu'aux visiteurs une multitude de merveilles architecturales et culturelles.

Cuarta ciudad más grande de California y centro cultural, comercial y financiero de la parte norte del estado, la ecléctica mezcla de arquitecturas de San Francisco pone de manifiesto su geografía y su rica historia. Han pasado más de cincuenta años desde que San Francisco disfrutara de su revolucionario Verano del Amor y, luego de un enorme desarrollo, la Ciudad junto a la Bahía ofrece hoy un amplio abanico de delicias arquitectónicas y culturales a residentes y visitantes por igual.

"San Francisco has only one drawback: it's hard to leave."

« Le seul inconvénient à San Francisco : vous ne voudrez plus partir. »

"San Francisco tiene un único inconveniente: es duro tener que irse".

Rudyard Kipling

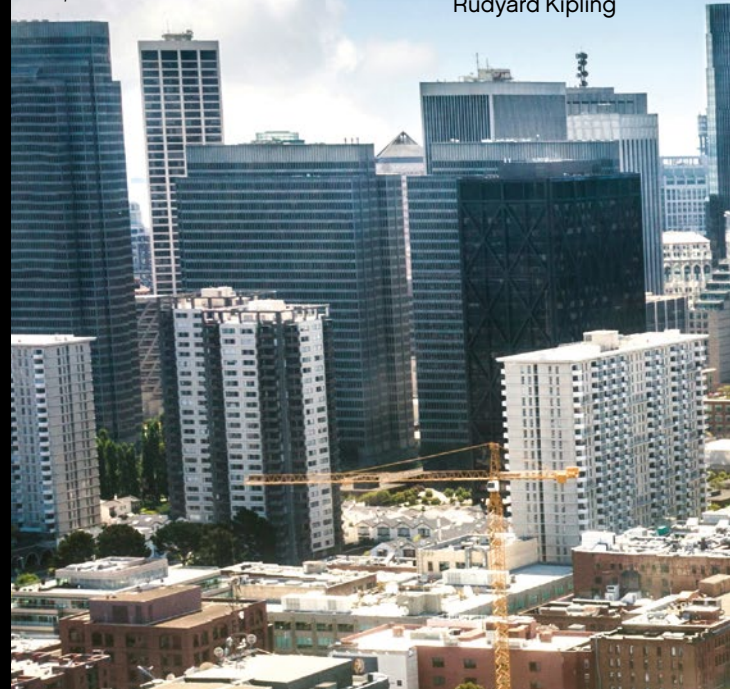



555 California Street

Le 555 California Street

(formerly known as Bank of America Center)
(anciennement le Bank of America Center)
(antes Bank of America Center)

Located in the center of San Francisco's financial district, this iconic skyscraper is the fourth tallest building in the city and the largest by floor area. Until the merger in 1998 with NationsBank, it was the headquarters of the Bank of America and was intended as a display of prosperity, power and importance. Wurster, Bernardi and Emmons and Skidmore, Owings and Merrill designed the carnelian-clad building, in consultation with architect Pietro Belluschi.

Situé au cœur du quartier des affaires de San Francisco, ce gratte-ciel emblématique se classe au quatrième rang des plus hauts bâtiments de la ville et remporte la palme de l'édifice ayant la plus grande superficie. Édifié comme un symbole de prospérité, de puissance et d'envergure, l'immeuble a été le siège de la Bank of America jusqu'à sa fusion avec la NationsBank en 1998. De concert avec l'architecte Pietro Belluschi, les firmes Wurster, Bernardi & Emmons et Skidmore, Owings & Merrill ont conçu le gratte-ciel au revêtement cornaline.

Ubicado en el centro del distrito financiero de San Francisco, este emblemático rascacielos es el cuarto edificio más alto de la ciudad y el más grande por superficie útil. Hasta su fusión



con NationsBank en 1998, fue la sede del Bank of America y se pretendía que fuera un símbolo de prosperidad, poder e importancia. Wurster, Bernardi & Emmons y Skidmore, Owings & Merrill diseñaron el edificio, recubierto de cornalina, con la colaboración del arquitecto Pietro Belluschi.

“Painted Ladies”

Les « Dames peintes »

Damas Pintadas

Painted Ladies refers to the San Franciscan architectural phenomenon of brightly painted Victorian or Edwardian houses, acquiring its name from a 1978 photo essay by writers Elizabeth Pomada and Michael Larsen. The transformation of these formerly sober-colored houses into cheerful and colorful buildings is believed to have been led by a local artist who painted his own Victorian house in vivid blues and greens in the 1960s, starting what was known as the 'colorist movement', which continues to this day.

In parts of the city, San Francisco's Painted Ladies stand in stark contrast to the skyscrapers of the downtown area.

Les « Dames peintes » désignent les maisons de style victorien ou édouardien peintes de couleurs vives. Ce phénomène architectural sanfranciscain doit son nom à un reportage photo réalisé par les écrivains Elizabeth Pomada et Michael Larsen en 1978, intitulé *Painted Ladies*. On dit que ces demeures autrefois sobres auraient été transformées en charmants édifices colorés après qu'un artiste de la région eût peint sa propre maison victorienne de bleus et de verts éclatants dans les années 1960, et donné le coup d'envoi du « mouvement coloriste » de l'époque que l'on connaît encore aujourd'hui.

Dans certaines parties de San Francisco, le contraste entre ces couleurs vives et les gratte-ciel du centre-ville est frappant.



Este término hace referencia al fenómeno arquitectónico sanfranciscano que dio lugar a la proliferación de casas victorianas o eduardianas pintadas de llamativos colores, teniendo su origen en un ensayo fotográfico redactado por los escritores Elizabeth Pomada y Michael Larsen en 1978. Se cree que la transformación de estas casas, antes de sobrios colores, en alegres y pintorescos edificios fue liderada por un artista local que pintó su propia casa victoriana en vivos azules y verdes durante la década de 1960, dando lugar al movimiento colorista, que perdura hasta la actualidad.

En ciertas partes de la ciudad, las Damas Pintadas de San Francisco contrastan dramáticamente con los rascacielos del centro.

Transamerica Pyramid

La Transamerica Pyramid

Pirámide Transamerica

At 48 stories, the Transamerica Pyramid is the second tallest building in the San Francisco skyline and is one of the symbols of the city. Commissioned by The Transamerica Corporation, the striking, angular building was designed by architect William Pereira, and built by Hathaway Dinwiddie, with construction being completed in 1972. During the seasonal holidays and for special occasions, a bright beacon known as the 'Crown Jewel' lights up the pyramid's peak.

Du haut de ses 48 étages, la Transamerica Pyramid est le second sommet en importance de la silhouette de San Francisco, et l'un des symboles de la ville. Réalisé à la demande de la Transamerica Corporation, ce saisissant bâtiment angulaire est l'œuvre de l'architecte William Pereira. Sa construction, entreprise par Hathaway Dinwiddie, s'est achevée en 1972. Durant la période des fêtes et les occasions spéciales, un phare surnommé le « joyau de la couronne » illumine le sommet de la pyramide.

Con 48 pisos, la Pirámide Transamerica es el segundo edificio más alto del horizonte de San Francisco y uno de los símbolos de la ciudad. Encargada por Transamerica Corporation, la impresionante estructura angular fue diseñada por el arquitecto William Pereira y construida por Hathaway Dinwiddie, que la



acabó en 1972. Durante la Navidad y en ocasiones especiales, se enciende la Joya de la Corona: un brillante foco que ilumina la cúspide de la pirámide.

Salesforce Tower

La tour Salesforce

Torre Salesforce

Located downtown in the 'SoMa' district of the city, the Salesforce Tower is the tallest building in the San Francisco skyline. Designed by César Pelli and opened in 2018, the soaring 1,070 ft. (326m) tall, 61-story tower has an elegant, obelisk shape with horizontal metal fins that act as sunshades. The building has been created with an emphasis on sustainable design, including a water recycling system and high efficiency air ventilation. The sunshades on the outside maximize light but reduce solar gain, while heat-exchanging coils in the foundation utilize the earth's constant cooler temperature to aid cooling of the building.

Située au centre-ville dans le quartier de SoMa (South of Market), la tour Salesforce est le plus haut édifice de la silhouette sanfranciscaine. Dessinée par César Pelli, la construction de 61 étages d'une hauteur vertigineuse de 326 mètres a ouvert ses portes en 2018. Son élégante forme d'obélisque est pourvue d'ailettes métalliques horizontales qui servent d'auvents. Construit dans un esprit de conception durable, le bâtiment est équipé d'un système de recyclage de l'eau et d'un appareil de circulation de l'air à haute efficacité. À l'extérieur, les auvents maximisent la lumière tout en réduisant l'apport solaire, alors que les bobines d'échange thermique de la fondation tirent profit de la fraîcheur constante du sol pour faciliter la climatisation de l'édifice.



Situada en el céntrico distrito SoMa de la ciudad, la Torre Salesforce es el edificio más alto del horizonte de San Francisco. Diseñada por César Pelli e inaugurada en 2018, posee una increíble altura de 326 m, 61 pisos y una elegante forma de obelisco con aletas metálicas horizontales que sirven para dar sombra. Todo en este edificio gira en torno al diseño sustentable, incluidos su sistema de reciclaje de agua y su tecnología de ventilación de alta eficiencia. Las aletas metálicas exteriores maximizan la luz y reducen la radiación solar, mientras que los serpentines intercambiadores de calor de los cimientos aprovechan la temperatura de la tierra, constantemente más baja, para contribuir a la refrigeración de la estructura.

Coit Tower

La Coit Tower

Torre Coit

The Lillian Coit Memorial Tower is a memorial tower located in Pioneer Park in the Telegraph Hill neighborhood of San Francisco. This art deco monument was designed by architects Arthur Brown Jr and Henry Howard and dedicated in 1933. The tower was built to commemorate Lillian Hitchcock Coit, who was a local character and a champion and benefactor of firefighters. Her bequest to the city of San Francisco also sponsored the creation of a statue of three firefighters in Washington Square Park.

La tour commémorative Lillian Coit Memorial Tower est située au Pioneer Park, dans le quartier de Telegraph Hill à San Francisco. Ce monument de style Art déco inauguré en 1933 est l'œuvre des architectes Arthur Brown Jr. et Henry Howard. L'édifice a été construit en hommage à Lillian Hitchcock Coit, une résidente audacieuse pour son époque qui a mis à contribution sa passion du métier de pompier. Son legs à la ville de San Francisco a également servi à ériger une statue représentant trois sapeurs-pompiers au Washington Square Park.

Esta torre monumental, erigida en homenaje a Lillian Coit, se encuentra en el parque Pioneer, en pleno barrio Telegraph Hill de San Francisco. La estructura, de estilo *art déco*, fue diseñada por los arquitectos Arthur Brown Jr. y Henry Howard,



e inaugurada en 1933. La torre se construyó para conmemorar la vida de Lillian Hitchcock Coit, una celebridad local, defensora y benefactora del cuerpo de bomberos. Su legado a la ciudad de San Francisco incluye también la creación de una estatua de tres bomberos en el parque de la plaza Washington.

Fort Point

Le Fort Point

The masonry seacoast fortification, Fort Point, dates all the way back to the American Civil War when it was built by the United States Army to defend San Francisco against hostile warships. Now protected as the Fort Point National Historic Site, the fortification never saw hostilities during the Civil War and over the subsequent years was used for military barracks, training and storage.

La construction par l'armée américaine du Fort Point, une fortification côtière en maçonnerie, remonte jusqu'à la guerre de Sécession pour défendre San Francisco contre des navires ennemis. Désormais, le Fort Point National Historic Site est un lieu protégé. L'ouvrage n'a jamais subi les hostilités de la guerre civile, et au cours des années suivantes, a servi de base militaire pour la formation et l'entreposage.

Esta fortificación costera de ladrillo data de la guerra civil americana, cuando el ejército de Estados Unidos la construyó para defender San Francisco de los barcos de guerra enemigos. Hoy protegida como parte del Parque Histórico Nacional de Fort Point, la fortificación no fue testigo de hostilidades durante aquella guerra y, en los años que siguieron, se usó como cuartel militar con fines de entrenamiento y almacenamiento.



Golden Gate Bridge

Le Golden Gate Bridge

Puente Golden Gate

The Golden Gate Bridge is one of the best-known and most beautiful bridges in the world and one of the emblems of San Francisco. With its iconic color, spectacular location and graceful lines, this suspension bridge is a design and engineering marvel and the city's most popular tourist attraction. Designed by Irving Morrow, Charles Alton Ellis and Joseph Strauss, the bridge was created to make travel between San Francisco and Marin County easier; but due to differing interests among the stakeholders, it was over a decade before it got the green light. Construction took four years and it was finally opened in 1937 during a week of official celebrations.

Le Golden Gate Bridge, l'un des emblèmes de San Francisco, figure parmi les ponts les plus connus et les plus magnifiques au monde. La couleur emblématique, l'emplacement spectaculaire et les lignes gracieuses de ce pont suspendu en font une merveille de conception et d'ingénierie, ainsi que l'attraction touristique la plus prisée de la ville. Conçue par Irving Morrow, Charles Alton Ellis et Joseph Strauss, la structure visait à faciliter les déplacements entre San Francisco et le comté de Marin. Mais, la construction n'a obtenu le feu vert qu'une décennie plus tard, en raison des intérêts divergents des intervenants. Après quatre ans de chantier, l'ouverture s'est finalement déroulée en 1937 à l'occasion d'une semaine de célébrations officielles.



El puente Golden Gate es uno de los puentes más populares y hermosos del mundo, además de uno de los emblemas de San Francisco. Con su famoso color, su espectacular ubicación y sus graciosas líneas, este puente colgante constituye una maravilla del diseño y la ingeniería y es la atracción turística más visitada de la ciudad. Diseñado por Irving Morrow, Charles Alton Ellis y Joseph Strauss, el puente se creó para facilitar el transporte entre San Francisco y el condado de Marin; sin embargo, debido a los diferentes intereses de las partes implicadas, pasó más de una década antes de que comenzara su construcción. Después de cuatro años, el puente fue finalmente inaugurado en 1937, durante una semana de celebraciones oficiales.

Alcatraz Island

L'île d'Alcatraz

Isla de Alcatraz

Located 1.25 miles (2 kilometers) offshore from San Francisco in its bay, Alcatraz was developed with facilities for a lighthouse and a military fortification and was used as a prison between 1934 and 1963. Today it is part of the Golden Gate National Recreation Area and is open for tours.

Située dans la baie de San Francisco à deux kilomètres au large, l'île d'Alcatraz, où sont aménagées des installations comprenant un phare et une fortification militaire, a servi de prison de 1934 à 1963. Aujourd'hui, le territoire insulaire fait partie du Golden Gate National Recreation Area et ouvre ses portes aux visiteurs.

Ubicada a 2 km de la costa de San Francisco, en su bahía, Alcatraz se equipó con instalaciones para un faro y una fortificación militar, y sirvió como prisión entre 1934 y 1963. Hoy forma parte del Área Recreativa Nacional Golden Gate y se puede visitar.



1



2



3

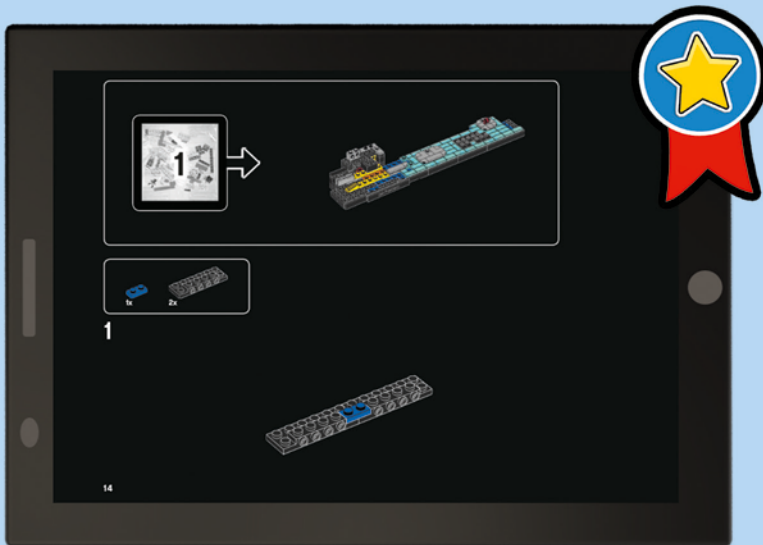

LEGO.com/apps

Check for compatibility
Vérifier la compatibilité
Comprueba tu compatibilidad

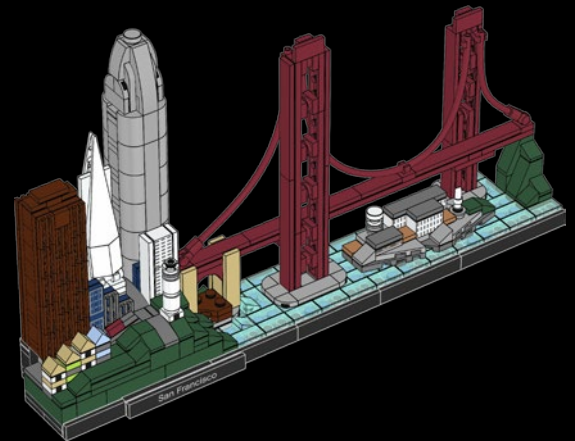
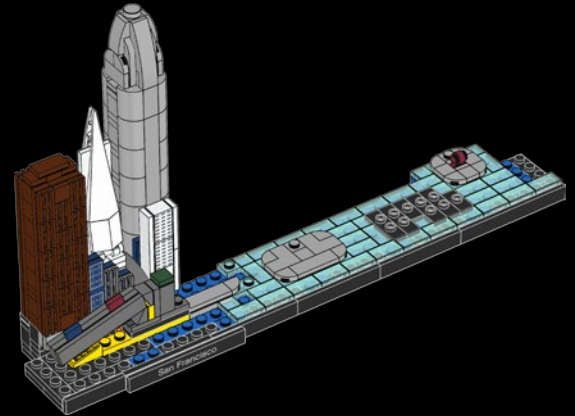
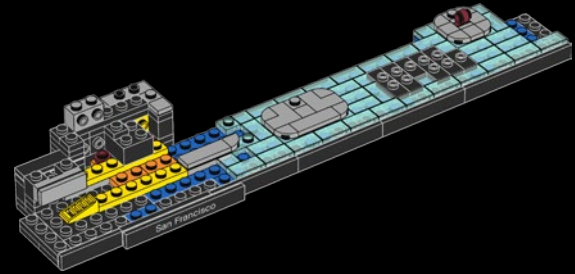

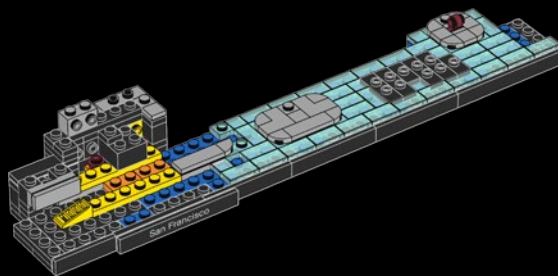

1x

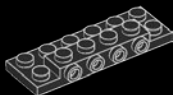

2x

1

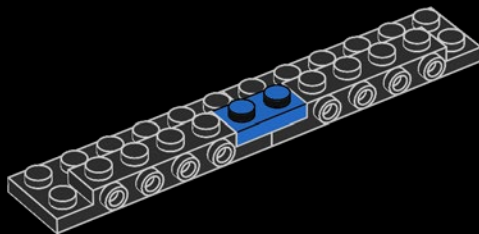

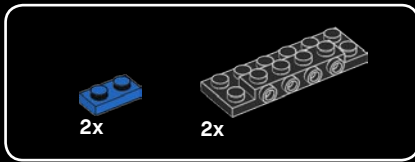

2

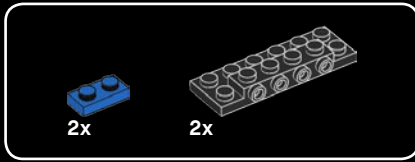
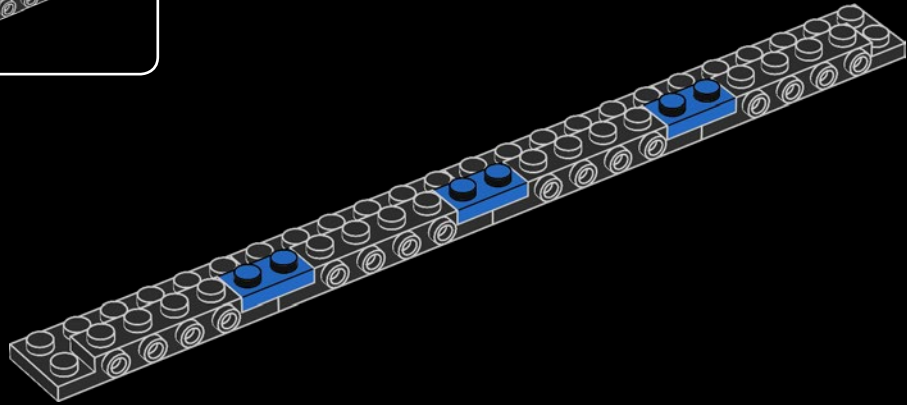

3

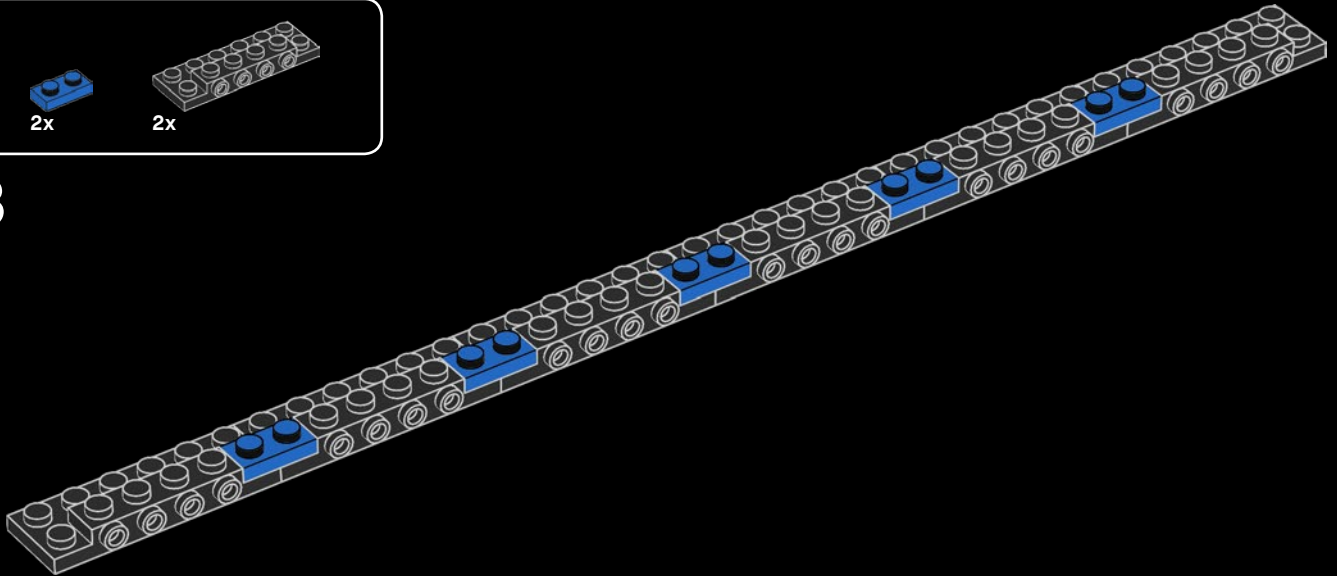

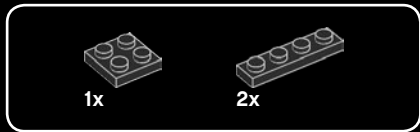

4

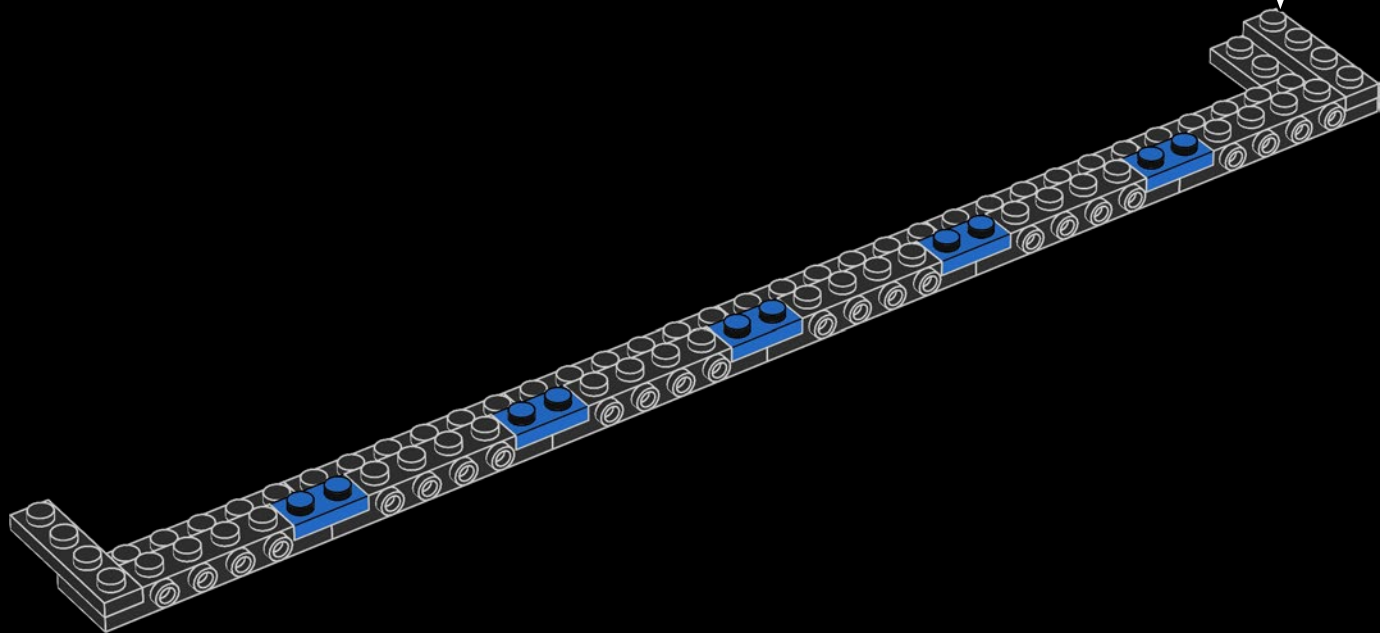
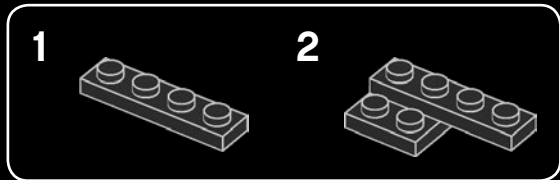

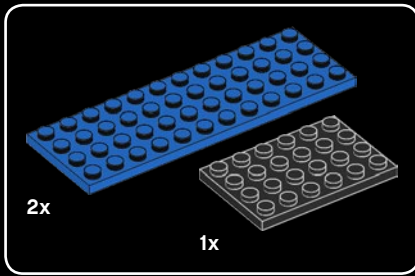

5

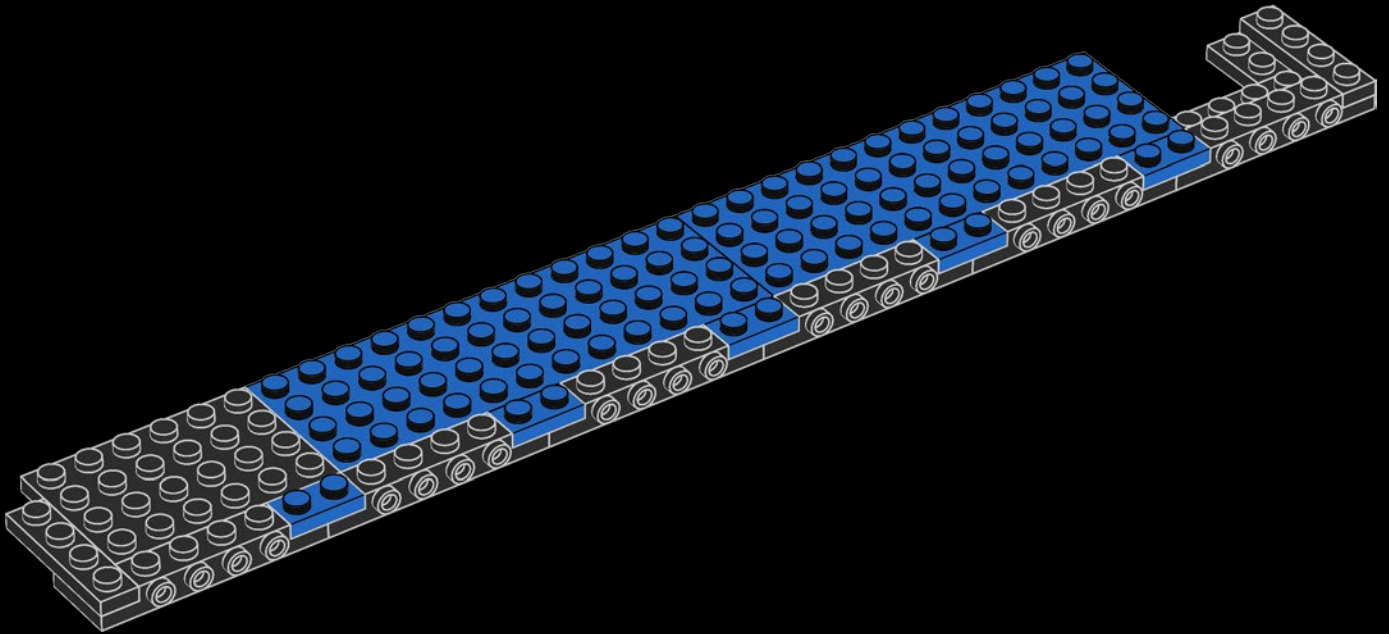

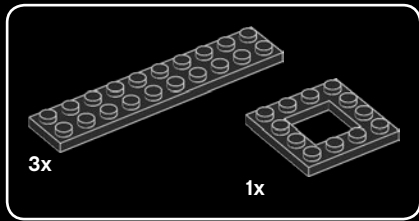

6

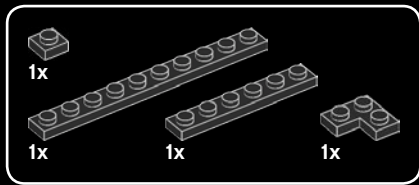
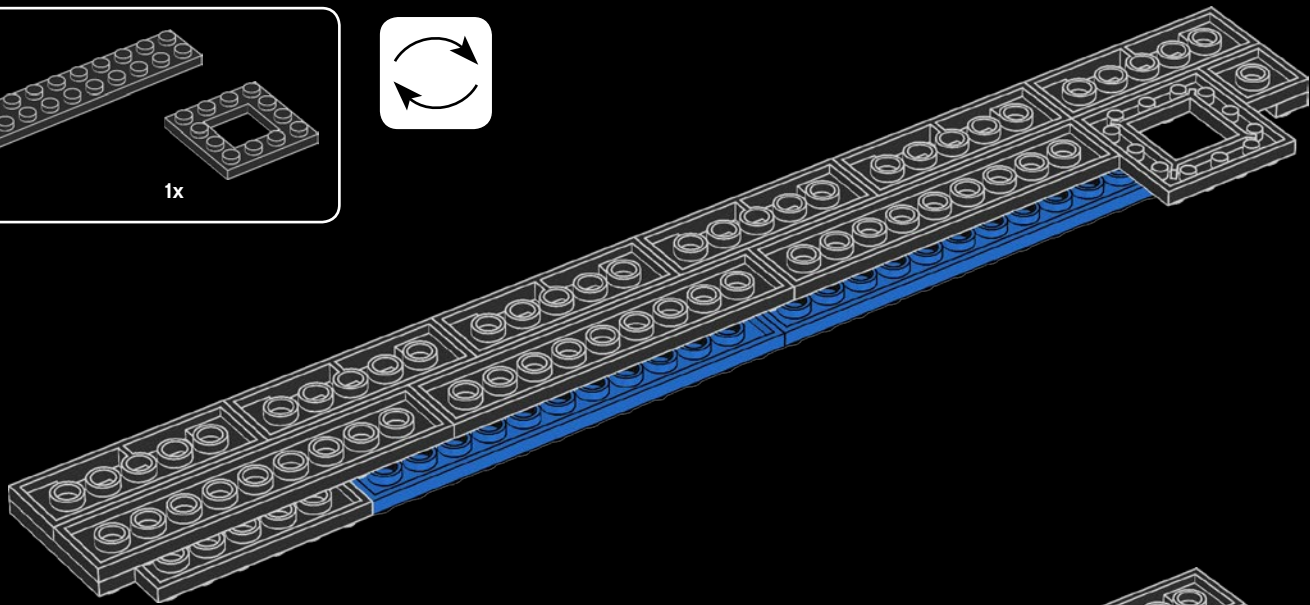

7

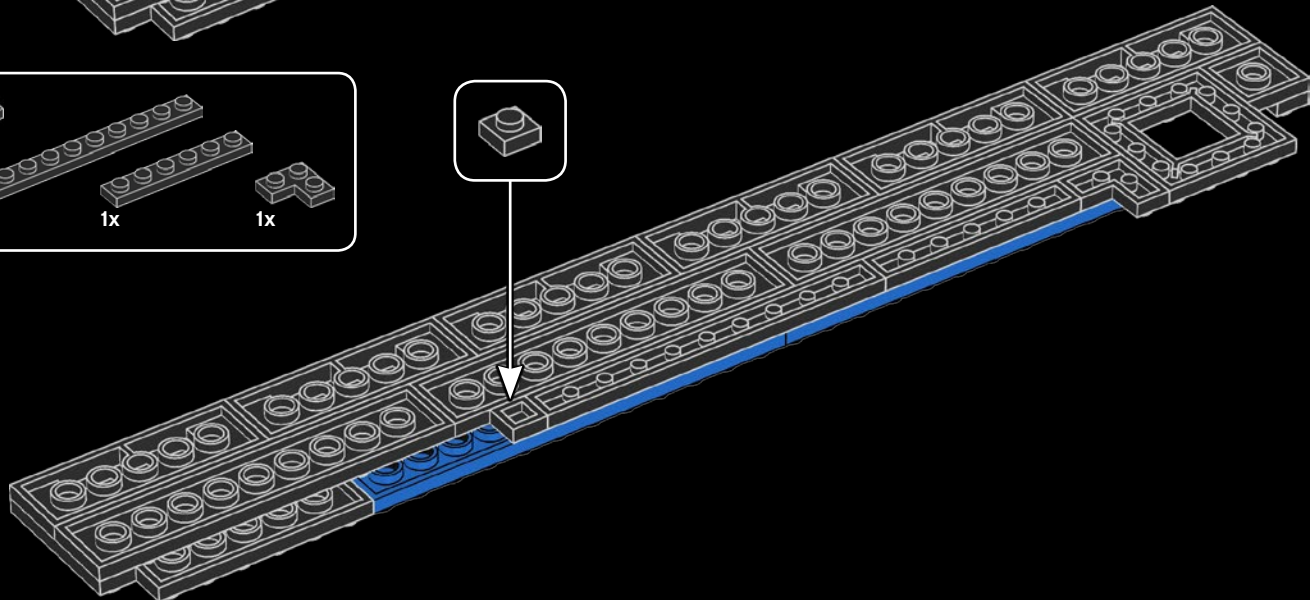

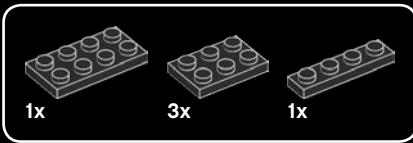

8

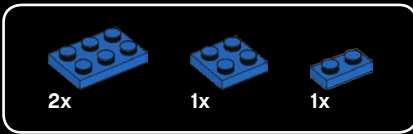
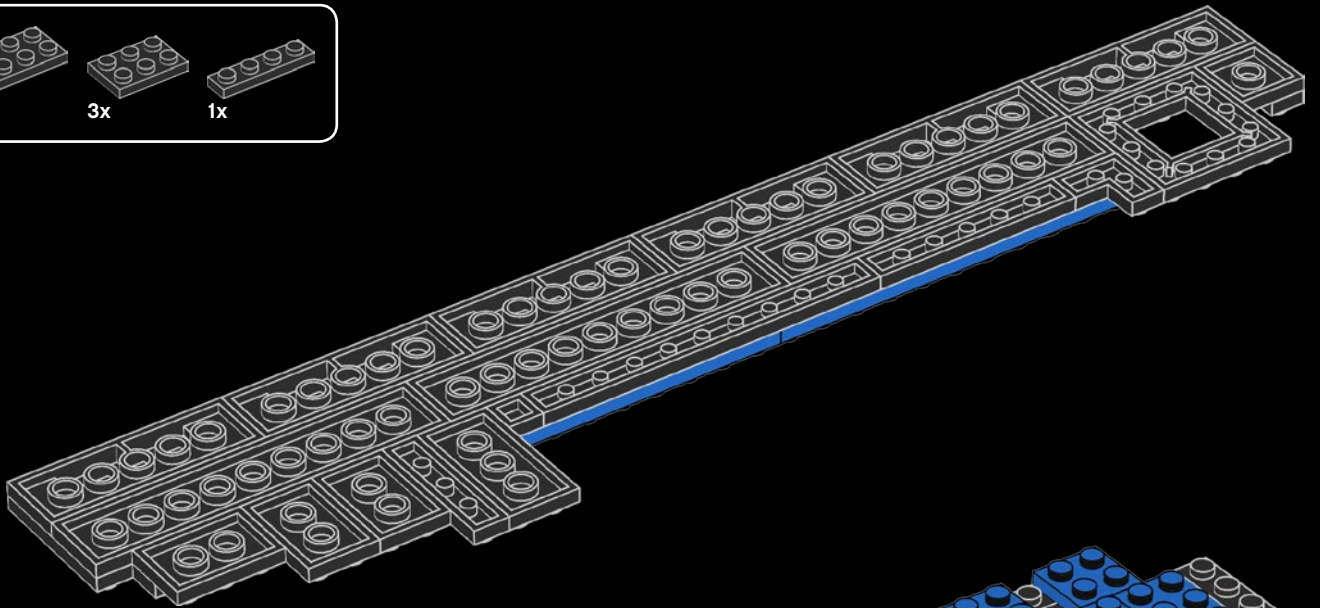

9

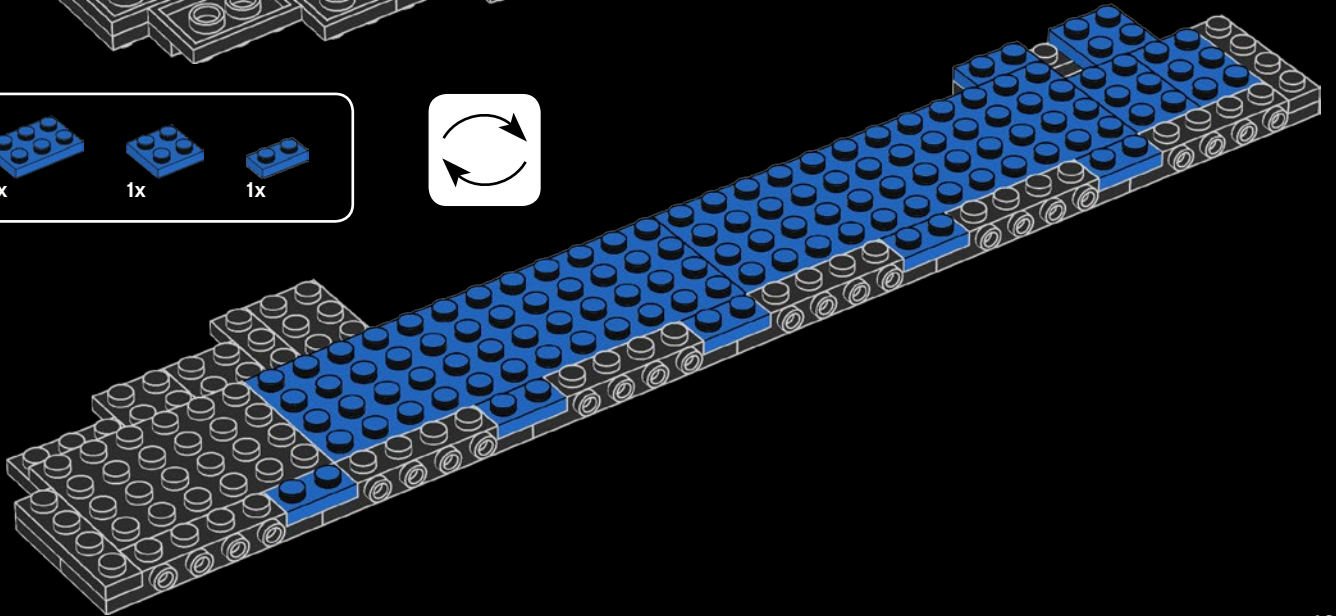



1x

10

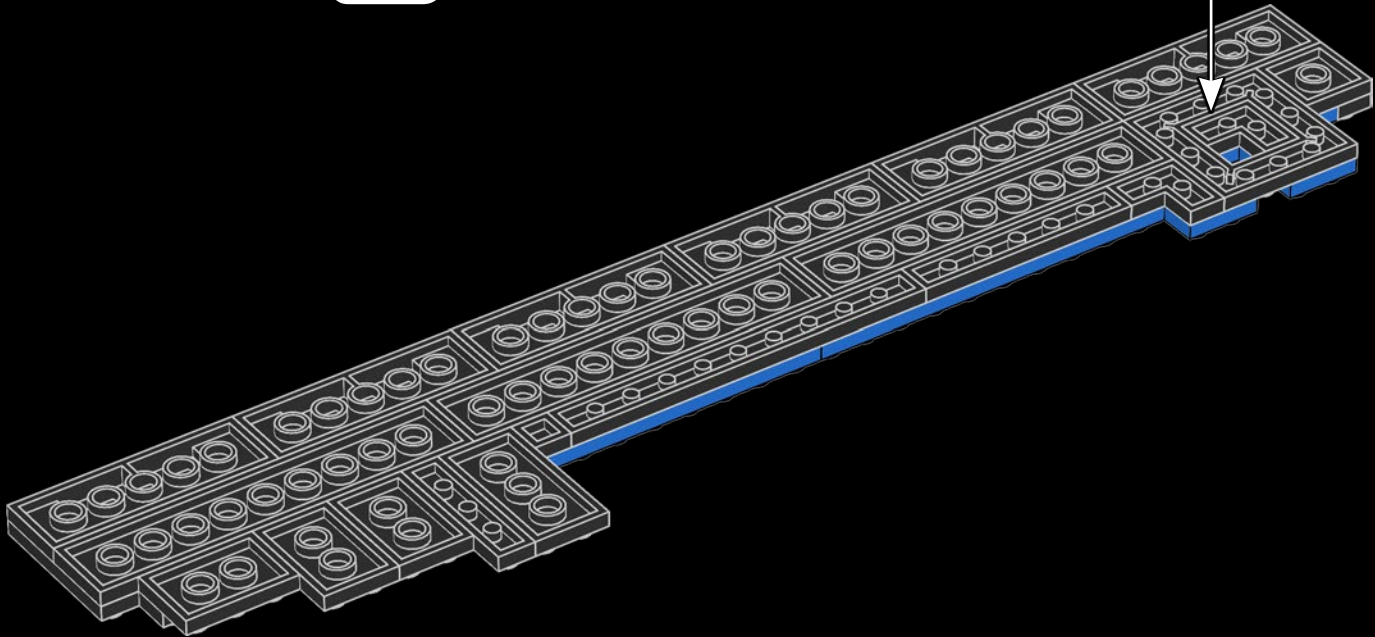
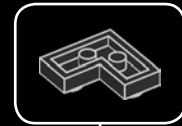

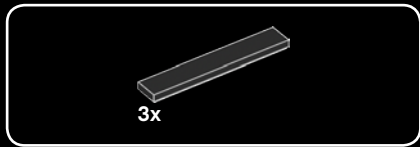

12

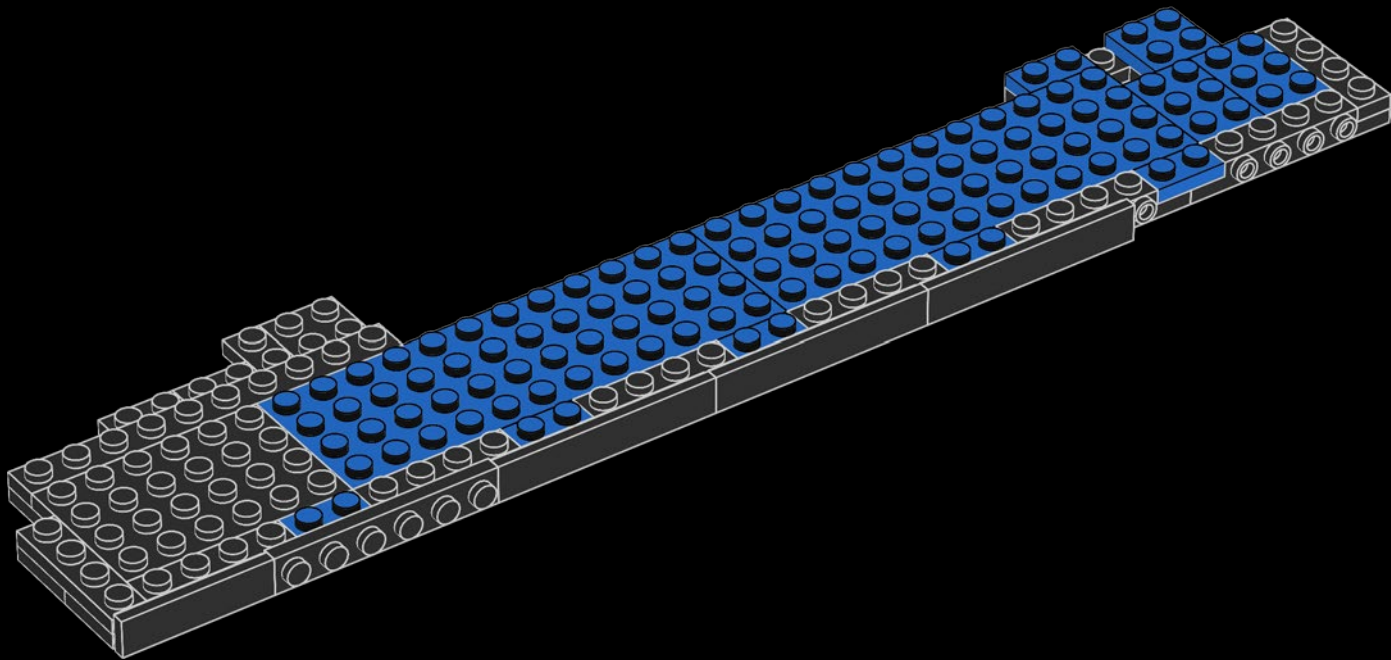

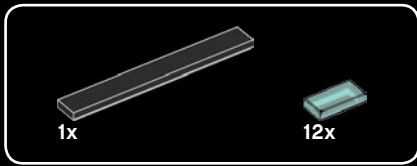

13

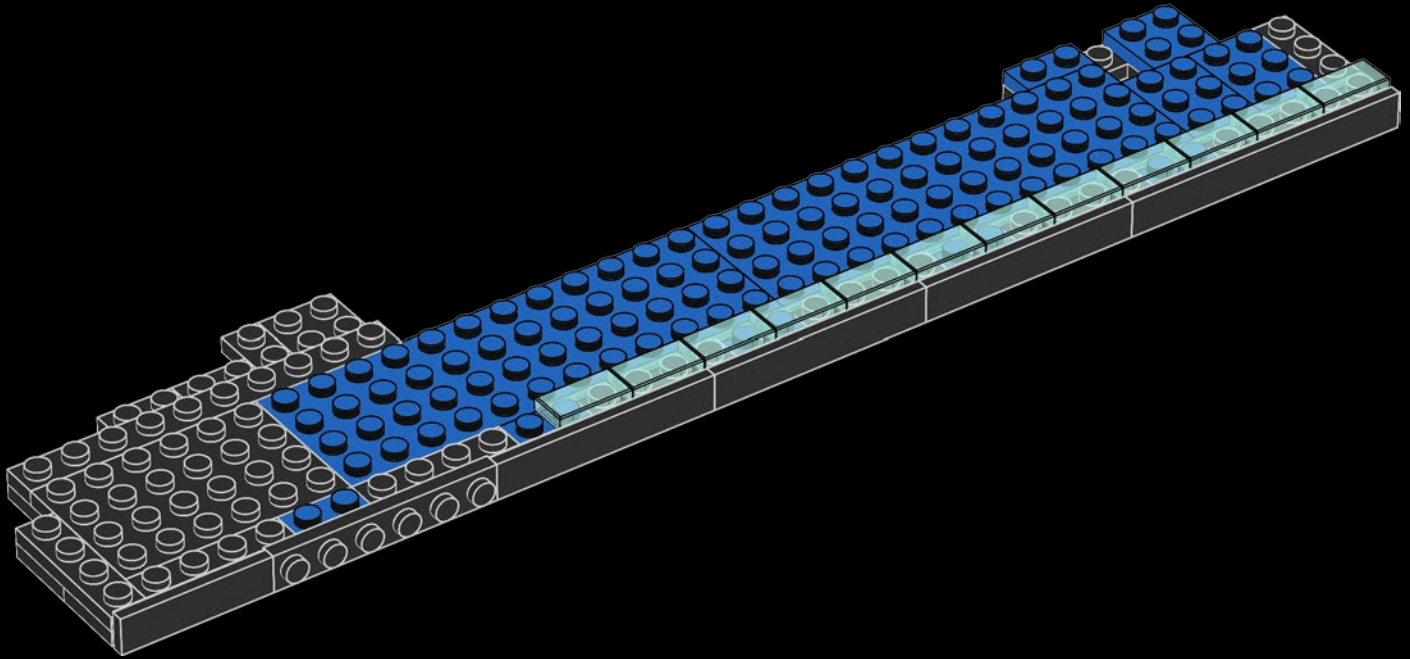



14

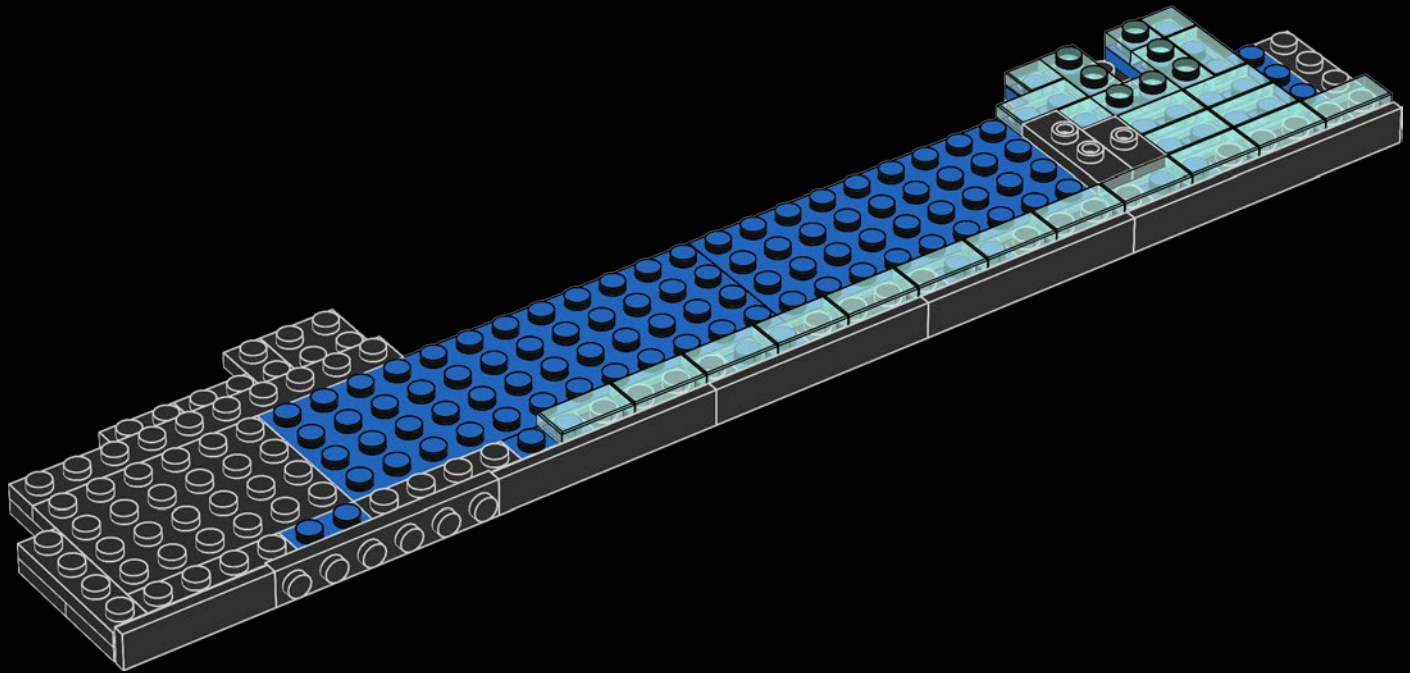



15

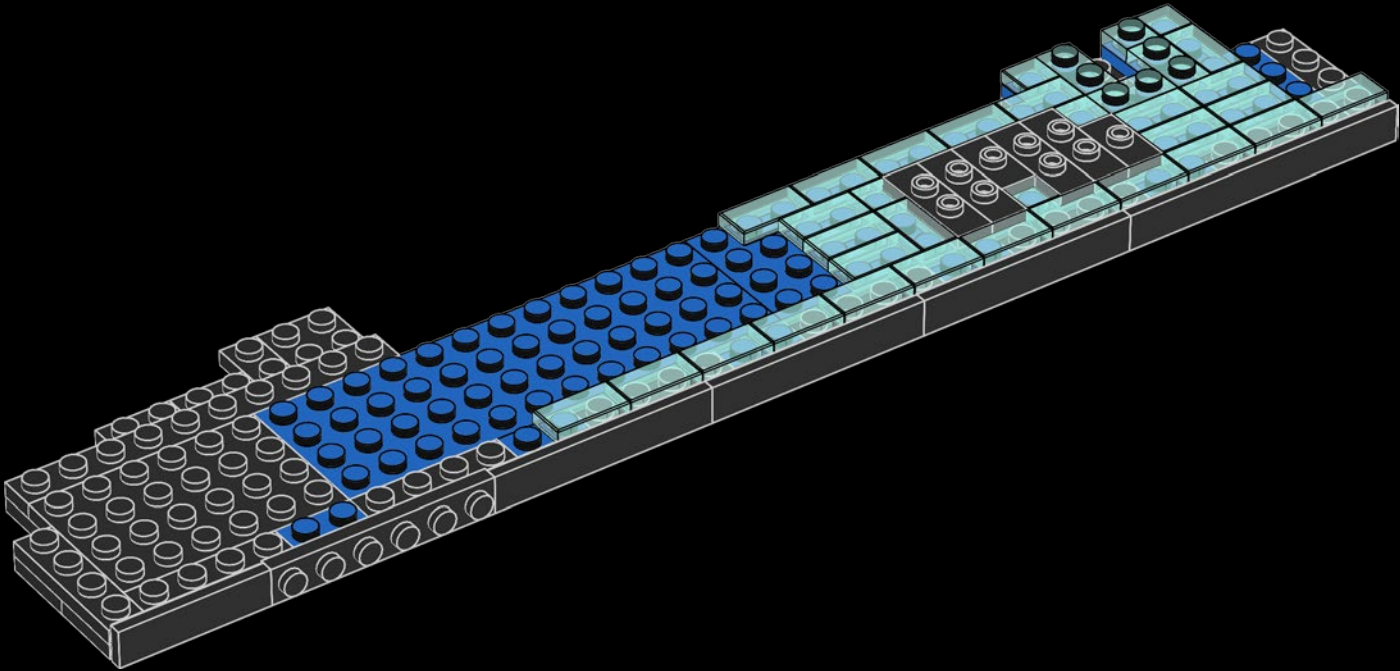



16

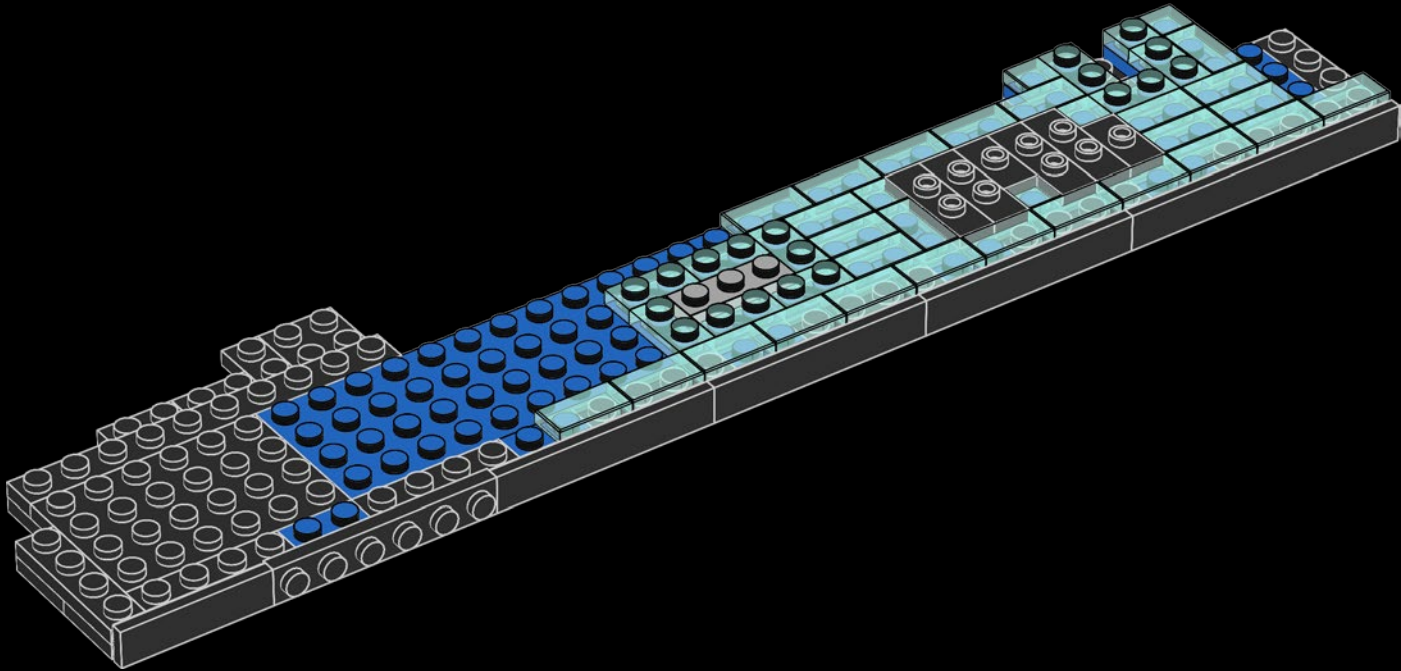



17

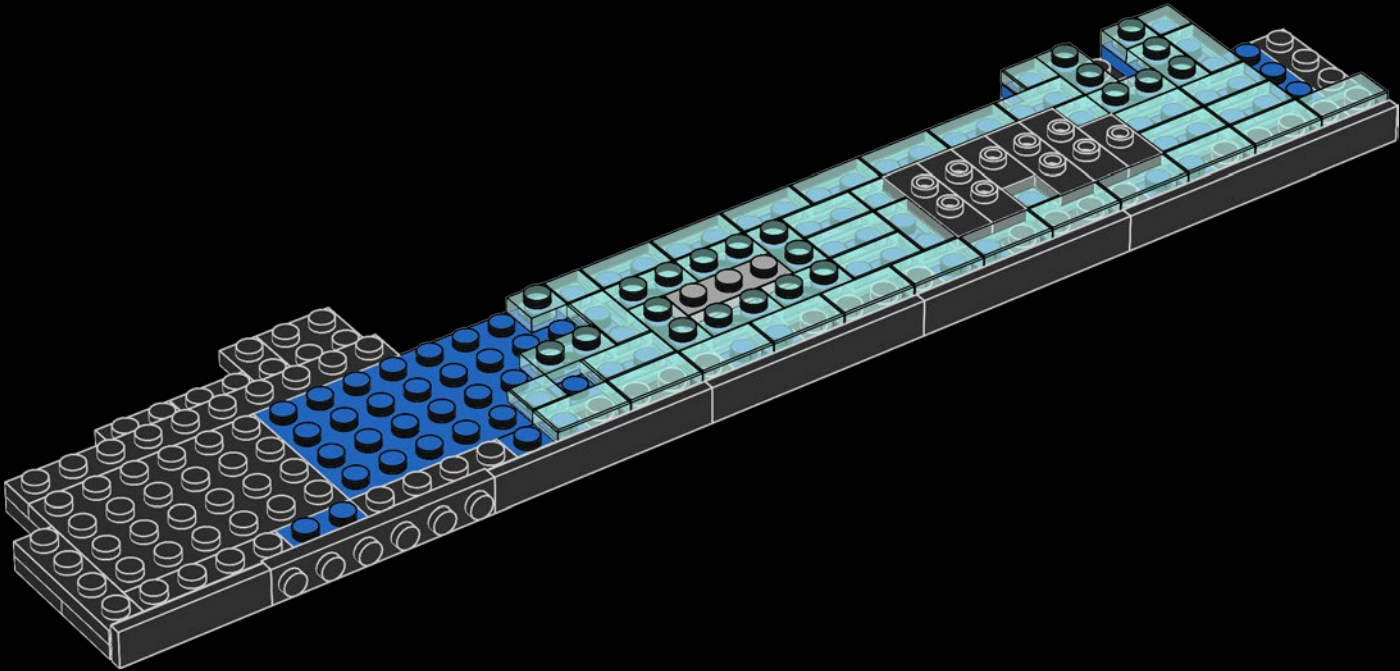

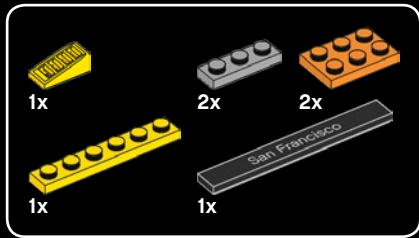

18

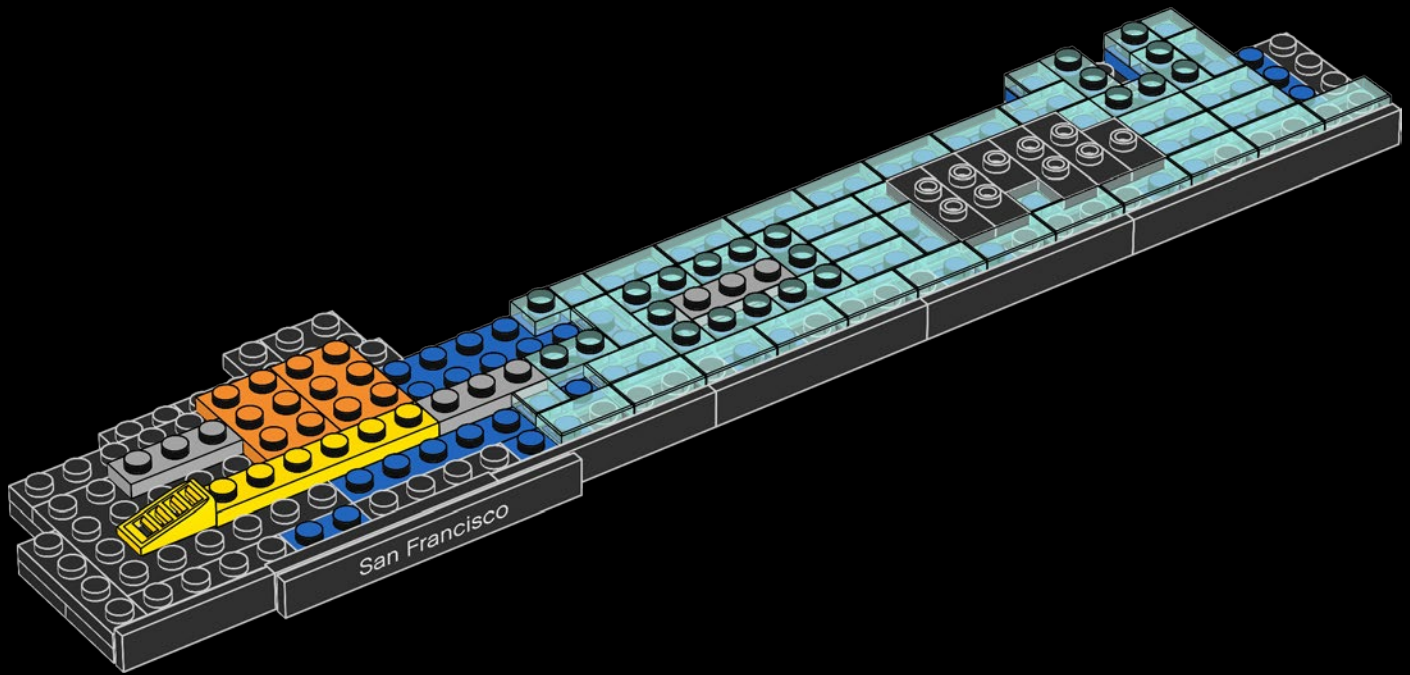

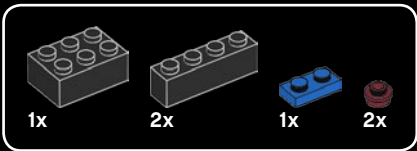

19

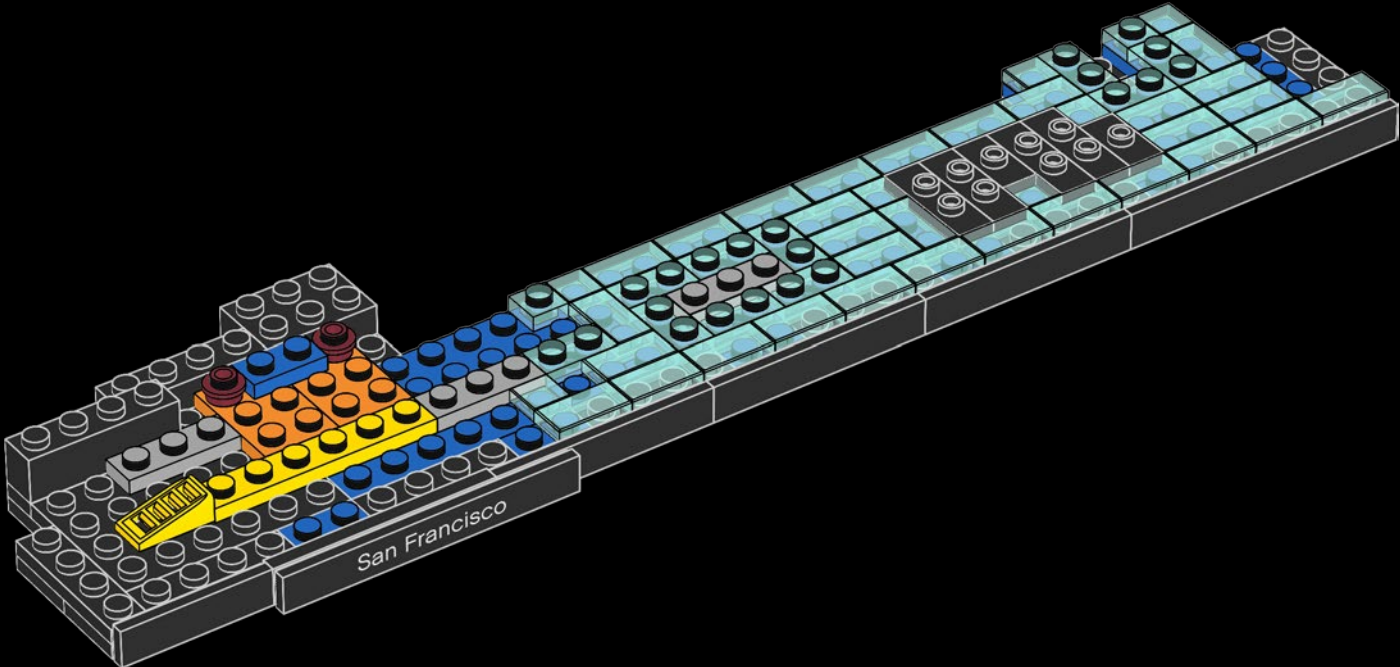



20

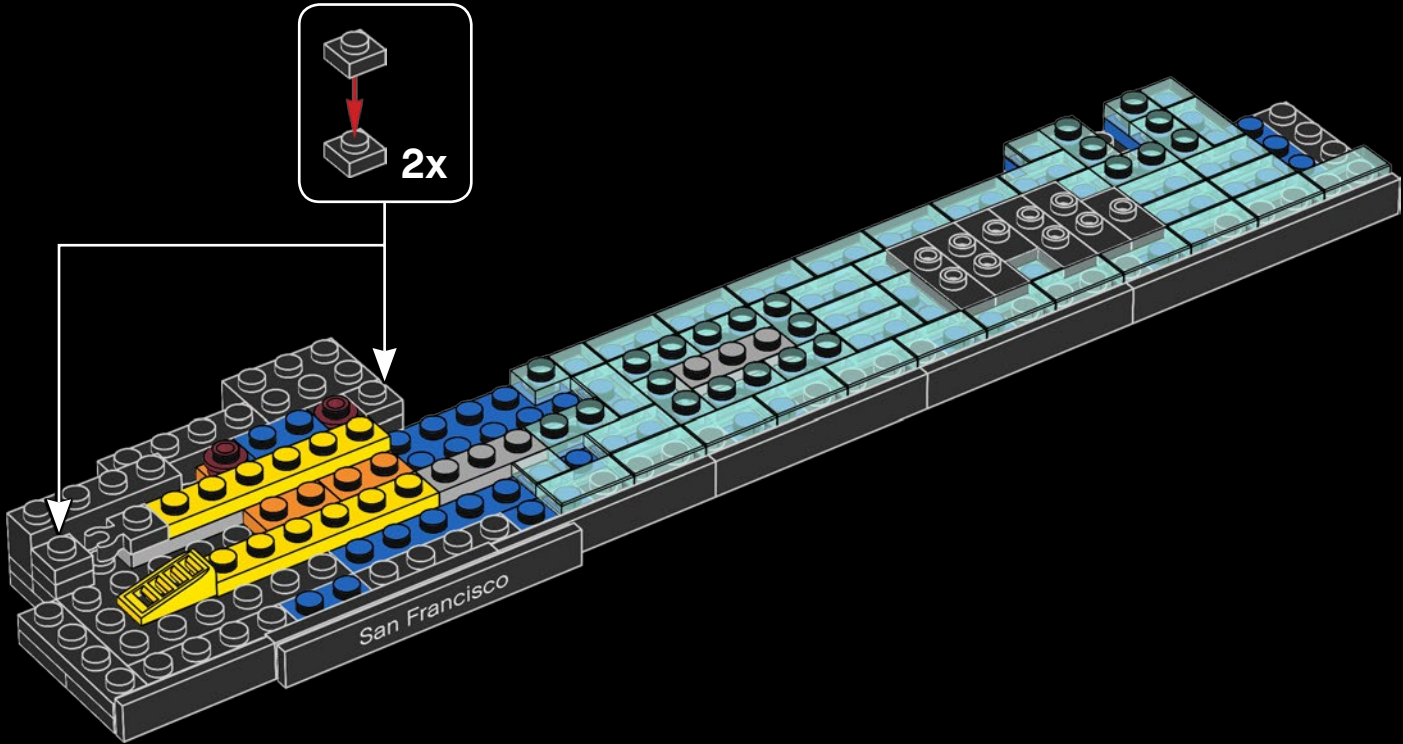

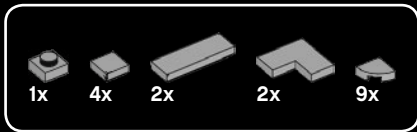

21

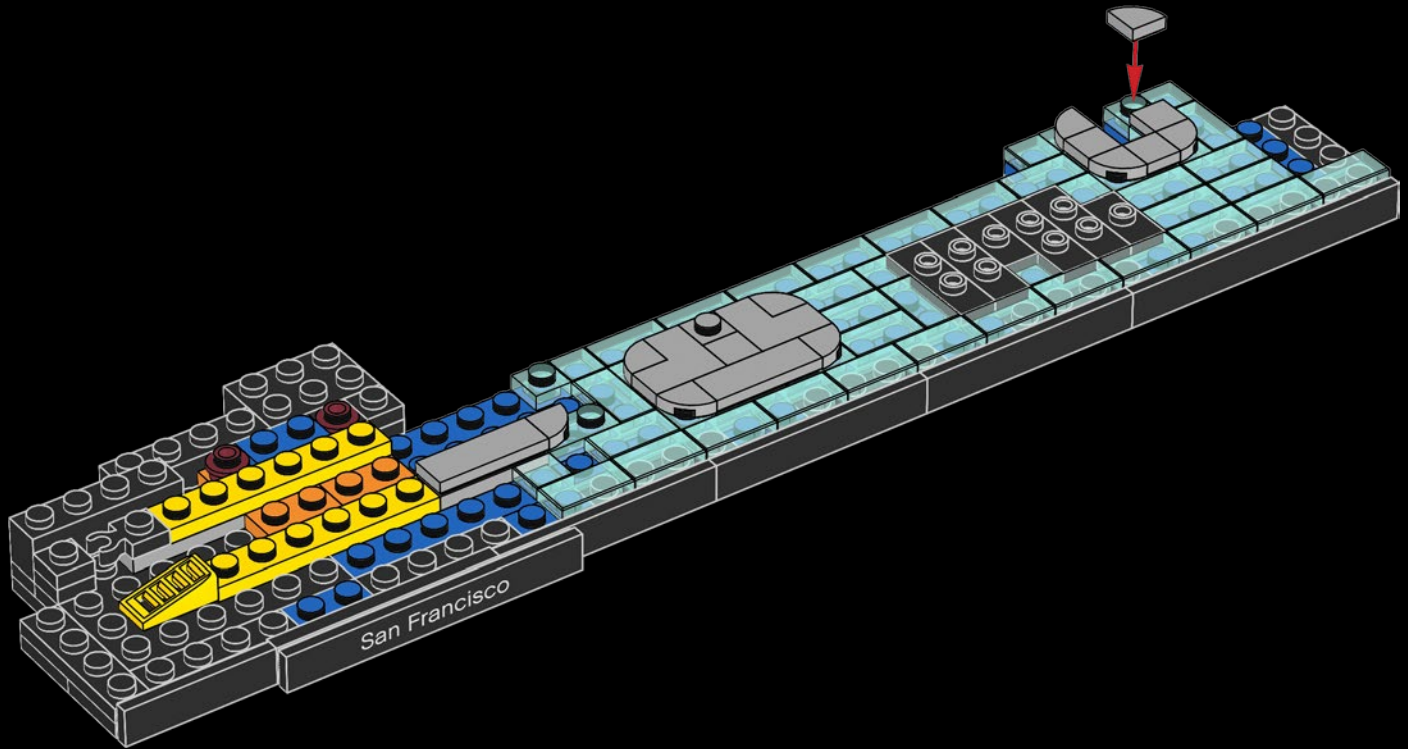

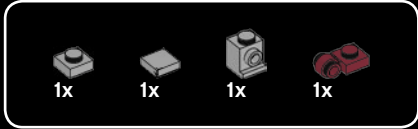

22

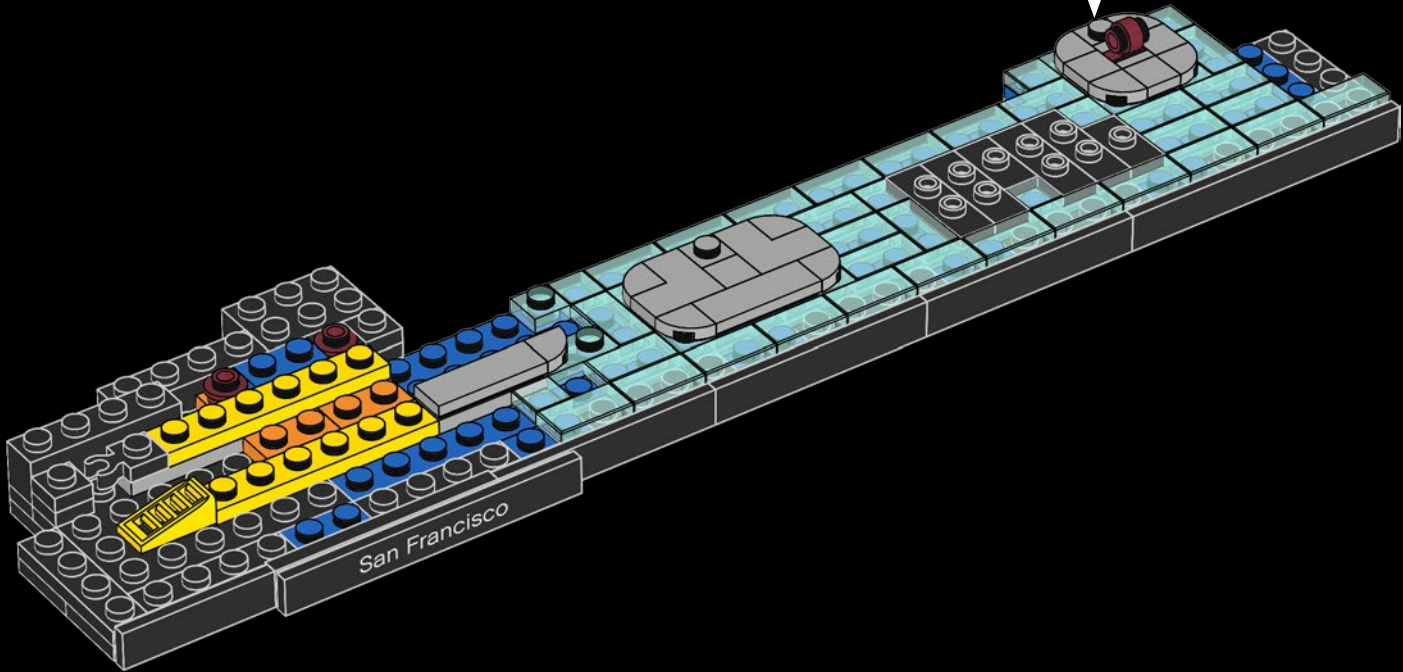
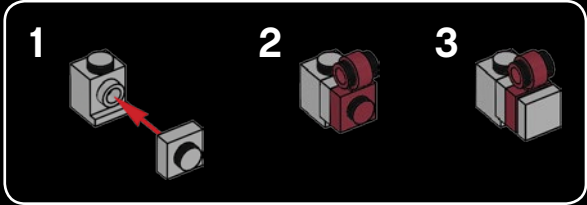

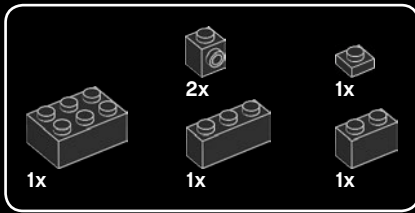

23

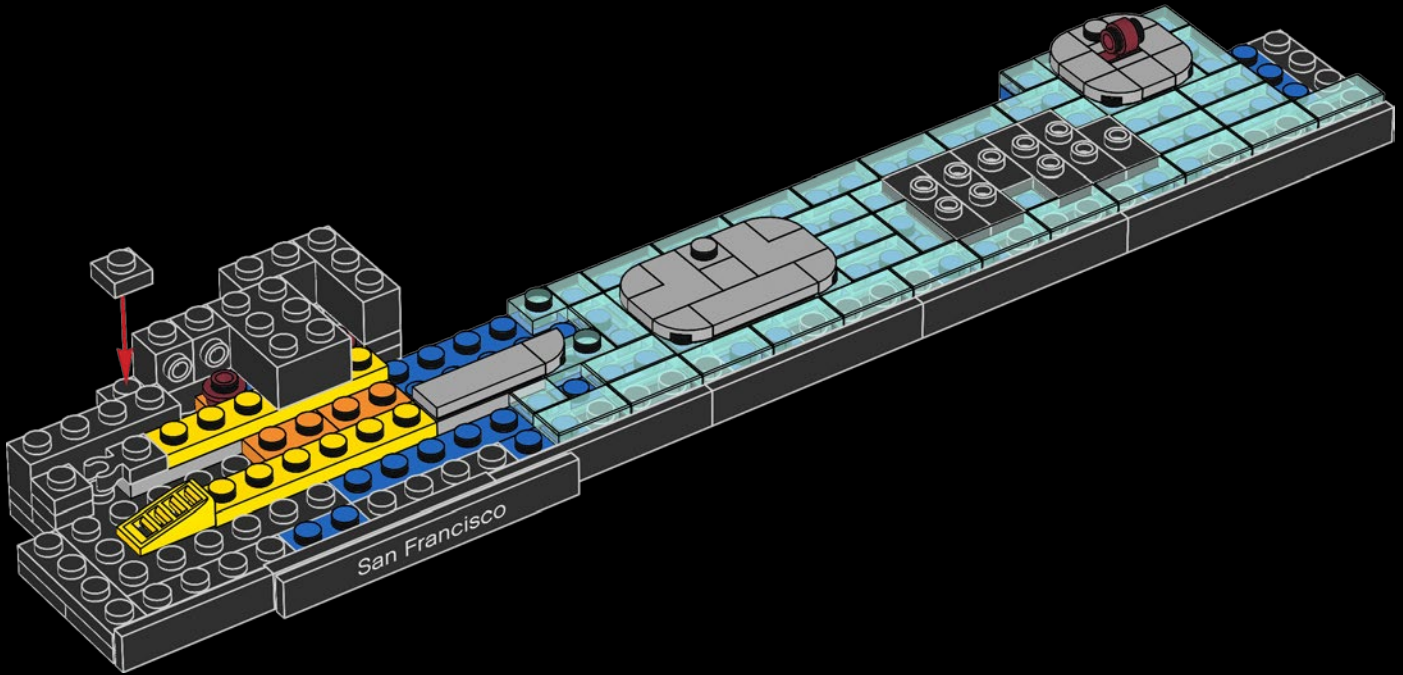

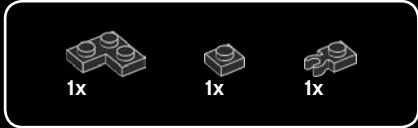

24

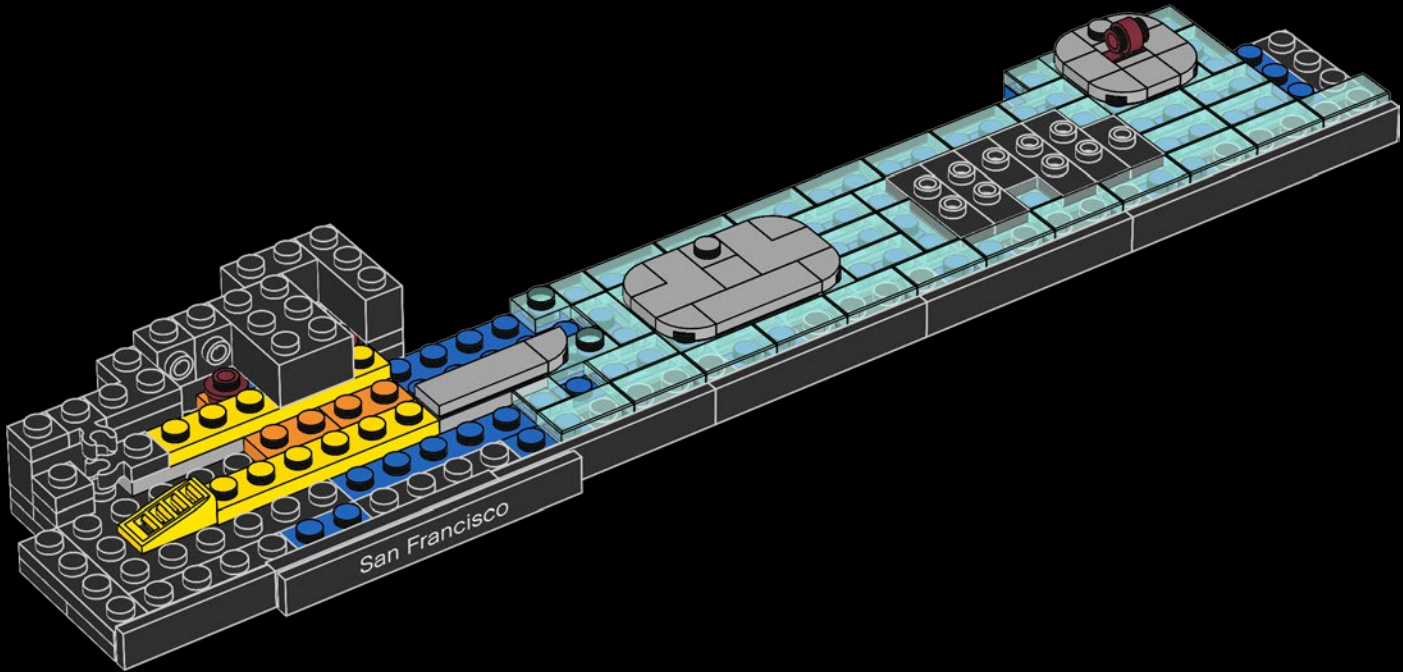

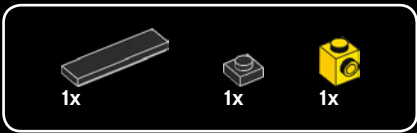

25

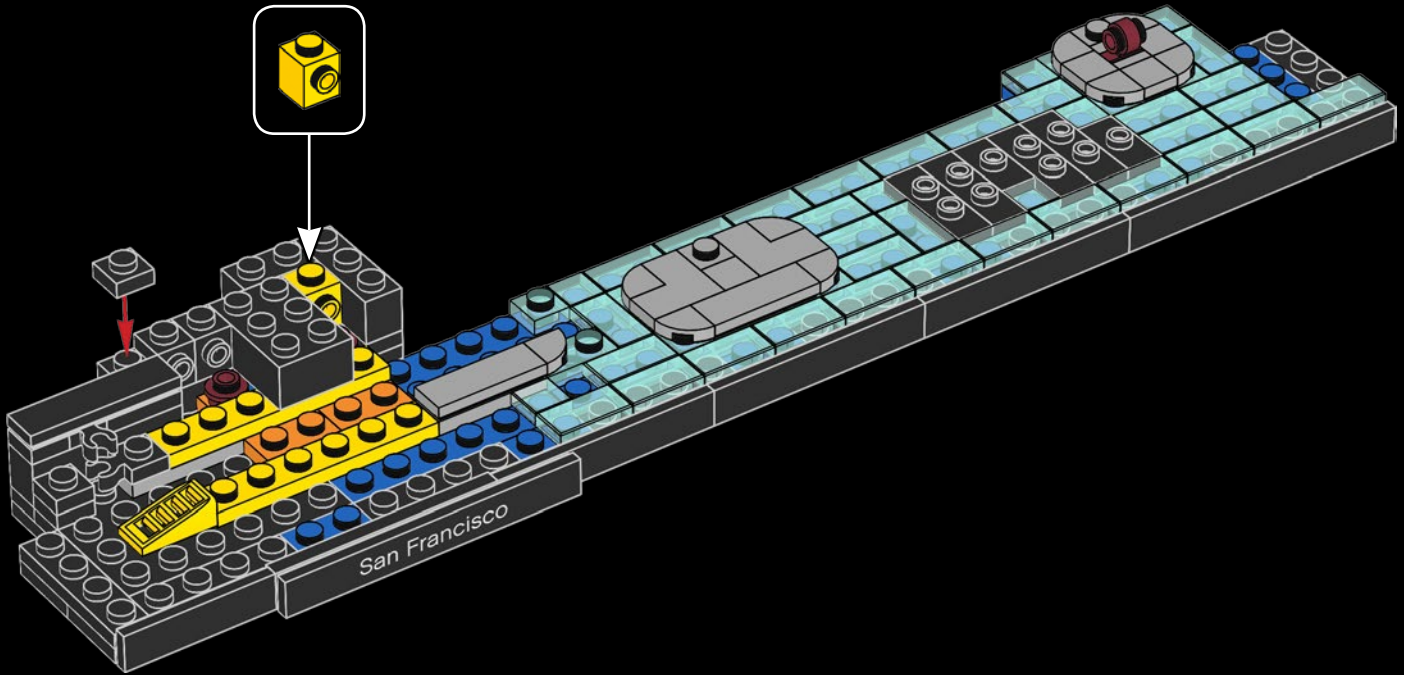

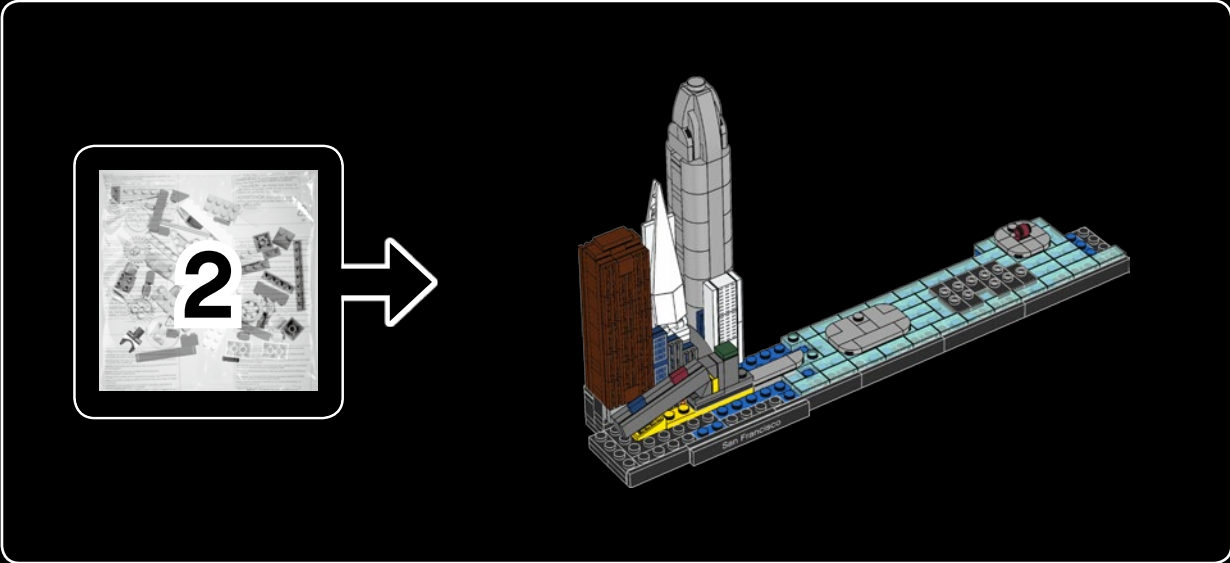

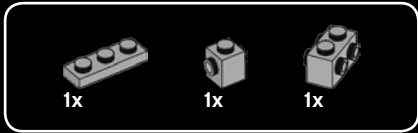

29

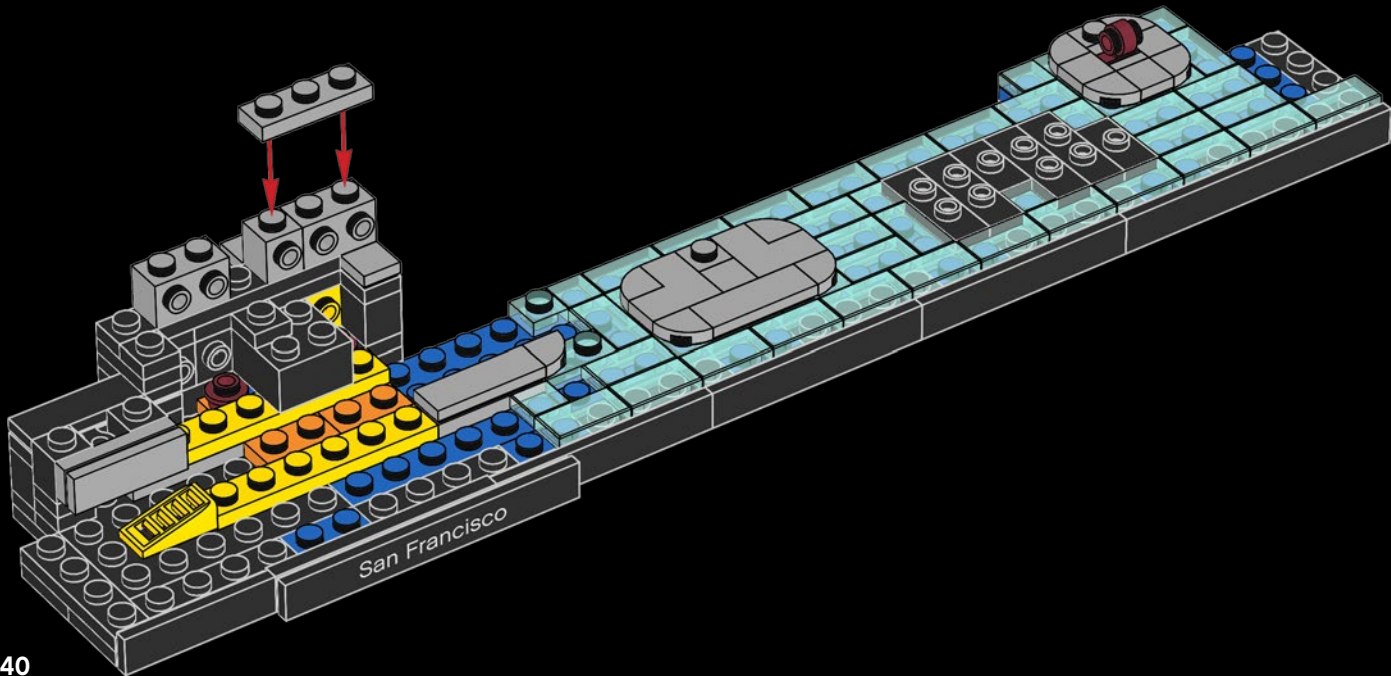



30

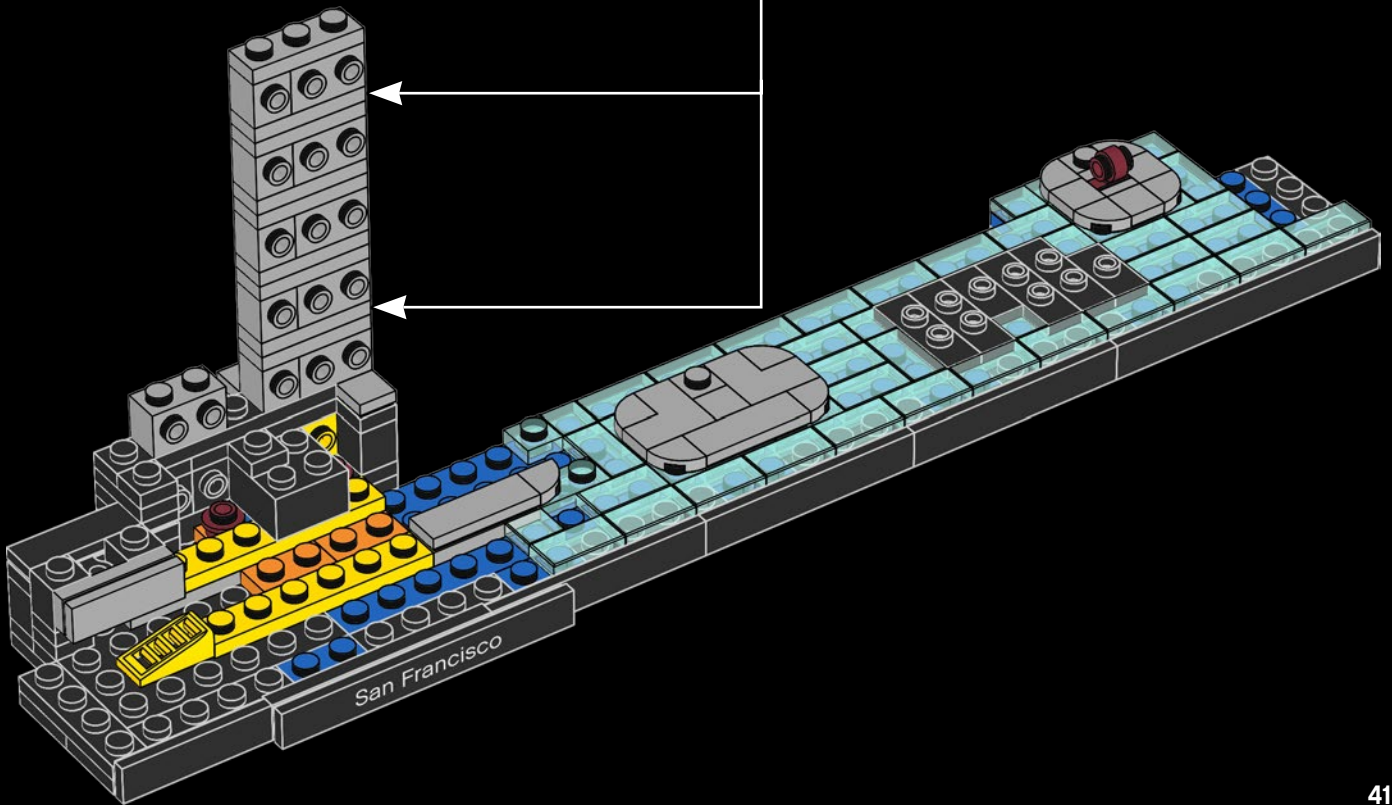
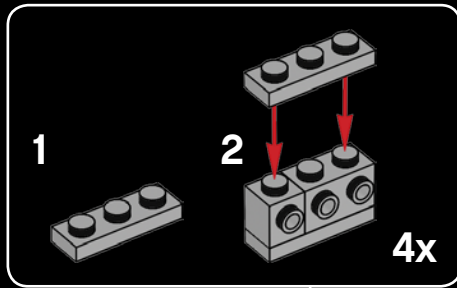

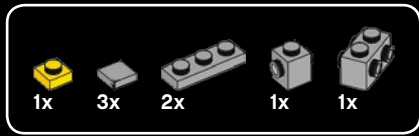

31

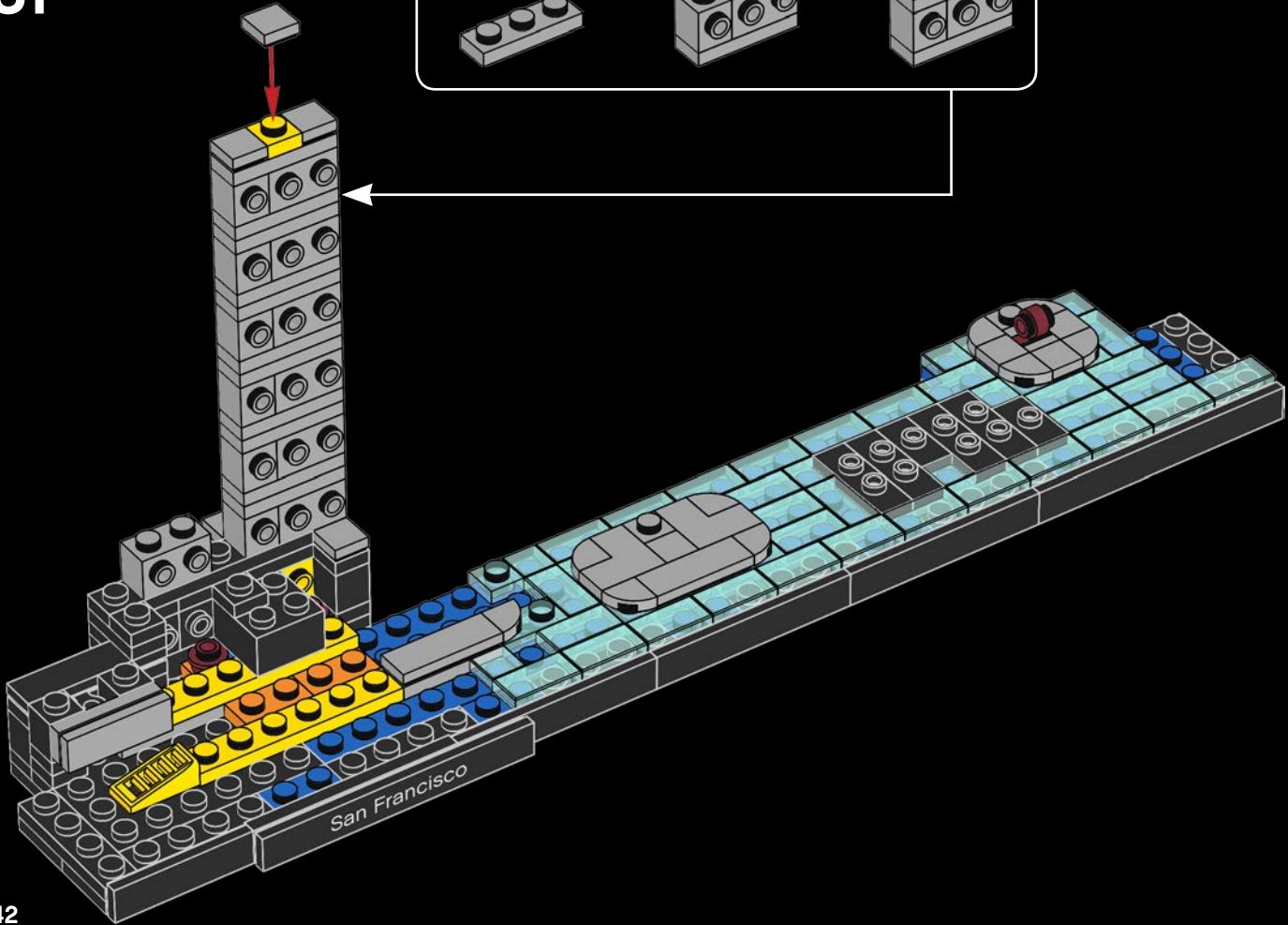
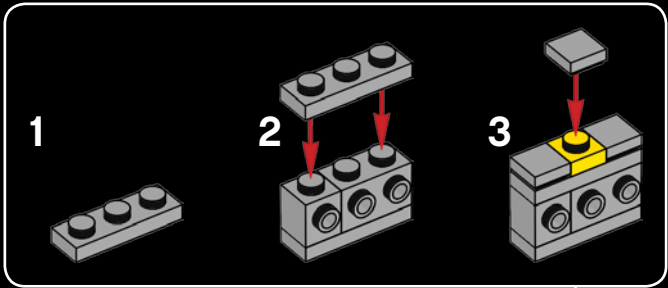

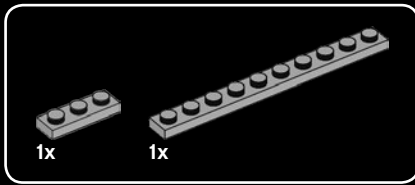

32

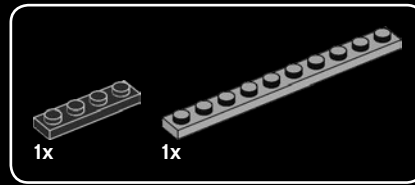
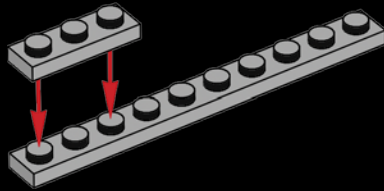

33

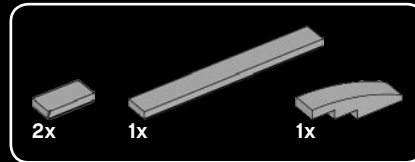
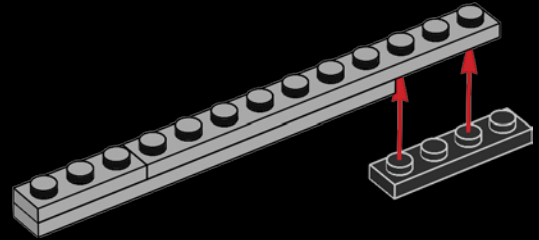

34

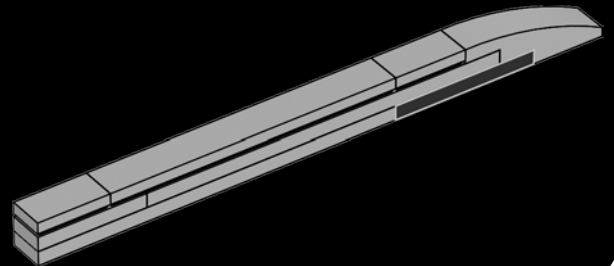

35

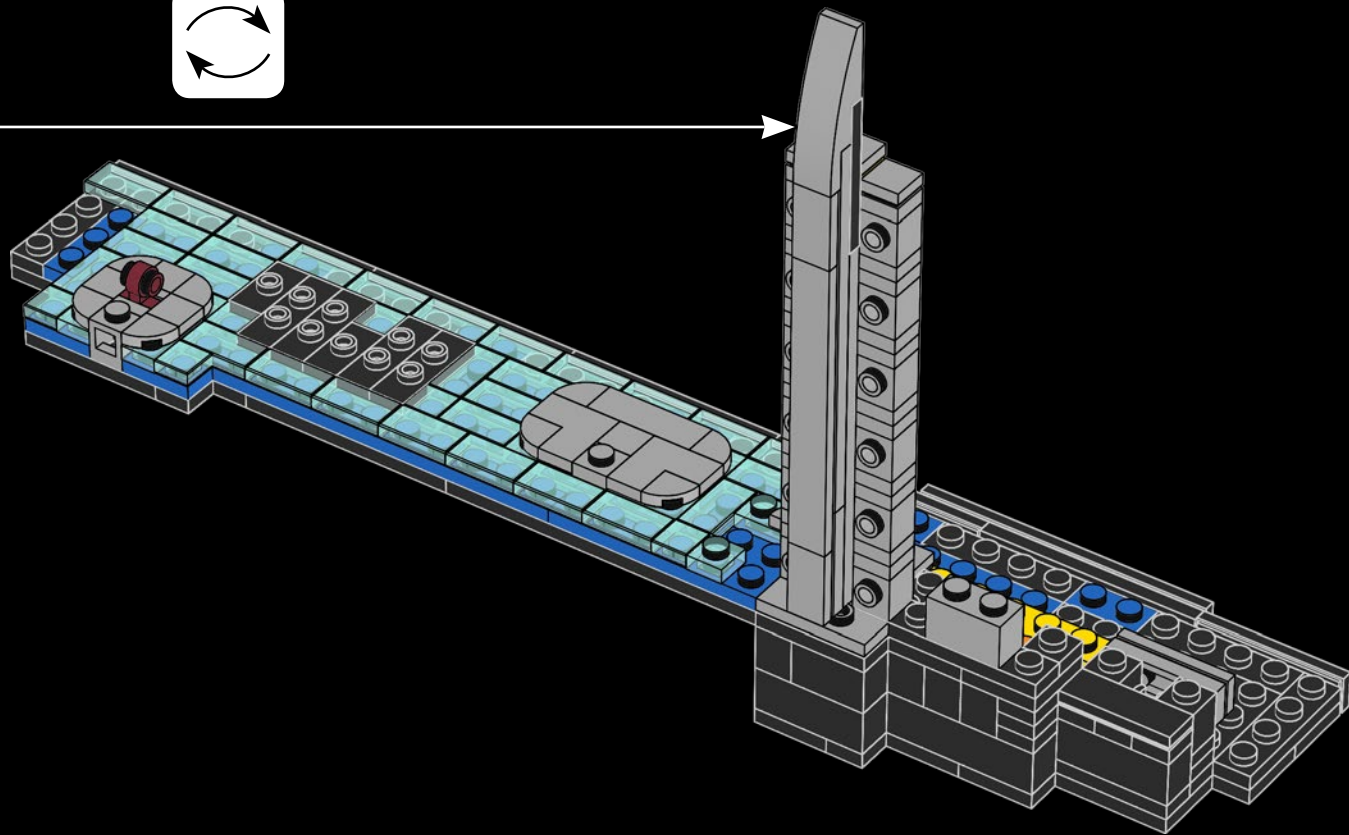



36

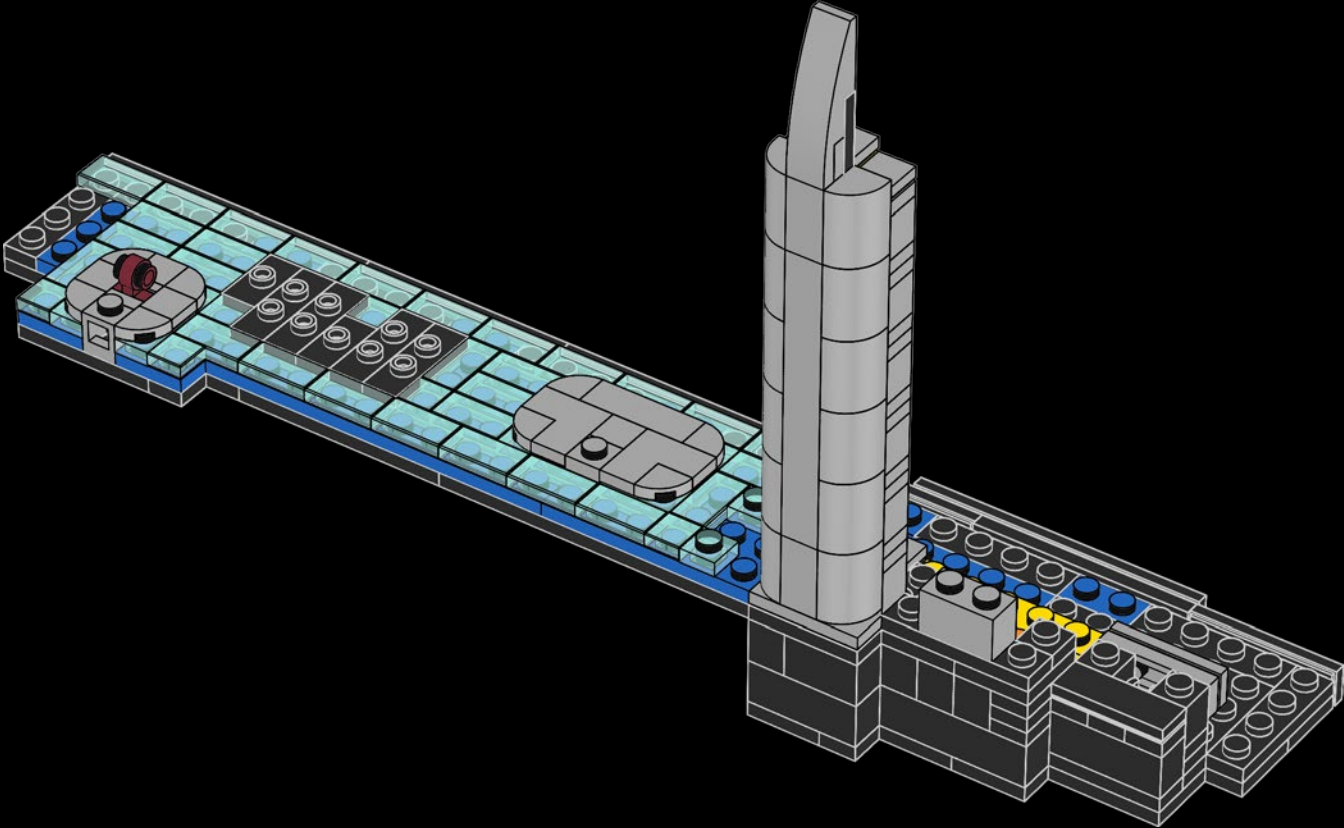

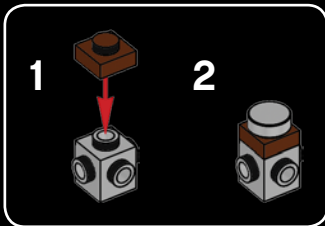
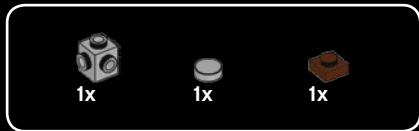

37

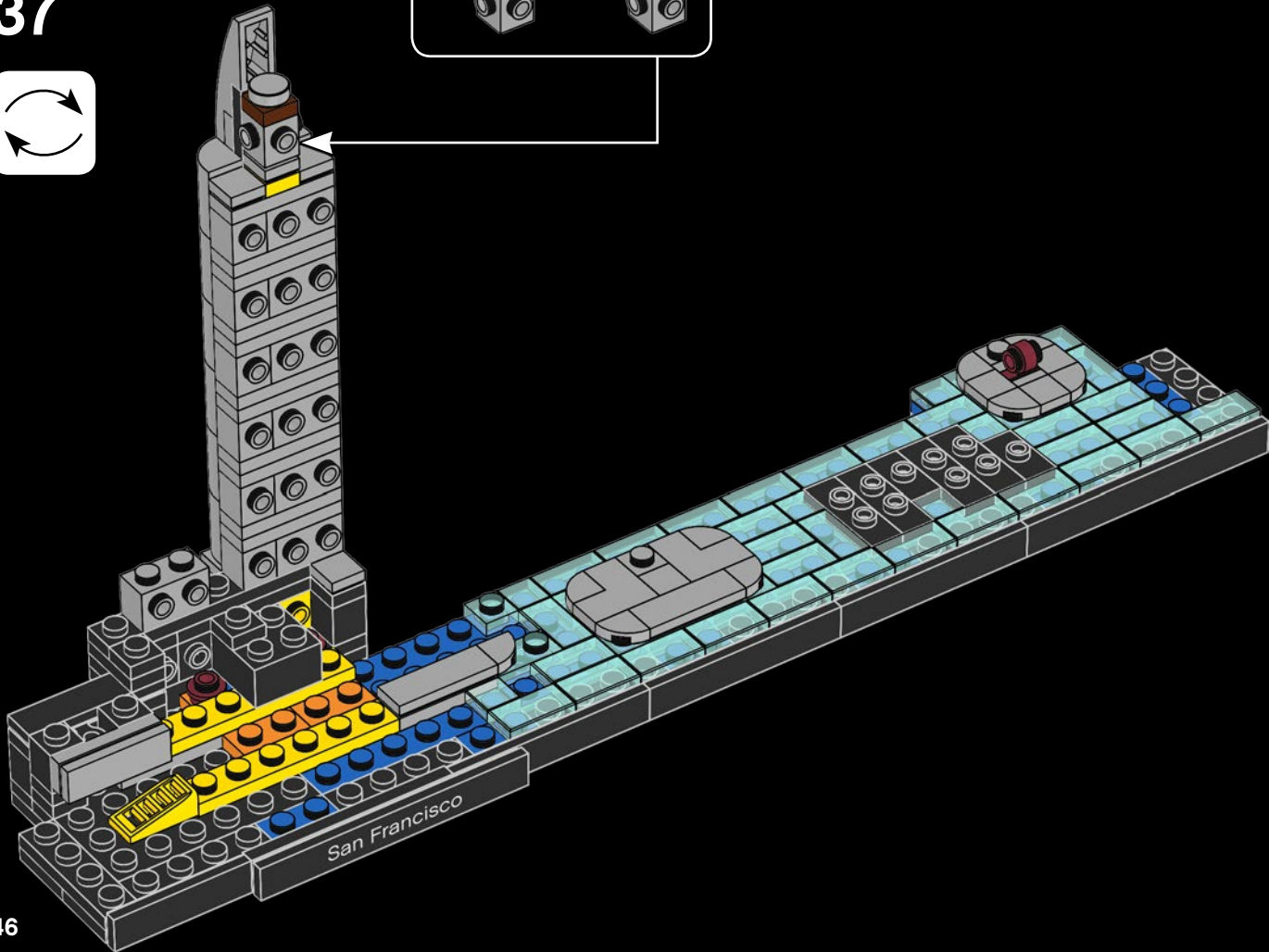

- 1x 
- 1x 
- 1x 

38

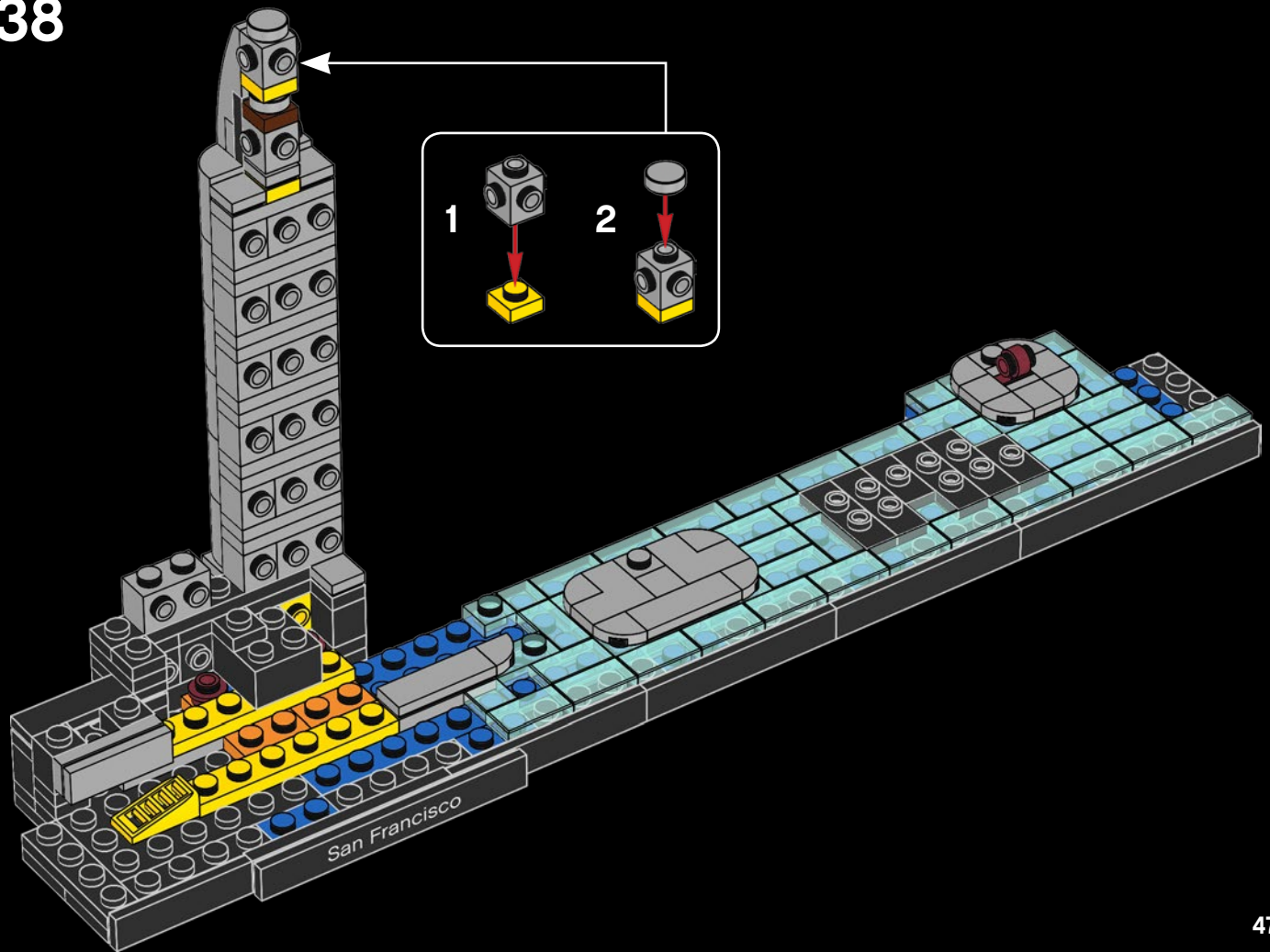

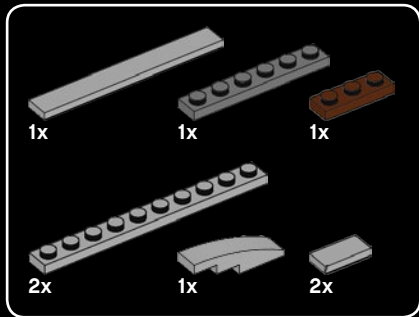

39

1

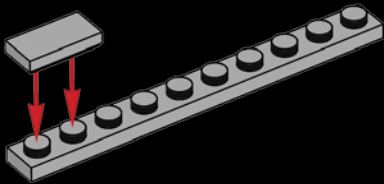

2

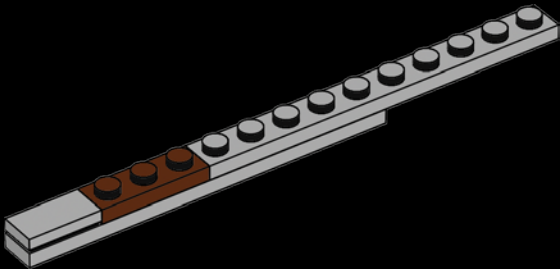

3

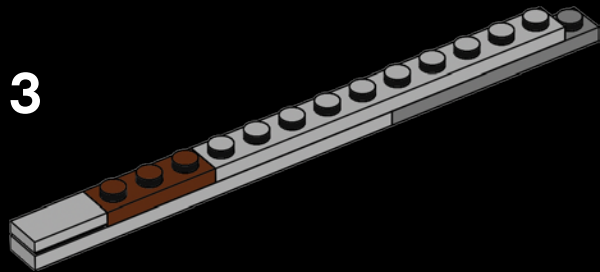

4

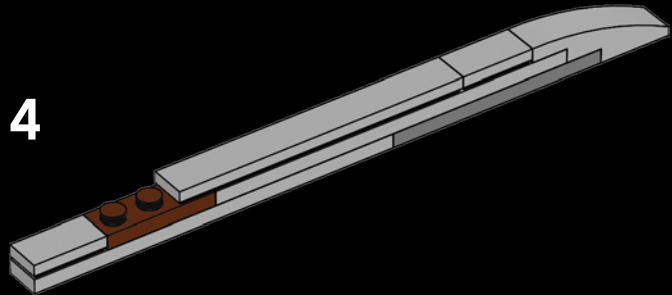

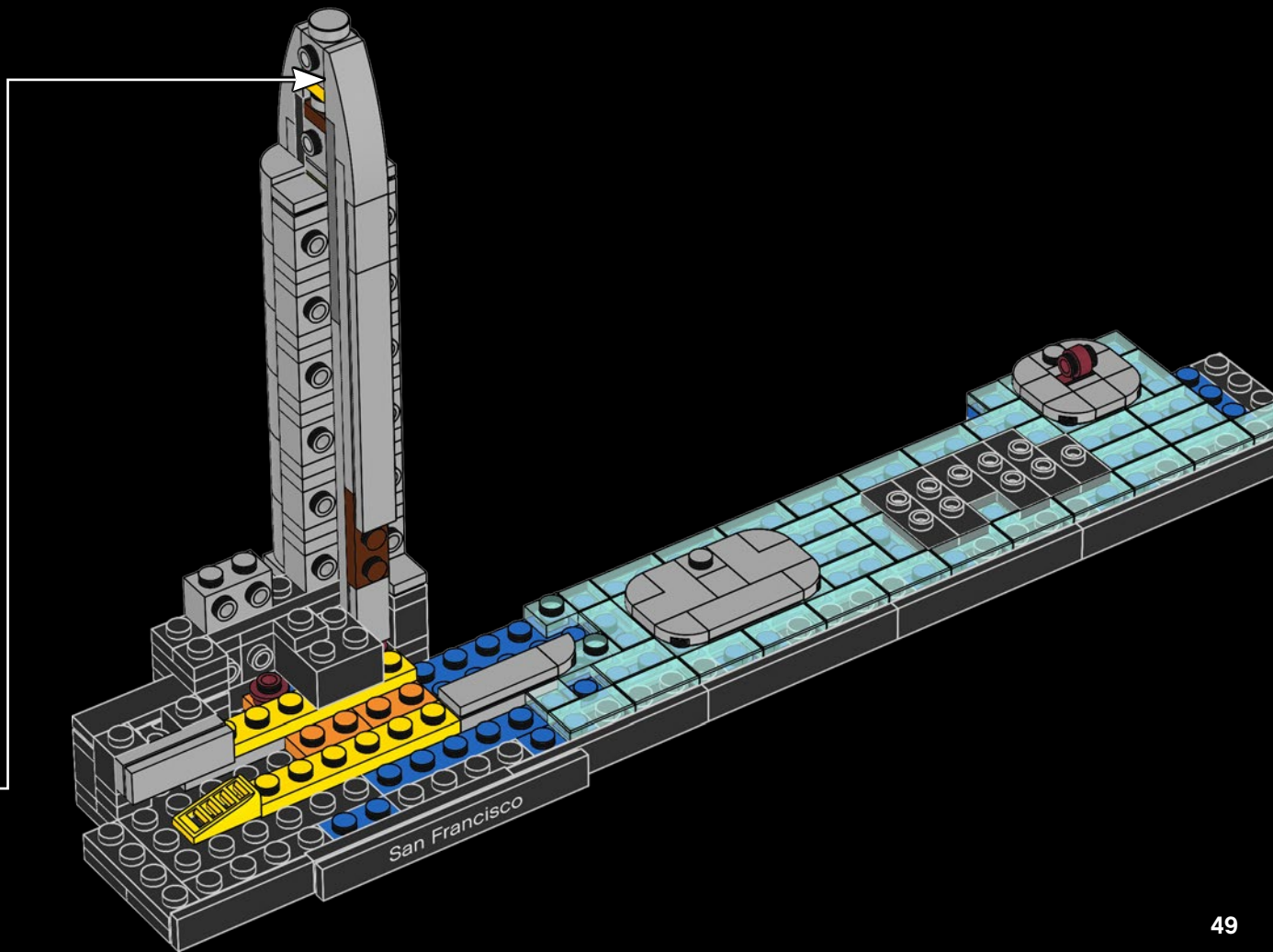

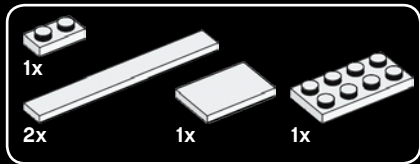

40

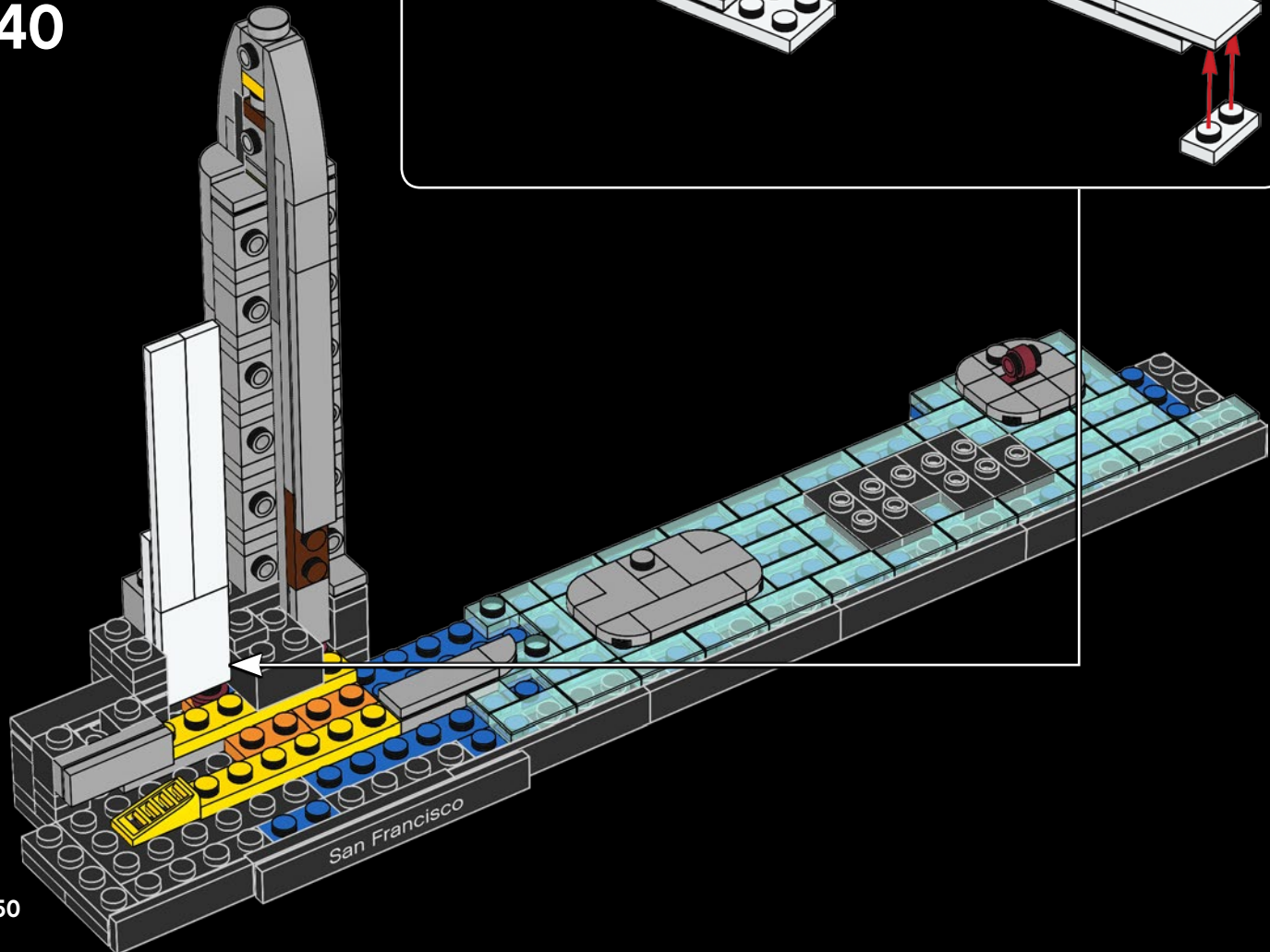
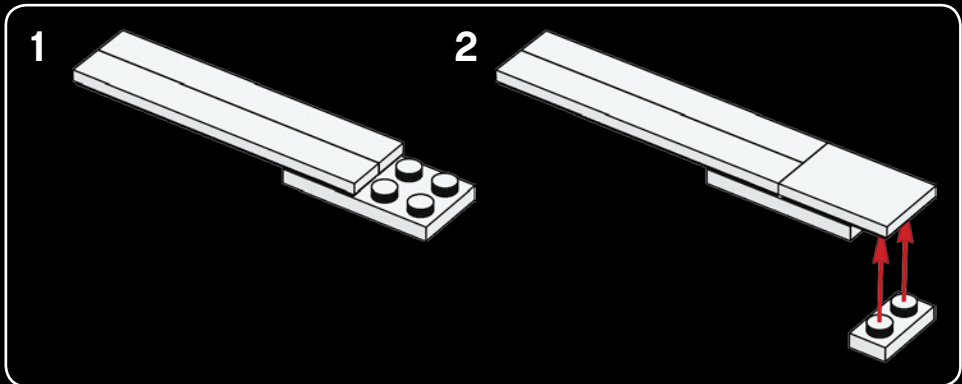

50





2x

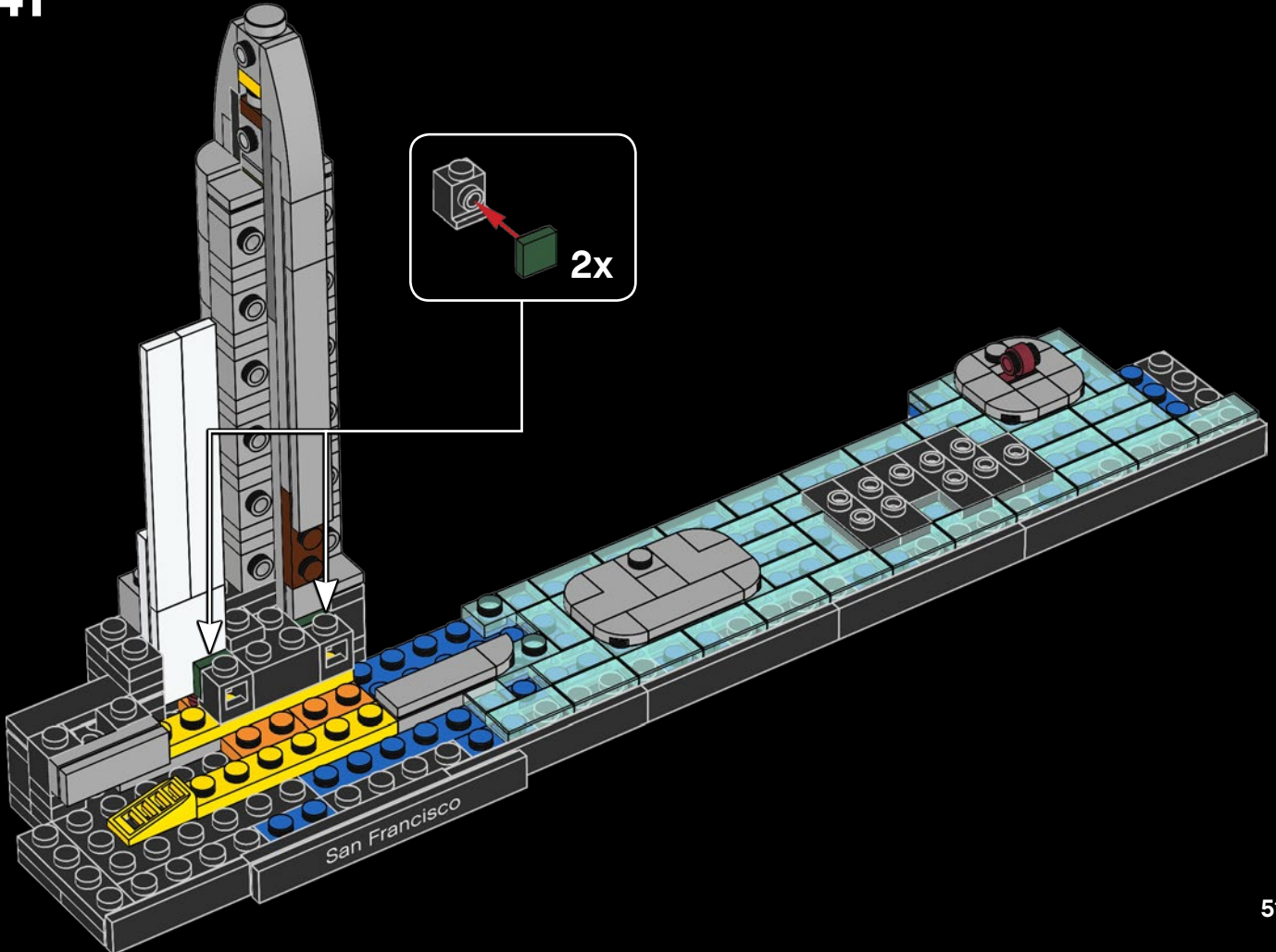
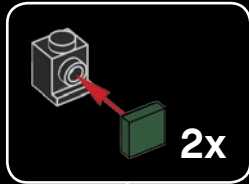

2x

41

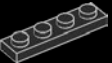

2x  2x 

42

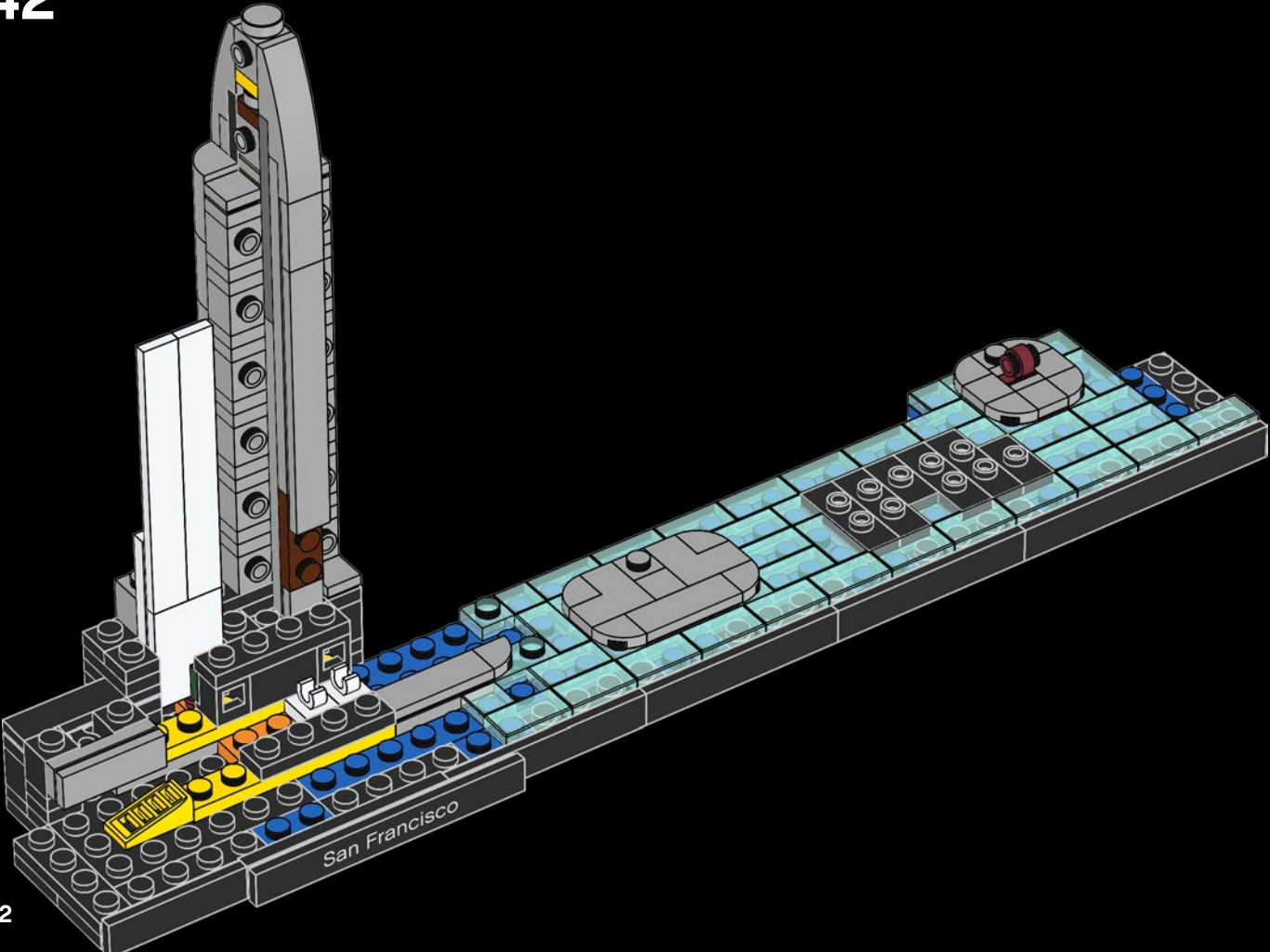

52

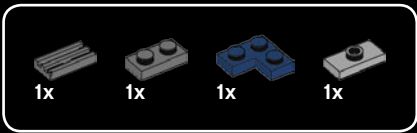

43

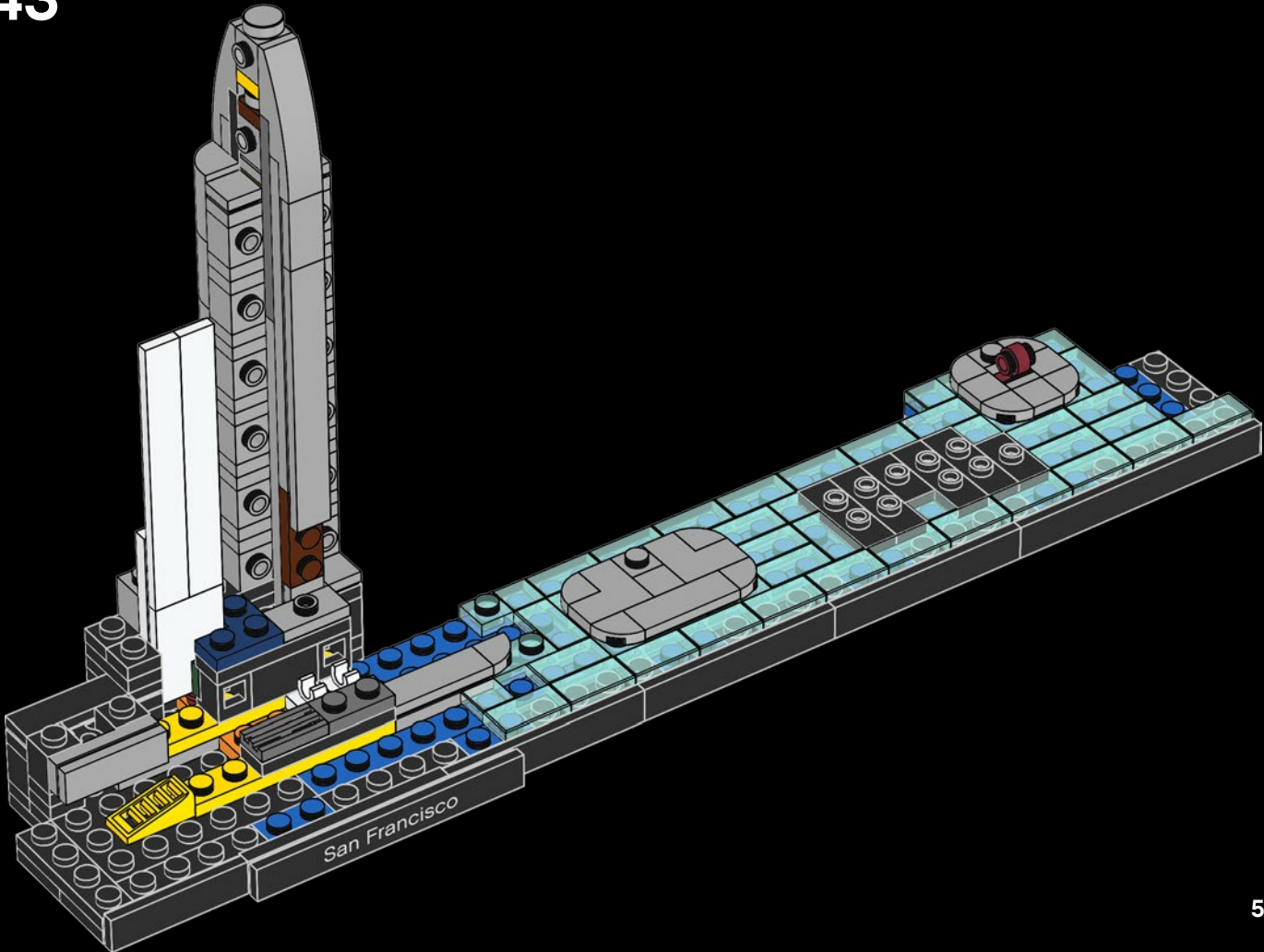

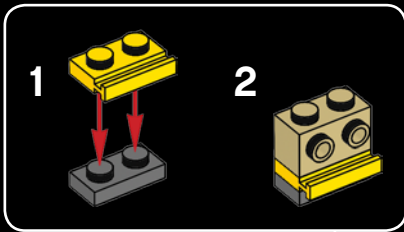

44

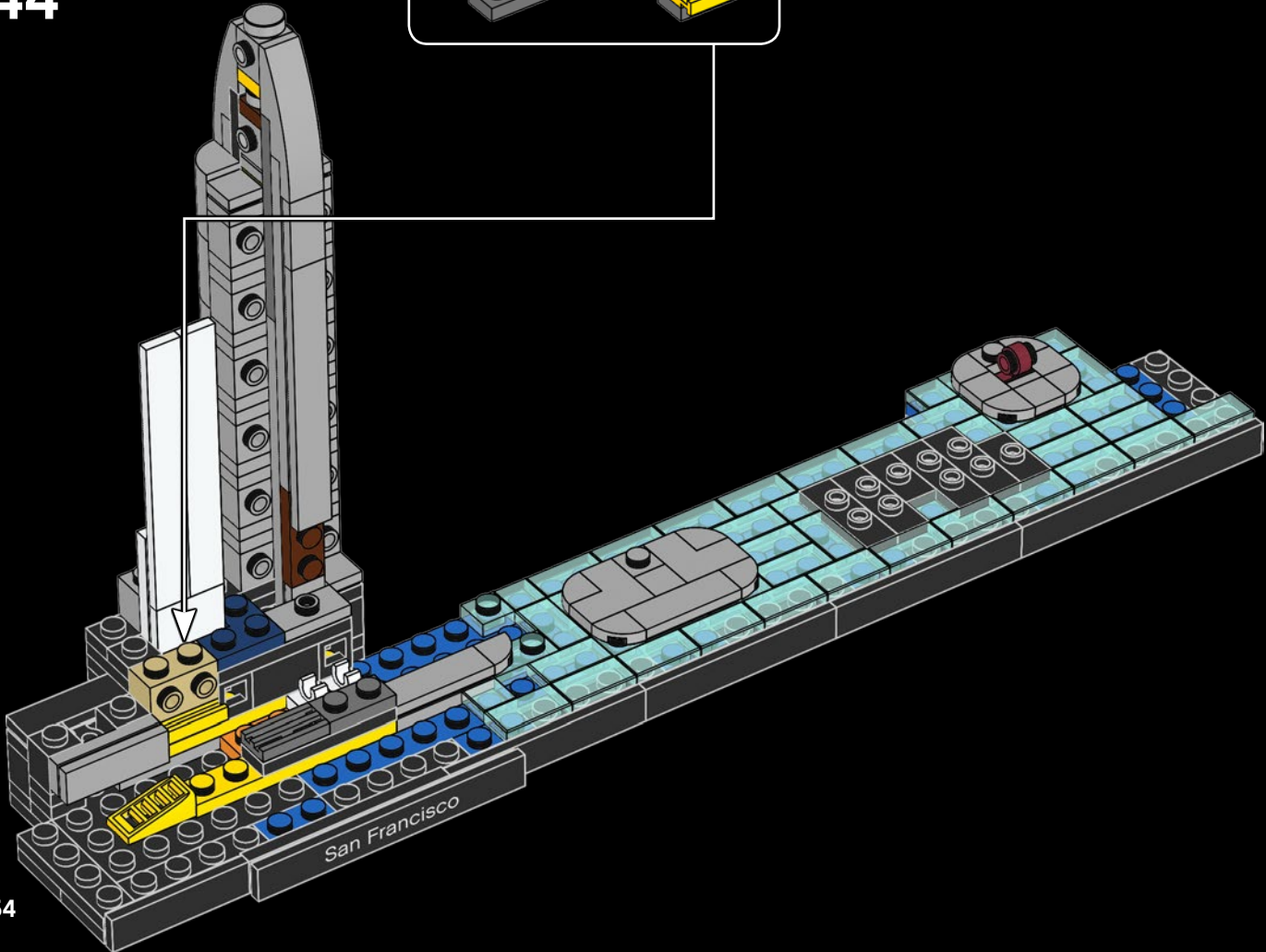

54

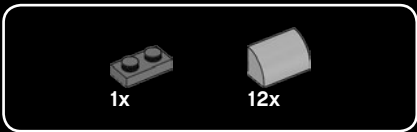

45

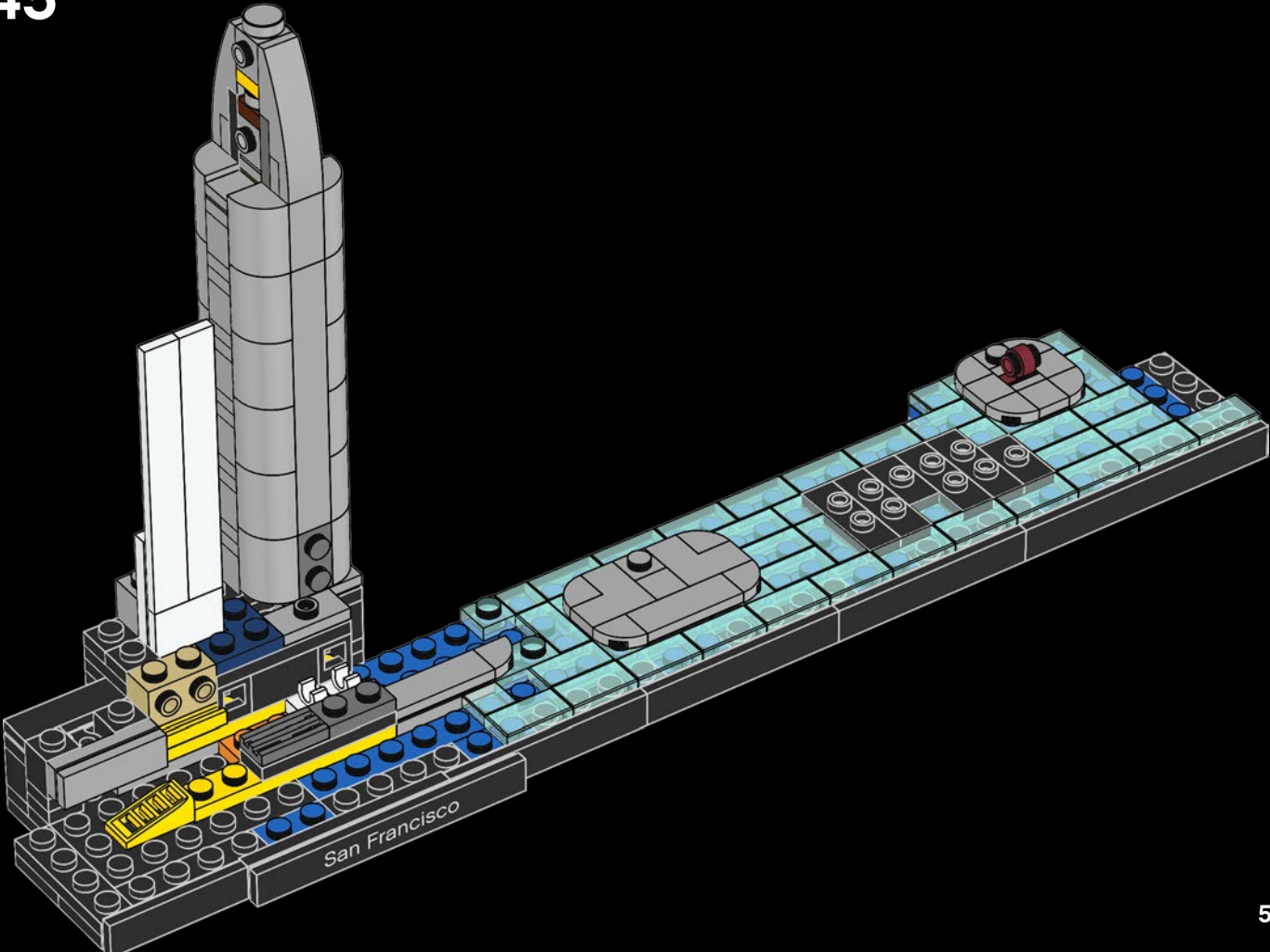



46

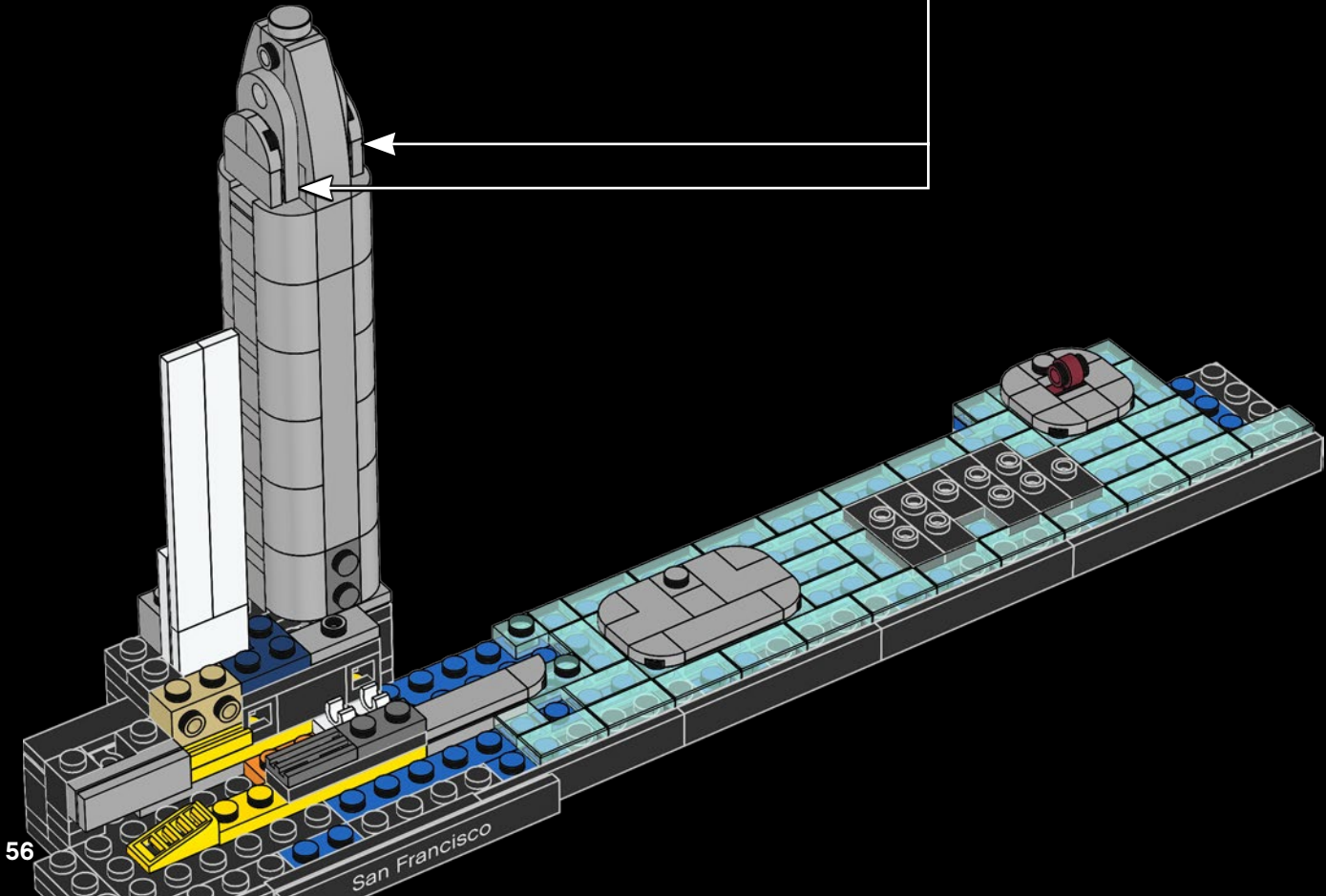
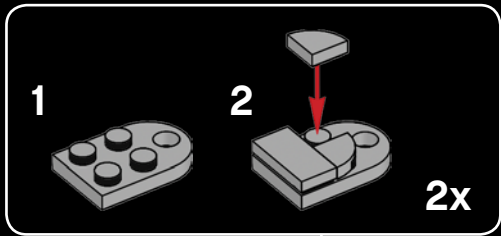



47

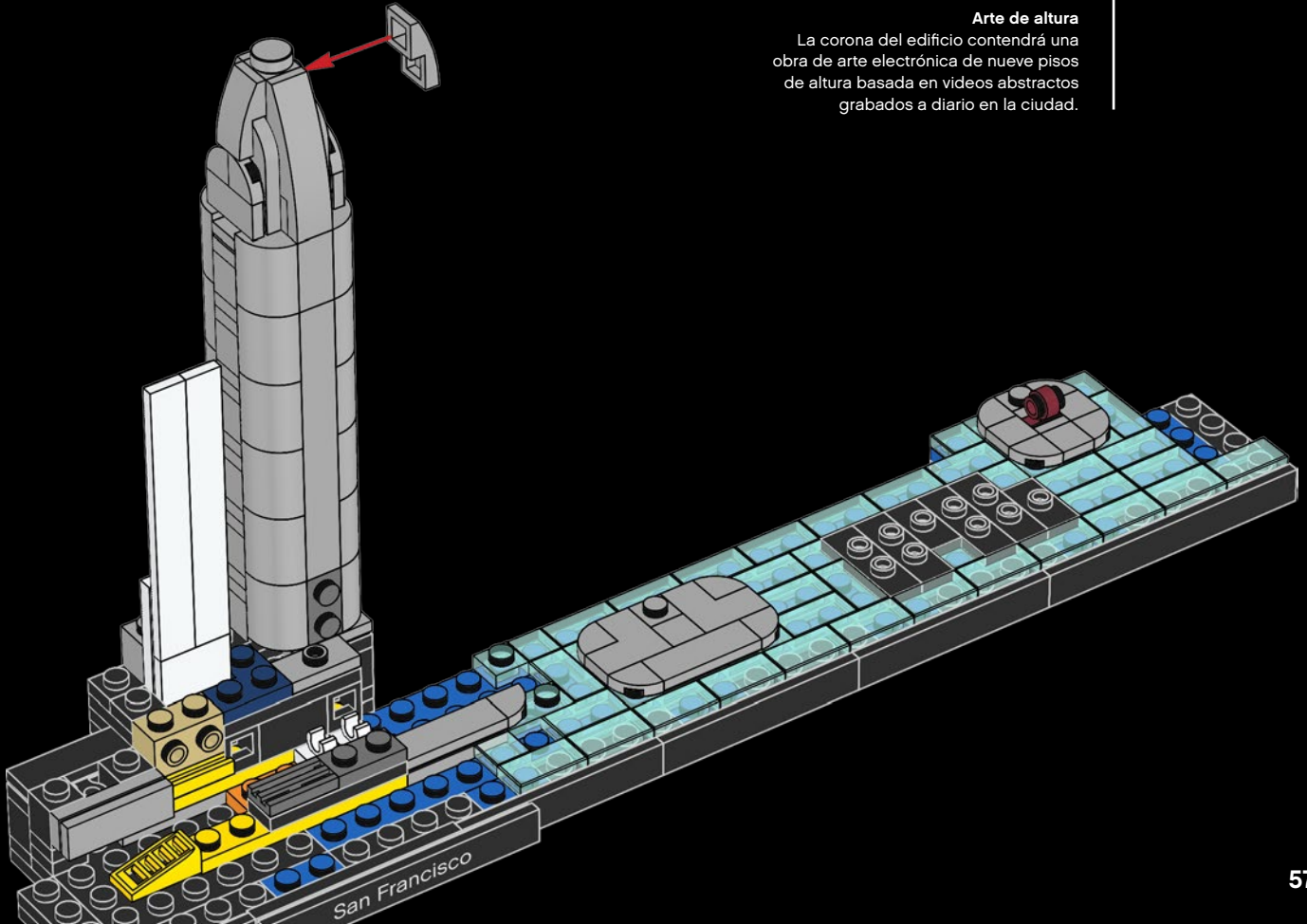

Top Art

The building's crown will feature a nine-story electronic art piece based on abstract videos filmed each day in the city.





L'art au sommet

Une œuvre d'art électronique composée de vidéos abstraites de la ville filmées quotidiennement sera disposée sur neuf étages au sommet de la tour.

Arte de altura

La corona del edificio contendrá una obra de arte electrónica de nueve pisos de altura basada en vídeos abstractos grabados a diario en la ciudad.



			
1x	1x	2x	1x

48

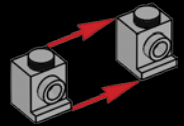
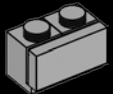
1	2
	

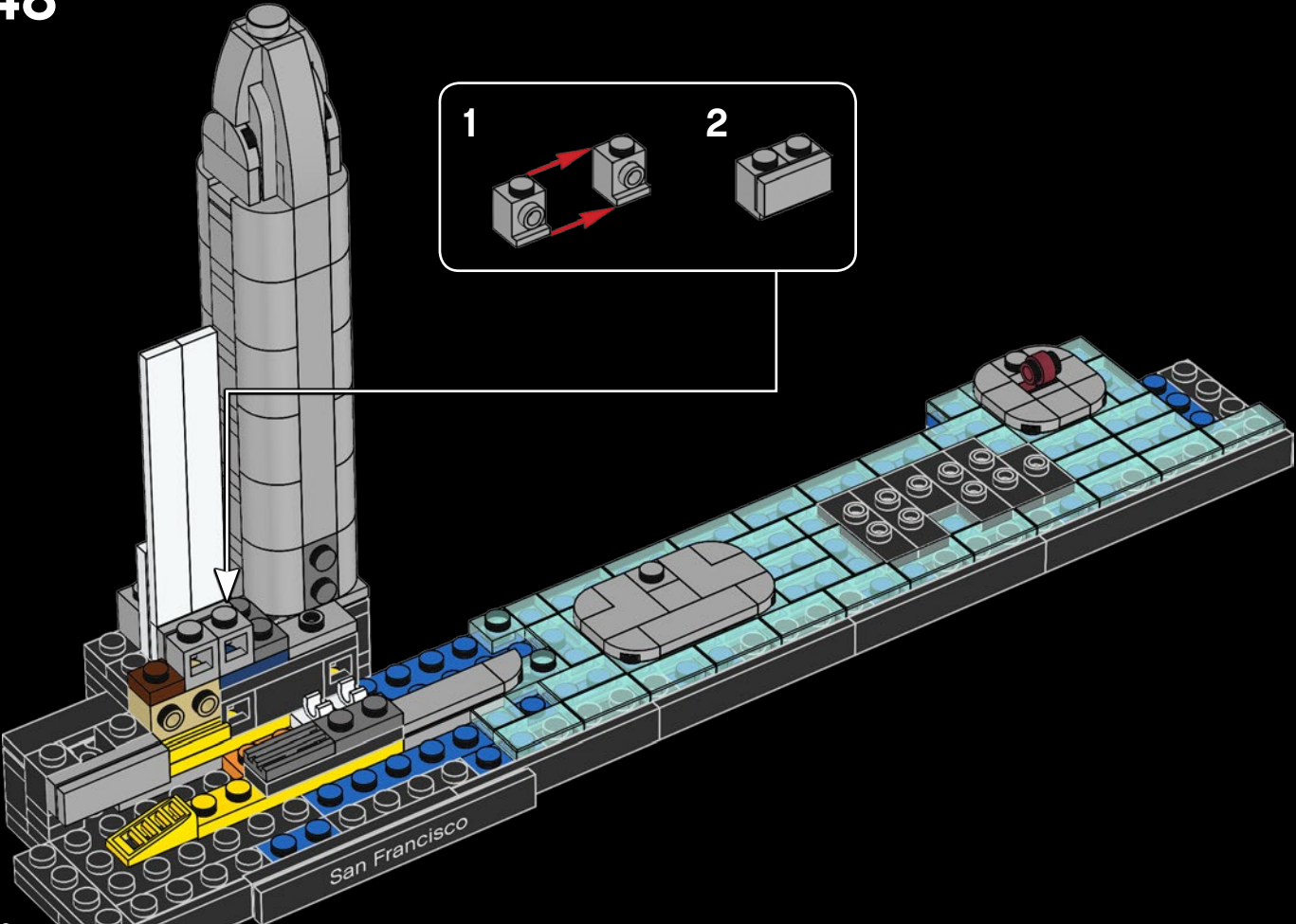

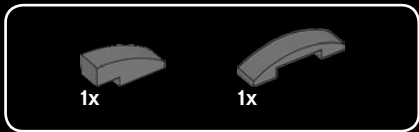

49

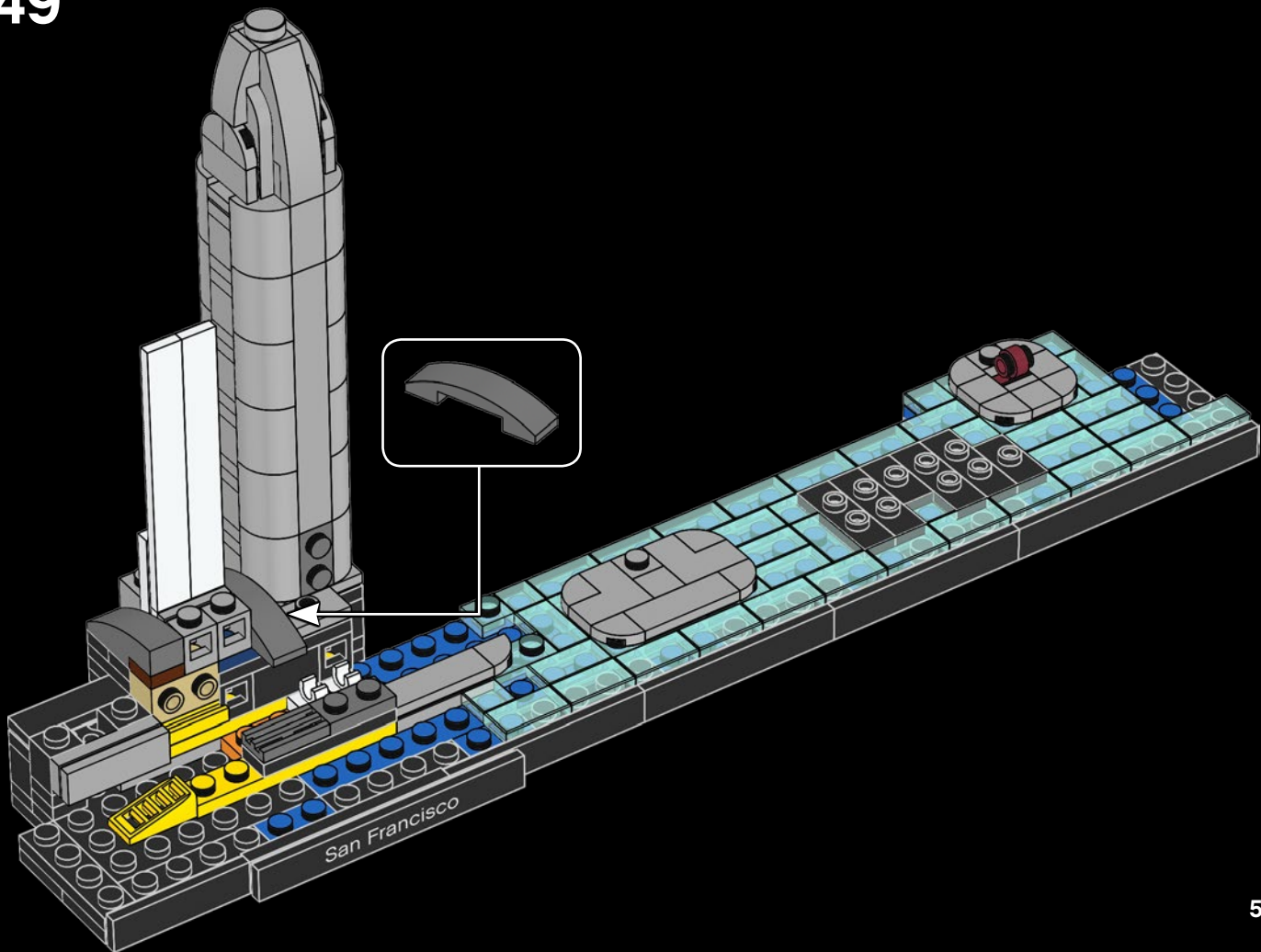

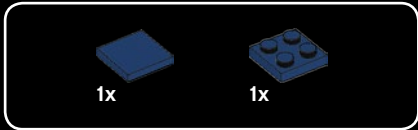

50

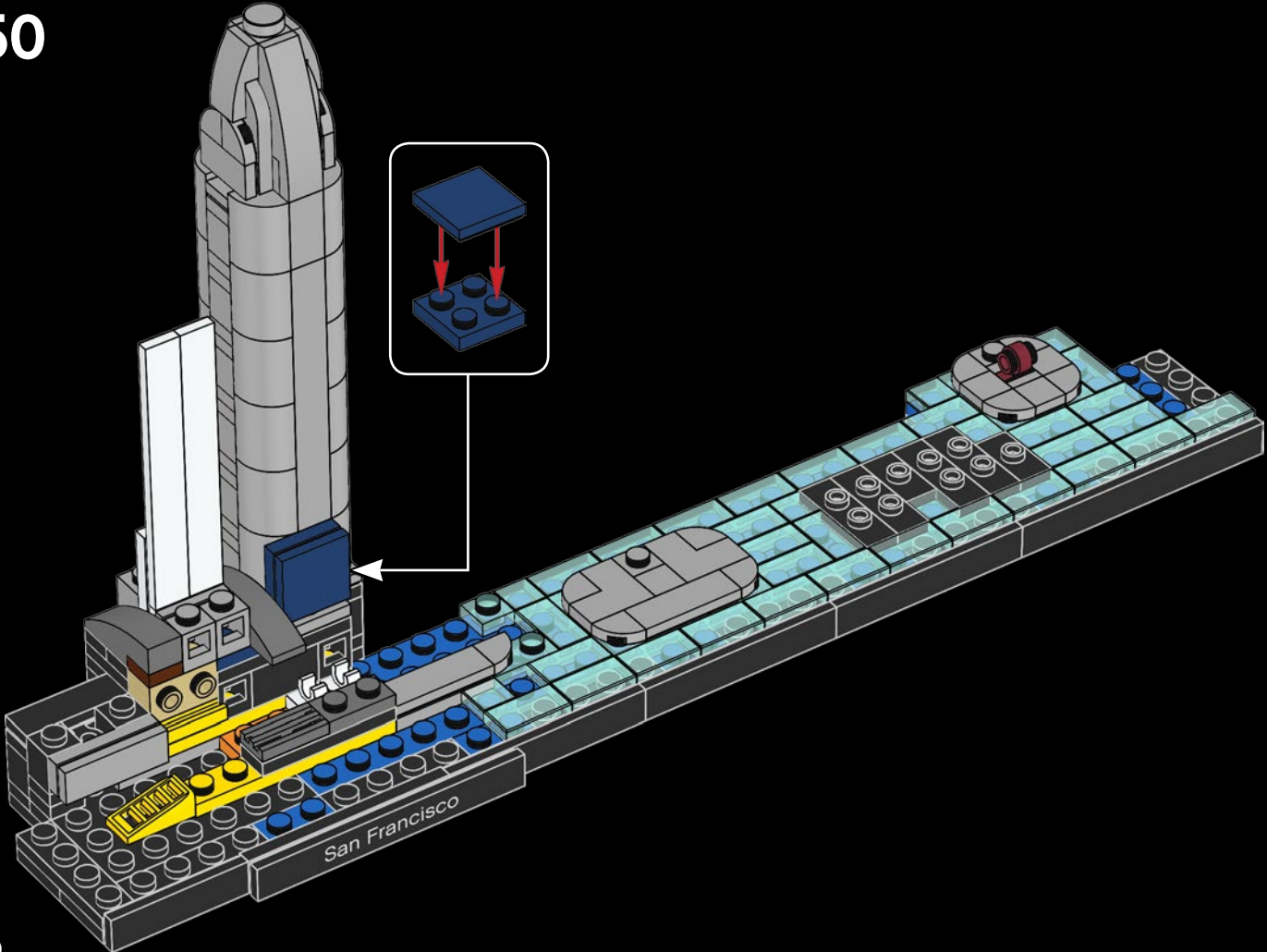

60



2x



4x

51

1



2



2x

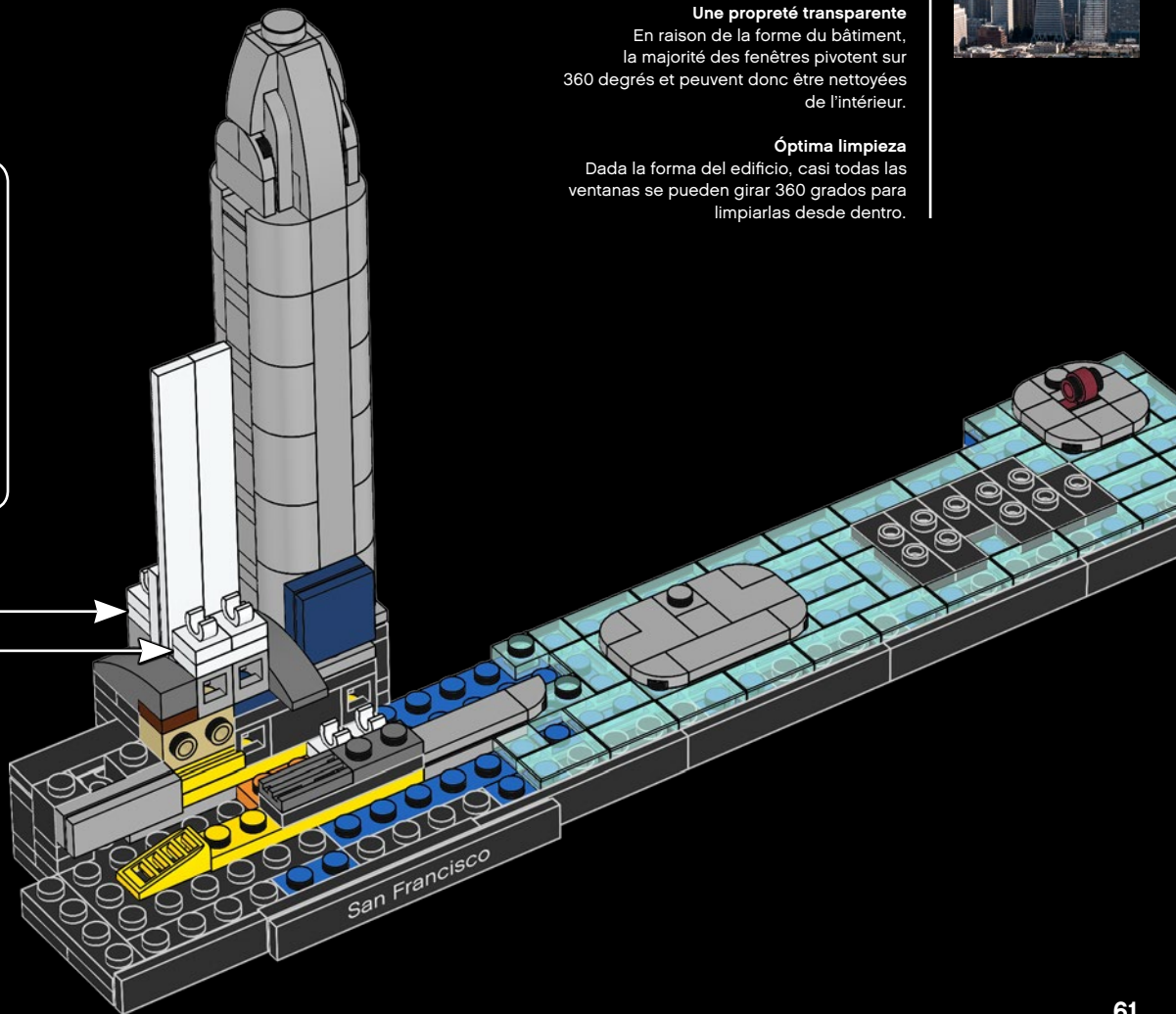

Keeping Clean

Because of the shape of the building, the majority of the windows can pivot 360 degrees so they can be washed from the inside.

Une propreté transparente

En raison de la forme du bâtiment, la majorité des fenêtres pivotent sur 360 degrés et peuvent donc être nettoyées de l'intérieur.

Óptima limpieza

Dada la forma del edificio, casi todas las ventanas se pueden girar 360 grados para limpiarlas desde dentro.

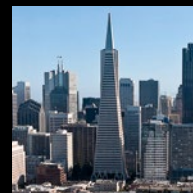

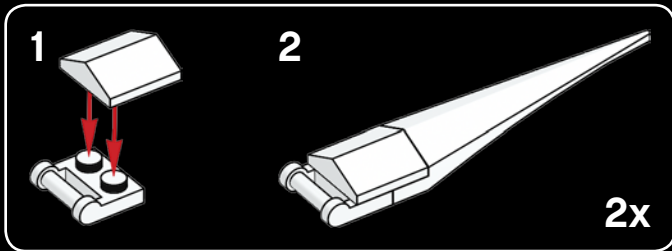
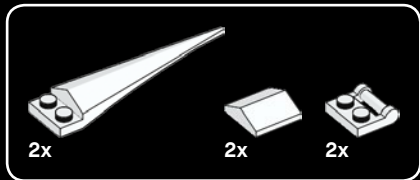

52

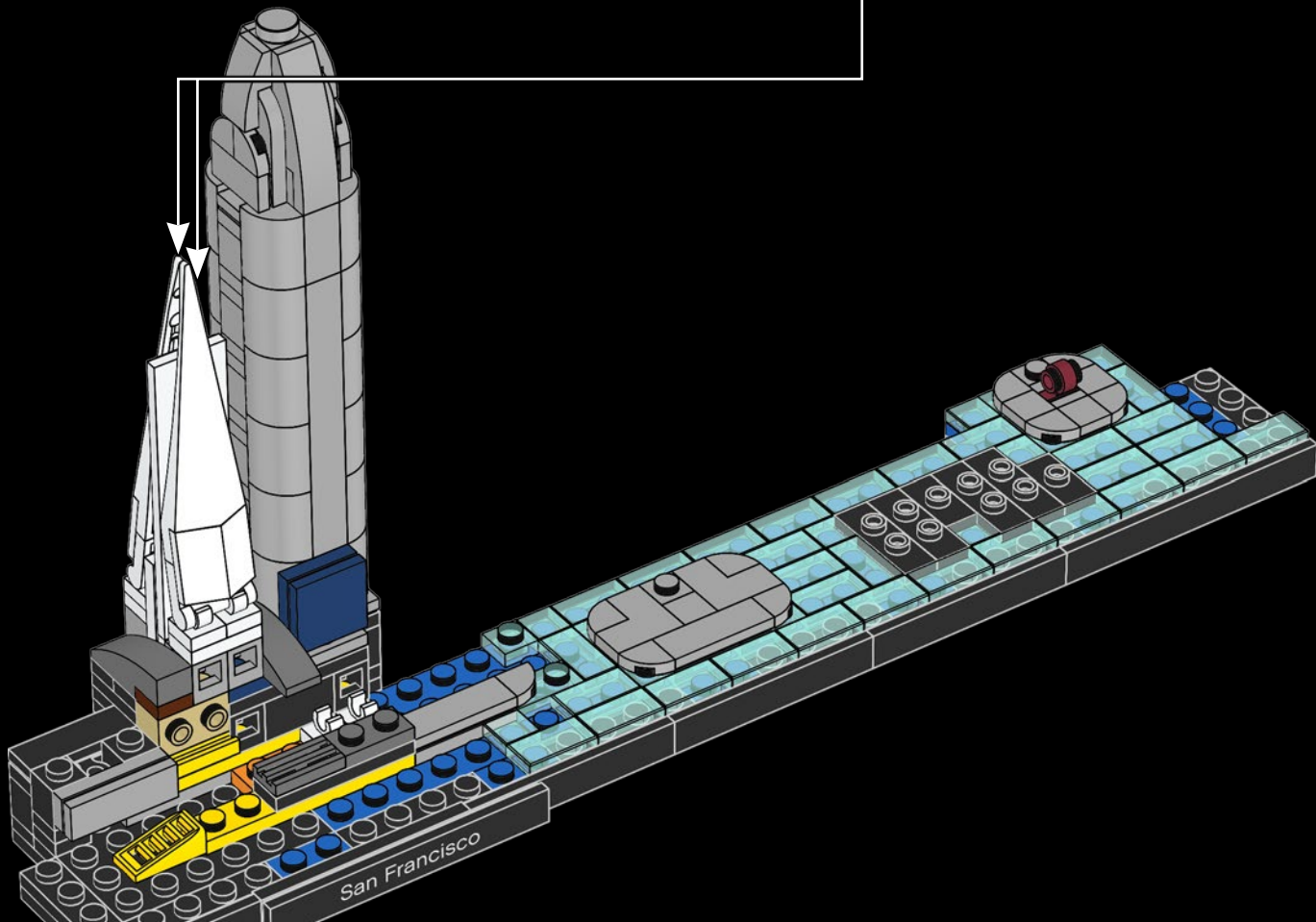

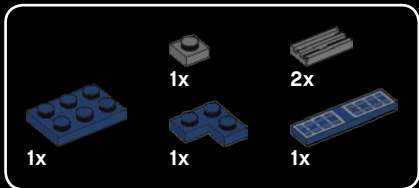

53

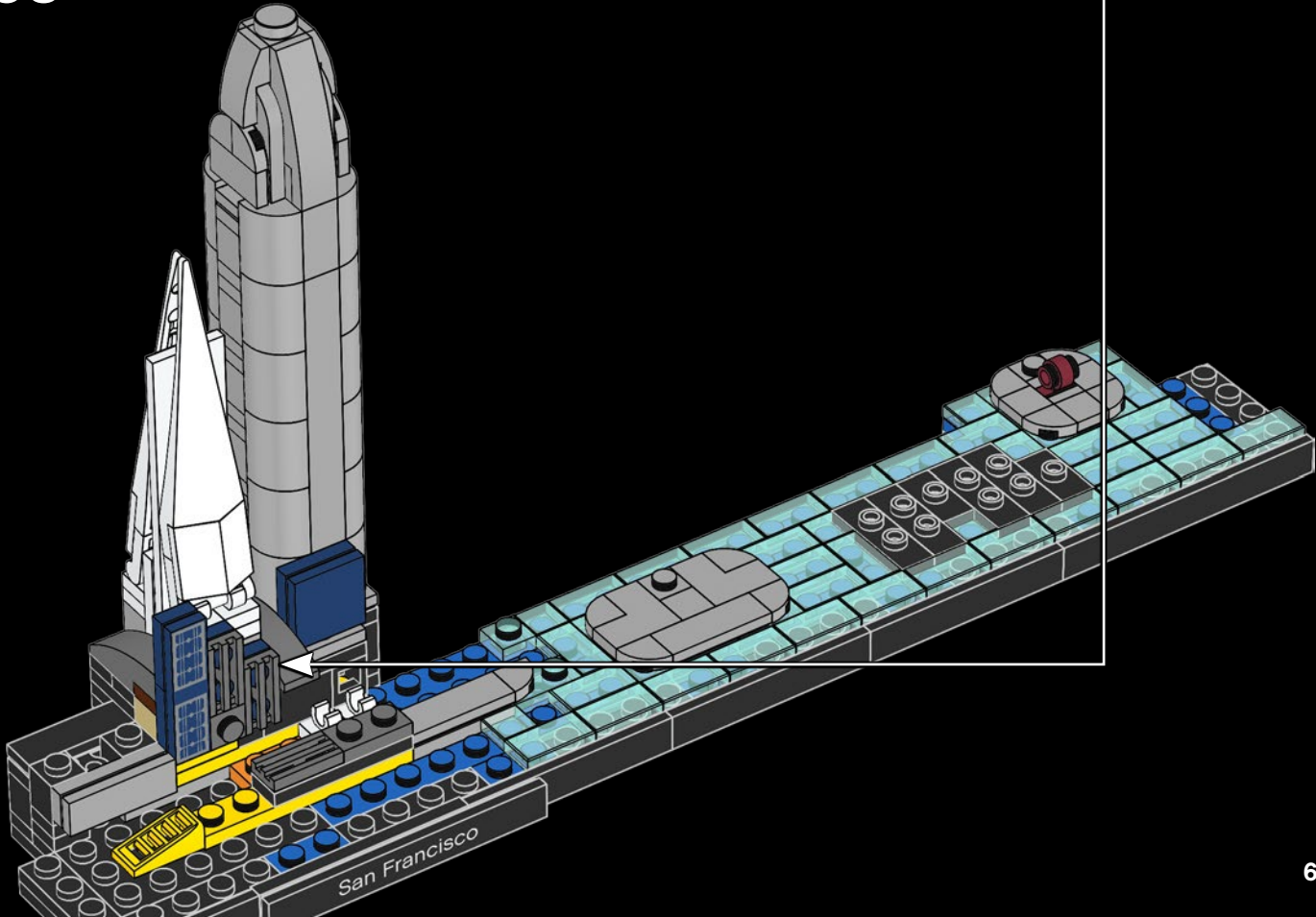
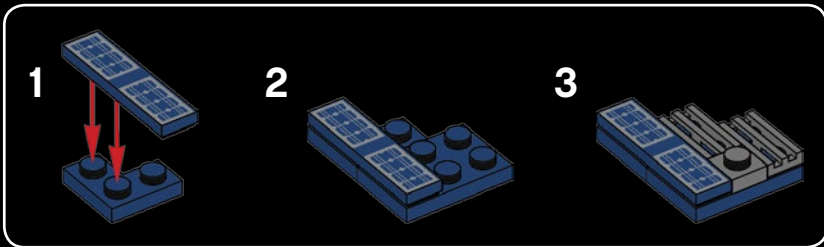

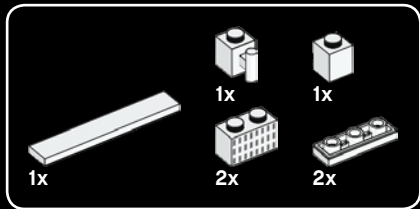

54

1



2

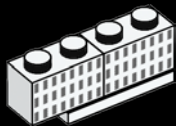

3

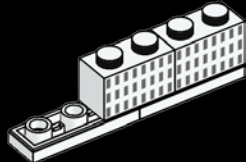

4

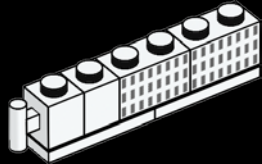

5

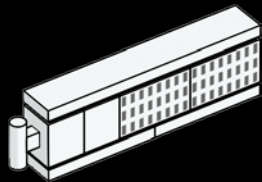

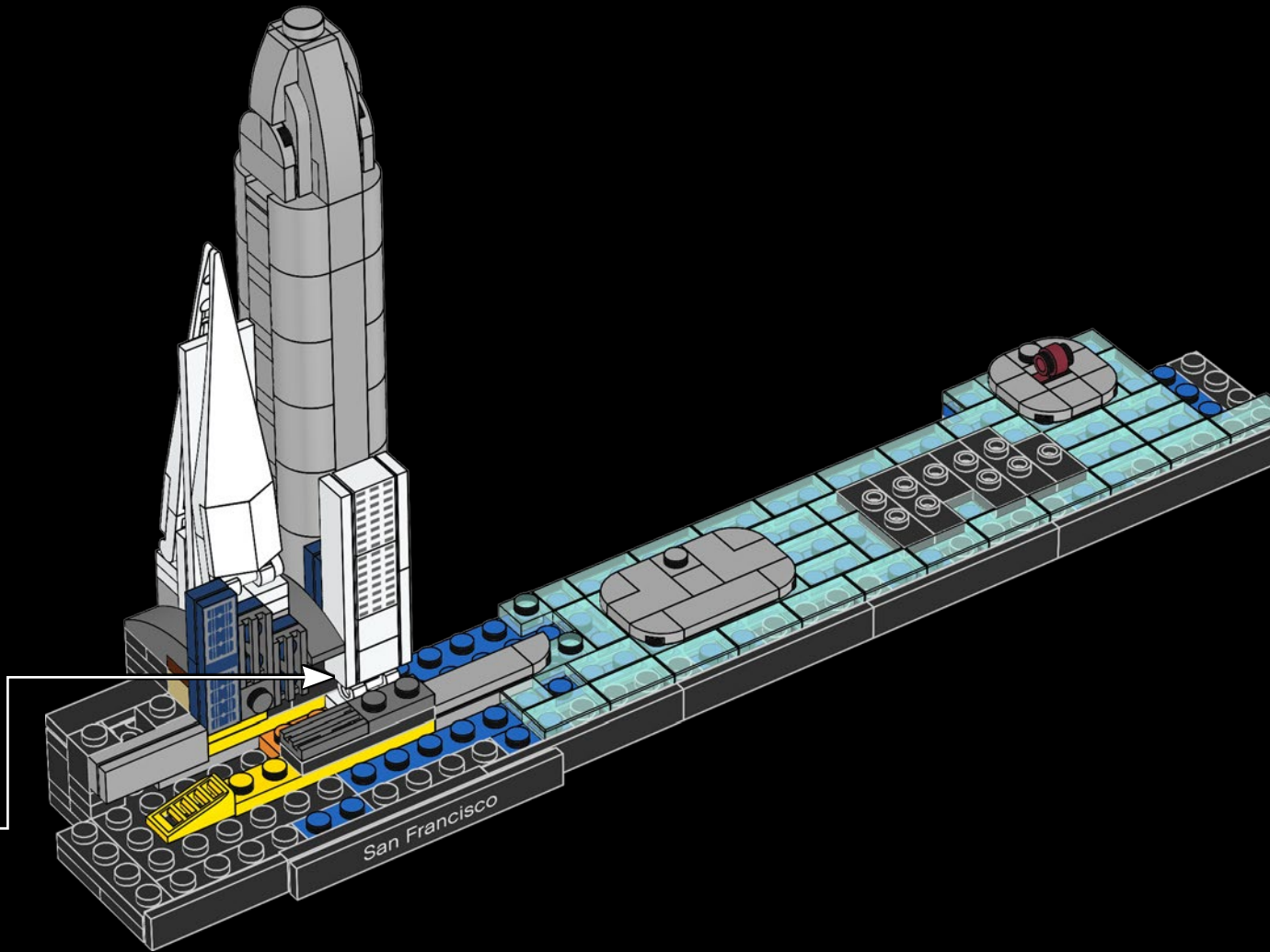

- 1x 
- 1x 
- 2x 
- 1x 
- 1x 

55

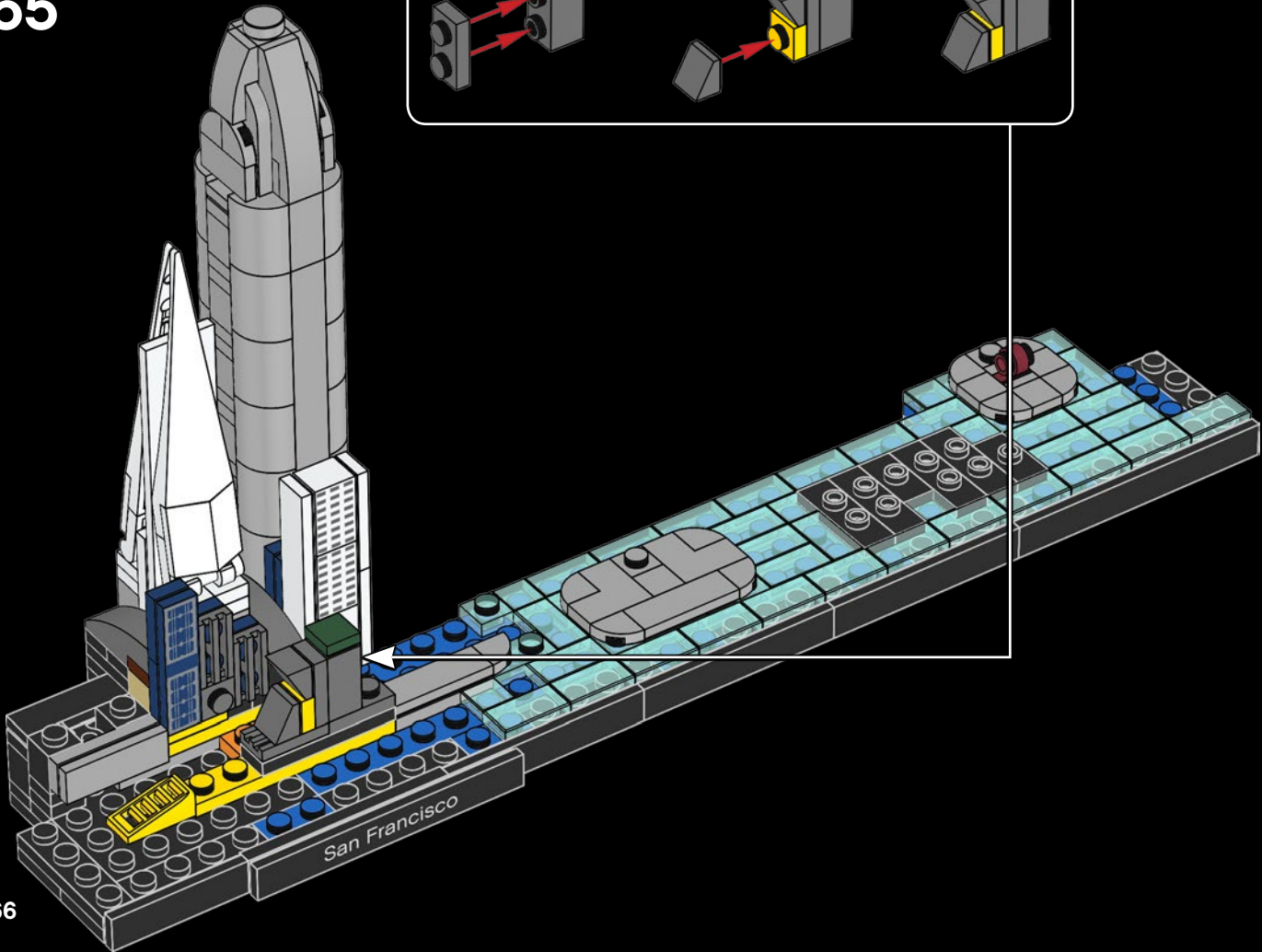
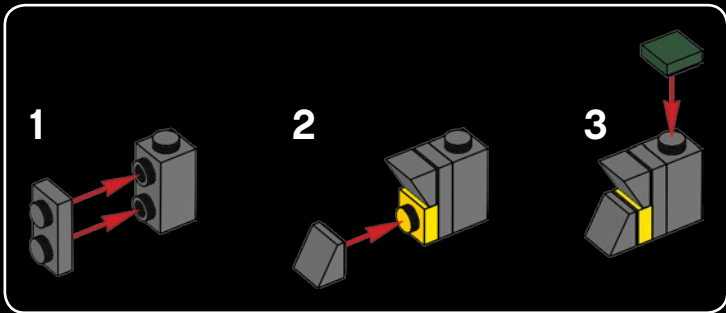

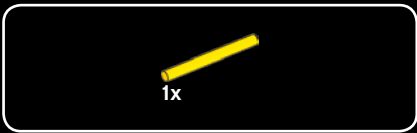

56

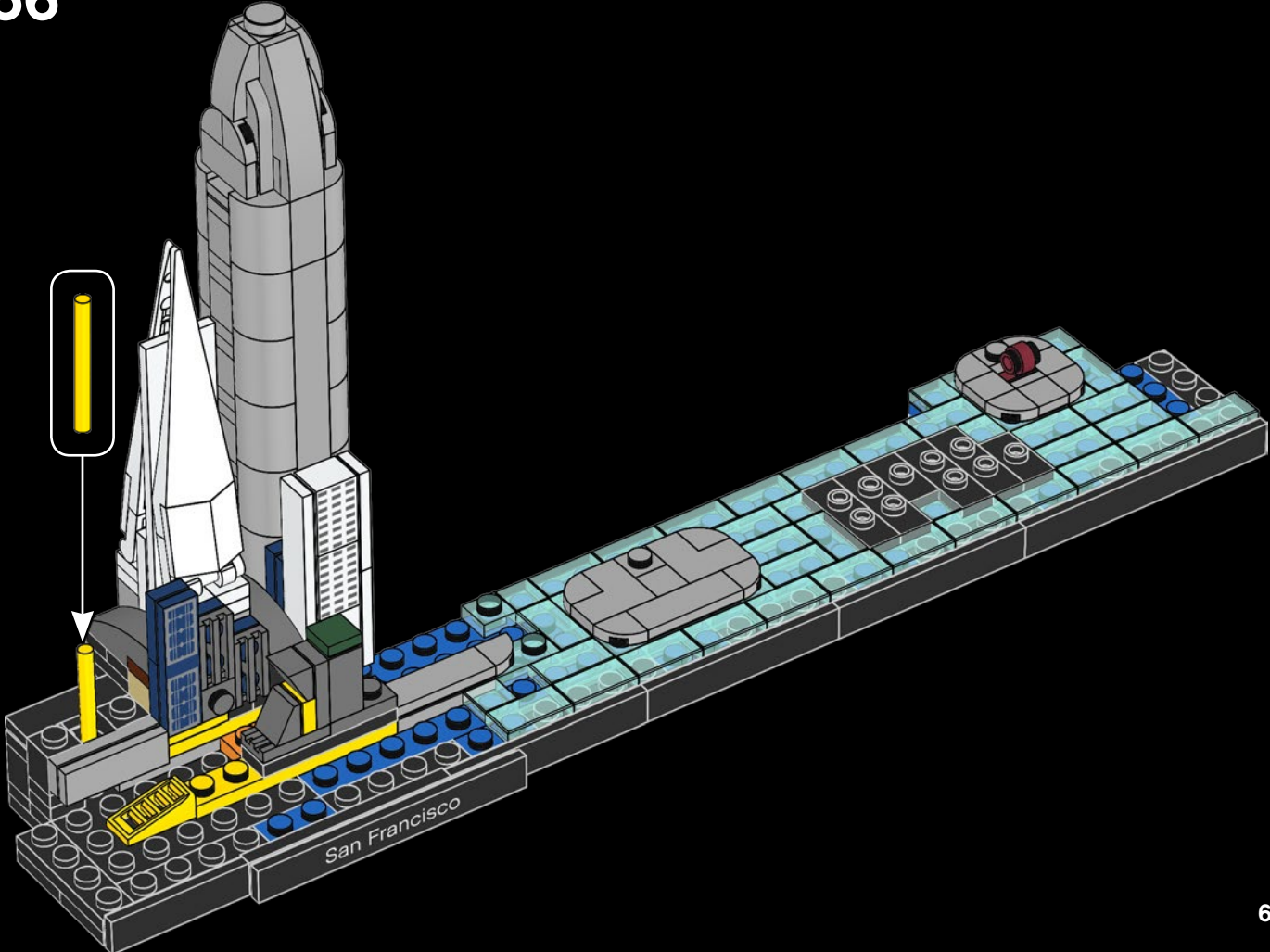



1x



1x

57

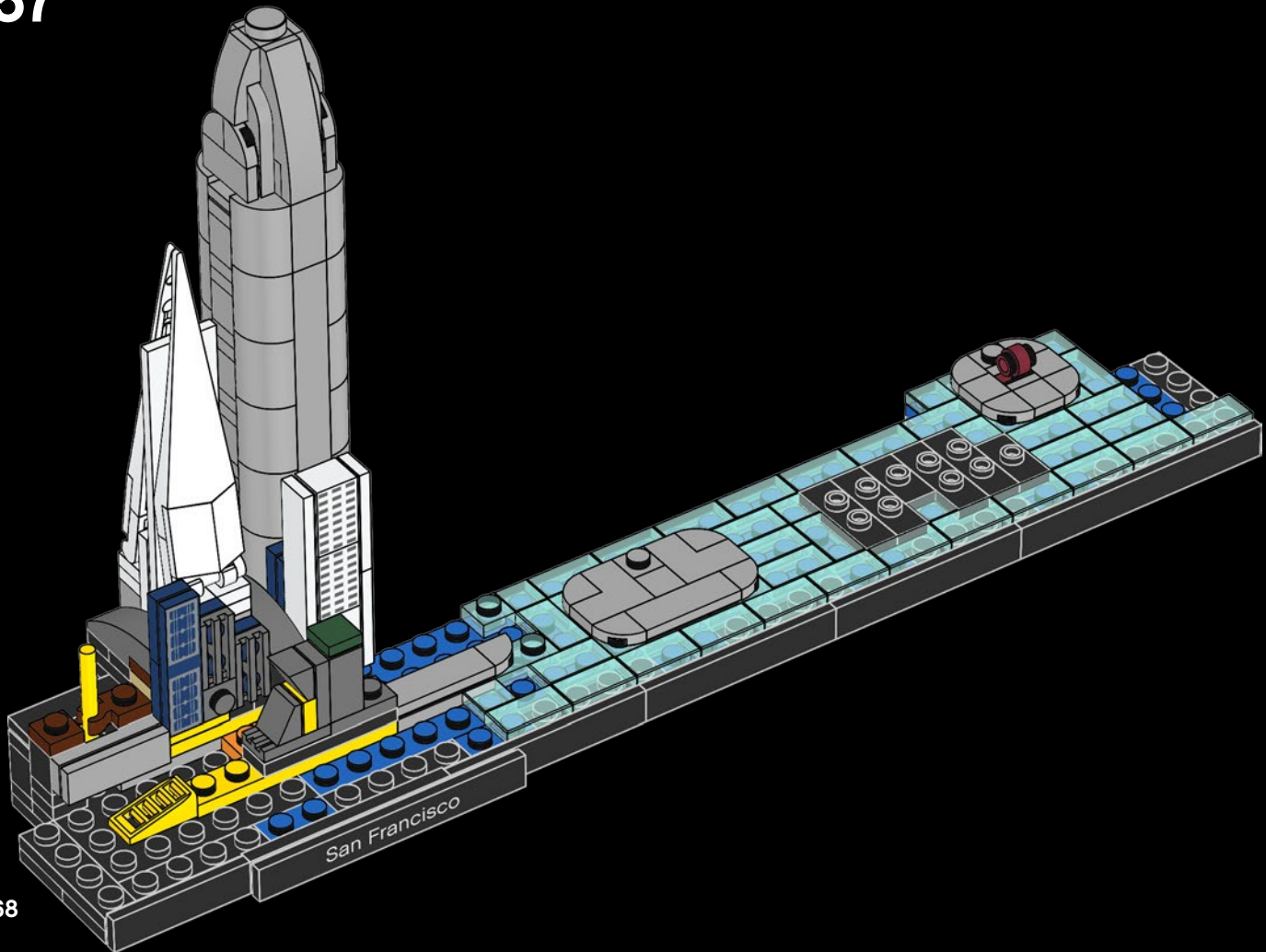

68

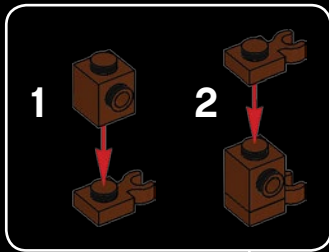

58

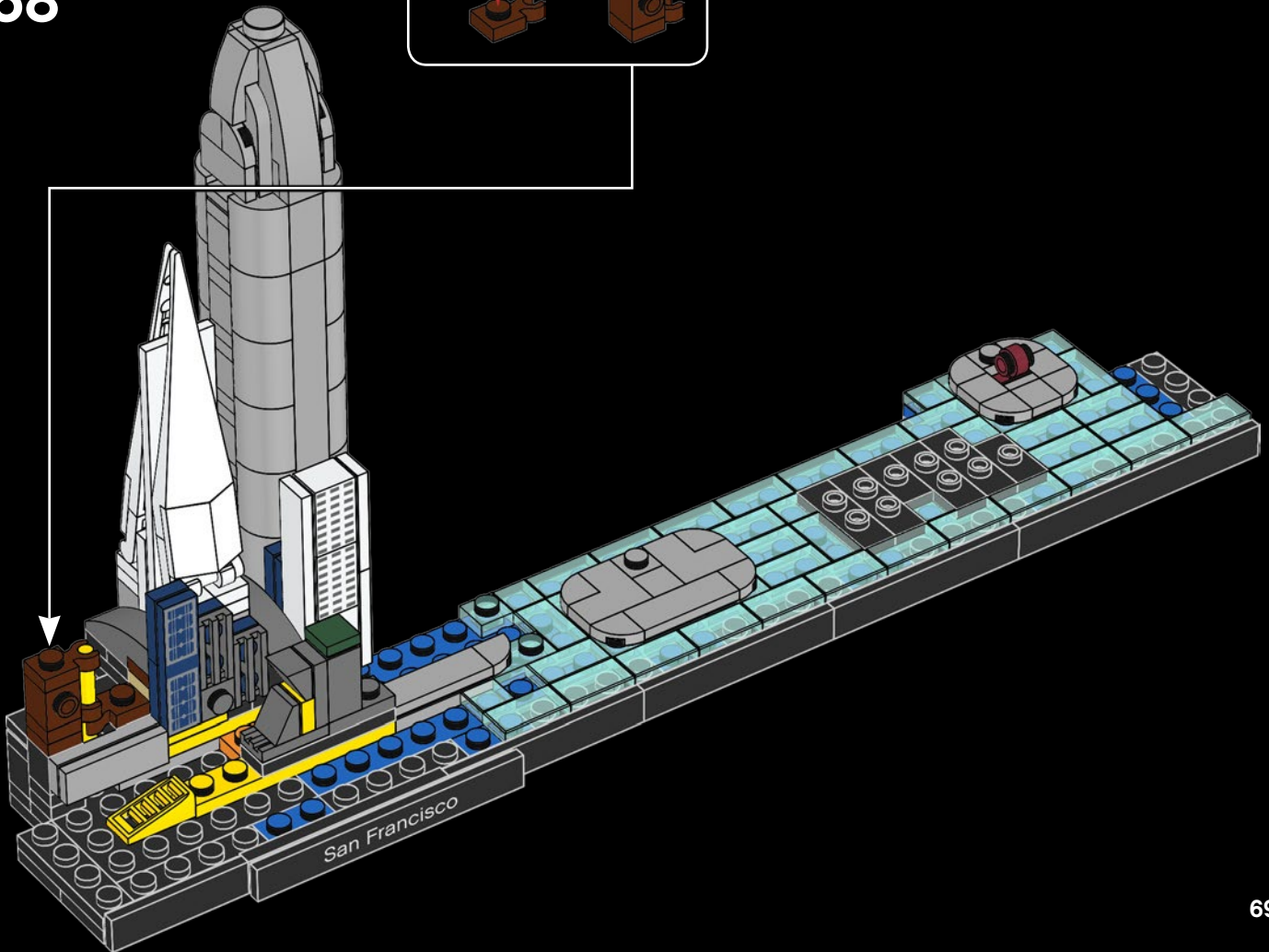

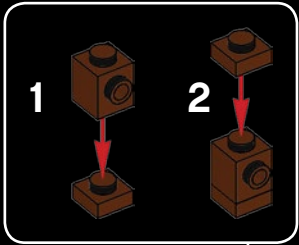
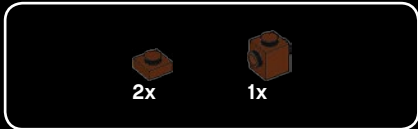

59

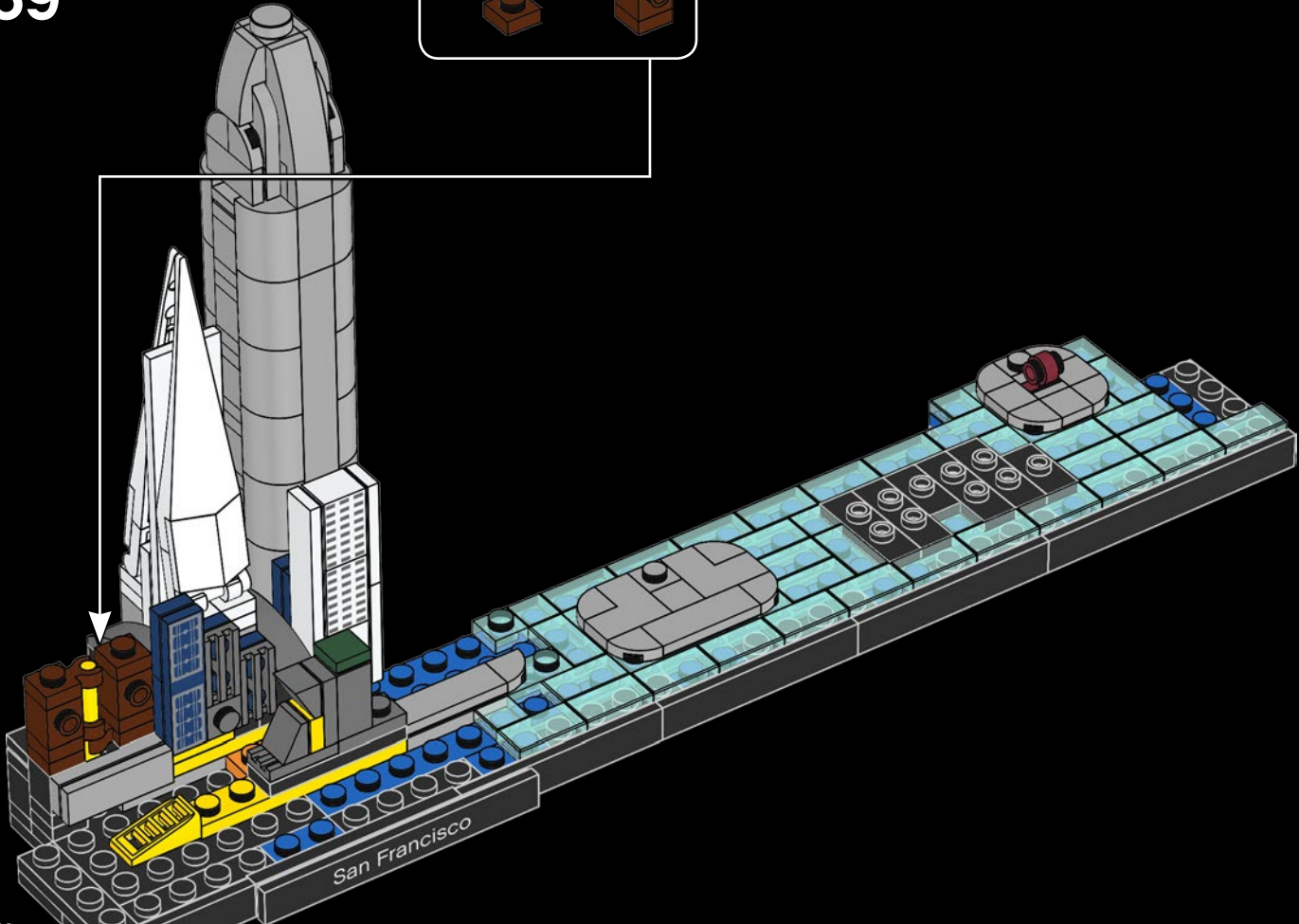

70

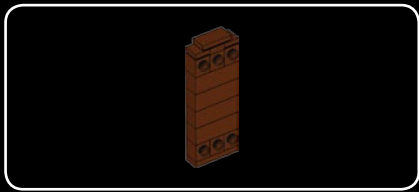

60



61

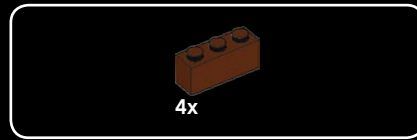
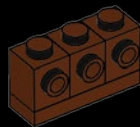

62

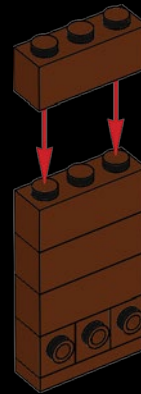



3x

63



1x



2x



1x

64



65

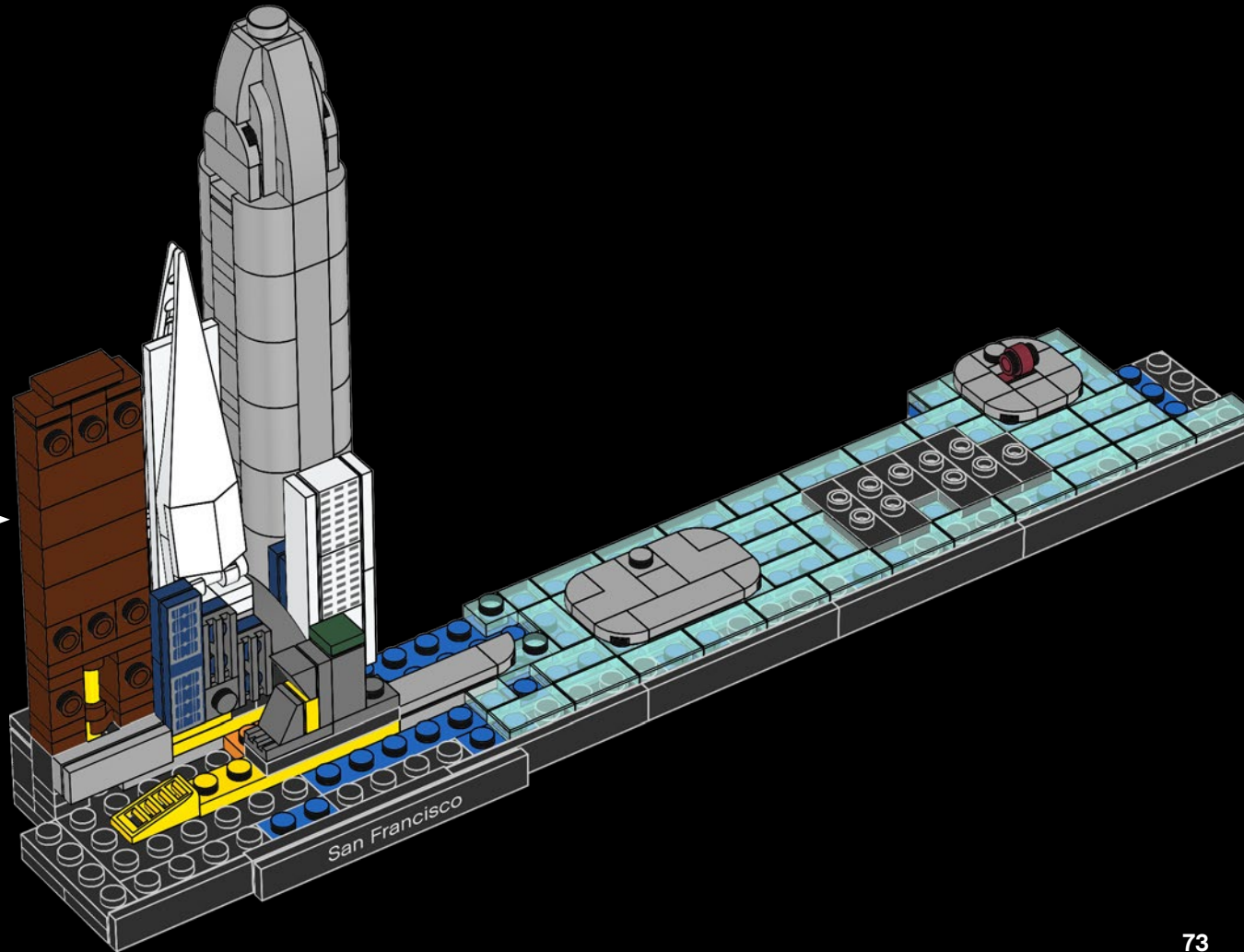

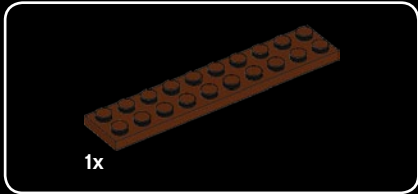

66

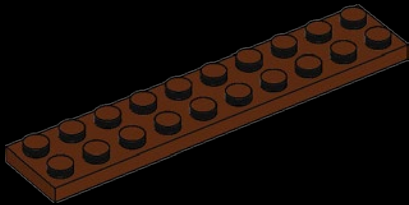

67

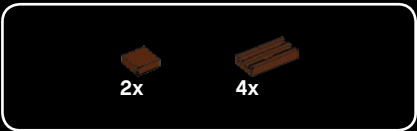
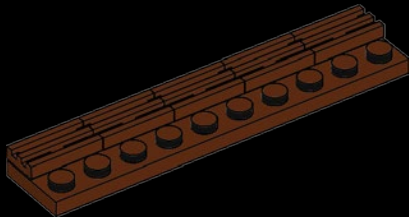

68

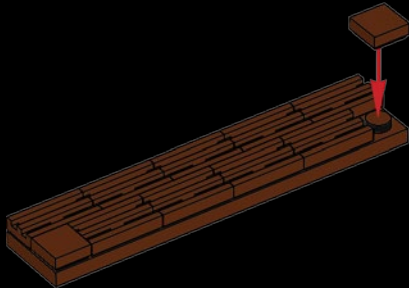

2x

69

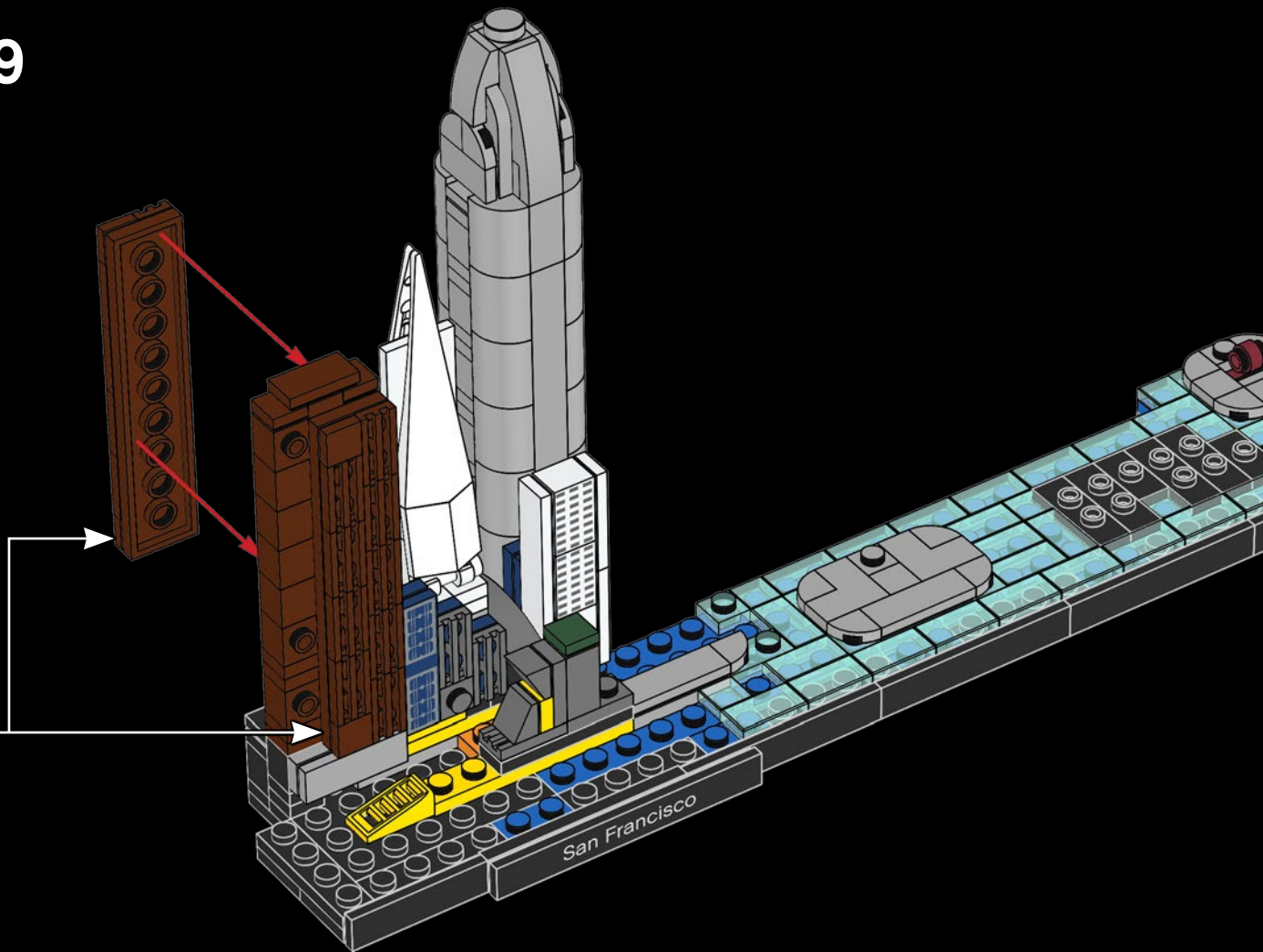

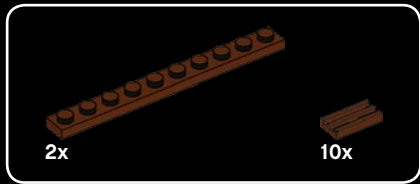

70

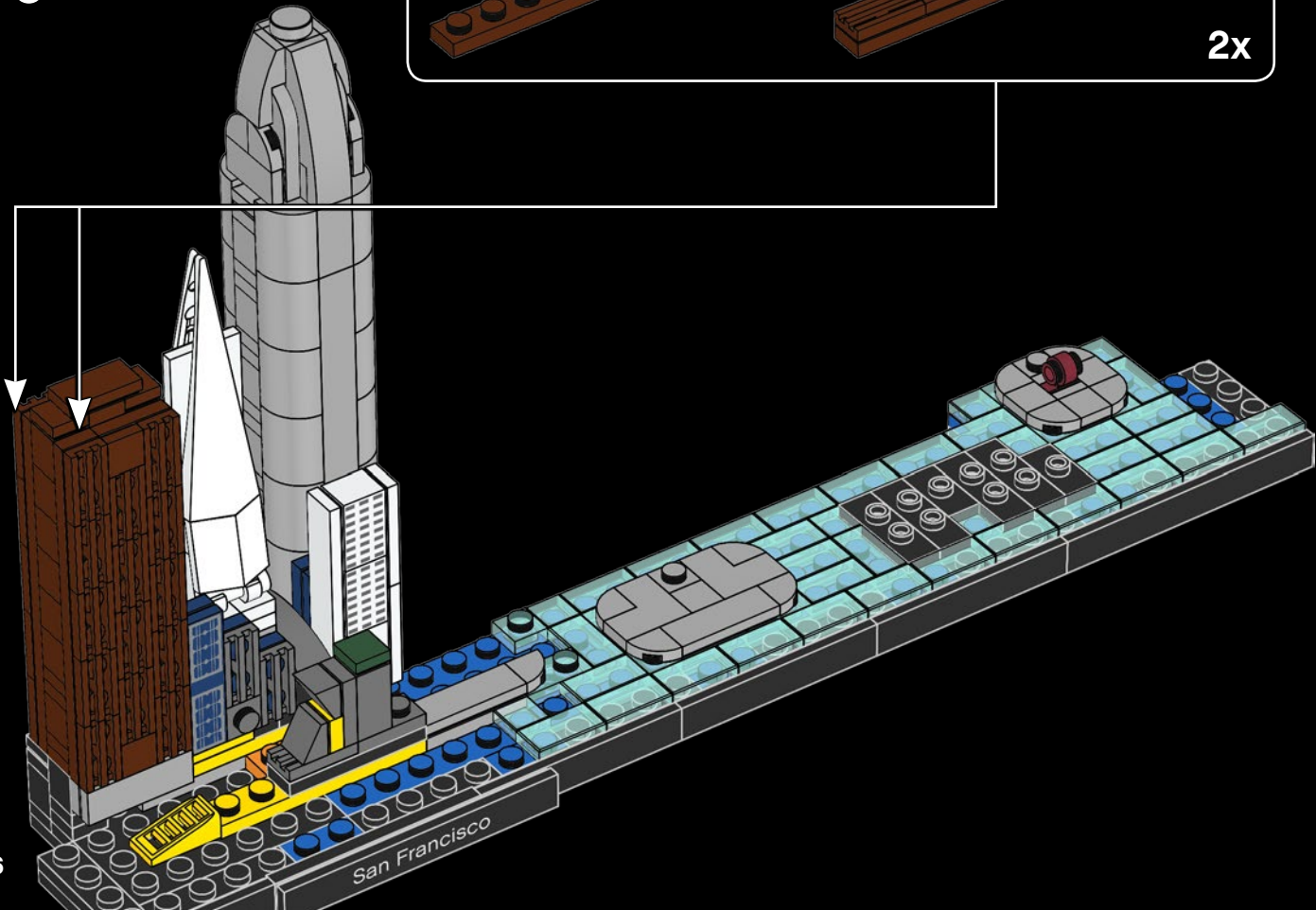
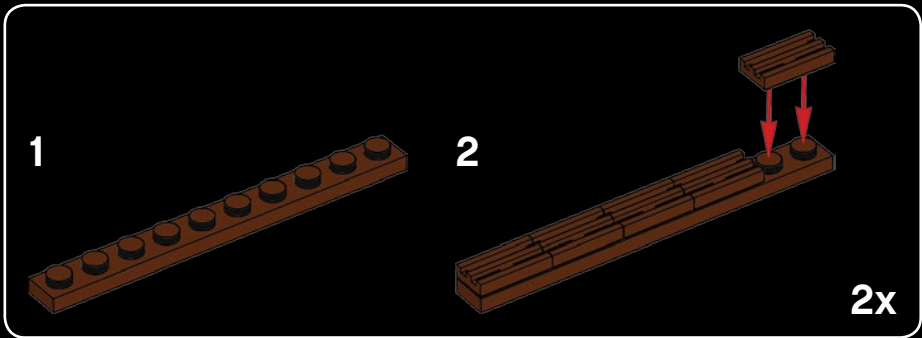

76

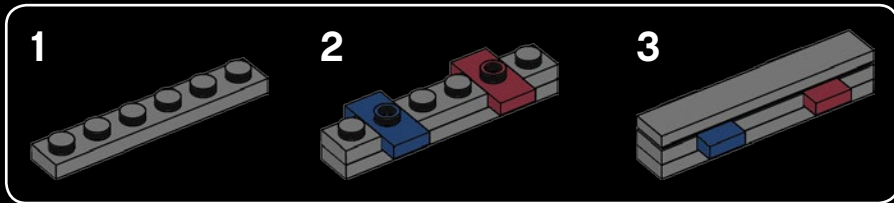
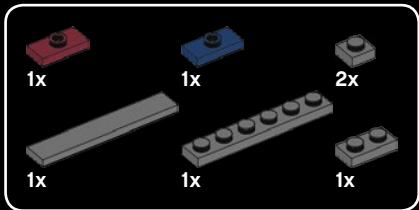

71

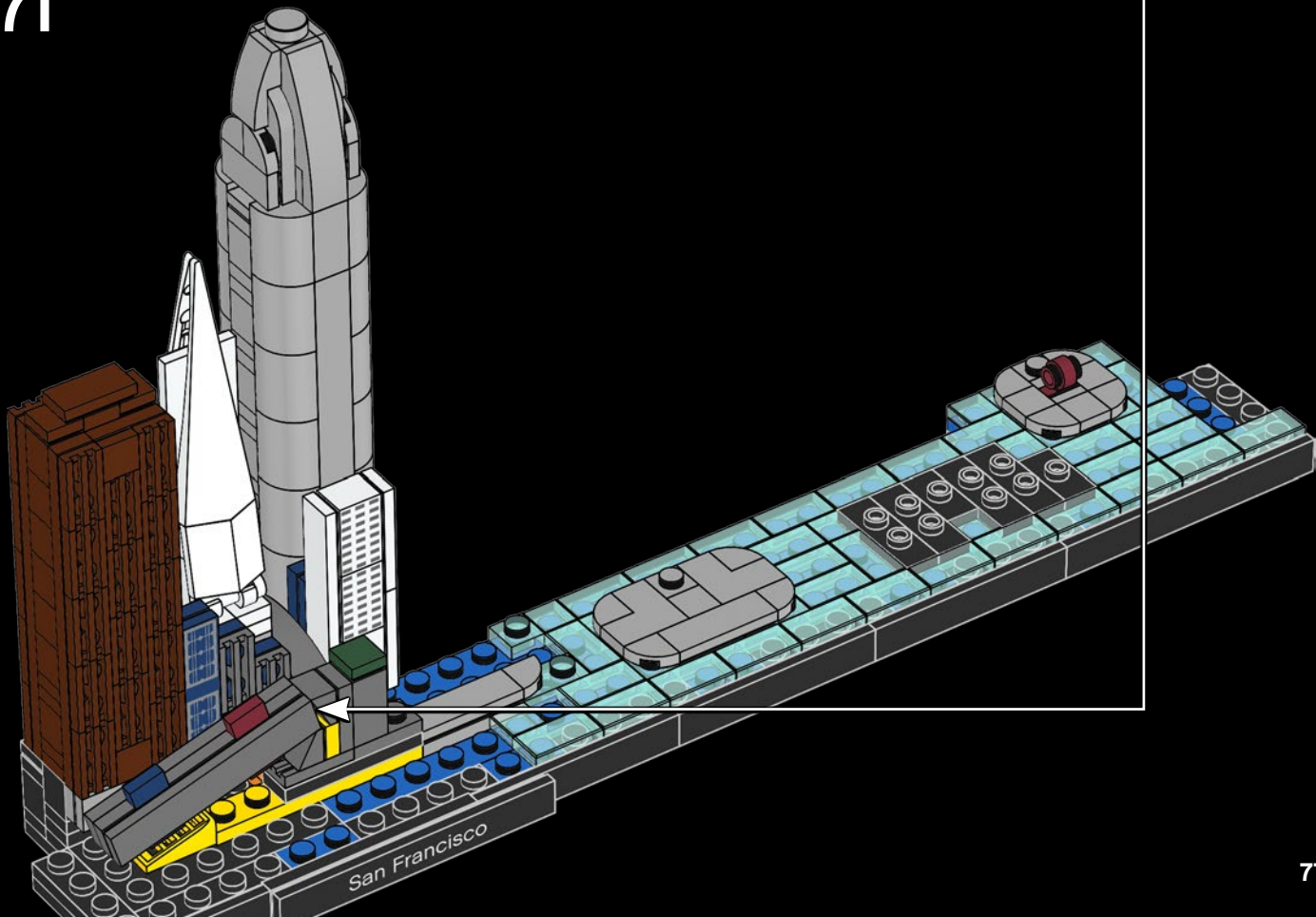

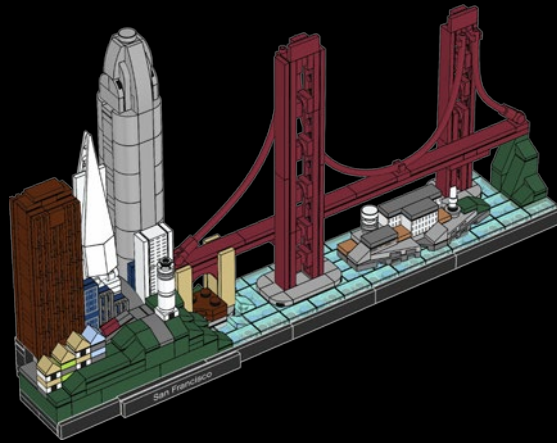

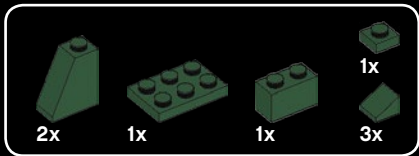

72

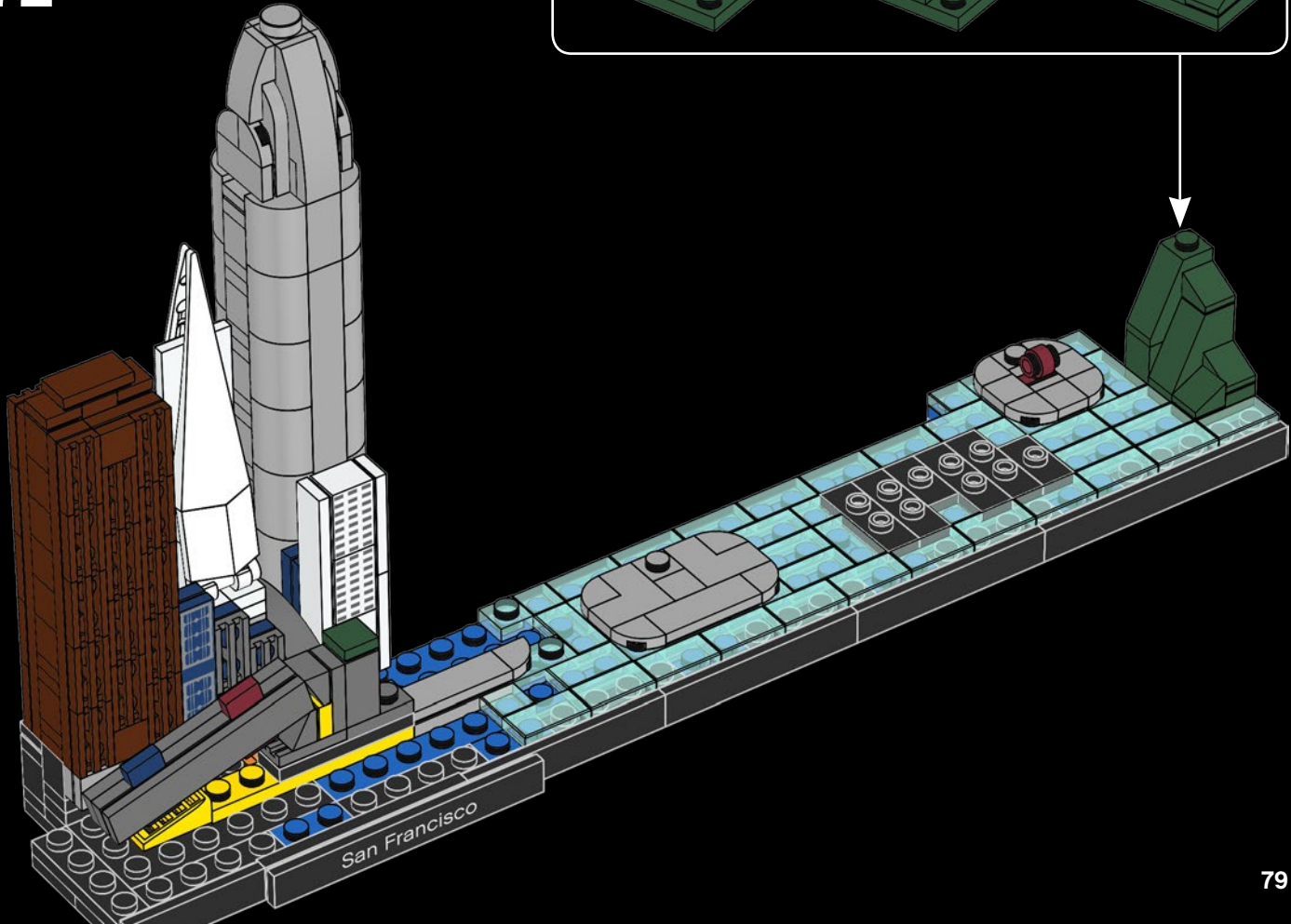
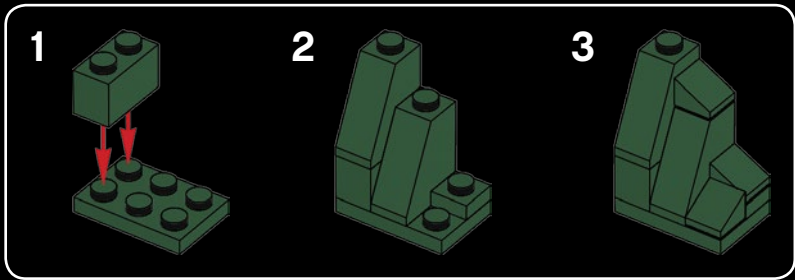

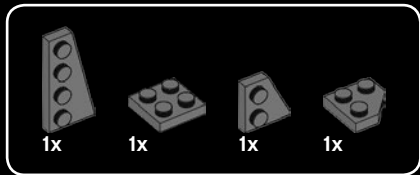

73

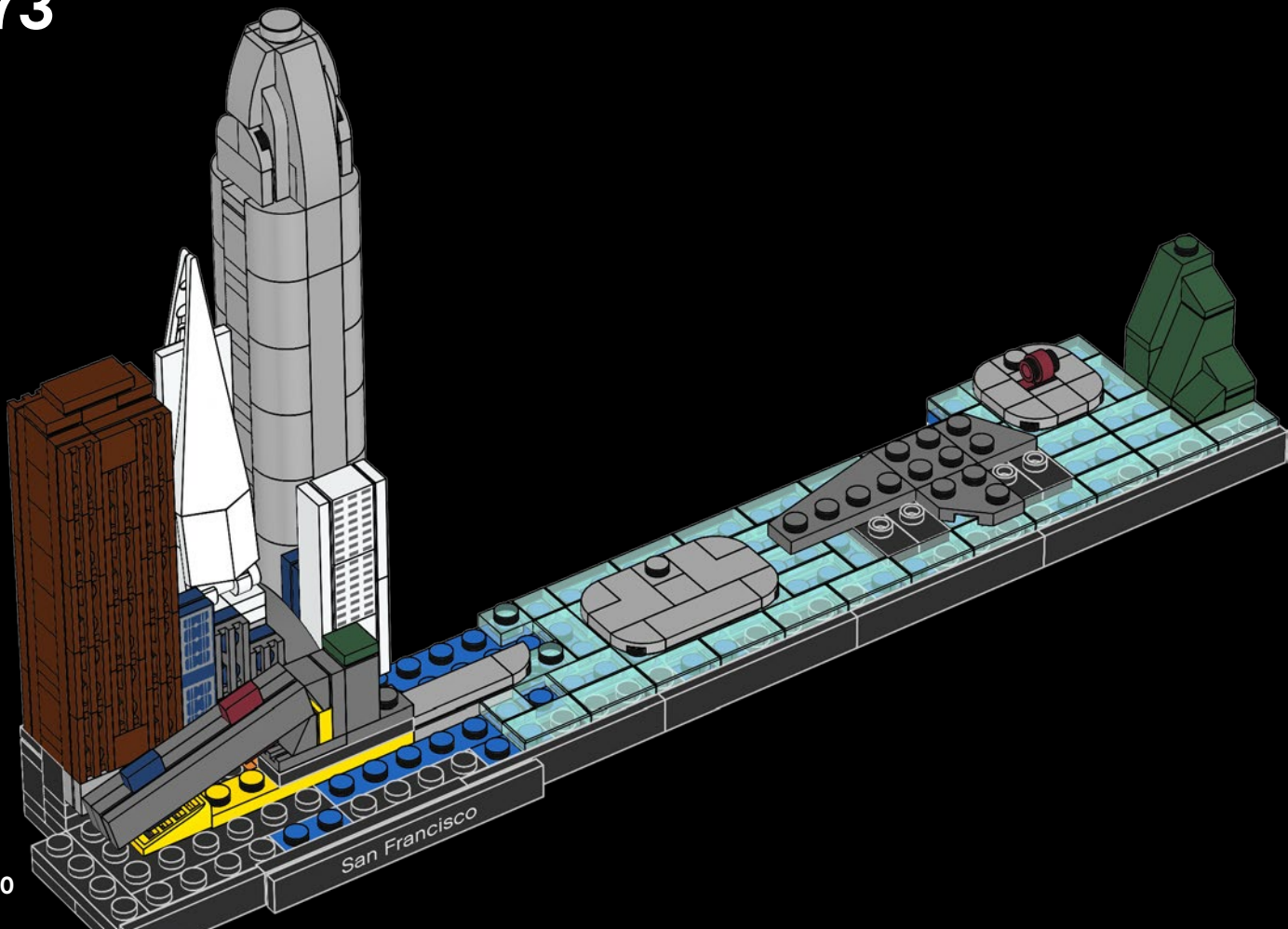

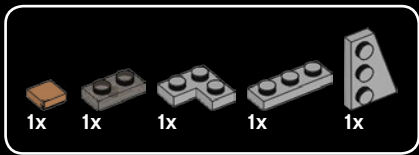

74

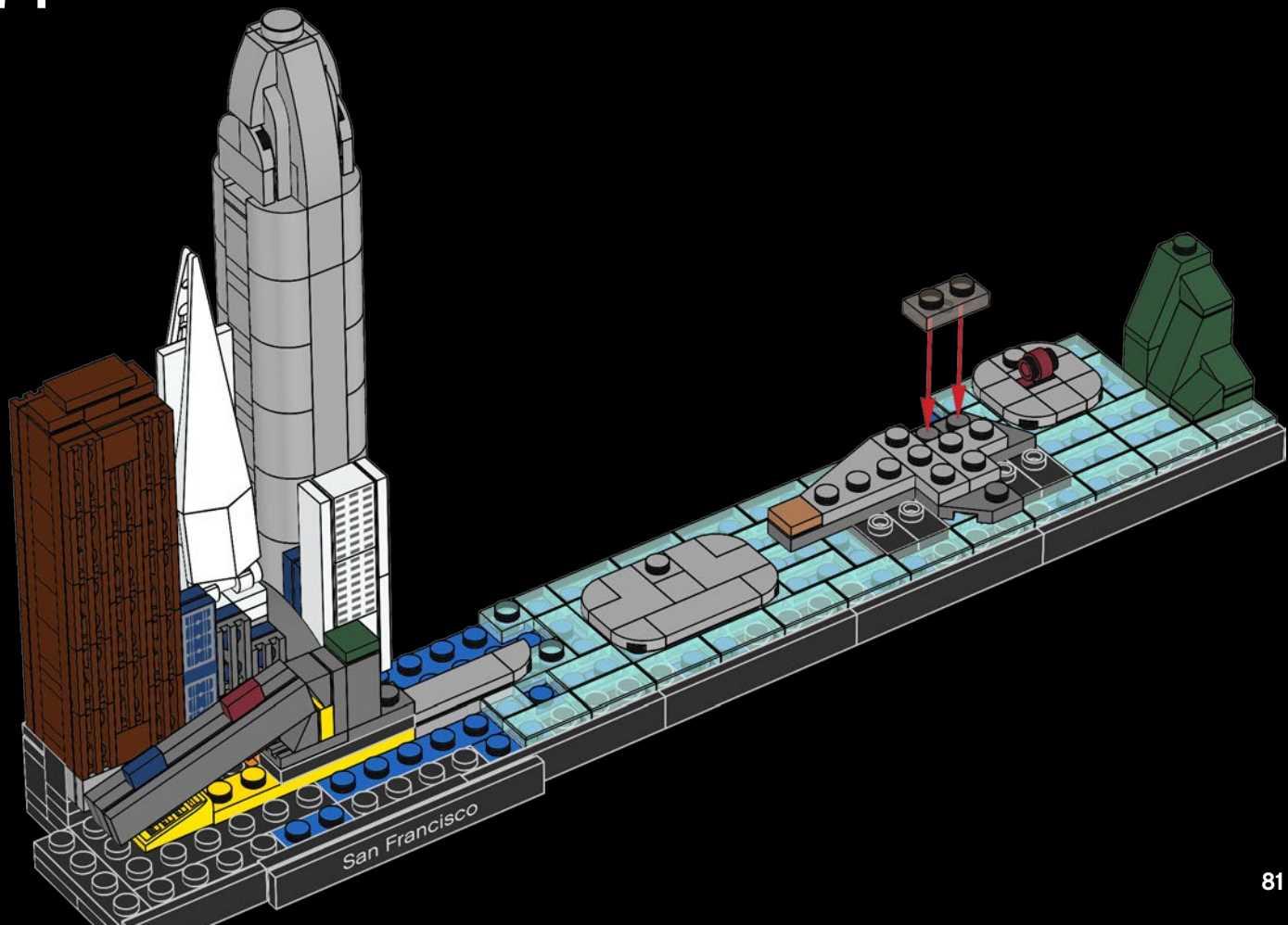



75

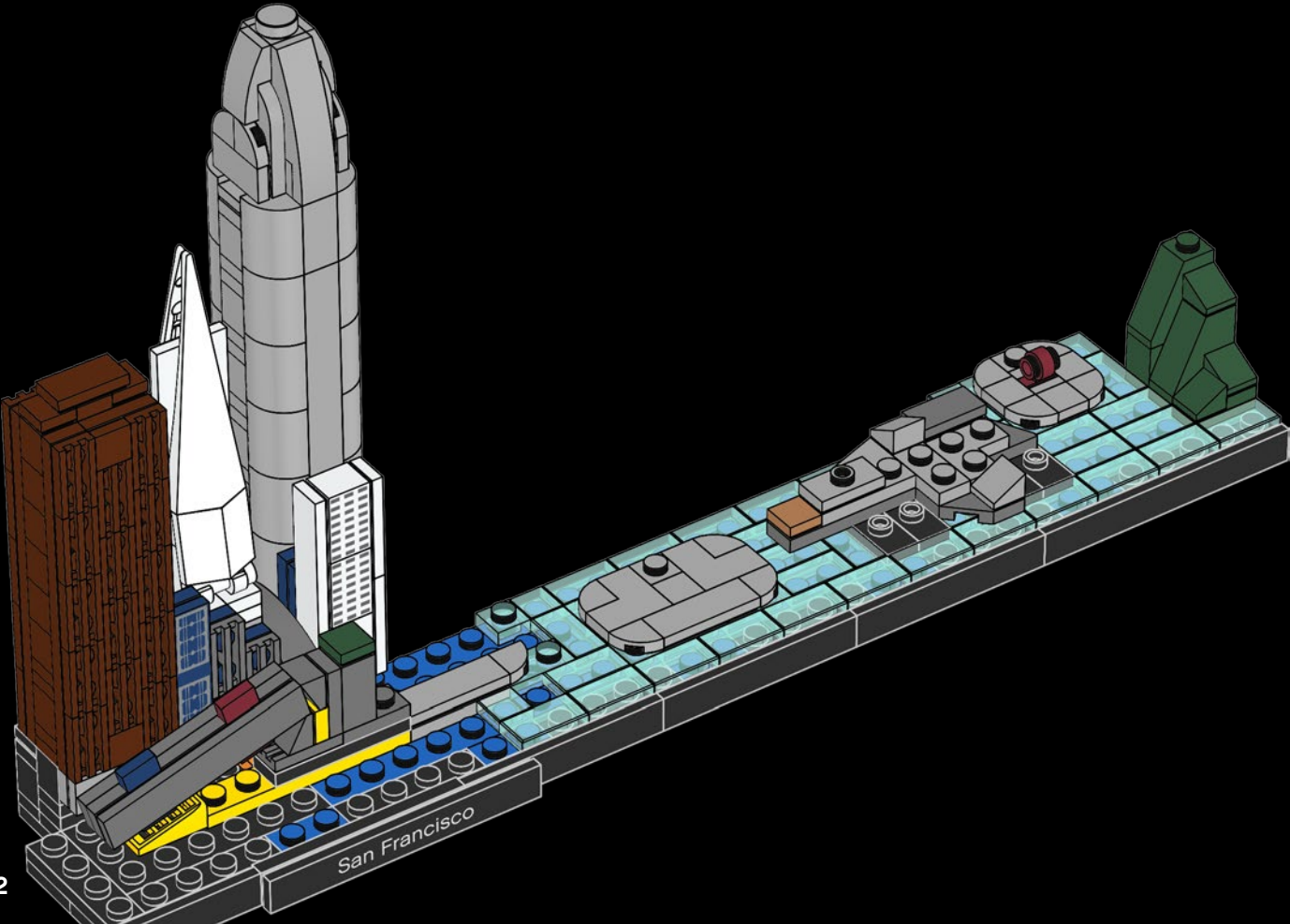



76

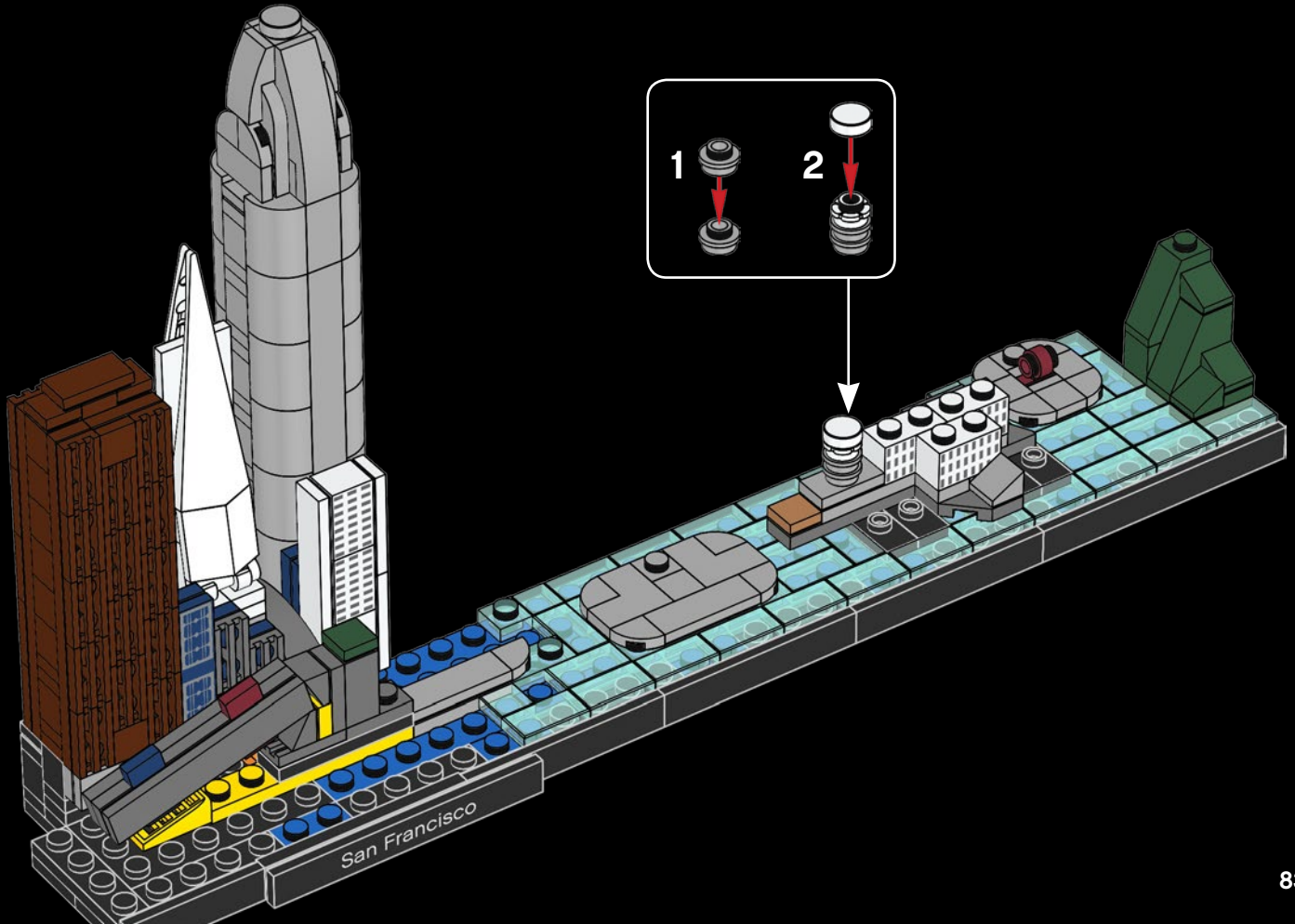

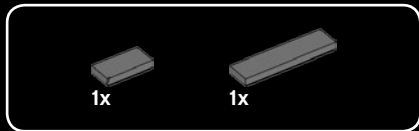

77

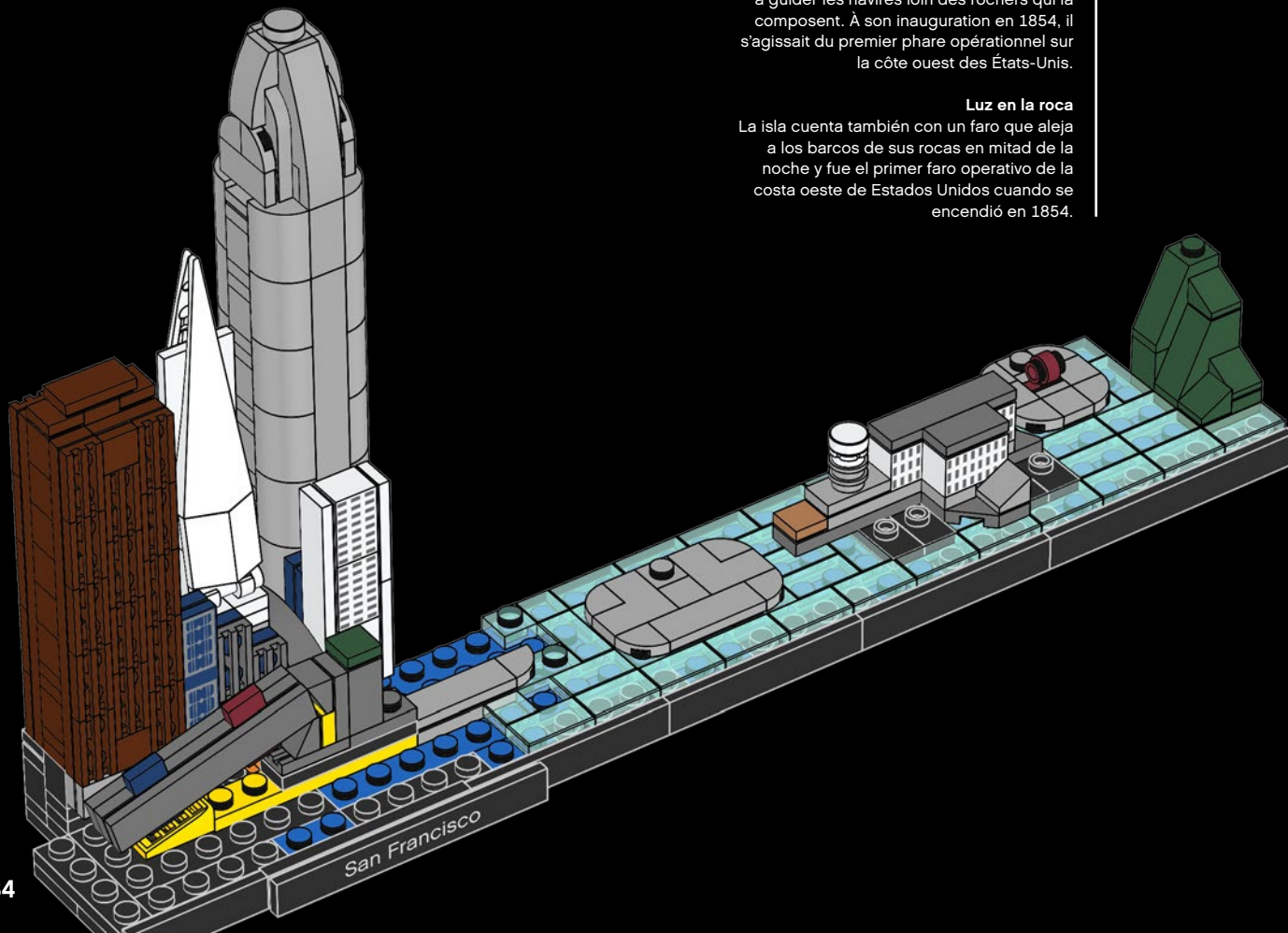

Light on The "Rock"

The island also has a lighthouse on it to help guide ships away from its rocks in the middle of the night, and was the first operational lighthouse on the west coast of the USA when it was lit in 1854.

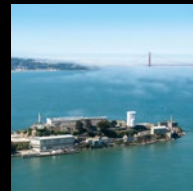

Une lumière dans l'obscurité

Sur l'île, un phare éclaire la nuit pour aider à guider les navires loin des rochers qui la composent. À son inauguration en 1854, il s'agissait du premier phare opérationnel sur la côte ouest des États-Unis.

Luz en la roca

La isla cuenta también con un faro que aleja a los barcos de sus rocas en mitad de la noche y fue el primer faro operativo de la costa oeste de Estados Unidos cuando se encendió en 1854.

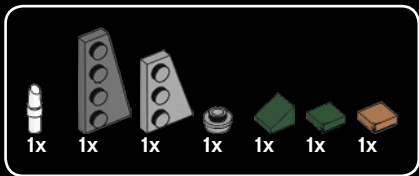

78

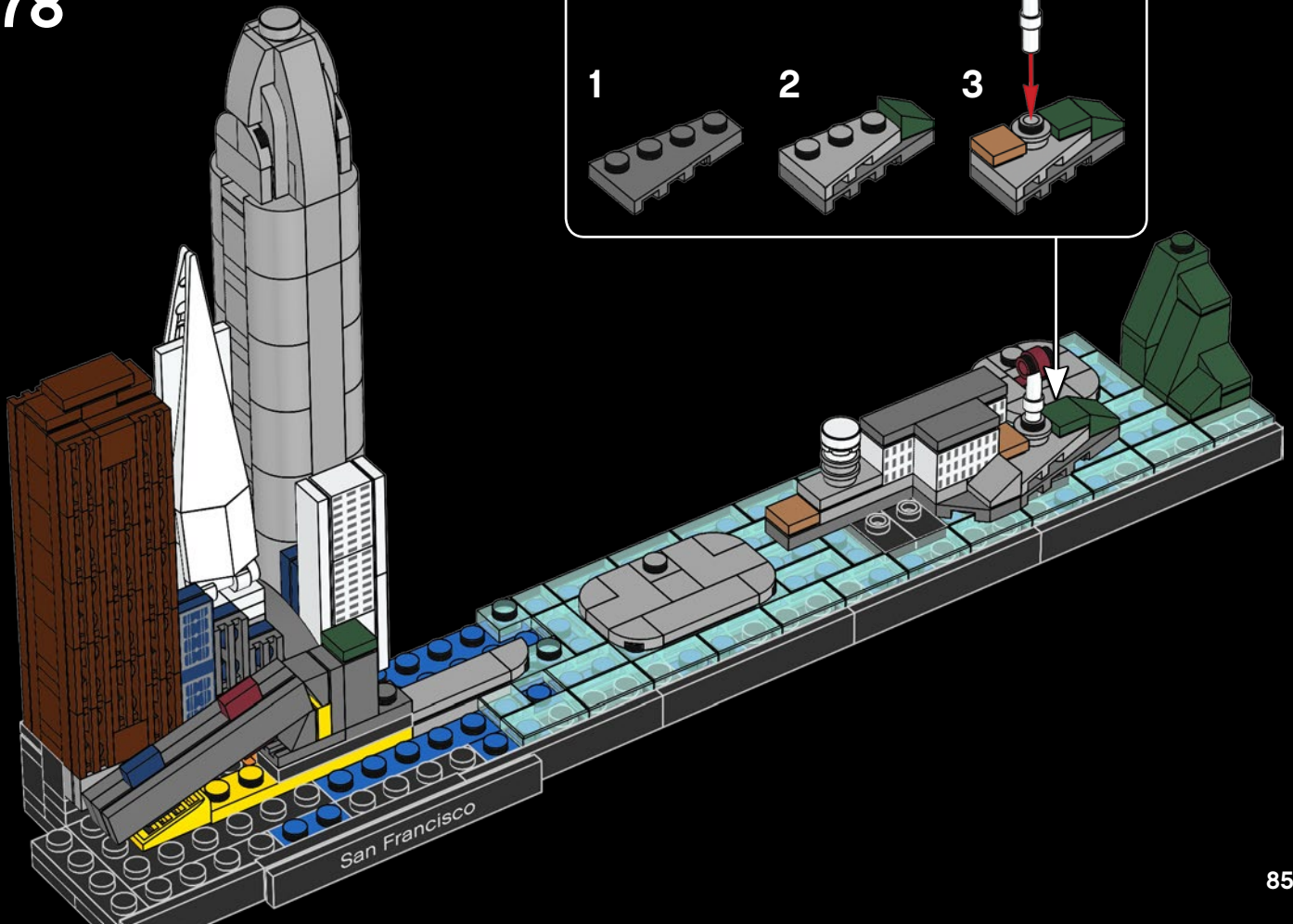
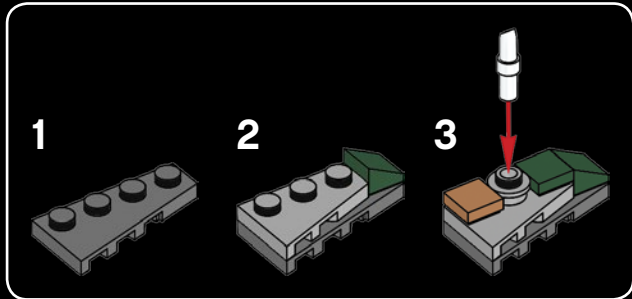

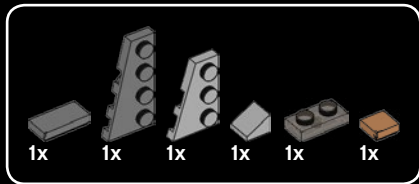

79

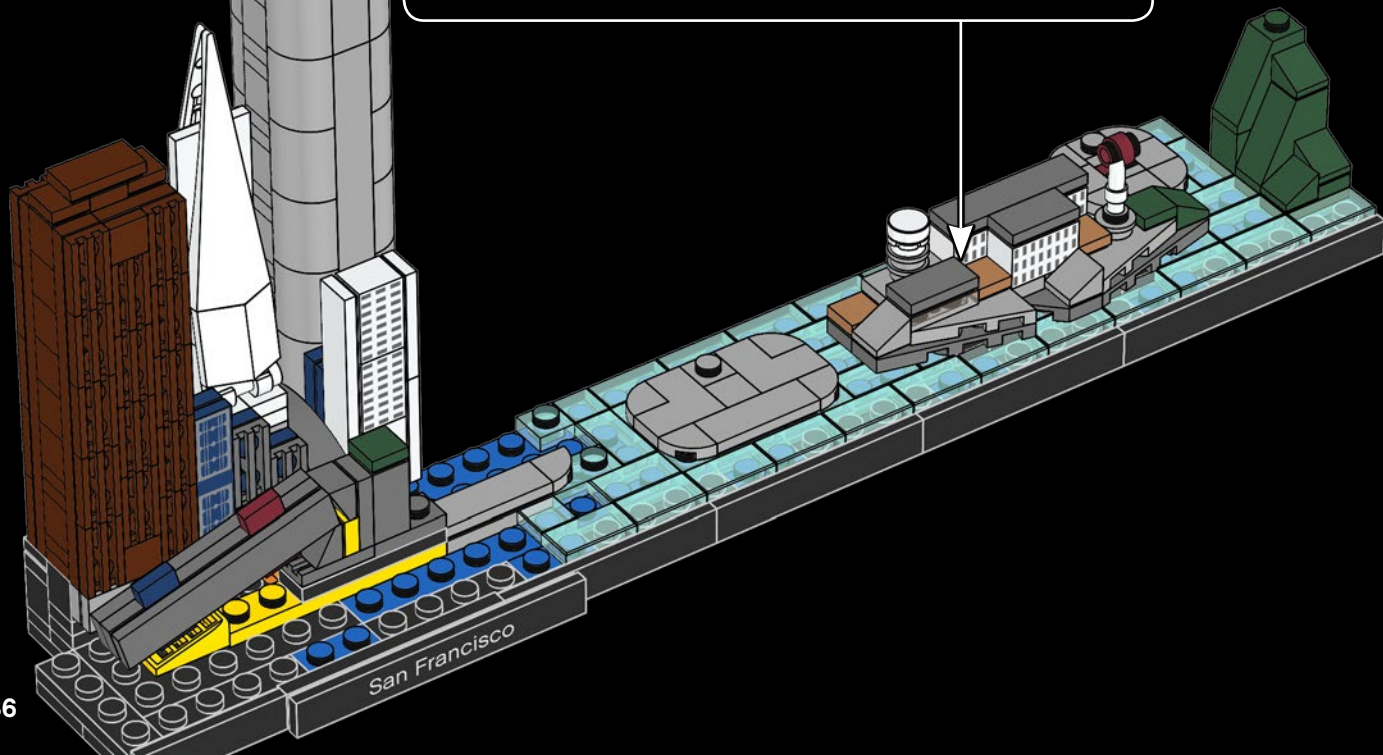
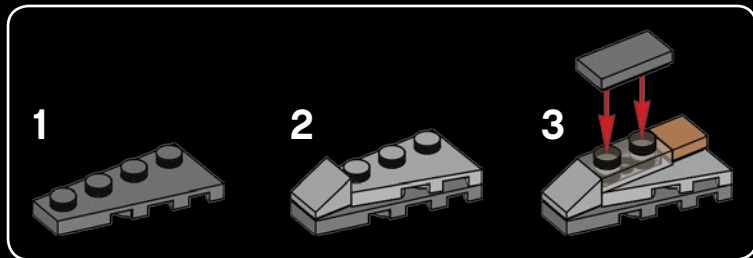

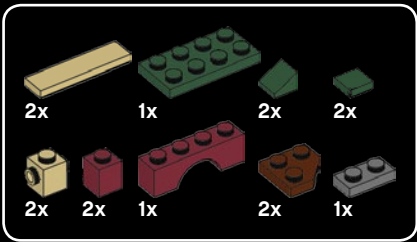

80

1



2

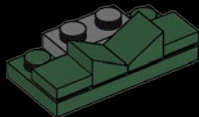

3

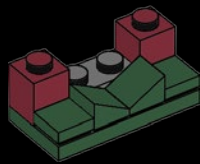

4

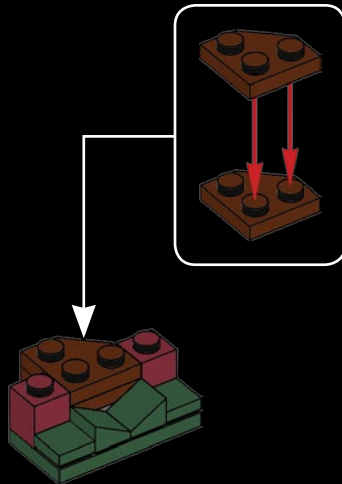

5

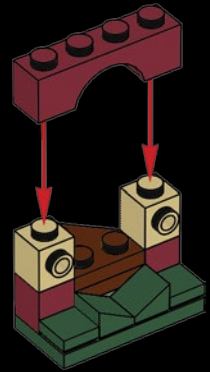

6

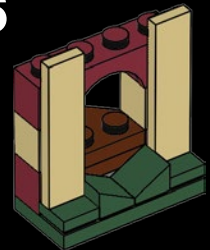

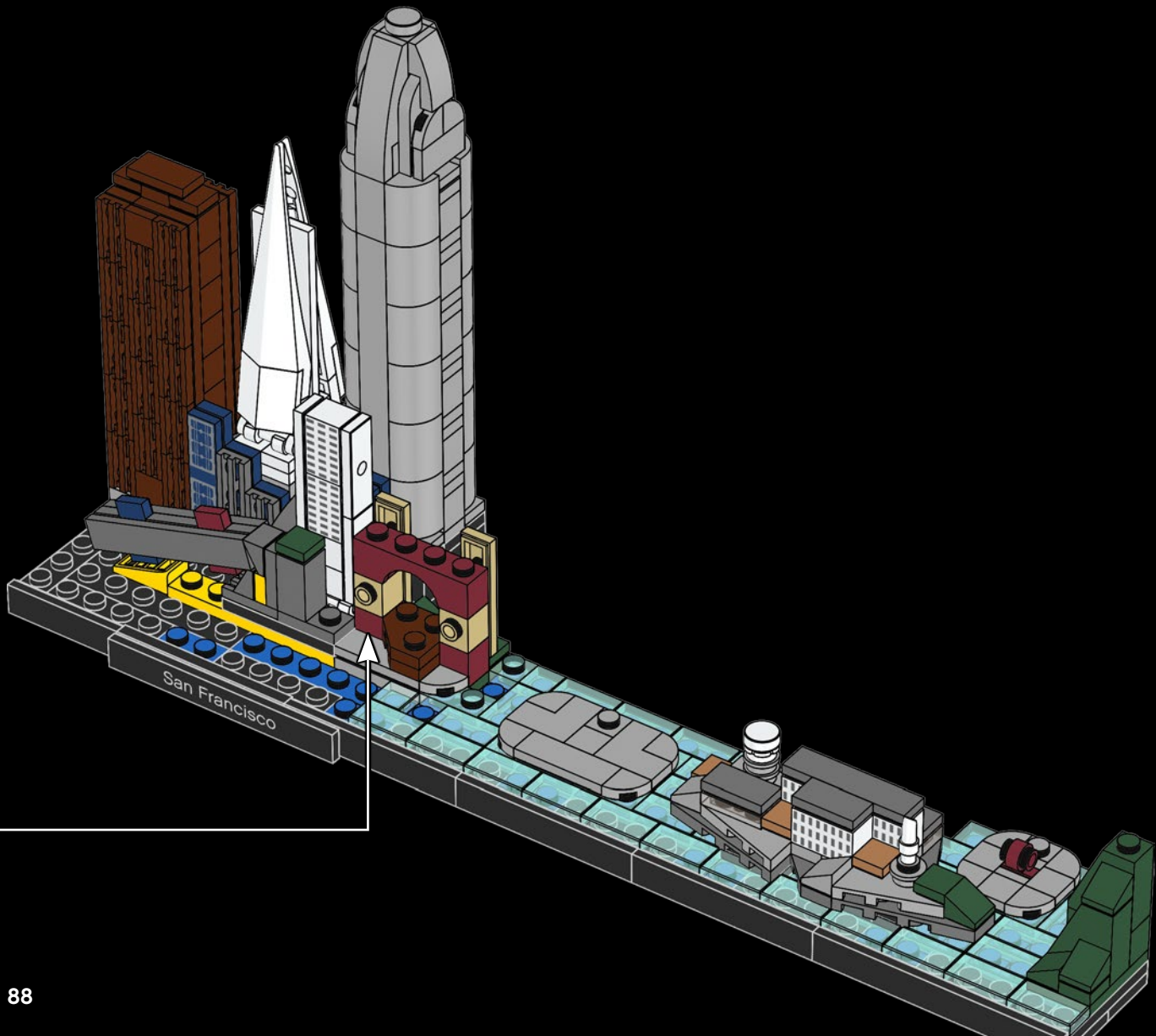

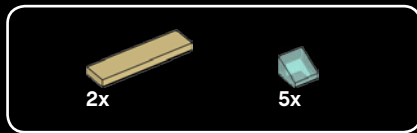

81

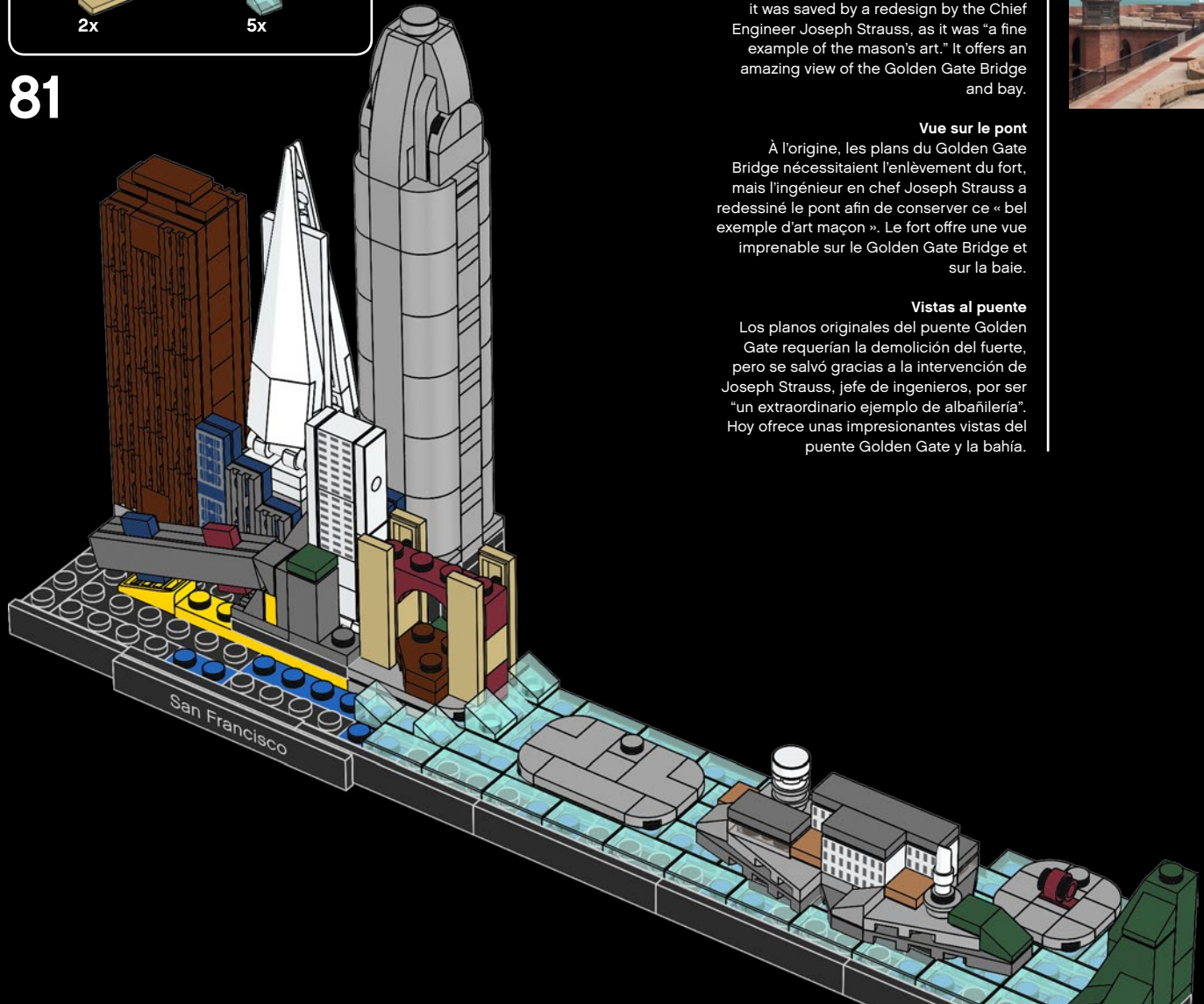

View of the bridge

Original plans for the Golden Gate Bridge would have required the fort's removal, but it was saved by a redesign by the Chief Engineer Joseph Strauss, as it was "a fine example of the mason's art." It offers an amazing view of the Golden Gate Bridge and bay.



Vue sur le pont

À l'origine, les plans du Golden Gate Bridge nécessitaient l'enlèvement du fort, mais l'ingénieur en chef Joseph Strauss a redessiné le pont afin de conserver ce « bel exemple d'art maçon ». Le fort offre une vue imprenable sur le Golden Gate Bridge et sur la baie.

Vistas al puente

Los planos originales del puente Golden Gate requerían la demolición del fuerte, pero se salvó gracias a la intervención de Joseph Strauss, jefe de ingenieros, por ser "un extraordinario ejemplo de albañilería". Hoy ofrece unas impresionantes vistas del puente Golden Gate y la bahía.

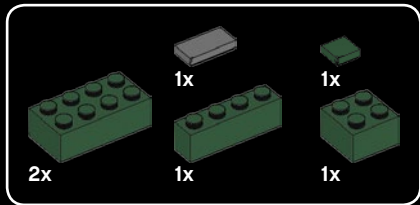

82

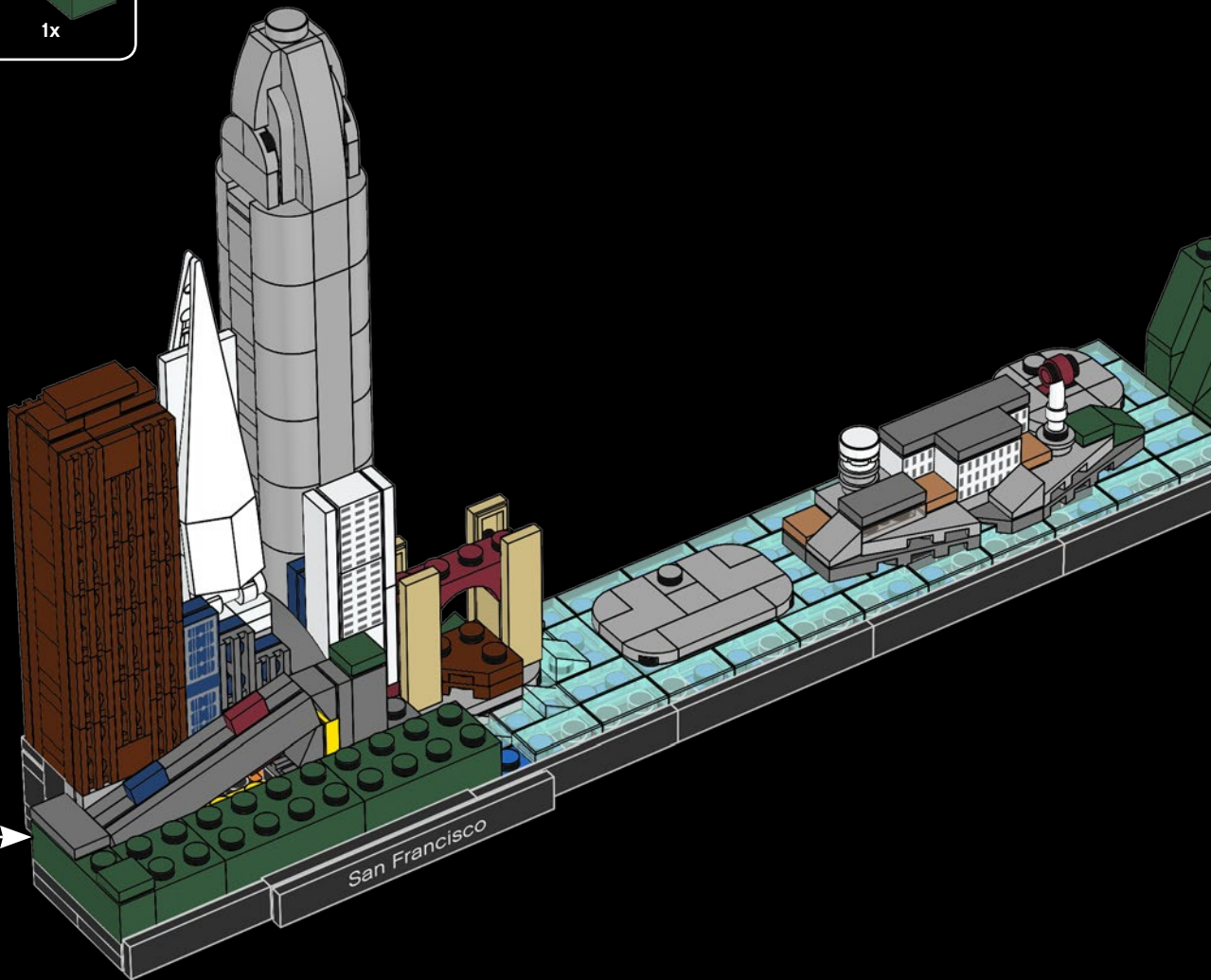
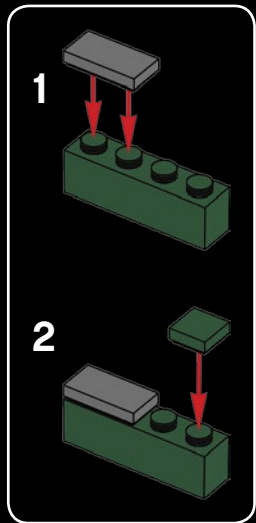

84

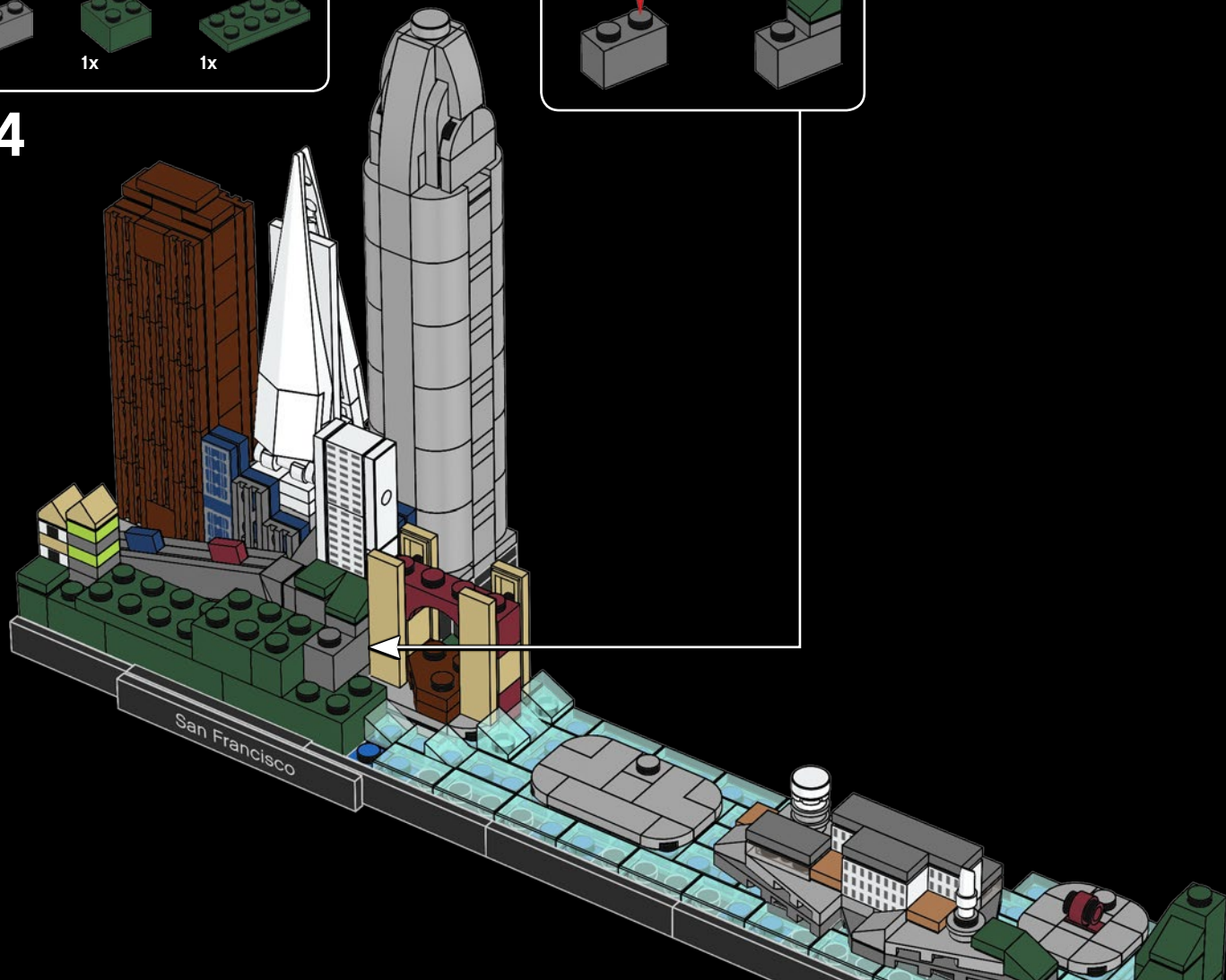
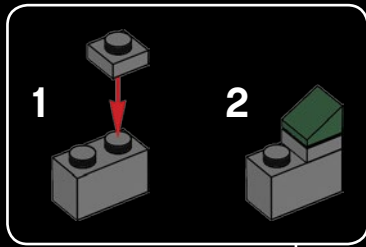
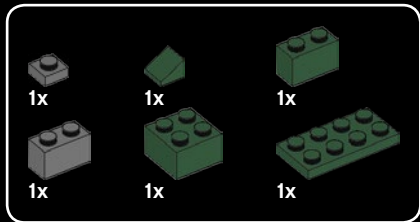



85

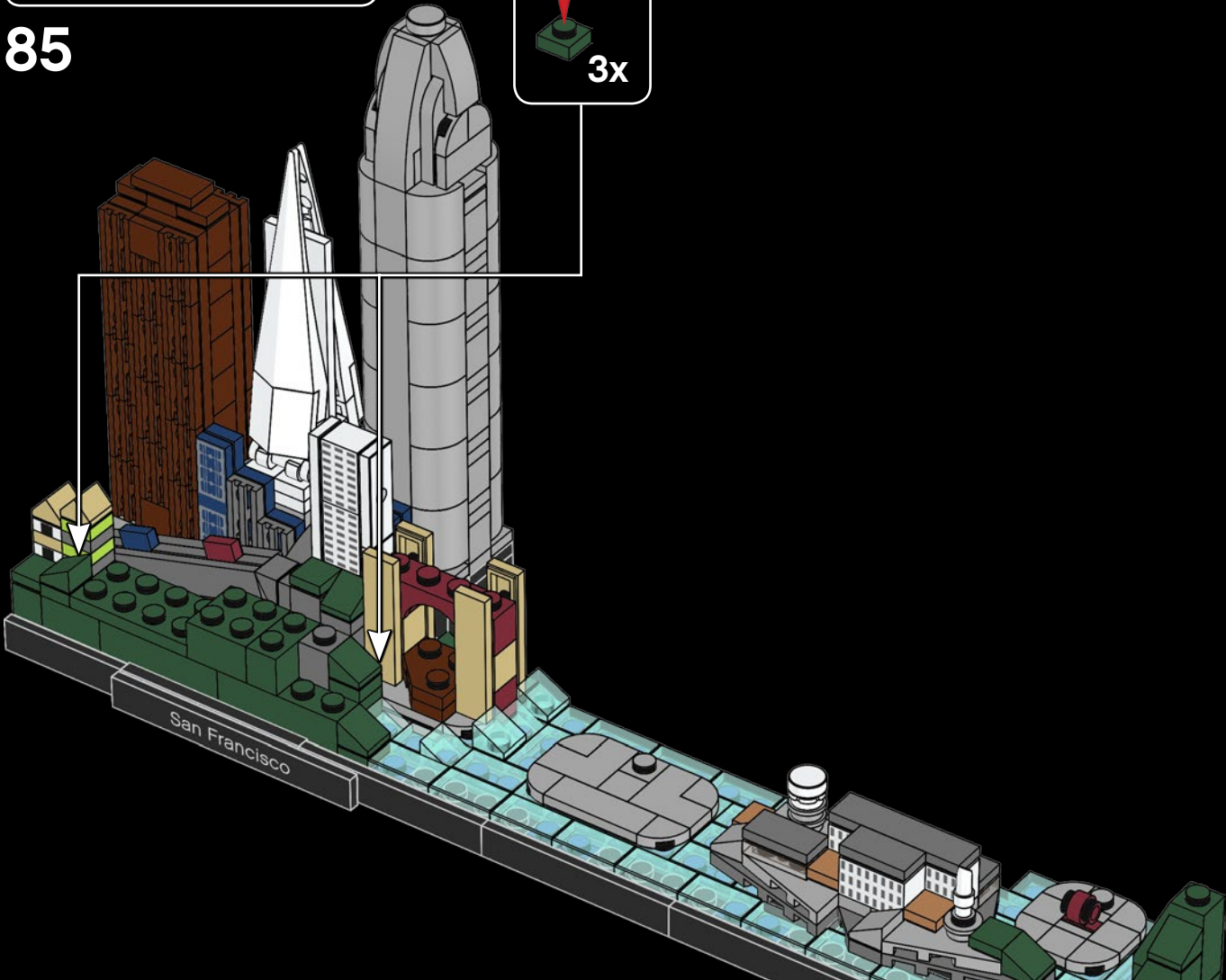
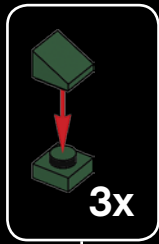

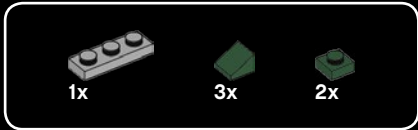

86

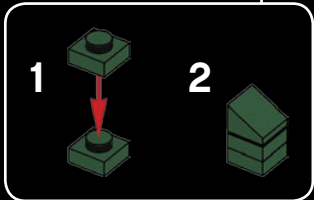
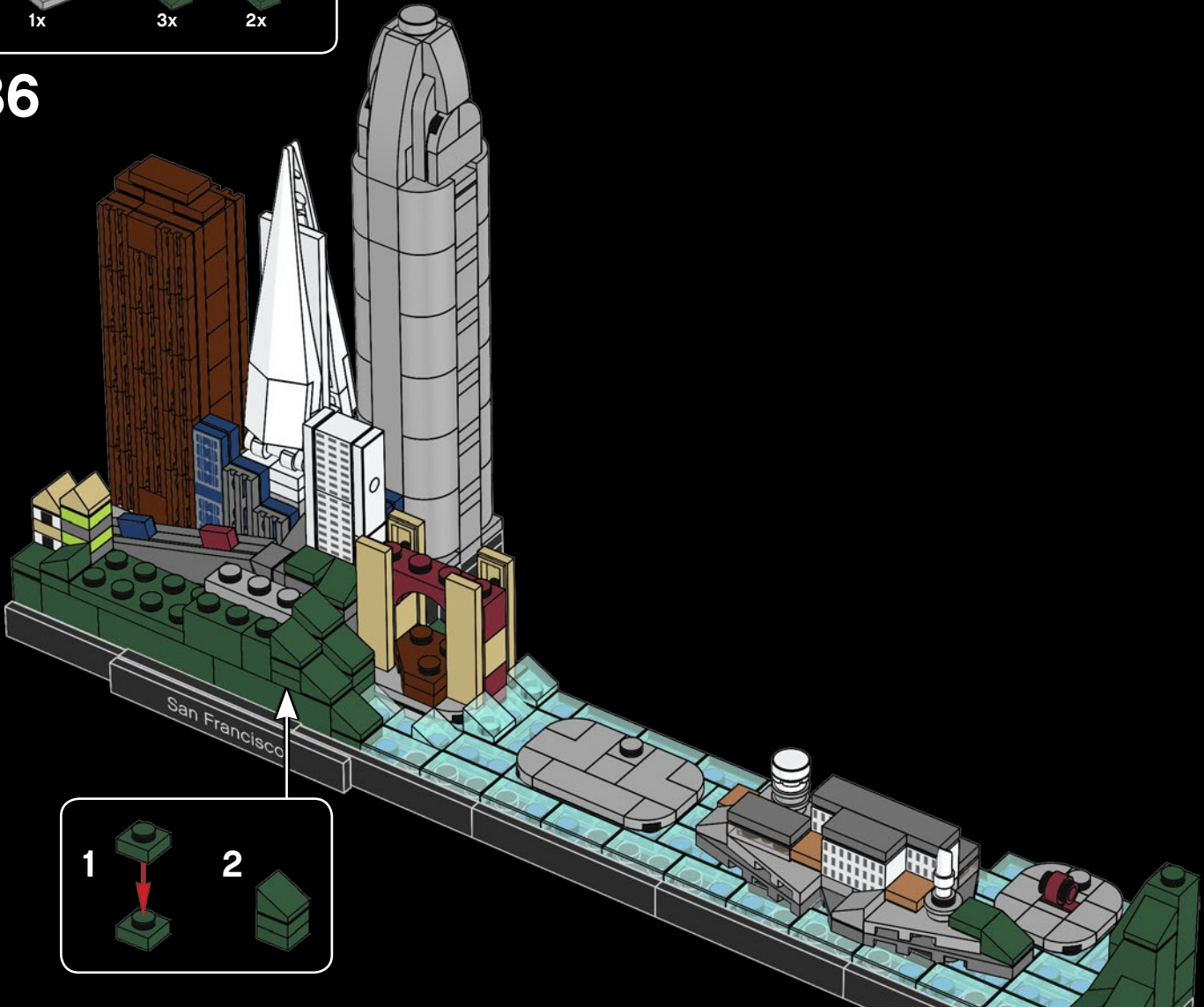

2x	1x	1x	1x

87



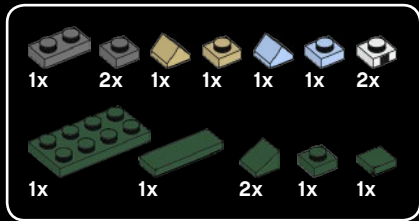

88

1

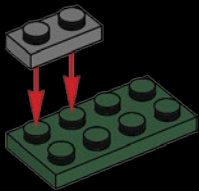

2

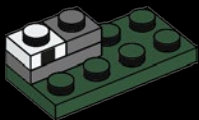

3

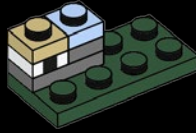

4

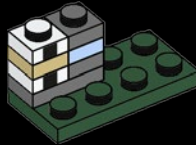

5



6



7



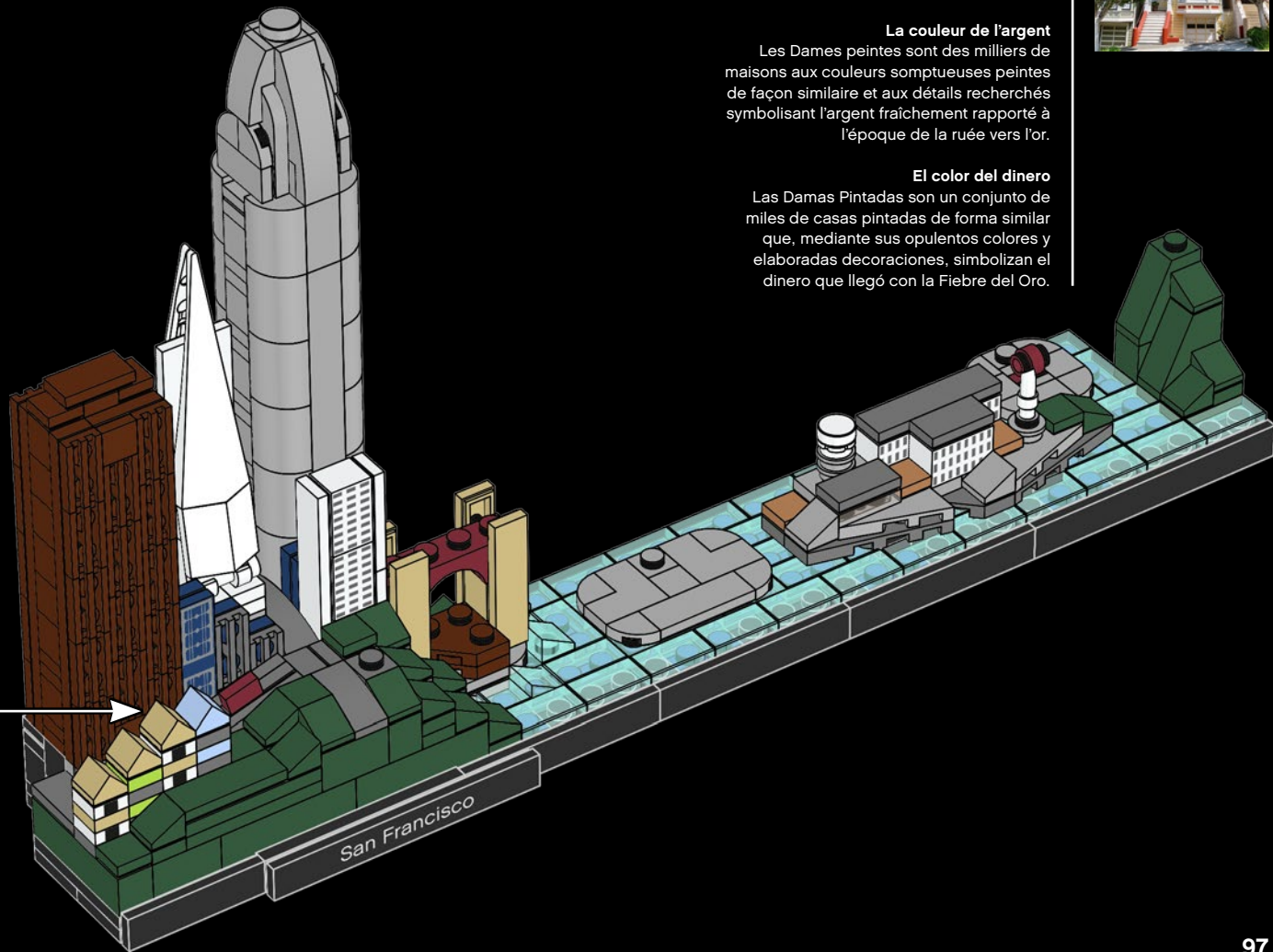

The Color of Money
Painted Ladies consist of thousands of similarly painted houses that, with their opulent colors and elaborate decorations, symbolize the new money that came with the Gold Rush Era.



La couleur de l'argent
Les Dames peintes sont des milliers de maisons aux couleurs somptueuses peintes de façon similaire et aux détails recherchés symbolisant l'argent fraîchement rapporté à l'époque de la ruée vers l'or.

El color del dinero
Las Damas Pintadas son un conjunto de miles de casas pintadas de forma similar que, mediante sus opulentos colores y elaboradas decoraciones, simbolizan el dinero que llegó con la Fiebre del Oro.



2x



1x



1x



1x

89

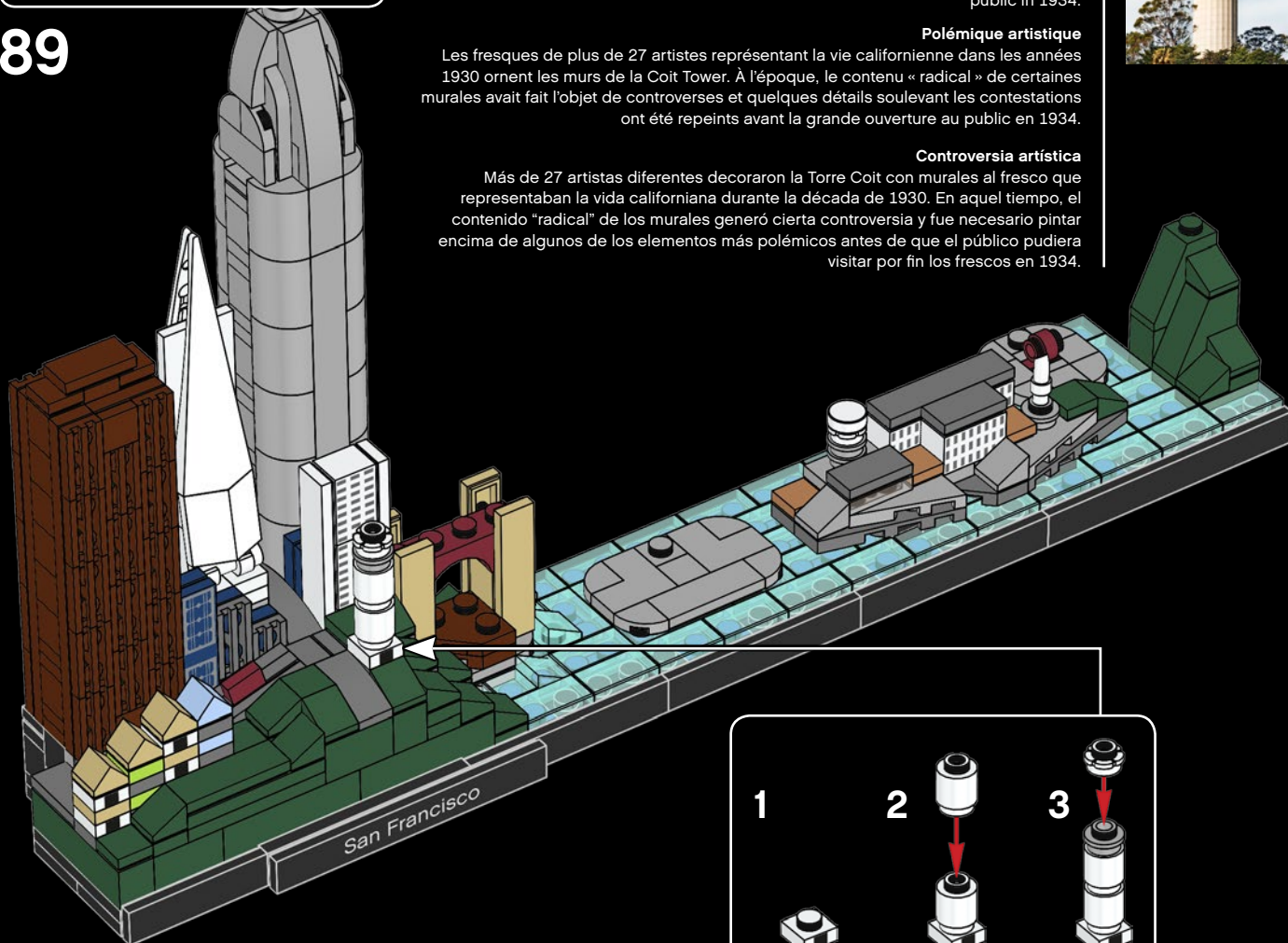

San Francisco

Artistic Controversy

Over 27 different artists decorated the Coit Tower with fresco murals depicting California life in the 1930s. At the time, there was some controversy over the murals' 'radical' content and some of the most contentious elements were painted over before the frescoes were finally open to the public in 1934.

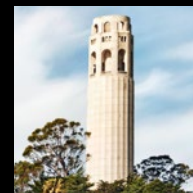

Polémique artistique

Les fresques de plus de 27 artistes représentant la vie californienne dans les années 1930 ornent les murs de la Coit Tower. À l'époque, le contenu « radical » de certaines murales avait fait l'objet de controverses et quelques détails soulevant les contestations ont été repeints avant la grande ouverture au public en 1934.

Controversia artística

Más de 27 artistas diferentes decoraron la Torre Coit con murales al fresco que representaban la vida californiana durante la década de 1930. En aquel tiempo, el contenido "radical" de los murales generó cierta controversia y fue necesario pintar encima de algunos de los elementos más polémicos antes de que el público pudiera visitar por fin los frescos en 1934.

1



2



3



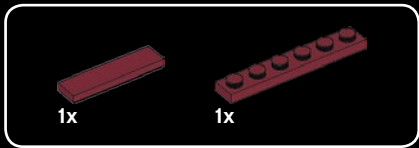

90

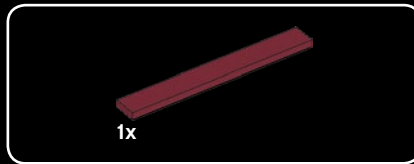
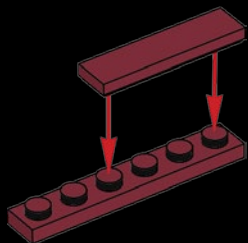

91

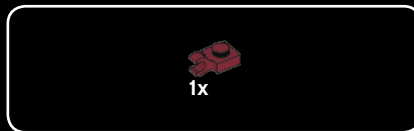
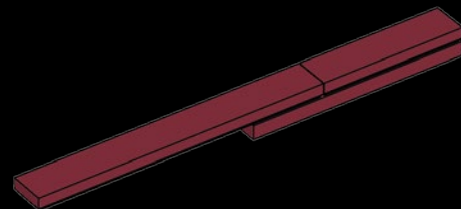

92

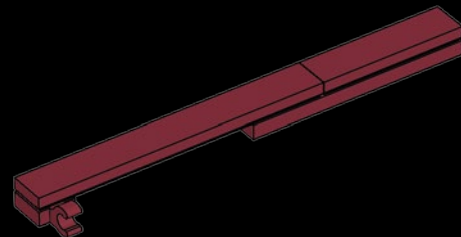

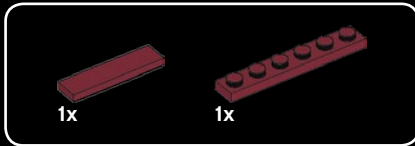

94

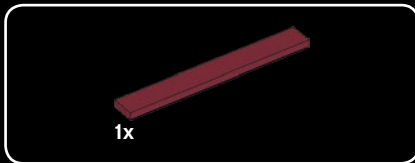
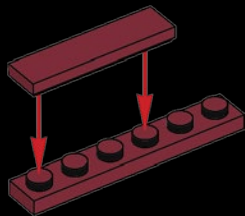

95

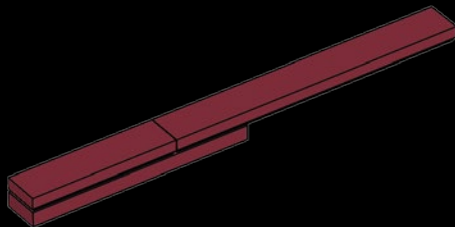

96

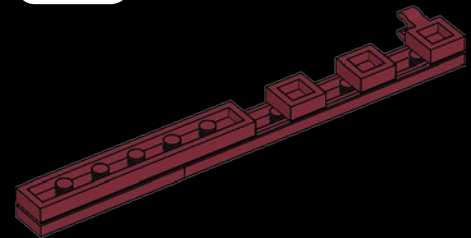
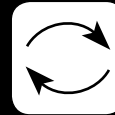

97

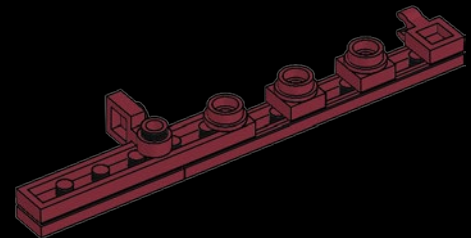

1x

98

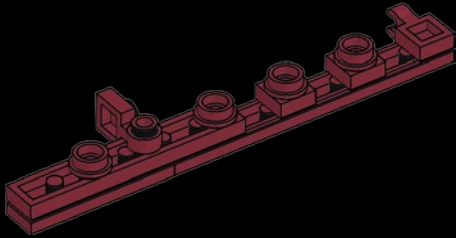

2x

1x

99

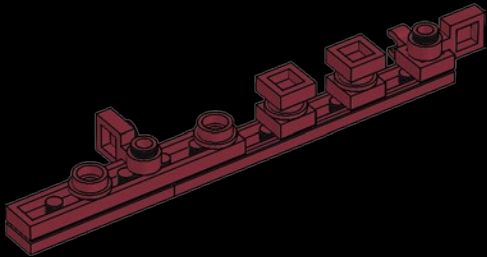

1x

100

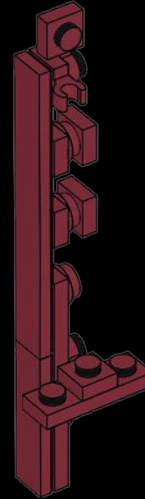

101

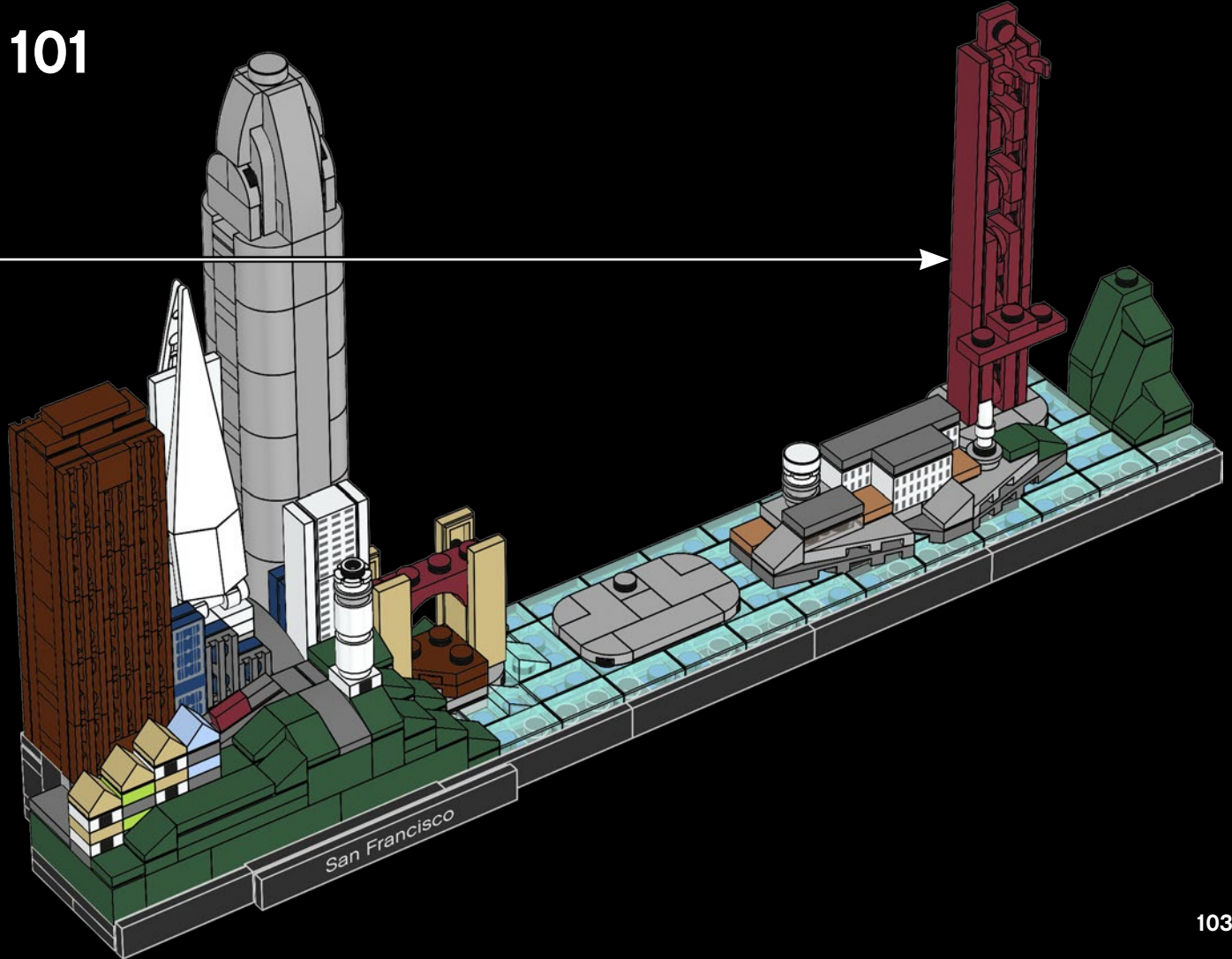

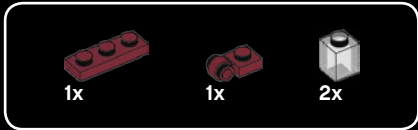

102

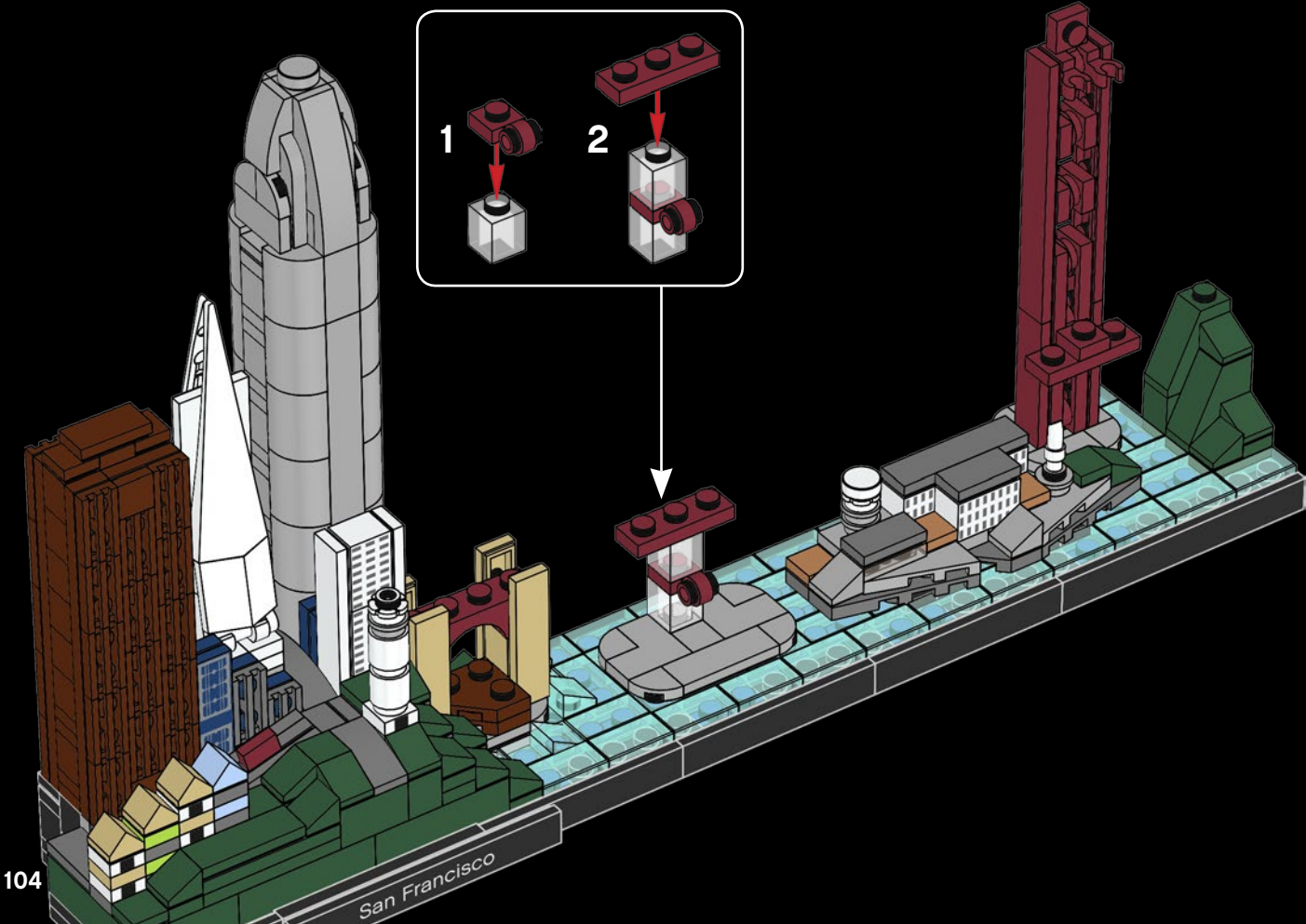
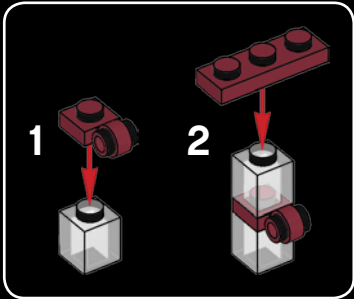

104

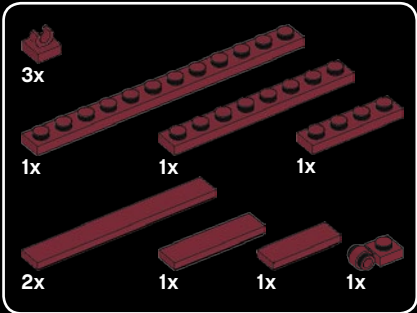
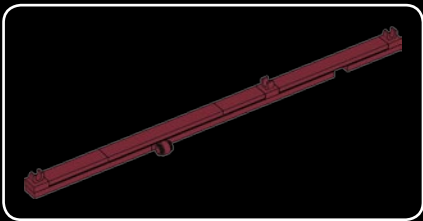

103

1

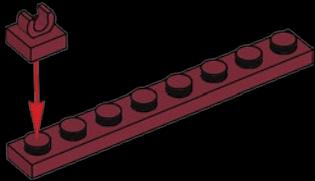

2

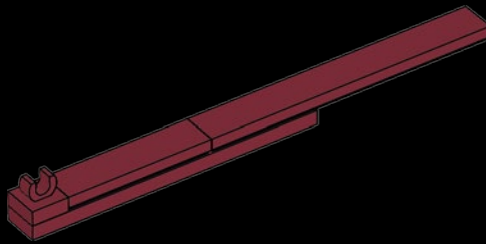

3

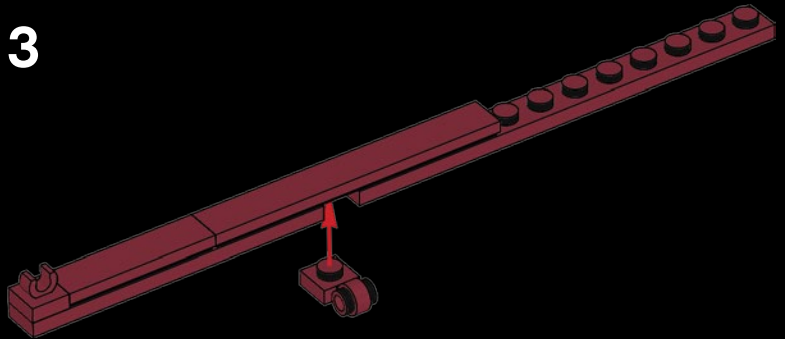

4

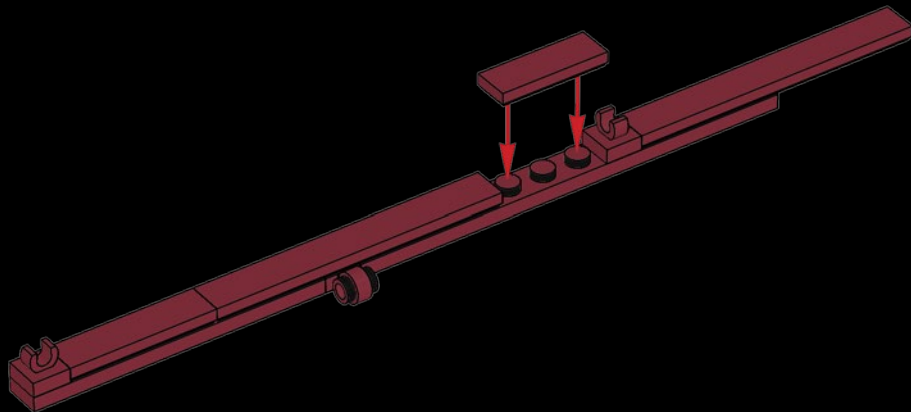

5

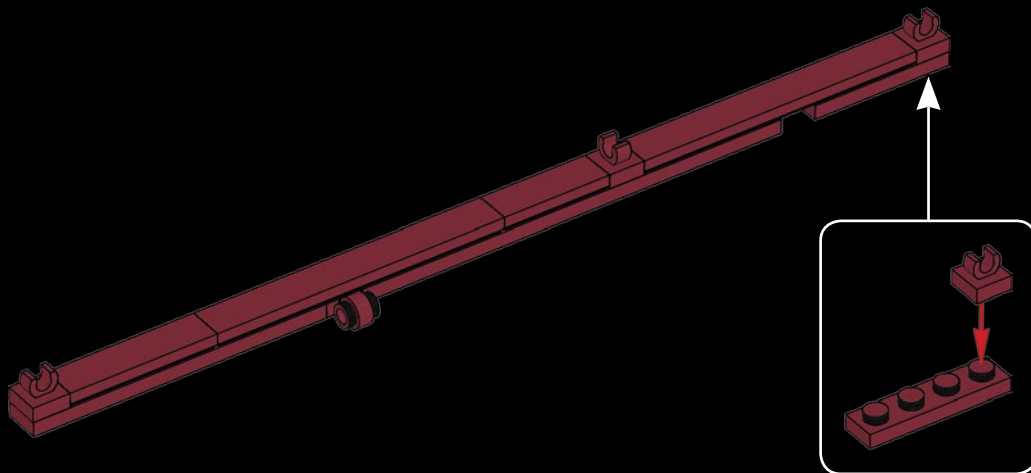

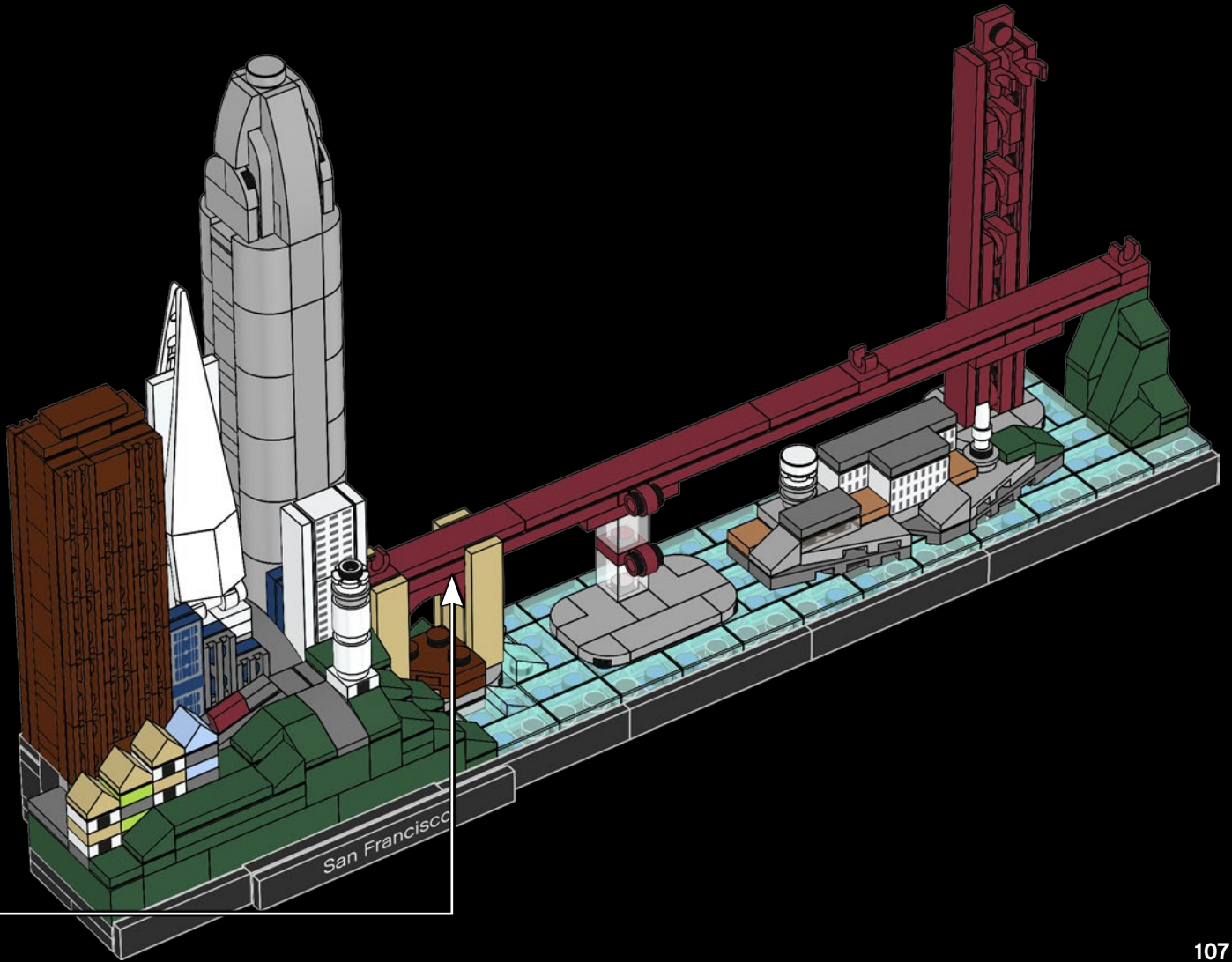

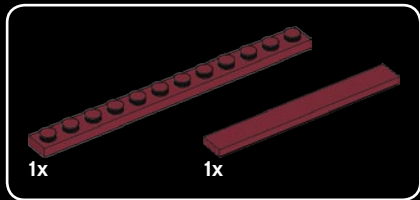

104

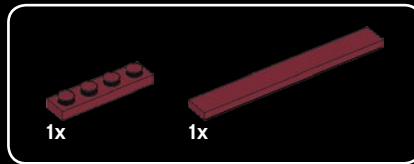
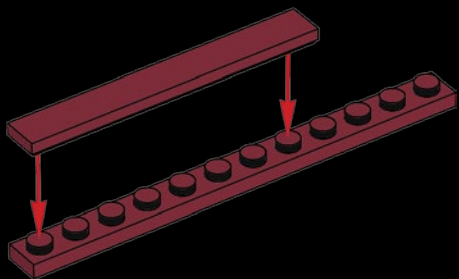

105

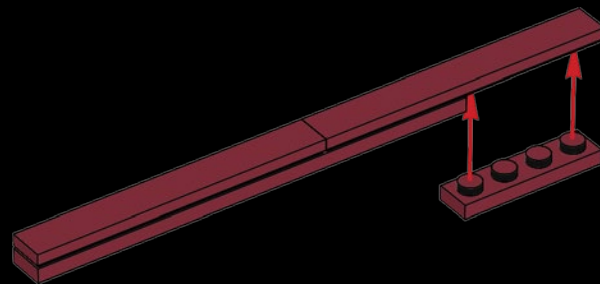

106

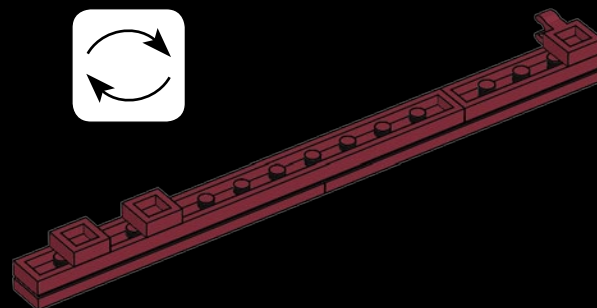

107

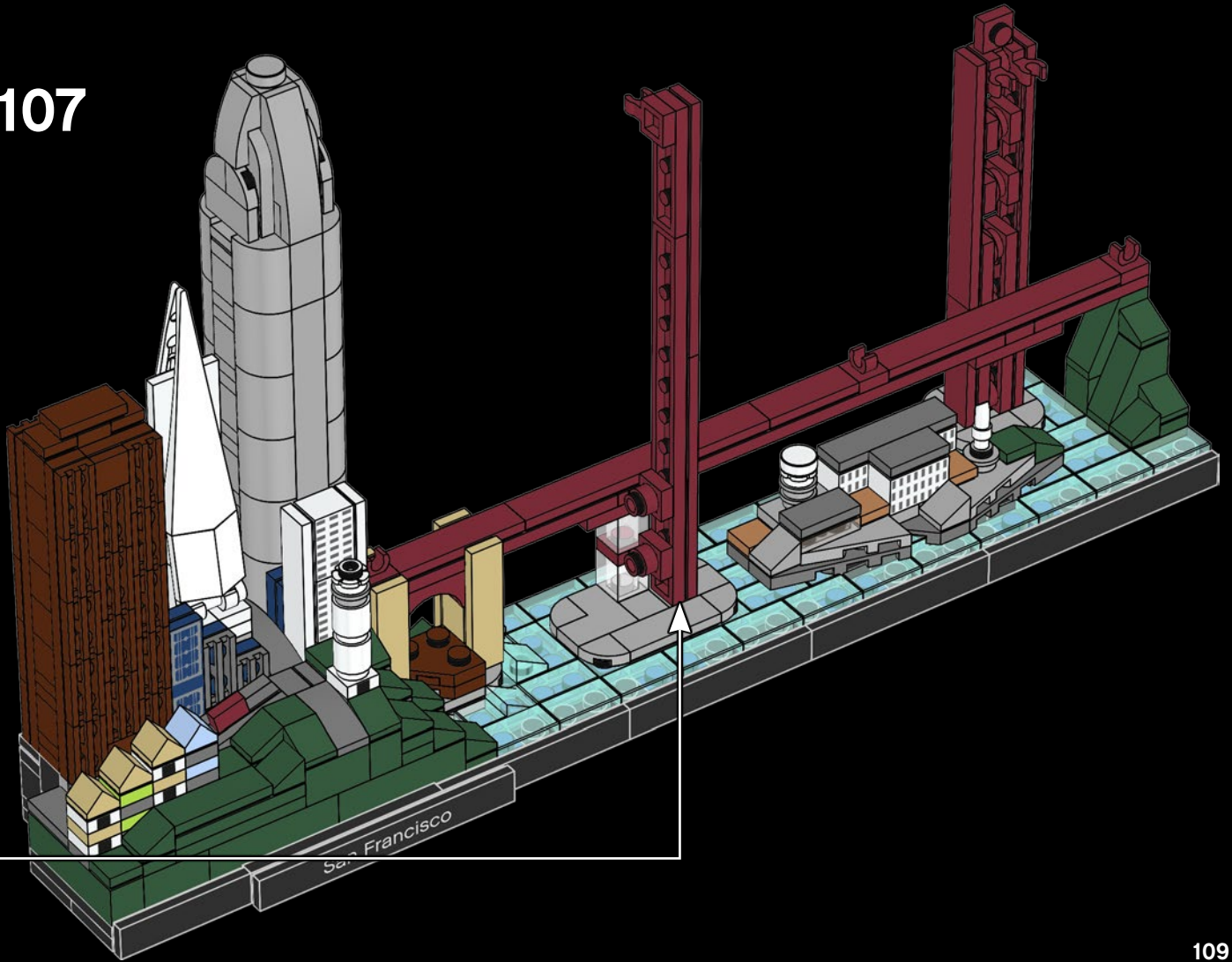

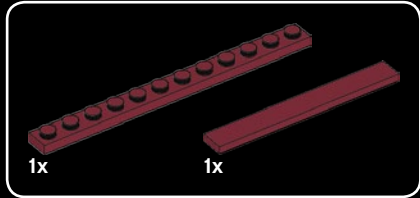
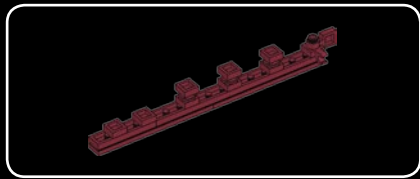

108

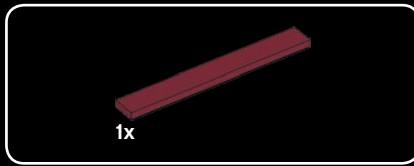
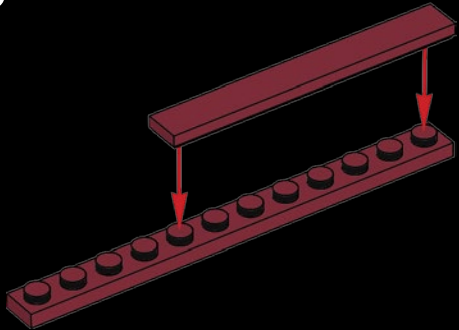

109

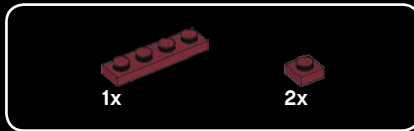
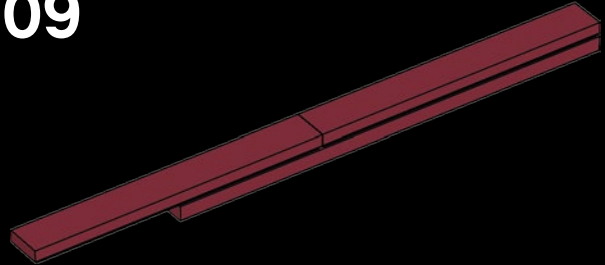

110

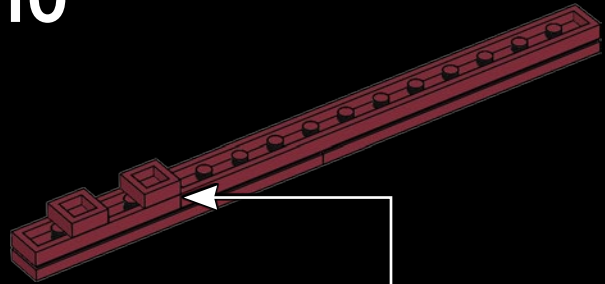



3x



1x

111

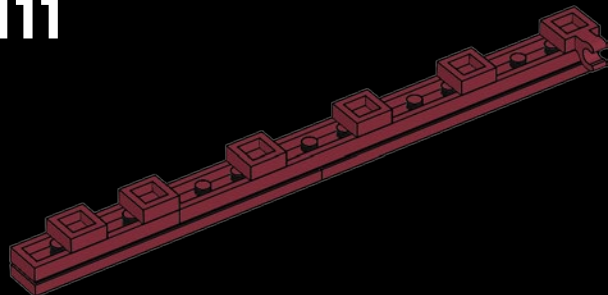

1x



3x

112

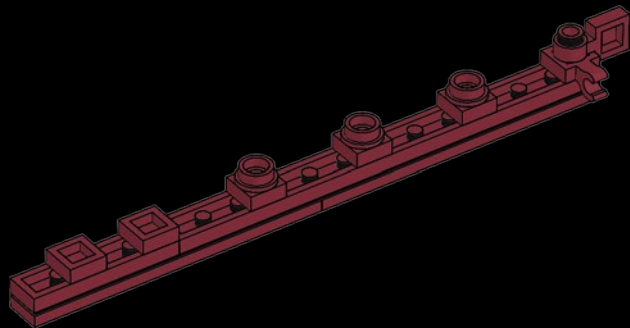

3x

113

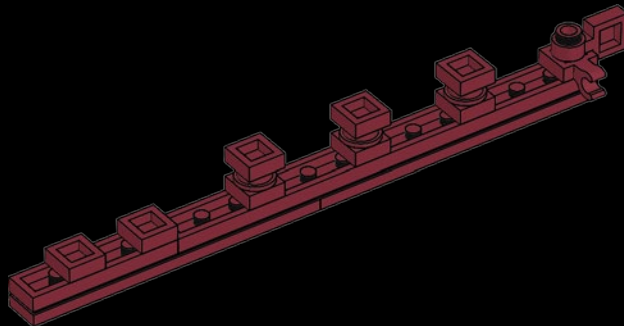

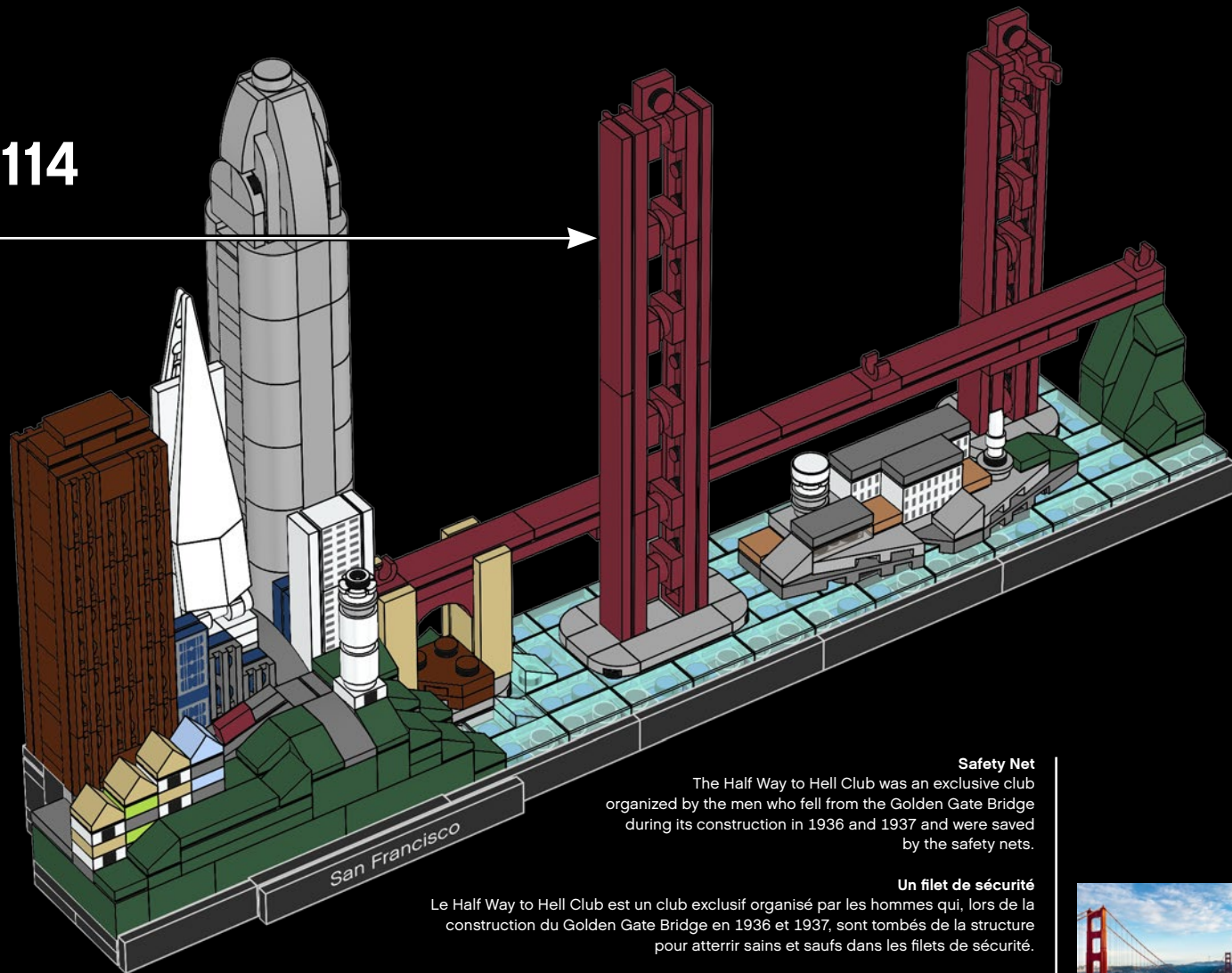

Safety Net

The Half Way to Hell Club was an exclusive club organized by the men who fell from the Golden Gate Bridge during its construction in 1936 and 1937 and were saved by the safety nets.

Un filet de sécurité

Le Half Way to Hell Club est un club exclusif organisé par les hommes qui, lors de la construction du Golden Gate Bridge en 1936 et 1937, sont tombés de la structure pour atterrir sains et saufs dans les filets de sécurité.

Red de seguridad

El club Half Way to Hell fue una exclusiva asociación organizada por los hombres que se cayeron del puente Golden Gate durante su construcción entre 1936 y 1937 y se salvaron gracias a las redes de seguridad.



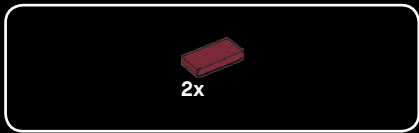

115

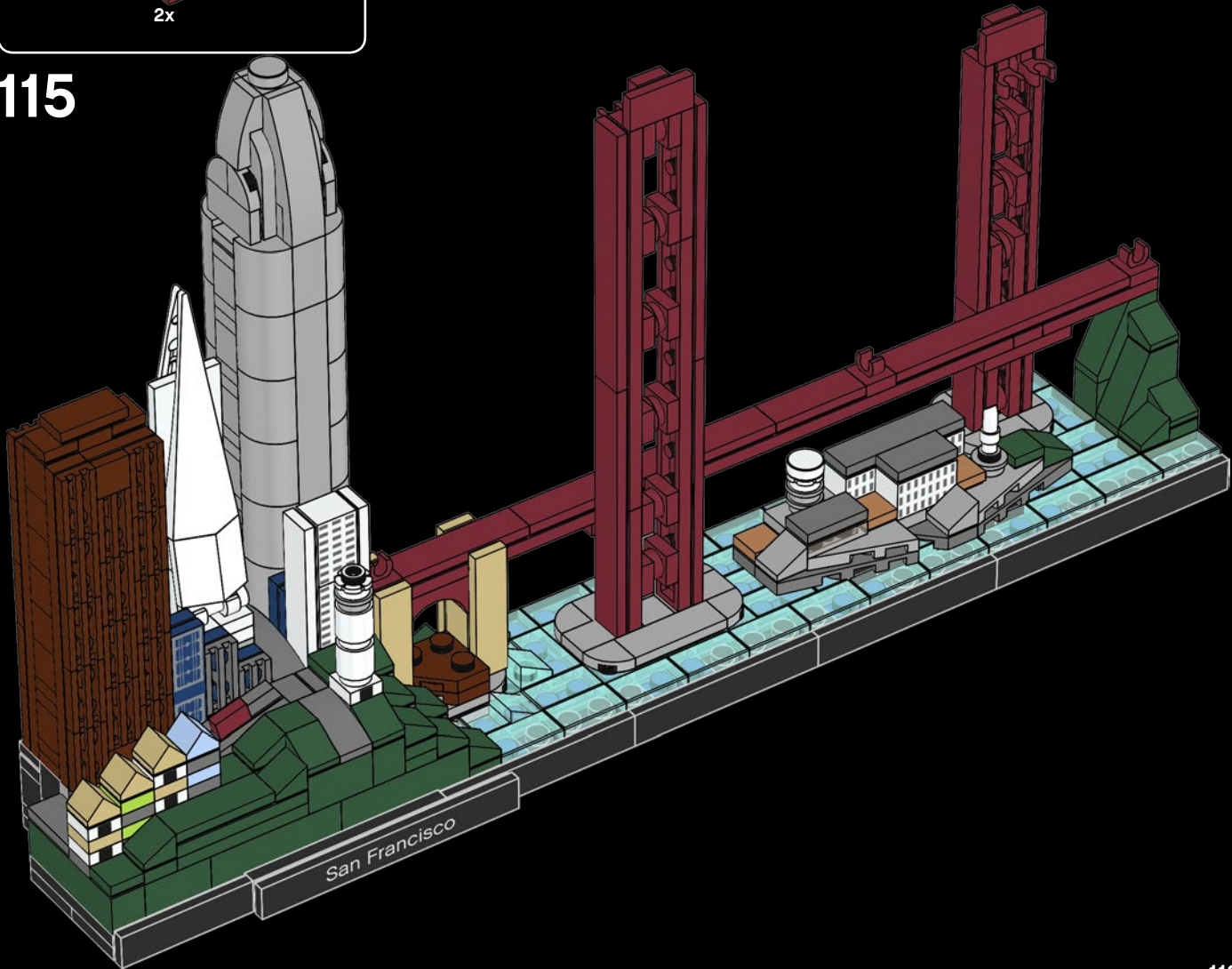

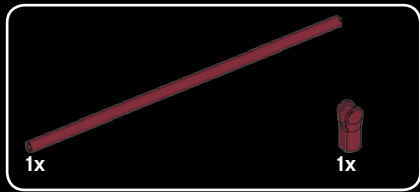

116

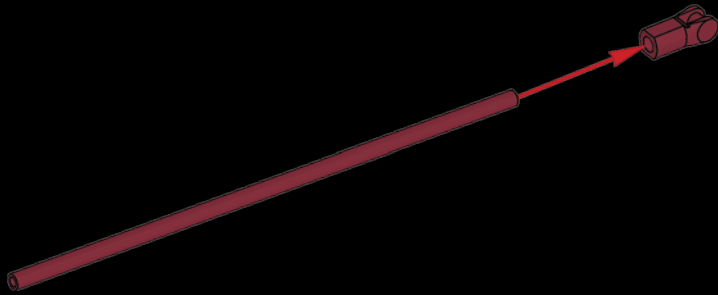

117

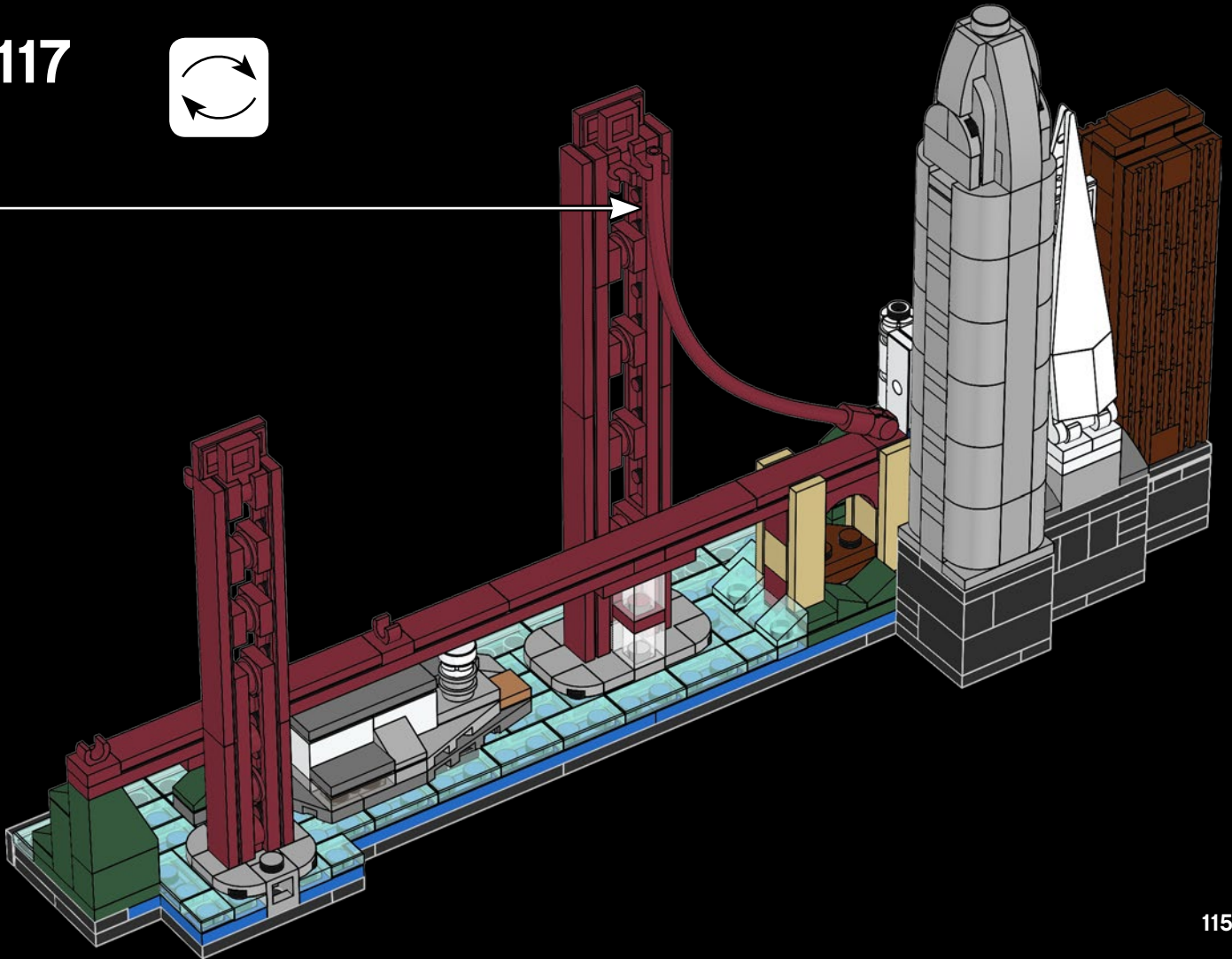

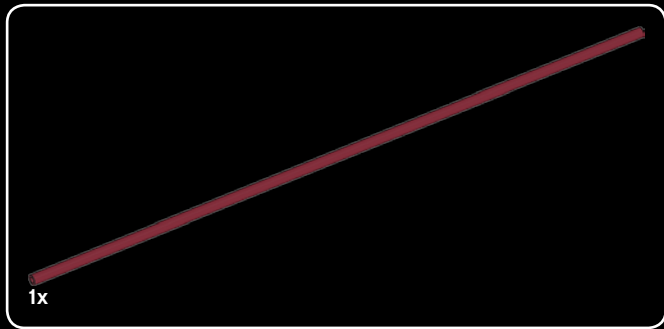

118

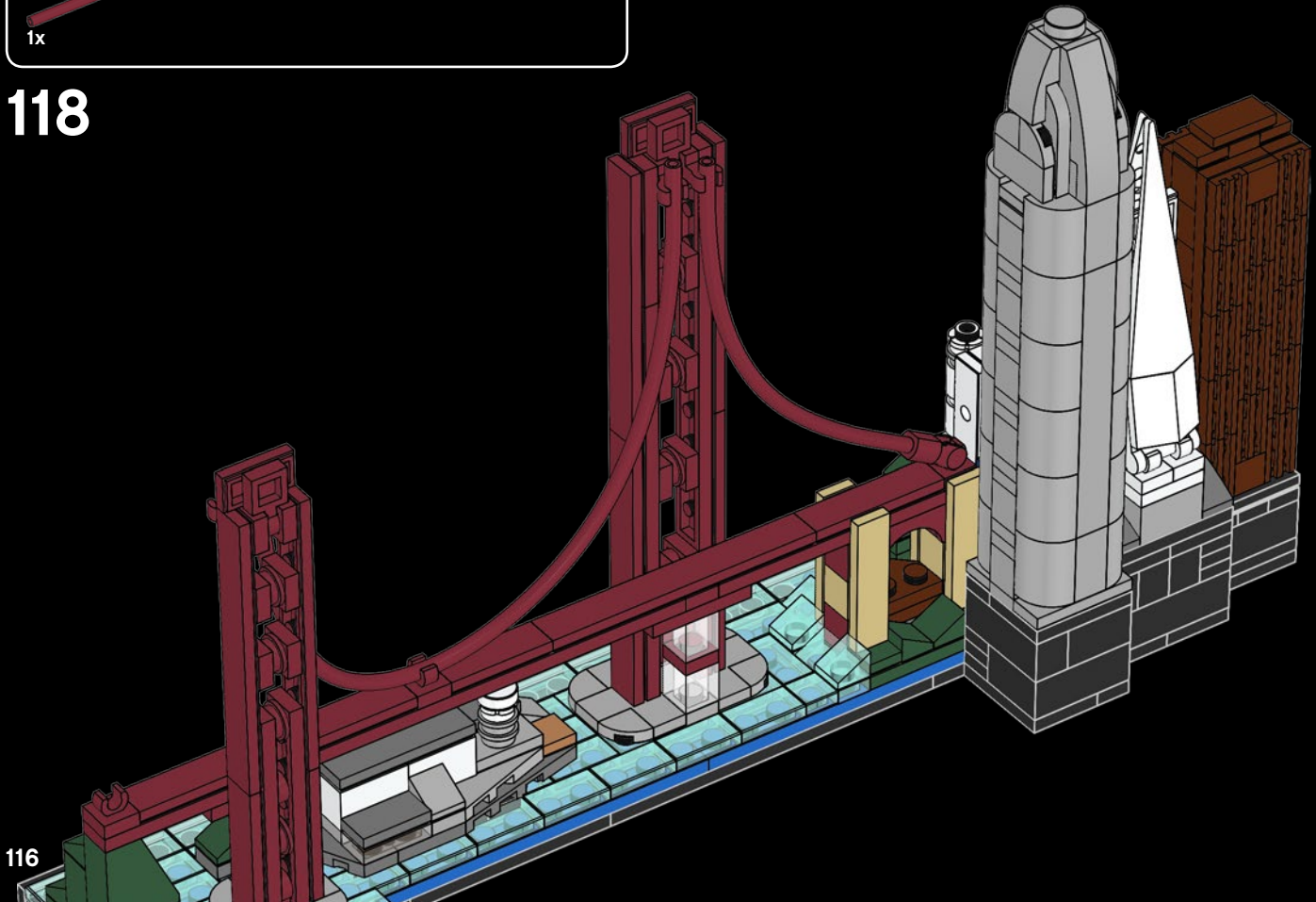

116

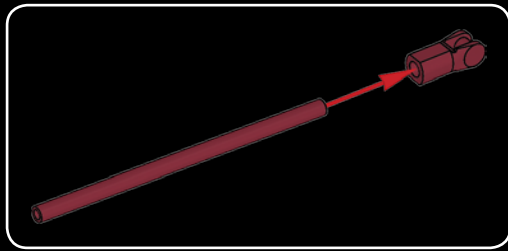
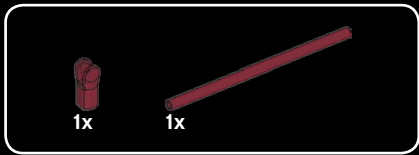

119

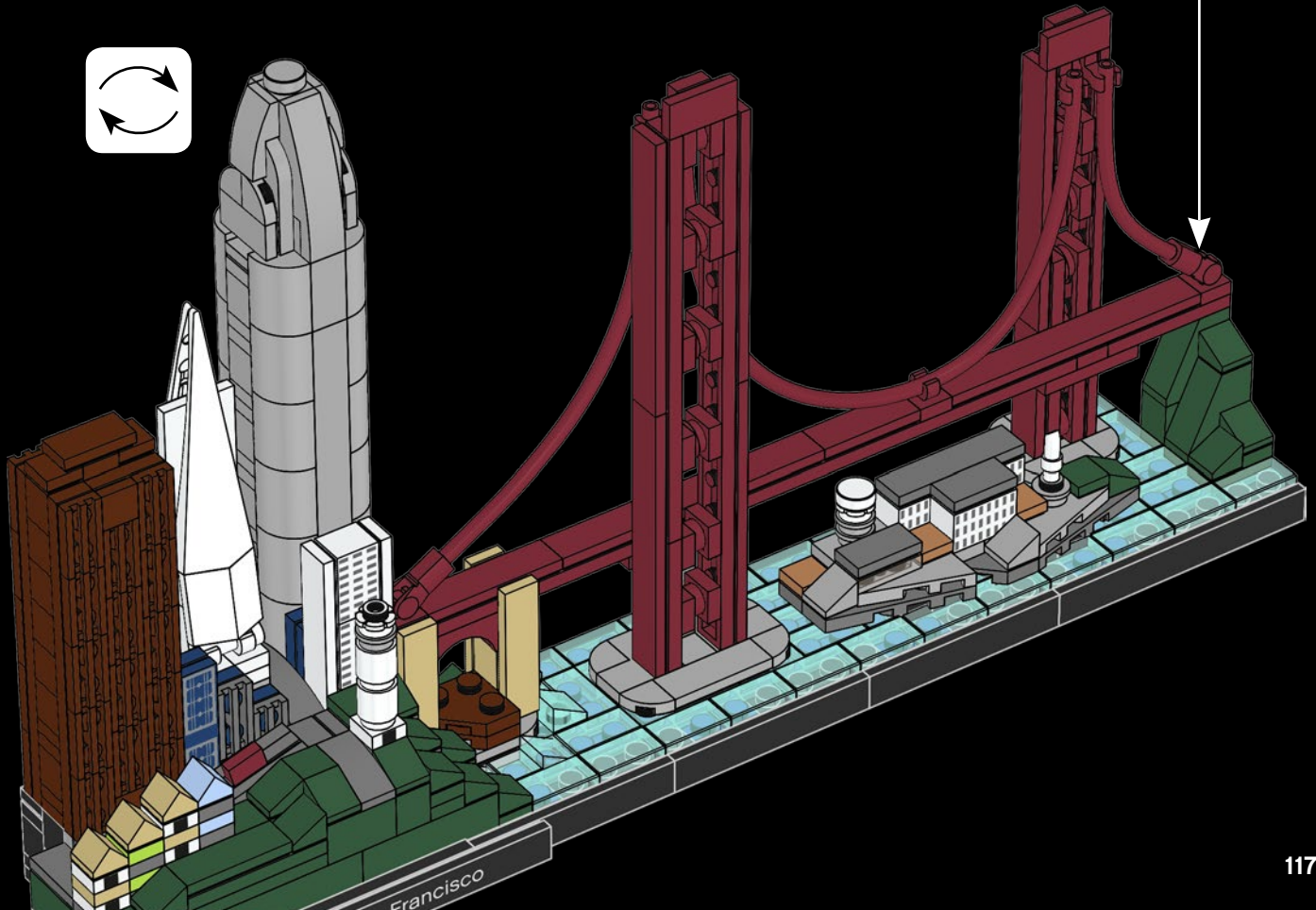
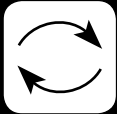



LEGO® Architecture – do you like it? Aimez-vous LEGO® Architecture ? LEGO® Architecture: ¿te gusta?

The LEGO Group would like your opinion on the new product you have just purchased. Your feedback will help shape the future development of this product series. Please visit:

Le Groupe LEGO aimerait connaître votre opinion sur le produit que vous venez d'acheter. Vos commentaires nous aideront à concevoir les futurs produits de cette gamme. Veuillez visiter :

The LEGO Group quiere conocer tu opinión acerca del nuevo producto que acabas de comprar. Tus comentarios nos ayudarán a dar forma a los futuros productos de esta serie. Visita:

[LEGO.com/productfeedback](https://www.lego.com/productfeedback)

By completing our short feedback survey, you will be automatically entered into a drawing to win a LEGO® prize.

En remplissant ce court sondage sur le produit, vous serez automatiquement inscrit à un tirage au sort pour gagner un prix LEGO®.

Al contestar este breve cuestionario de opinión, participarás automáticamente en el sorteo de un producto LEGO®.



LEGO® Architecture

The LEGO® Architecture series creatively captures the essence of many of the world's most iconic landmarks while giving you an enjoyable and engaging LEGO building experience.

Whether your interest is in travel, design, history or architecture, these sets are a physical memento of a great trip abroad, a famous building you know well, or a city you still dream of visiting.

Every LEGO Architecture set is designed to be displayed. Much more than just a photo, building and displaying your model on your desk, in the bookcase or on the shelf, lets you be transported every time you admire the view.

La série LEGO® Architecture capture l'essence de nombreux monuments parmi les plus célèbres du monde tout en vous offrant une expérience agréable et stimulante de construction LEGO.

Que votre intérêt porte sur les voyages, le design, l'histoire ou l'architecture, ces ensembles constituent un souvenir tangible d'un voyage mémorable, d'un célèbre bâtiment que vous connaissez bien ou d'une ville que vous rêvez de visiter.

Chaque ensemble LEGO Architecture est conçu pour être exposé. Construire votre modèle et l'exposer sur votre bureau, une bibliothèque ou une tablette vous fera voyager à chaque coup d'œil, bien plus qu'une simple photo ne pourrait le faire.

La línea LEGO® Architecture captura con creatividad la esencia de muchos de los monumentos más populares del mundo y pone a tu alcance una experiencia de construcción gratificante y cautivadora con el sello característico de LEGO.

Ya sea que sientas atracción por los viajes, el diseño, la historia o la arquitectura, estos sets expresan físicamente tus recuerdos de aquel fantástico viaje al extranjero, ese famoso edificio que conoces tan bien o la ciudad que sueñas con visitar algún día.

Todos los sets LEGO Architecture están diseñados para decorar. Mucho más que una simple fotografía, construir y exponer un modelo en tu escritorio, un librero o una repisa te traslada a otro lugar al admirar las vistas.

Follow us on

Suivez-nous sur

Síguenos en



Adam Reed Tucker is the co-developer of the LEGO Architecture product line.

Adam Reed Tucker est le codéveloppeur de la gamme de produits LEGO Architecture.

Adam Reed Tucker es el codesarrollador de la línea de productos LEGO Architecture.



Celebrate the world of architecture
and collect all the models

Célébrez le monde de l'architecture
et collectionnez tous les modèles

Celebra el mundo de la arquitectura
y colecciona todos los modelos



21041
Great Wall of China
La Grande Muraille de Chine
Gran Muralla China



21030
United States Capitol Building
Le Capitole des États-Unis
Edificio del capitolio de Estados Unidos



21042
Statue of Liberty
La statue de la Liberté
Estatua de la Libertad

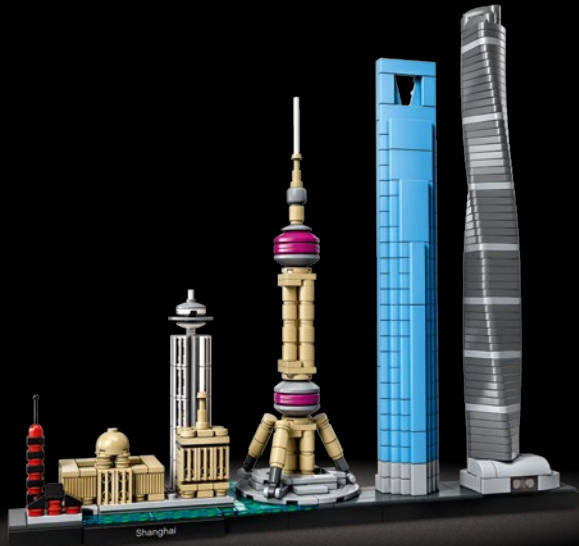

21039
Shanghai
Shanghái



21047
Las Vegas



21034
London
Londres



21028
New York City
New York
Nueva York

References

Références

Referencias

*Pictures -
Images -
Fotografias -*

© GettyImages

Customer Service
Kundenservice
Service Consommateurs
Servicio Al Consumidor
LEGO.com/service or dial

 00800 5346 5555 ;
 1-800-422-5346 ;



1



2



3

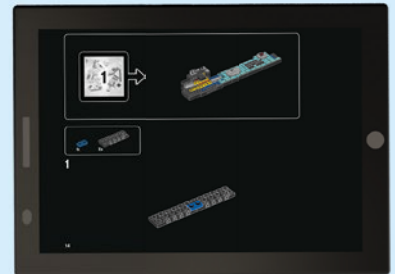

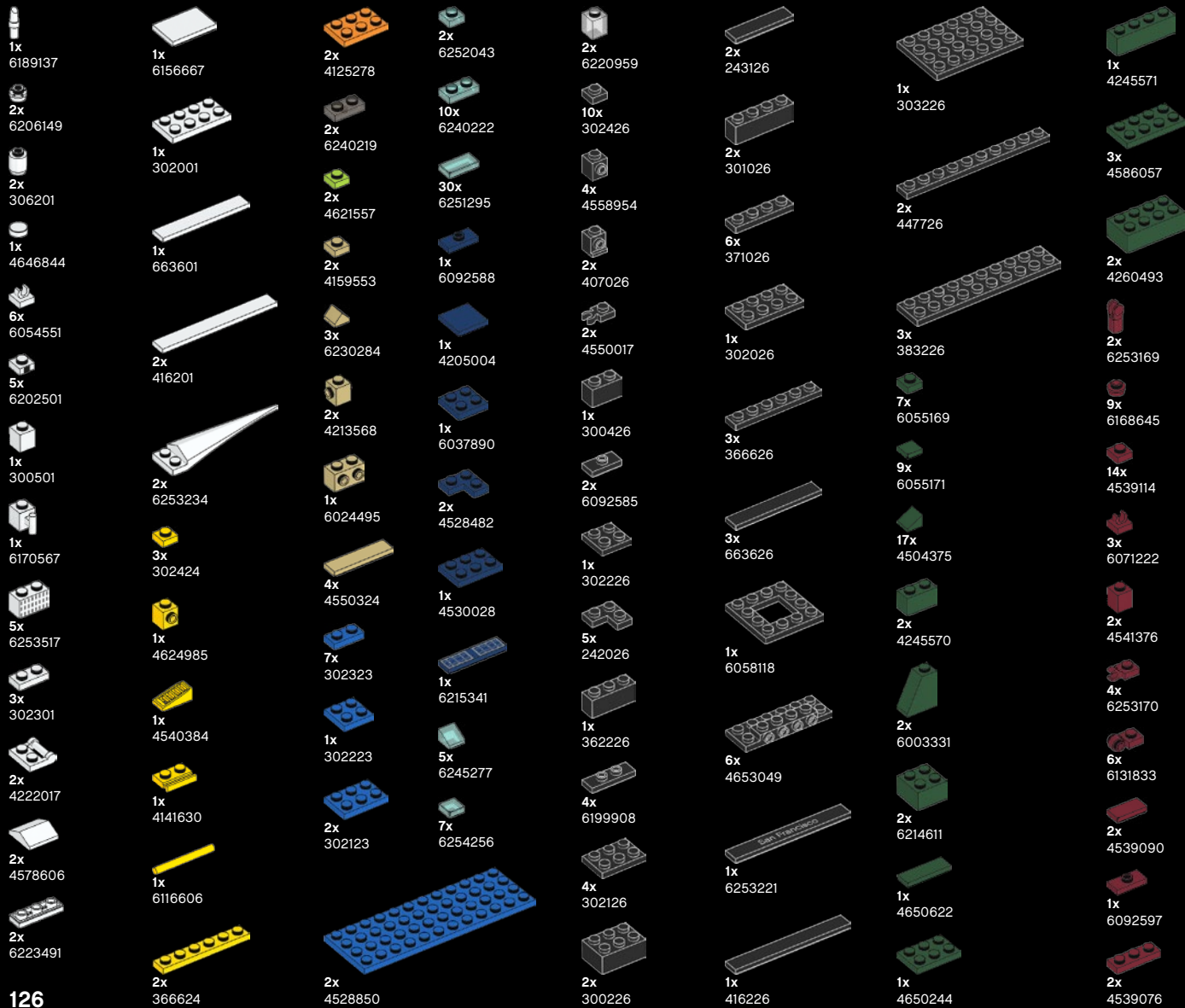



1x
6146854



3x
4539060



3x
4539061



2x
4539062



1x
6256143



8x
4539083



1x
4541507

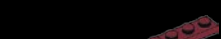

3x
6253142

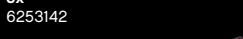

1x
6256144



1x
6256145



8x
6253167



3x
6066142



28x
4224243



2x
6218366



1x
4211151



2x
4211152



4x
4211220

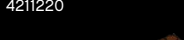

2x
4223683



2x
4211214



2x
4211214

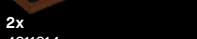

2x
4211214



2x
4211214

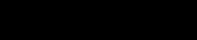

2x
4211214



1x
4583299



6x
4221744



6x
4211288



2x
4650260



4x
6168647



13x
6176433



3x
4211399



3x
4521921



3x
4211476



9x
4211415



2x
4211511



6x
4213567



2x
4211791



2x
4211791



2x
4211791



1x
4211794



6x
4657459



2x
6028813



24x
6227184



2x
6066097



7x
4211414



1x
6015344



1x
4211353



2x
6065824



1x
6211969



18x
4211429



3x
4558169



3x
4558169



3x
4558169



2x
4211419



2x
6042950



2x
4211481



4x
4251149



2x
4504378



9x
4210719



1x
6228923



1x
6143417



1x
4210788



1x
4210788



1x
4210788



1x
4210788



1x
4210788



1x
4210788



1x
4246896



2x
4210782



3x
4210631



1x
6164073



4x
4211052



1x
4211088



9x
4211063



1x
6029948



3x
6177146



3x
6177146



3x
6177146



3x
6177146



3x
6177146



3x
6177146



1x
4648256



1x
4211094



1x
4211053



2x
4211056



1x
4210651



1x
6184484



1x
6228085



3x
6177146



3x
6177146



3x
6177146



3x
6177146



3x
6177146



3x
6177146



3x
6177146



Customer Service

Kundenservice

Service Consommateurs

Servicio Al Consumidor

LEGO.com/service or dial



: 00800 5346 5555

: 1-800-422-5346

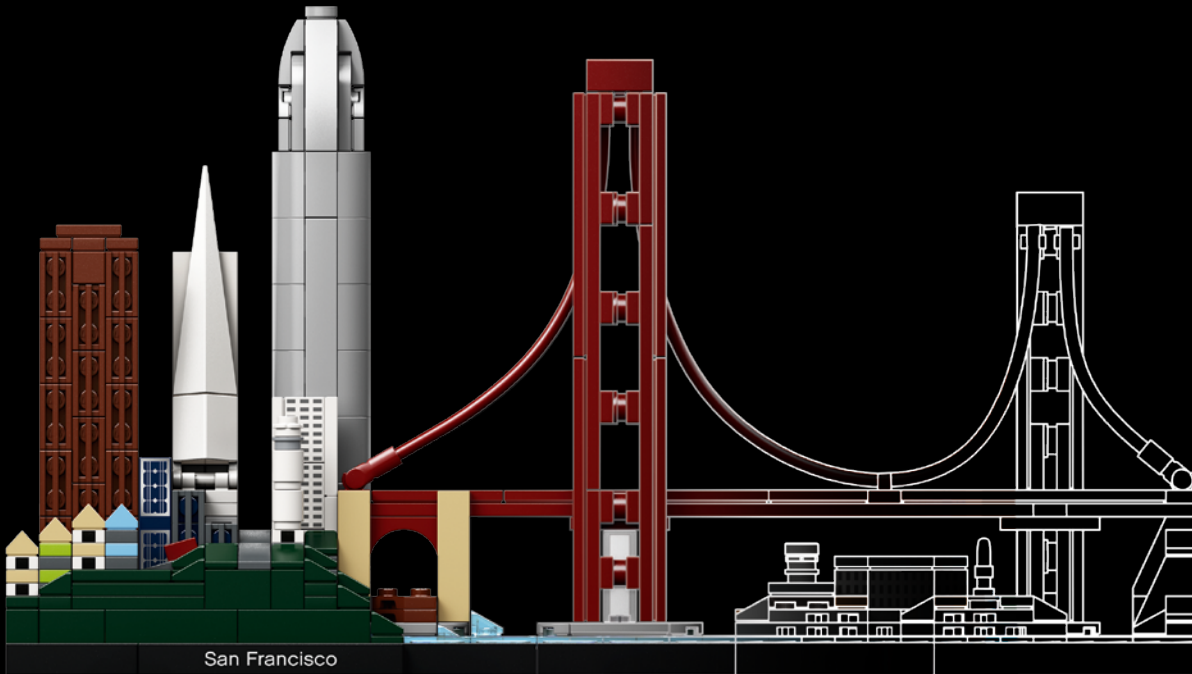

San Francisco

LEGO and the LEGO logo are trademarks of the/sont des marques de commerce du/son marcas registradas de LEGO Group. ©2019 The LEGO Group. 6268875

The Transamerica Pyramid Building is a registered service mark of Transamerica Corporation and is being used with permission.

 [LEGO.com/architecture](https://www.lego.com/architecture)

Follow LEGO® Architecture on
Suivez LEGO® Architecture sur
Sigue a LEGO® Architecture en

