



Architecture

21046

Empire State Building

New York, USA

New York, États-Unis

Nueva York, EE. UU.



An Icon of its Time

Un emblème de son temps

Un ícono de su época

At 102 stories, the Empire State Building may no longer be the tallest skyscraper in New York, but it is undoubtedly one of the most significant. No visit to the city is complete without a trip to the building's observation deck to experience the unforgettable views of the city. Designed by Shreve, Lamb & Harmon and completed in 1931, a lot of the building's cultural significance lies within its great history. A sign of hope and optimism during the Great Depression, it was built in record time and became the tallest building in the world, a title it retained for almost 40 years.

The Empire State Building also embodies the refinement and evolution of steel construction and technological prowess, though its design and construction faced many technical problems at the time. But a spirit of innovation and determination prevailed, and the building has taken its place in architectural and cultural history as a symbol of power and grandeur.

Avec ses 102 étages, l'Empire State Building peut ne plus être le plus haut gratte-ciel de New York, mais c'est sans contredit l'un des plus importants. Impossible de visiter la ville sans passer par la terrasse d'observation de l'édifice pour profiter d'une vue imprenable sur la ville. Le bâtiment, conçu par Shreve, Lamb & Harmon et achevé en 1931, est porteur d'un grand poids culturel découlant de son impressionnante histoire. Signe d'espoir et d'optimisme pendant la Grande Dépression, il a été construit en un temps record, s'imposant comme le plus haut bâtiment du monde, un titre qu'il a conservé pendant près de 40 ans.

L'Empire State Building incarne aussi le raffinement et l'évolution de la construction en acier ainsi que les prouesses technologiques, bien que sa conception et sa construction aient posé de nombreux problèmes techniques à l'époque. Mais l'innovation et la détermination ont eu raison de ces problèmes, et le bâtiment s'est inscrit dans l'histoire architecturale et culturelle comme symbole de puissance et de grandeur.

Con sus 102 pisos, el Empire State Building puede no ser ya el rascacielos más alto de Nueva York, pero sigue siendo, indiscutiblemente, uno de los más representativos. Ninguna visita a la ciudad está completa sin pasar por el mirador del edificio para experimentar las inolvidables vistas que ofrece. Diseñado por Shreve, Lamb & Harmon y terminado en 1931, gran parte del significado cultural del edificio radica en su extraordinaria historia. Signo de esperanza y optimismo durante la Gran Depresión, se construyó en tiempo récord y conservó el título de edificio más alto del mundo durante casi 40 años.

El Empire State Building encarna también el refinamiento y la evolución de las estructuras de acero, así como el espíritu de las hazañas tecnológicas, aunque su diseño y construcción se enfrentaron a numerosos problemas técnicos en su momento. Sin embargo, el ingenio y la determinación triunfaron sobre las dificultades, y el edificio pasó a formar parte de la historia de la arquitectura y la cultura como un símbolo de poder y grandeza.





The Creation of an Icon

La création d'une icône

La creación del ícono

Originally agricultural land, the prominent Astor family bought the area in 1827 and built the Waldorf-Astoria hotel on the site in the late 1890s. Eventually, businessman John Raskob and former governor Al Smith, who later became part of the Empire State Inc. group of investors, bought and demolished the outdated hotel, and contracted William Lamb to create the building design.

Before the designs were even finished, work started on the building's construction on March 17th, 1930. The pace of construction was phenomenal; with an average construction rate of four and a half stories a week. By September of the same year, 86 stories were built, and the mast was completed by November. The entire construction was finished, and the building officially opened by President Hoover on May 1st, 1931, 45 days ahead of schedule.

C'est la famille Astor qui a à l'origine acheté les terres agricoles en 1827, pour y construire l'hôtel Waldorf-Astoria à la fin des années 1890. L'homme d'affaires John Raskob et l'ancien gouverneur Al Smith, qui deviendront membres du groupe d'investisseurs Empire State Inc., ont plus tard acheté et démolit l'hôtel désuet. Ils ont du même coup signé un contrat avec William Lamb pour concevoir le nouveau bâtiment.

Les travaux de construction ont été lancés le 17 mars 1930, avant même que les dessins ne soient terminés. La

vitesse de construction a été phénoménale, le rythme de construction moyen étant de quatre étages et demi par semaine. En septembre de la même année, 86 étages étaient construits, et le mât a été achevé en novembre. La construction étant terminée, l'édifice a pu être officiellement inauguré par le président Hoover le 1^{er} mai 1931, 45 jours avant la date prévue.

El terreno, destinado originalmente a la explotación agrícola, fue adquirido en 1827 por la prestigiosa familia Astor, que construyó el hotel Waldorf-Astoria en ese lugar a finales de la década de 1890. Años más tarde, el empresario John Raskob y el antiguo gobernador Al Smith, quienes luego se convertirían en miembros del grupo de inversionistas Empire State Inc., compraron el anticuado hotel, lo demolieron y contrataron a William Lamb para que diseñara un nuevo edificio.

Las obras comenzaron el 17 de marzo de 1930, incluso antes de que el diseño estuviera acabado. La construcción se llevó a cabo a un ritmo espectacular, con un promedio de cuatro pisos y medio por semana. En septiembre del mismo año ya se habían construido 86 pisos; el mástil se instaló en noviembre. El edificio se consideró completo con la inauguración oficial, que corrió a cargo del presidente Hoover, el 1 de mayo de 1931 (45 días antes de lo previsto).

A Symbol of New York

Un symbole de New York

Un símbolo de Nueva York

After its construction, the Empire State Building became an instant tourist attraction, with visitors coming to see the spectacular views from the observation deck of the “World’s Tallest Building.” It became a National Historic Landmark in 1986 and was added to the National Register of Historic Places the year after. The American Society of Civil Engineers has also named it as one of the Seven Wonders of the Modern World, and in 2007 it was ranked at number one on the list of America’s Favorite Architecture by the American Institute of Architects. Aside from its many accolades and titles, the Empire State Building is a cultural symbol of New York, with starring roles in many movies, from the original *King Kong* to *Sleepless in Seattle*.

Après sa construction, l’Empire State Building est devenu une attraction touristique instantanée, les visiteurs accourant pour admirer la vue spectaculaire depuis la terrasse d’observation du « plus haut bâtiment du monde ». Le bâtiment a été nommé lieu historique national en 1986 et a été ajouté au registre national des lieux historiques l’année suivante. L’American Society of Civil Engineers l’a également nommé comme étant l’une des sept merveilles du monde moderne et, en 2007, il s’est hissé au premier rang de la liste des favoris de l’architecture américaine par l’American Institute of Architects. En plus de ses nombreux honneurs et titres, l’Empire State Building est devenu un symbole culturel de New York, en vedette dans de nombreux films, du *King Kong* original à *La magie du destin*.

Luego de su construcción, el Empire State Building se convirtió rápidamente en una atracción turística a la que acudían los visitantes para disfrutar de las espectaculares vistas del mirador del edificio más alto del mundo. Fue declarado Hito Histórico Nacional en 1986 e incluido en el Registro Nacional de Lugares Históricos al año siguiente. La Sociedad Estadounidense de Ingenieros Civiles también lo considera una de las siete maravillas del mundo moderno y en 2007 obtuvo el primer lugar en la lista “Arquitectura favorita de Estados Unidos”, elaborada por el Instituto Estadounidense de Arquitectos. Más allá de sus muchos reconocimientos y títulos, el Empire State Building es un símbolo cultural de Nueva York que ha protagonizado numerosas películas, desde la primera versión de *King Kong* hasta *Sintonía de Amor*.



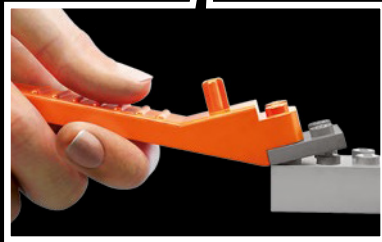
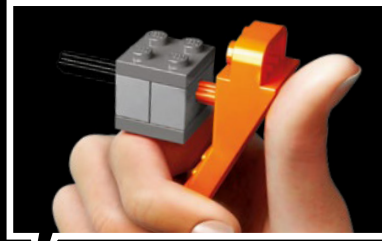
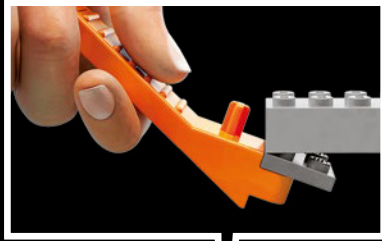

LEGO.com/brickseparator



- 1** Download the LEGO® Life App
 Lade dir die LEGO® Life App herunter
 Télécharge l'application LEGO® Life
 Télécharger l'application LEGO® Life
 Scarica l'app LEGO® Life
 Descarga la app LEGO® Life
 Descarrega a App LEGO® Life
 Töltsd le a LEGO® Life Appot!
 Lejupielādē lietotni LEGO® Life
 下載 LEGO® Life 应用程序



- 2** Scan the code on the front cover
 Scanne den Code auf der Titelseite
 Scanne le code sur la page de couverture
 Scanner le code sur la page couverture
 Scansiona il codice sulla copertina
 Escanea el código de la portada
 Faz scan do código na frente da capa
 Olvasd be a borítón látható kódot!
 Noskenē kodu uz priekšējā vāka
 扫描封面上的二维码

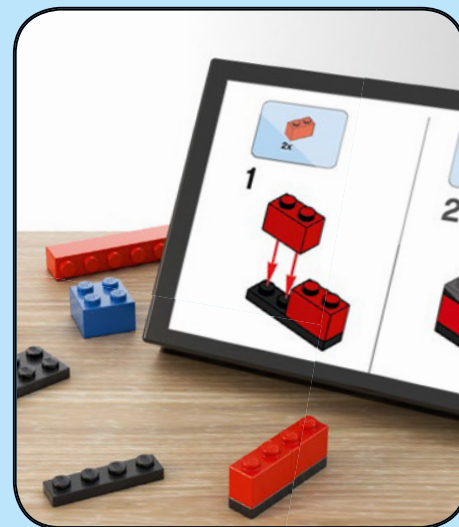

- 3** Get the Building Instructions
 Hol dir die Bauanleitung
 Obtens les instructions de montage
 Obtenir les instructions de montage
 Scarica le istruzioni per la costruzione
 Consulta las instrucciones de construcción
 Obtém as Instruções de Construção
 Szerezd be az építési útmutatókat!
 Saņem būvēšanas instrukcijas
 获取拼搭说明

LEGO.com/apps

Check for compatibility
 Kompatibilität prüfen
 Vérifier la compatibilité
 Controlla la compatibilità
 Comprueba tu compatibilidad

Verificar a compatibilidade
 Ellenőrizd a kompatibilitást
 Pārbaudīt saderību
 检查兼容性

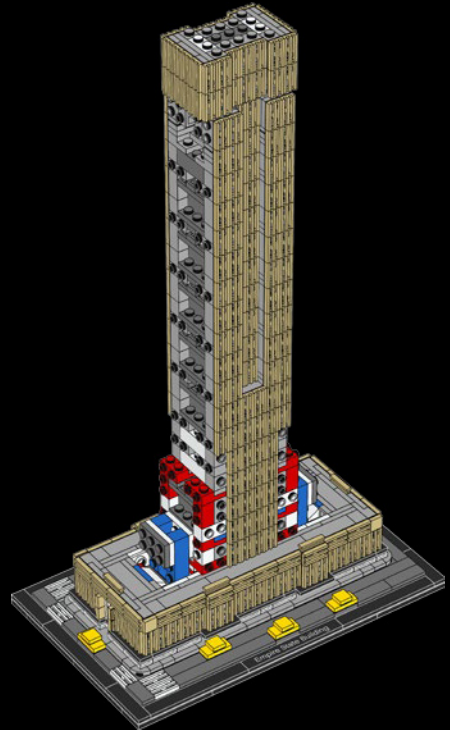
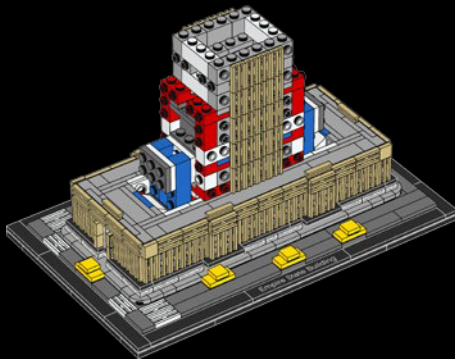
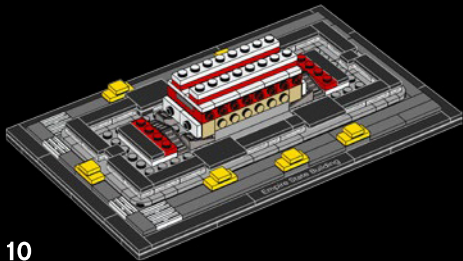

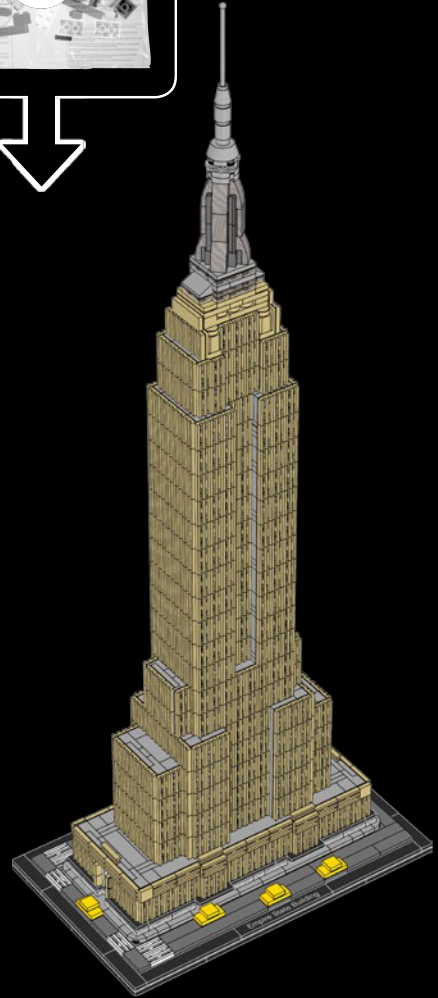
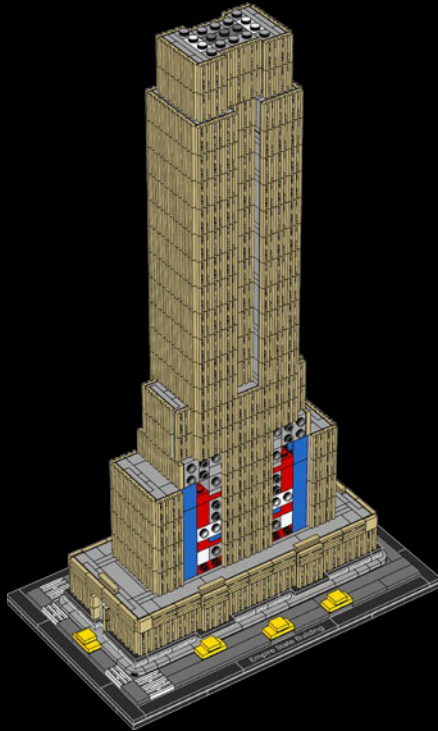

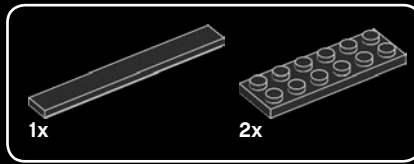

1

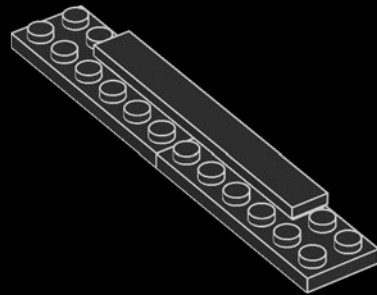
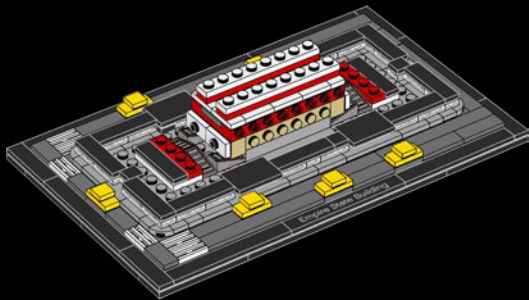

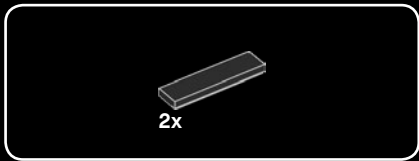

2

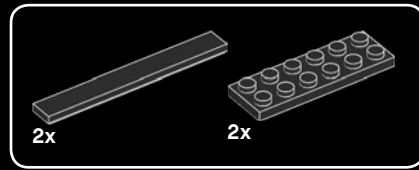
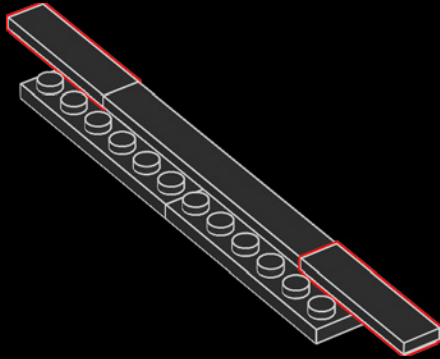

3

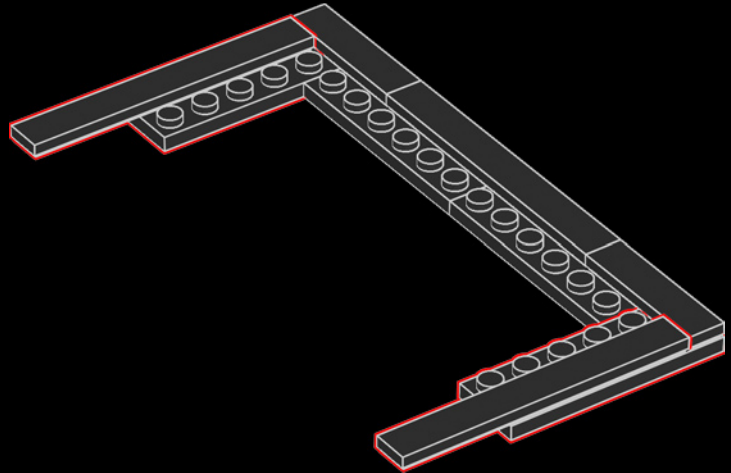

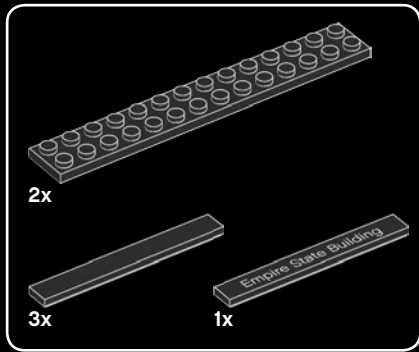

4

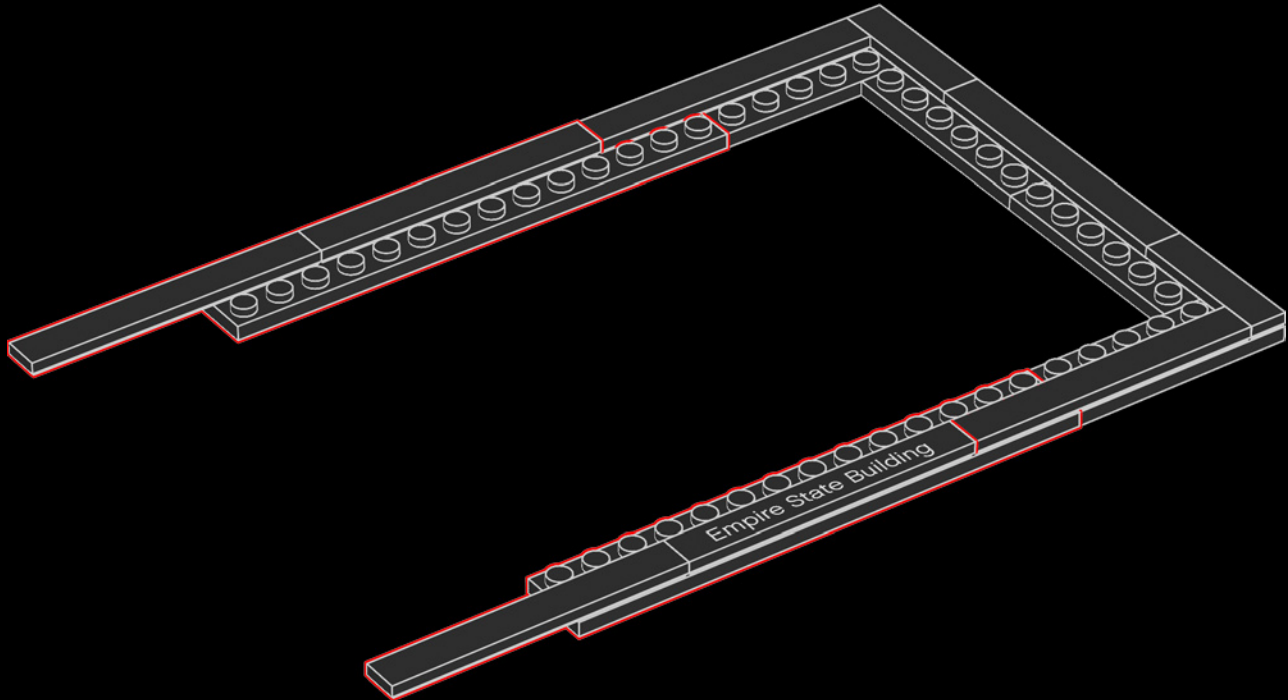

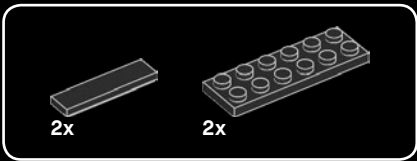

5

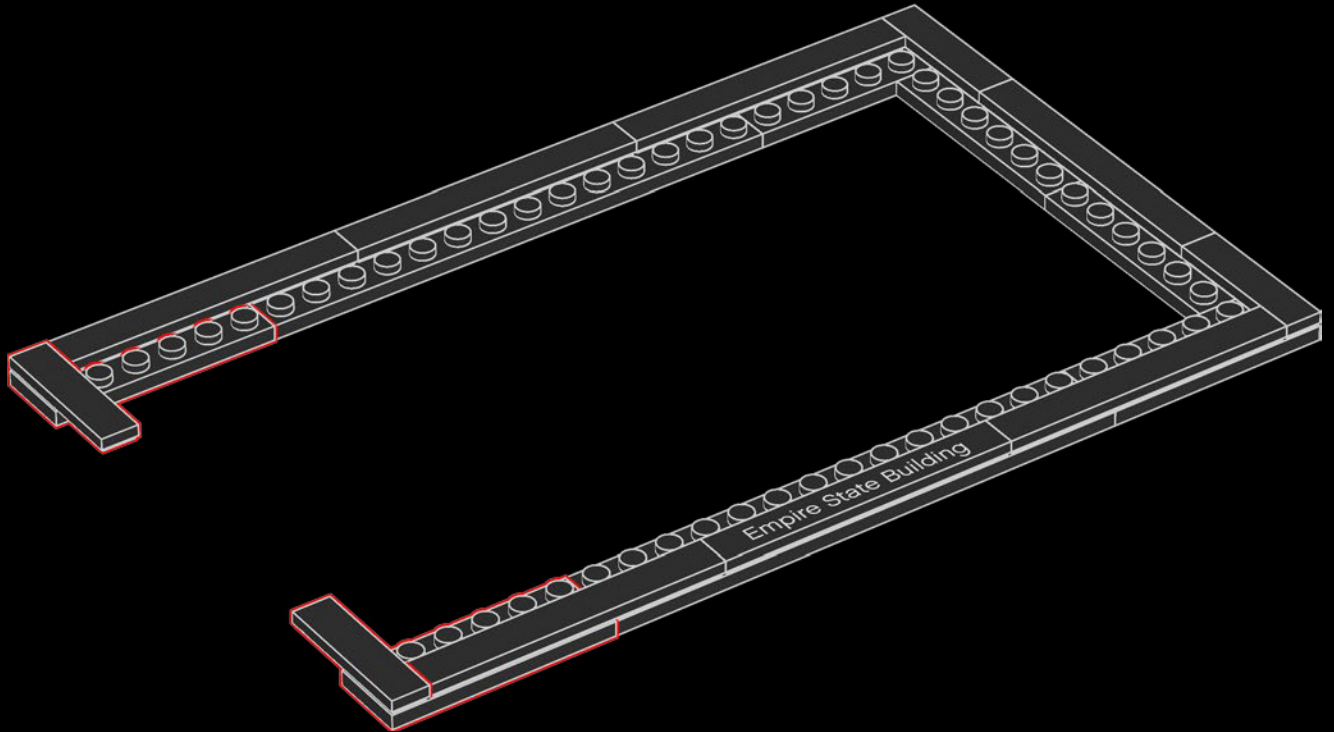

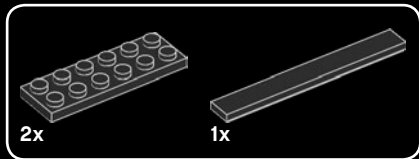

6

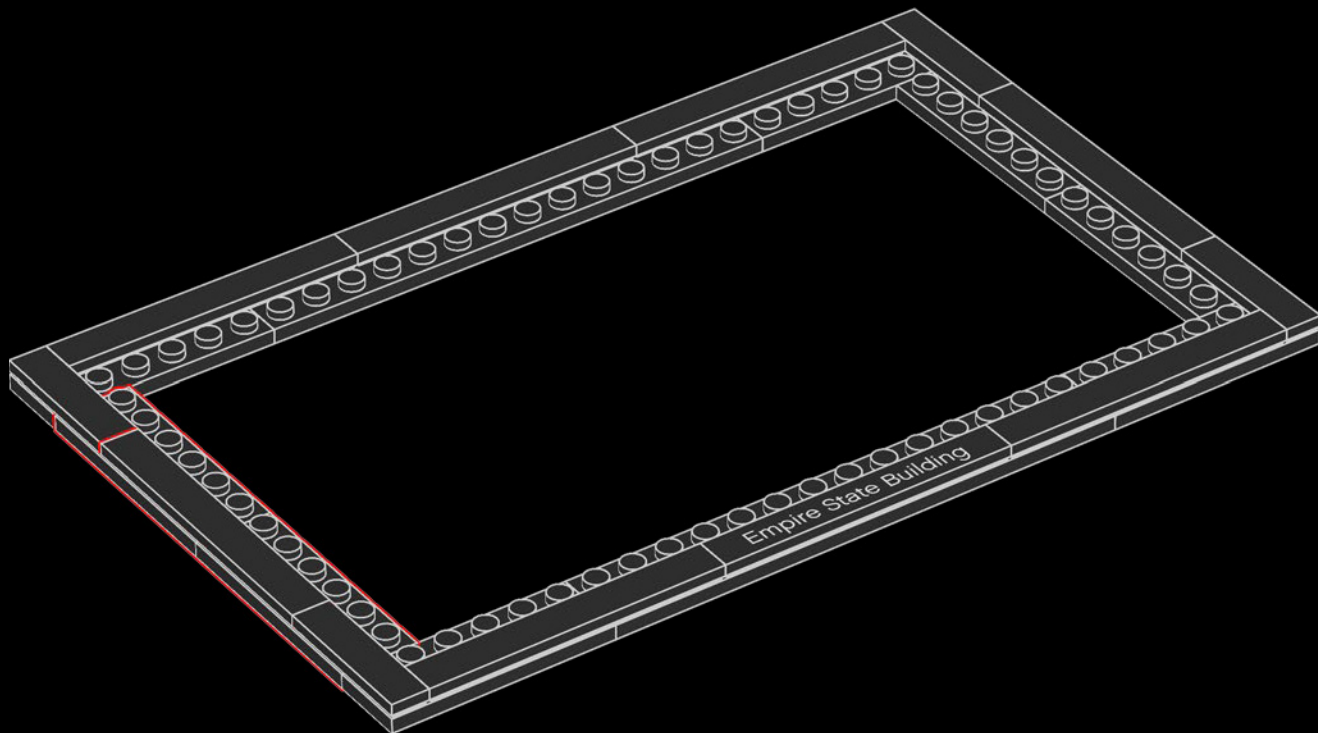

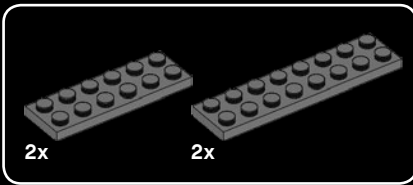

7

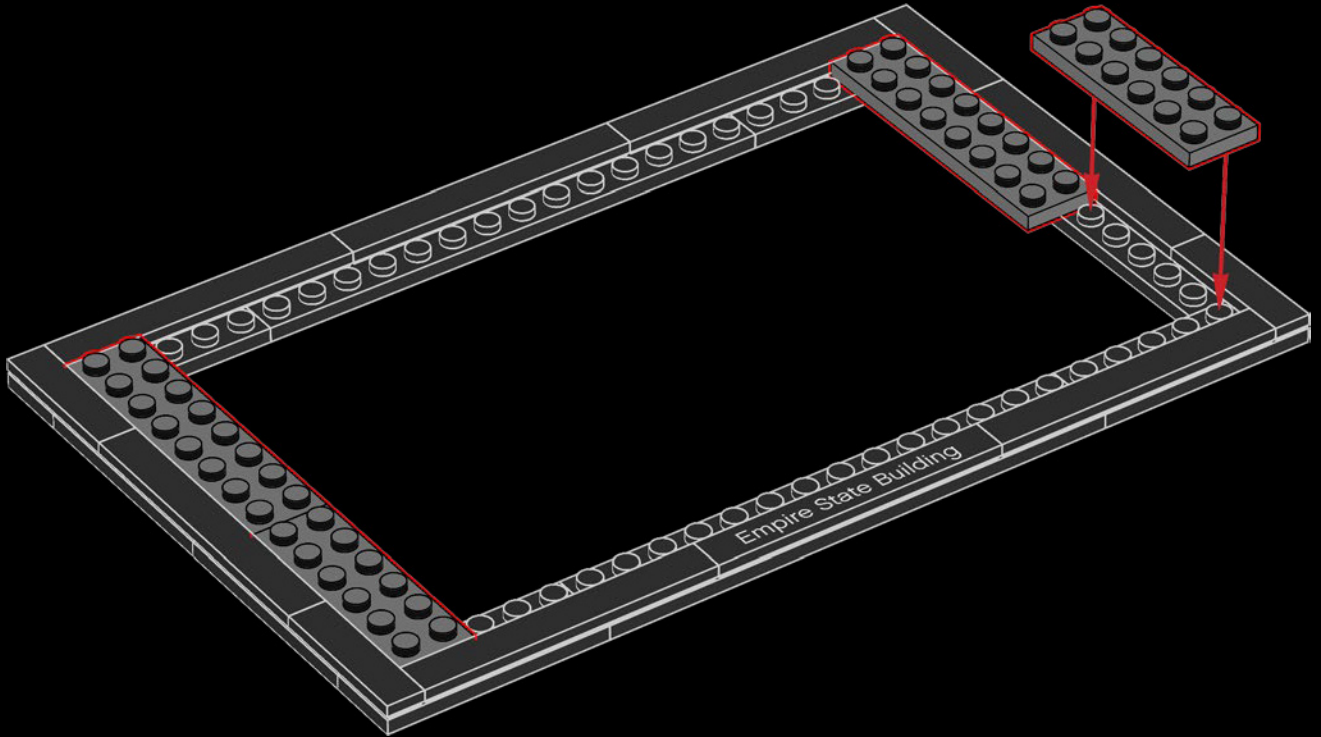

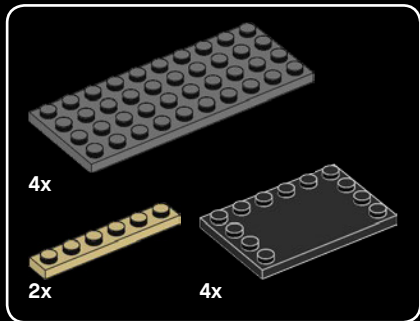
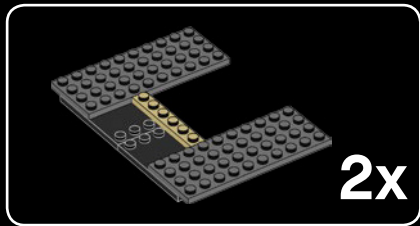

8

1

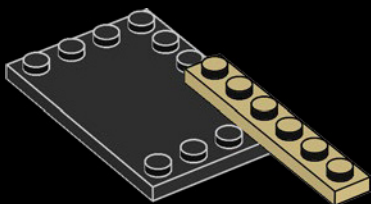

2

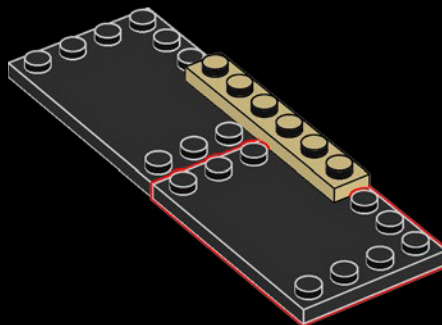

3

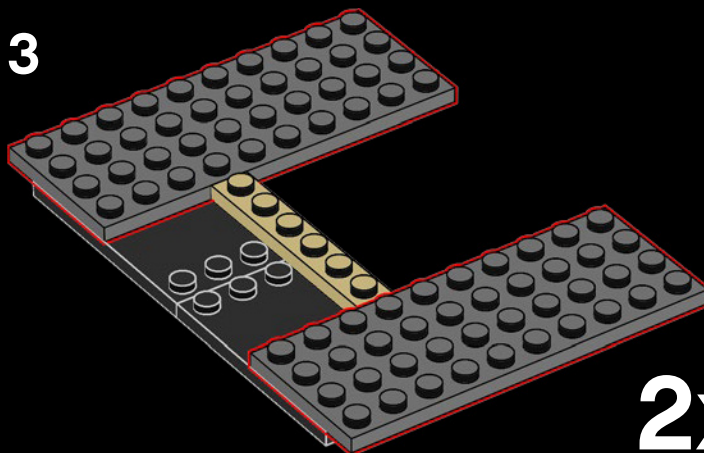

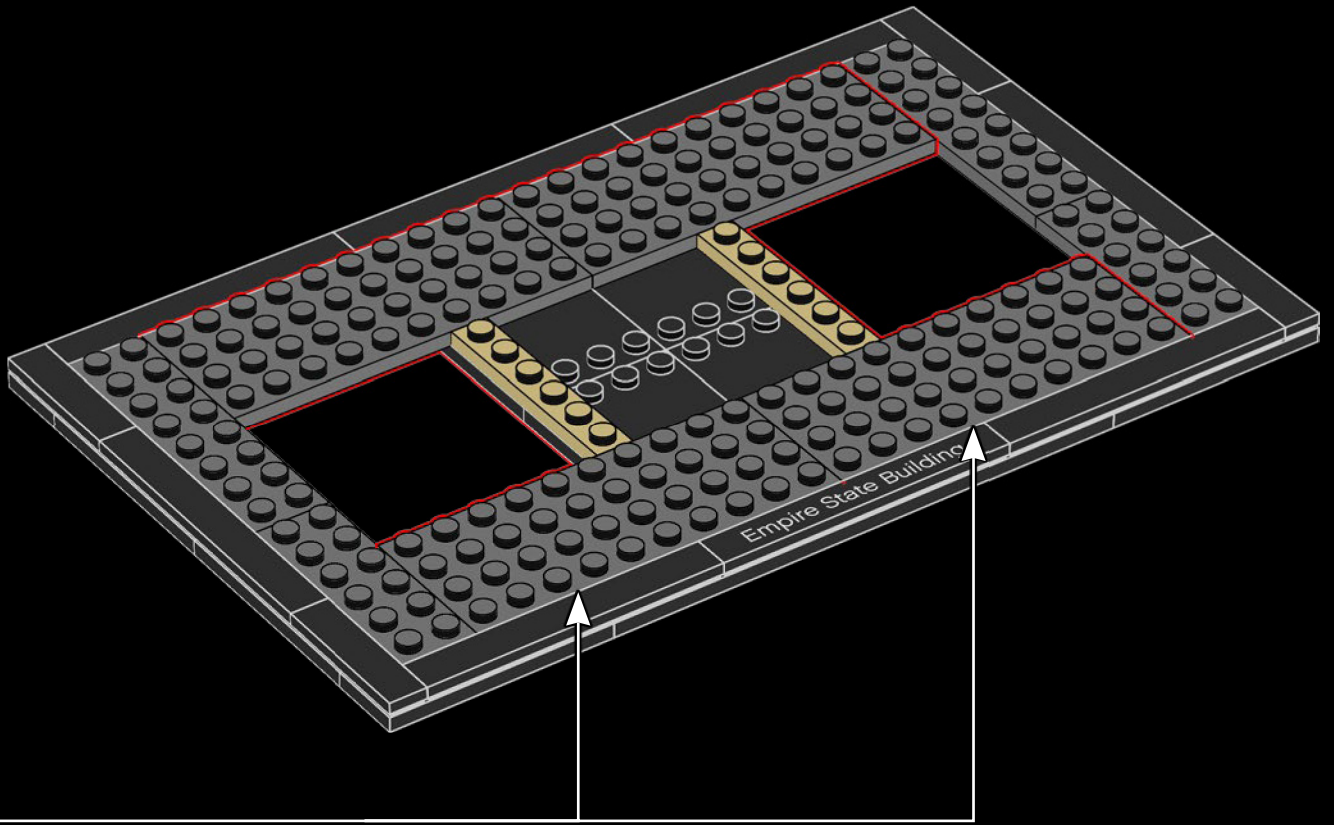



4x

9

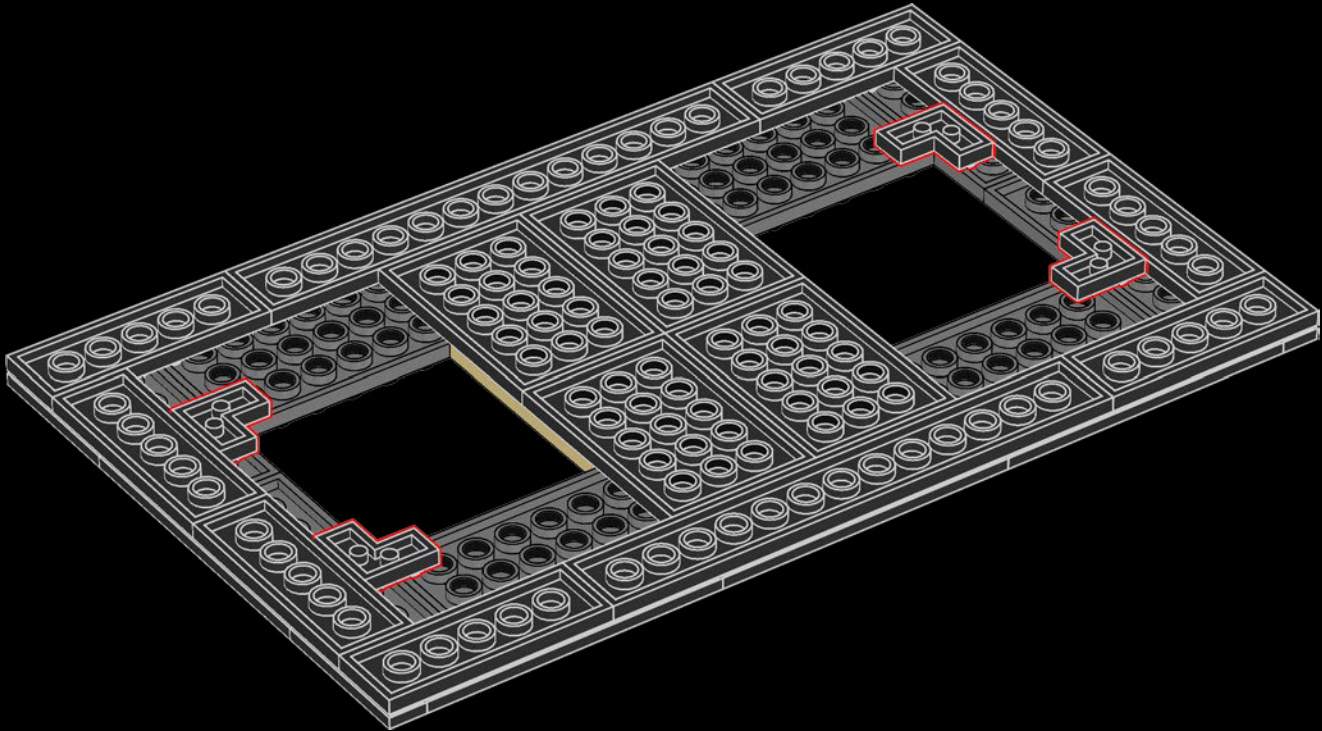

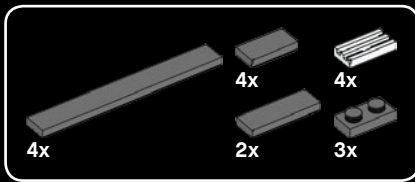

10

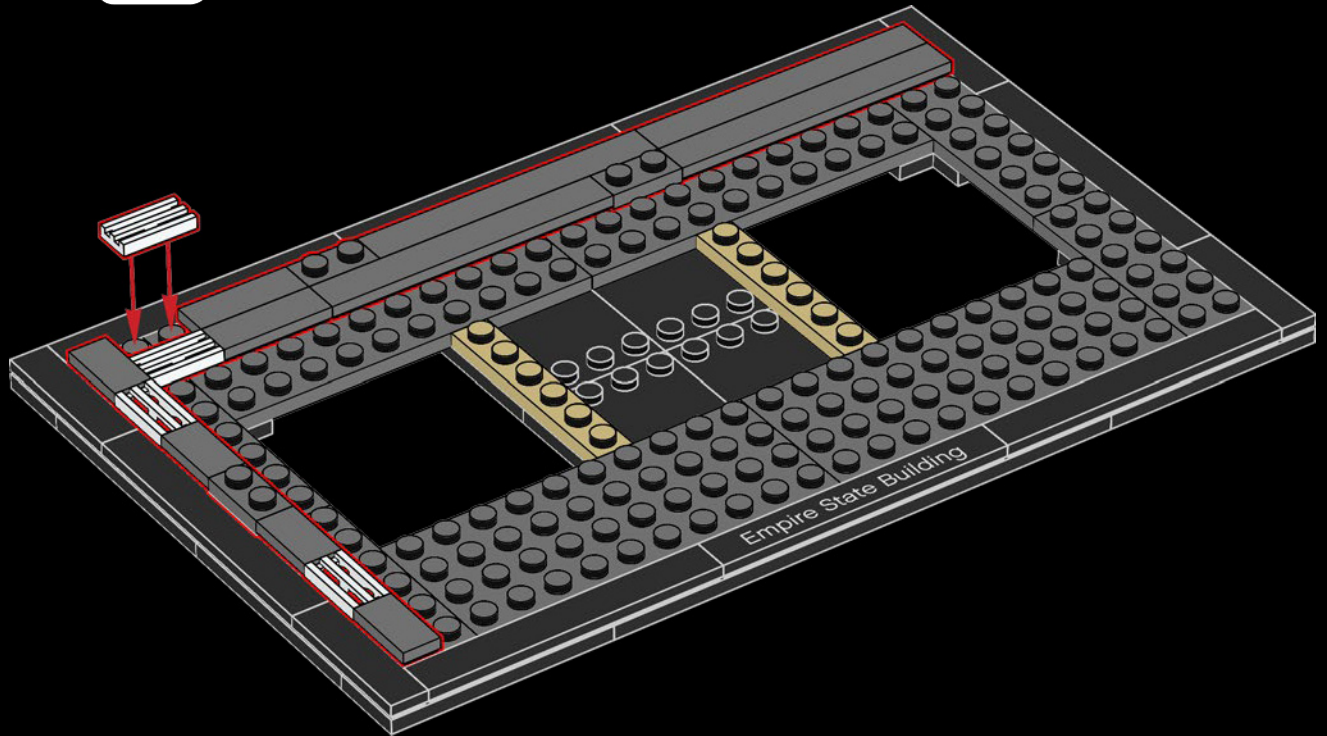

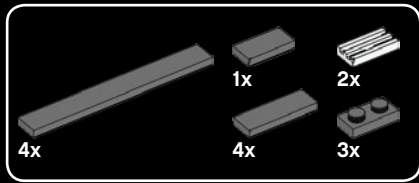

11

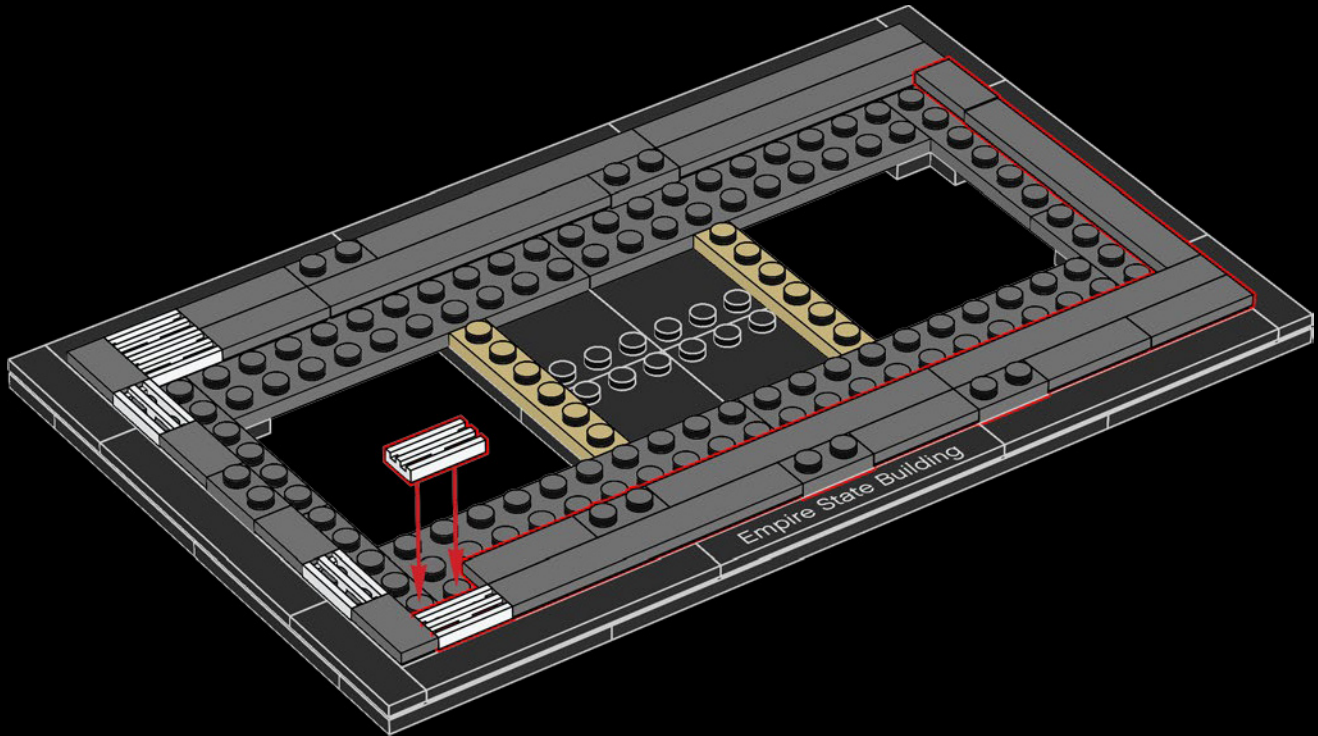

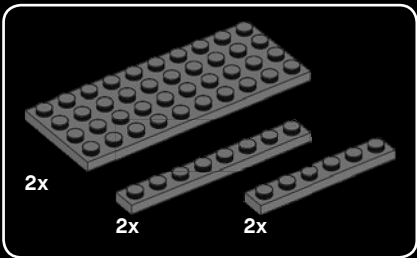

12

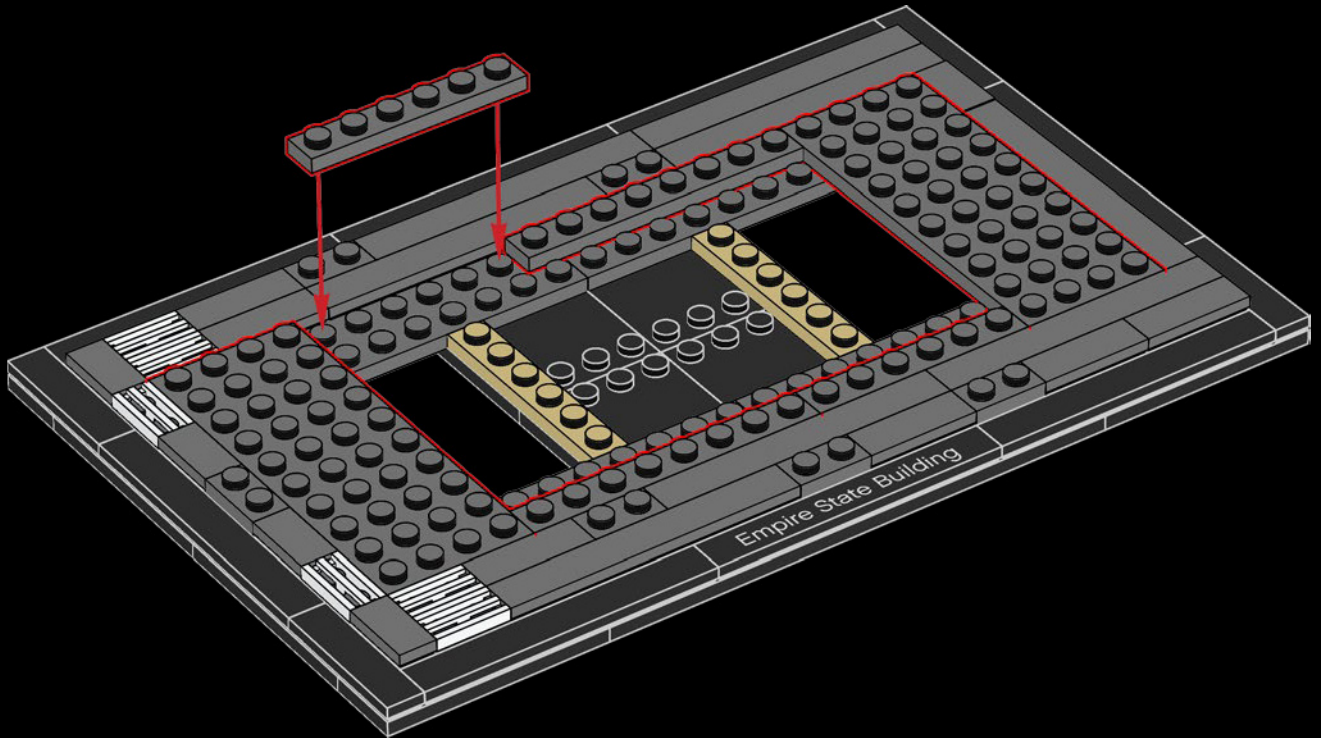

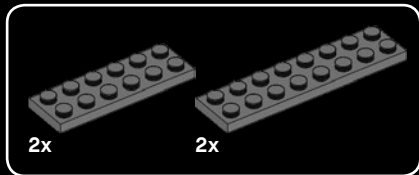

13

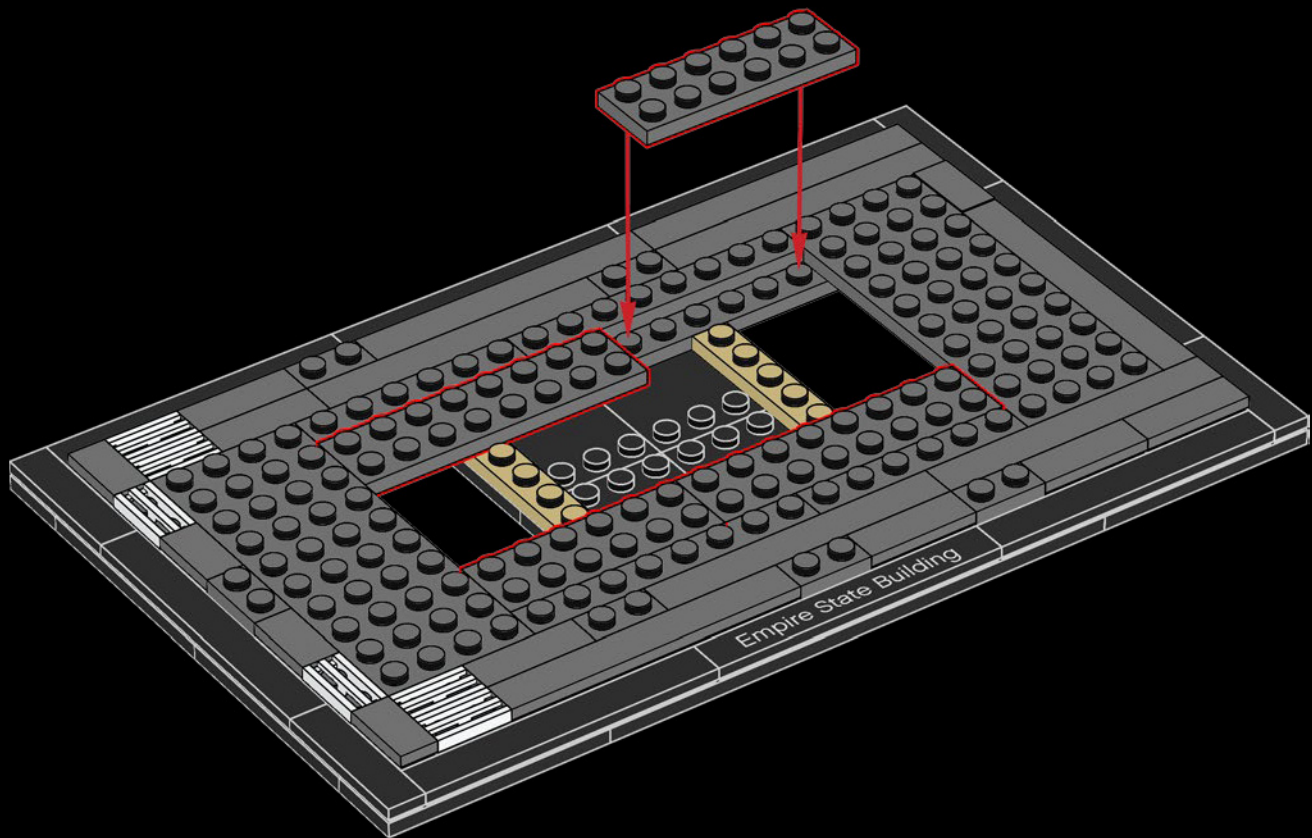

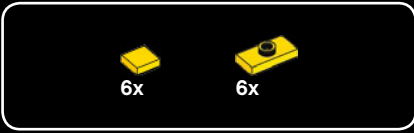

14

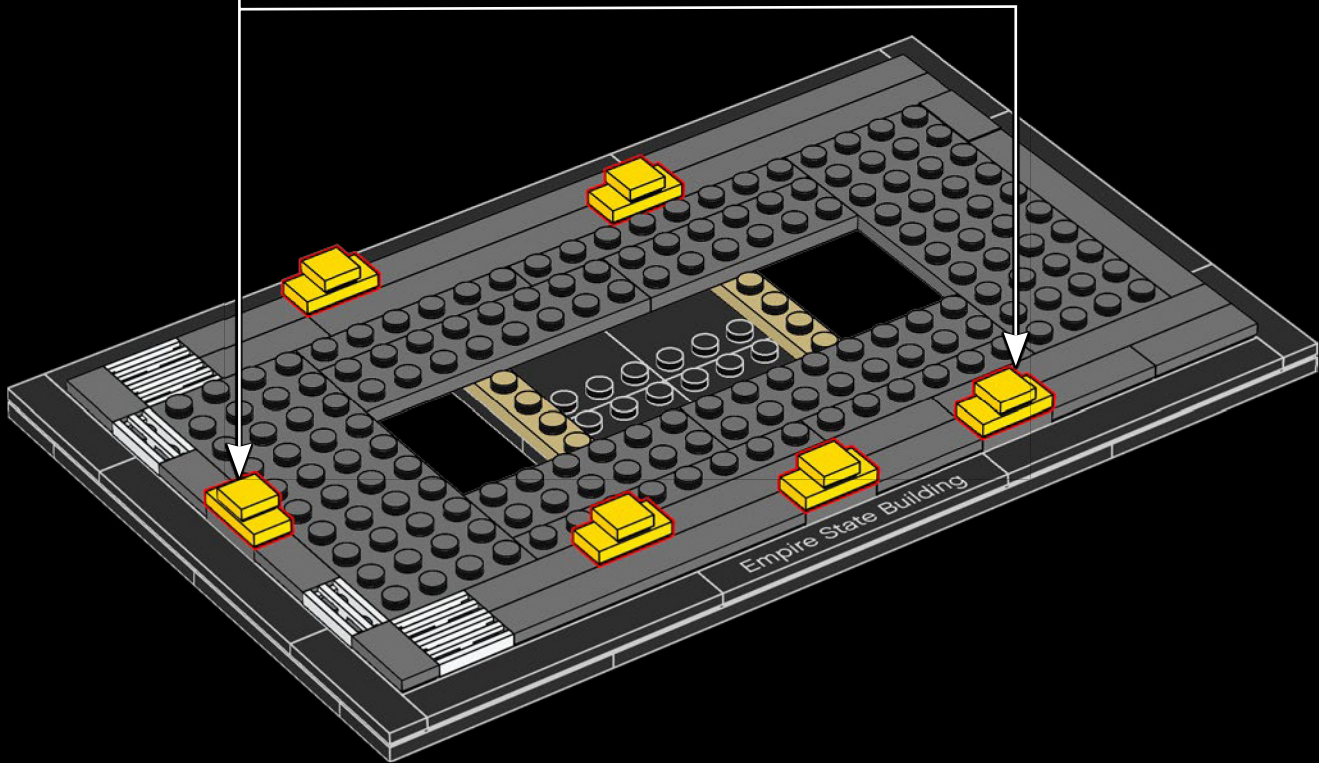
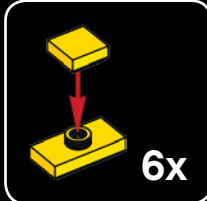

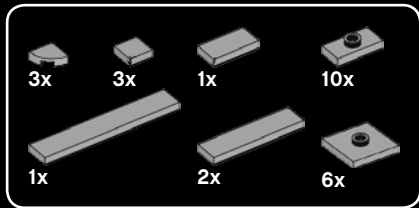

15

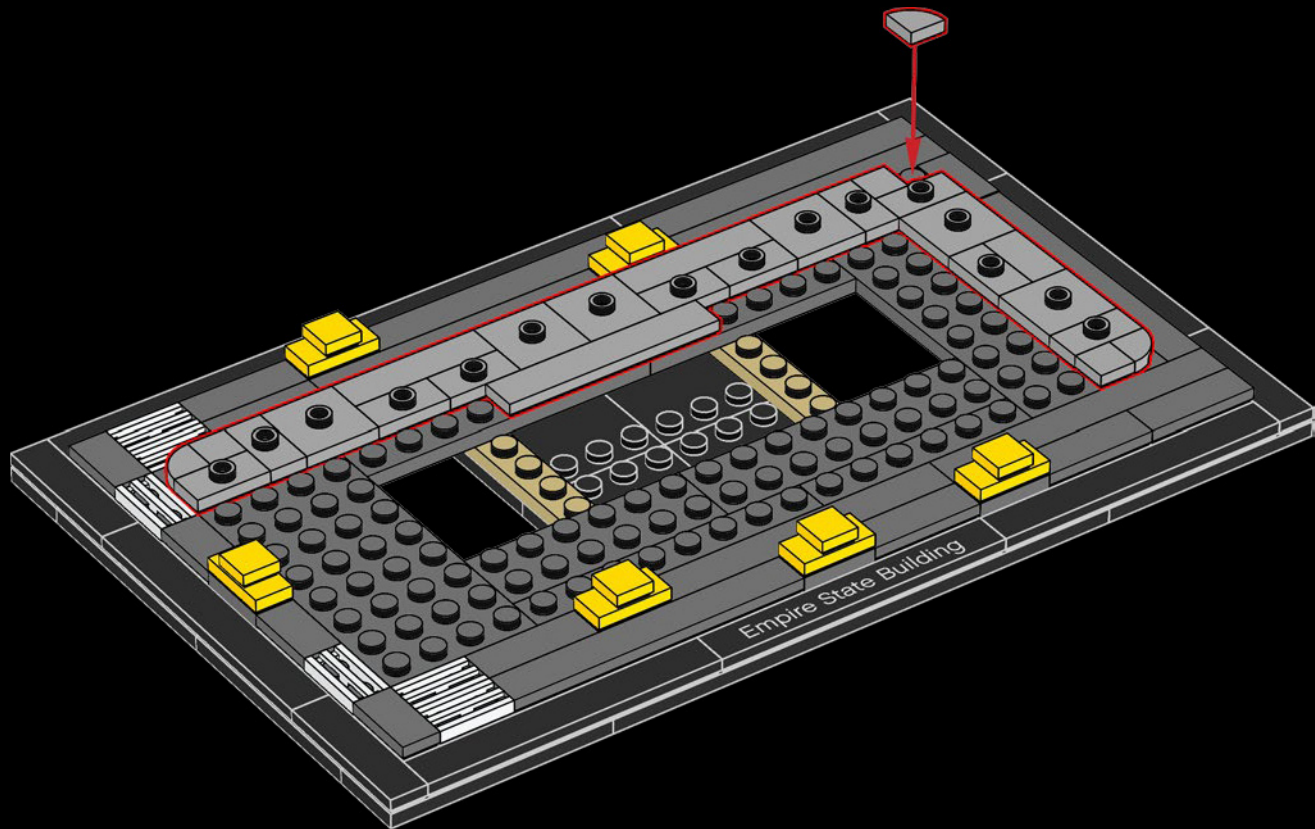

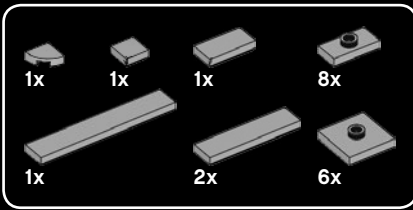

16

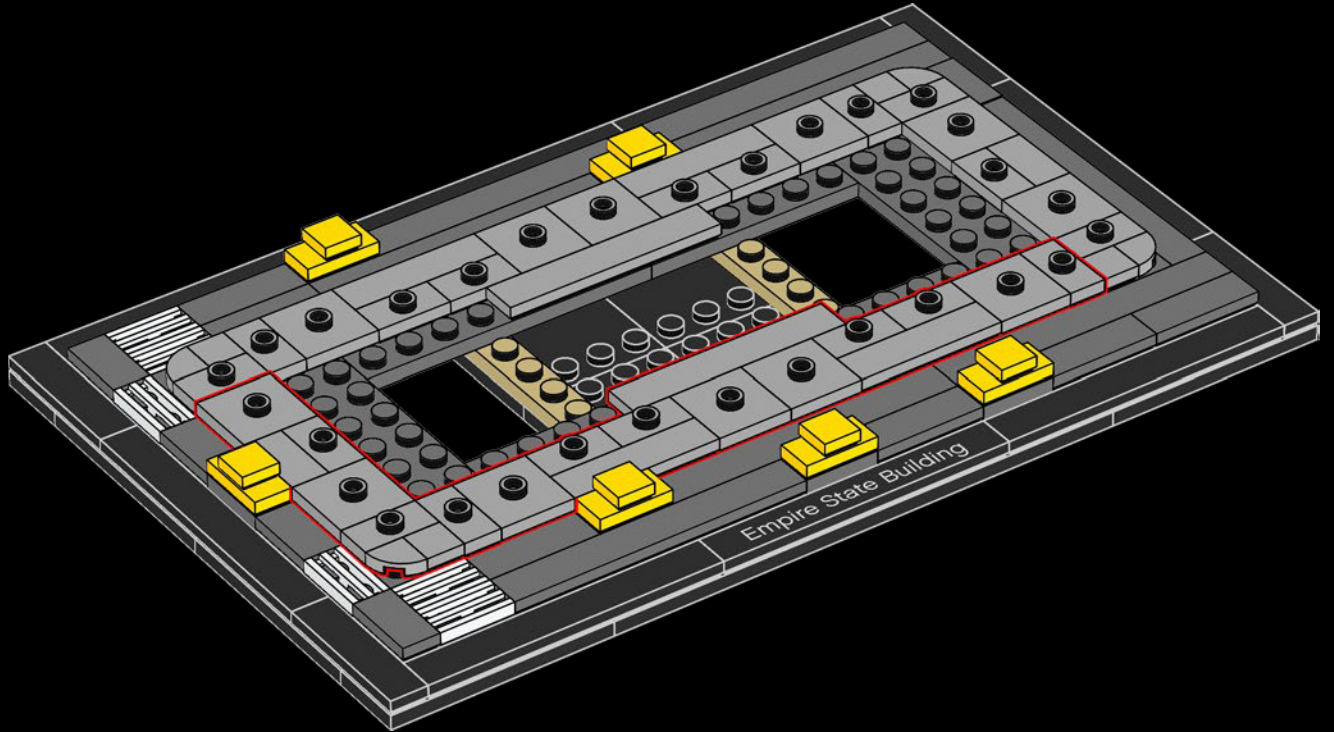



17

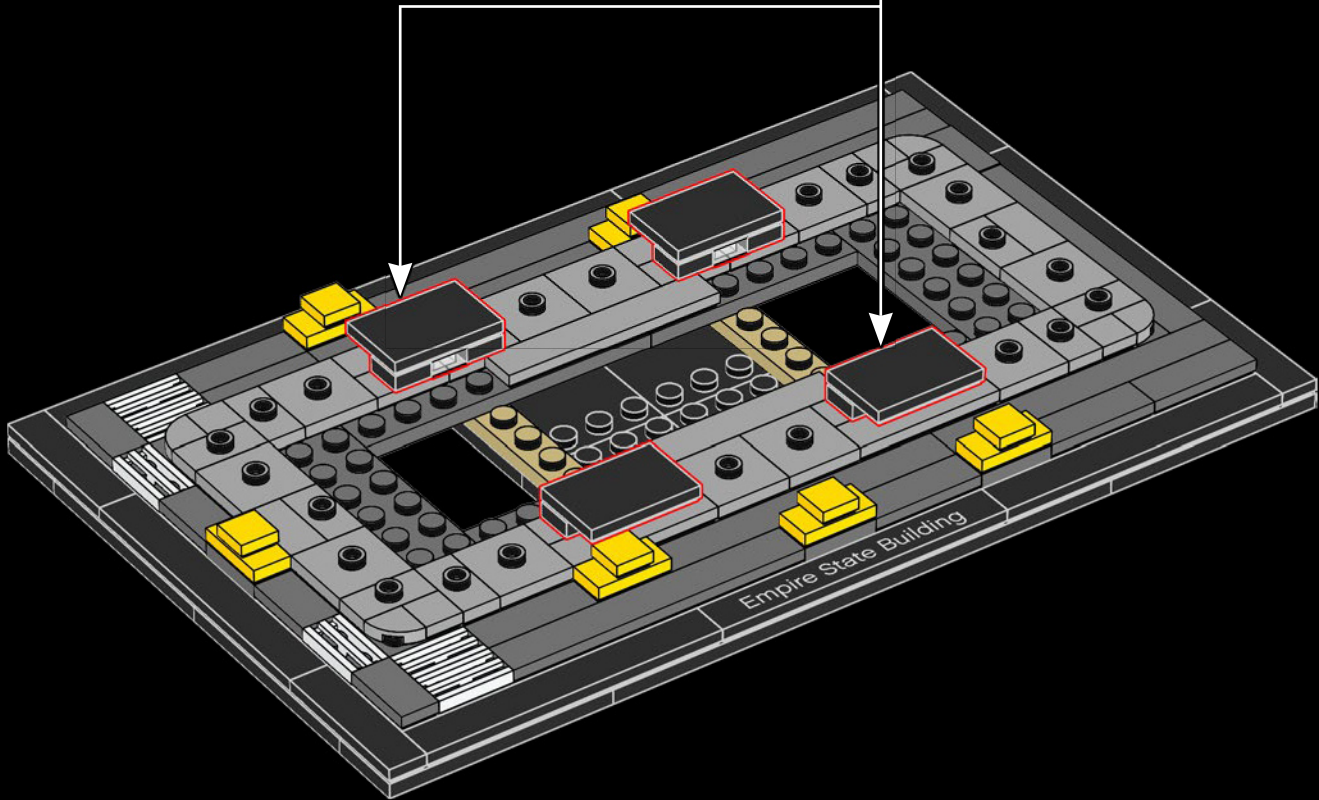
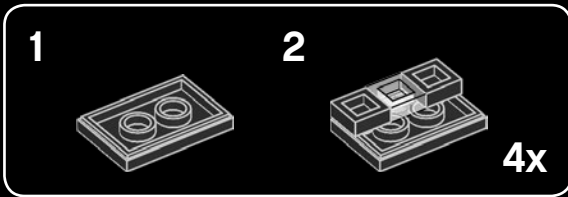

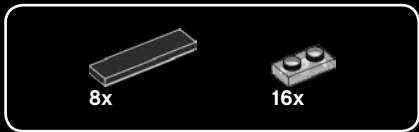

18

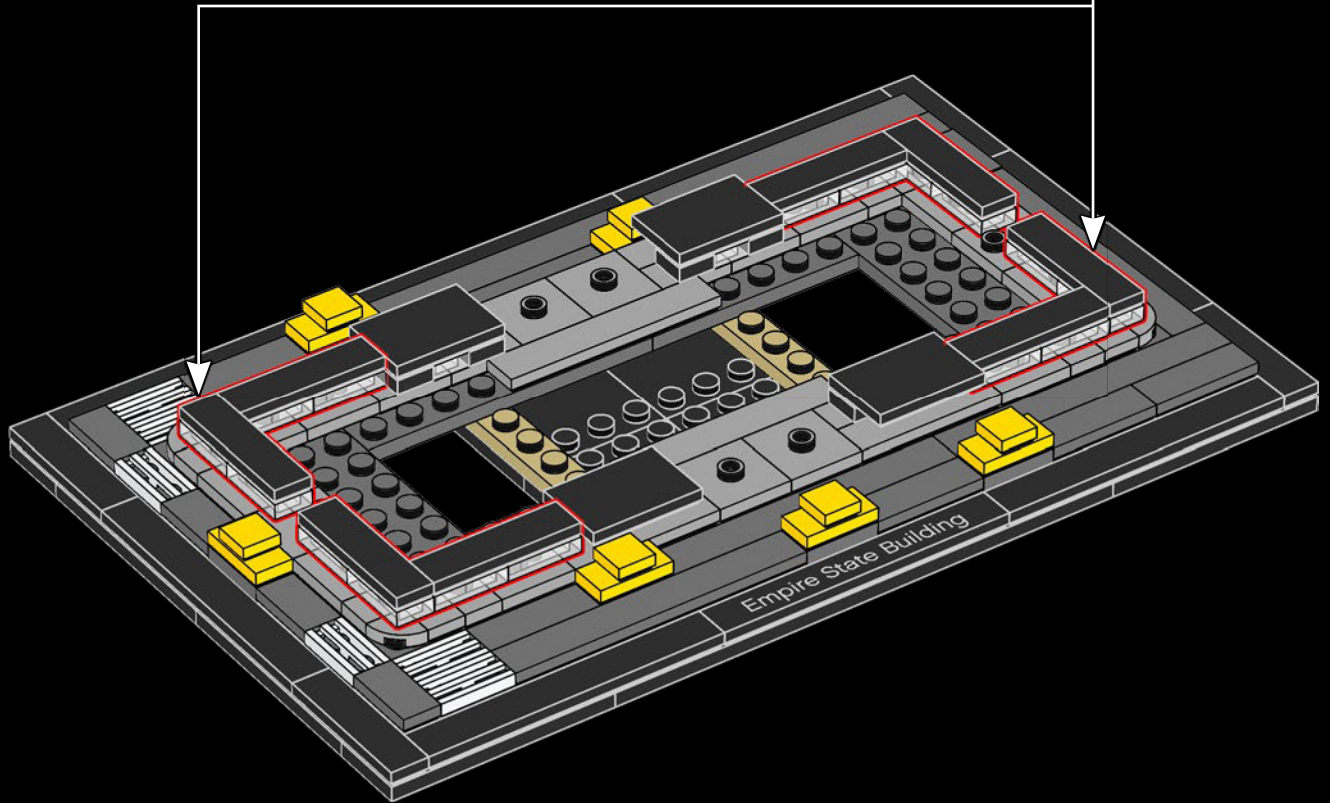
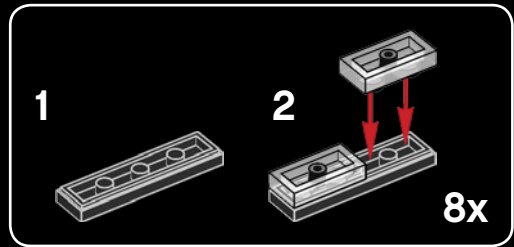



2x



2x

19



2x

Running parallel to 33rd and 34th Streets, the chapel-like, three-story-high lobby has storefronts on its north and south sides.

Parallèle aux 33^e et 34^e rues, le hall d'entrée de trois étages de haut rappelant une chapelle a pignon sur rue des côtés nord et sud.

El vestíbulo, de tres pisos de altura y disposición similar a la de una capilla, se extiende paralelo a las calles 33 y 34, y tiene fachadas comerciales en los extremos norte y sur.

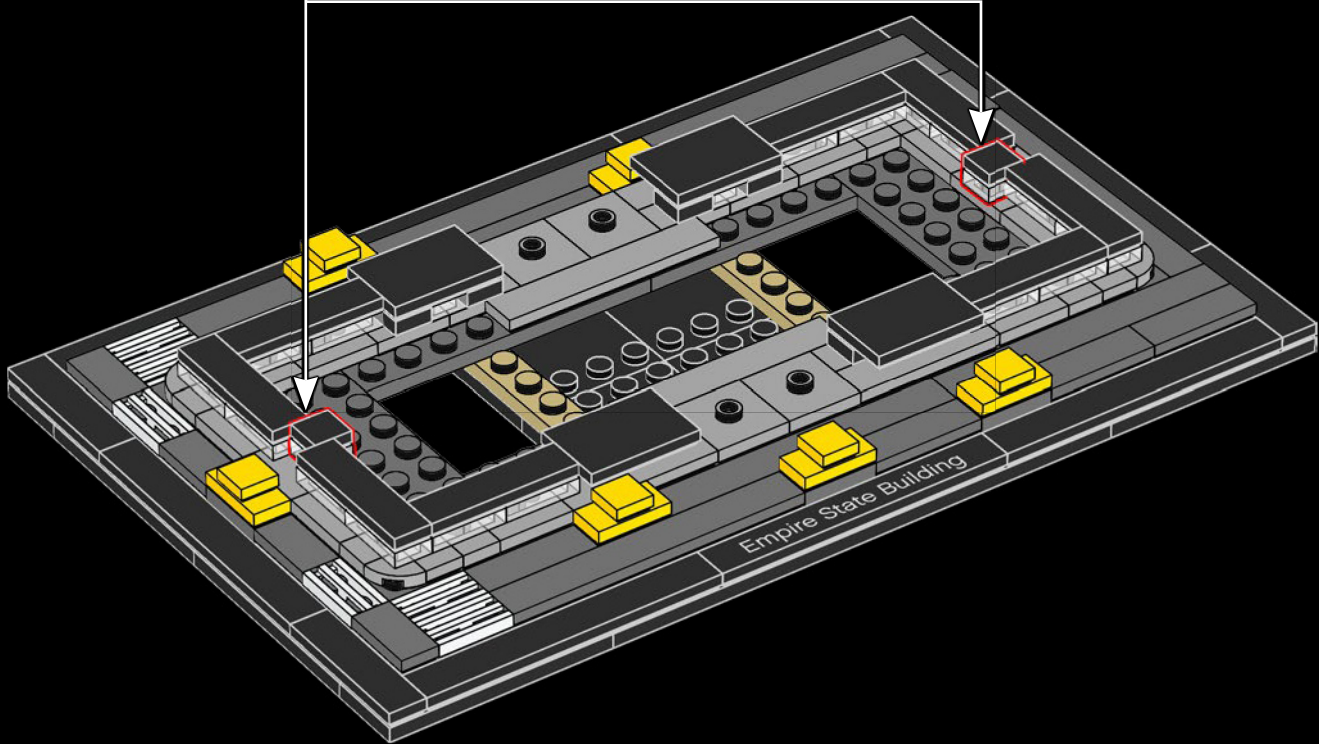



20

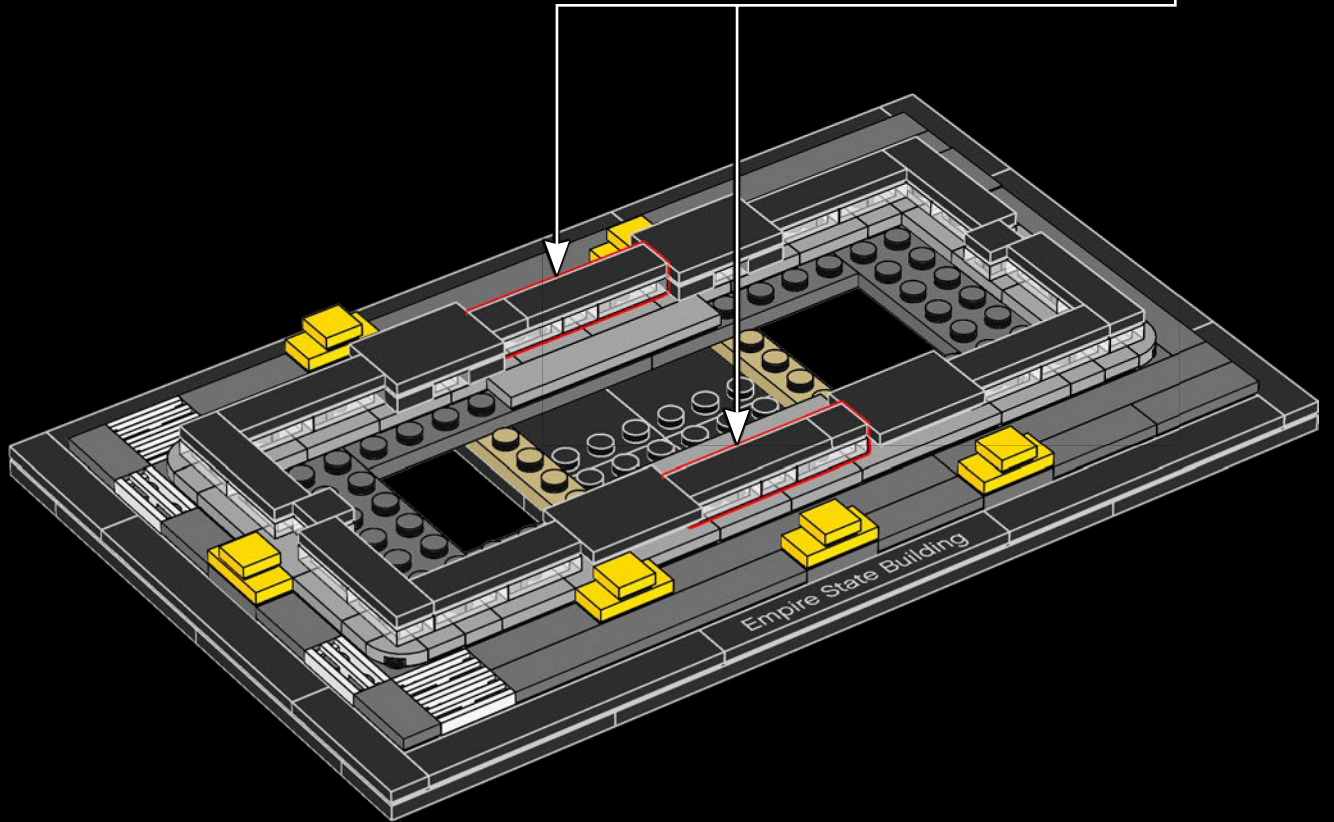
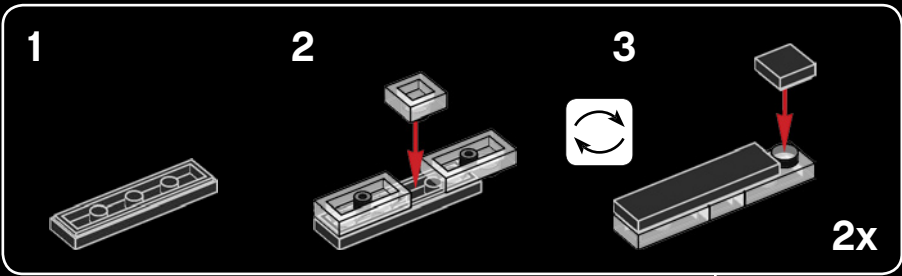

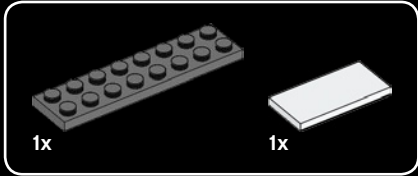

21

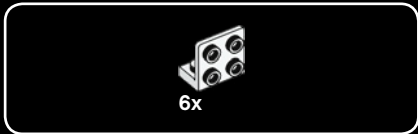
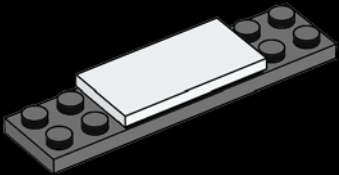

22

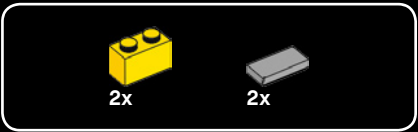
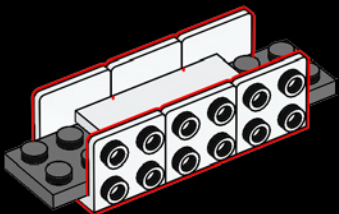

23

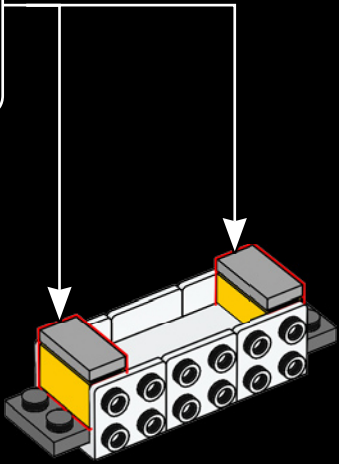
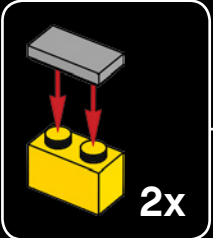



2x



6x

24

1



2

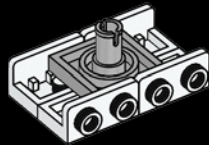

3

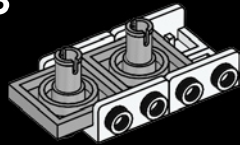

4

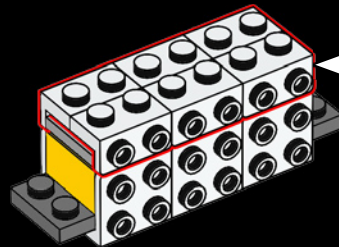
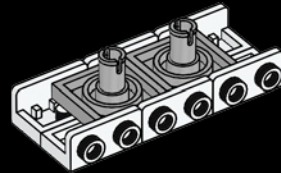

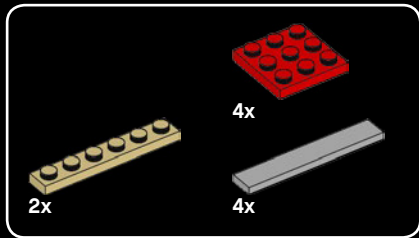

25

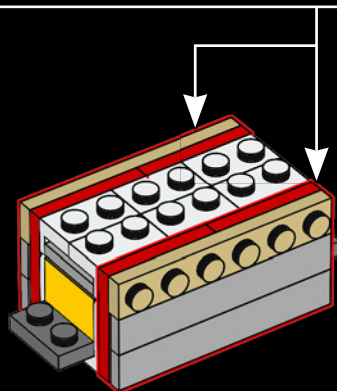
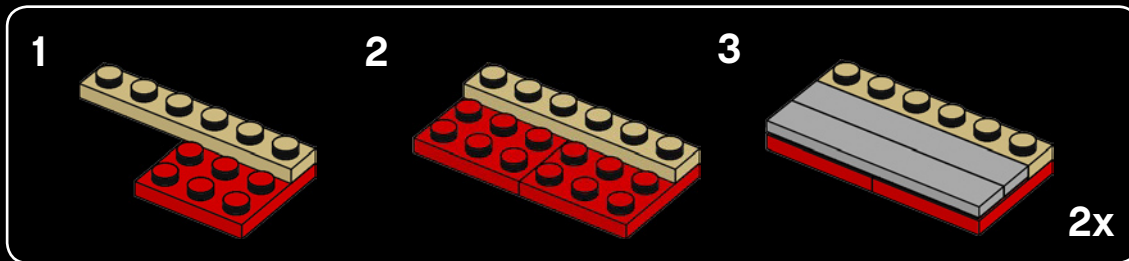

The Empire State Building has 68 modernized, high-speed elevators that transport passengers to their destinations up to 20-40% faster than conventional elevators in other modern commercial buildings. Using regenerated energy, as one elevator descends, the energy created powers the ascending elevators.

L'Empire State Building compte 68 ascenseurs modernisés à grande vitesse qui transportent les passagers à leur destination de 20 à 40 % plus rapidement que les ascenseurs classiques d'autres édifices commerciaux modernes. Ces ascenseurs utilisent de l'énergie régénérée : lorsqu'un ascenseur descend, l'énergie créée alimente les ascenseurs qui montent.

El Empire State Building cuenta con 68 elevadores renovados de alta velocidad que transportan a los pasajeros hasta sus destinos un 20-40 % más rápido que los elevadores convencionales que se pueden encontrar en otros edificios comerciales modernos. Mediante un sistema de regeneración energética, cuando un elevador desciende, la energía que crea se usa para alimentar los elevadores que ascienden.

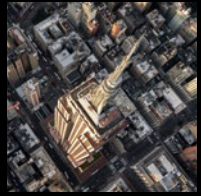

26

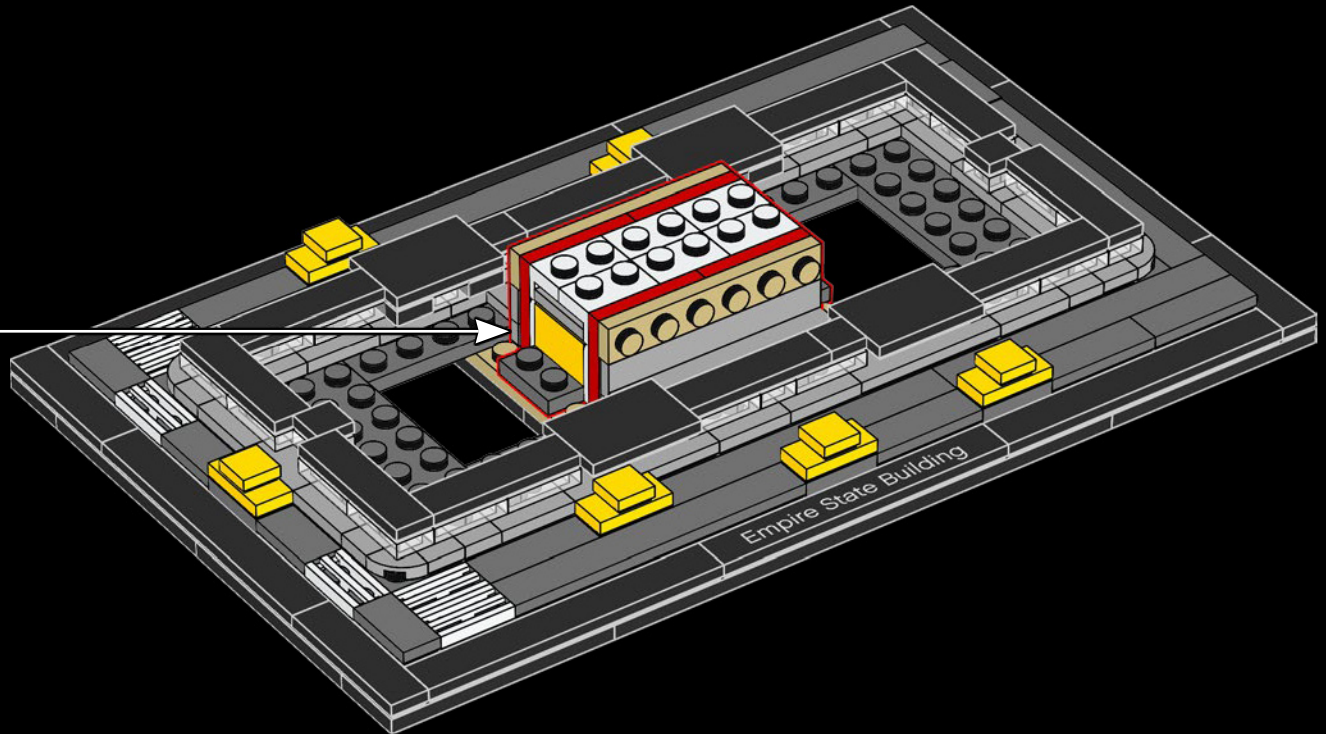

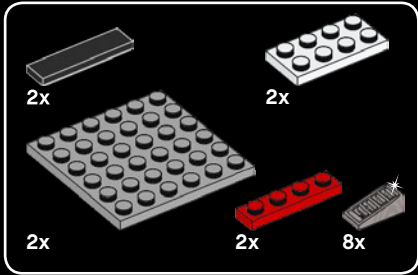

27

1

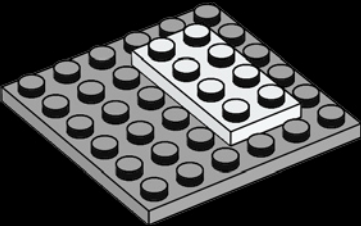

2

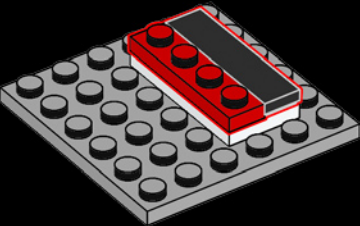

3

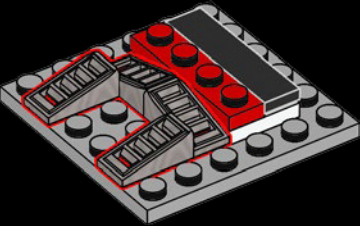

2x

There are eight high-speed escalators in the building's
concourse and second floor areas.

Le rez-de-chaussée et le deuxième étage du bâtiment
comprennent huit escaliers roulants à haute vitesse.

Hay ocho escaleras eléctricas de alta velocidad en las
zonas del recibidor y del segundo piso del edificio.

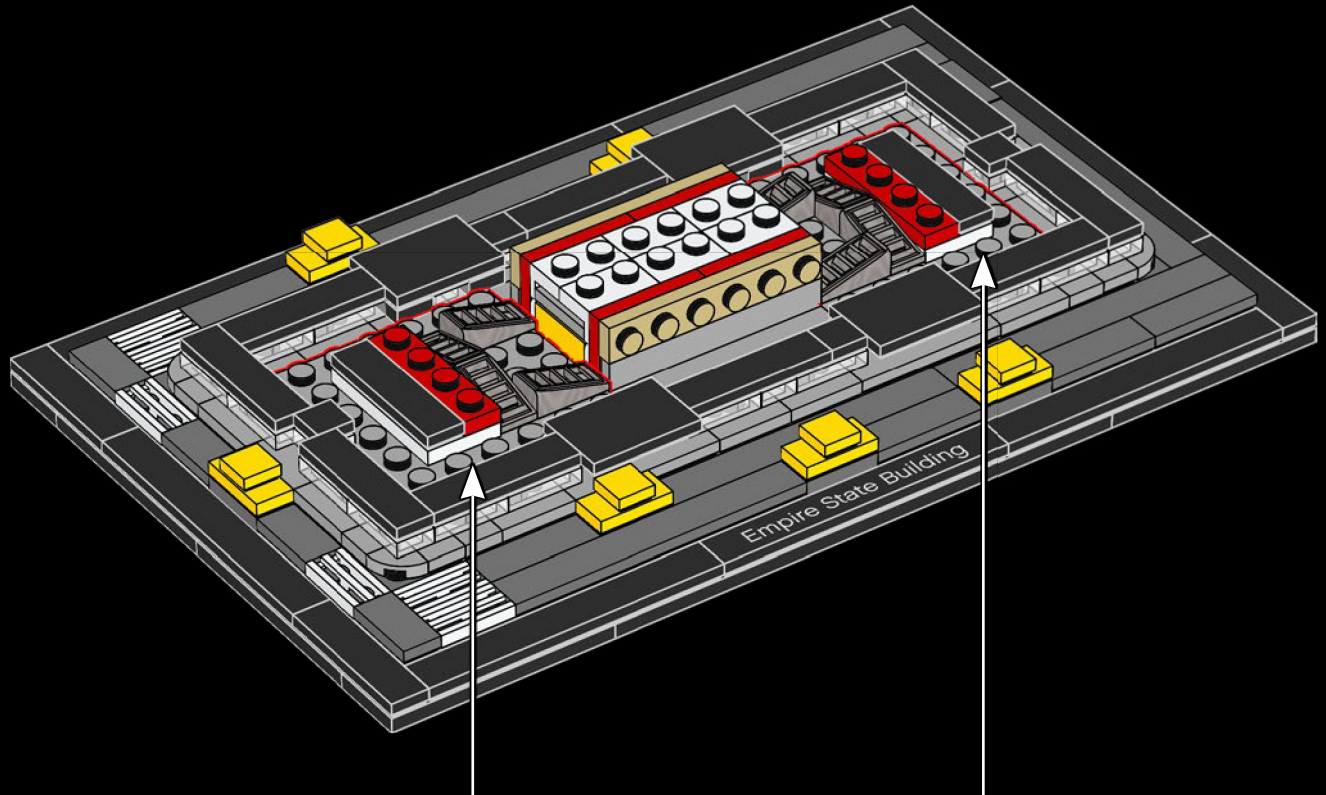
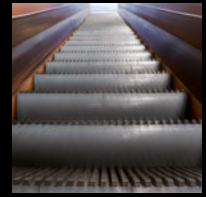

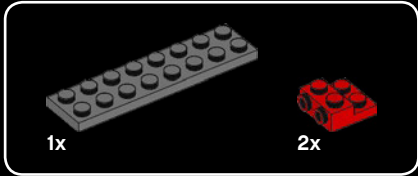
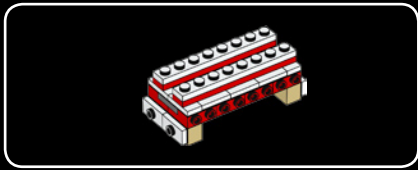

28

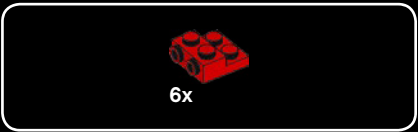
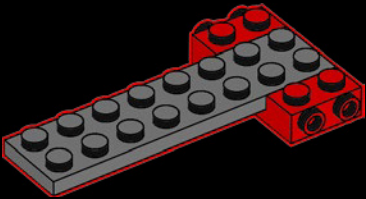

29

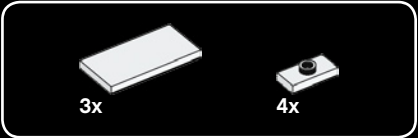
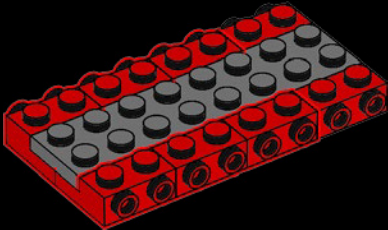

30

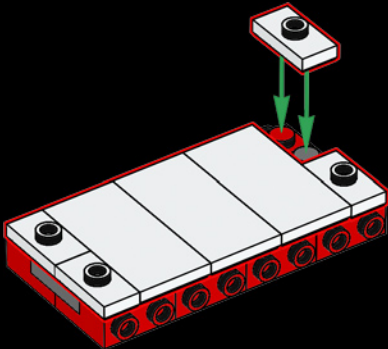

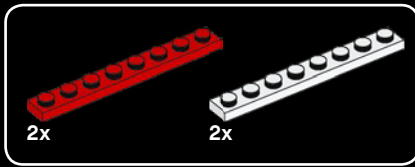

31

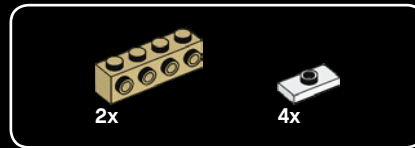
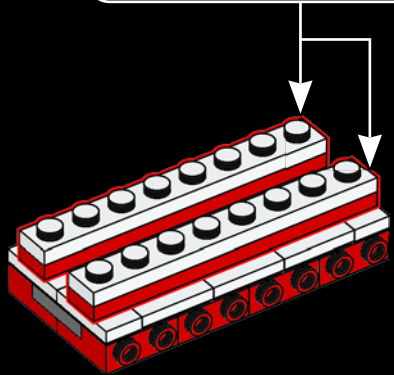
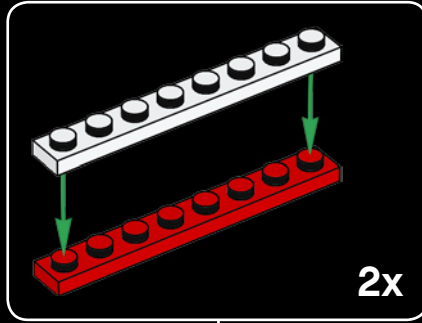

32

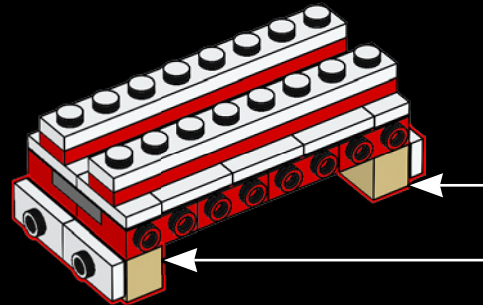
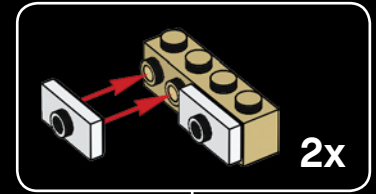

33

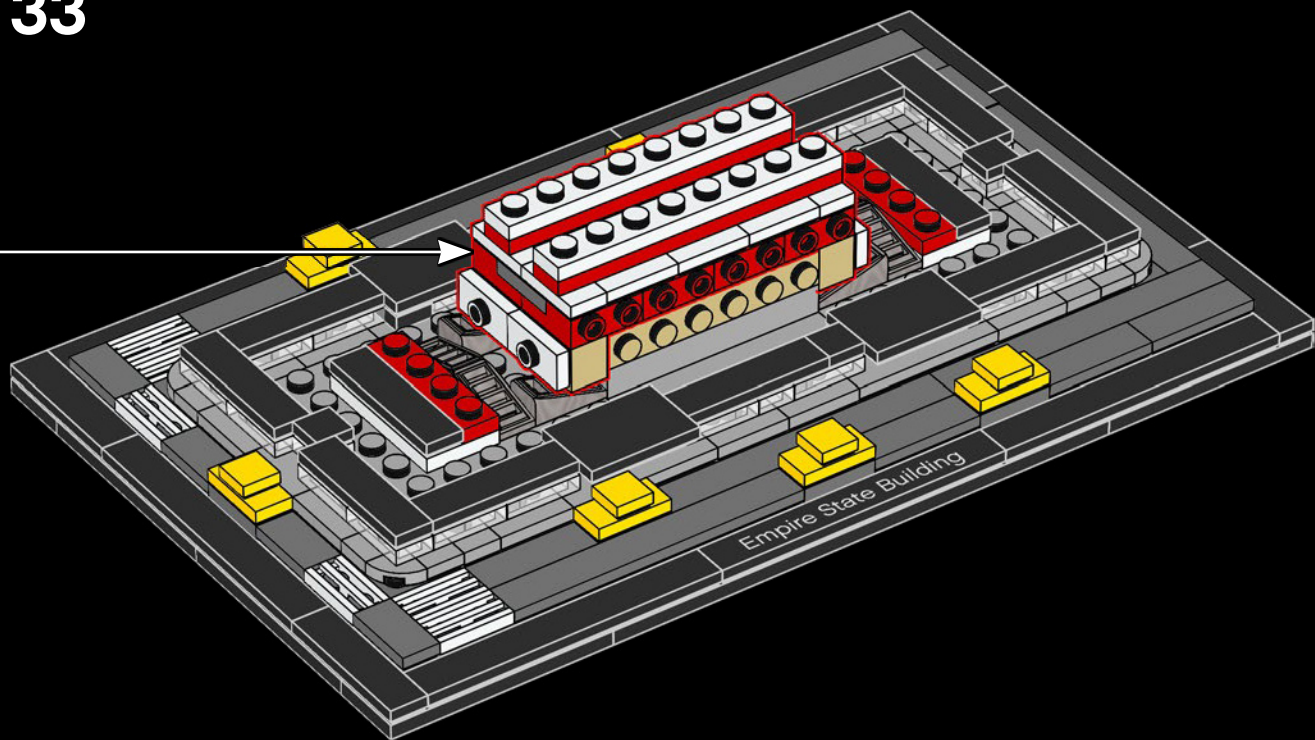

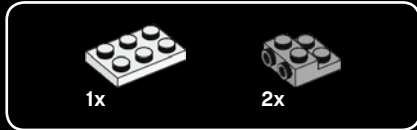
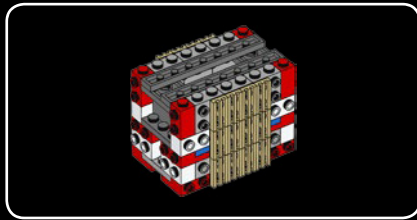
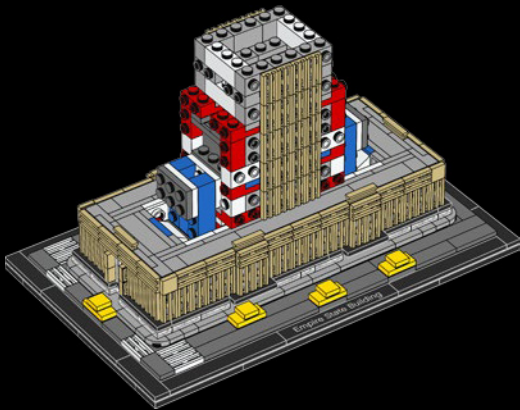

34

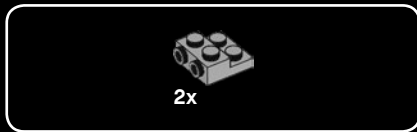

35

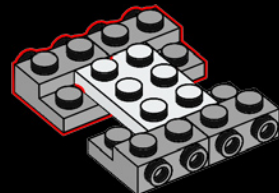



2x

36

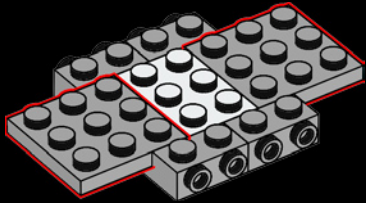

4x

37

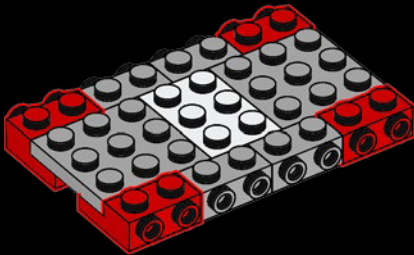

6x



4x

38

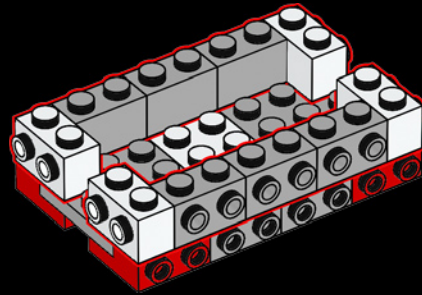



39

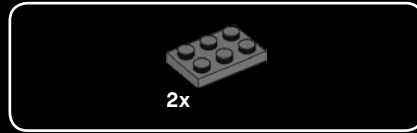
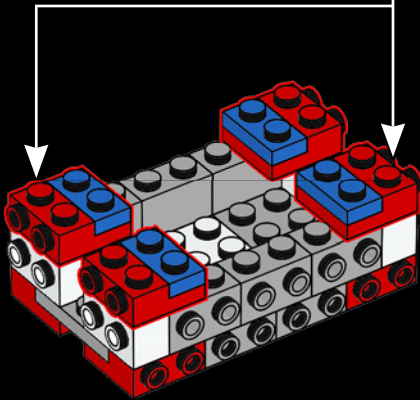
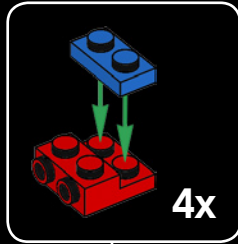

40

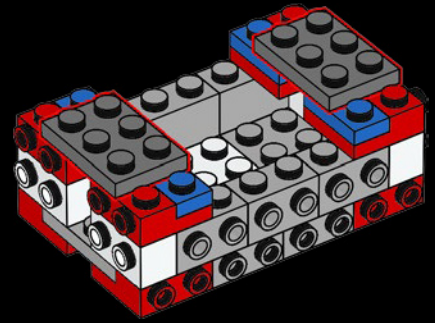



4x

41

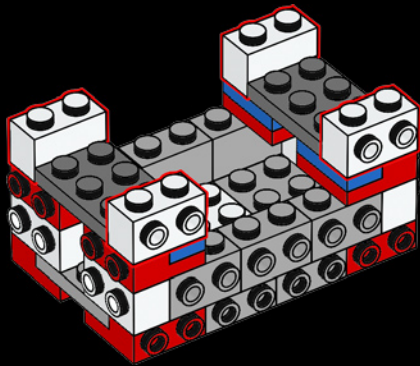

4x

42

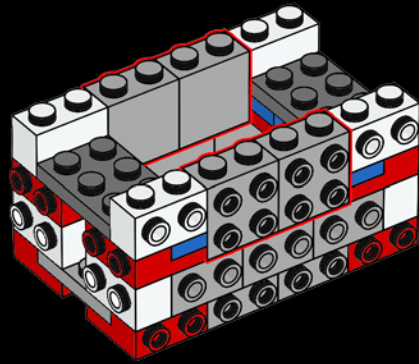

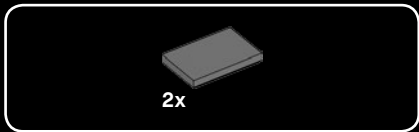

43

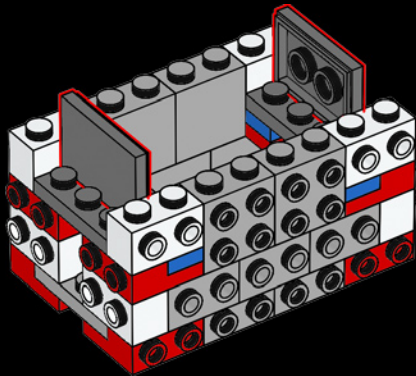

44

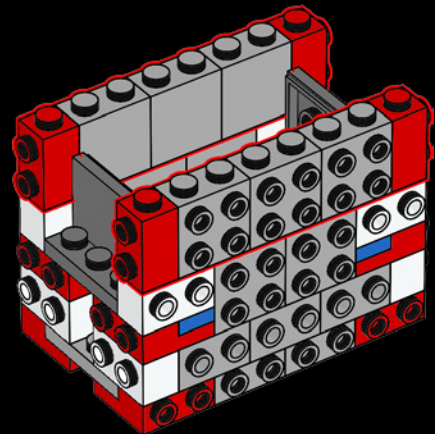

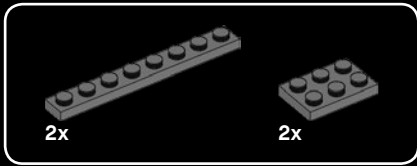

45

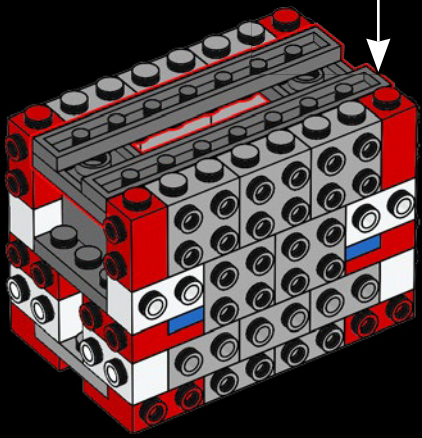
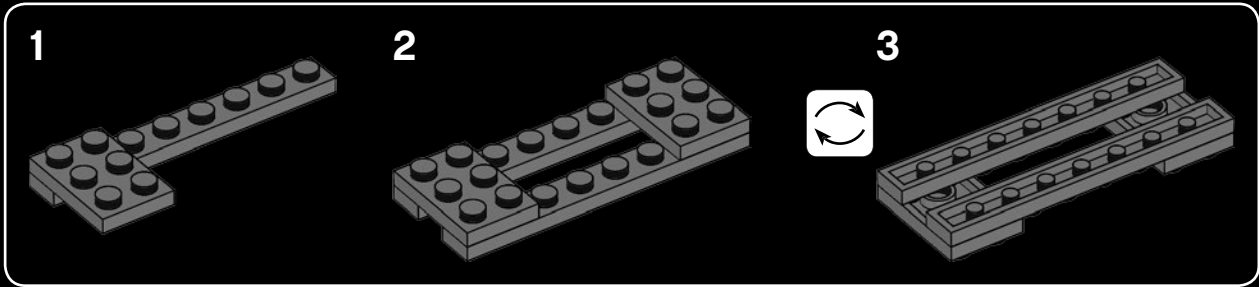



46

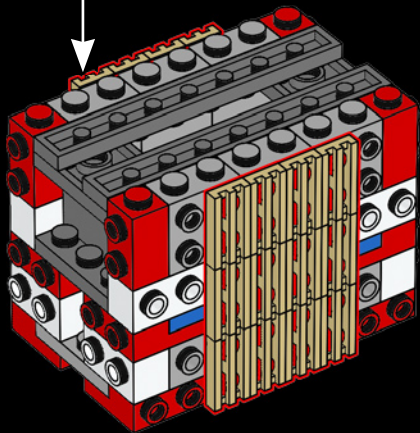

47

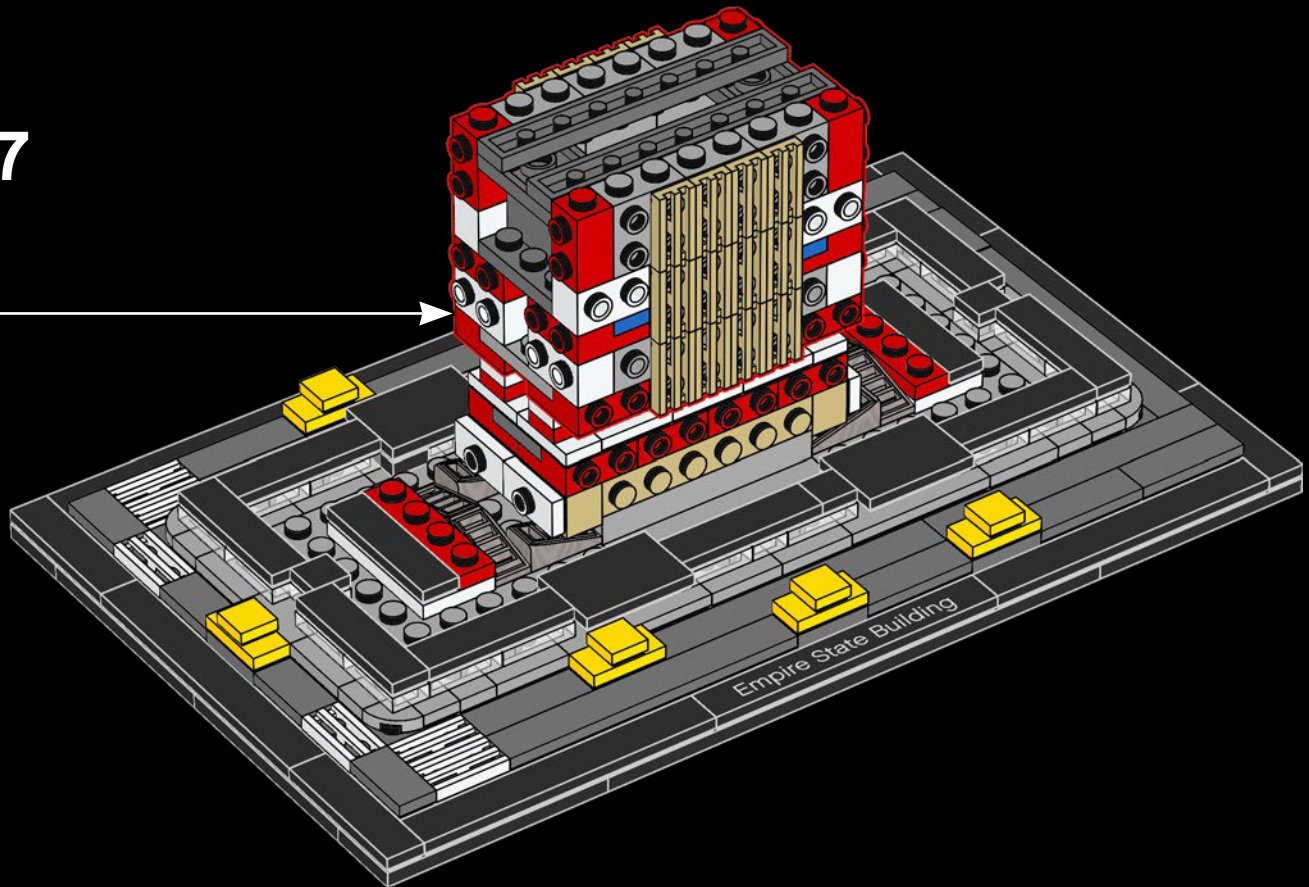

48

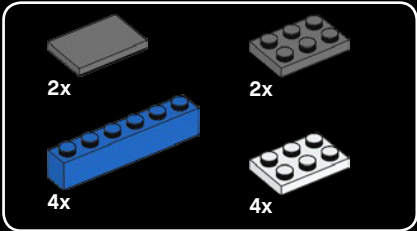

48

1

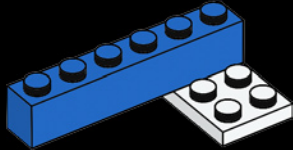

2

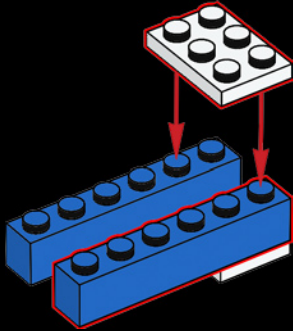

3

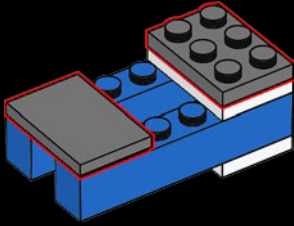

2x

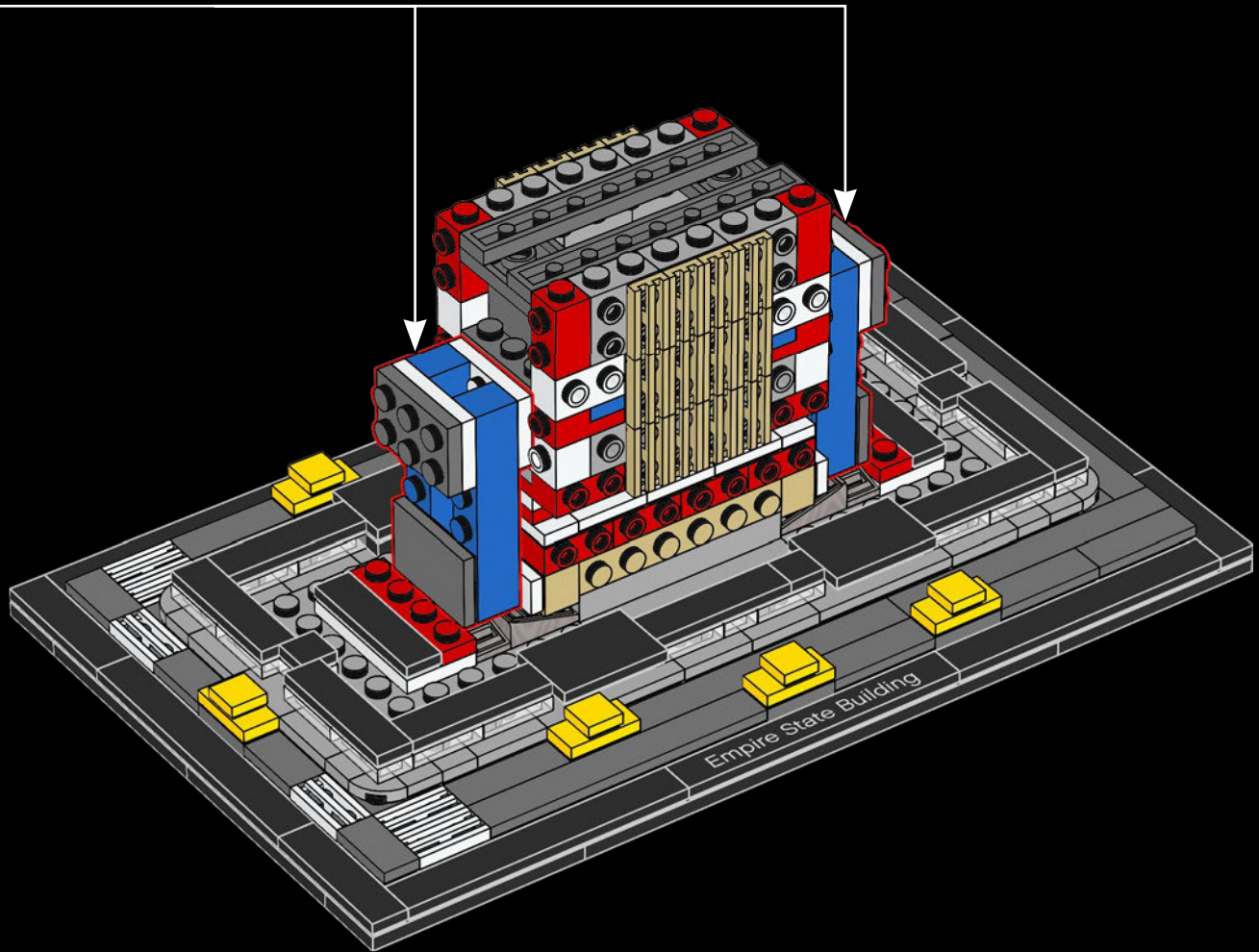

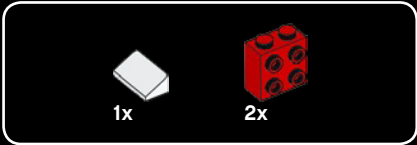
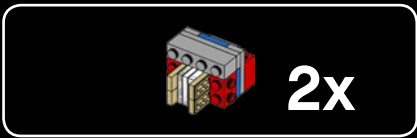

49

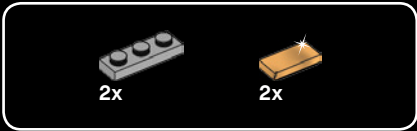
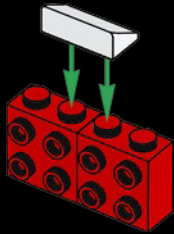

50

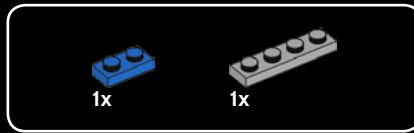
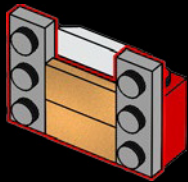

51

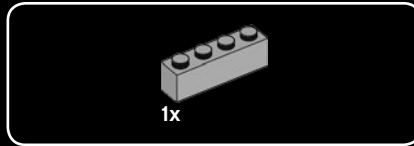
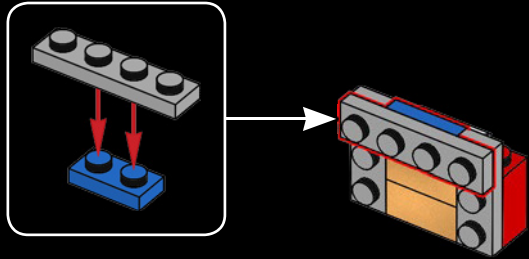

52

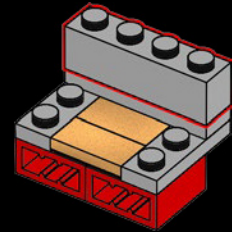
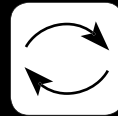

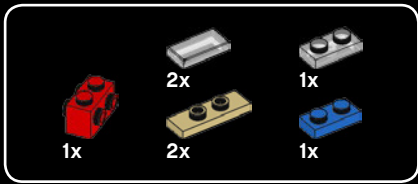

53

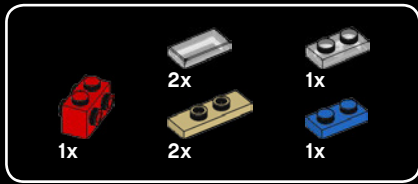
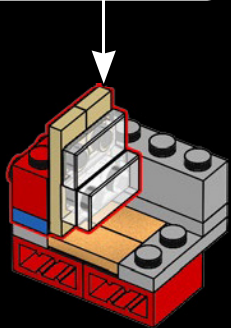
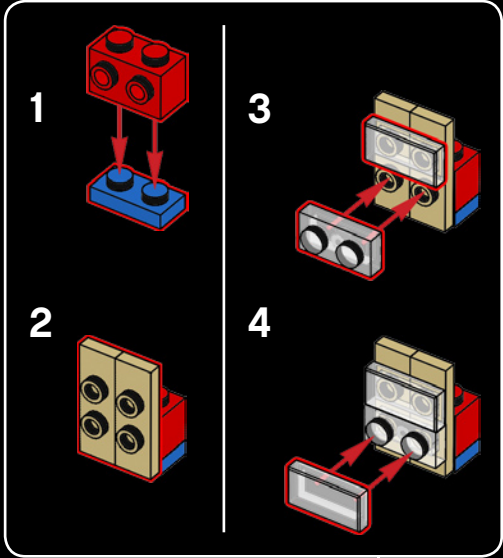

54

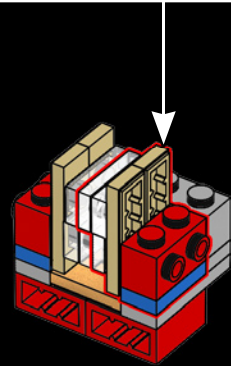
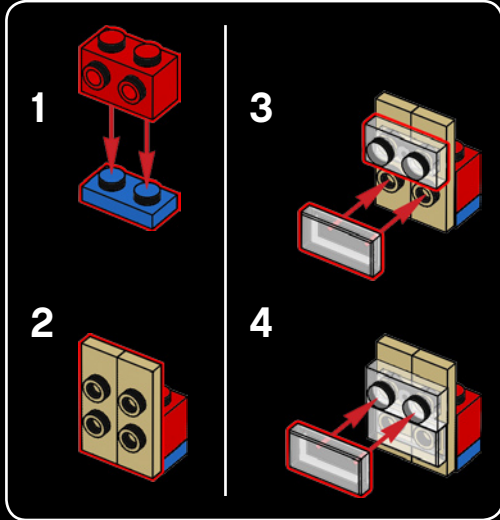

2x

The Famous Art Deco lobby includes an aluminum relief of the building. On the wall above the front desk in the Fifth Avenue lobby is one of the most famous images in New York City, a depiction of the building itself with beams of lights radiating from the mast.

Le célèbre hall d'entrée Art déco comporte un relief en aluminium du bâtiment. Sur le mur de la réception du hall d'entrée donnant sur la Cinquième Avenue se trouve l'une des images les plus célèbres de New York, une représentation du bâtiment lui-même dont le mât semble projeter des faisceaux lumineux.

El famoso vestíbulo *art déco* incluye un relieve del edificio hecho de aluminio. Sobre la pared que se alza detrás del mostrador de recepción del vestíbulo de la Quinta Avenida se encuentra una de las imágenes más famosas de la ciudad de Nueva York: una representación del mismo edificio con rayos de luz que emanan del mástil.

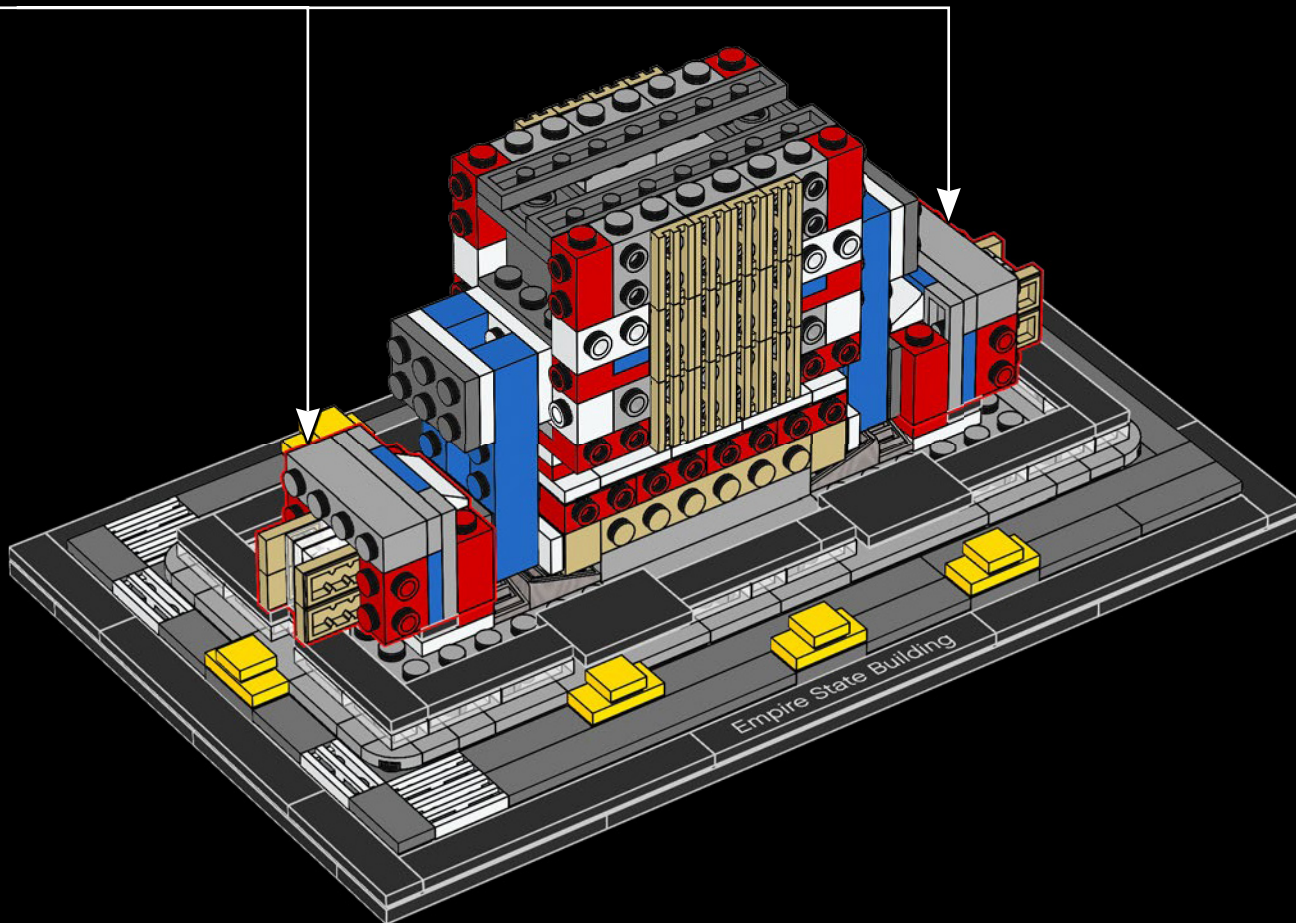

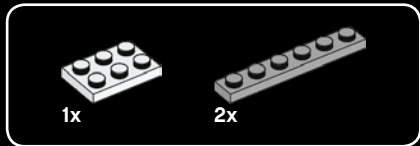
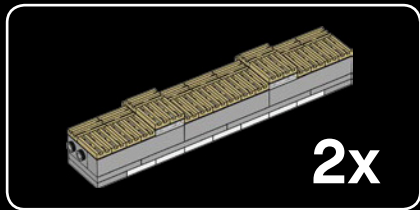

56

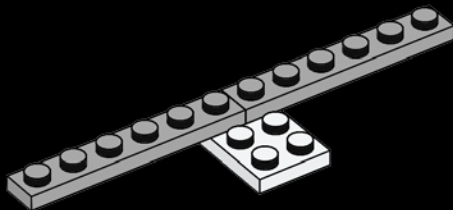

57

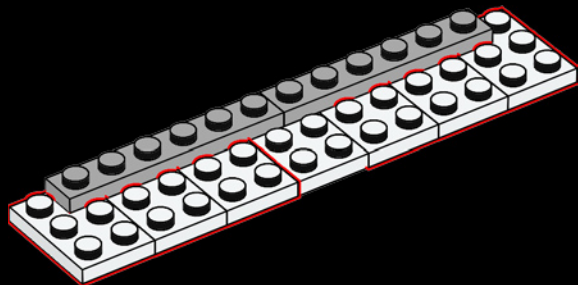

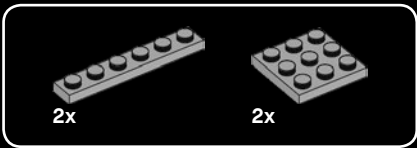

58

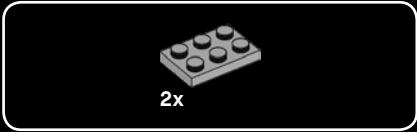
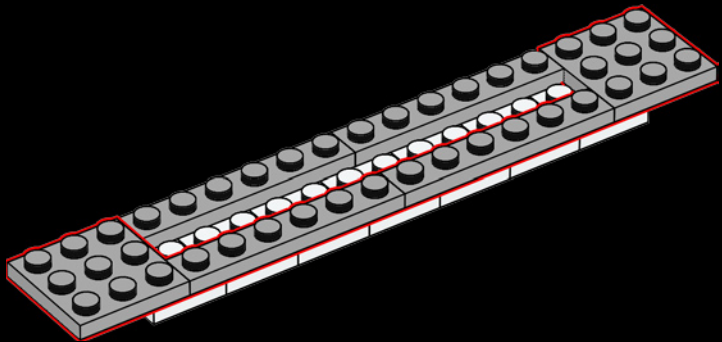

59

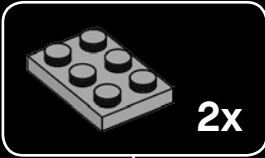
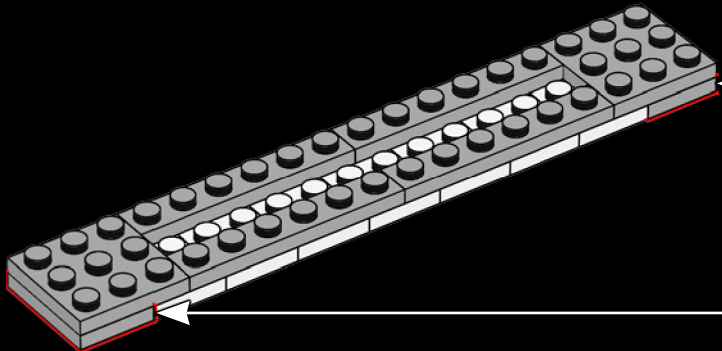

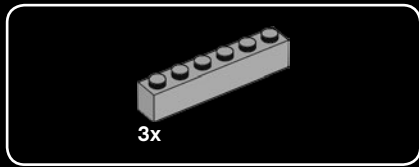

60

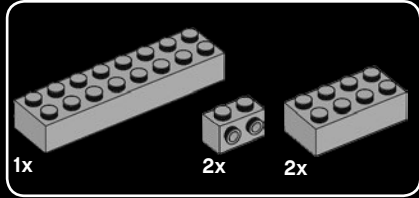
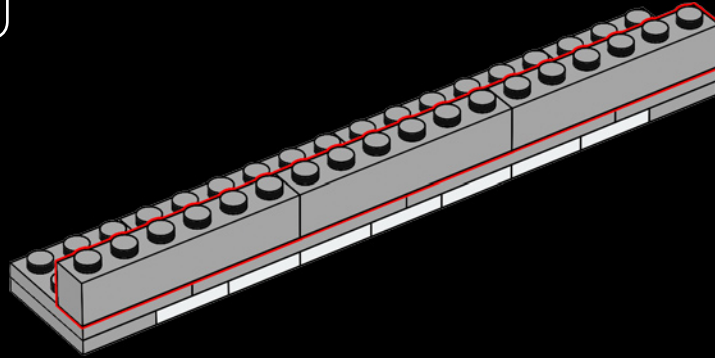

61

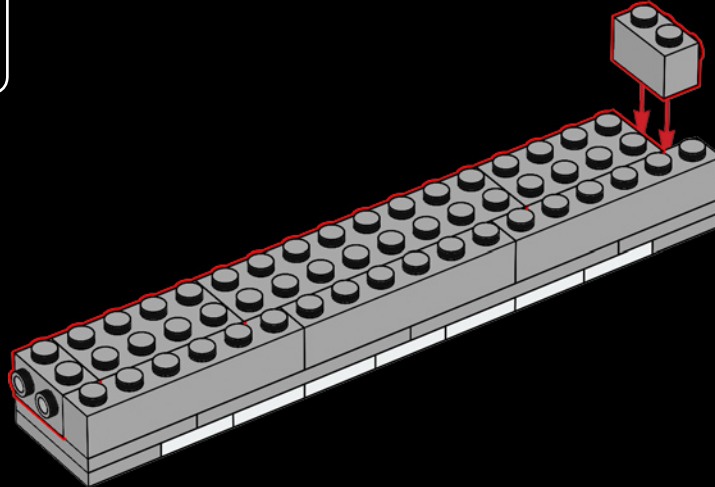

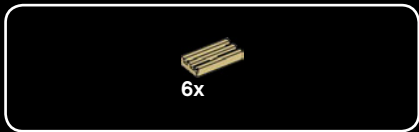

62

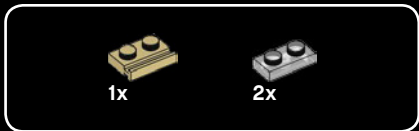
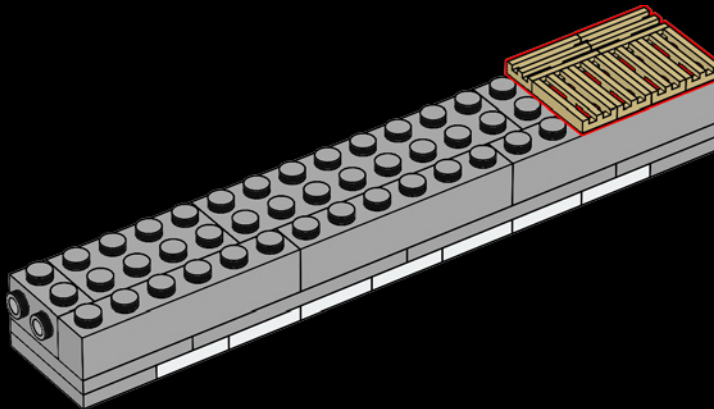

63

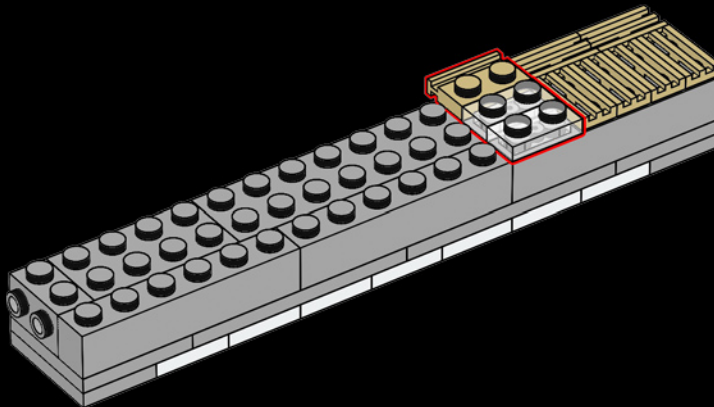



9x

64

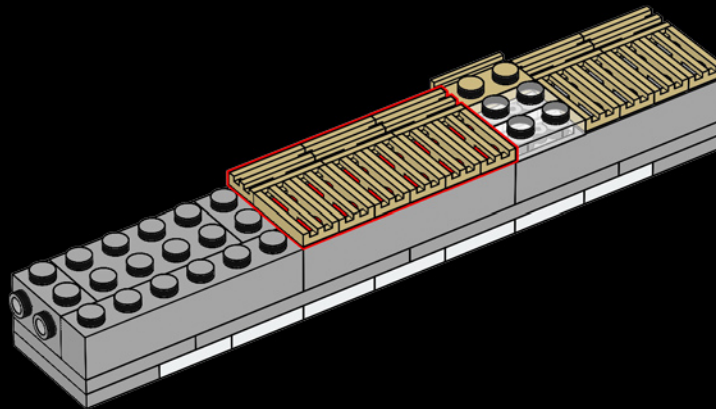

1x



2x

65

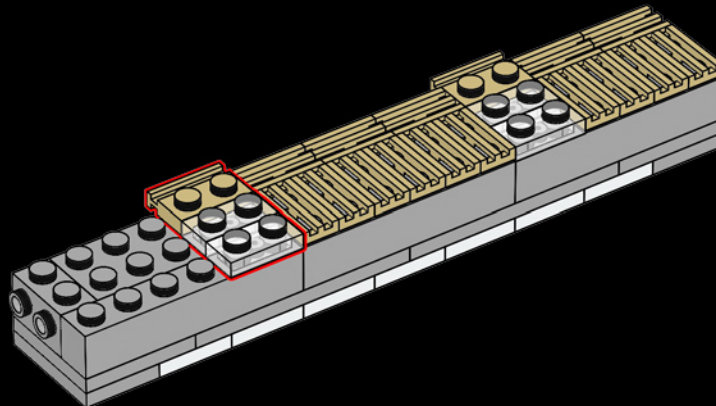



66

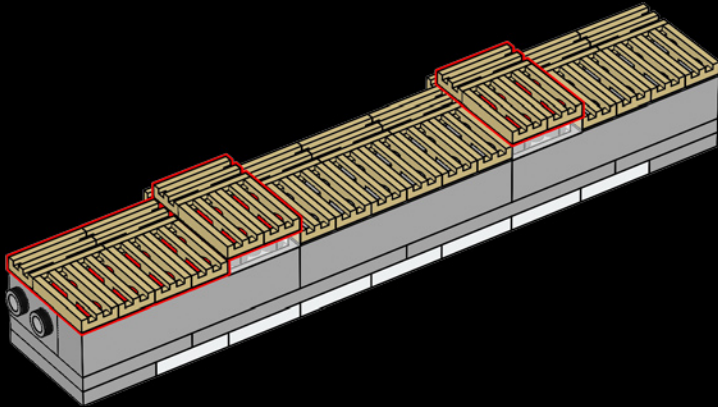

2x

67

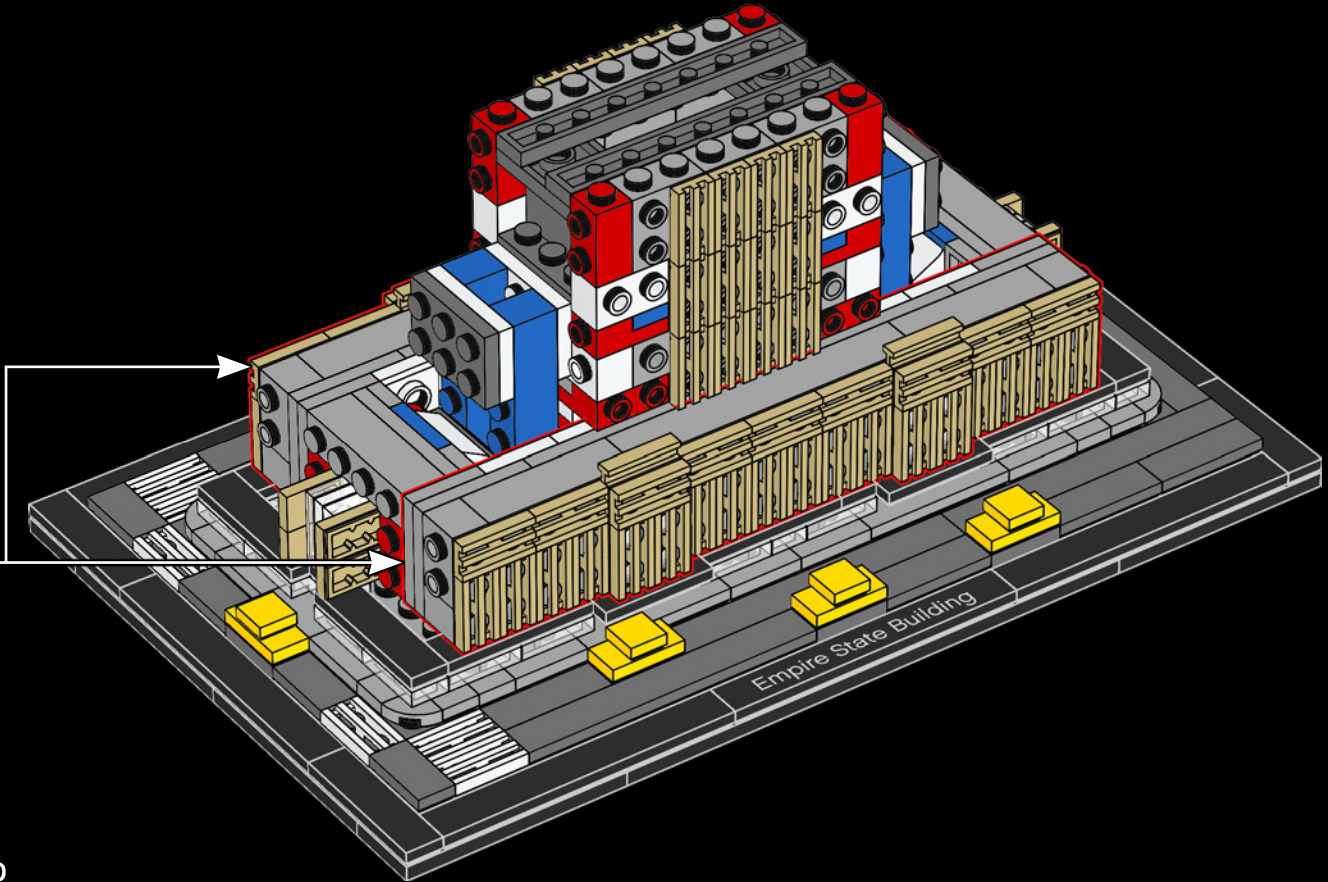

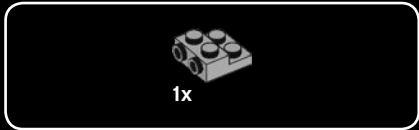
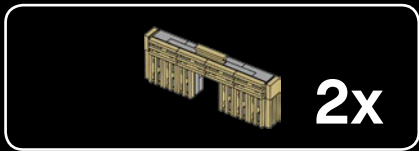

68

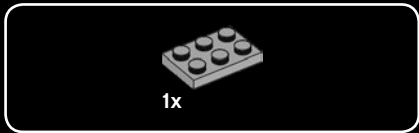

69

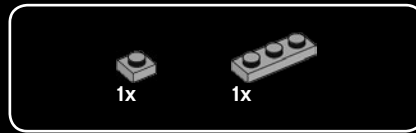

70

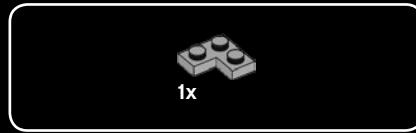
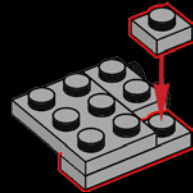

71

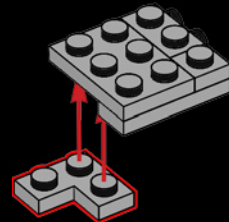



1x

72

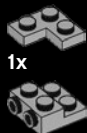
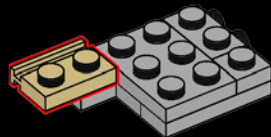

1x

1x

1x

73

1



2



3

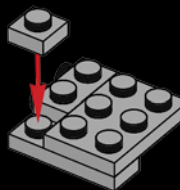

4

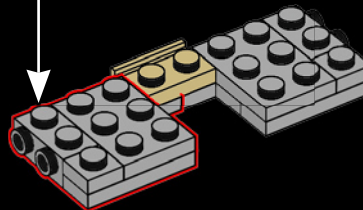
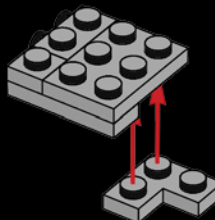

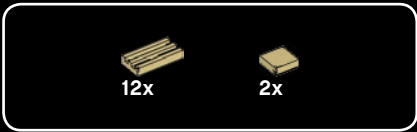

74

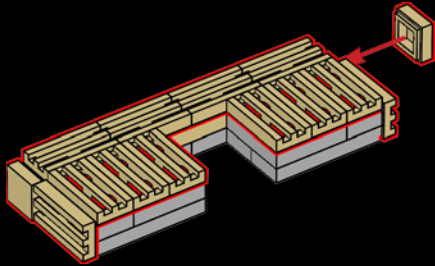

2x

75

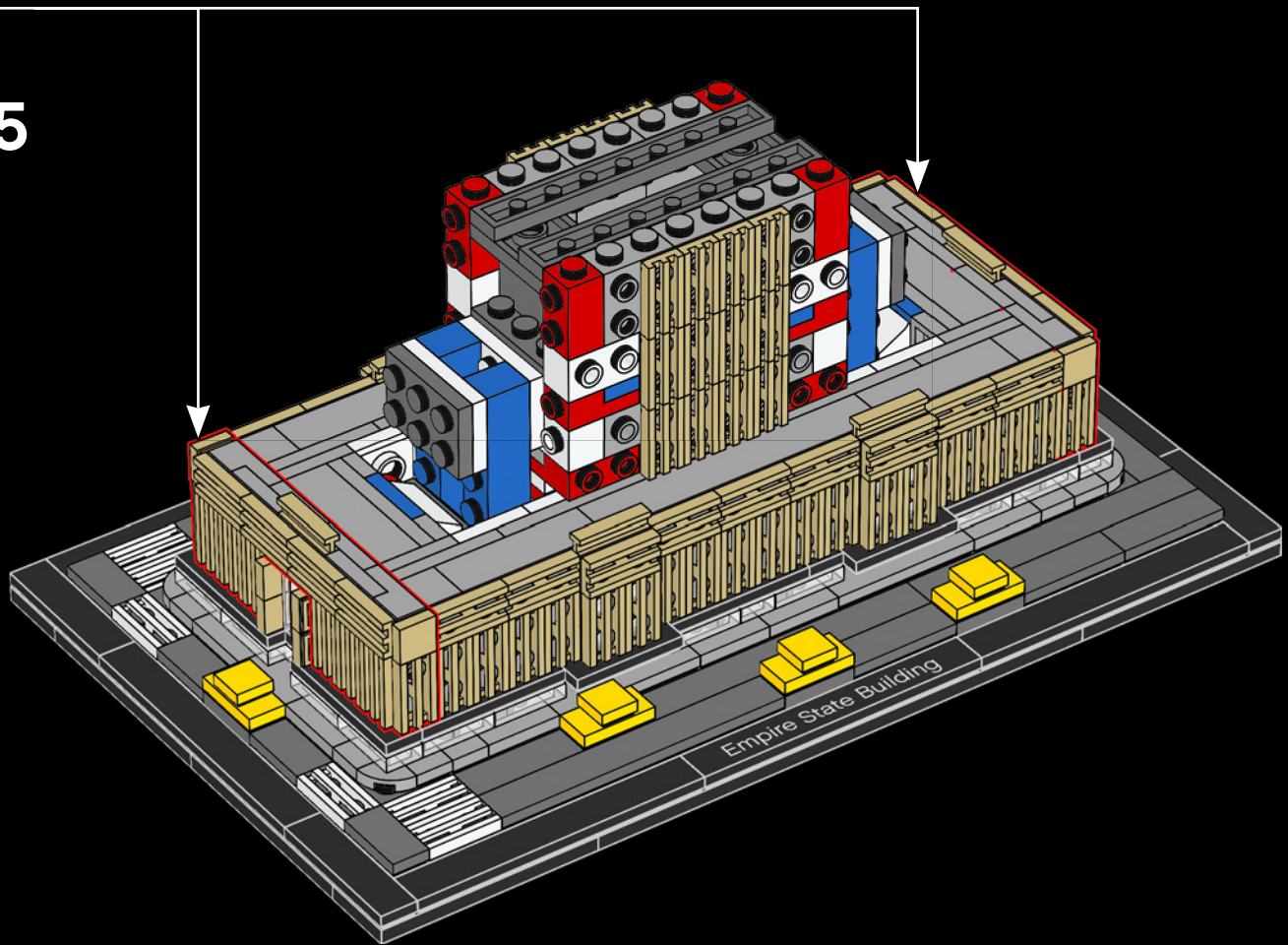

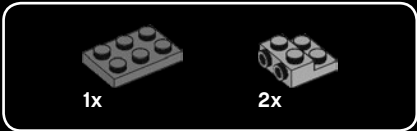
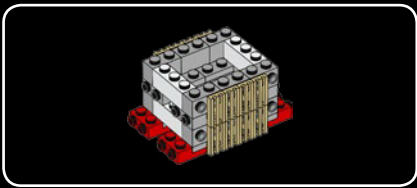

76

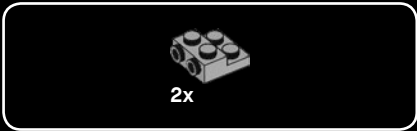
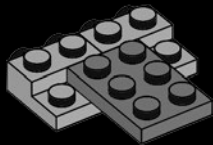

77

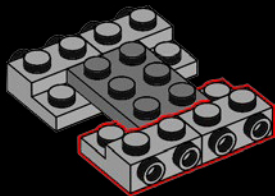

78

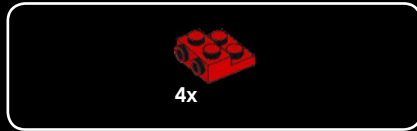
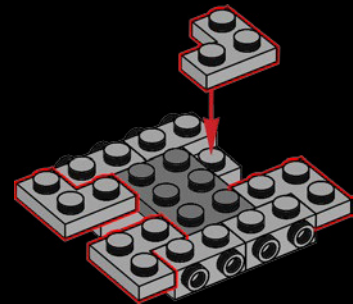

79

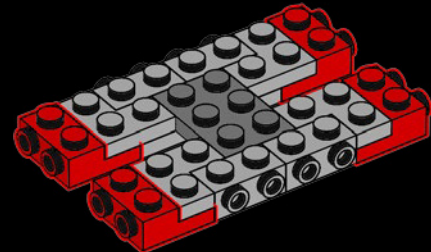

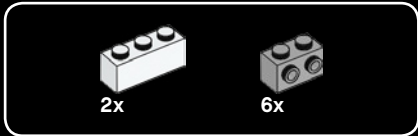

80

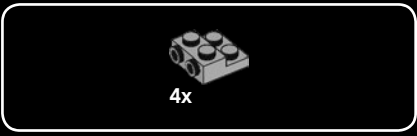
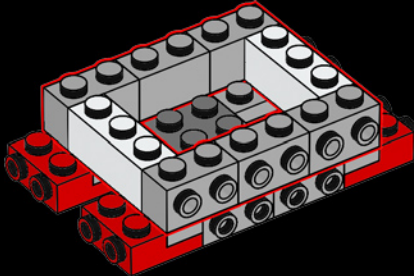

81

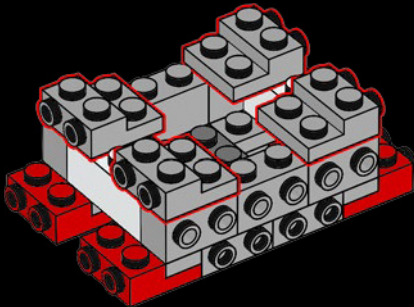



82

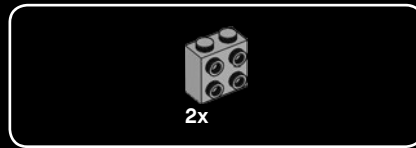
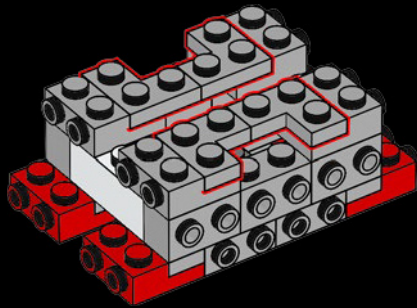

83

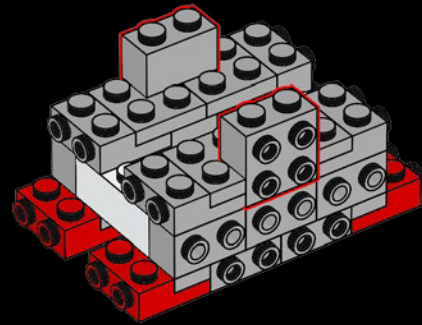



2x



4x

84

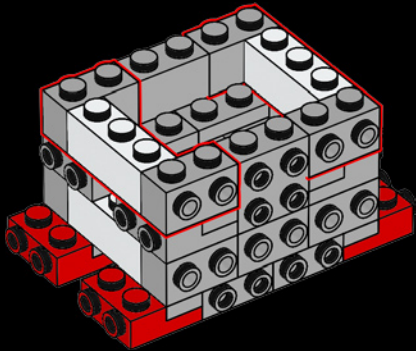

16x

85

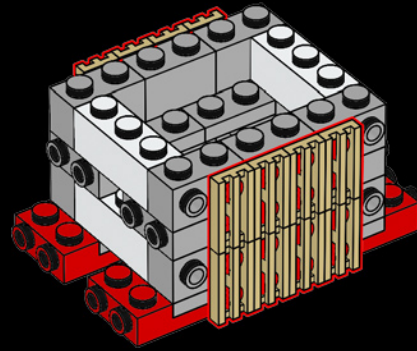

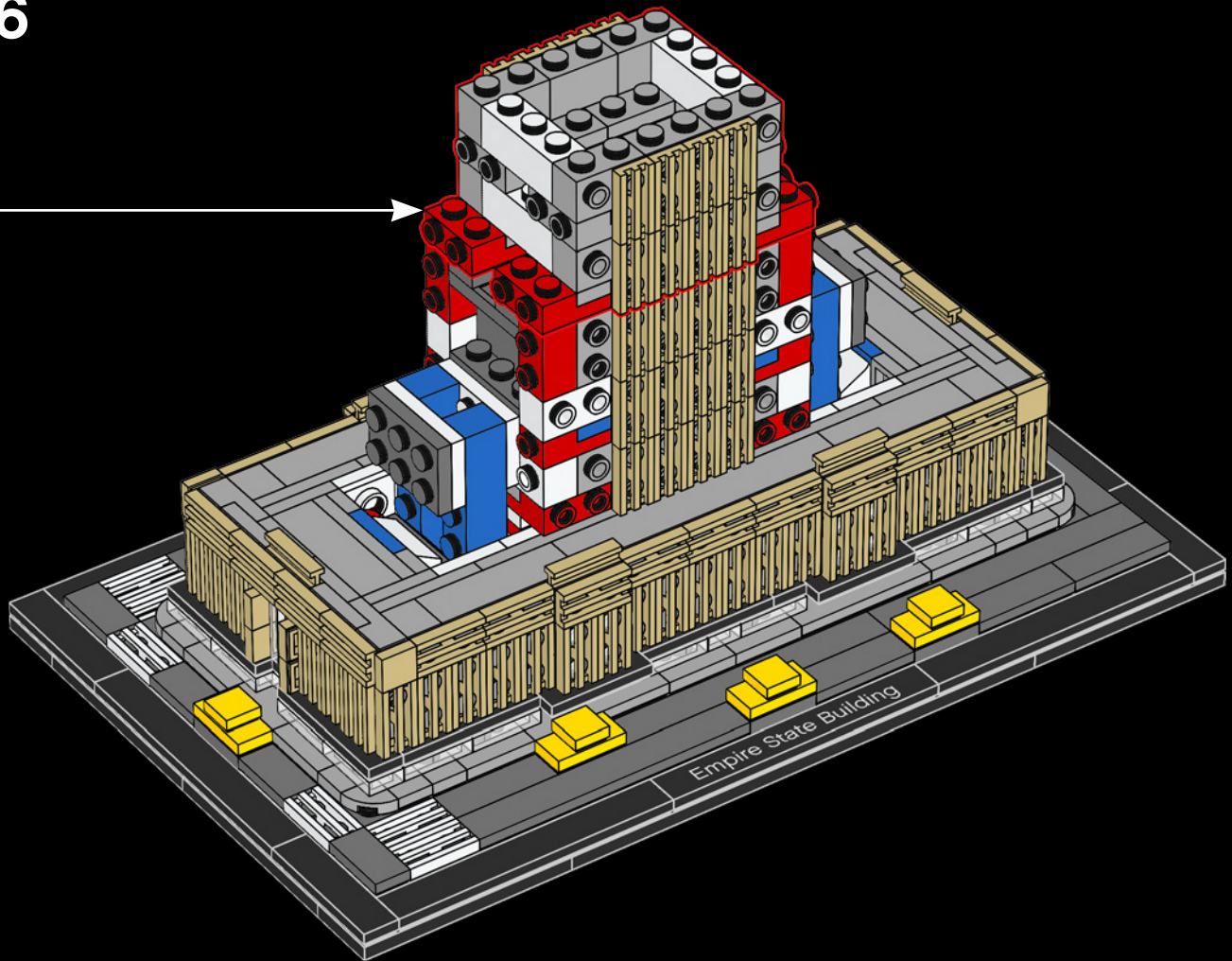

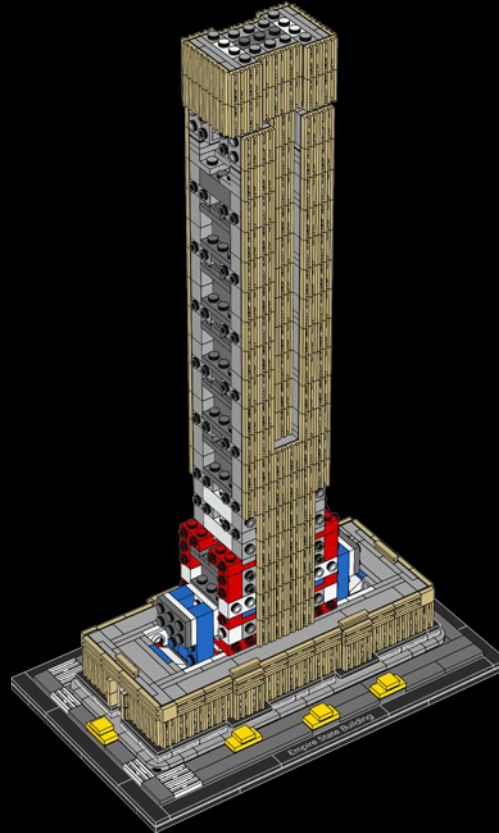

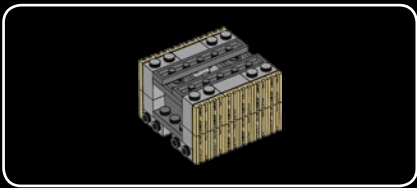

87

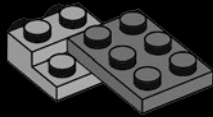

88

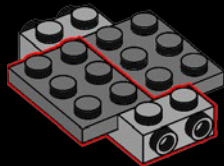

89

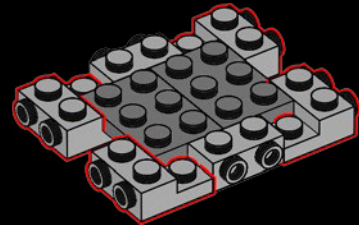

90

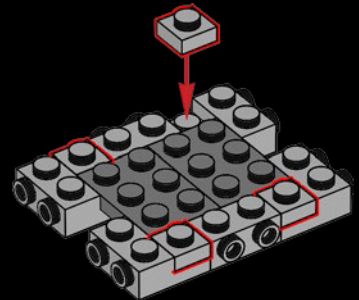



1x

91

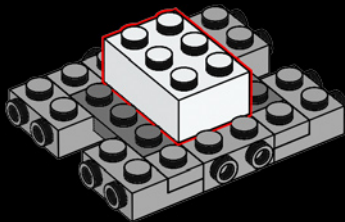

2x

92

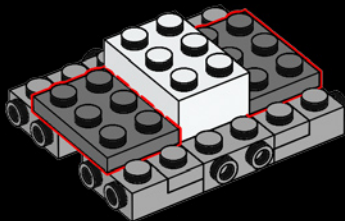

6x

93

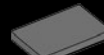
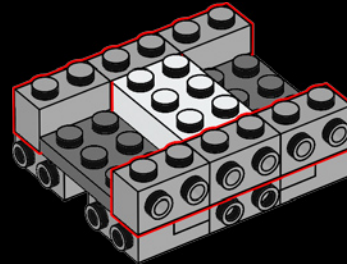

2x

94

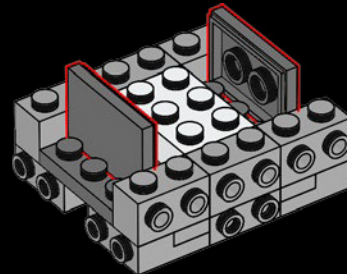

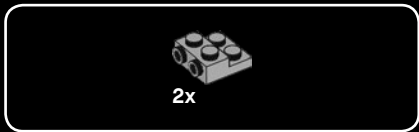

95

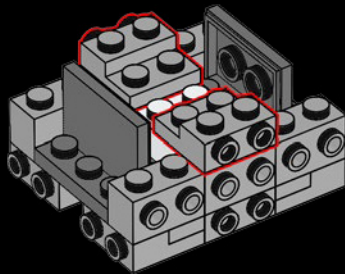

96

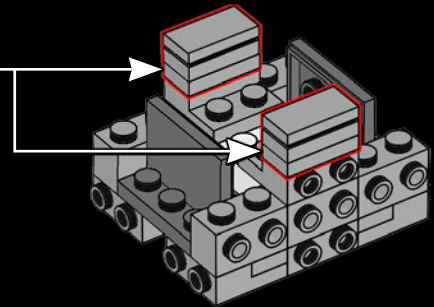
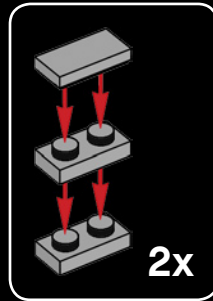



4x

97

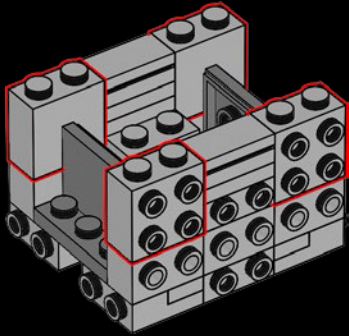

24x

98

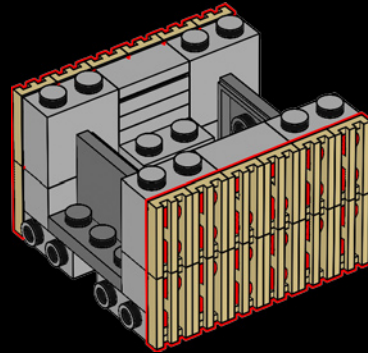

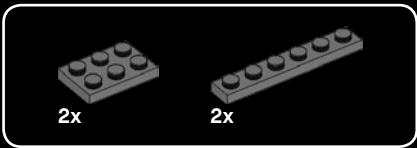

99

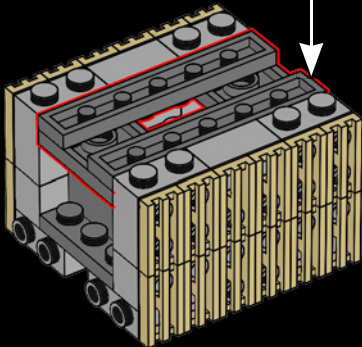
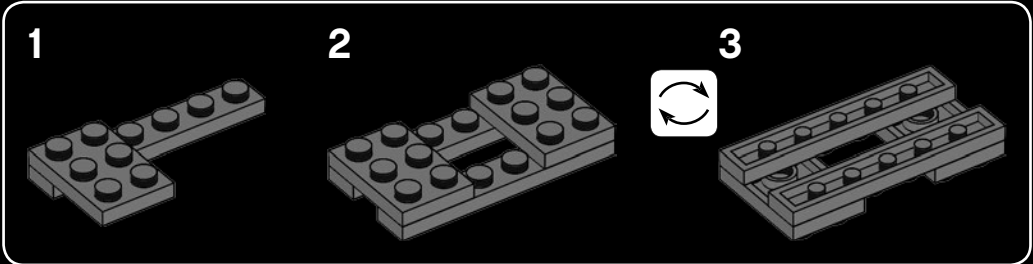

The steel frame construction of the building is made from riveted steel beams and girders.

La charpente en acier du bâtiment est faite de poutres et de poutrelles en acier rivetées.

La estructura de acero del edificio está hecha de vigas y traves de acero remachadas.

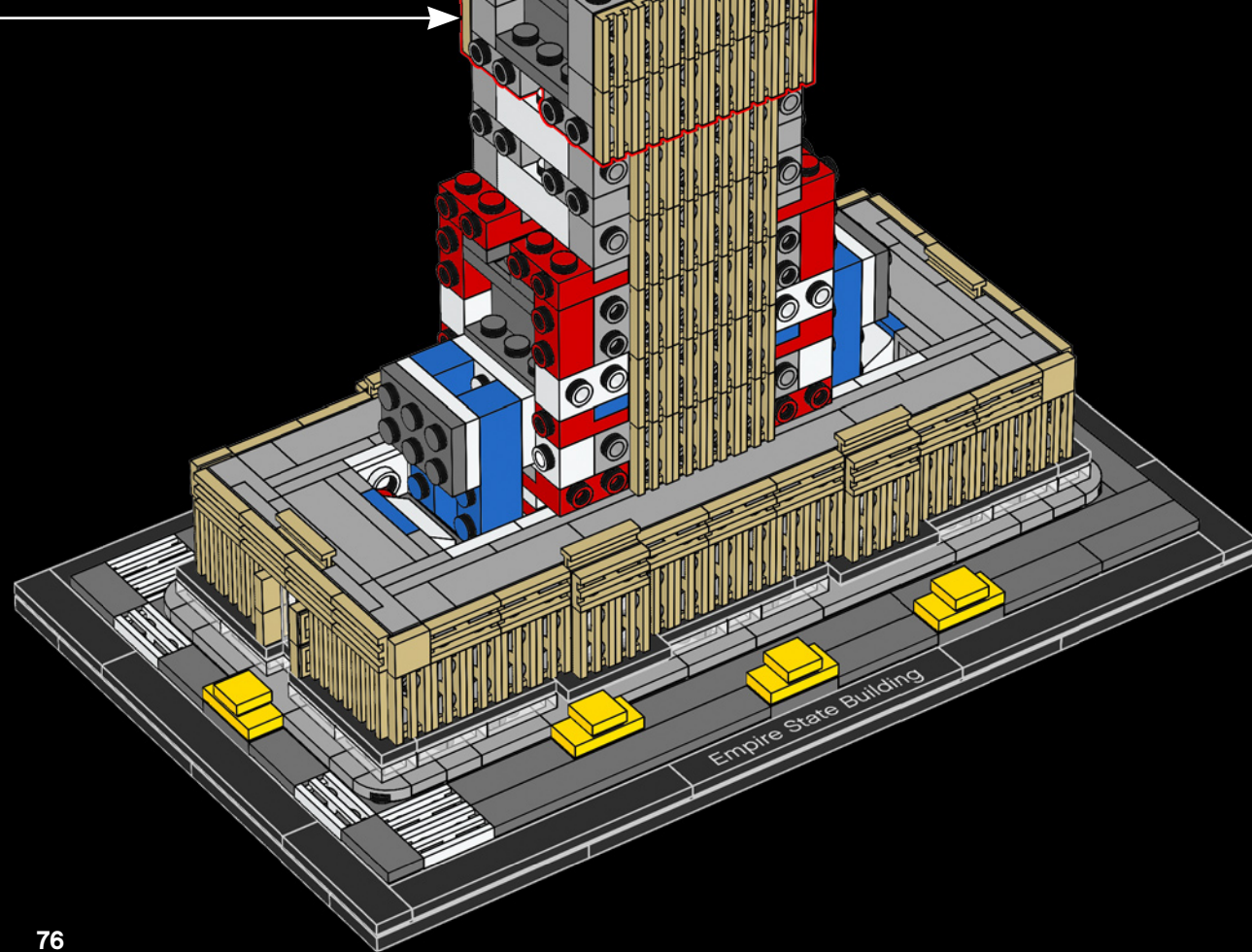

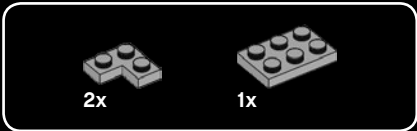
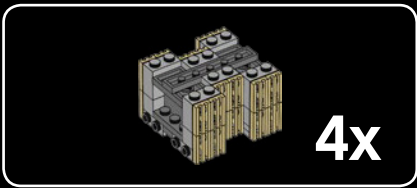

101

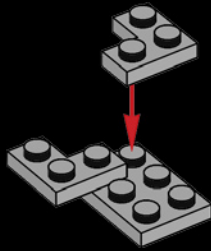

102

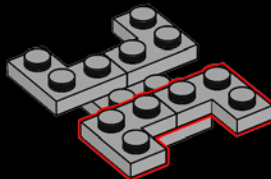

103

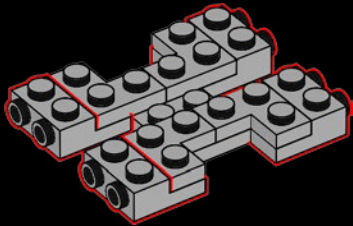

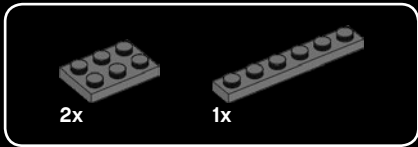

104

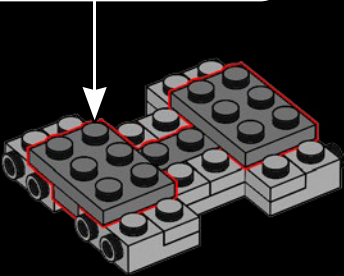
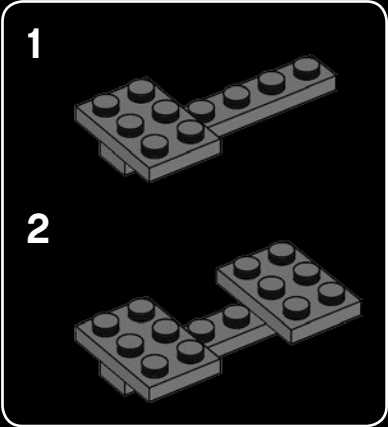

105

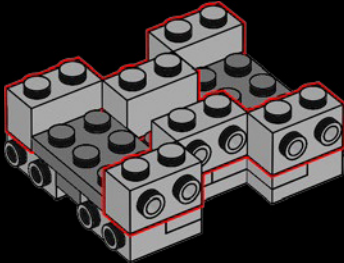

106

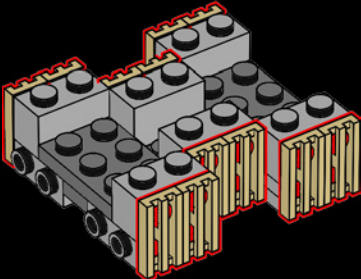

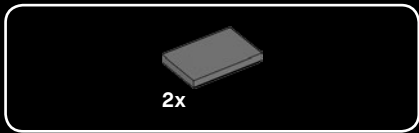

107

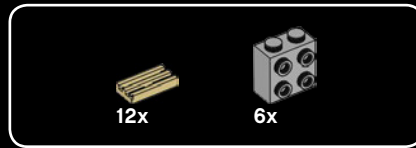
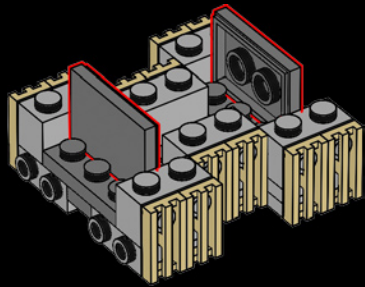

108

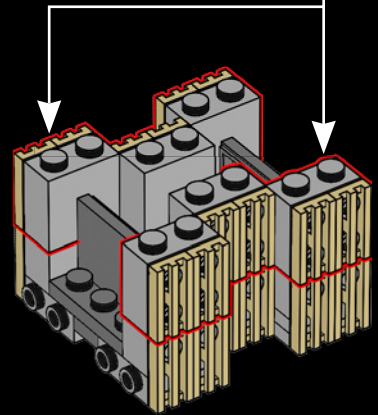
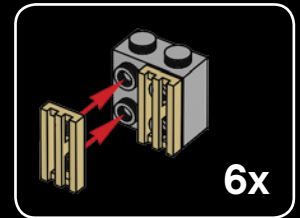

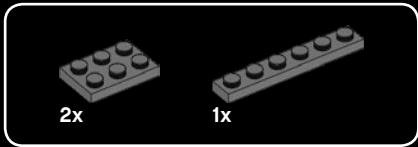

109

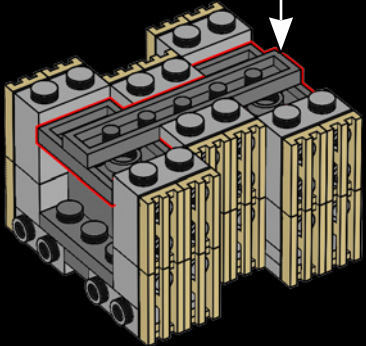
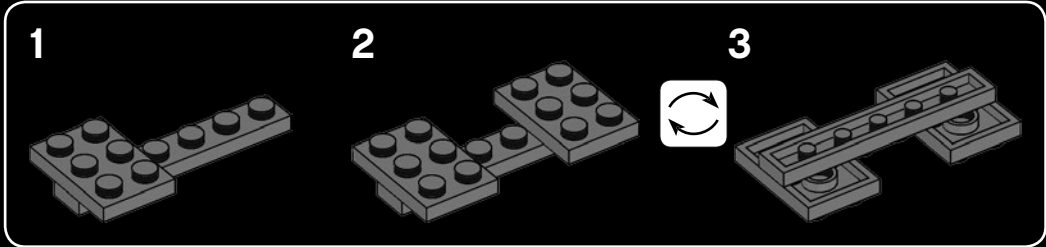

4x

110

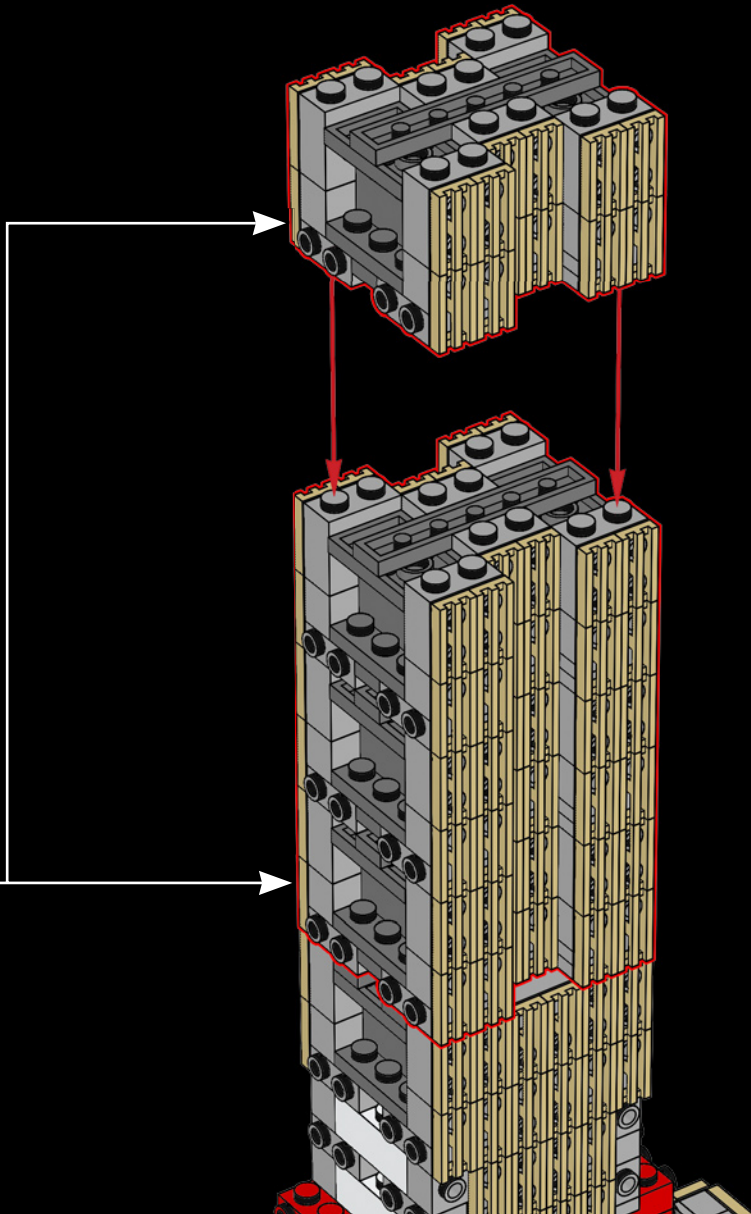

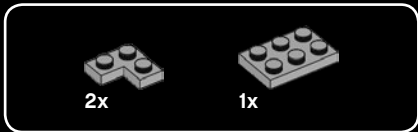
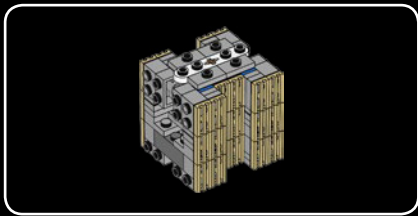

111

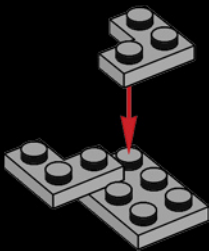

112

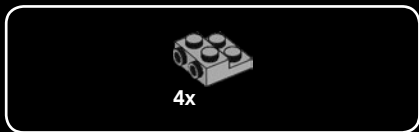
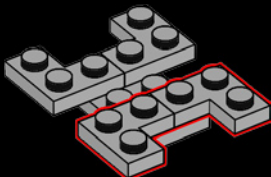

113

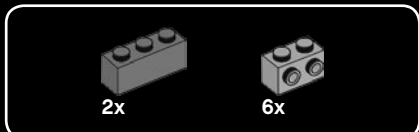
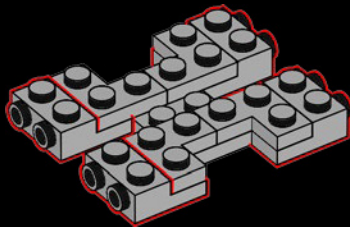

114

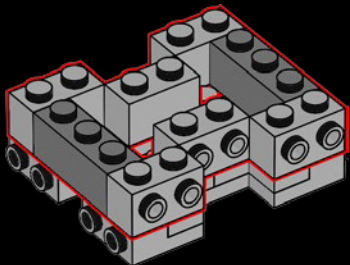

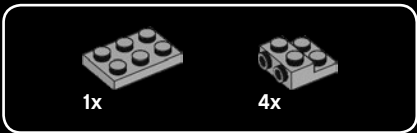

115

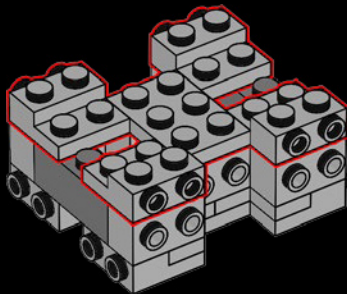

116

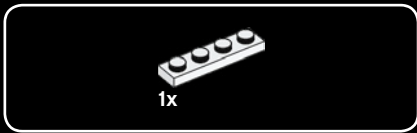
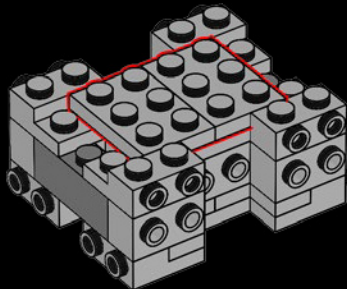

117

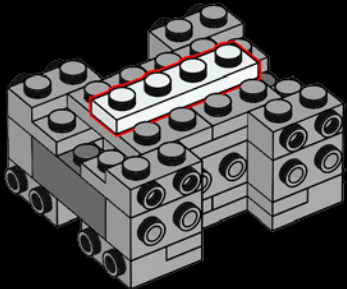

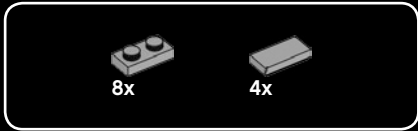

118

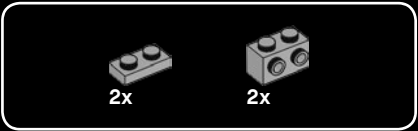
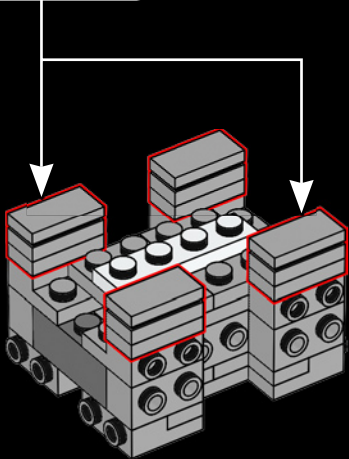
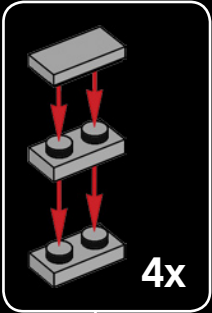

119

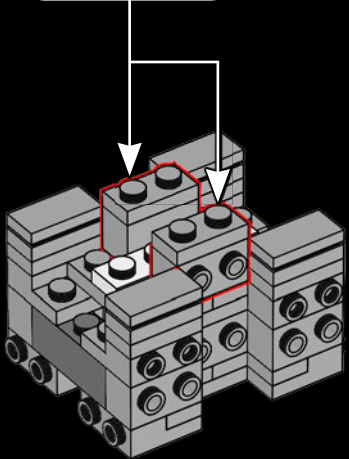
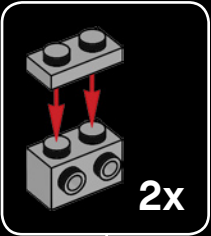

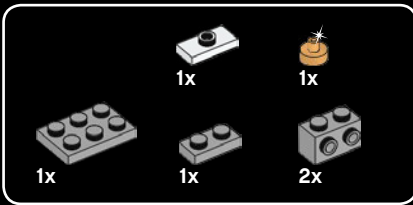

120

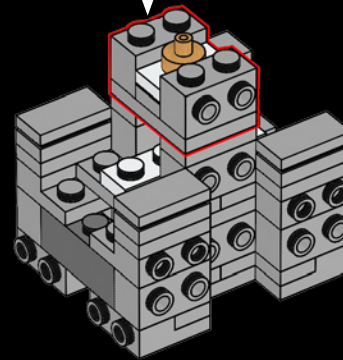
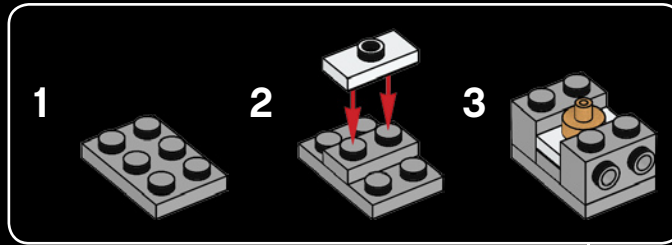



2x

121

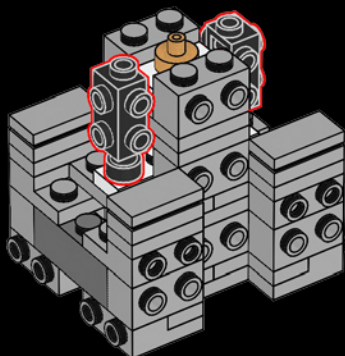

1x

122

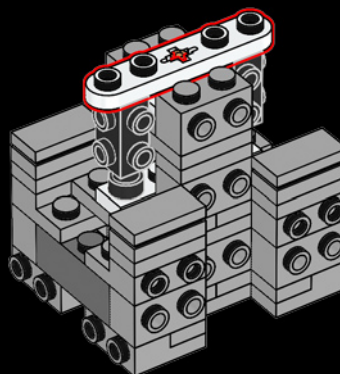

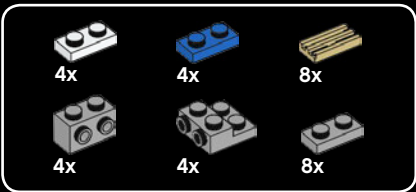

123

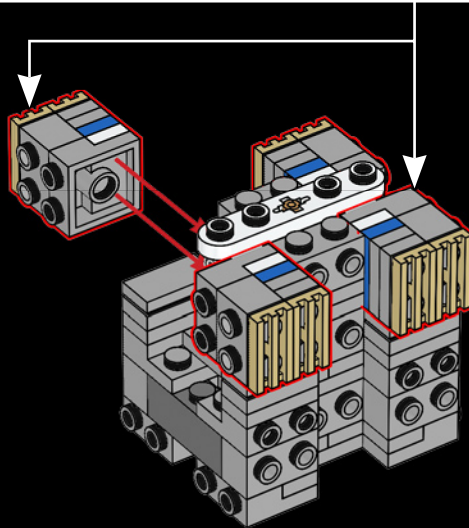
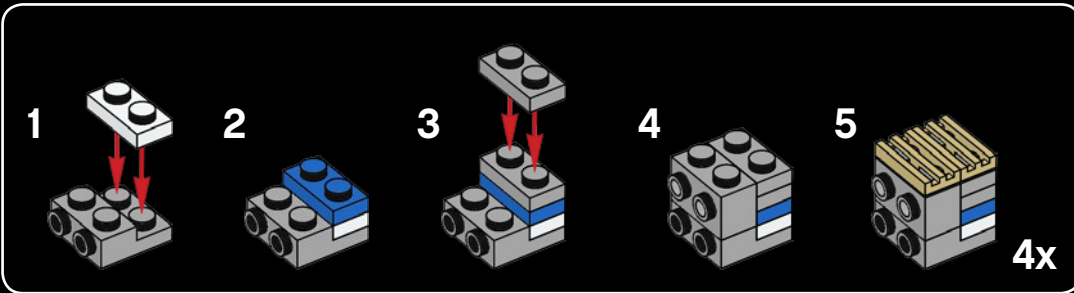



4x

124

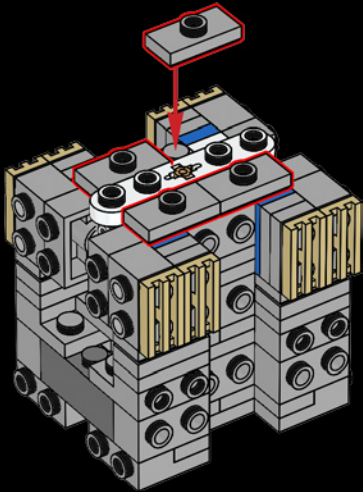

28x

125

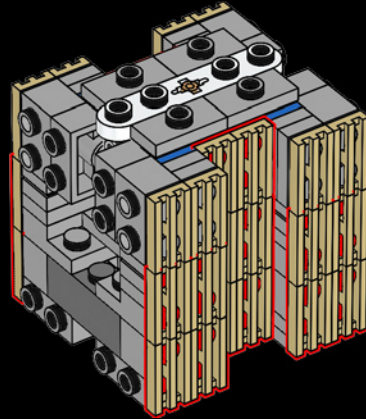

126

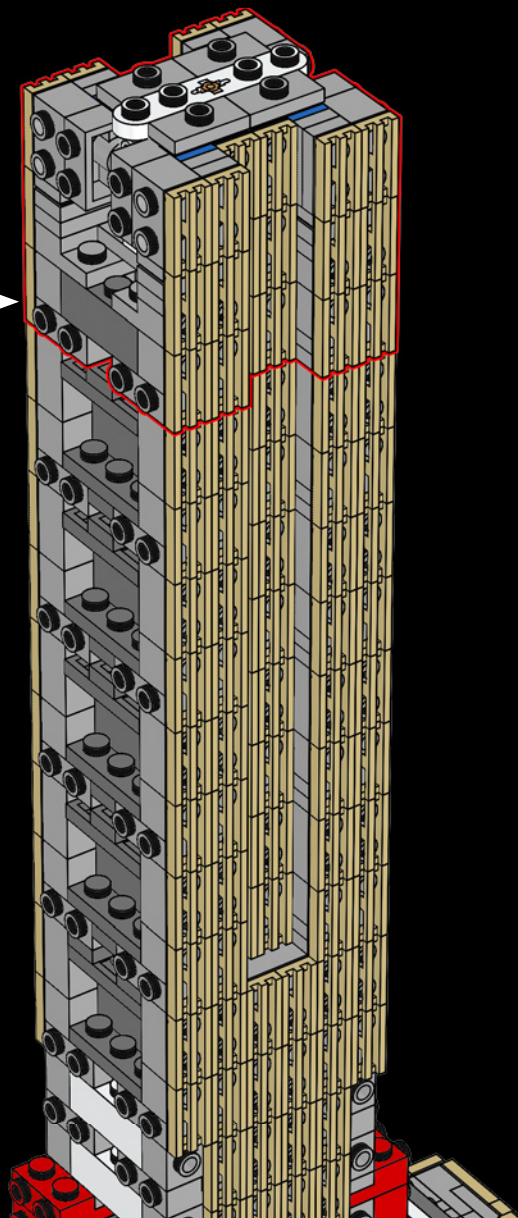



1x



1x

127

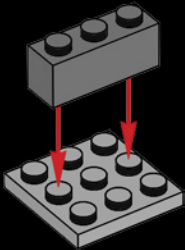

2x



2x

128

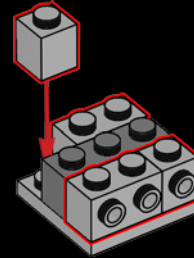

2x



1x

129

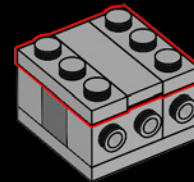



130

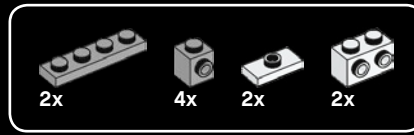
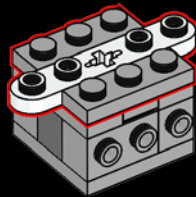

131

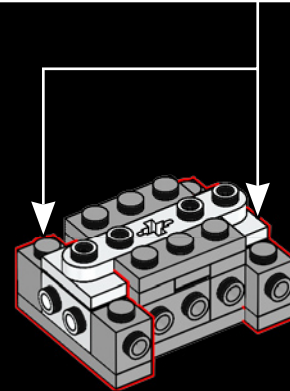
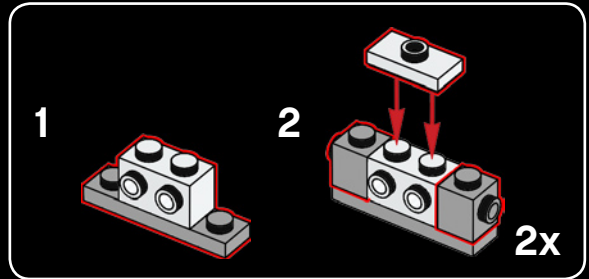



1x

132

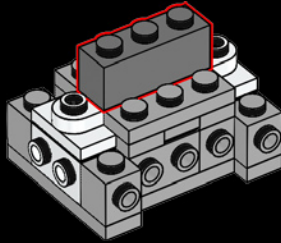

2x



2x

133

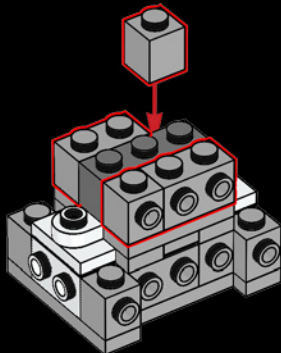

2x

134

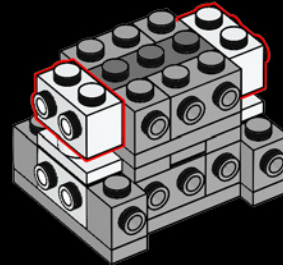



4x

135

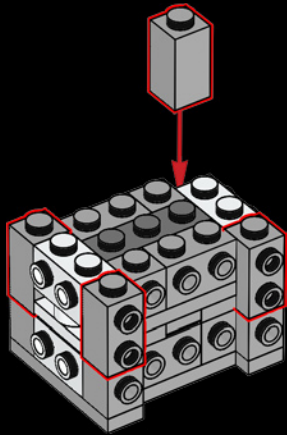

10x

136

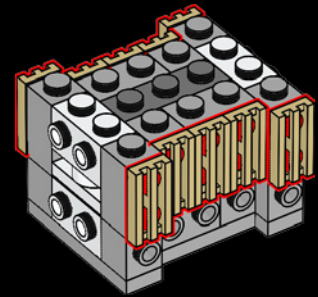

137

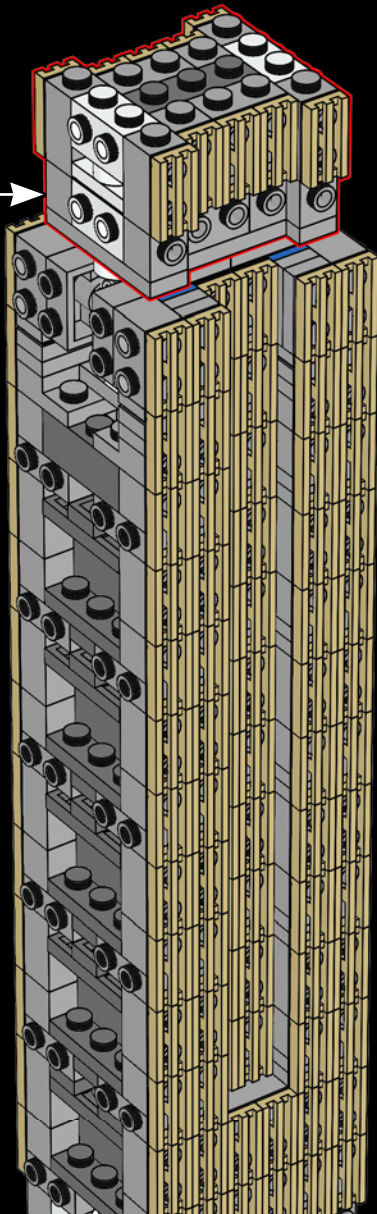



10x

138

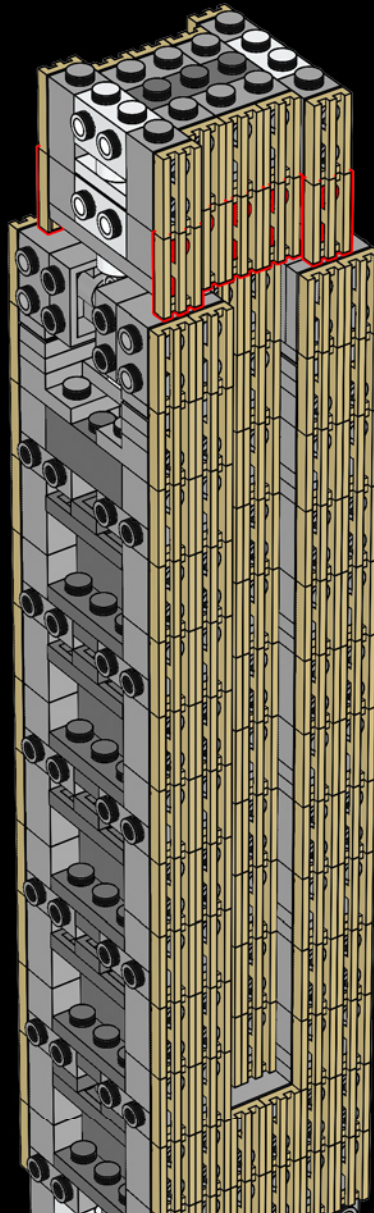

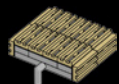

2x



1x



1x

139

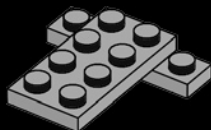

2x

140

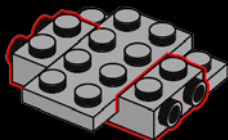

1x

141

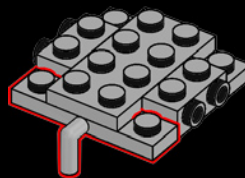



142

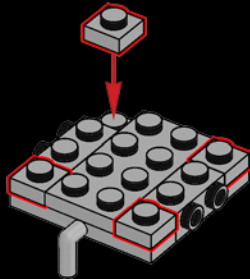

143

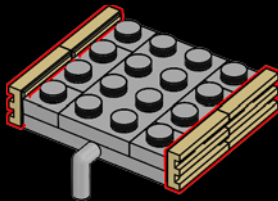

144

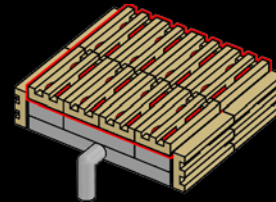

2x

145

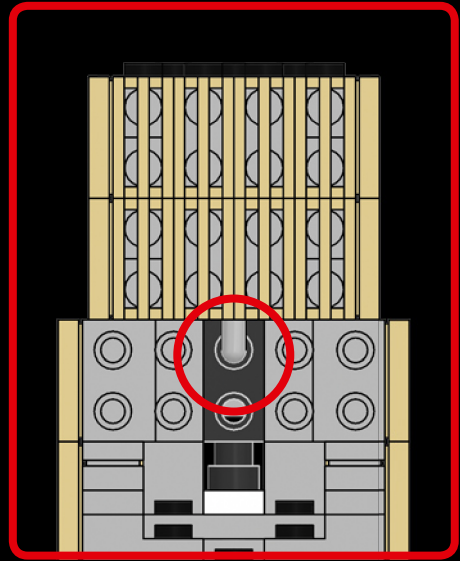
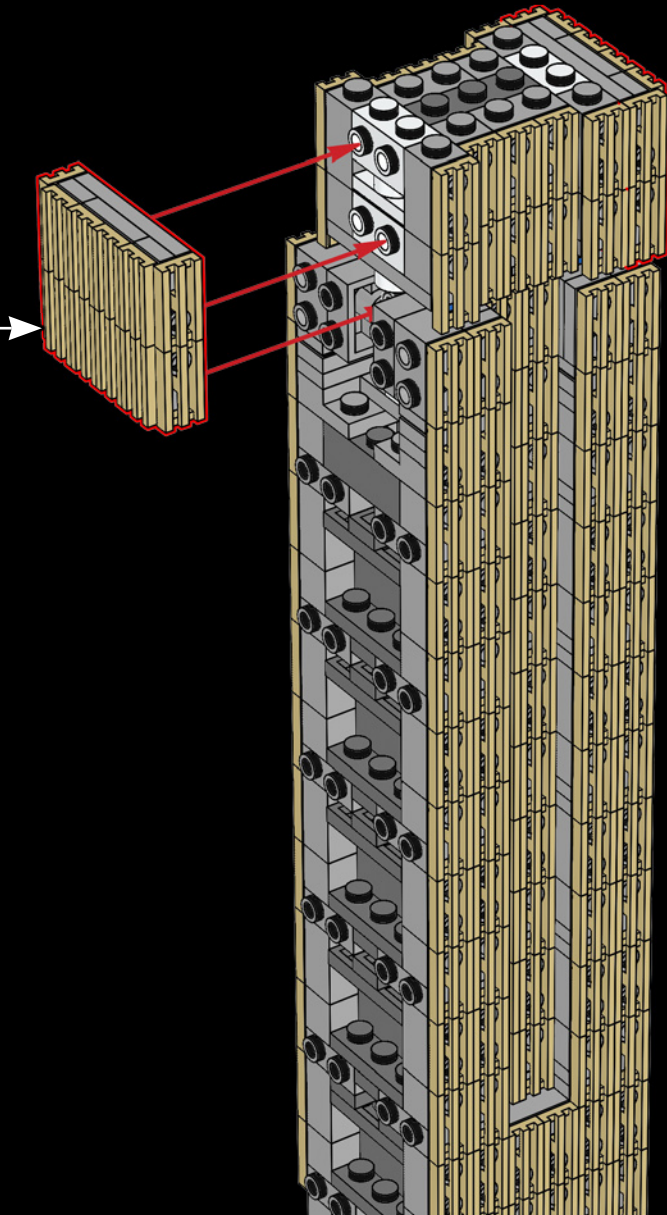

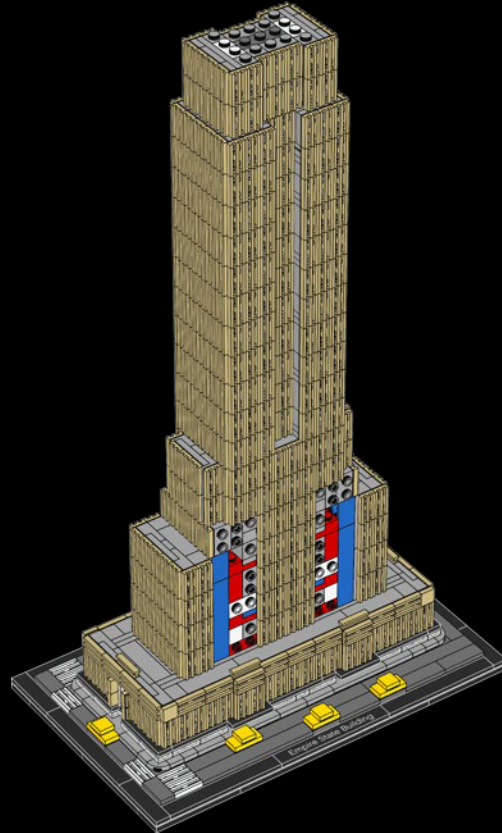
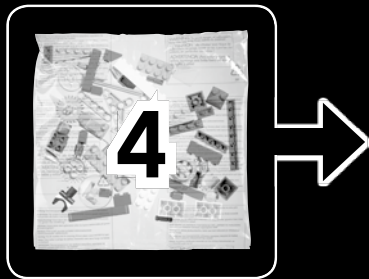

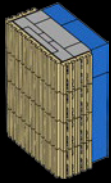

2x



1x

146



1x



1x

147

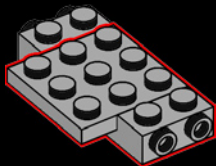

1x



4x

148

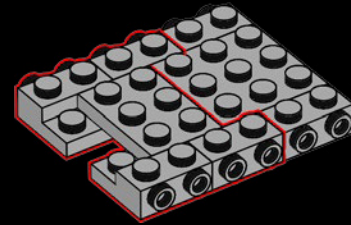

2x



1x

149

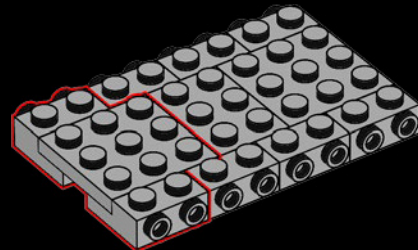

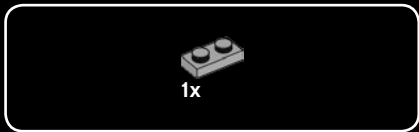

150

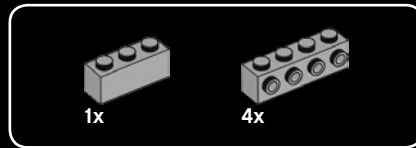
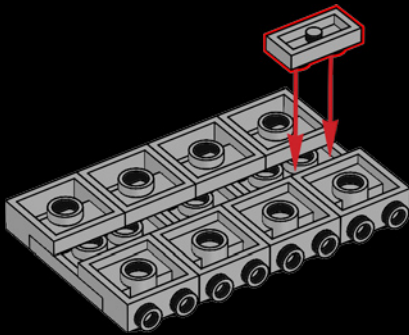

151

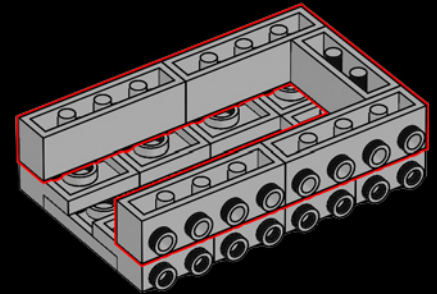

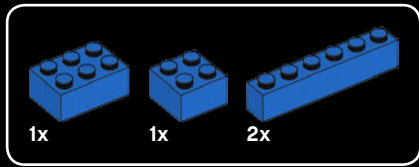

152

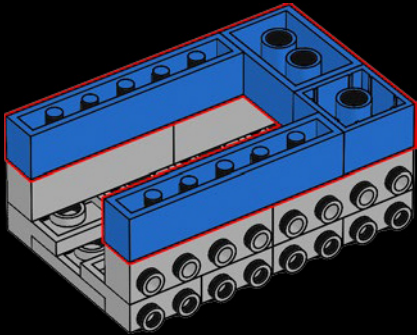

153

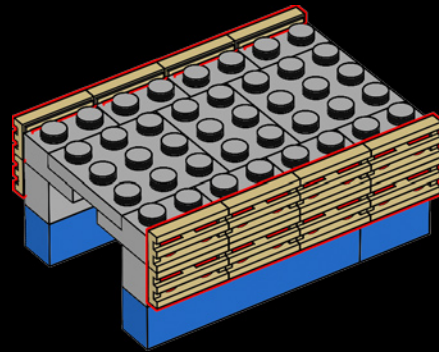
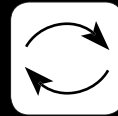

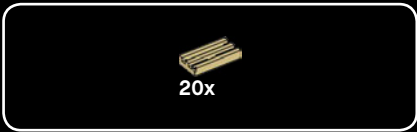

154

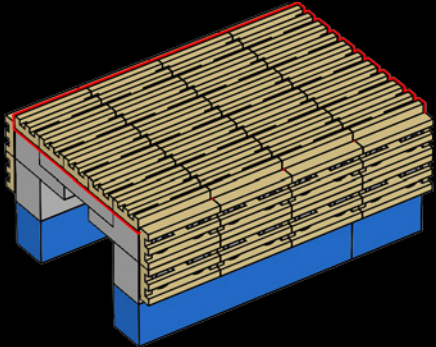

2x

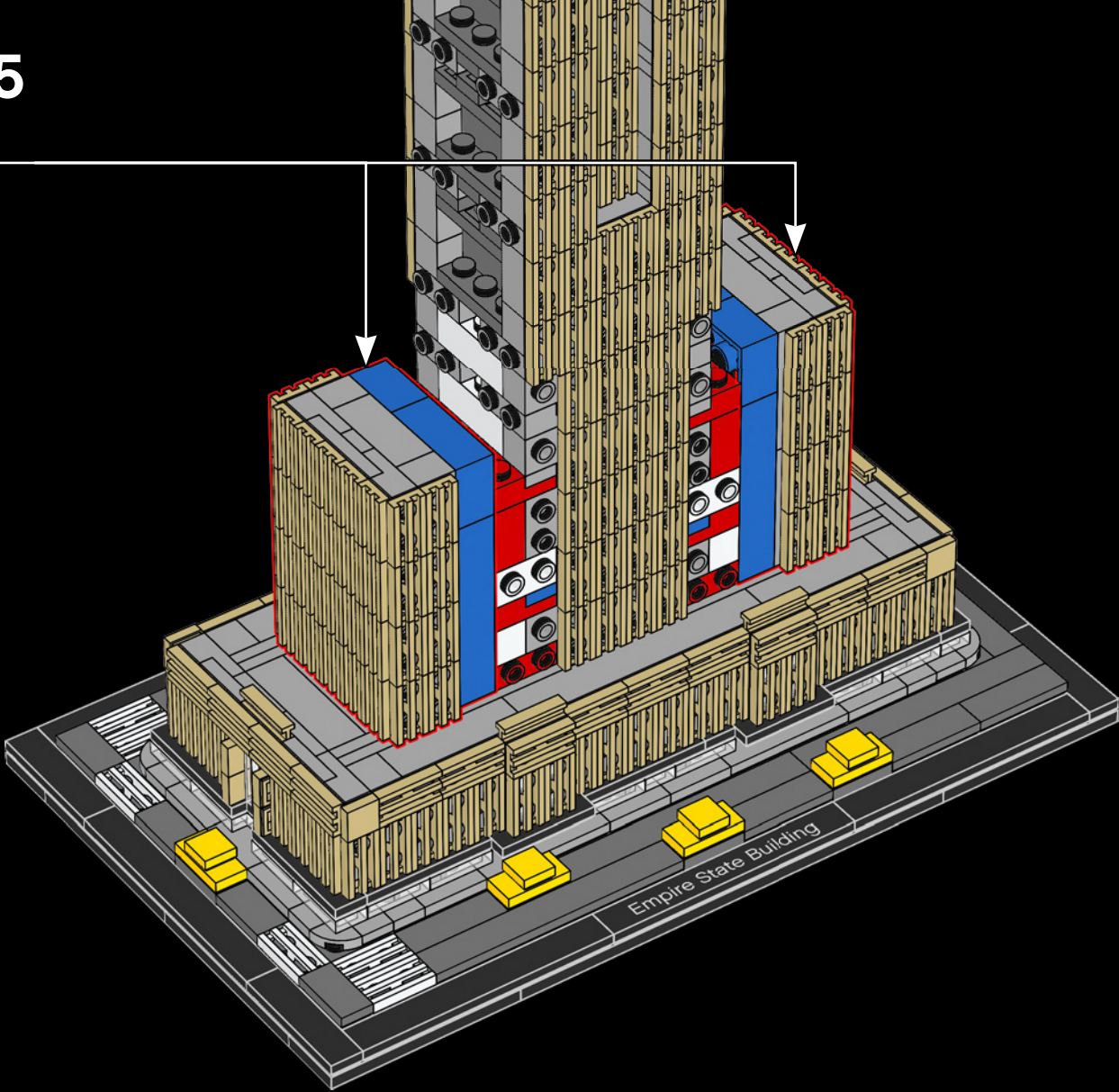

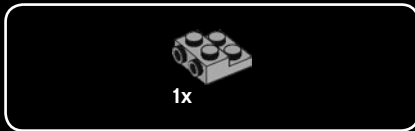
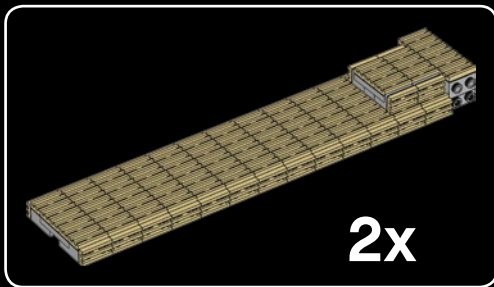

156

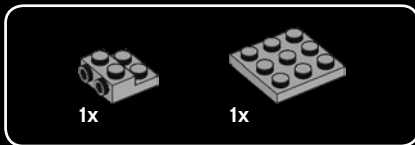

157

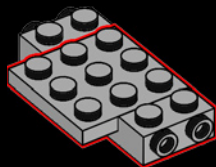

158

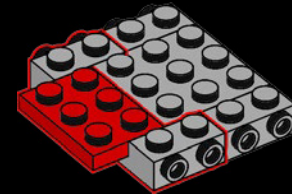

159

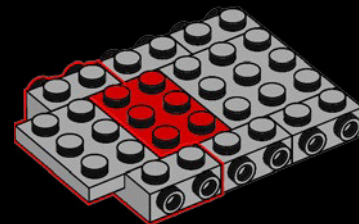

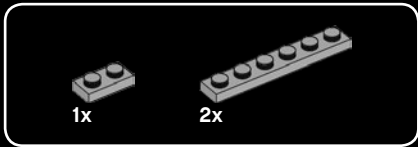

160

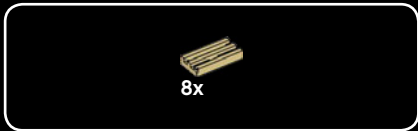
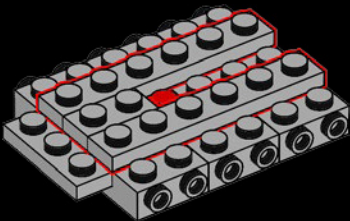

161

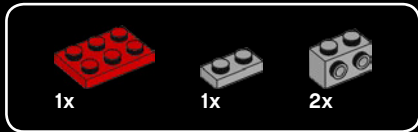
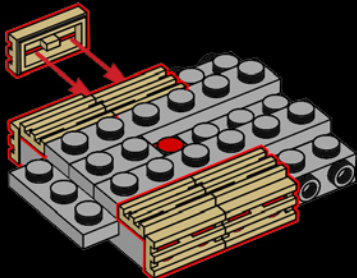

162

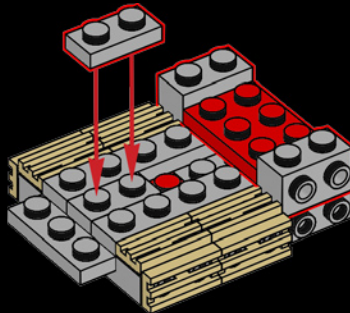

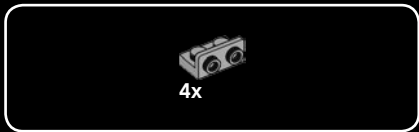

163

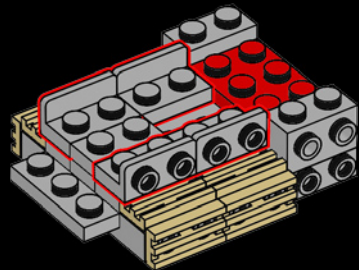

164

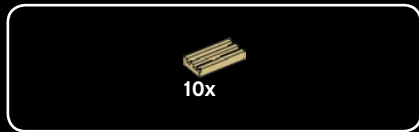
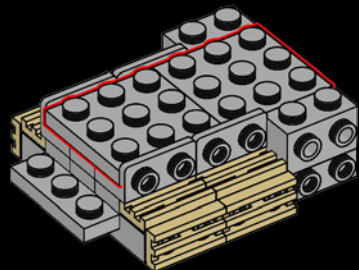

165

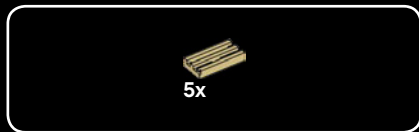
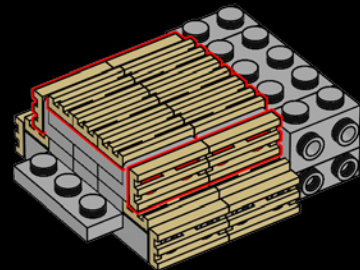

166

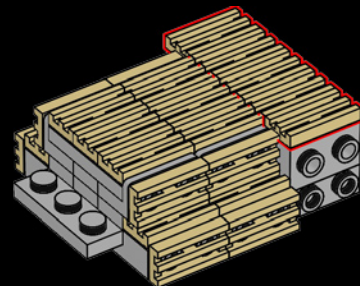



167

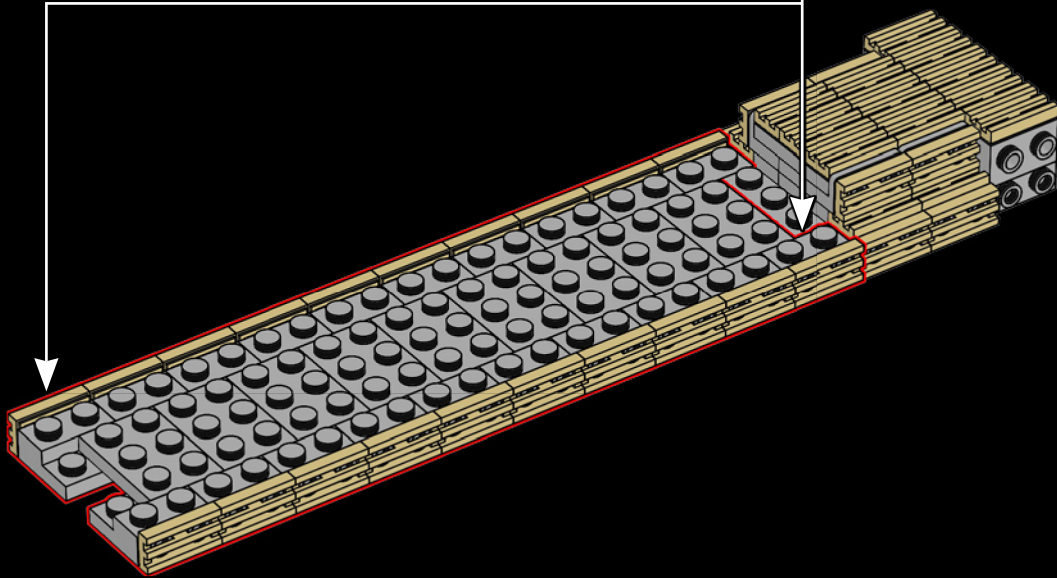
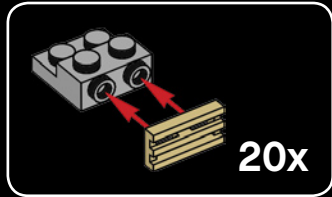

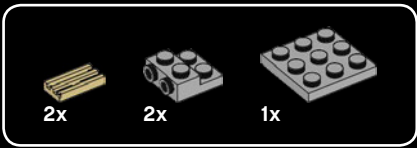

168

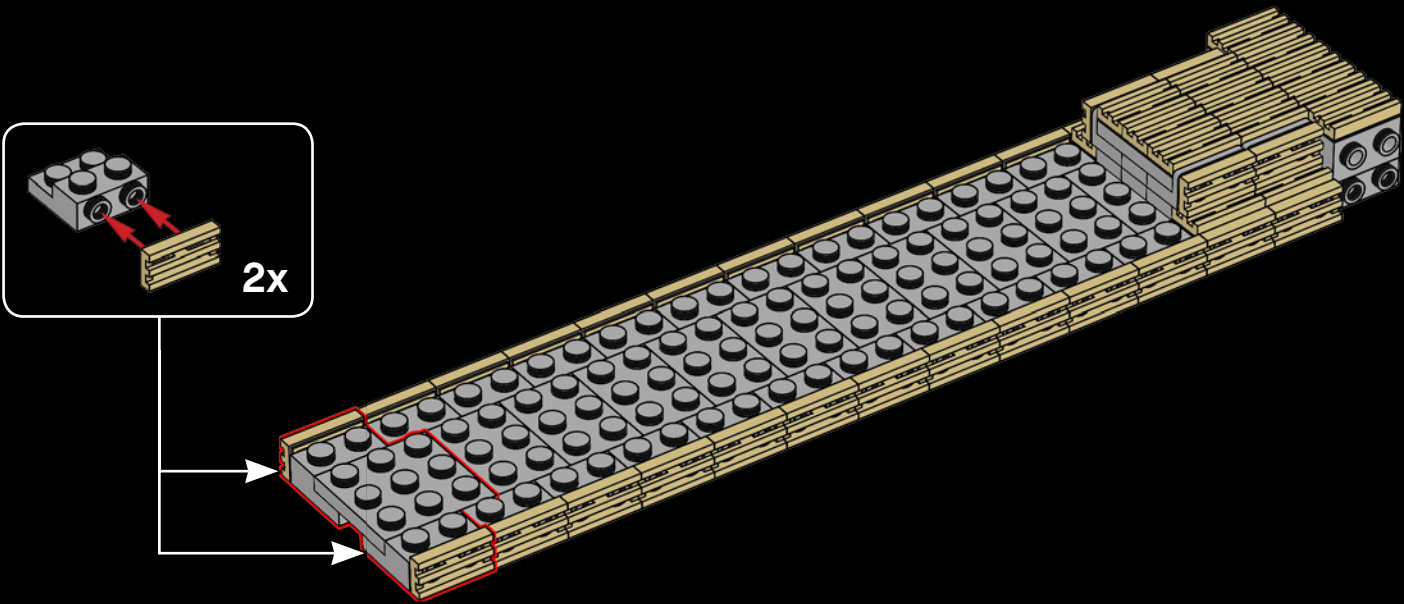



55x

169

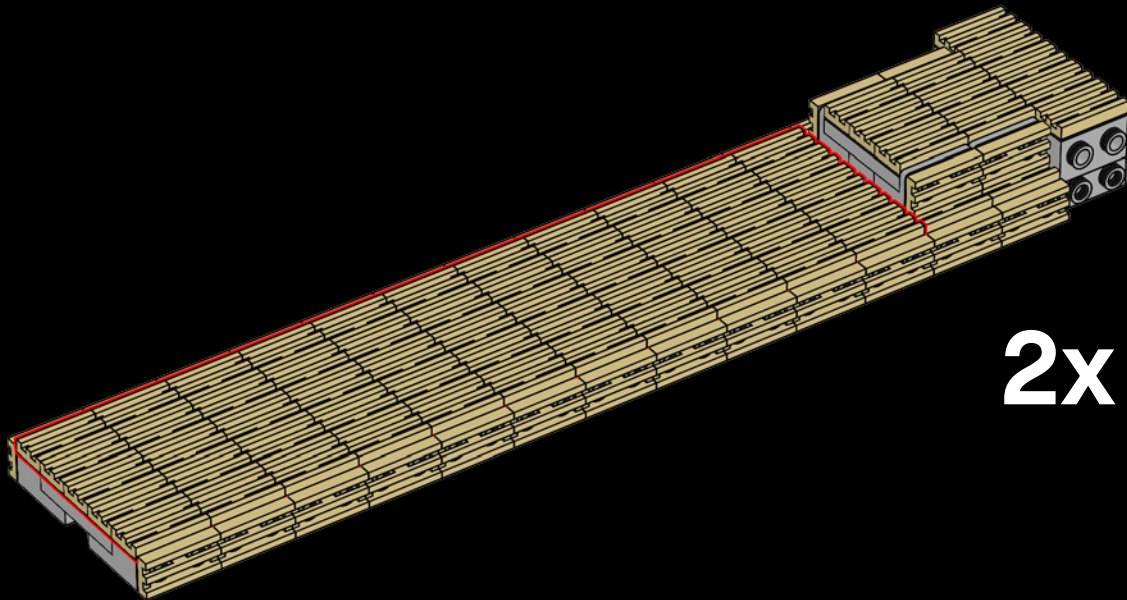

2x

170

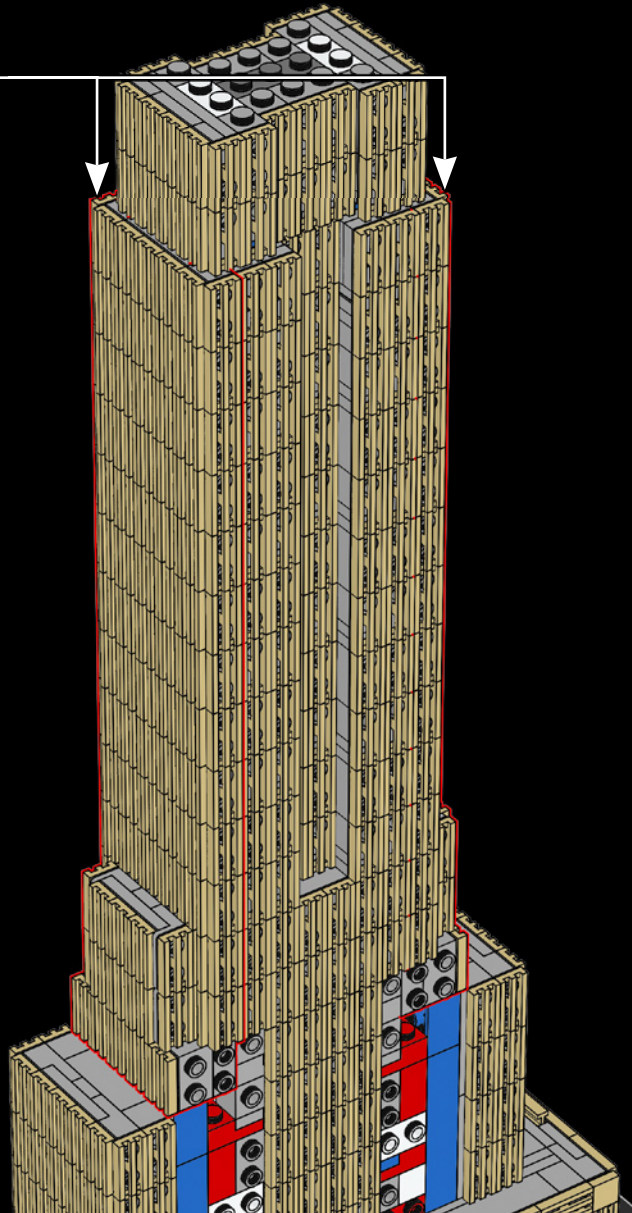

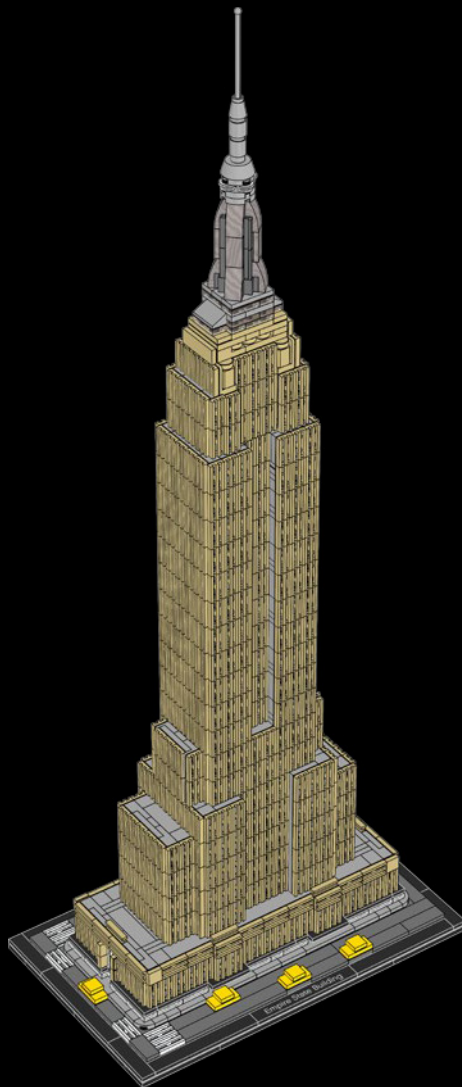

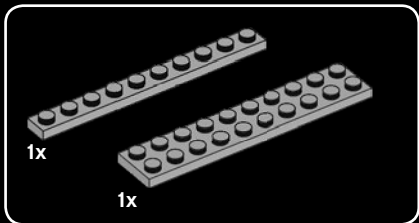
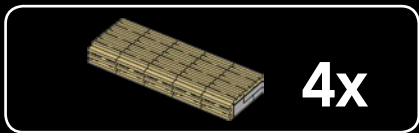

171

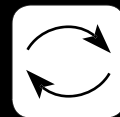
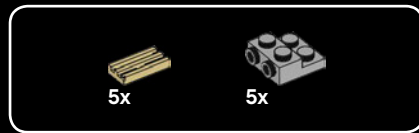
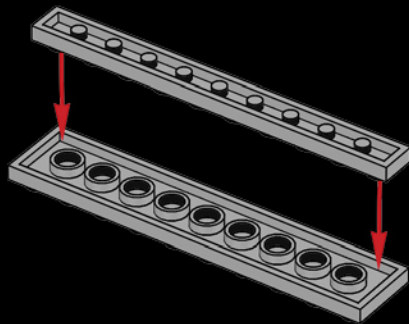

172

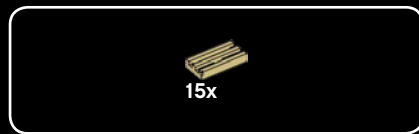
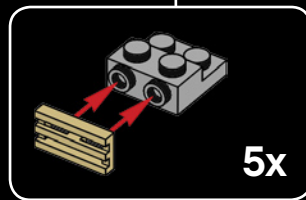
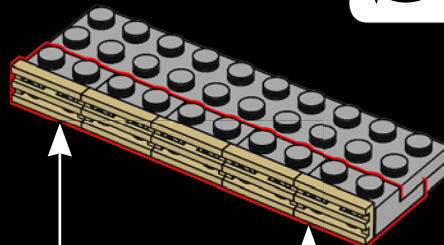

173

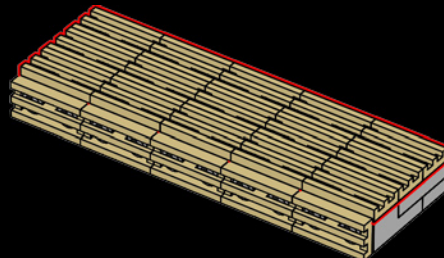

4x

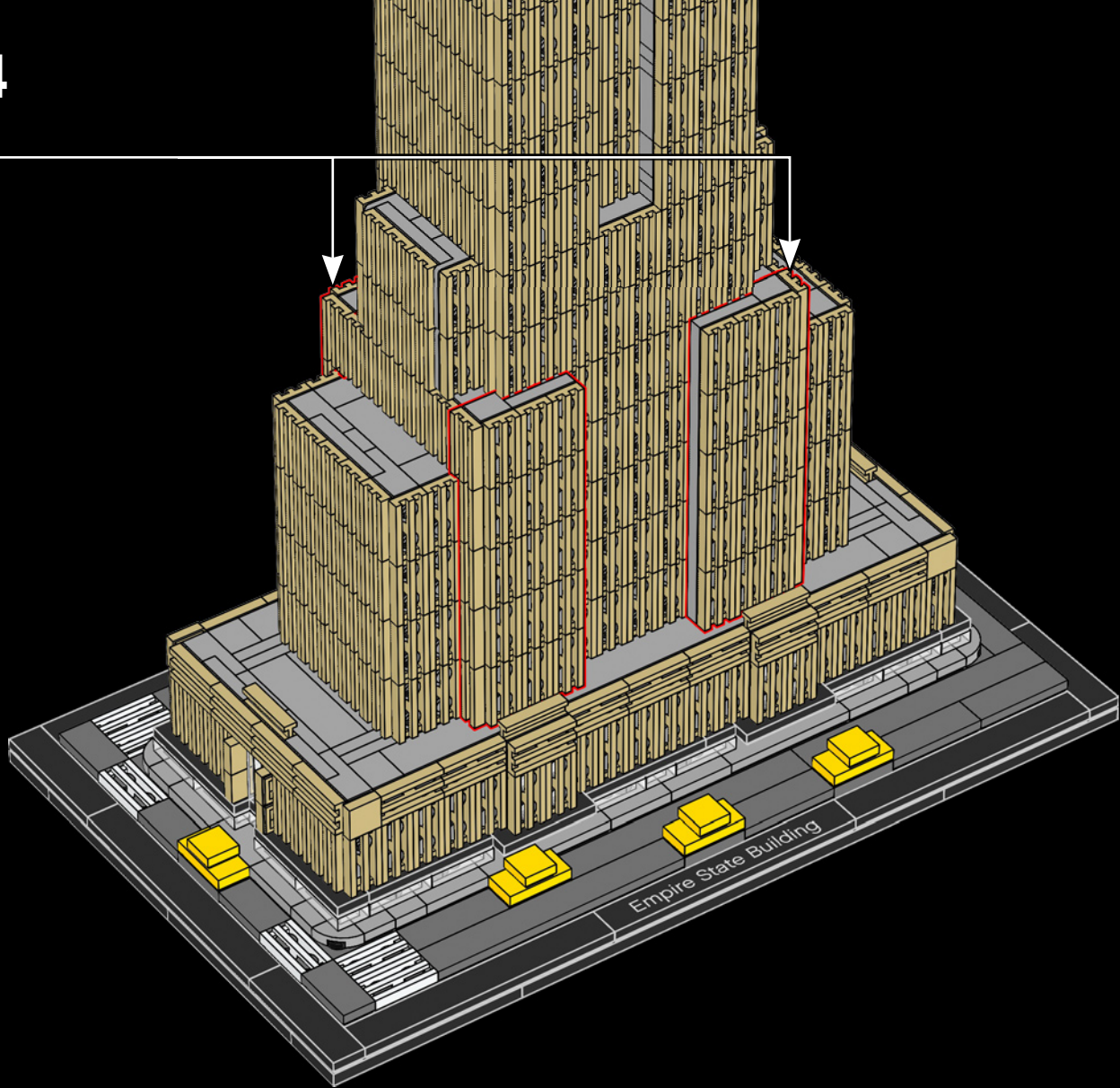

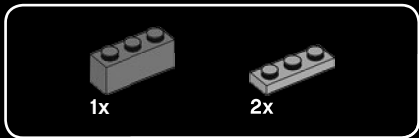

175

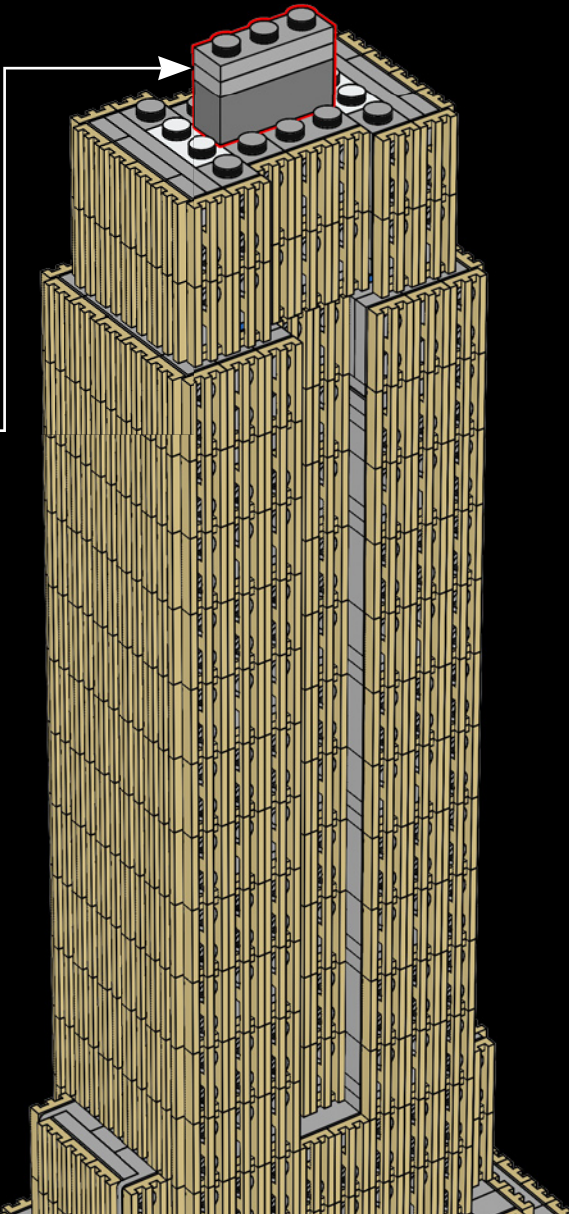
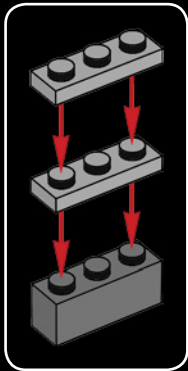



2x



2x

176

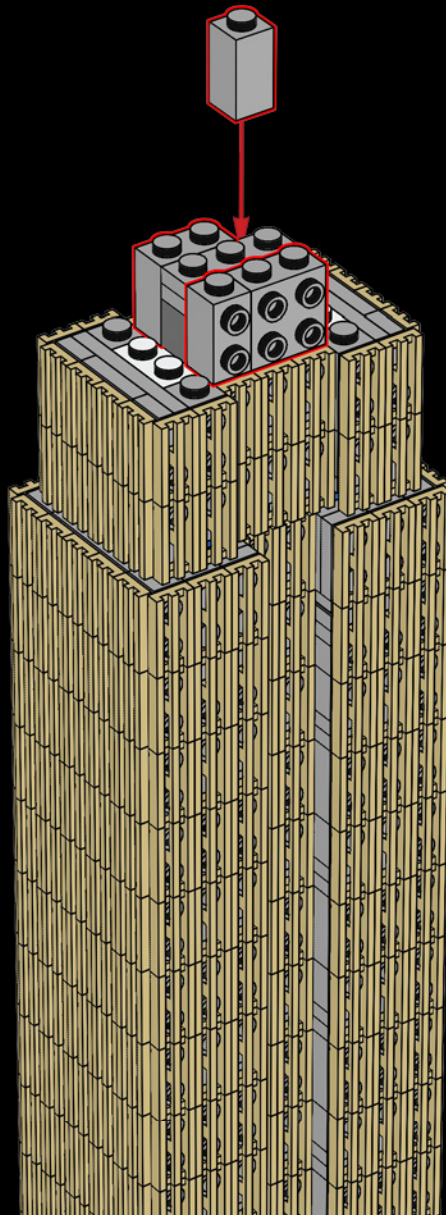



177

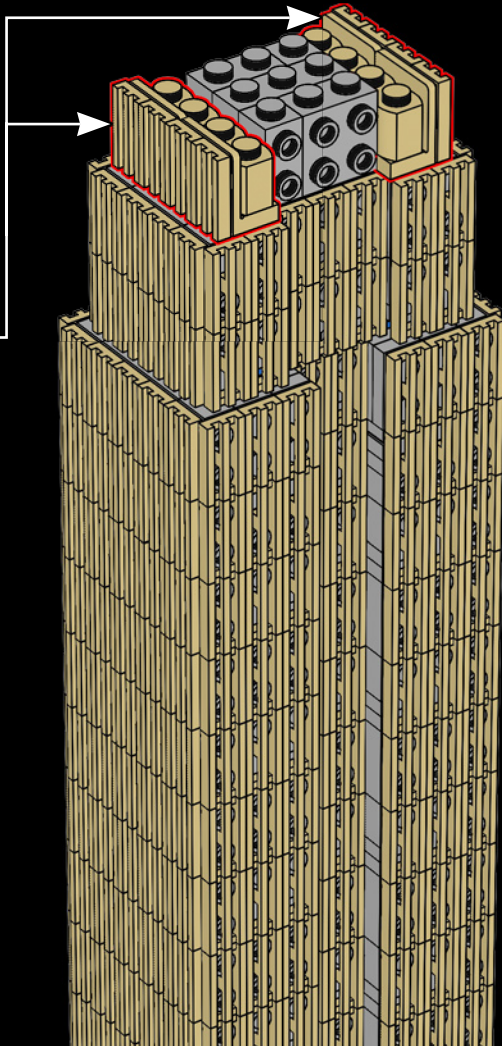
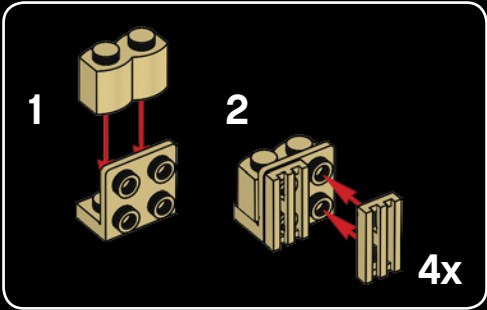

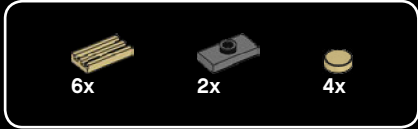

178

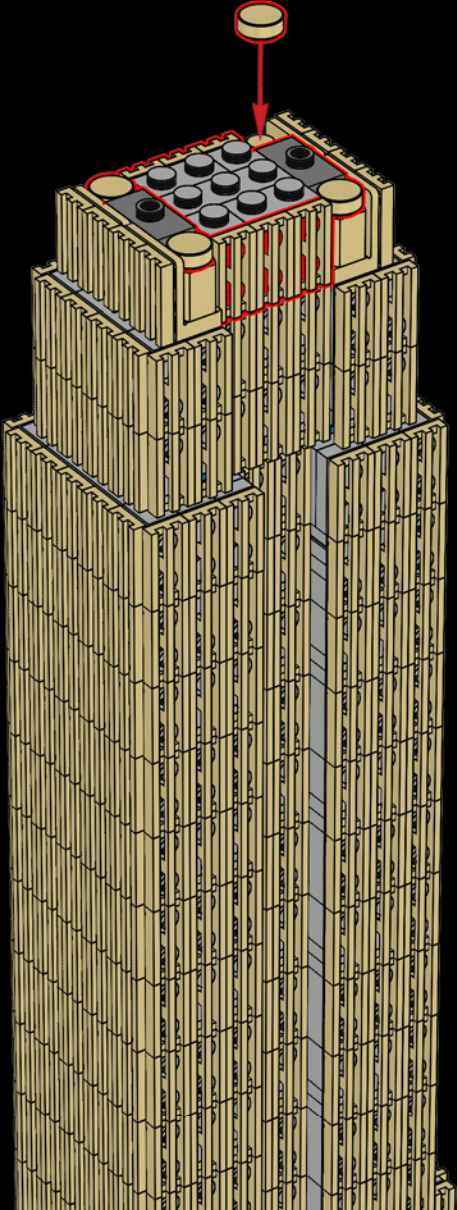



2x



1x

179

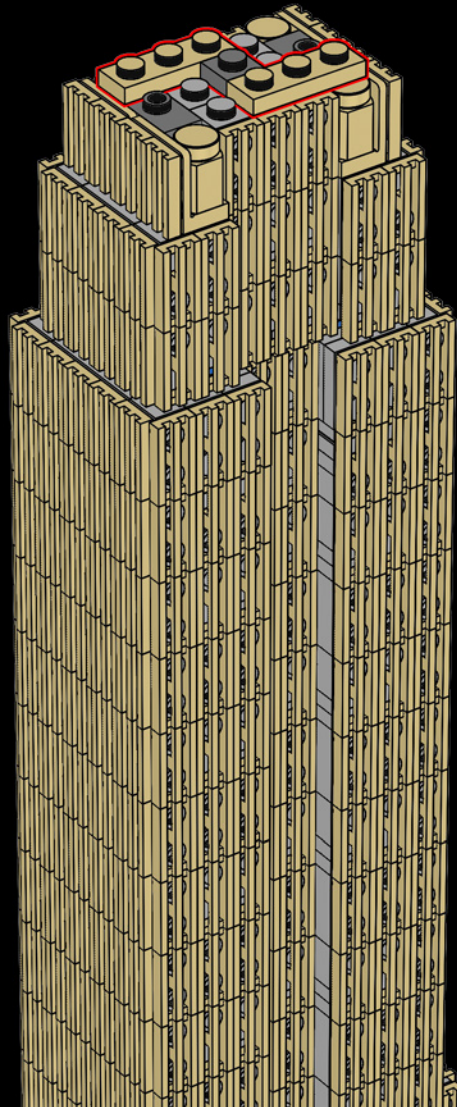



2x

180

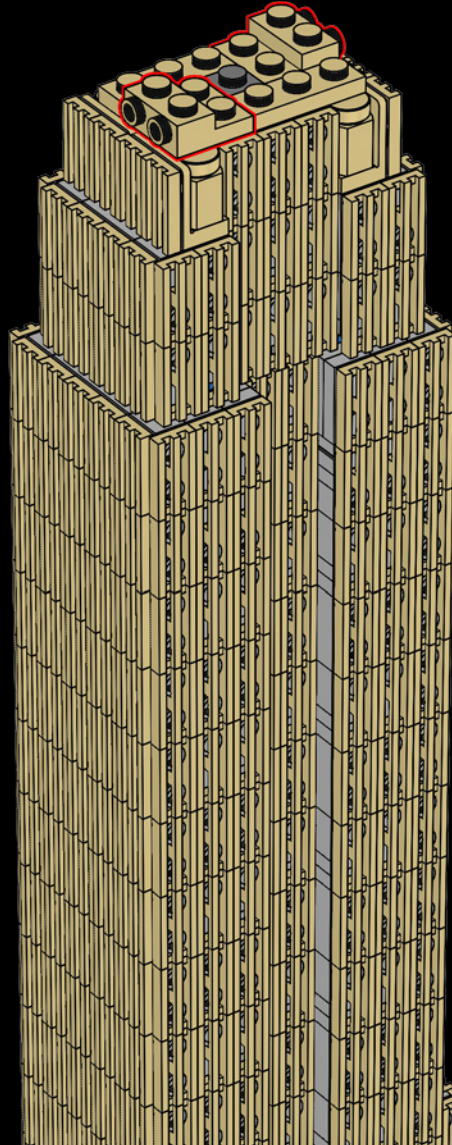

120

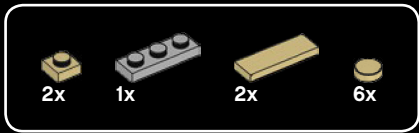

181

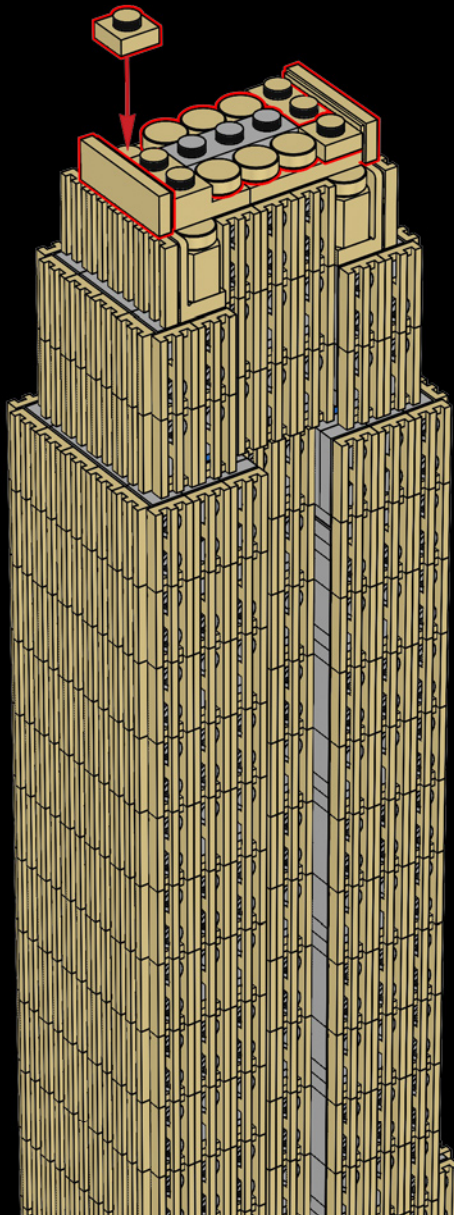

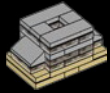

1x



1x

182

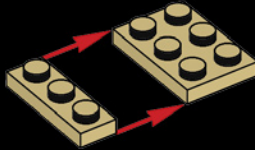

1x



1x

183

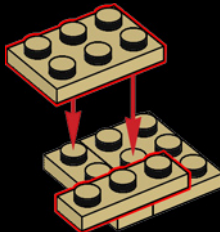

1x

184

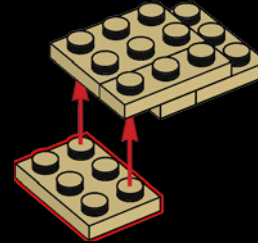

4x

185

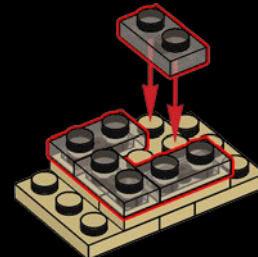



186

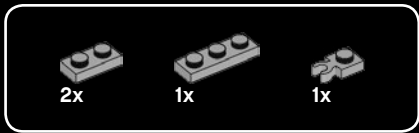
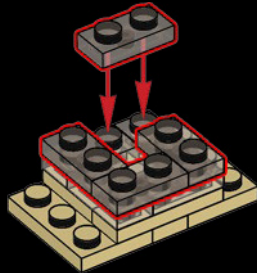

187

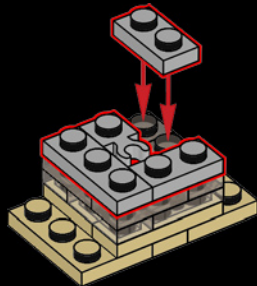

188

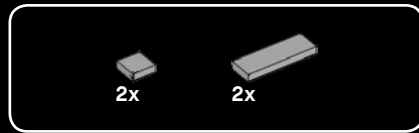
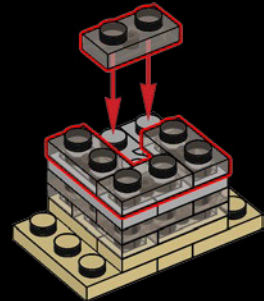

189

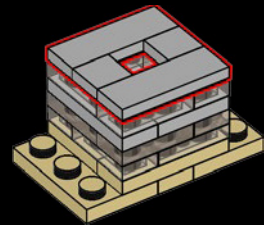



190

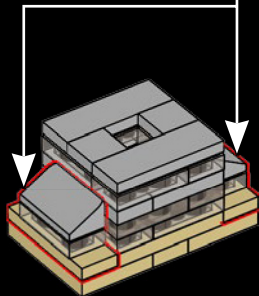
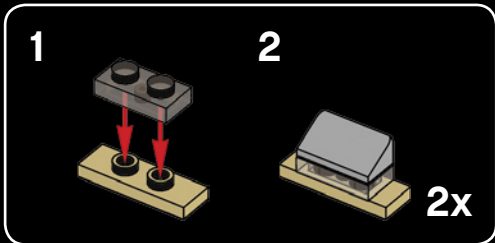

191

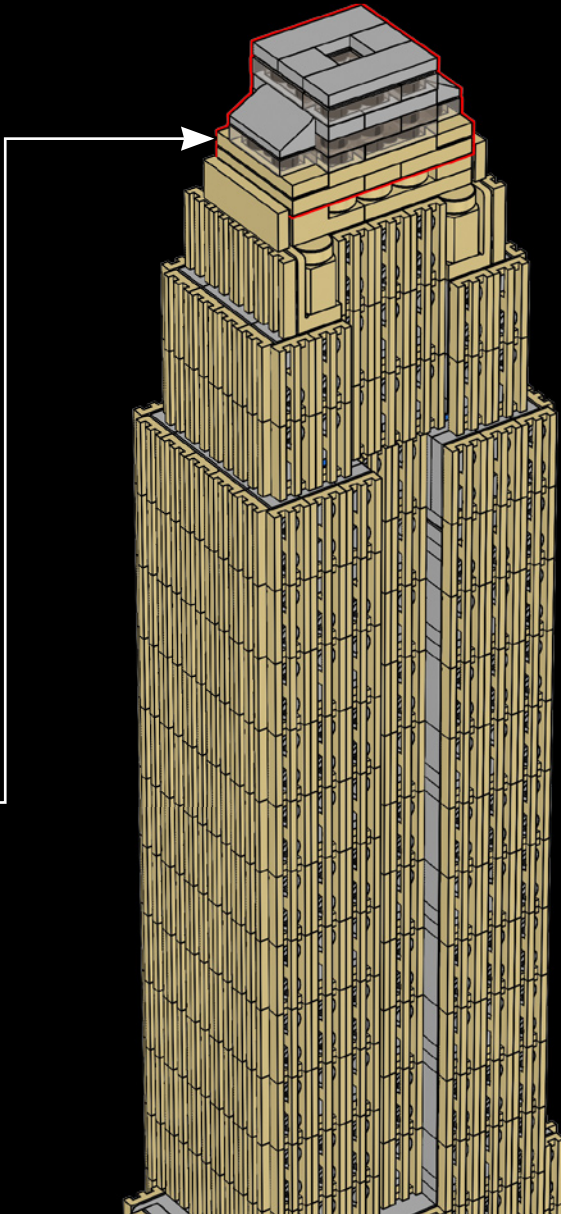



192

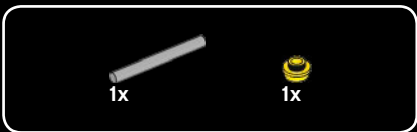
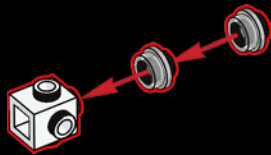

193

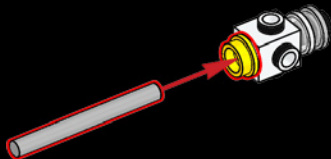

194

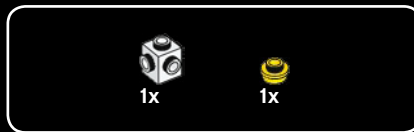
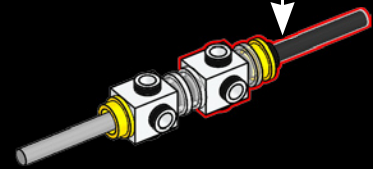
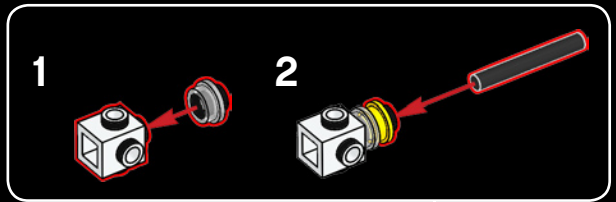

195

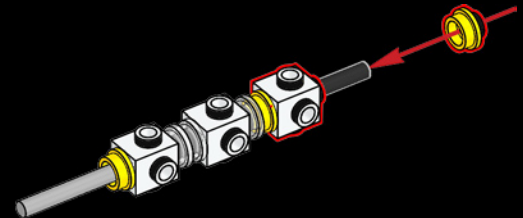



4x

196

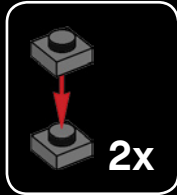

2x

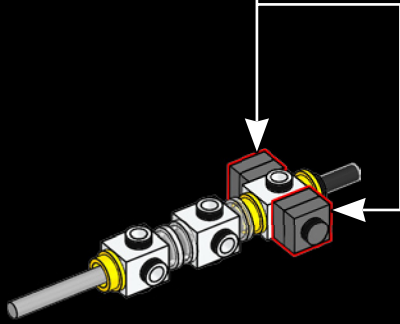

2x



2x



2x



4x



2x



4x

197

1

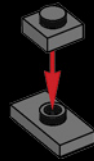

2

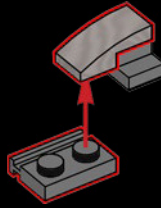

3

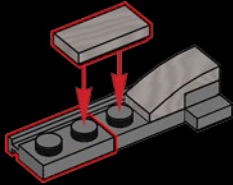

4

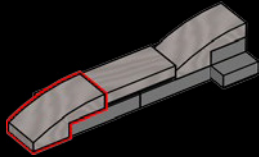

2x

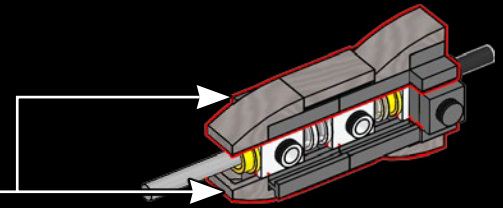



198

A 222 ft. (68 m) radio antenna was erected on top of the tower in 1950, allowing the area's television stations to broadcast from the building. Atop the tower is the 203 ft. (61.9 m) pinnacle, much of which is covered by broadcast antennas and surmounted with a lightning rod.

Une antenne radio de 68 m a été érigée au sommet de la tour en 1950, permettant aux stations de télévision de la région de diffuser à partir de l'édifice. Au sommet de la tour se trouve le pinnacle de 61,9 m, dont une grande partie est couverte par des antennes de radiodiffusion et surmontée d'un paratonnerre.

En 1950 se erigió una antena de radio de 68 m en el extremo superior de la torre, lo que permitió a las cadenas de televisión de la zona emitir sus señales desde el edificio. En lo alto de la torre hay un pináculo de 61,9 m, gran parte del cual está cubierto por antenas de transmisión; el pináculo está rematado por un pararrayos.

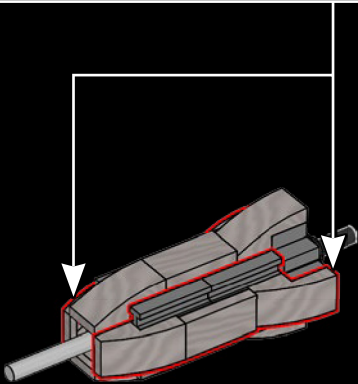
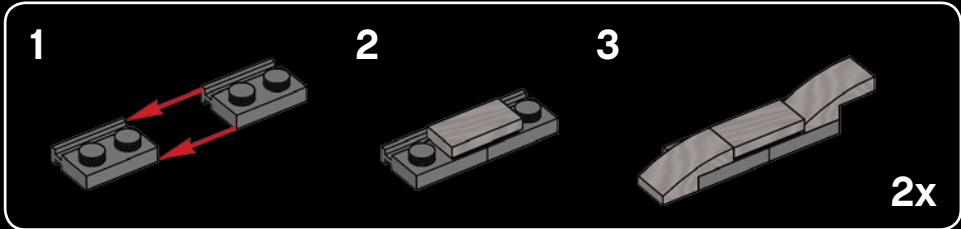



199

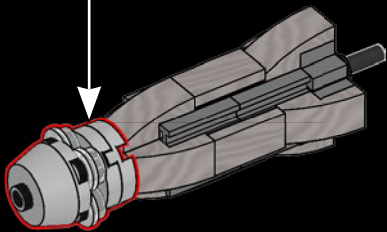
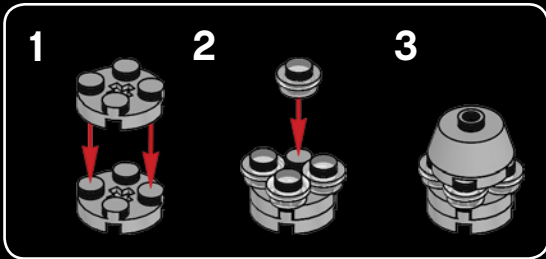

200

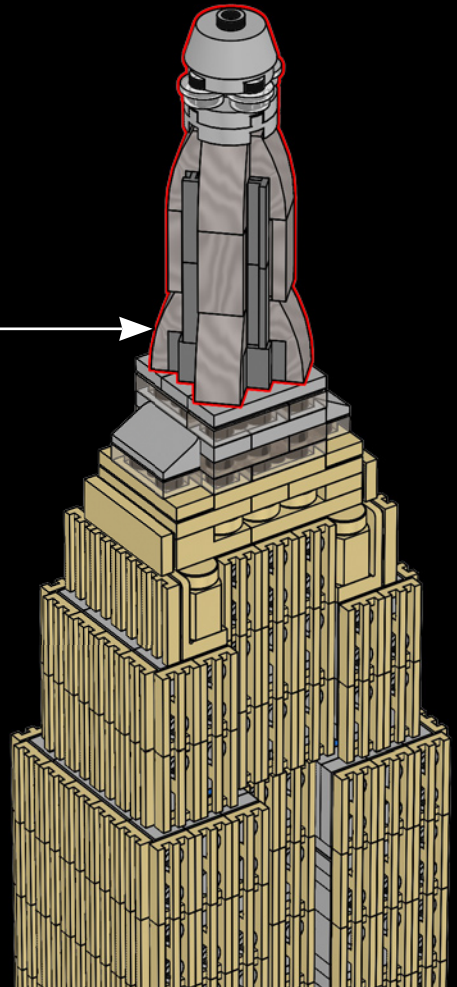

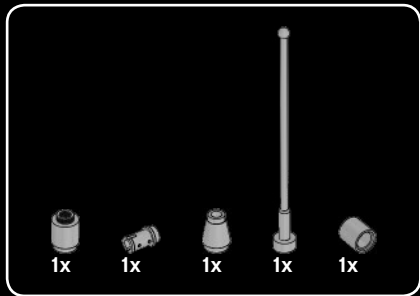

201

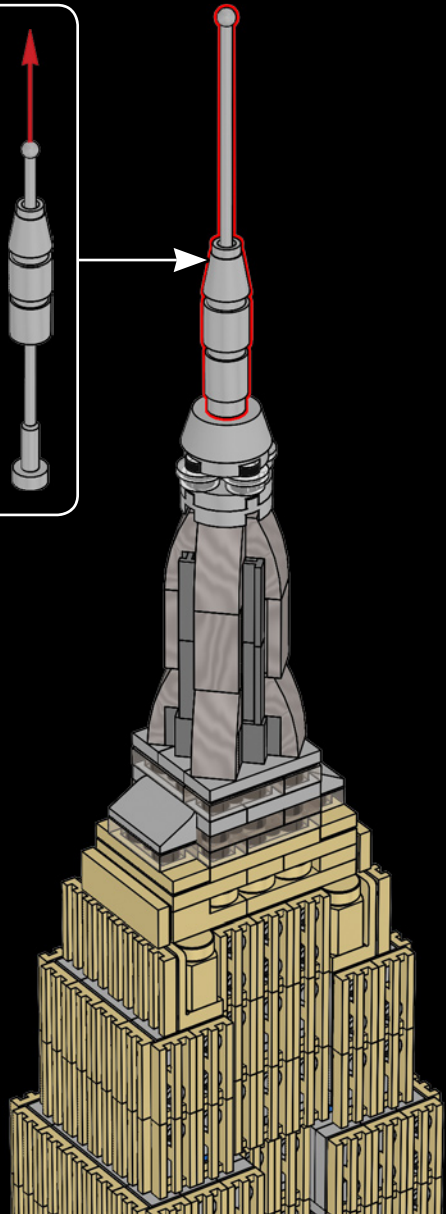
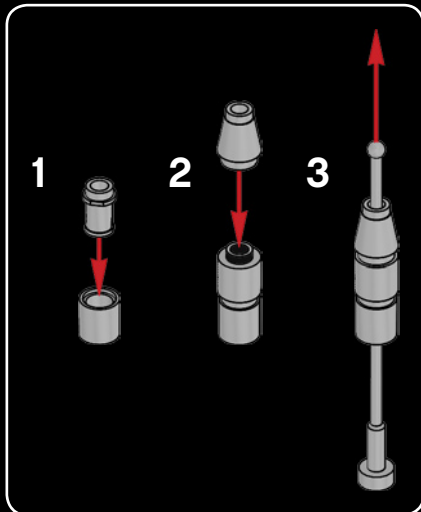

LEGO® Architecture – do you like it? Aimez-vous LEGO® Architecture ? LEGO® Architecture: ¿te gusta?

The LEGO Group would like your opinion on the new product you have just purchased. Your feedback will help shape the future development of this product series. Please visit:

Le Groupe LEGO aimerait connaître votre opinion sur le produit que vous venez d'acheter. Vos commentaires nous aideront à concevoir les futurs produits de cette gamme. Veuillez visiter :

The LEGO Group quiere conocer tu opinión acerca del nuevo producto que acabas de comprar. Tus comentarios nos ayudarán a dar forma a los futuros productos de esta serie. Visita:

[LEGO.com/productfeedback](https://www.lego.com/productfeedback)

By completing our short feedback survey, you will be automatically entered into a drawing to win a LEGO® prize.

En remplissant ce court sondage sur le produit, vous serez automatiquement inscrit à un tirage au sort pour gagner un prix LEGO®.

Al contestar este breve cuestionario de opinión, participarás automáticamente en el sorteo de un producto LEGO®.



LEGO® Architecture

The LEGO® Architecture series creatively captures the essence of many of the world's most iconic landmarks while giving you an enjoyable and engaging LEGO building experience.

Whether your interest is in travel, design, history or architecture, these sets are a physical memento of a great trip abroad, a famous building you know well, or a city you still dream of visiting.

Every LEGO Architecture set is designed to be displayed. Much more than just a photo, building and displaying your model on your desk, in the bookcase or on the shelf, lets you be transported every time you admire the view.

La série LEGO® Architecture capture l'essence de nombreux monuments parmi les plus célèbres du monde tout en vous offrant une expérience agréable et stimulante de construction LEGO.

Que votre intérêt porte sur les voyages, le design, l'histoire ou l'architecture, ces ensembles constituent un souvenir tangible d'un voyage mémorable, d'un célèbre bâtiment que vous connaissez bien ou d'une ville que vous rêvez de visiter.

Chaque ensemble LEGO Architecture est conçu pour être exposé. Construire votre modèle et l'exposer sur votre bureau, une bibliothèque ou une tablette vous fera voyager à chaque coup d'œil, bien plus qu'une simple photo ne pourrait le faire.

La línea LEGO® Architecture captura con creatividad la esencia de muchos de los monumentos más populares del mundo y pone a tu alcance una experiencia de construcción gratificante y cautivadora con el sello característico de LEGO.

Ya sea que sientas atracción por los viajes, el diseño, la historia o la arquitectura, estos sets expresan físicamente tus recuerdos de aquel fantástico viaje al extranjero, ese famoso edificio que conoces tan bien o la ciudad que sueñas con visitar algún día.

Todos los sets LEGO Architecture están diseñados para decorar. Mucho más que una simple fotografía, construir y exponer un modelo en tu escritorio, un librero o una repisa te traslada a otro lugar al admirar las vistas.

Follow us on

Suivez-nous sur

Síguenos en



Adam Reed Tucker is the co-developer of the LEGO Architecture product line.

Adam Reed Tucker est le codéveloppeur de la gamme de produits LEGO Architecture.

Adam Reed Tucker es el codesarrollador de la línea de productos LEGO Architecture.



Celebrate the world of architecture
and collect all the models

Célébrez le monde de l'architecture
et collectionnez tous les modèles

Celebra el mundo de la arquitectura
y colecciona todos los modelos



21045
Trafalgar Square

21041
Great Wall of China
La Grande Muraille de Chine
Gran Muralla China

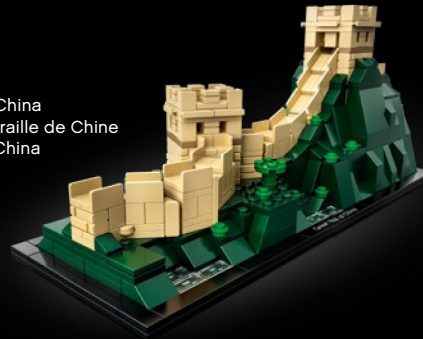

21030
United States Capitol Building
Le Capitole des États-Unis
Edificio del Capitolio de Estados Unidos

21042
Statue of Liberty
La statue de la Liberté
Estatua de la Libertad



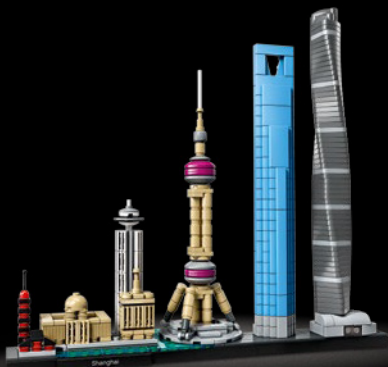

21039
Shanghai
Shanghai



21047
Las Vegas



21034
London
Londres



21028
New York City
New York
Nueva York



21043
San Francisco



21044
Paris
Paris

References

Références

Referencias

*Pictures -
Photos :
Fotografias:*

© GettyImages

Customer Service
Kundenservice
Service Consommateurs
Servicio Al Consumidor
LEGO.com/service or dial

 00800 5346 5555 ;
 1-800-422-5346 ;

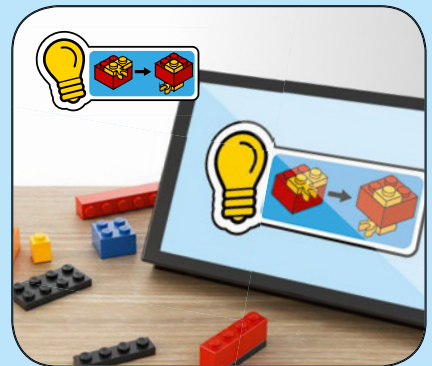



3x
4111971



2x
4547489



12x
6058177



6x
241201



11x
6051511



4x
302301



6x
6018774



6x
6097637



4x
362201



19x
302101



1x
300201



1x
371001

138



2x
4527839



2x
302001



4x
4560178



2x
346001



10x
6139649



4x
4125253



2x
4159553



4x
4218749



684x
4124456



4x
6174925



6x
4160483



2x
6132769



4x
4121921



2x
6131896



10x
6211966



3x
4118790



2x
4201062



4x
4124067



4x
6187620



4x
4569056



4x
6135130



20x
6061711



4x
302121



2x
371021



4x
6217123



2x
346021



14x
302323



2x
300323



2x
300223



8x
300923



3x
6168644



6x
307024



2x
300424



6x
6092583



4x
307026



8x
302426



1x
6093525



4x
242026



2x
4523339



4x
6162892



16x
243126



8x
379526



7x
416226



1x
6265011



4x
4100378



2x
6001494



7x
6240030



8x
6252041



32x
6240204



8x
6251294

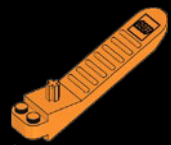

1x
6240515



14x
6240219



1x
6164381



1x
4211412



1x
4529241



1x
6183784



1x
4211483



4x
6176433



16x
4211399



8x
4558953



6x
4211415

6x
6225242

1x
4594238

2x
4211475

1x
6028324

2x
4568637

22x
6066097

31x
4211398

10x
4211414

72x
6015344

42x
6123809

8x
6004990

12x
6126082

32x
4211353

2x
4237084

148x
4654577

16x
4211429

2x
4211428

3x
4558169

1x
6116608

39x
4211396

4x
4211356

8x
4211636

2x
4211394

2x
6173095

6x
4211445

19x
6015347

2x
4211395

4x
4211385

6x
4211393

6x
4211549

12x
4211438

2x
6037399

2x
4211474

4x
4251149

4x
4211462

7x
4210719

5x
4211052

6x
4211063

4x
6092572

8x
4543086

5x
4211104

6x
4568734

14x
6187008

29x
4211043

12x
4211056

4x
4211002

8x
4211008

4x
4210998

6x
4210997

6x
4211122

1x
6186672

4x
6107197

4x
6217492

8x
6092115

8x
6066028

Customer Service
Kundenservice
Service Consommateurs
Servicio Al Consumidor

LEGO.com/service or dial

 : 00800 5346 5555
: 1-800-422-5346

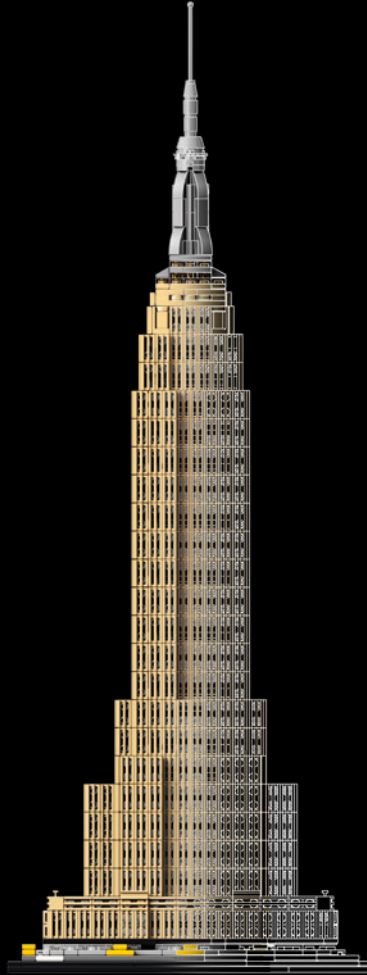

LEGO and the LEGO logo are trademarks of the/son des marques de commerce
du/son marcas registradas de LEGO Group. ©2019 The LEGO Group. 6281925

The Empire State Building name and images® are registered trademarks of ESRT Empire State Building,
L.L.C and are used with permission.

 [LEGO.com/architecture](https://www.lego.com/architecture)

Follow LEGO® Architecture on
Suivez LEGO® Architecture sur
Sigue a LEGO® Architecture en

