



Architecture

21051

Tokyo

Japan

Tokyo

Japon

Tokio

Japón

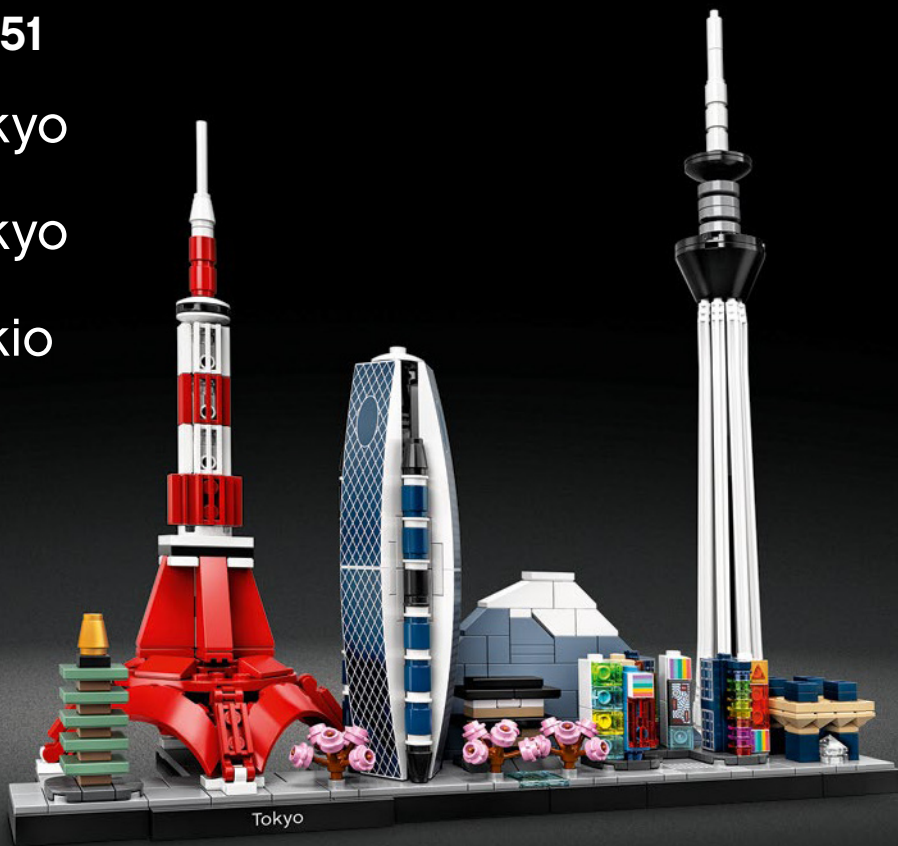

Tokyo

Tokio

With Mount Fuji as its spectacular backdrop, Japan's capital city successfully mixes ancient tradition and the ultra-modern into one bustling, remarkable metropolis. Full of culture, commerce and people, Tokyo also contains some of the world's most stunning architecture.

Avec le mont Fuji comme toile de fond spectaculaire, la capitale du Japon mélange avec succès les anciennes traditions et l'ultra-moderne dans une métropole animée et remarquable. Pleine de culture, de commerces et de gens, Tokyo comporte également quelques-unes des plus belles architectures du monde.

Con el Monte Fuji como espectacular telón de fondo, la capital de Japón mezcla con acierto las viejas tradiciones con lo más moderno en una bulliciosa y extraordinaria metrópoli. Llena de cultura, comercio y gente, Tokio exhibe también obras arquitectónicas que se cuentan entre las más deslumbrantes del mundo.



*“Living right in the heart of Tokyo itself is quite like living in the mountains
– in the midst of so many people, one hardly sees anyone.”*

*« Vivre en plein cœur de Tokyo, c'est comme vivre dans les montagnes :
au milieu de tant de gens, on ne voit presque personne. »*

*“Vivir en el corazón de Tokio se parece mucho a vivir en las montañas.
Entre tanta gente, casi nunca ves a nadie”.*

Yūko Tsushima



Tokyo Tower

La tour de Tokyo

Torre de Tokio

Built in prefabricated steel and reaching a height of 1,092 ft. (333m), this iconic structure has been one of the city's most popular attractions since its completion in 1958. As well as transmitting Tokyo's TV and radio stations signals, instruments at the top of the tower also monitor air conditions above the crowded city.

En acier préfabriqué, cette structure emblématique de 333 m de haut est l'une des attractions les plus populaires de la ville depuis son achèvement en 1958. Non seulement les instruments situés au sommet de la tour transmettent les signaux des stations de télévision et de radio de Tokyo, mais ils surveillent également la qualité de l'air au-dessus de la ville bondée.

Construida en acero prefabricado y con una altura de 333 m, esta llamativa estructura es una de las atracciones más populares de la ciudad desde que se erigió en 1958. Además de transmitir las señales de las emisoras de televisión y radio de Tokio, los instrumentos instalados en el extremo superior de la torre monitorean también las condiciones ambientales de la abarrotada ciudad.







Mode Gakuen Cocoon Tower La tour Mode Gakuen Cocoon Torre Mode Gakuen Cocoon

Located in the Nishi-Shinjuku high-rise district, this 669 ft. (204 m) tall building is home to three colleges and over 10,000 students. Its distinctive curved shape, dark blue glass and crisscrossed web of white diagonal lines creates a nurturing environment for the students studying inside.

Situé dans le quartier des gratte-ciels de Nishi-Shinjuku, ce bâtiment de 204 m de haut abrite trois écoles et plus de 10 000 étudiants. Sa forme courbe distincte, ses vitres bleu foncé et sa structure quadrillée par une bande de lignes diagonales blanches créent un environnement stimulant pour les étudiants.

Ubicado en Nishi-shinjuku, un distrito de rascacielos, este edificio de 204 m de altura aloja tres universidades y admite más de 10,000 estudiantes. Su característica forma curva, su revestimiento de vidrio azul oscuro y su entramado de diagonales blancas entrecruzadas crean un acogedor espacio para los estudiantes que aprenden en su interior.

Chidorigafuchi Park

Le parc Chidorigafuchi

Parque Chidorigafuchi

The park is a narrow path that runs alongside the moat of the city's Imperial Palace. Many locals and tourists flock to the area in early Spring to witness the spectacular cherry blossoms during the brief hanami or flower viewing season.



Ce parc est un chemin étroit qui longe les douves du Palais impérial de la ville. De nombreux habitants et touristes affluent dans la région au début du printemps pour admirer les spectaculaires cerisiers en fleurs pendant la brève saison de la floraison.

El parque es un angosto sendero que se extiende junto al foso del palacio imperial de la ciudad. Numerosos lugareños y turistas acuden a la zona a comienzos de la primavera para presenciar el espectacular florecimiento de los cerezos durante la breve temporada de *hanami* (u observación de flores).



"Tokyo was a place you could quite happily exist alone and be self-contained."

« Tokyo était un endroit où l'on pouvait tout à fait vivre heureux, seul et indépendant. »

"Tokio es un lugar en el que podrías existir felizmente en soledad y ser autosuficiente".

Olivia Sudjic



TOKYO SKYTREE

TOKYO SKYTREE is the new symbol of the city of Tokyo. Though ultra-modern in both its appearance and construction, the architecture of TOKYO SKYTREE is similar to the classical design of the traditional 5-story Japanese pagoda. Opened to the public in May 2012, TOKYO SKYTREE is the tallest free-standing tower in the world, rising 2,080 ft. (634m)

TOKYO SKYTREE est le nouveau symbole de la ville de Tokyo. Bien qu'ultra-moderne dans son apparence et sa construction, l'architecture de TOKYO SKYTREE est similaire à la conception classique de la pagode japonaise traditionnelle de 5 étages. Ouverte au public en mai 2012, TOKYO SKYTREE est la plus haute tour autoportante du monde. Elle s'élève à 634 m.

La TOKYO SKYTREE es el nuevo símbolo de la ciudad de Tokio. A pesar del ultramoderno carácter tanto de su apariencia como de su construcción, la arquitectura de la TOKYO SKYTREE se asemeja al clásico diseño de una pagoda tradicional japonesa de 5 pisos. Abierta al público en mayo de 2012, la TOKYO SKYTREE es la torre autónoma más alta del mundo, elevándose hasta 634 m sobre el suelo.





Shibuya Crossing Le carrefour de Shibuya Cruce de Shibuya

This iconic crossing at the heart of the Shibuya shopping district is the busiest in Japan (and possibly the world). At peak times up to 3000 people will cross the intersection, coming from several directions at once. In the evening, the area comes alive with the colorful lights of the neon signs and jumbo screens.

Ce carrefour emblématique au cœur du quartier commerçant de Shibuya est le plus fréquenté au Japon (et peut-être au monde). Aux heures de pointe, jusqu'à 3 000 personnes venant de plusieurs directions traversent ce carrefour. Le soir, l'endroit s'anime avec les lumières colorées des enseignes au néon et des écrans géants.

Este inconfundible cruce, ubicado en el corazón del distrito comercial de Shibuya, es el más transitado de Japón (y, posiblemente, del mundo). En hora pico, hasta 3000 personas cruzan la intersección en diferentes direcciones a la vez. Por la noche, la zona cobra vida gracias a las vistosas luces de los letreros de néon y las pantallas gigantes.

Tokyo Big Sight

Overlooking Tokyo Bay and officially known as the Tokyo International Exhibition Center, Tokyo Big Sight attracts over 16 million visitors each year. Its most striking feature is the 190 ft. (58m) tall glass and titanium conference tower shaped like an inverted pyramid.

Surplombant la baie de Tokyo et officiellement connu sous le nom de Tokyo International Exhibition Center, le Tokyo Big Sight attire plus de 16 millions de visiteurs chaque année. Il se caractérise principalement par sa haute tour de 58 m en verre et titane, qui présente la forme d'une pyramide inversée.

Con vista a la bahía de Tokio y oficialmente conocido como Centro Internacional de Exposiciones de Tokio, el Tokyo Big Sight atrae a más de 16 millones de visitantes cada año. Su característica más llamativa es una gigantesca torre de conferencias de vidrio y titanio con una altura de 58 m y forma de pirámide invertida.



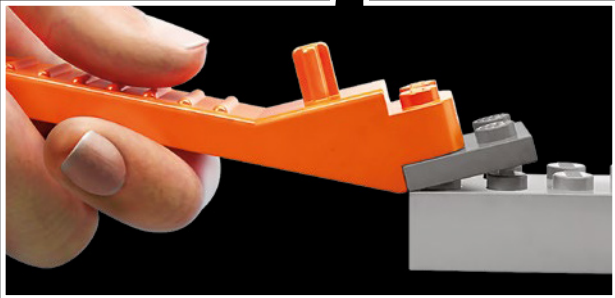
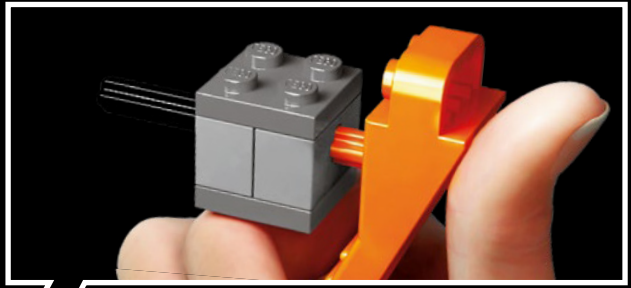
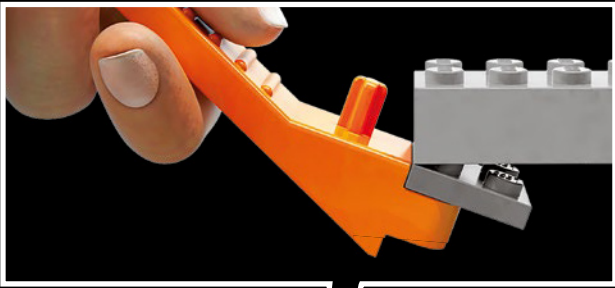



- 1** Scan the code on the front cover
 Scanne den Code auf der Titelseite
 Scanne le code sur la page de couverture
 Scanner le code sur la page couverture
 Scansiona il codice sulla copertina
 Escanea el código de la portada
 Faz scan do código na frente da capa
 Olvasd be a borítón látható kódot!
 Noskenē kodu uz priekšējā vāka
 扫描封面上的二维码

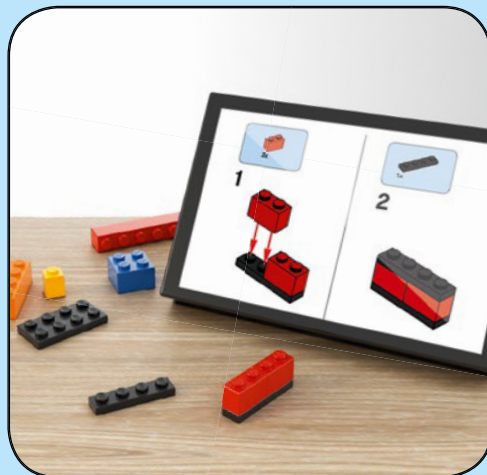

- 2** Get the Building Instructions
 Hol dir die Bauanleitung
 Obtens les instructions de montage
 Obtenir les instructions de montage
 Scarica le istruzioni per la costruzione
 Consulta las instrucciones de construcción
 Obtém as Instruções de Construção
 Szerezd be az építési útmutatókat!
 Saņem būvēšanas instrukcijas
 获取拼搭说明

LEGO.com/apps

Check for compatibility
 Kompatibilität prüfen
 Vérifier la compatibilité
 Controlla la compatibilità
 Comprueba tu compatibilidad

Verificar a compatibilidade
 Ellenőrizd a kompatibilitást
 Pārbaudīt saderību
 检查兼容性

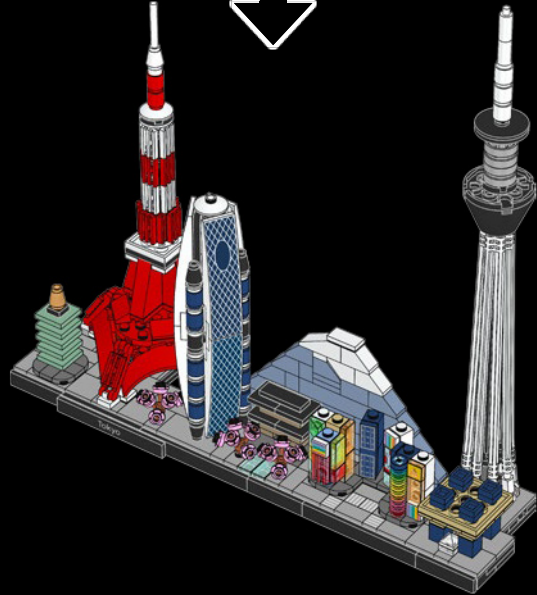
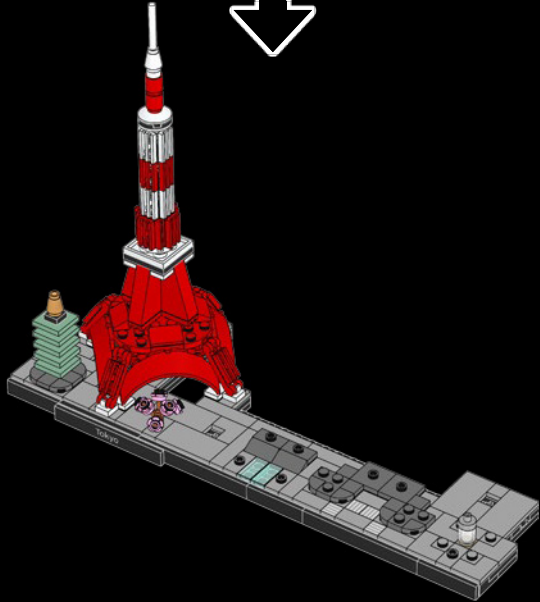

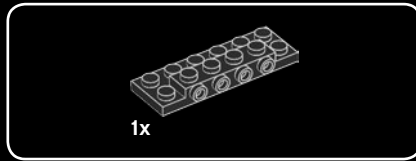
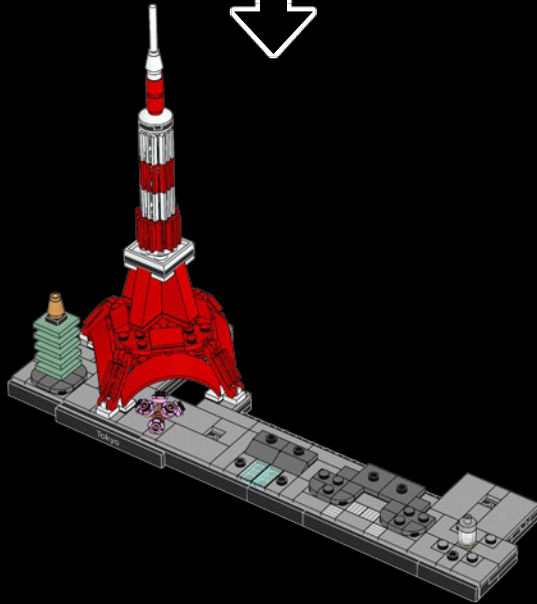

1

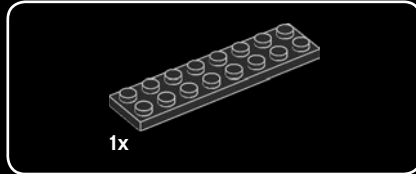
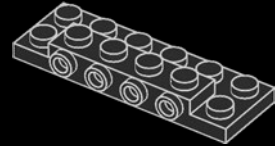

2

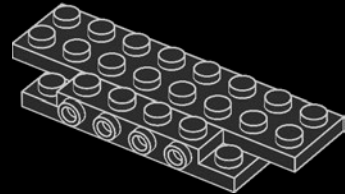

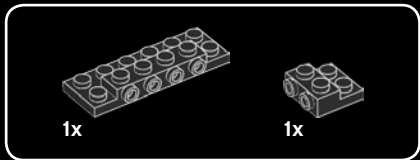

3

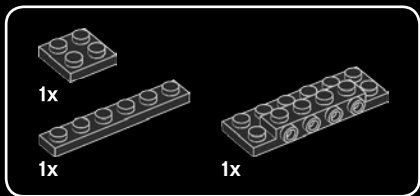
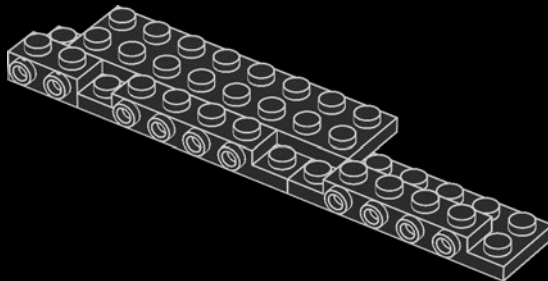

4

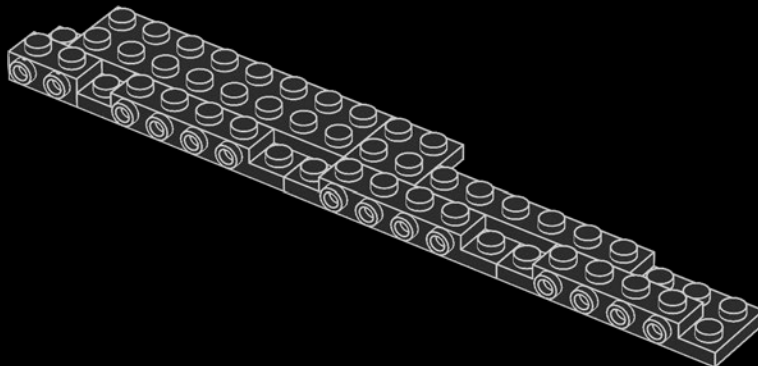

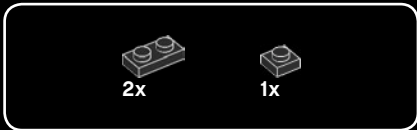

5

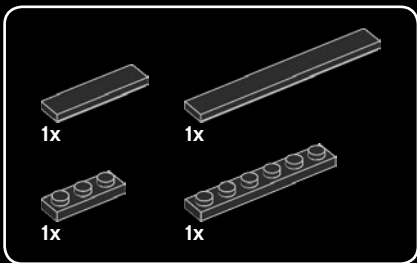
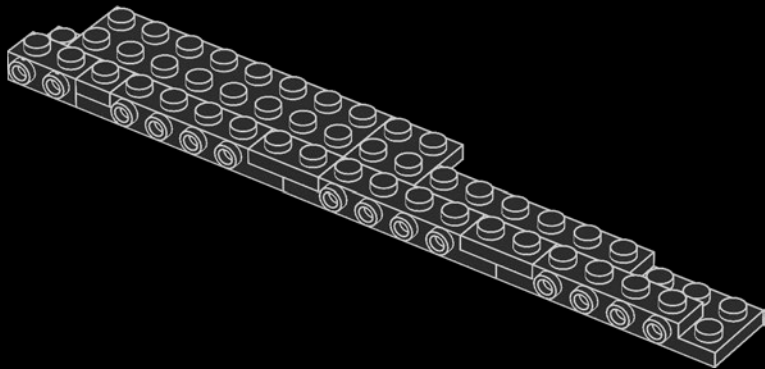

6

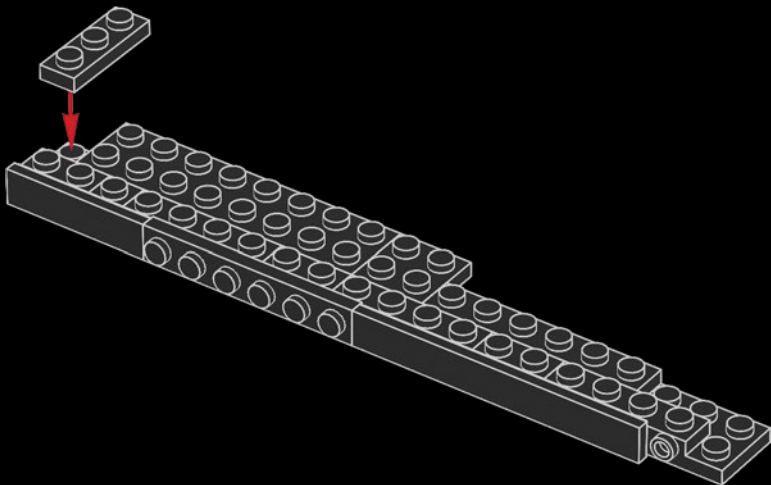

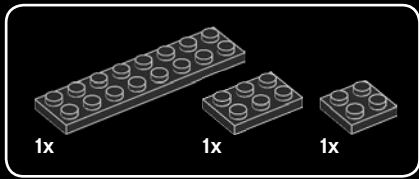

7

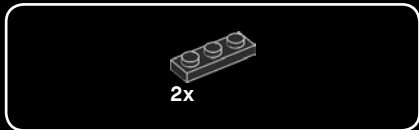
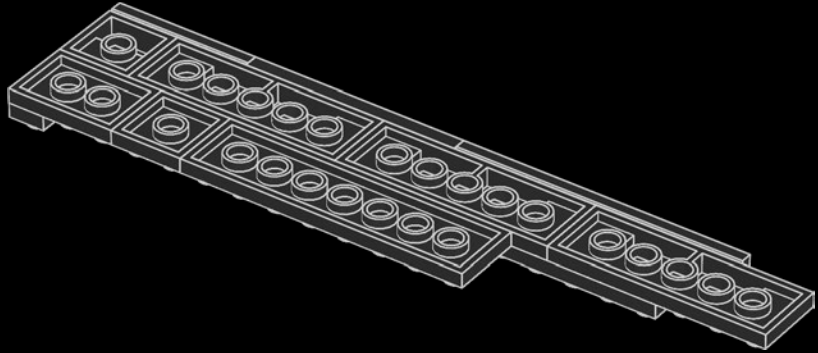

8

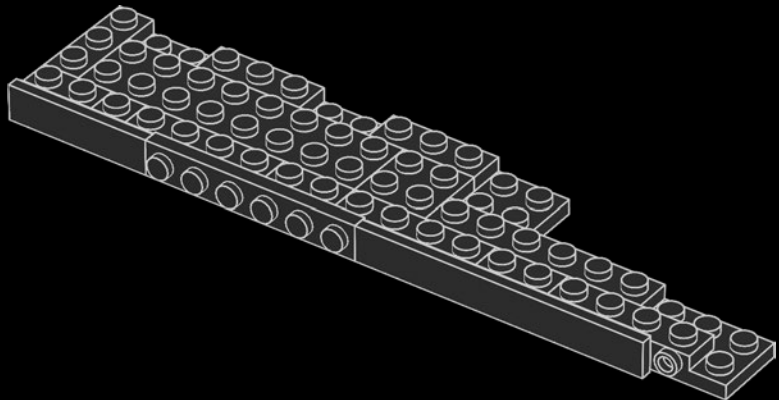

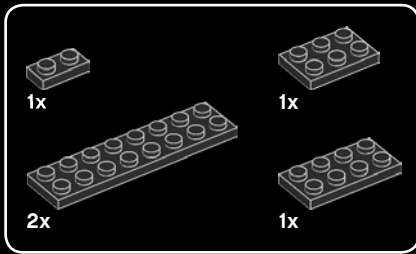

9

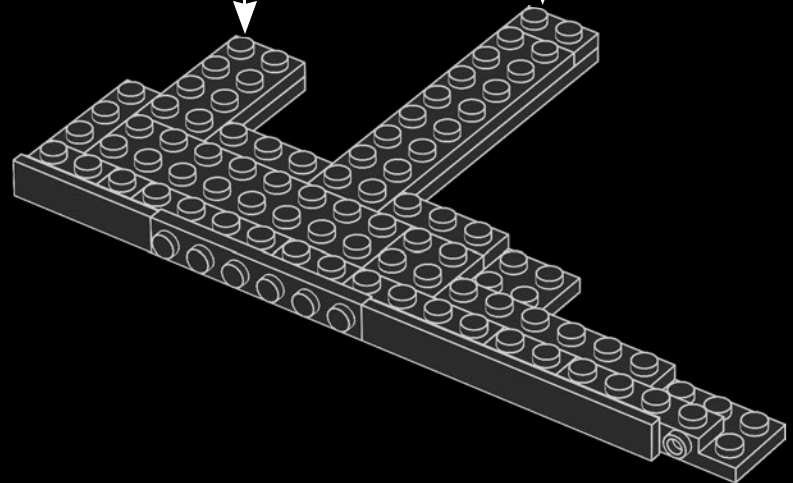
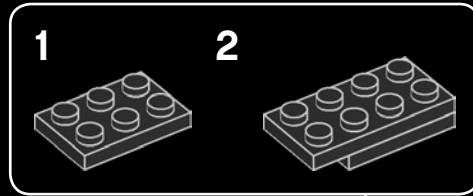
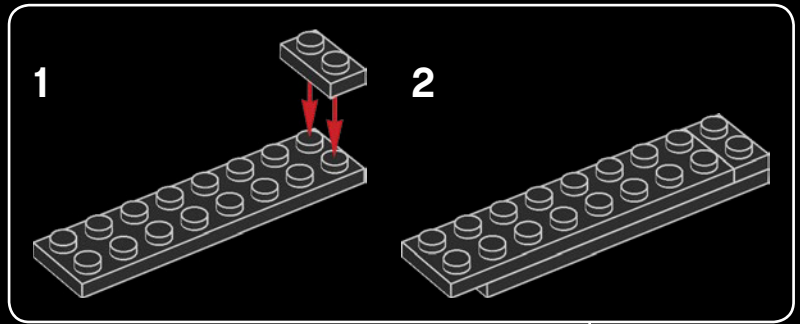

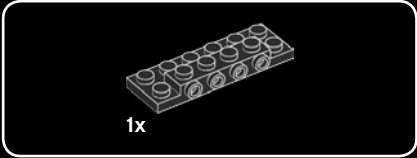
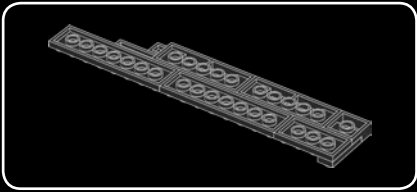

1x

10

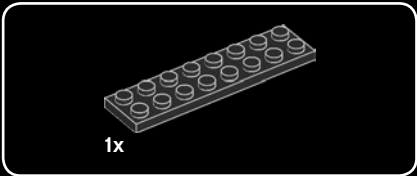
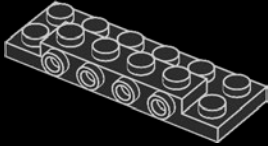

1x

11

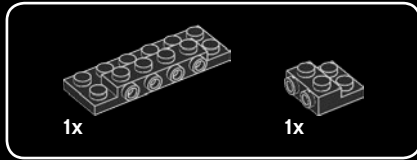
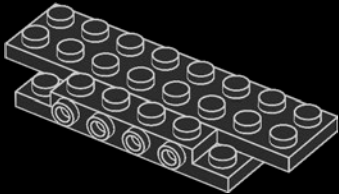

1x

1x

12

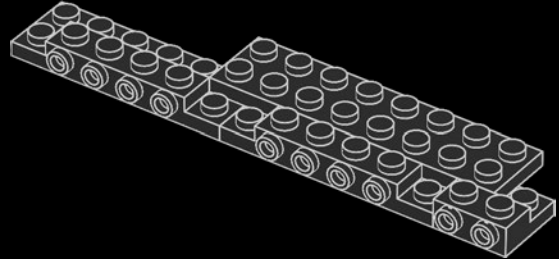

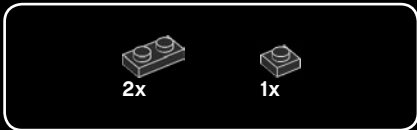

13

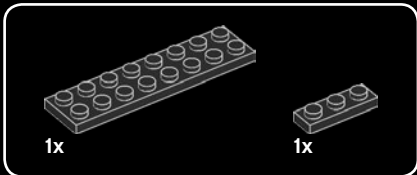
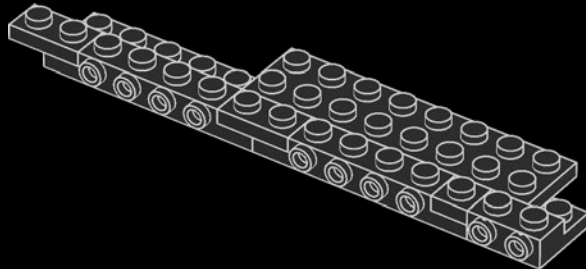

14

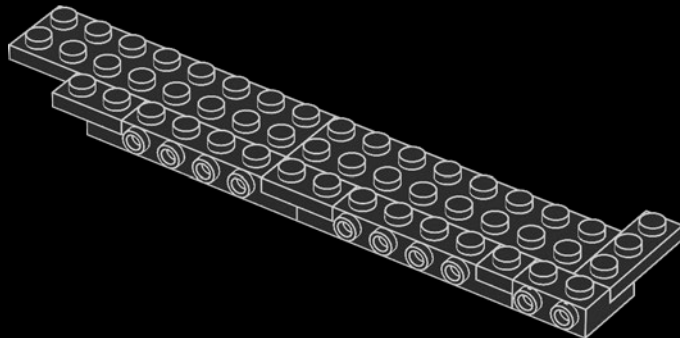

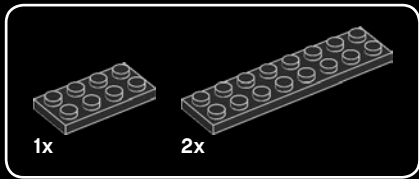

15

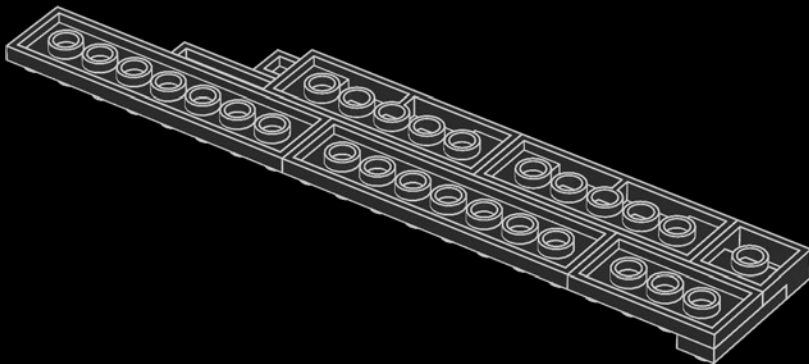

16

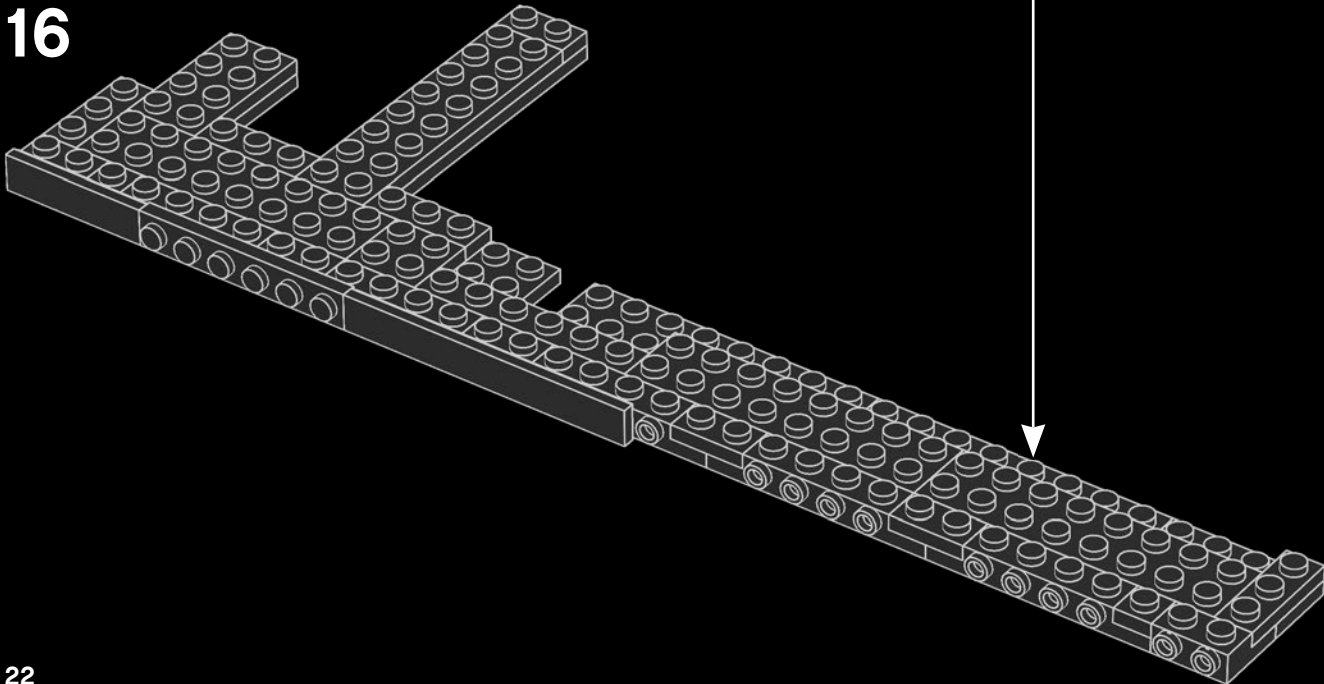

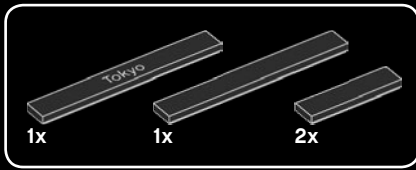

17

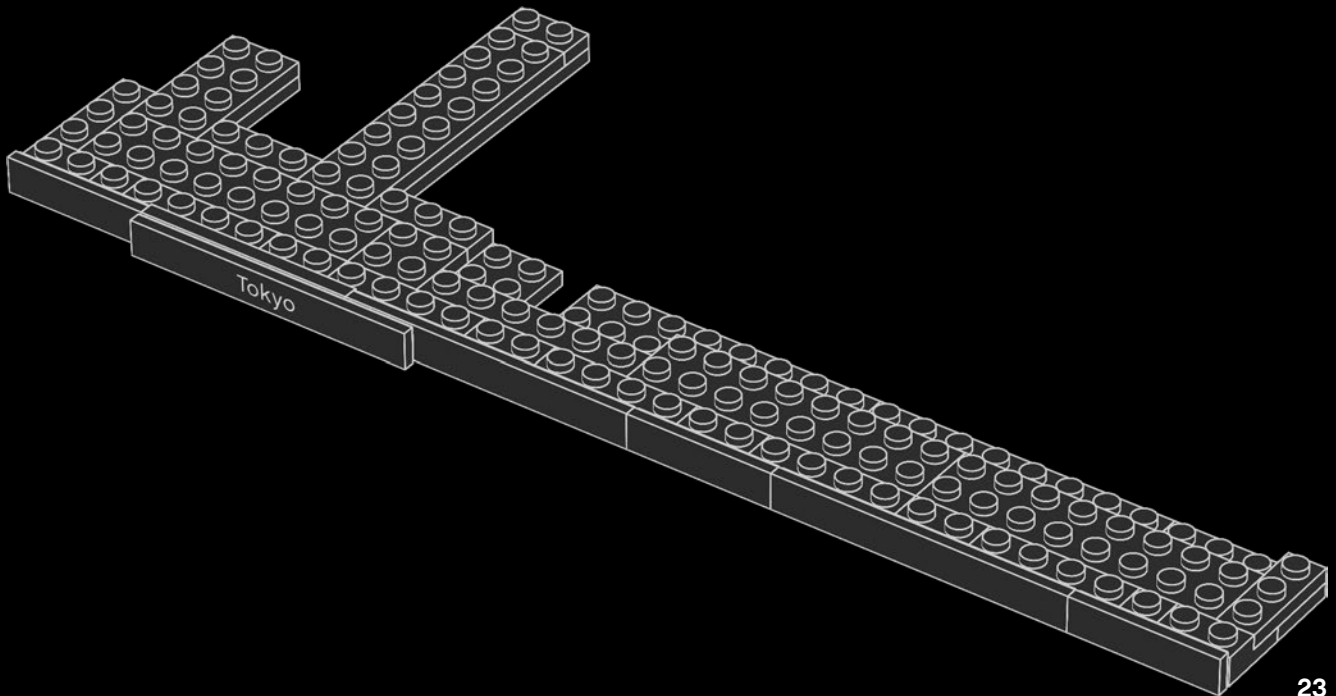

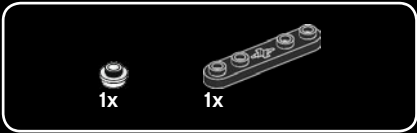

18

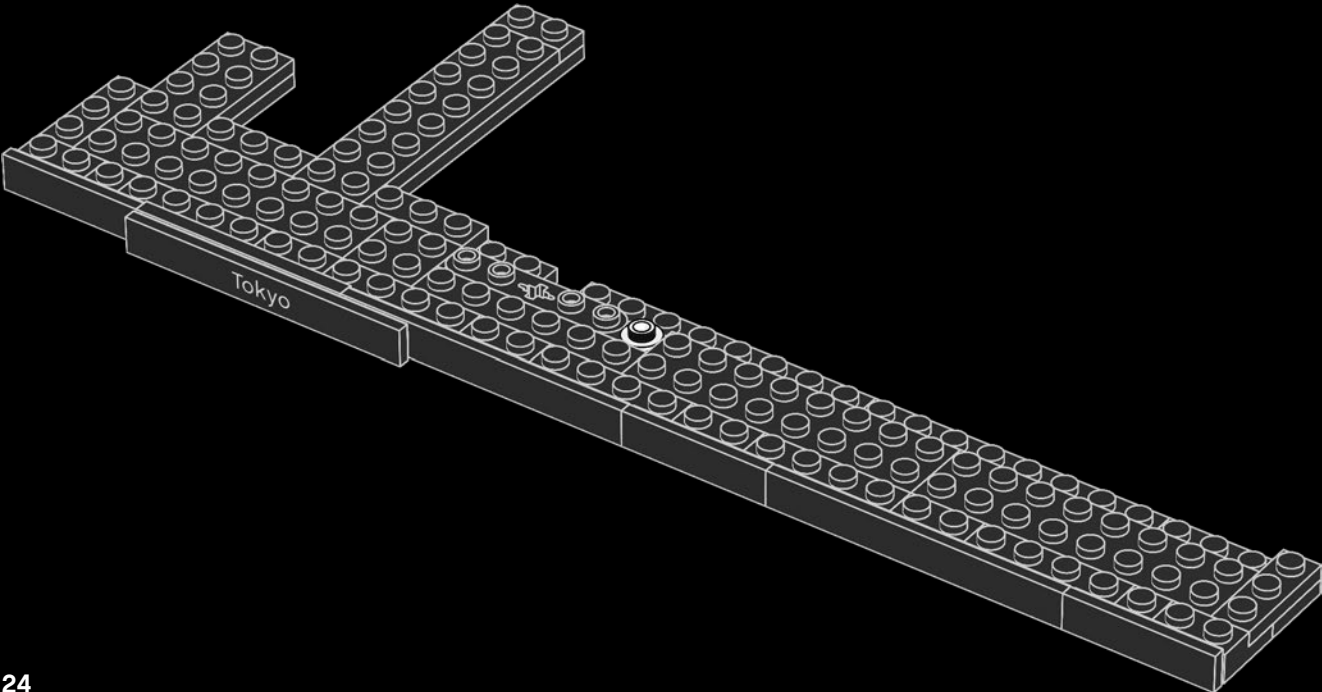

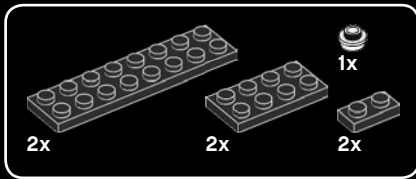

19

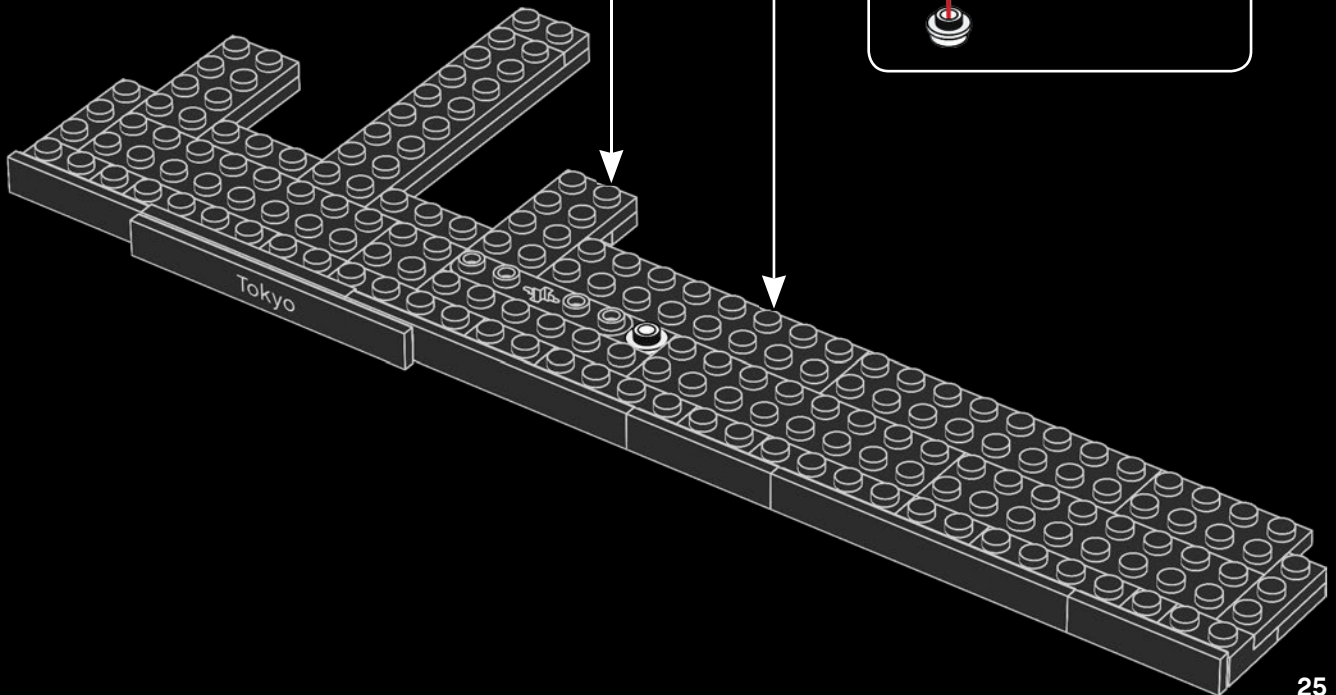
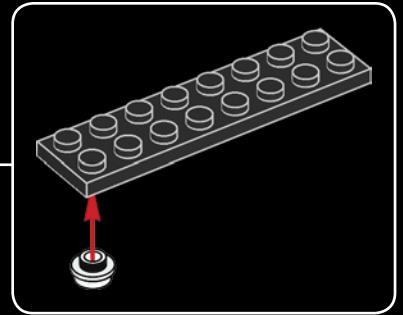
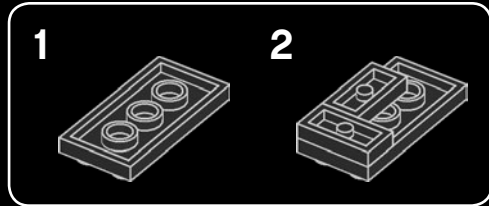

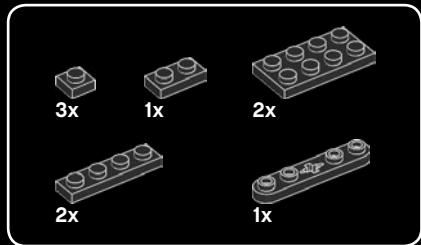

20

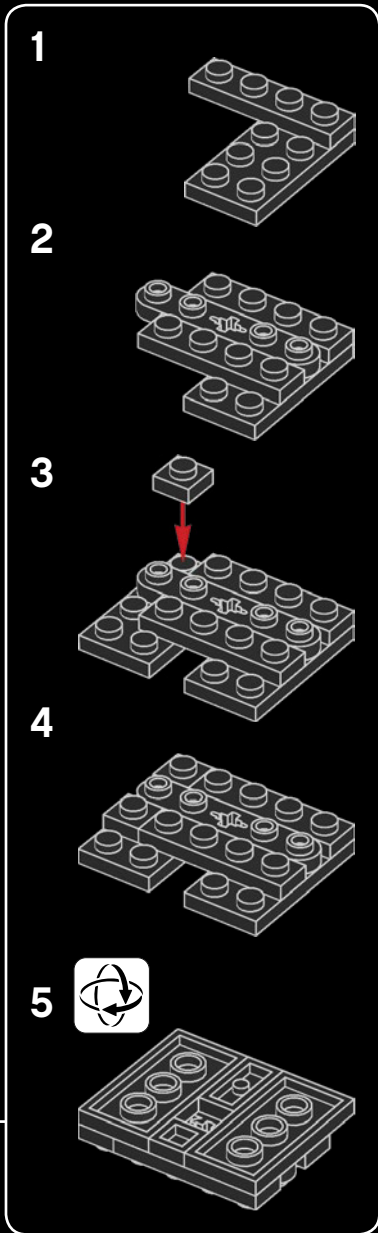
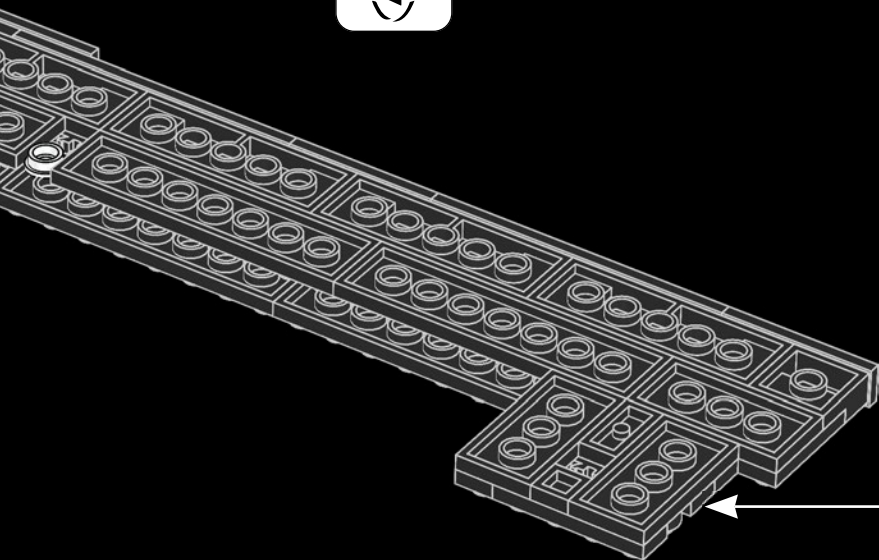

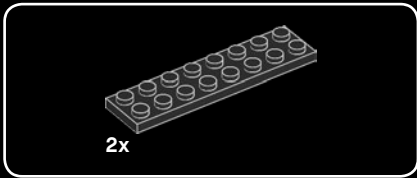

21

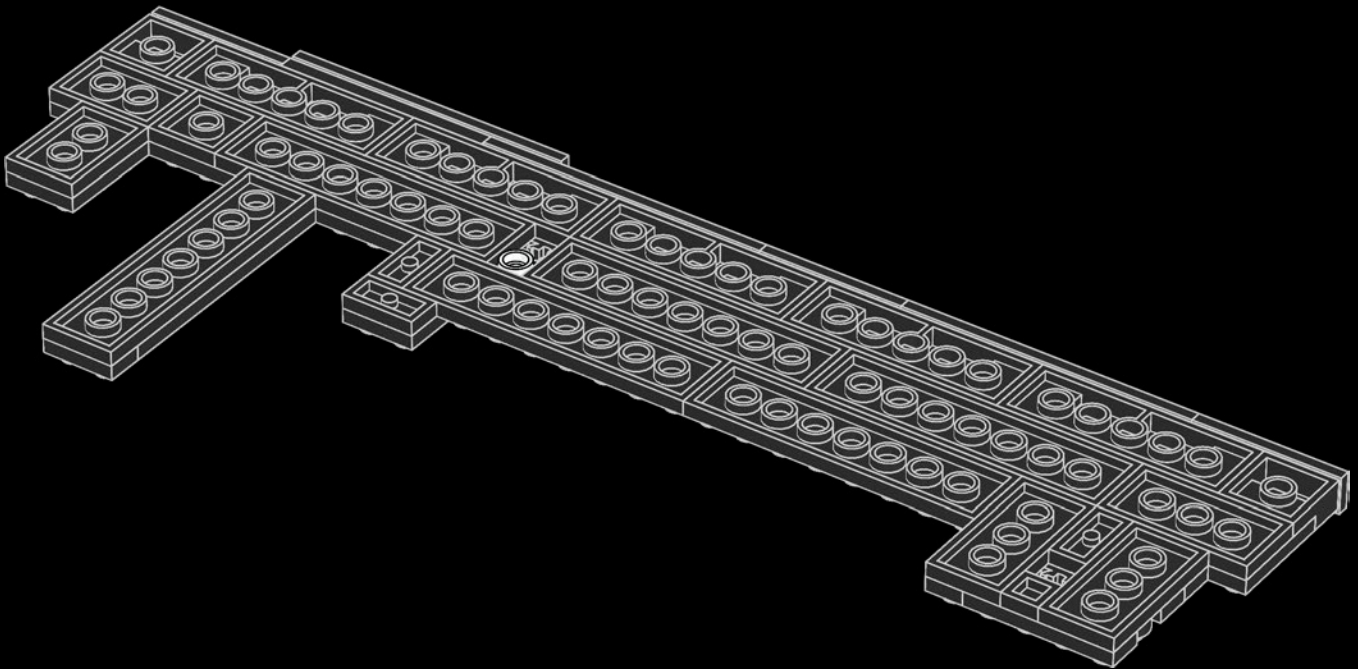

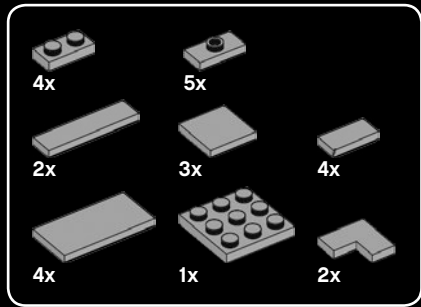

22

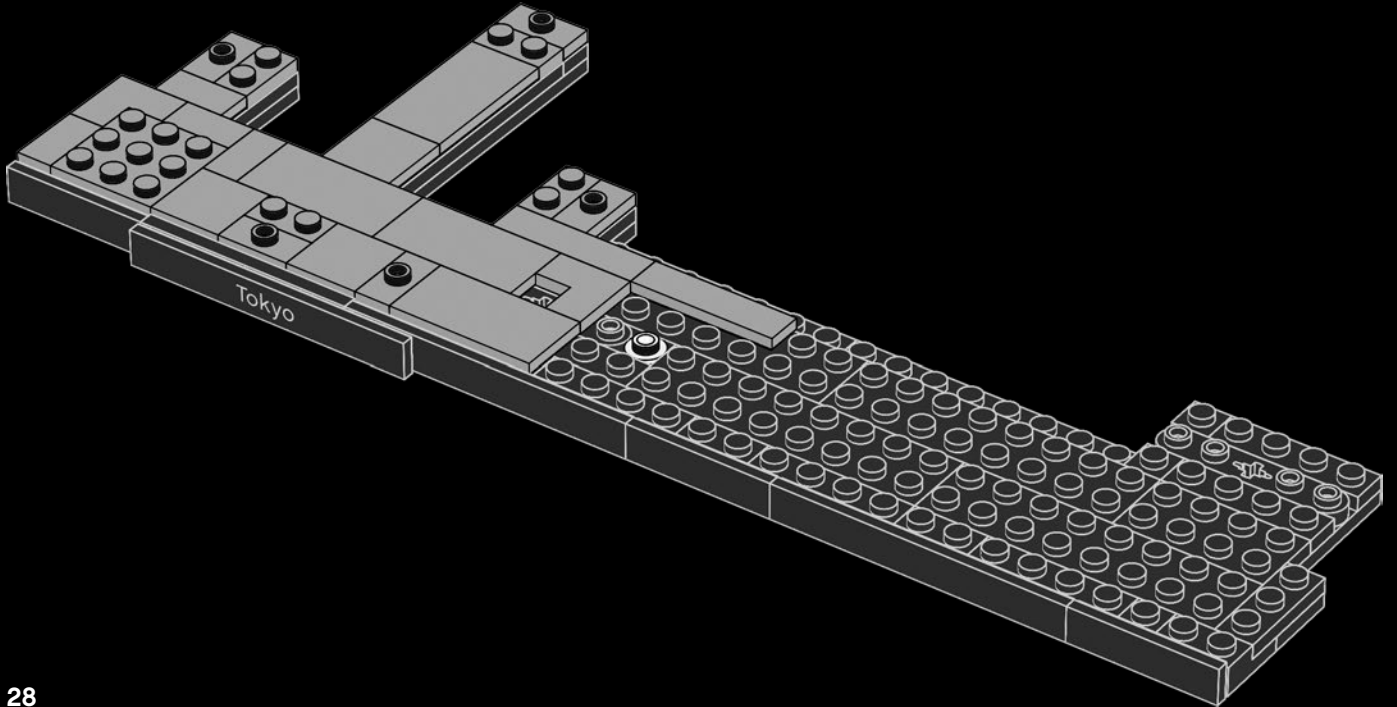

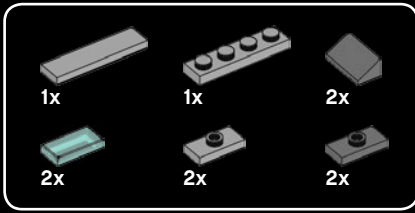

23

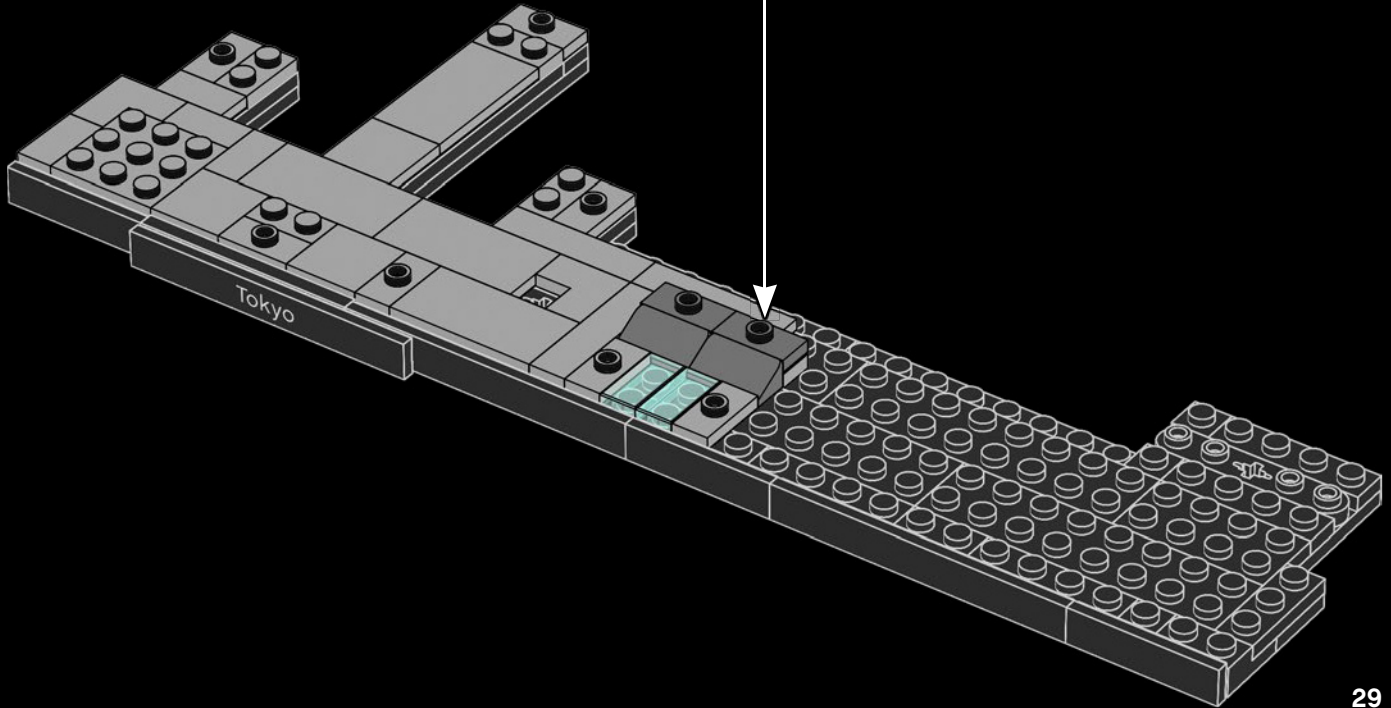
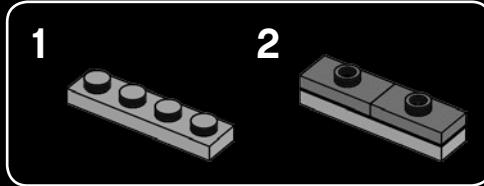

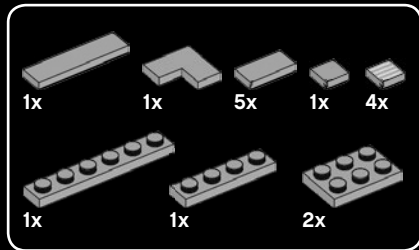

Shibuya Crossing / Le carrefour de Shibuya /
Cruce de Shibuya

Seven crossroads meet at the Shibuya Crossing.
Sept artères se rencontrent au carrefour de Shibuya.
Siete avenidas se encuentran en el Cruce de Shibuya.



24

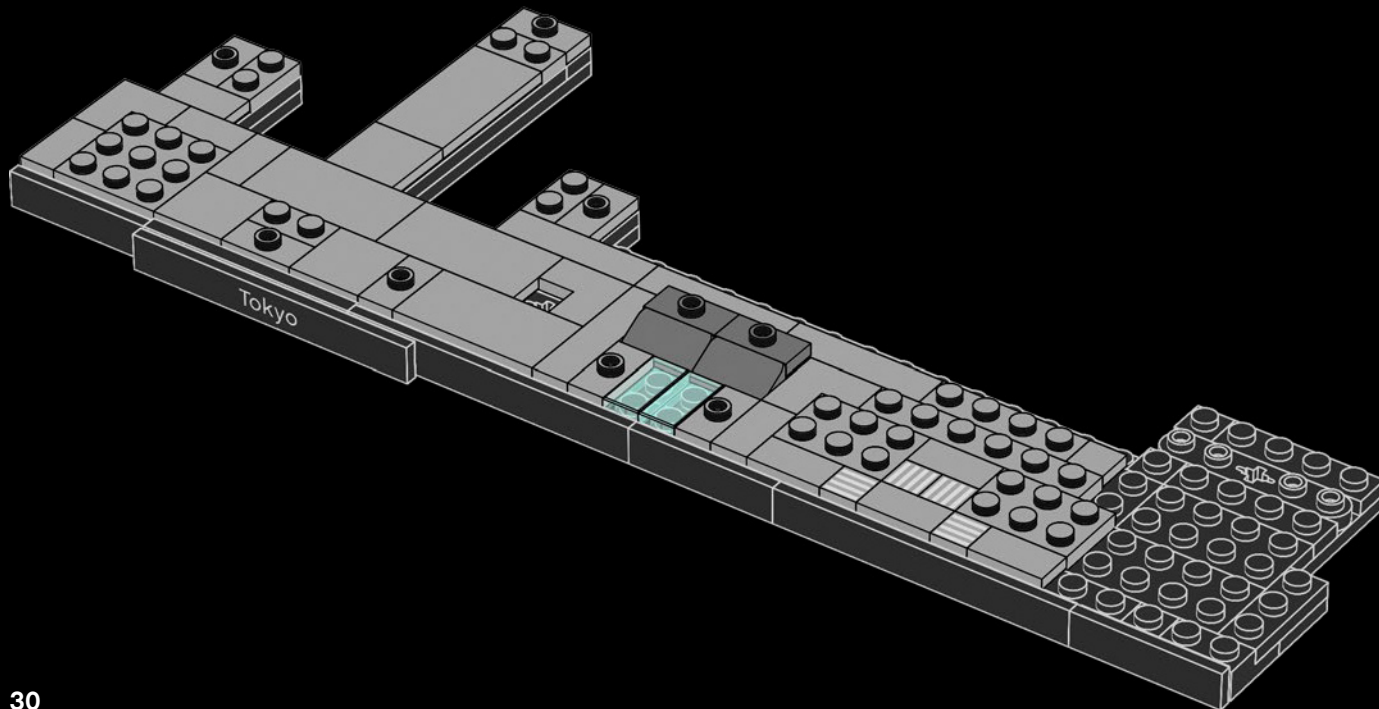

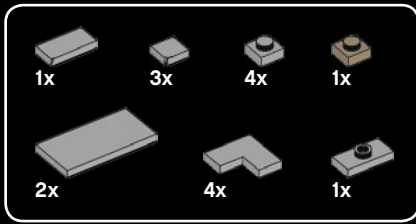

25

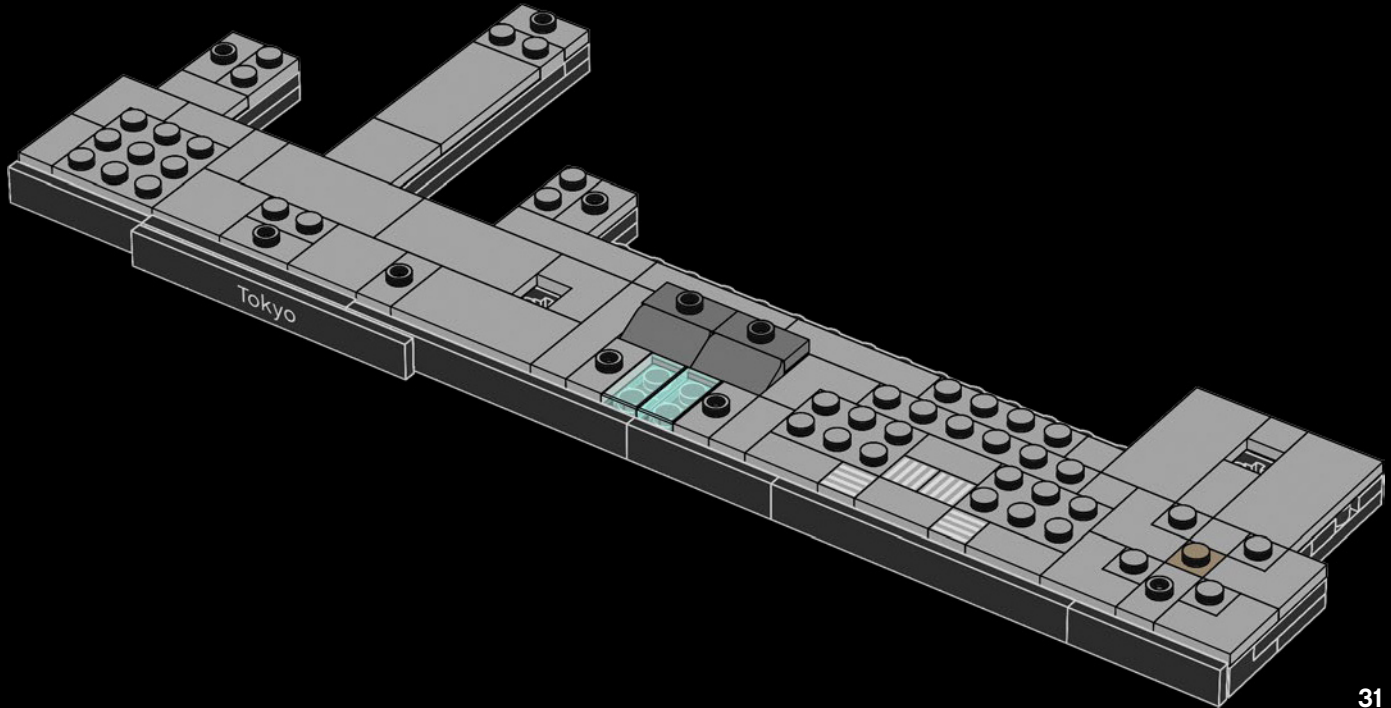

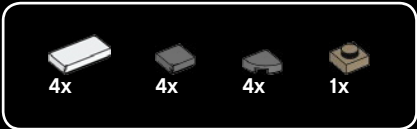

26

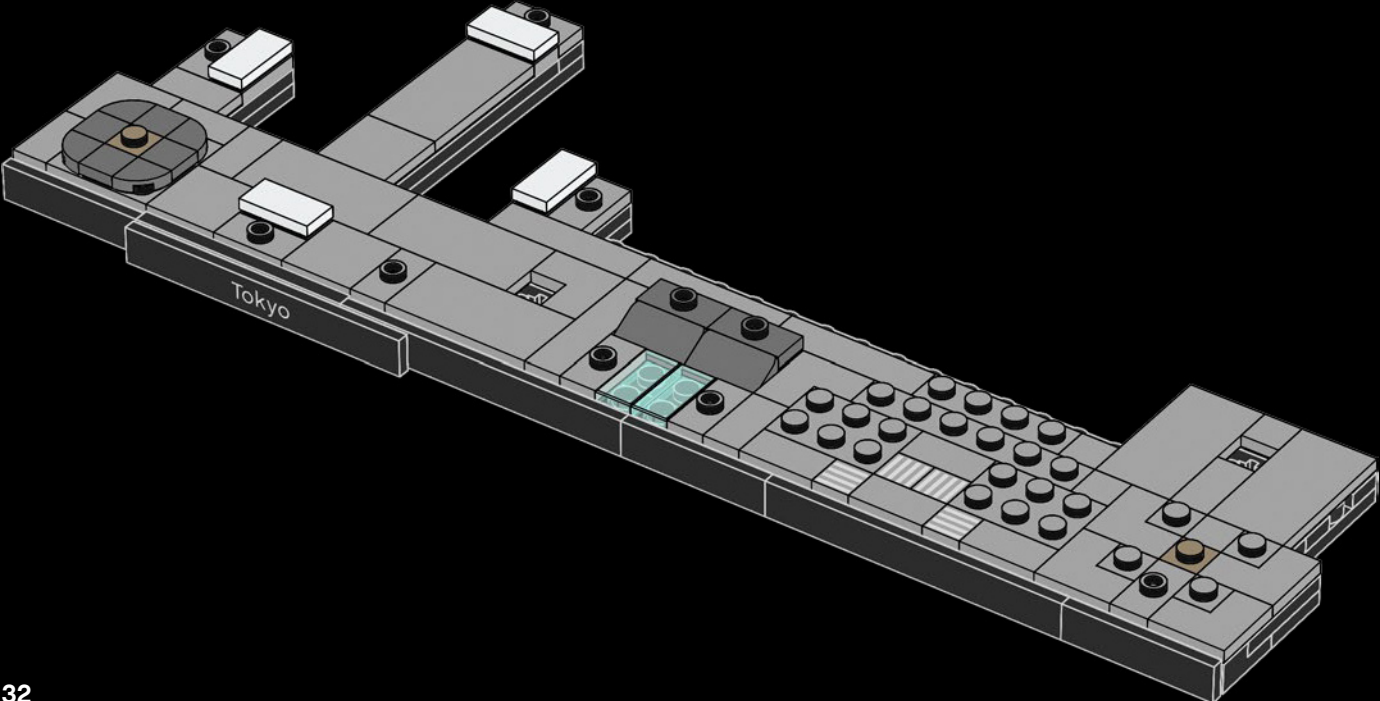

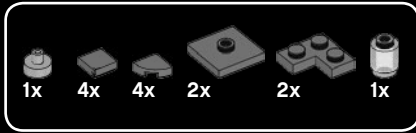

27

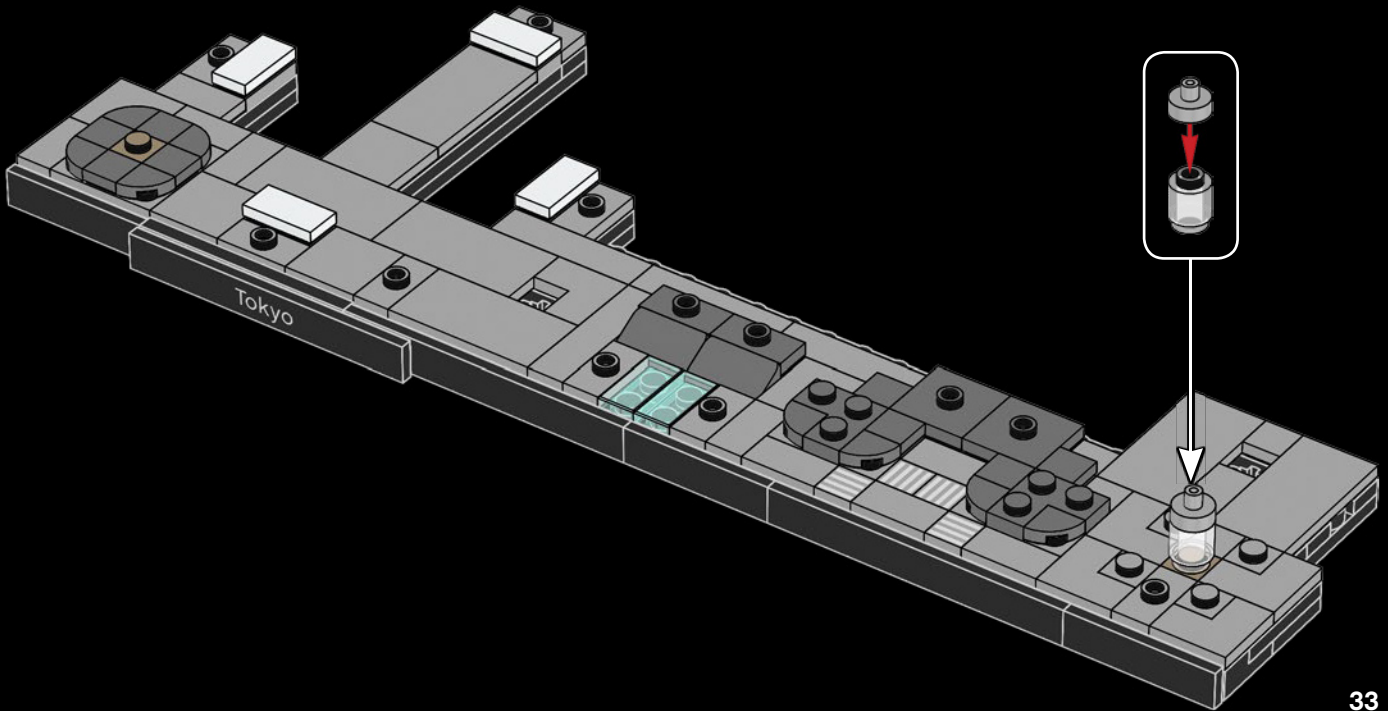

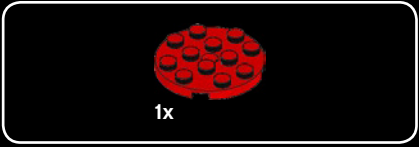
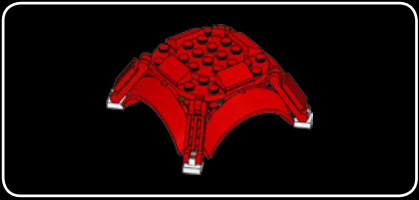

1x

28



2x

29

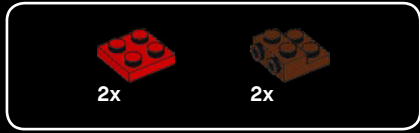
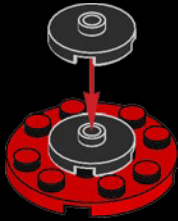

2x

2x

30

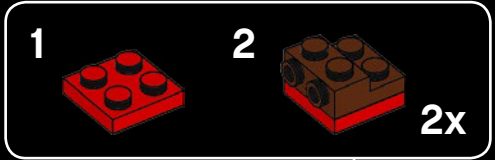

1

2

2x

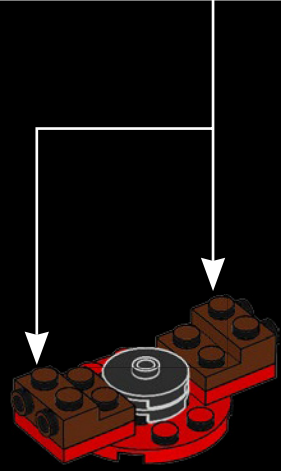

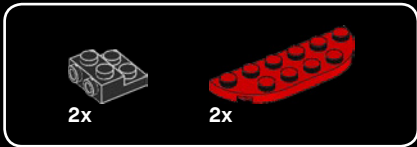

31

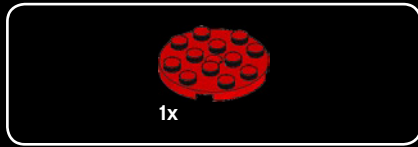
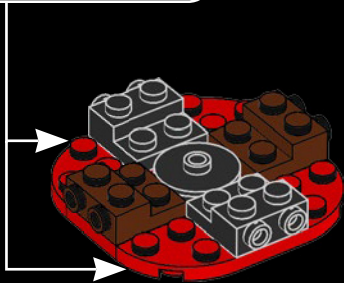
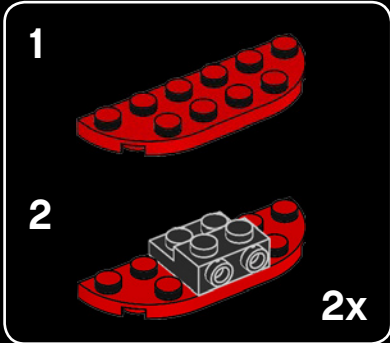

32

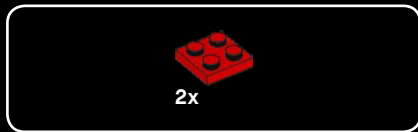

33

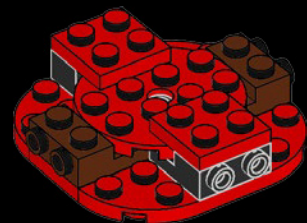

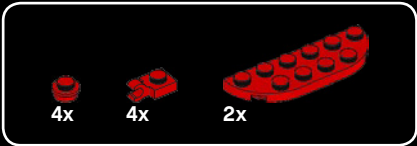

34

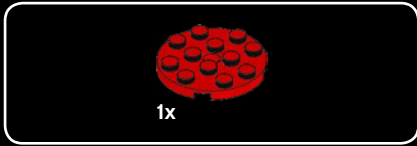
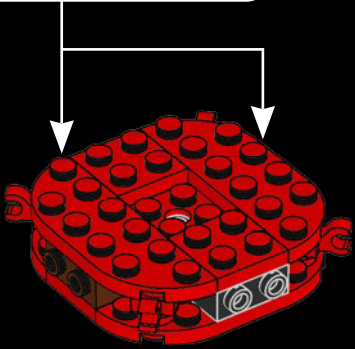
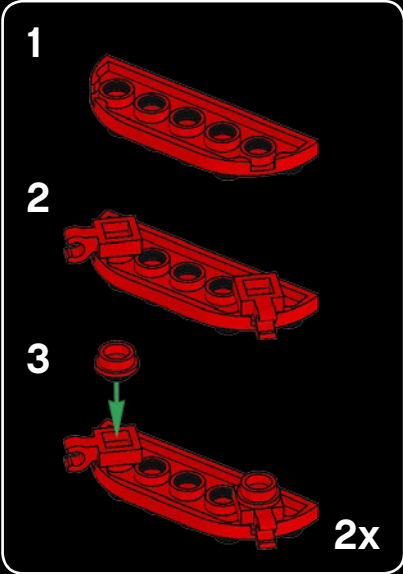

35

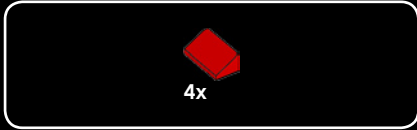
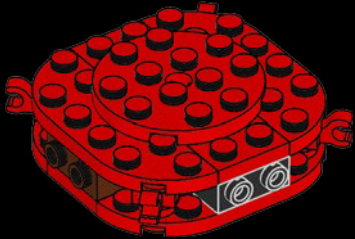

36

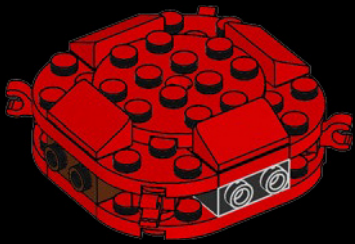

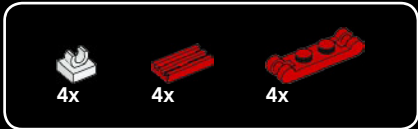

37

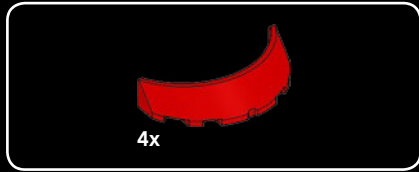
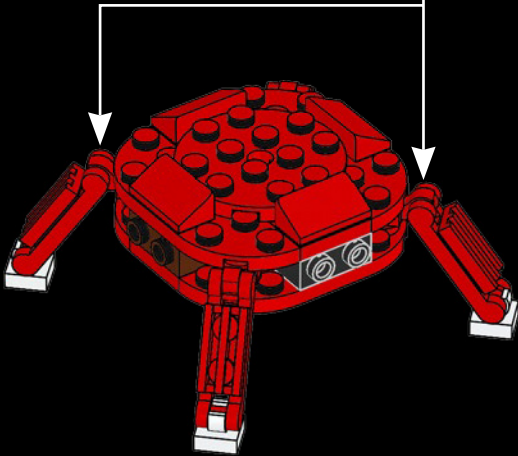
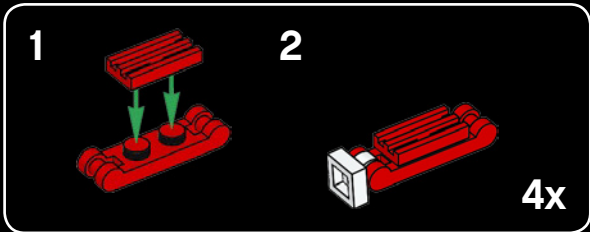

38

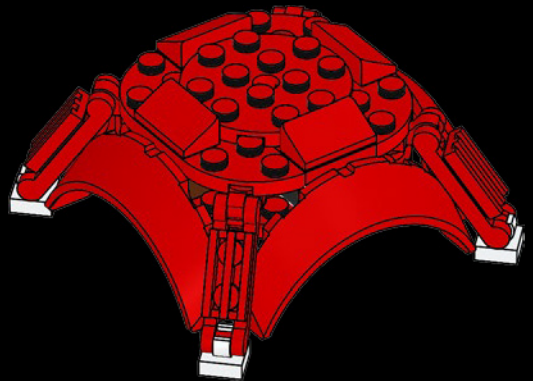

Tokyo Tower / La tour de Tokyo / Torre de Tokio

The Tower has observation decks at 492 ft. (150m) and 820 ft. (250m).

La tour possède des ponts d'observation situés à une hauteur de 150 m et 250 m.

La torre cuenta con plataformas de observación a 150 m y 250 m.



39

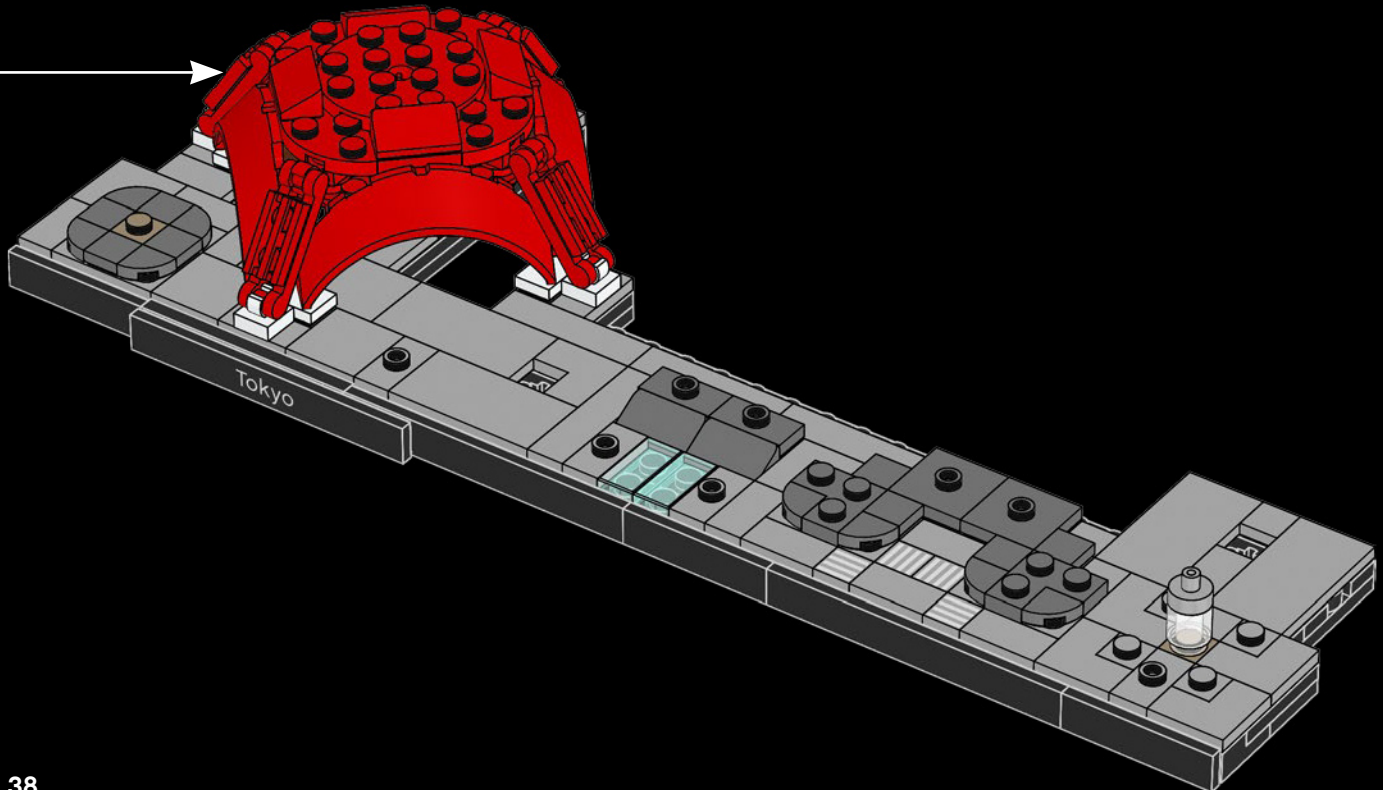

38

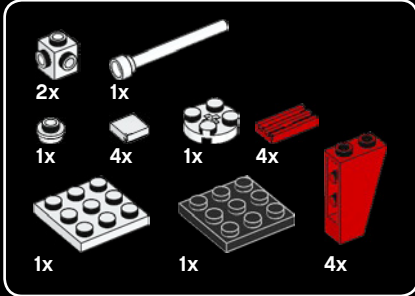

40

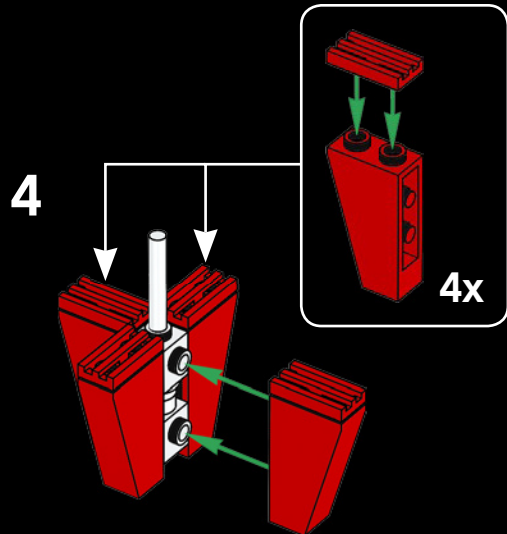
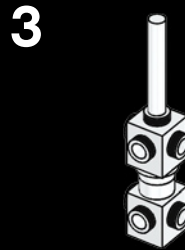
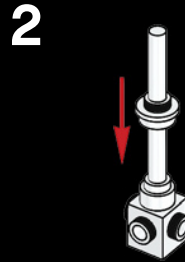
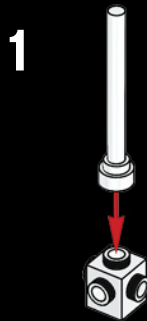

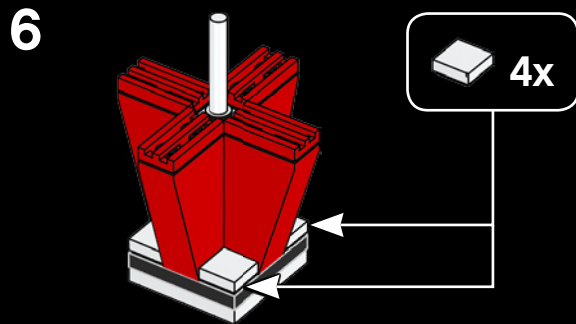
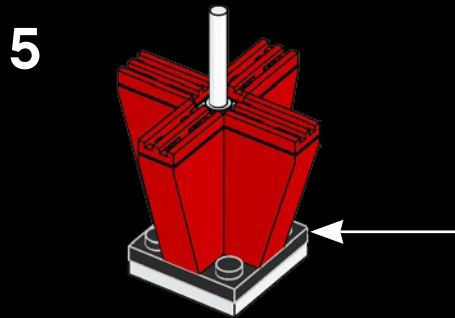
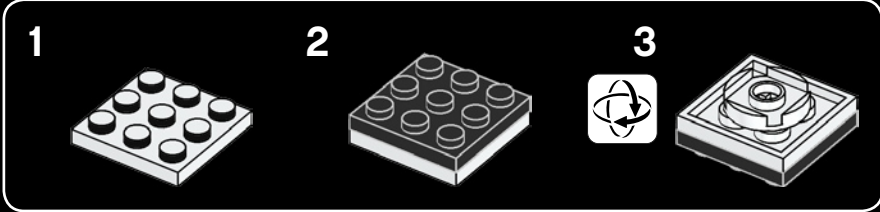

Tokyo Tower / La tour de Tokyo / Torre de Tokio

The Tower can withstand windspeeds of up to 201 mph (90m/s).

La tour est capable de résister à des vents pouvant atteindre 90 m/s.

La torre puede soportar vientos de hasta 90 m/s.

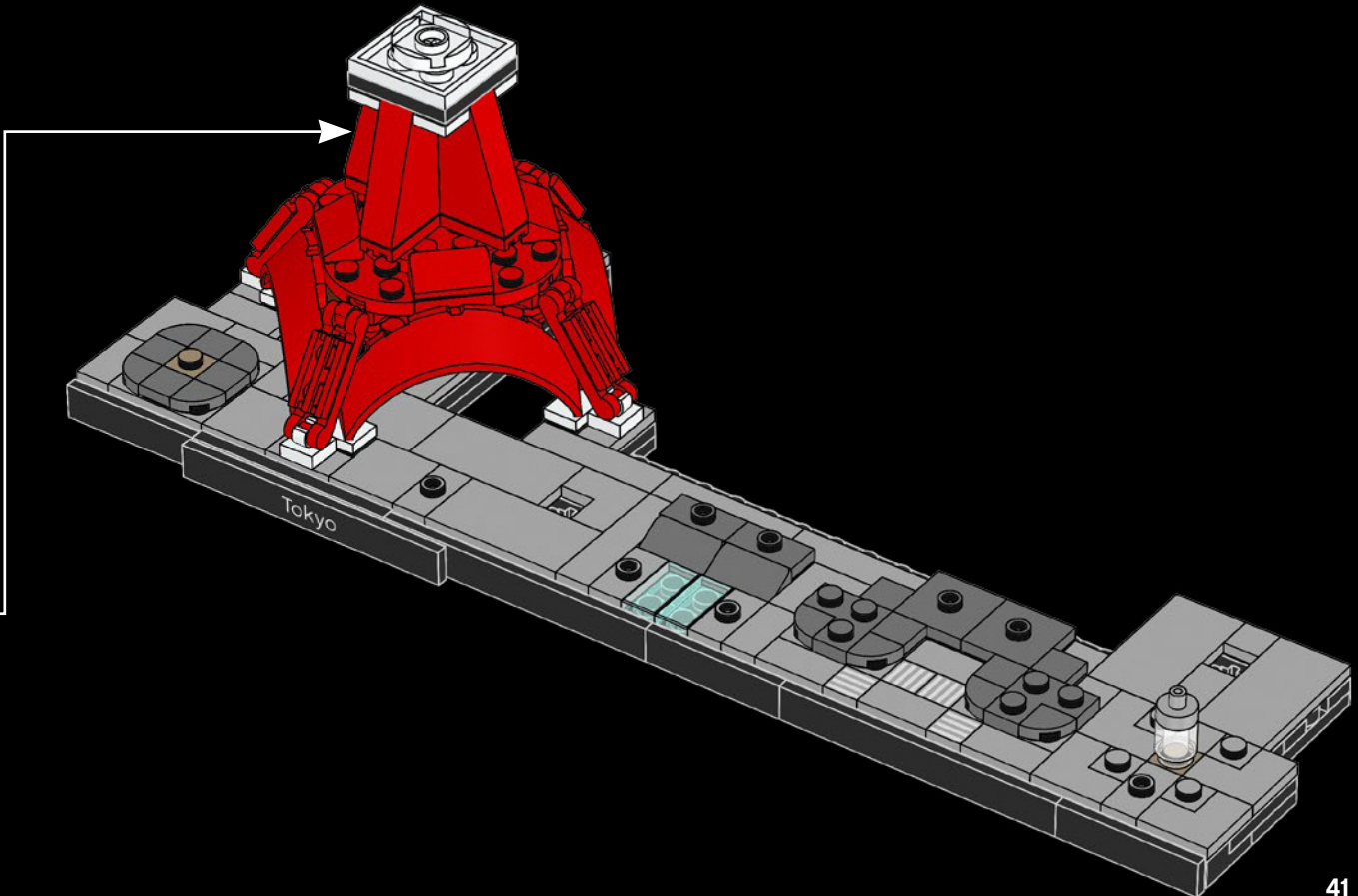

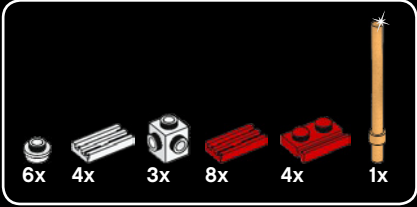
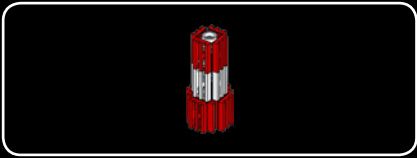

41

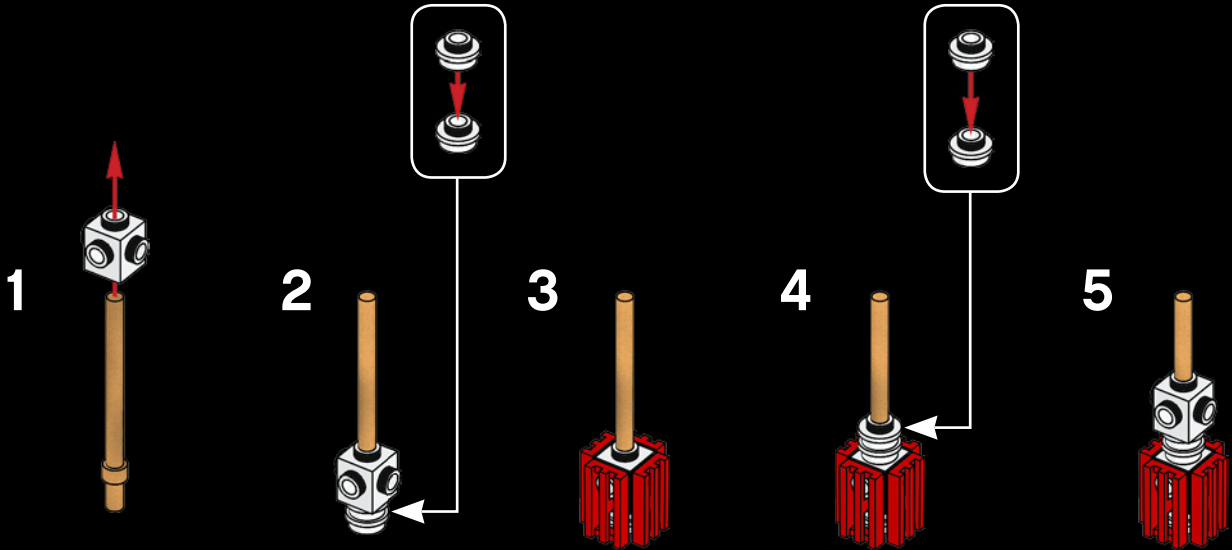

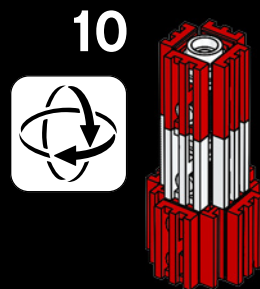
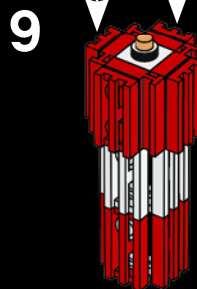
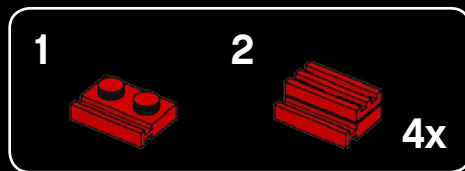
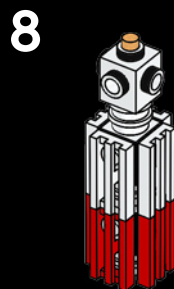
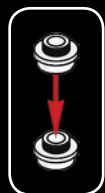
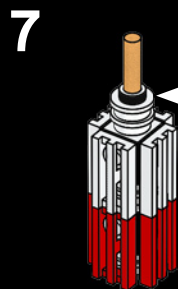
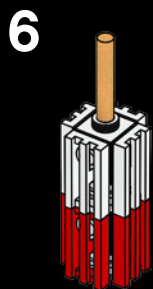

Tokyo Tower / La tour de Tokyo / Torre de Tokio

Over 450 lamps light up the Tower in the evening.

Plus de 450 lampes illuminent la tour le soir.

Más de 450 lámparas iluminan la torre por la noche.

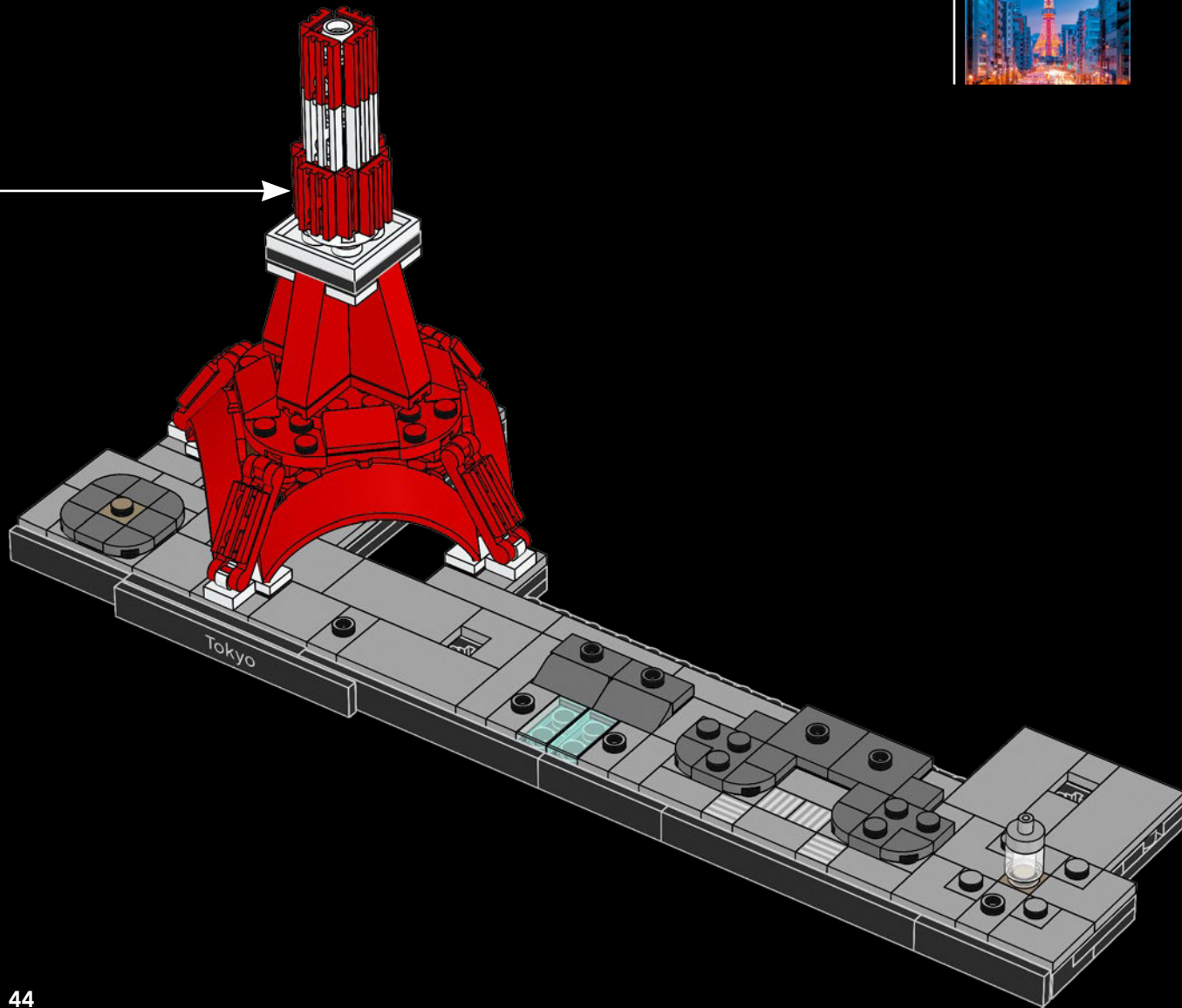

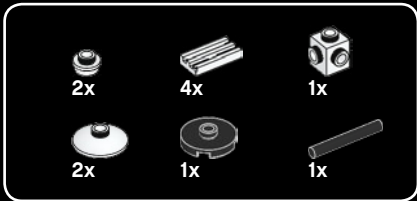

42

1



2



3

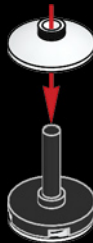

4

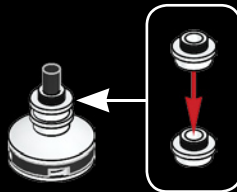

5



6



7



Tokyo Tower / La tour de Tokyo / Torre de Tokio

It takes almost 8,982 gallons (34,000 litres) of paint to cover the Tower's surface.

Près de 34 000 litres de peinture sont nécessaires pour recouvrir la surface de la tour.

Se necesitan casi 34,000 l de pintura para cubrir la superficie de la torre.

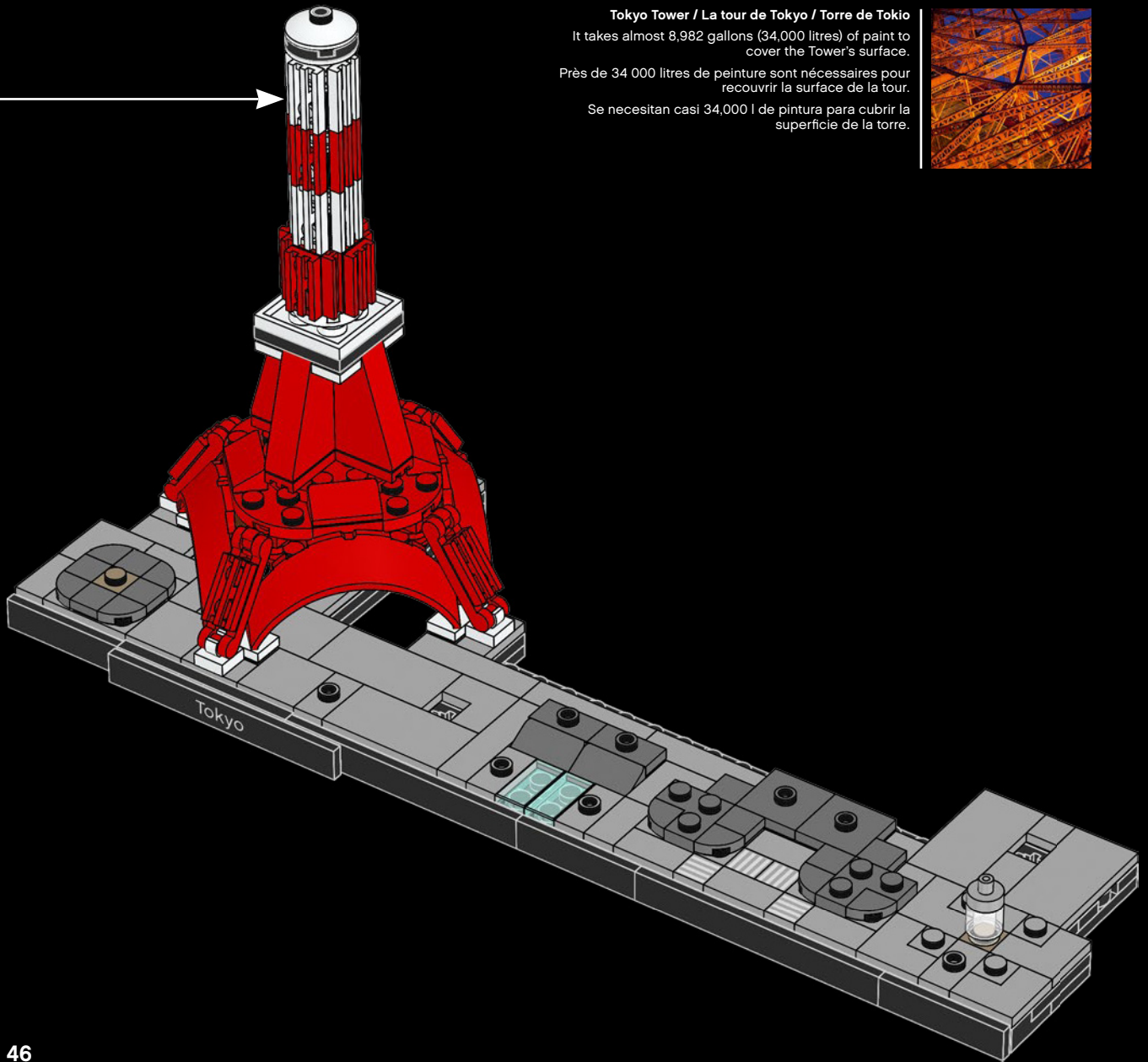



43

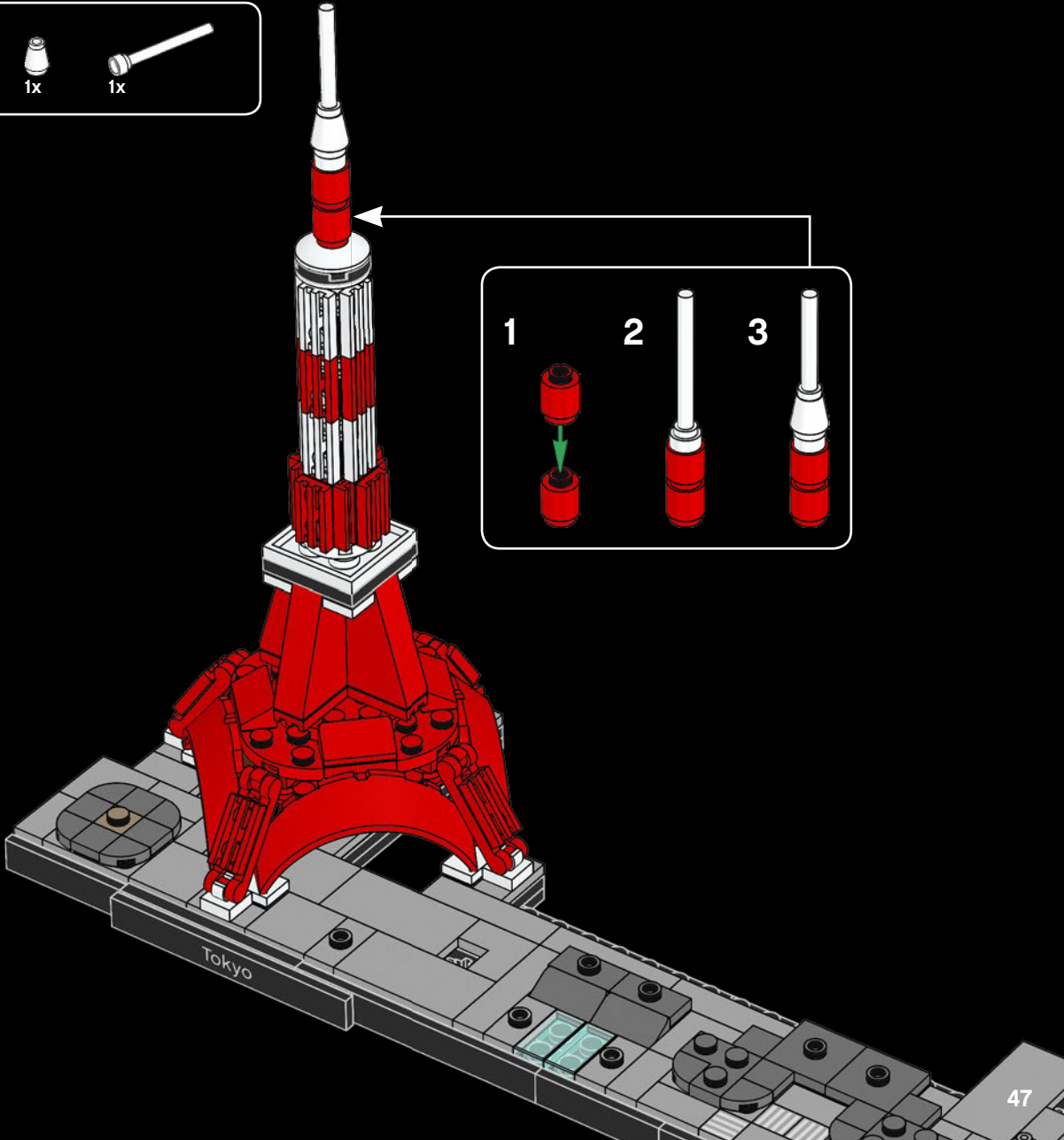

- 1x
- 5x
- 1x
- 5x

44

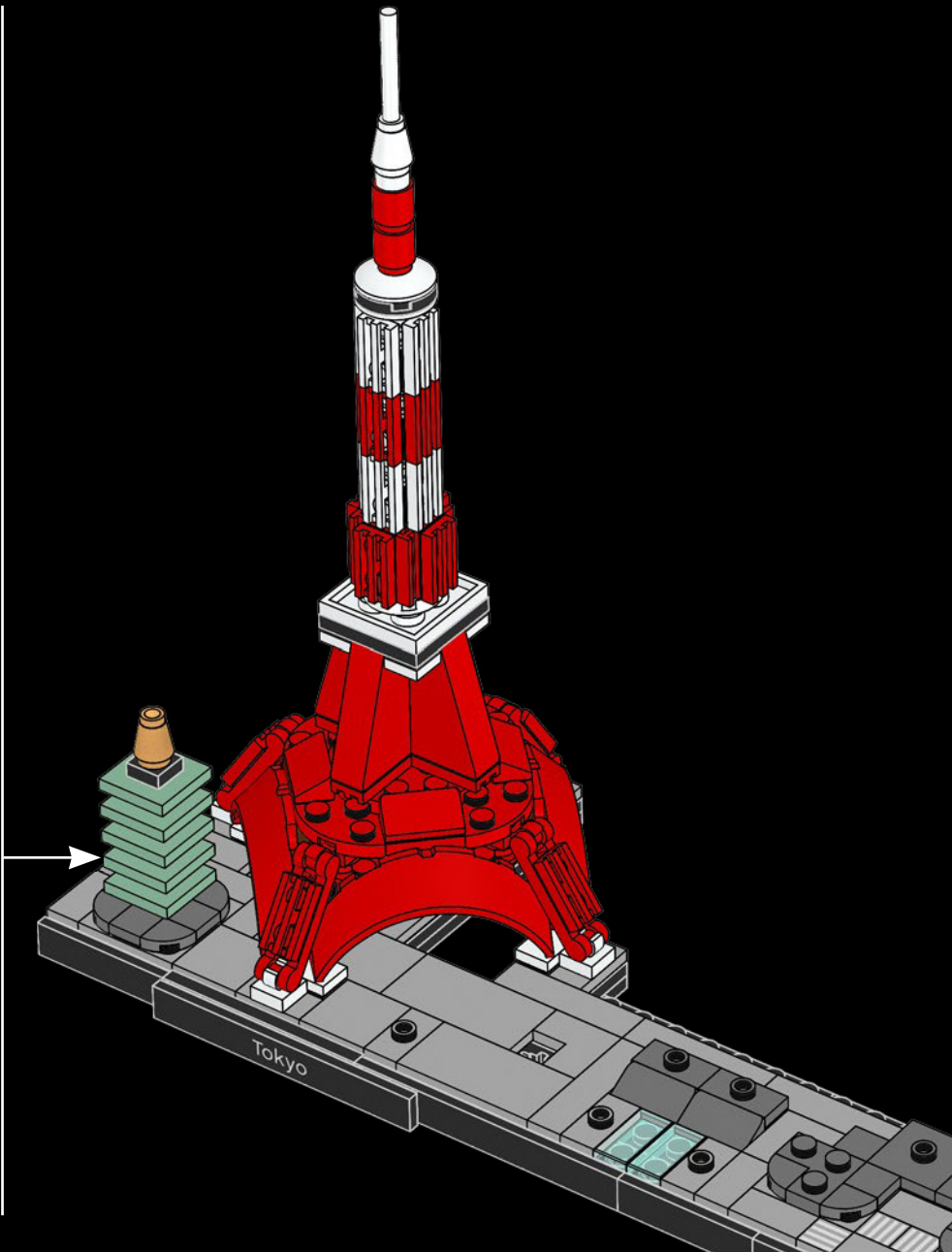
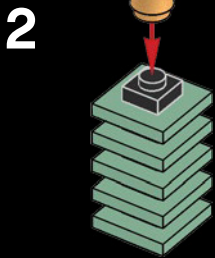
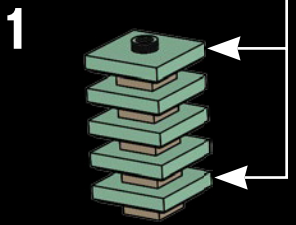
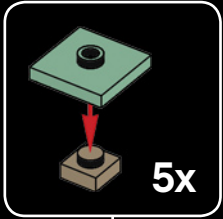

6x

1x

45

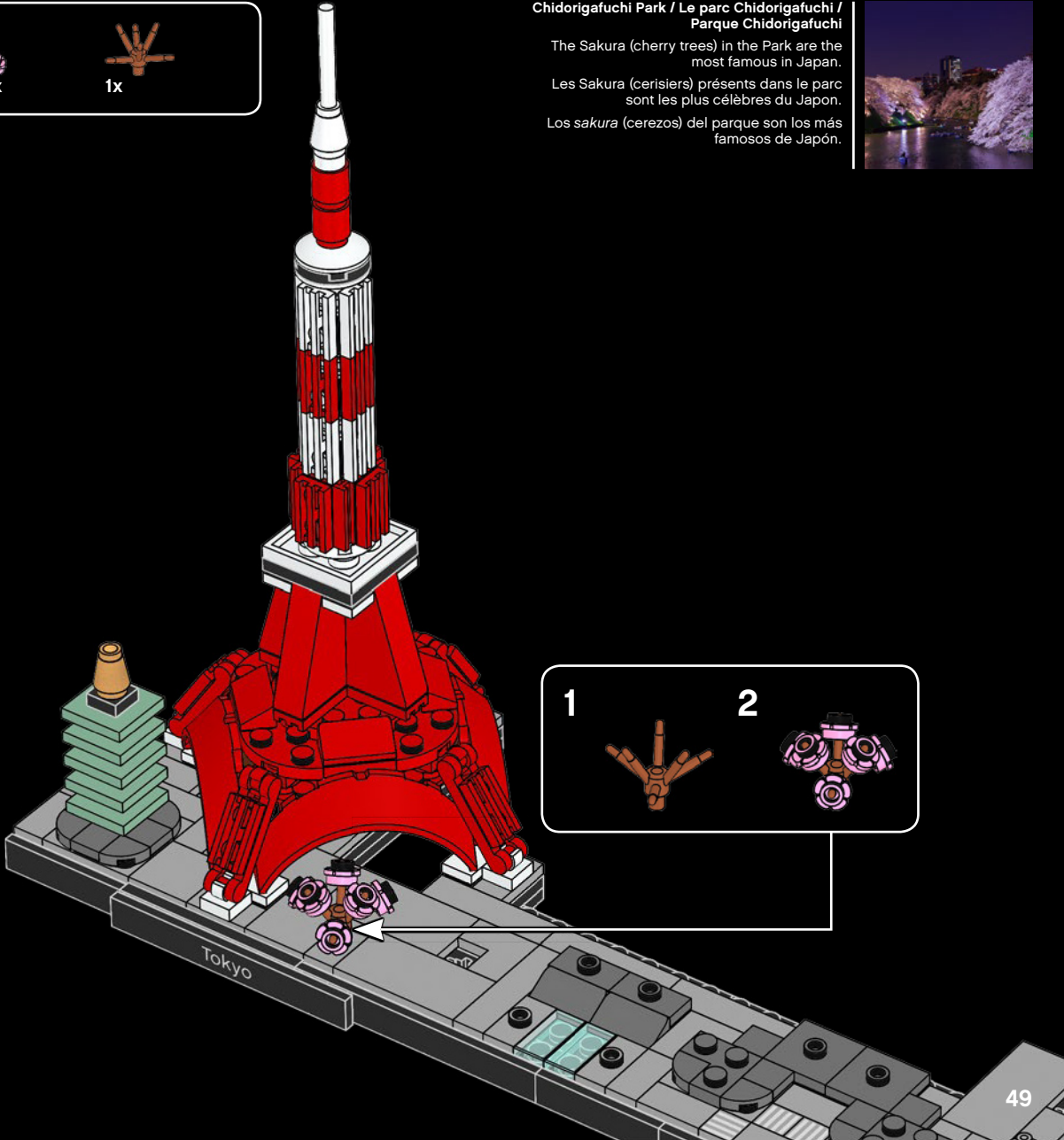

Chidorigafuchi Park / Le parc Chidorigafuchi / Parque Chidorigafuchi

The Sakura (cherry trees) in the Park are the most famous in Japan.

Les Sakura (cerisiers) présents dans le parc sont les plus célèbres du Japon.

Los sakura (cerezos) del parque son los más famosos de Japón.



1

2

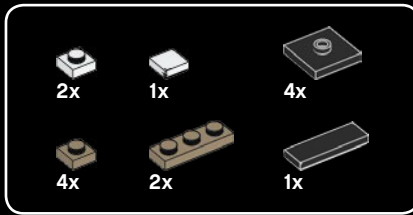
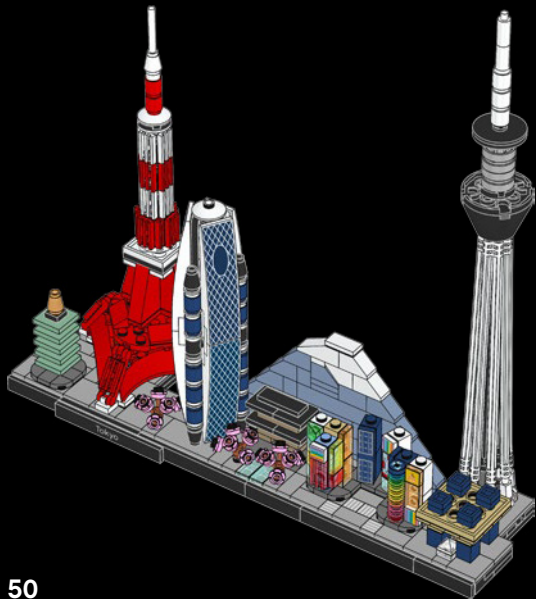
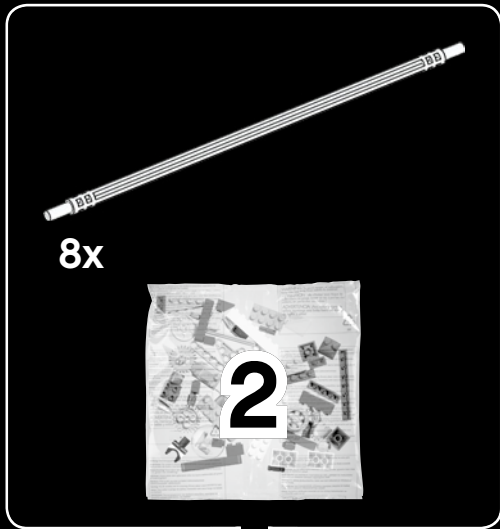

46

1



2

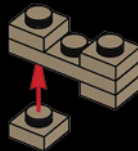

3

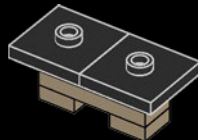

4

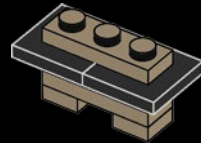

5

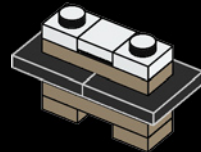

6

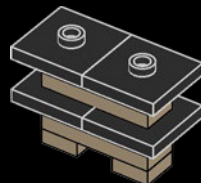

7

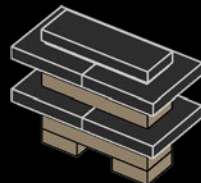

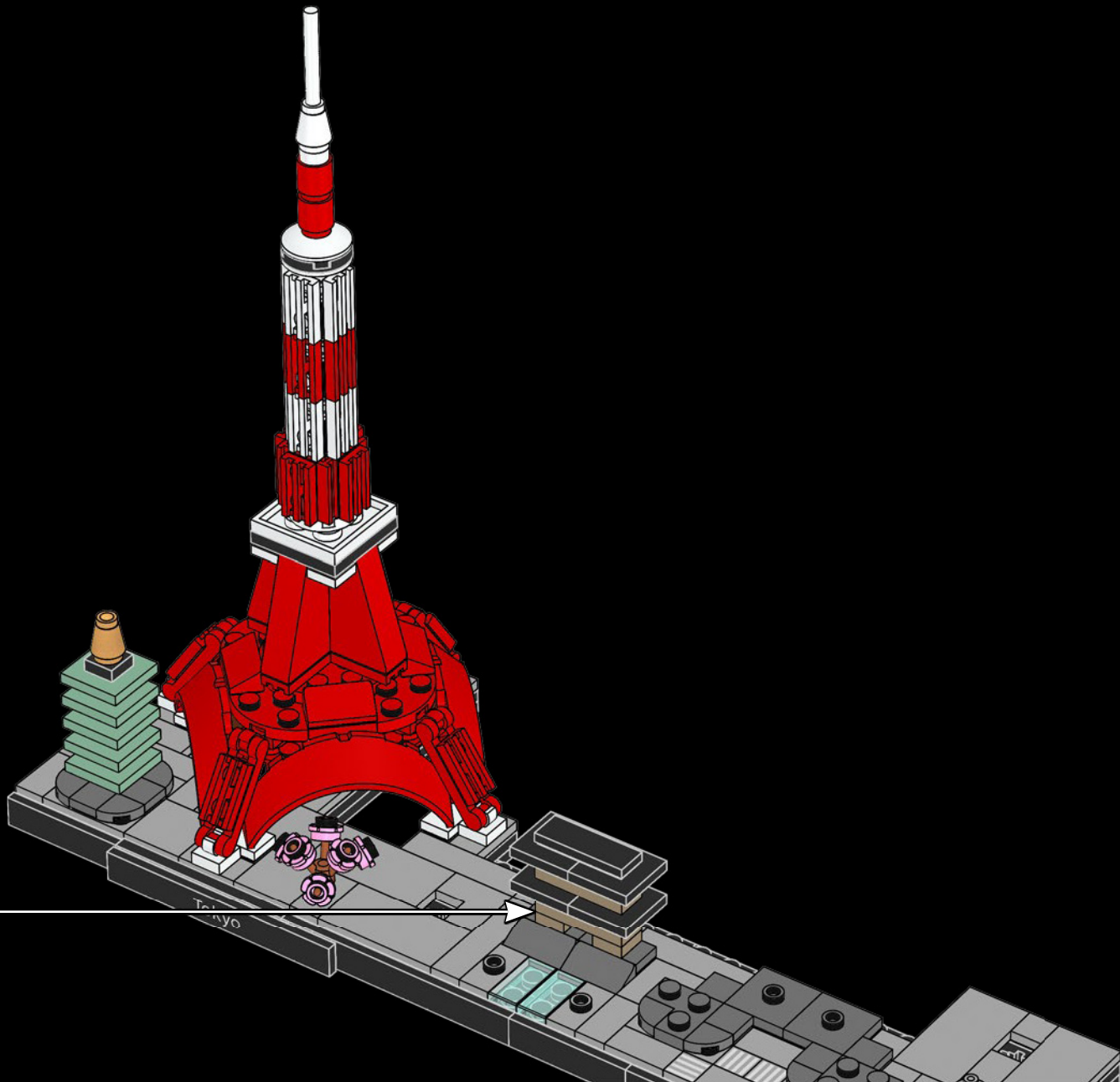



12x



2x

47

Chidorigafuchi Park / Le parc Chidorigafuchi /
Parque Chidorigafuchi

The flowering season occurs between late
March and early May.

La période de floraison a lieu entre la fin du
mois de mars et le début du mois de mai.

La temporada de floración tiene lugar entre
finales de marzo y principios de mayo.

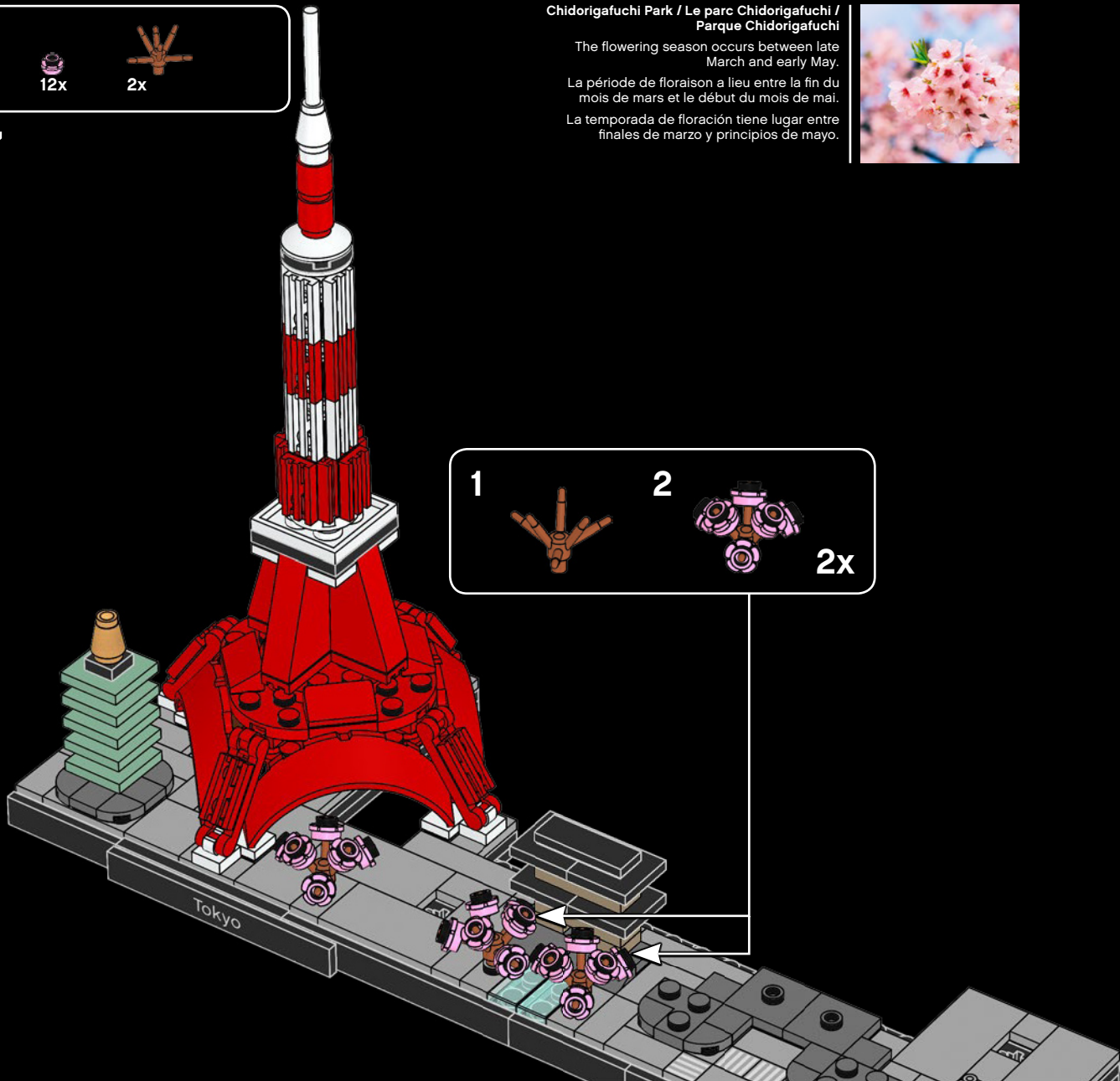

1



2









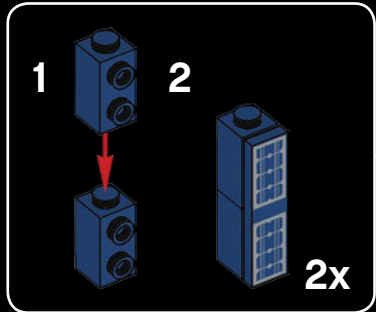
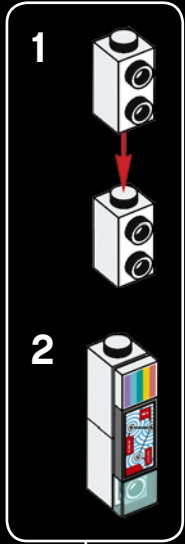
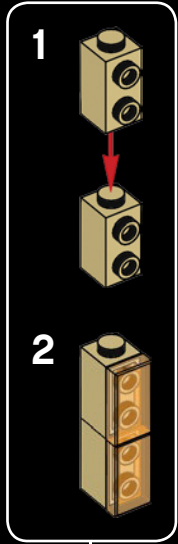
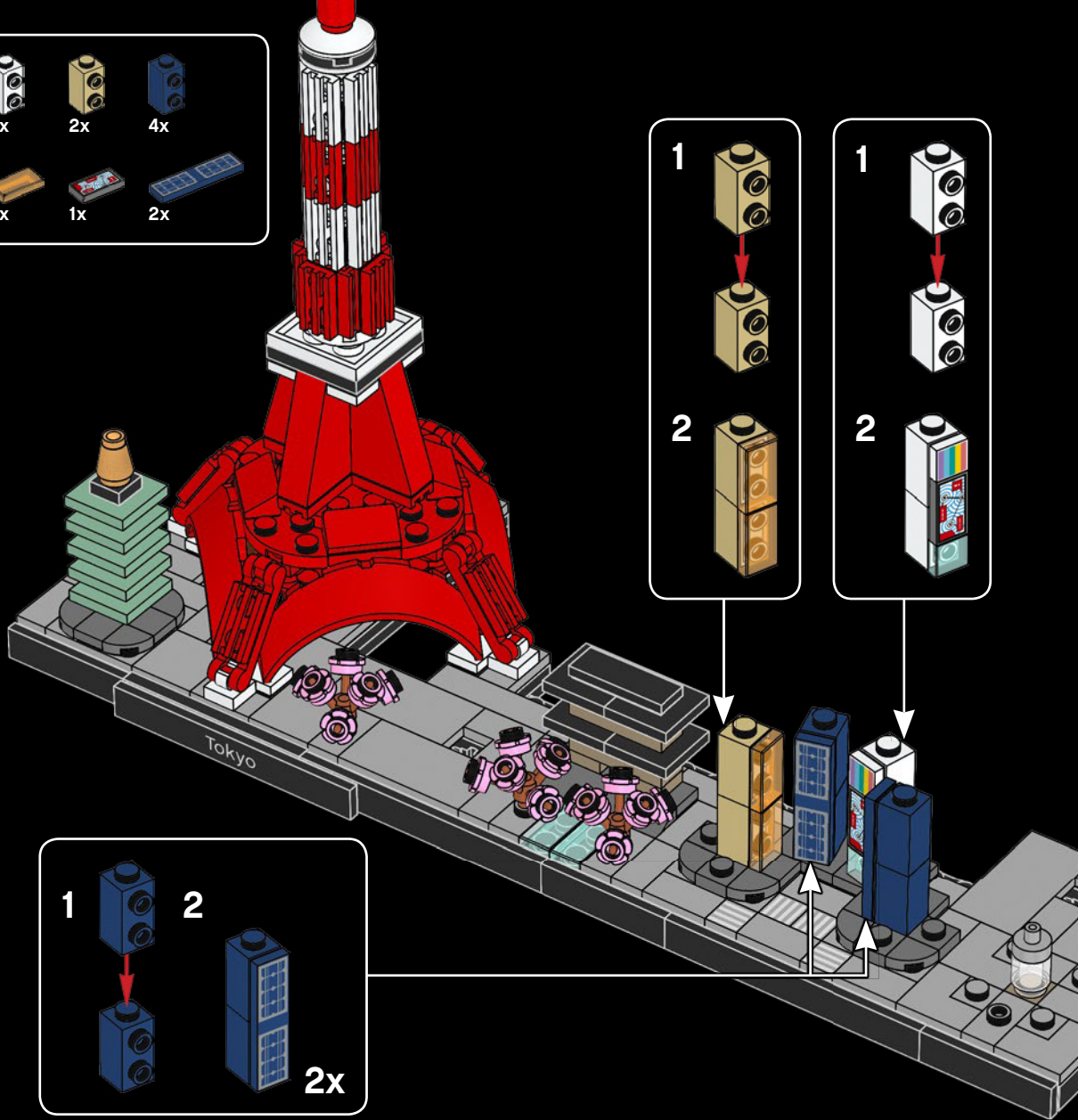

2x

Tokyo

- 1x
- 2x
- 2x
- 4x
- 1x
- 2x
- 1x
- 2x





48



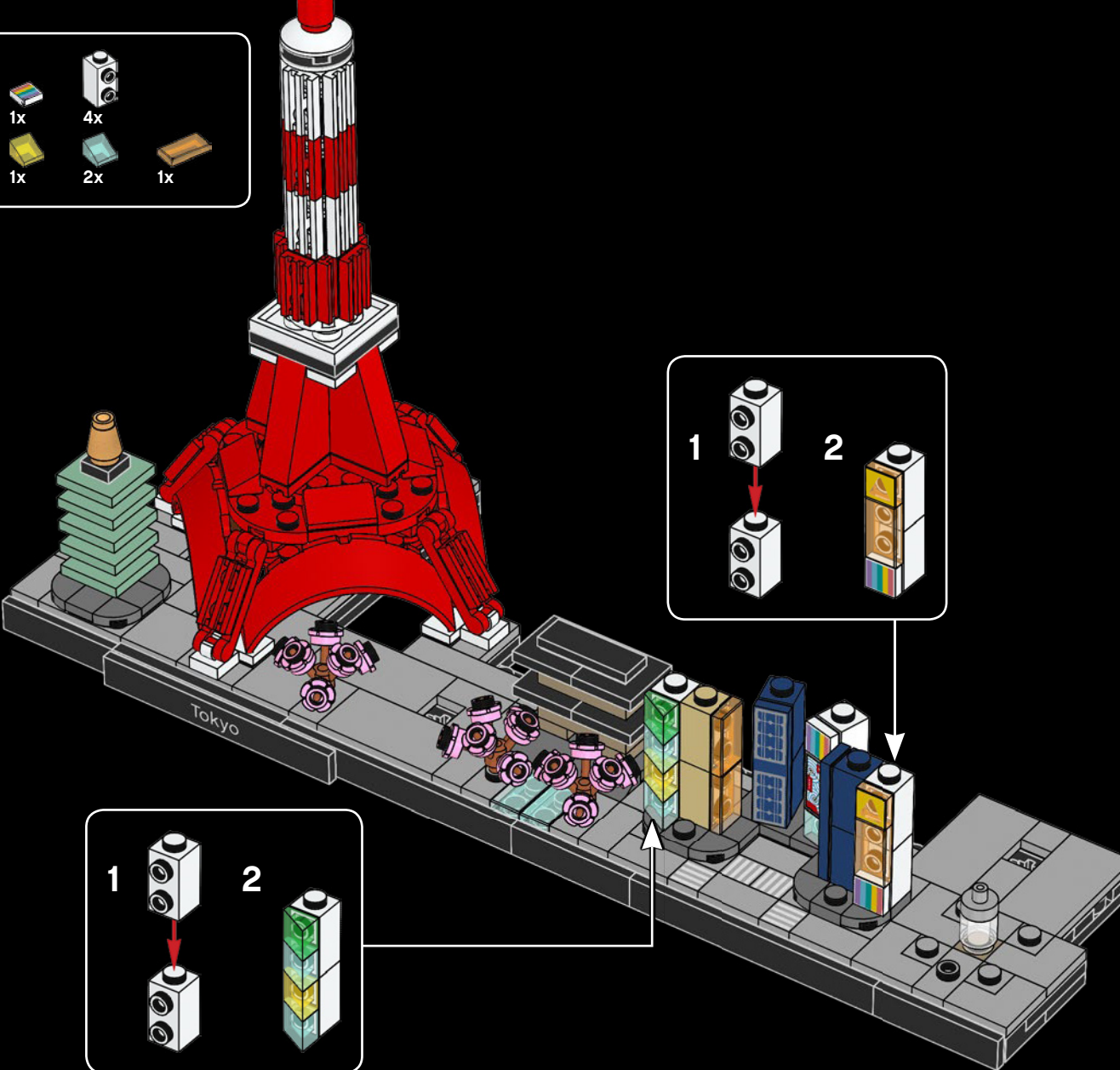



		
1x	1x	4x
		
1x	1x	2x
		
		1x

49



1		2	
			
			

1		2	
			
			

- | | | | | |
|----|----|----|----|----|
| | | | | |
| 2x | 1x | 1x | 1x | 1x |
| | | | | |
| 1x | 1x | 1x | 1x | 1x |
| | | | | |
| 1x | 2x | 1x | 2x | 2x |

Shibuya Crossing / Le carrefour de Shibuya / Cruce de Shibuya

The Crossing is located in front of the busy Shibuya railway station.
 Le carrefour est situé face à la gare très animée de Shibuya.
 El cruce está ubicado frente a la concurrida estación de ferrocarril de Shibuya.

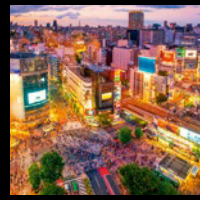

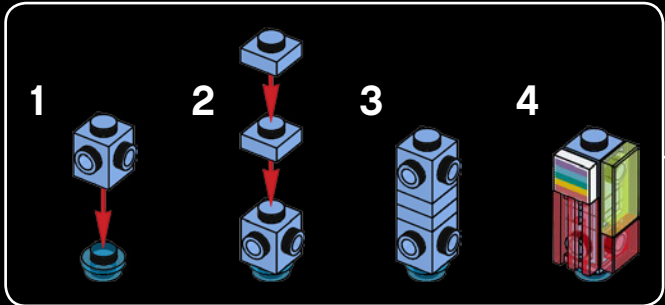
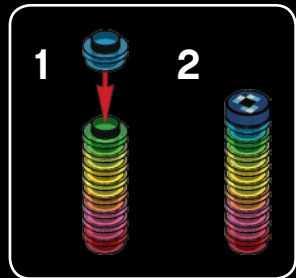
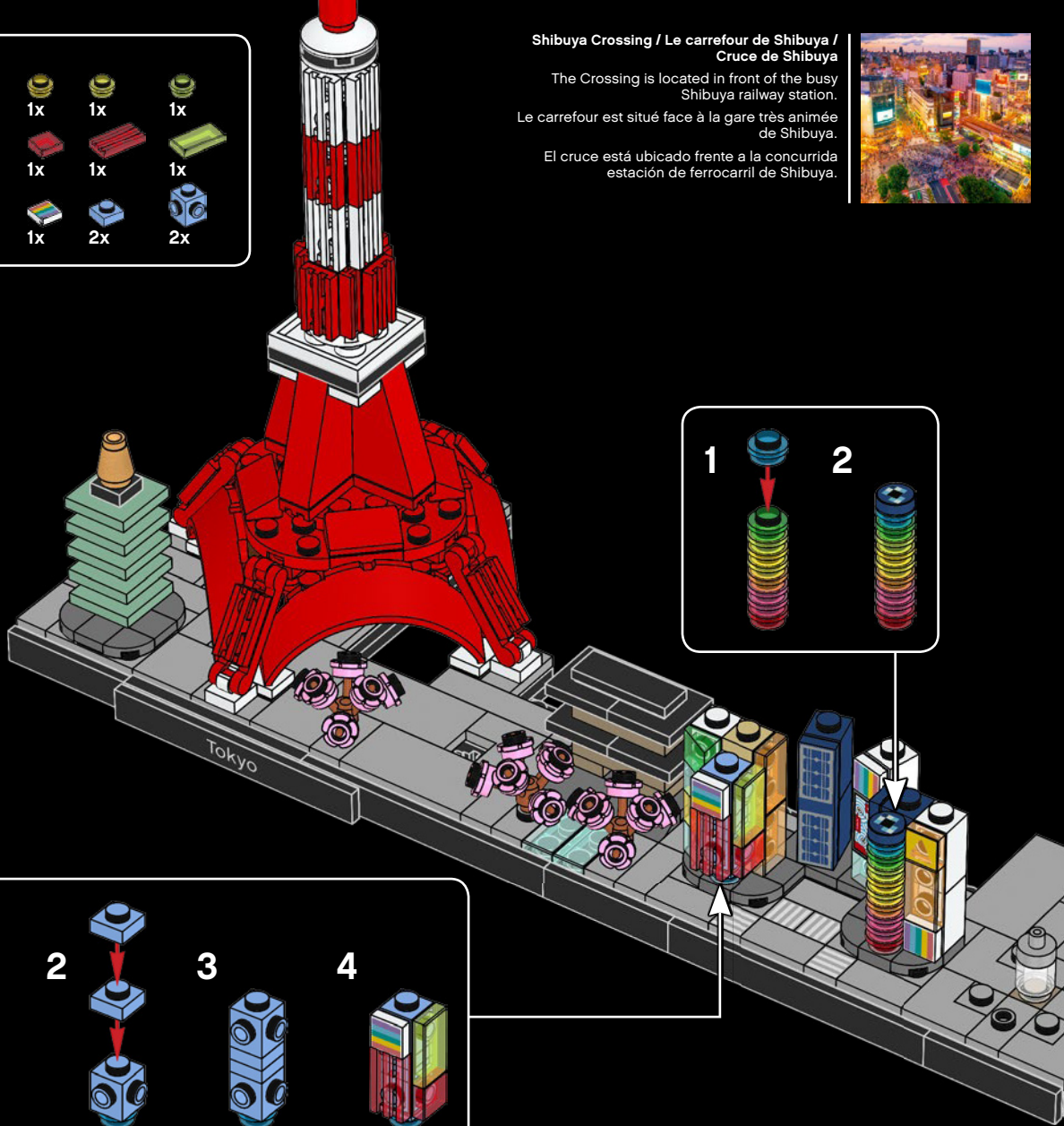

50

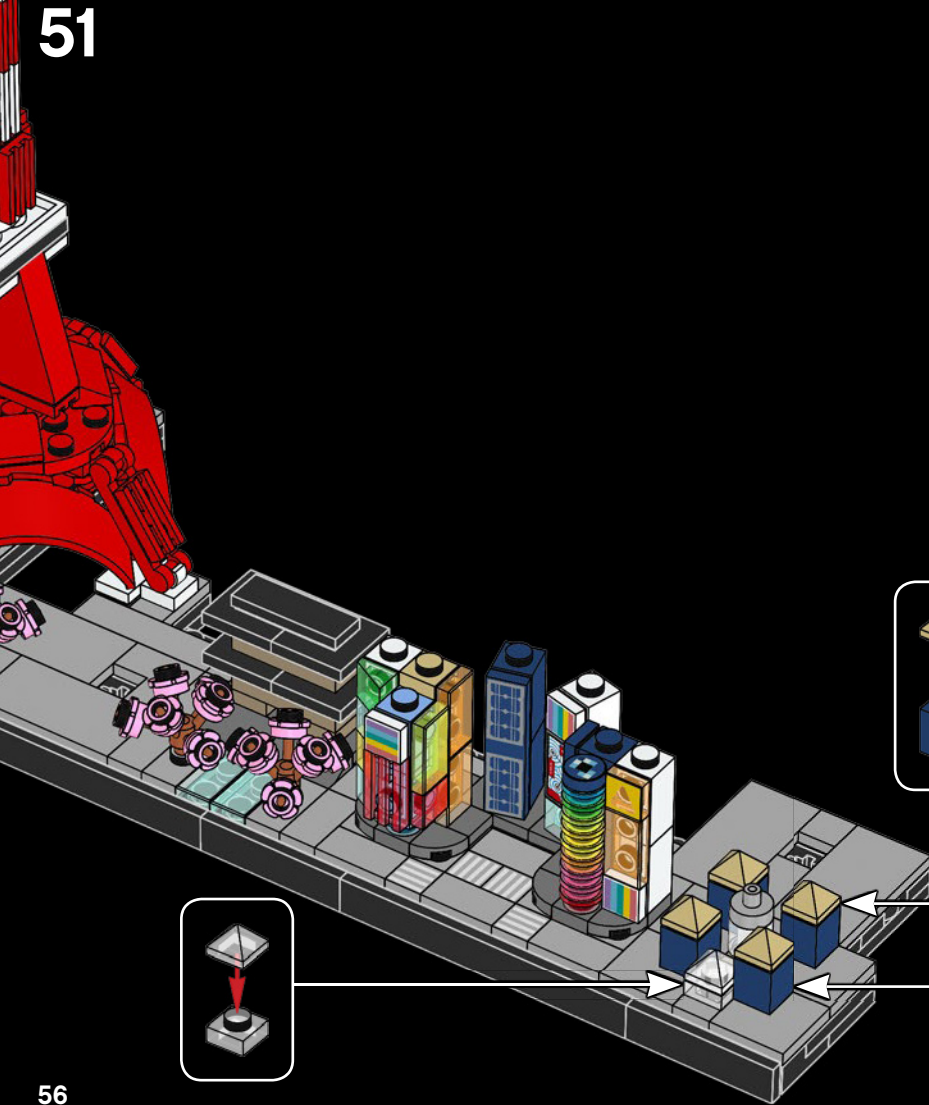

			
4x	4x	1x	1x

51

4x



Tokyo Big Sight

Inside the 8-story tower is a 1100-seat reception hall.

La tour de huit étages abrite une salle de réception de 1 100 places.

Dentro de la torre, de ocho pisos de altura, hay un recibidor con capacidad para 1100 personas.

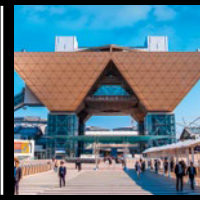

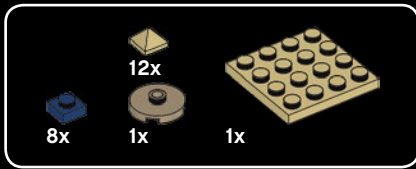

52

1



2

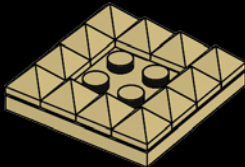

3

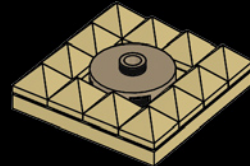

4

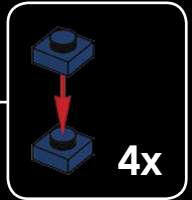
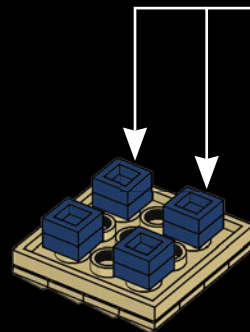

Tokyo Big Sight

Eight oversized art pieces have been placed at the base of the tower.

Huit œuvres d'art surdimensionnées ont été placées au pied de la tour.

En la base de la torre se han instalado ocho obras de arte de gran formato.



Tokyo Big Sight

The tower opened in 1996 and cost 198.5 billion yen to construct.

La tour a ouvert ses portes en 1996 et sa construction a coûté 198,5 milliards de yens.

La torre se inauguró en 1996 y su construcción costó 198,500 millones de yenes.

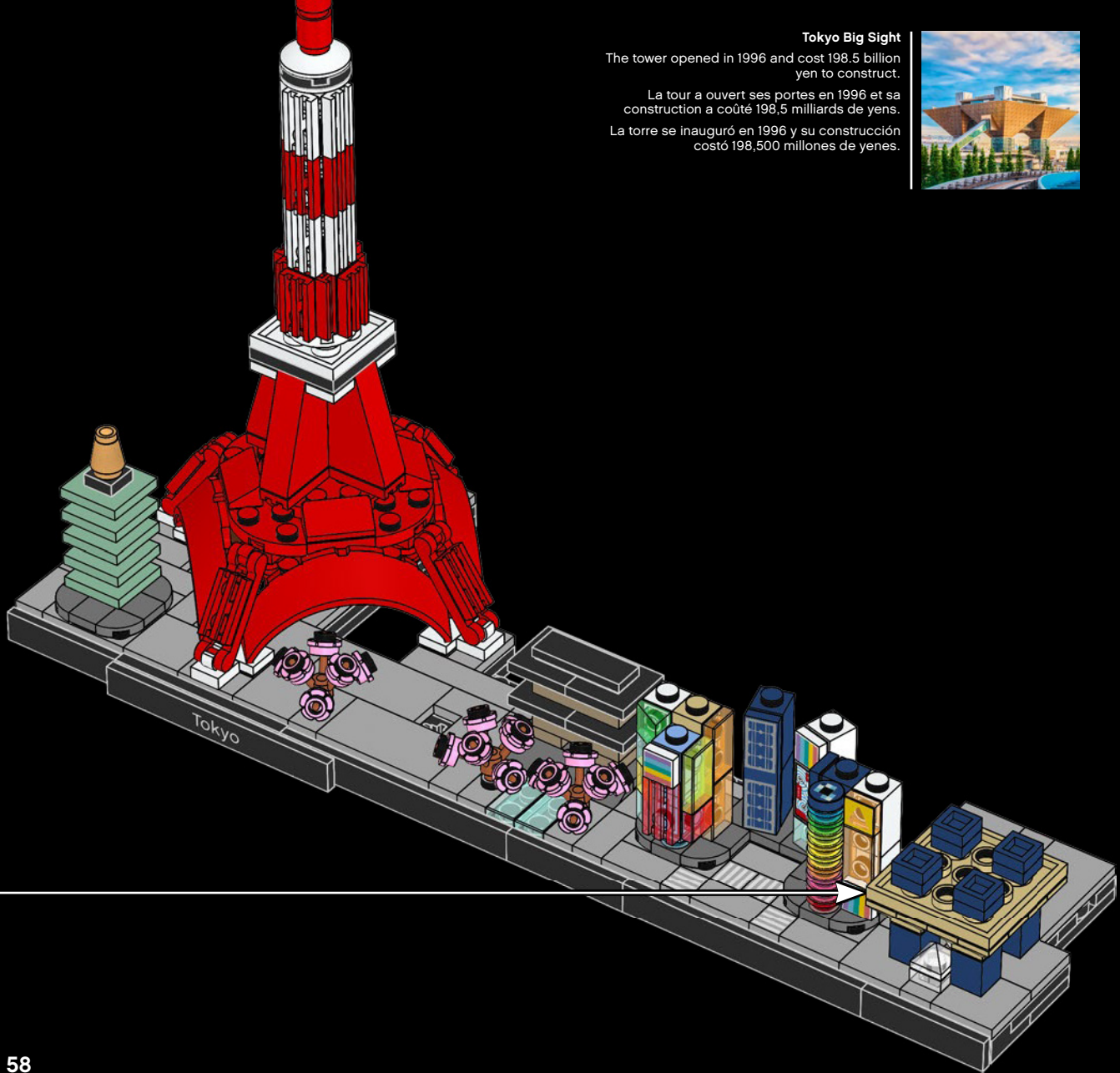

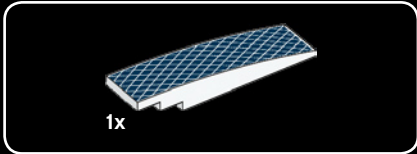

53

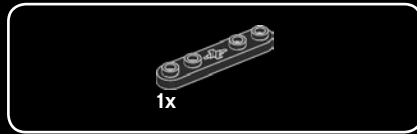
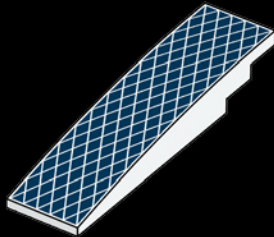

54



55





1x



1x

56

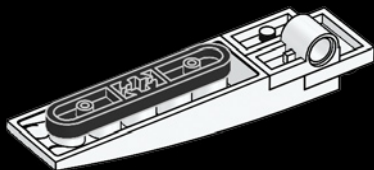

1x

57

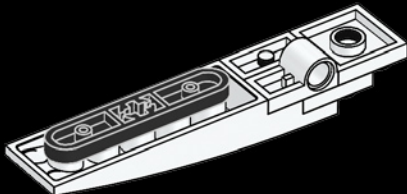

1x



1x

58

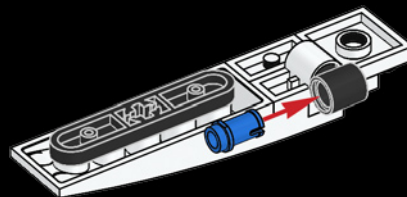

Mode Gakuen Cocoon Tower / La tour Mode Gakuen Cocoon / Torre Mode Gakuen Cocoon

The Tower has 50 floors above ground level and 3 below.

Cette tour compte 50 étages au-dessus du niveau du sol et 3 dessous.

La torre cuenta con 50 pisos sobre el nivel del suelo de la ciudad y 3 subterráneos.



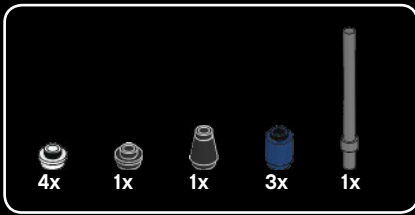

59

1



2



3



4

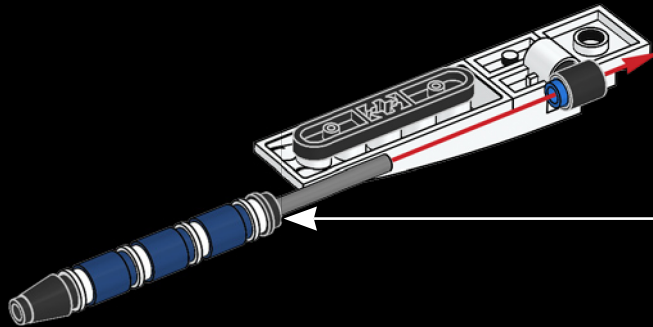

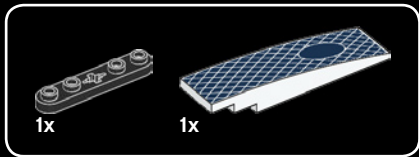

60

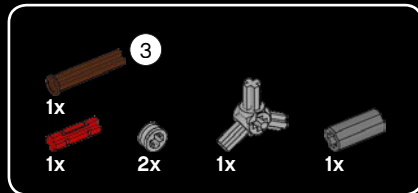
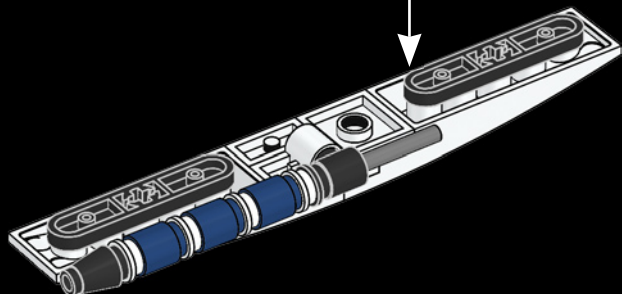
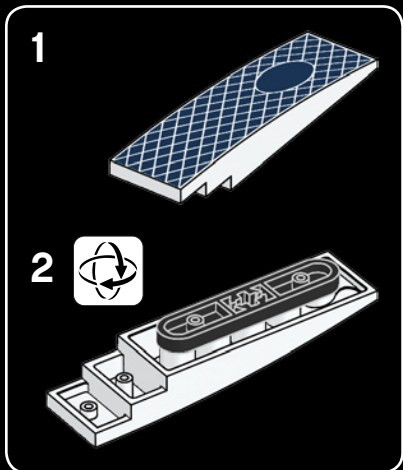

61

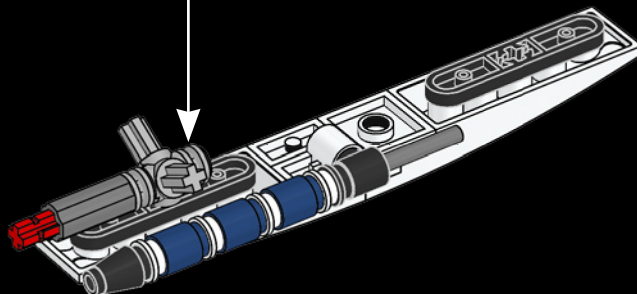
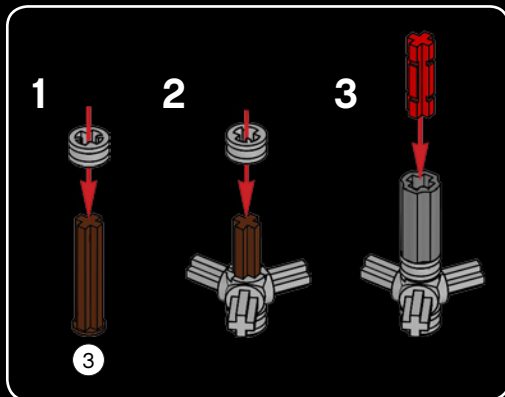

62

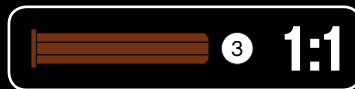



62

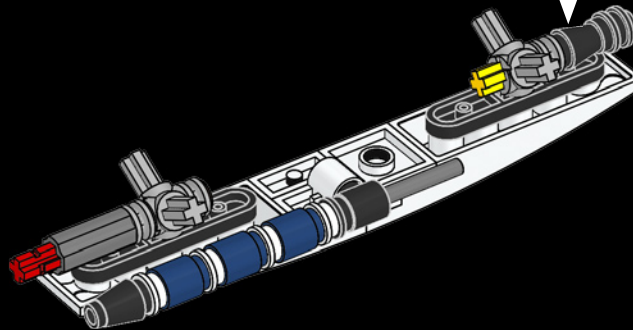
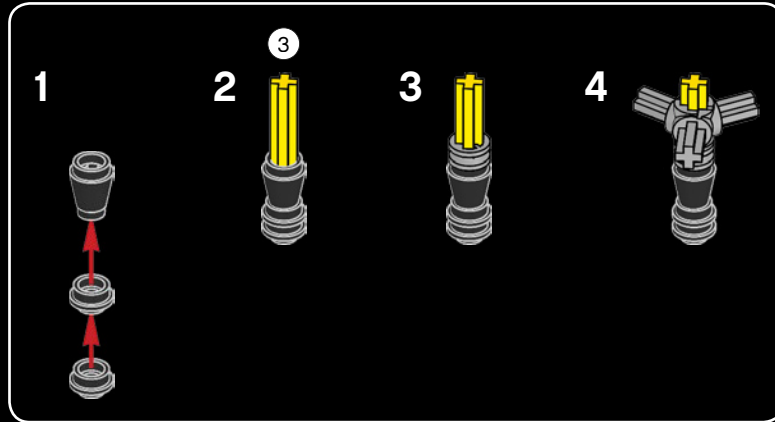

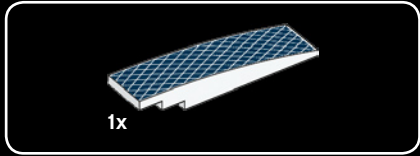
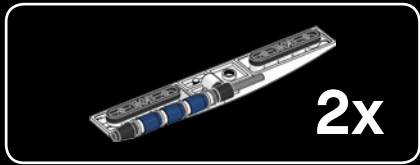

63

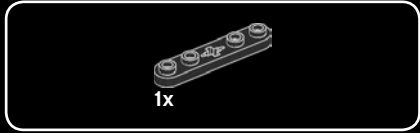
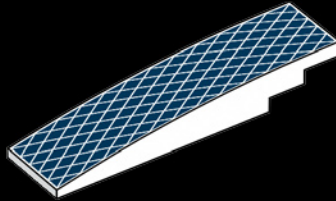

64



Mode Gakuen Cocoon Tower / La tour Mode Gakuen Cocoon
Gakuen Cocoon / Torre Mode Gakuen Cocoon
The Tower is the second-highest educational building
in the world.

Cette tour est le deuxième plus haut bâtiment
d'enseignement au monde.

La torre es el segundo edificio educativo más alto
del mundo.



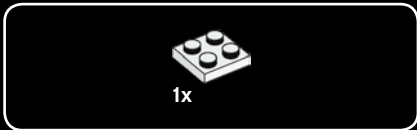

65

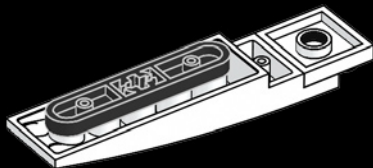

66

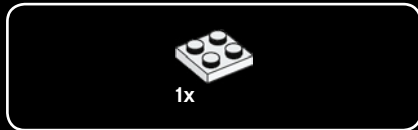
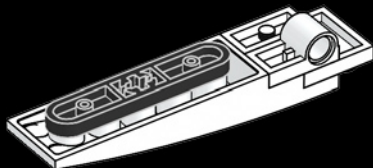

67

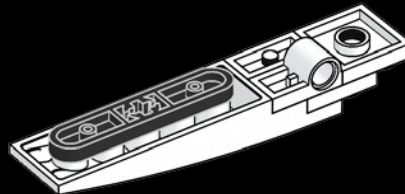

68

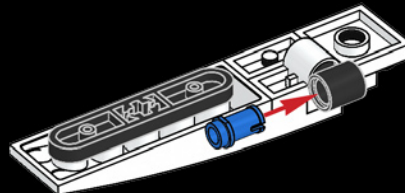

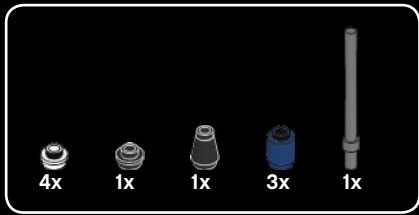

69

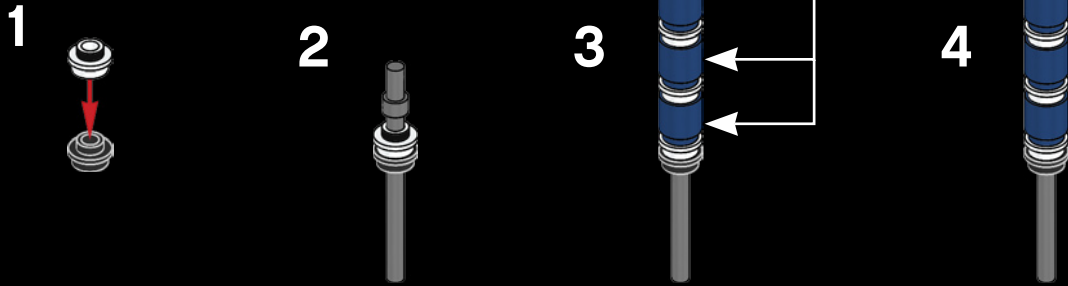

Mode Gakuen Cocoon Tower / La tour Mode Gakuen Cocoon / Torre Mode Gakuen Cocoon

The Tower is home to colleges of design, technology and medicine.

Cette tour abrite des écoles de design, de technologie et de médecine.

La torre es el hogar de las facultades de Diseño, Tecnología y Medicina.

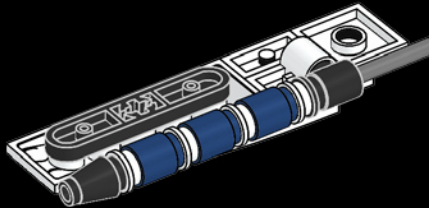

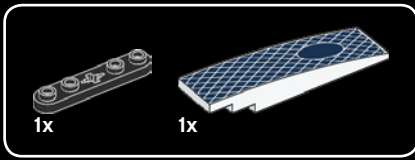

70

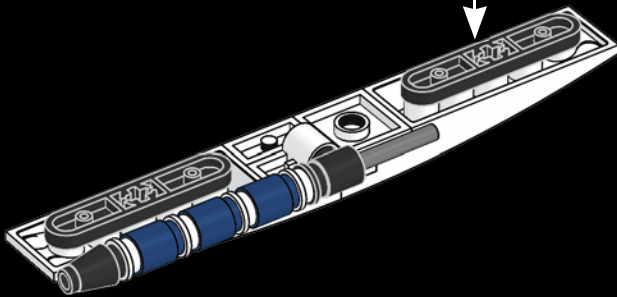
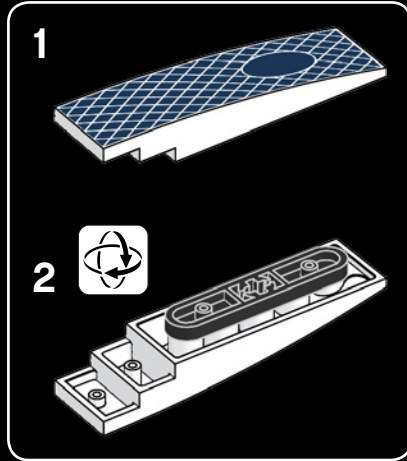

71

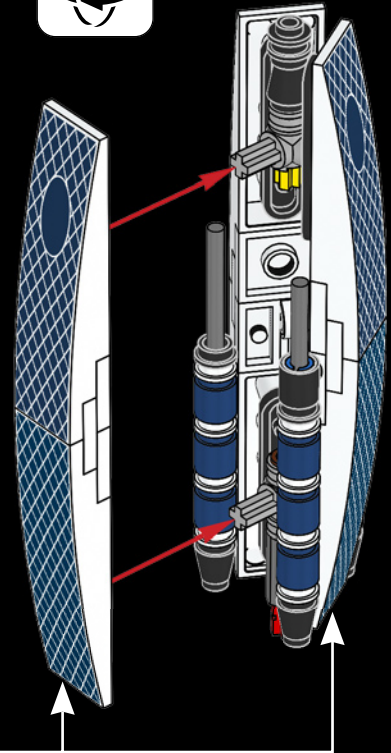



1x

72

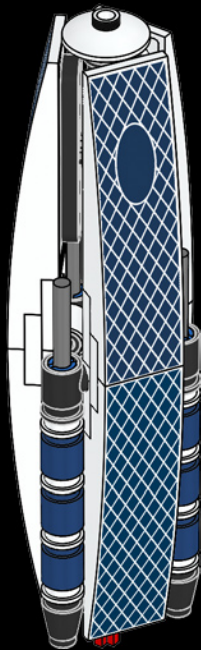

Mode Gakuen Cocoon Tower / La tour Mode Gakuen Cocoon
 Gakuen Cocoon Tower / Torre Mode Gakuen Cocoon

The design was selected from more than
 150 proposals.

Le design a été choisi parmi plus de
 150 propositions.

El diseño fue seleccionado entre más de
 150 propuestas.

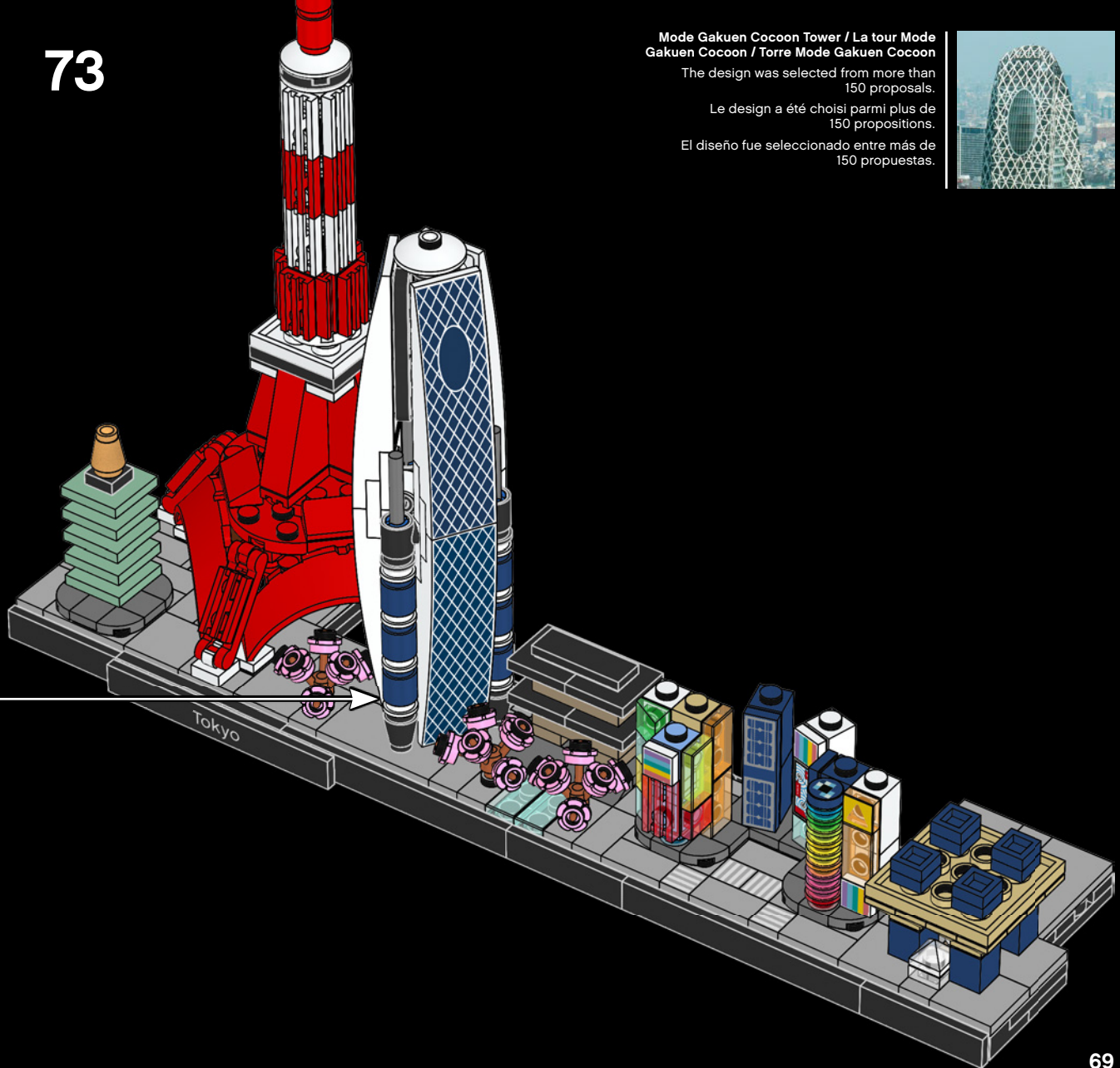

- 9x 
- 6x 
- 3x 

74

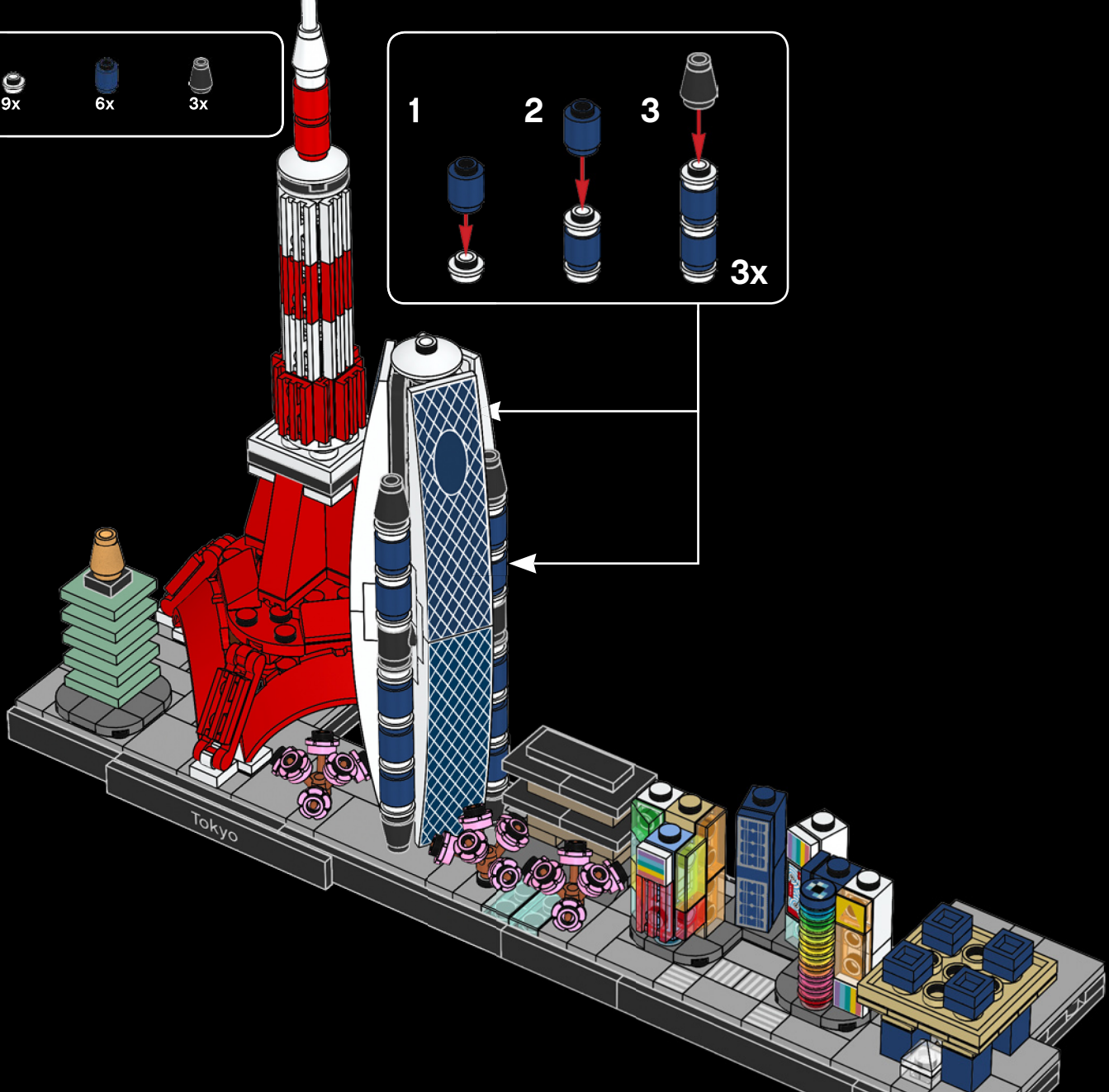
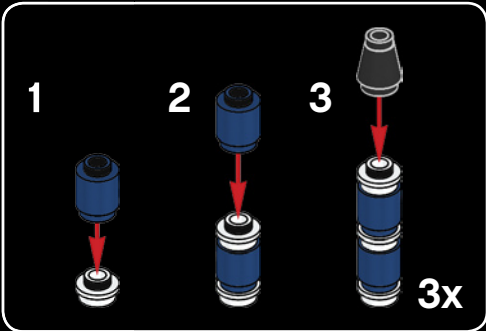

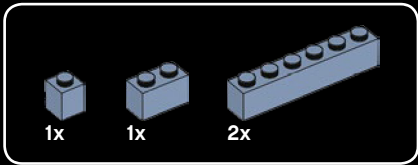

75

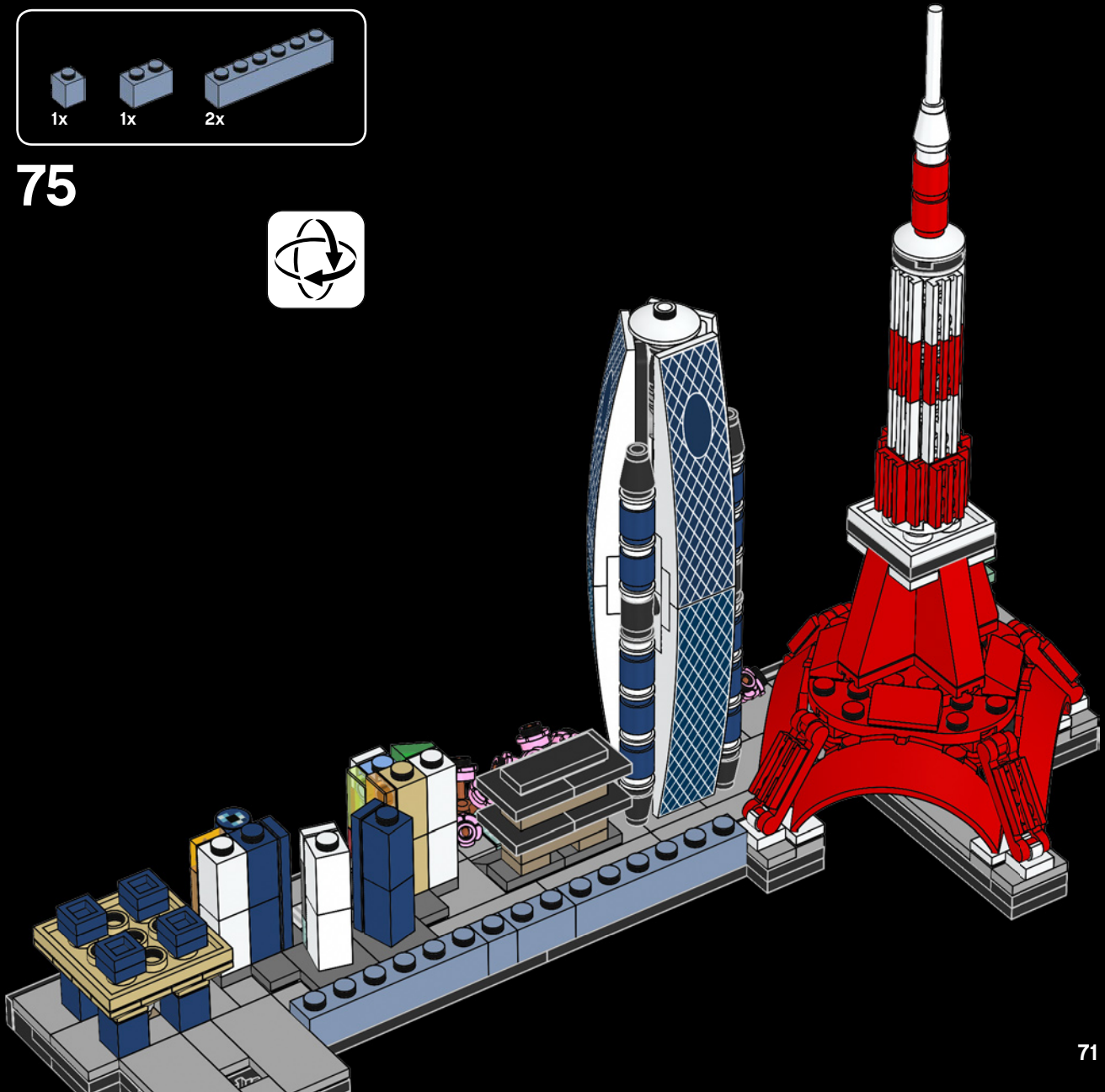

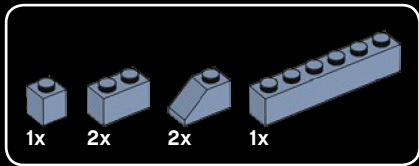

76

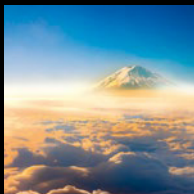

Mount Fuji / Le mont Fuji / Monte Fuji

Mount Fuji is the tallest mountain in Japan and stands 12,380 ft. (3,776m) high.

Le mont Fuji est la plus haute montagne du Japon et il s'élève à 3 776 m.

El Monte Fuji es la montaña más alta de Japón y tiene una altura de 3776 m.

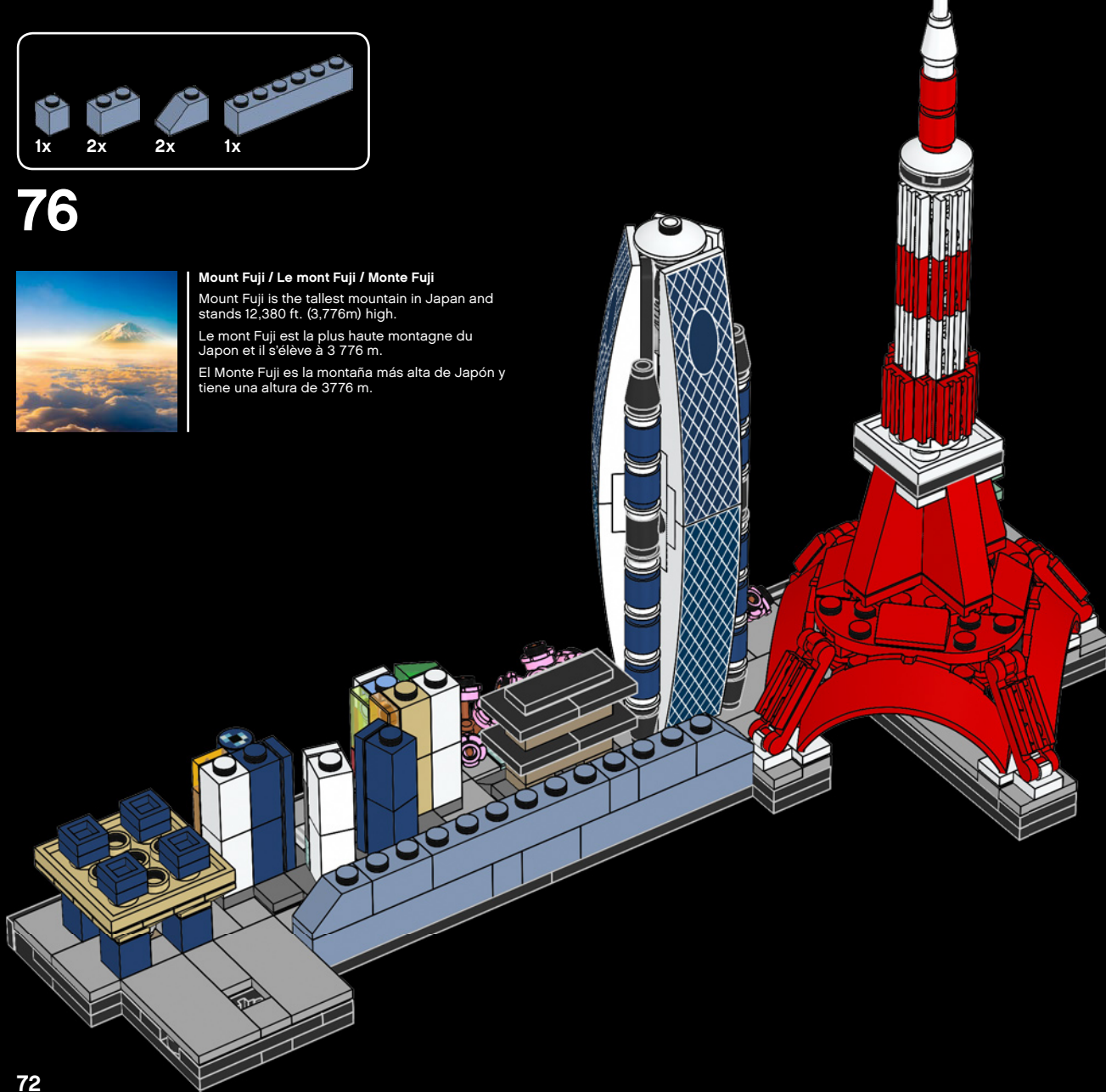

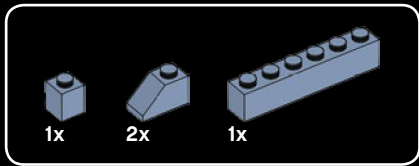

78



Mount Fuji / Le mont Fuji / Monte Fuji

Mount Fuji is located only 60 miles (96 km) from the city of Tokyo.

Le mont Fuji est situé à seulement 96 km de la ville de Tokyo.

El Monte Fuji está a solo 96 km de la ciudad de Tokio.

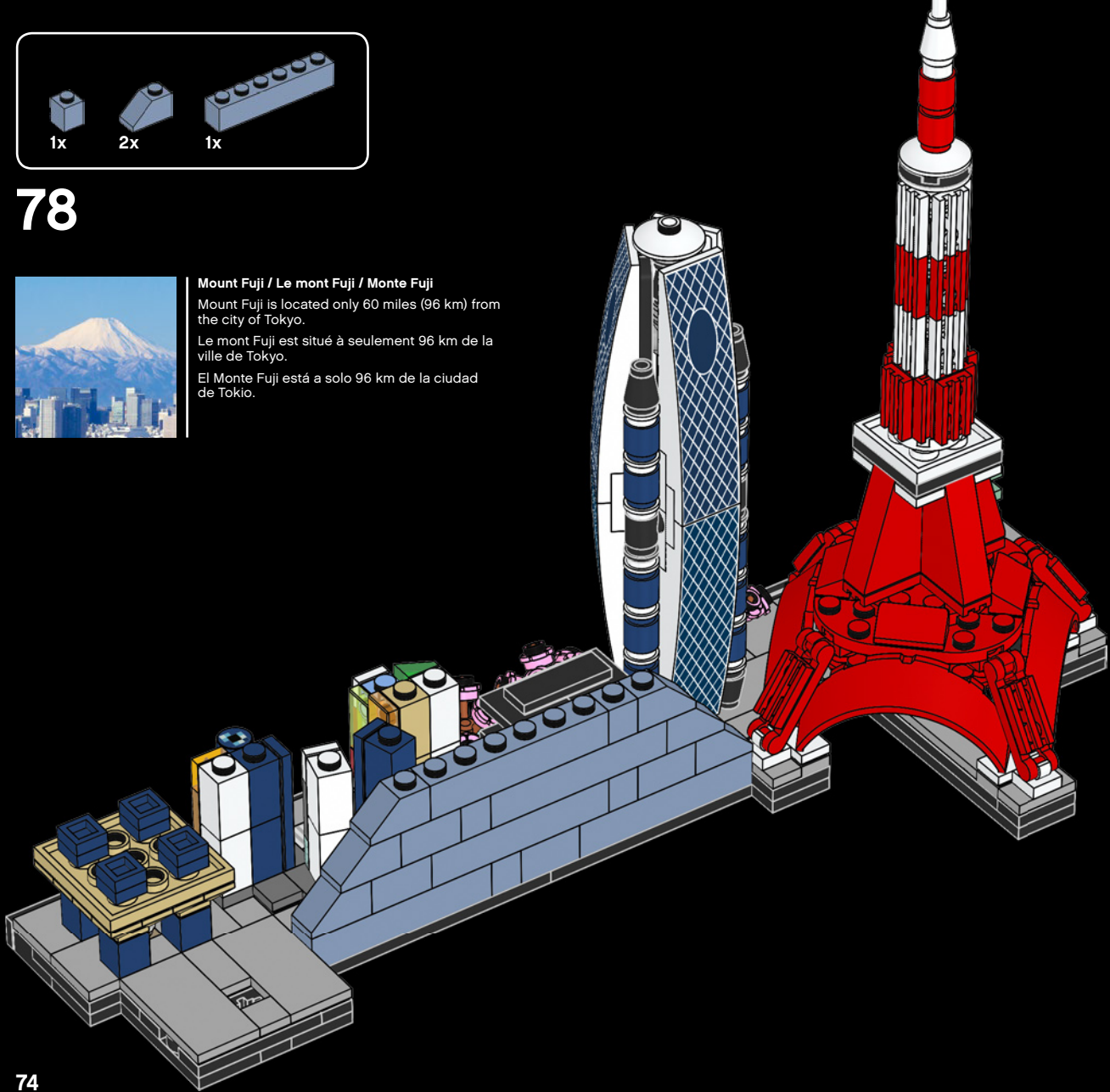

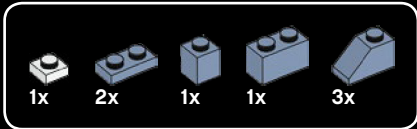

79

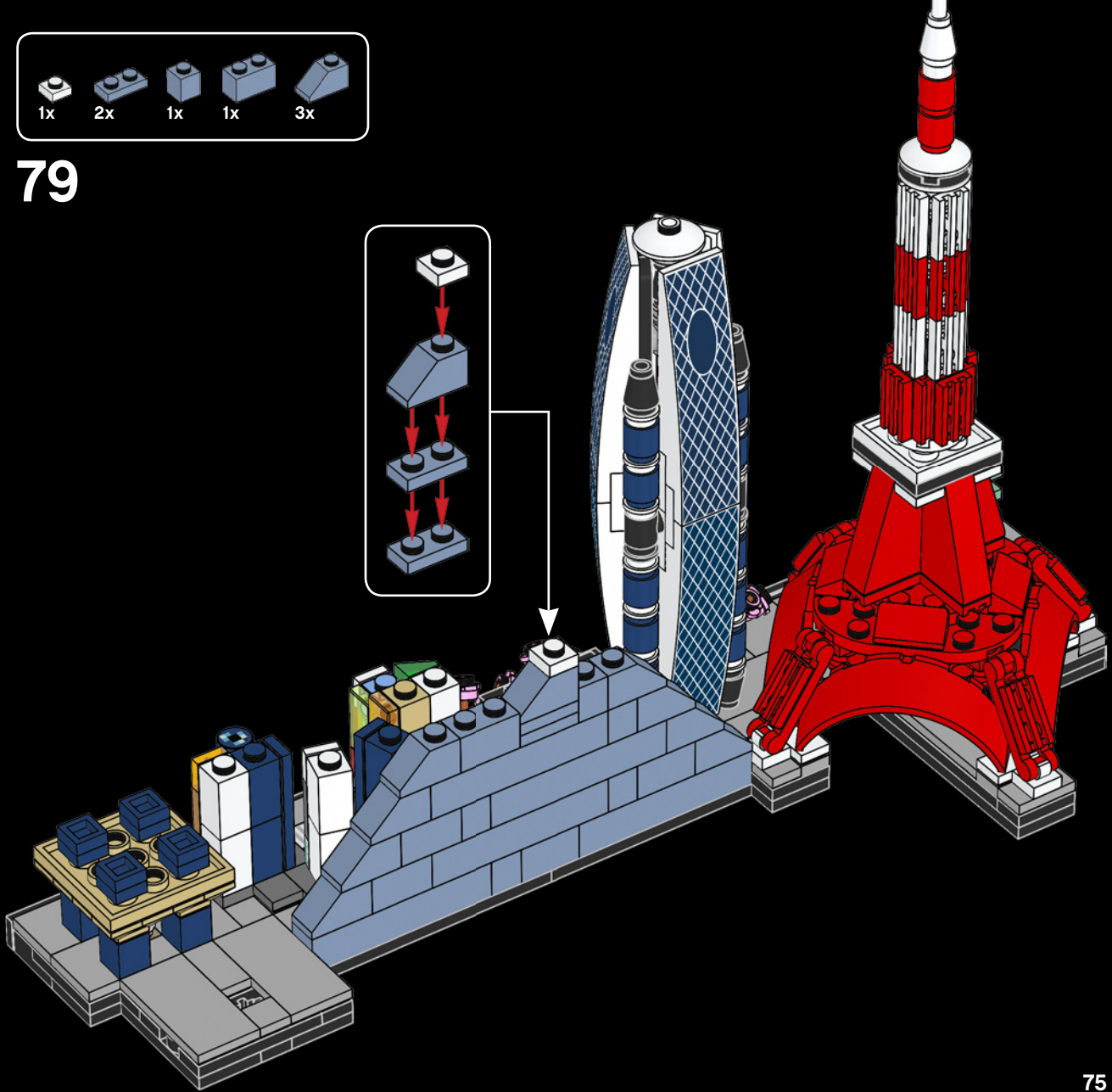
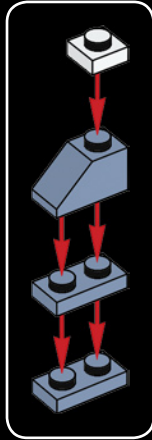



80

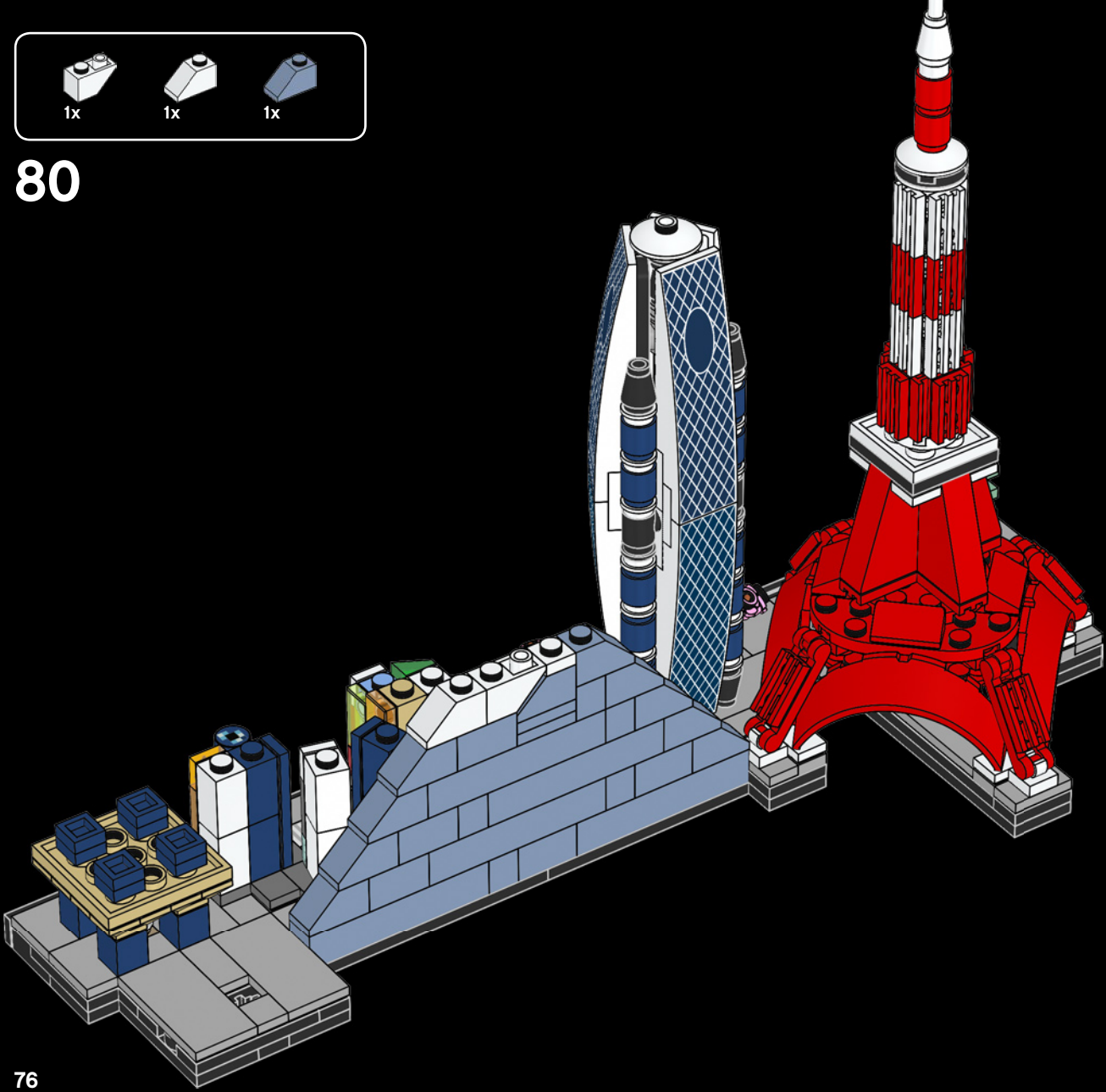



81



Mount Fuji / Le mont Fuji / Monte Fuji

Mount Fuji is an active volcano. The last time it erupted was in 1707.

Le mont Fuji est un volcan actif. Il est entré en éruption pour la dernière fois en 1707.

El Monte Fuji es un volcán activo. La última vez que entró en erupción fue en 1707.

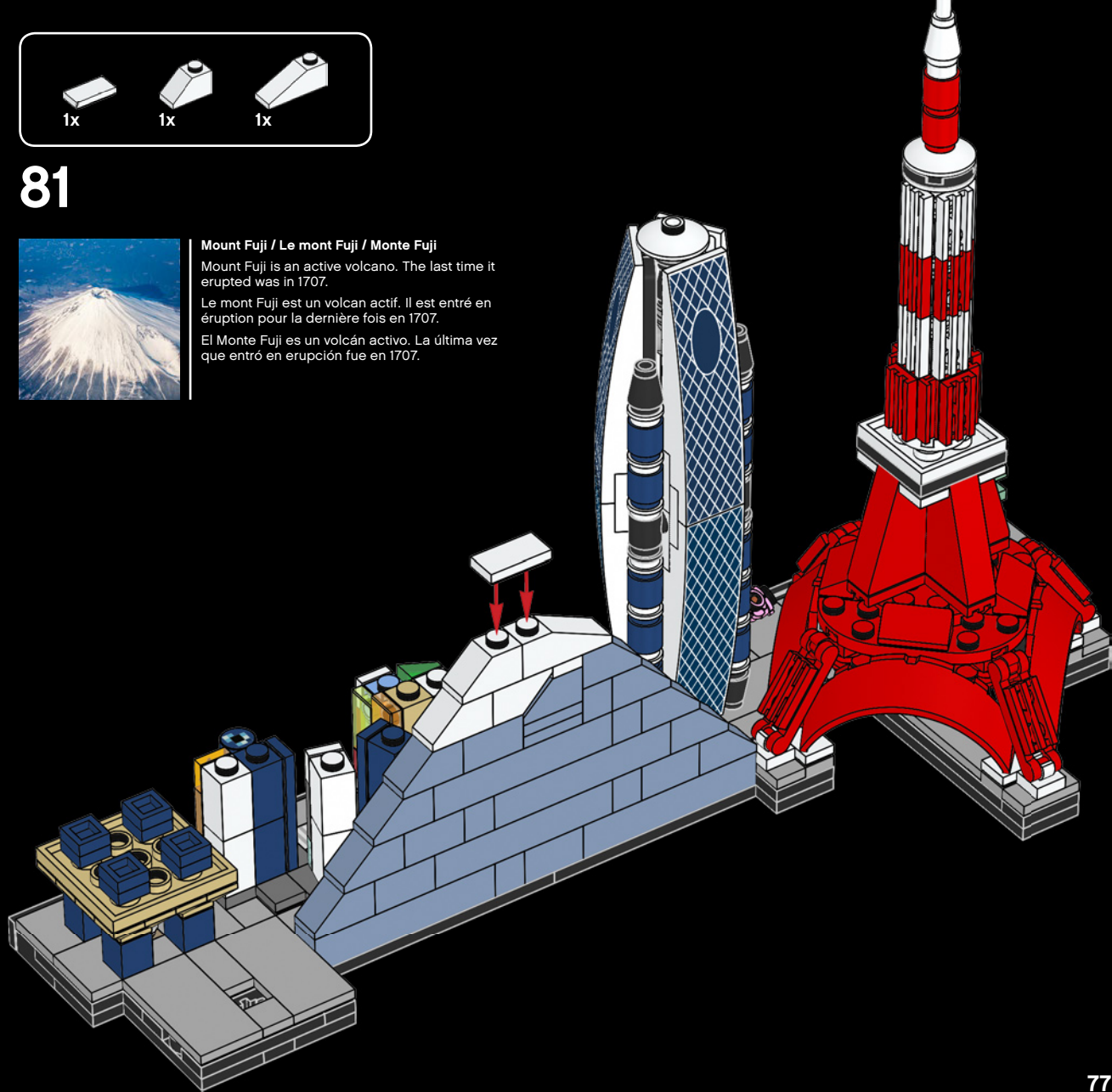

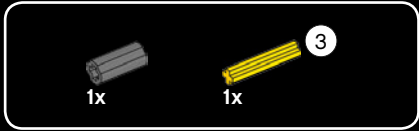
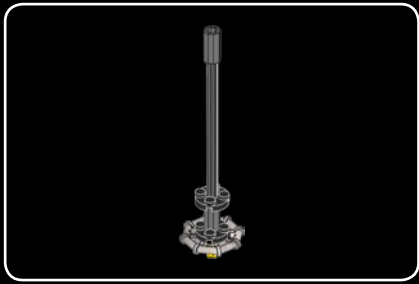

82

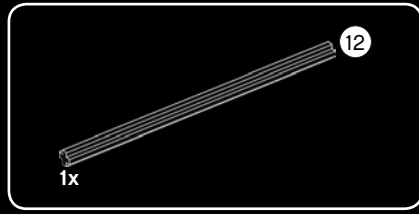

83

12





84

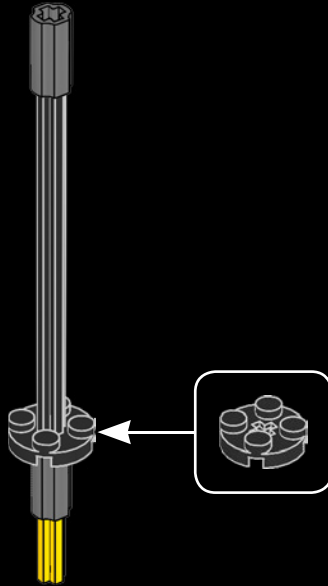

TOKYO SKYTREE

It took 1,325 days to complete the construction of the tower.

Il a fallu 1 325 jours pour achever la construction de la tour.

La construcción de la torre duró 1325 días.



85

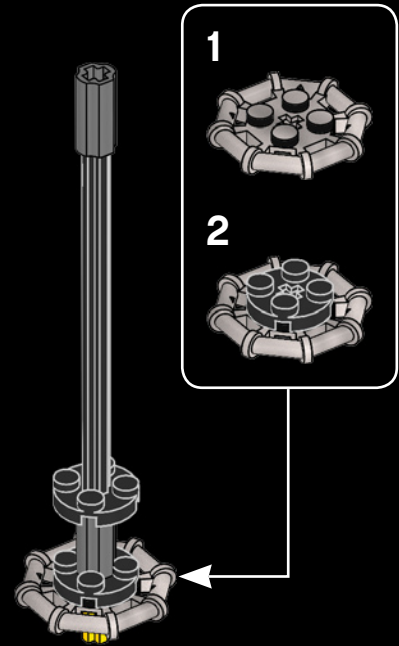



TOKYO SKYTREE

The exterior bluish-white color is based on a traditional Japanese color.

La couleur extérieure bleu-blanc est basée sur une couleur japonaise traditionnelle.

El color blanco azulado del exterior se basa en un color tradicional japonés.

86

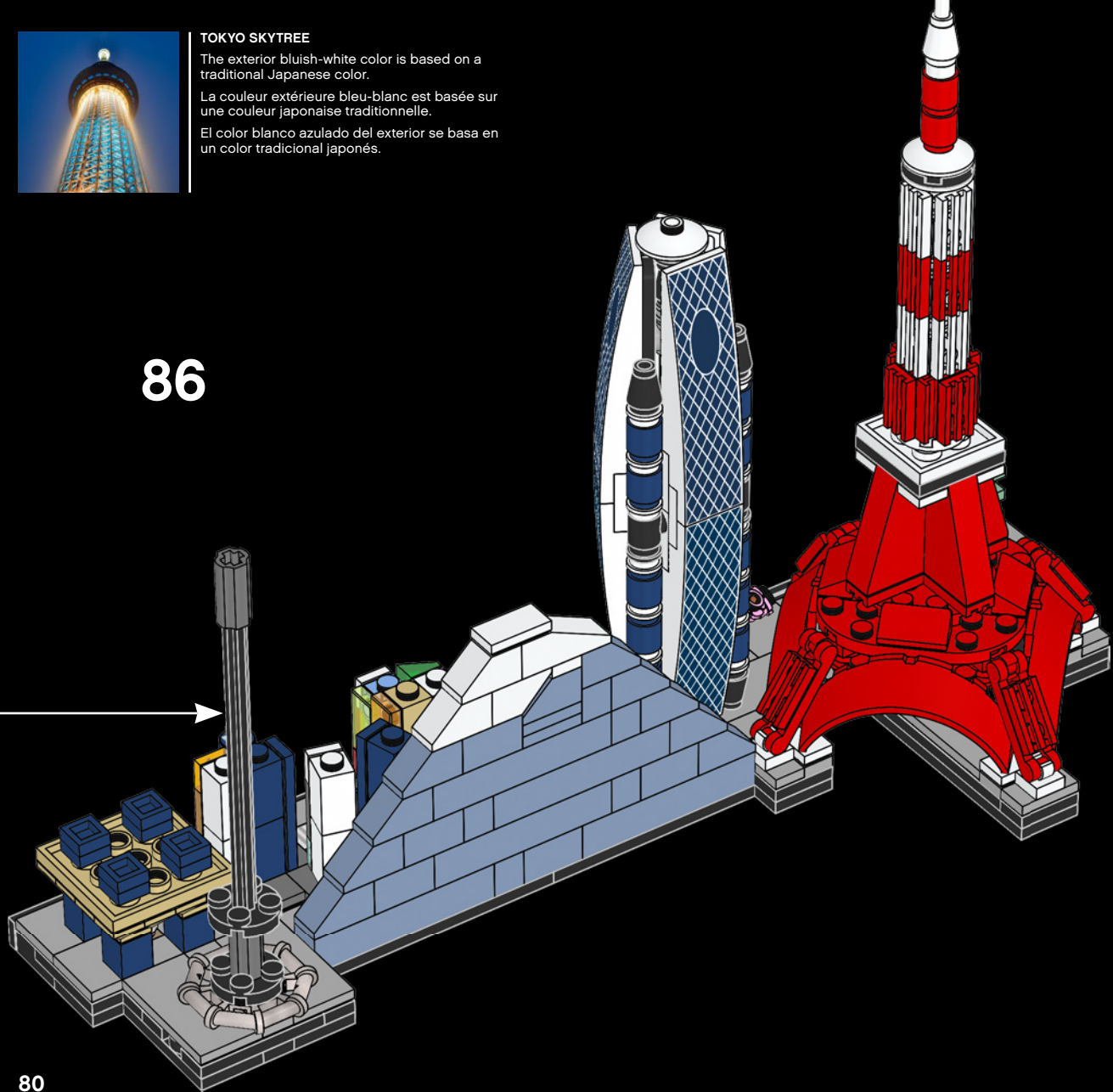

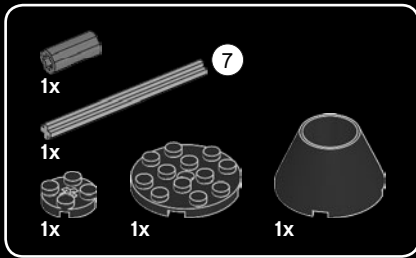

87

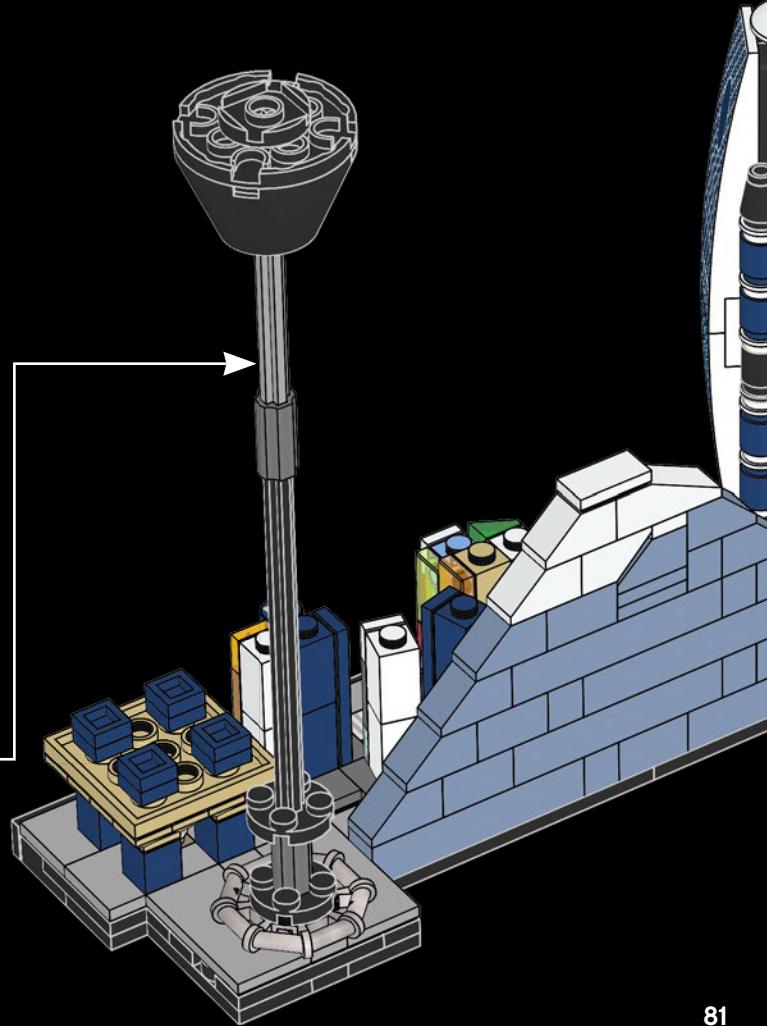
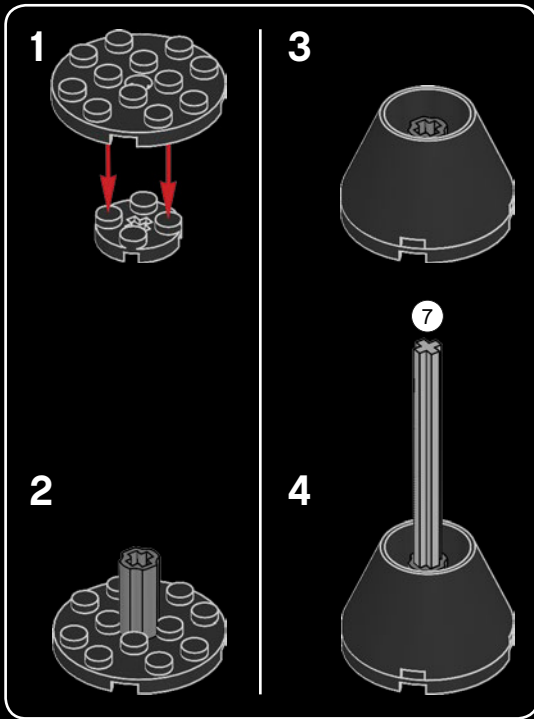

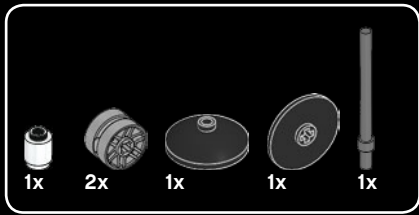

88

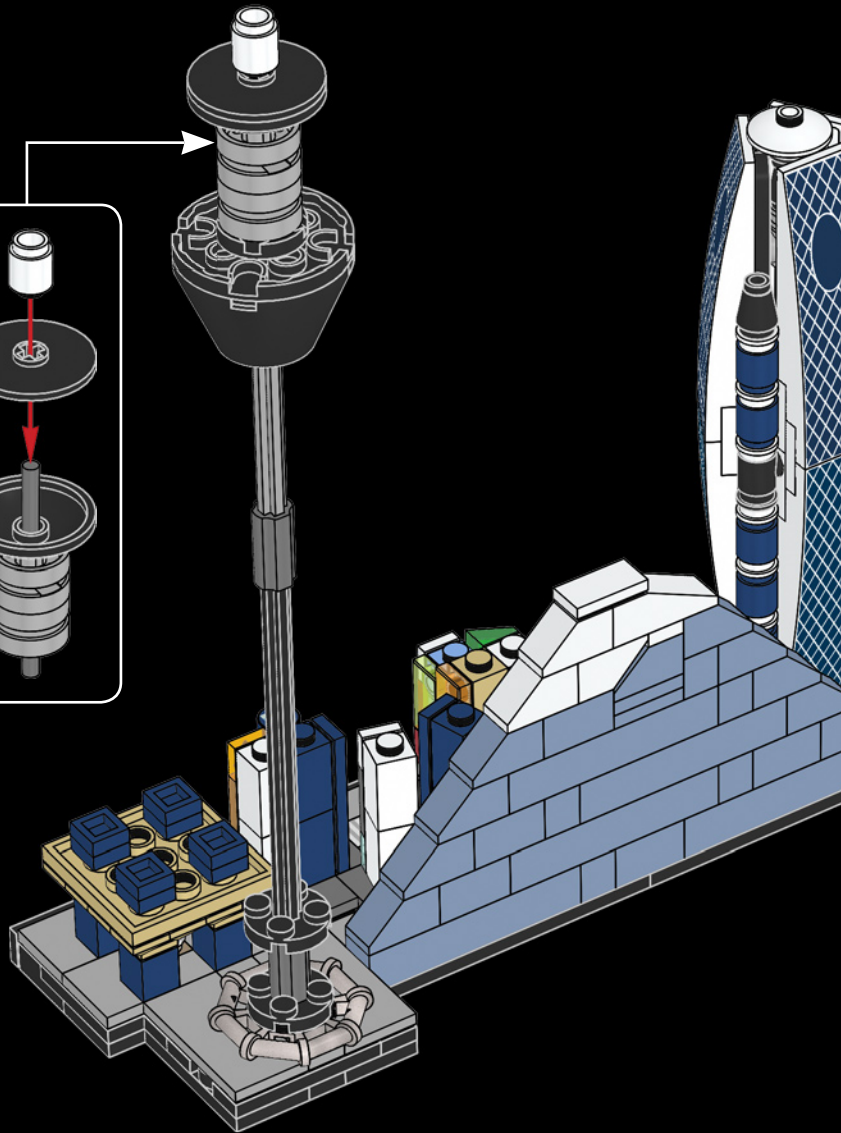
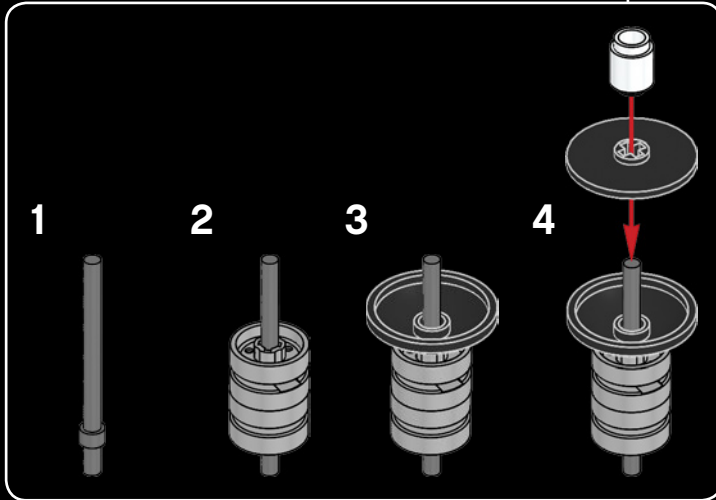



89

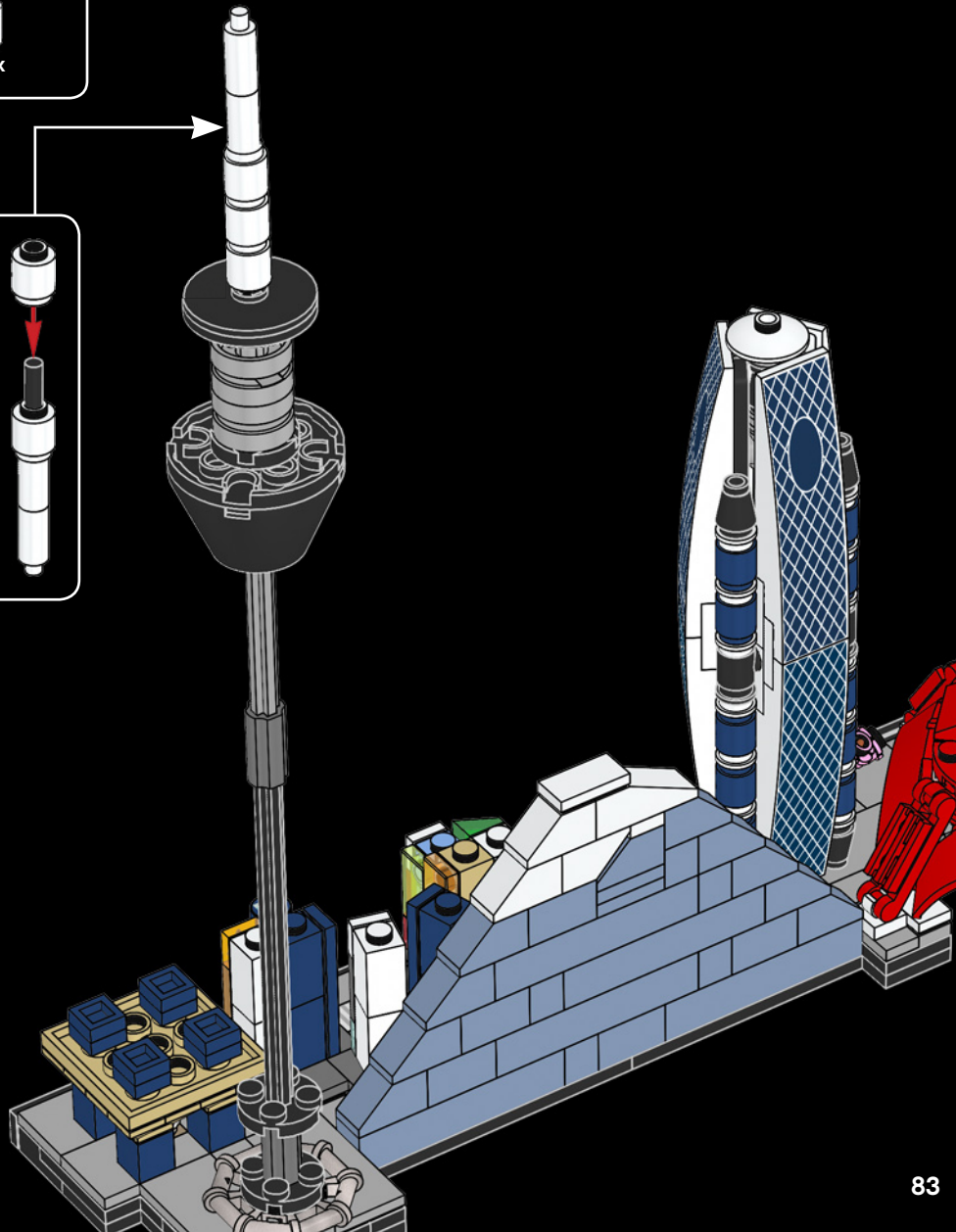
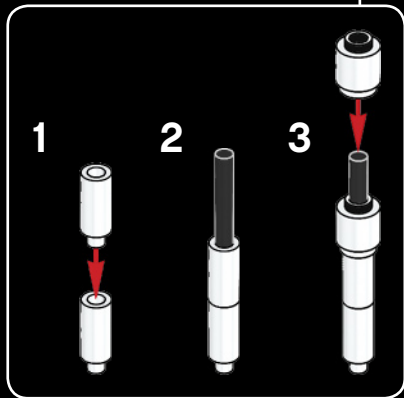

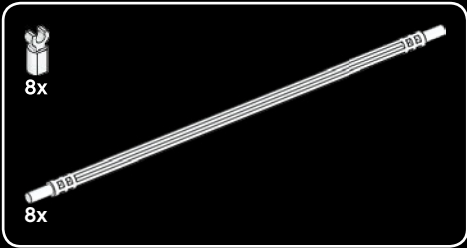

90

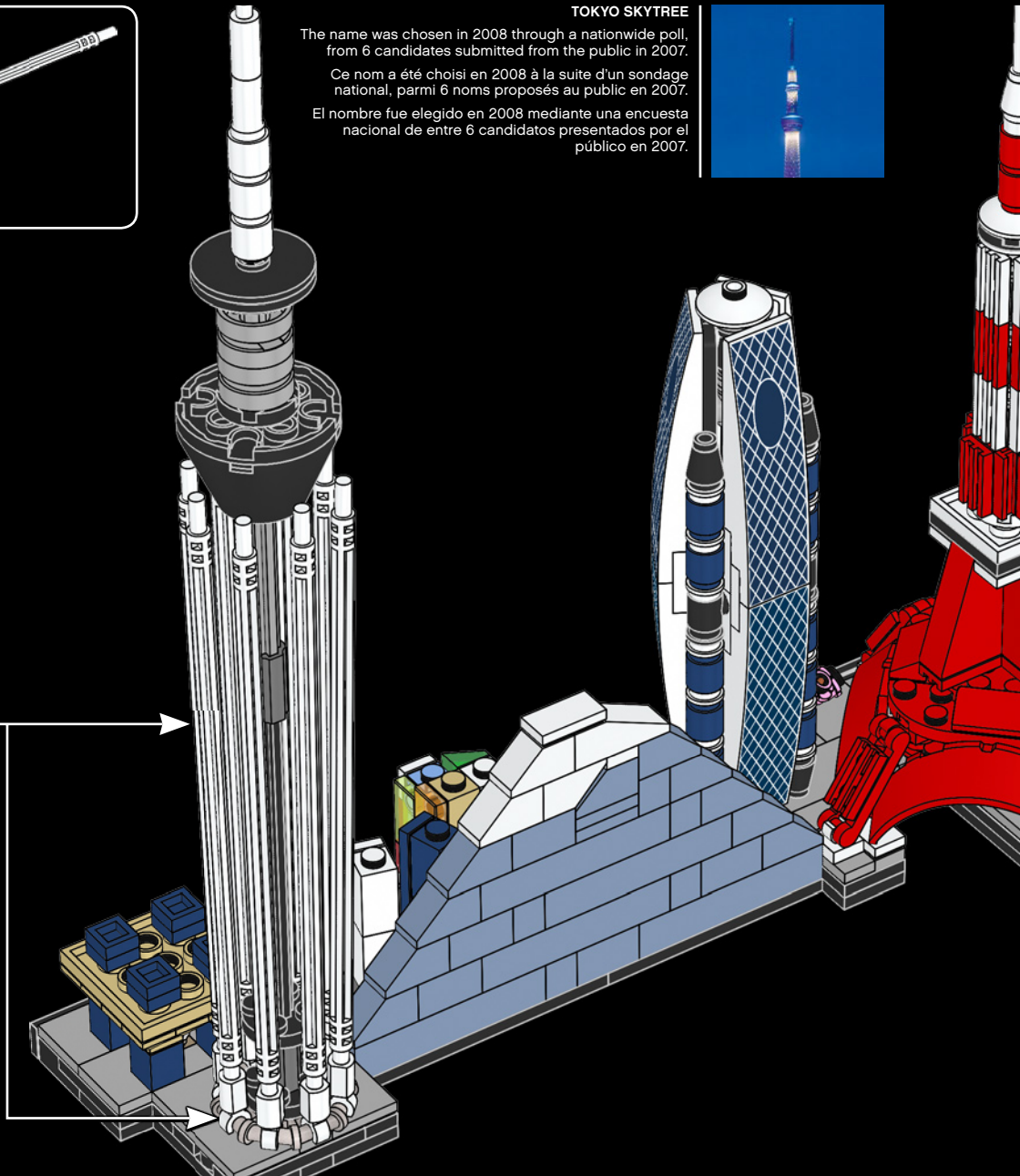
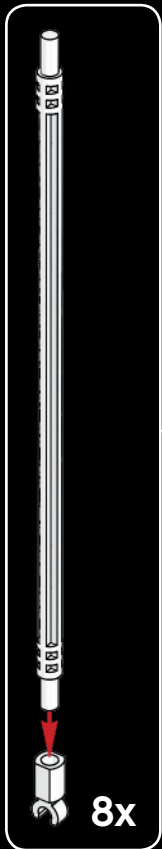

TOKYO SKYTREE

The name was chosen in 2008 through a nationwide poll, from 6 candidates submitted from the public in 2007.

Ce nom a été choisi en 2008 à la suite d'un sondage national, parmi 6 noms proposés au public en 2007.

El nombre fue elegido en 2008 mediante una encuesta nacional de entre 6 candidatos presentados por el público en 2007.

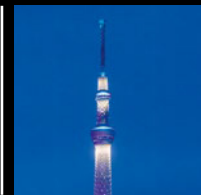

91

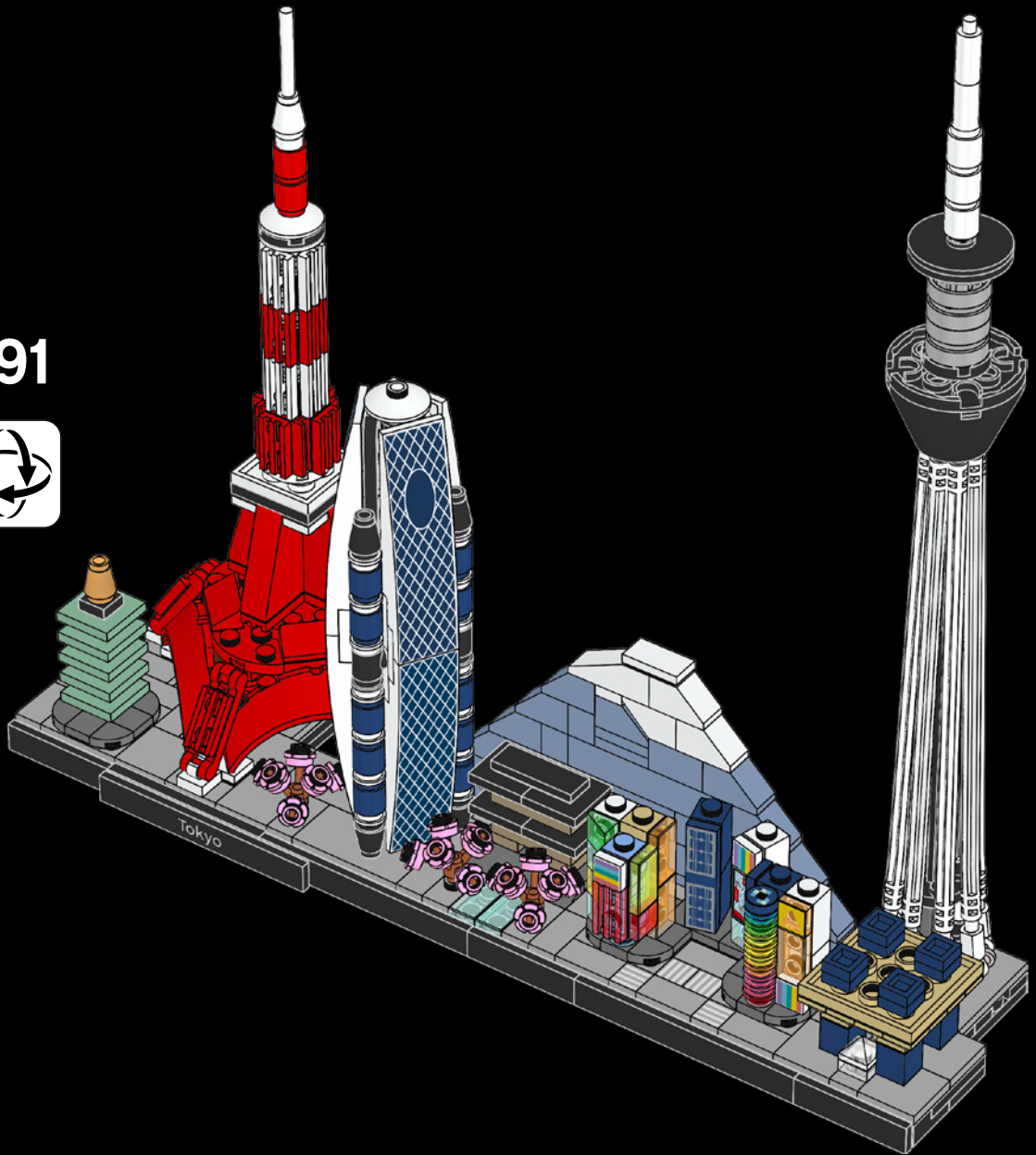



LEGO® Architecture – do you like it? Aimez-vous LEGO® Architecture ? LEGO® Architecture: ¿te gusta?

The LEGO Group would like your opinion on the new product you have just purchased. Your feedback will help shape the future development of this product series. Please visit:

Le Groupe LEGO aimerait connaître votre opinion sur le produit que vous venez d'acheter. Vos commentaires nous aideront à concevoir les futurs produits de cette gamme. Veuillez visiter :

The LEGO Group quiere conocer tu opinión acerca del nuevo producto que acabas de comprar. Tus comentarios nos ayudarán a dar forma a los futuros productos de esta serie. Visita:

[LEGO.com/productfeedback](https://www.lego.com/productfeedback)

By completing our short feedback survey, you will be automatically entered into a drawing to win a LEGO® prize.

En remplissant ce court sondage sur le produit, vous serez automatiquement inscrit à un tirage au sort pour gagner un prix LEGO®.

Al contestar este breve cuestionario de opinión, participarás automáticamente en el sorteo de un producto LEGO®.

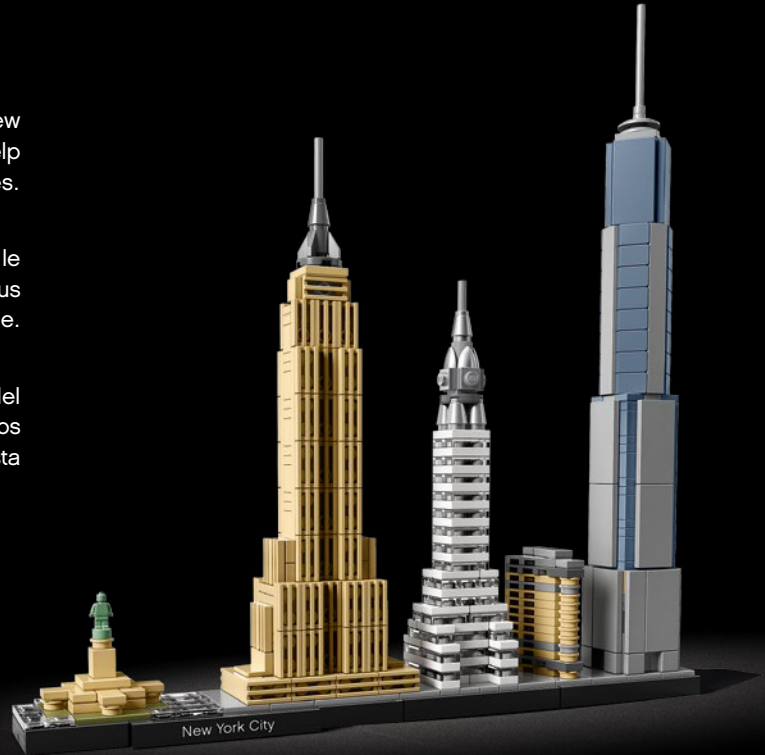

Terms & Conditions apply. Des conditions générales s'appliquent. Sujeto a Términos y Condiciones.

LEGO® Architecture

The LEGO® Architecture series creatively captures the essence of many of the world's most iconic landmarks while giving you an enjoyable and engaging LEGO building experience.

Whether your interest is in travel, design, history or architecture, these sets are a physical memento of a great trip abroad, a famous building you know well, or a city you still dream of visiting.

Every LEGO Architecture set is designed to be displayed. Much more than just a photo, building and displaying your model on your desk, in the bookcase or on the shelf, lets you be transported every time you admire the view.

La série LEGO® Architecture capture l'essence de nombreux monuments parmi les plus célèbres du monde tout en vous offrant une expérience agréable et stimulante de construction LEGO.

Que votre intérêt porte sur les voyages, le design, l'histoire ou l'architecture, ces ensembles constituent un souvenir tangible d'un voyage mémorable, d'un célèbre bâtiment que vous connaissez bien ou d'une ville que vous rêvez de visiter.

Chaque ensemble LEGO Architecture est conçu pour être exposé. Construire votre modèle et l'exposer sur votre bureau, une bibliothèque ou une tablette vous fera voyager à chaque coup d'œil, bien plus qu'une simple photo ne pourrait le faire.

La línea LEGO® Architecture captura con creatividad la esencia de muchos de los monumentos más populares del mundo y pone a tu alcance una experiencia de construcción gratificante y cautivadora con el sello característico de LEGO.

Ya sea que sientas atracción por los viajes, el diseño, la historia o la arquitectura, estos sets expresan físicamente tus recuerdos de aquel fantástico viaje al extranjero, ese famoso edificio que conoces tan bien o la ciudad que sueñas con visitar algún día.

Todos los sets LEGO Architecture están diseñados para decorar. Mucho más que una simple fotografía, construir y exponer un modelo en tu escritorio, un librero o una repisa te traslada a otro lugar al admirar las vistas.

Follow us on

Suivez-nous sur

Síguenos en



Adam Reed Tucker is the co-developer of the LEGO Architecture product line.

Adam Reed Tucker est le codéveloppeur de la gamme de produits LEGO Architecture.

Adam Reed Tucker es el codesarrollador de la línea de productos LEGO Architecture.



Celebrate the world of architecture and collect all the models
Célébrez le monde de l'architecture et collectionnez tous les modèles
Celebra el mundo de la arquitectura y colecciona todos los modelos

21045
Trafalgar Square



21042
Statue of Liberty
La statue de la Liberté
Estatua de la Libertad



21046
Empire State Building
L'Empire State Building



21028
New York City
New York
Nueva York



21039
Shanghai
Shanghái

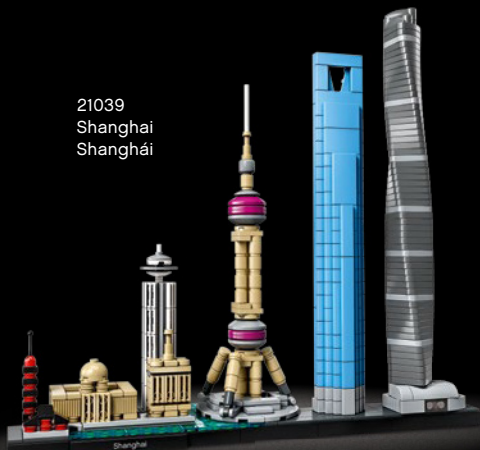

21043
San Francisco



21034
London
Londres



21044
Paris
Paris



21052
Dubai
Dubai
Dubai

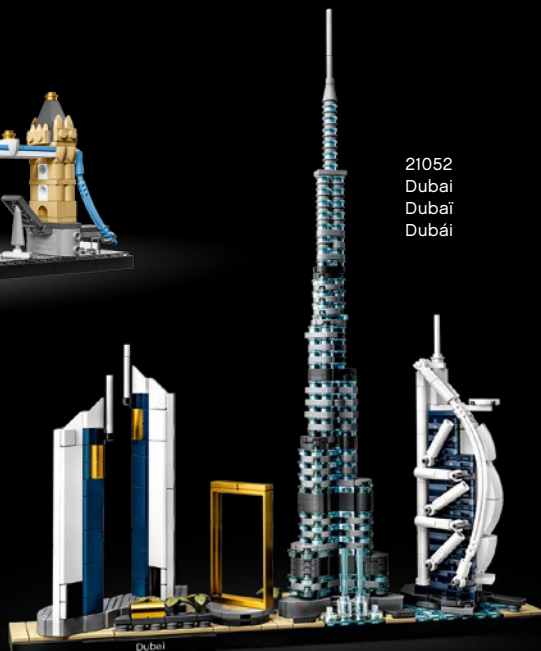

References

Références

Referencias

Pictures
Images
Fotografías

© Shutterstock

Text
Texte
Texto

www.tokyotower.co.jp
www.tangeweb.com
www.gotokyo.org
www.tokyo-skytree.jp

Customer Service
Kundenservice
Service Consommateurs
Servicio Al Consumidor
LEGO.com/service or dial



00800 5346 5555 :

1-800-422-5346 :

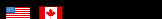

32x
6168642

4x
6054551

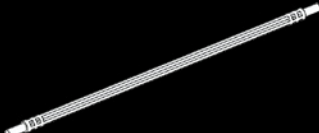
8x
6102484

1x
4518400

2x
6234807

5x
307001

3x
302401

3x
6253635

6x
6218841

6x
4111971

1x
403201

3x
474001

1x
366501

3x
302301

8x
6052824

8x
241201

5x
306901

3x
306201

3x
6232029

2x
4121932

6x
302201

1x
428601

1x
6104805

2x
395701



3x
6291465

3x
6286276

4x
614121

2x
306221

4x
4524644

4x
6108802

4x
4612575

4x
302221

4x
6286215

3x
4515348

4x
6286218

1x
4142865

4x
4651524

16x
241221

4x
4501534

5x
6168646

7x
4529236

3x
6073231

6x
302426

3x
403226

2x
366626

1x
370826

3x
6195325

8x
302326



1x
4218868



2x
6093525

2x
302226

5x
4653049

1x
6285764

2x
416226

12x
303426

12



4x
4565323



4x
6052126



1x
4180087



4x
362326



1x
4558170



2x
302126



3x
243126



2x
371026



1x
4515350



1x
4550922

94

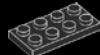

6x
302026

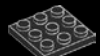

1x
6174917



8x
6280168



1x
6208450



1x
6254248



1x
6250158



1x
6240223



1x
6240216



1x
6245272



1x
6240227



1x
6255958



3x
6251306



2x
6130007



11x
4549436



1x
6132767



2x
6132768



16x
6249125



2x
6232135



1x
4243824



1x
6240206



1x
6251298



2x
6245277



1x
6254256



2x
6251295



2x
6240214



18x
6212501



2x
6240230



1x
6240221



1x
6245270



2x
4179826



2x
6195548



5x
4620077



2x
6198156



3x
4143005



15x
4177741



1x
6253178



8x
4184108



4x
4255413



4x
6253883



2x
6215341



5x
6177142



10x
6212055



5x
4620992



1x
6223655



1x
6252041



1x
6252962



10x
4211414



2x
4211396



1x
6258831



3x
4211573



4x
4211399



4x
4211415



4x
6286223



4x
4211398



8x
6066097



2x
6029209



2x
4502595



3x
4211413



7x
6065824



4x
4211356



6x
4560183



1x
4211438



1x
4211805



2x
4211445



1x
6015347



4x
6170420



8x
4210848



8x
6199549



2x
4567887



4x
4516546



1x
6226606



2x
6092572



2x
6126083



2x
4210635



1x
4529247



1x
6170470



2x
6146301



1x
6135494



5x
6186826



3x
6269941



1x
6020990

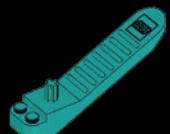

1x
6254100

7

3

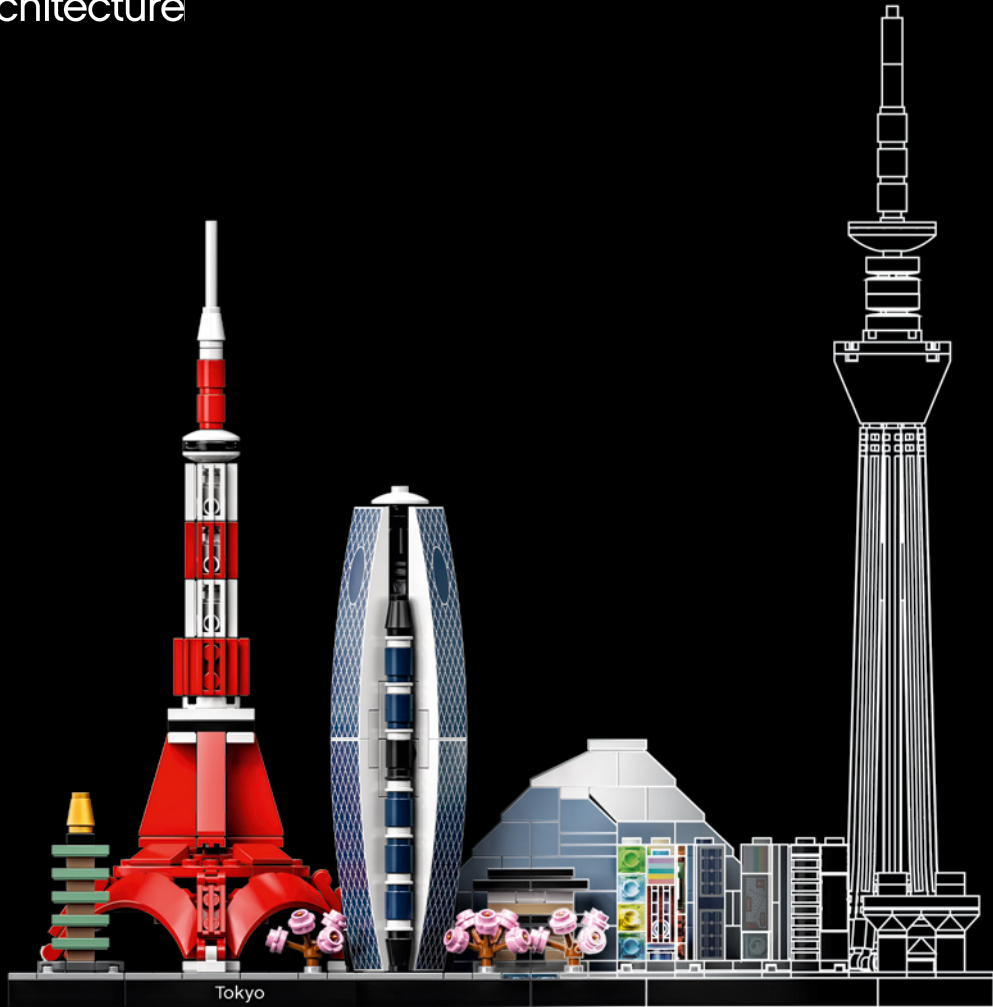

Tokyo

[LEGO.com/architecture](https://www.lego.com/architecture)

LEGO and the LEGO logo are trademarks of the/son des marques de commerce du/son marcas registradas de LEGO Group. ©2020 The LEGO Group. 6326833

©TOKYO-SKYTREE
東京スカイツリー®/東京晴空塔®/TOKYO SKYTREE

Follow LEGO® Architecture on
Suivez LEGO® Architecture sur
Sigue a LEGO® Architecture en

