



MINECRAFT

21254



Q LEGO® Builder



Get excited about our new packaging!

We're switching from plastic to paper-based packaging. That's why you might find a mix of paper and plastic in our boxes!

Nos nouveaux emballages vous emballeront !

Nous passons des emballages en plastique aux emballages à base de papier. C'est pourquoi vous pourriez trouver un mélange de papier et de plastique dans nos boîtes !

¡Te presentamos nuestros nuevos empaques!

Estamos sustituyendo las bolsas de plástico por bolsas con base de papel. ¡Por eso, puedes encontrar una mezcla de papel y de plástico en nuestras cajas!

[LEGO.com/sustainable-packaging](https://www.lego.com/sustainable-packaging)

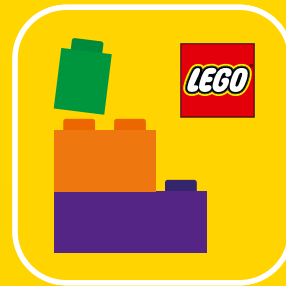

BUILDER



Apple and the Apple logo are trademarks of Apple Inc., registered in the U.S. and other countries and regions. App Store is a service mark of Apple Inc. Google Play and the Google Play logo are trademarks of Google LLC. Tencent and the Tencent logo are trademarks of Tencent Inc.

LEGO.com/devicecheck

EN Ask parents' permission before going online | DE Eltern um Erlaubnis bitten, bevor du online gehst | FR Demande l'autorisation d'un parent avant d'aller en ligne | IT Chiedi il permesso ai tuoi genitori prima di andare online | ES Pídeles permiso a tus papás antes de conectarte a Internet | PT Pede autorização aos pais antes de acederes online | ZH 上网前应先征得父母的同意 | PL Poproś rodziców o zgodę, zanim wejdiesz do Internetu | CS Než půjdeš na internet, požádej rodiče o svolení | SK Skôr než pôjdeš na internet, vypýtaj si povolenie od rodičov | HU Kérj szülői engedélyt, mielőtt online csatlakoznál! | RO Cere permisiunea părinților înainte de a te conecta online | BG Поискайте разрешение от родител, преди да влезете онлайн | LV Pirms došanās tiešsaistē palūdz atļauju vecākiem | ET Enne Interneti kasutamist küsi vanematelt luba | LT Prieš prisijungdami prie interneto, atsilkauskite tėvų

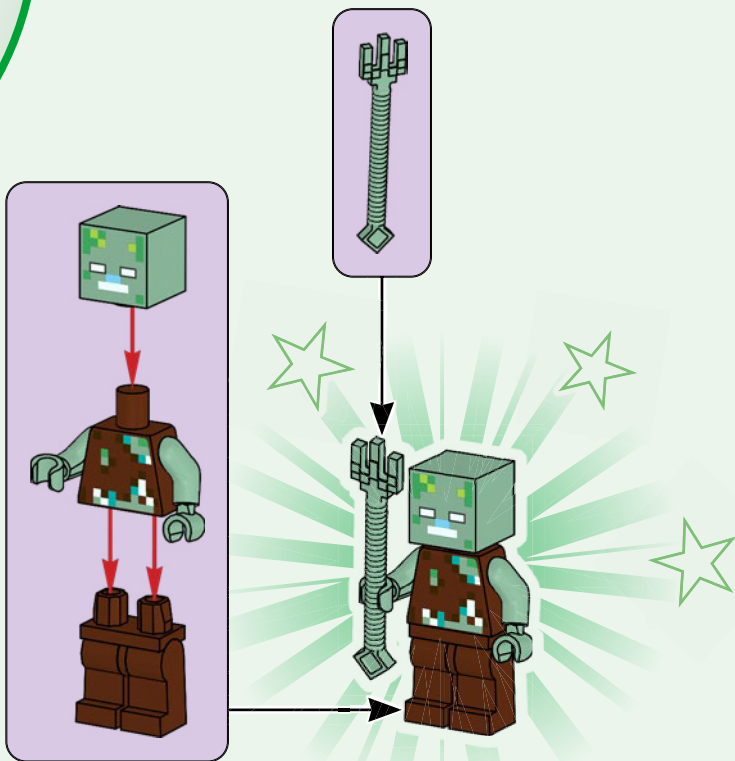

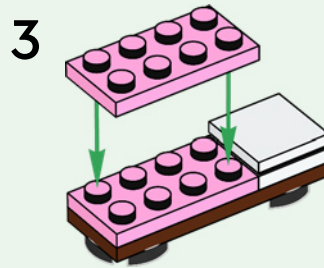
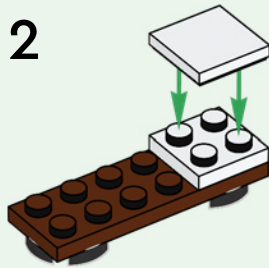
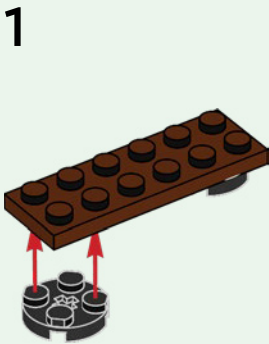
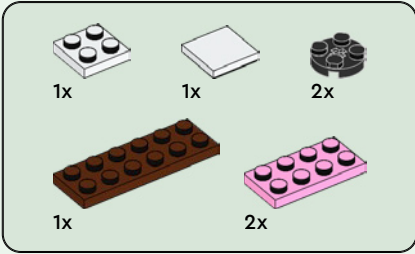
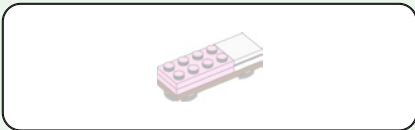

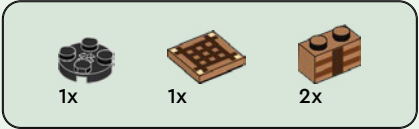

1



2

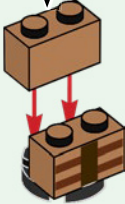
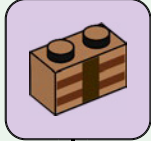

3



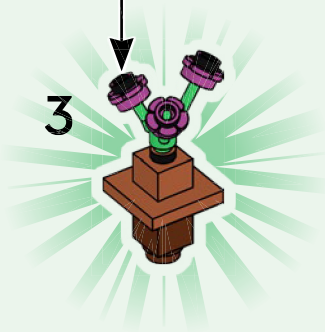
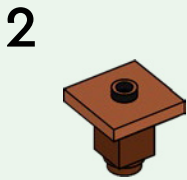
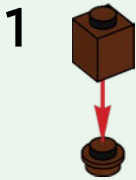
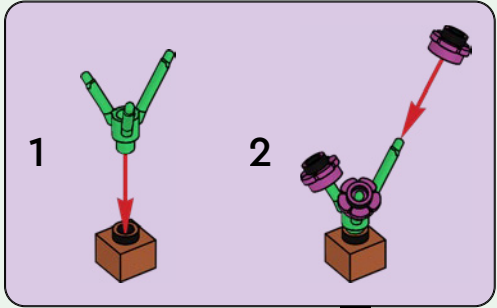
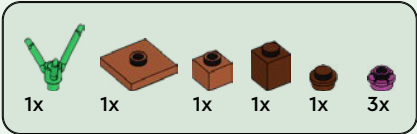

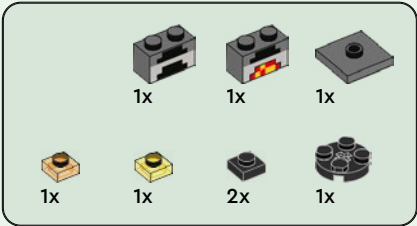

1



2

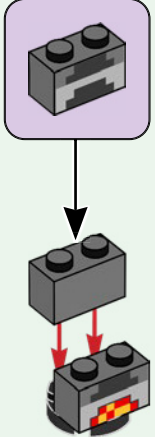

3



4

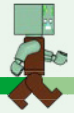
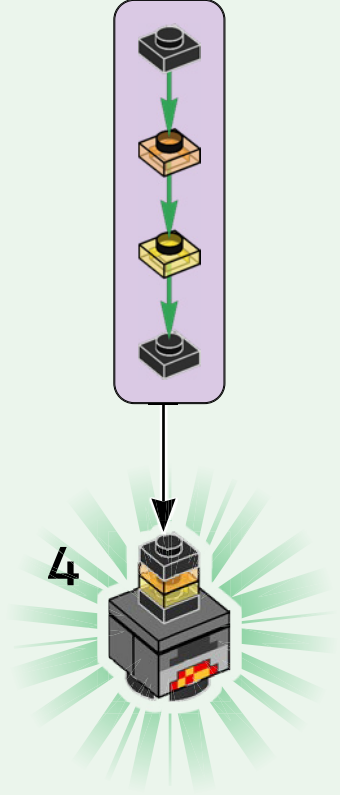

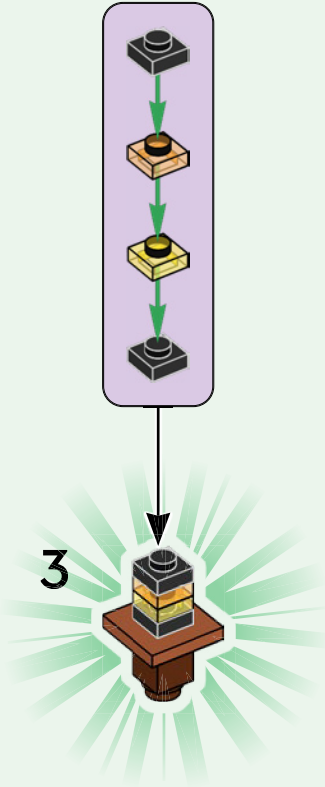
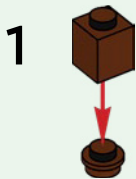

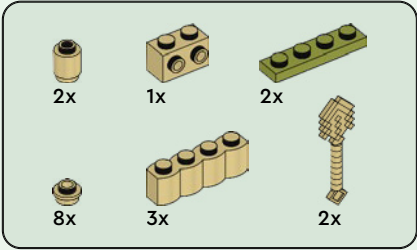

1

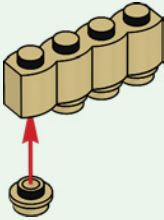

2

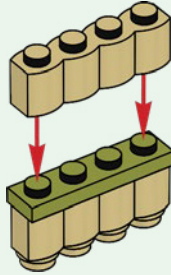

3

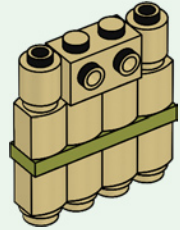

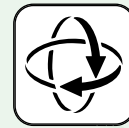
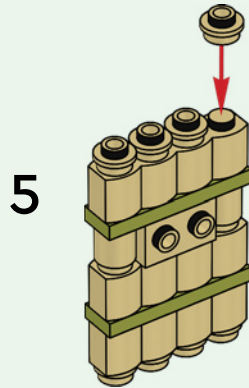
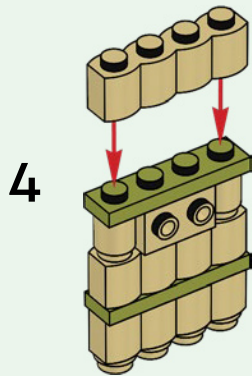

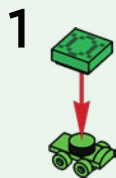

3x

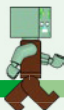

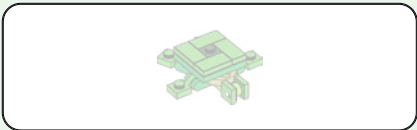

1



2

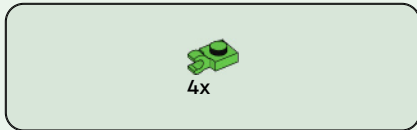
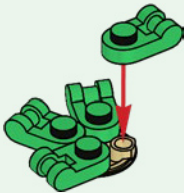

3

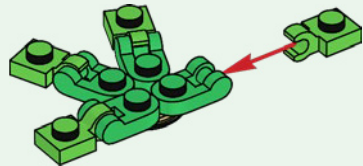

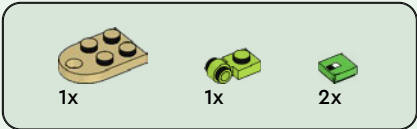

4

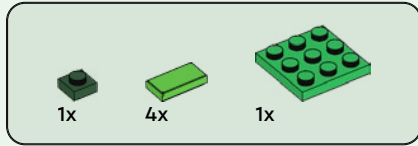
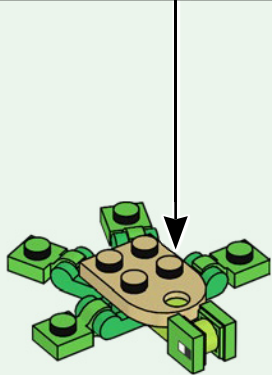
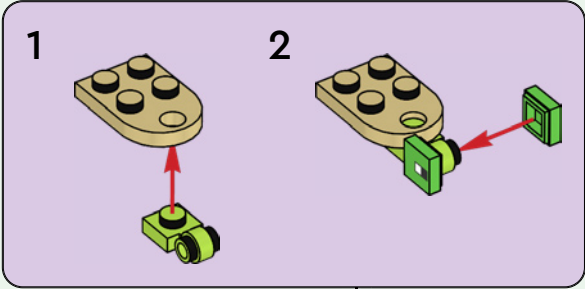

5

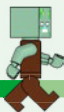
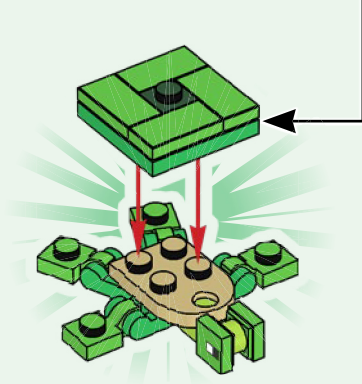
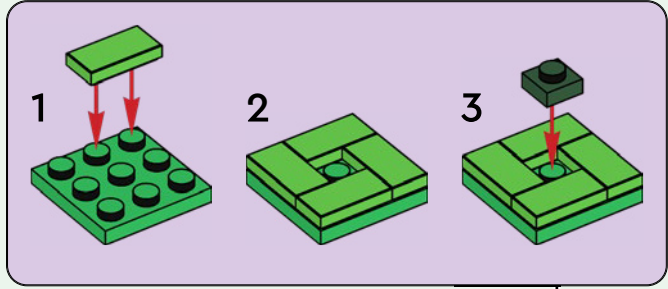

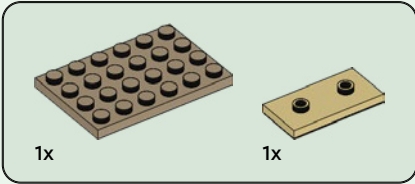
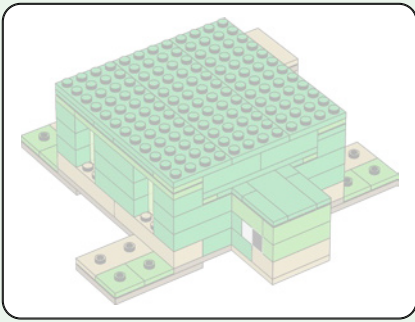

1

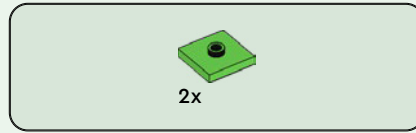
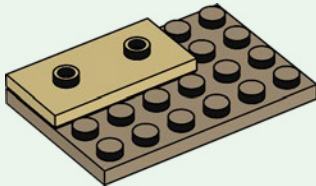

2

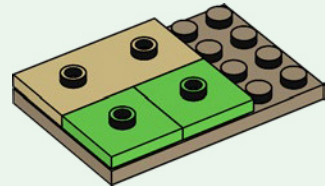

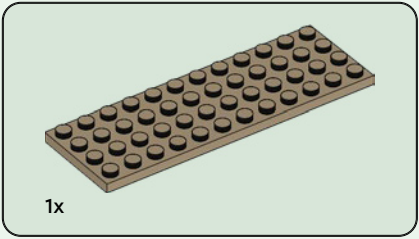

3

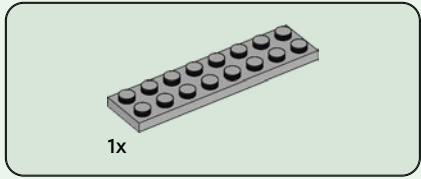
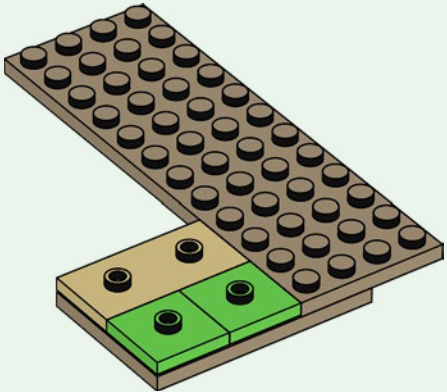

4

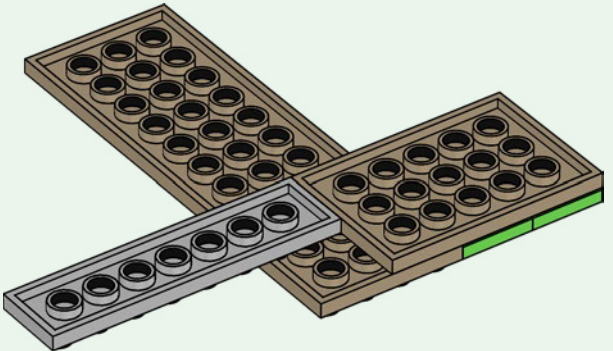

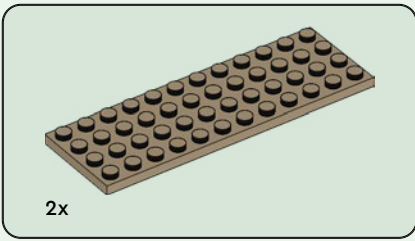

5

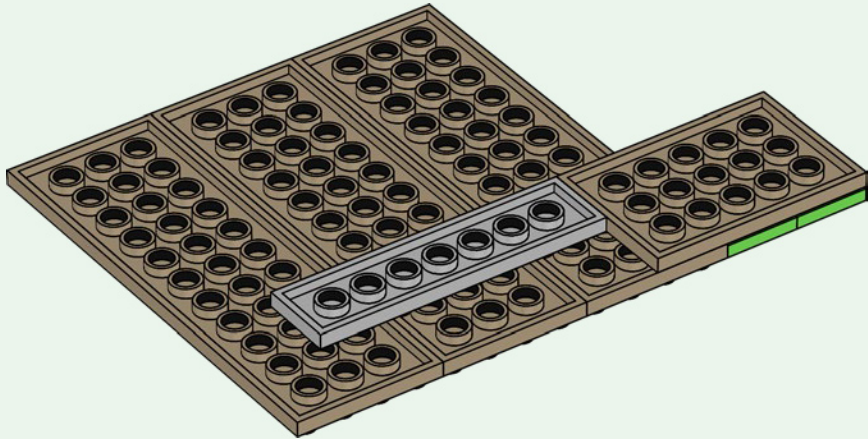

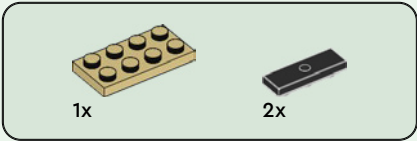

6

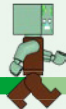
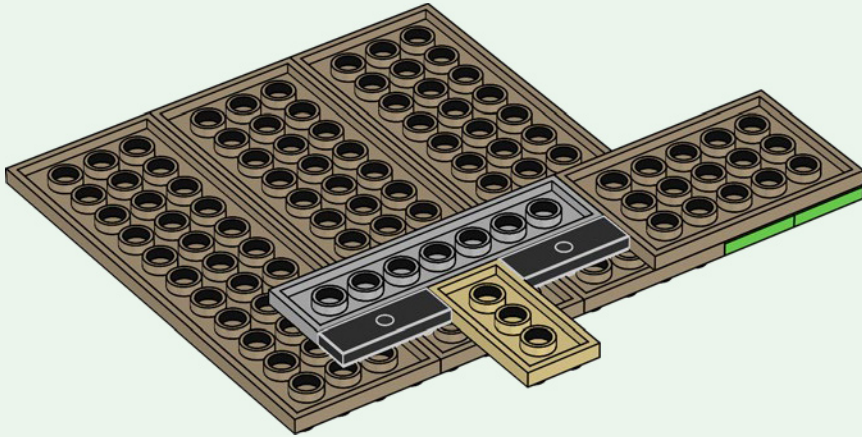

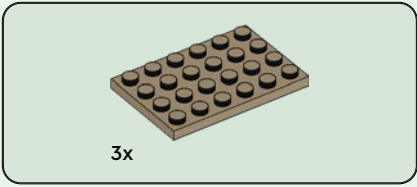

8

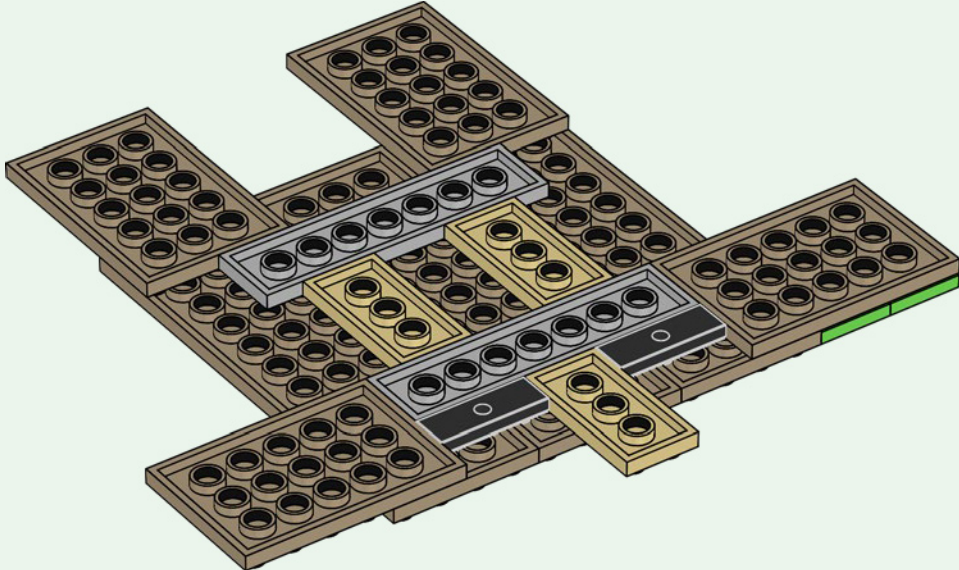

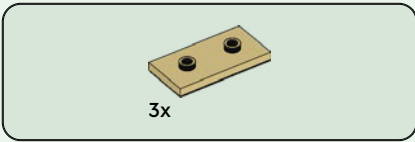

9

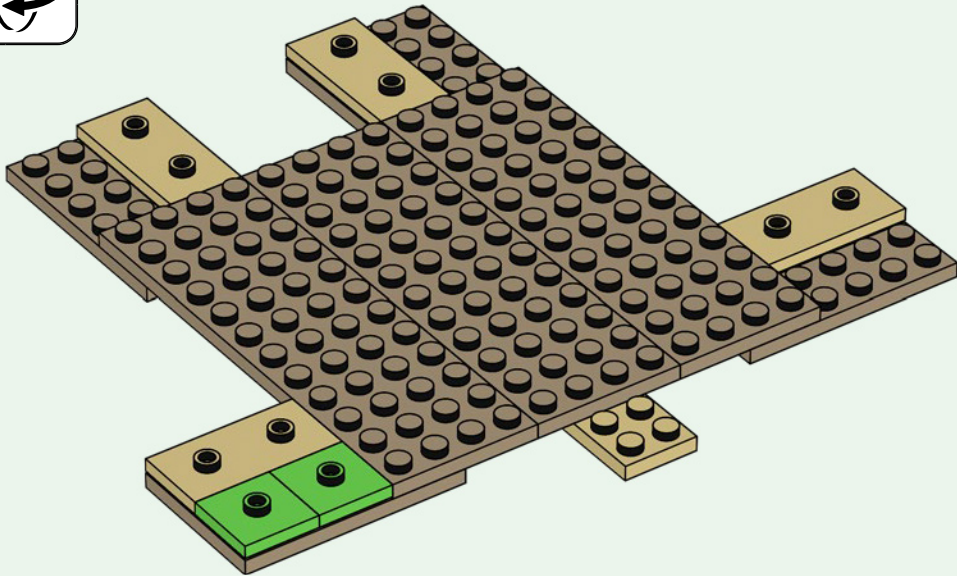



6x

10

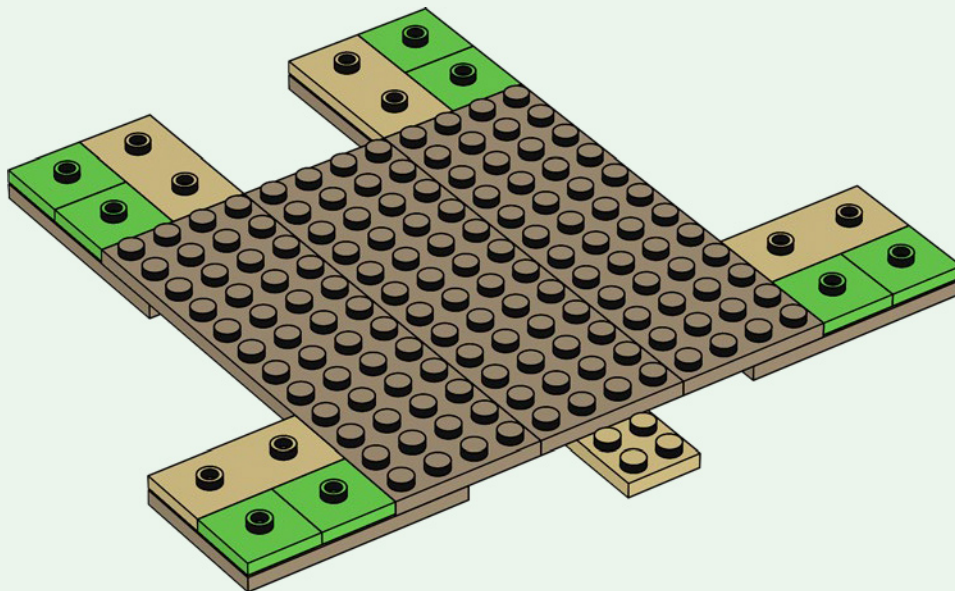

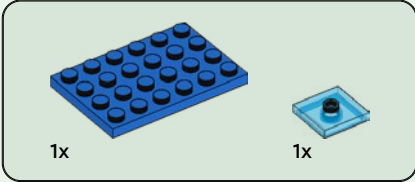
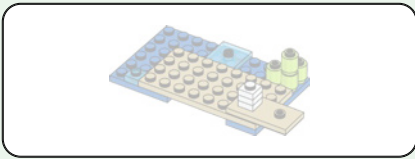

11

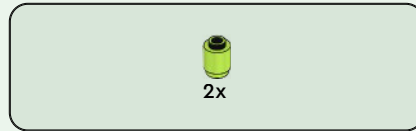
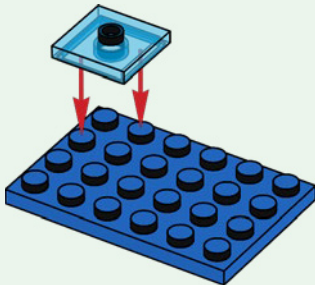

12

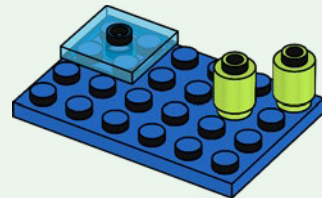



13

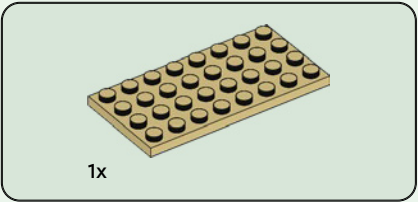
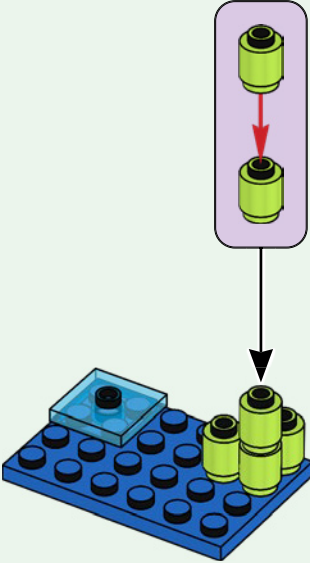

14

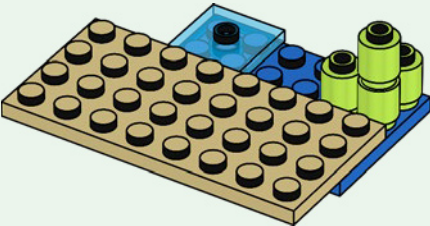

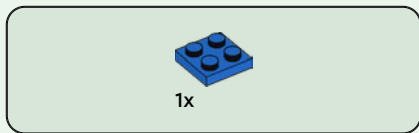

15

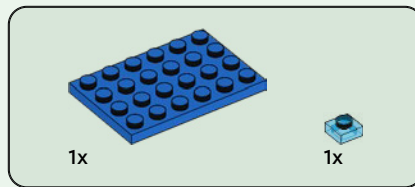
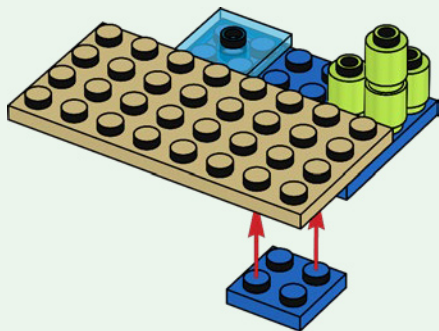

16

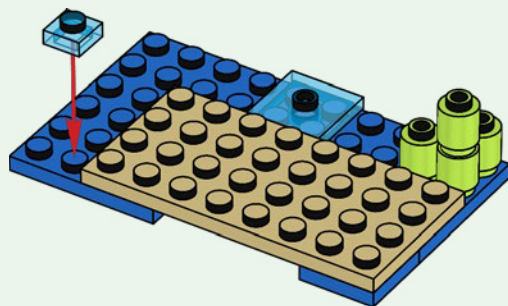

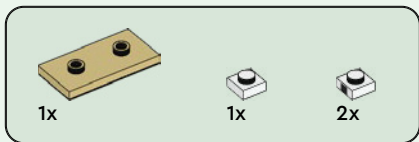

17

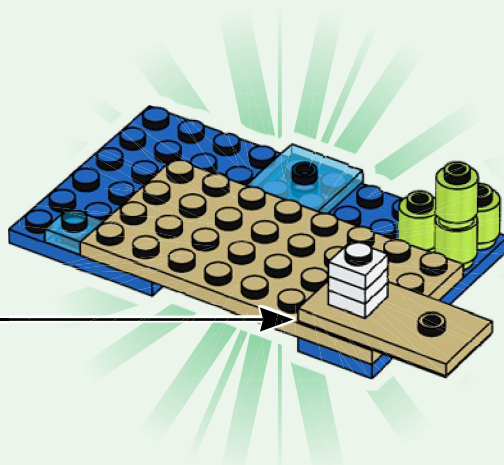
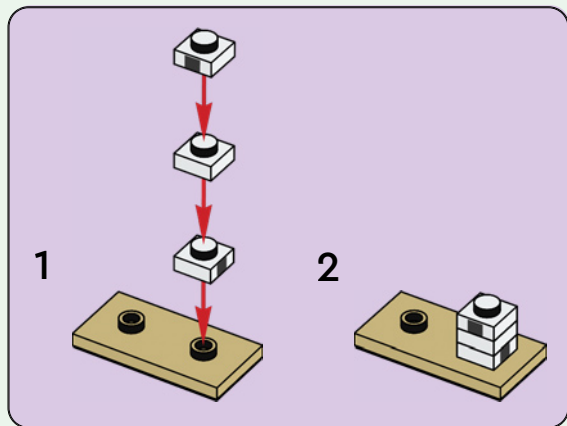

18

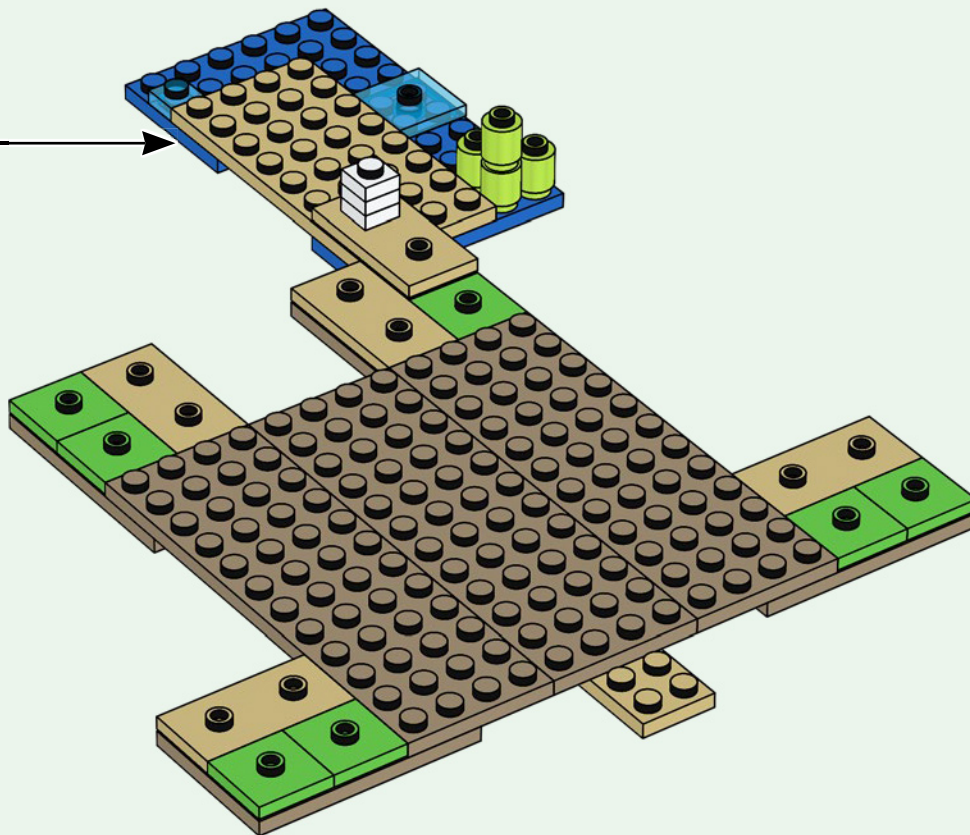

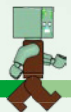
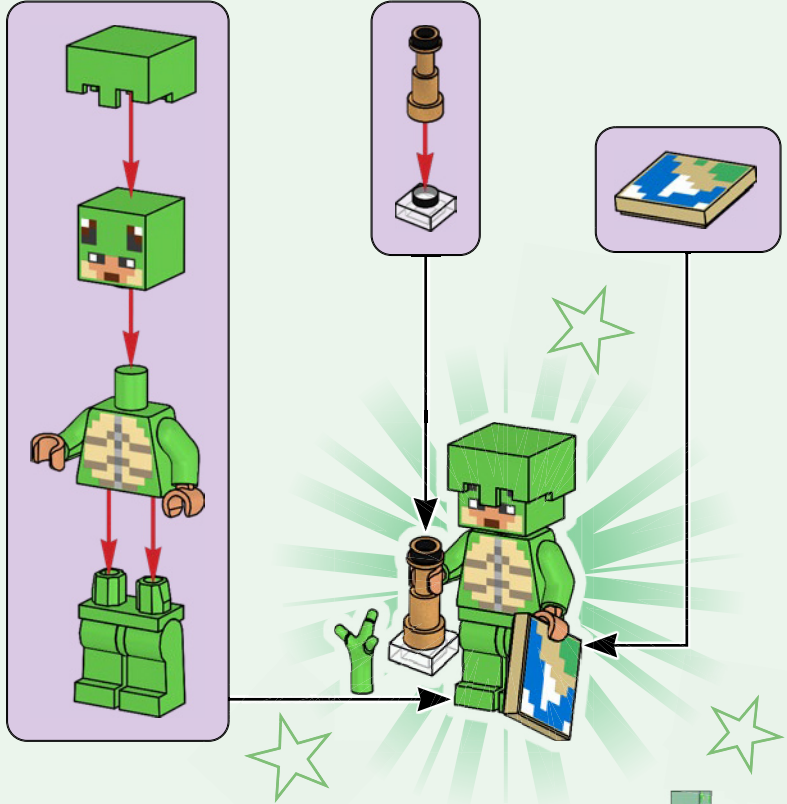
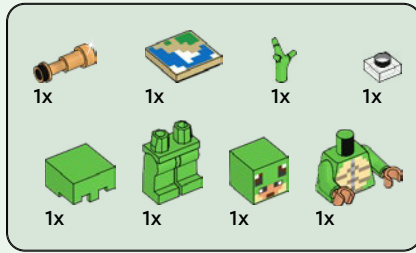

20

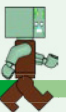
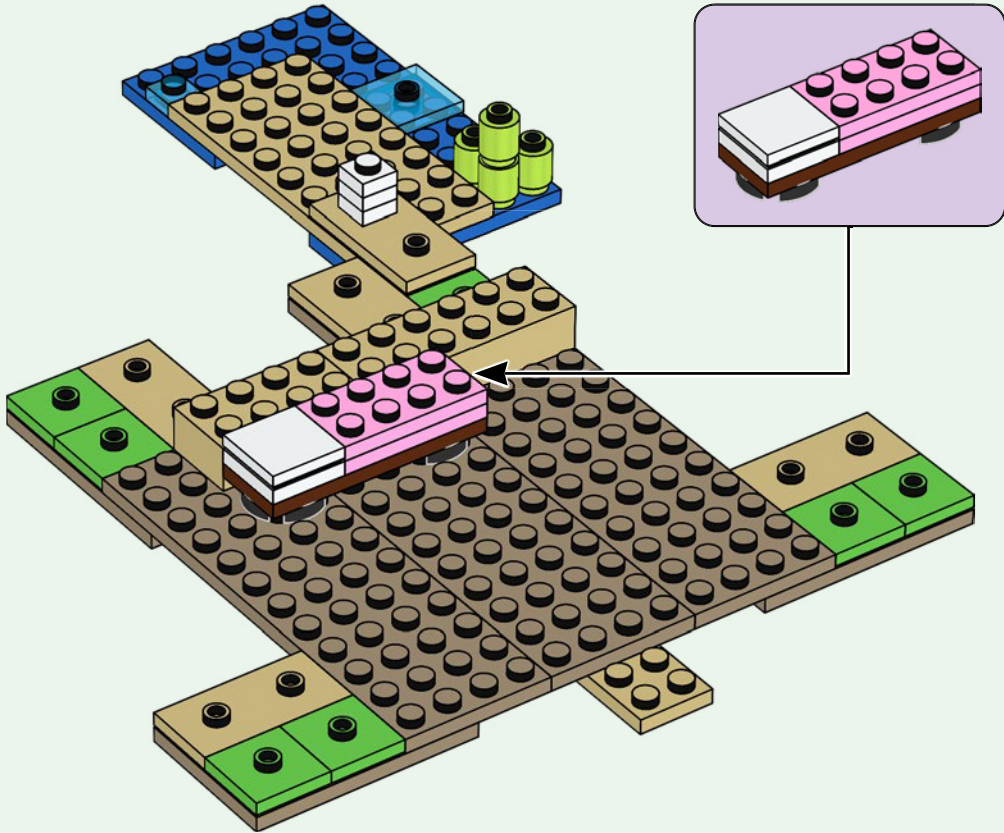

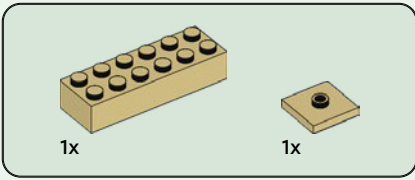

21

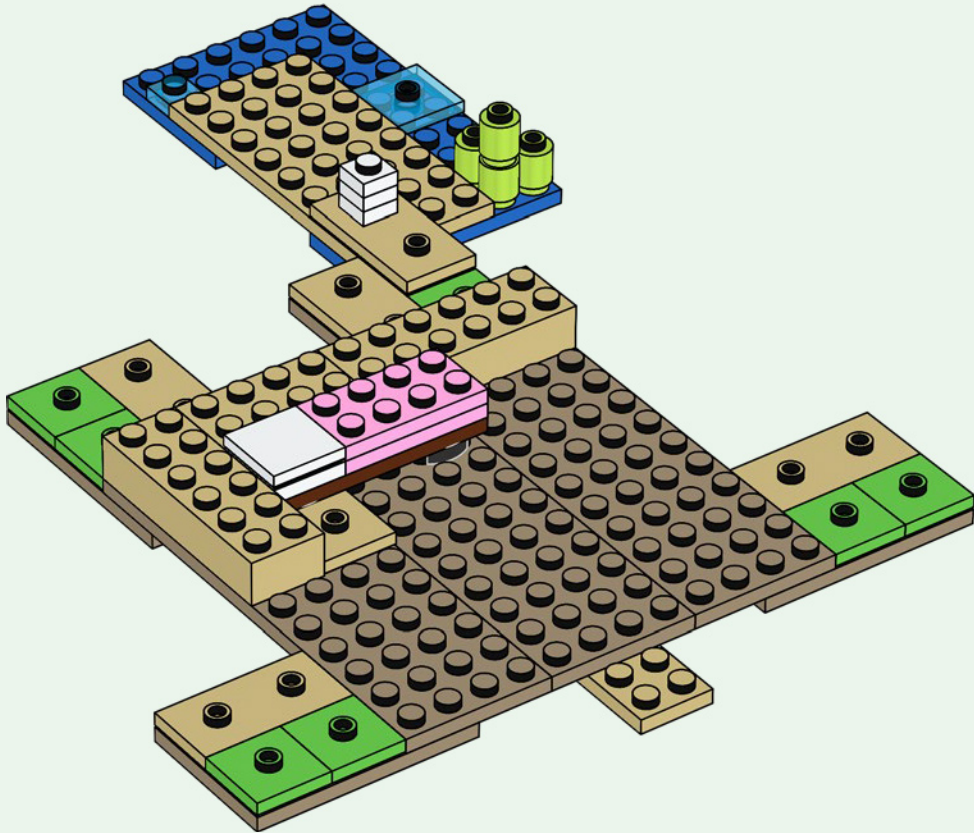

22

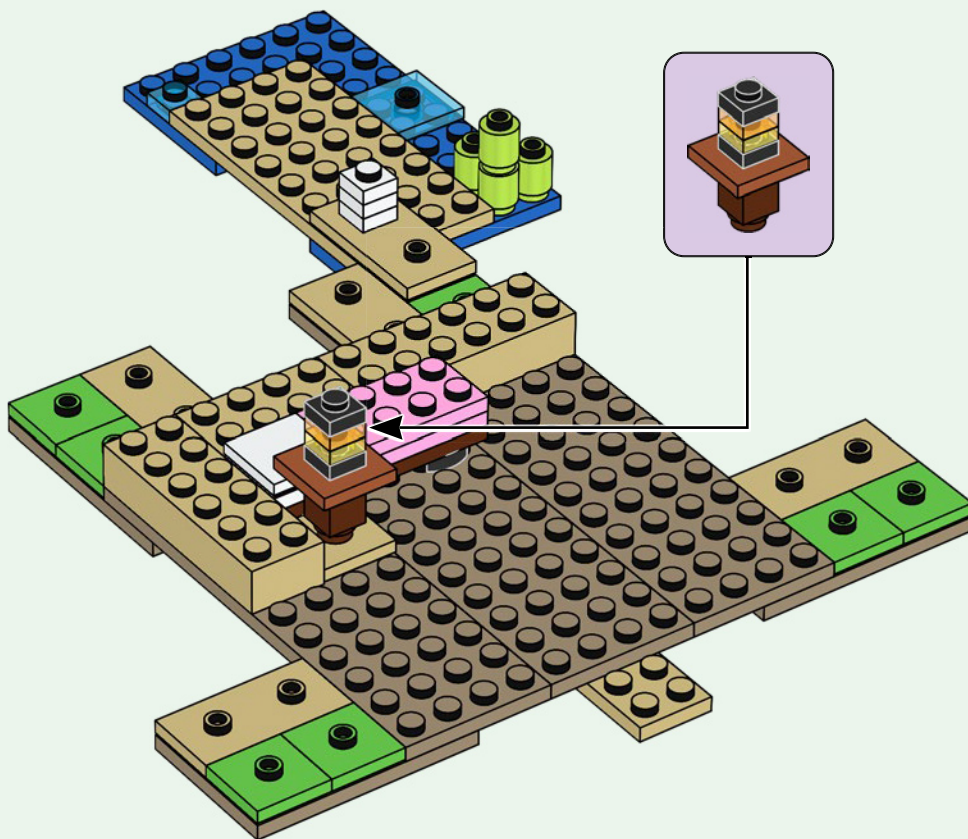

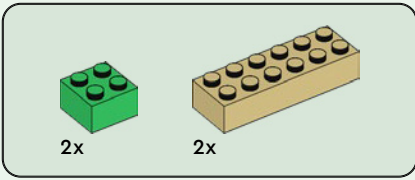

23

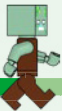
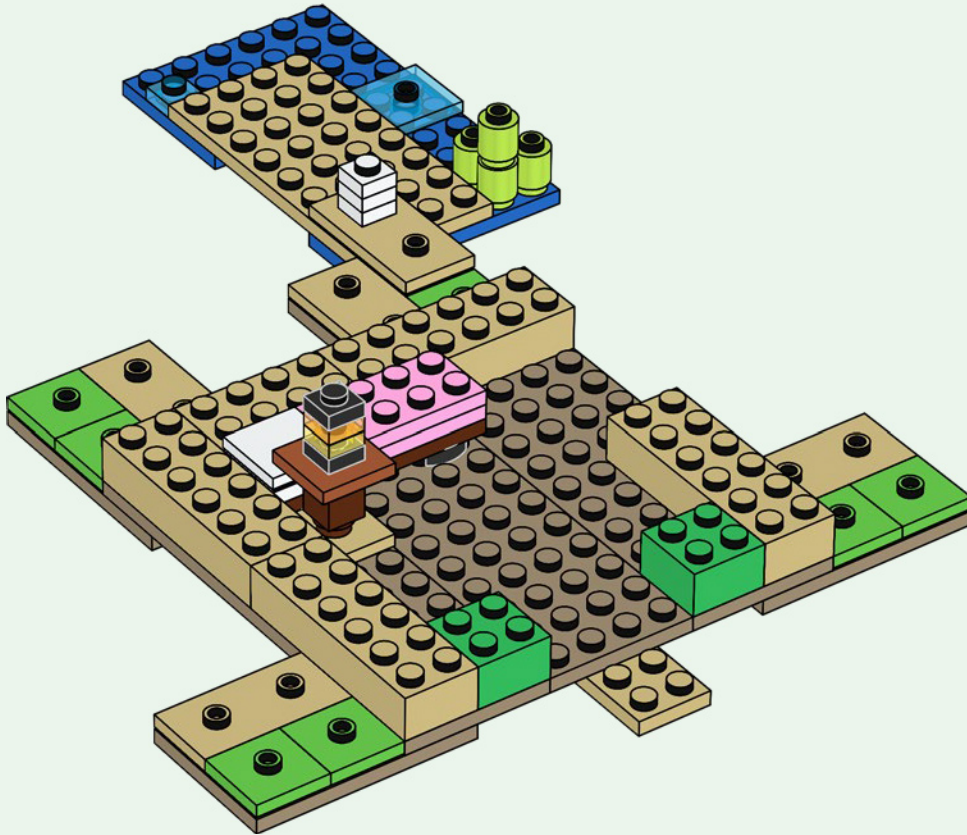

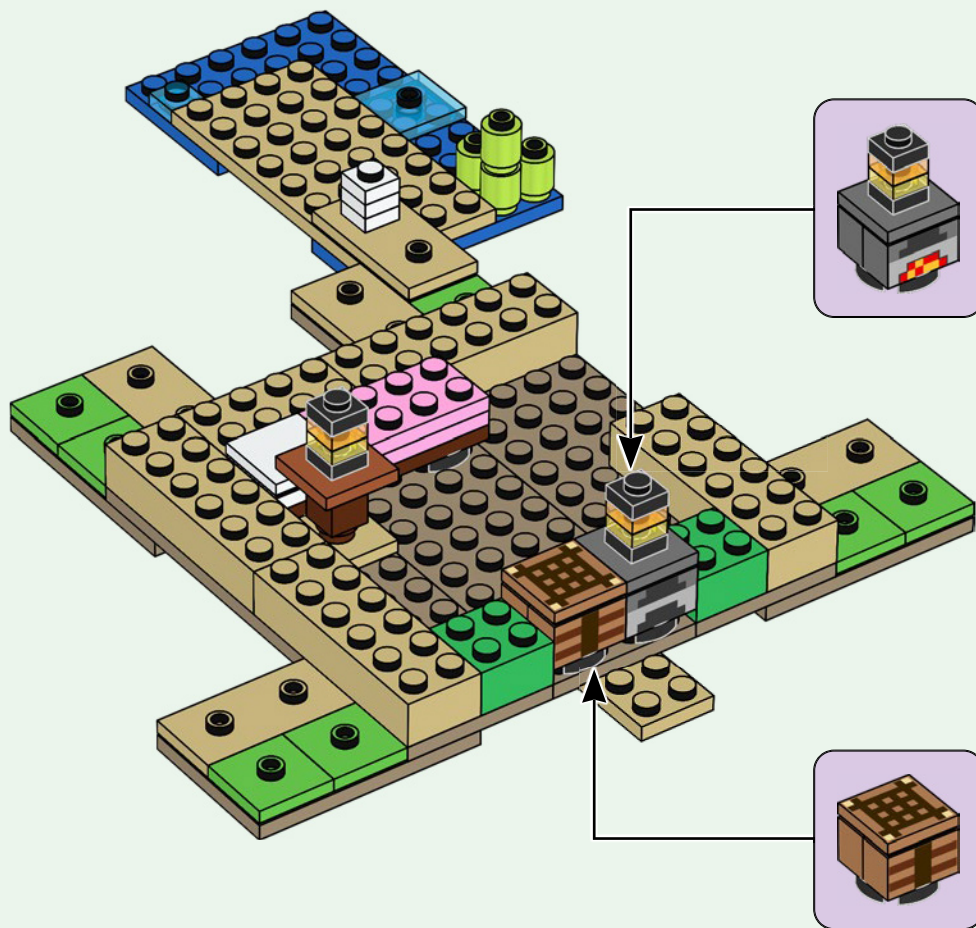



6x

27

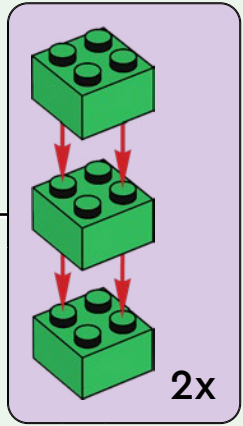
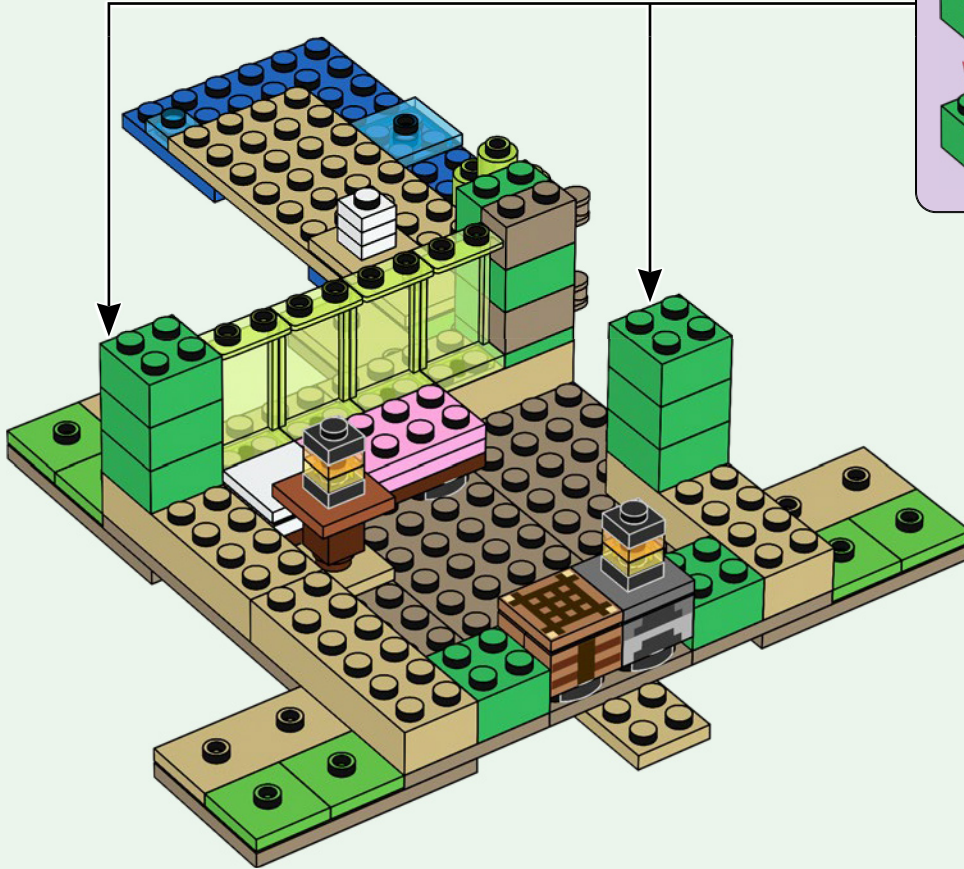

2x



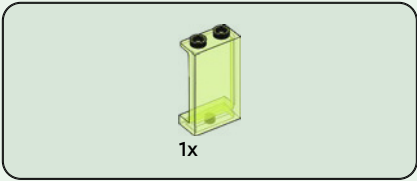

28

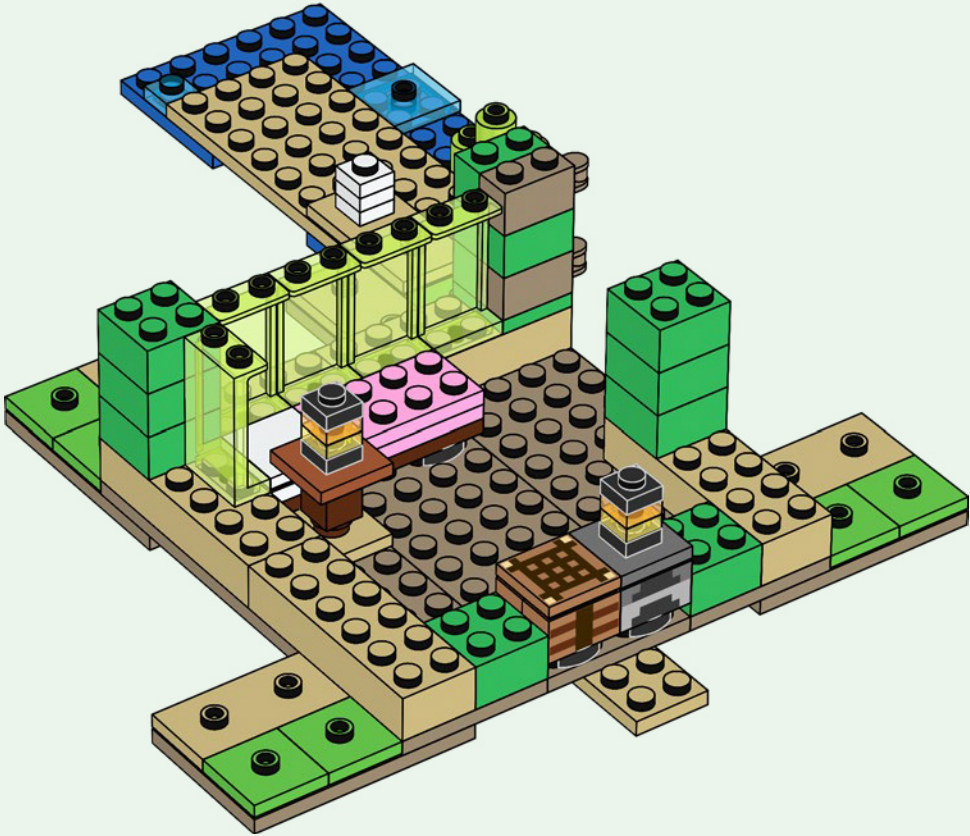

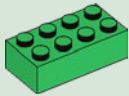

3x

29

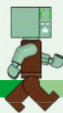
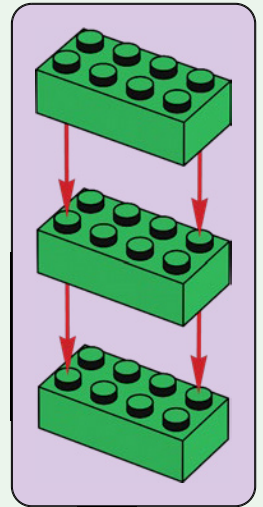
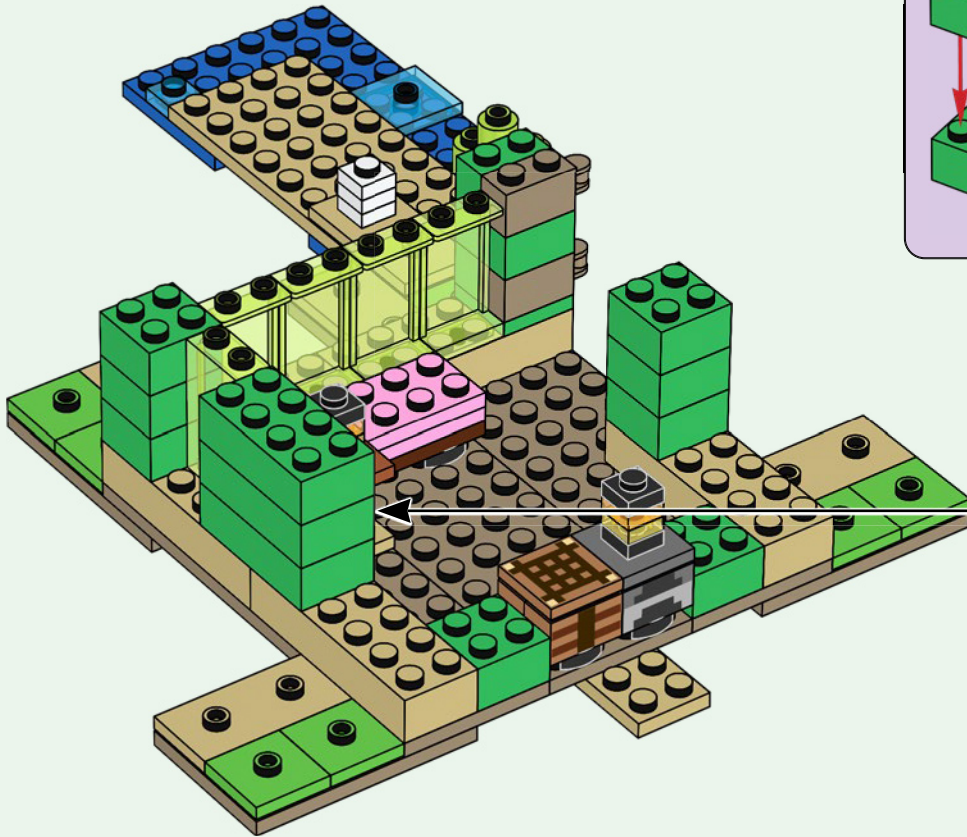

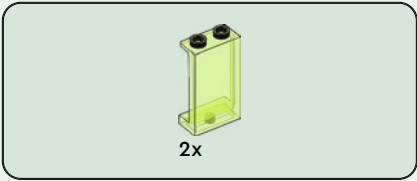

30

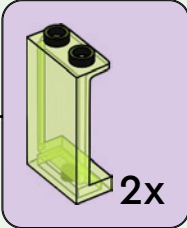
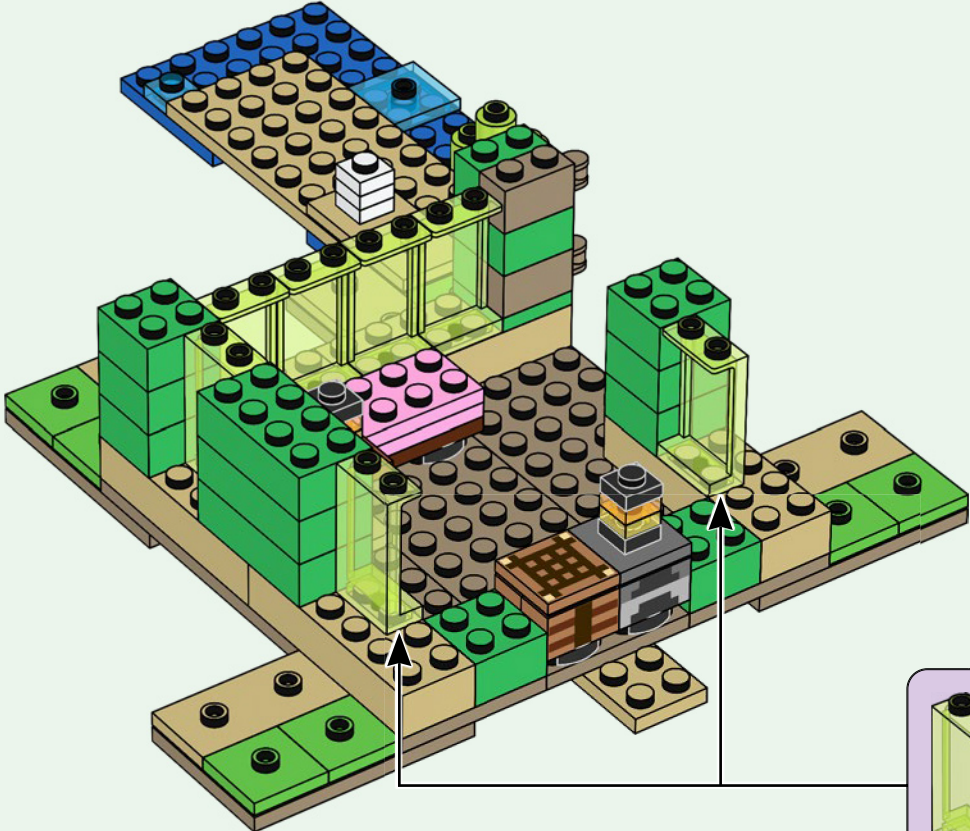

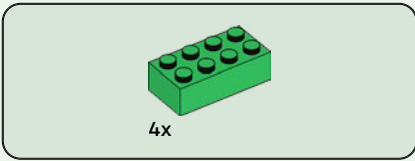

31

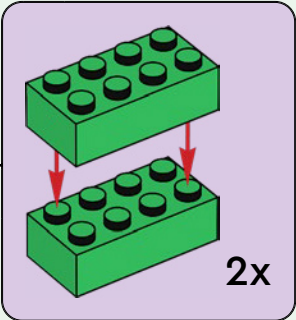
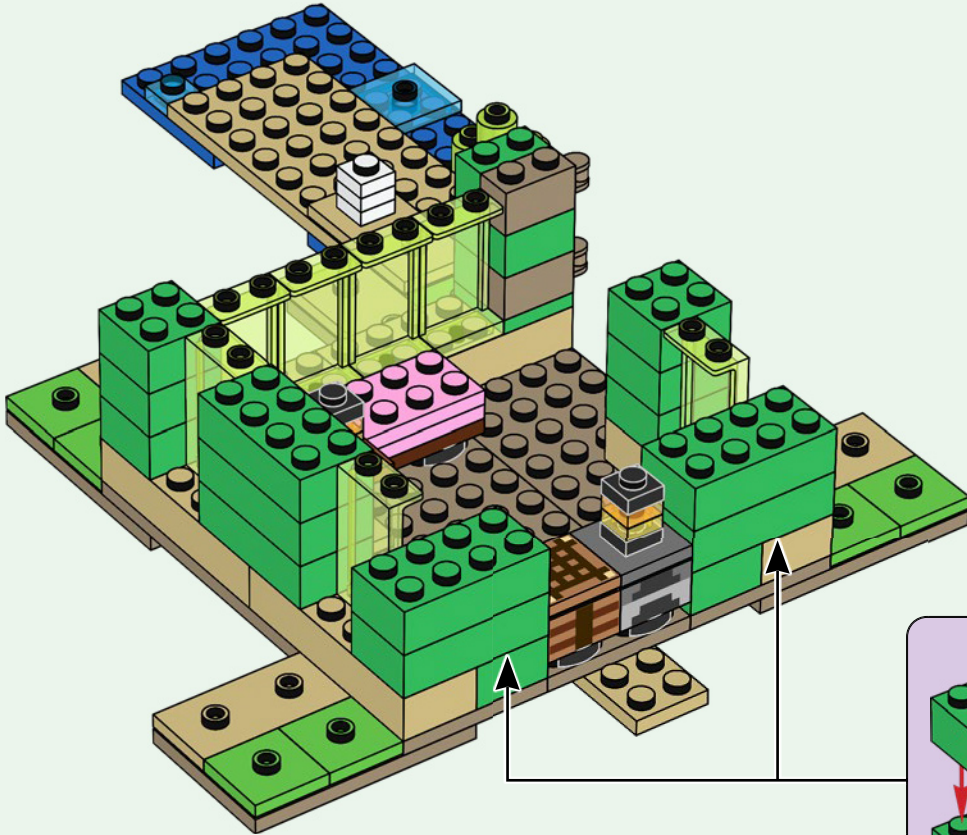



2x



2x



2x

32

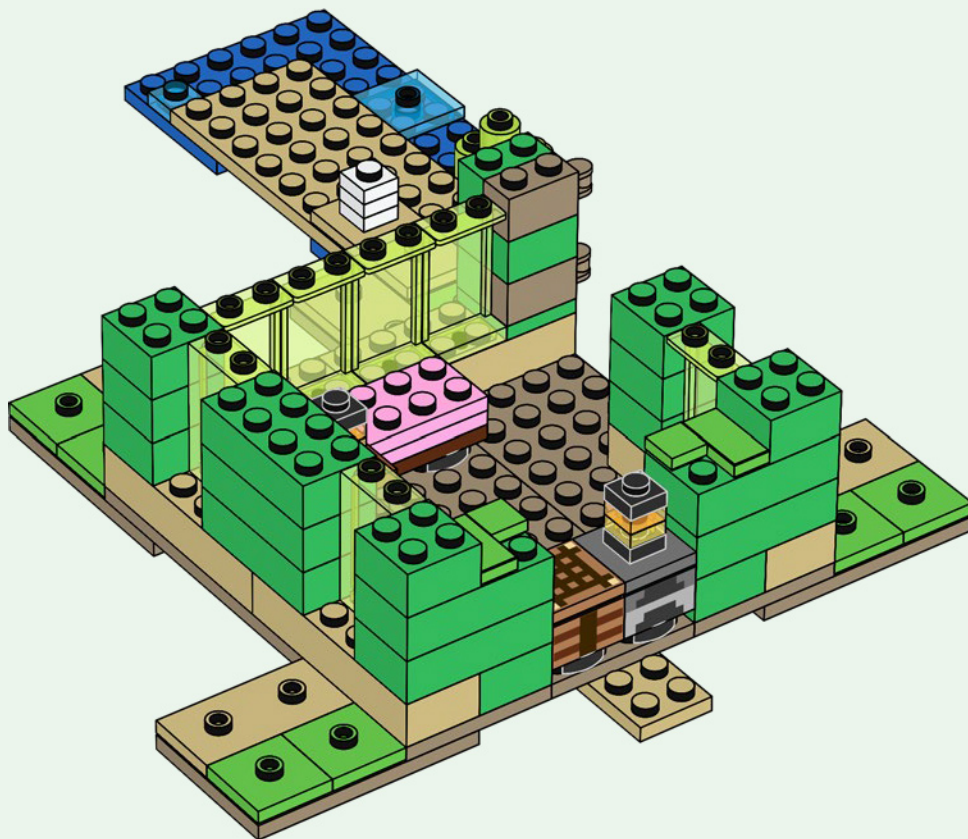

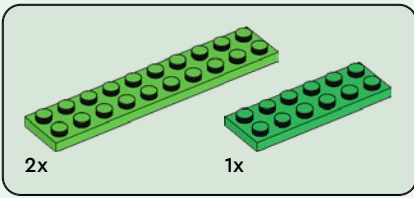

33

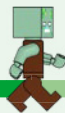
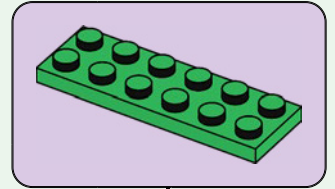
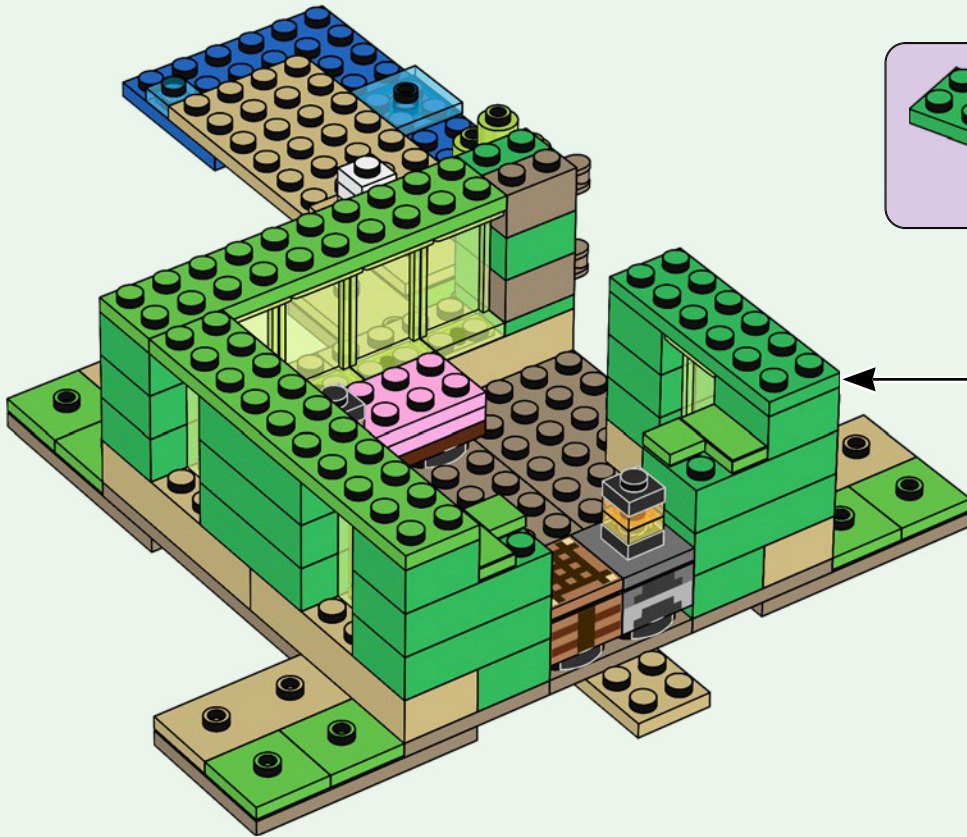

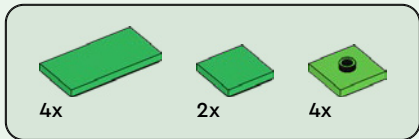

34

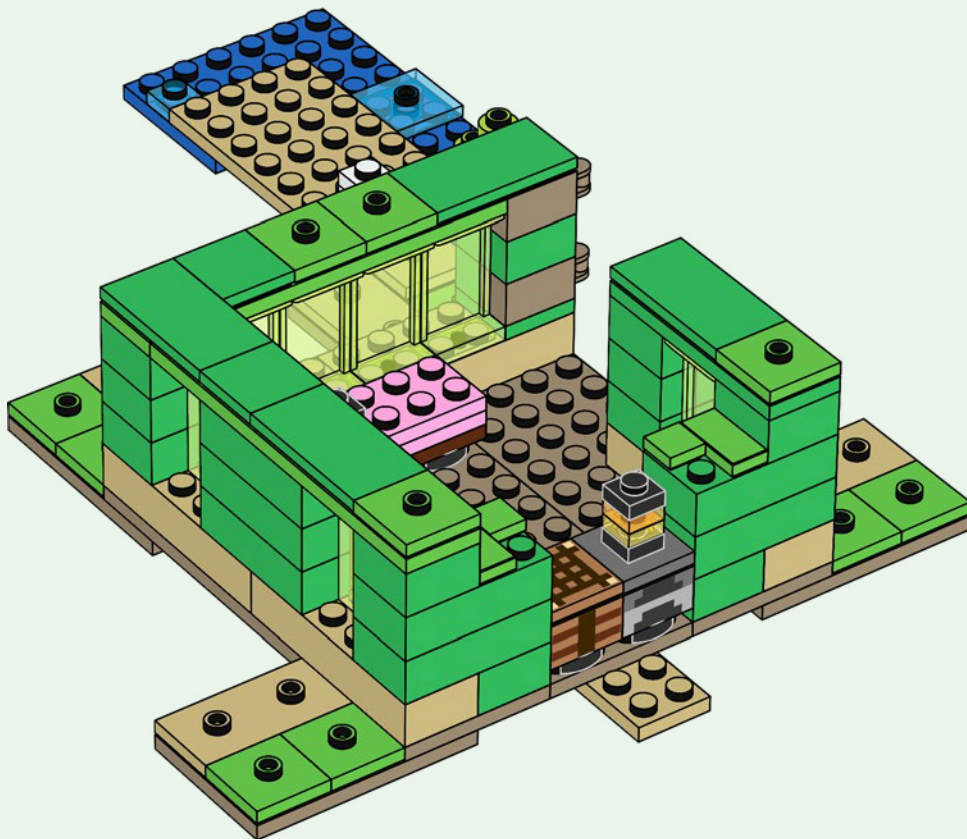

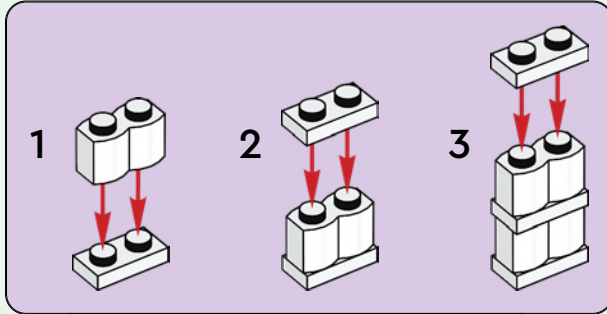
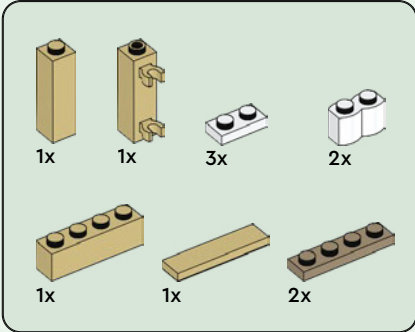
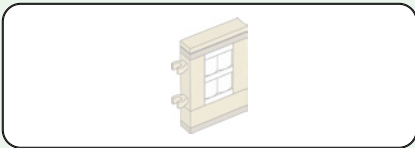

35

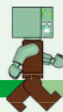
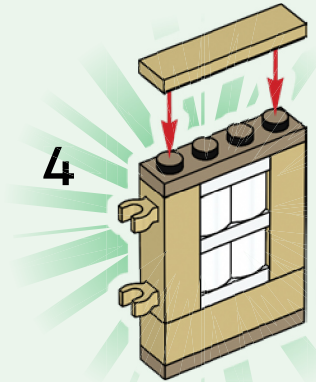
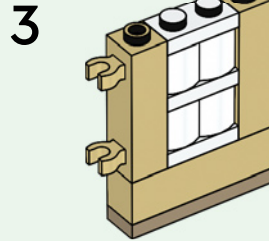
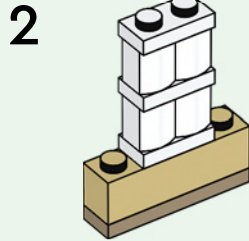
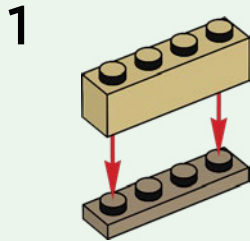

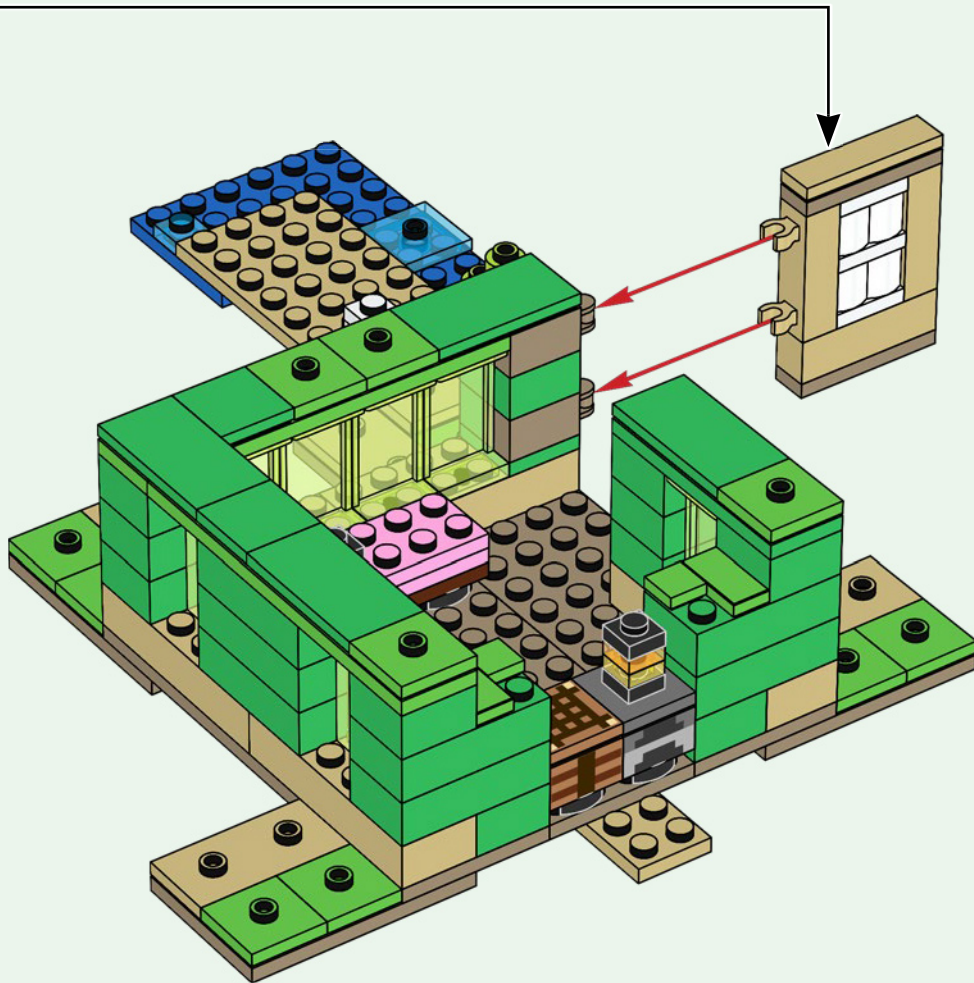

36

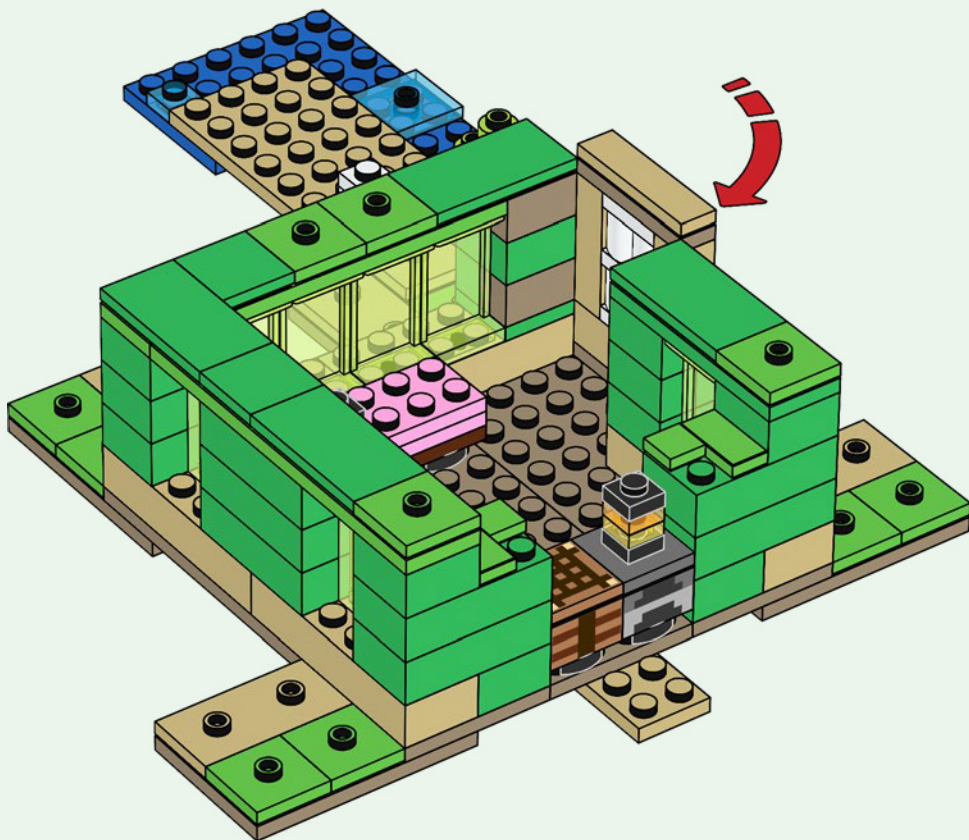

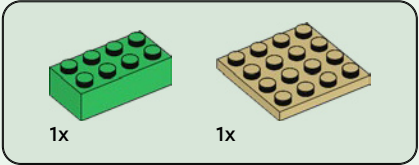
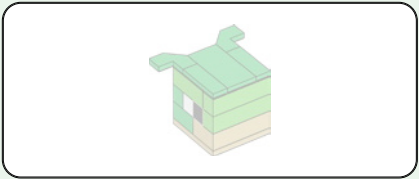

37

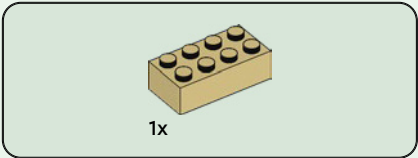
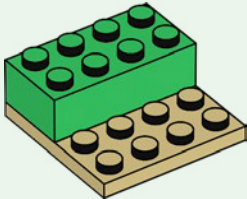

38

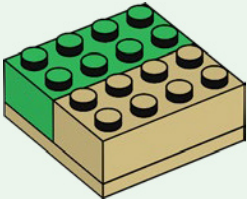



2x

39

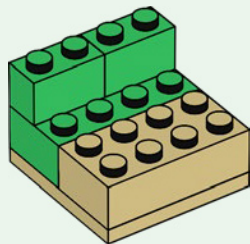

1x



1x

40

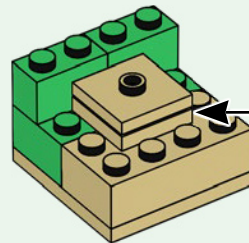
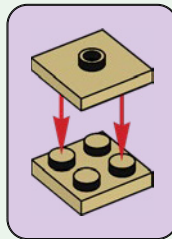

2x



2x

41

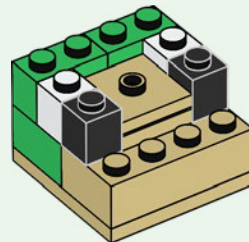

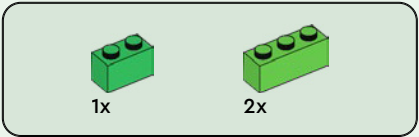

42

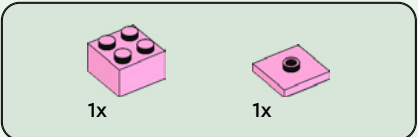
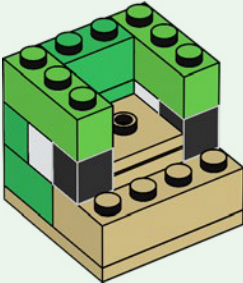

43

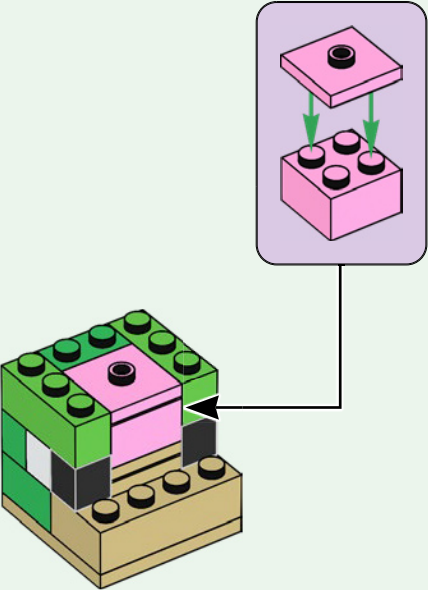

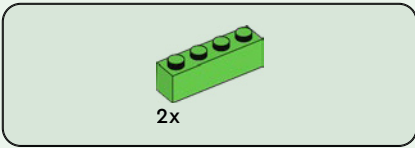

44

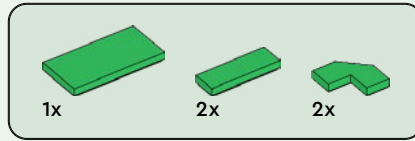
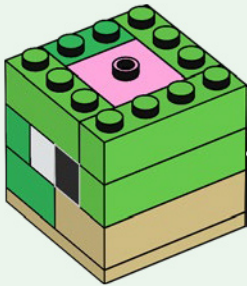
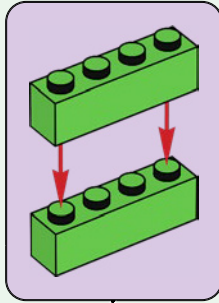

45

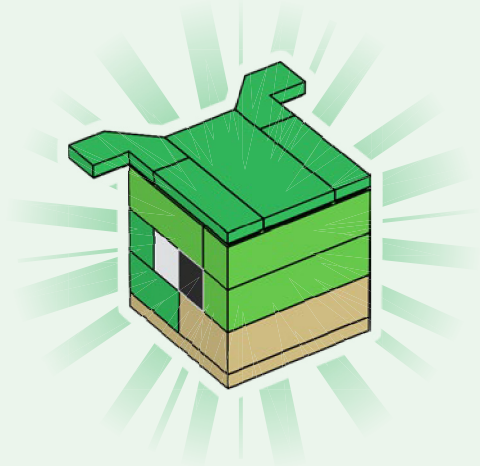

46

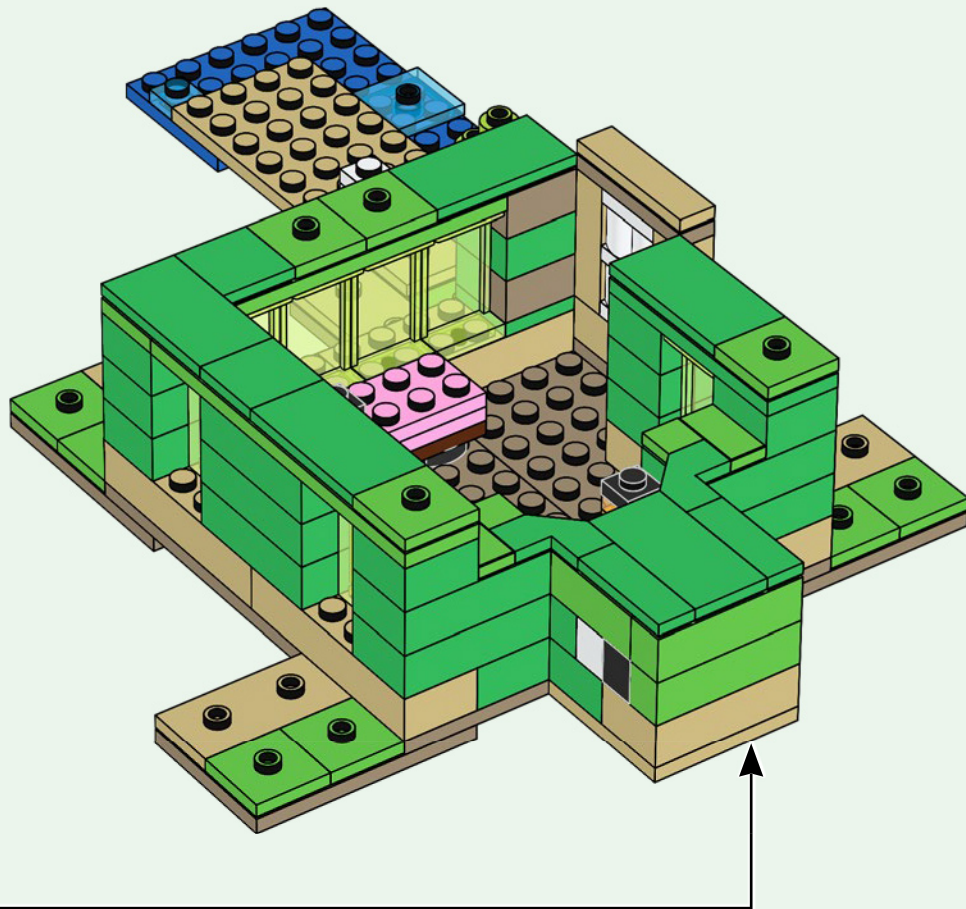

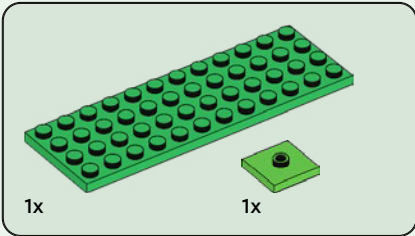
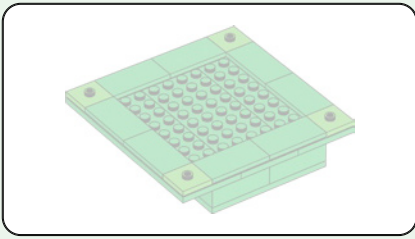

47

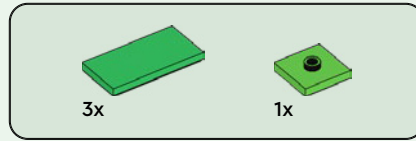
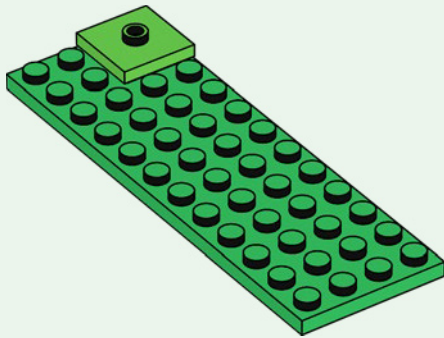

48

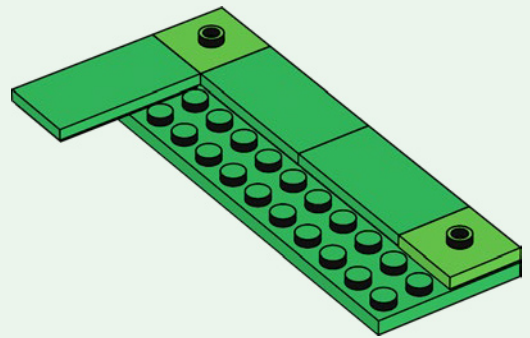

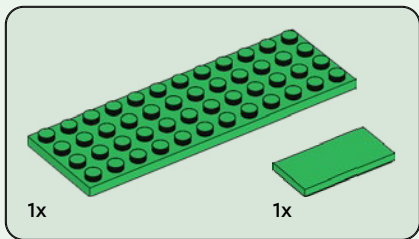

49

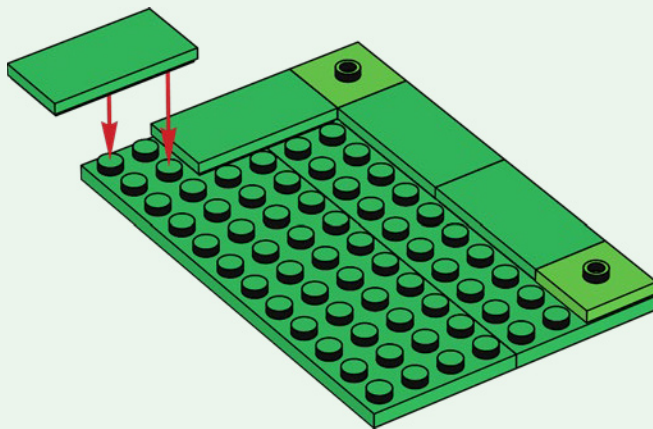

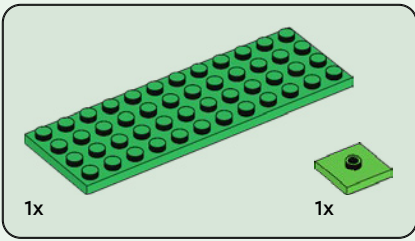

50

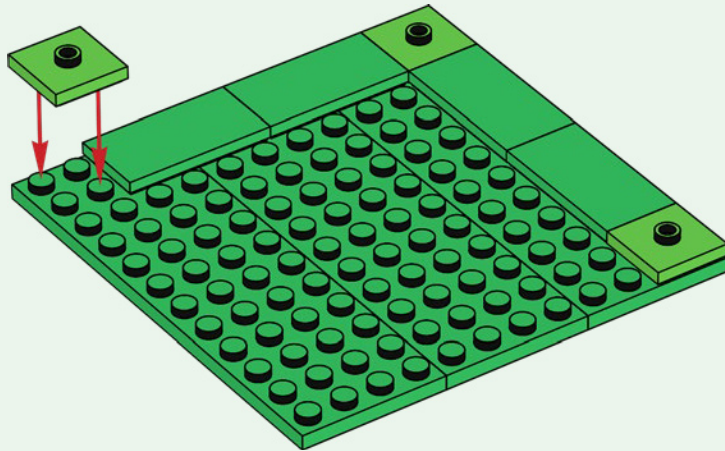

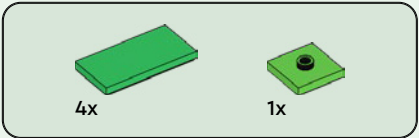

51

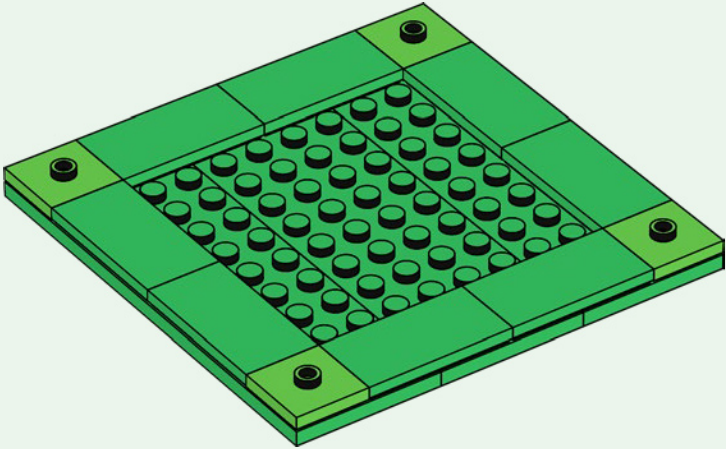

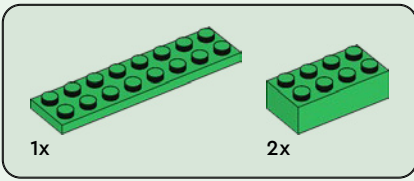

52

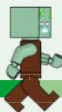
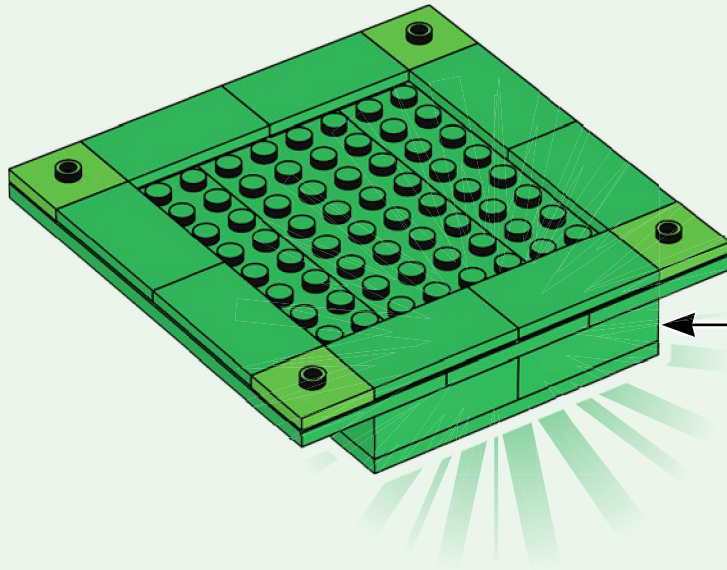
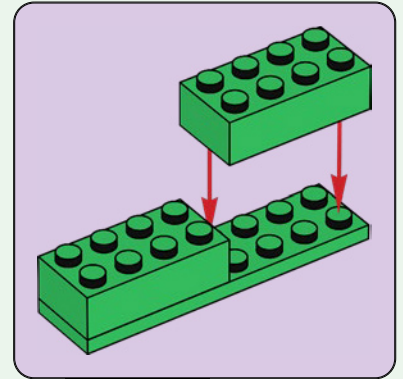

53

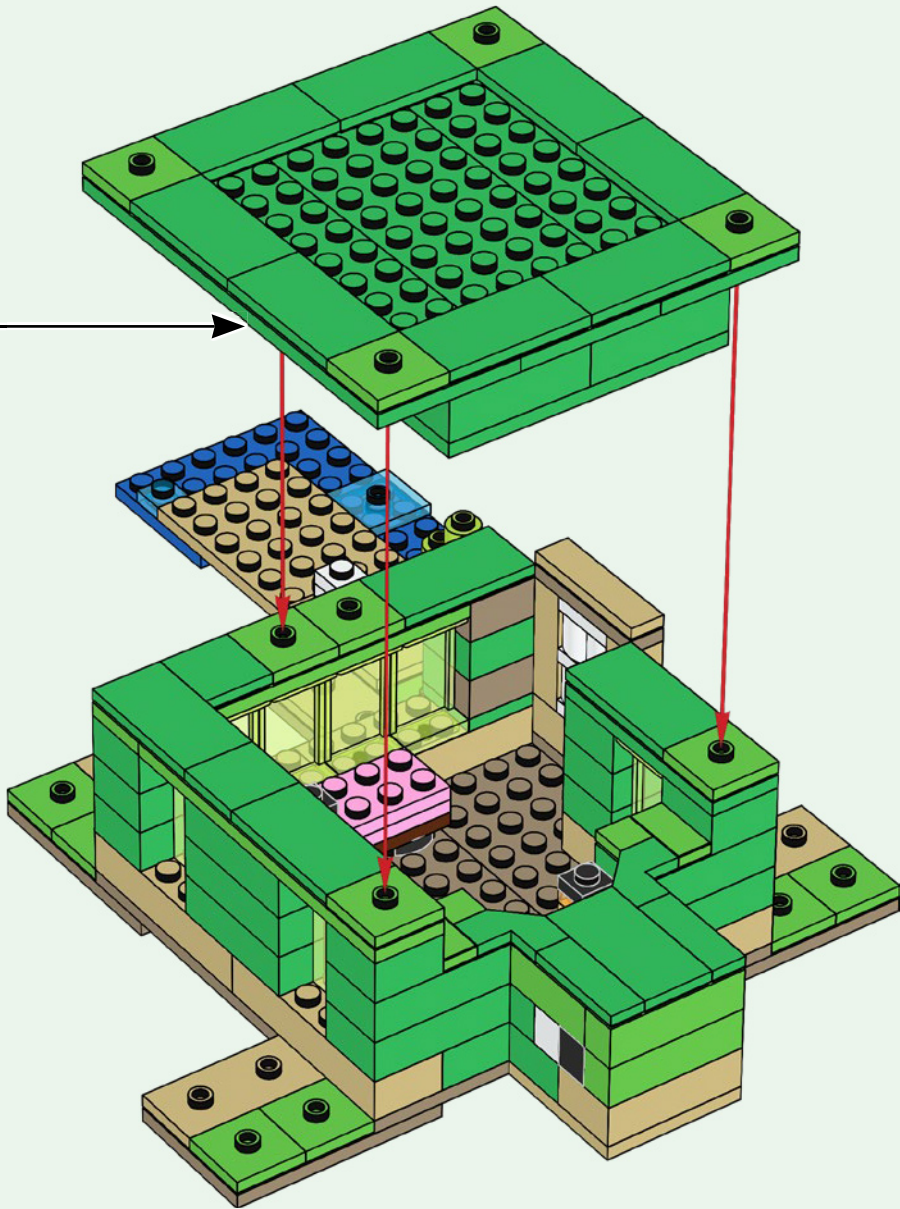





MINECRAFT

21256



21257



21251



21255



21252

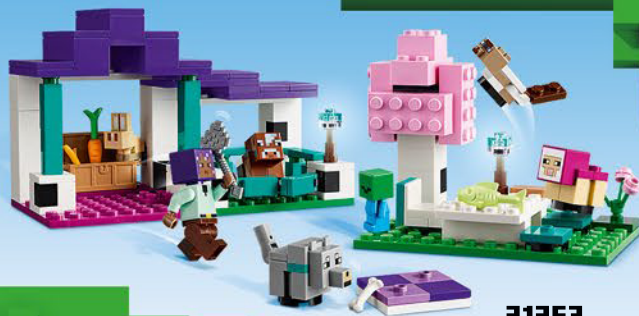

21253



21254



MINECRAFT

Combine sets to expand your play!
Combiner les ensembles pour encore plus de jeu !
¡Combina sets para jugar mucho más!

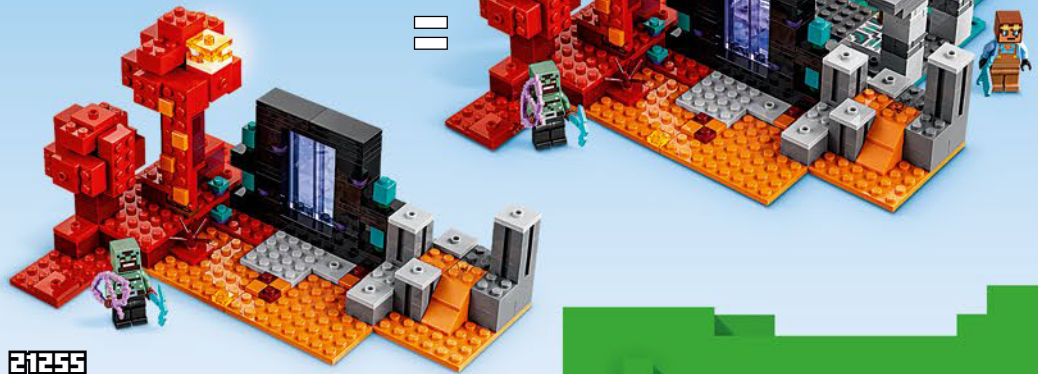
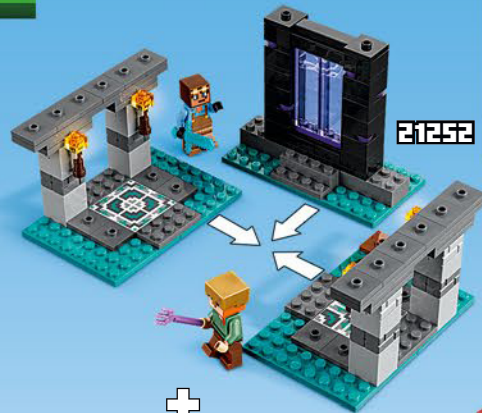



21253



21254





Rebuild
the
world™





Rebuild
the
world™



2x
6202501

1x
302401

2x
300501

2x
6059185

3x
302301



1x
306801



1x
302201

2x
4117070

8x
6443061

2x
6468818

1x
6057517

1x
6320357

1x
4278422

1x
6024495

2x
4565387

1x
4114084

1x
6385114

1x
6170776

3x
6468819

1x
4113916



1x
4550324

5x
6294227

2x
4114319

3x
4114309

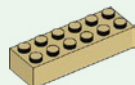
1x
4243824

4x
4181134

1x
4509897

1x
302223

2x
303223

4x
302426

2x
300526

4x
403226

2x
6272184

4x
6253140

1x
6269971

5x
4107736

11x
300328

2x
4107762

1x
302228

2x
6385275

2x
6023083



3x
6468474



1x
6253139

13x
4566179

10x
4106356

1x
379528

1x
303428

3x
4279059



1x
6434871



2x
6253176



2x
6172375



4x
6347296



1x
6368255



6x
6195258



1x
6336574



16x
6389695



2x
6343280



1x
6470514



1x
6468470



2x
6310856



2x
6462430



2x
6462430



3x
6468821



1x
6382577



2x
6315197



1x
6252041



1x
6252044



1x
6382531



2x
6252045



4x
4212454



1x
6281999



3x
6209682



2x
6310836



2x
4626904



4x
6167894



3x
6114515



1x
6114515



1x
6114515



1x
6114515



1x
6347366



1x
6335312



2x
6252040



2x
4216581



2x
4211242



7x
6468820



1x
4221886



1x
6336857



1x
6336857



1x
4211247



2x
4211406



1x
6216862



1x
6216860



1x
6216860



1x
6126083



1x
6126083



1x
6055169



1x
6251842



1x
4550359



2x
6204535



1x
4538126



1x
4538126



7x
6468820



2x
6097024



1x
6097003



2x
6097003



2x
6186030



2x
6186030



2x
6186030



2x
6186030



2x
6186030



2x
6186030



2x
6186030

 [LEGO.com/service](https://www.lego.com/service)

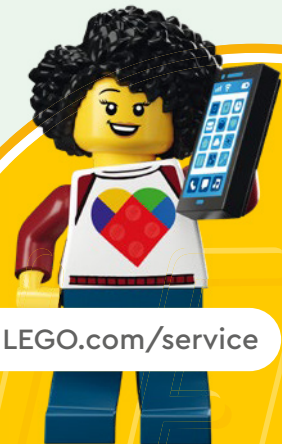

YOU COULD **WIN**



Scan this QR code or go to **LEGO.COM/PRODUCTFEEDBACK** and give us your short feedback about this LEGO® set for a chance to win a cool LEGO prize.

Terms and Conditions apply*

EN: YOU COULD WIN. Terms and Conditions apply* **DE: Du könntest GEWINNEN.** Es gelten die Teilnahmebedingungen* **FR: Tu pourrais GAGNER.** Des conditions s'appliquent* **IT: Potresti VINCERE tu.** Termini e condizioni sono applicabili* **ES: Puedes GANAR.** Aplican términos y condiciones* **PT: Poderá GANHAR.** Aplicam-se termos e condições* **ZH: 轻松获奖. 条款和条件适用*** **PL: Szansa na WYGRANĄ.** Obowiązują warunki korzystania* **CS: Máte šanci VYHRÁT.** Platí všeobecné smluvní podmínky* **SK: Máte šancu VYHRAŤ.** Platia všeobecné zmluvné podmienky* **HU: TE IS NYERHETSZ.** Felhasználási feltételek érvényesek* **RO: Ai putea CÂȘTIGA.** Se aplică termeni și condiții* **BG: Можете да СПЕЧЕЛИТЕ.** Има определени правила и условия* **LV: Tu vari LAIMĒT.** Ir spēkā noteikumi un nosacījumi.* **ET: Sul on võimalus VÕITA.** Kehtivad tingimused* **LT: Jūs galite LAIMĖTI.** Taikomos sąlygos*

*[LEGO.com/productfeedback-terms](https://www.lego.com/productfeedback-terms)