



Booklet available in English on
Heft in deutscher Sprache erhältlich auf
Livret disponible en français sur
Libretto disponibile in italiano su
Folleto en español disponible en
如需中文版手册, 请访问



FR

**DONNEZ
OU
RECYCLEZ**



ASSOCIATION
OU



MAGASIN
OU



DÉCHÈTERIE

Adresses sur quefairemesdechets.fr



LEGO.com/sustainable-packaging

LEGO® VIP

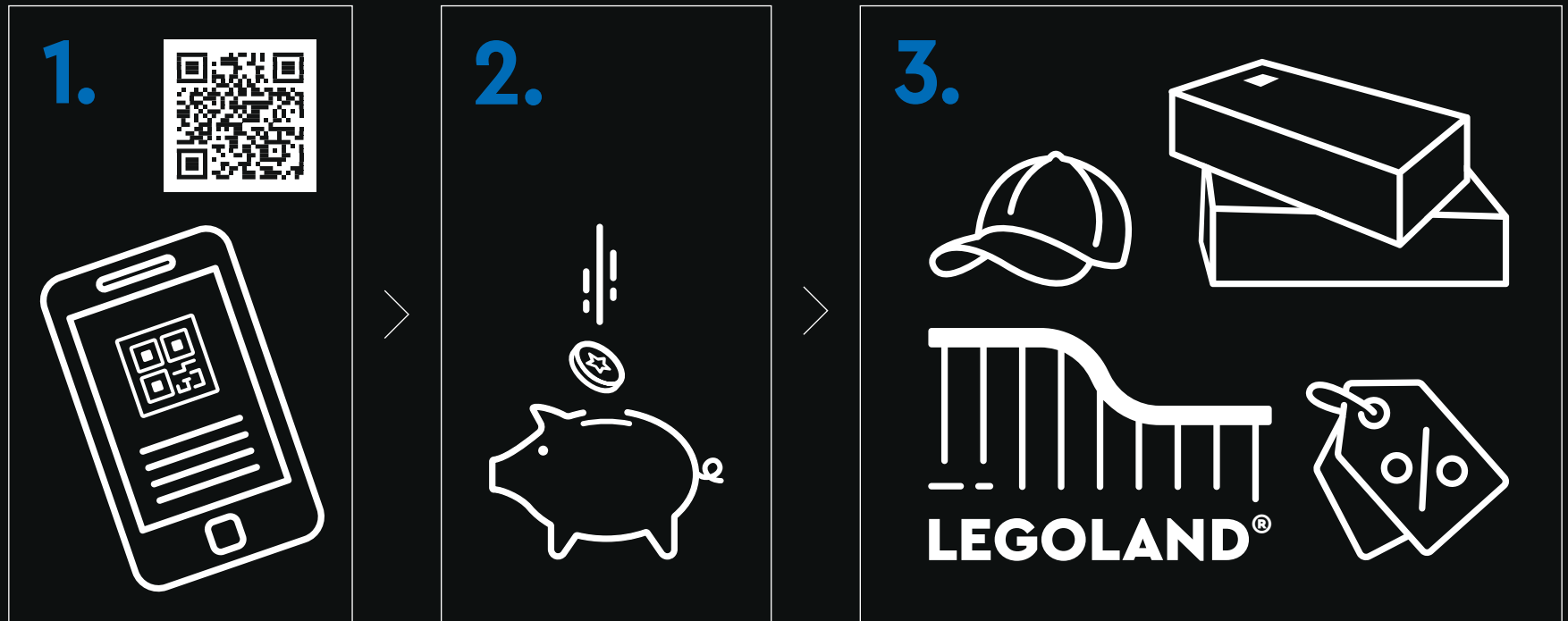

1. Sign up **2.** Earn points for purchases **3.** Redeem points for rewards, experiences, discounts & more | **1.** Melde dich an **2.** Sammle Punkte bei jedem Kauf **3.** Löse die Punkte für Belohnungen, Erlebnisse, Rabatte und Ähnliches ein | **1.** Inscrivez-vous **2.** Gagnez des points lors de vos achats **3.** Échangez vos points contre des récompenses, des expériences, des remises et bien plus encore | **1.** Iscriviti **2.** Guadagna punti con i tuoi acquisti **3.** Riscatta punti per premi, esperienze, sconti e altro ancora | **1.** Regístrate **2.** Gana puntos por tus compras **3.** Canjea puntos por recompensas, experiencias, descuentos y mucho más | **1.** Registe-se **2.** Ganhe pontos em compras **3.** Troque os pontos para prémios, experiências, descontos e muito mais | **1.** 注册 **2.** 购物赚积分 **3.** 用积分兑换奖励、体验、折扣等 | **1.** Zarejestruj się **2.** Zdobywaj punkty za zakupy **3.** Wymieniaj punkty na rabaty, przygody i inne nagrody | **1.** Zaregistrujte se **2.** Sbírejte body za nákupy **3.** Vyměňujte body za odměny, zážitky, slevy a spoustu dalšího | **1.** Zaregistrujte se **2.** Získavajte body za nákupy **3.** Uplatnite si body a získajte odmeny, rôzne zážitky, zľavy a ešte viac | **1.** Regisztrálj **2.** Szerezz pontokat minden vásárlással **3.** Váltsd be pontjaidat jutalmakra, élményekre, kedvezményekre és egyebekre | **1.** Înscric-te **2.** Câștigă puncte pentru achiziții **3.** Valorifică puncte pentru recompense, experiențe, reduceri și multe altele | **1.** Регистрируйте се **2.** Получайте точки за покупки **3.** Используйте точки за награды, услуги, отстъпки и т.н. | **1.** Reģistrējies **2.** Pelni punktus par pirkumiem **3.** Izmanto punktus, lai saņemtu balvas, izklaides iespējas, atlaides un daudz ko citu | **1.** Registreeru **2.** Teeni ostude eest punkte **3.** Lunasta punktide eest preemiad, elamused, allahindlused ja muu | **1.** Užsiregistruokite **2.** Pelnykite taškų už pirkinius **3.** Panaudokite taškus atlygiui, funkcijoms, nuolaidoms ir ne tik



Meet the fan designer

Belgian fan designer Amber Veyt (LEGO® Ideas name TheAmbrinator) is a lifelong magic and LEGO fan and a passionate designer at heart. She loves drawing and gaming, and in 2021 she participated in the Dutch/Belgian LEGO Masters TV show.





“When I was little, my parents gave me lots of LEGO® sets, and I’ve always loved the limitless creations I could make with them. LEGO building is still a big part of my life and a great passion of mine. I’ve always been a huge fan of Disney’s *Hocus Pocus*. I watch it every year and still love it. The Sanderson Sisters’ cottage is full of details and almost a character of its own in the story and I thought it would make a great LEGO set. I had previously submitted a Disney *Hocus Pocus*-inspired set to the LEGO Ideas website, reaching 10,000 supporters, but I decided to upgrade my ideas for the house to make it more playable. I started over from scratch and applied new techniques and design details to the new version. It took several months, but using digital design programs really helped. The hinges in the house and the watermill were the most challenging to recreate. Movable objects are just really difficult for some reason! The outfits, minifigure faces and decorations were so much fun to design. When I shared the final model on Instagram and Facebook, a lot of fans helped me share it and spread the word (THANK YOU!). A few people from the original Disney *Hocus Pocus* cast even shared it. That was a dream come true. I was just ecstatic when this version gained enough support and was approved as an official set! I hope both Disney’s *Hocus Pocus* and LEGO fans will have fun building and playing with the house and the colourful characters.”



“It’s just a bunch of Hocus Pocus!”

I tch-it-a-cop-it-a, mel-a-ka-mys-tic-a... Ooh, Halloween. The holiday that invites us to dwell on our darker side and embrace the mysterious, messy and macabre, the grim and grotesque. All for fun and thrills, of course! But did you know the celebration most likely traces back to an ancient European tradition? *Sambain*, a 2,000-year-old Celtic feast, took place after the harvest and honoured the spirits of lost ones who were believed to reappear just this one solemn night a year, lingering in the realm between the living and the dead. Over time, Catholic saints were honoured on what became All Hallows’ Eve, which evolved into an evening to celebrate all our dearly departed – and to thwart off the not-so-dear in life and still feared in death: the cunning conjurers of dark magic and witchcraft. It’s the perfect recipe for an imagination-enhancing potion!



But look, they conjure!

For decades Halloween, as we know it today, has enthralled kids and adults of all ages. We love our traditions, from trick-or-treating and carving pumpkins to playing monsters and watching grueling, quirky or funny Halloween-themed movies with family and friends. One of the most iconic of these is Disney's *Hocus Pocus* (1993), which has become an undisputed Halloween comedy classic. The Sanderson Sisters, a troublesome trio of wily witches, meet their dismal end on a fateful night in 1693 after tricking the village children with their magic. But amid their misfortune, Winifred, the oldest and wisest of the sisters (though not by much), casts the spell that allows them to return to their physical form 300 years later. And behold, the anticipated, bewitching mayhem ensues for generations of fans to savour. Broom, ho! Dust off your flying Hoover, it's time to brew your own Disney *Hocus Pocus* stories and potions and build Amuck! Amuck! AMUCK!



“Oh look, another glorious morning. Makes me sick!”
— Winifred Sanderson

Trivia and treats

The house in the movie was inspired by 17th-century architecture and the cast and crew all pitched ideas to create layers upon layers of ghastly, ghoulish and goofy details.

In the movie, the witches' cauldron was lit from below to cast an eerie glow on the cottage interior. The feature in the LEGO® model works much the same way – with the light brick casting a chilling glow into the room.



The original title of
the movie was
The Halloween House.

“BOOOOOOOOOK!” Winifred’s book of spells was actually three books. One with a remote-controlled moving eye and two containing recipes and spells, with the eye open and closed. The book is bound in human skin and adorned with human fingers and metal serpents (eek!).

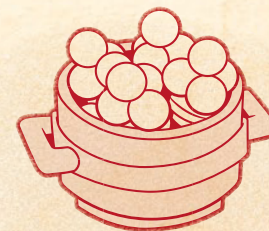

As the Disney *Hocus Pocus* story takes us to Halloween in 1993, Max, Dani and Allison are in school. That year, Halloween was actually on a Sunday – not a school day. Maybe someone cast a leap-year spell that year?



Which witch wore which robes? The witch costumes were designed to break with the conventional black robes that witch characters had traditionally worn in previous movies. Each dress, cape and hairstyle reflects the bubbly personalities of the Sanderson Sisters.



Thackery Binx, the talking cat, was the first partially computer-animated character in a movie. Six animatronic cats and eight live cats helped play the part, and groundbreaking new CGI technology brought the bewitched, spirited kitty to life.

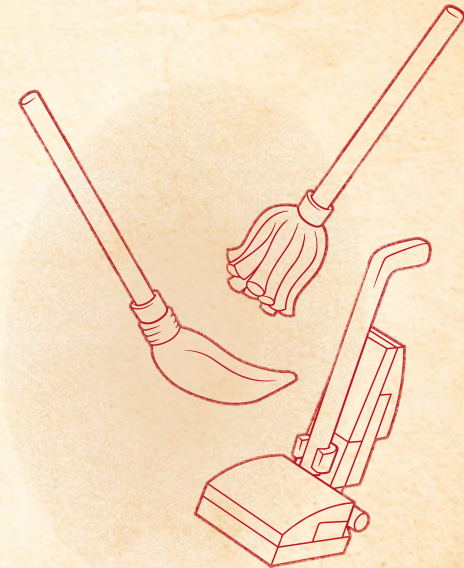

Meet the LEGO® Designers

Clever witches, beware of secret details haunting this cottage! Amber combined LEGO® humour and the quirkiness of the movie with some personal, funny touches, like the quilt that combines all the colours from the sisters' dresses. This set brings the magic and mischief from the movie to life, with skeletons and cobwebs, tombstones, potion bottles, broomsticks, Mary's flying hoover and the cauldron full of life-sucking potion! PS: Five years ago, I built my version of the witches' cottage, and I may have cast a few ~~curse~~ harmless spells to get to work on this set.'

—Ann Healy, LEGO Ideas Model Designer

Disney's *Hocus Pocus* is one of the great movies of the 90s, so it's fitting that this set came to life with support from the fans! I loved the level of detail in Amber's original submission. It really captured the atmosphere of the house from the movie, and we kept that density in the set. The chimney and the waterwheel were already lined up, so we connected those mechanisms so they both move. Being able to "light up" the fire pit is a nice extra feature to add to the haunting vibes. We've even installed a sprinkler (conjured from a grey flower element) for extra safety.'

—James May, LEGO Ideas Model Designer

The model really shows how much Amber loves the movie. Like so many other fans who grew up with the movie, I had been stalking her project on the LEGO Ideas website. She did such a great job with her research, and her model was a perfect framework. What can you do to improve on something that is already so well done? We had fun sneaking funny movie references and details into the graphics for fans to conjure into view as they build. Now grown-up fans can watch the movie with their kids and build this set with them, too, and I hope we did the movie and the fans justice!'

—Lauren Cullen King, LEGO Ideas
Senior Graphic Designer



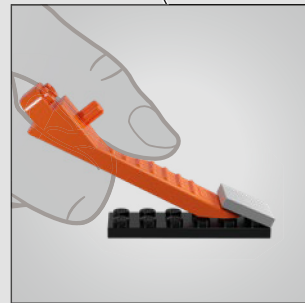
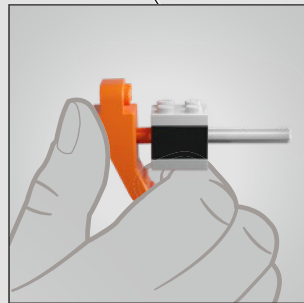
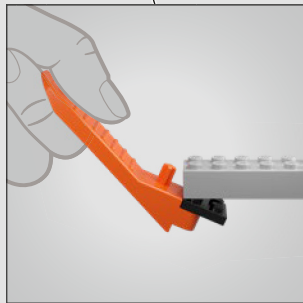
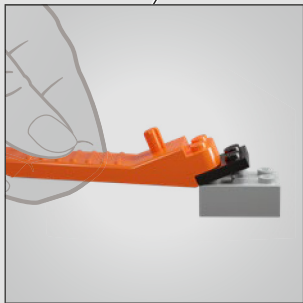
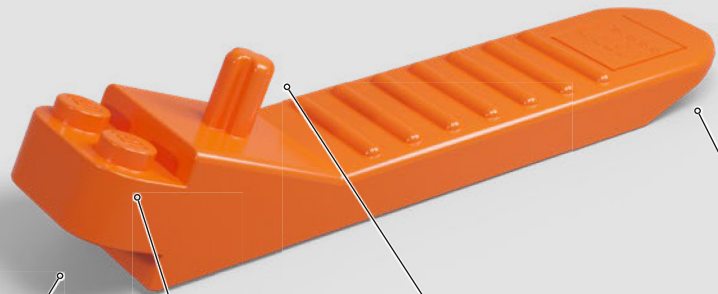

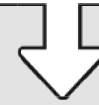
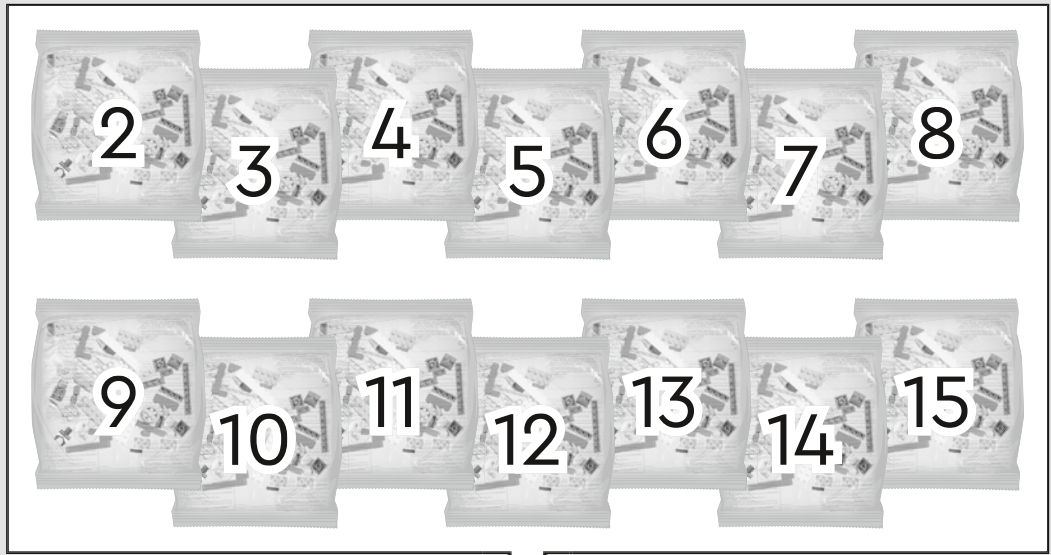
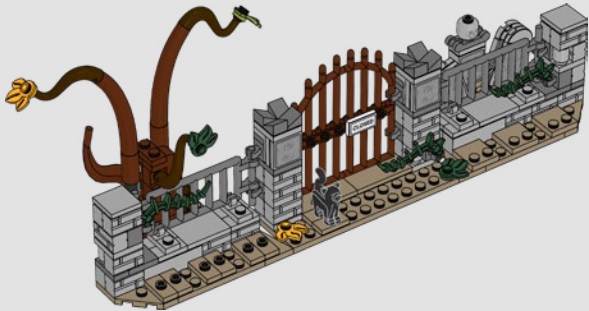
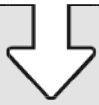

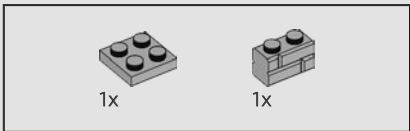
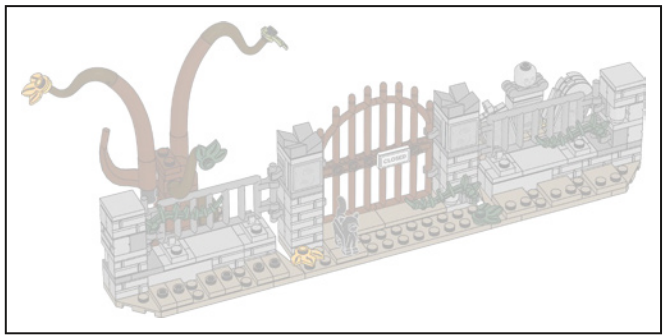

1

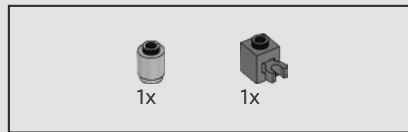
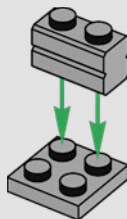

2

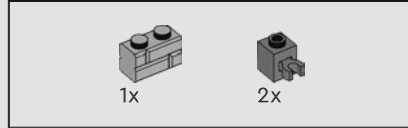
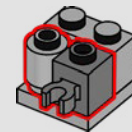

3

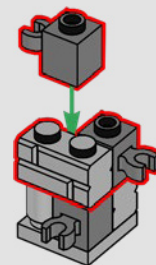

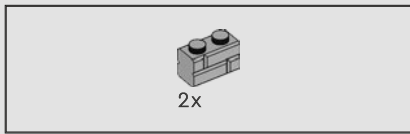

4

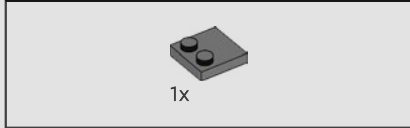
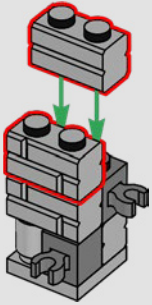

5

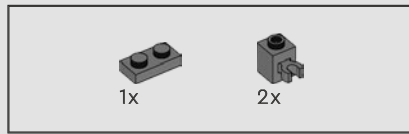
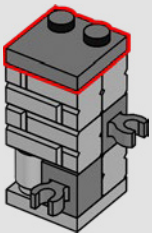

6

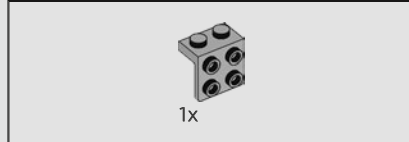
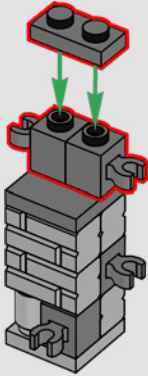

7

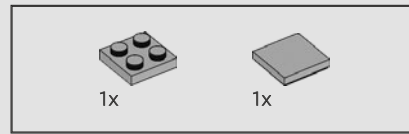
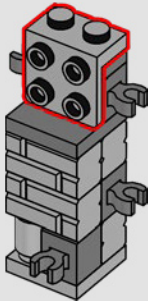

8

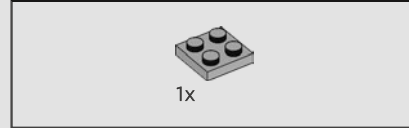
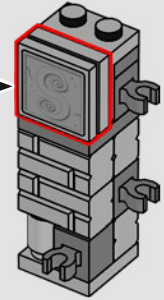
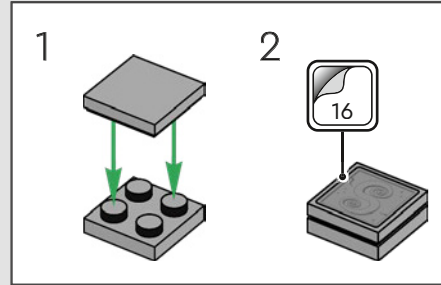

9

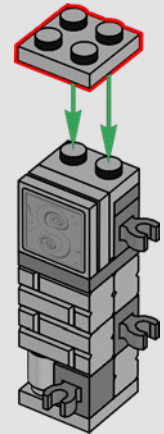

4x

10

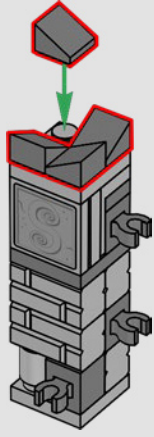

1x

11

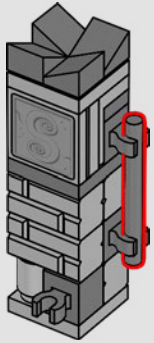

1x

12

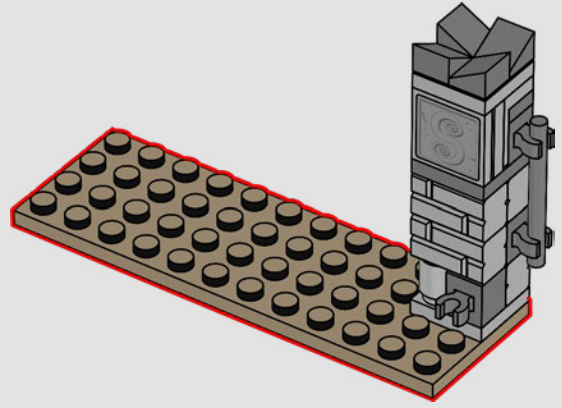
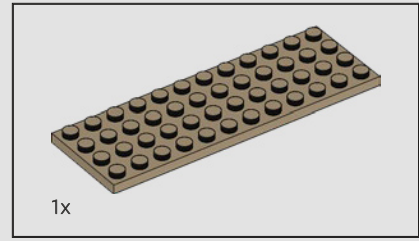

2x

2x

13

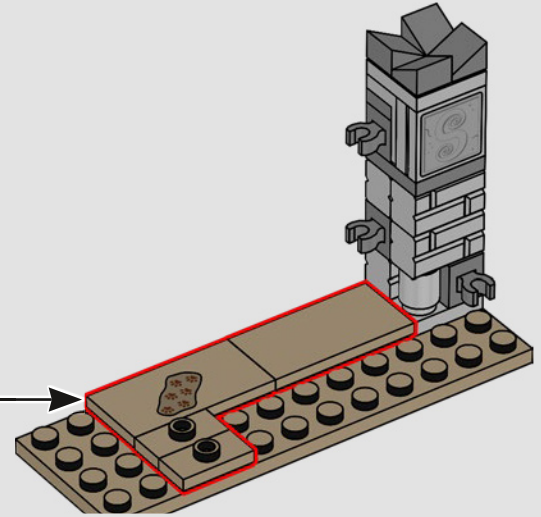
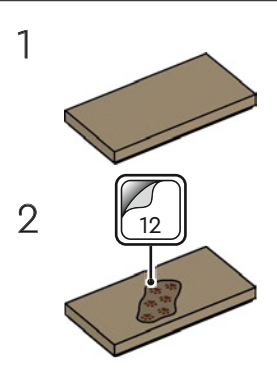

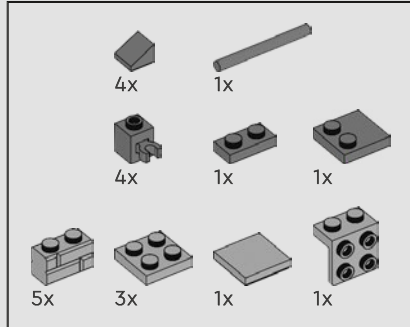
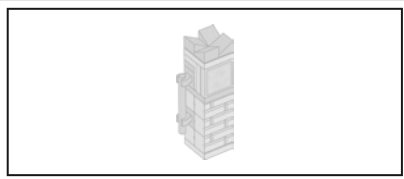

14

1

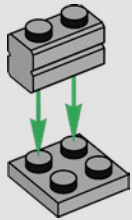

2

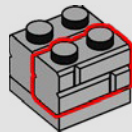

3

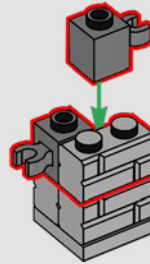

4

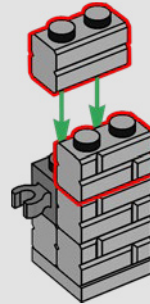

5

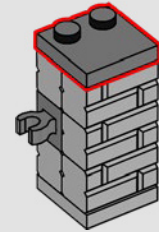

6

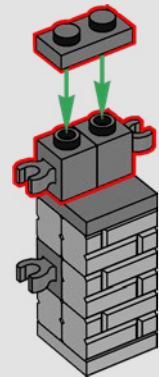

7

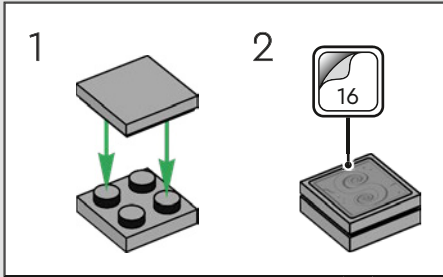
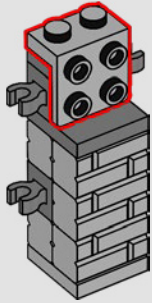

8

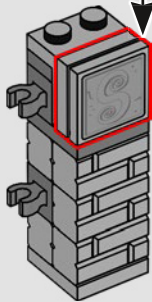

9

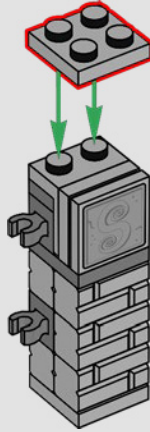

10

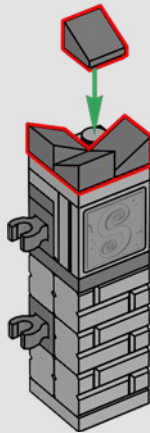

11

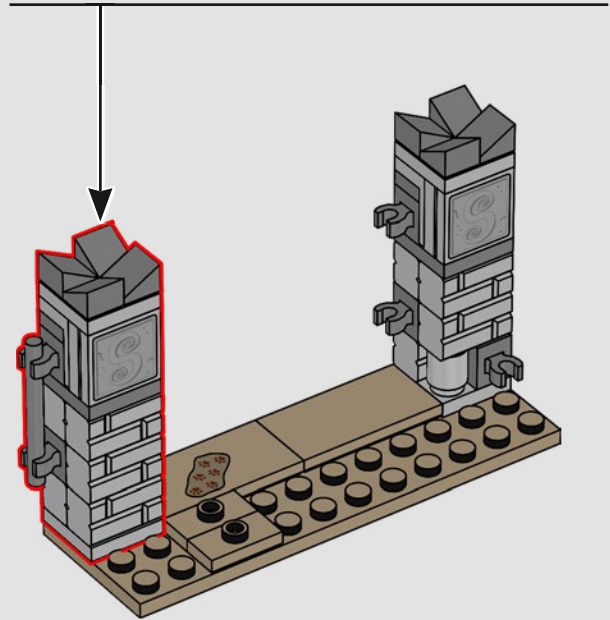
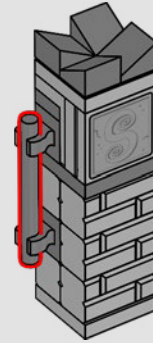

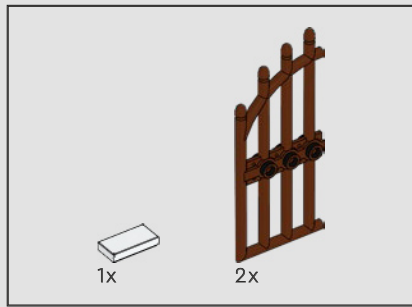

15

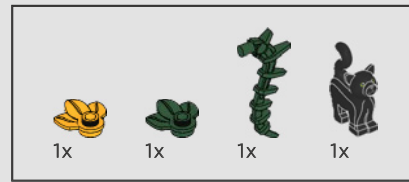
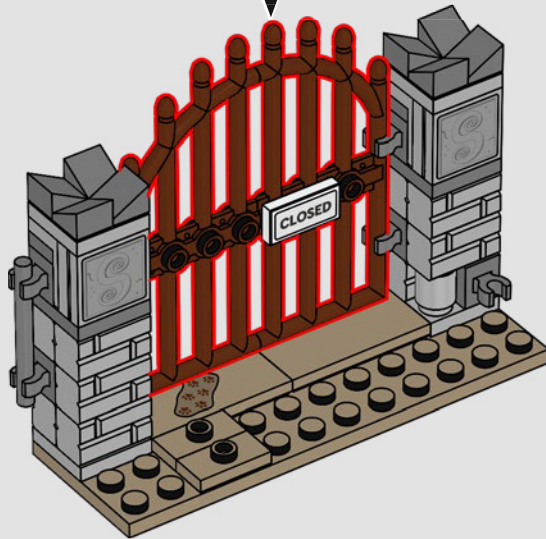
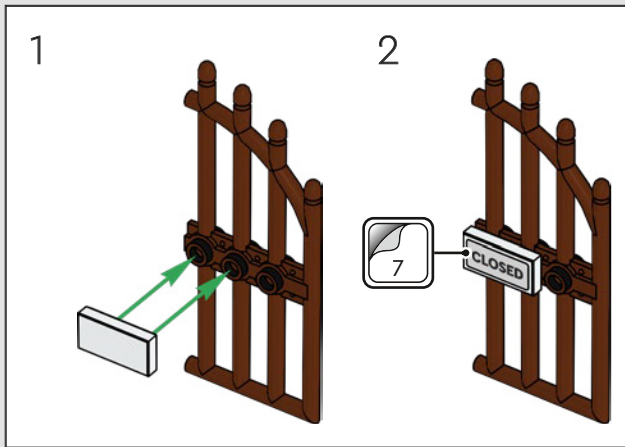

16



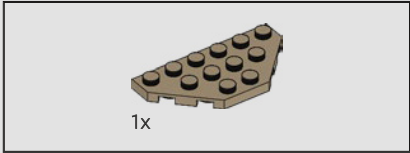
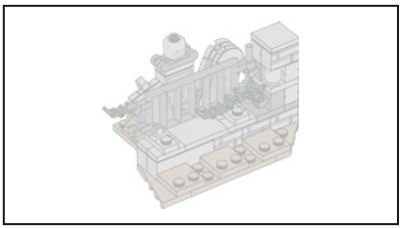

17

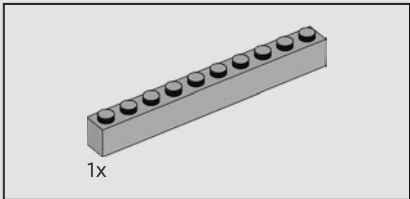
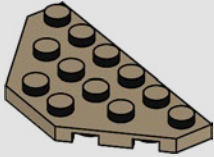

18

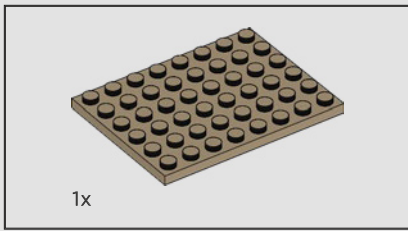
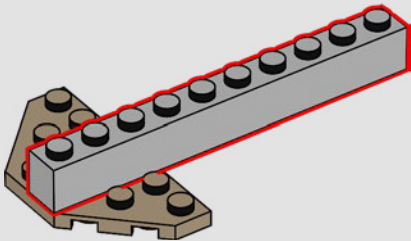

19

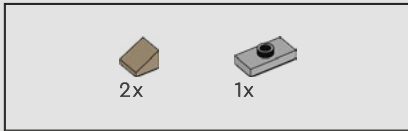
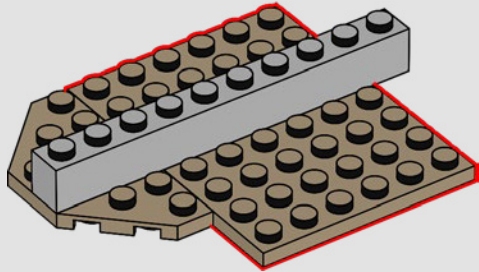

20

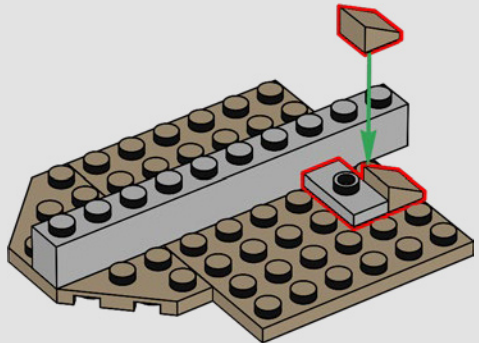

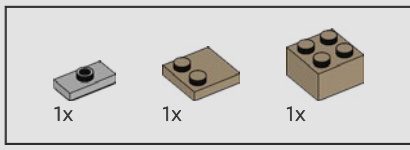

21

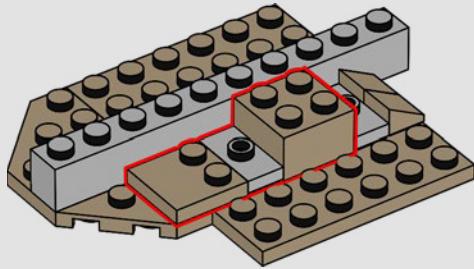

22

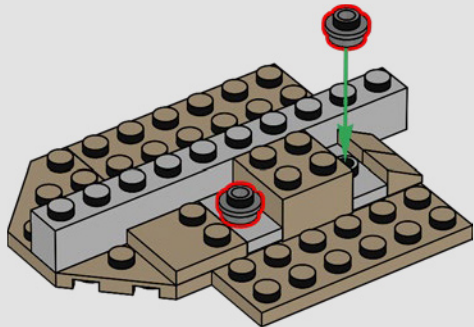

23

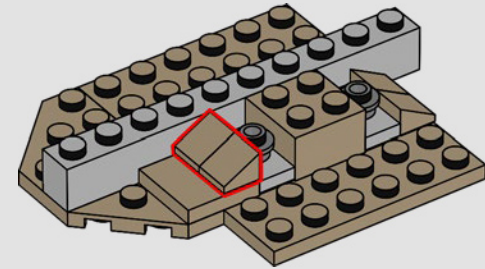

24

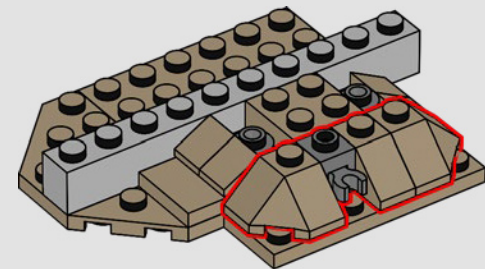

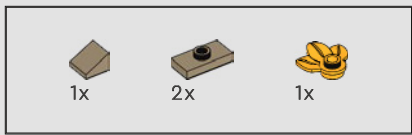

25

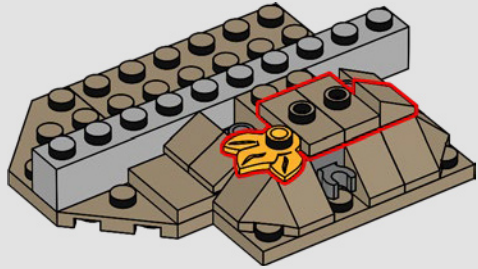

26

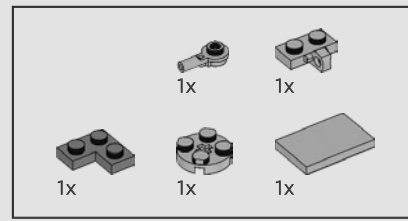
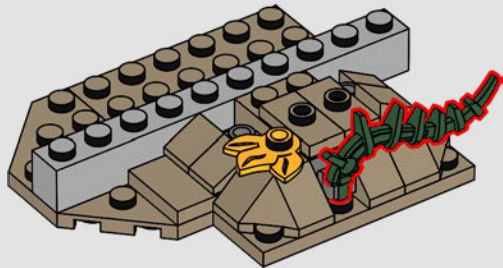

27

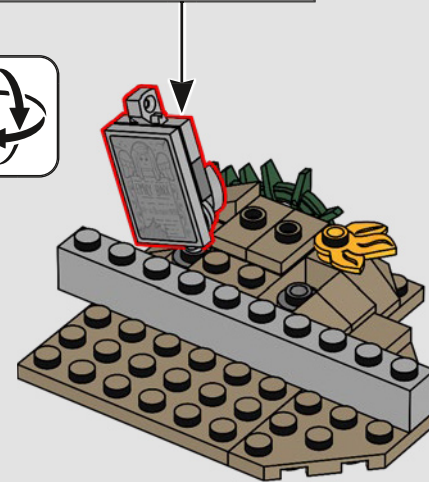
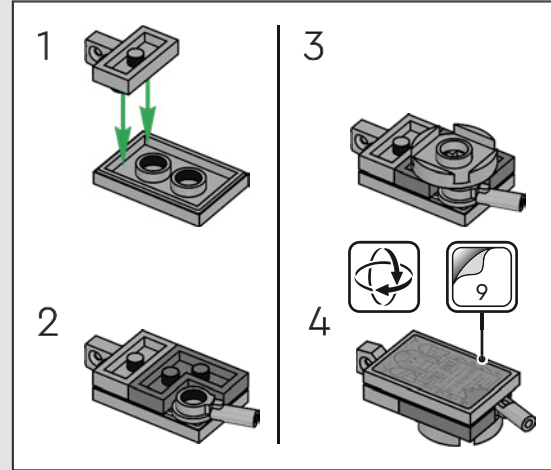

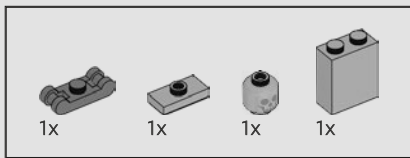

28

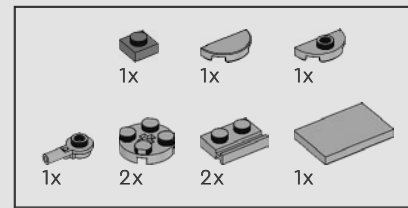
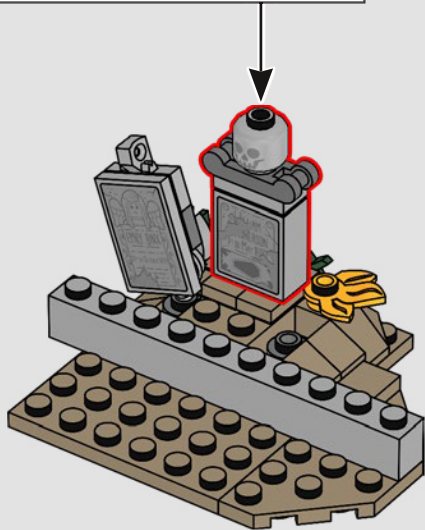
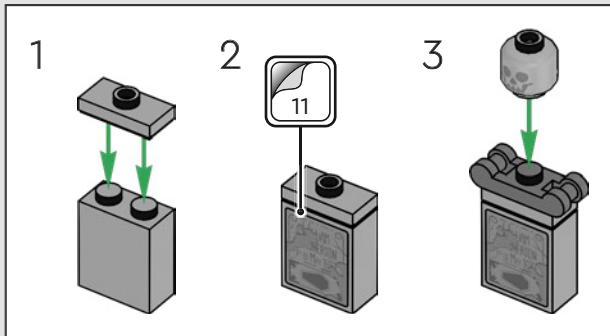

29

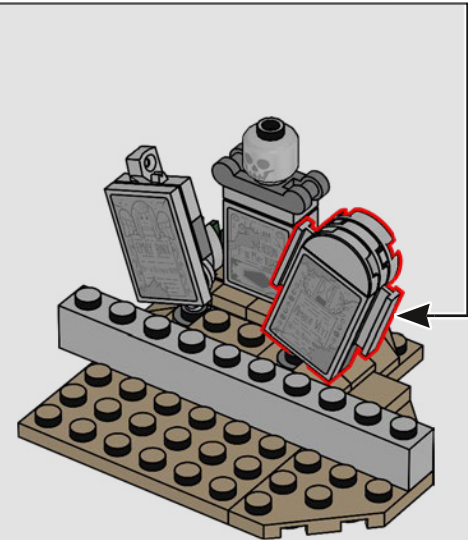
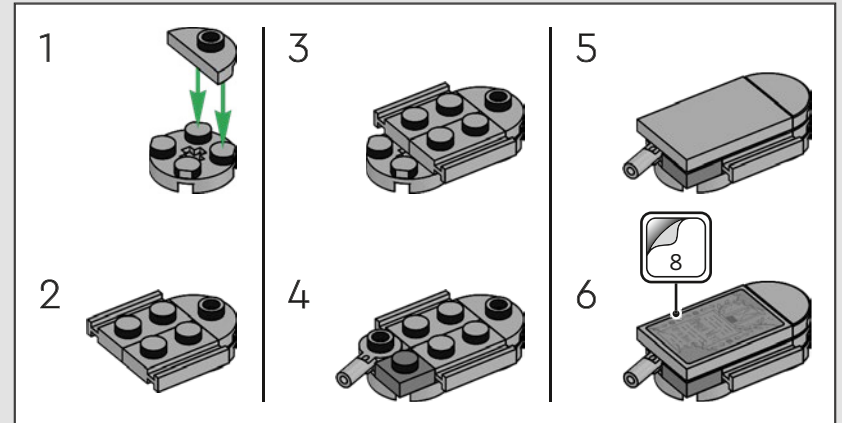

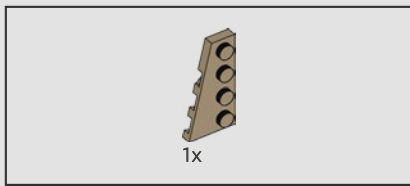

30

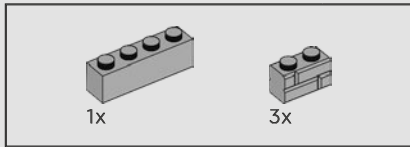
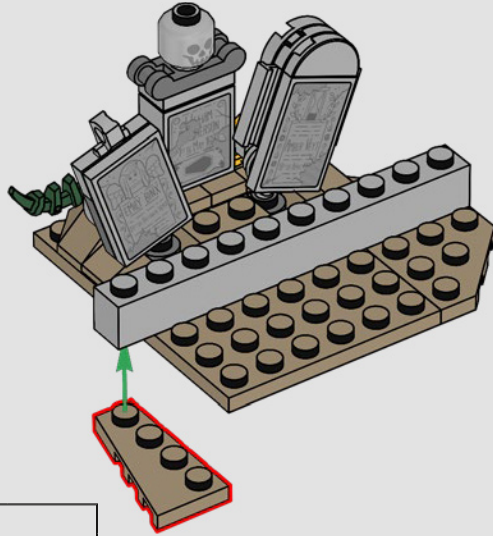

31

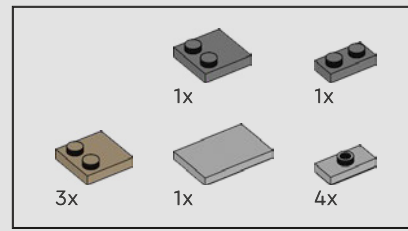
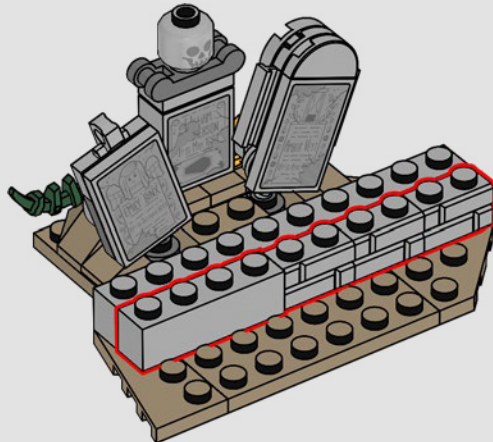

32

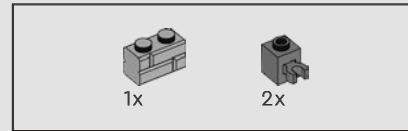
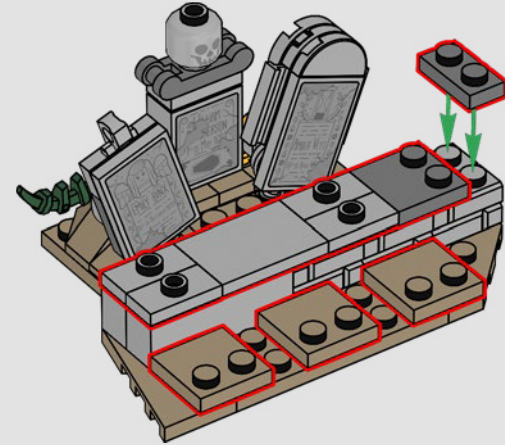

33

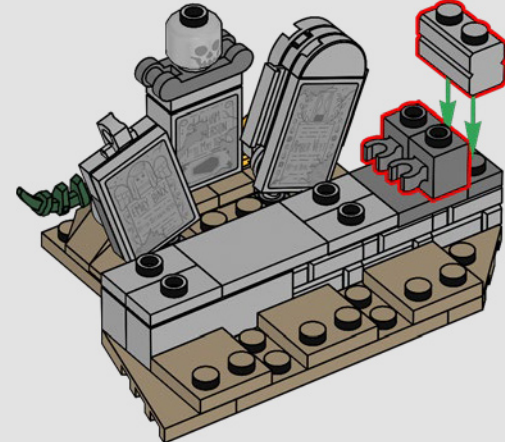

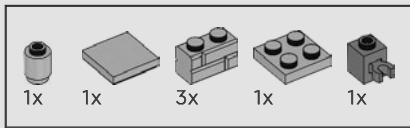

34

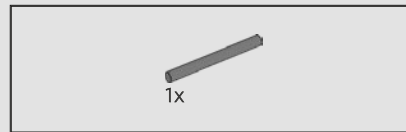
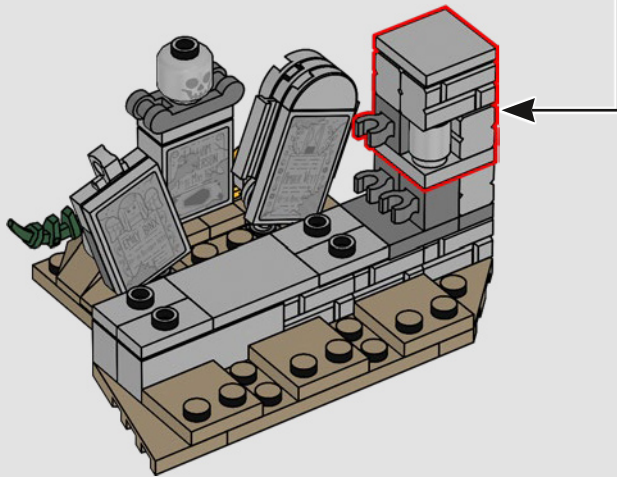
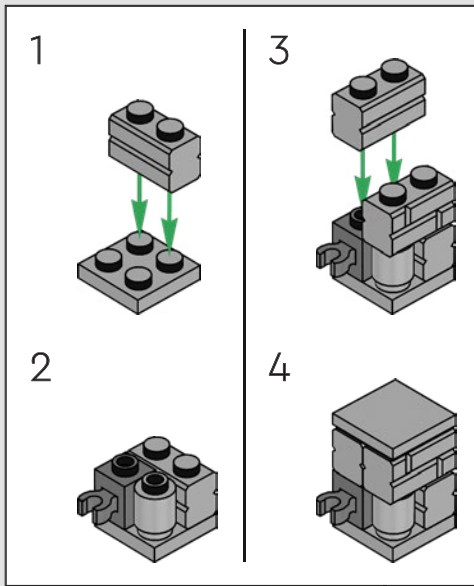

35

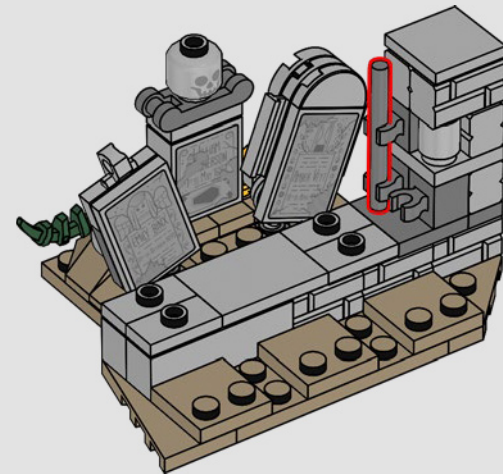

36

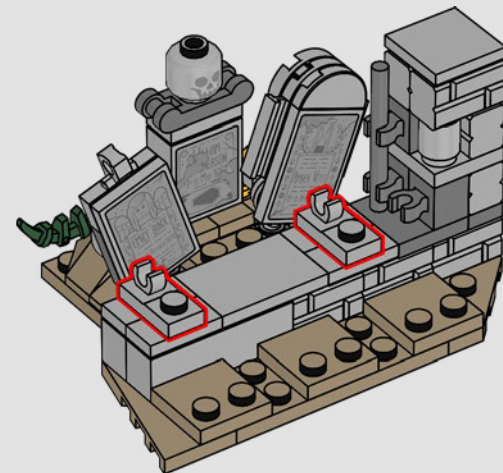

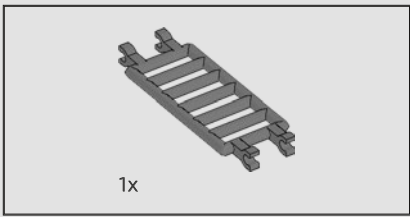

37

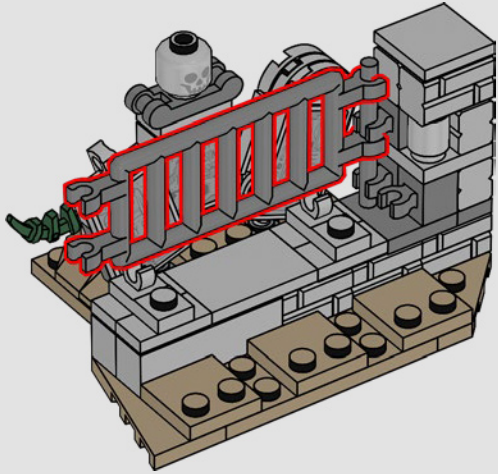

38

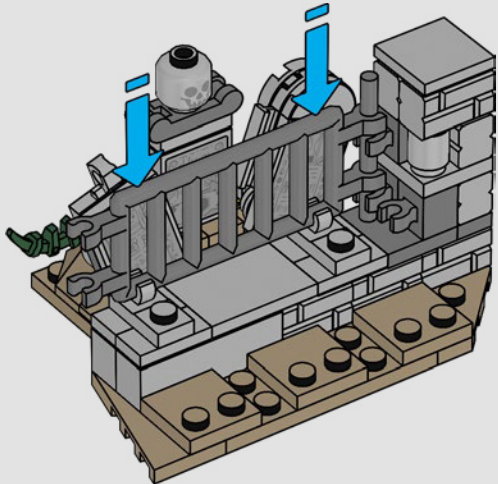

39

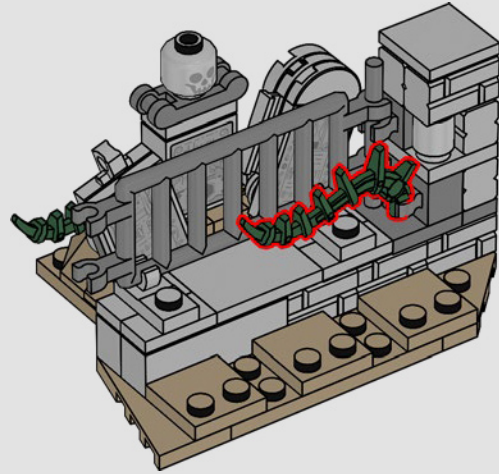

40

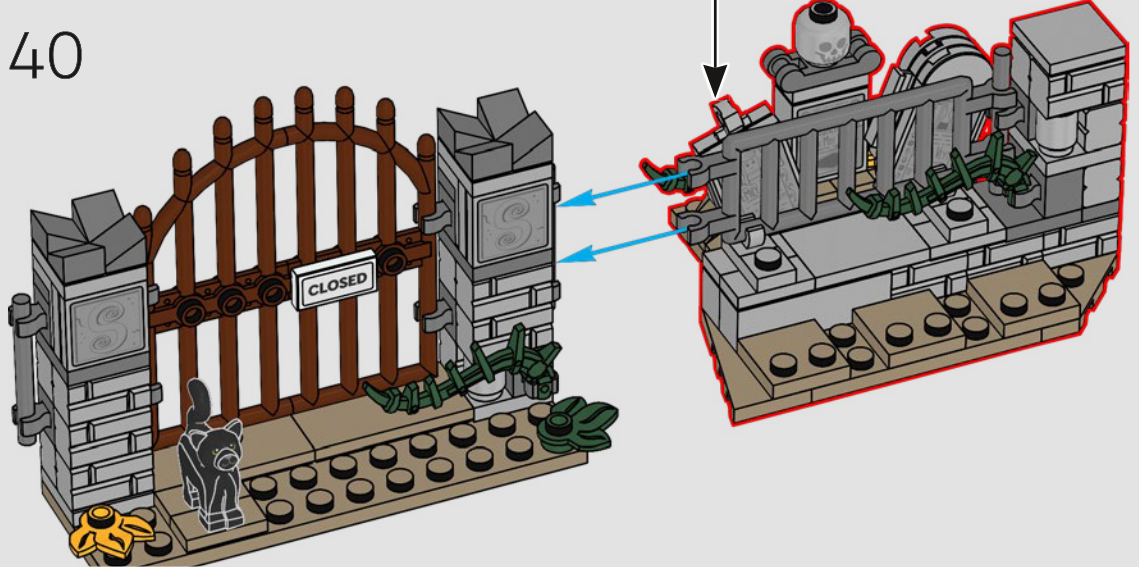

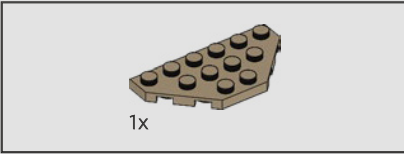
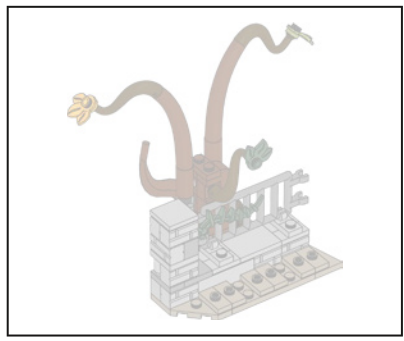

41

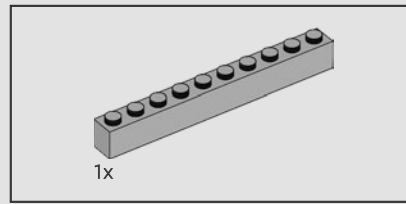
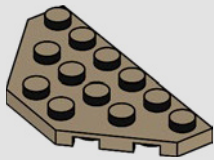

42

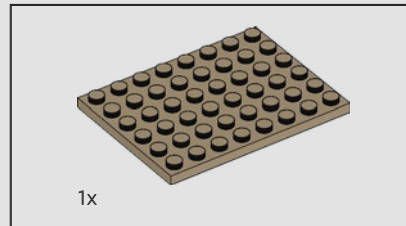
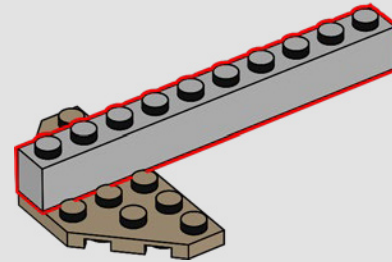

43

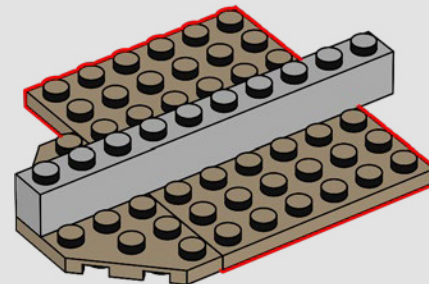

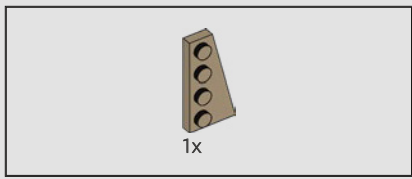

44

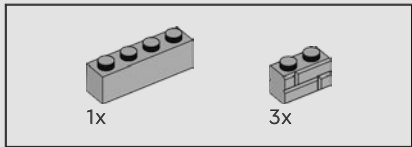
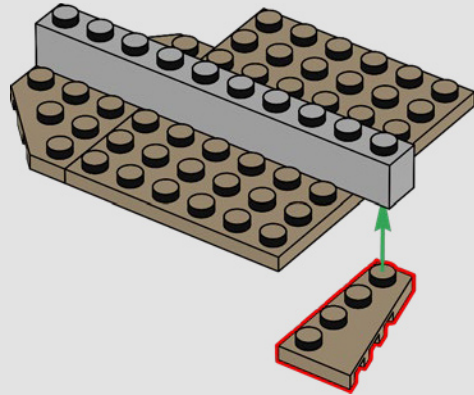

45

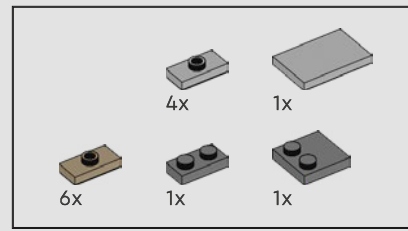
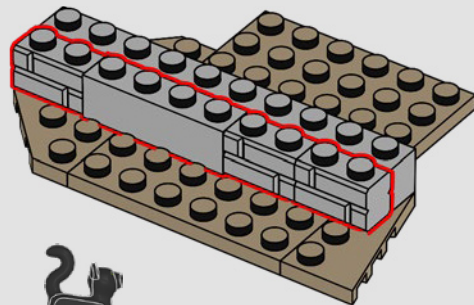

46

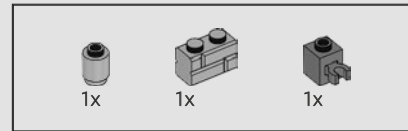
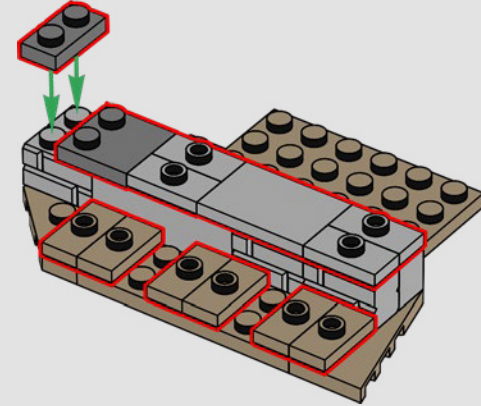

47

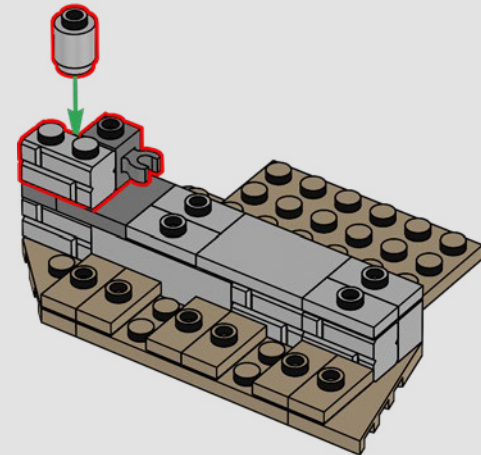

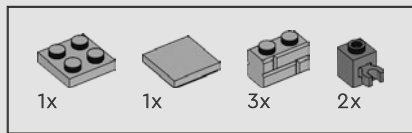

48

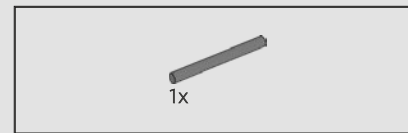
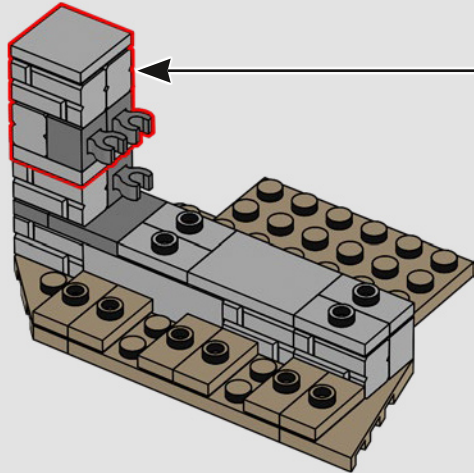
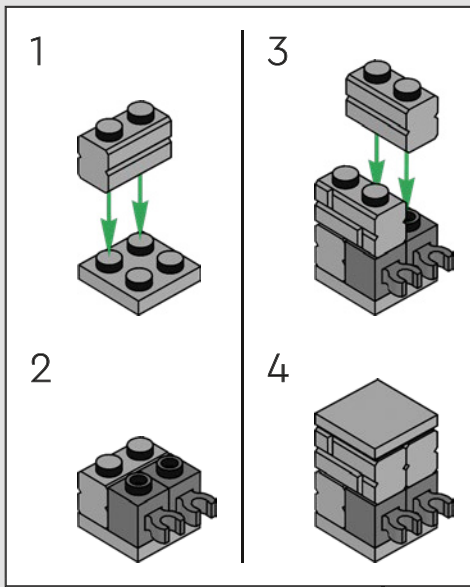

49

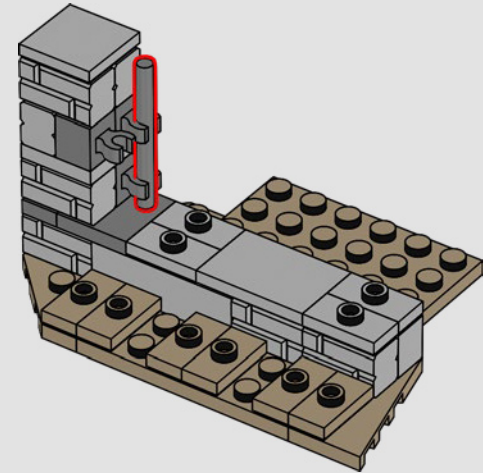

50

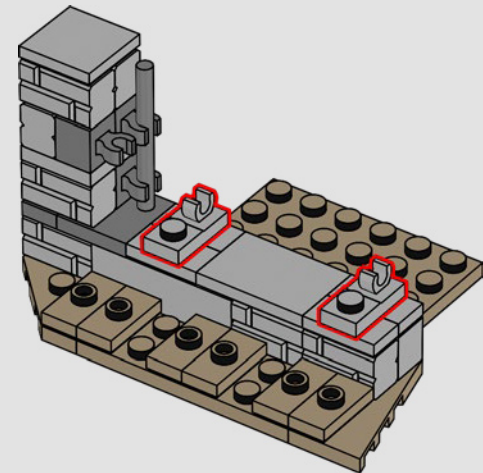



51

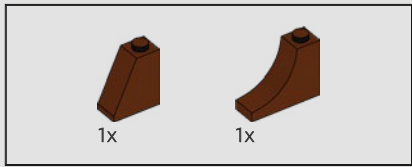
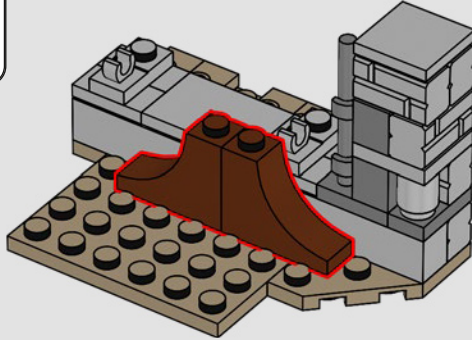

52

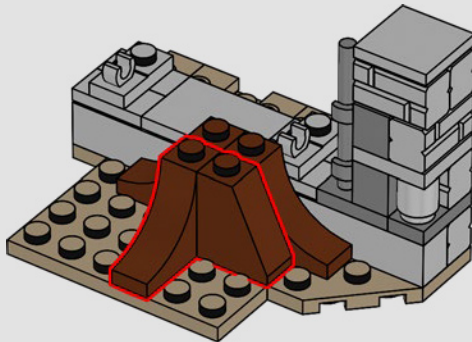

53

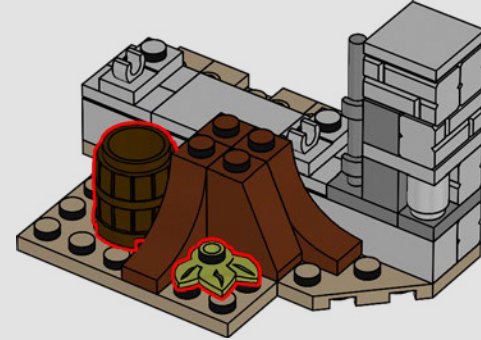

54

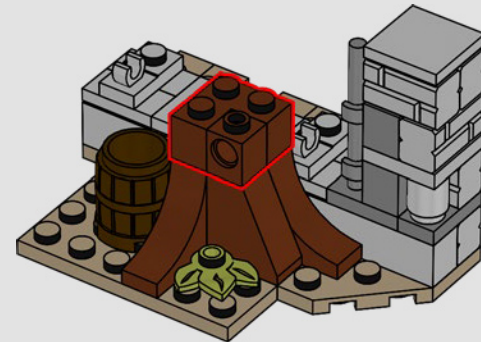

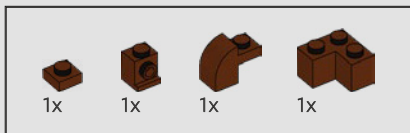

55

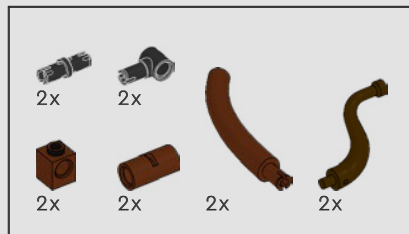
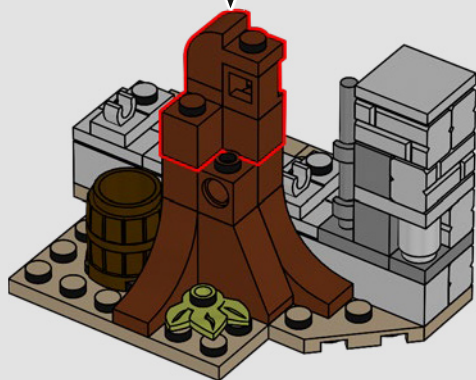
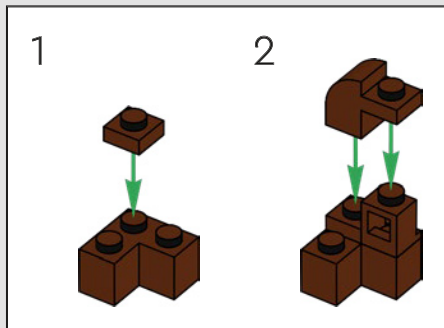

56

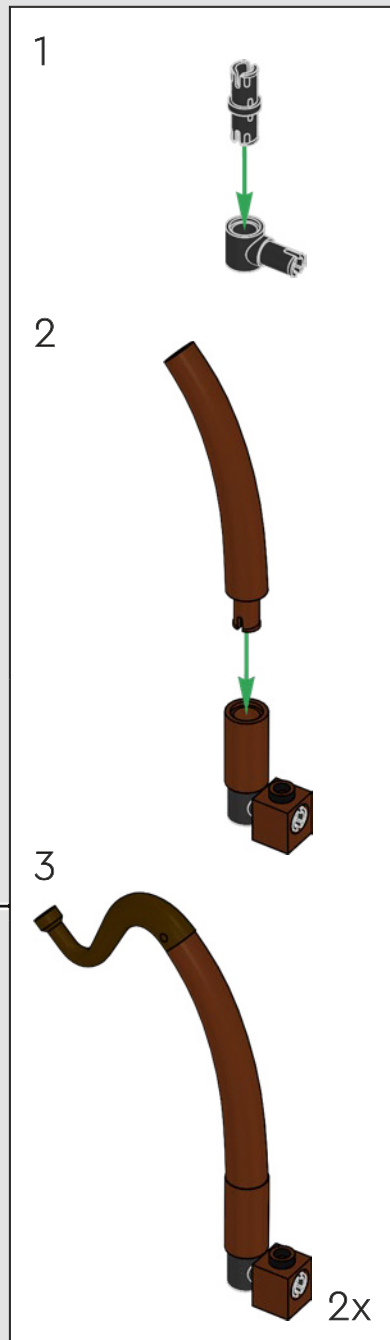
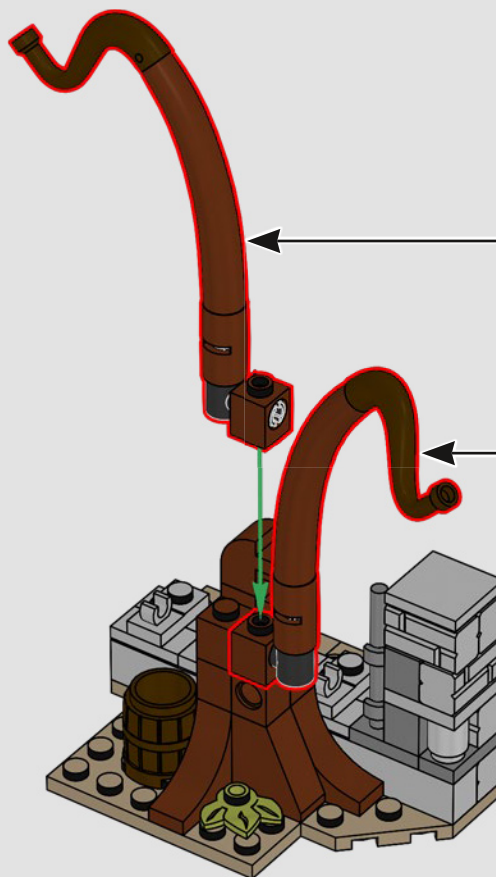

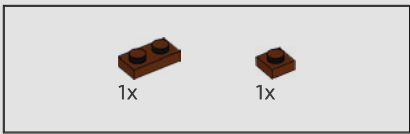

57

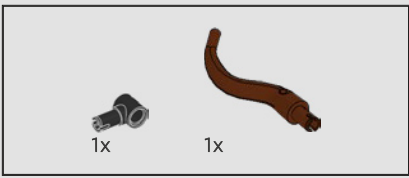
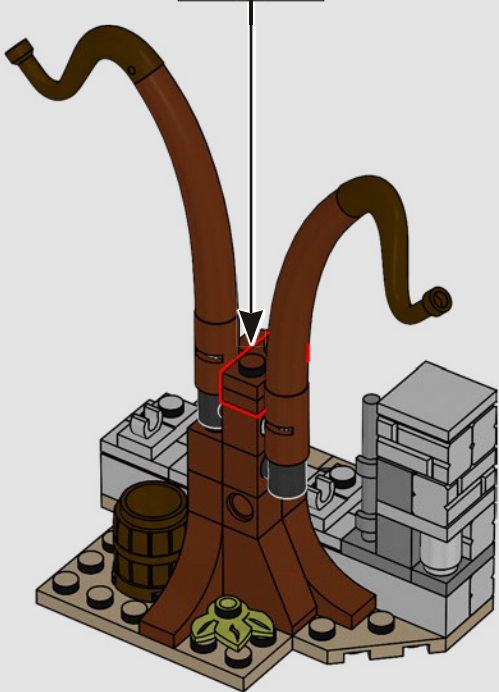
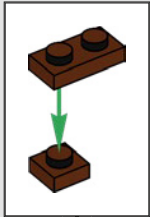

58

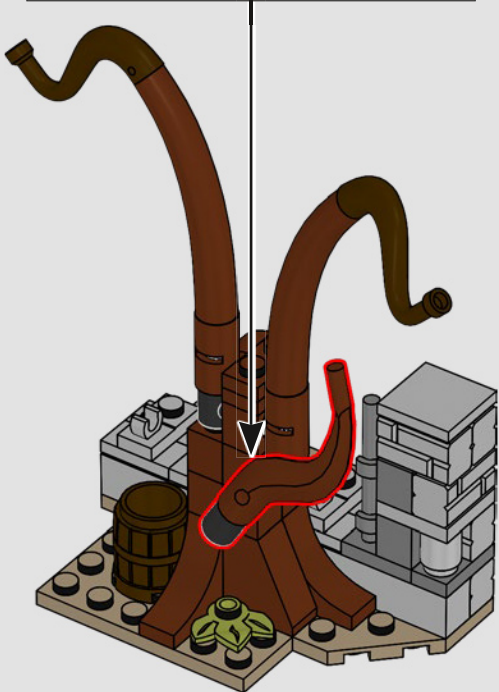
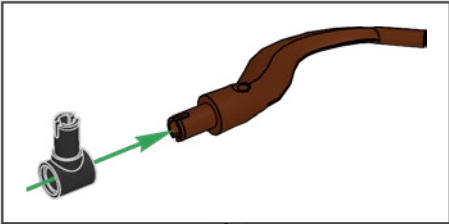

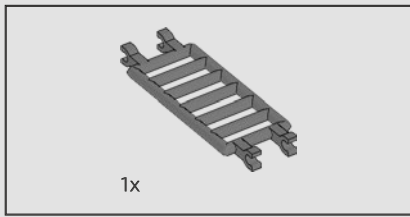

59

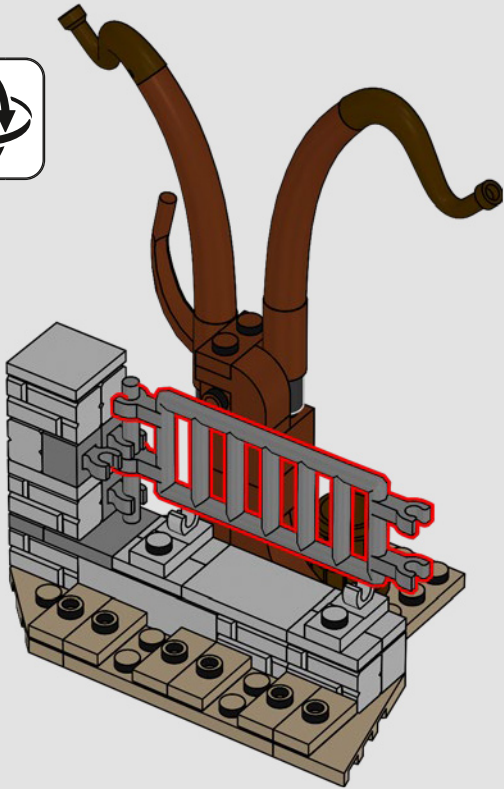

60

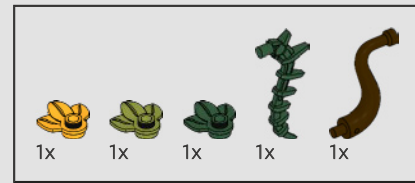
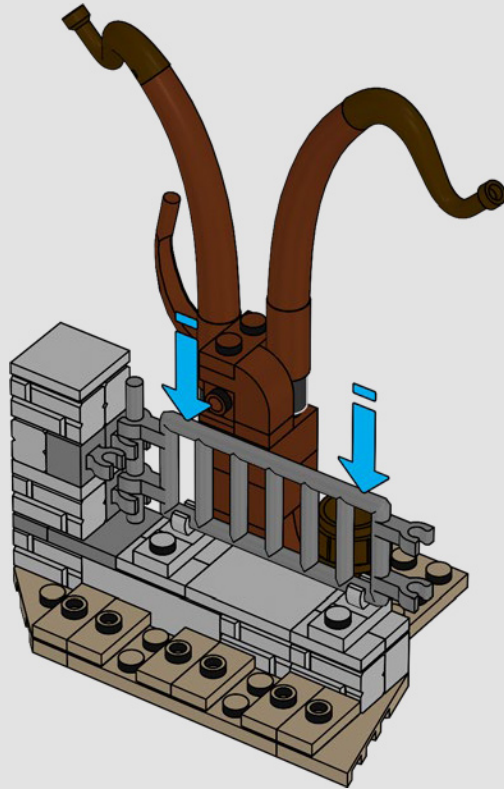

61

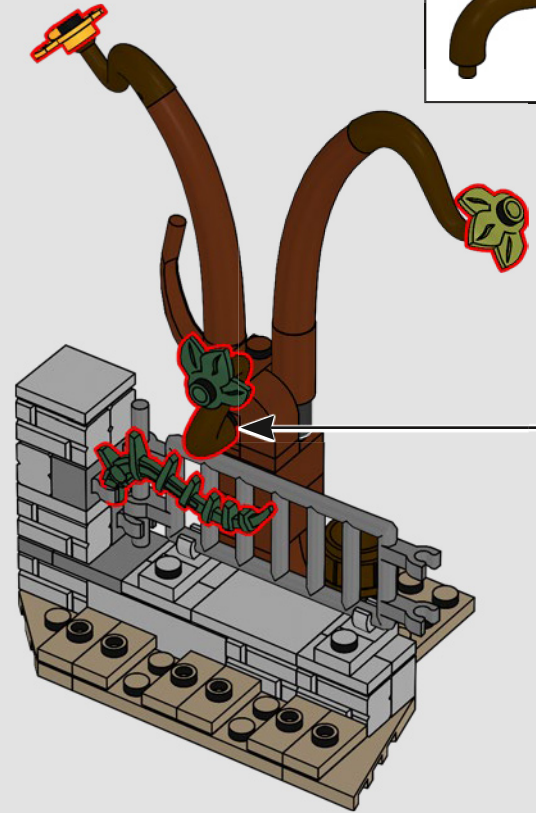
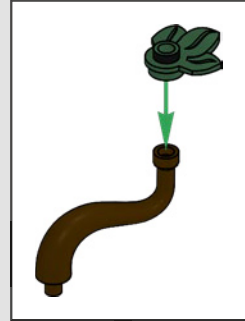

62

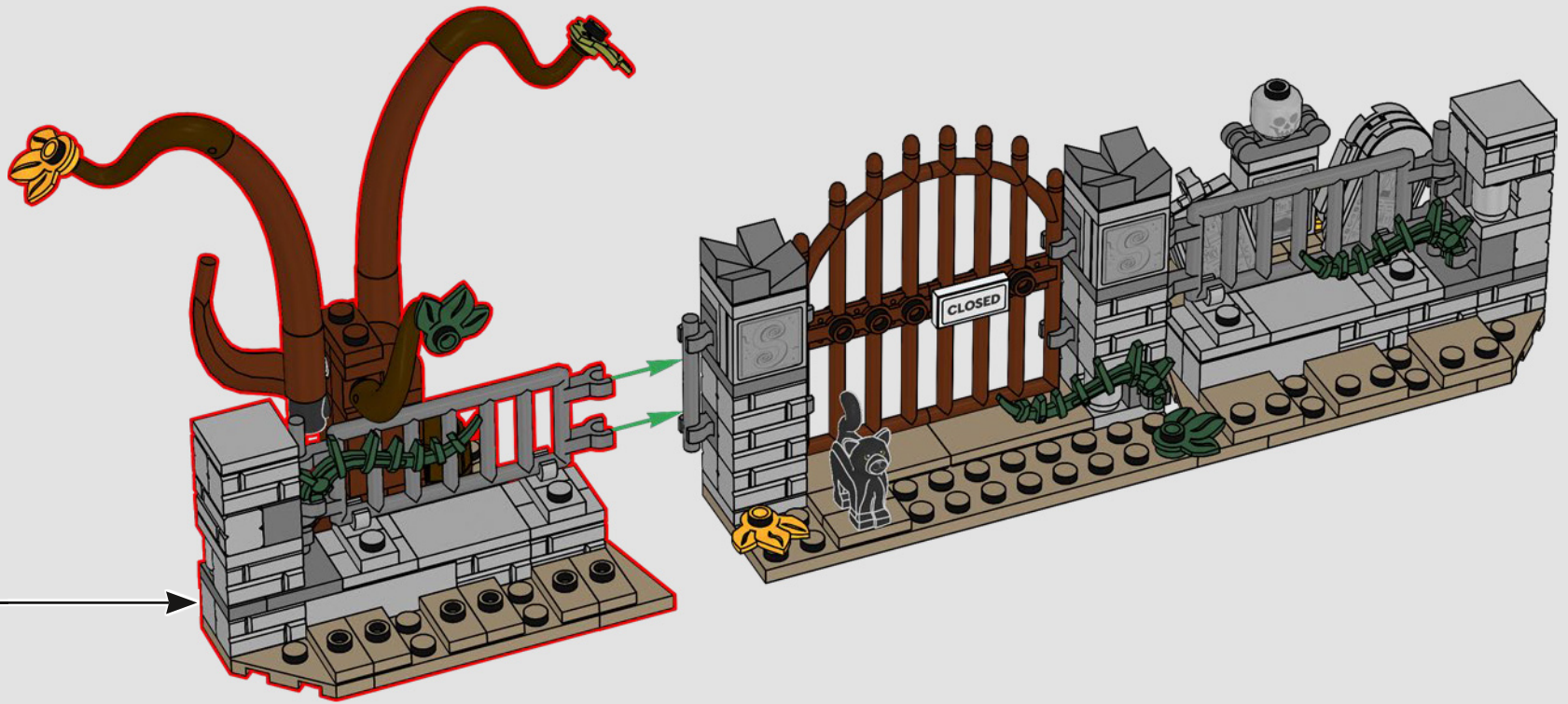

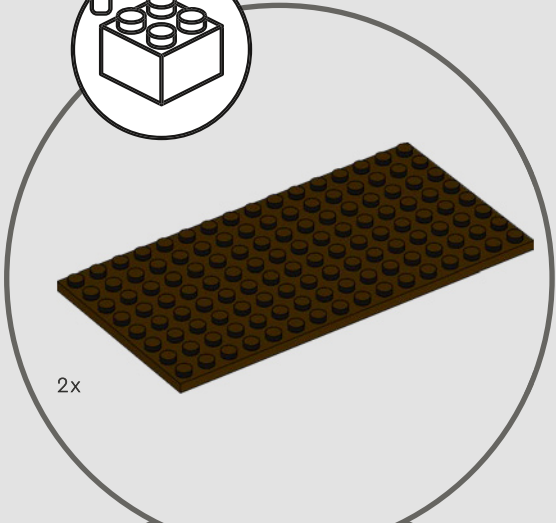
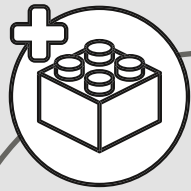

2x

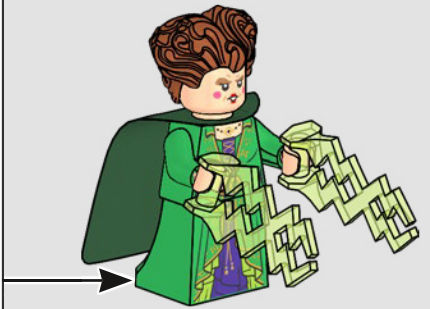
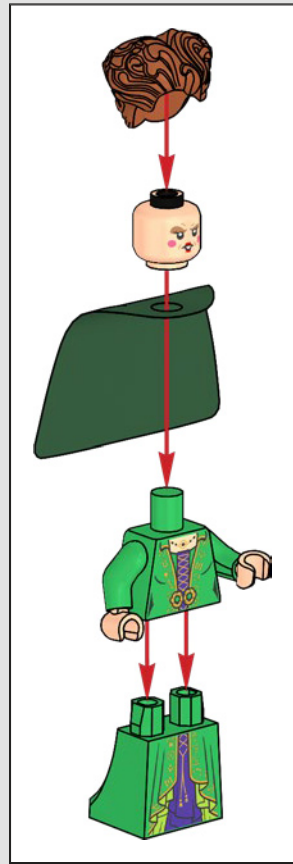

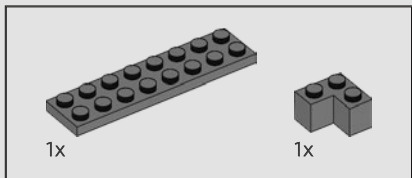

1

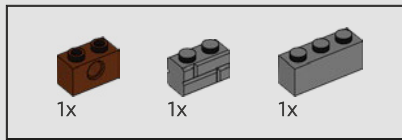
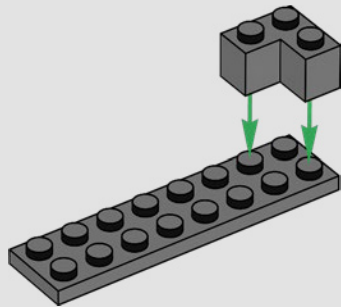

2

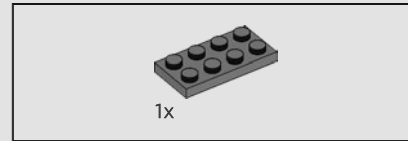
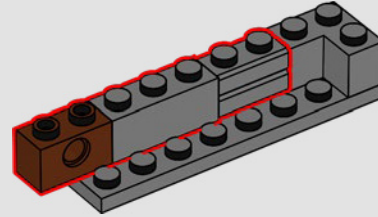

3

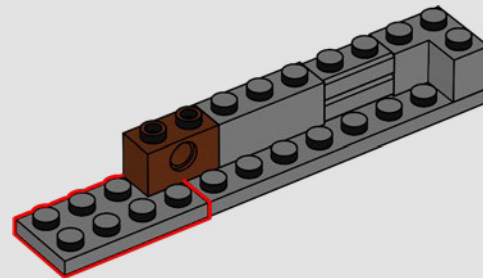

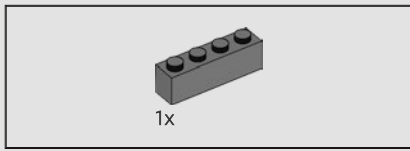

4

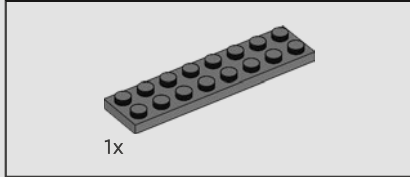
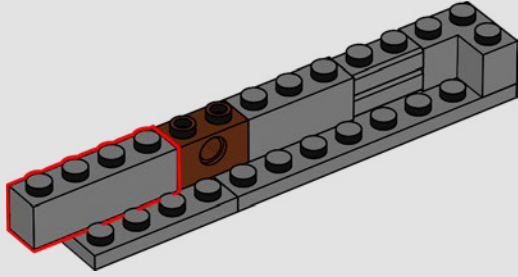

5

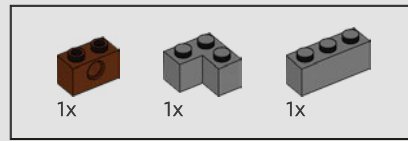
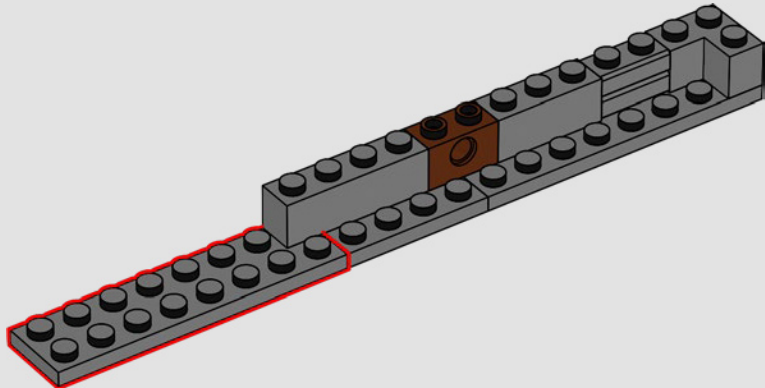

6

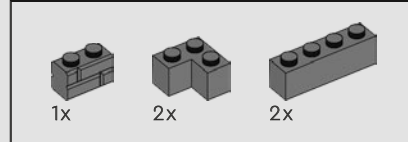
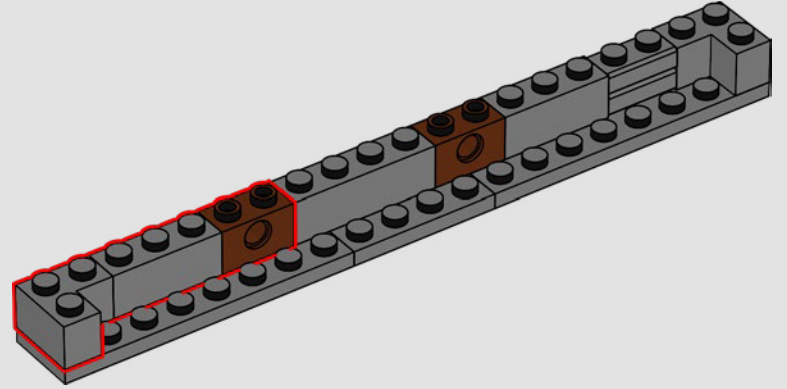

7

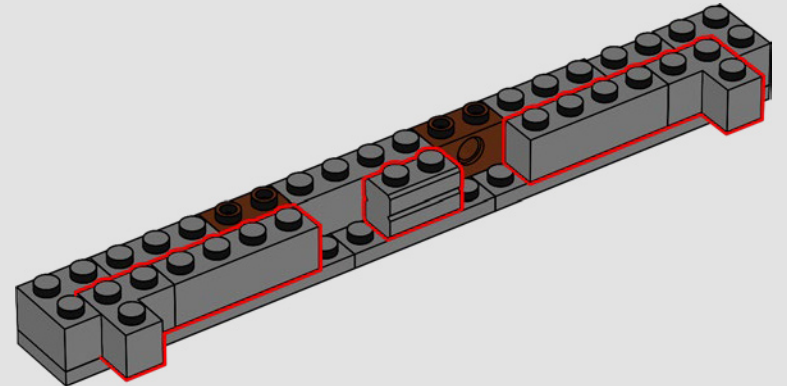

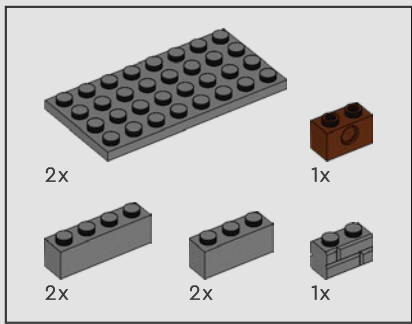

8

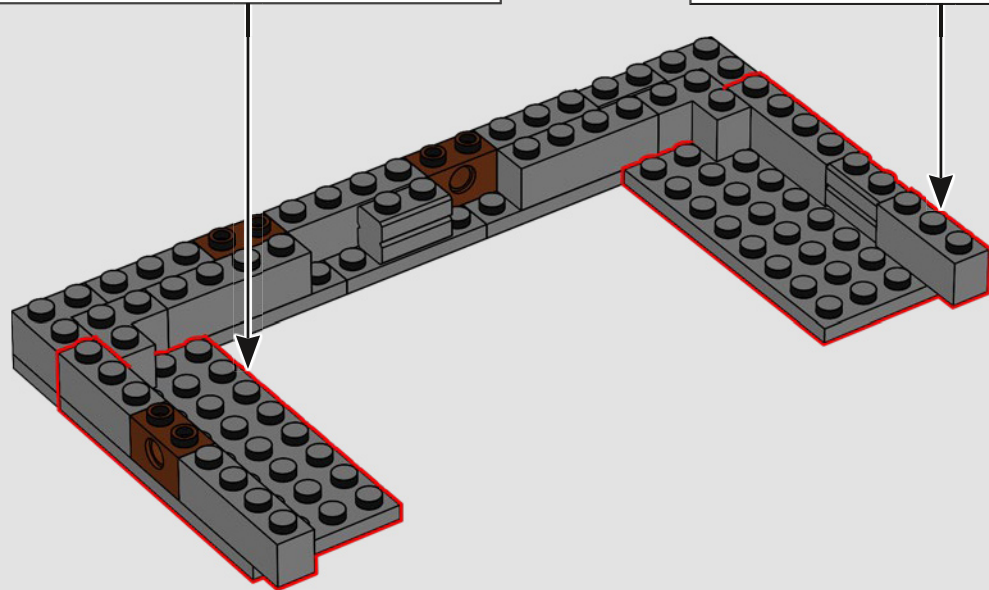
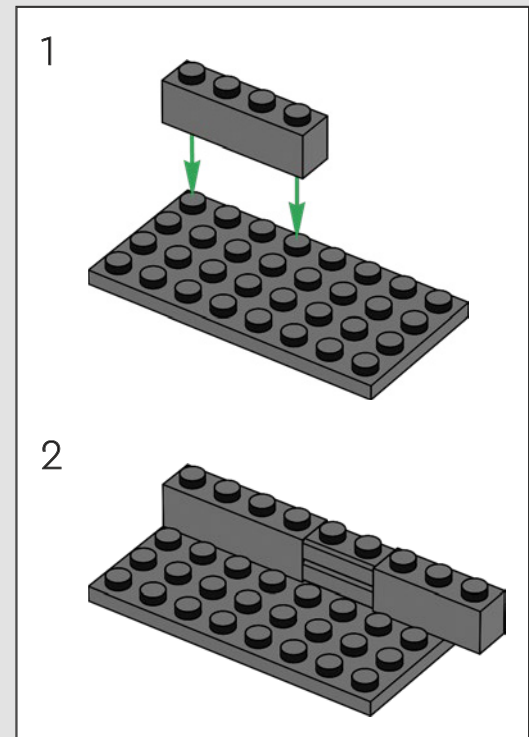
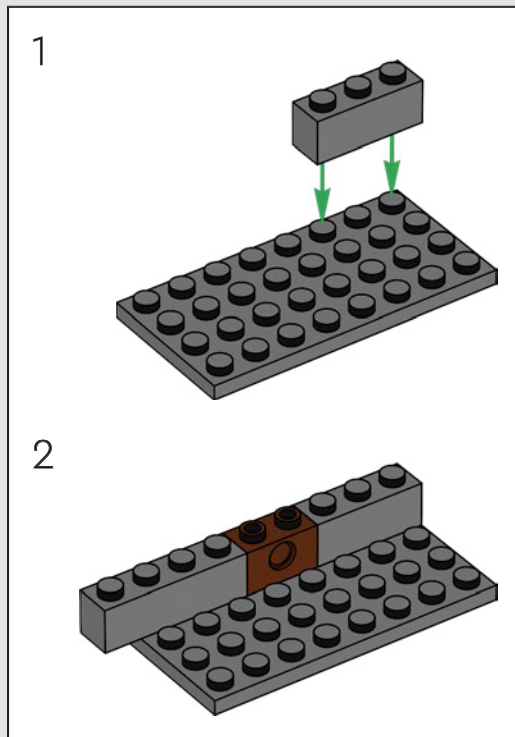

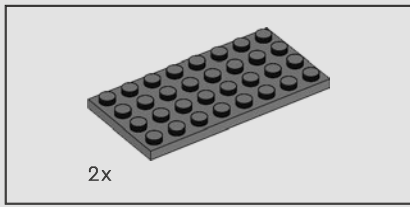

9

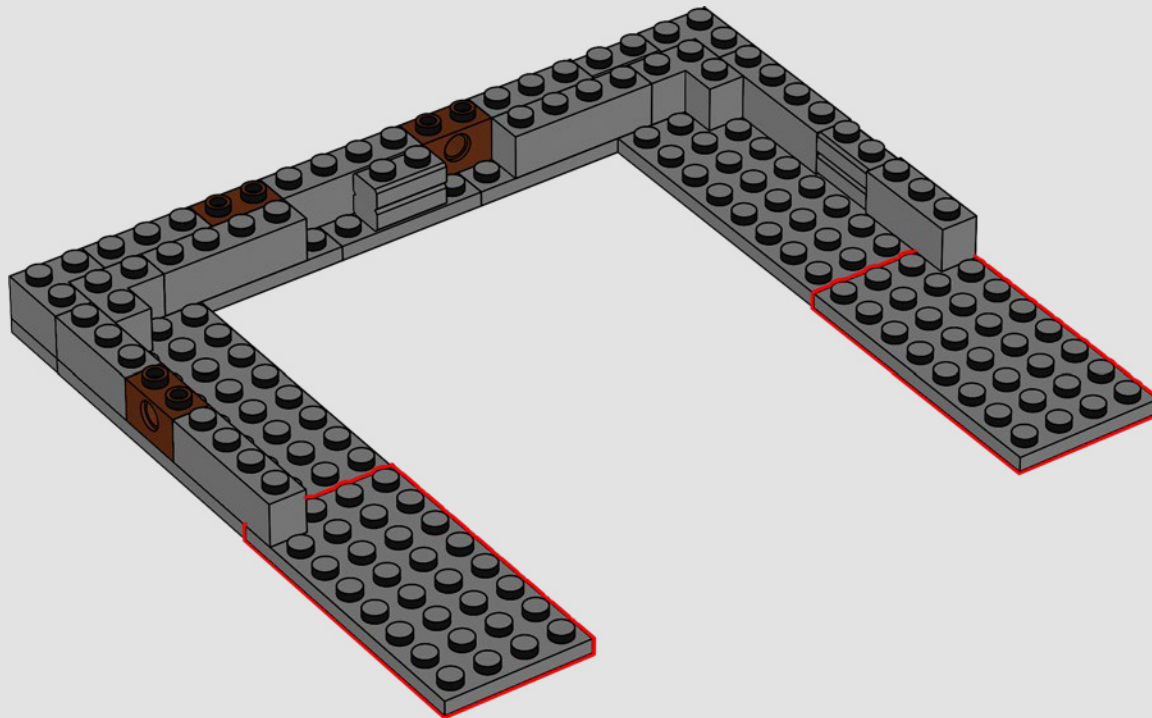

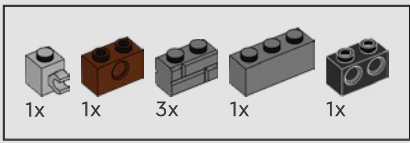

10

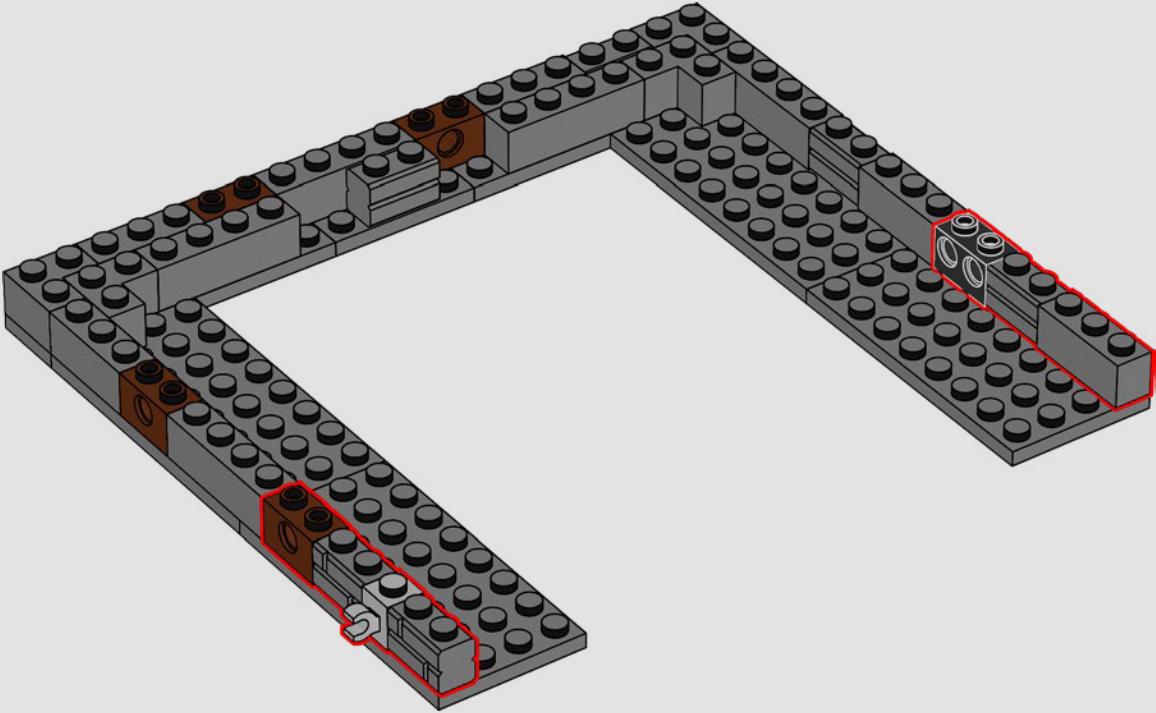

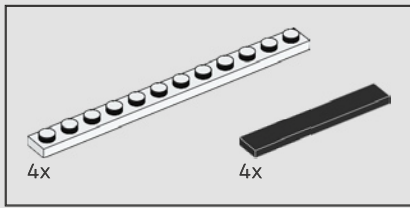

11

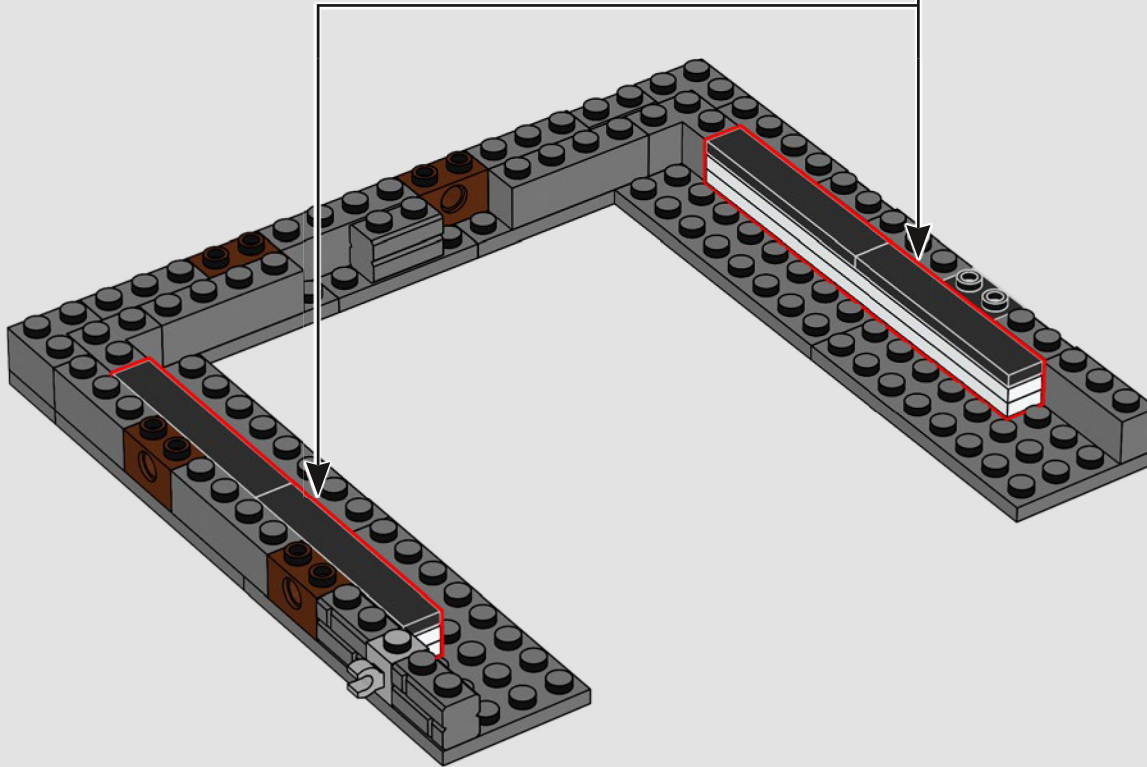
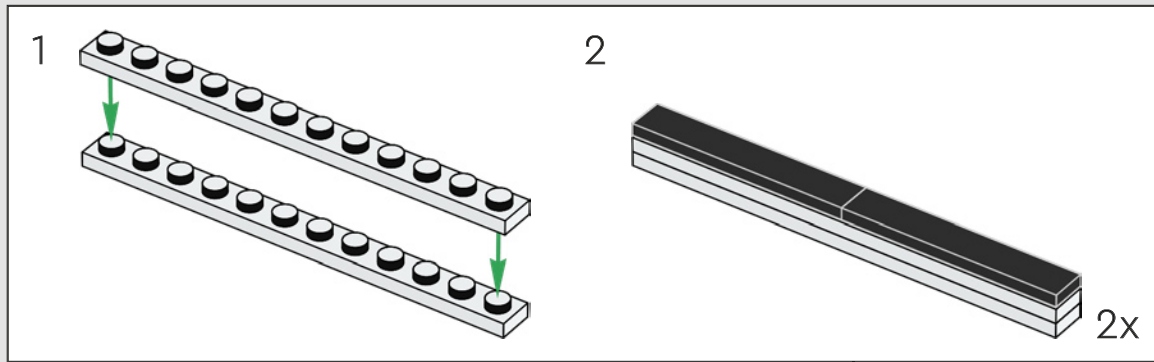

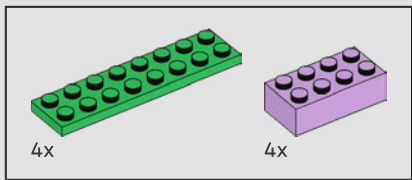

12

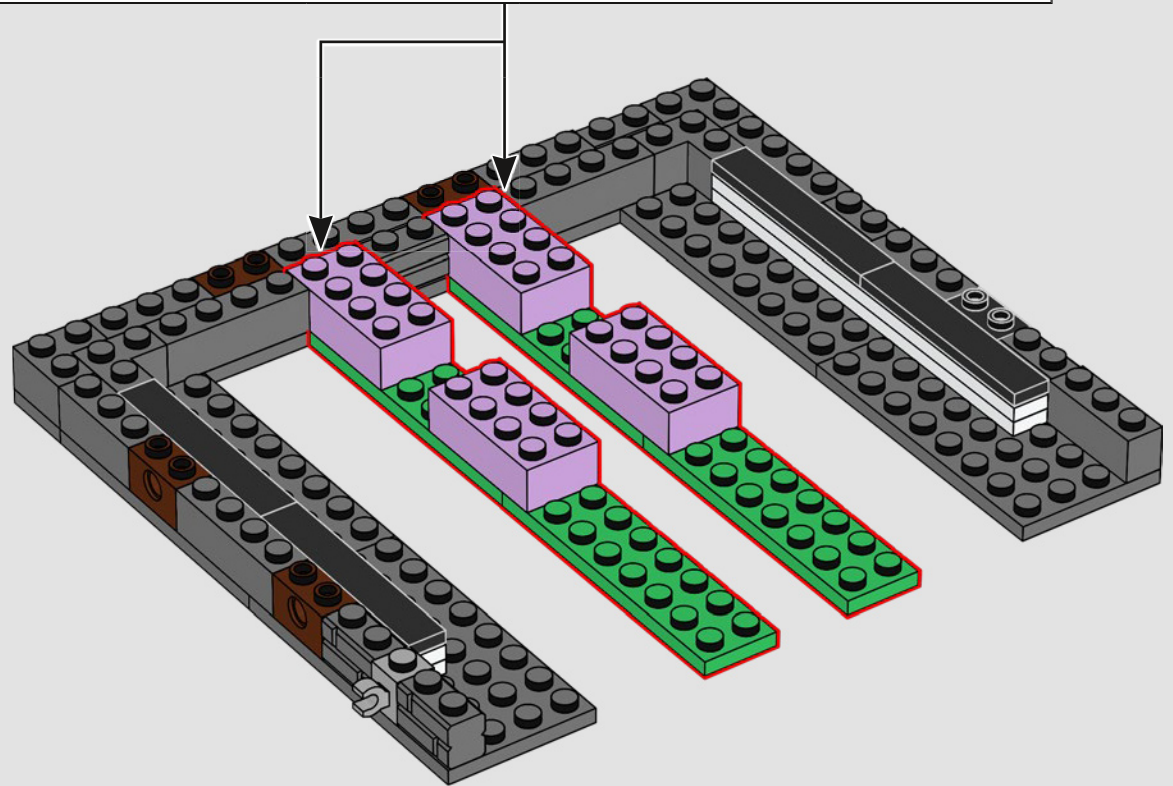
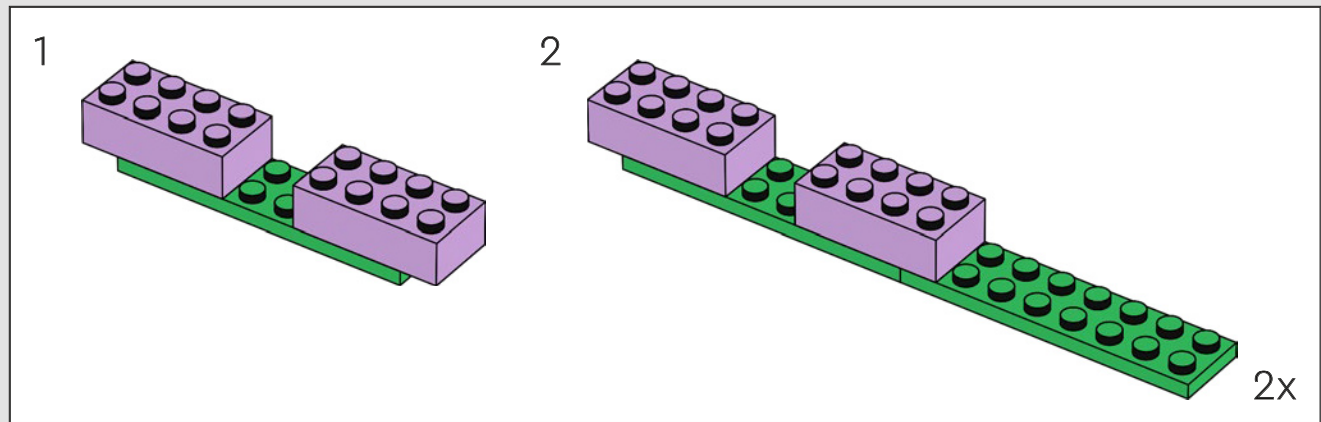

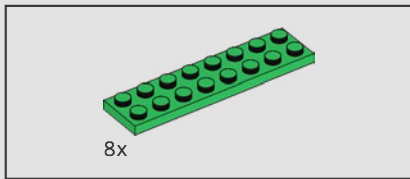

13

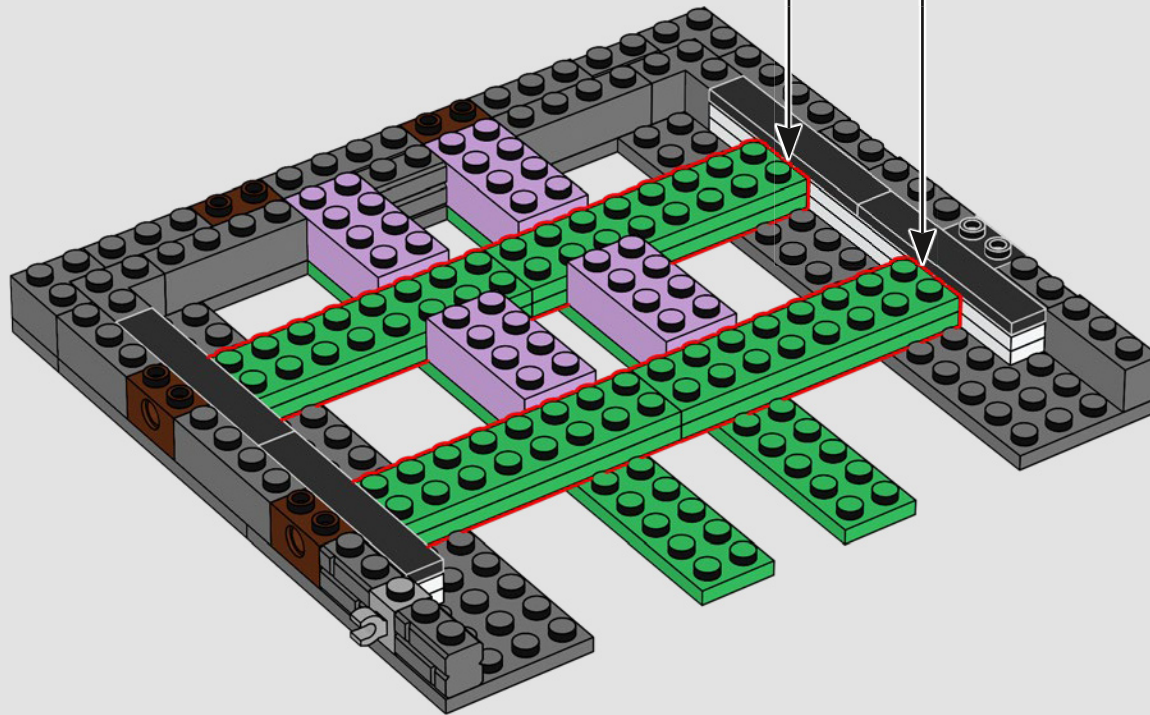
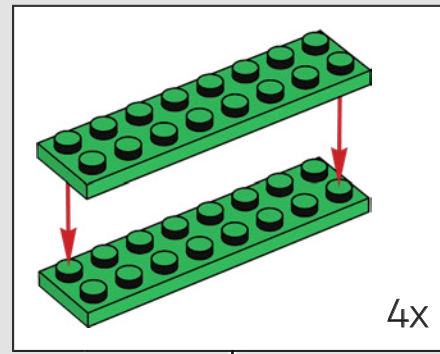

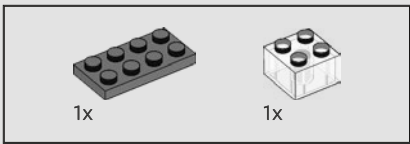

14

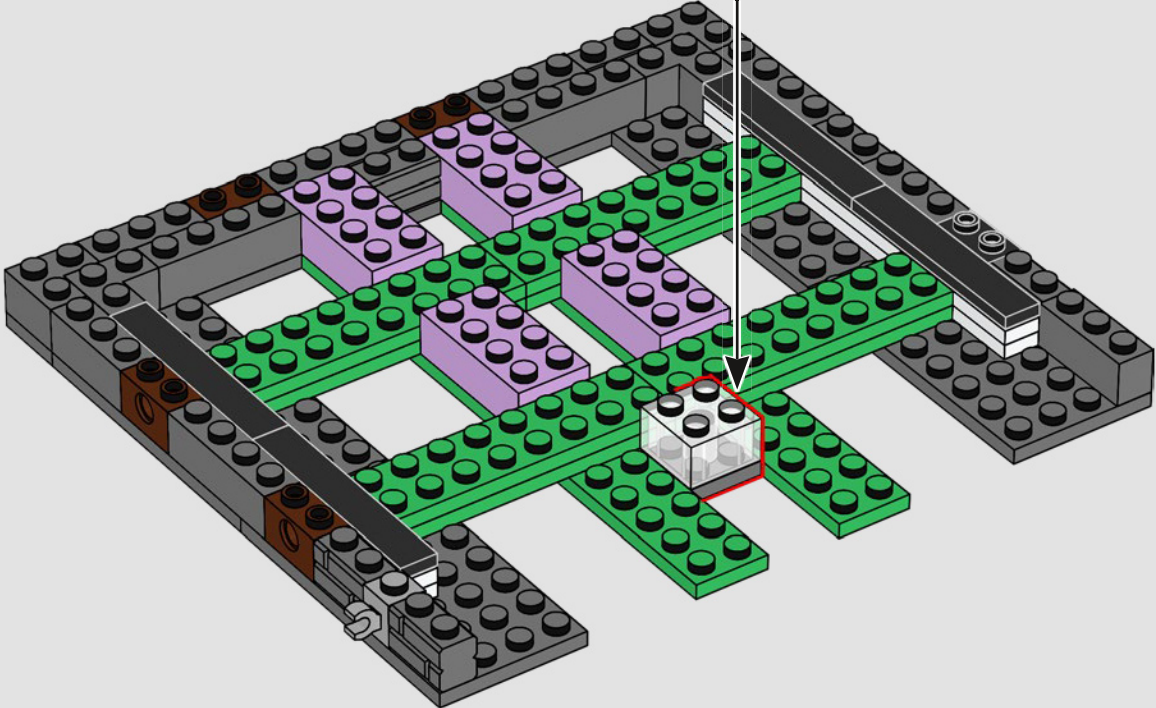
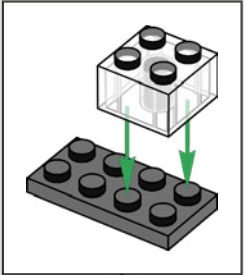

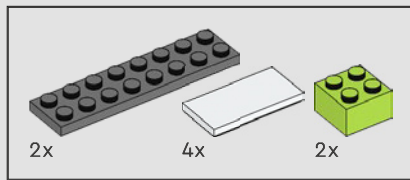

15

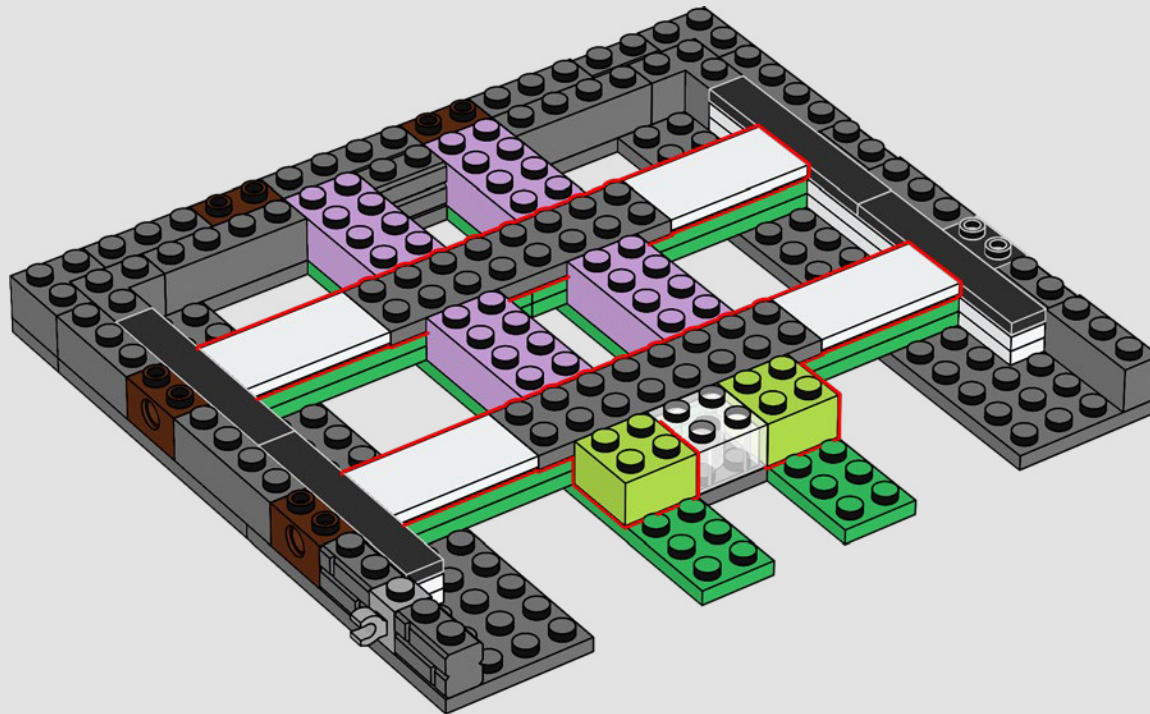

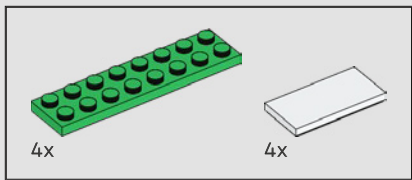

16

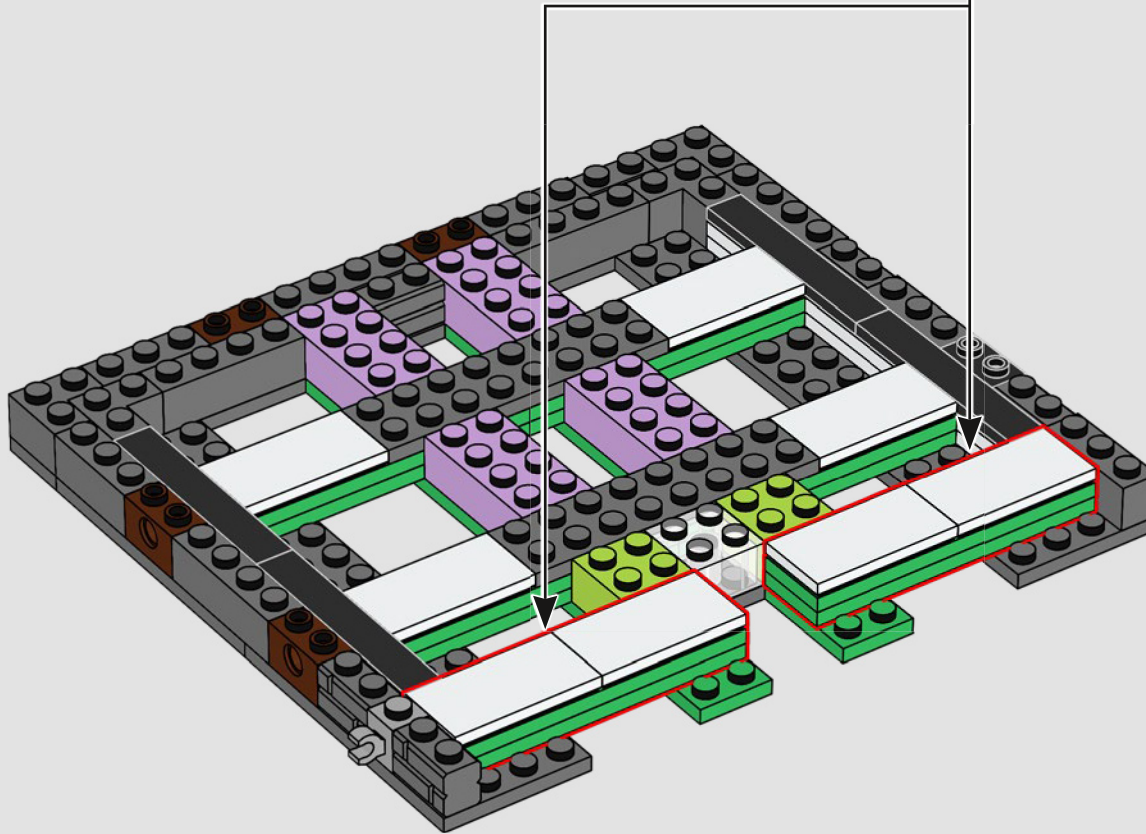
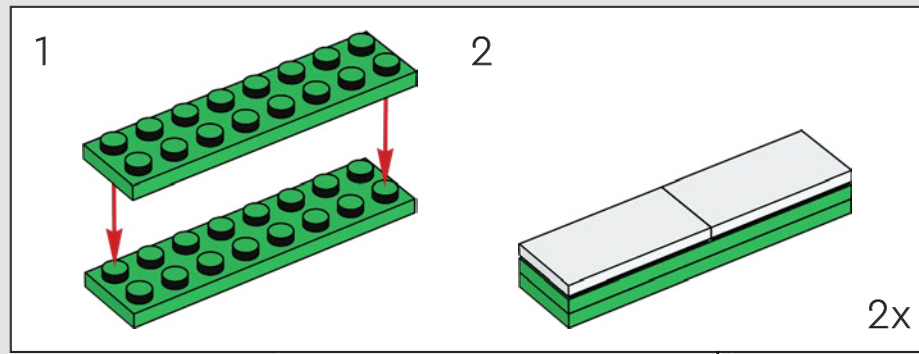

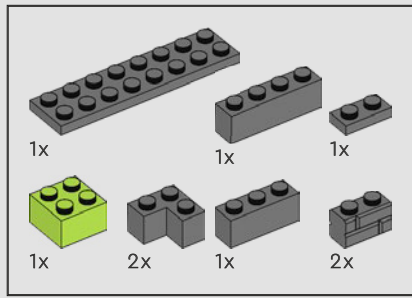

17

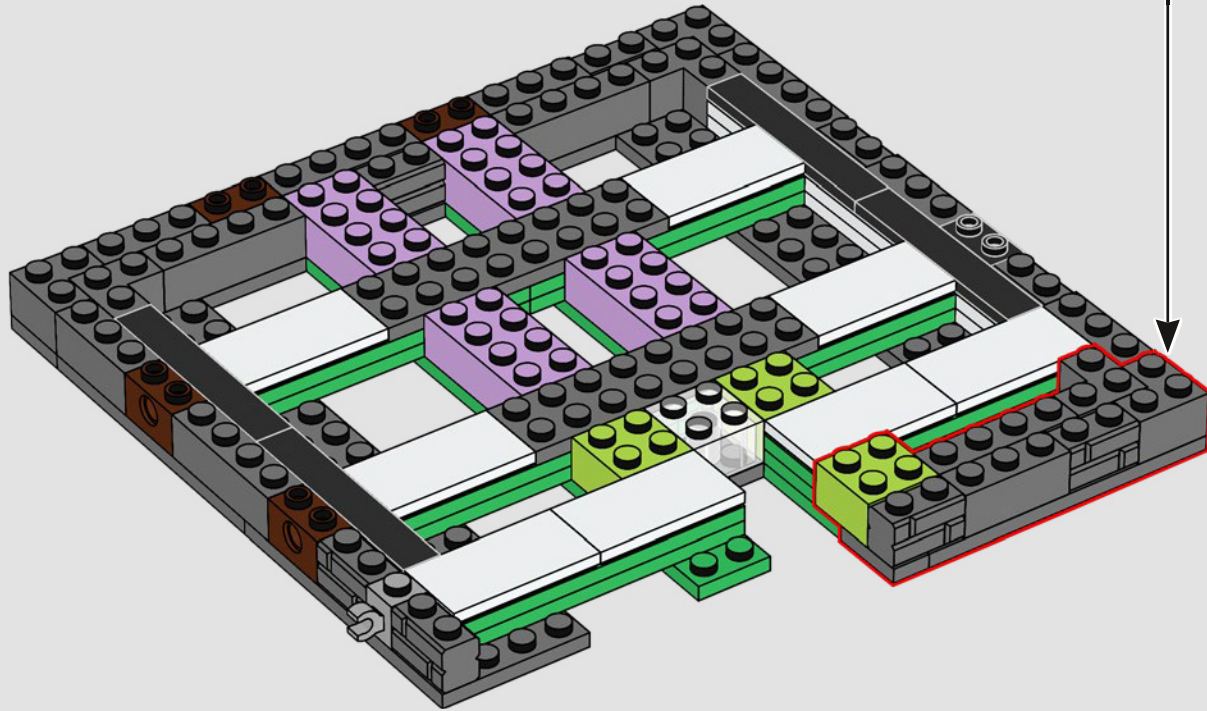
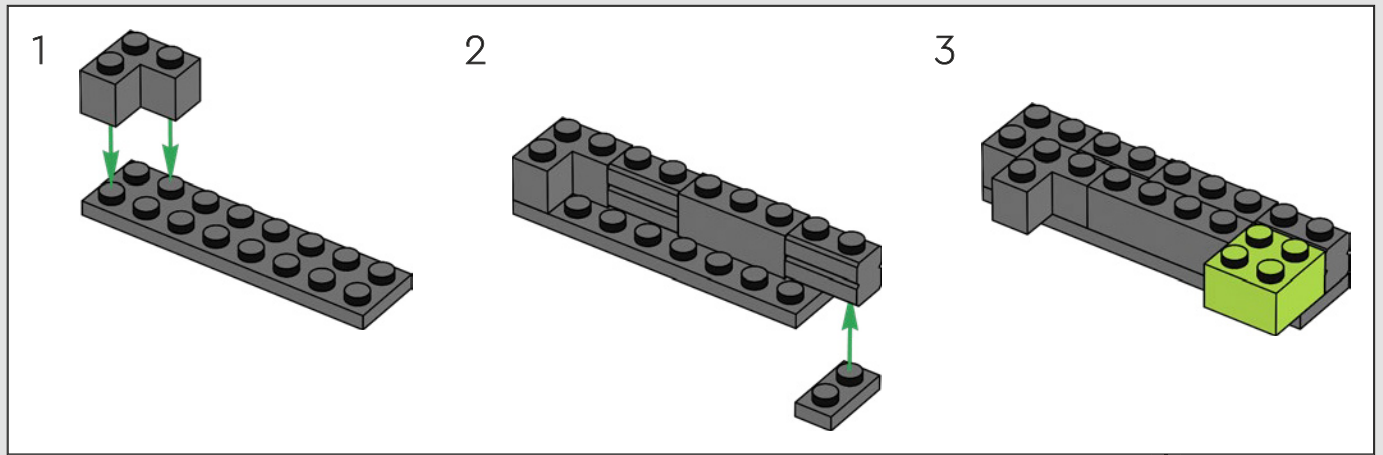

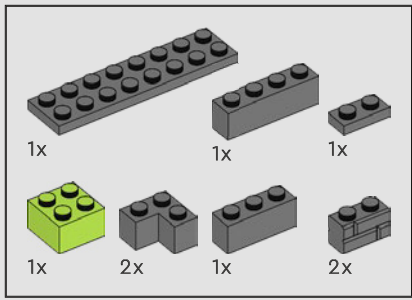

18

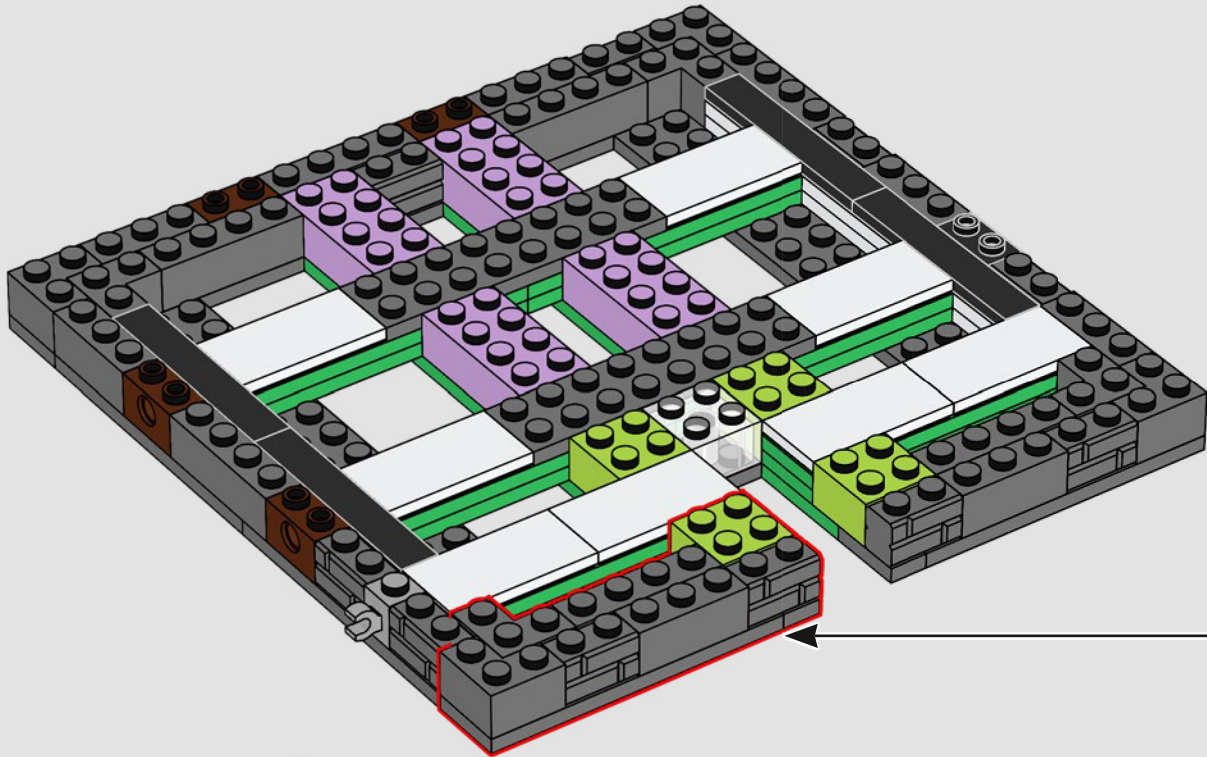
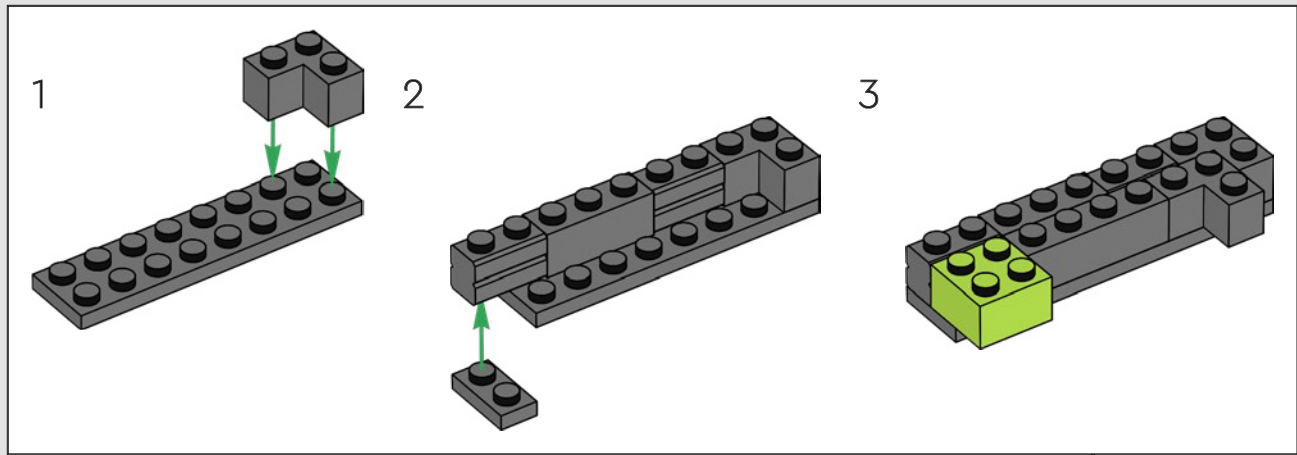



19

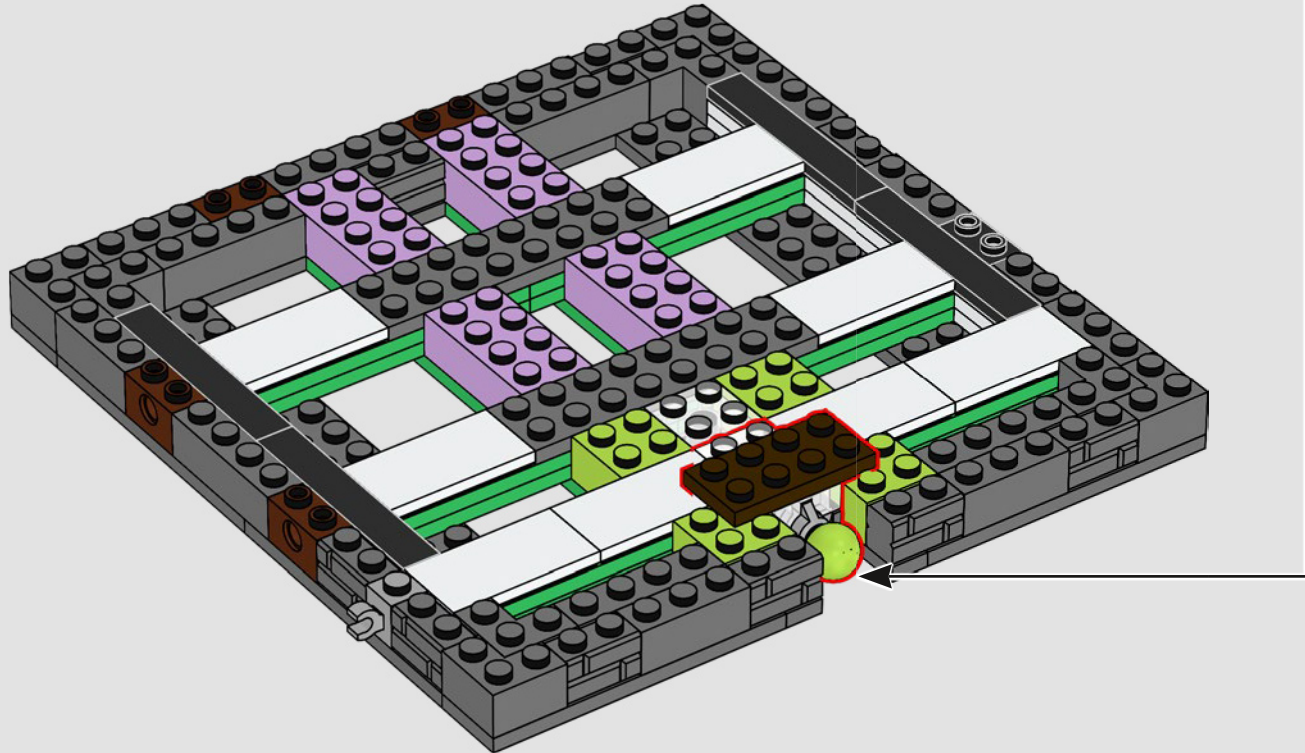
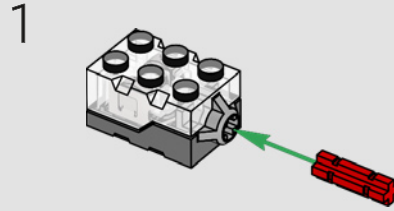
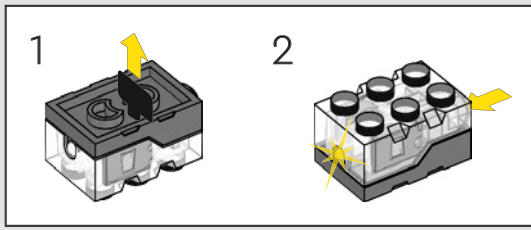

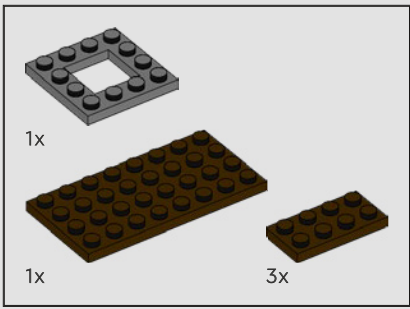

20

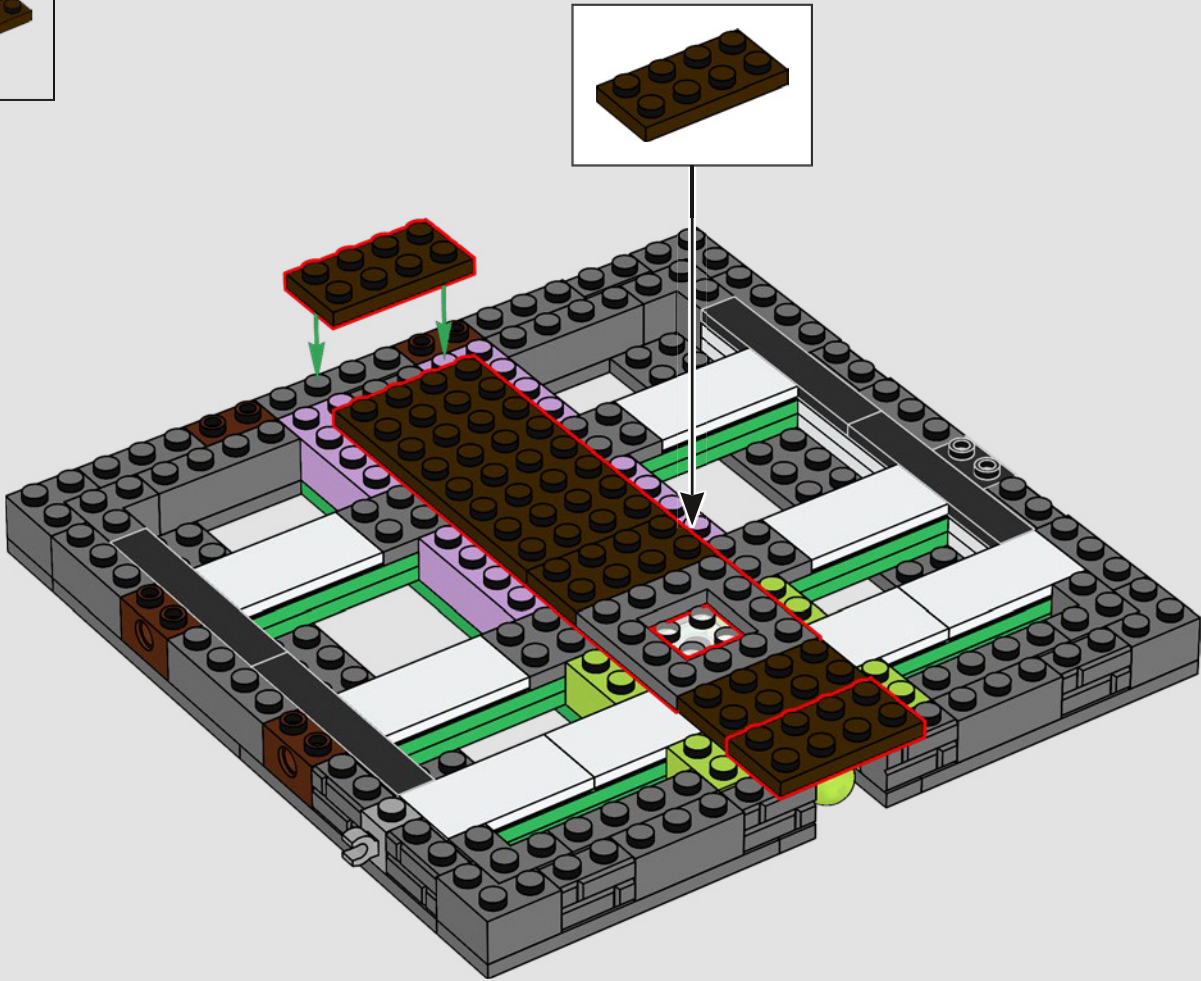

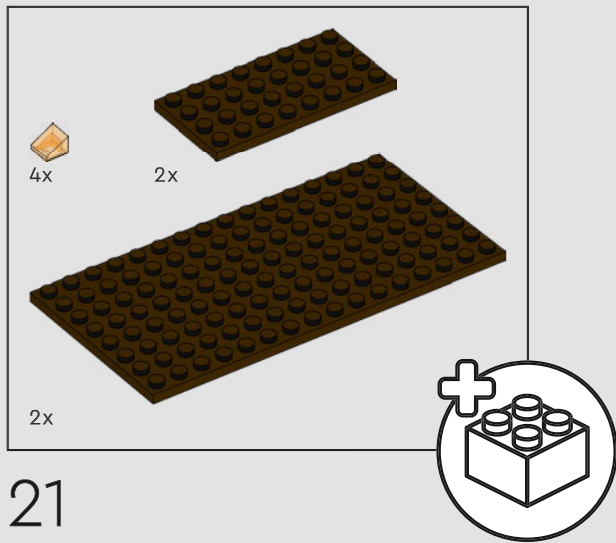

21

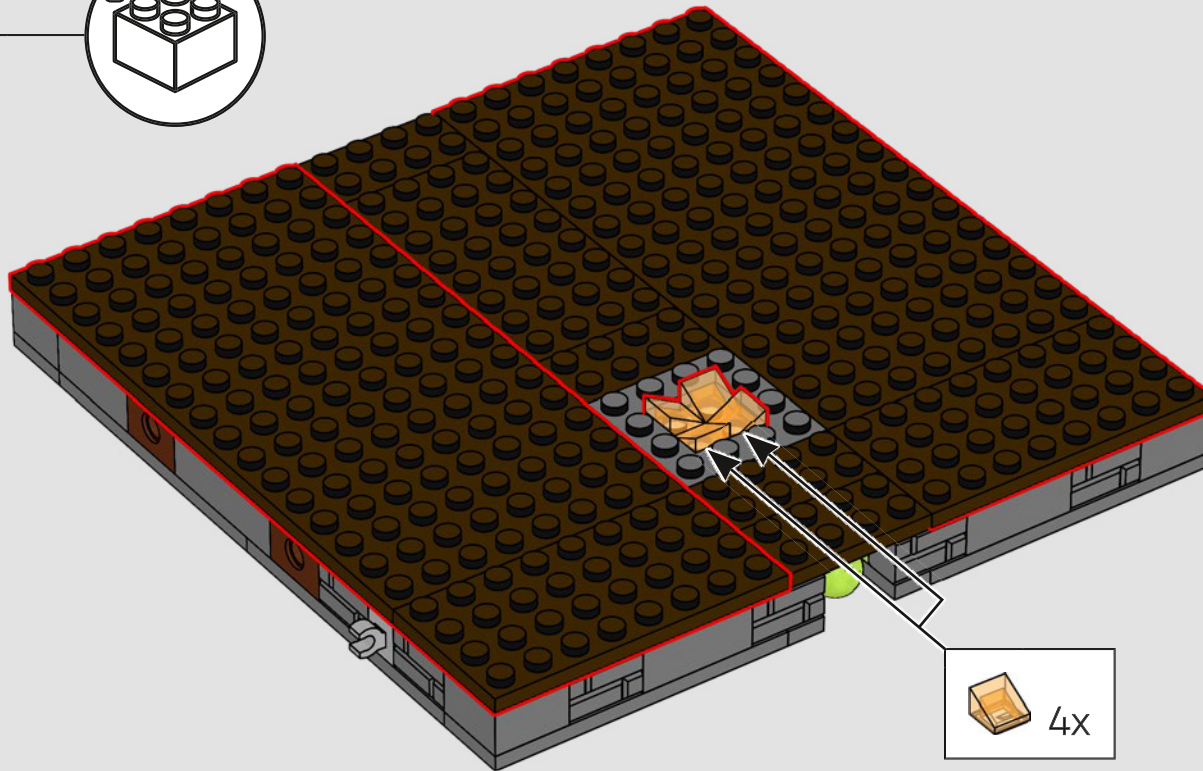

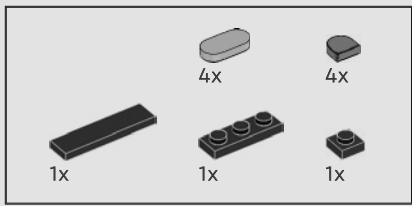

22

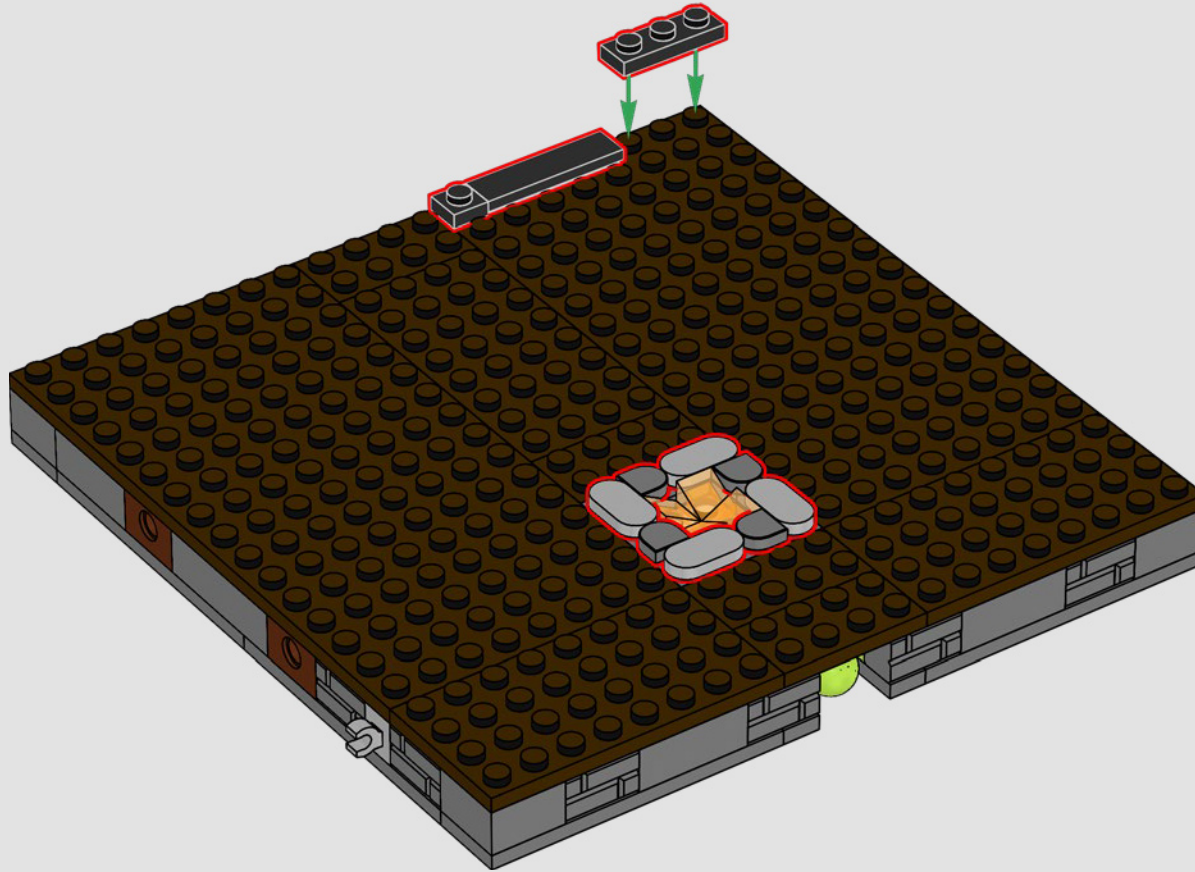

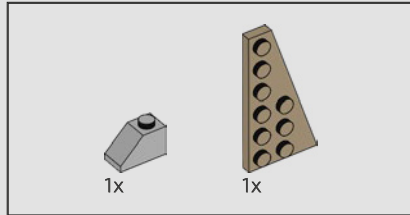
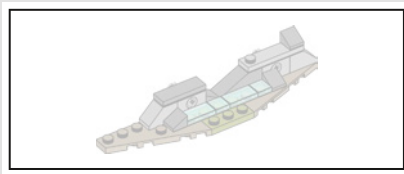

23

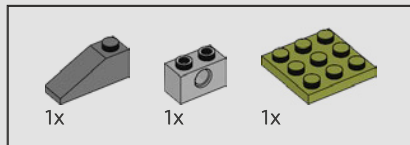
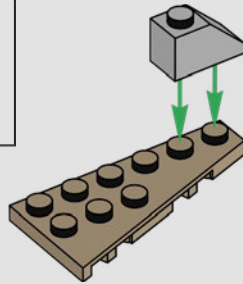

24

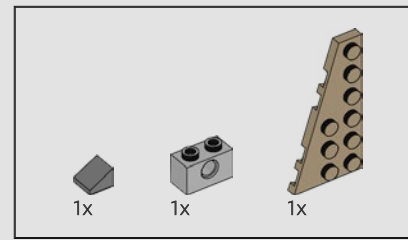
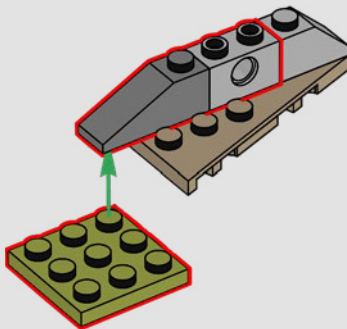

25

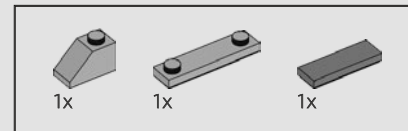
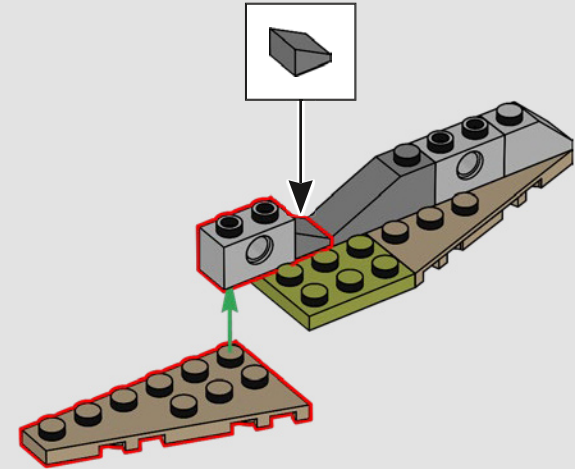

26

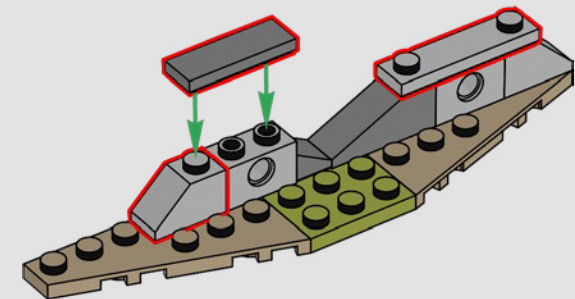



27

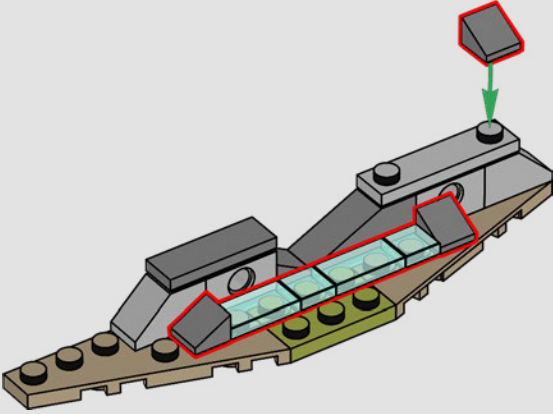

28

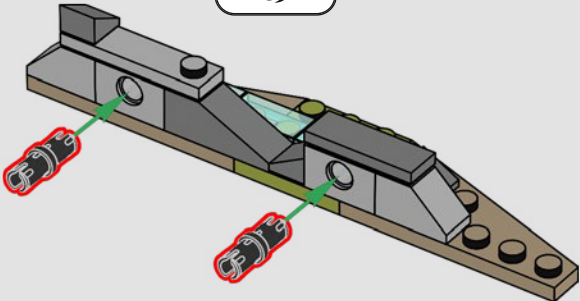

29

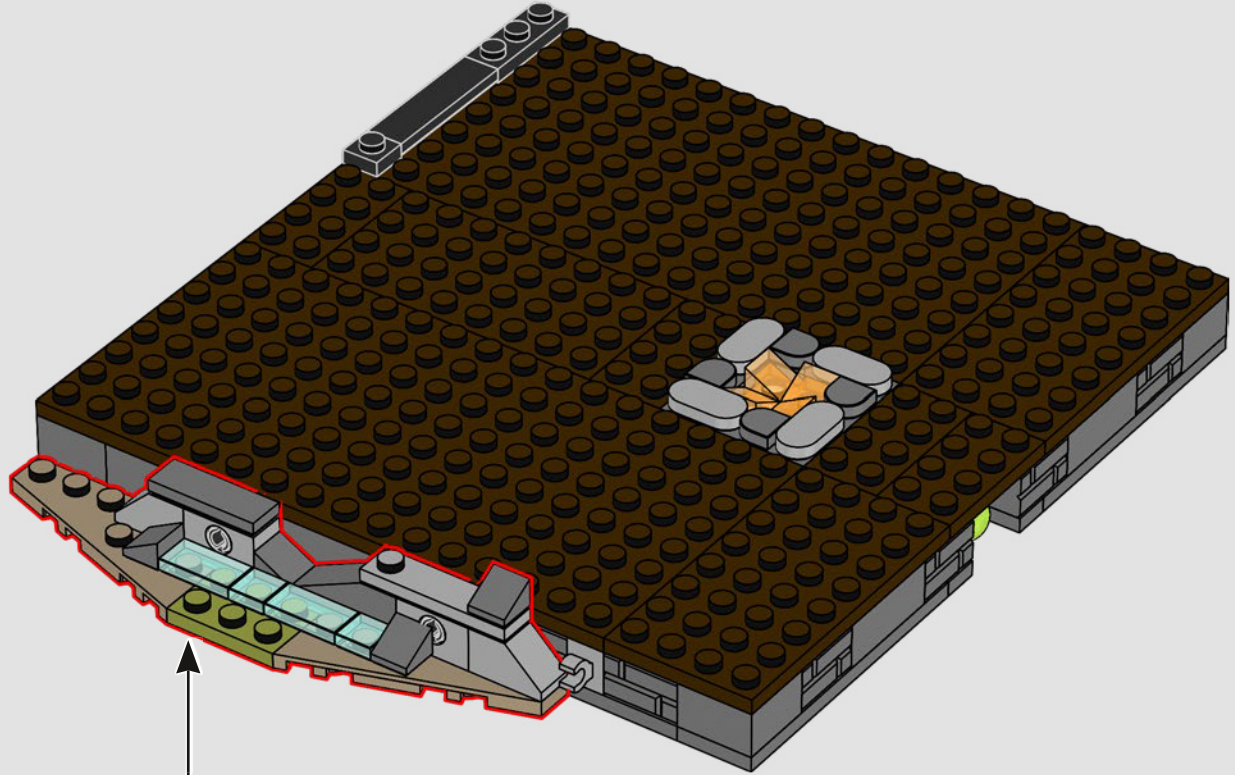

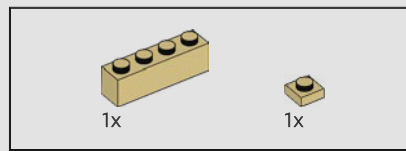

31

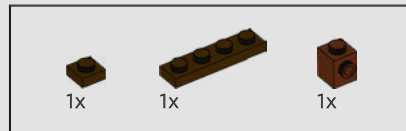
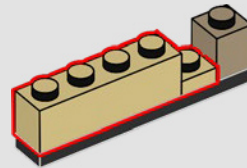

32

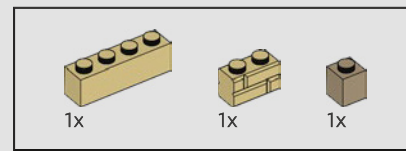
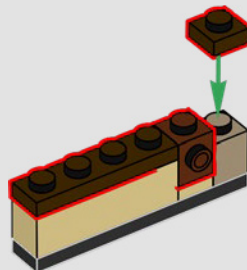

33

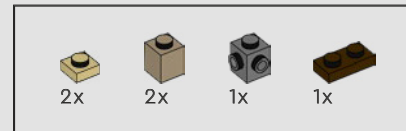
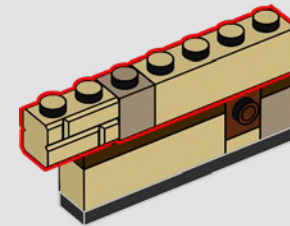

34

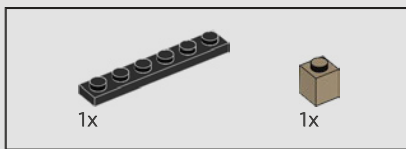
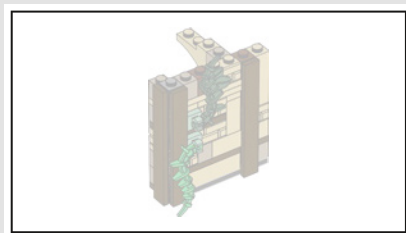
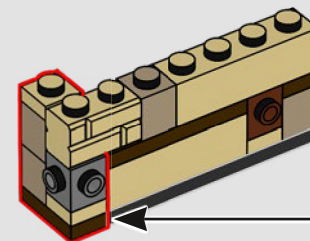
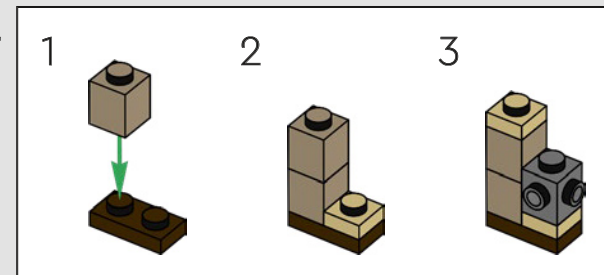

30

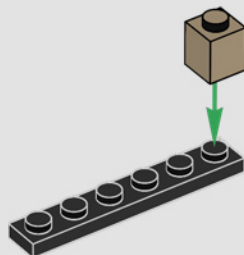

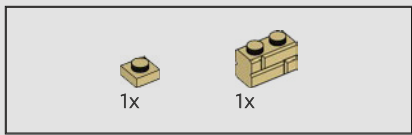

35

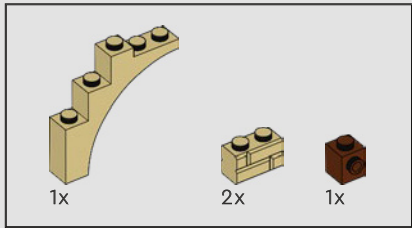
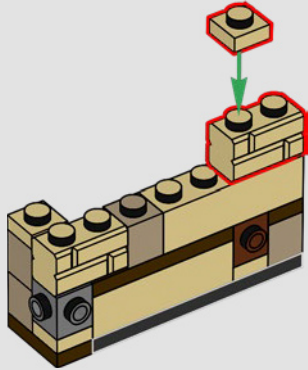

36

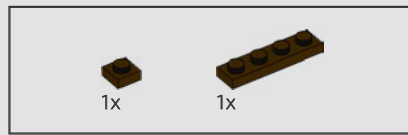
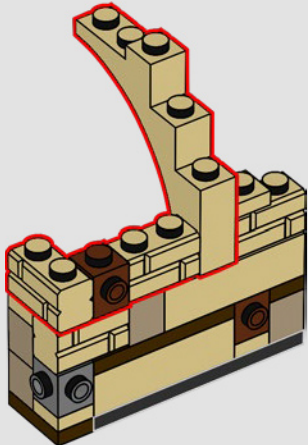

37

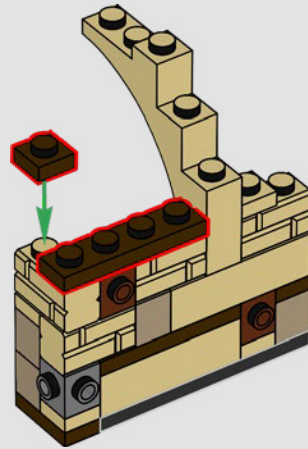

38

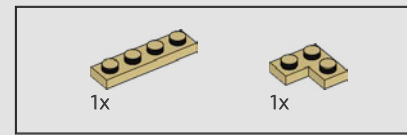
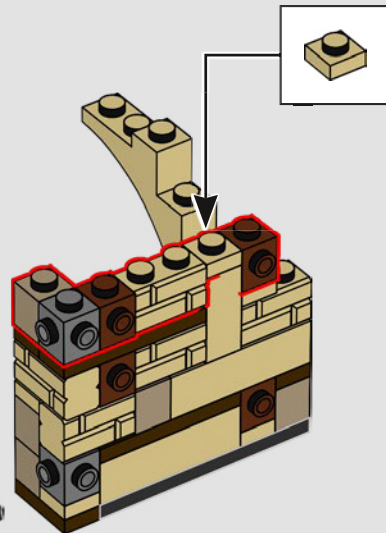

39

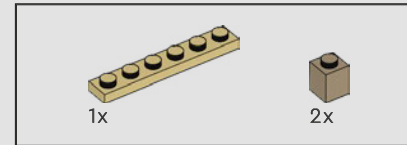
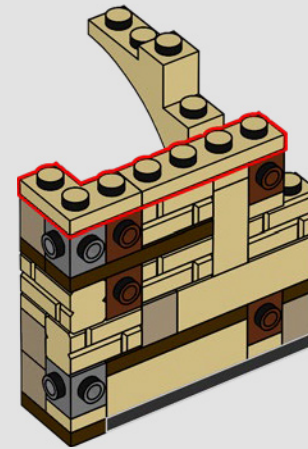

40

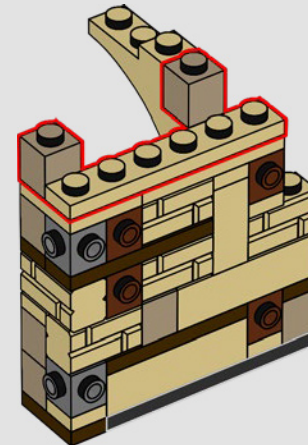

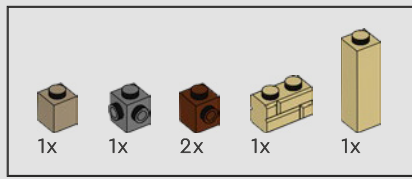

41

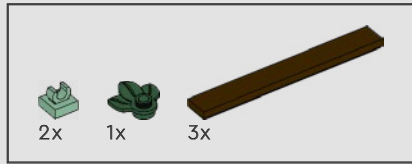
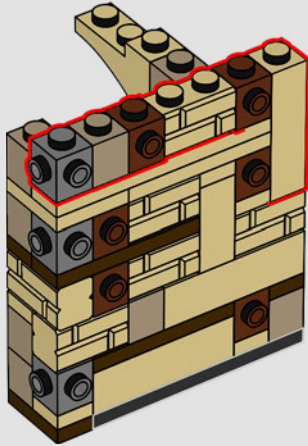

42

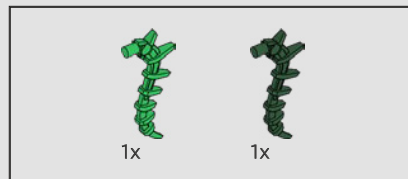
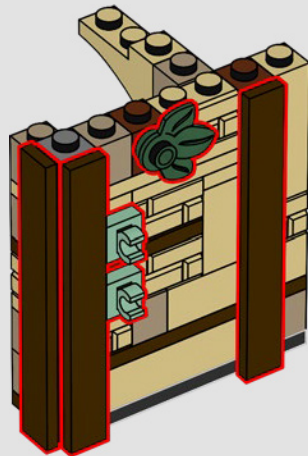

43

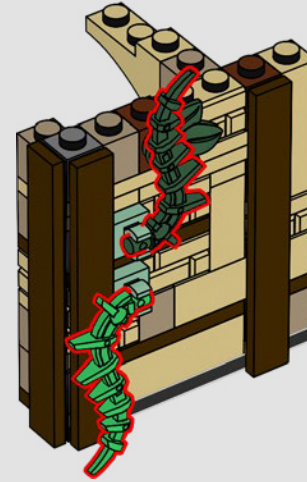

44

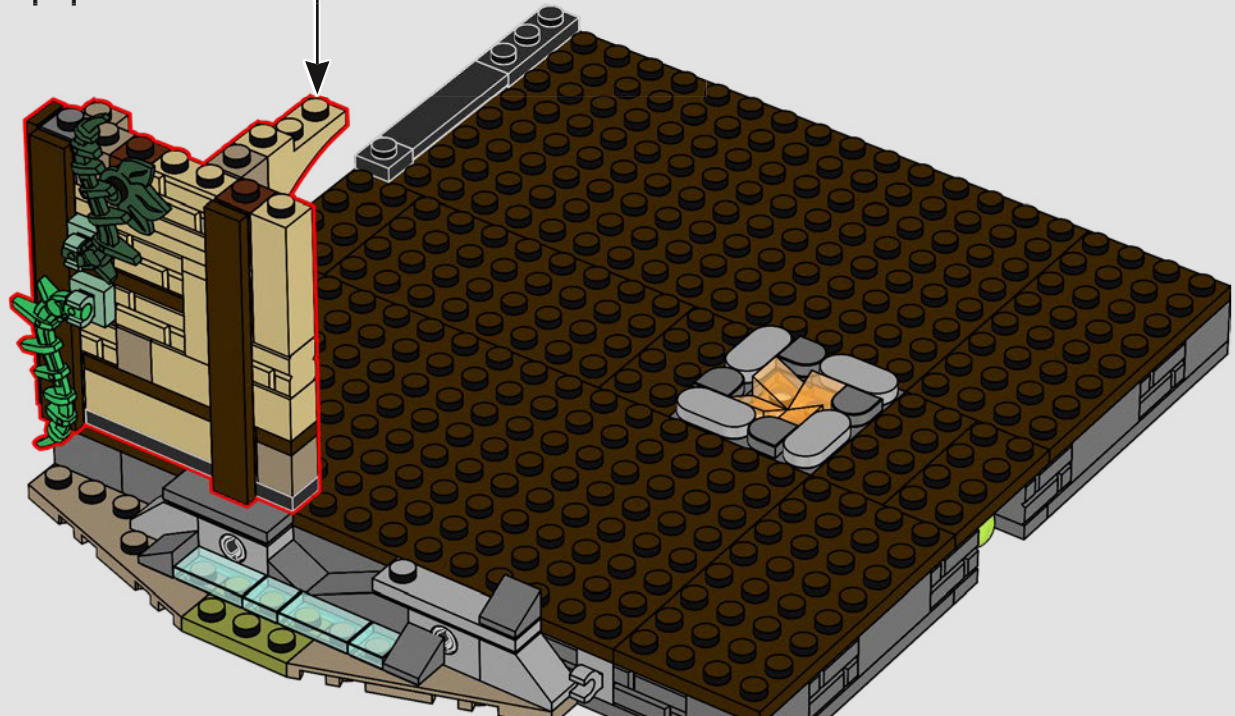

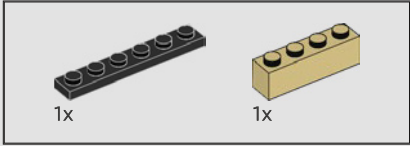
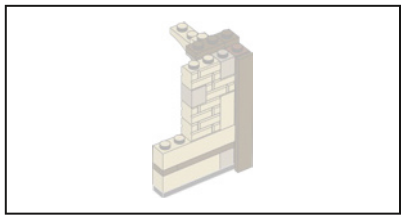

45

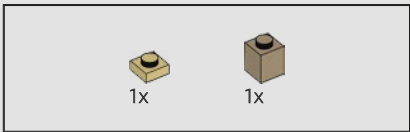
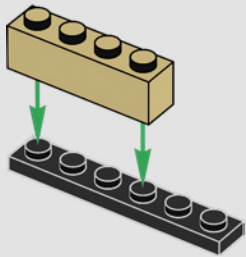

46

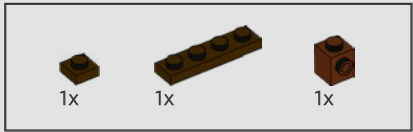
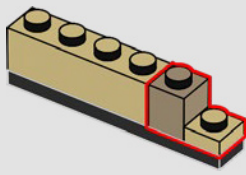

47

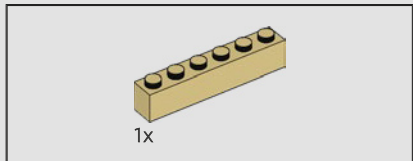
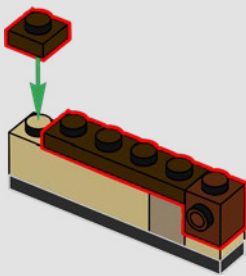

48

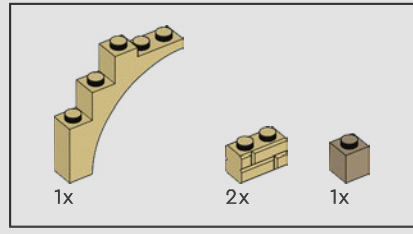
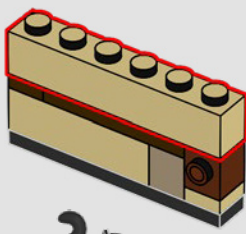

49

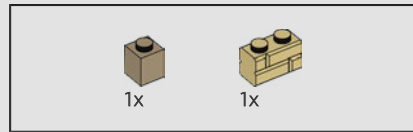
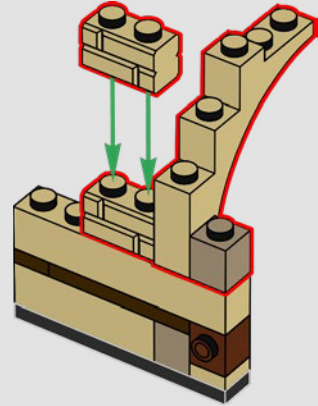

50

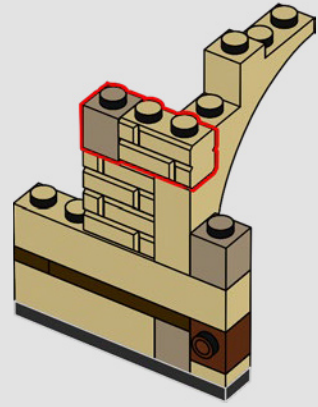

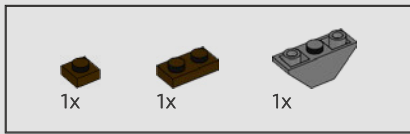

51

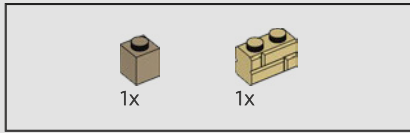
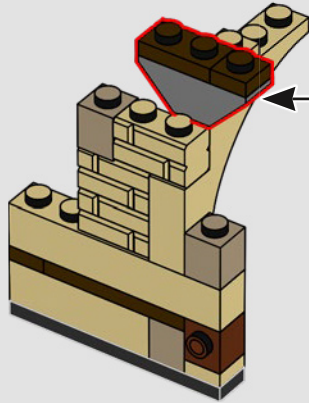
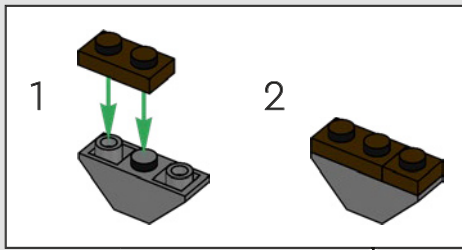

52

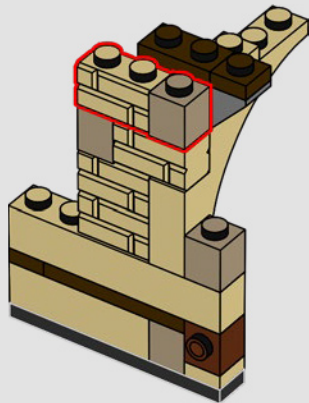

53

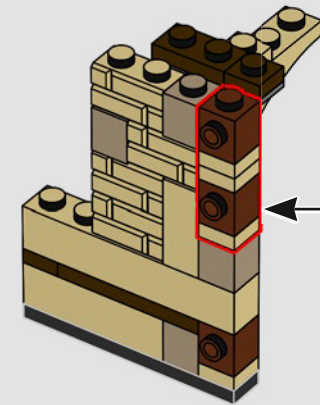
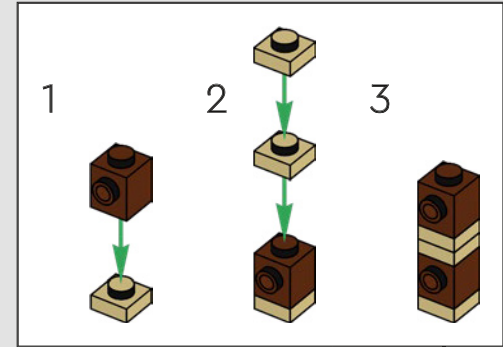

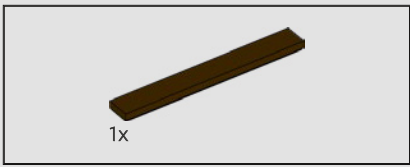

54

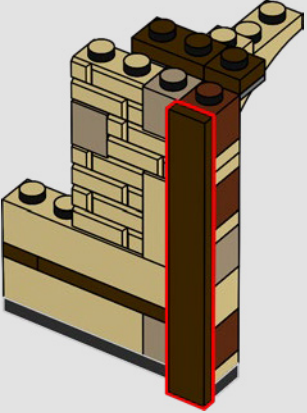

55

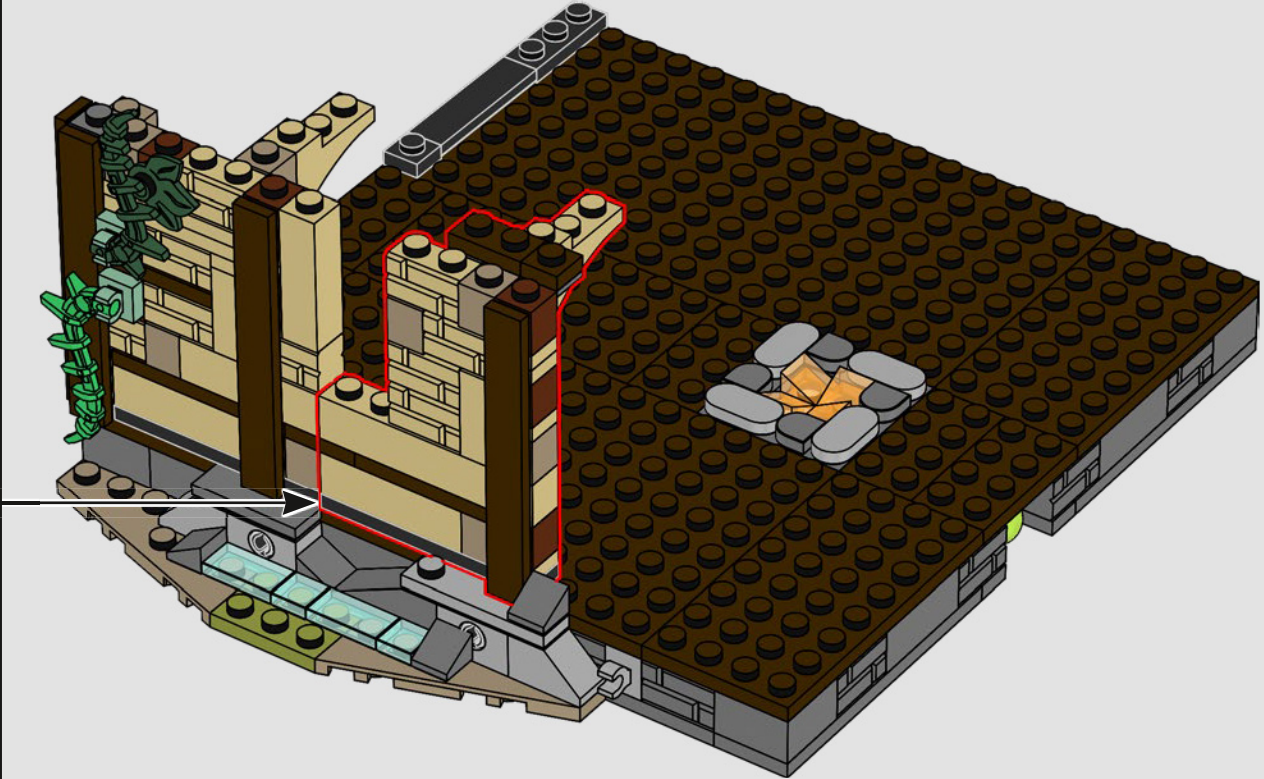

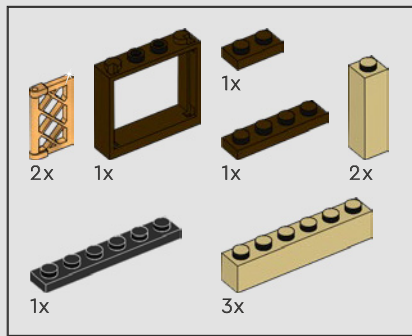

56

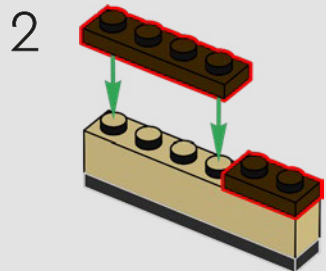
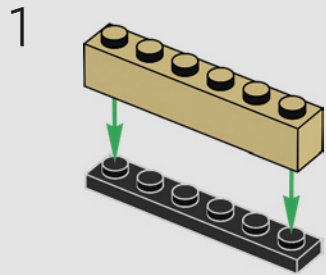

3

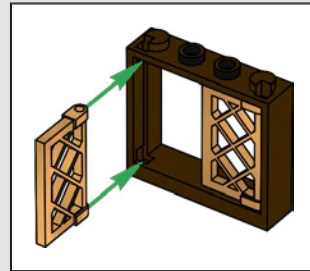
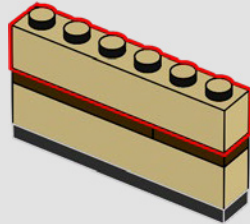

4

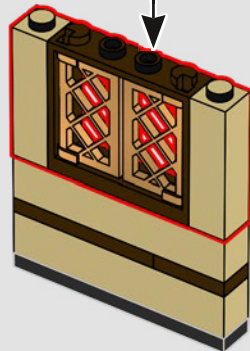

5

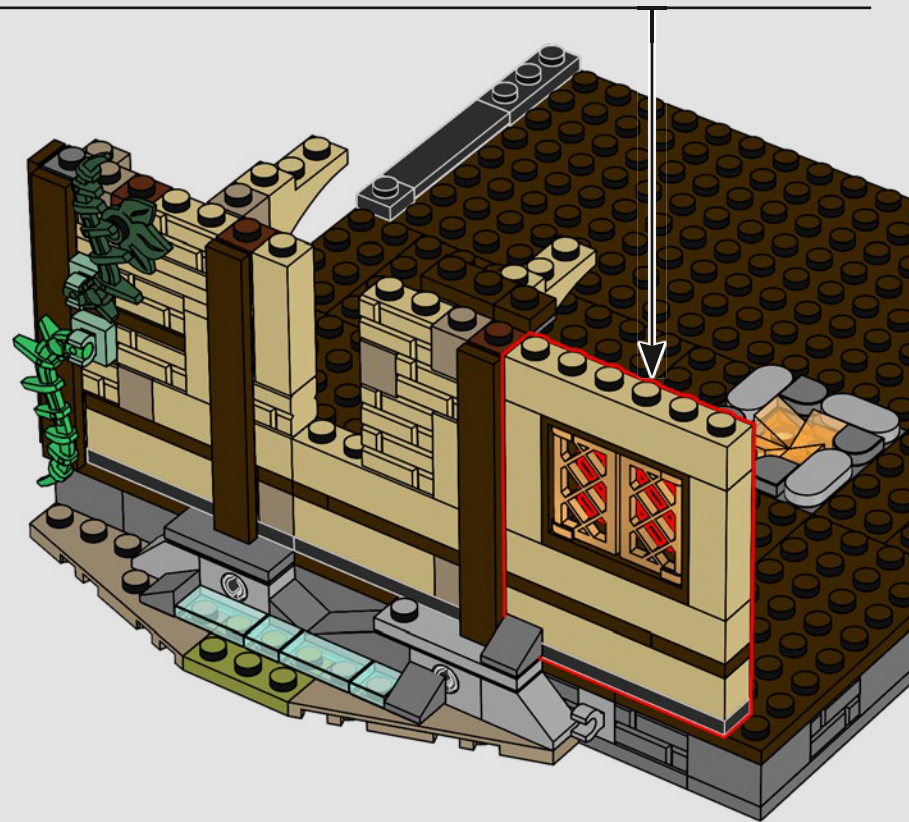
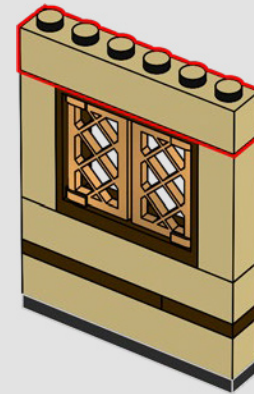

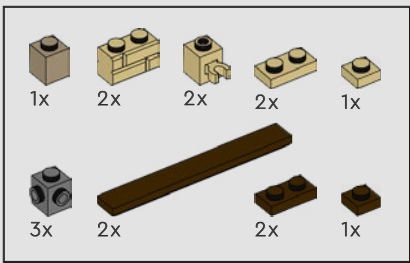

57

1



2

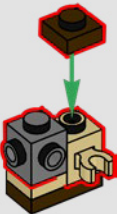

3

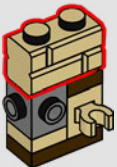

4

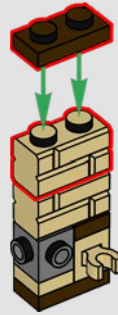

5



6

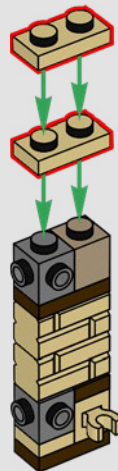

7

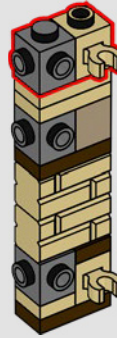

8

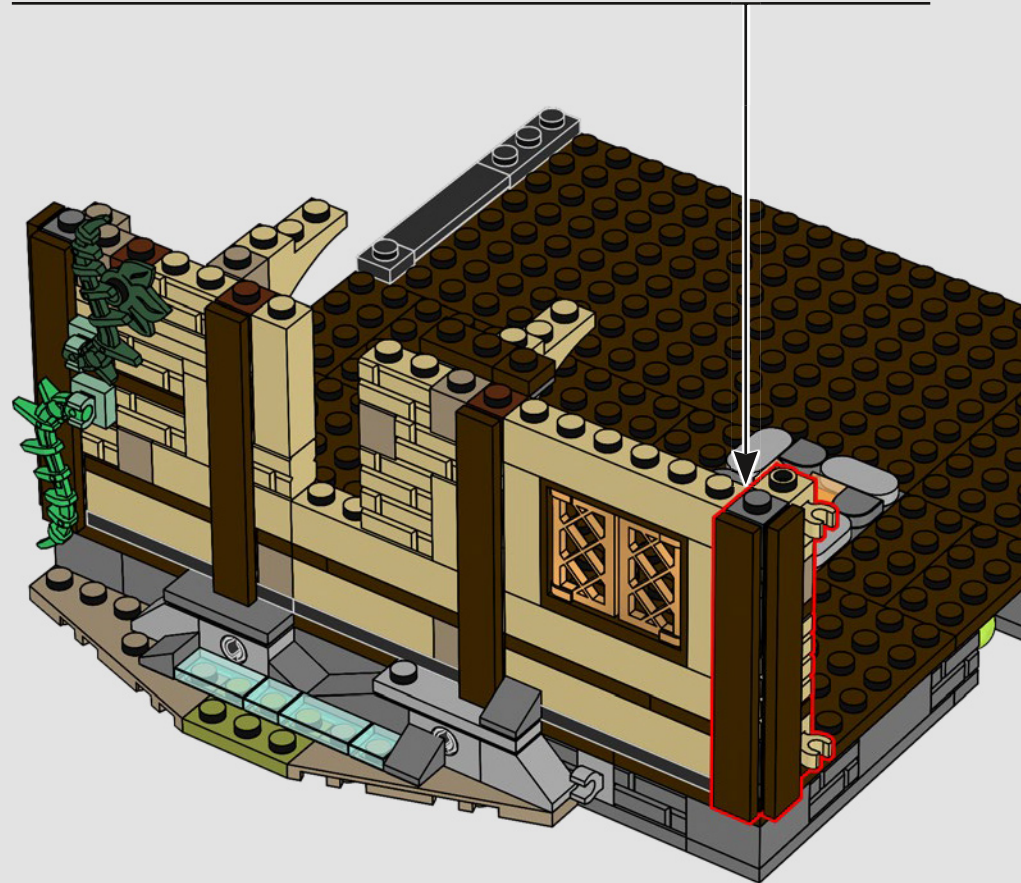
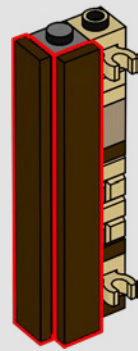

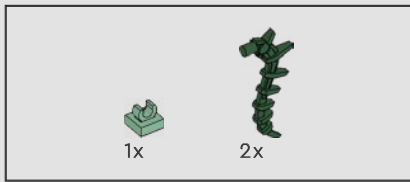

58

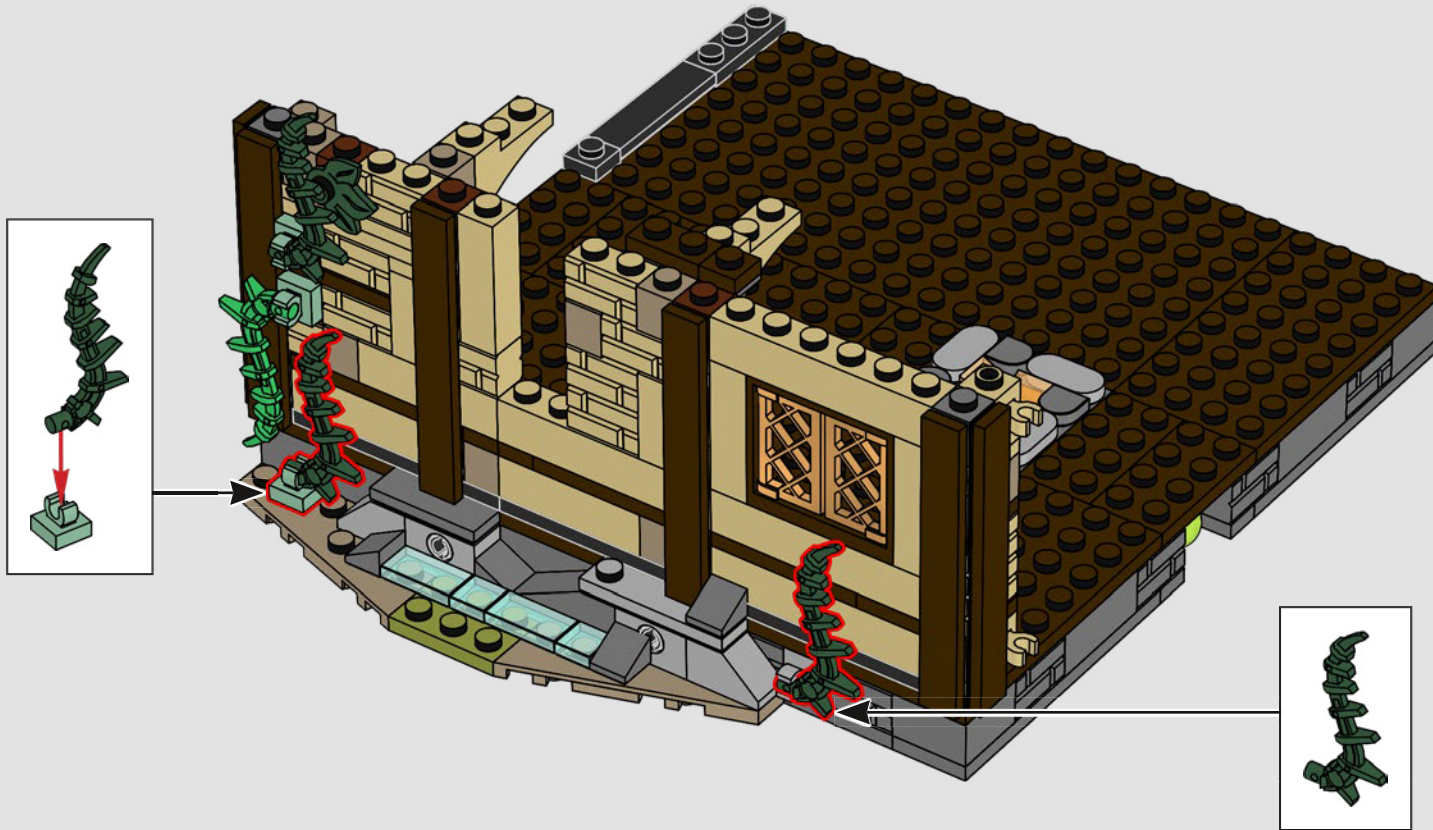

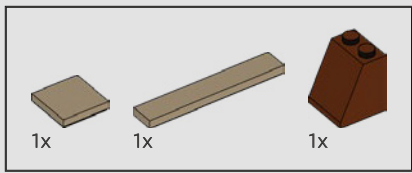

59

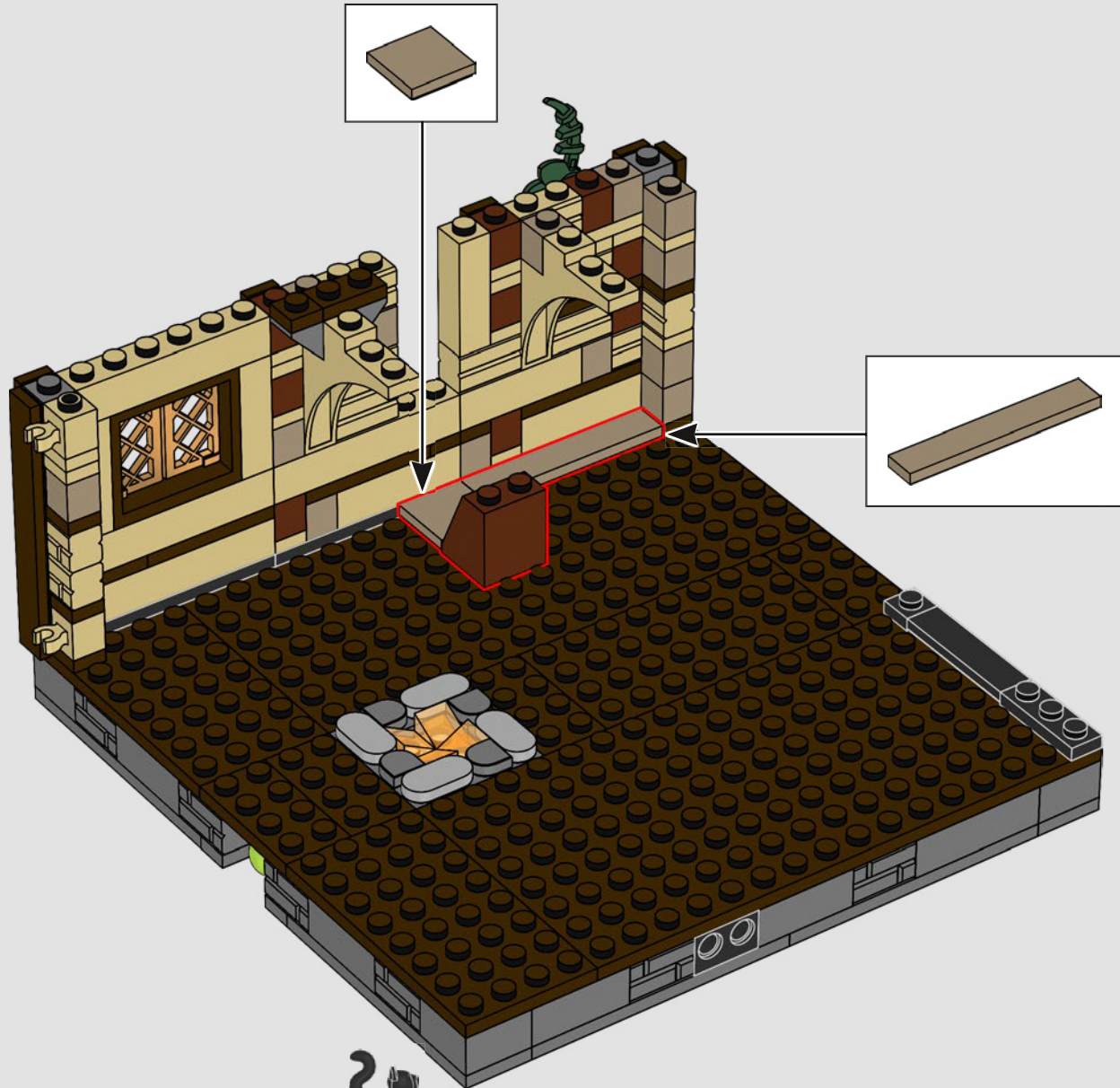

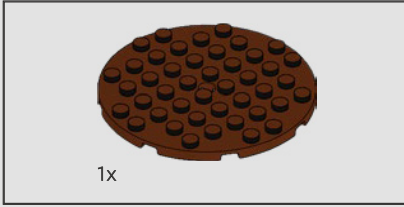
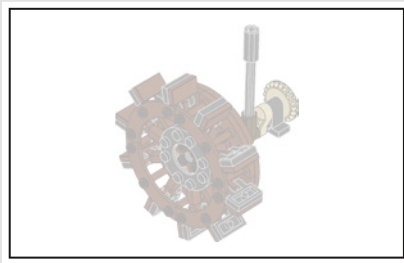

60

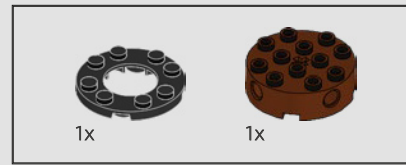
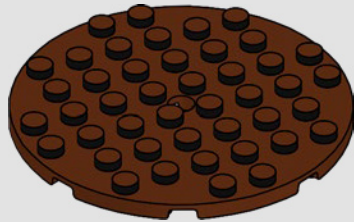

61

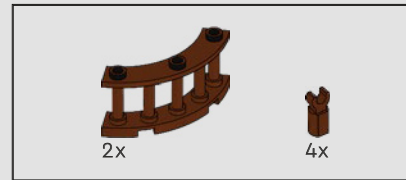
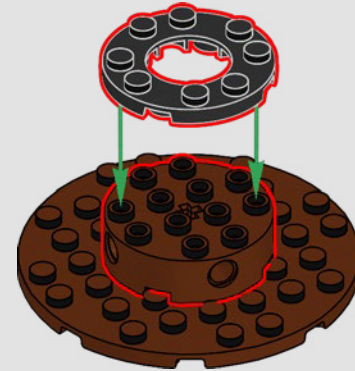

62

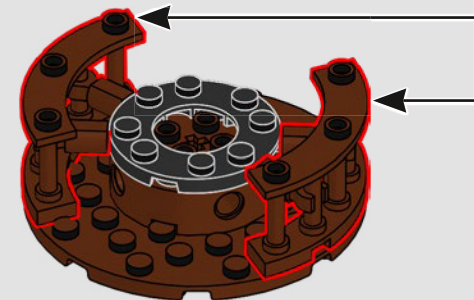
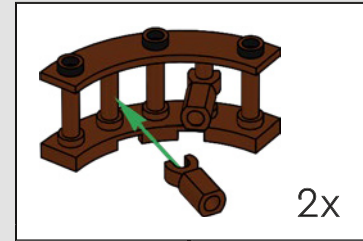

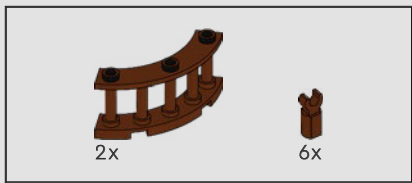

63

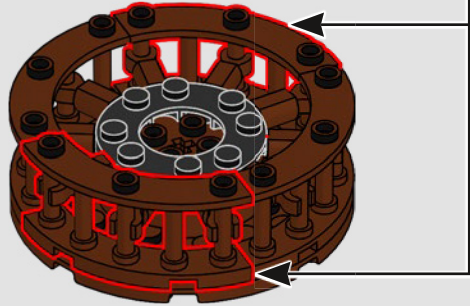
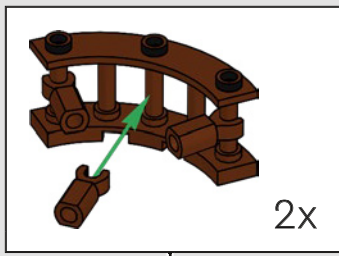

64

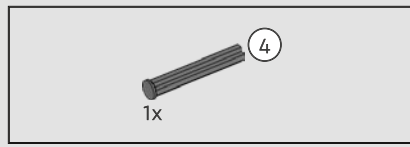
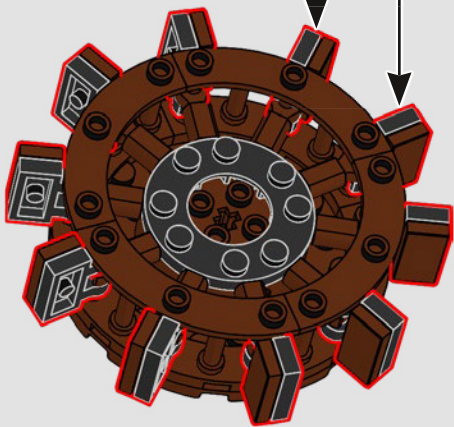
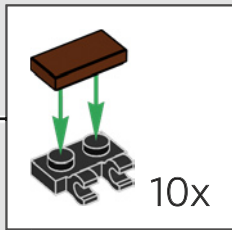

65

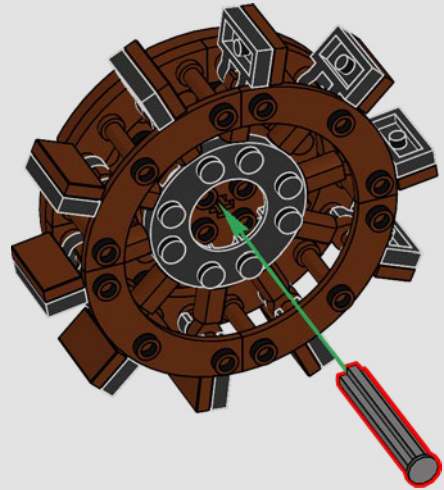
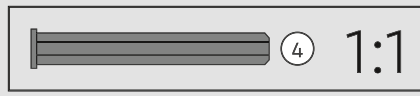

66

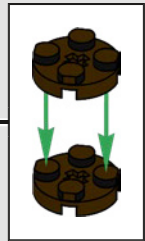
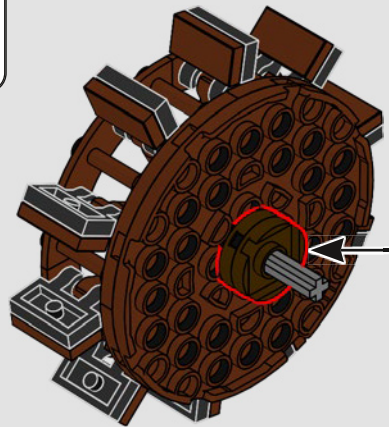

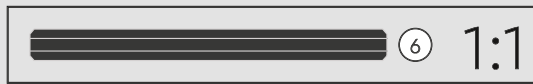
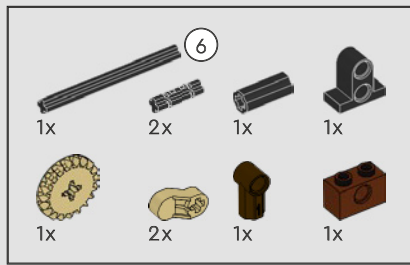

67

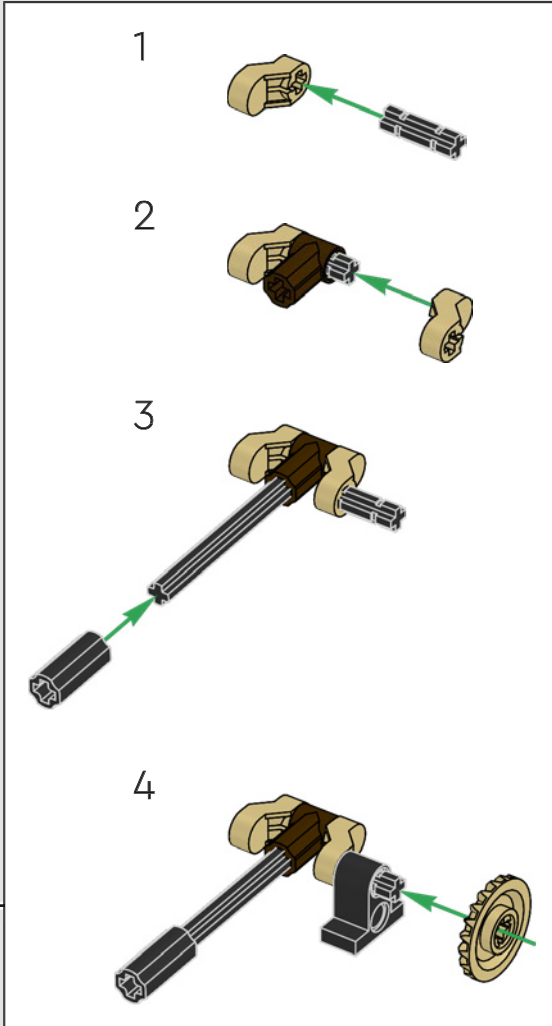
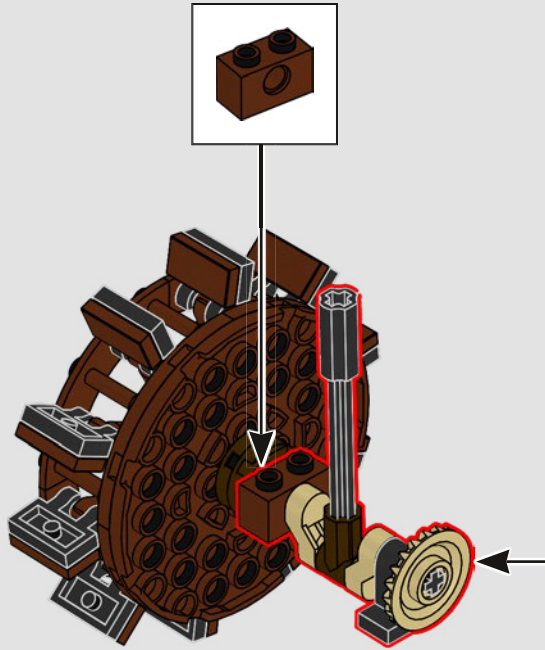

68

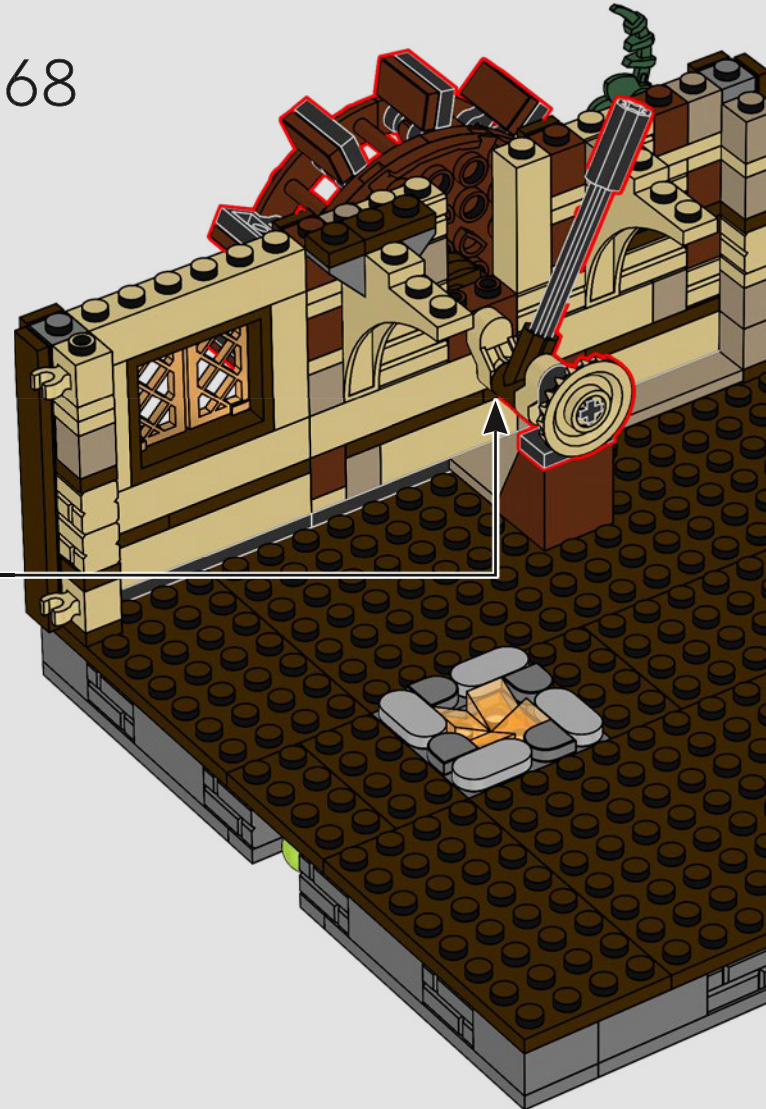

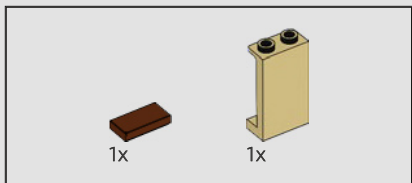

69

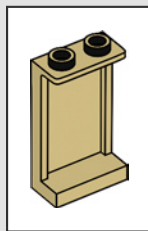

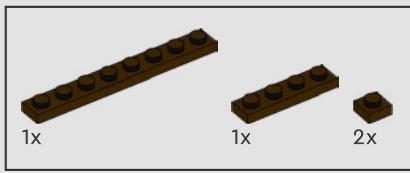

70

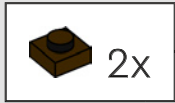

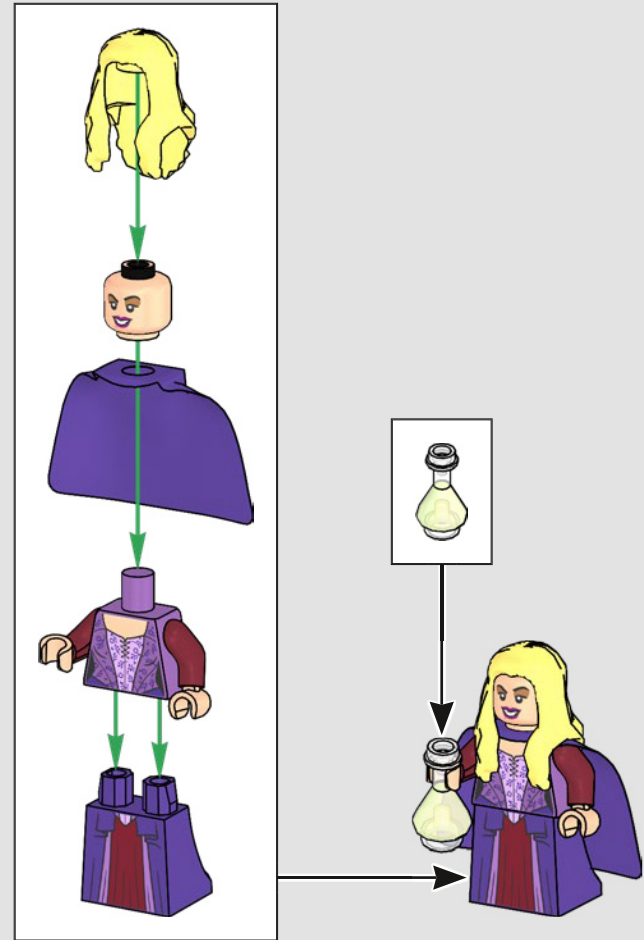

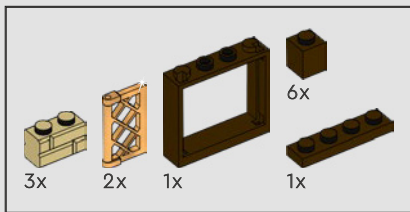

71

1

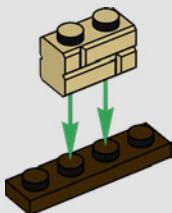

2

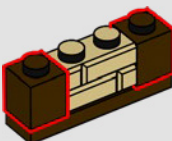

3

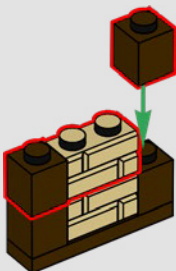

4



5

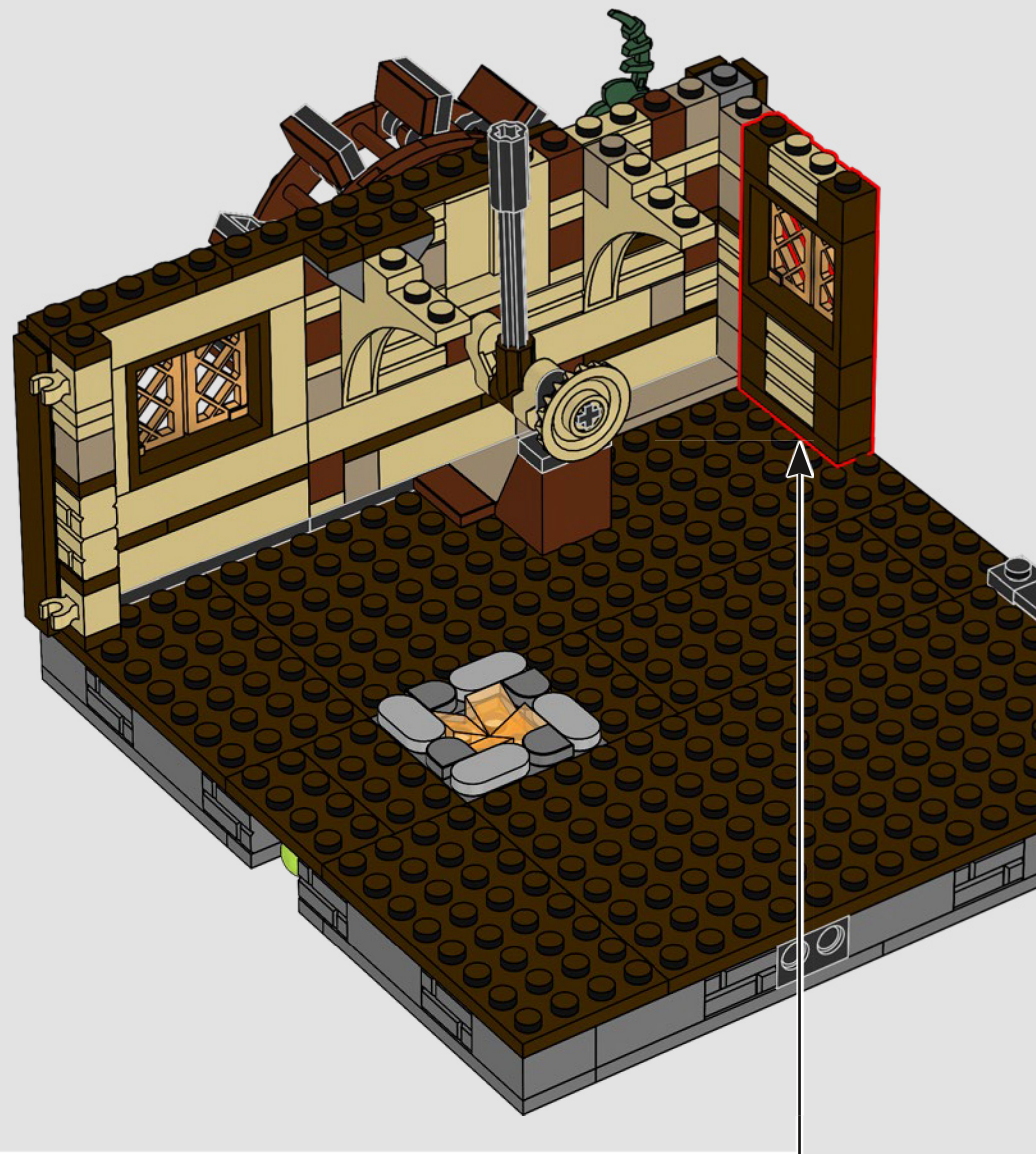
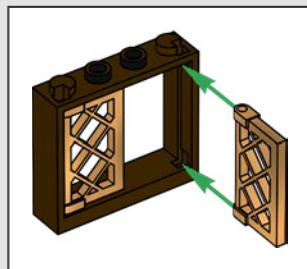
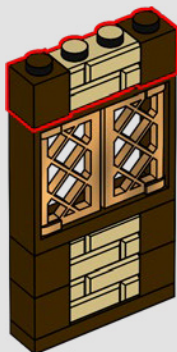

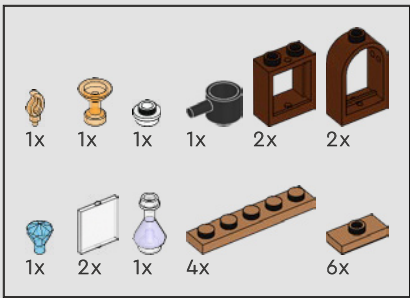

72

1

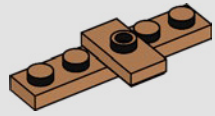

2

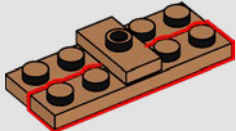

3

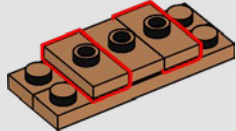

4

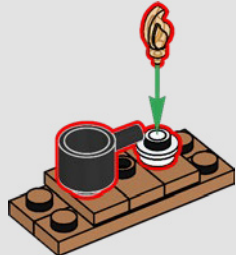

5

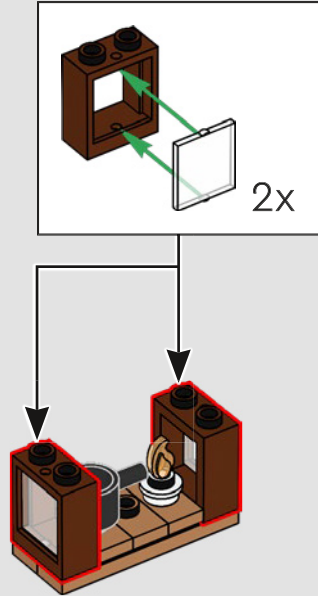

6

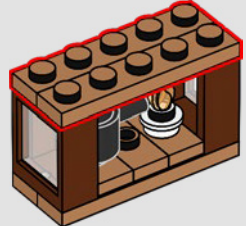

7

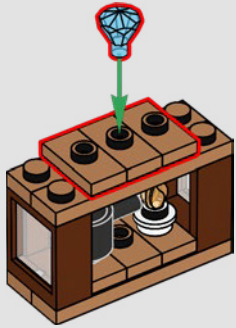

8

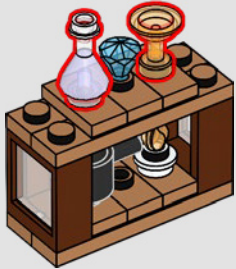

9

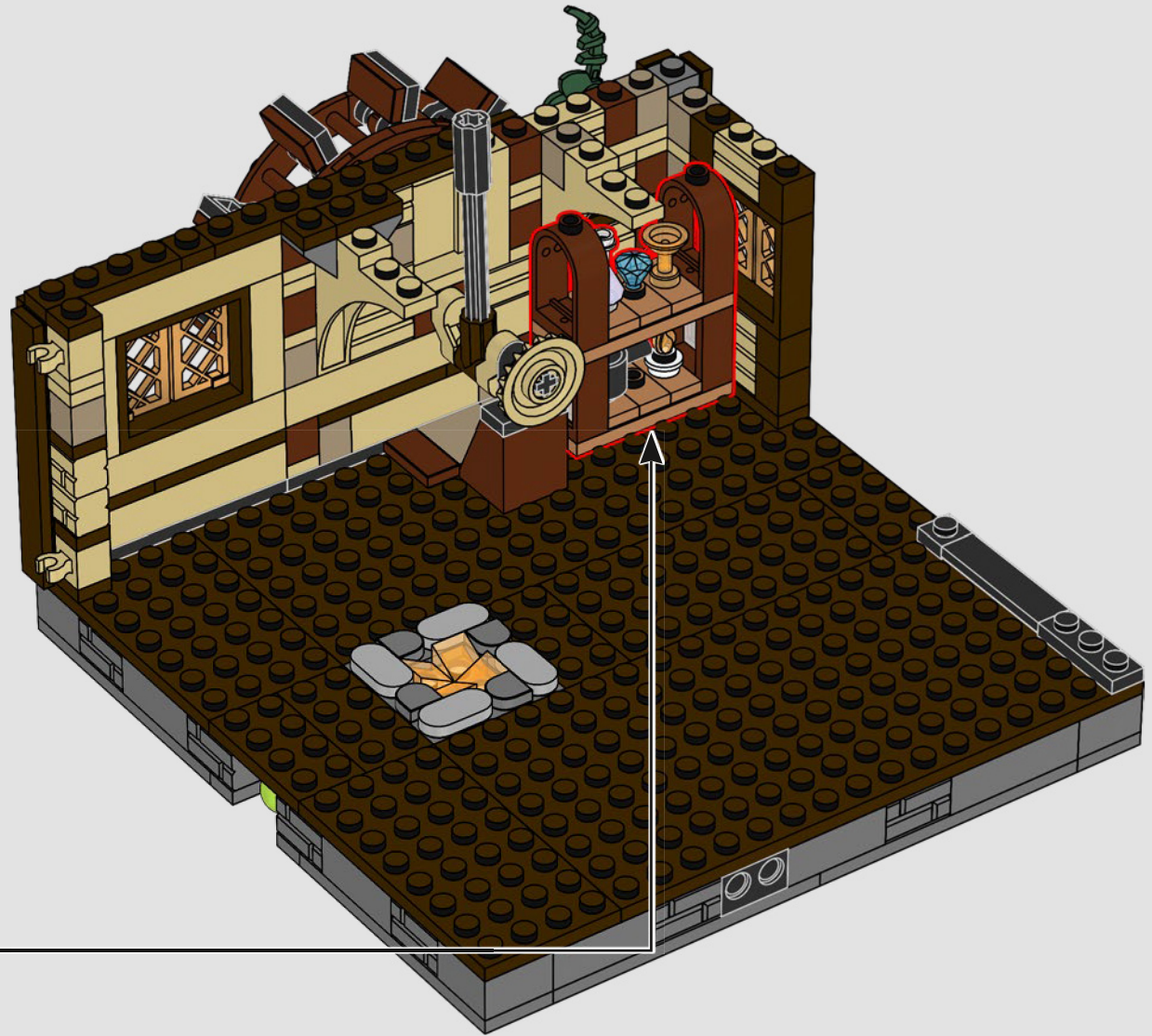
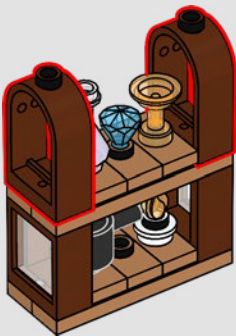

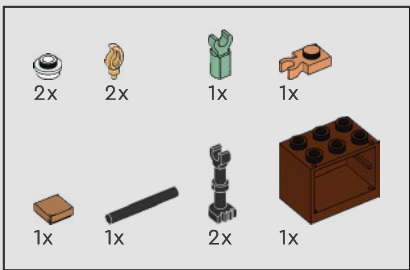

73

1

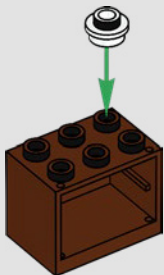

2

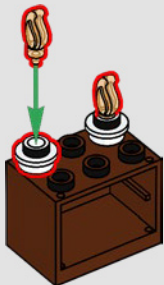

3

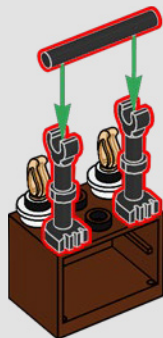

4

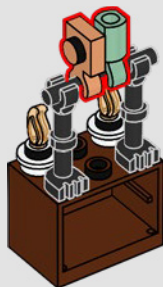

5

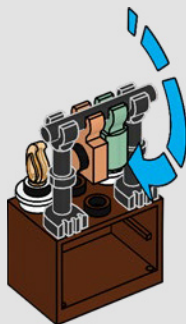

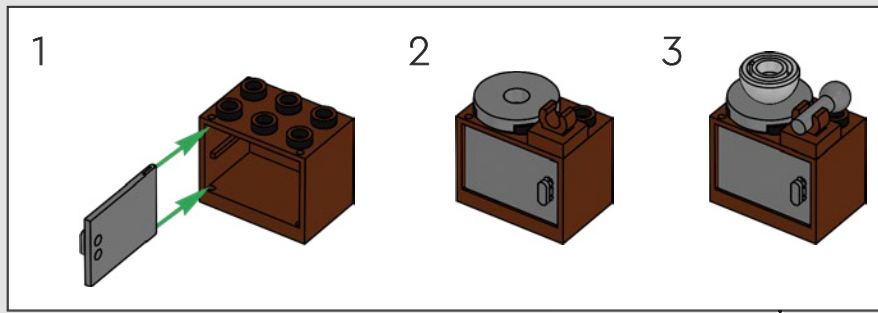
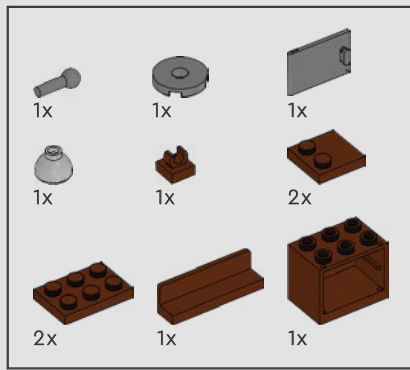

74

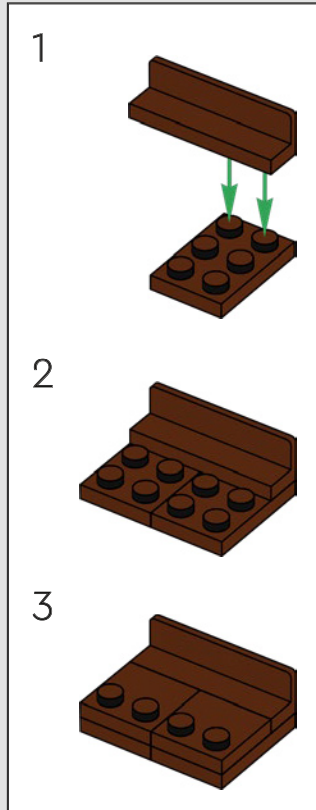

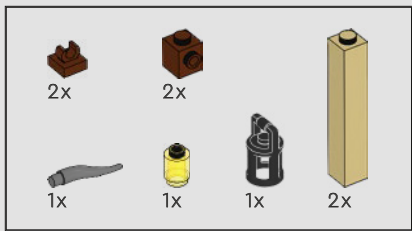

75

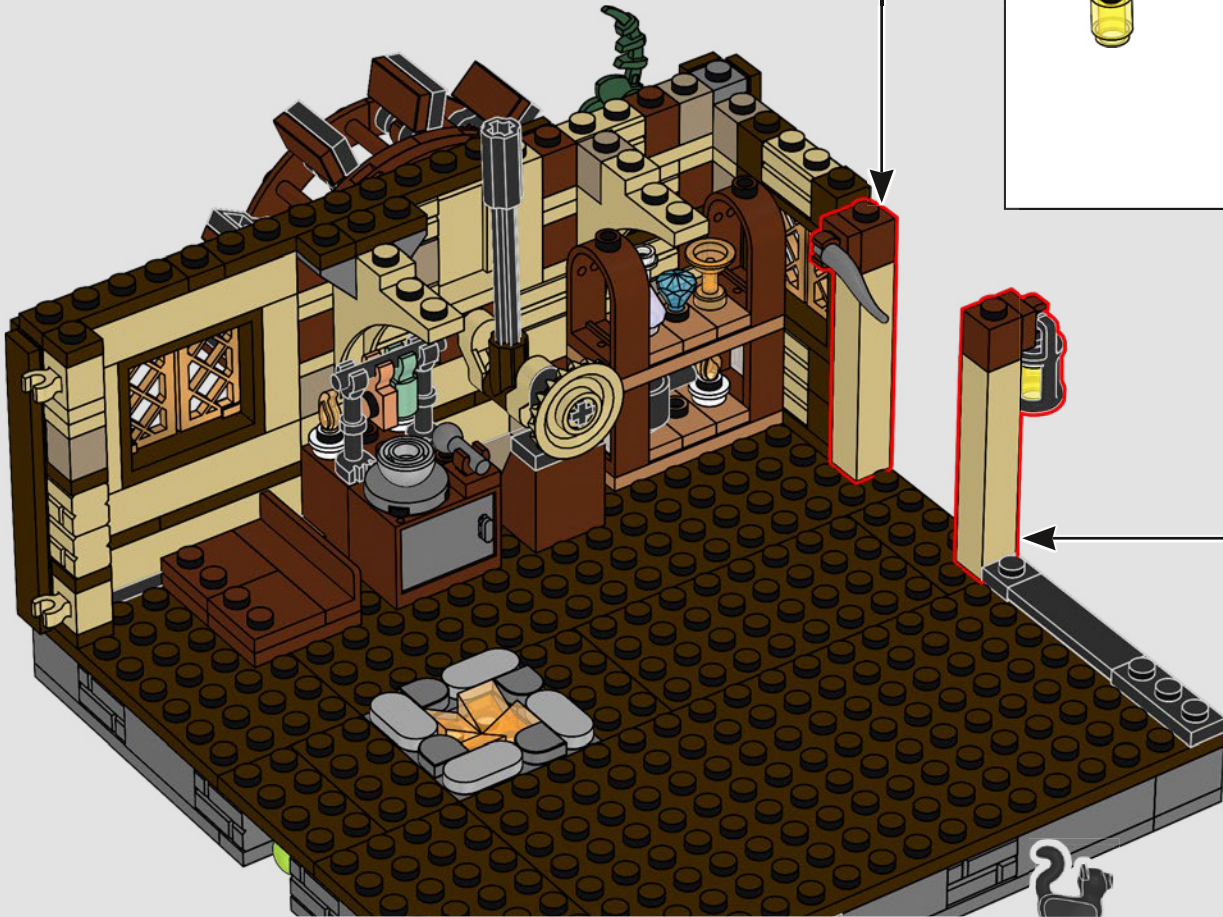
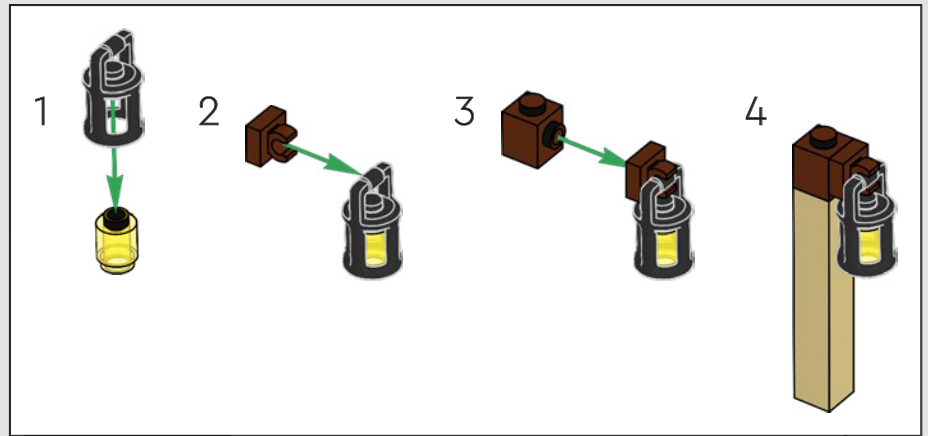
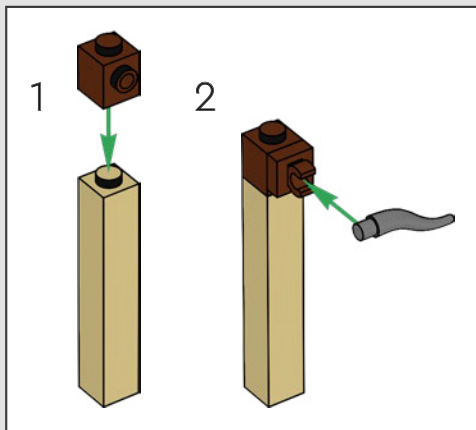

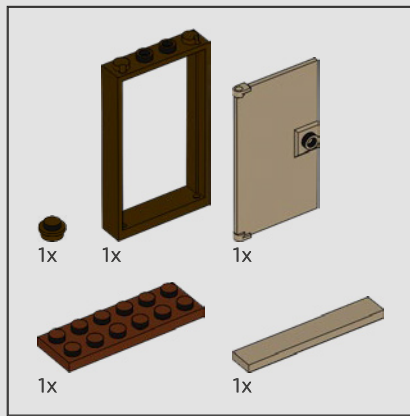

3



76

1



2

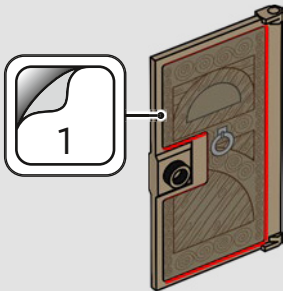

4

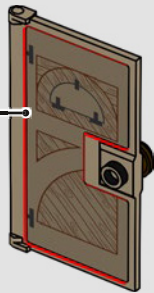

5

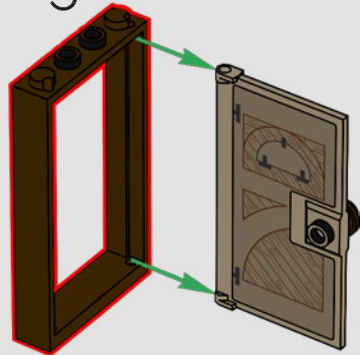

6

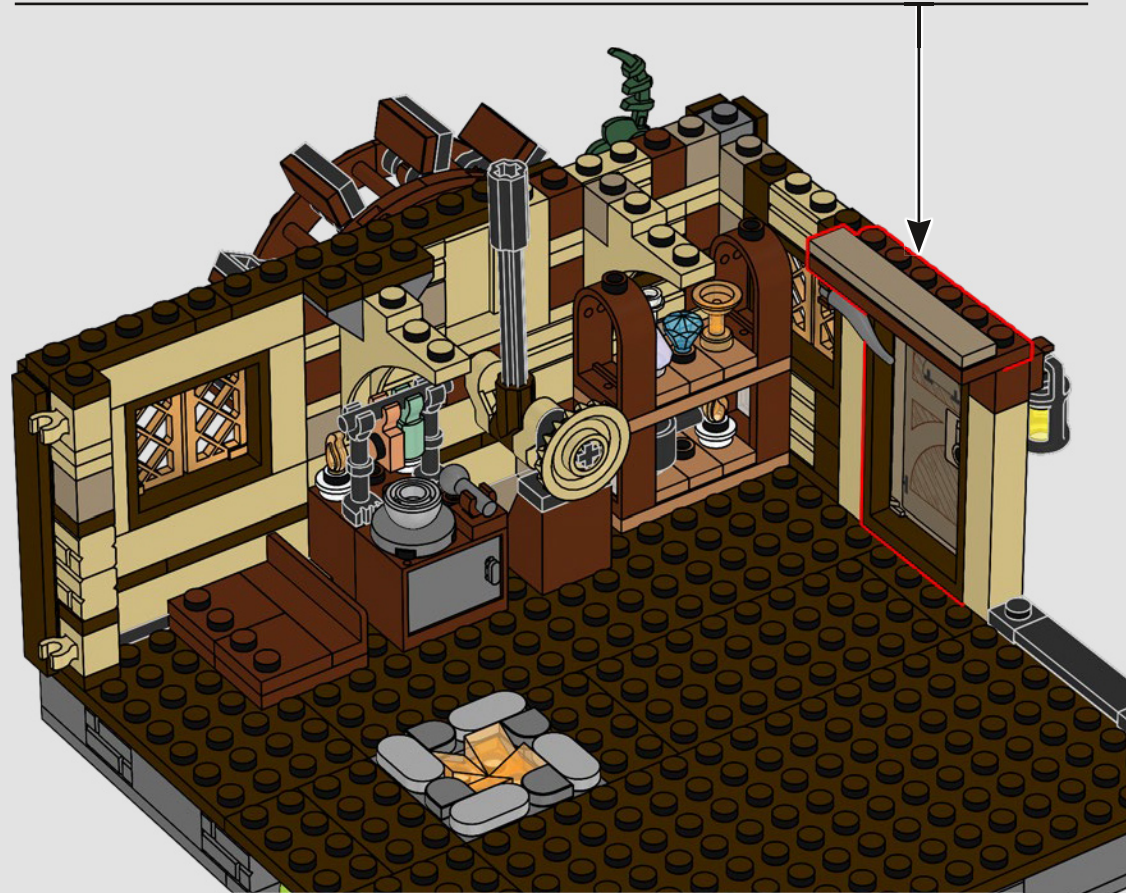
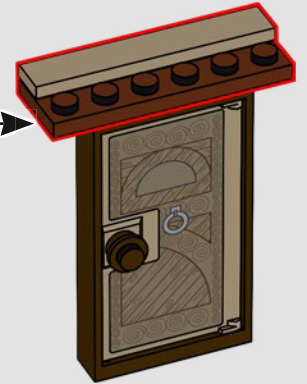
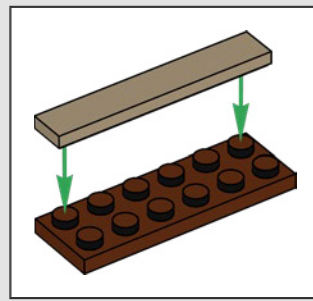

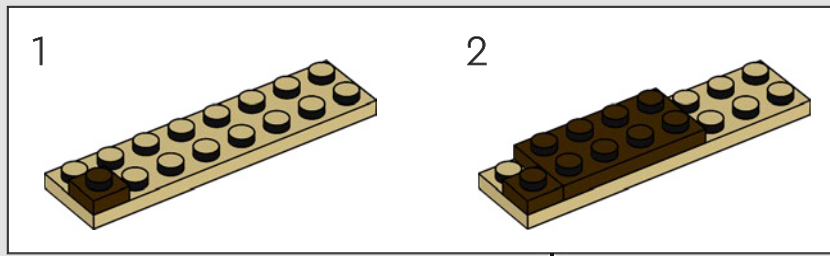
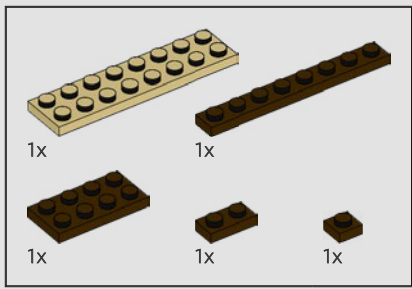

77



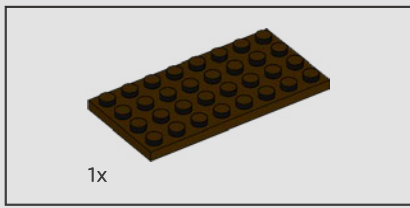

78



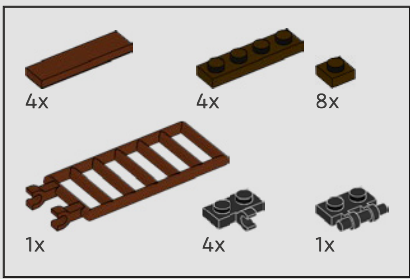

79

1

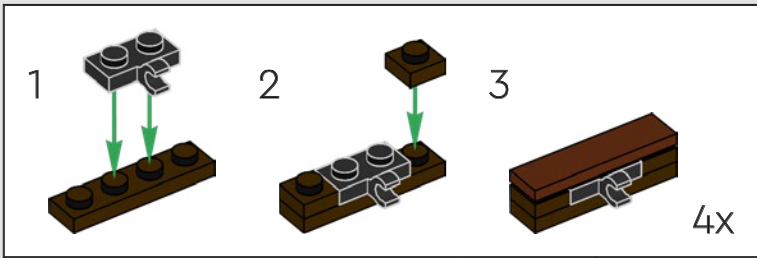
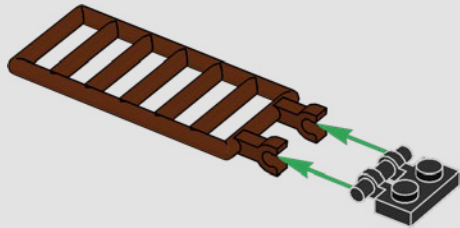

2

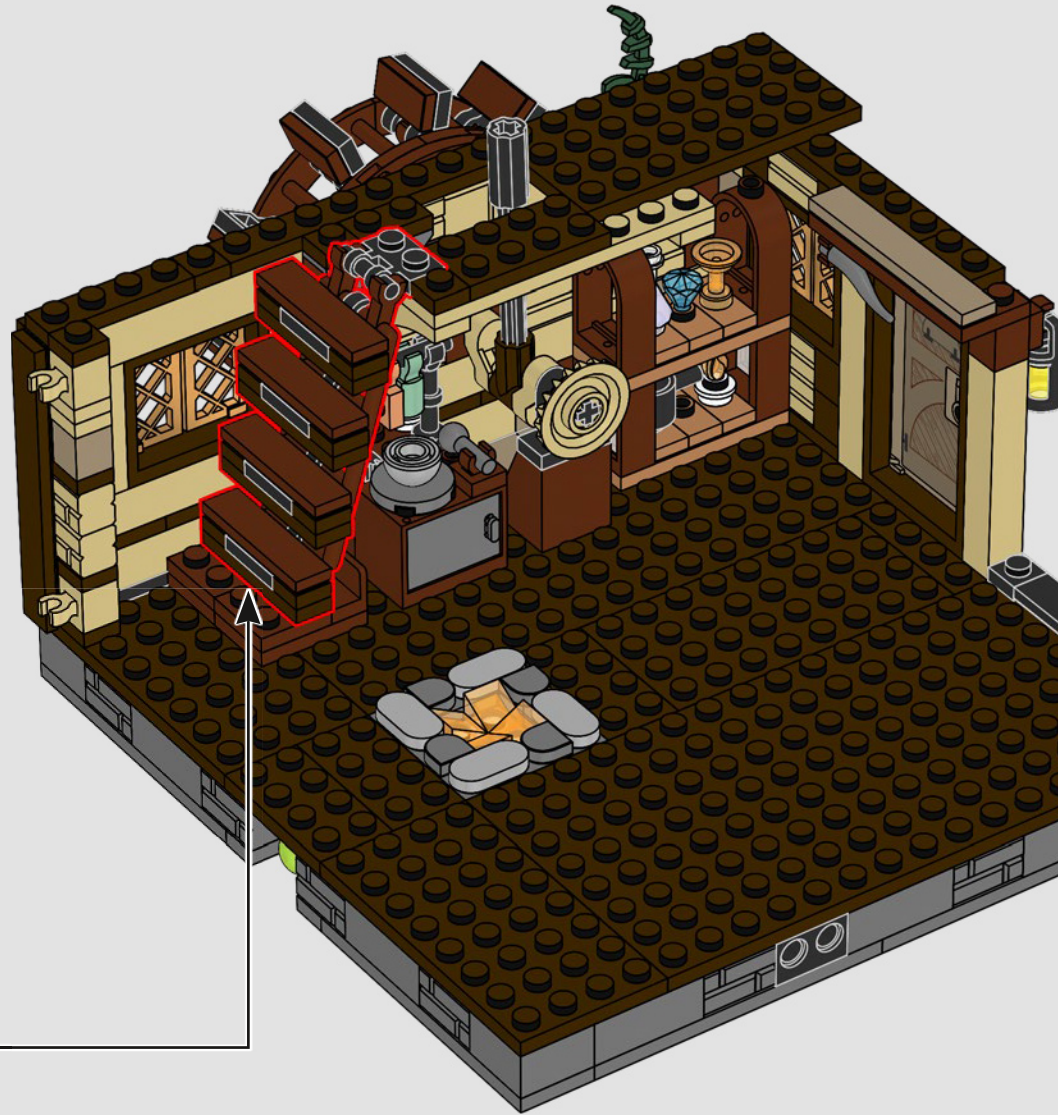
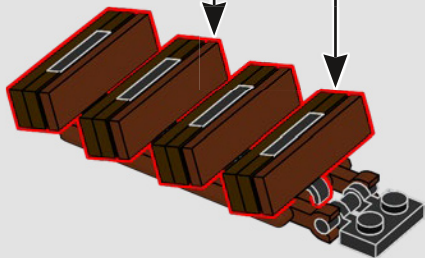

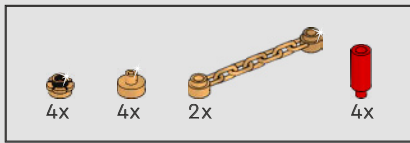

80

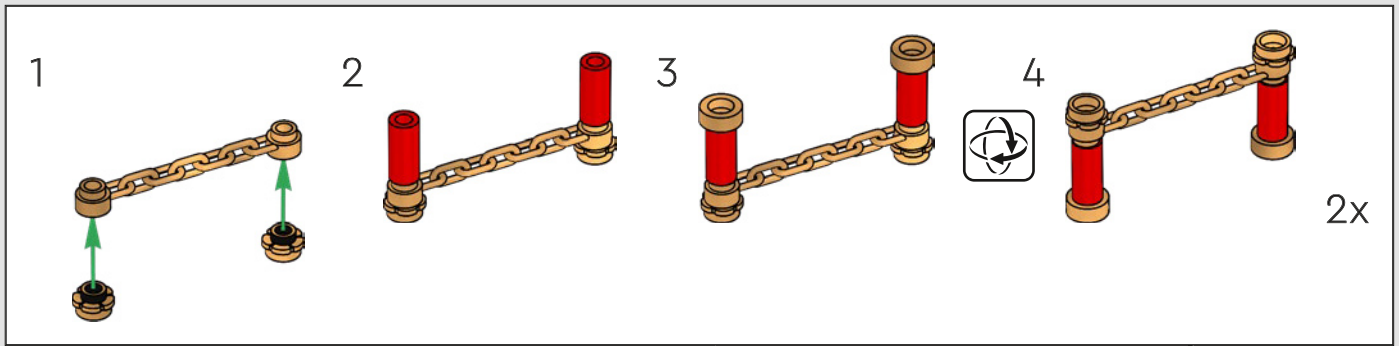

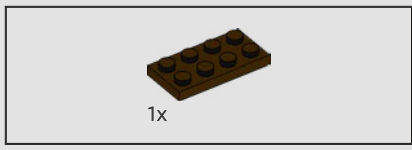

81

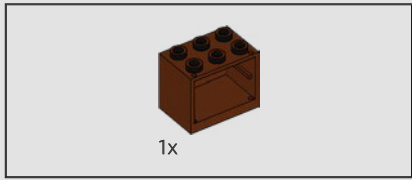
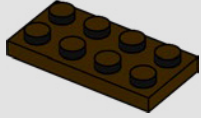

82

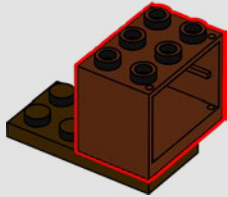

83

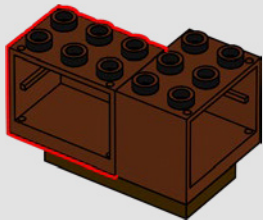

84

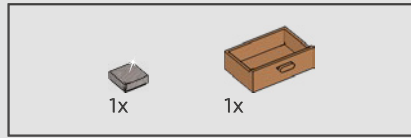
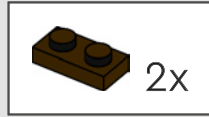
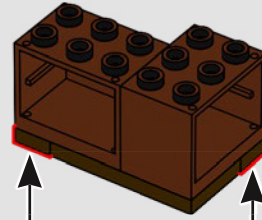

85

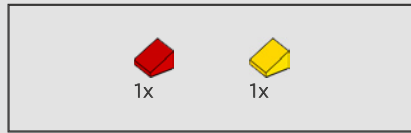
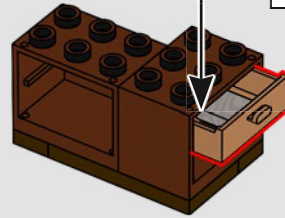

86

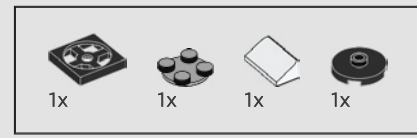
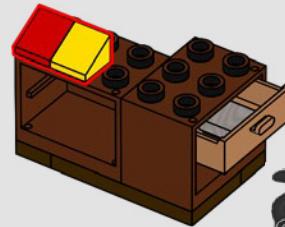

87

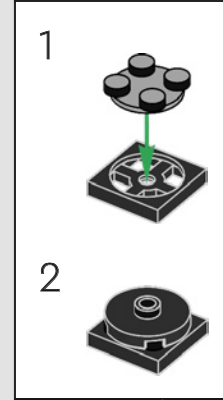

1

2

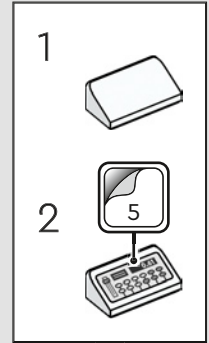

1

2

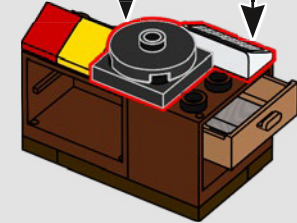



88

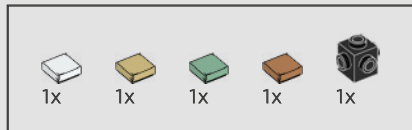
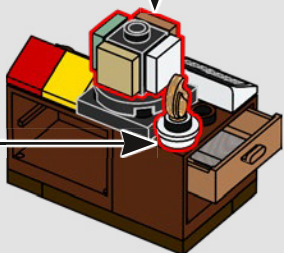
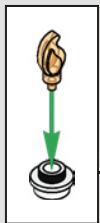
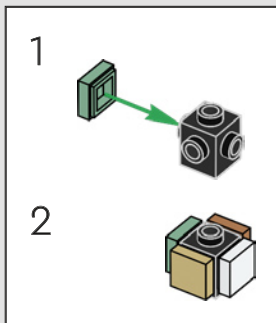

89

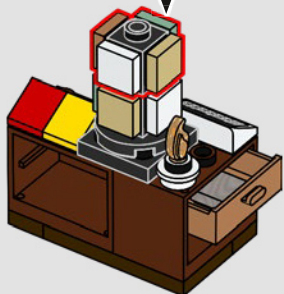
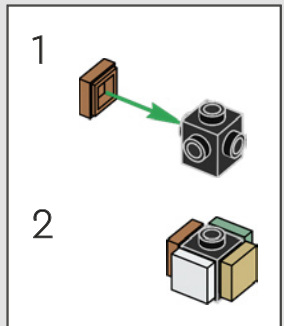

90



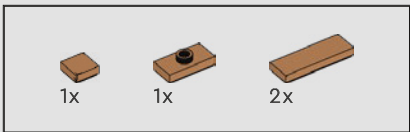

91



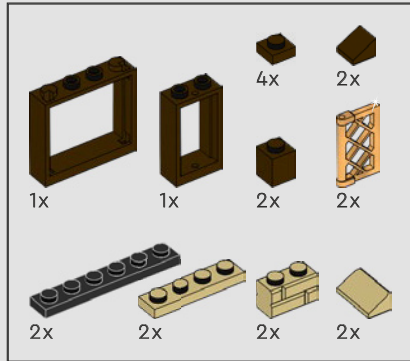
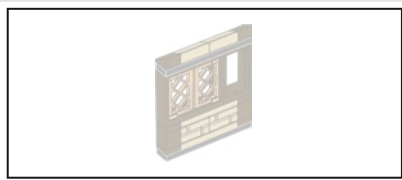

92

1

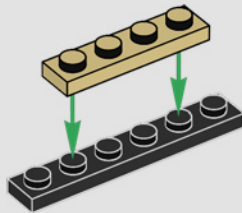

2

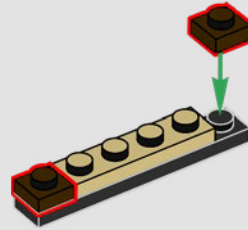

3

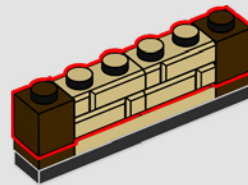

4

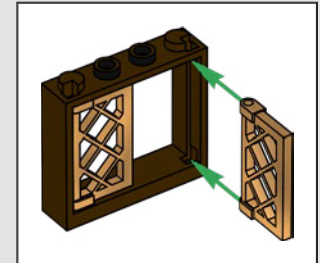
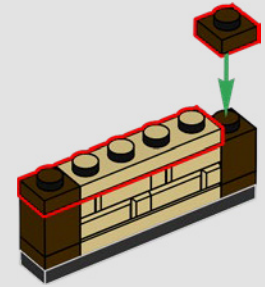

5

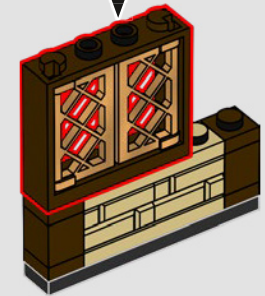

6

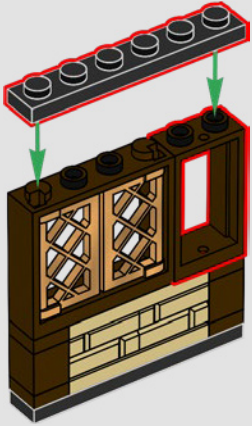

7

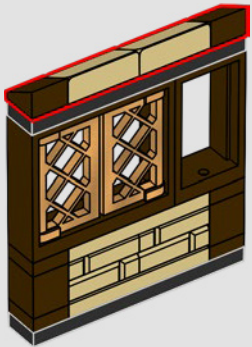

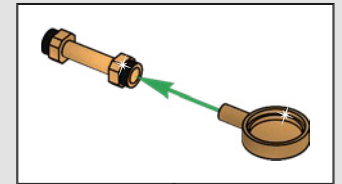
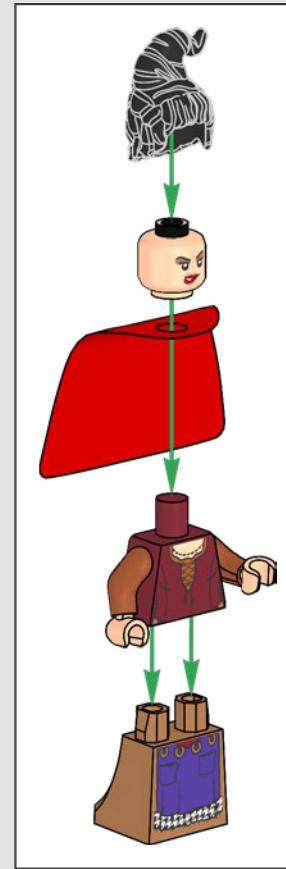

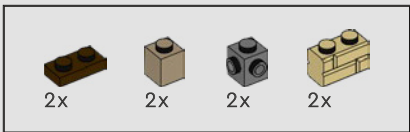

93

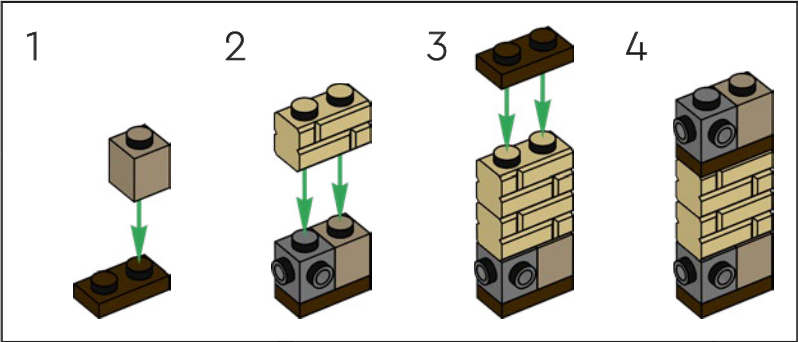

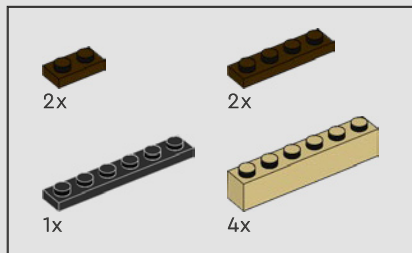

94

1

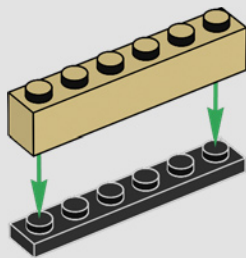

2

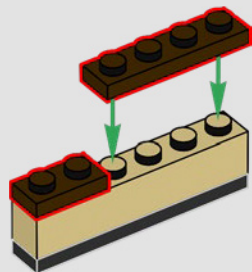

3

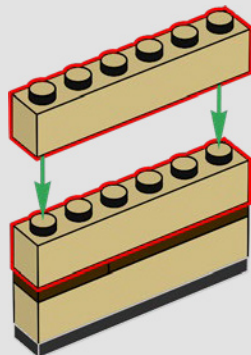

4

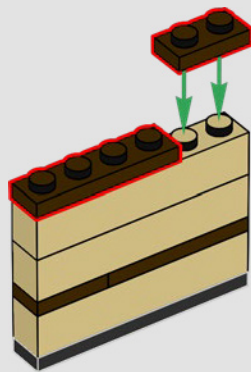

5

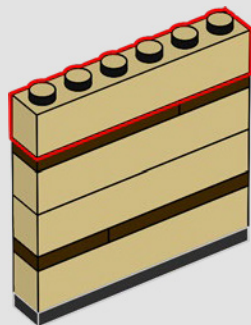

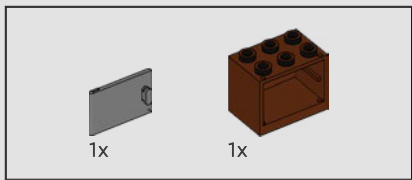

95

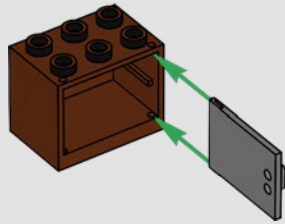

96

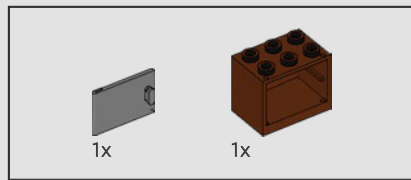
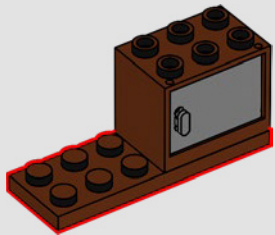

97

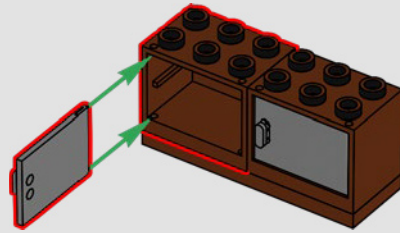

98

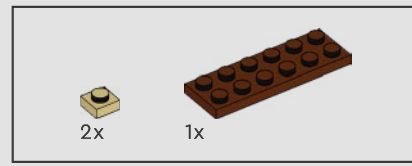

99

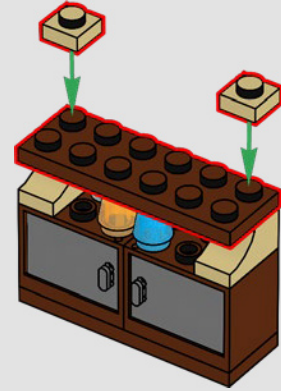

100

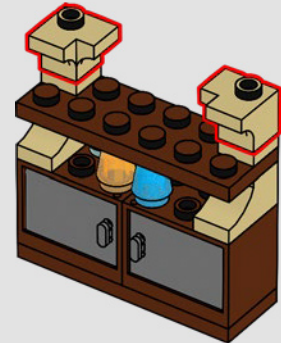

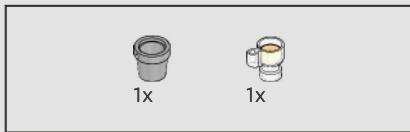

101

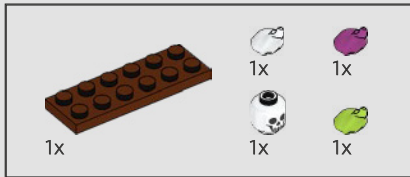
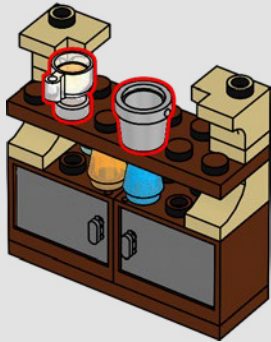

102

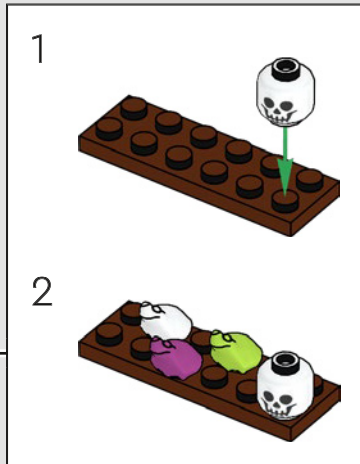

103



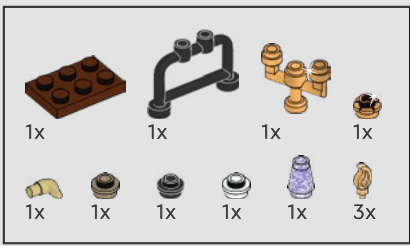

104

1

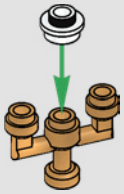

2

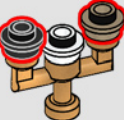

3



4



5

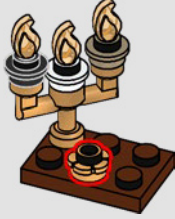

6



7



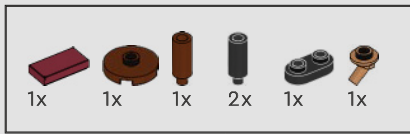

105

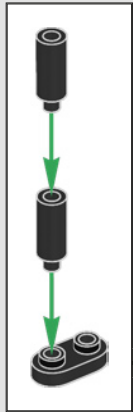
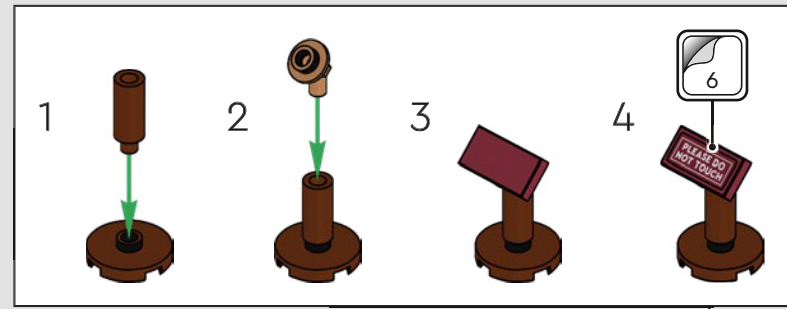

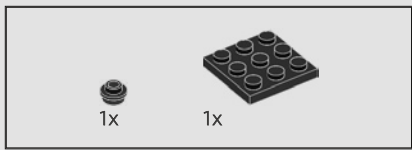

106

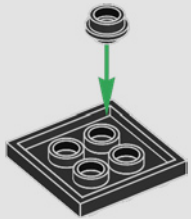

107



108

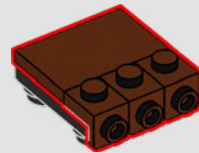

109

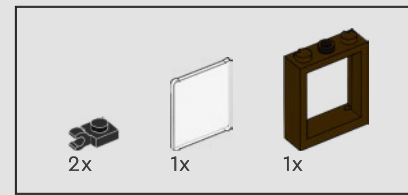
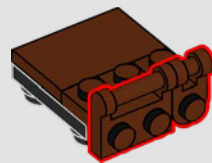

110

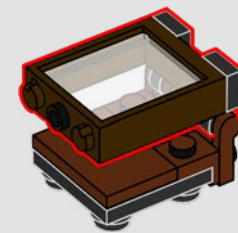
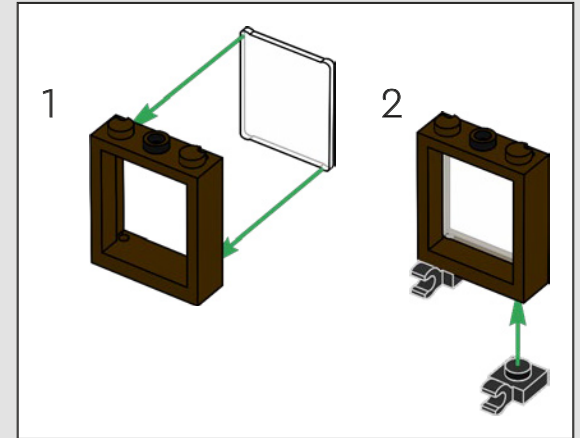

111

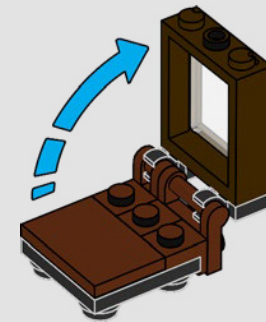

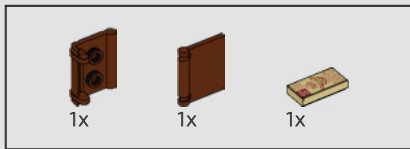

112

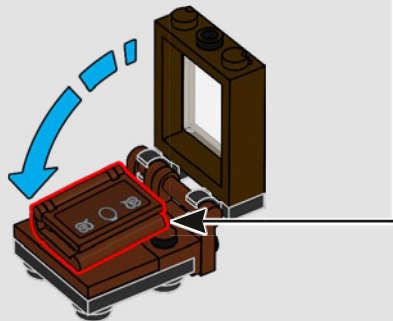
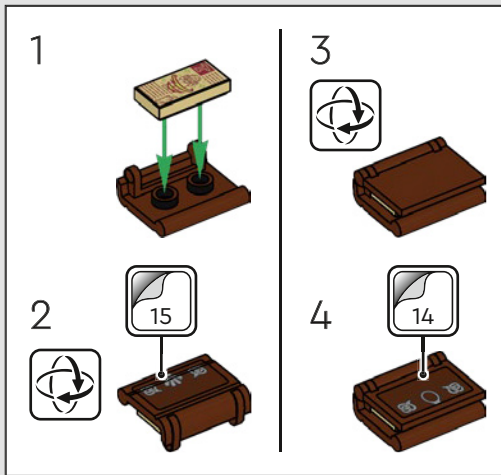

113

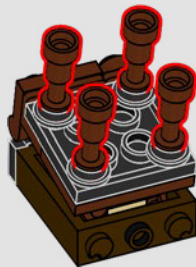

114



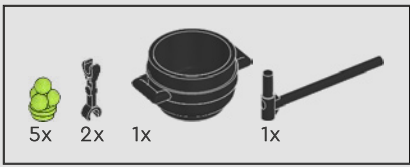

115

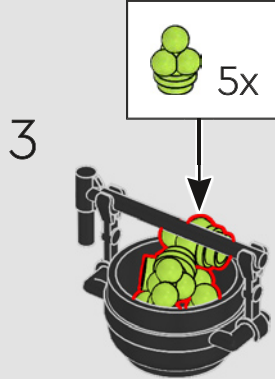
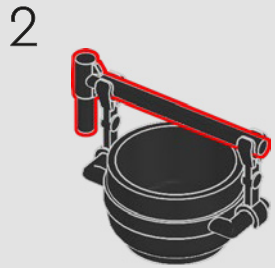
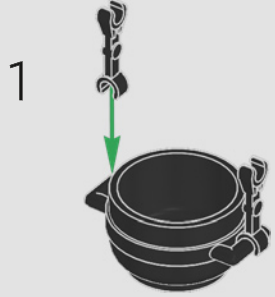

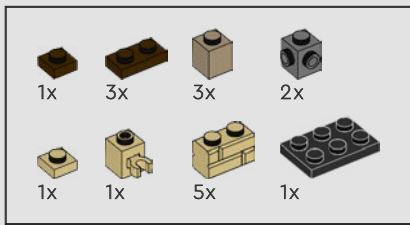

116

1

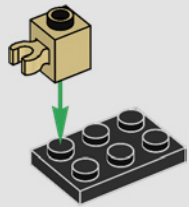

2

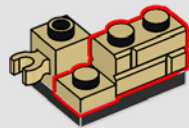

3

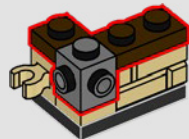

4

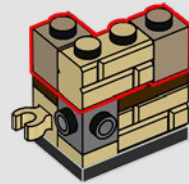

5

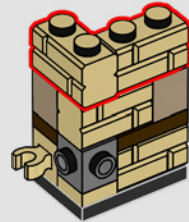

6

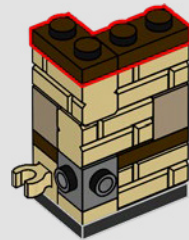

7

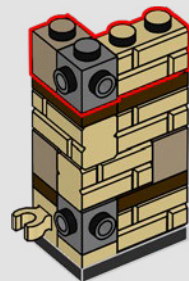

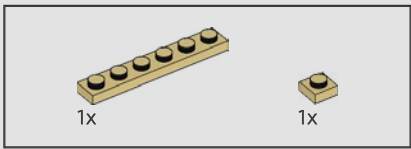
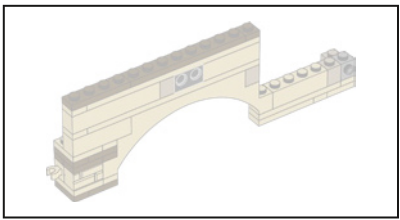

119

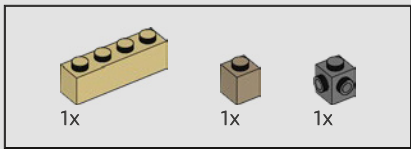

121

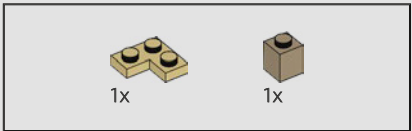

117

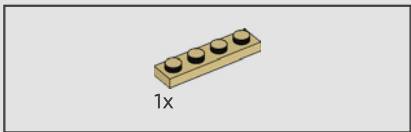
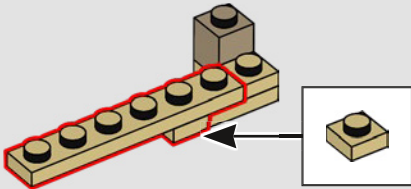
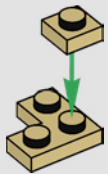

120

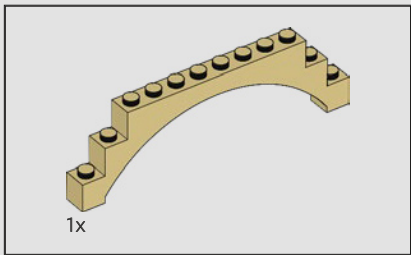

122



118

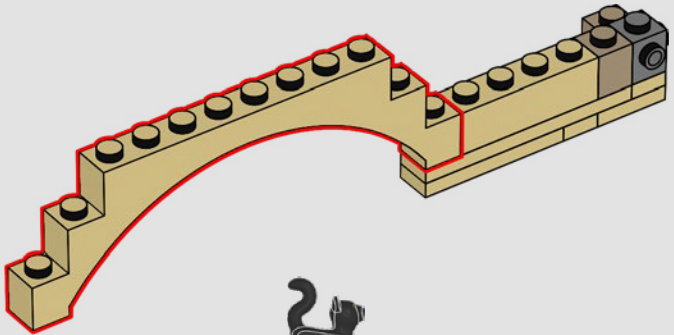
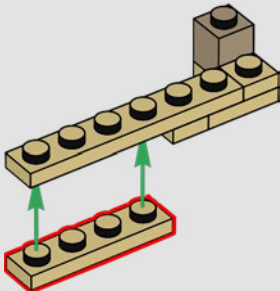
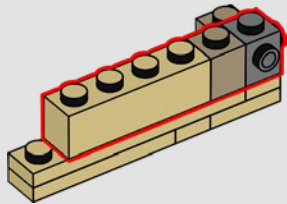
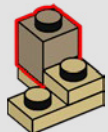

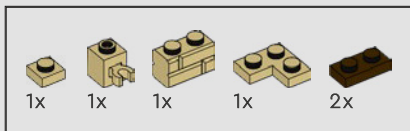

123

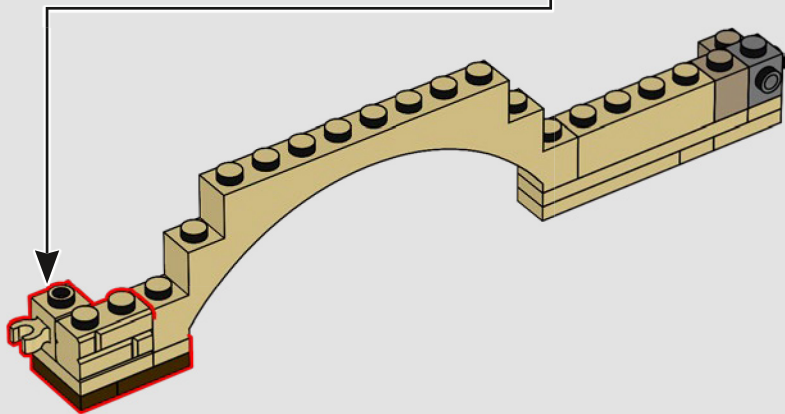
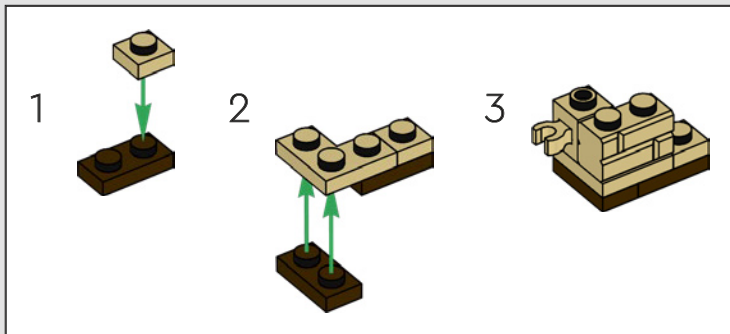

124

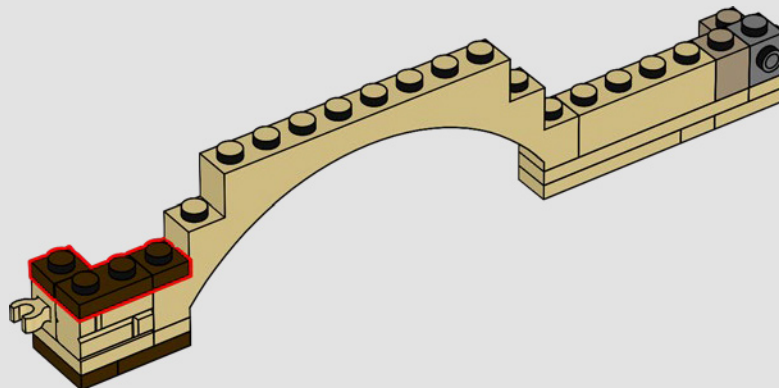

125

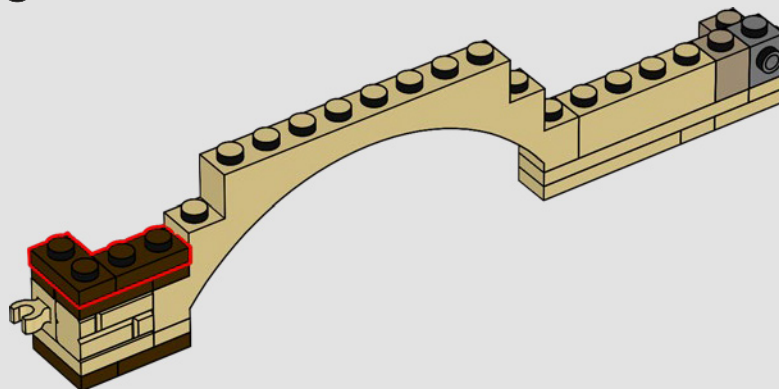

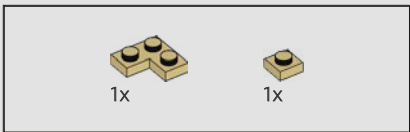

126

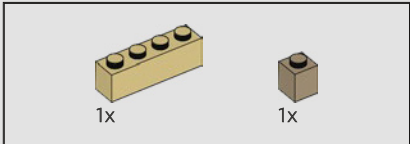
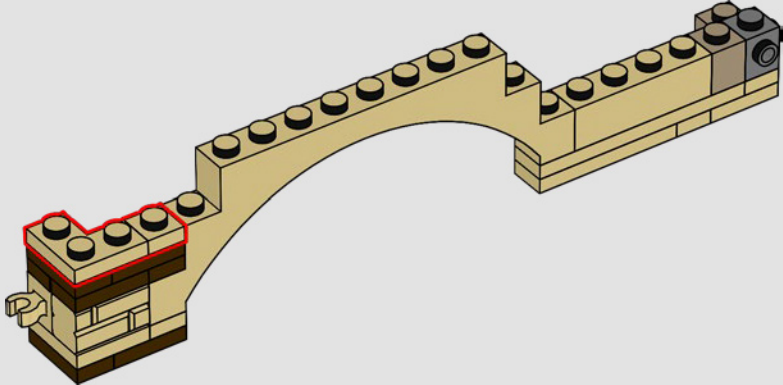

127

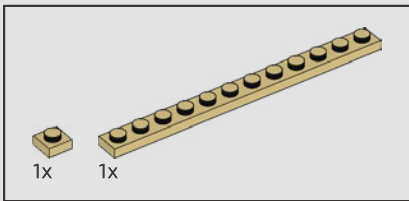
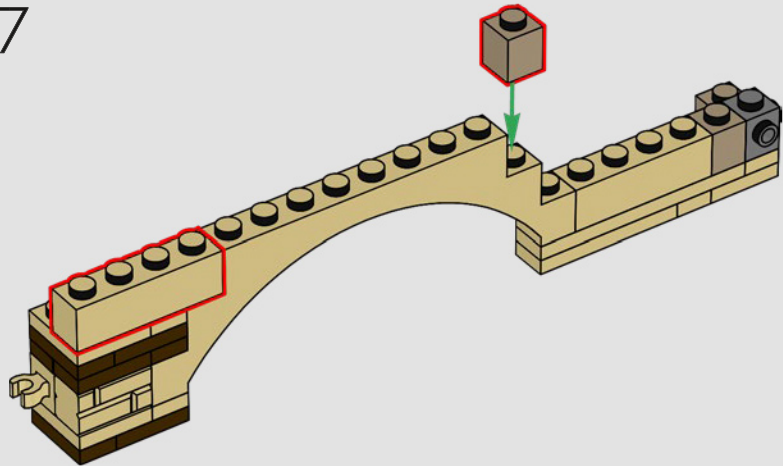

128

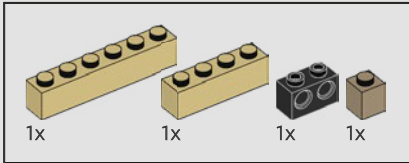
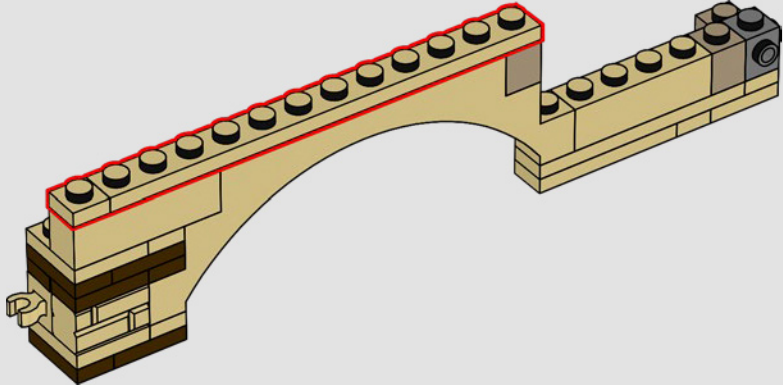

129

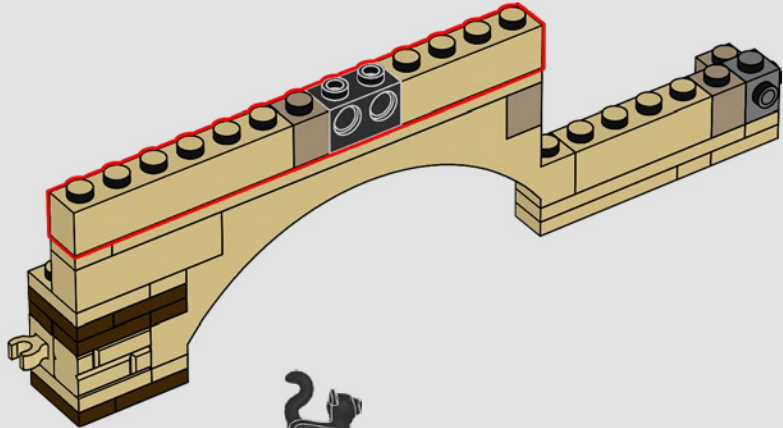

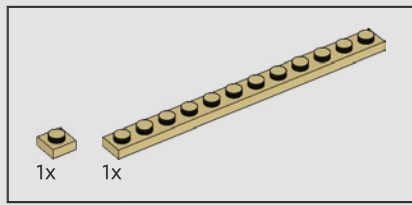

130

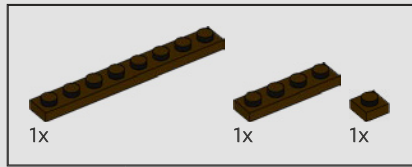
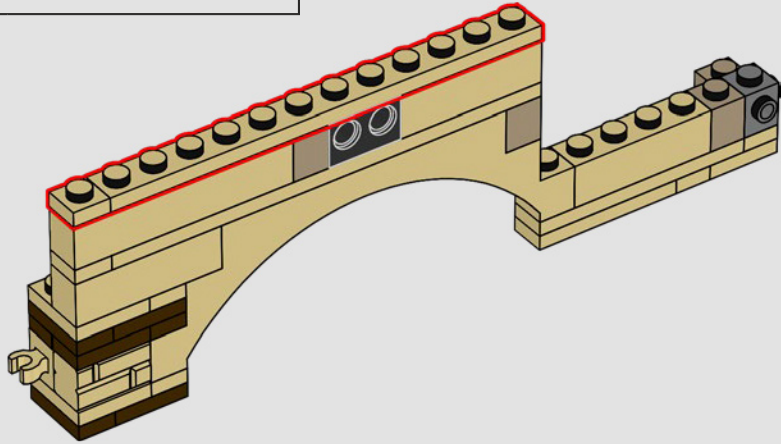

131

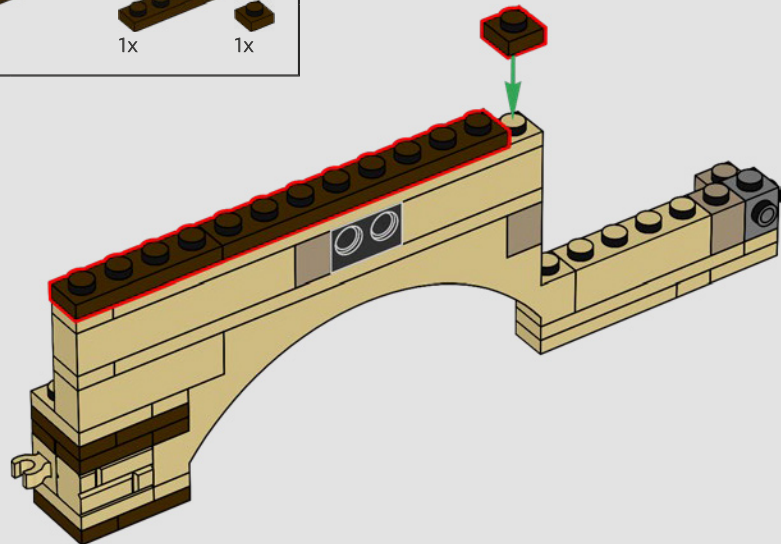

132

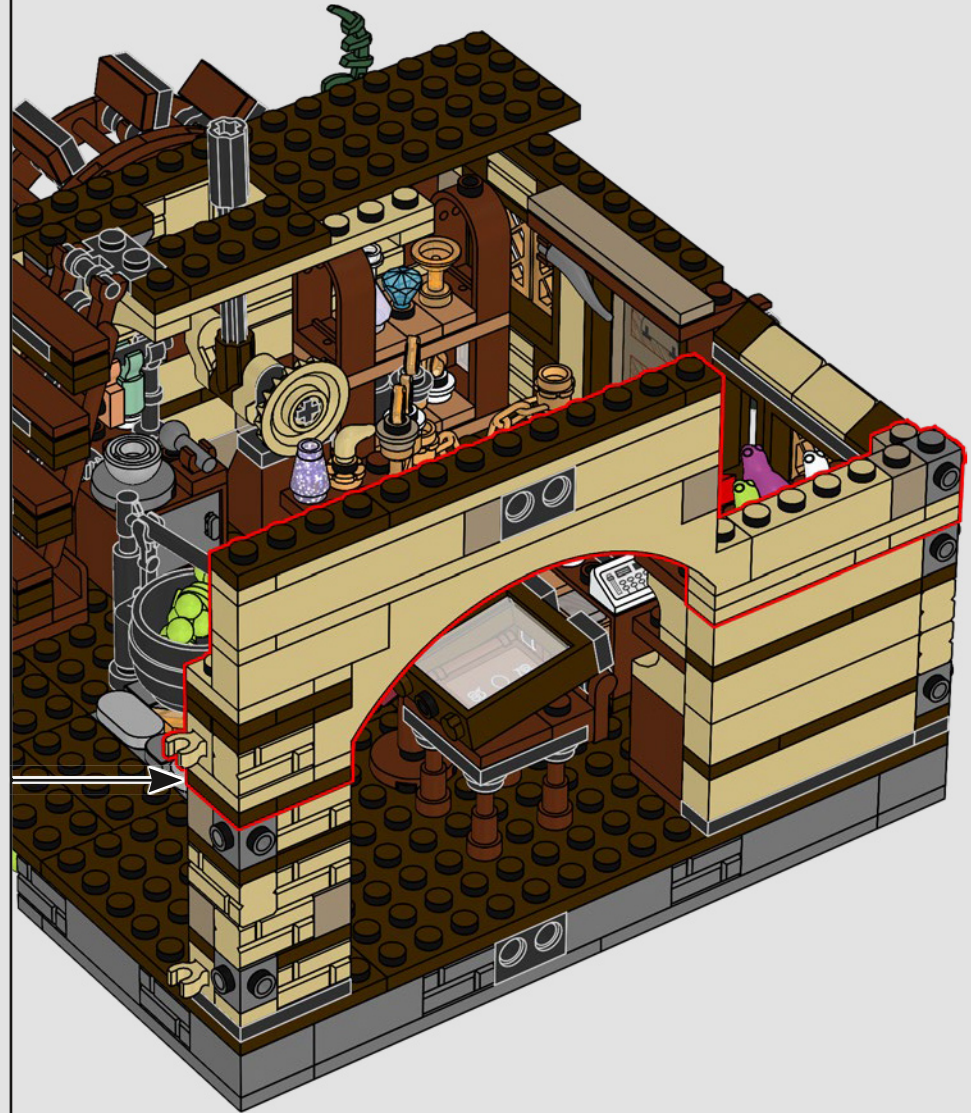

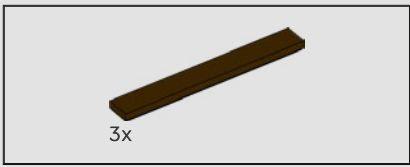

133

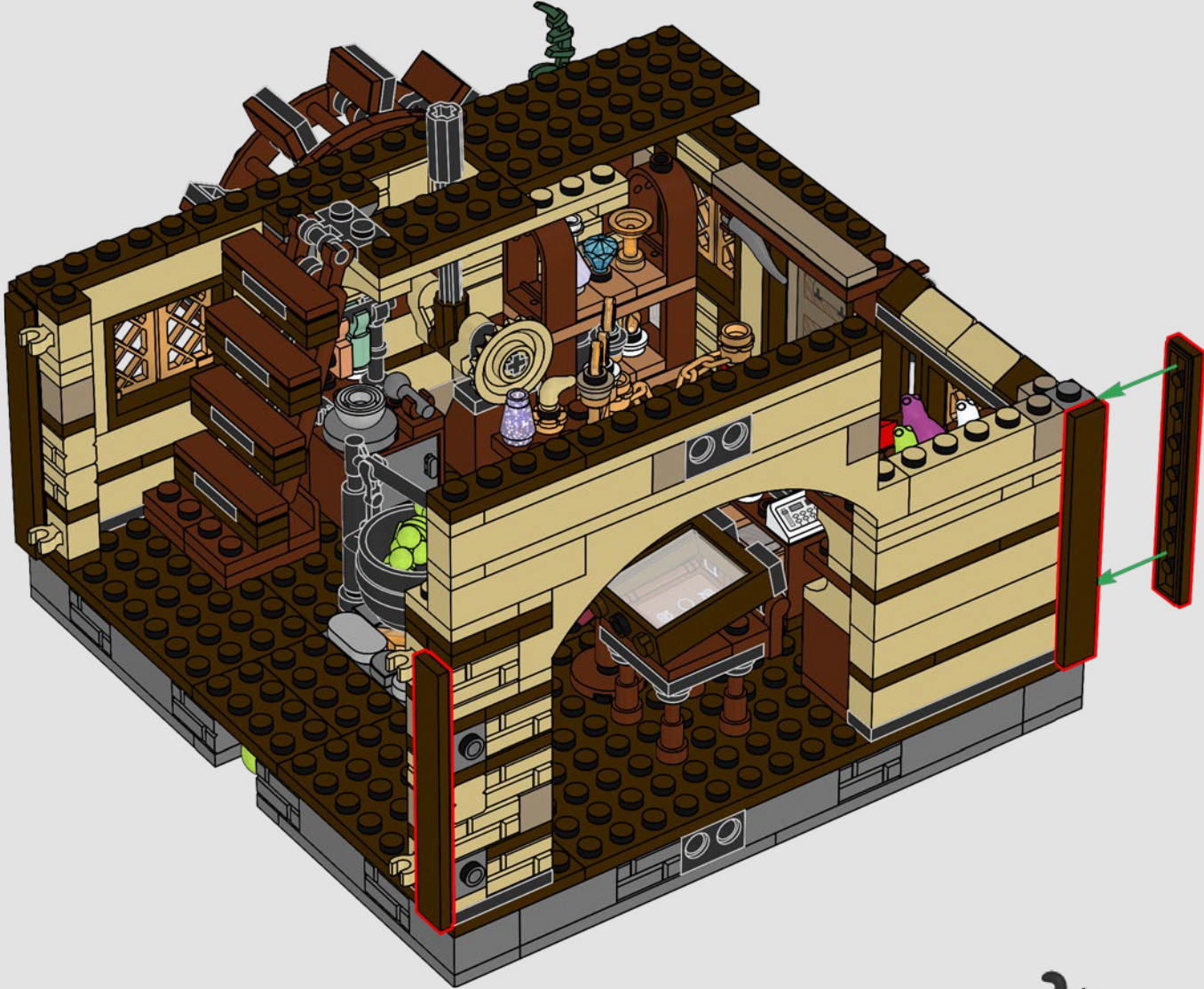

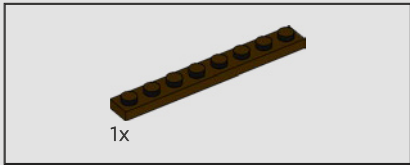

134

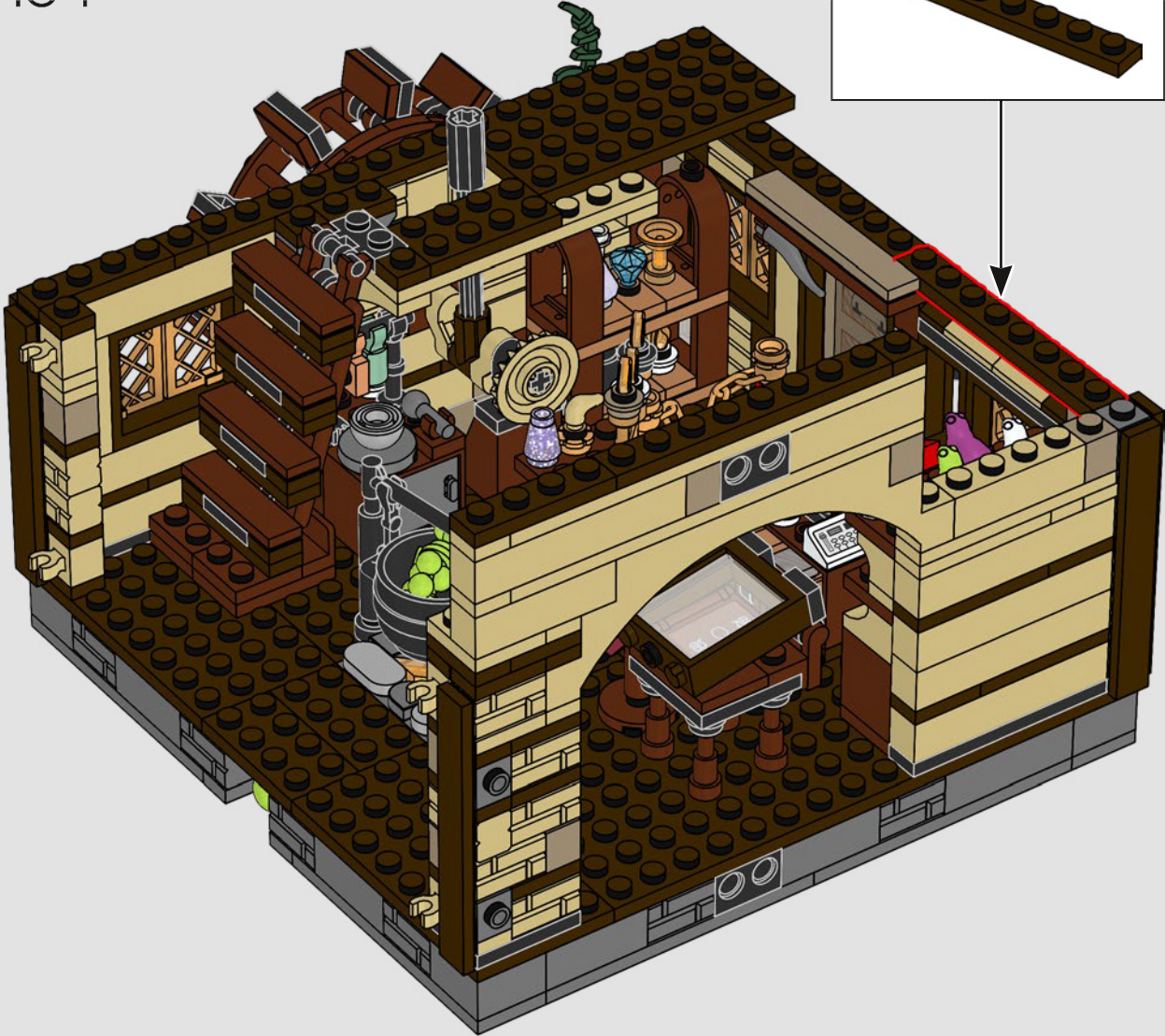
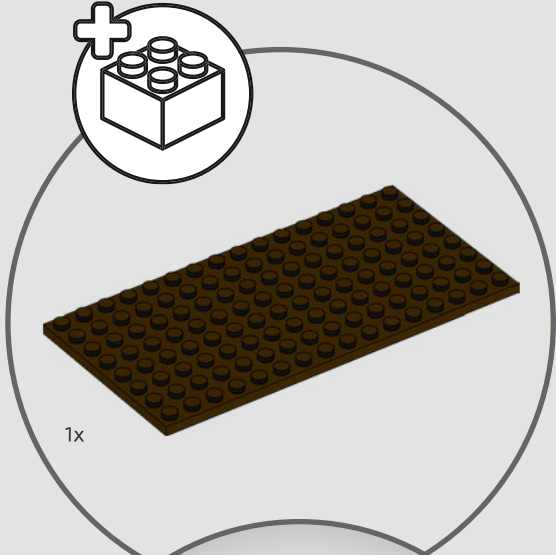
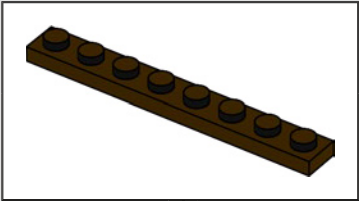

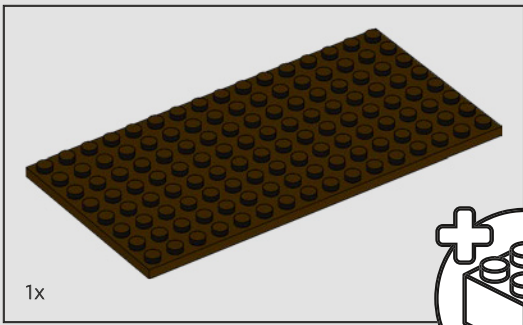

1x

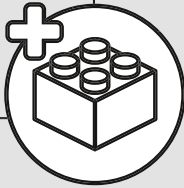

135



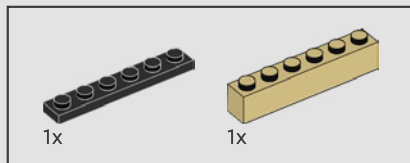
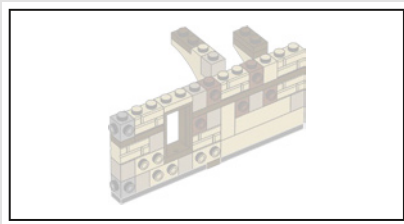

136

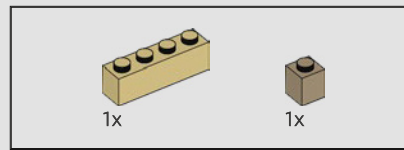
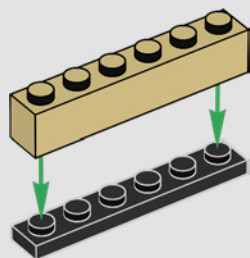

137

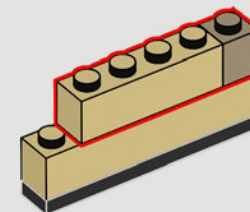

138

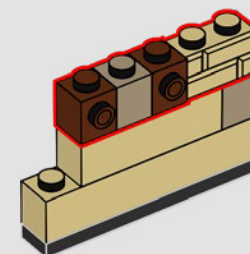

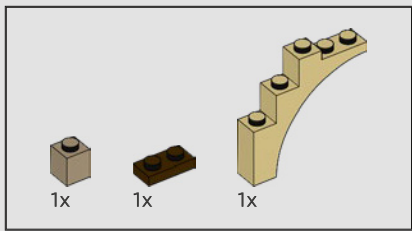

139

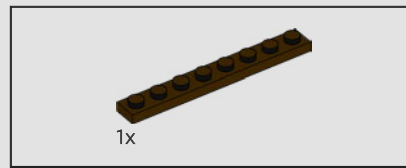
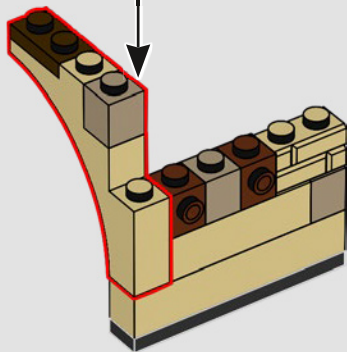
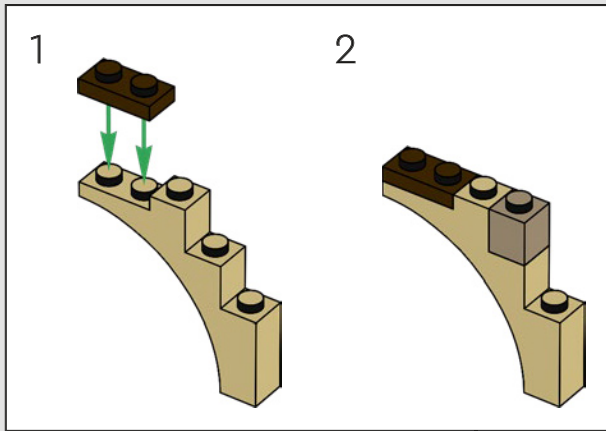

140

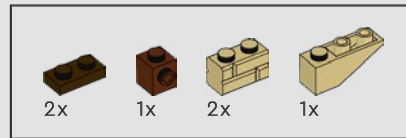
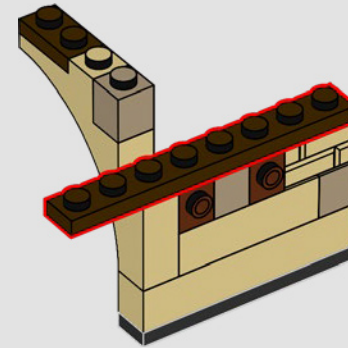

141

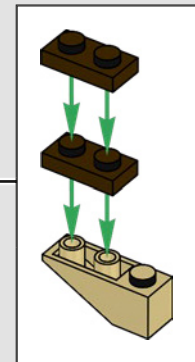
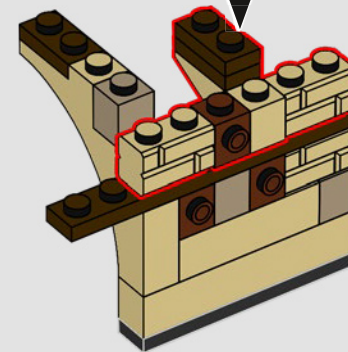

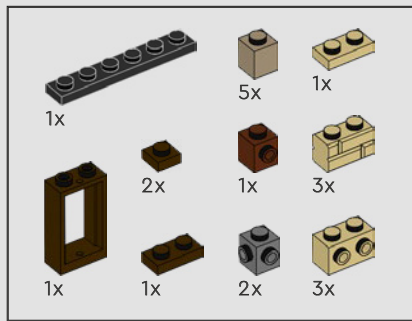

142

1

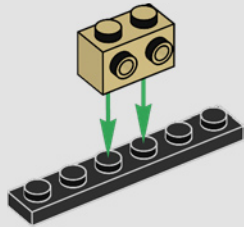

2

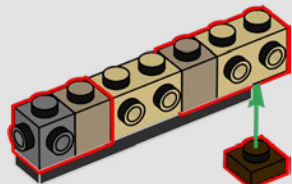

3

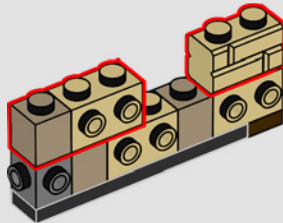

4

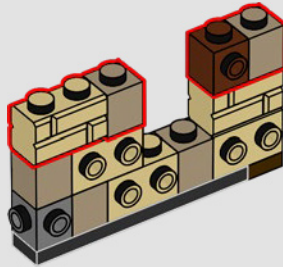

5

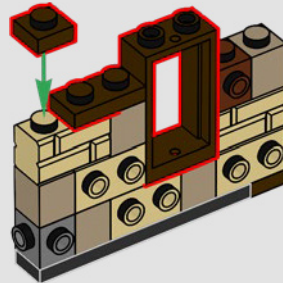

6

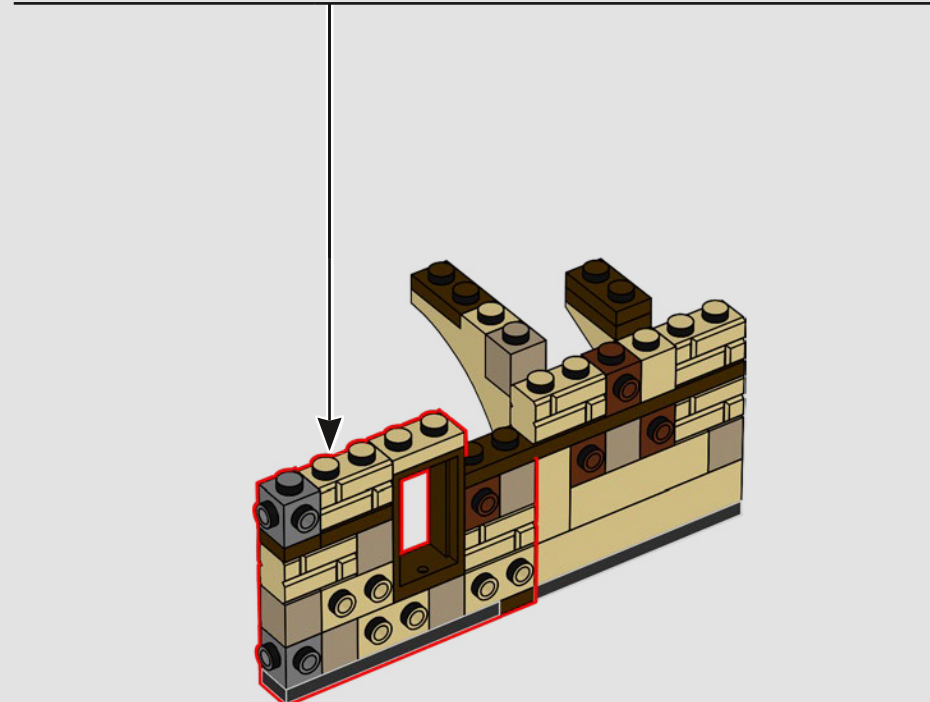
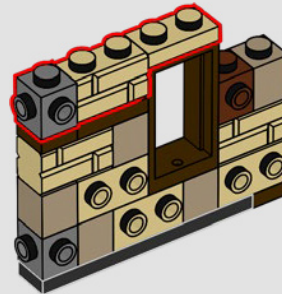

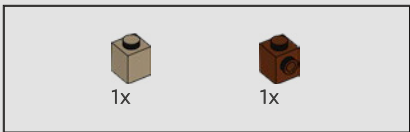

143

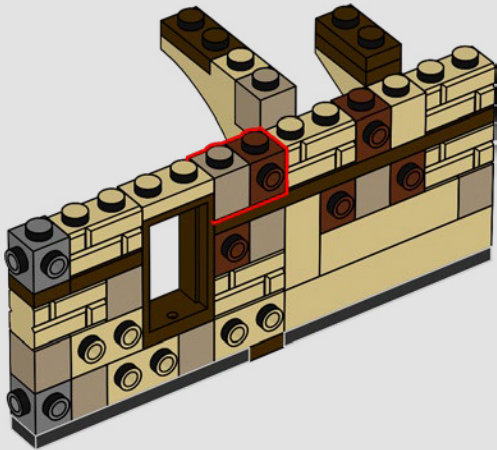

144



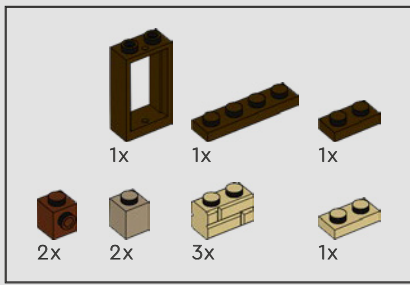

145

1

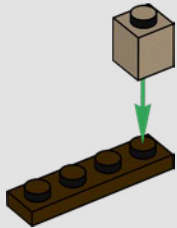

2

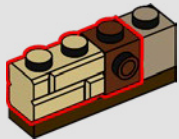

3

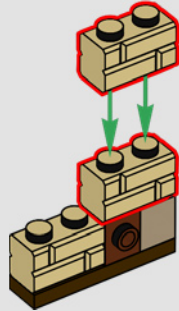

4

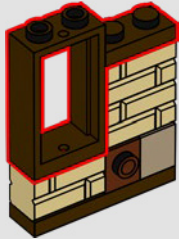

5

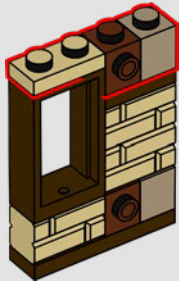

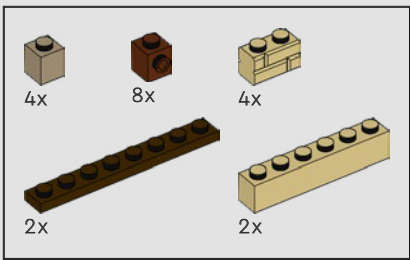

146

1

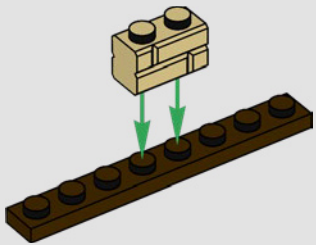

2

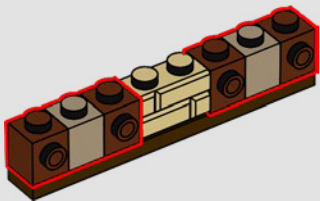

3

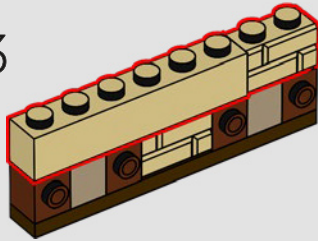

4

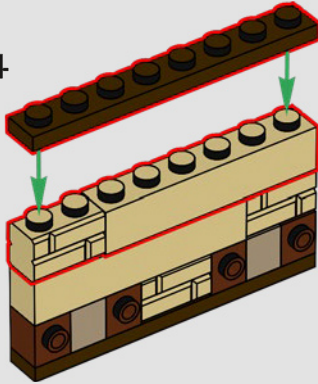

5

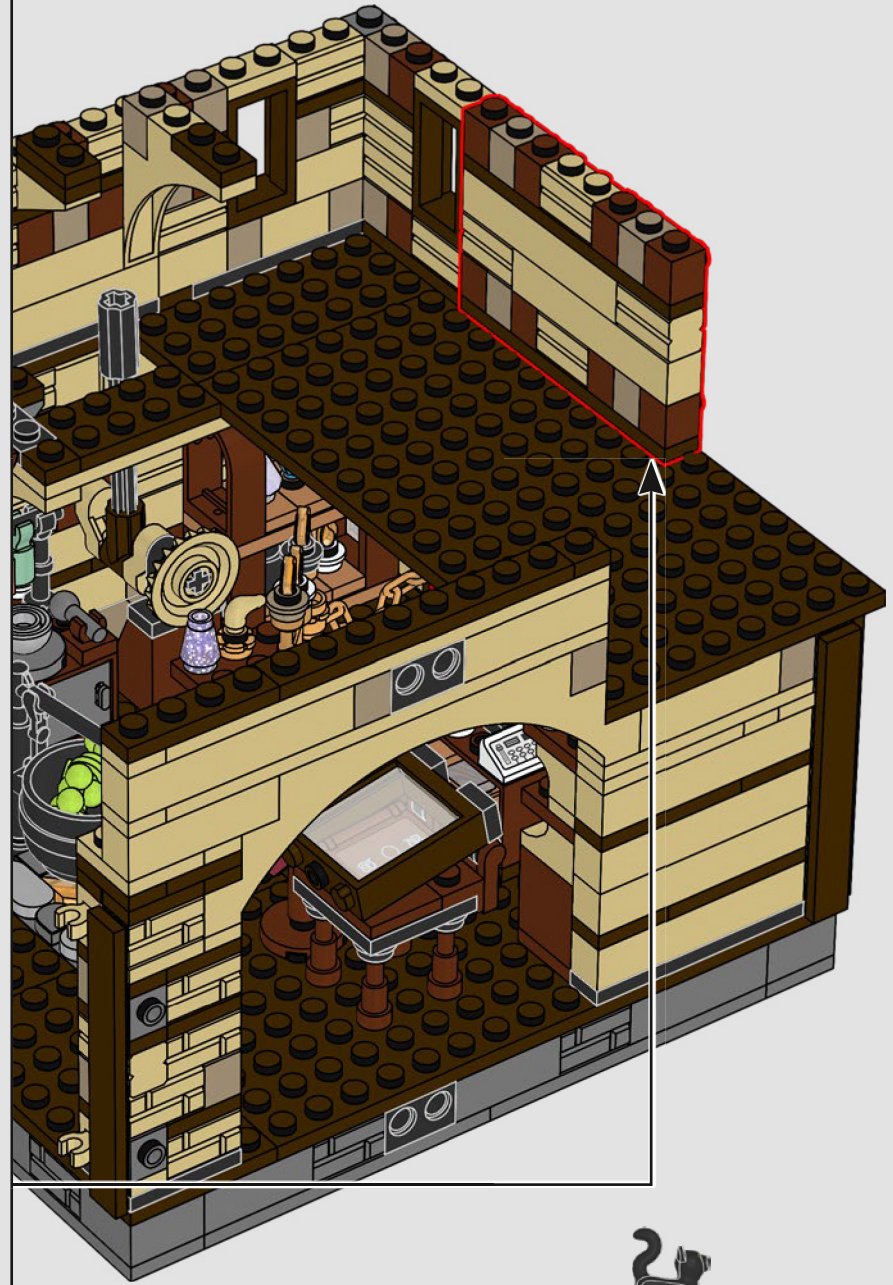
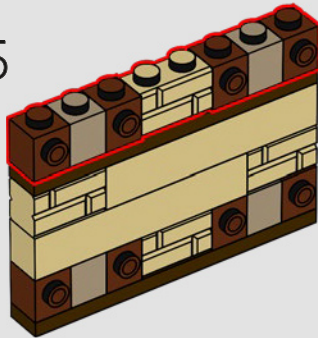

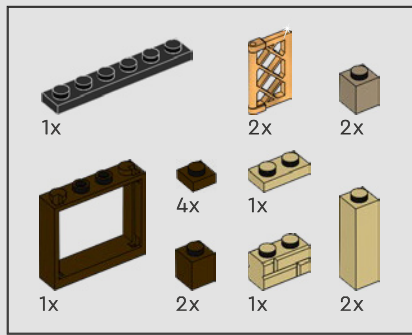

147

1

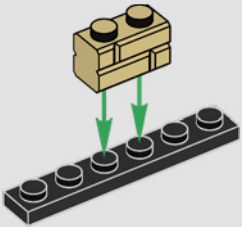

2

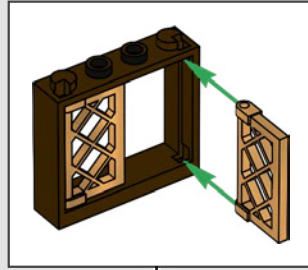
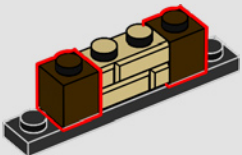

3

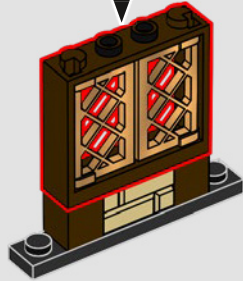

4

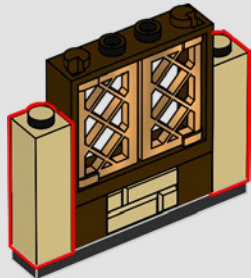

5

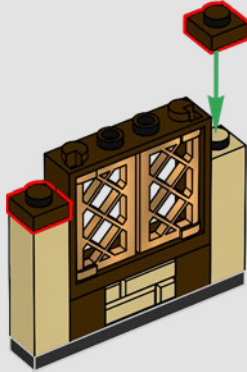

6

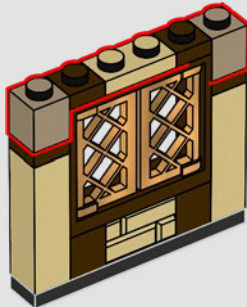

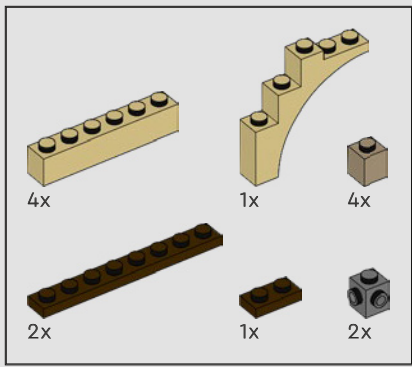

148

1

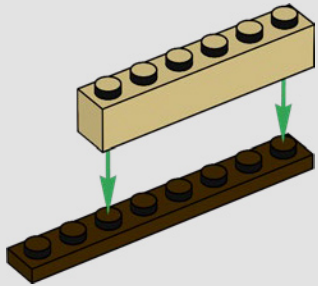

2

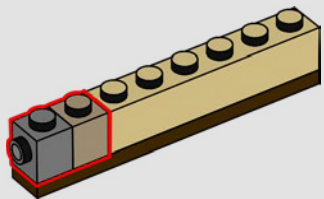

3

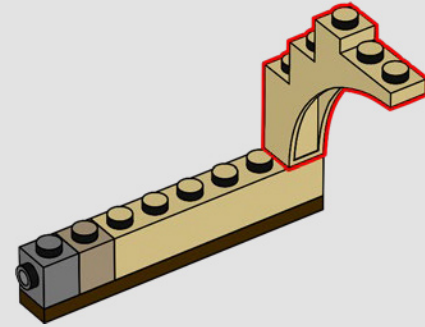

4

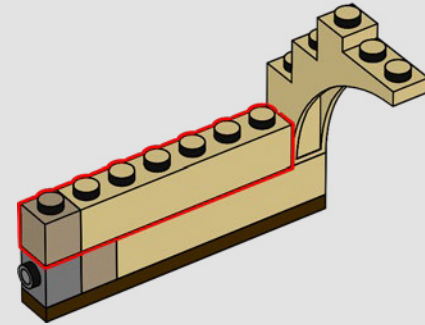

5

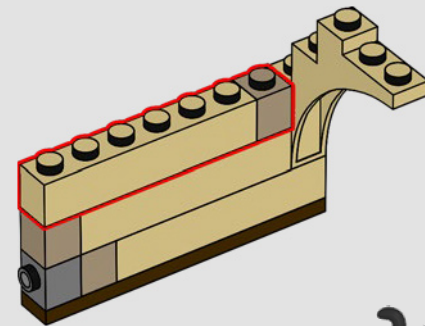

6

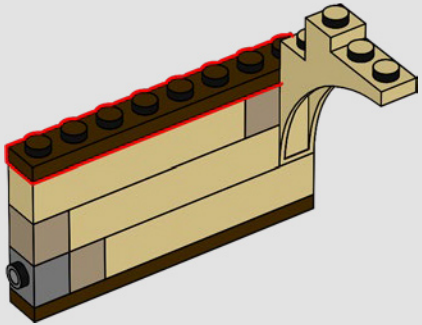

7

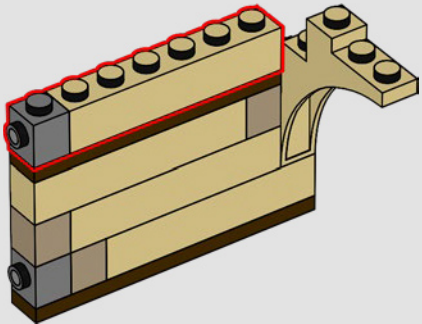

8

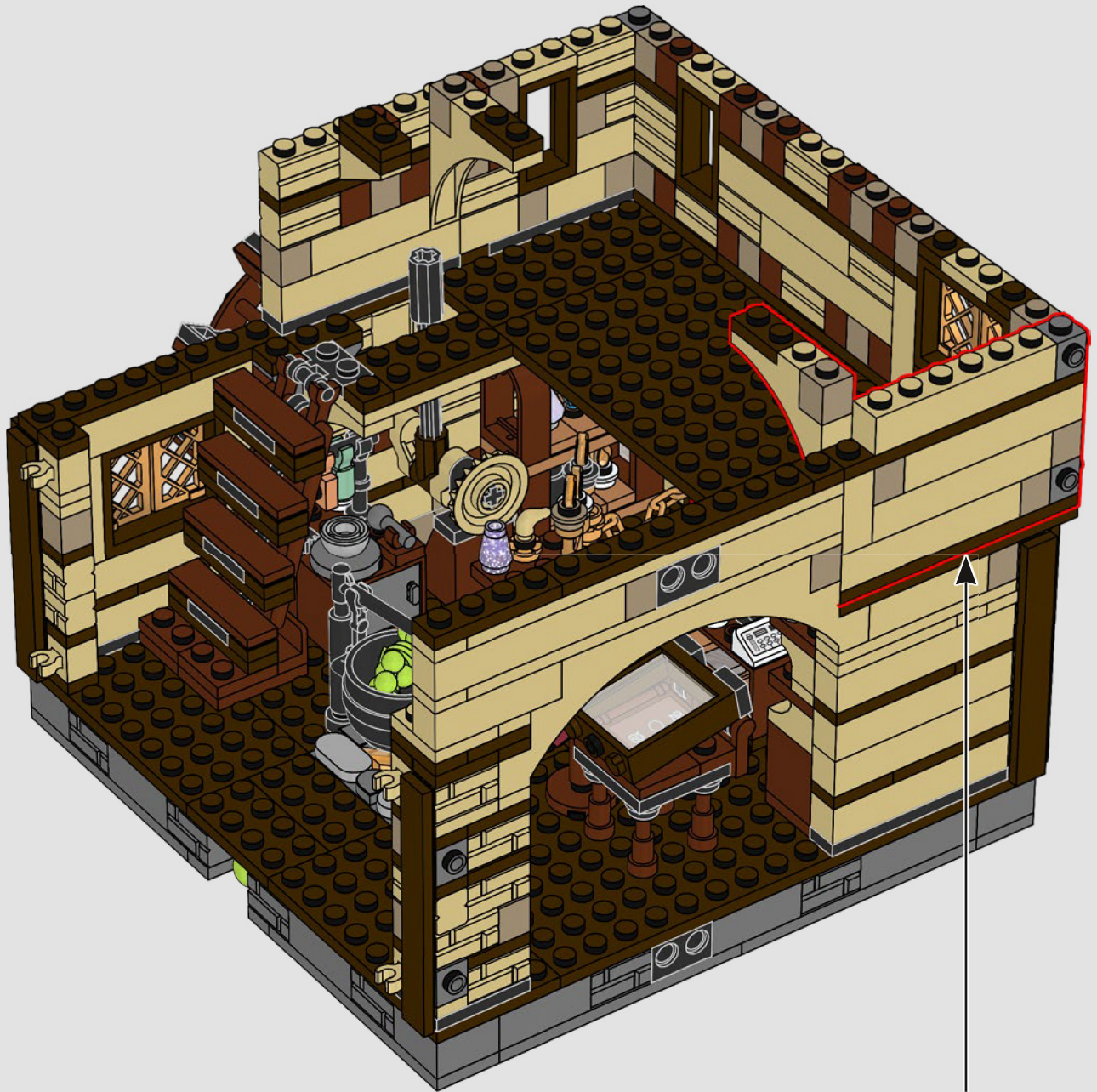
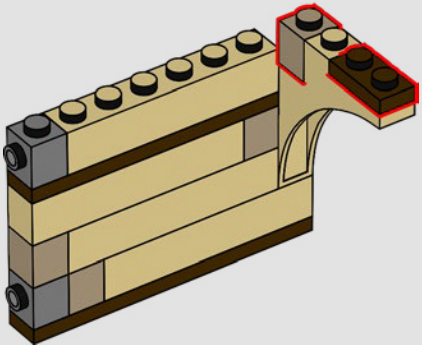

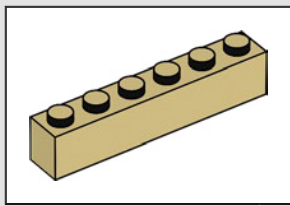
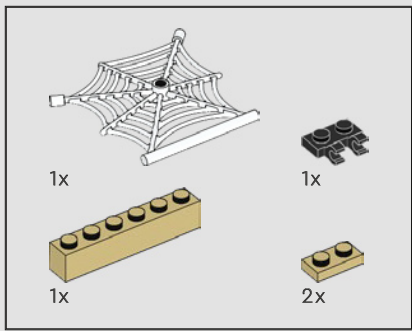

149

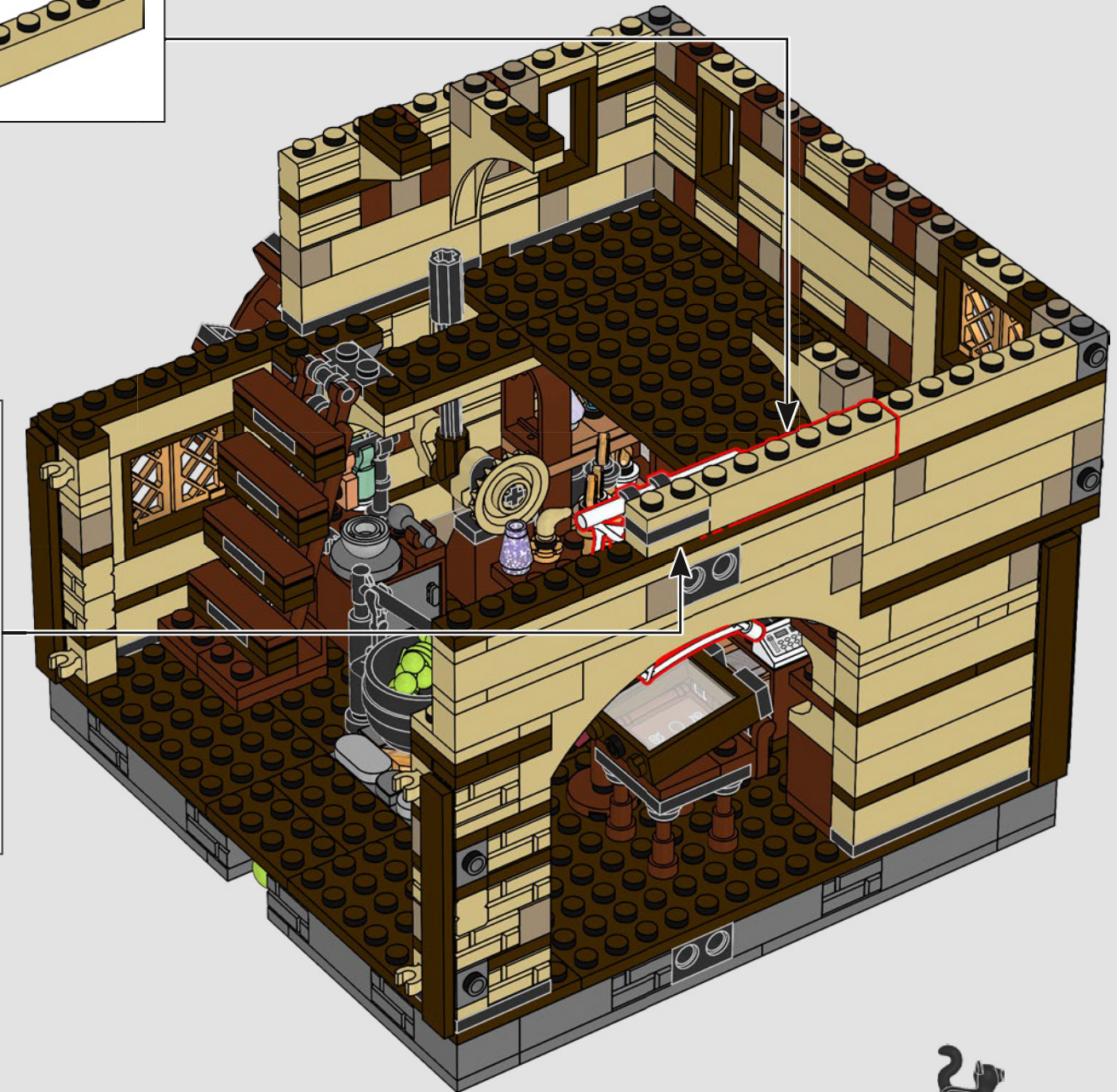
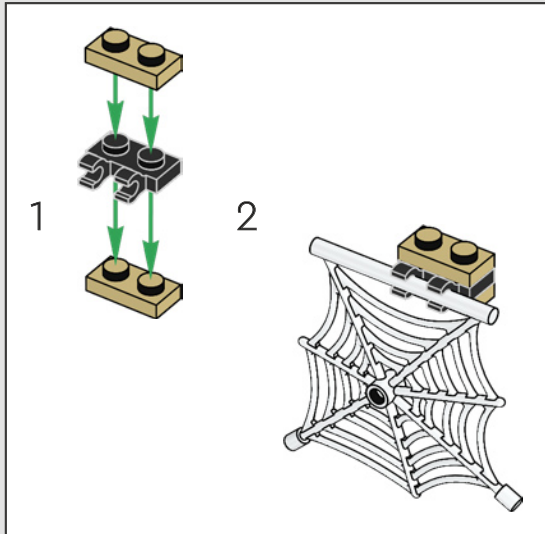

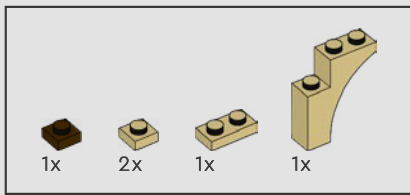

150

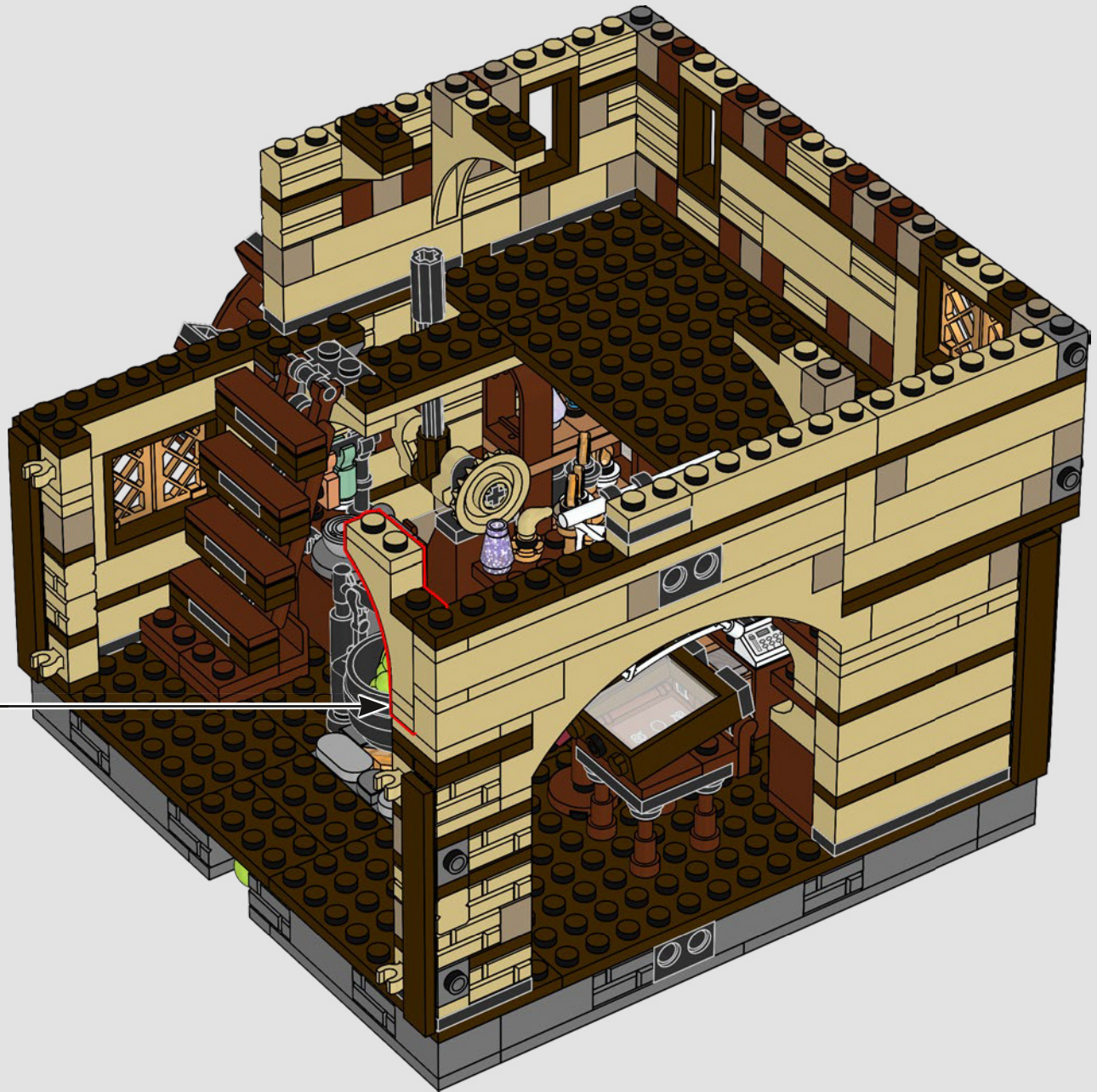
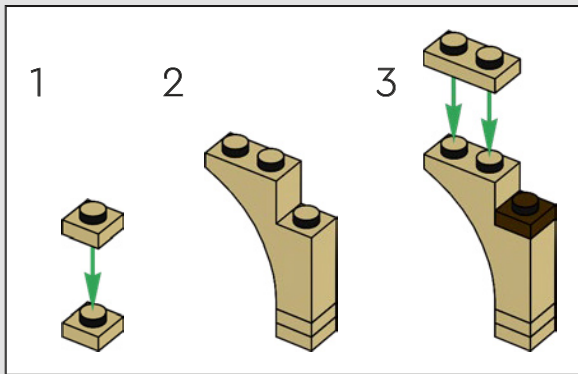

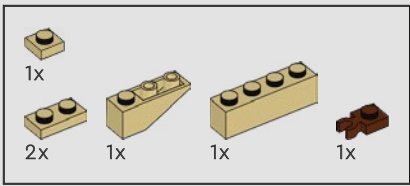

151

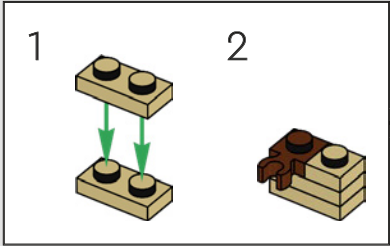
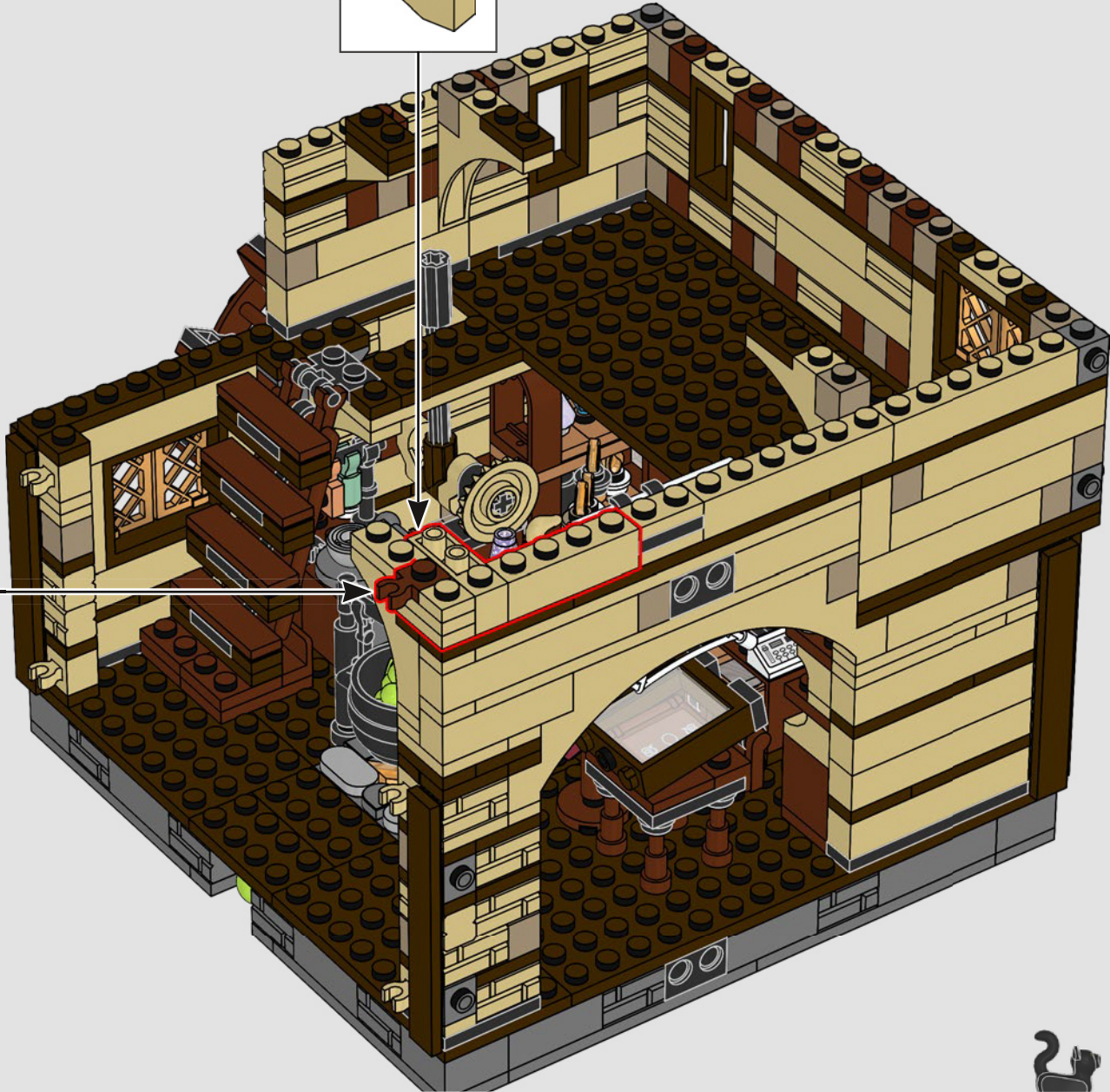
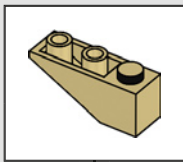

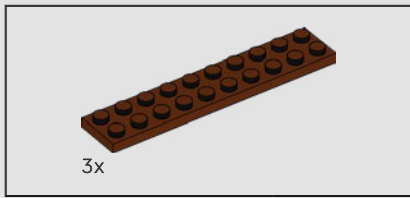

152

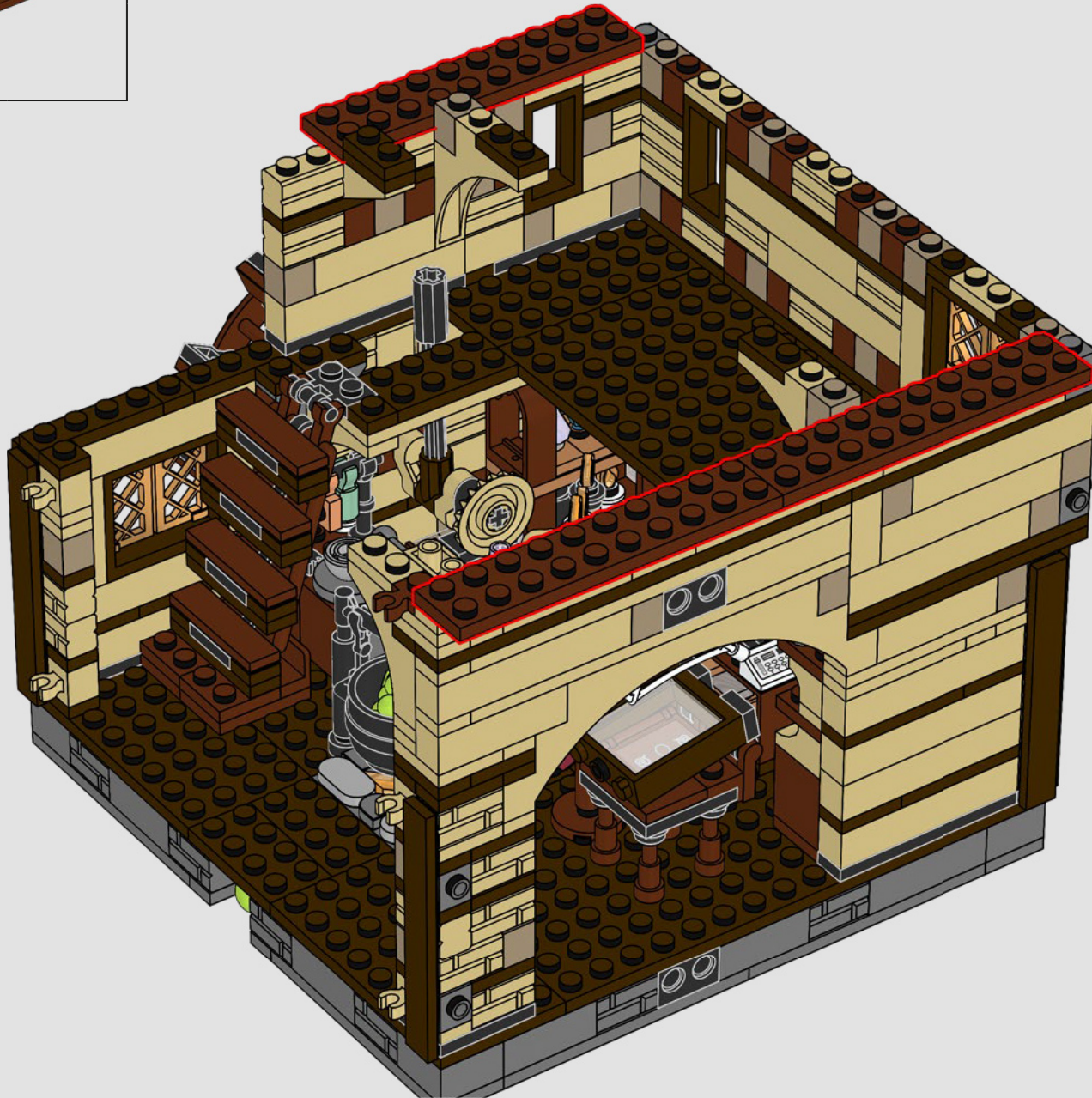

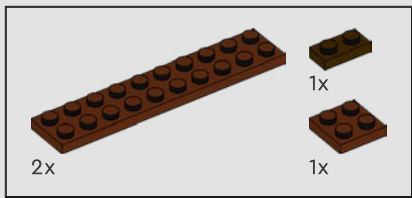

153

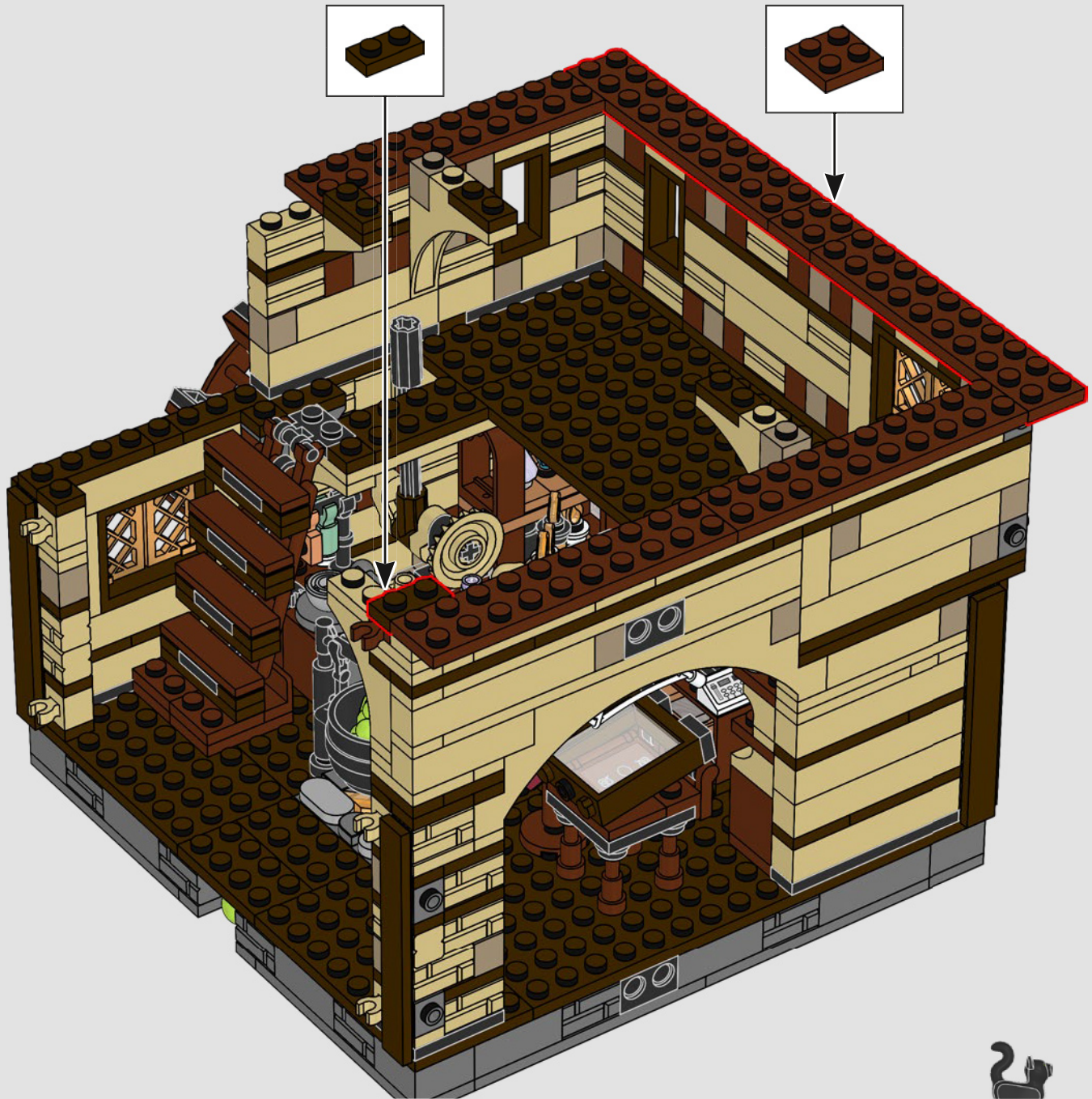

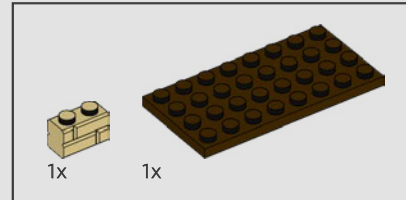
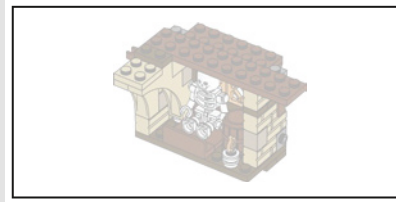

154

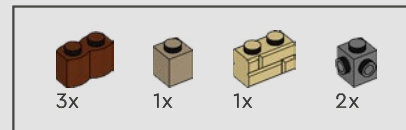
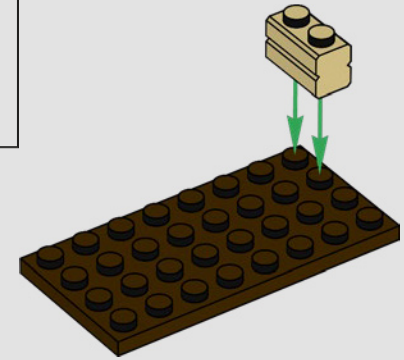

155

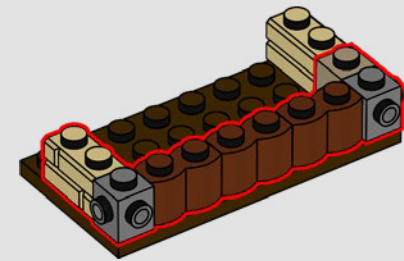

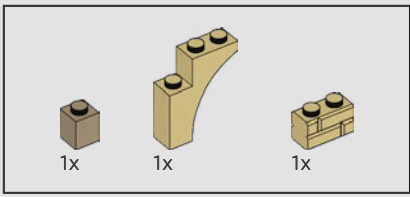

156

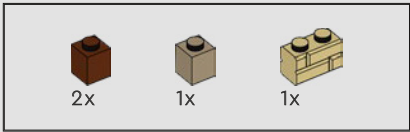
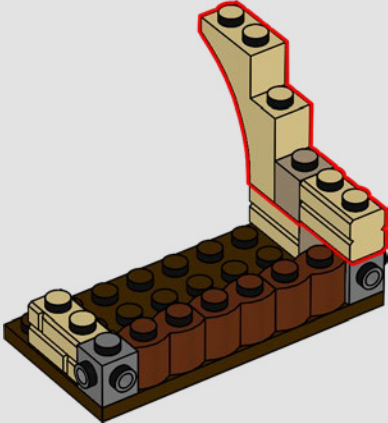

157

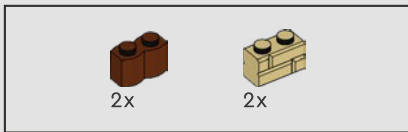
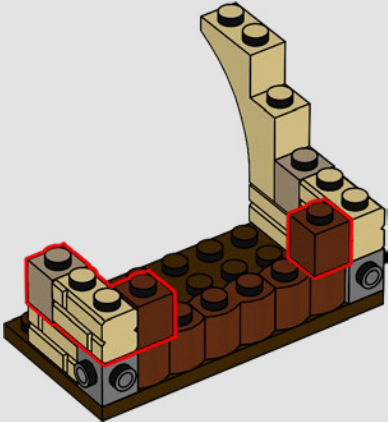

158

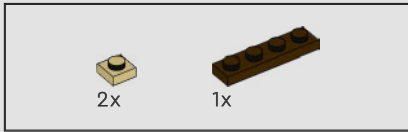
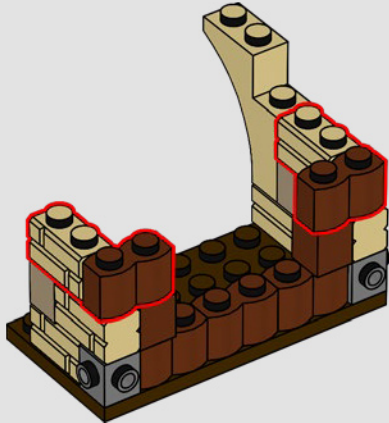

159

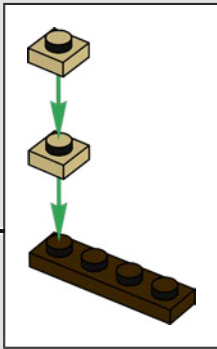
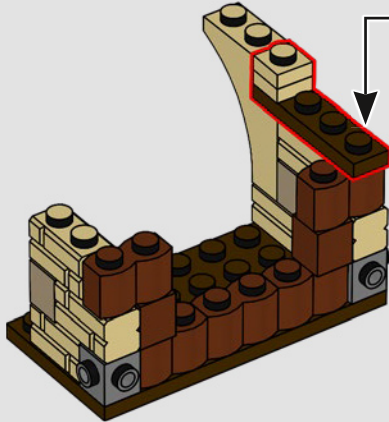

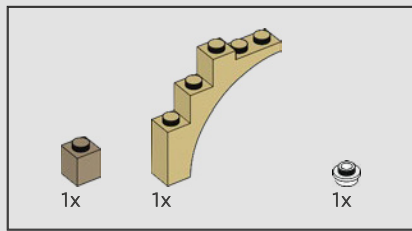

160

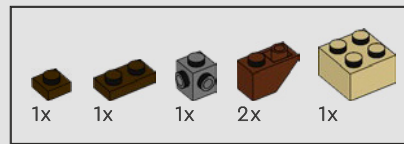
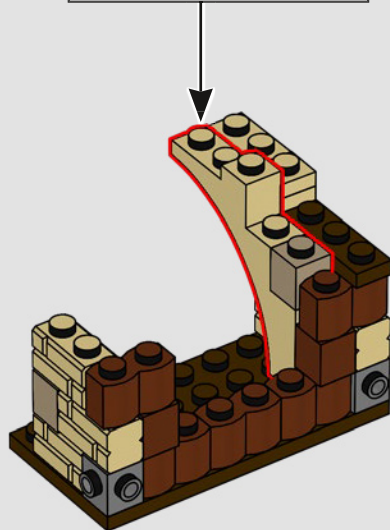
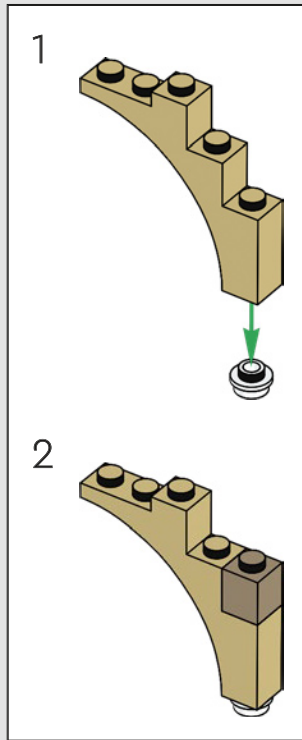

161

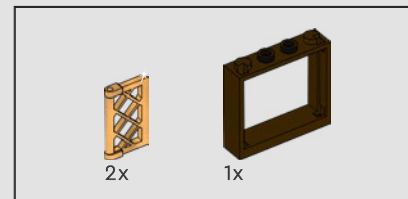
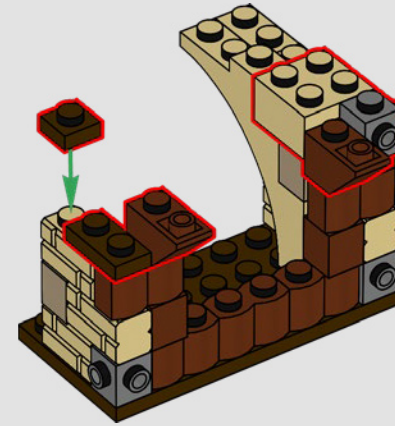

162

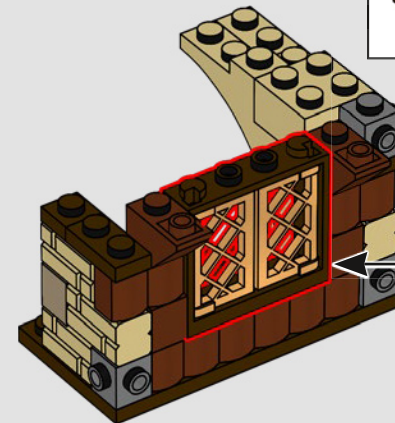
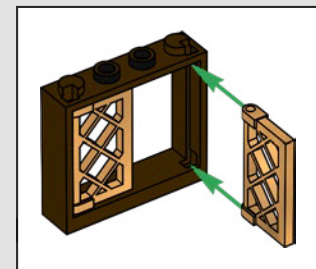

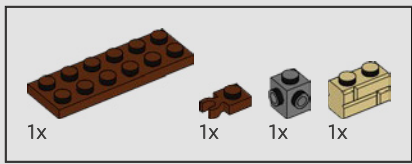

163

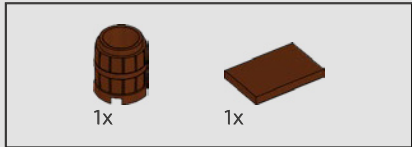
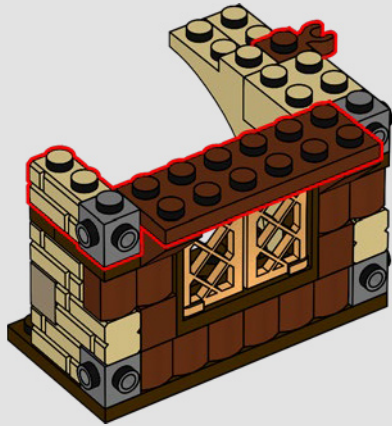

164

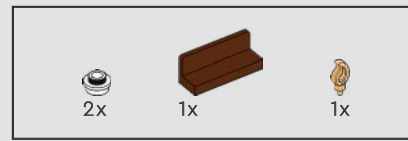
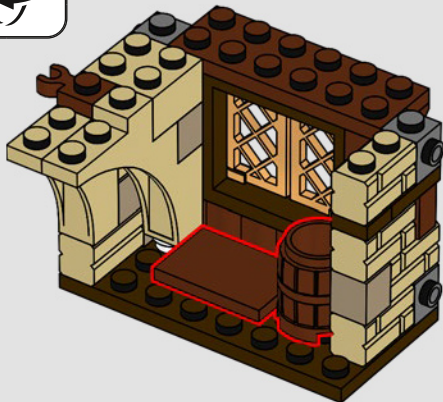

165

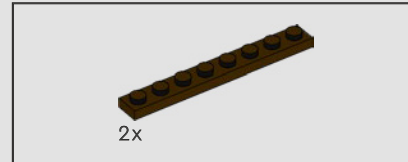
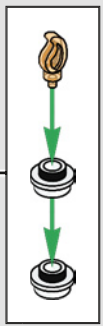
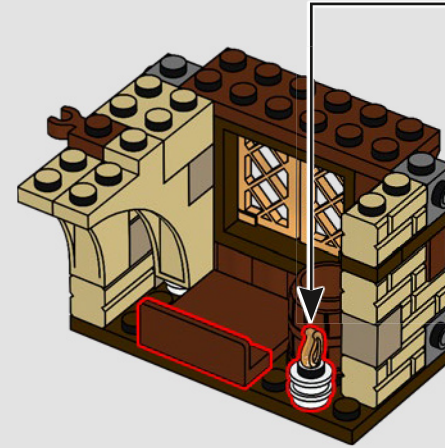

166

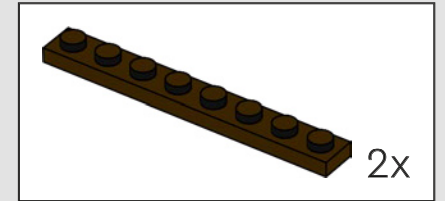
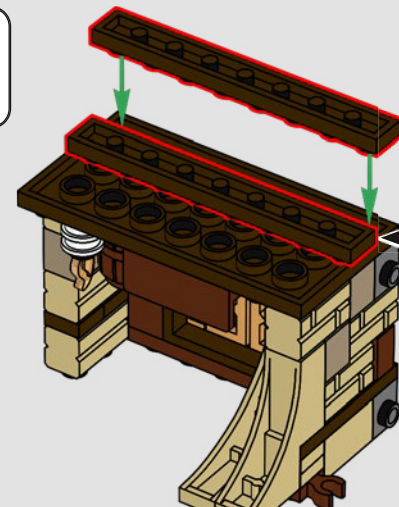

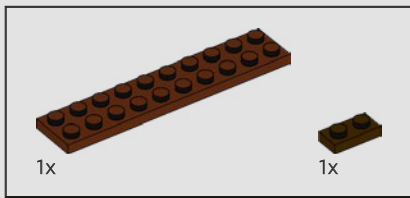

167

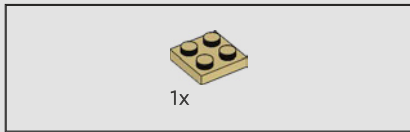
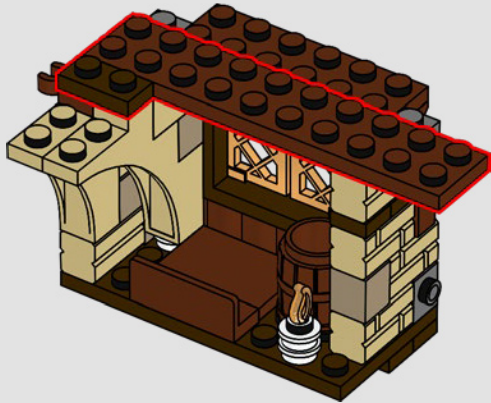

168

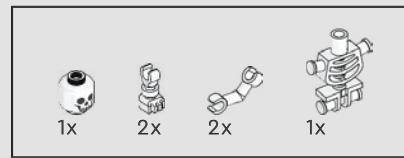
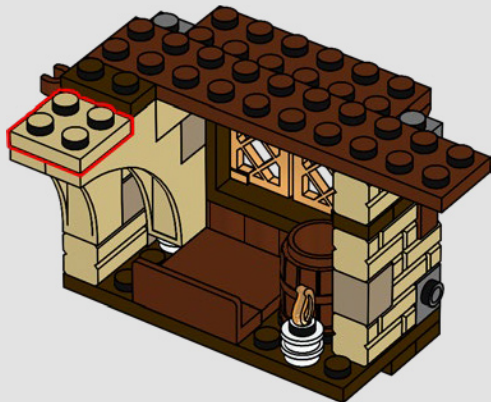

169

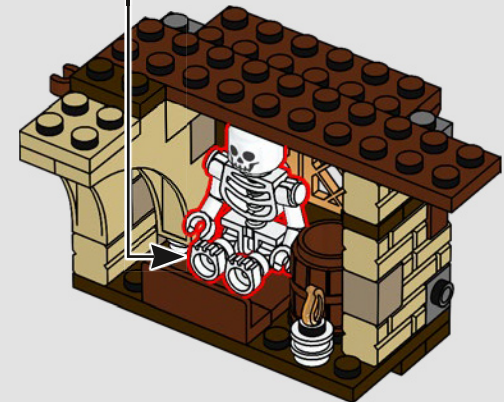
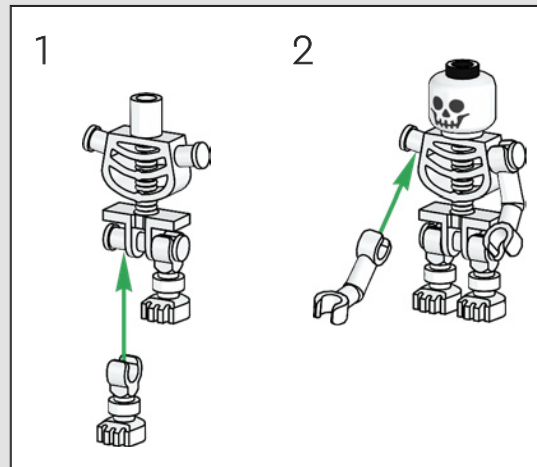

170

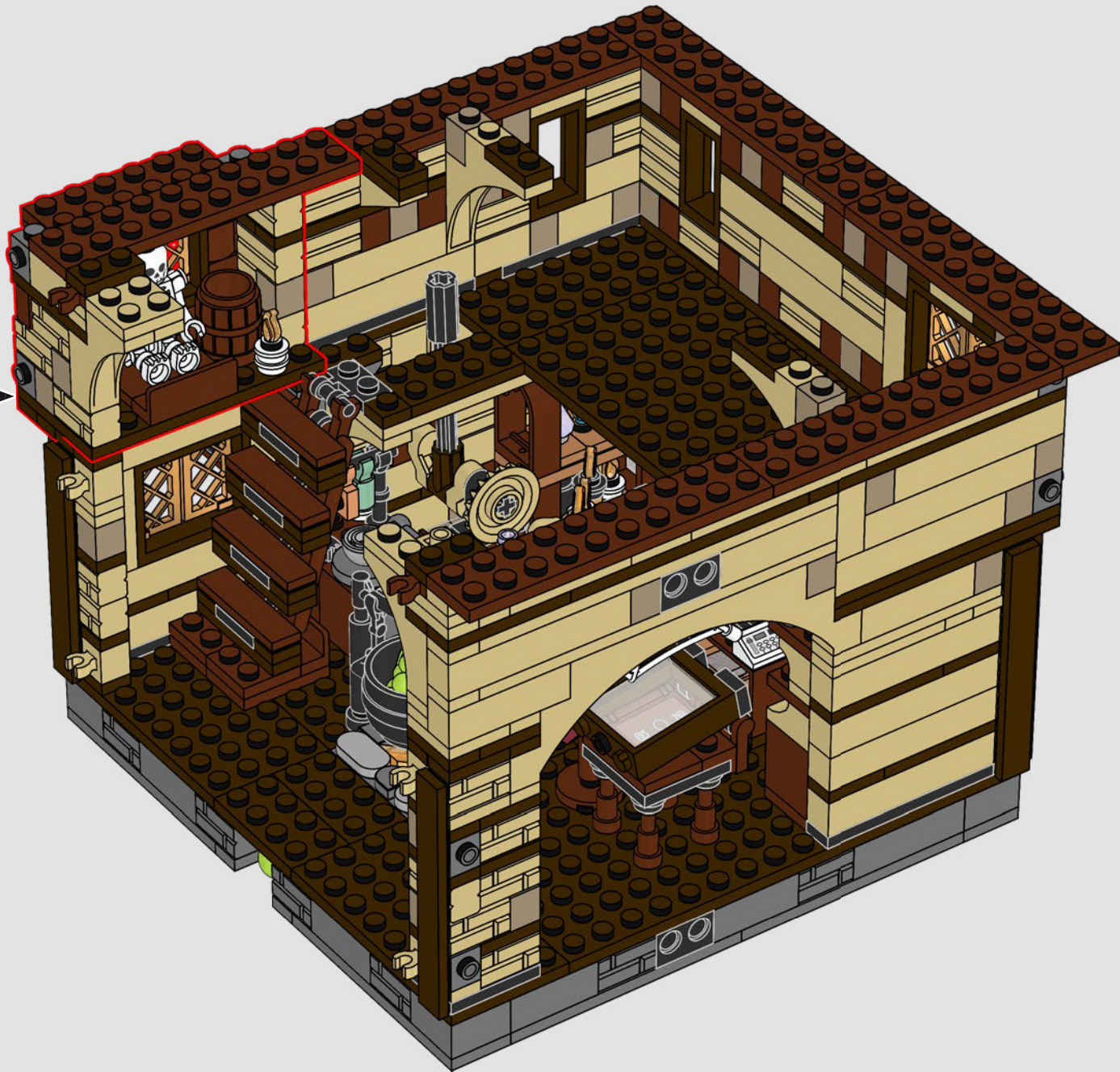

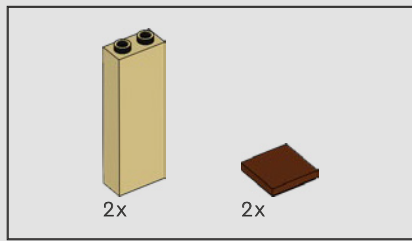

171

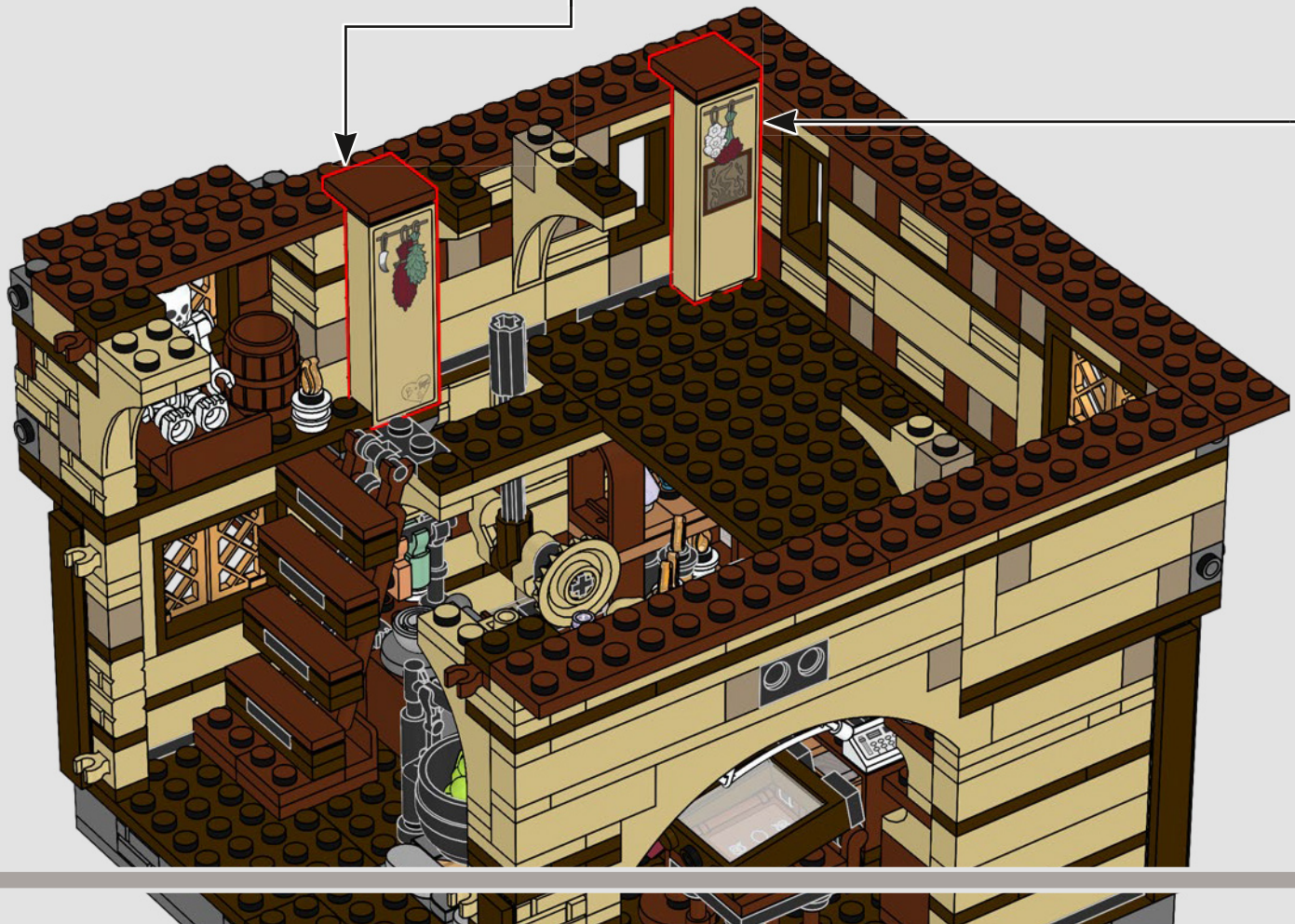
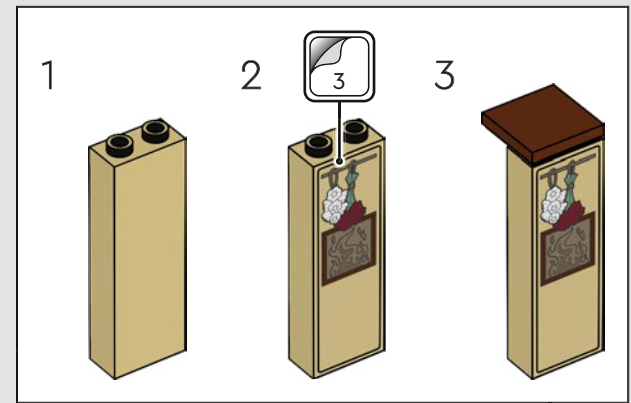
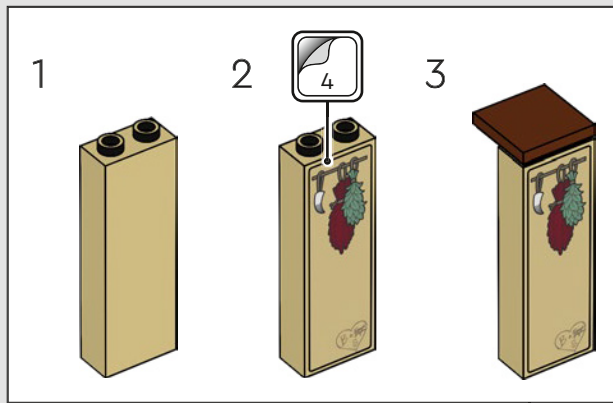

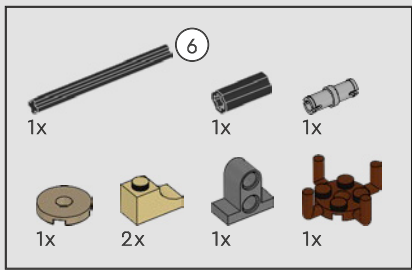

172

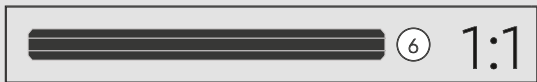
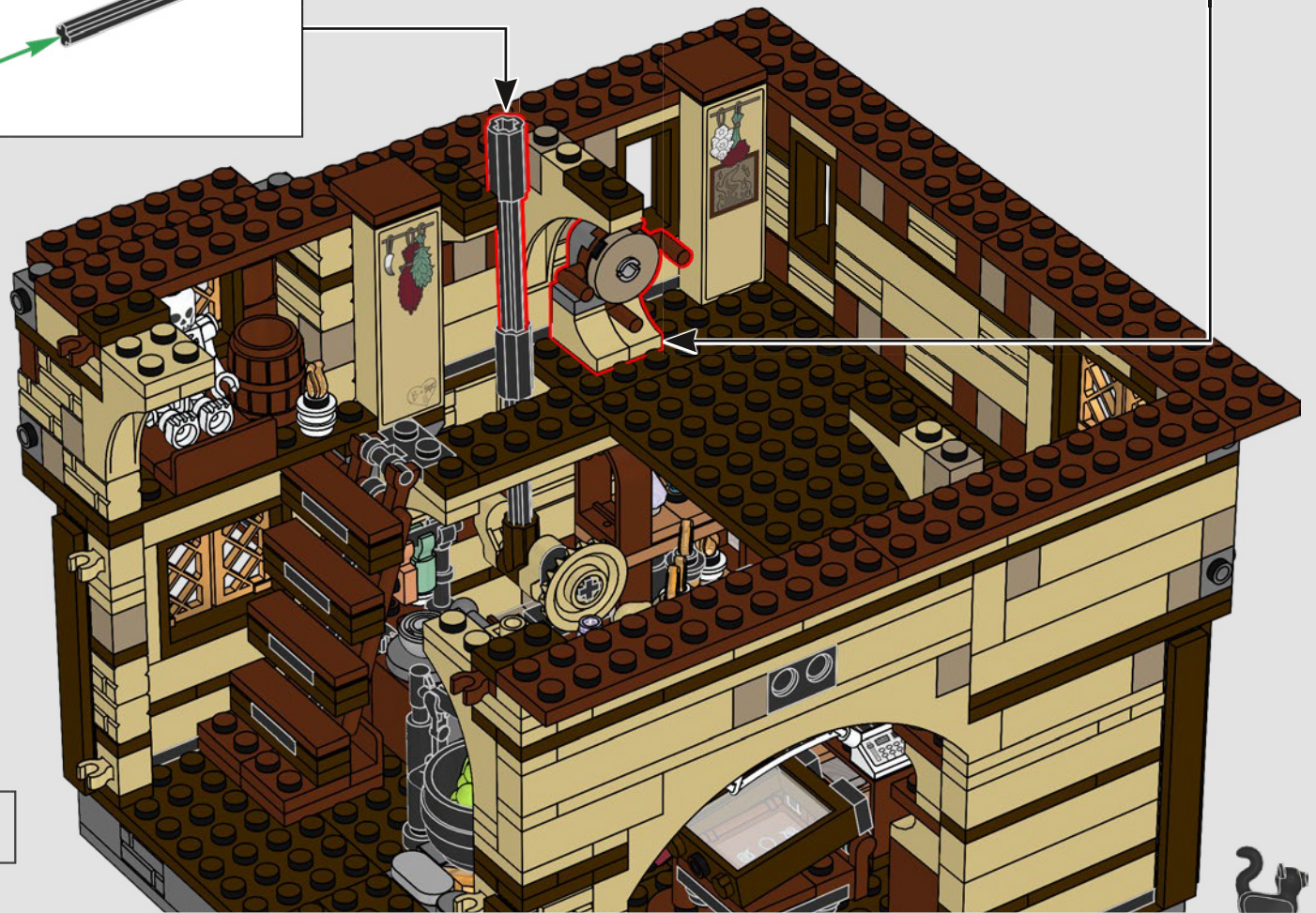
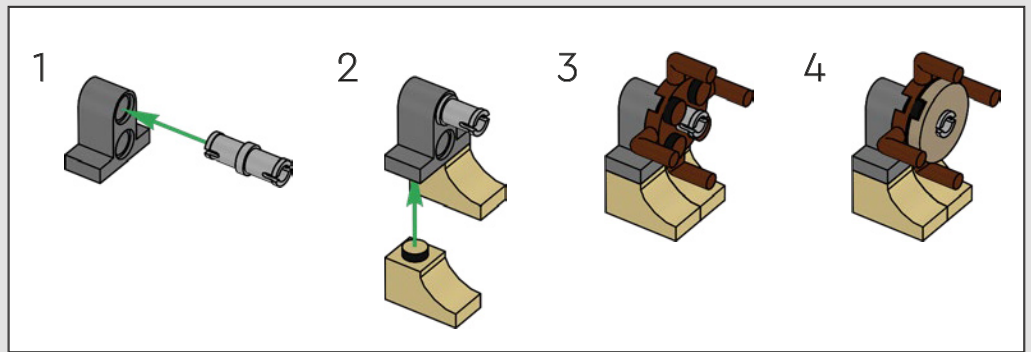
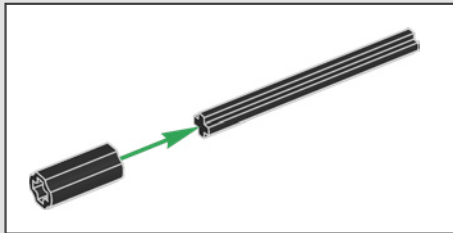

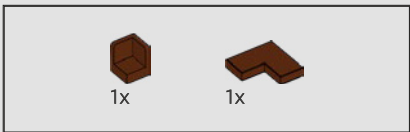

173



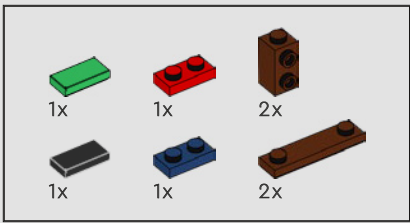

174

1

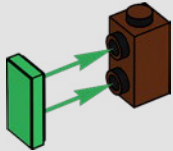

2

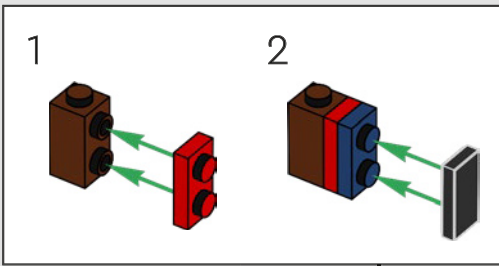
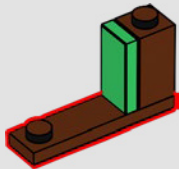

3

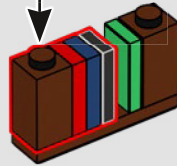

4

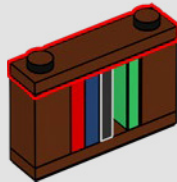

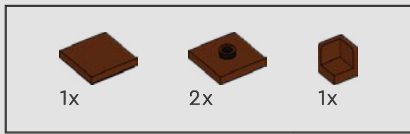

175

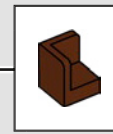

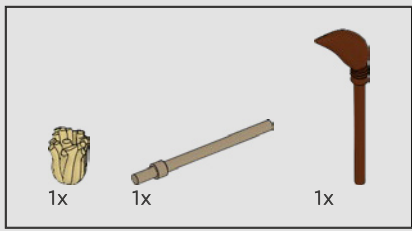

176

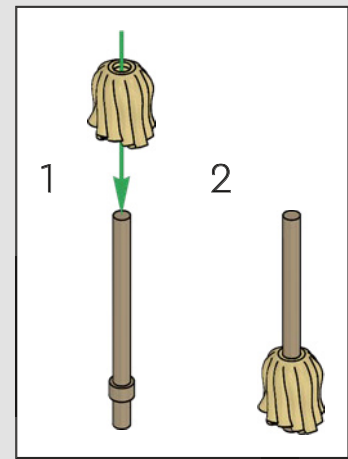
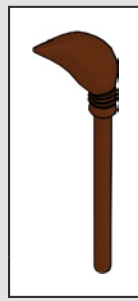

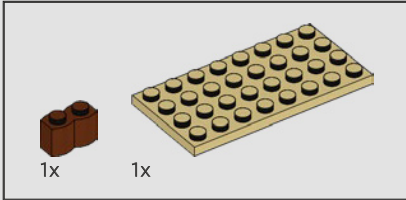

177

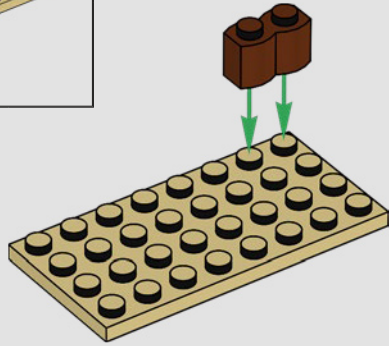

178

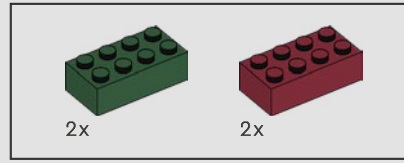
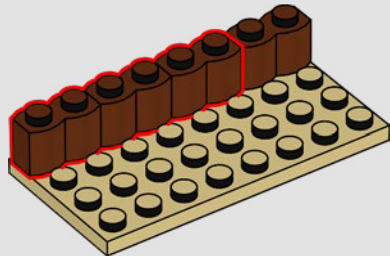

179

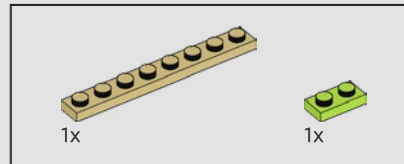
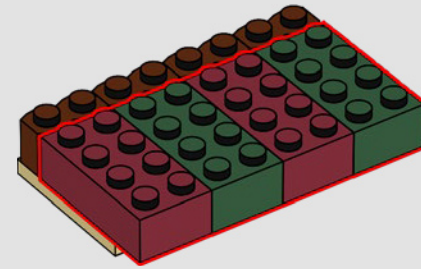

180

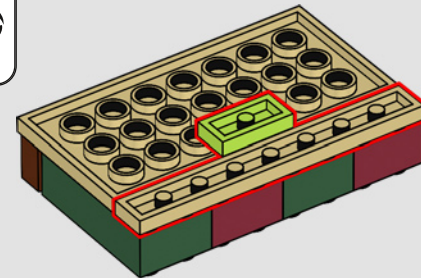



4x

181

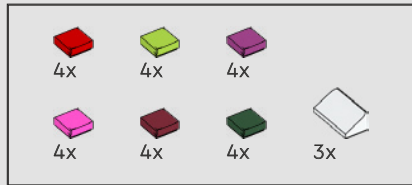
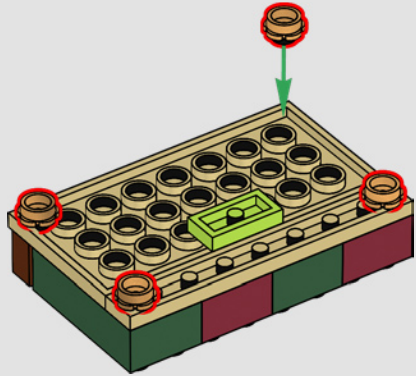

182

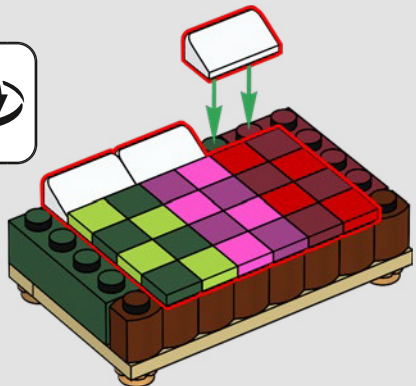

183



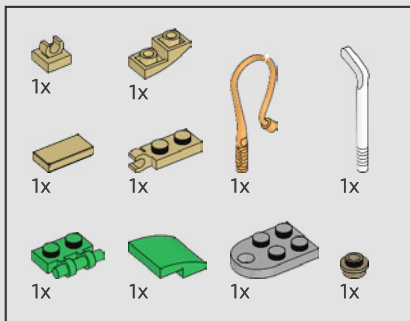

184

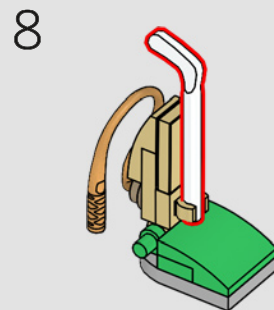
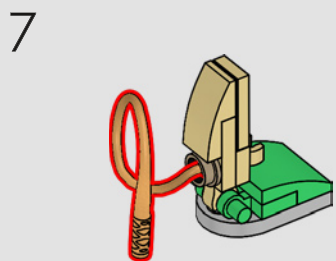
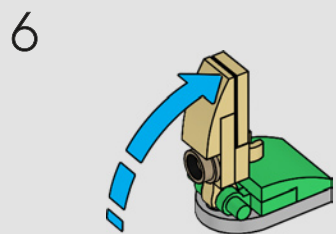
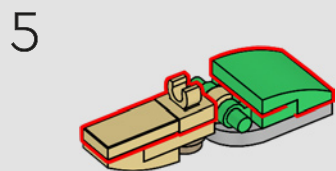
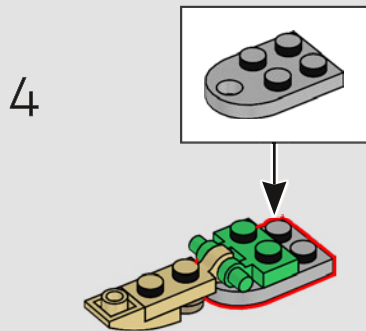
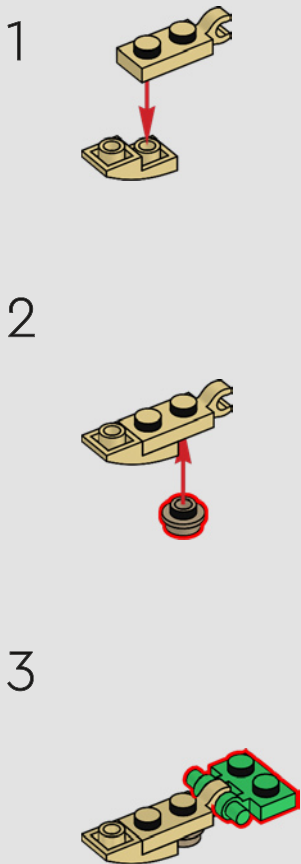



185

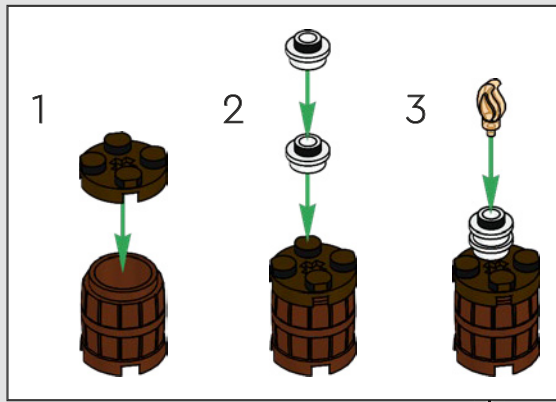



186

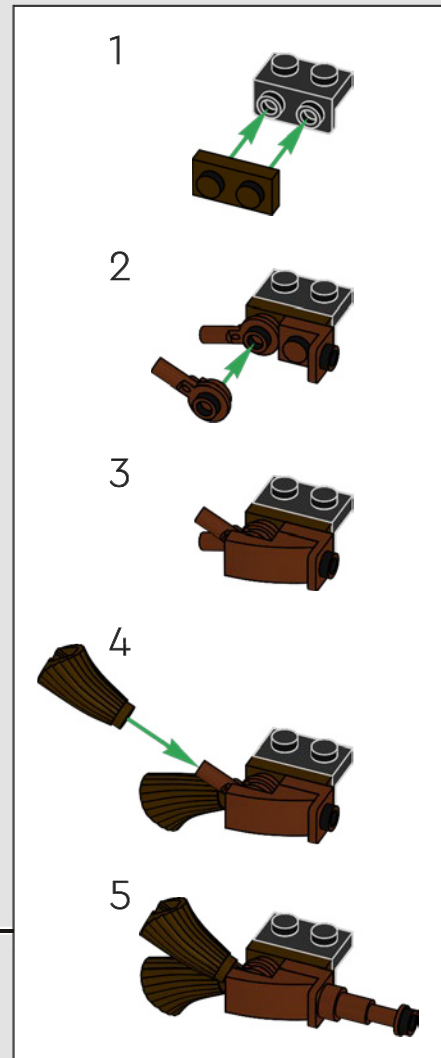



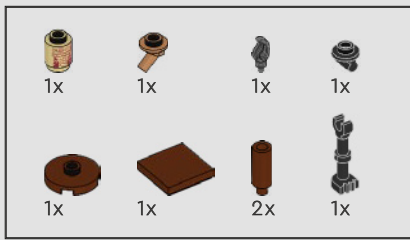

187

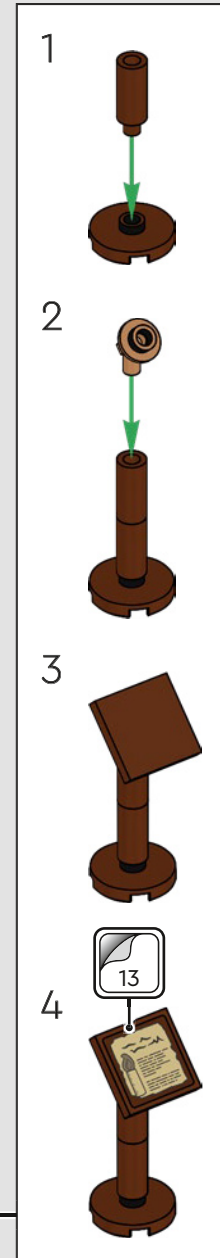
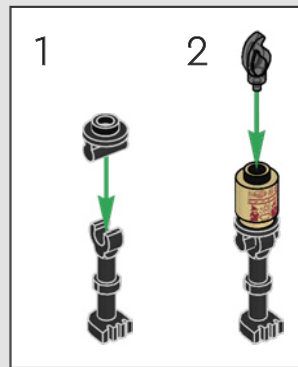

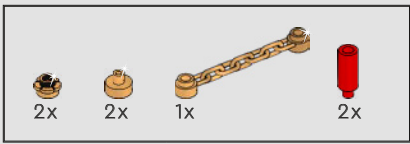

188

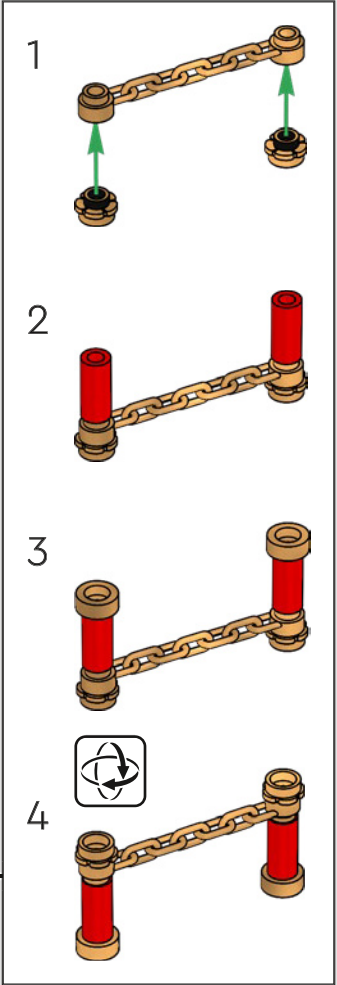

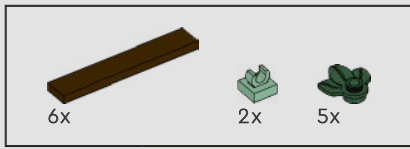

189

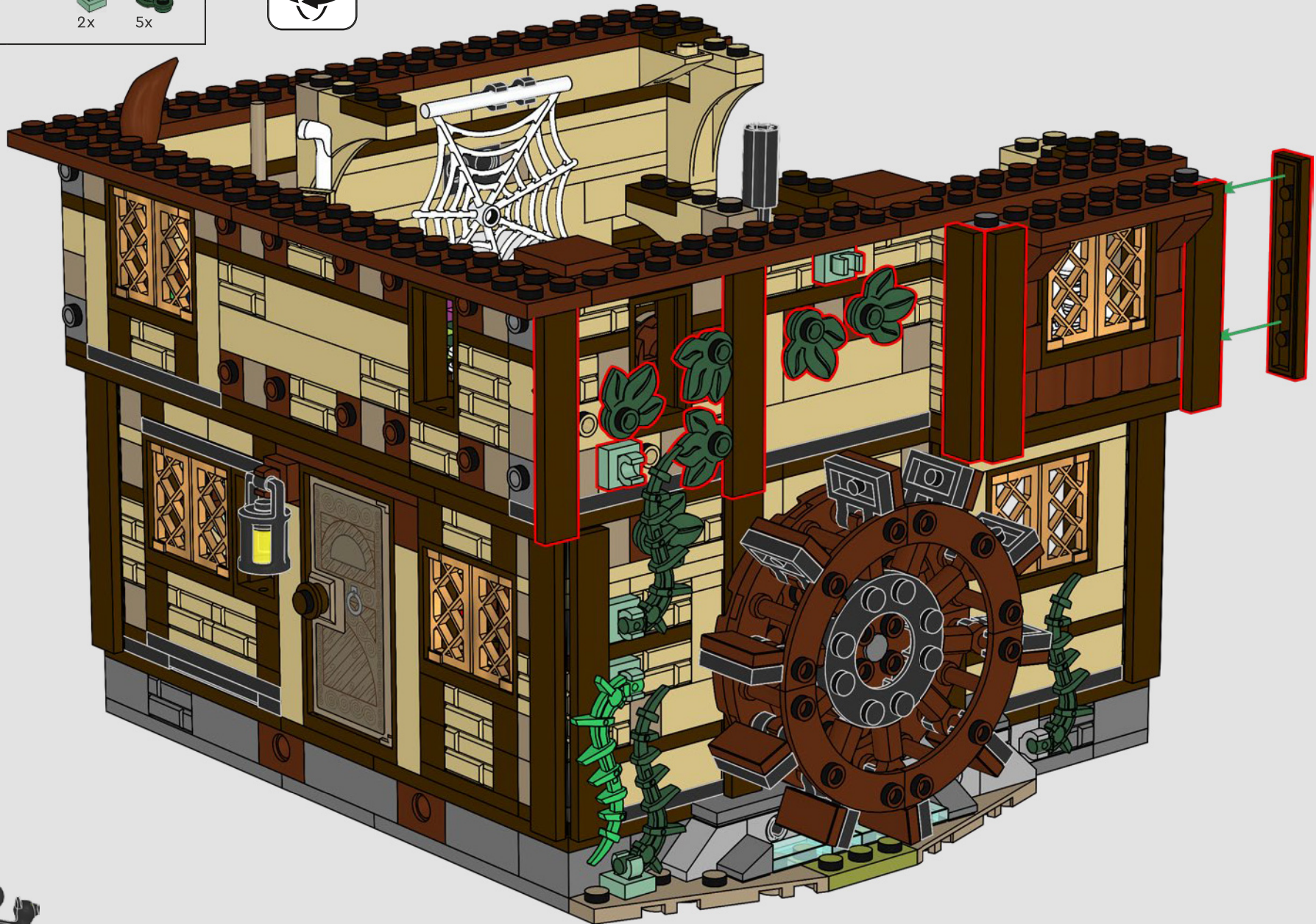

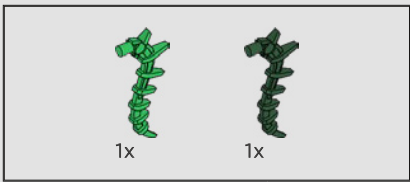

190

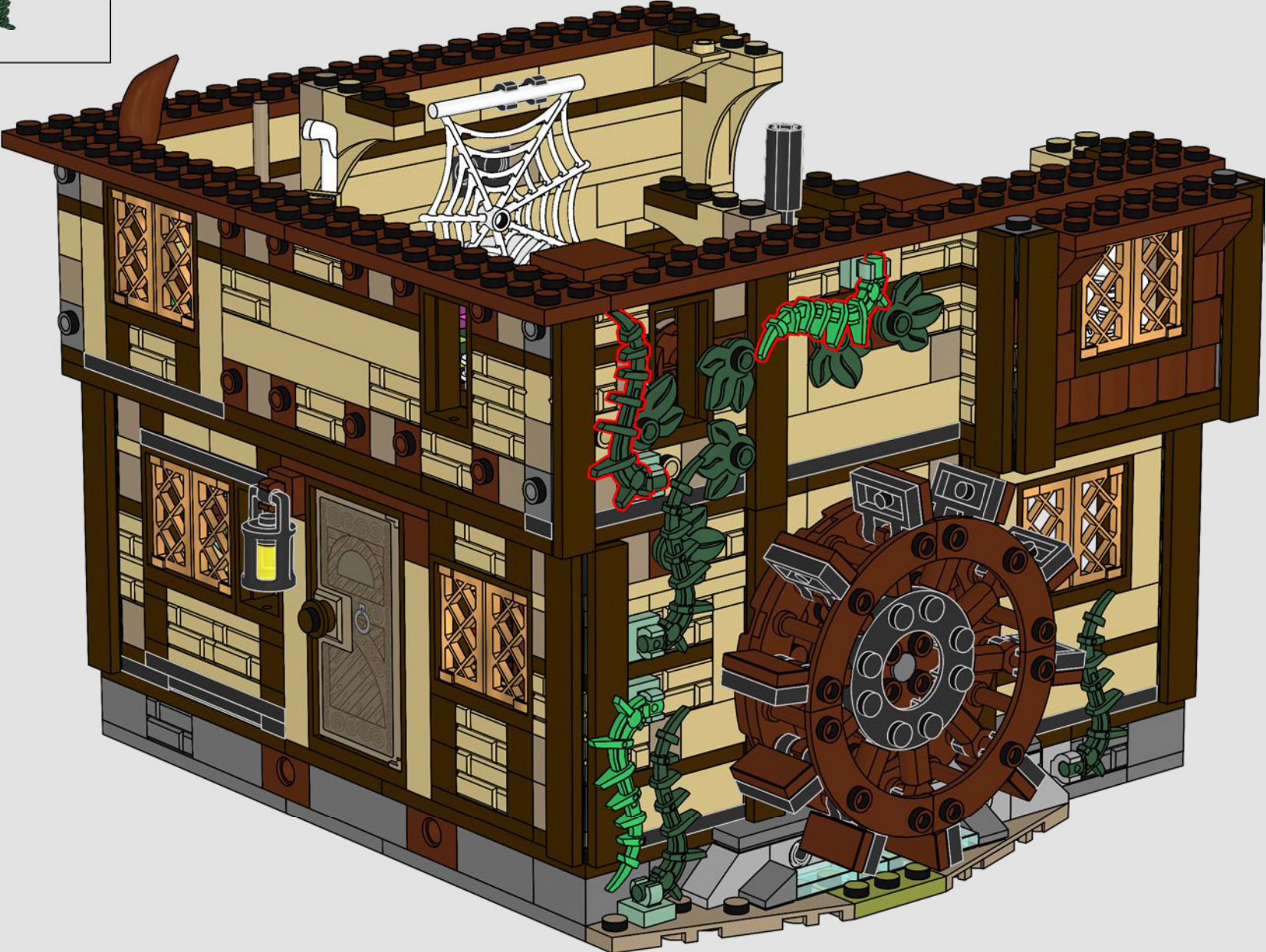

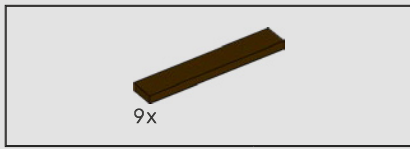

191

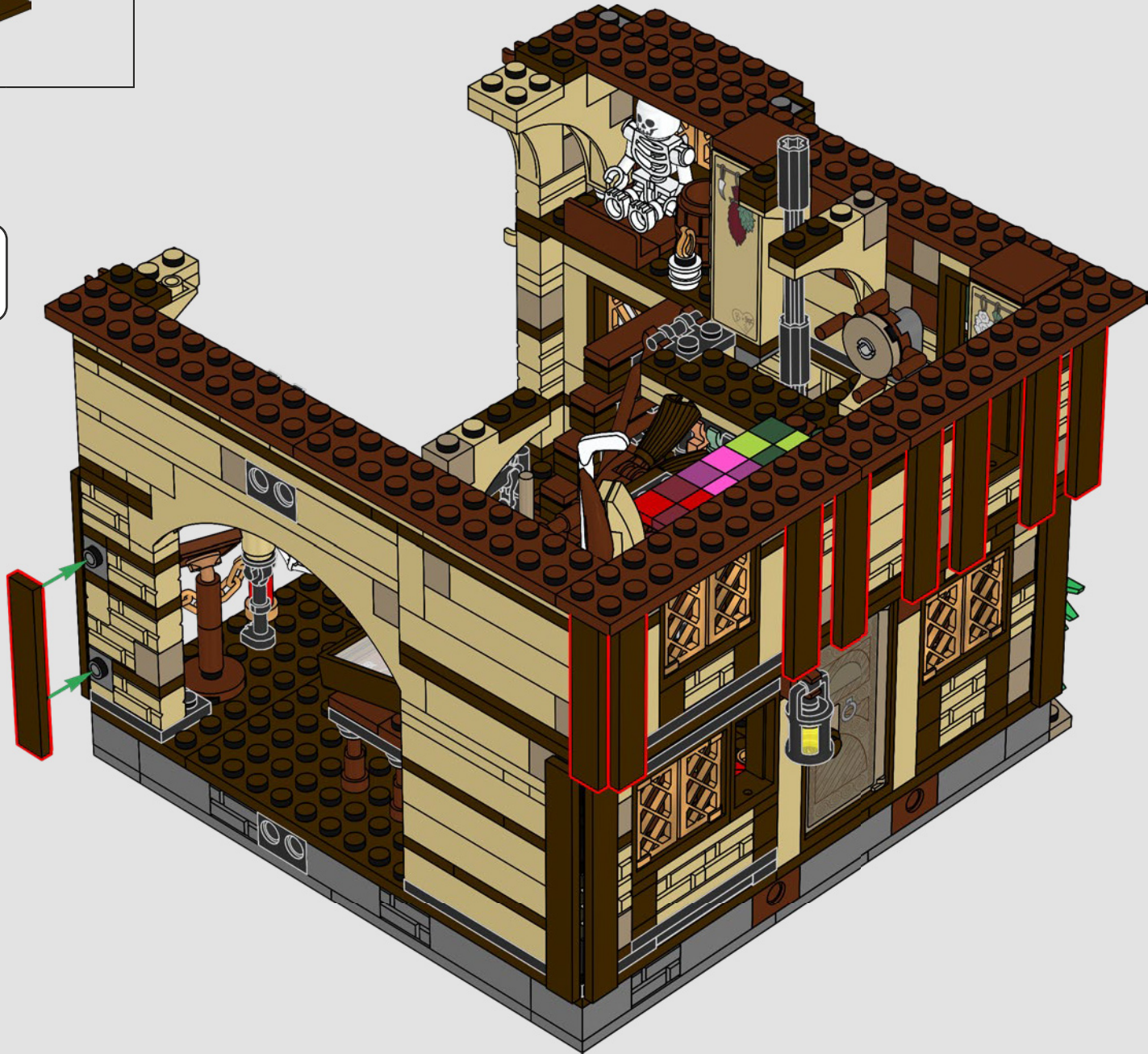

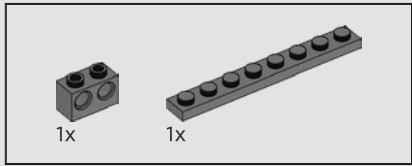
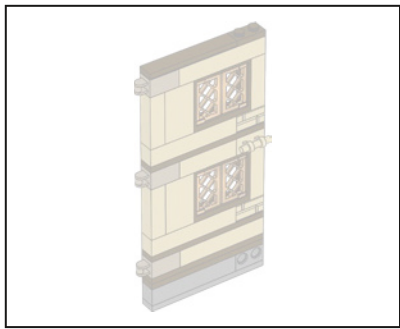

192

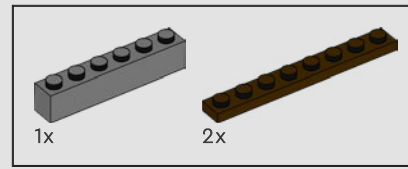
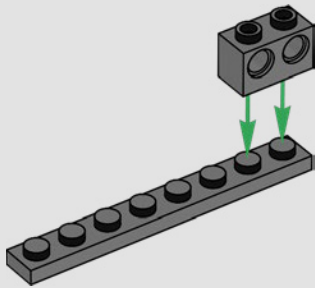

193

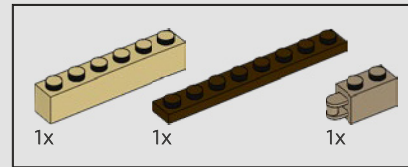
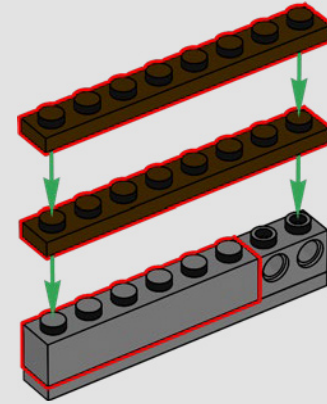

194

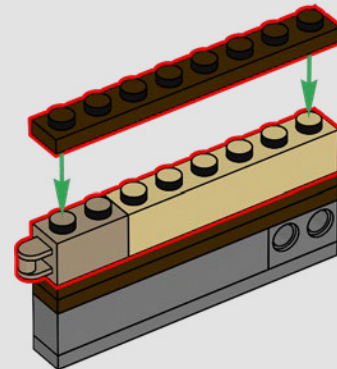

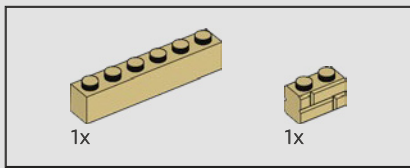

195

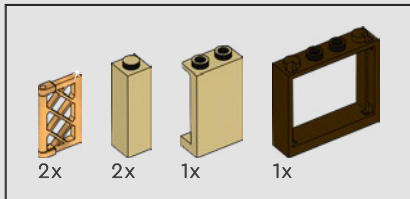
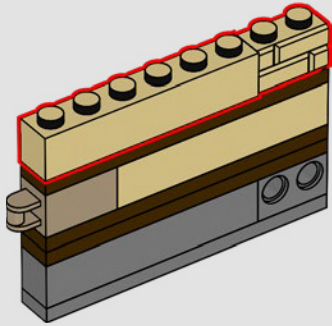

196

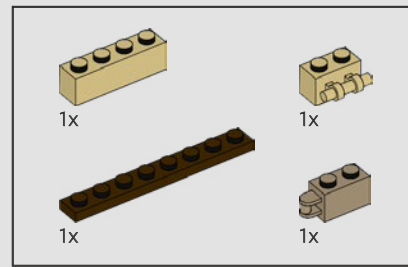
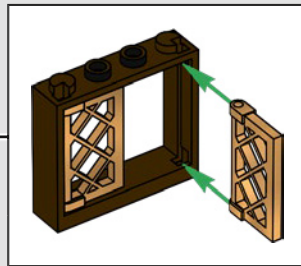
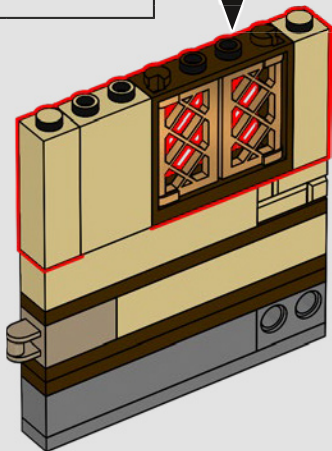

197

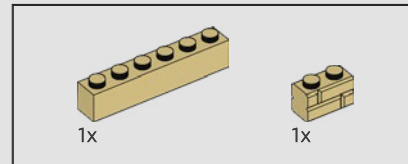
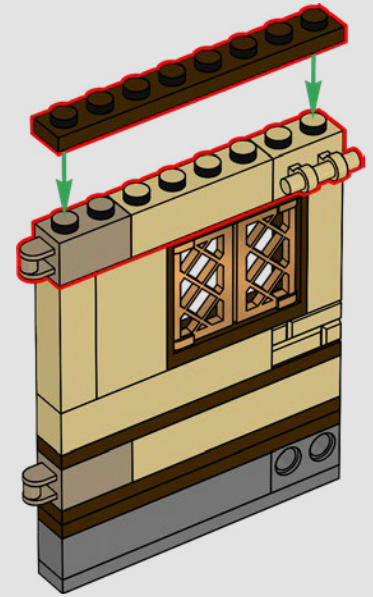

198

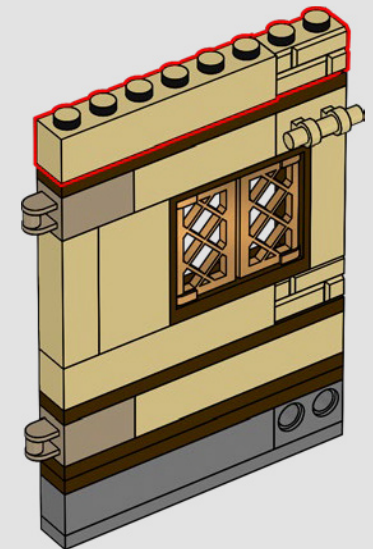

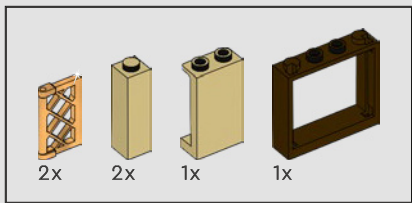

199

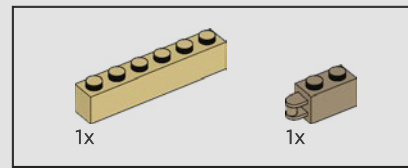
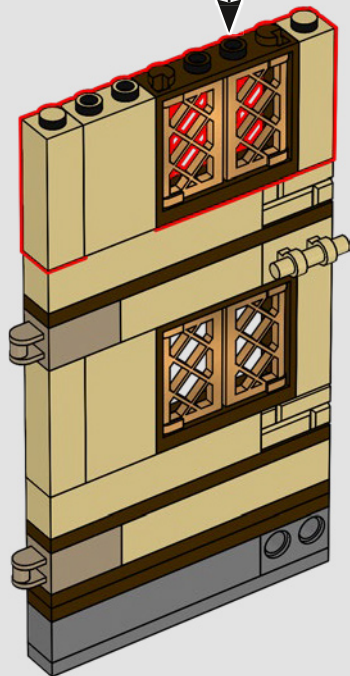
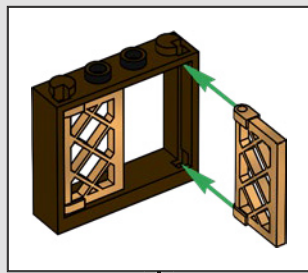

200

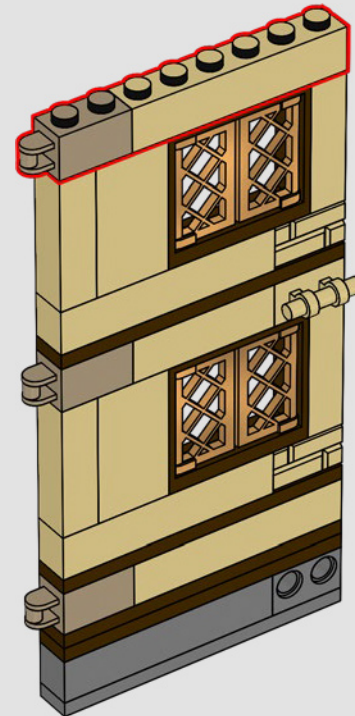

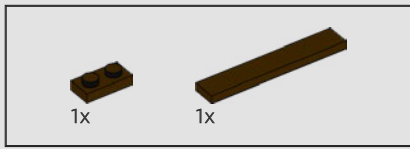

201

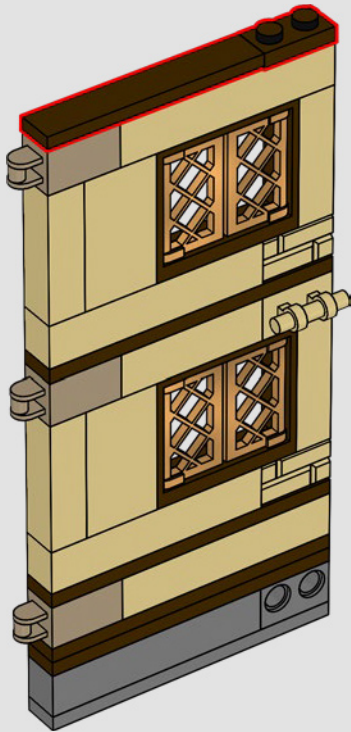

202

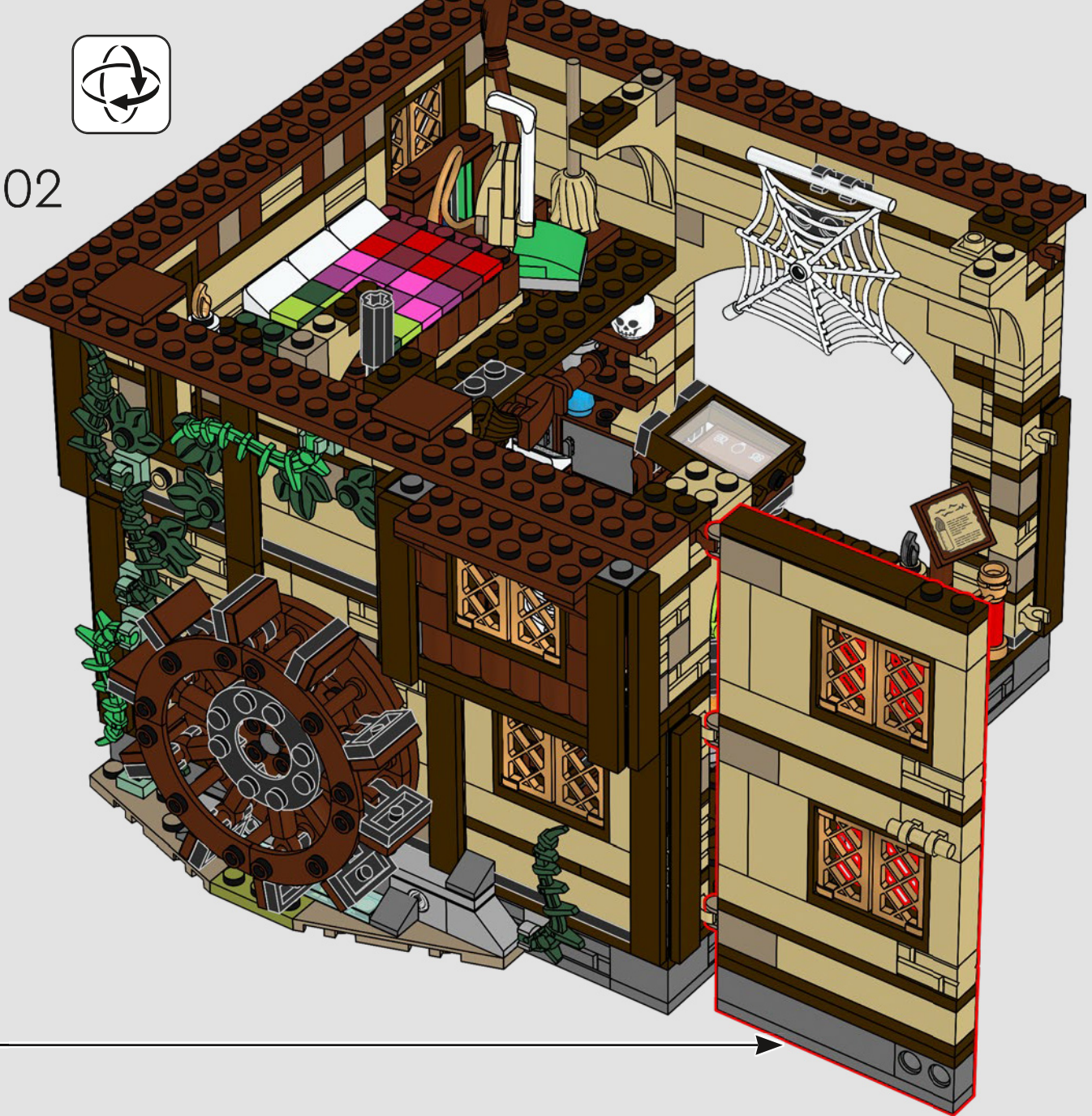

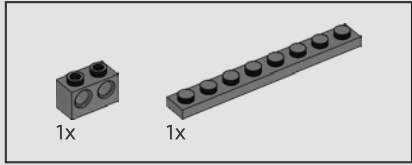
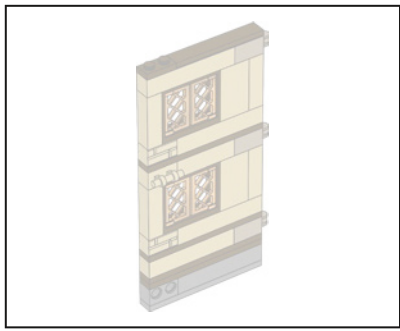

203

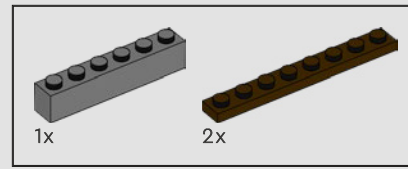
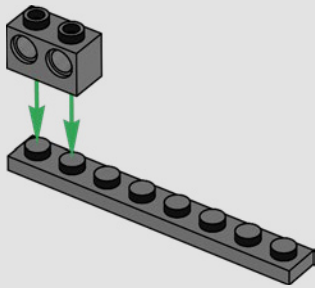

204

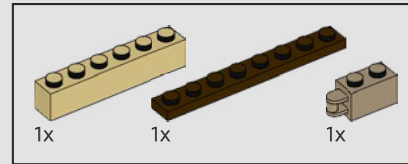
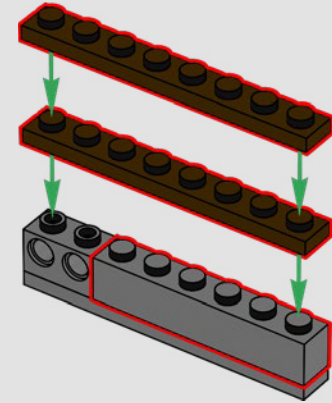

205

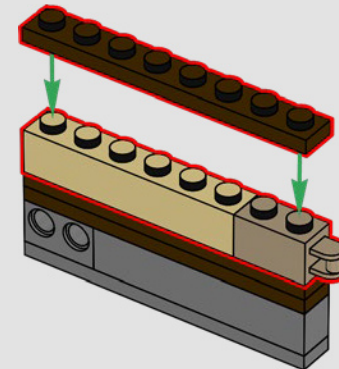

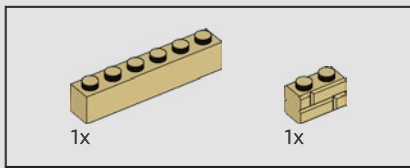

206

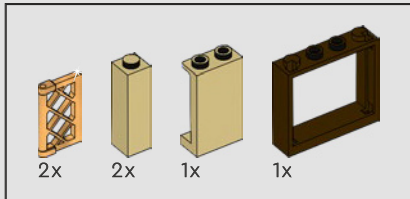
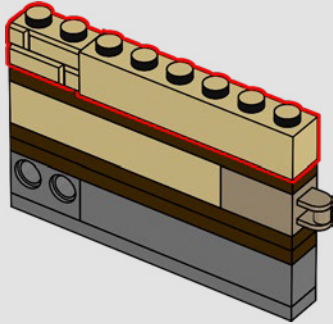

207

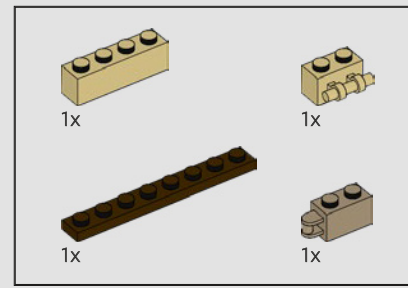
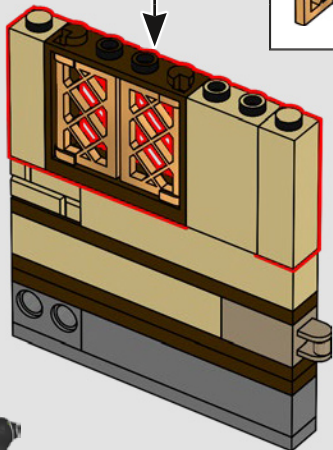
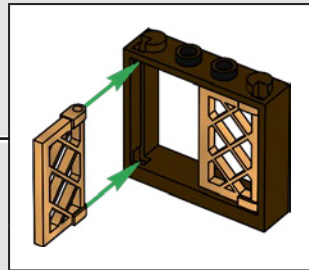

208

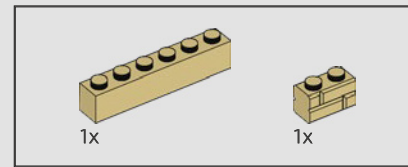
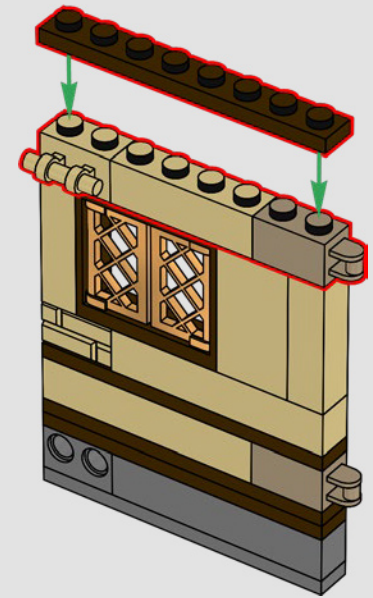

209

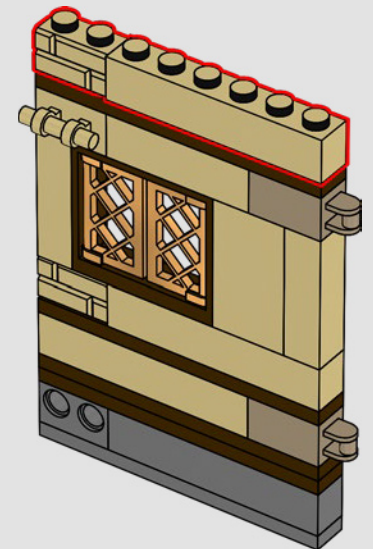

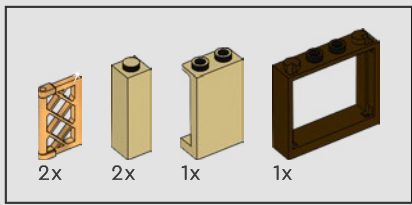

210

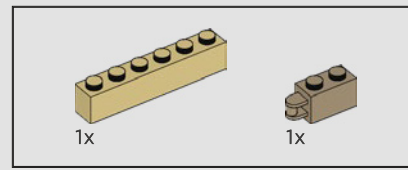
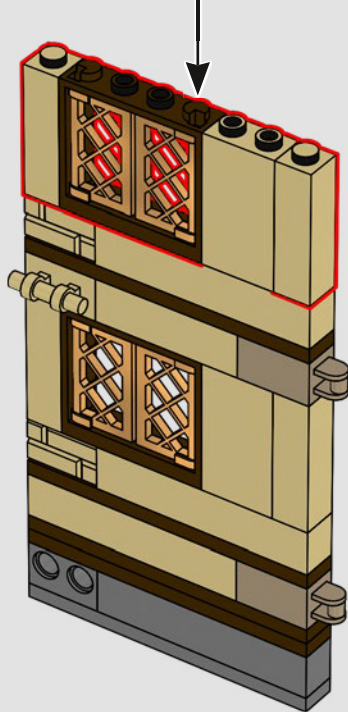
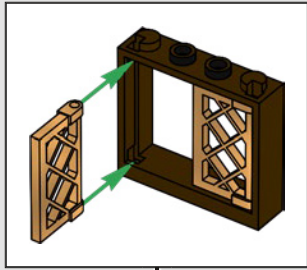

211

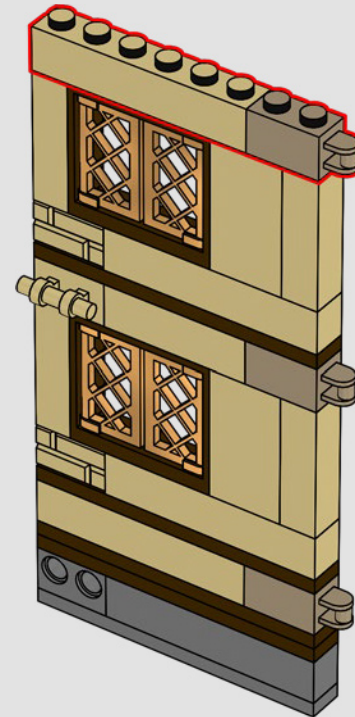

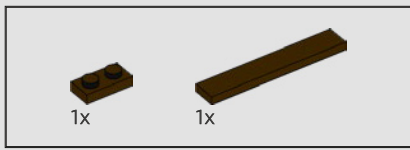

212

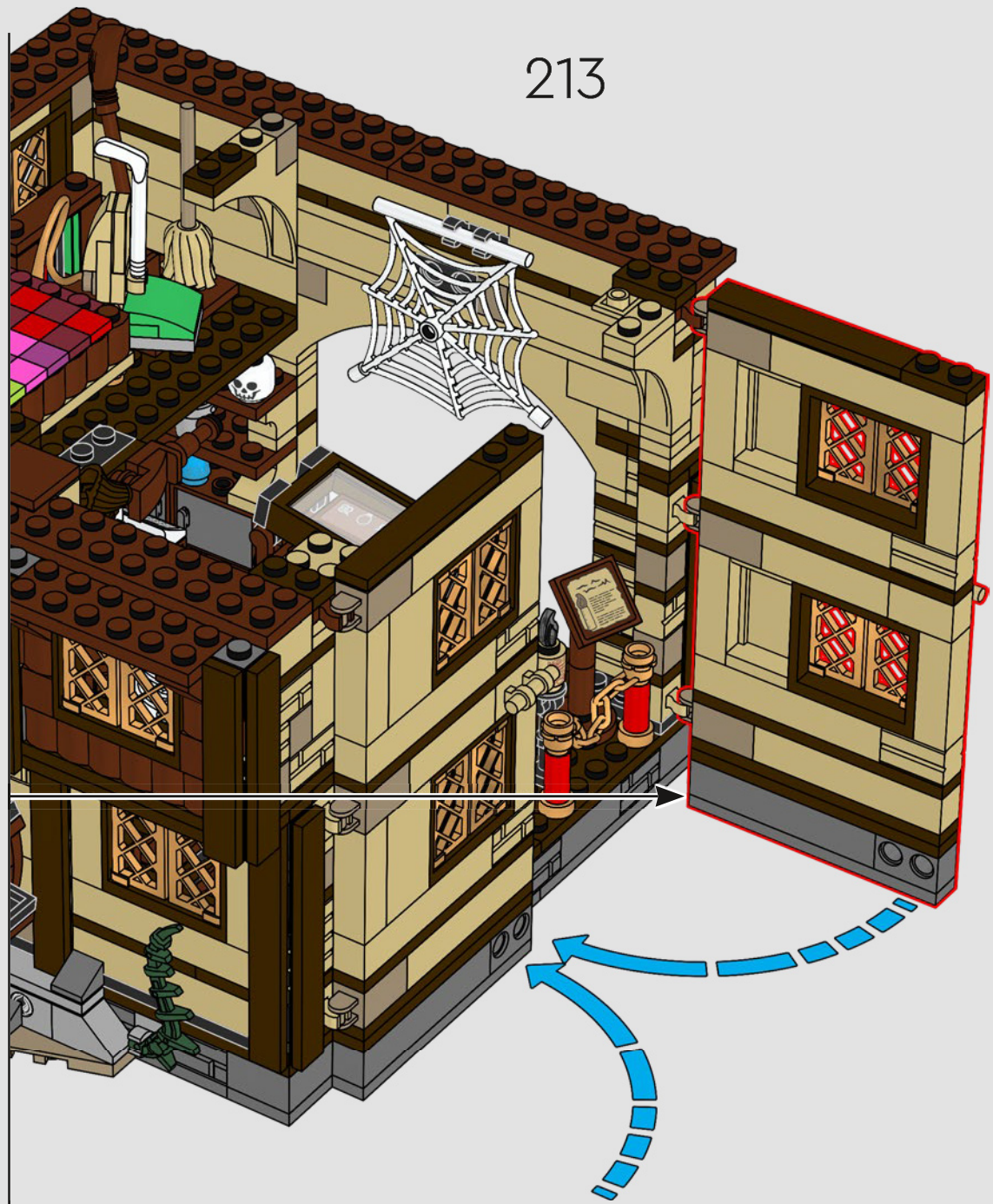
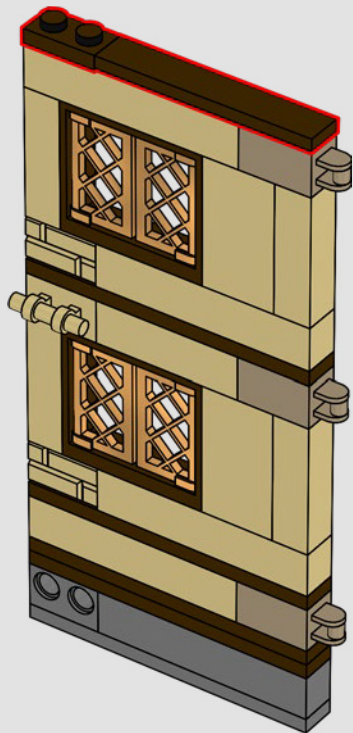

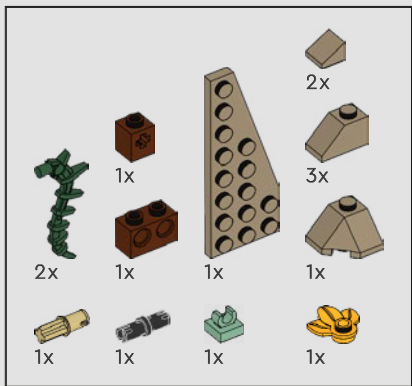

214

1

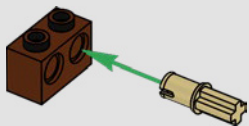

2

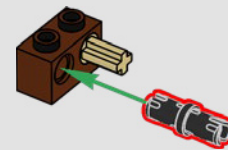

3

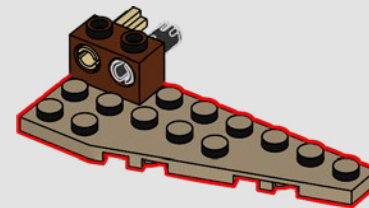

4

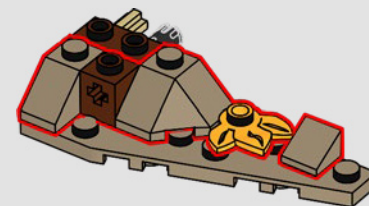

5

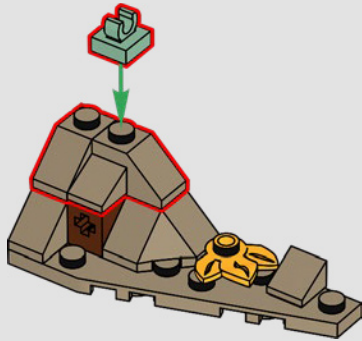

6

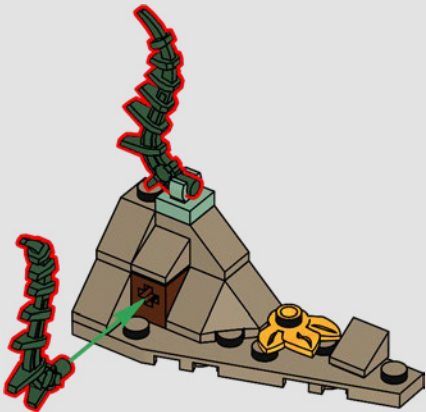

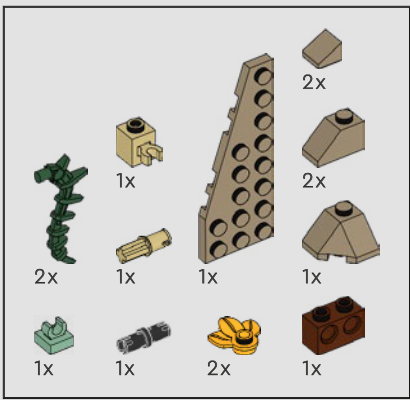

215

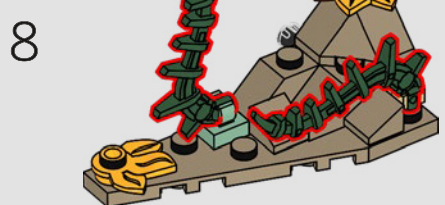
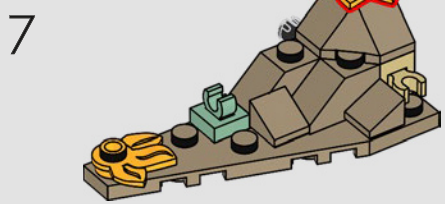
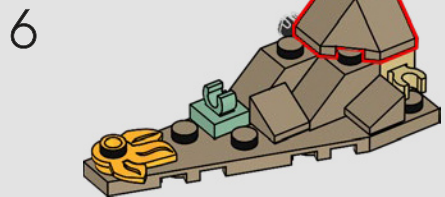
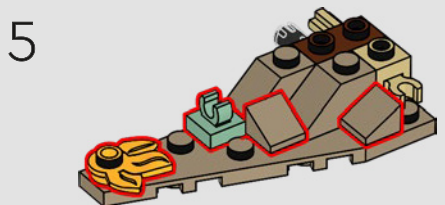
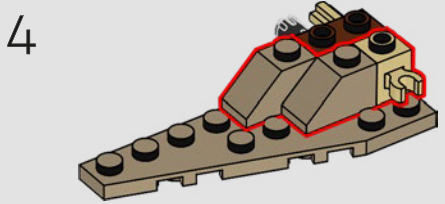
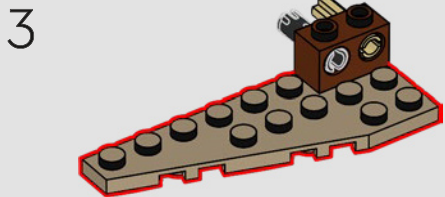
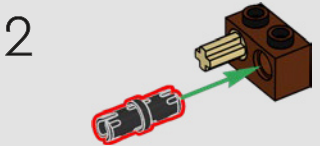
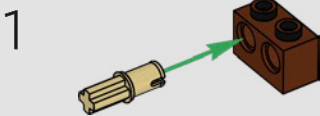



216



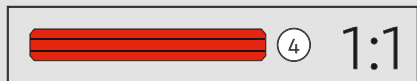

217

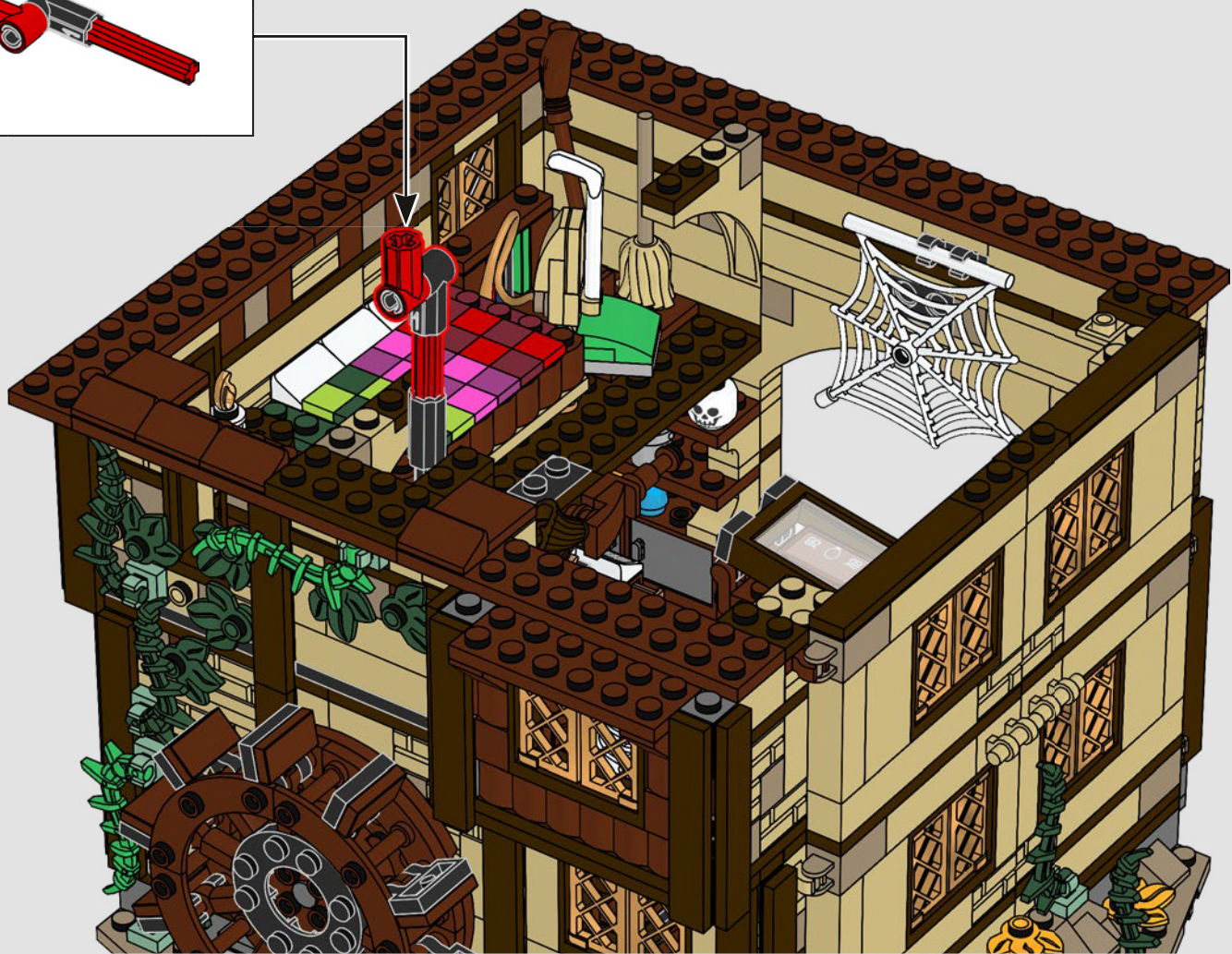
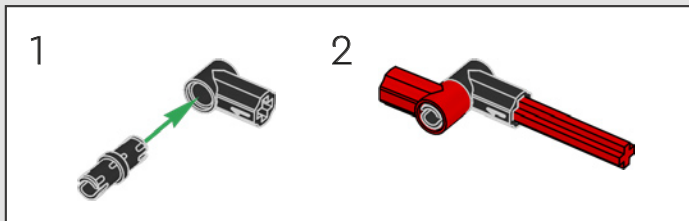

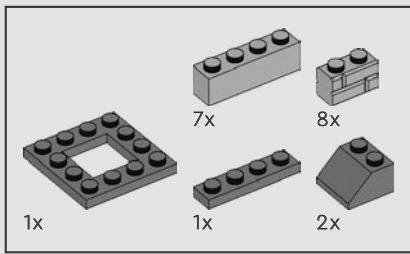

218

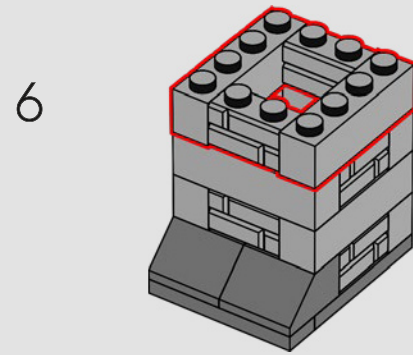
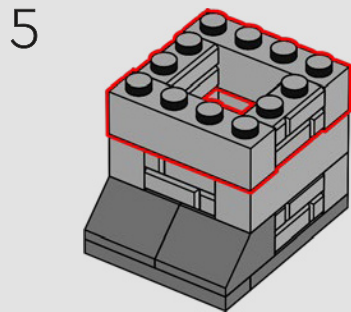
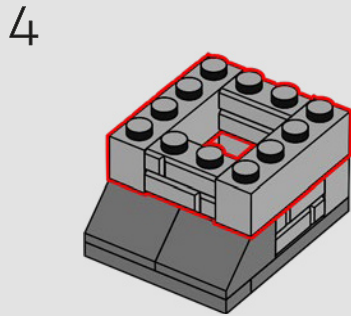
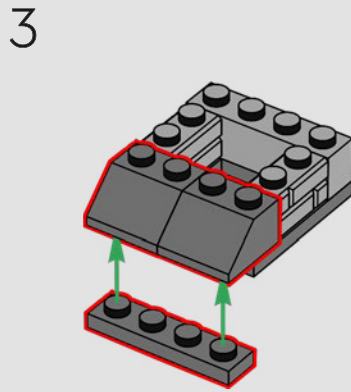
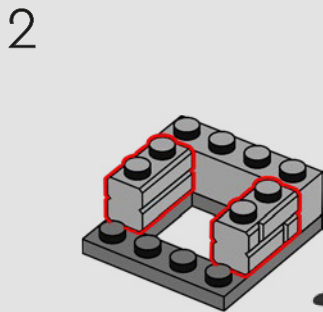
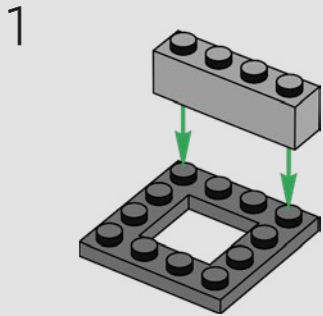

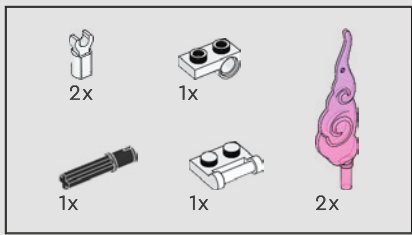

219

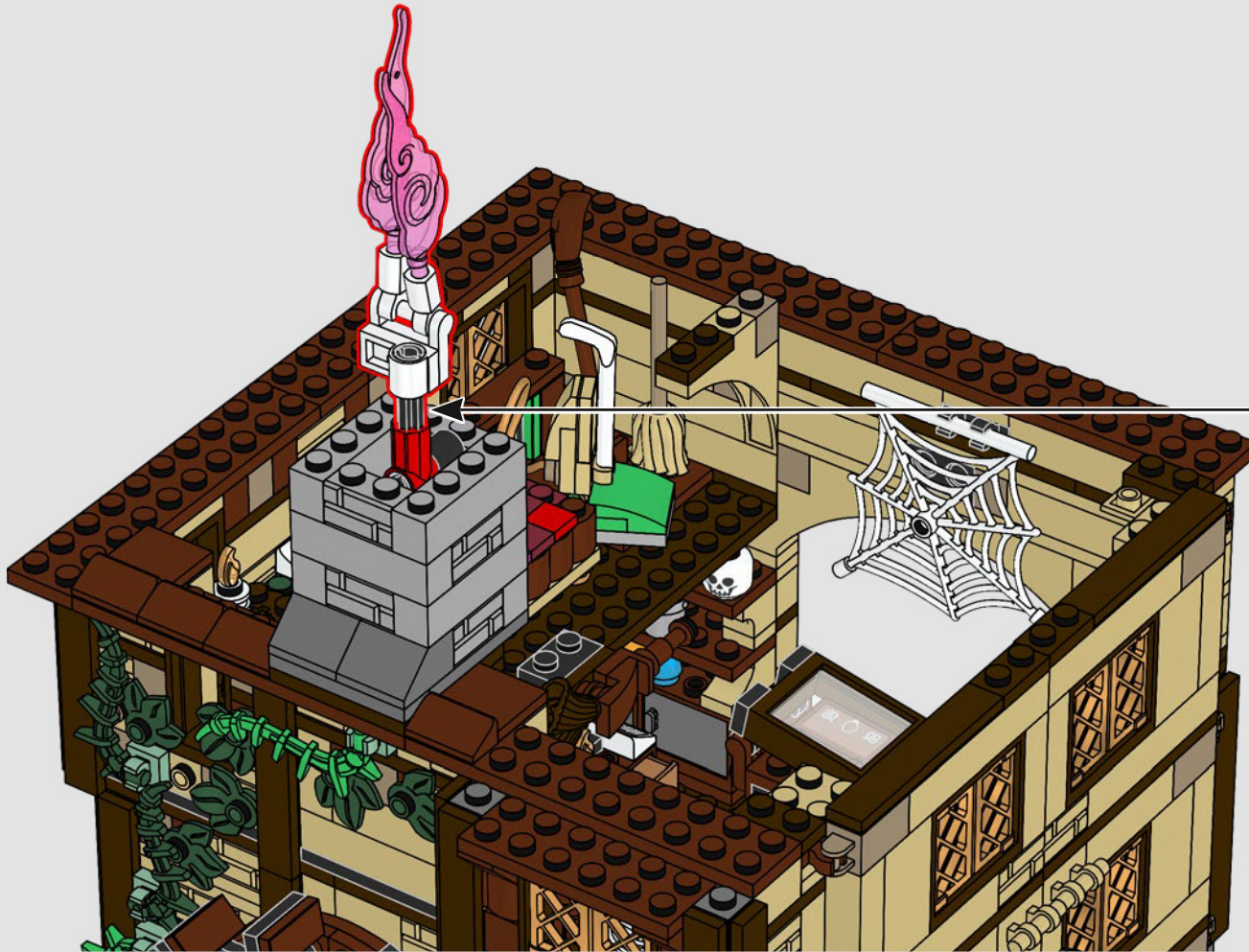
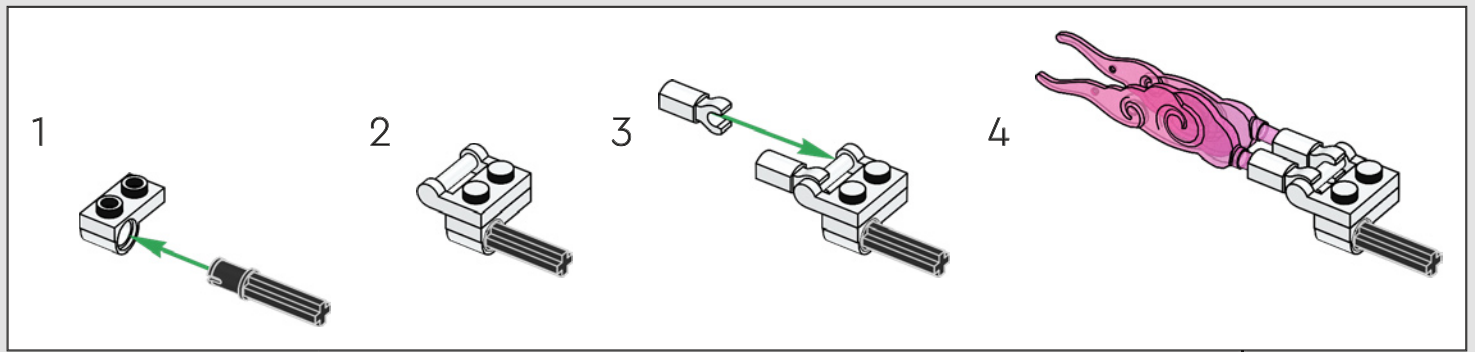

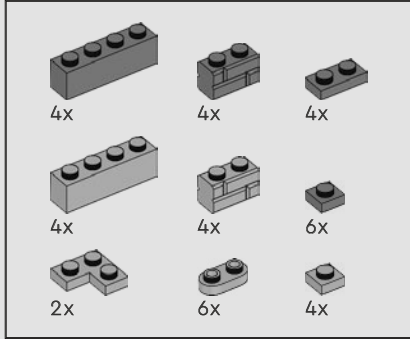
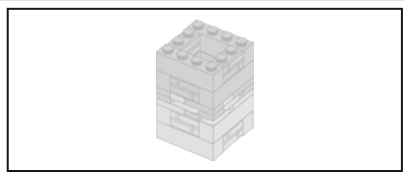

220

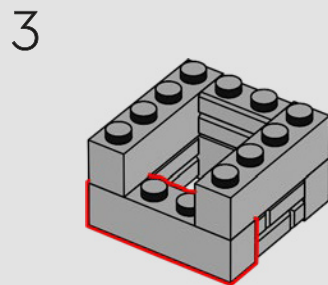
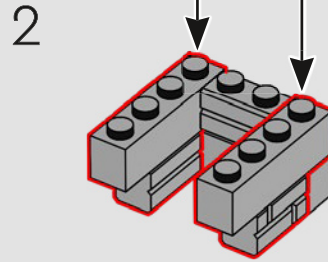
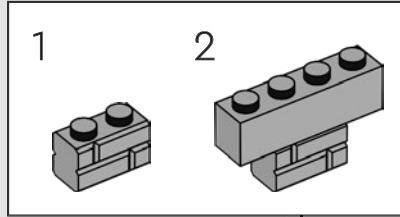
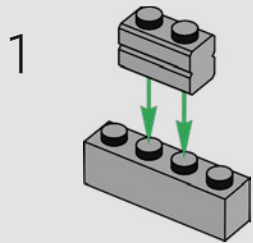

4

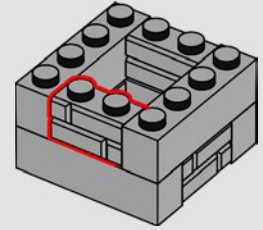

5

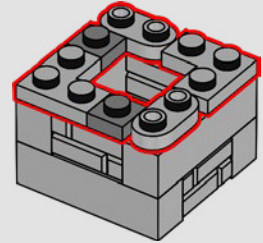

6

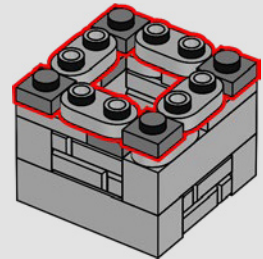

7

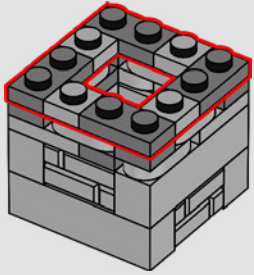

8

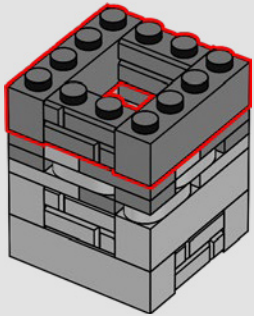

9

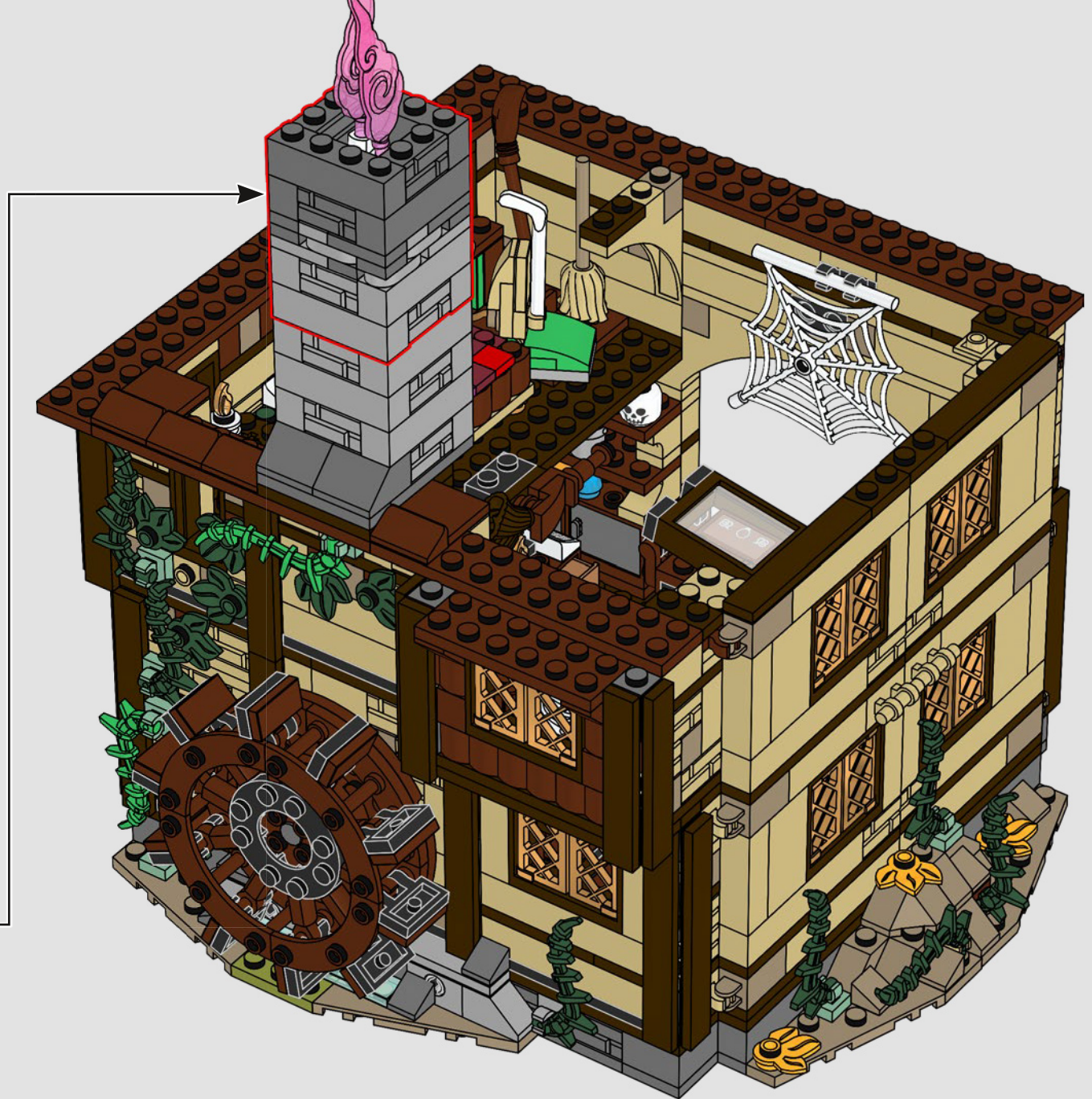
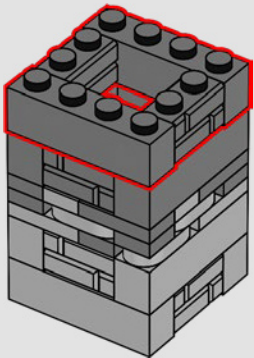

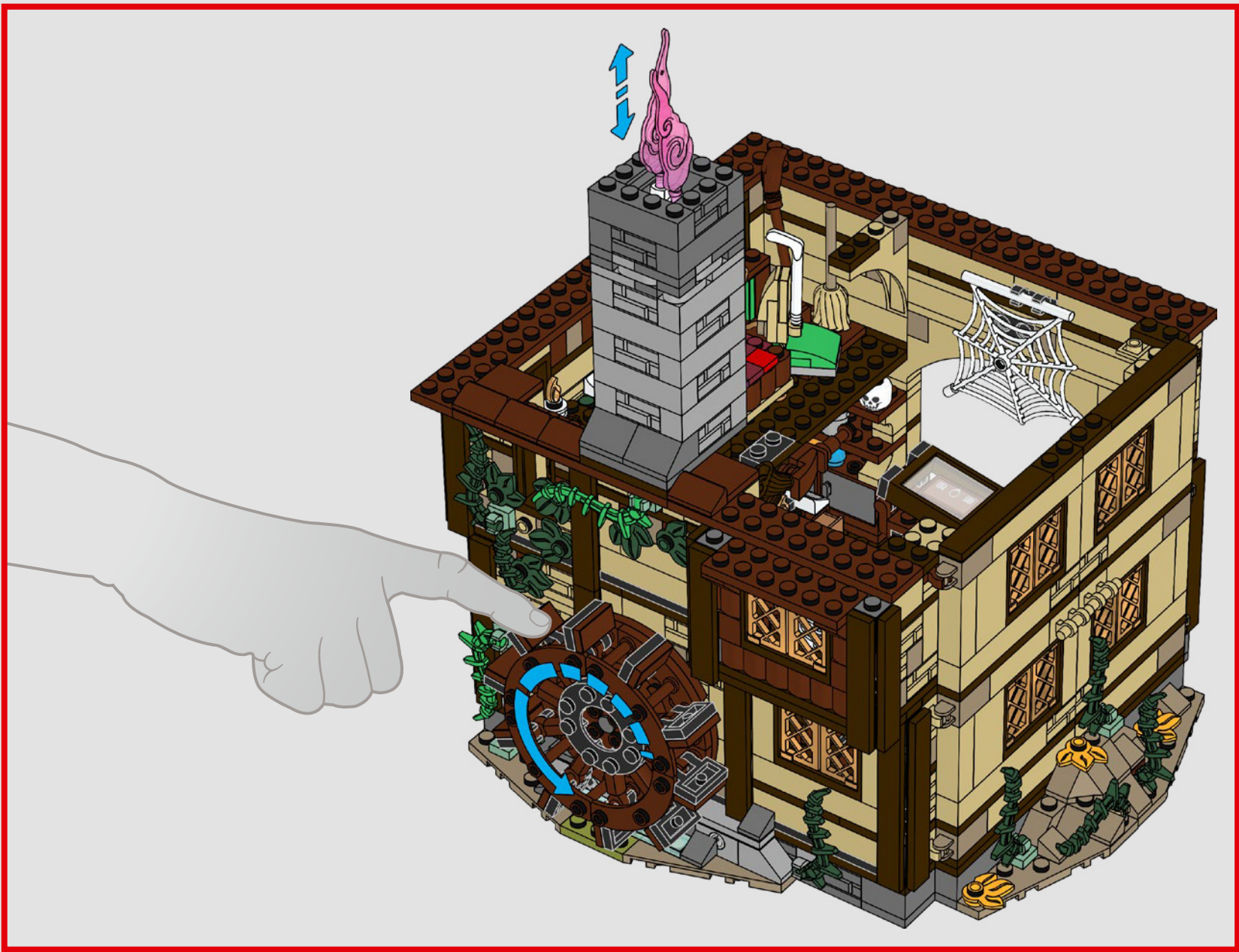

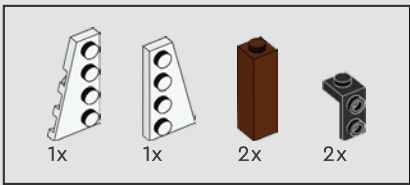

221

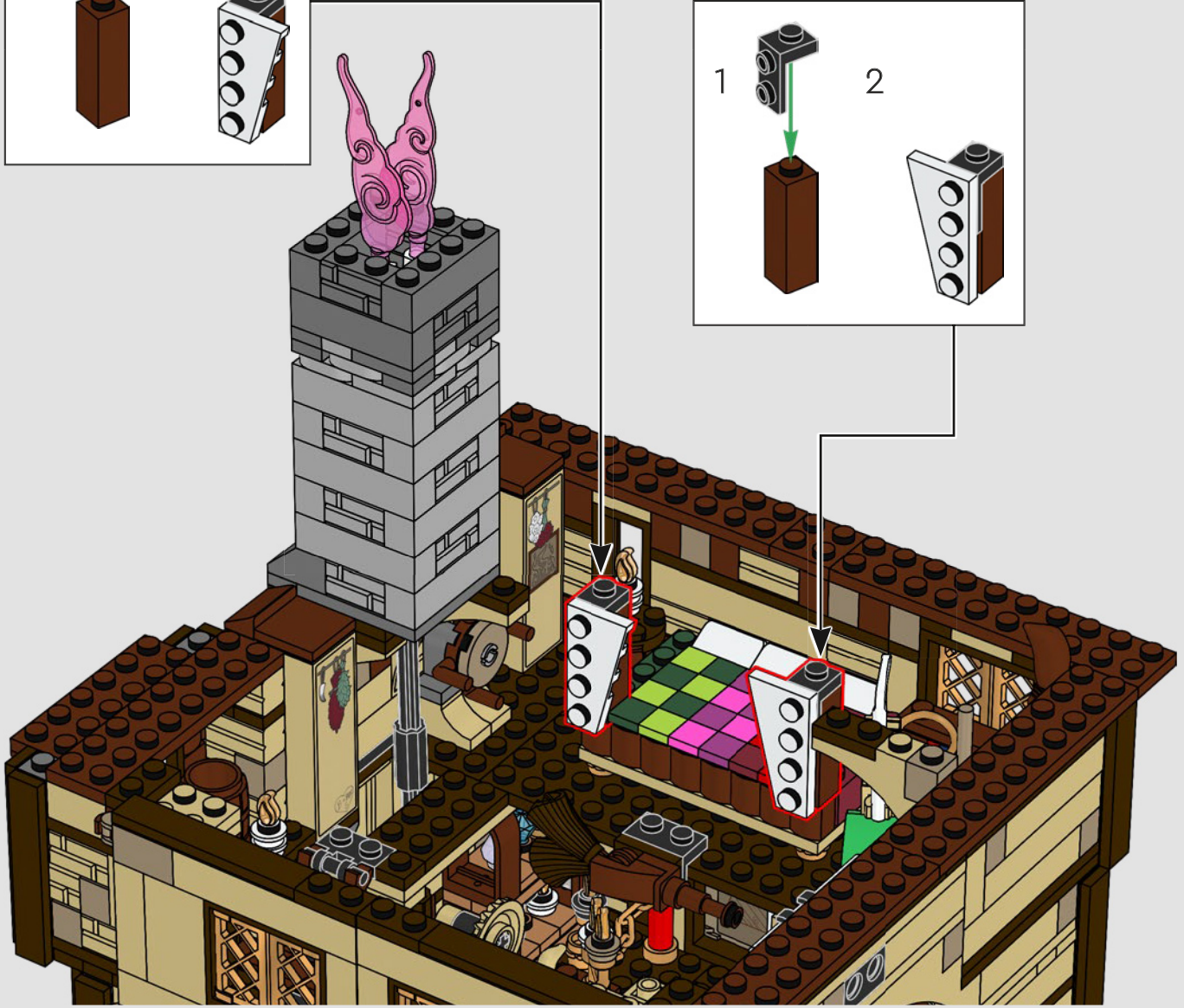
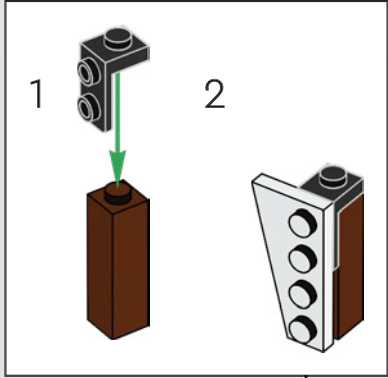
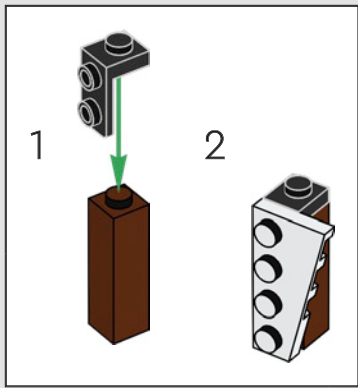

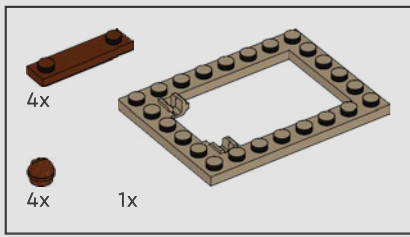

222

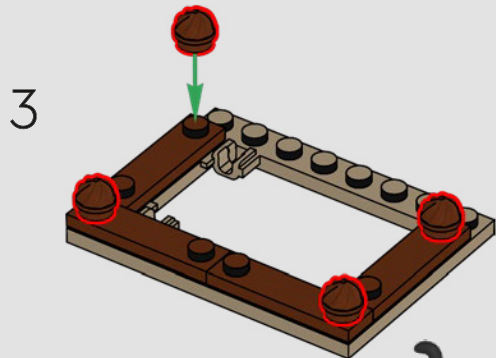
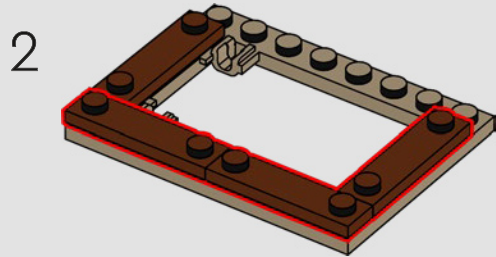
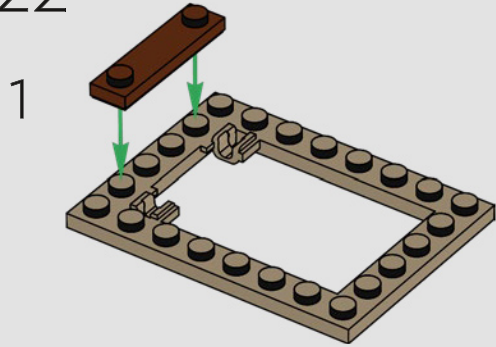

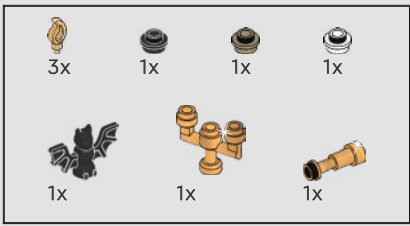

223

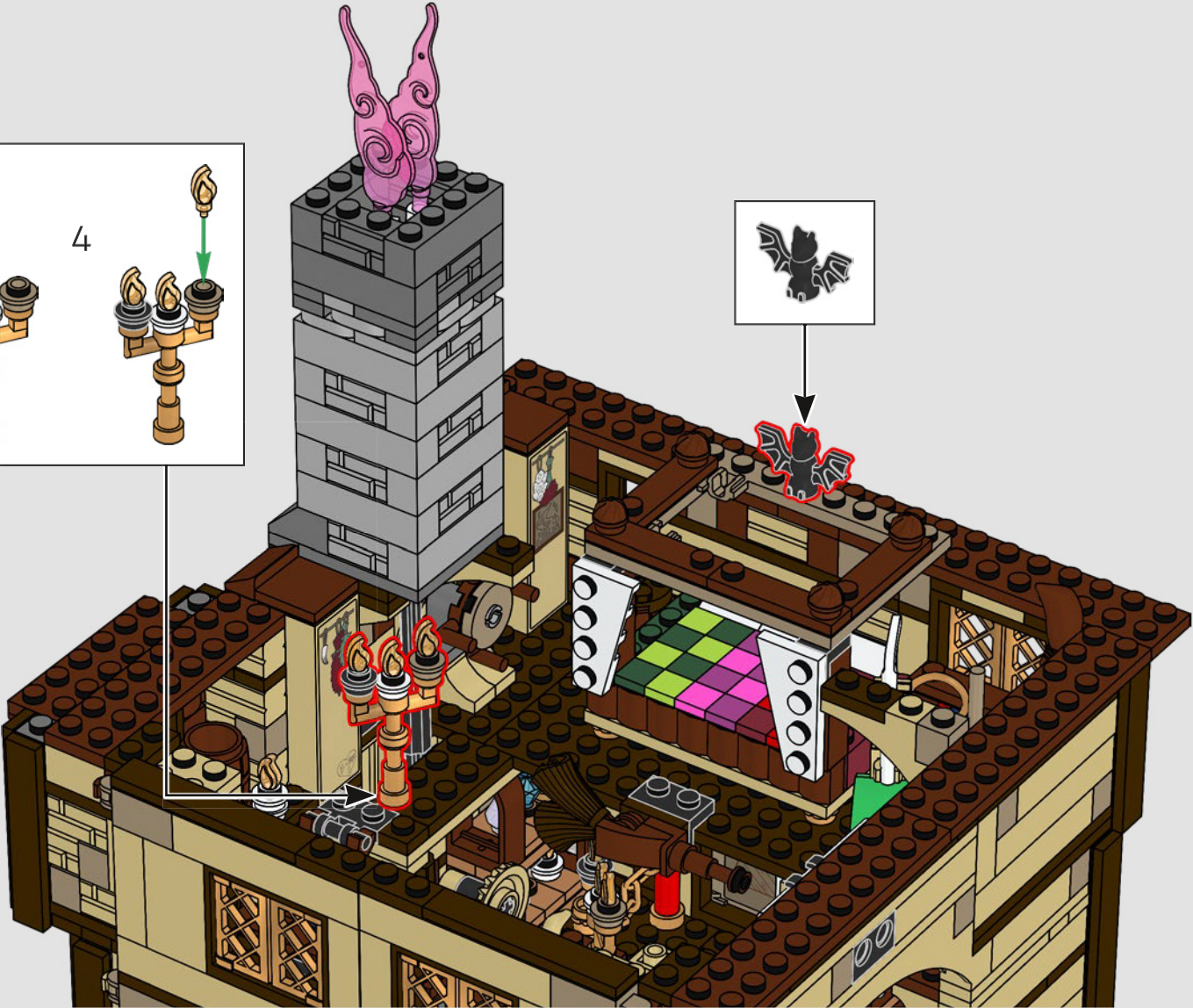
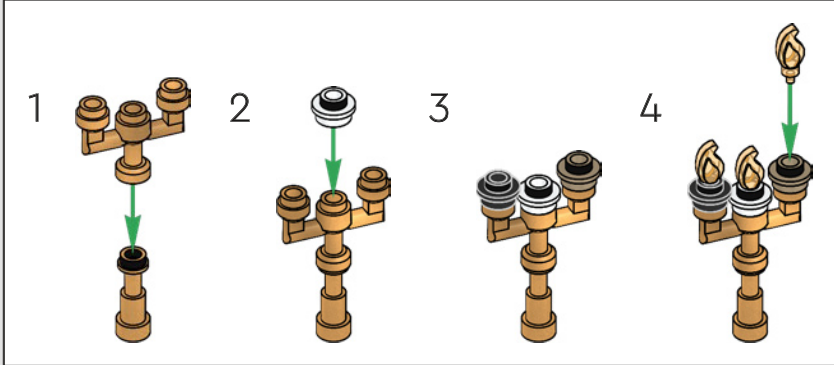

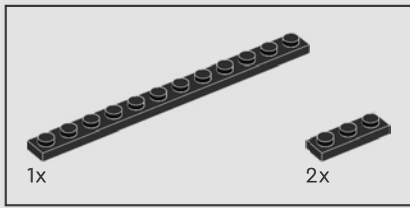

224





9x

225

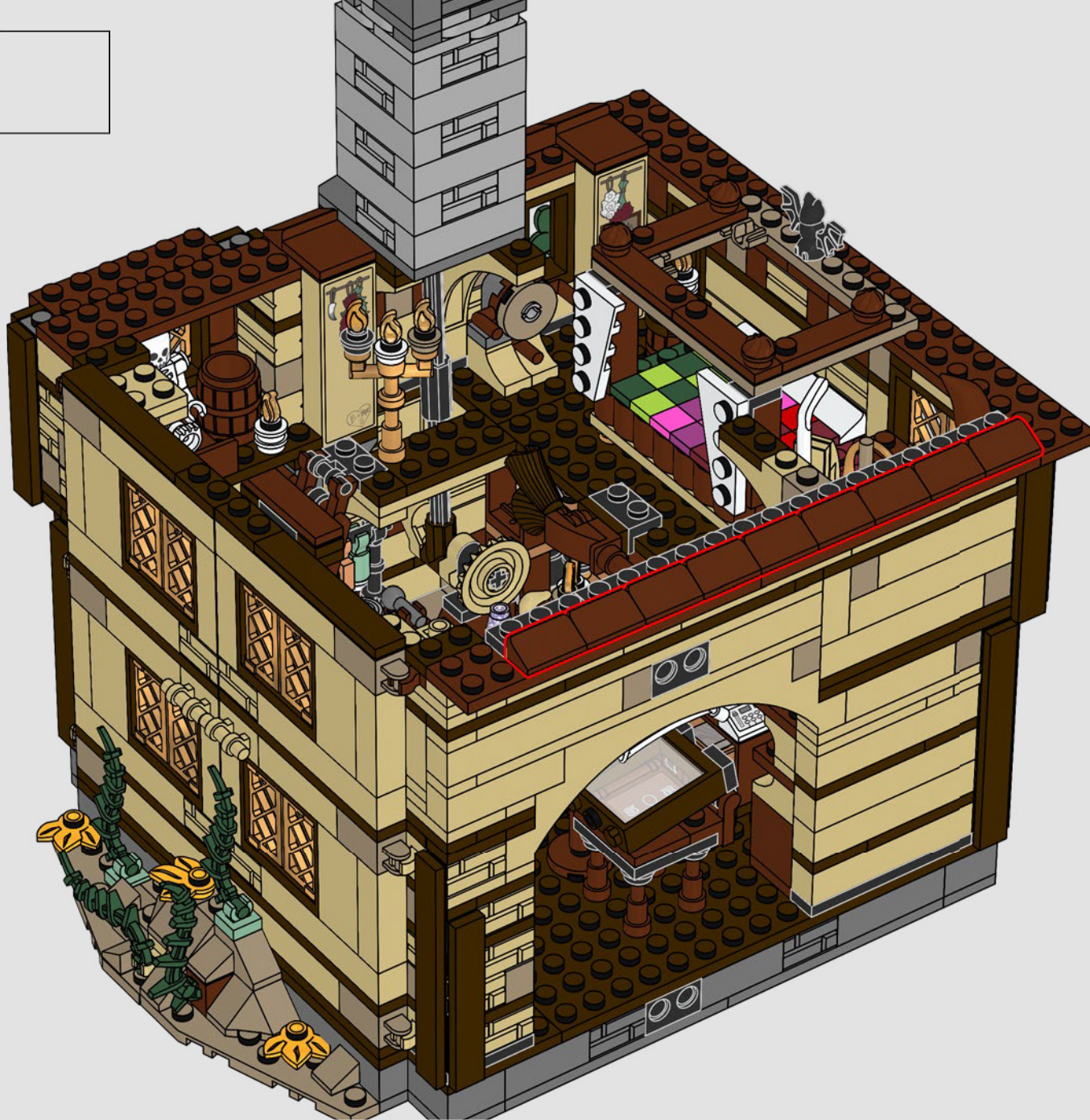

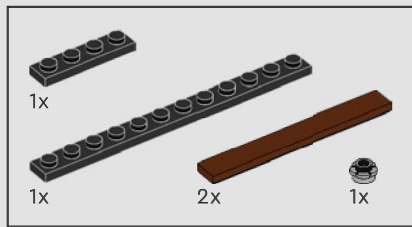

226

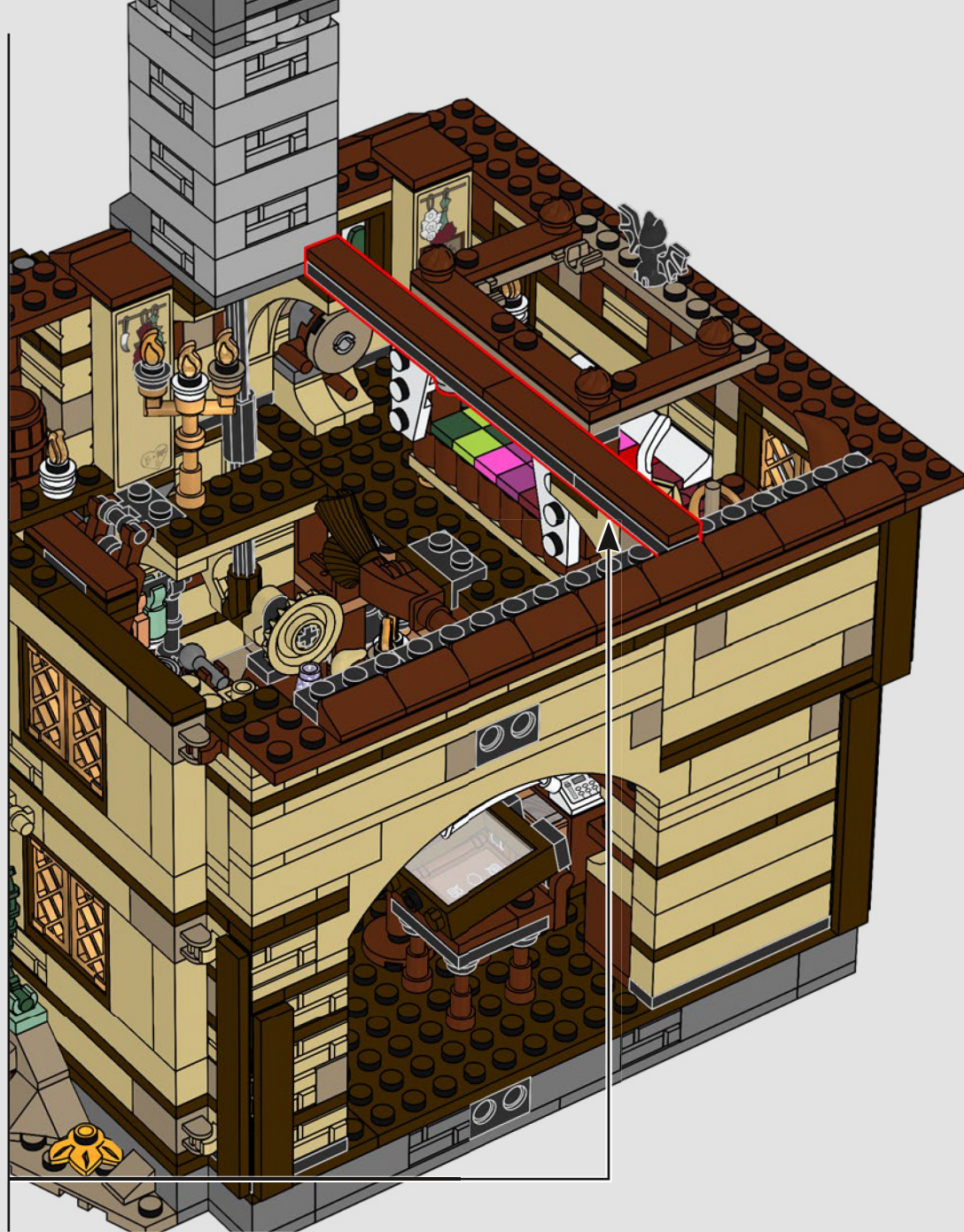
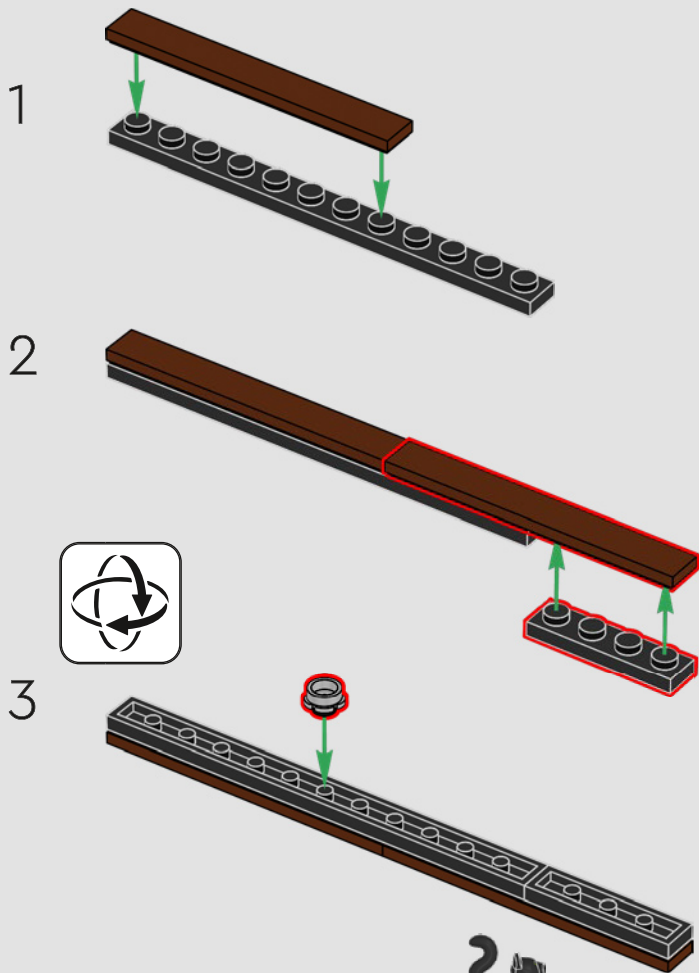

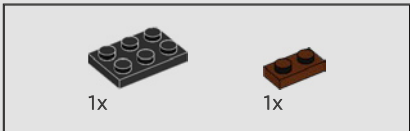
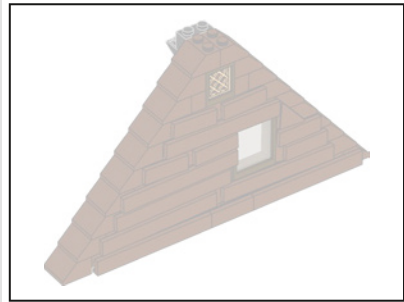

227

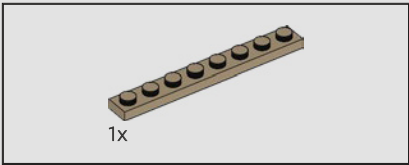
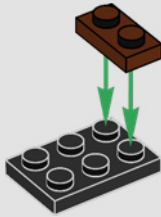

228

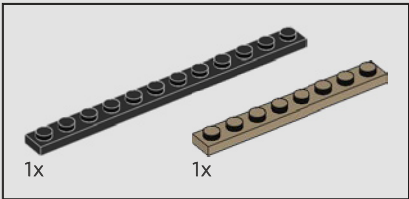
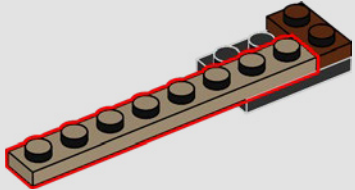

229

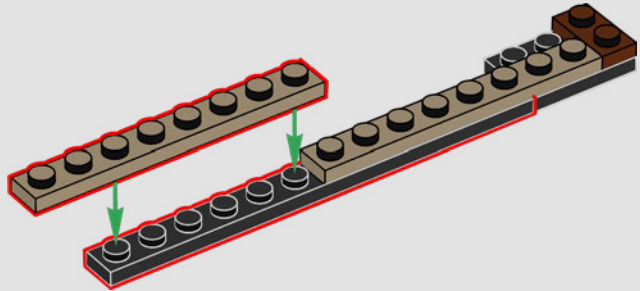

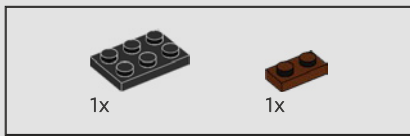

230



231

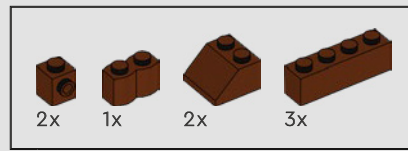
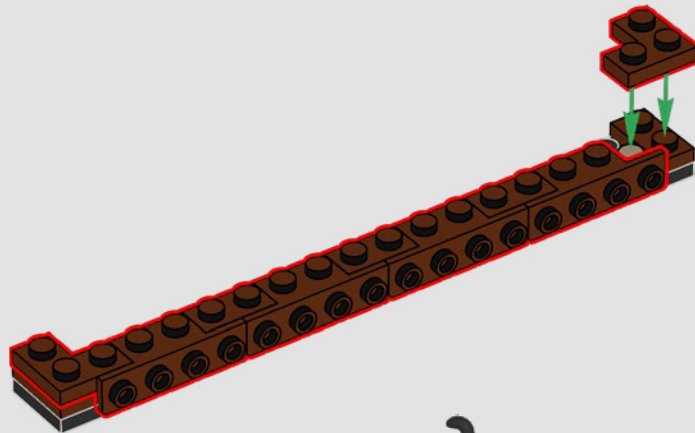

232

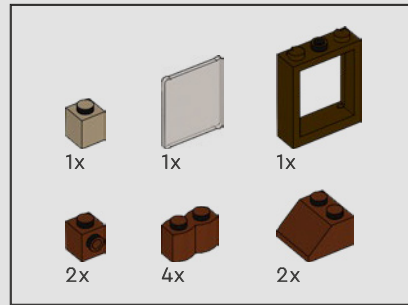
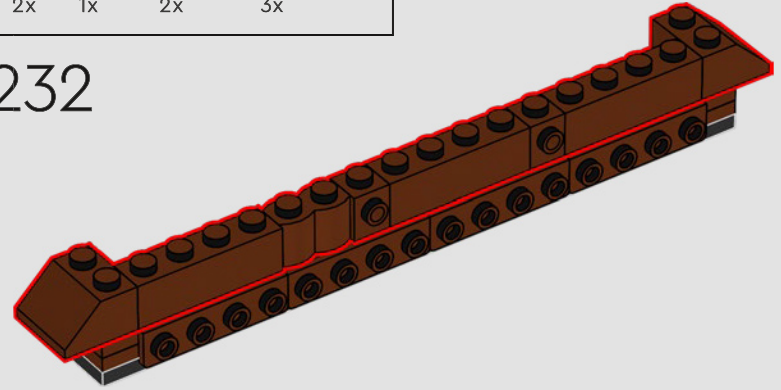

233

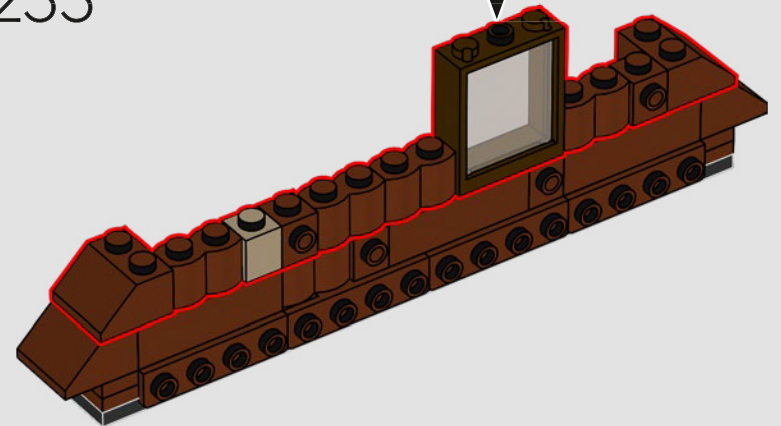
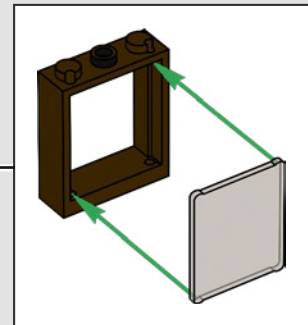

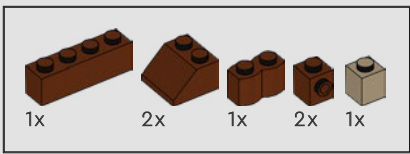

234

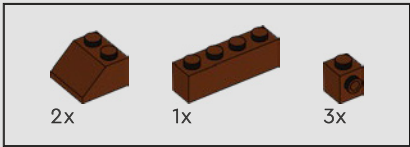
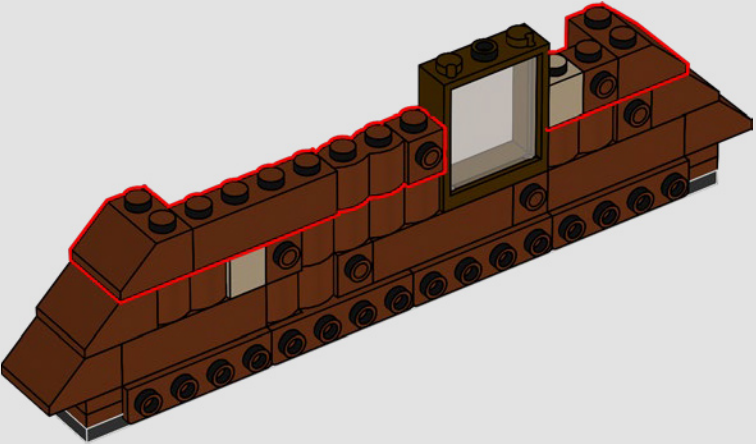

235

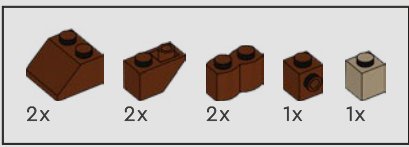
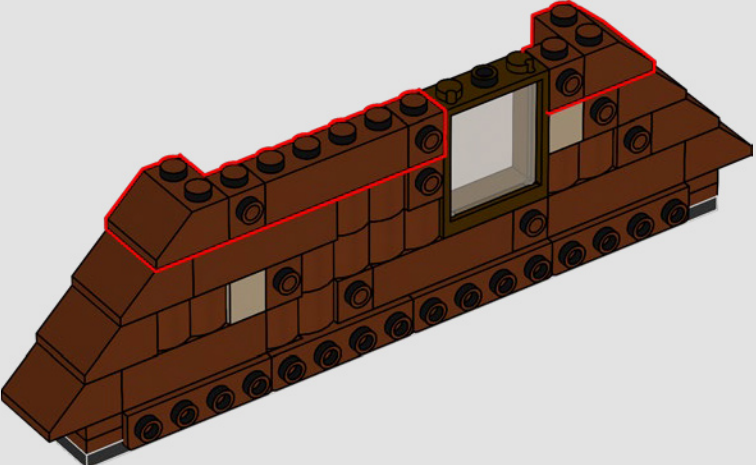

236

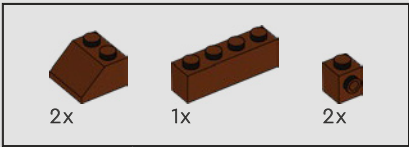
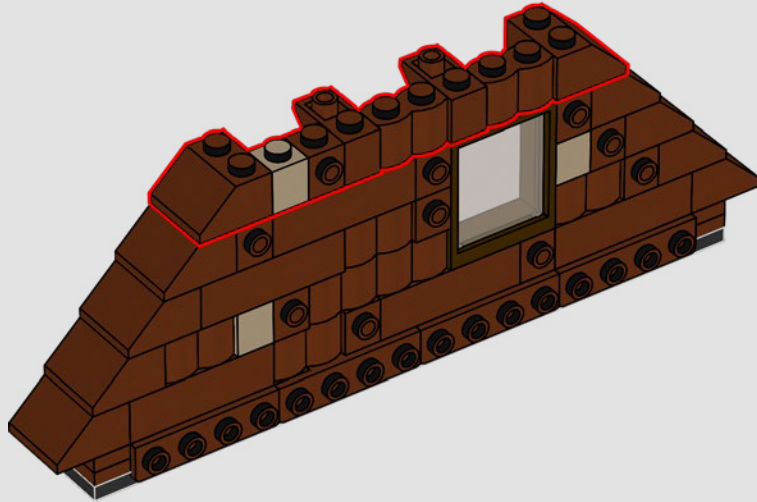

237

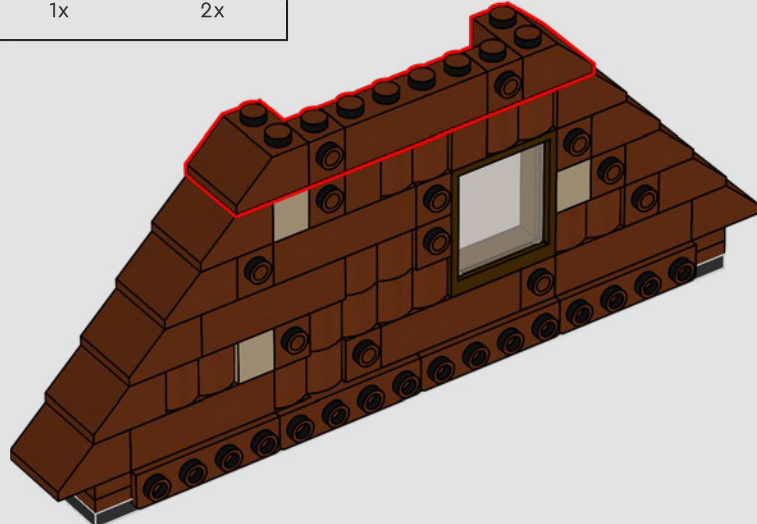

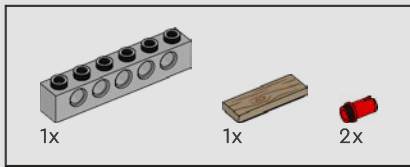

238

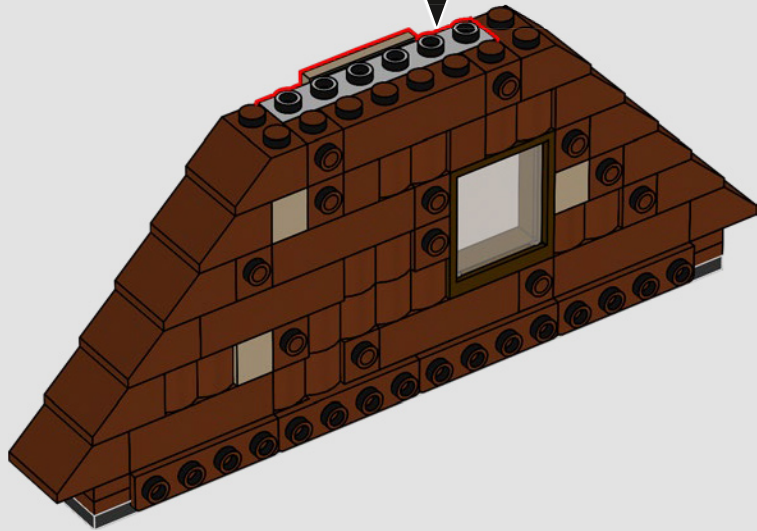
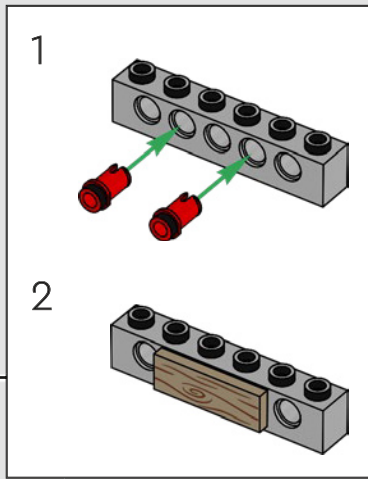

239

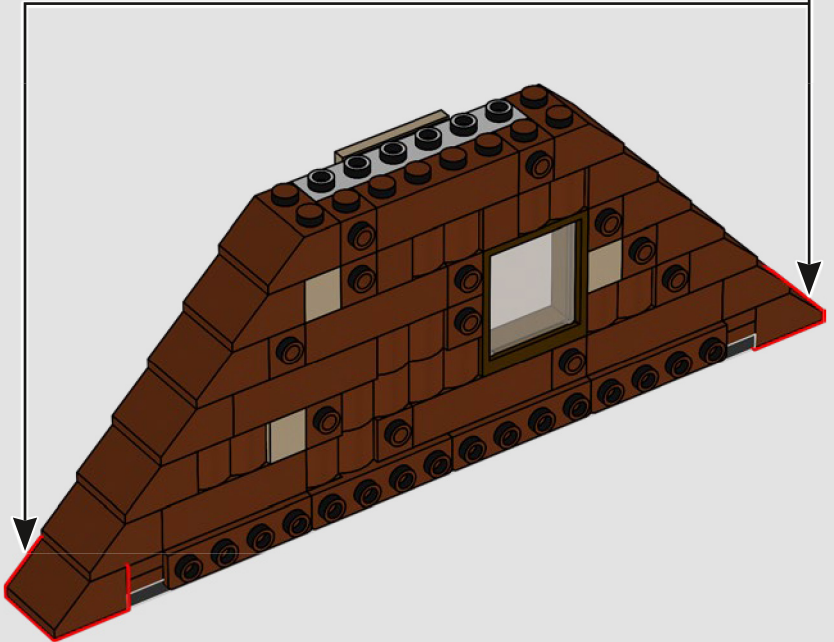
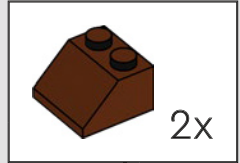

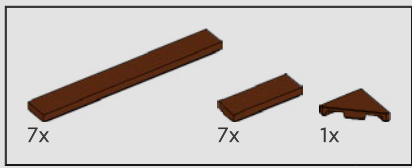

240

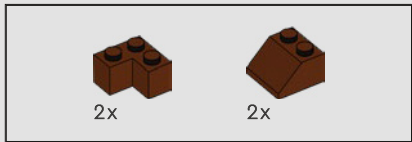
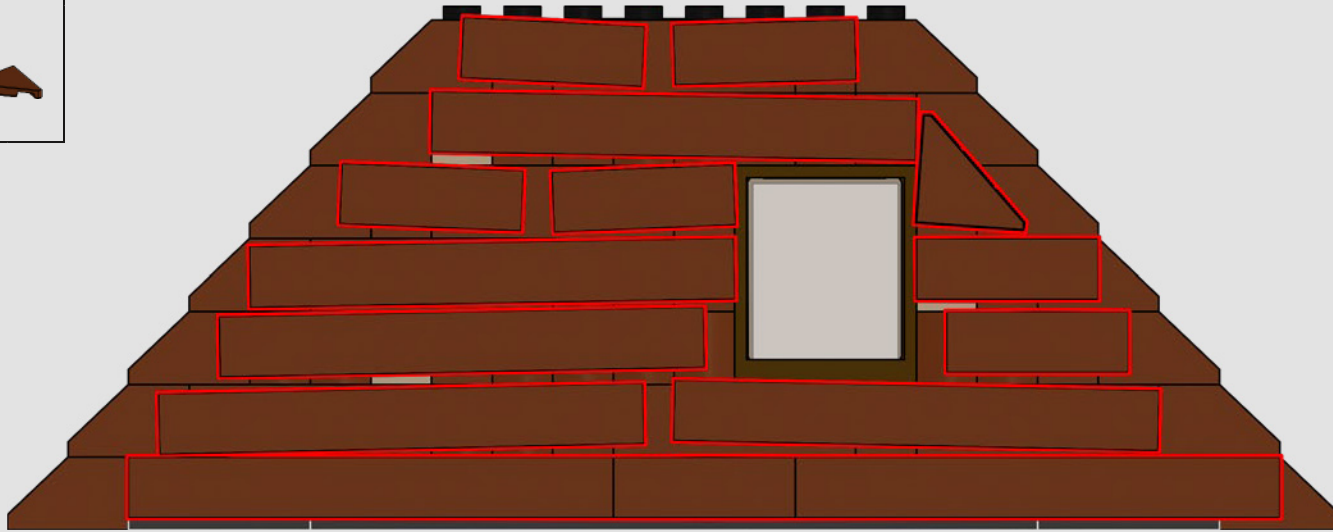

241

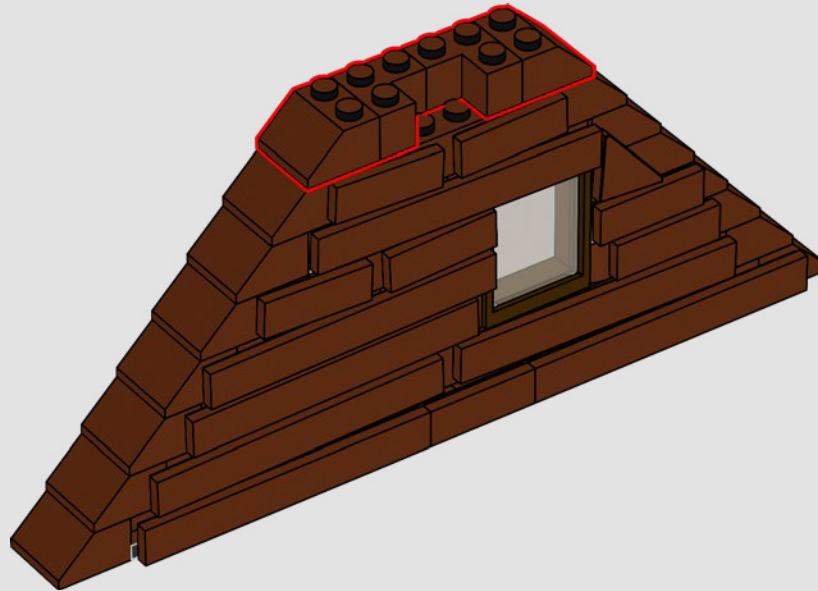



242

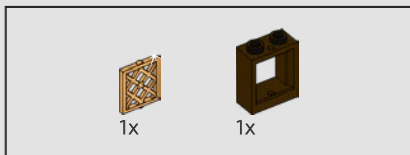
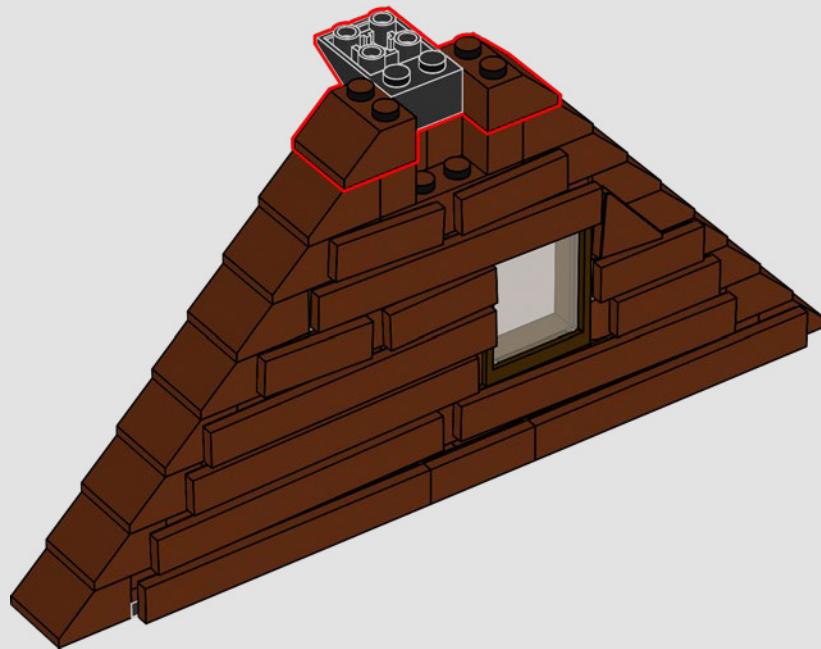

243

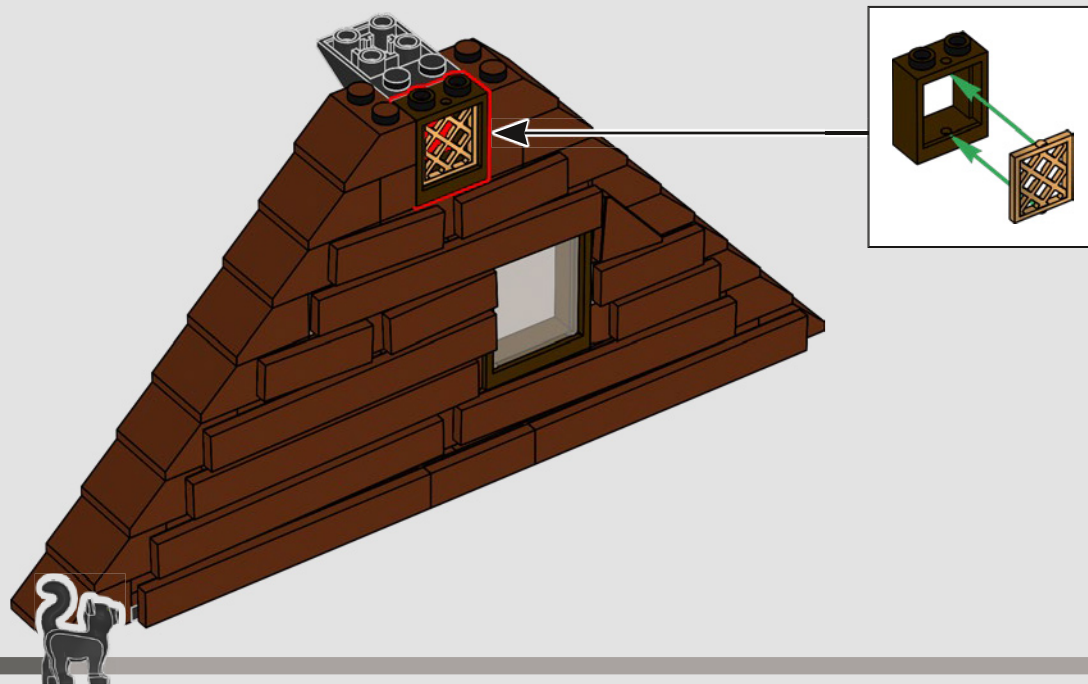



244

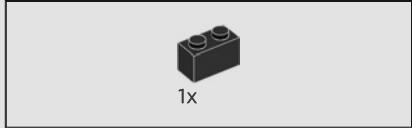
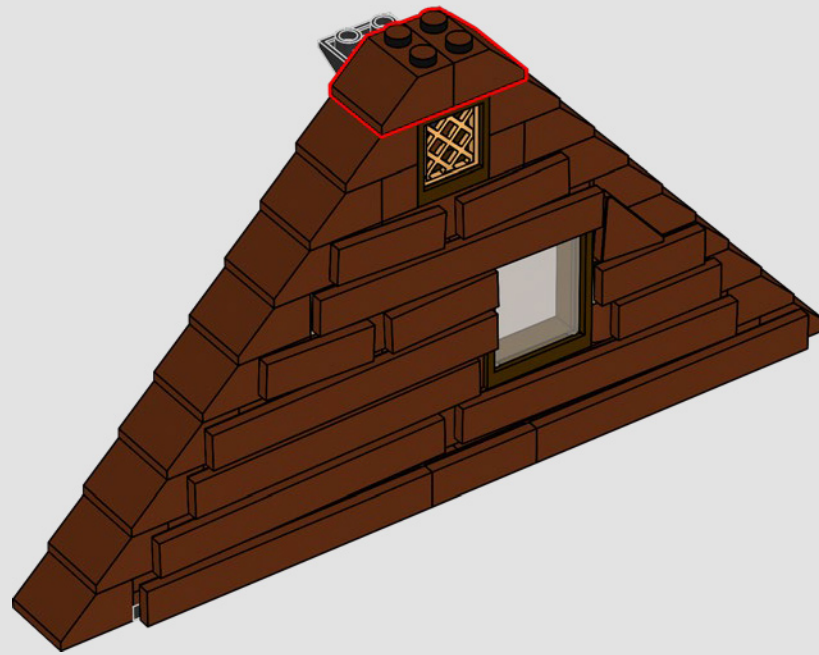

245

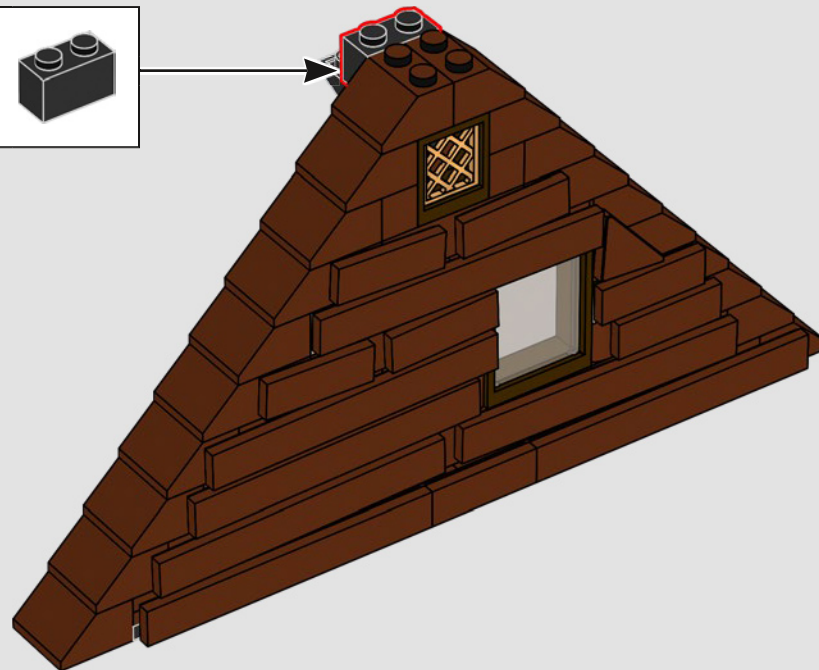
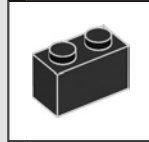

246

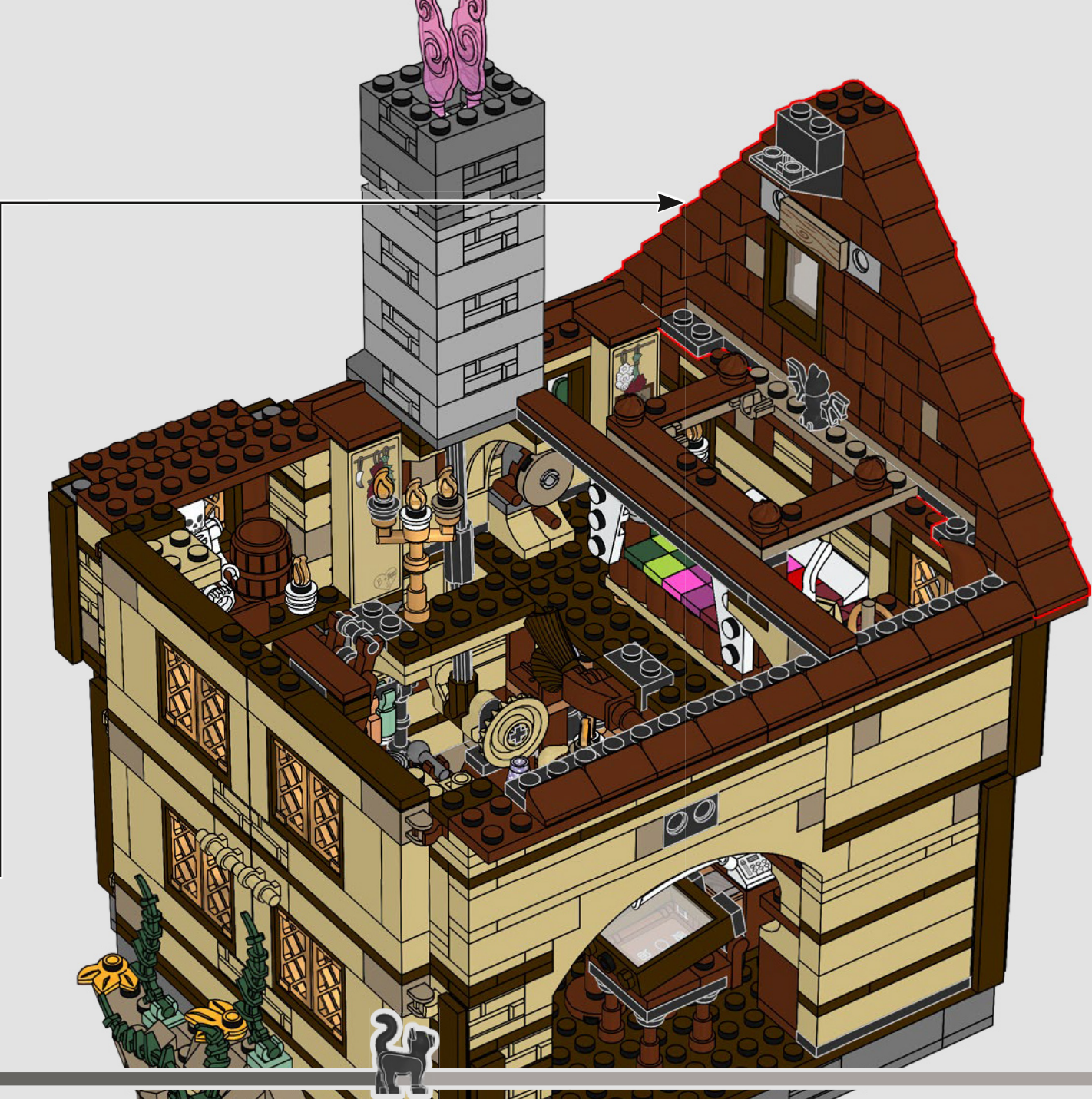

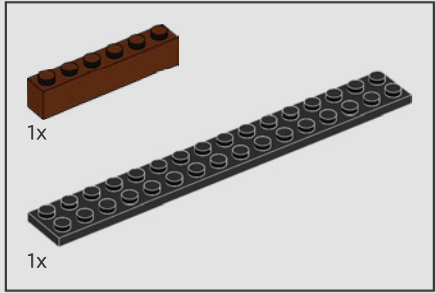
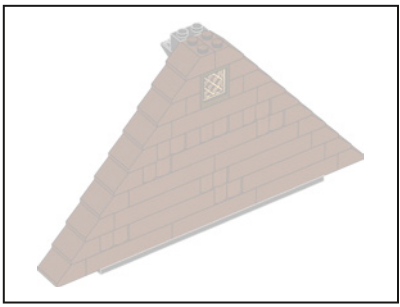

247

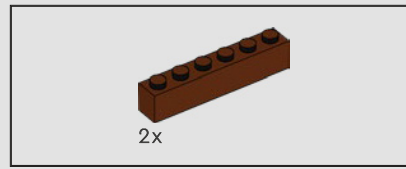
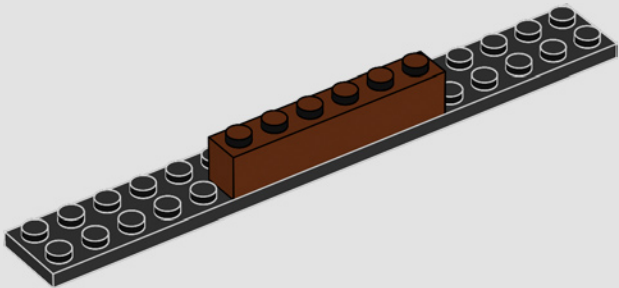

248

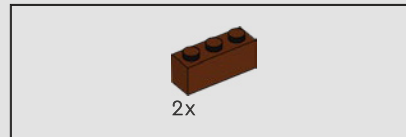
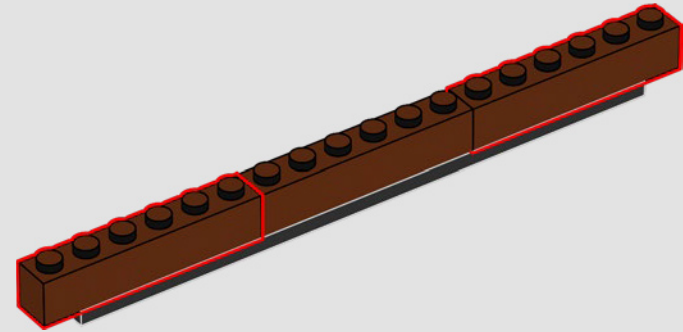

249

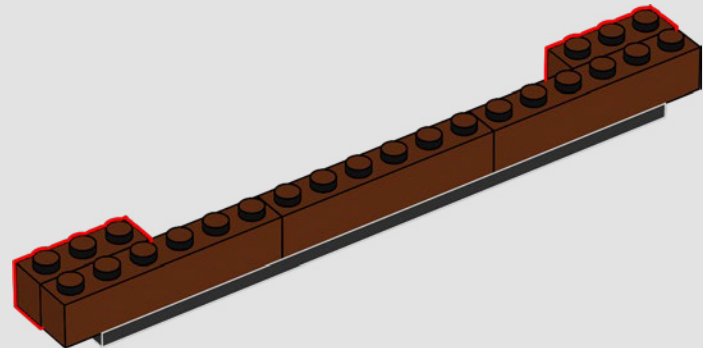

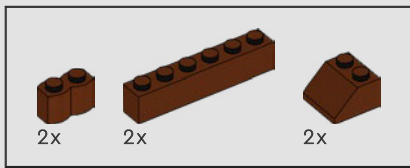

250

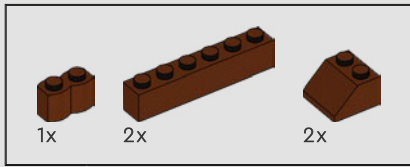
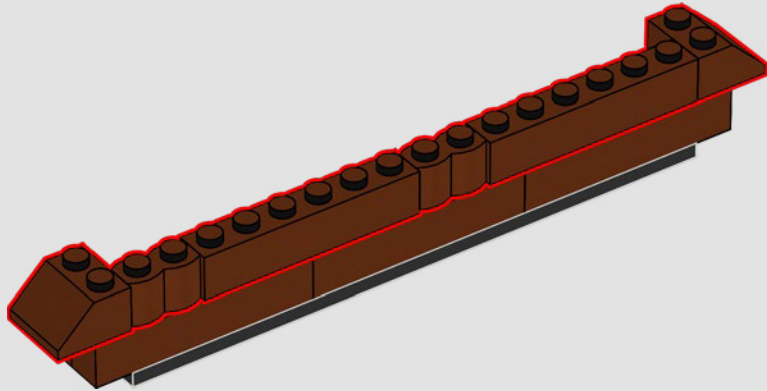

251

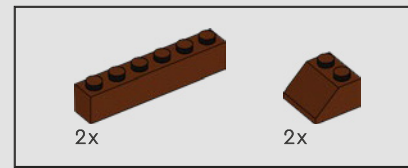
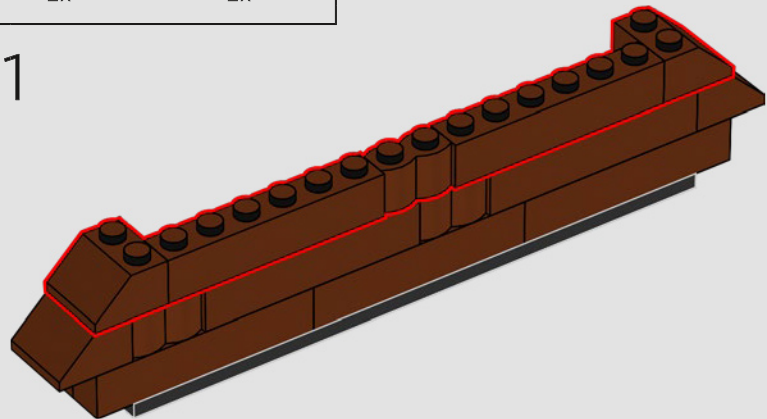

252

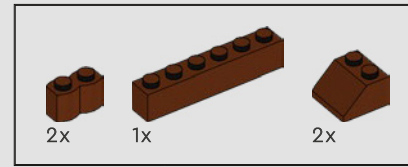
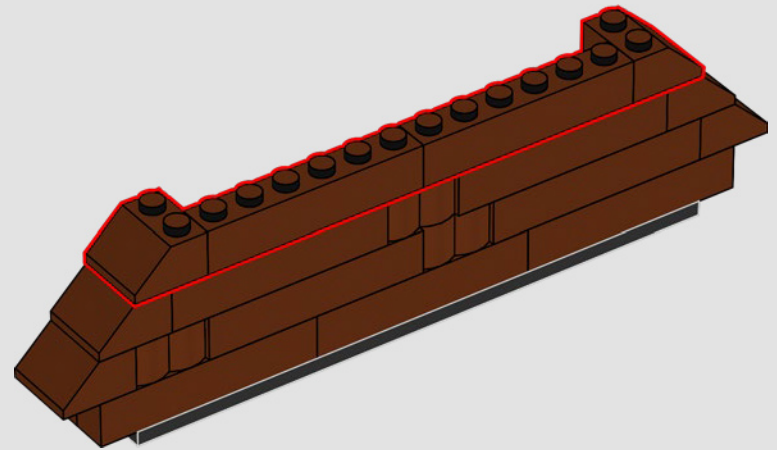

253

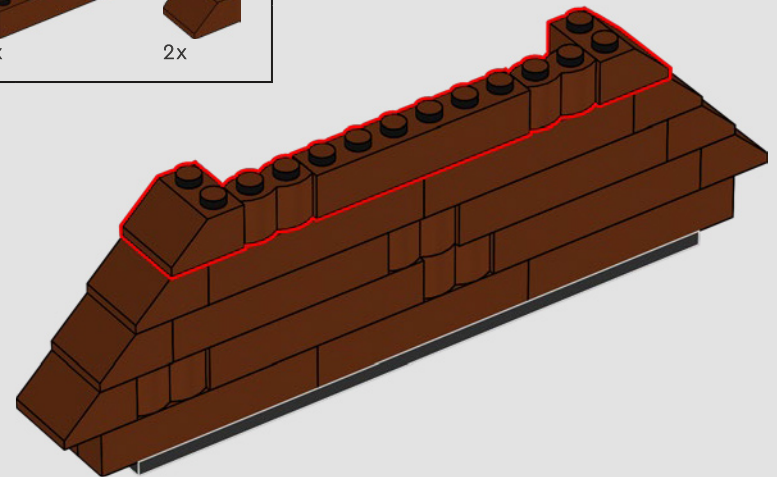



254

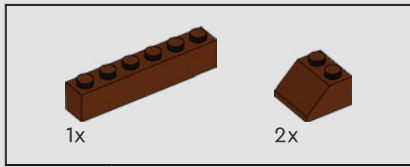
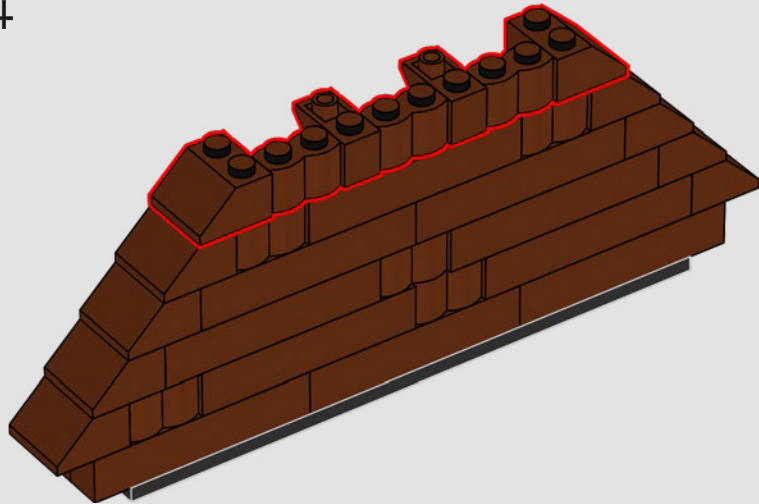

255

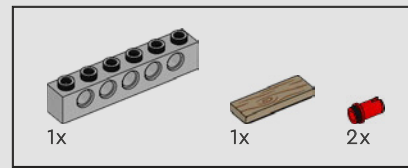
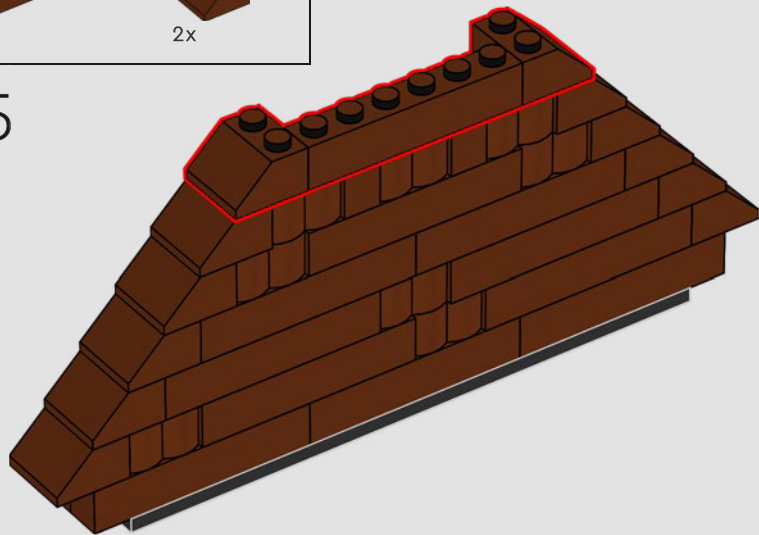

256

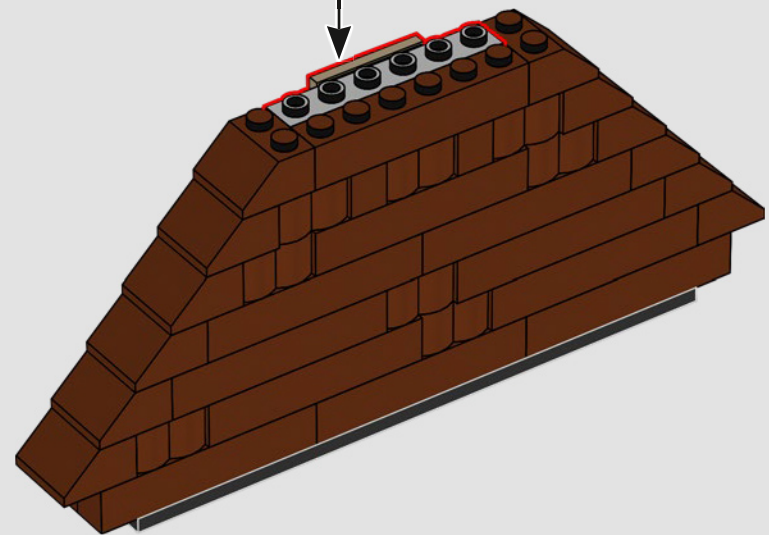
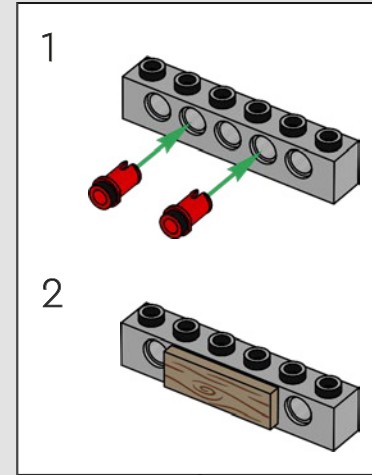



257

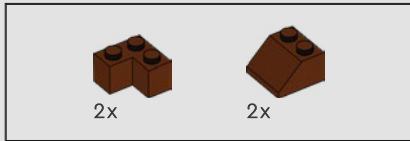
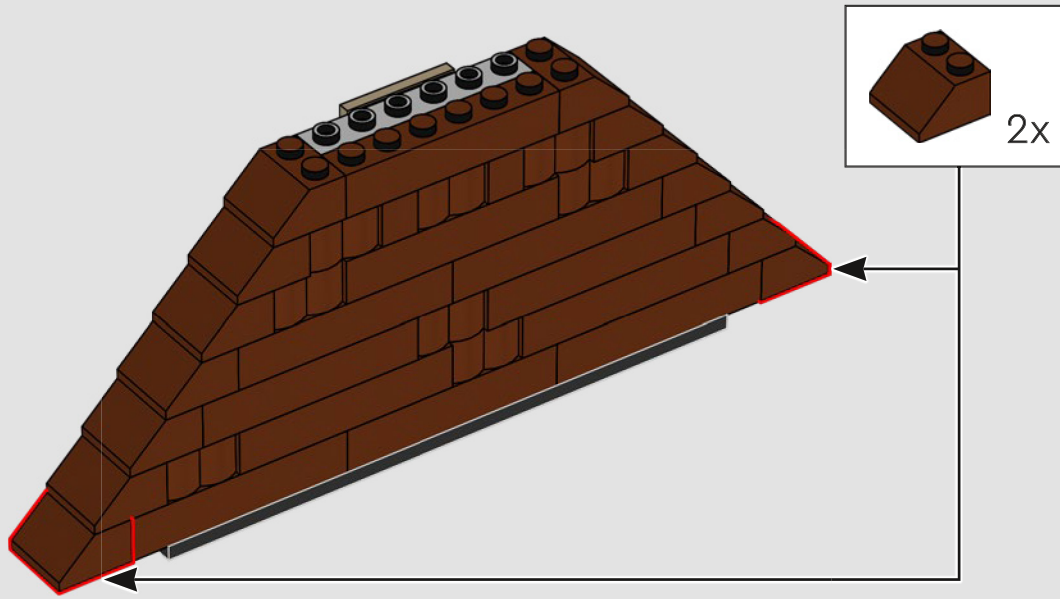

258

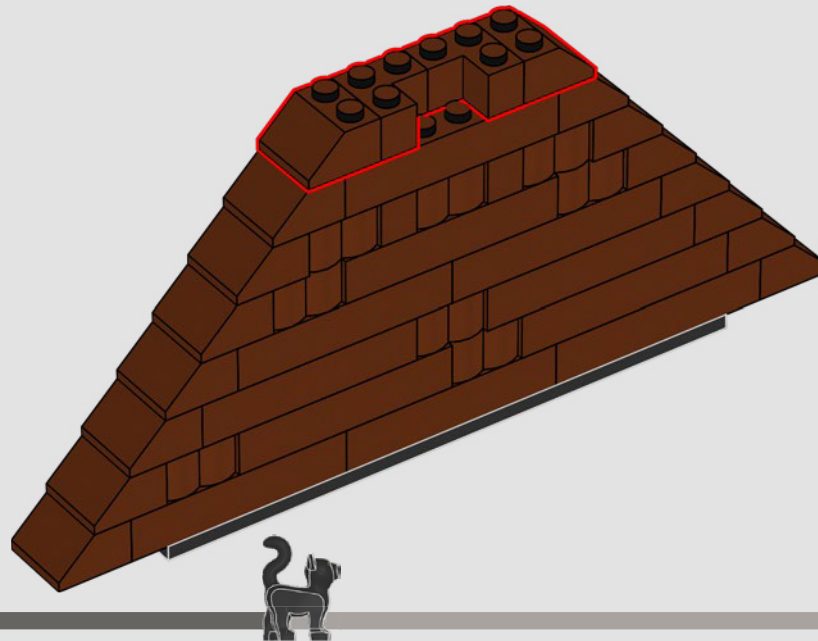



259

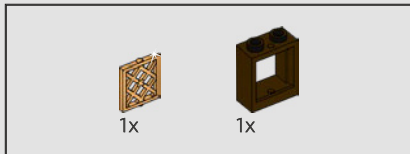
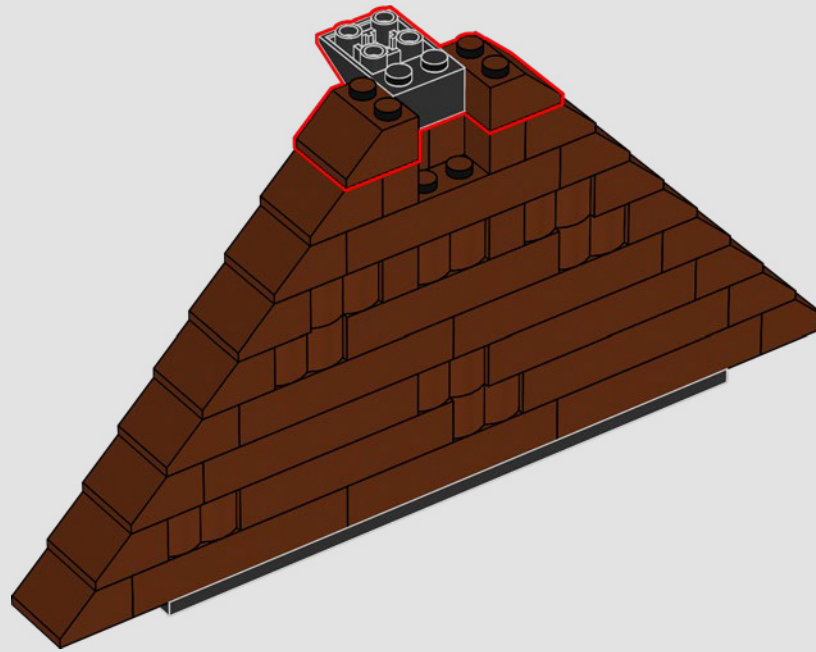

260

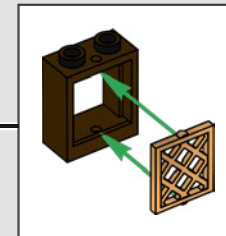
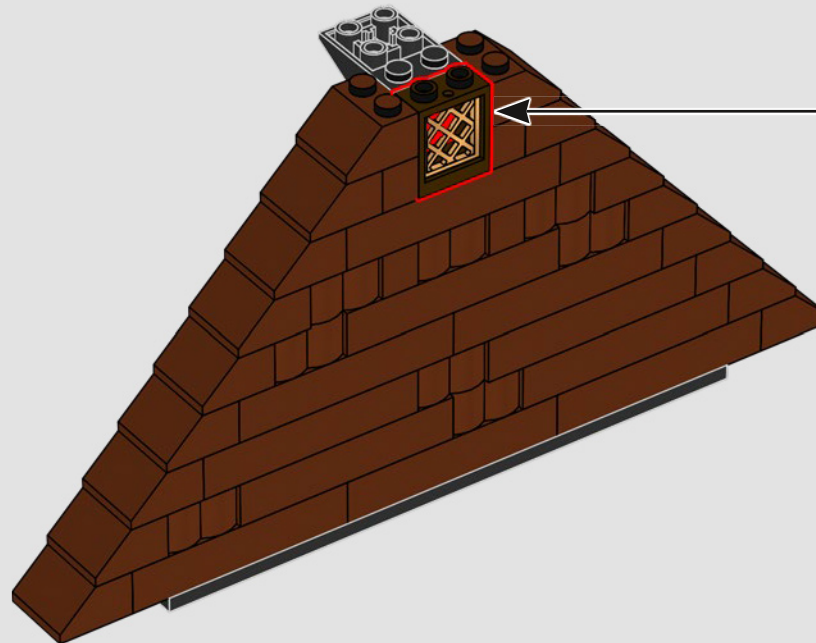



261

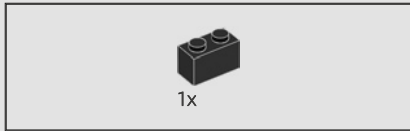
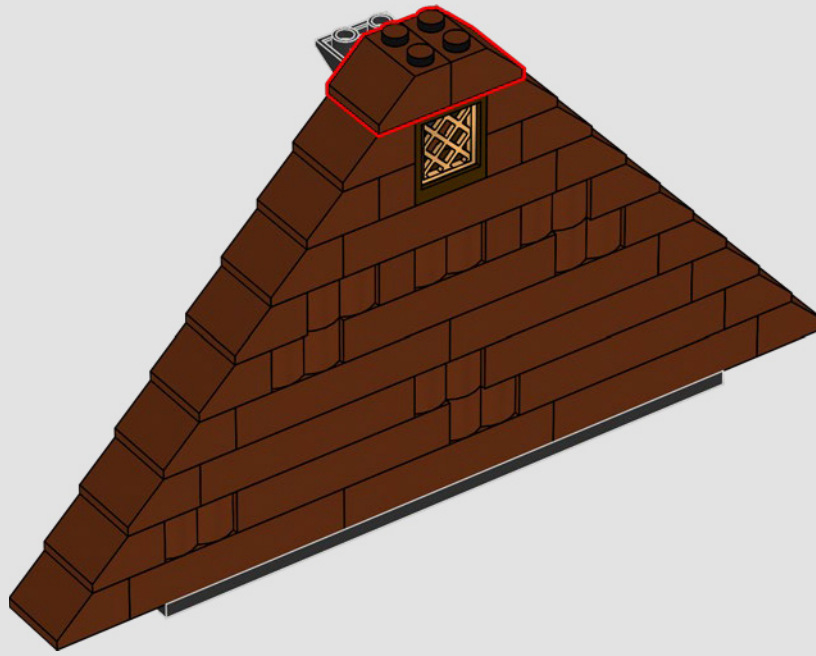

262

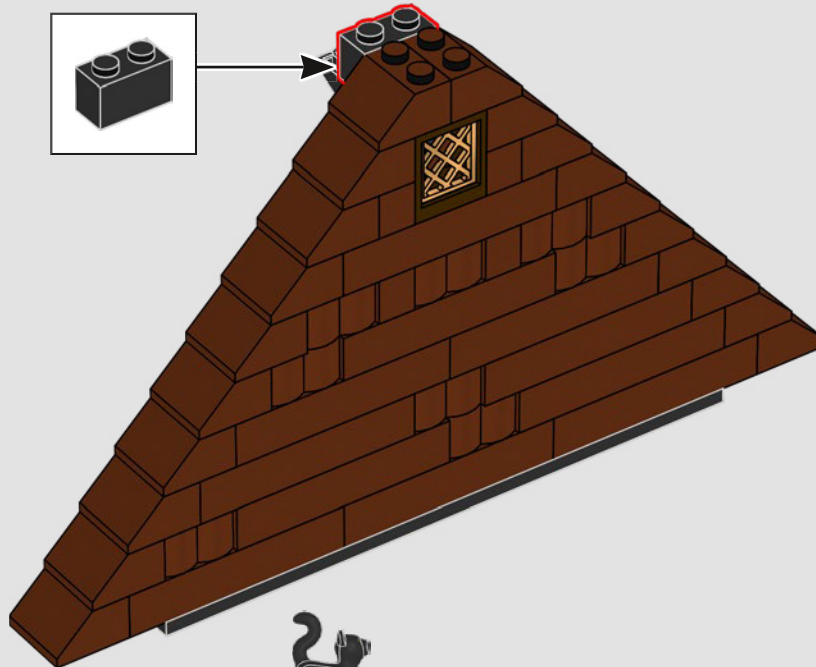
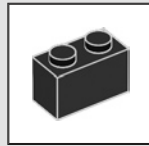

263

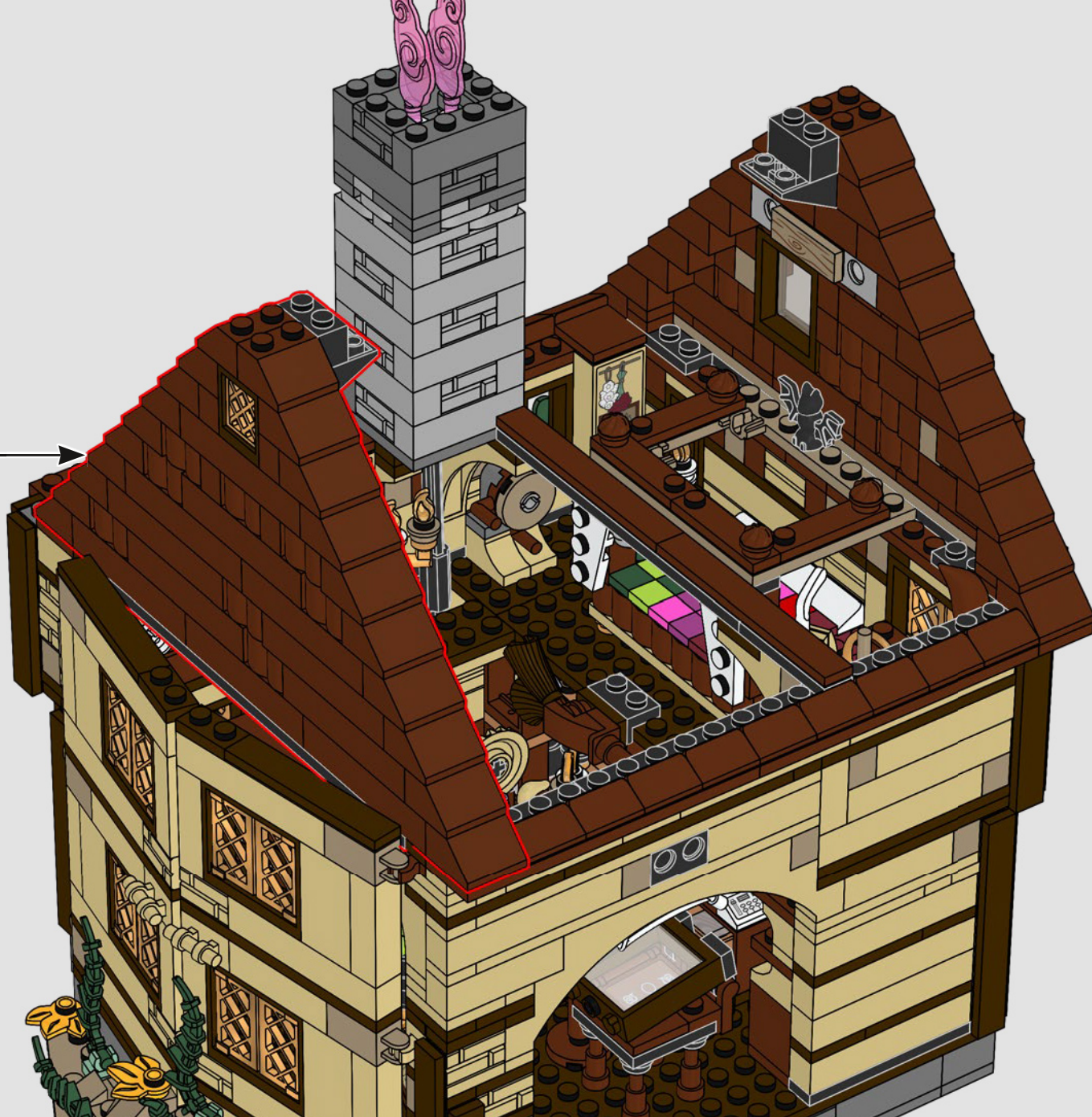

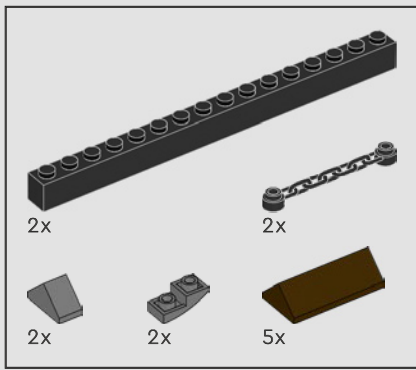

264

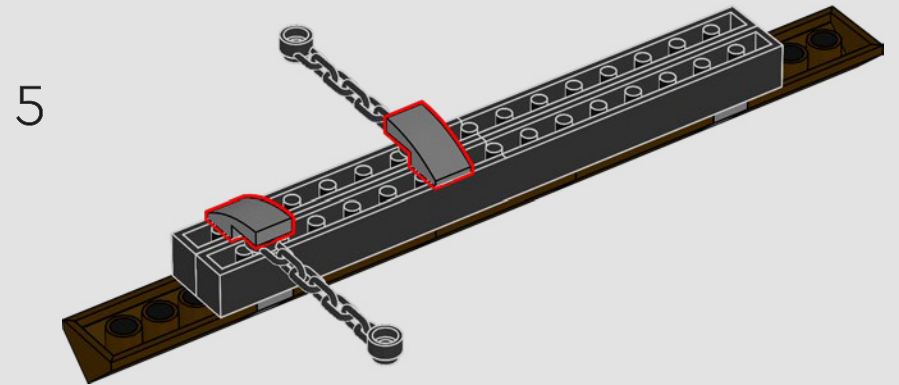
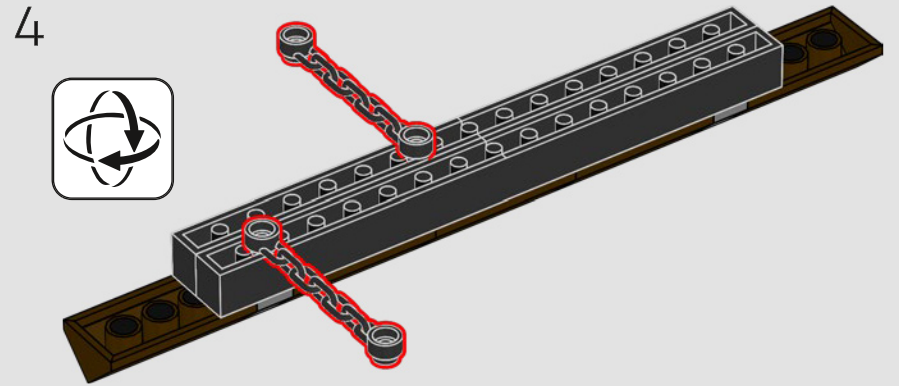
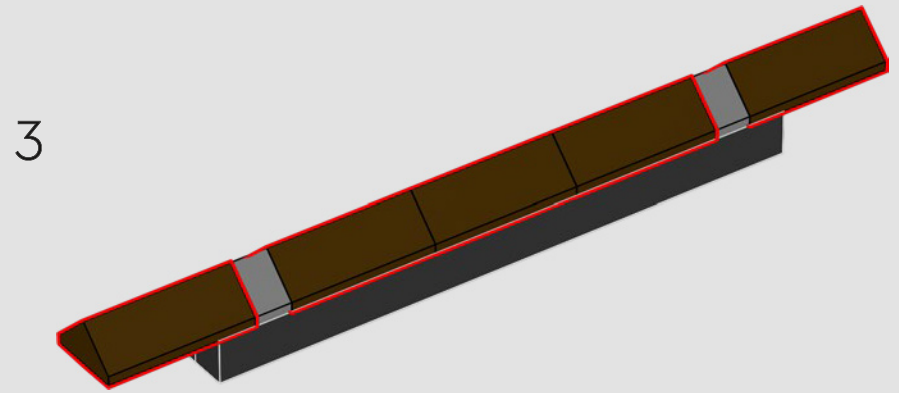
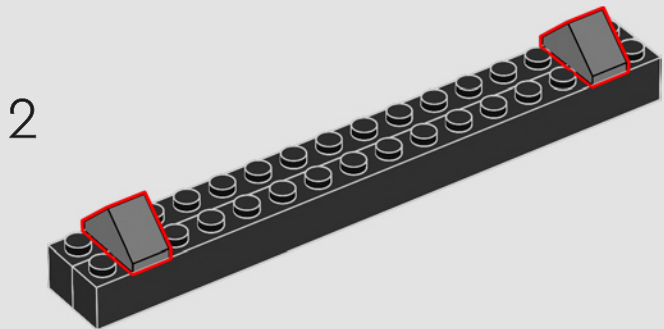
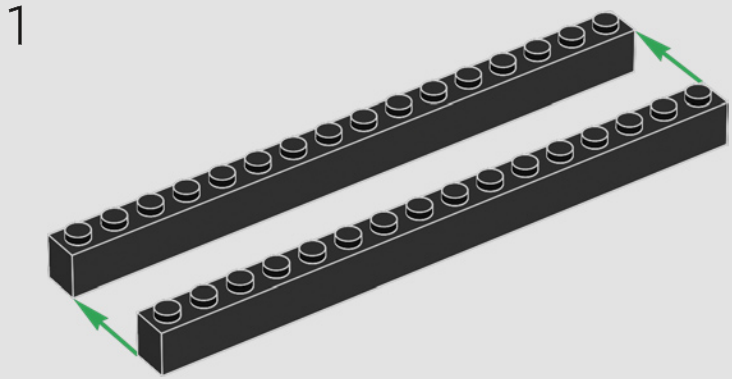

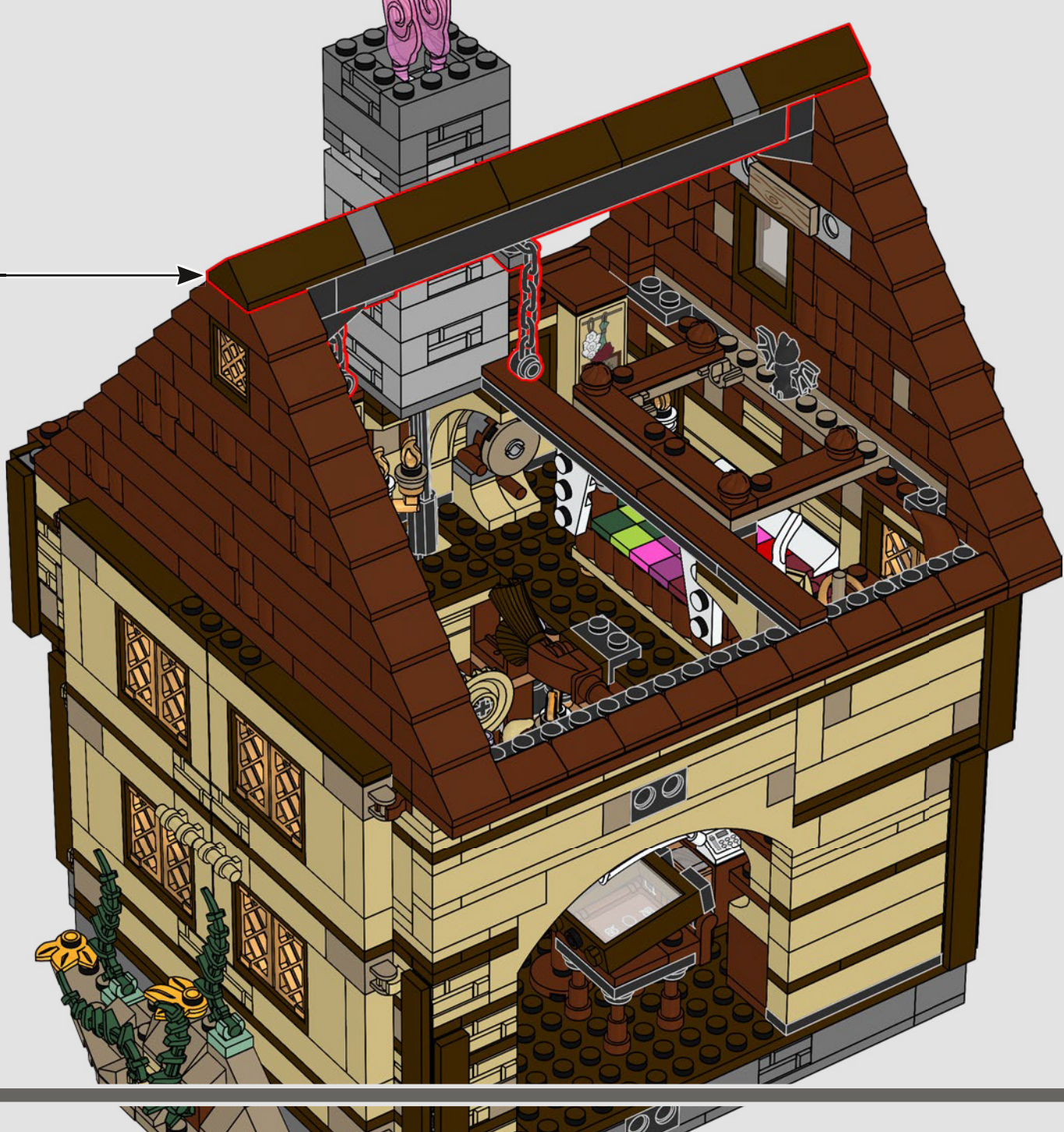

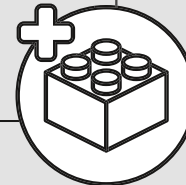
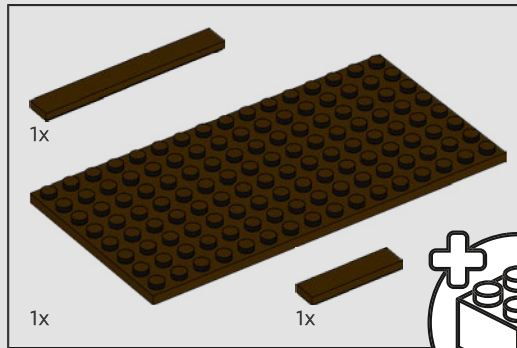
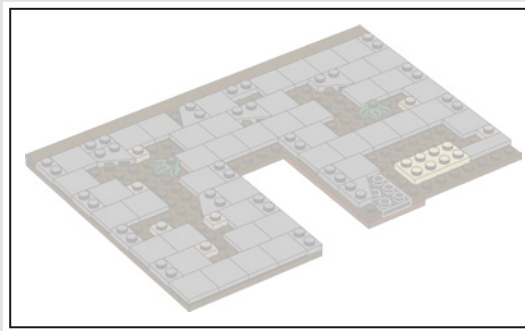
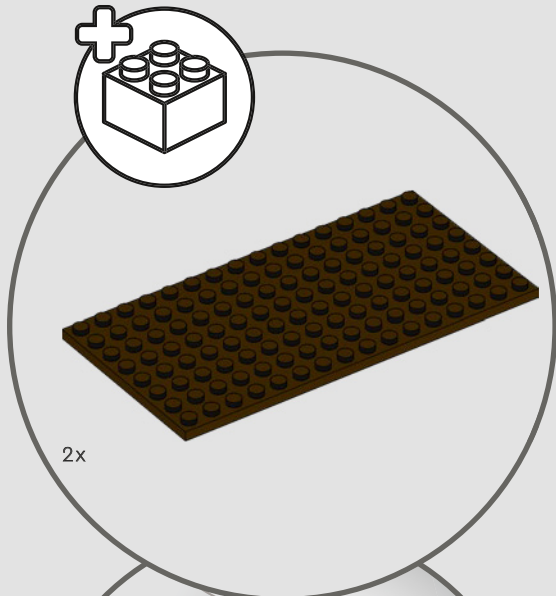

265

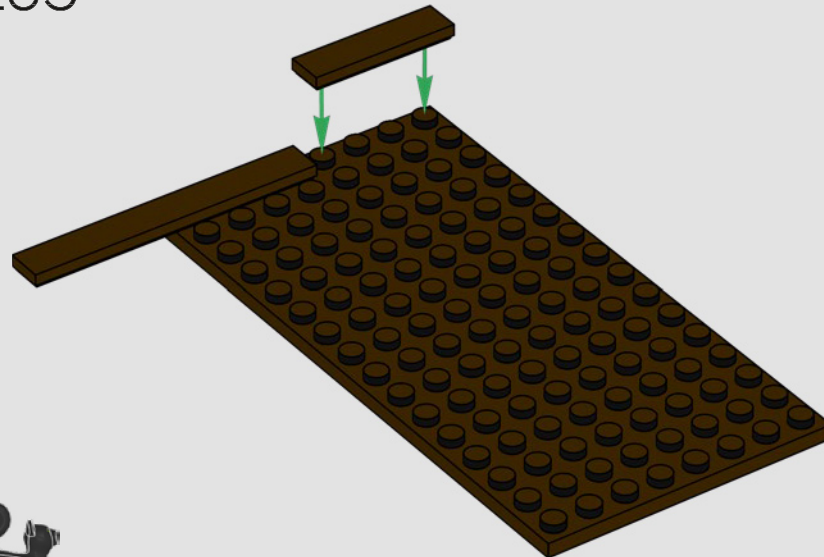

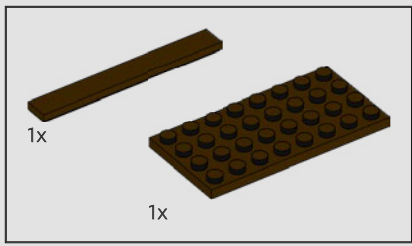

266

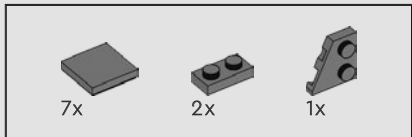
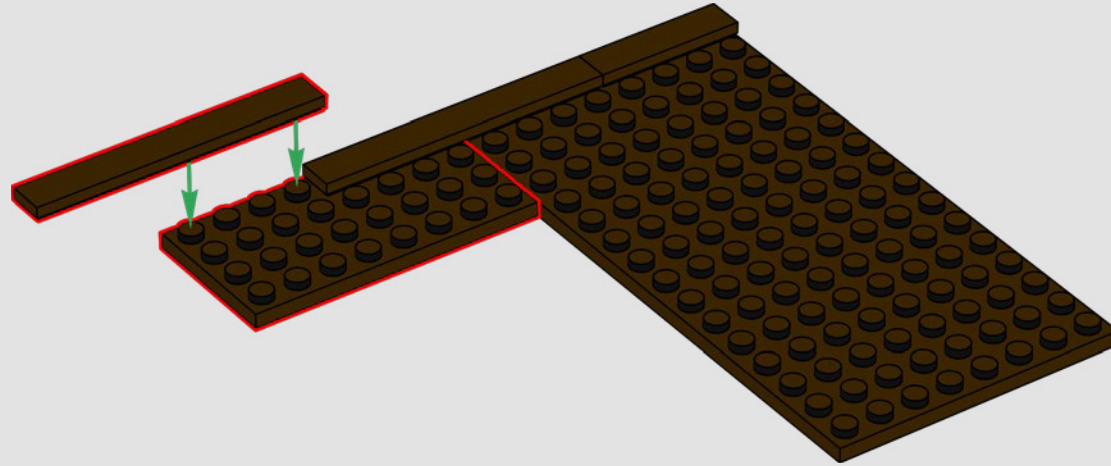

267

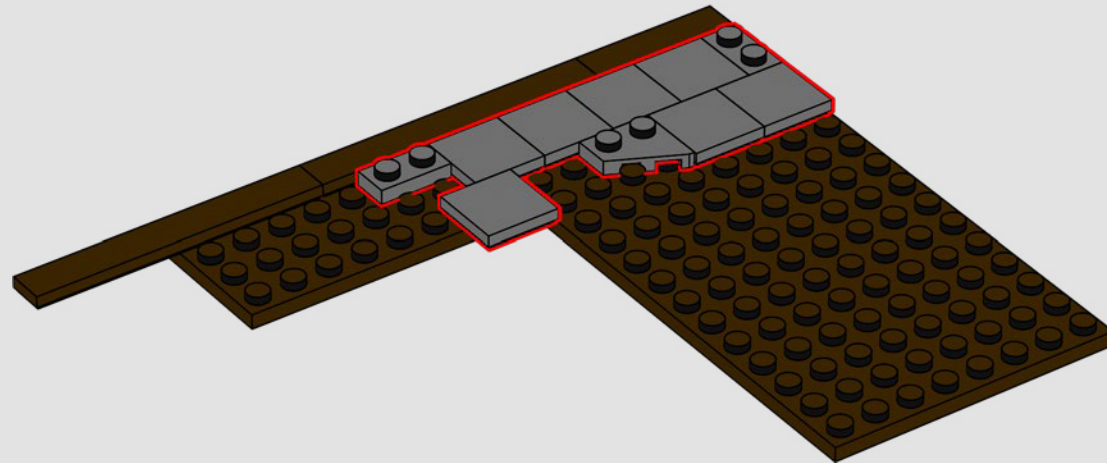

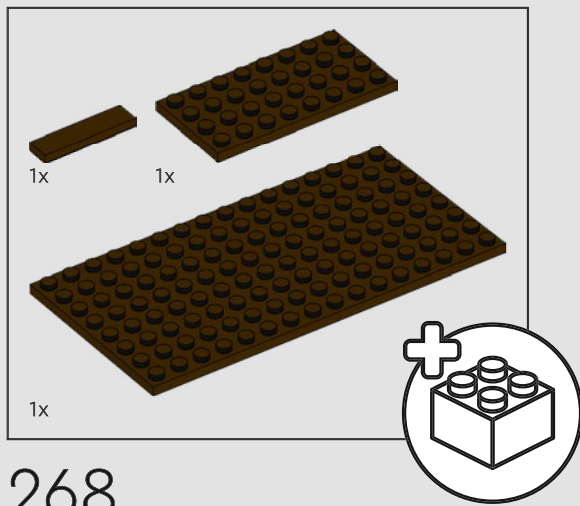

268

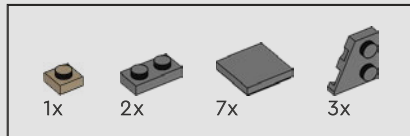
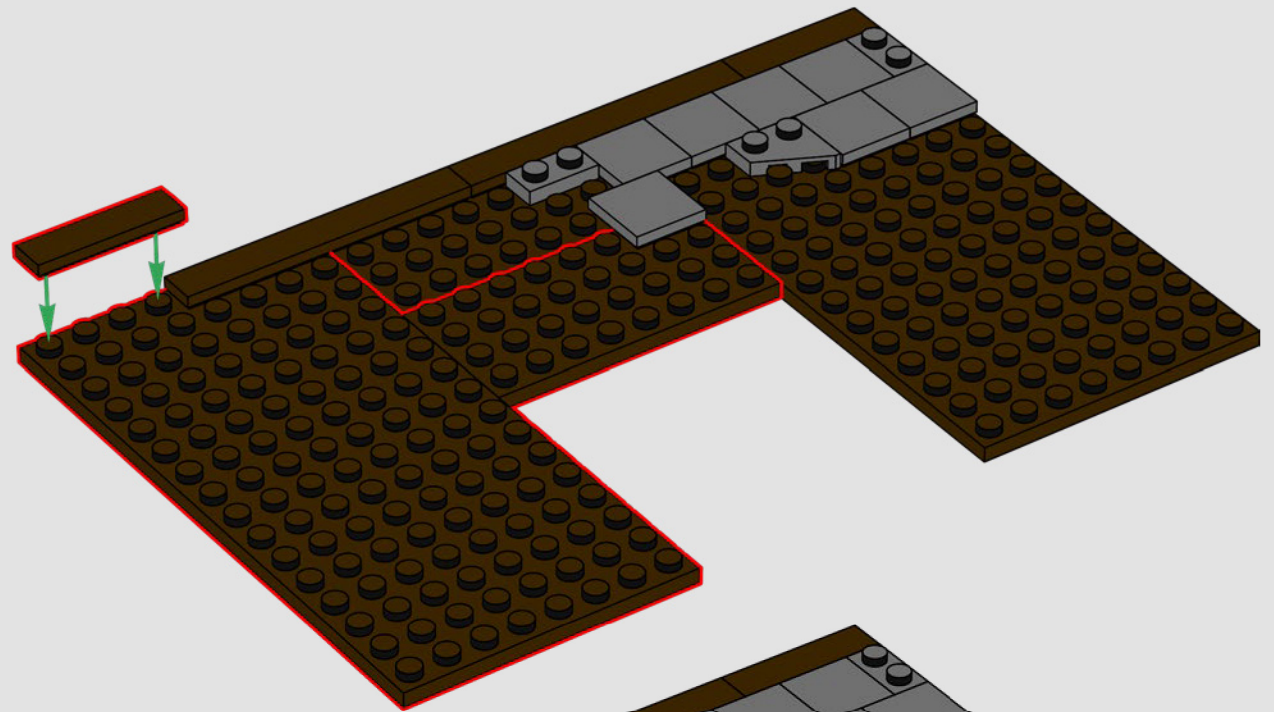

269

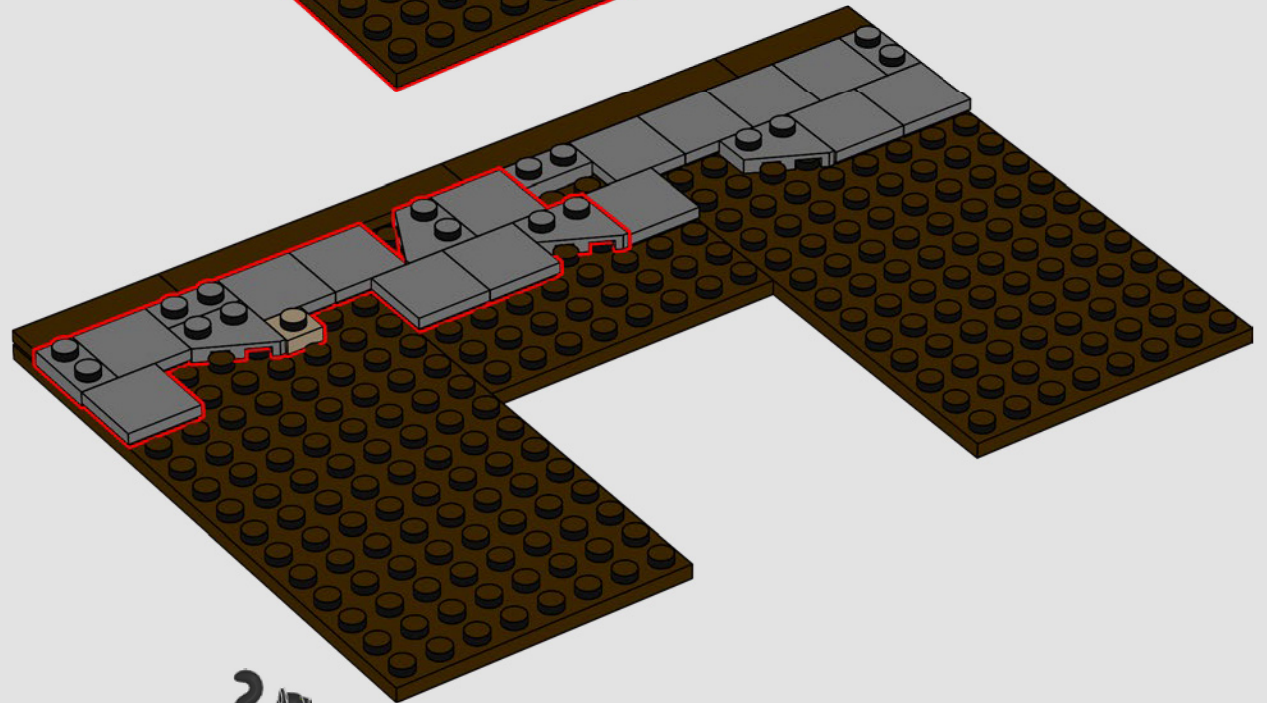

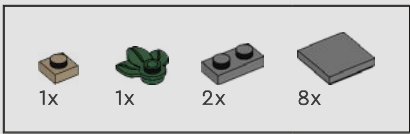

270

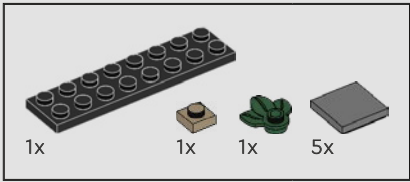
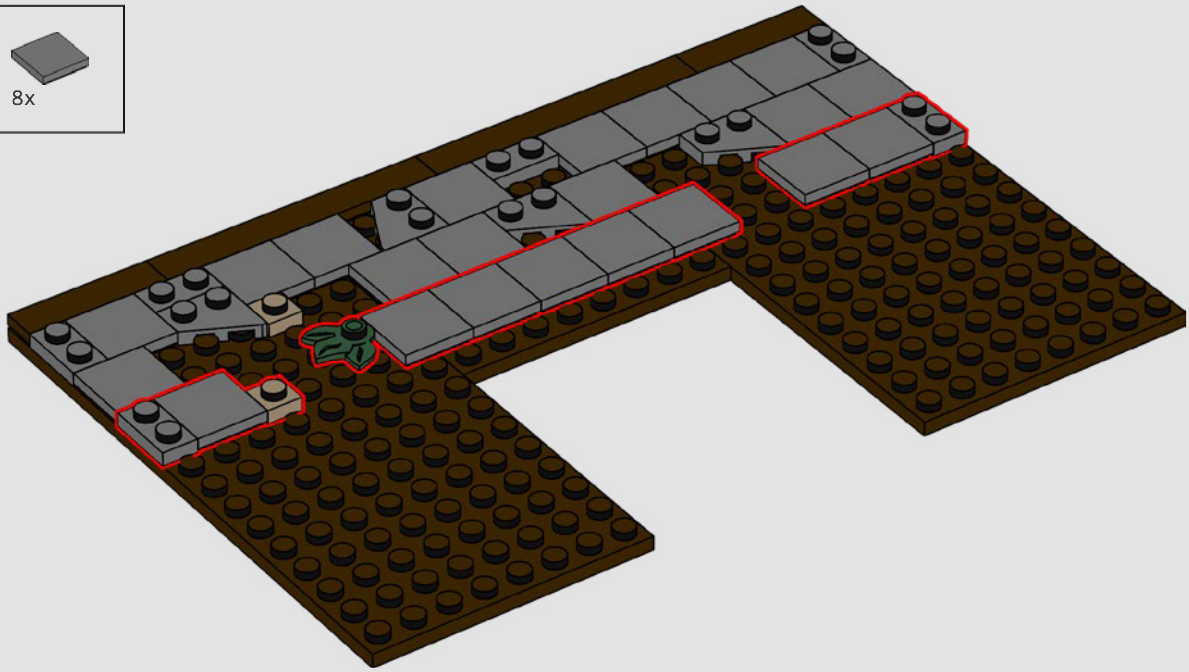

271

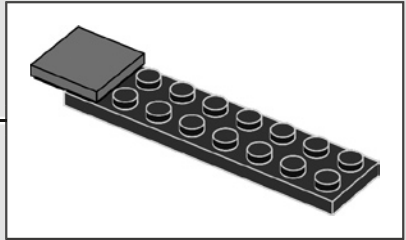
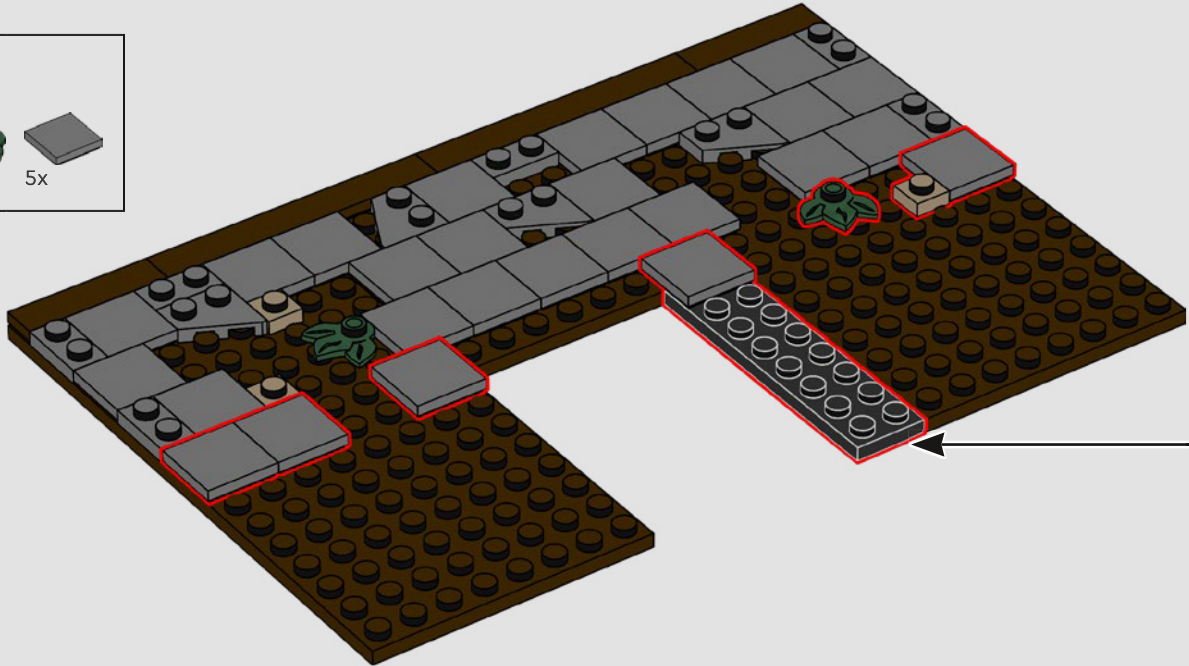

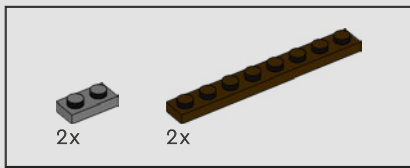

272

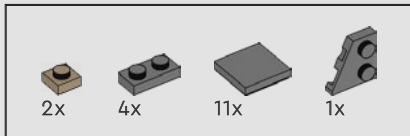
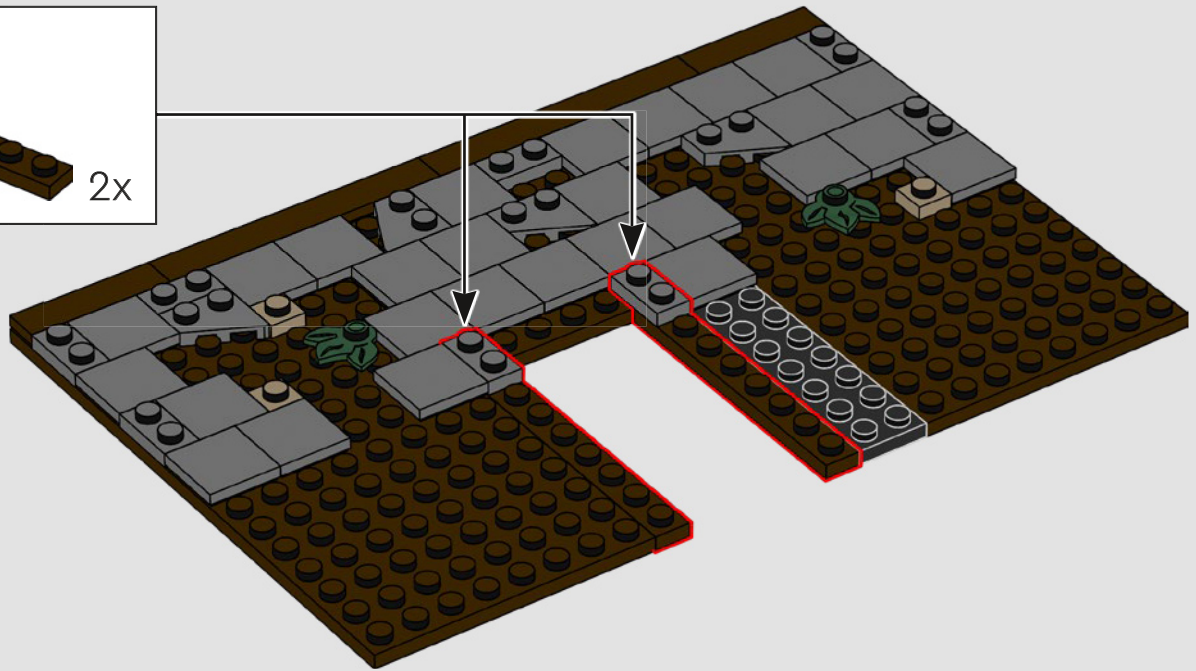
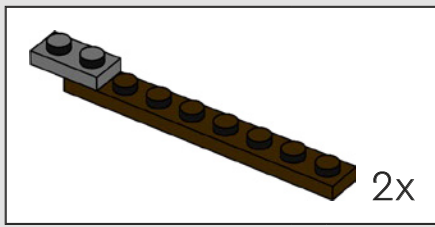

273

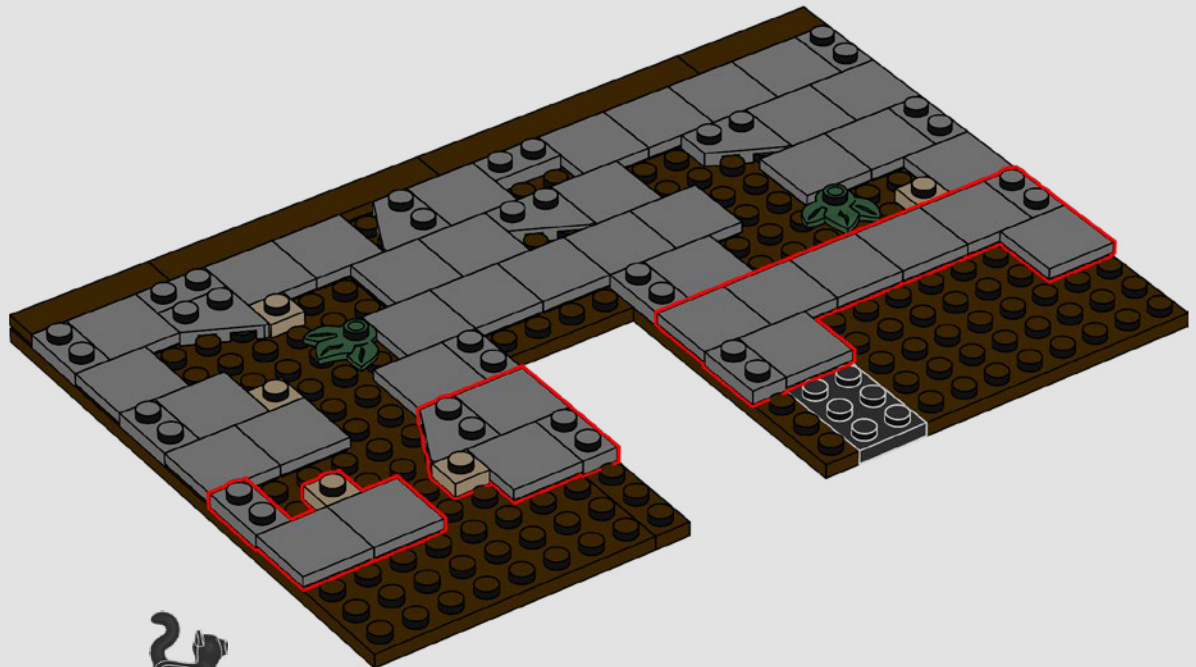

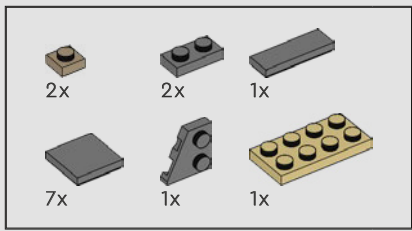

274

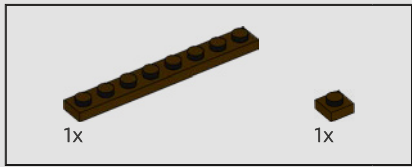
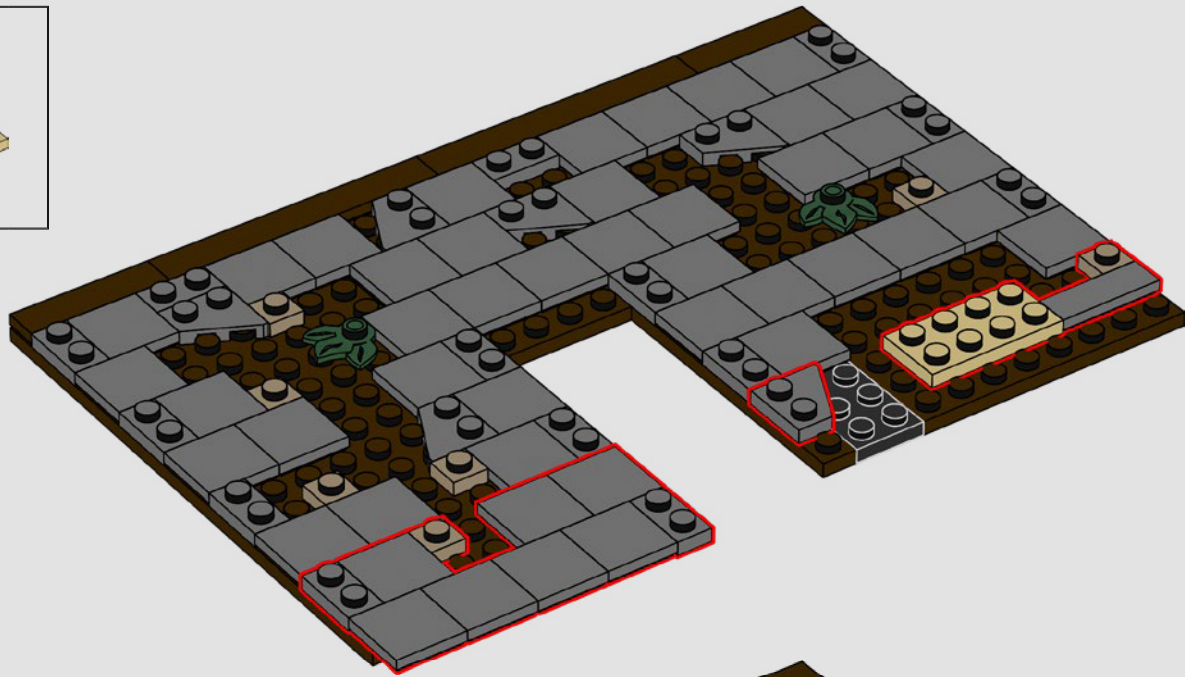

275

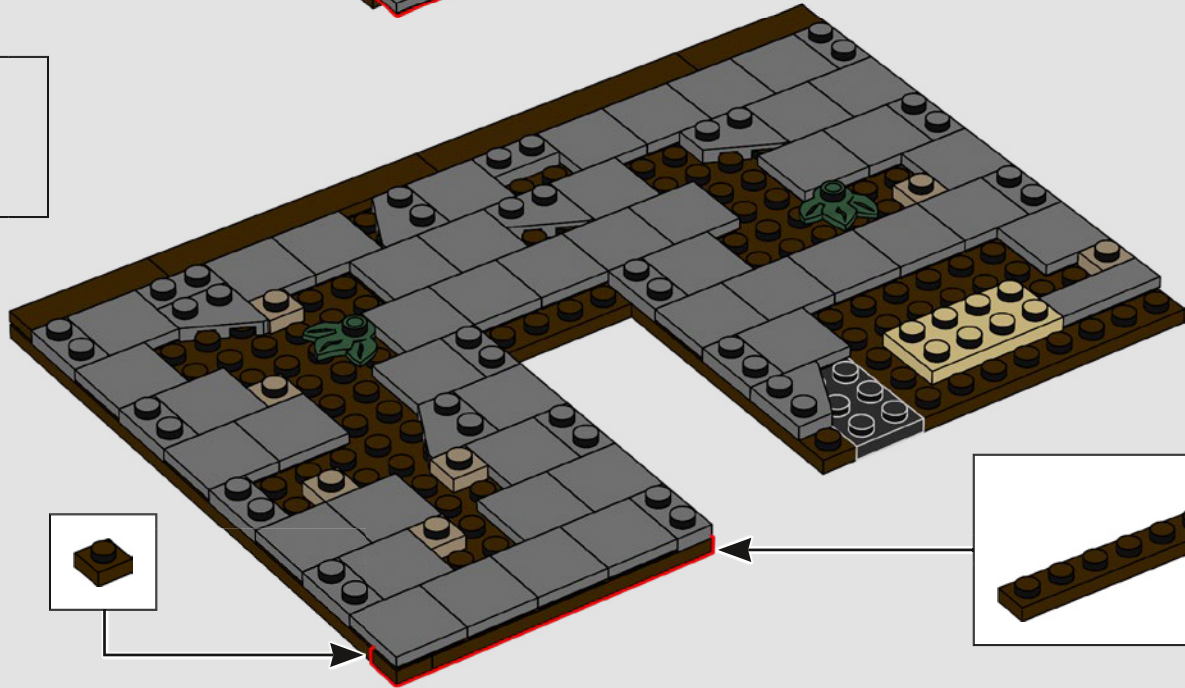

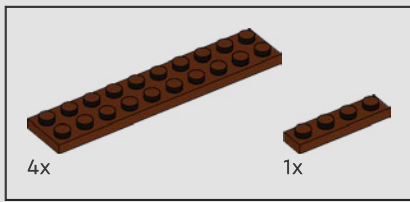

276

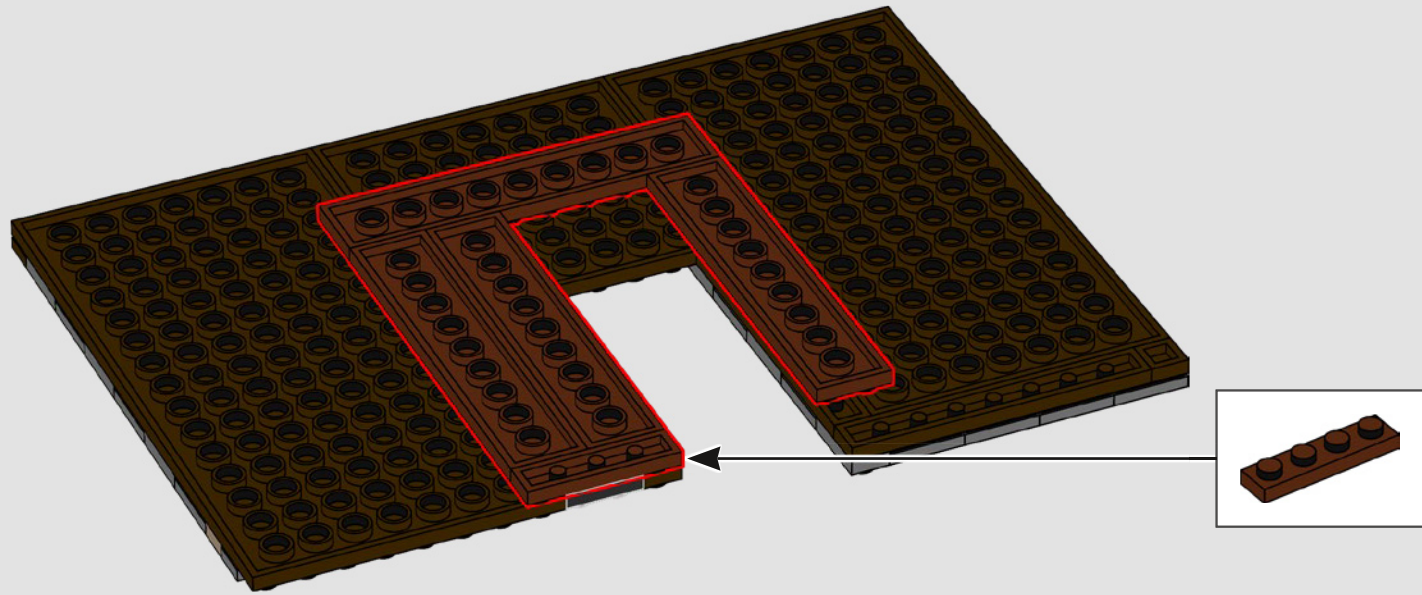

277

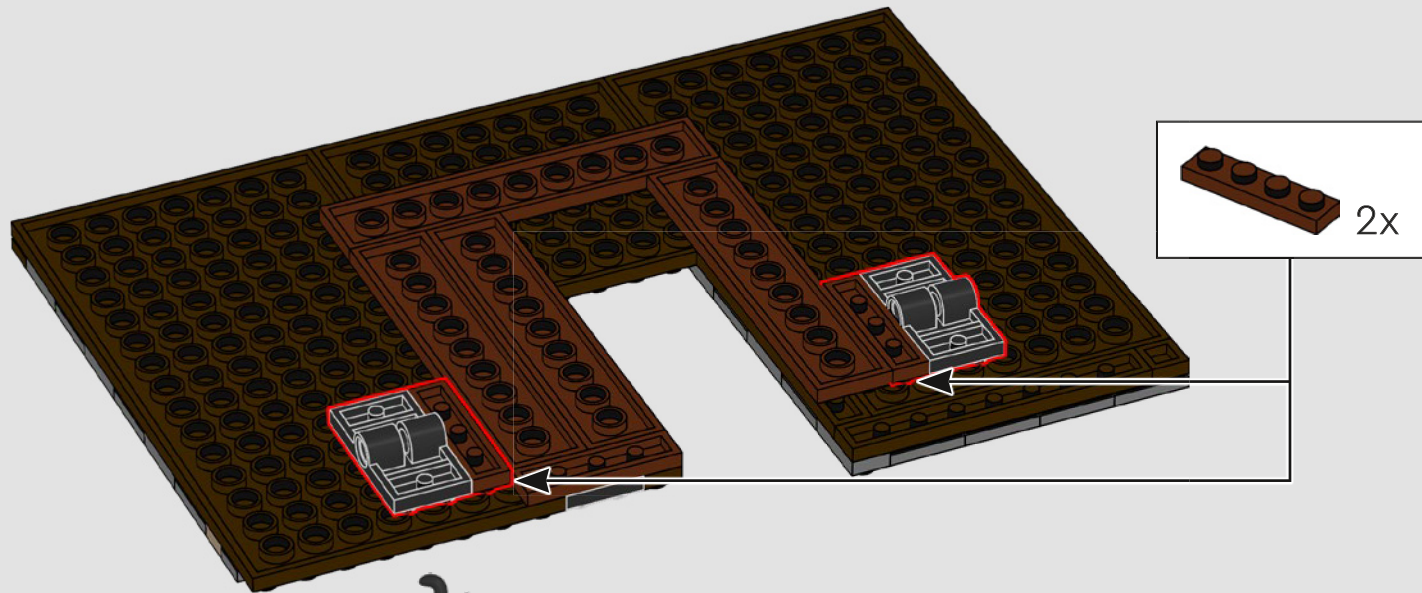

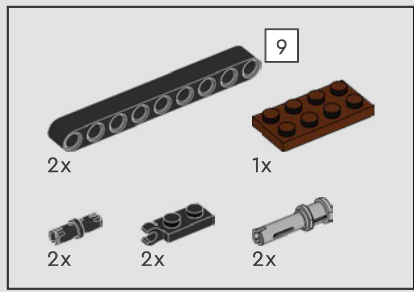

278

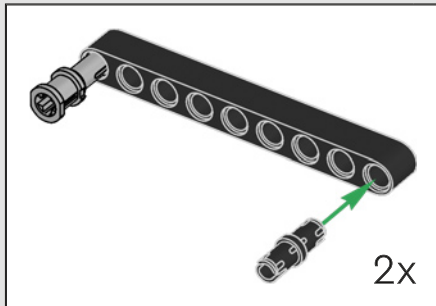
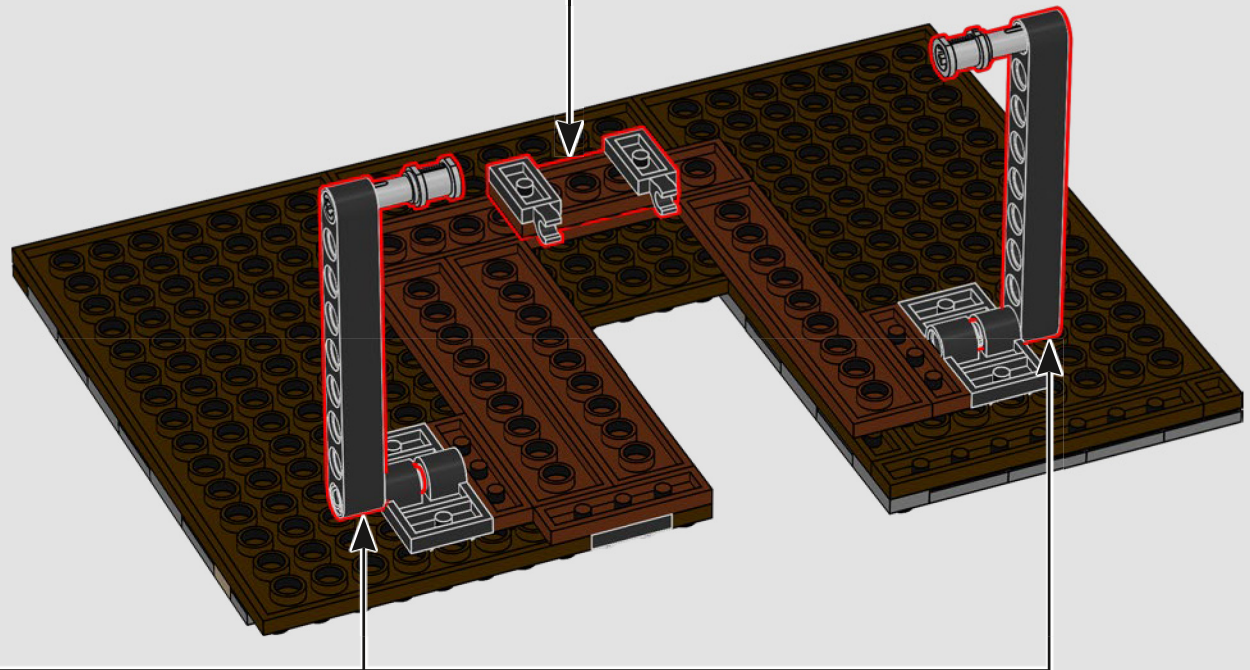
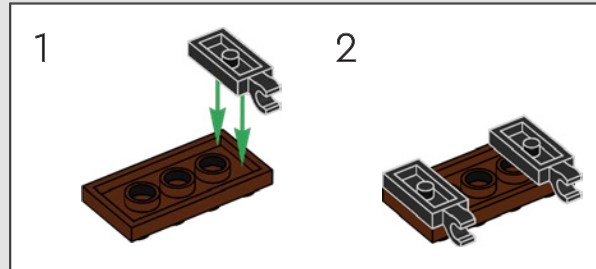

279

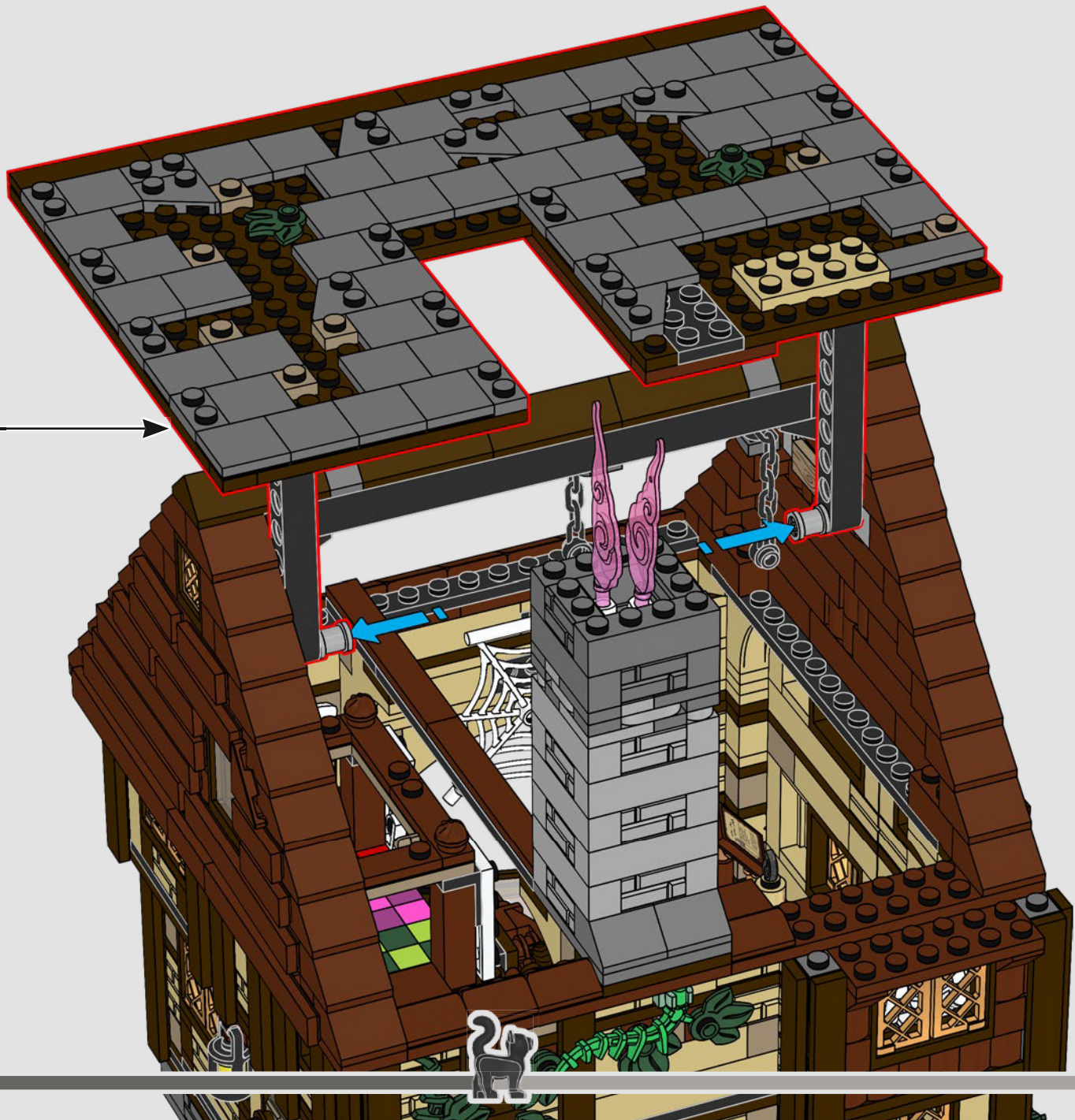

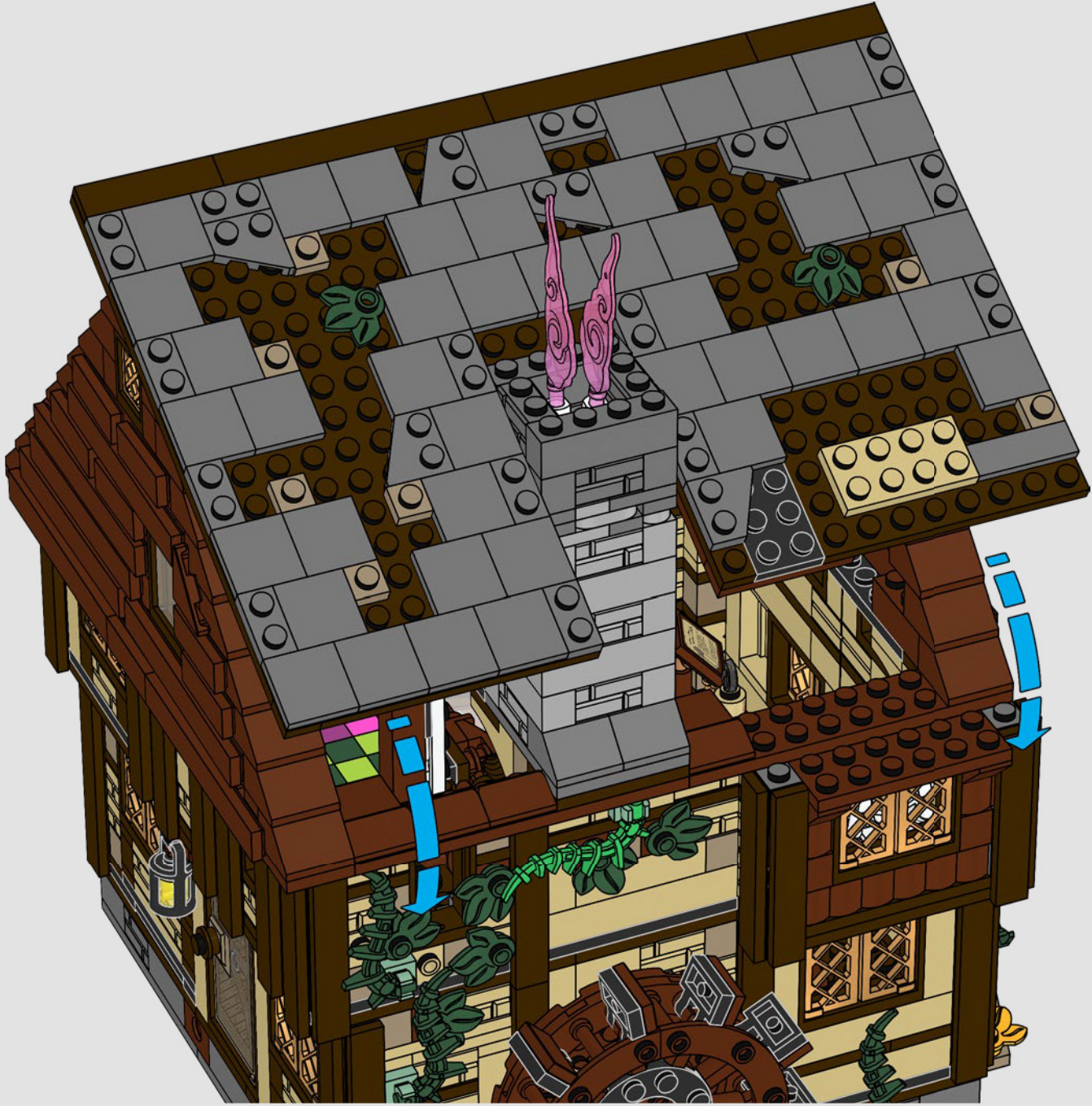

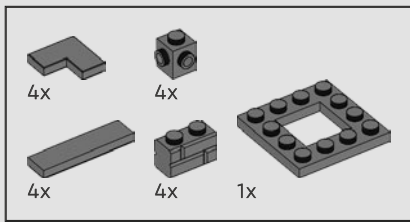

281

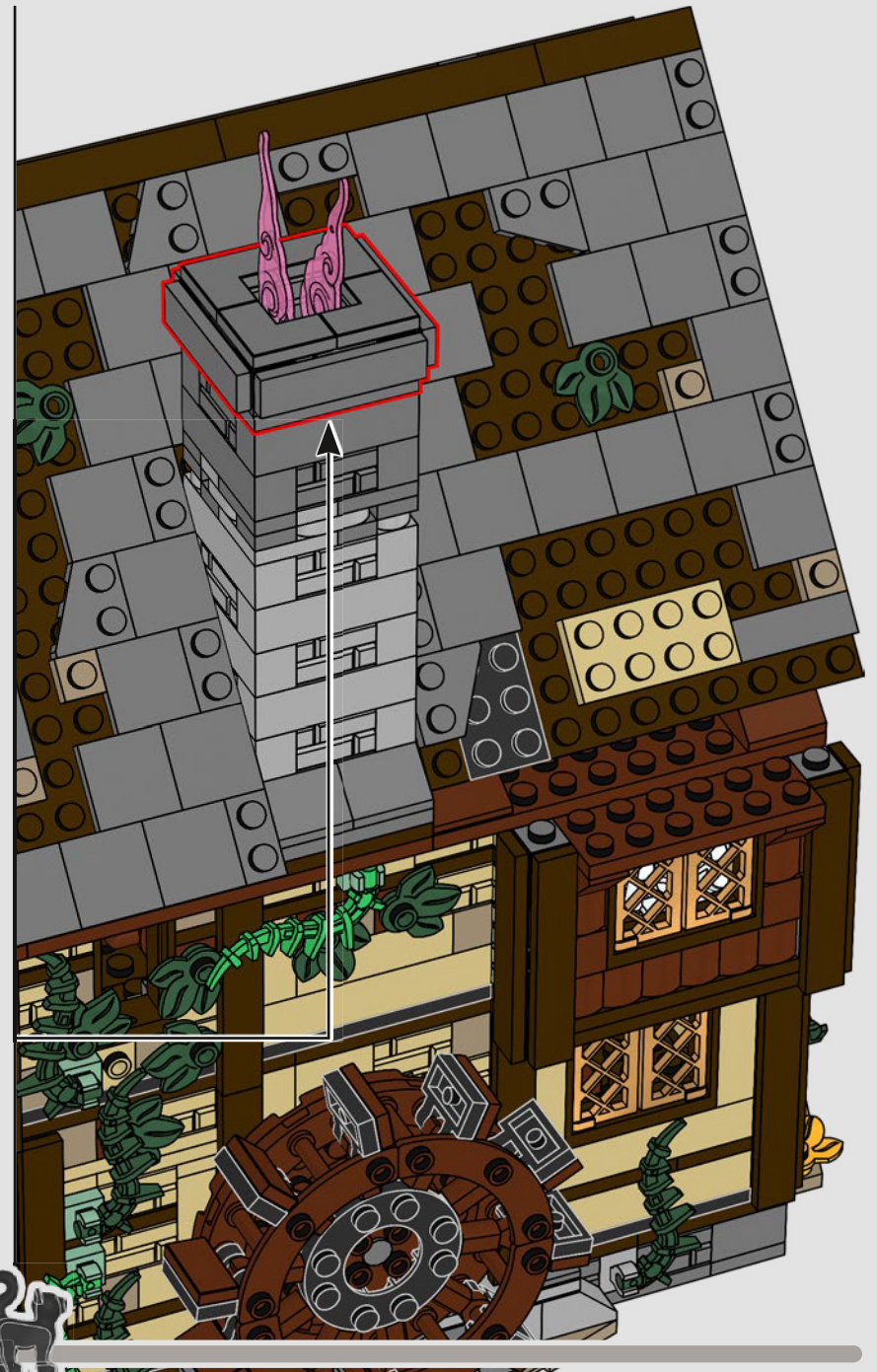
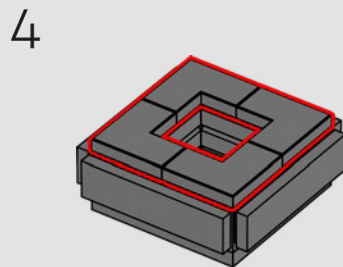
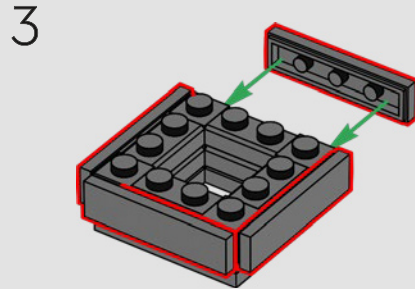
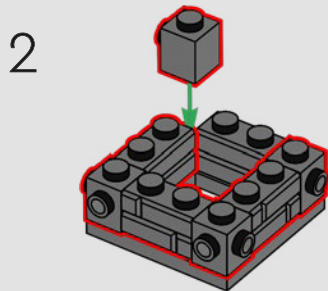
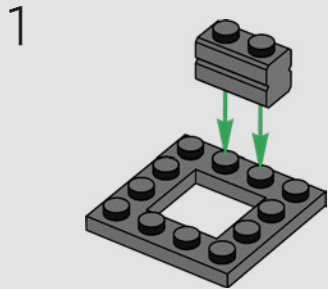

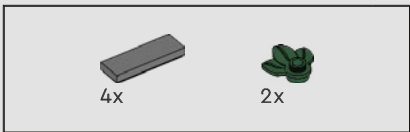

282

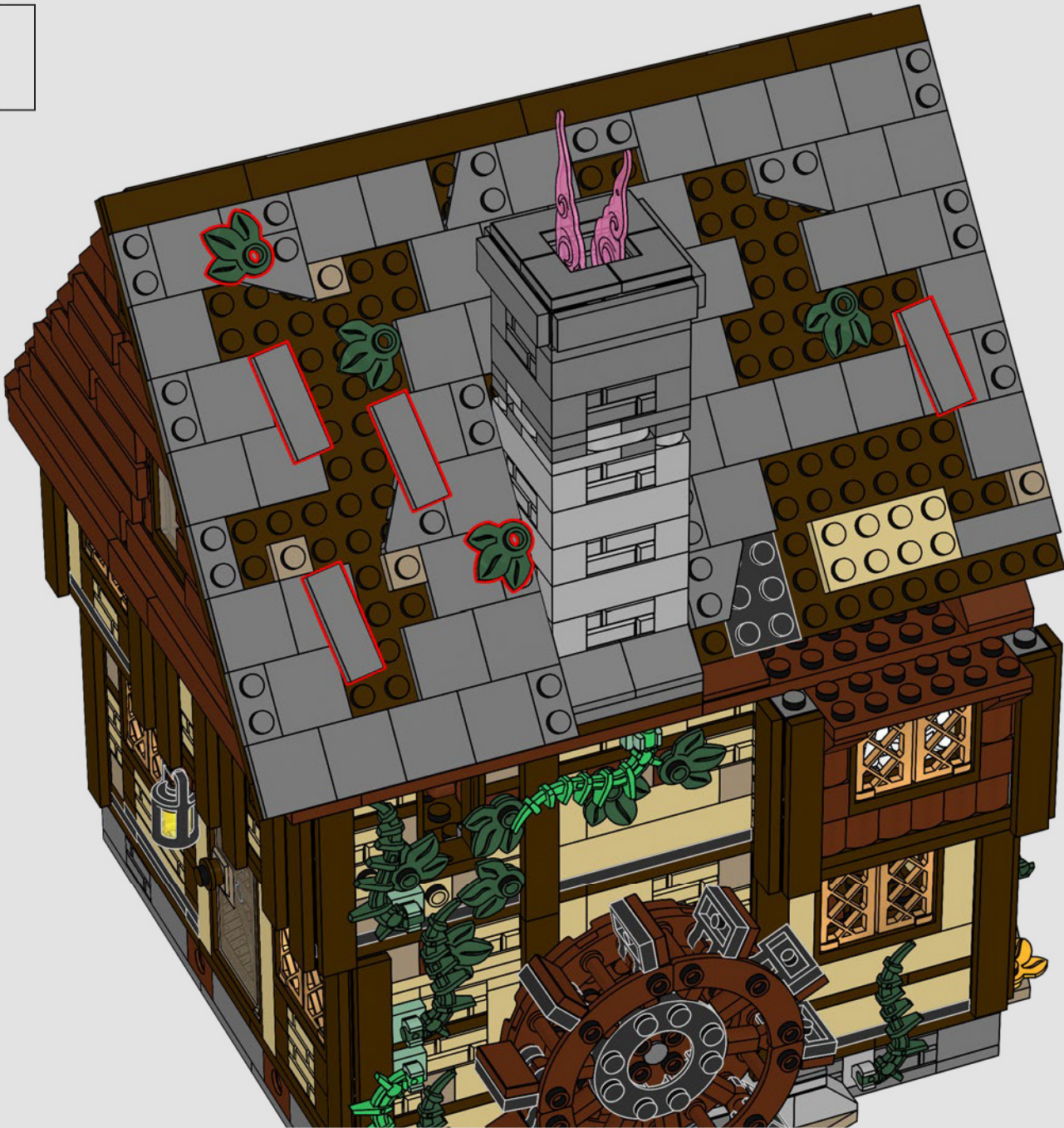

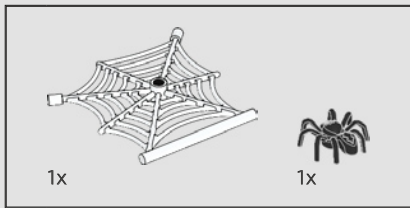

283

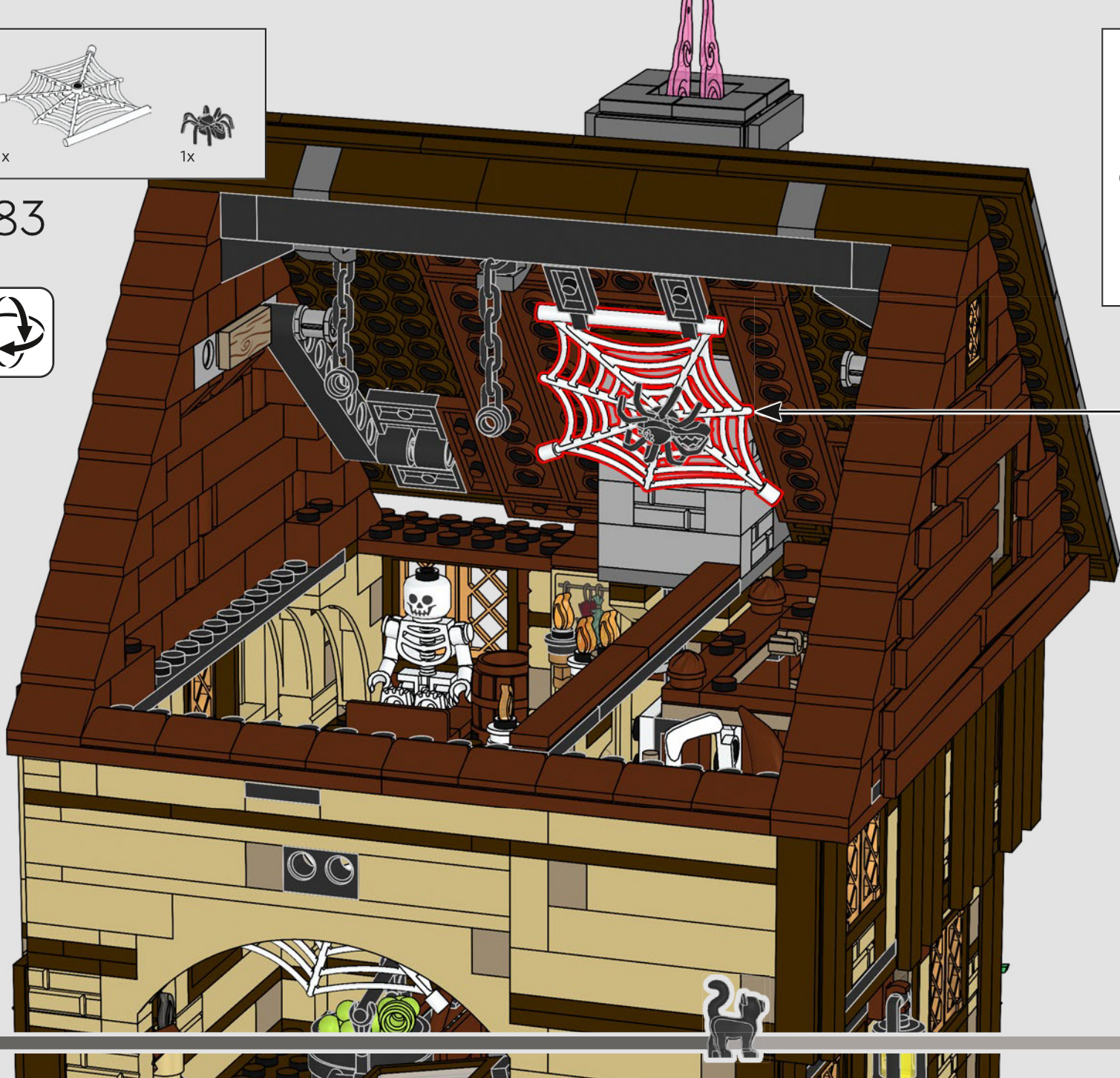
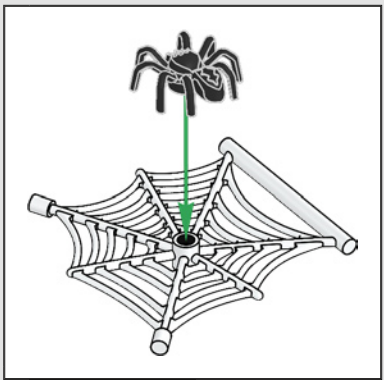

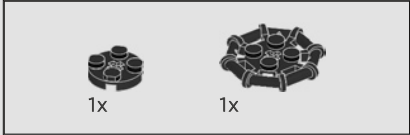
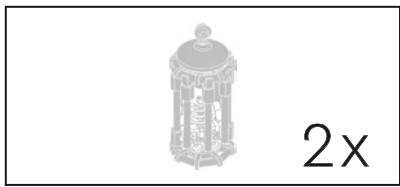

284

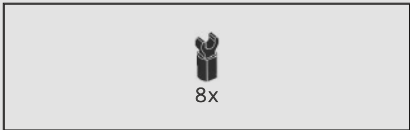
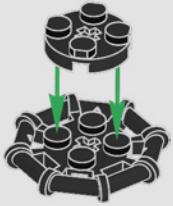

285

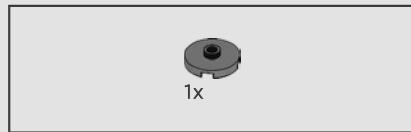
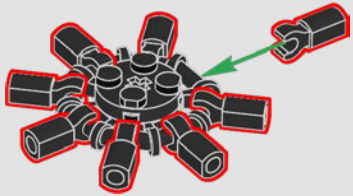

286

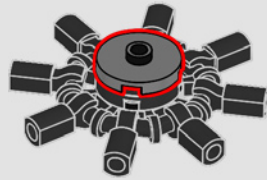

287

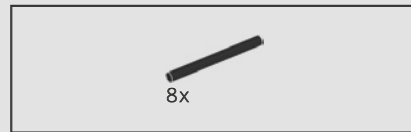
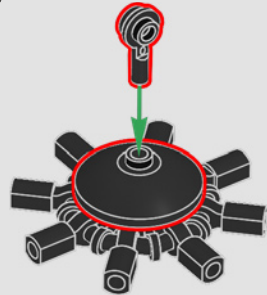

288

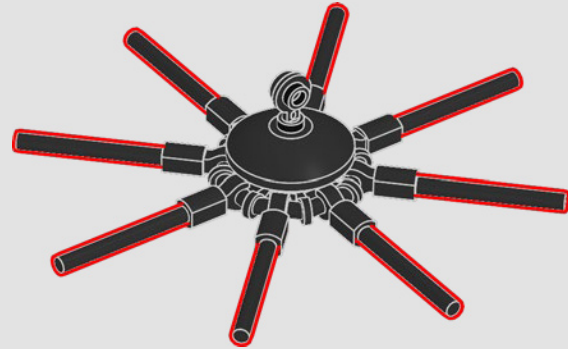

289

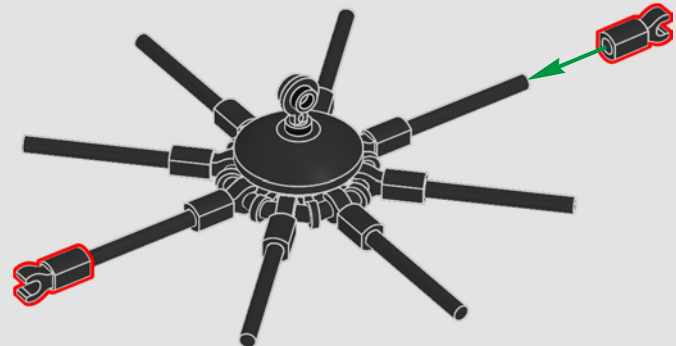



290

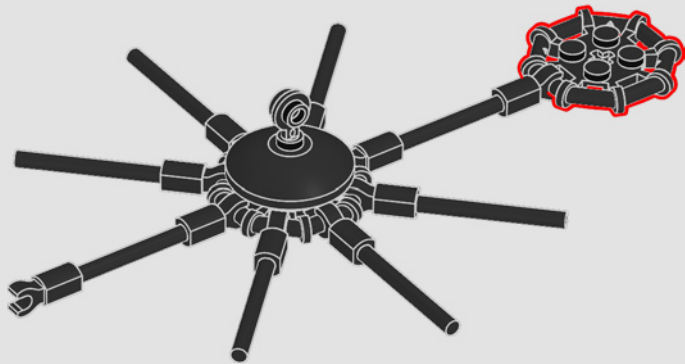

291

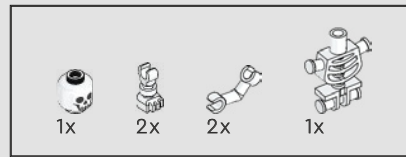
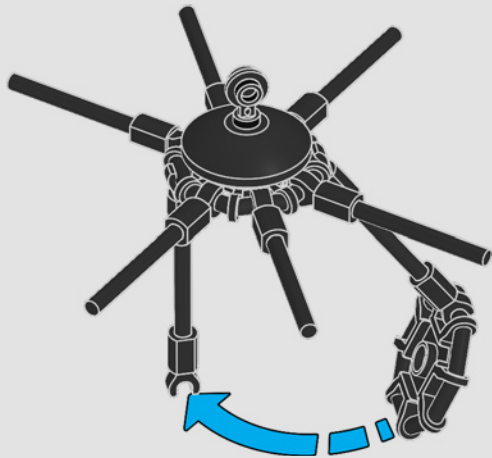

292

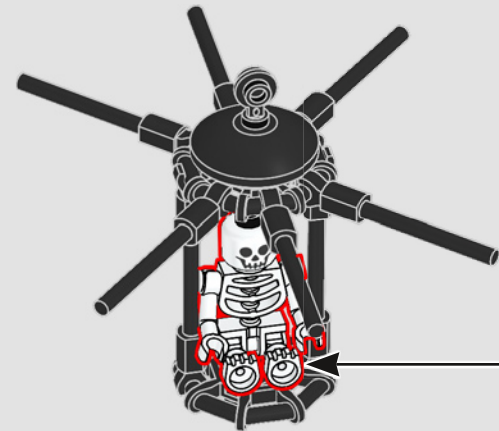
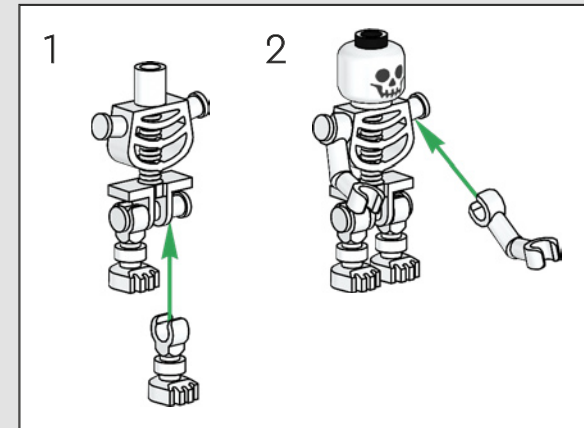

293

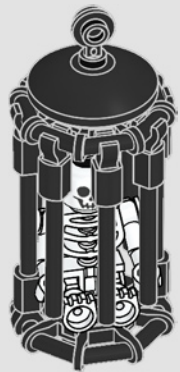

2x

294

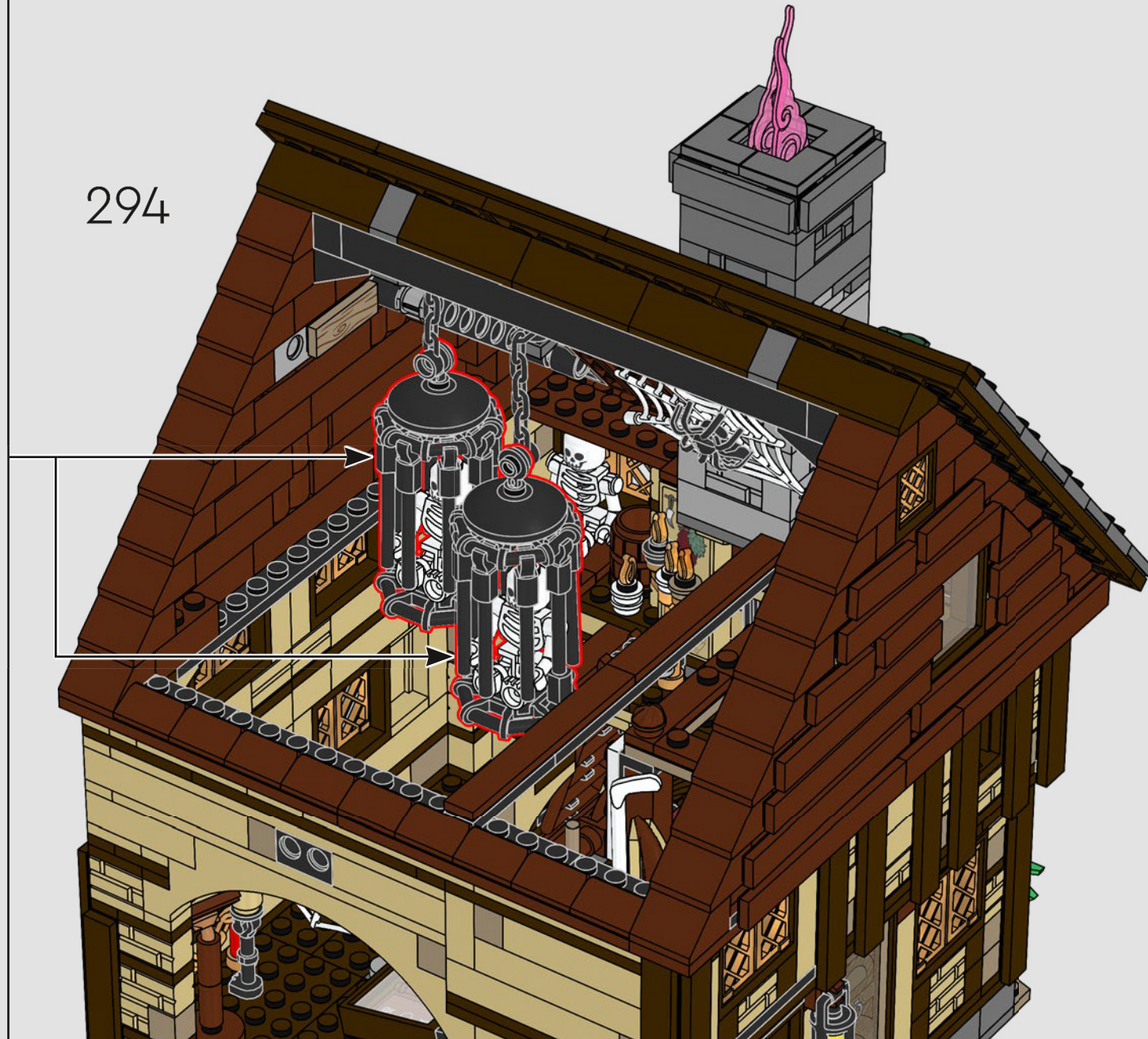

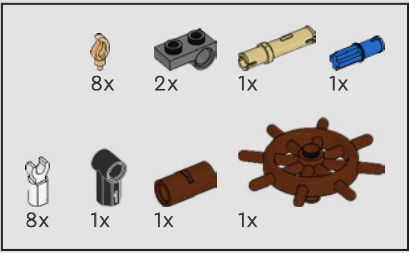
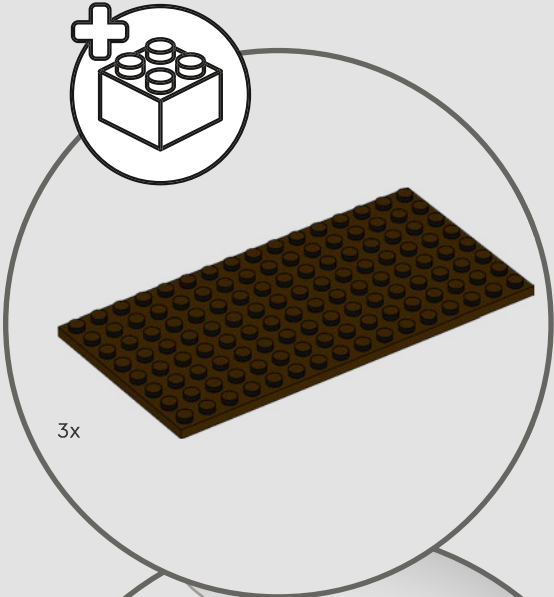

295

1

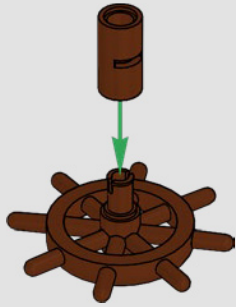

2

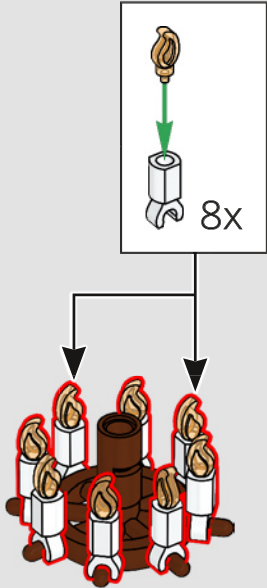

3

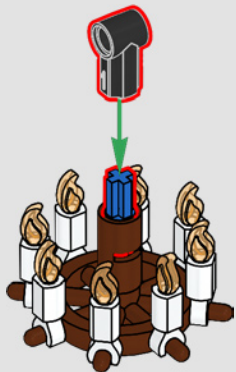

4

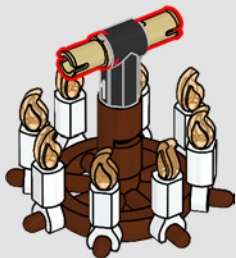

5

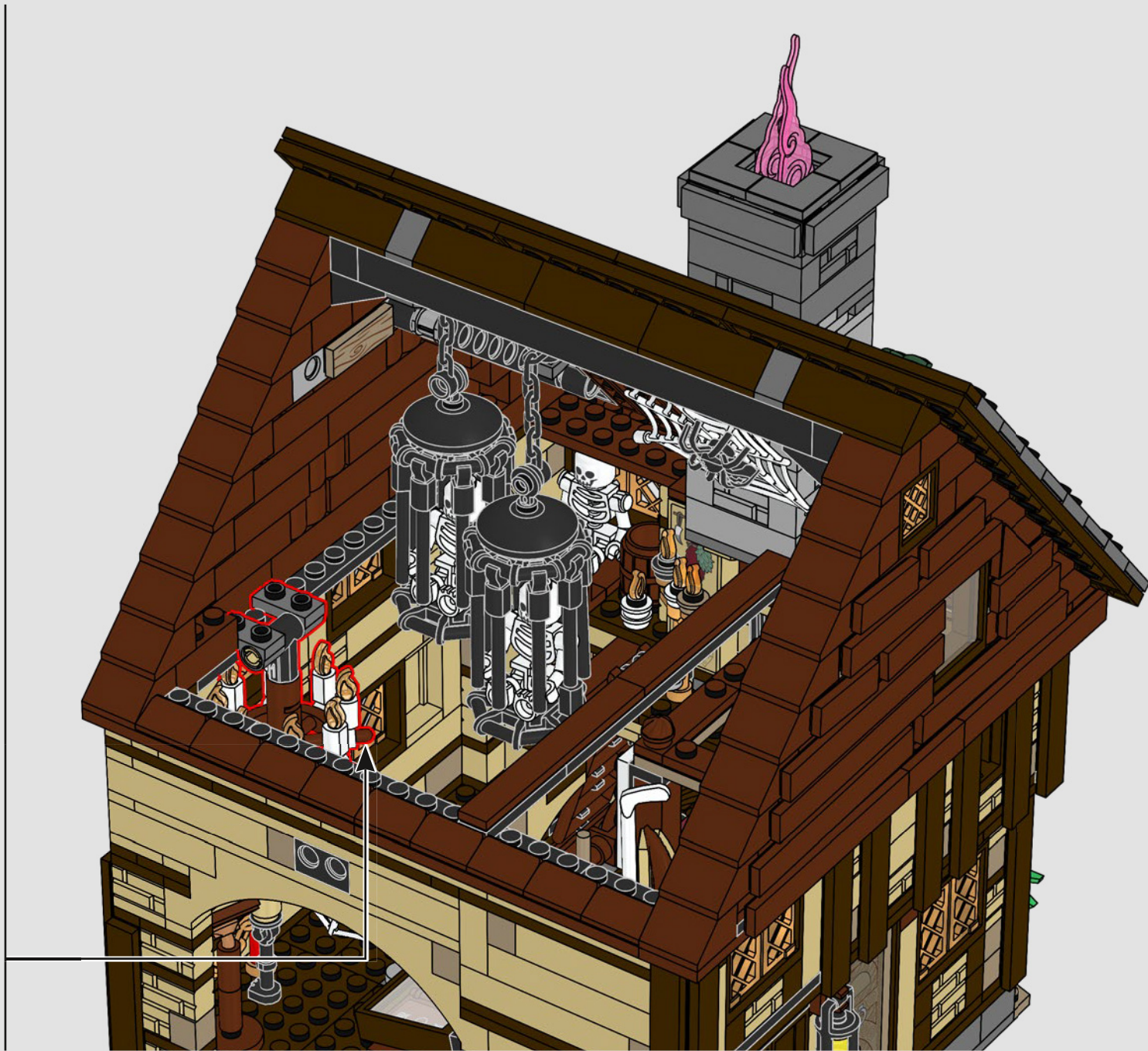
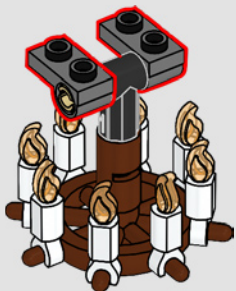



1x

296

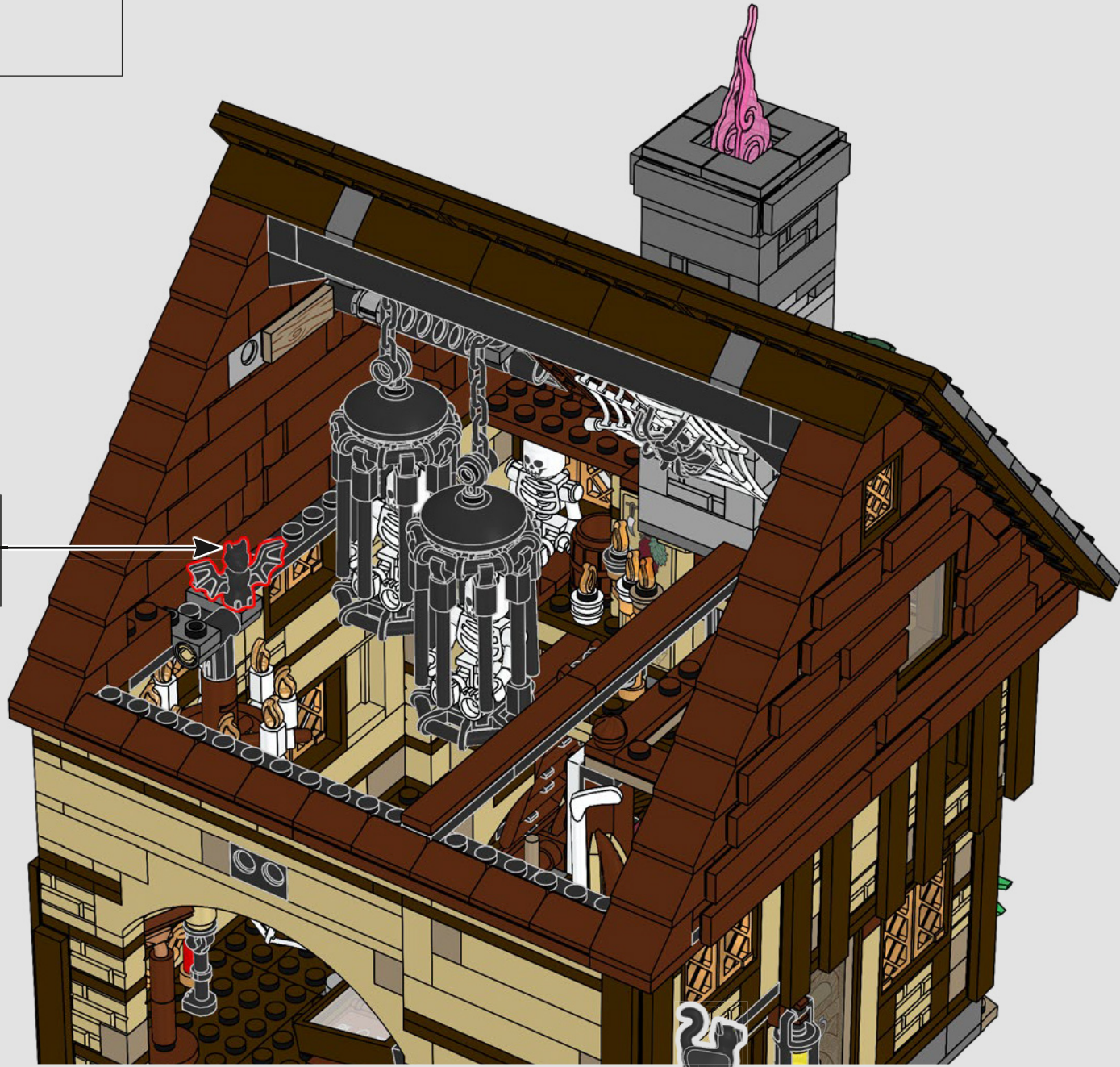

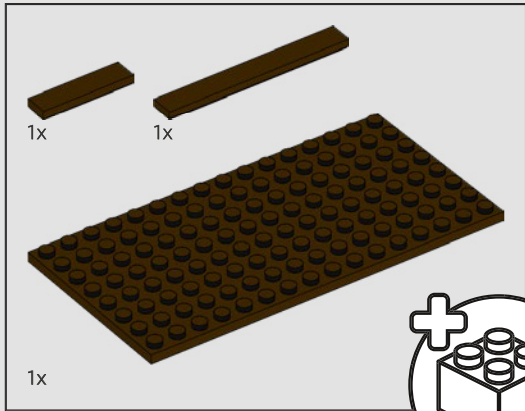
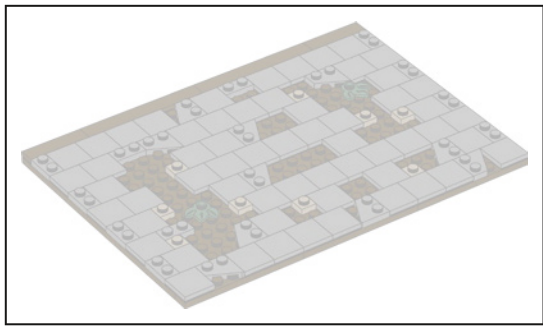

297

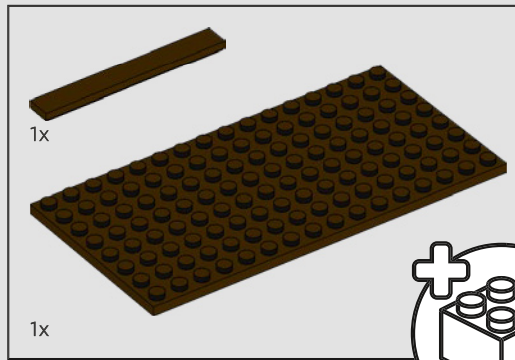
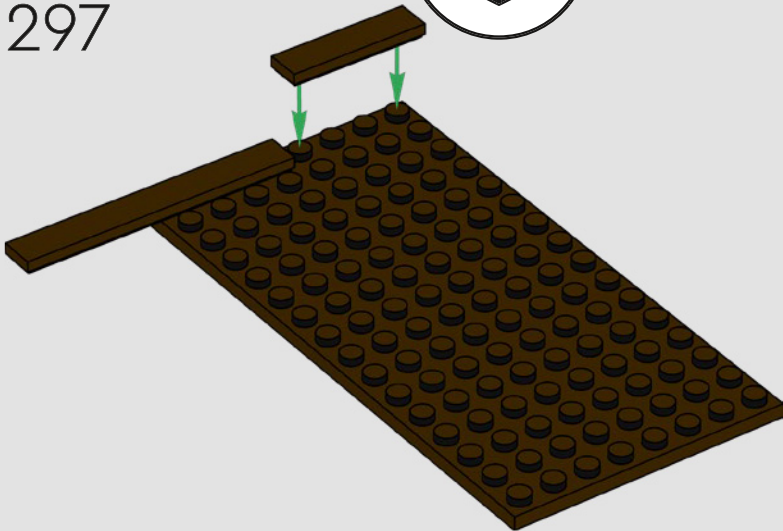

298

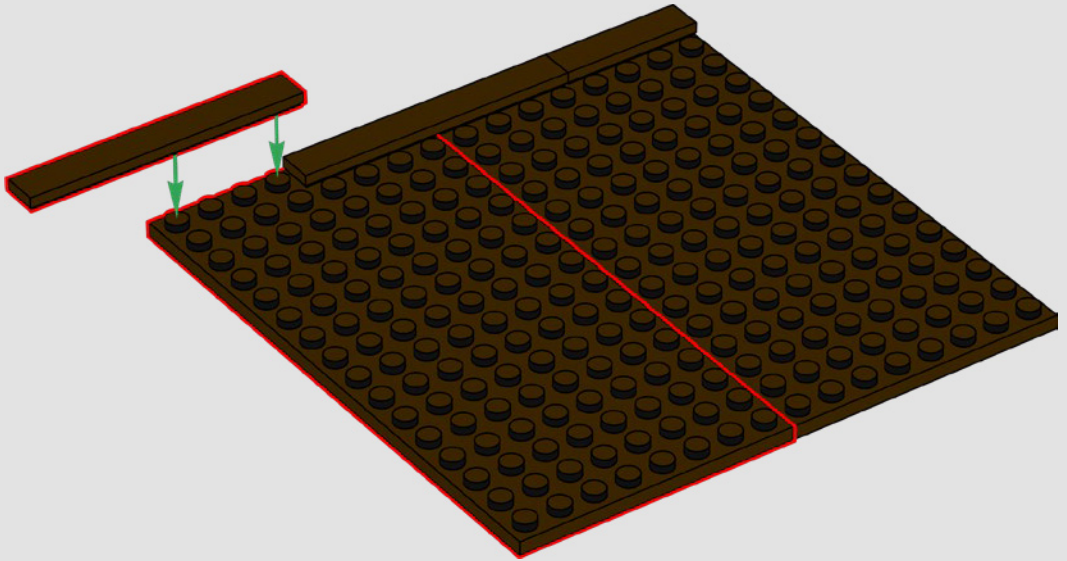

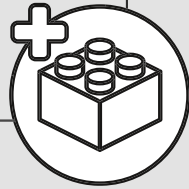
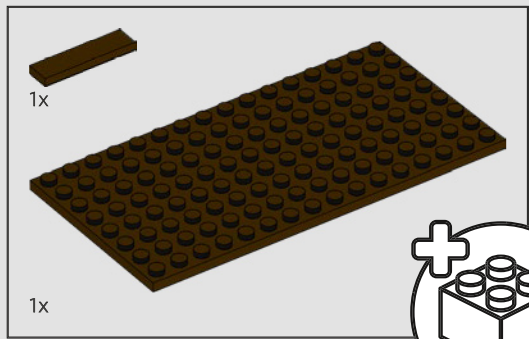

299

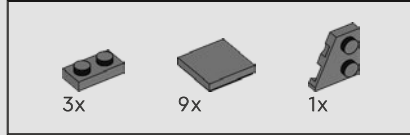
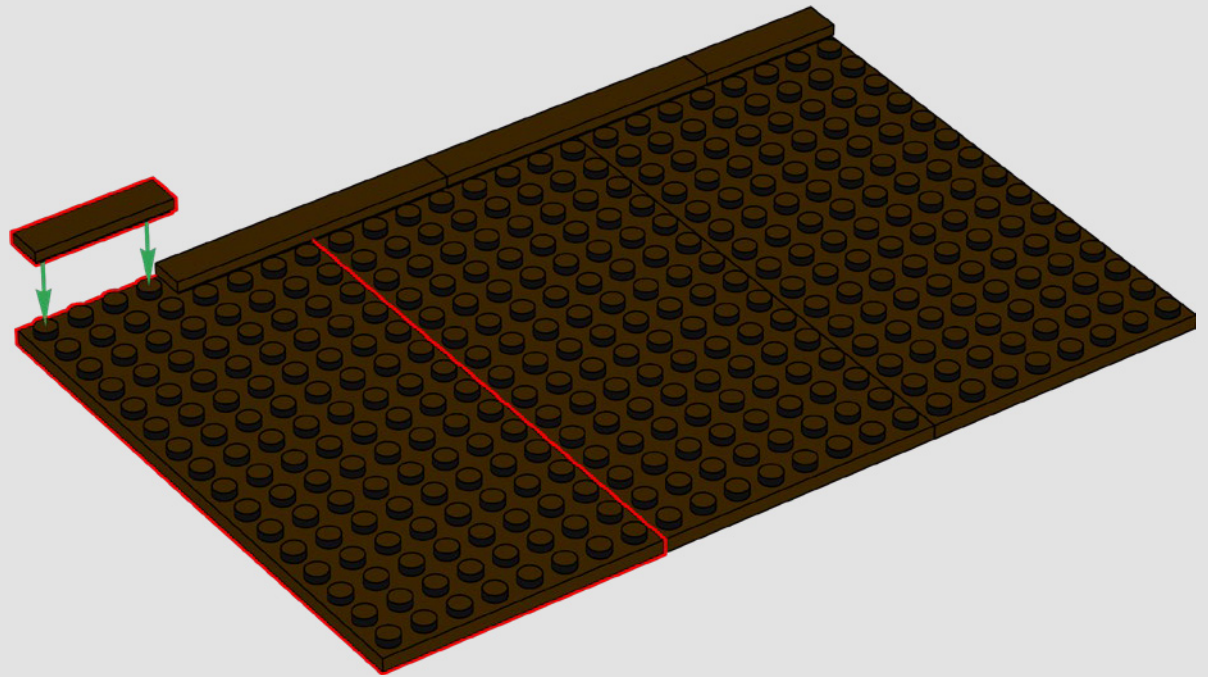

300

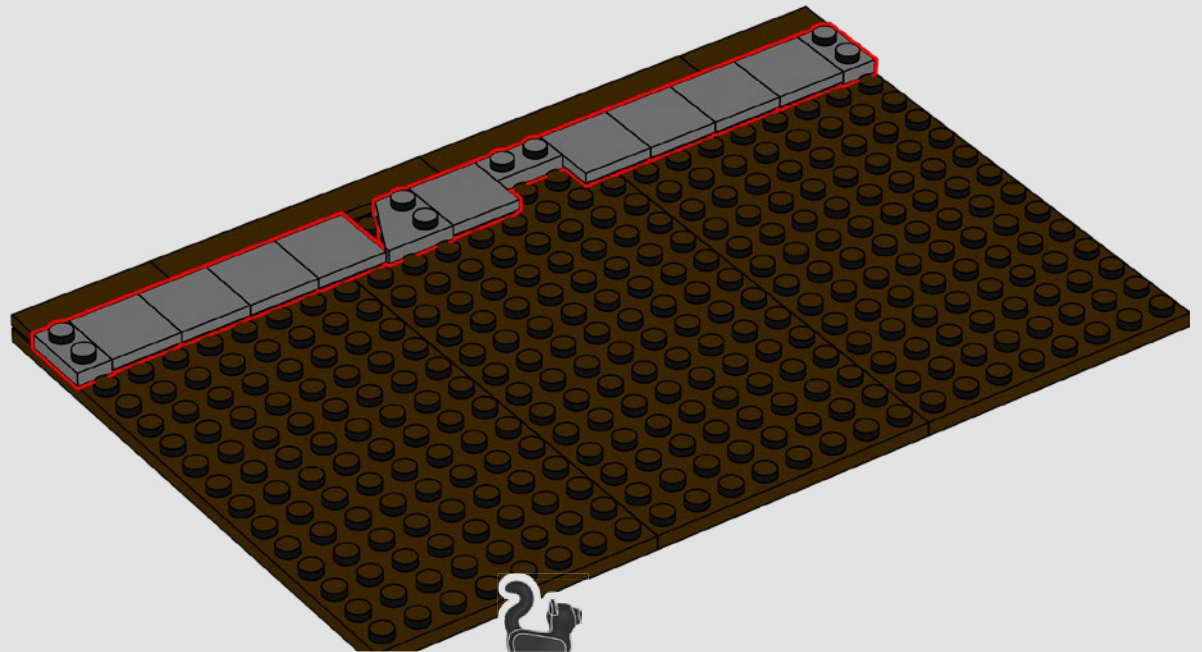

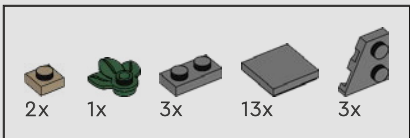

301

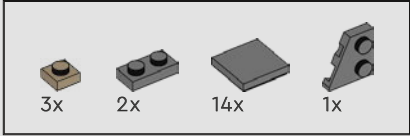
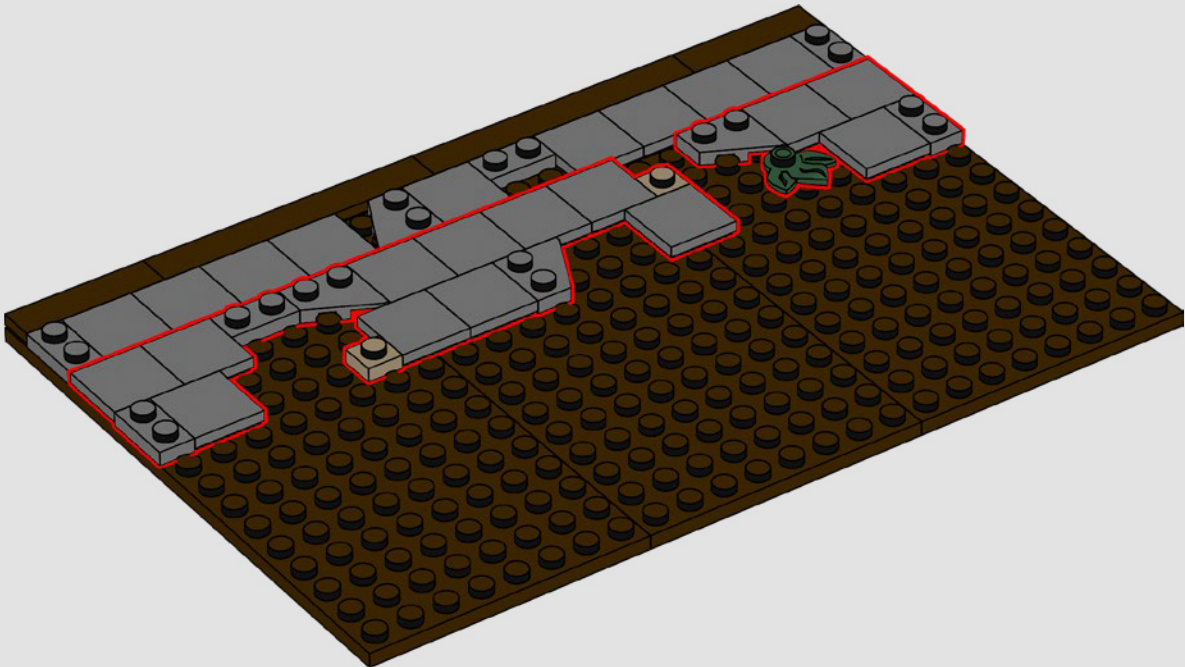

302

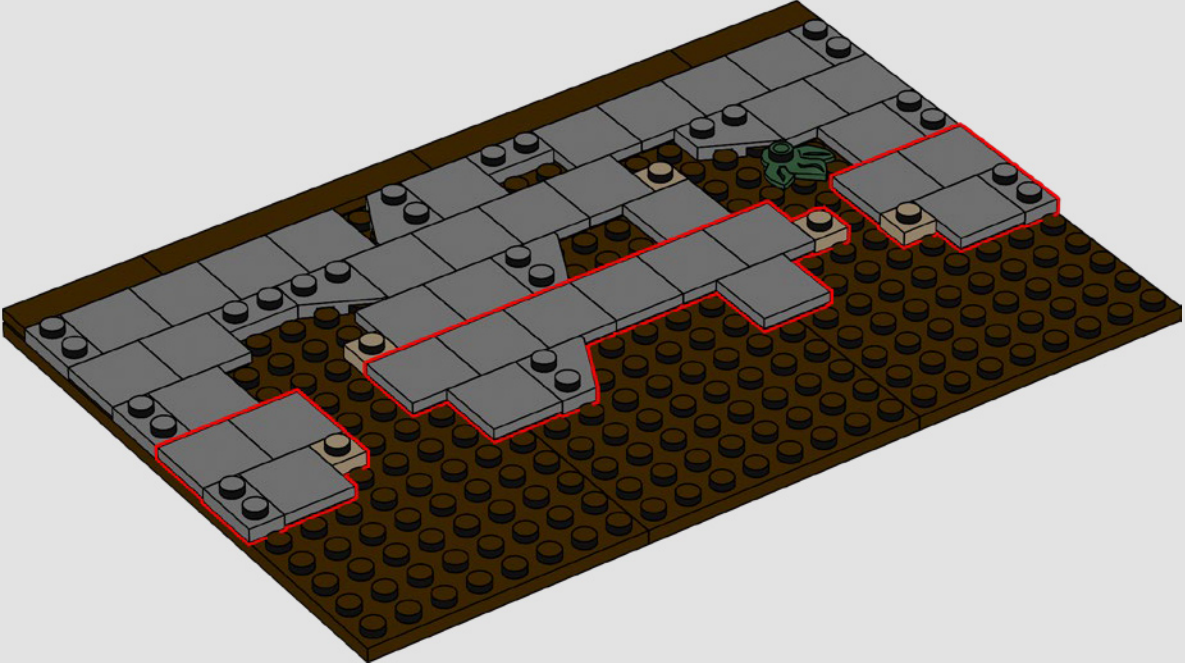

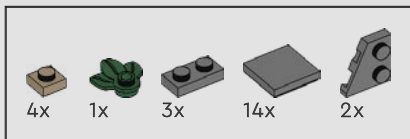

303

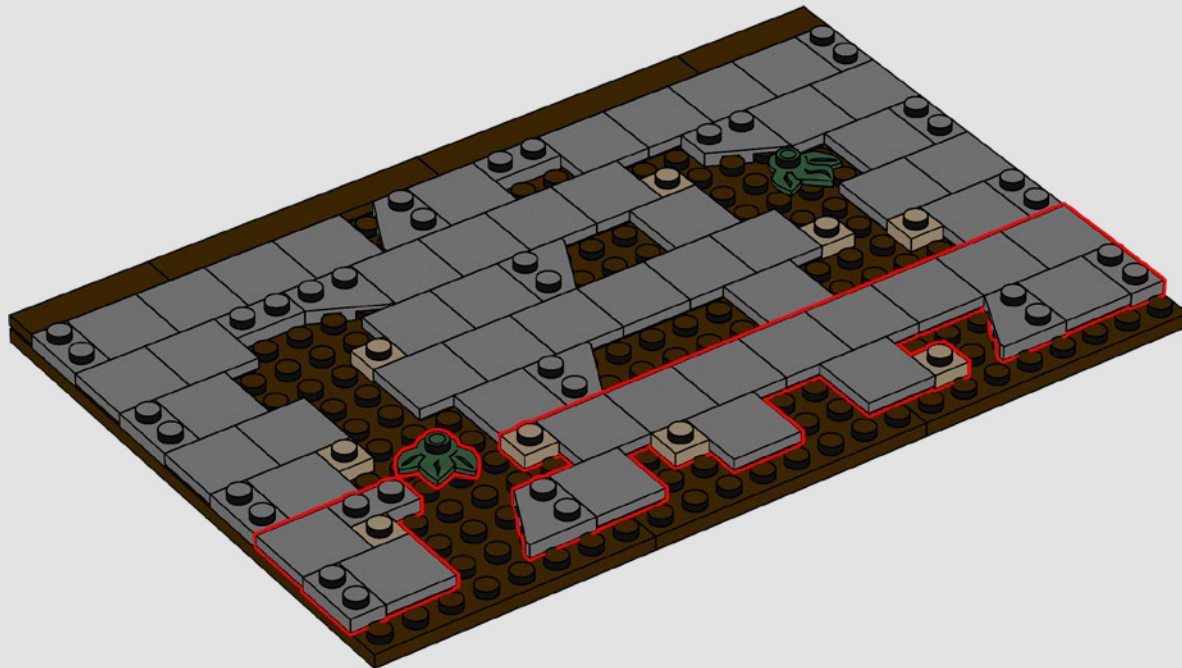

304

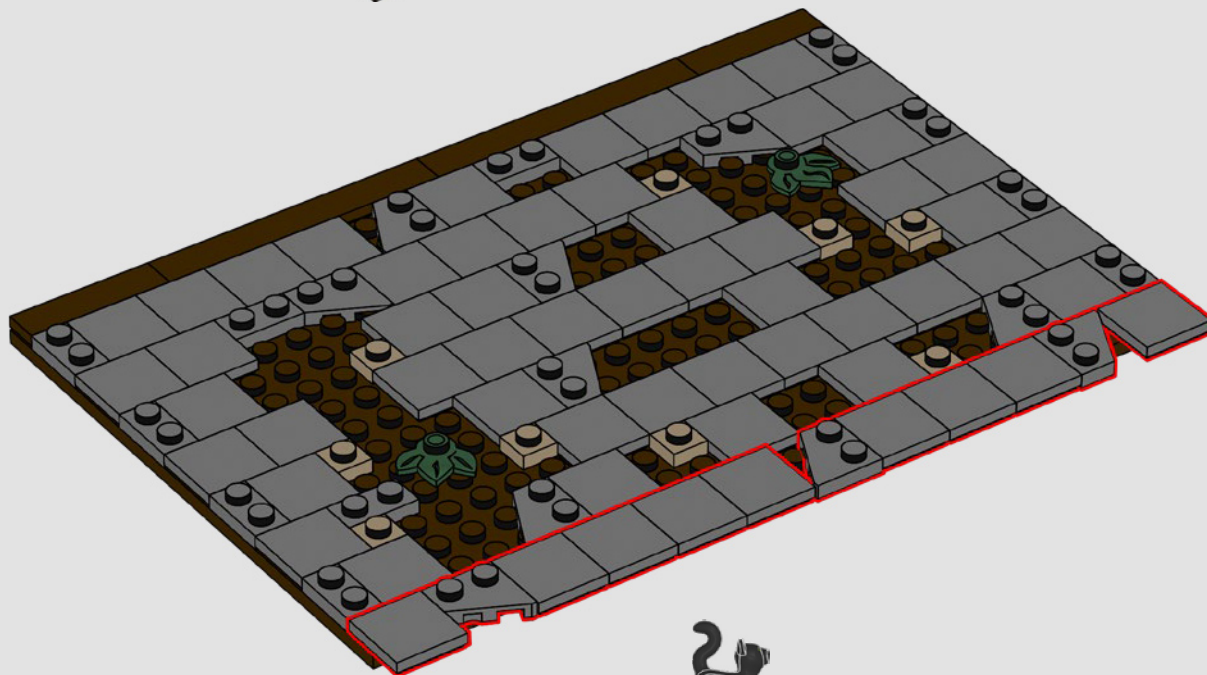

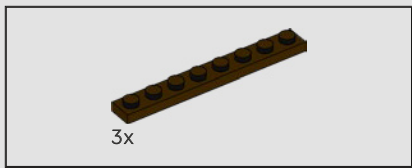

305

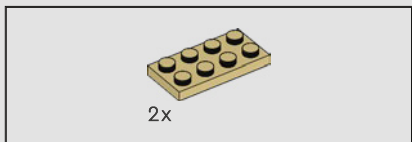
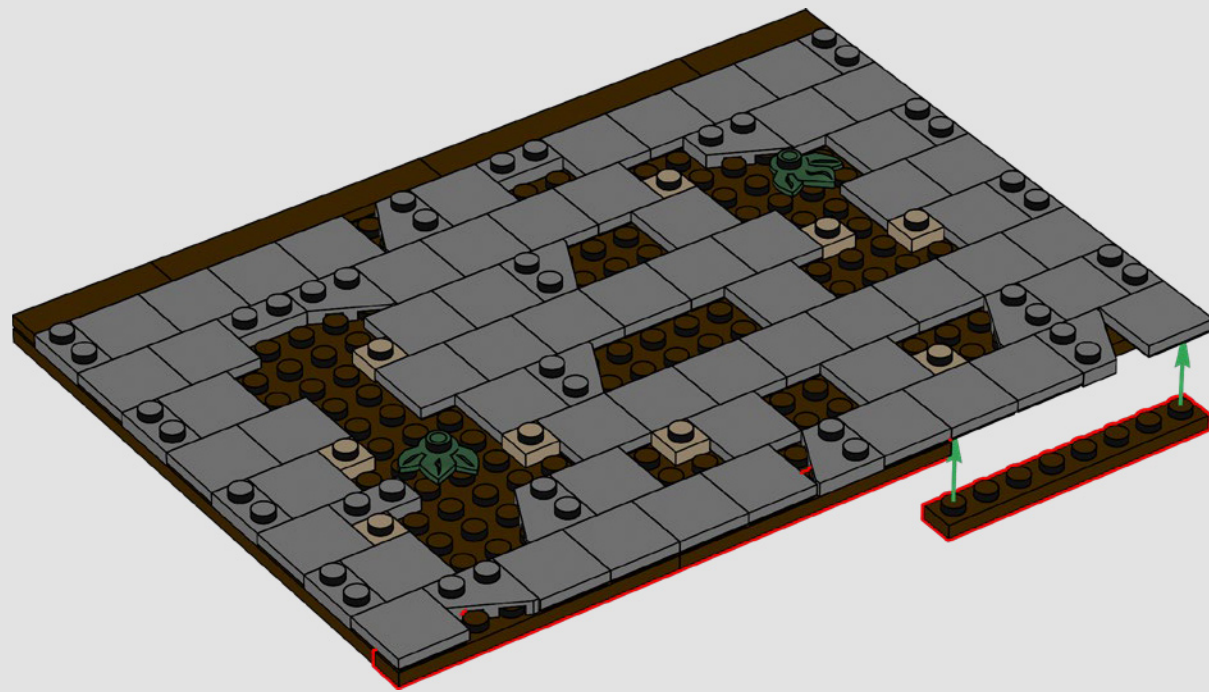

306

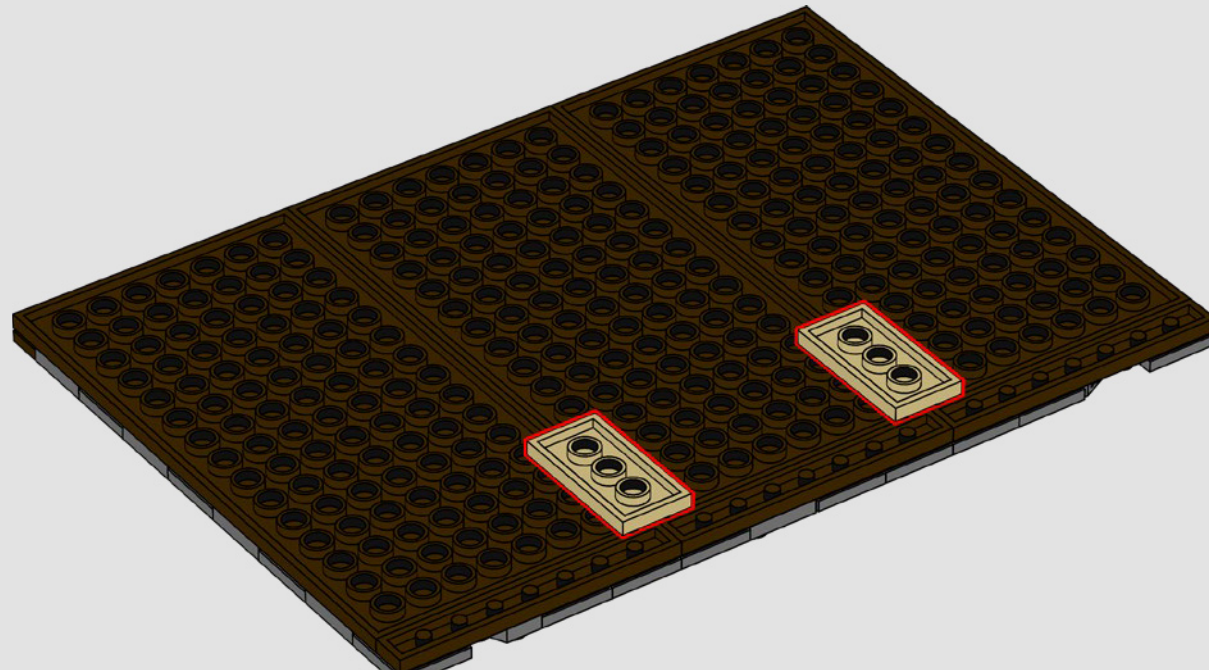

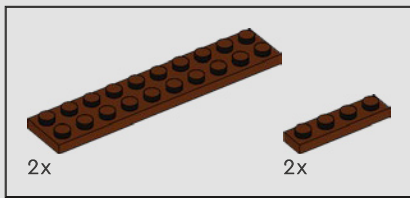

307

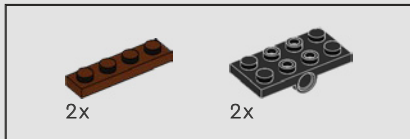
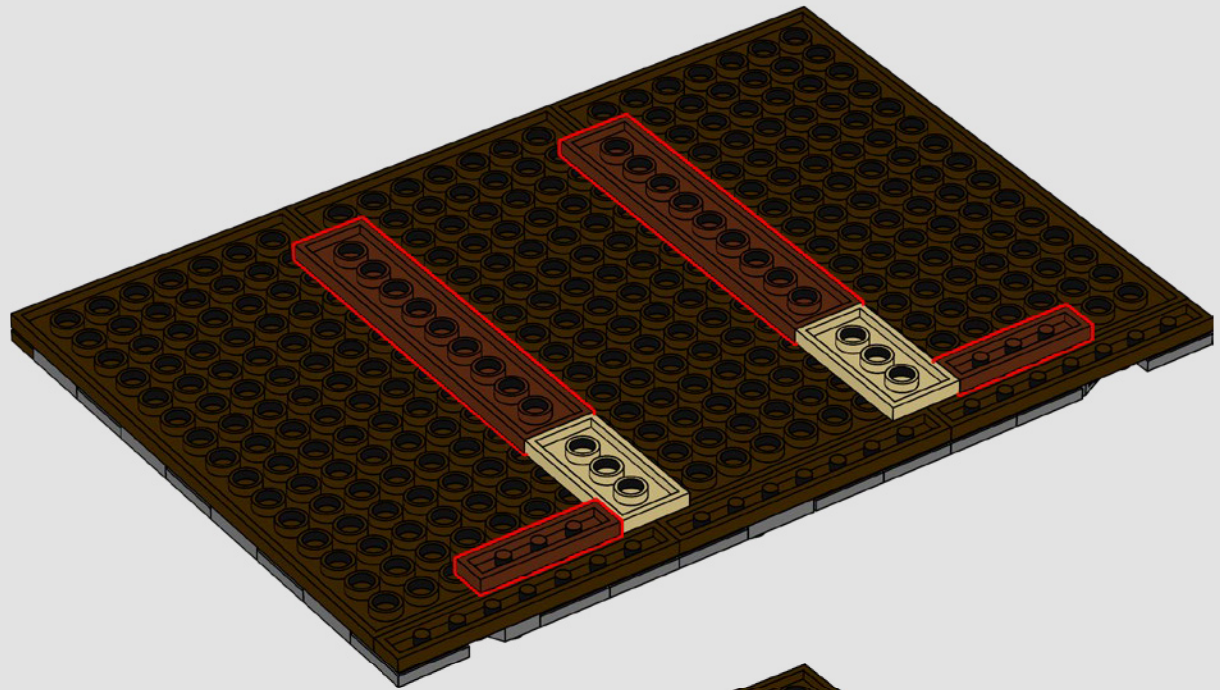

308

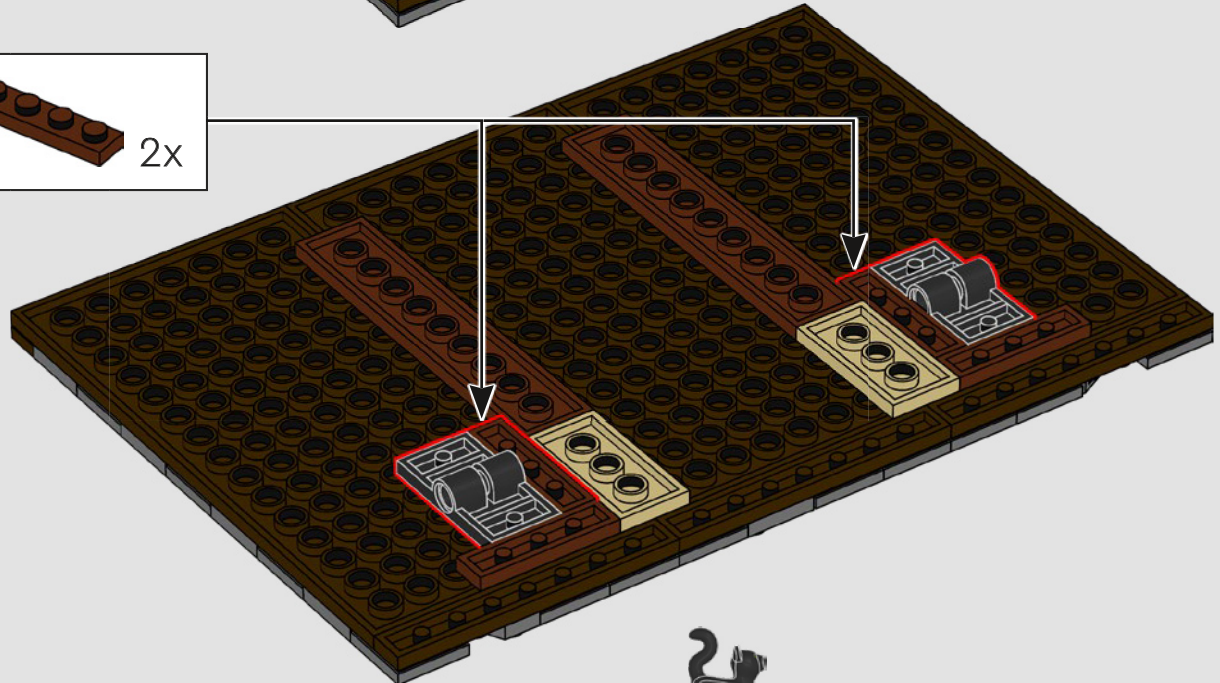
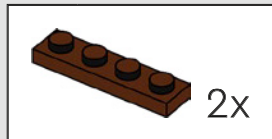

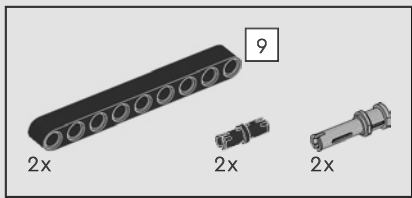

309

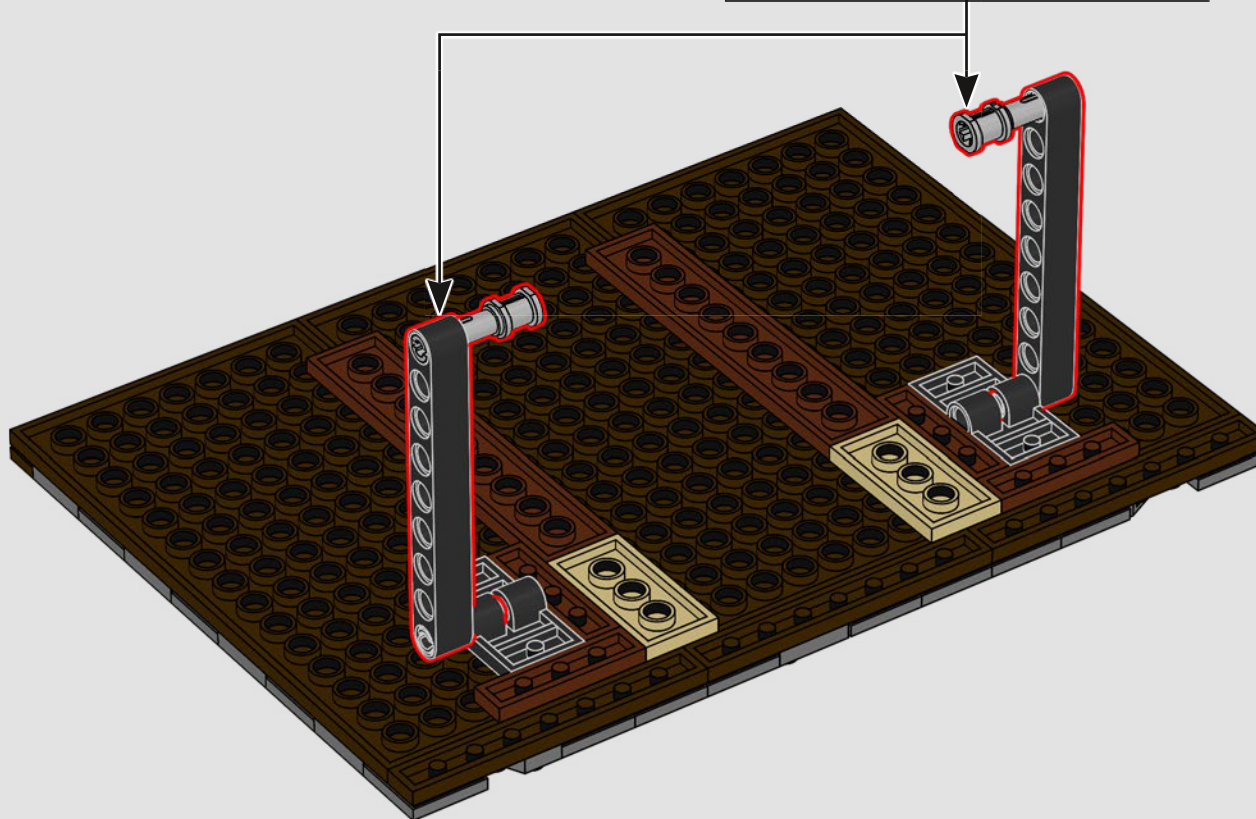
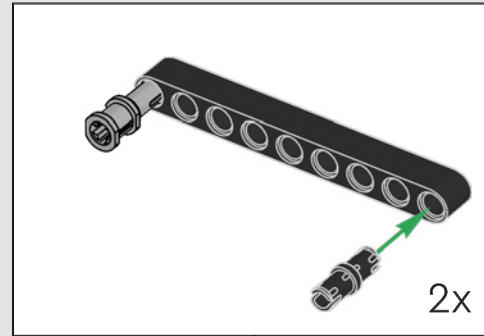

310

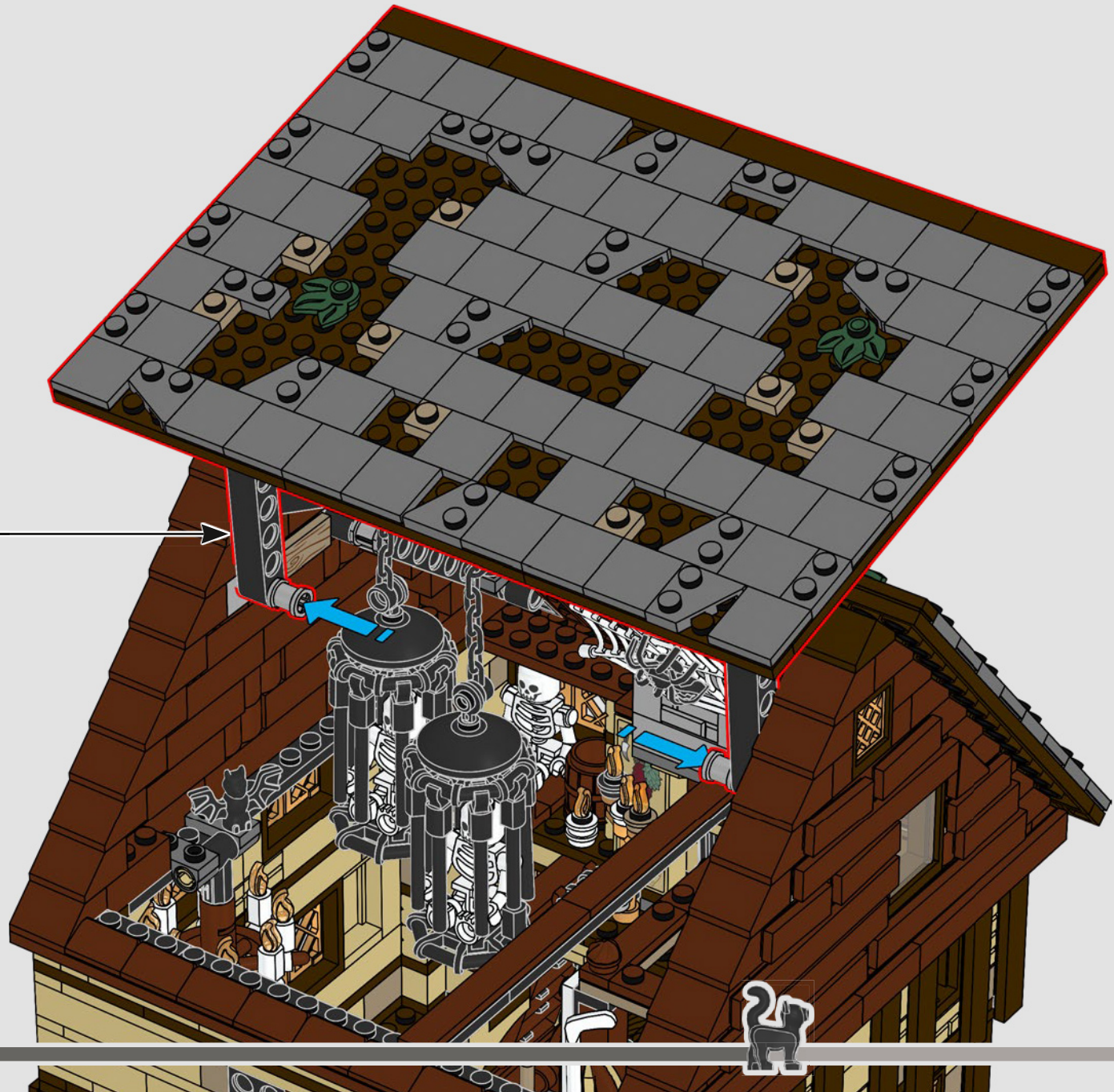

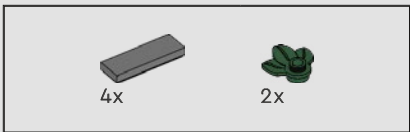

311



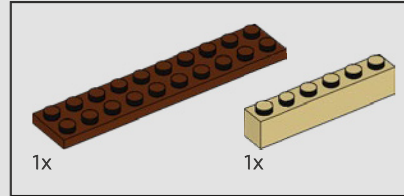
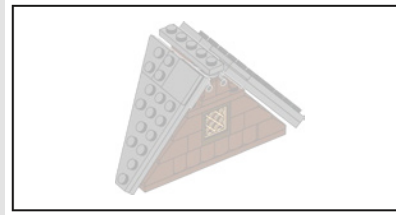
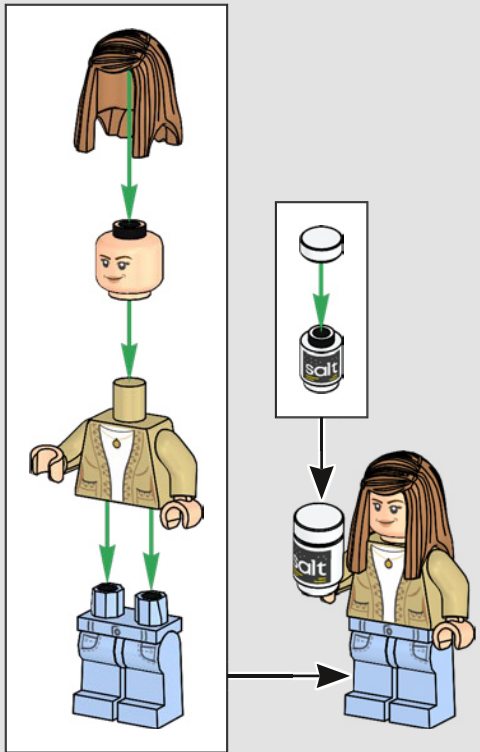

312

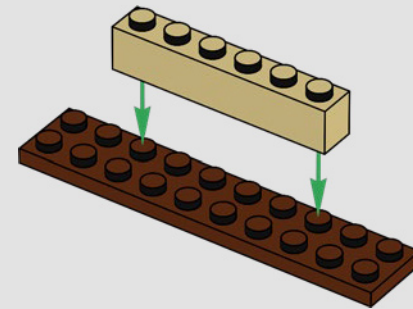

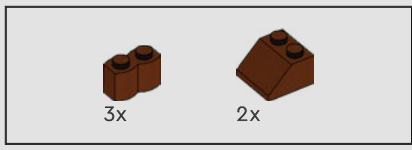

313

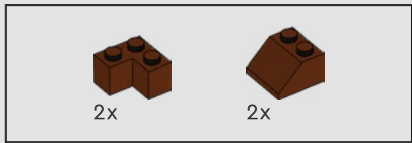
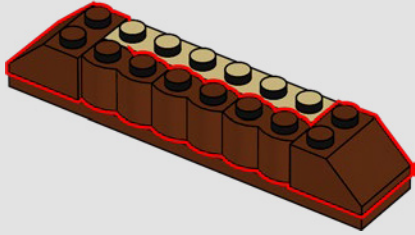

314

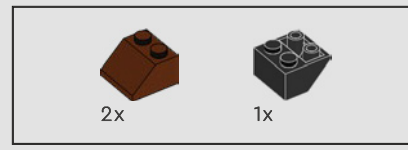
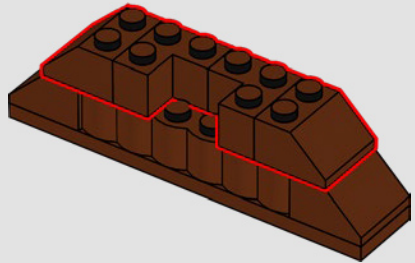

315

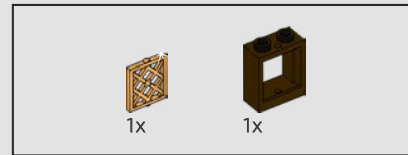
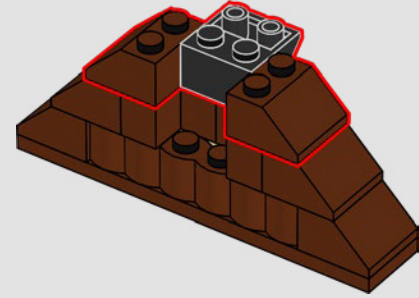

316

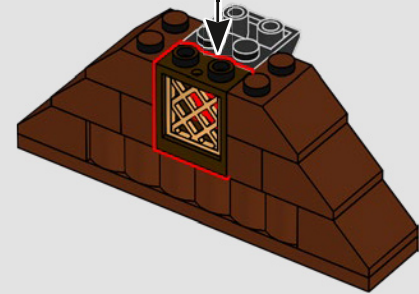
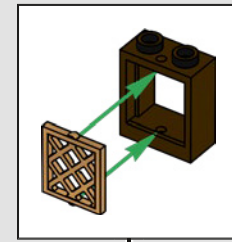

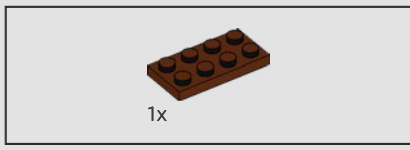

317

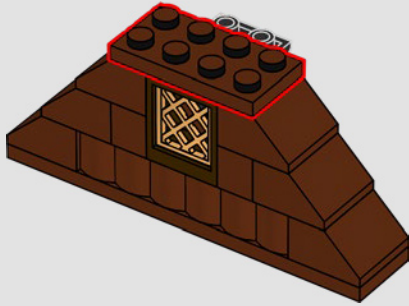

318

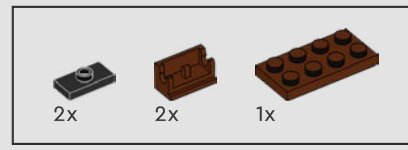
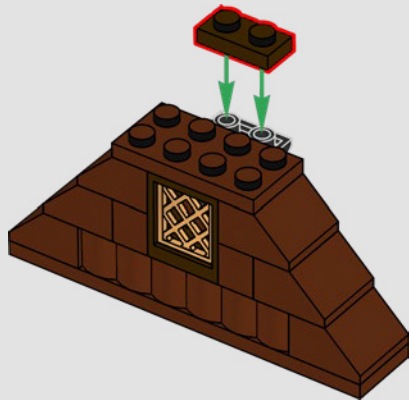

319

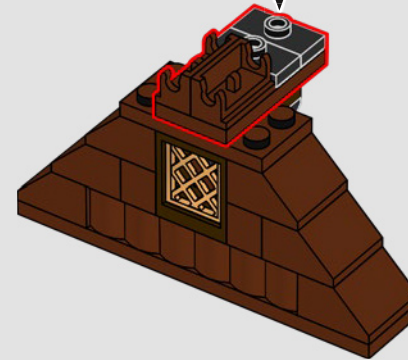
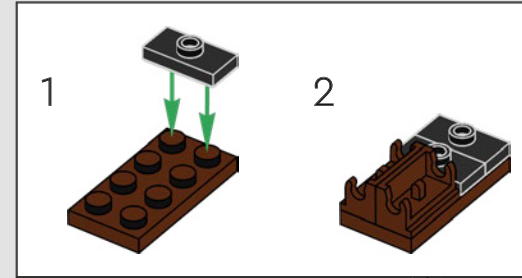

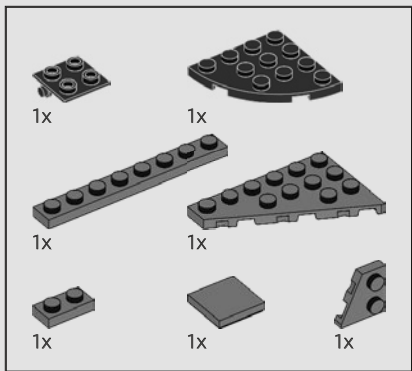

320

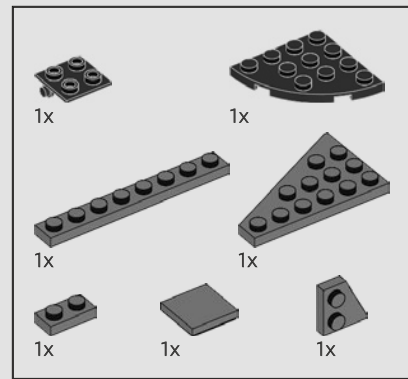
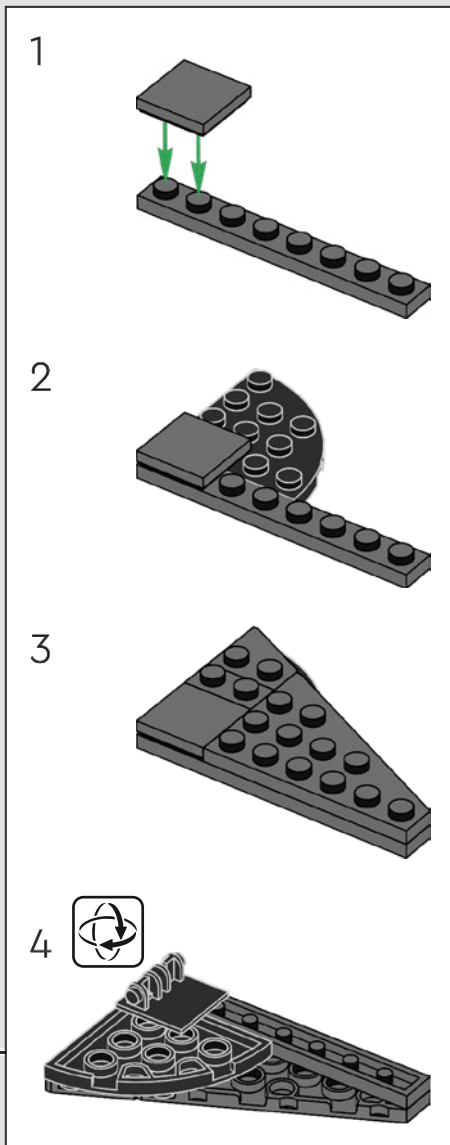
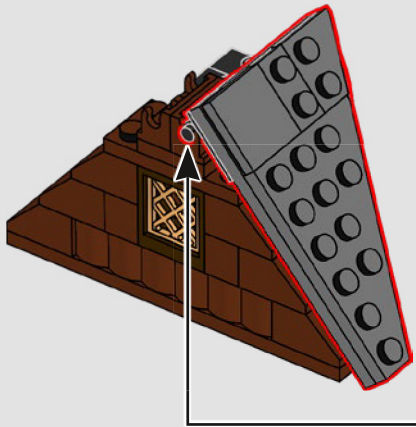

321

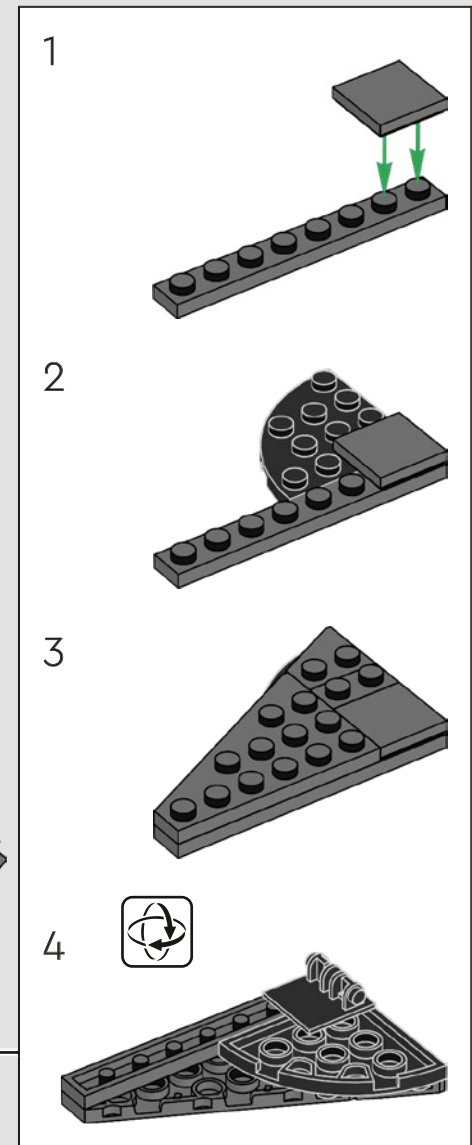
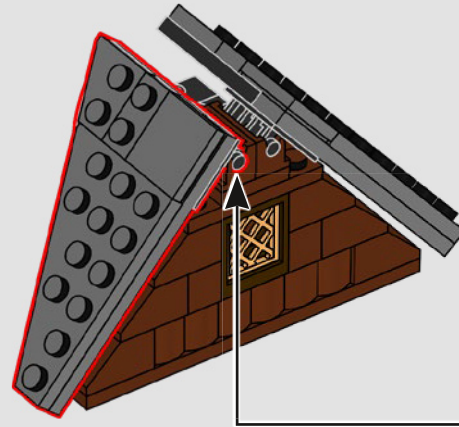

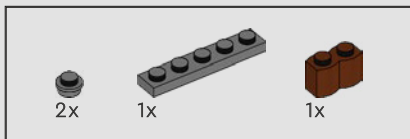

322

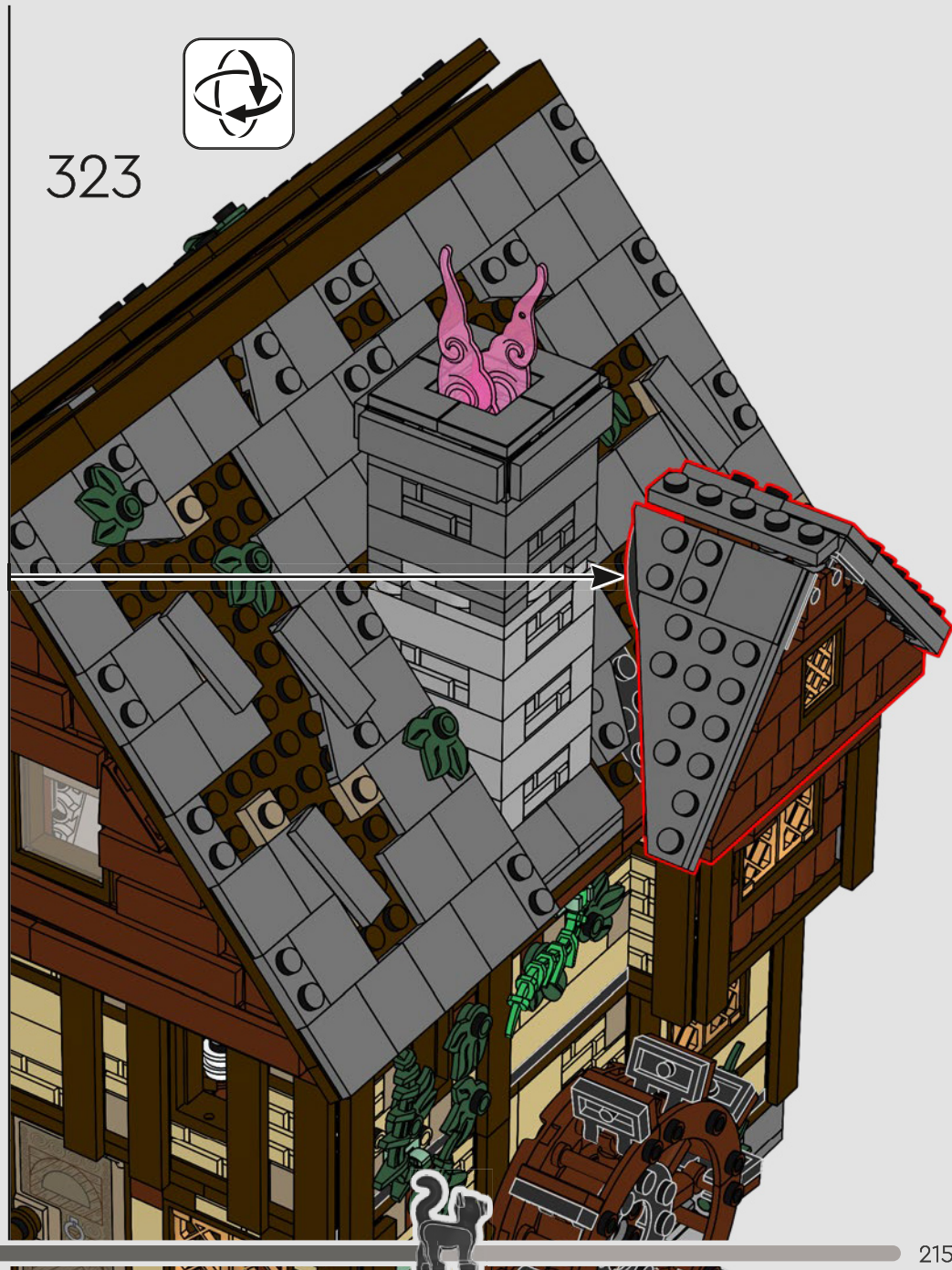
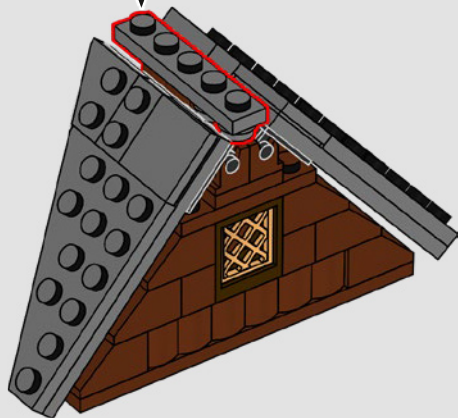
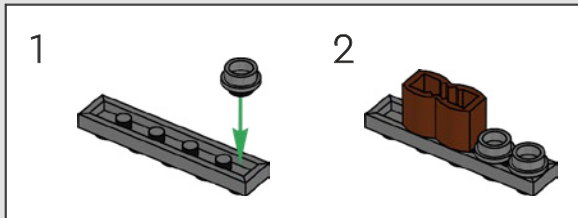

323



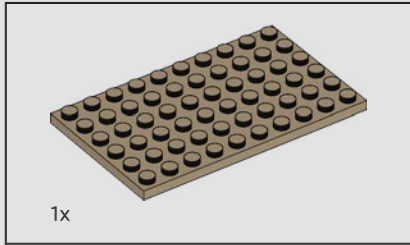
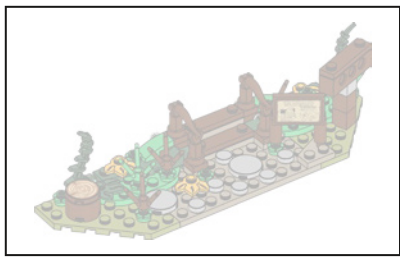

324

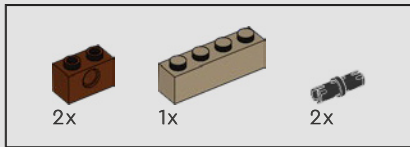

325

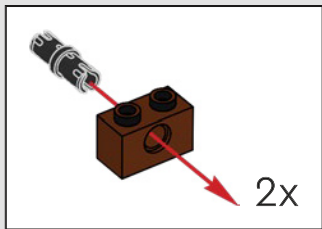

2x

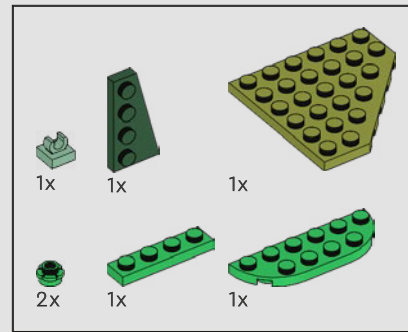
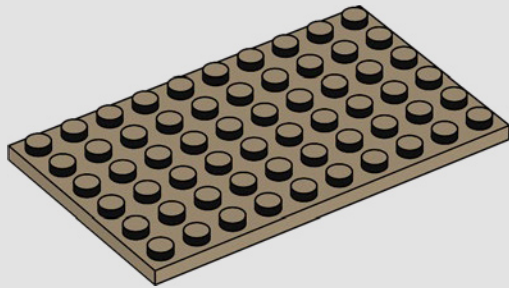

326

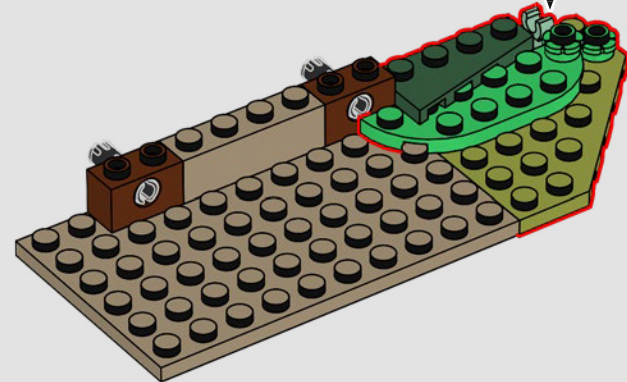
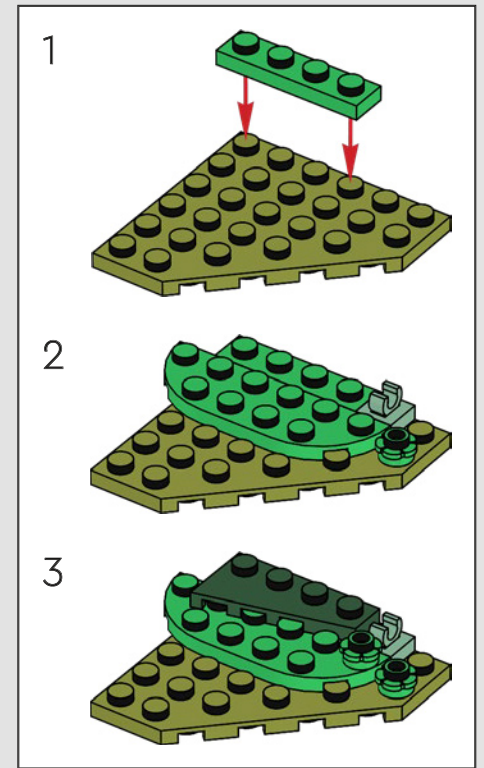

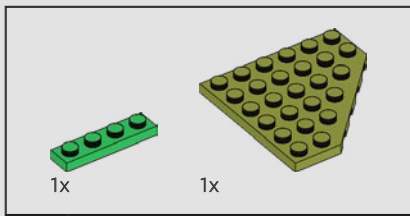

327

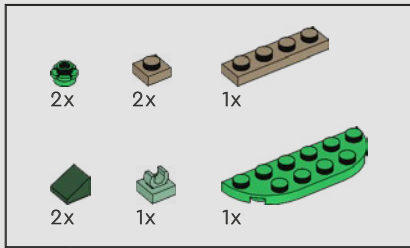
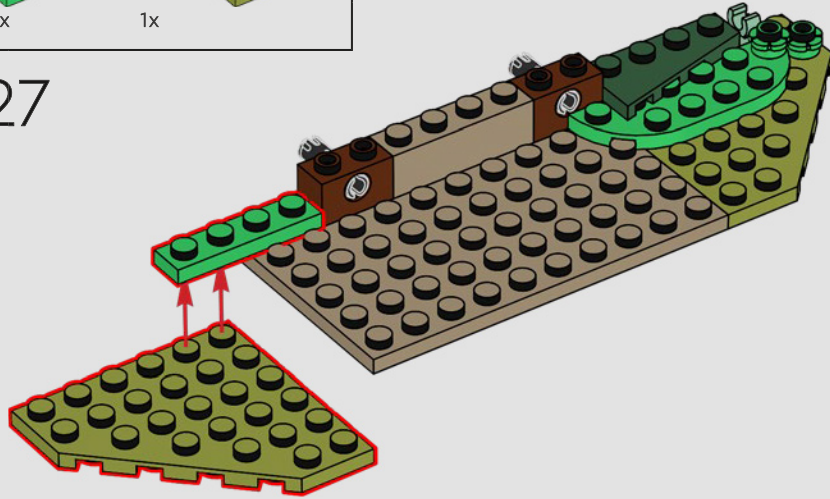

328

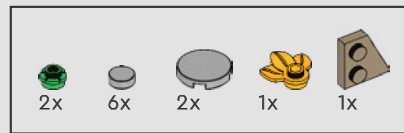
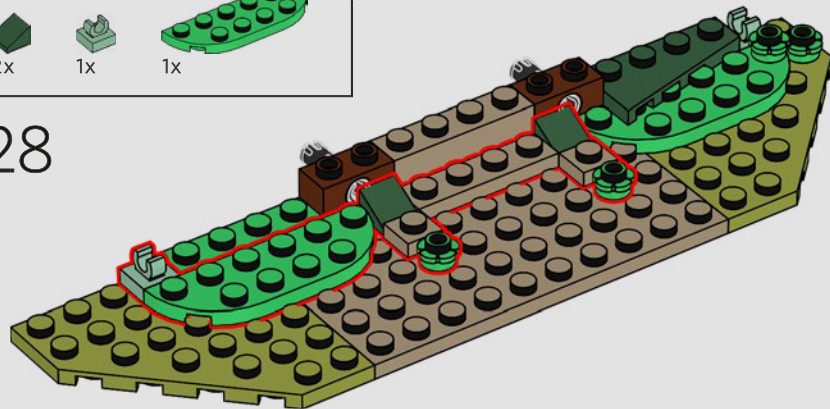

329

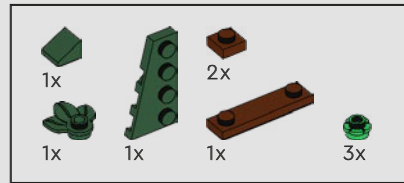

330

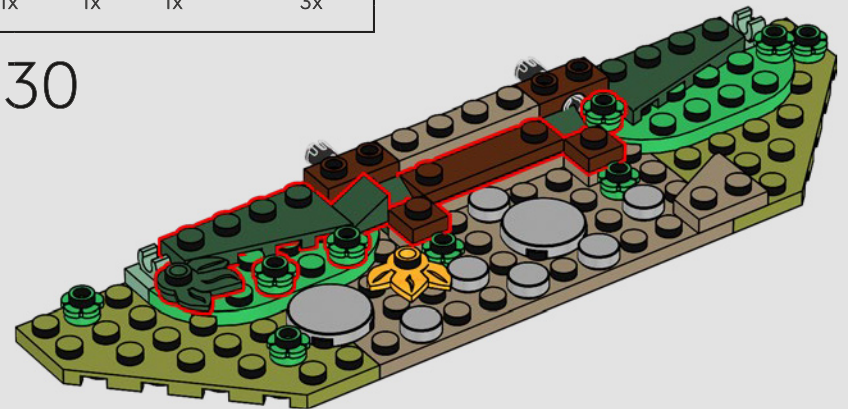

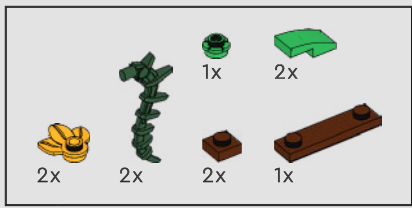

331

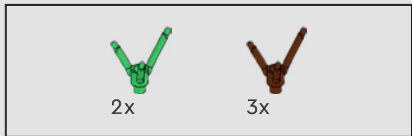
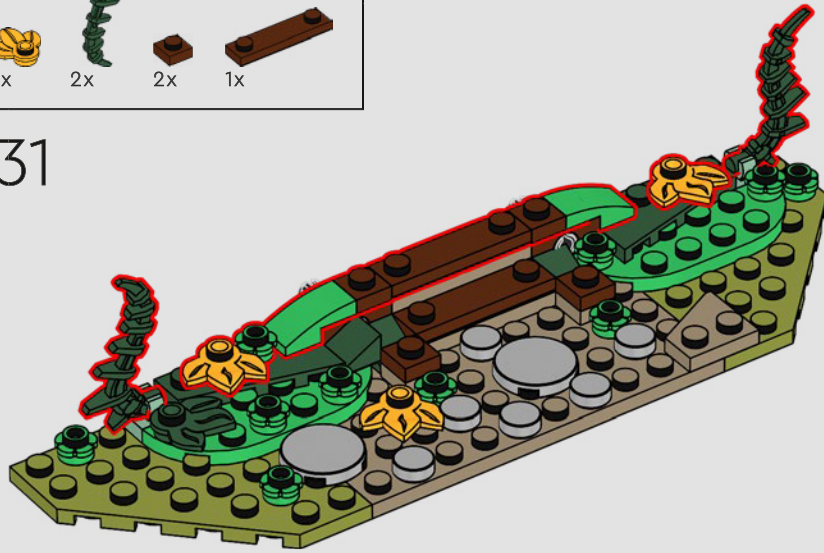

332



333

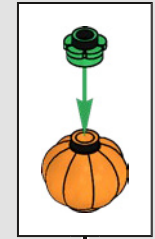
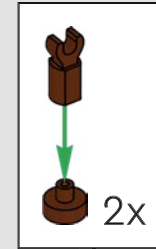



334

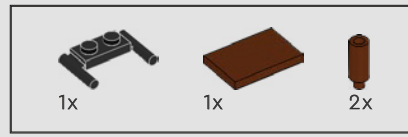
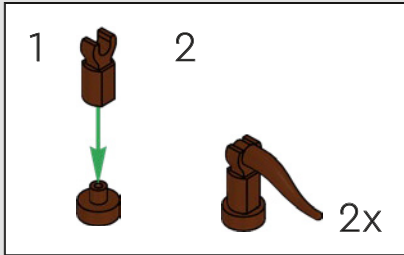
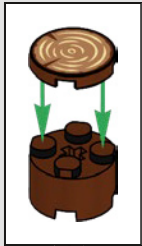

335

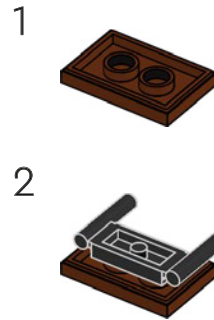

2

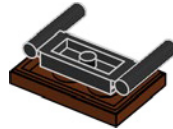

3

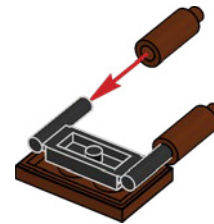

4

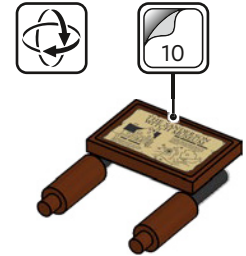



336

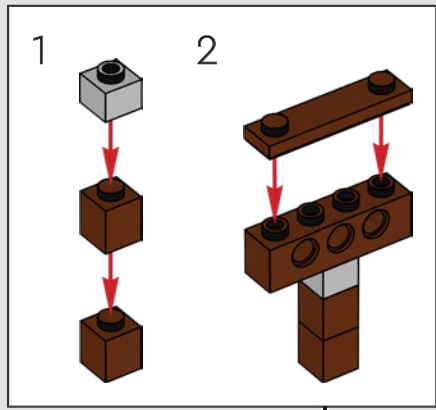

337

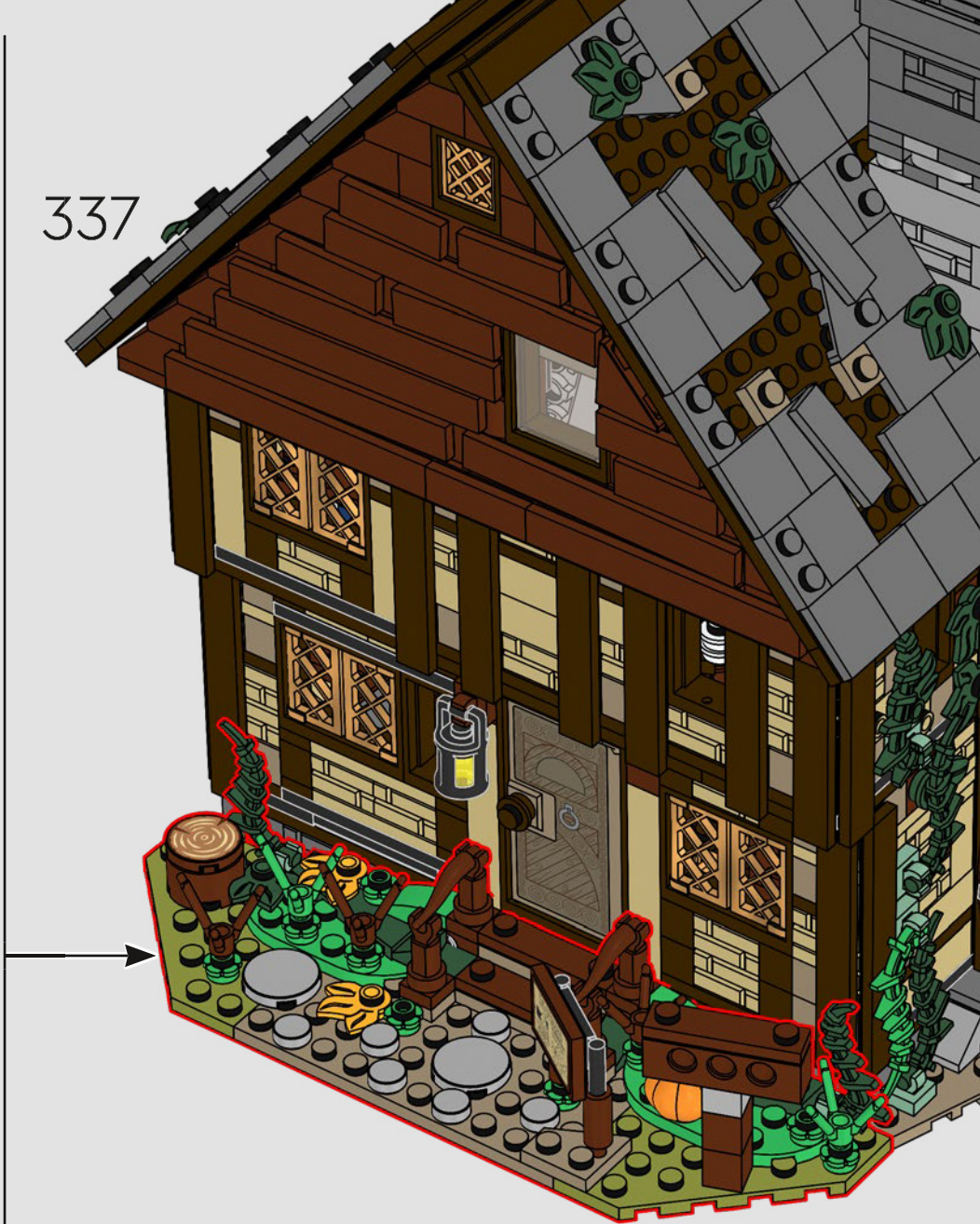

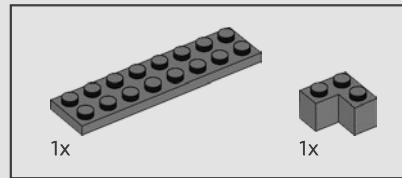
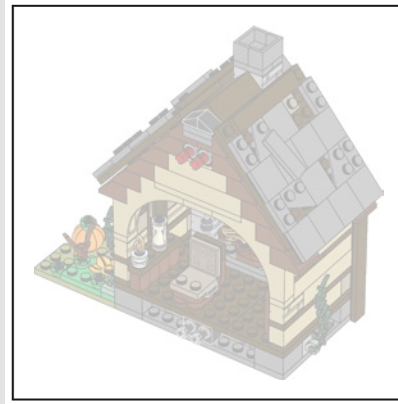
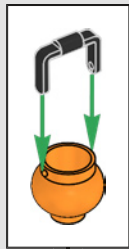
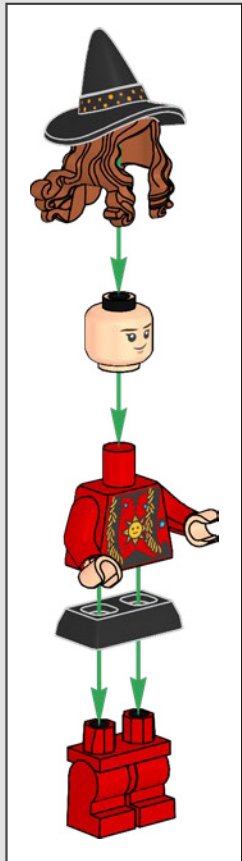

338

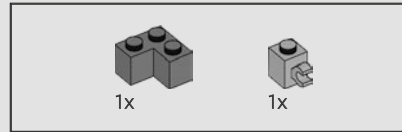
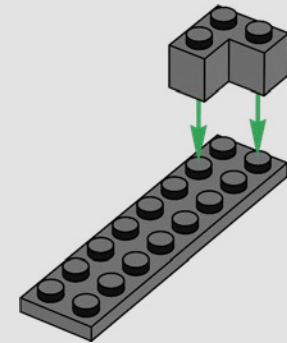

339

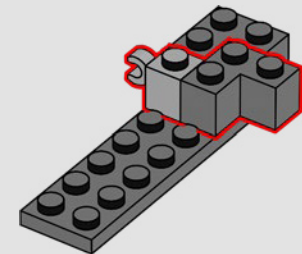

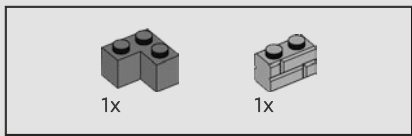

340

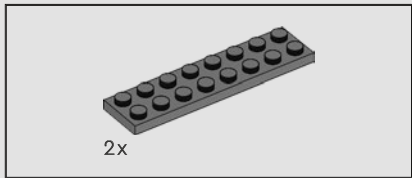
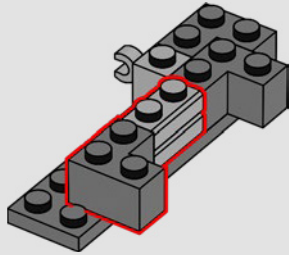

341

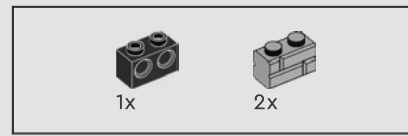
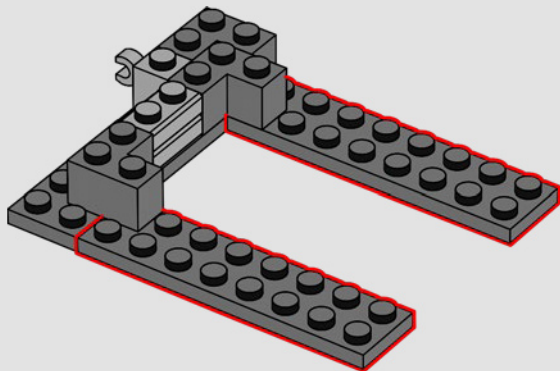

342

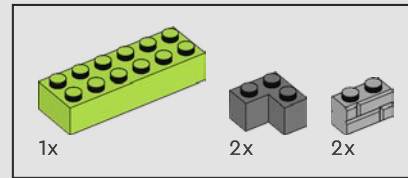
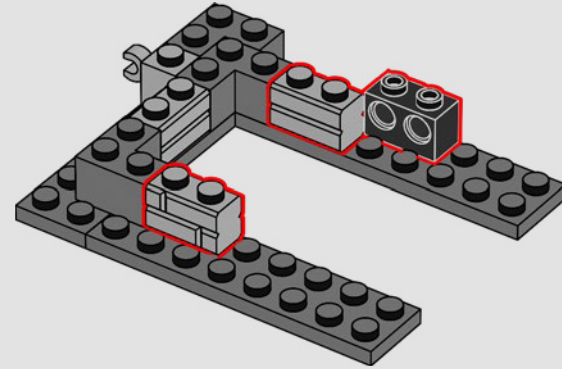

343

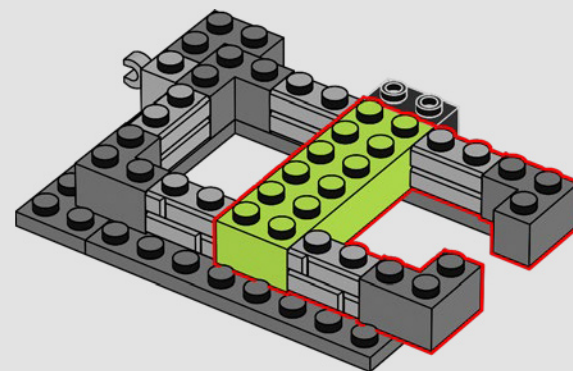

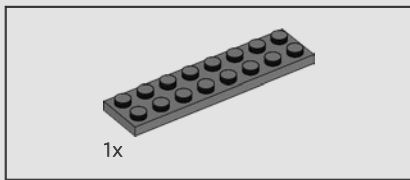

344

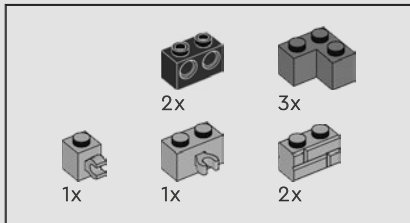
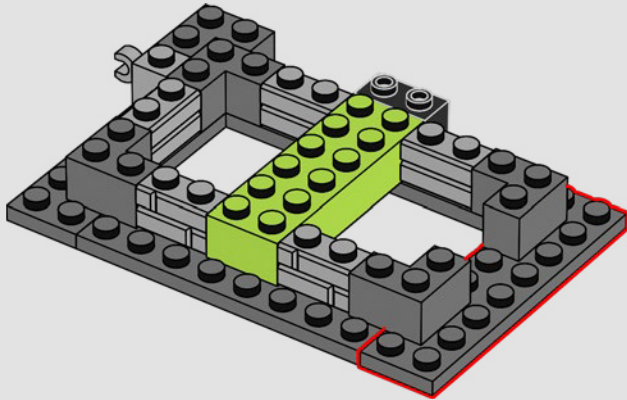

345

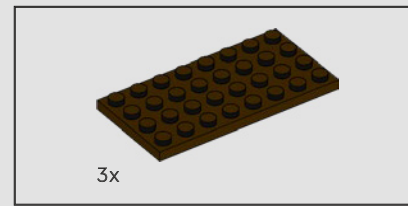
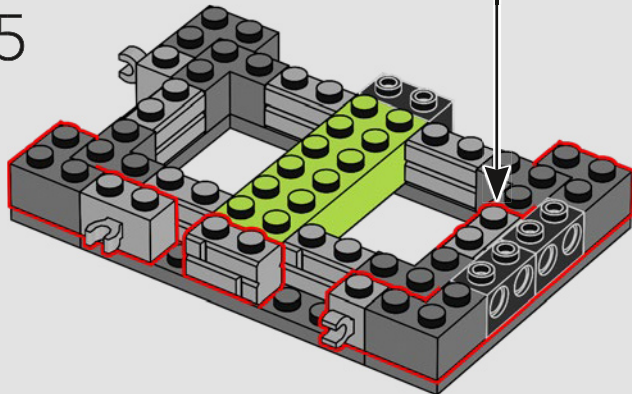

346

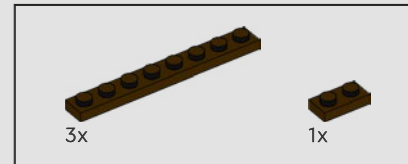
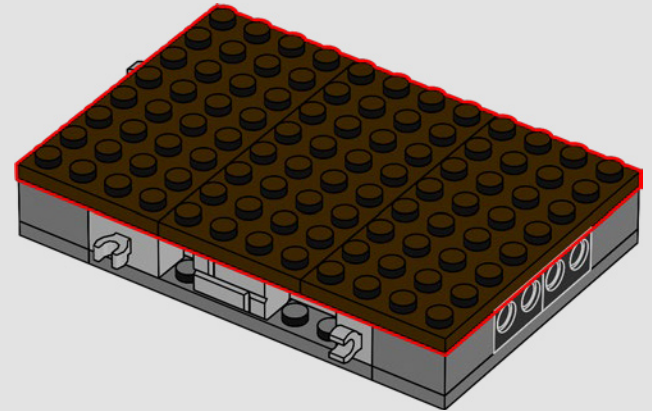

347

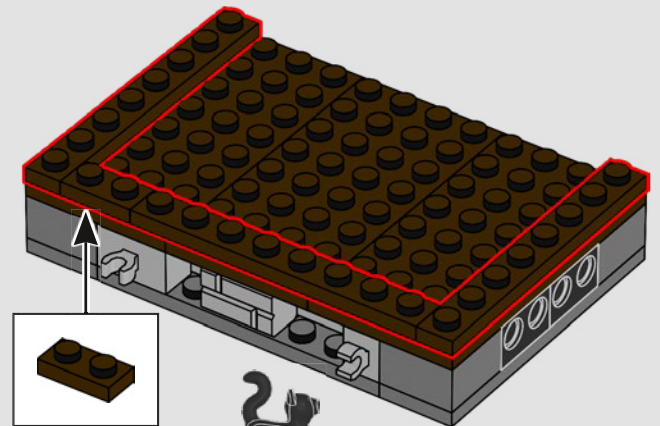

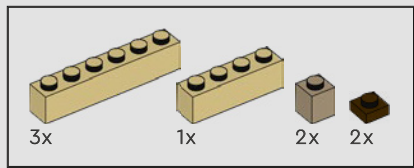

348

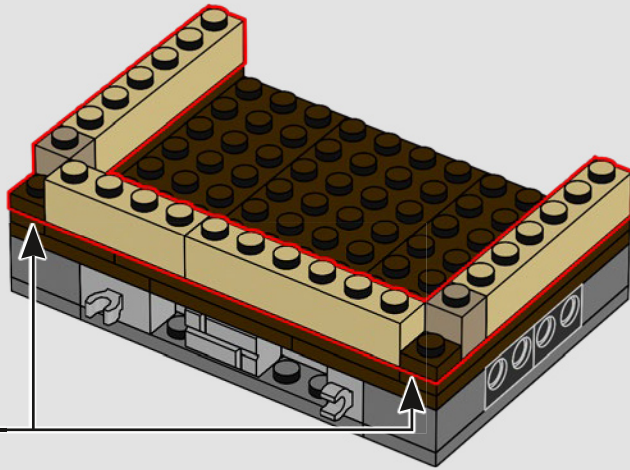

349

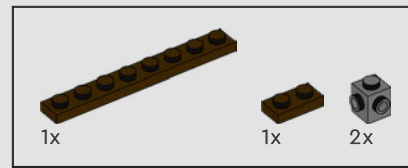
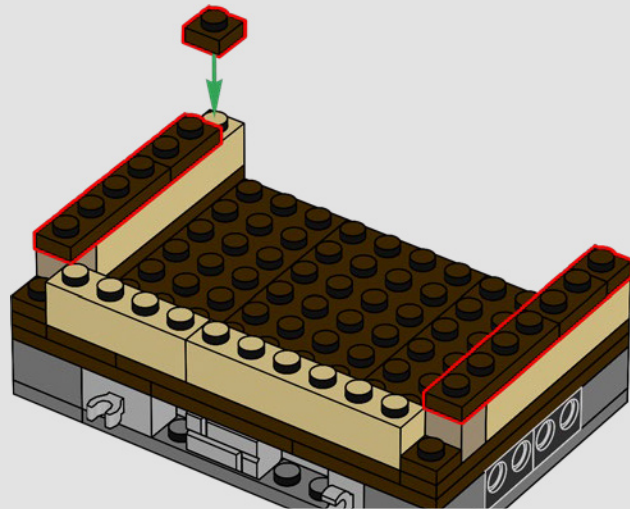

350

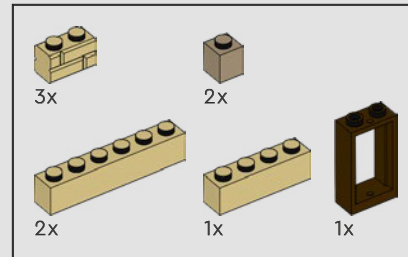
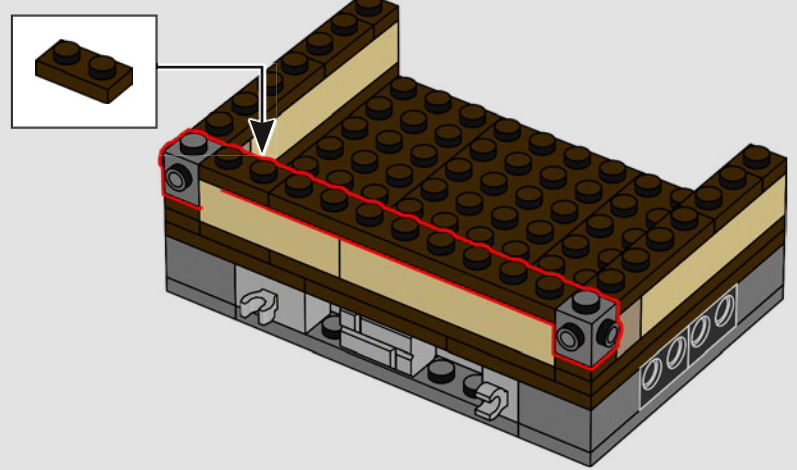

351

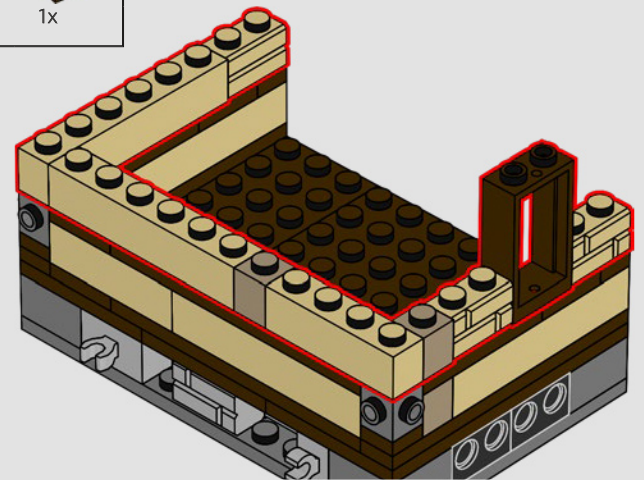

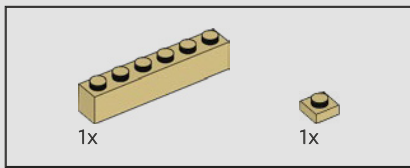

352

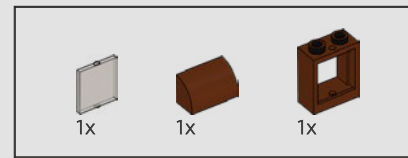
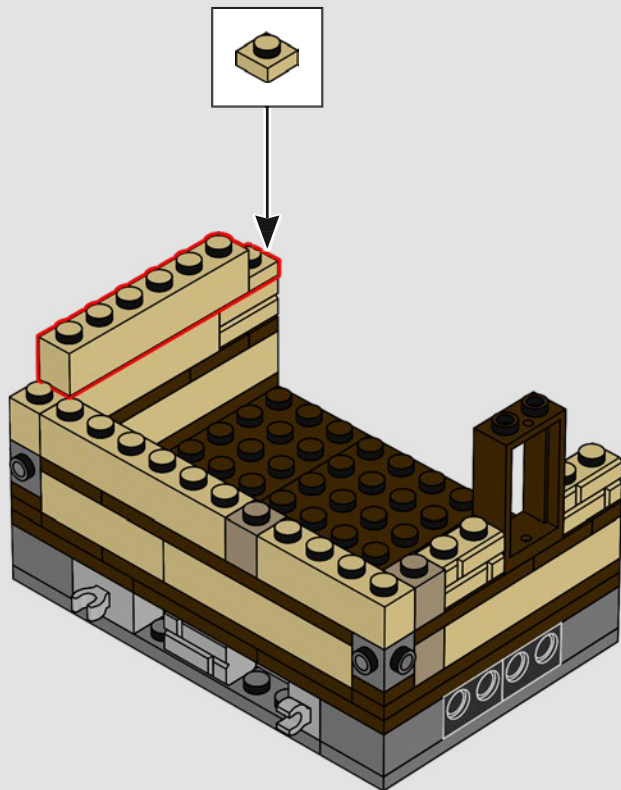

353

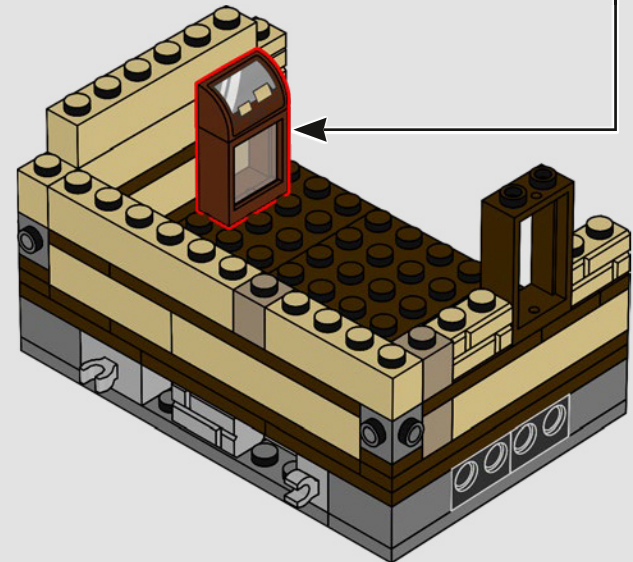
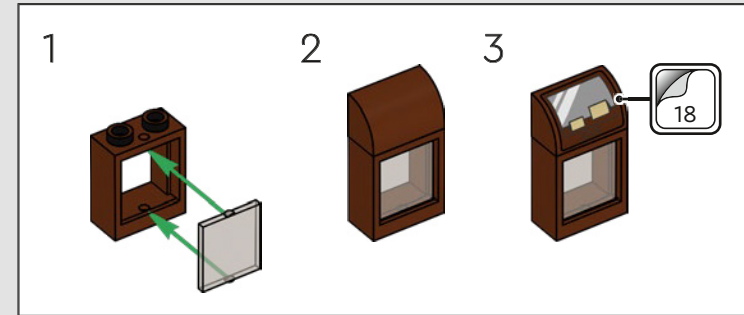

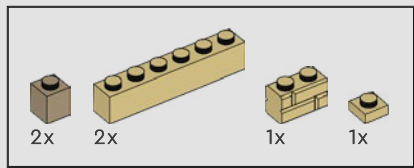

354

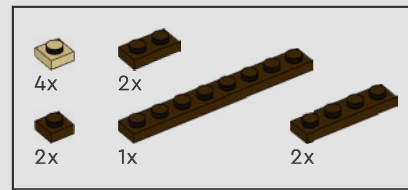
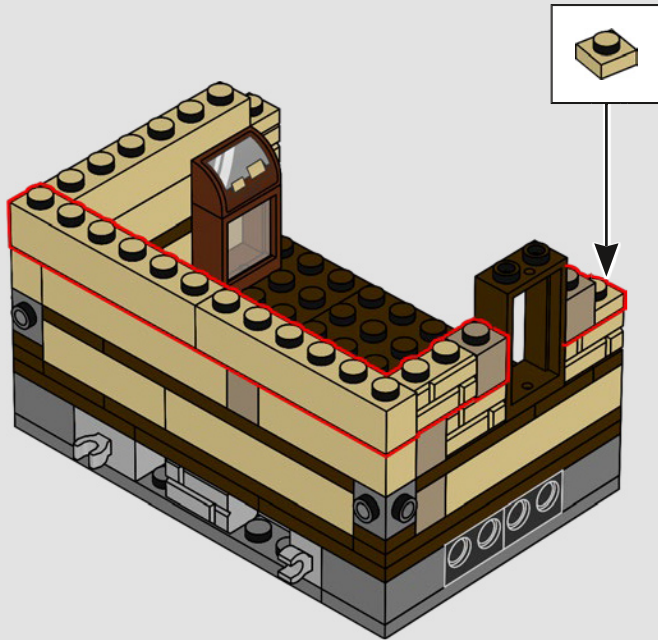

355

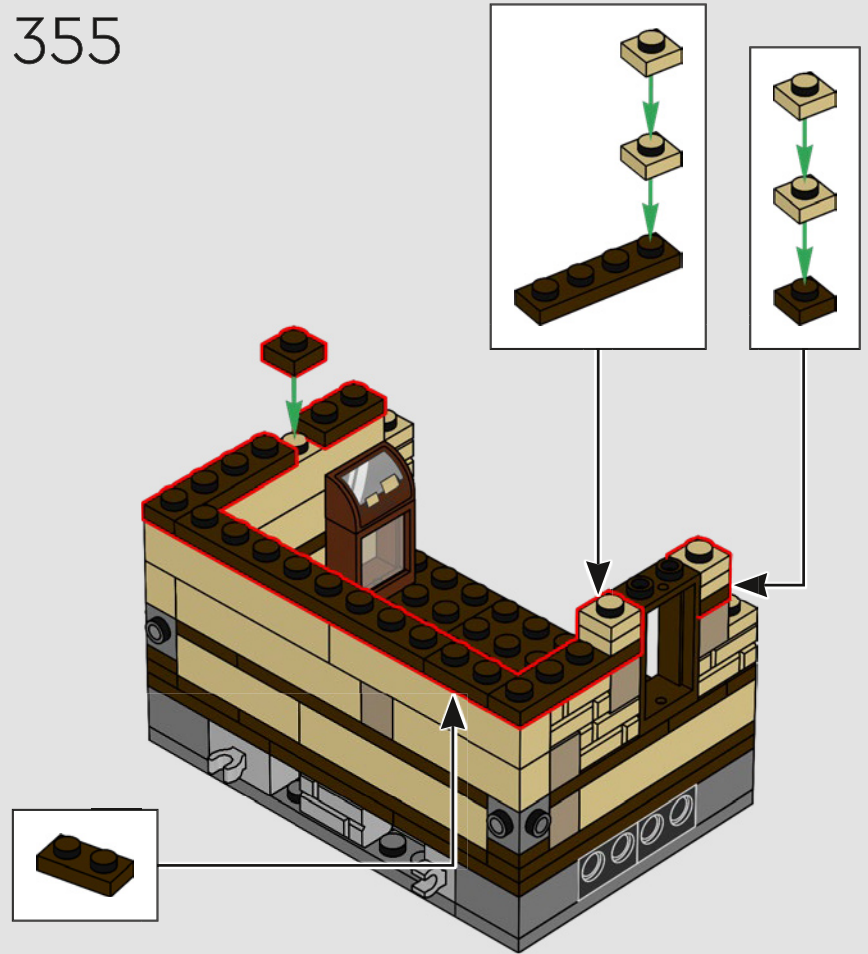

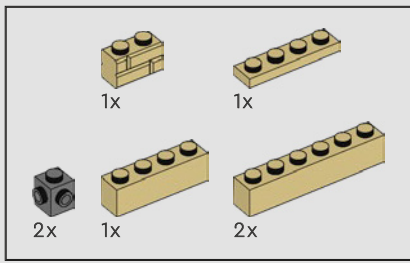

356

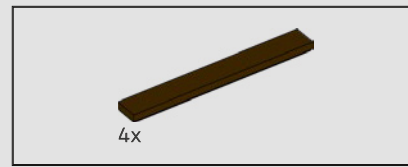
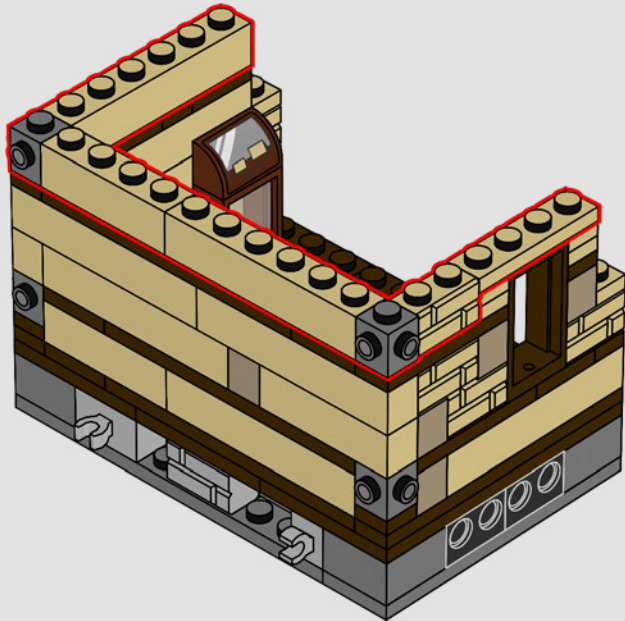

357

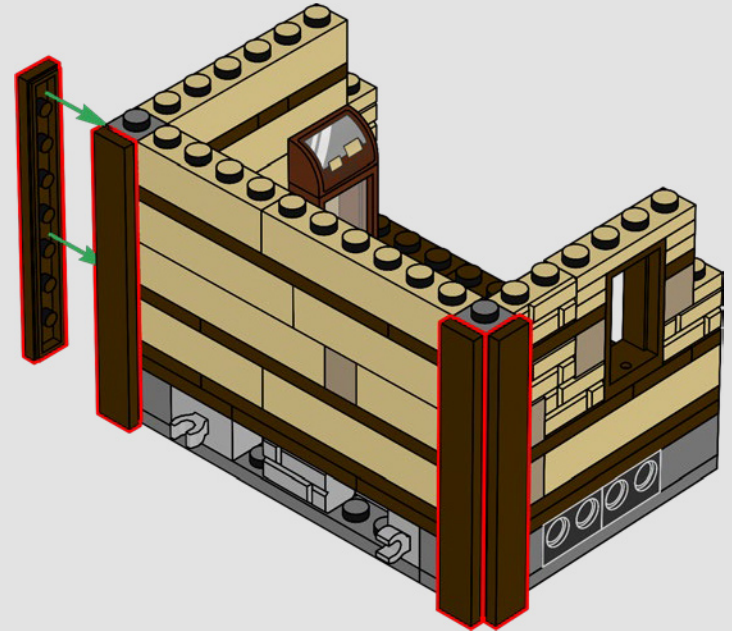

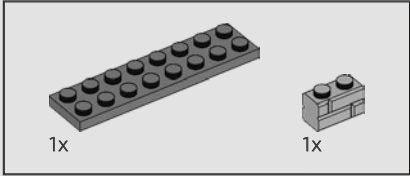
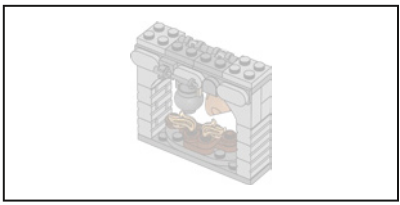

358

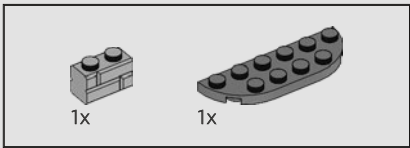
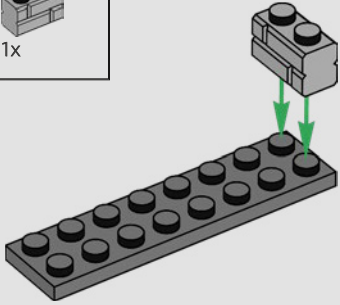

359

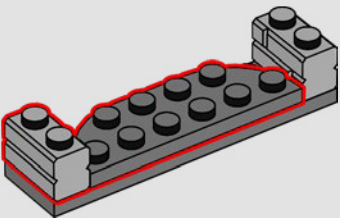

360

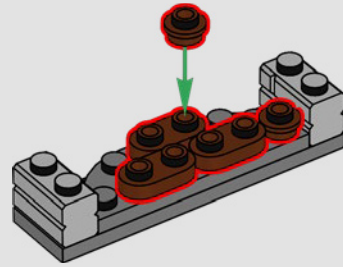

361

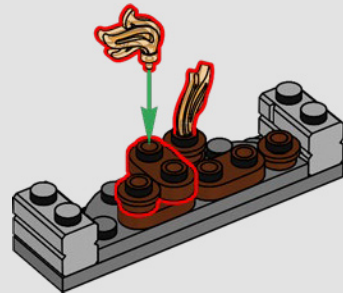

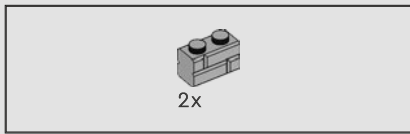

362

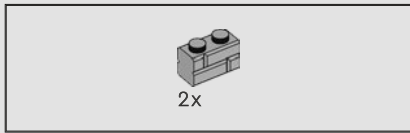
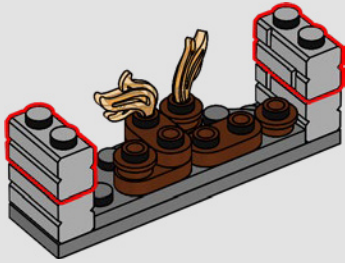

363

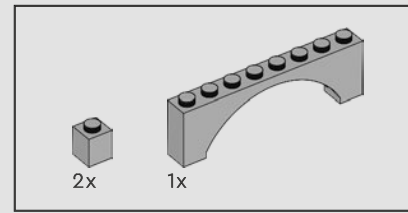
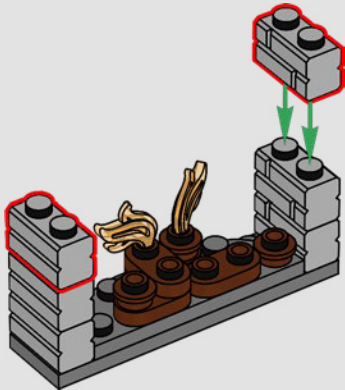

364

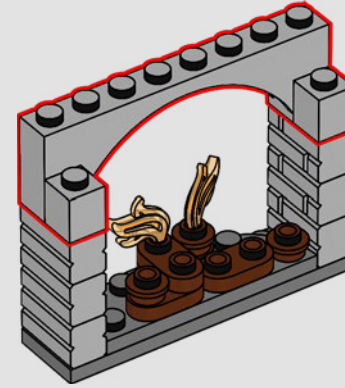

365

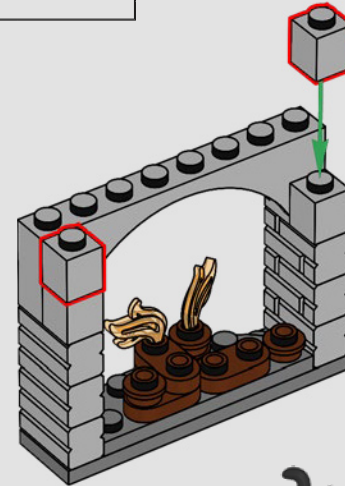

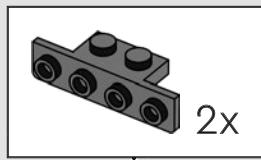
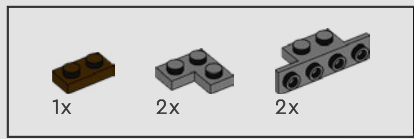

366

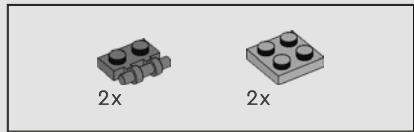
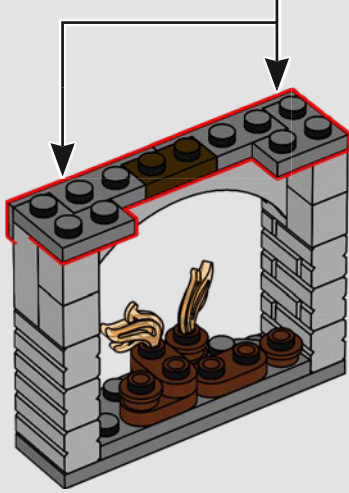

367

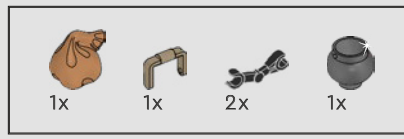
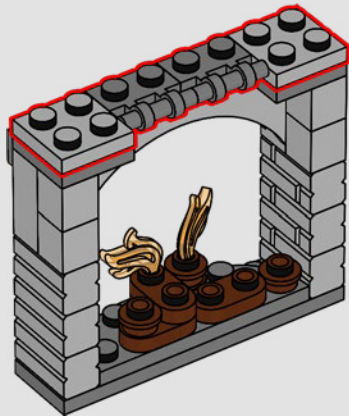

368

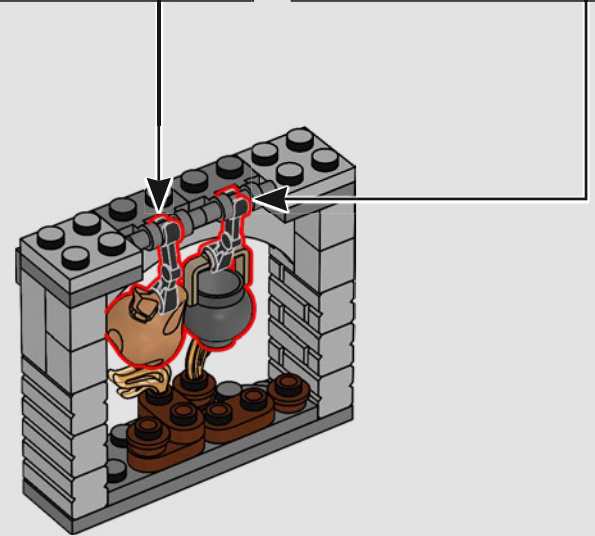
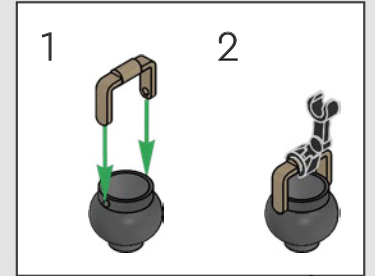
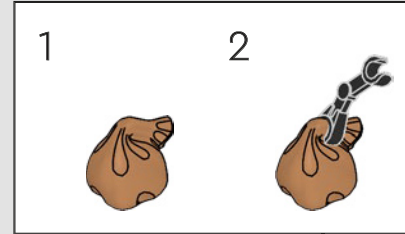



369

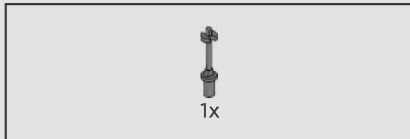
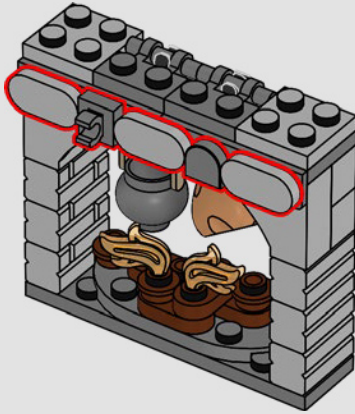

370

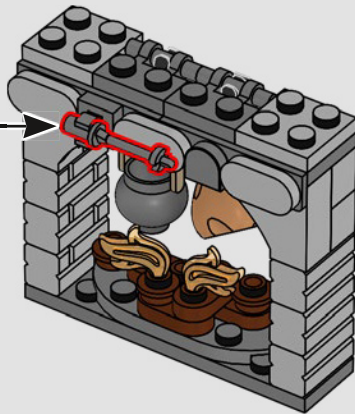
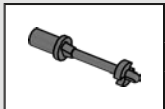

371

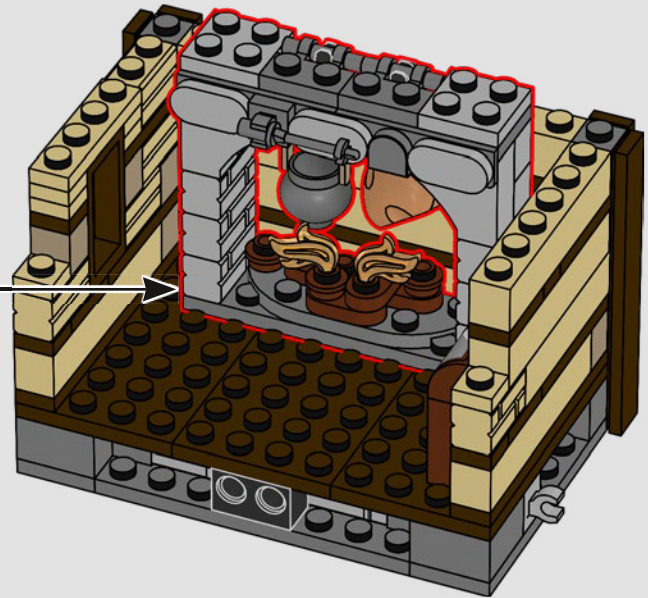



372

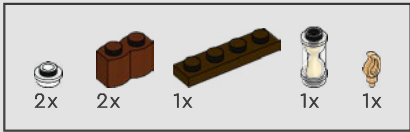
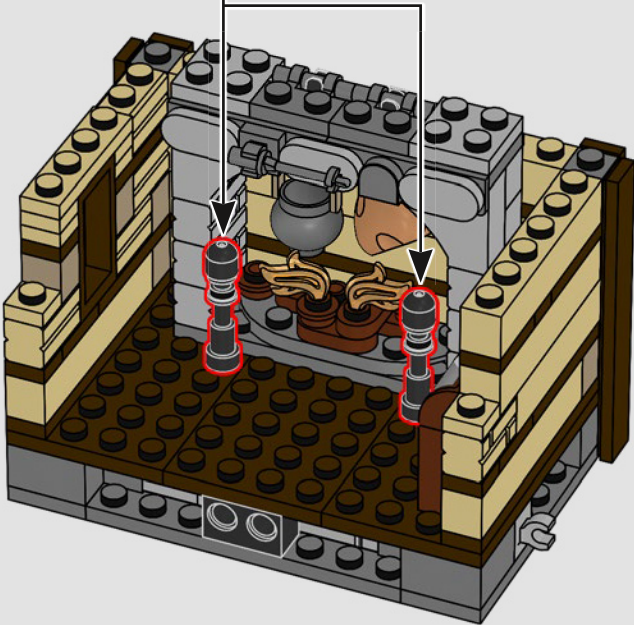
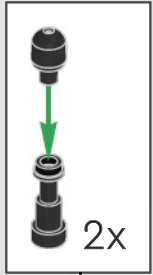

373

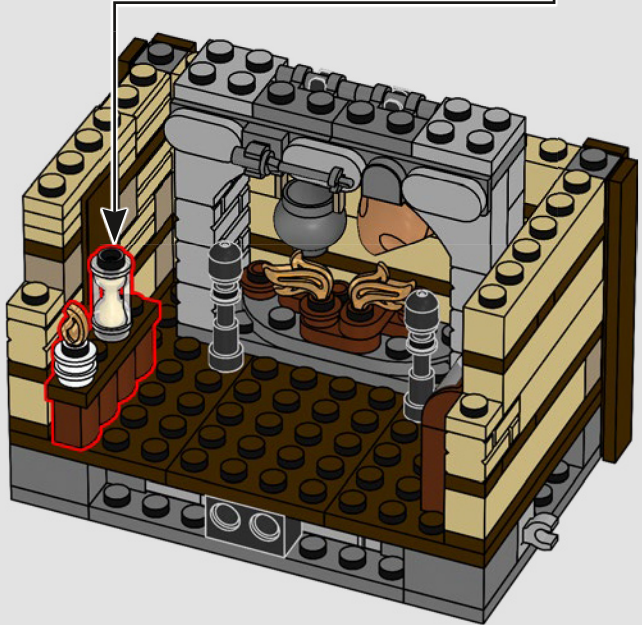
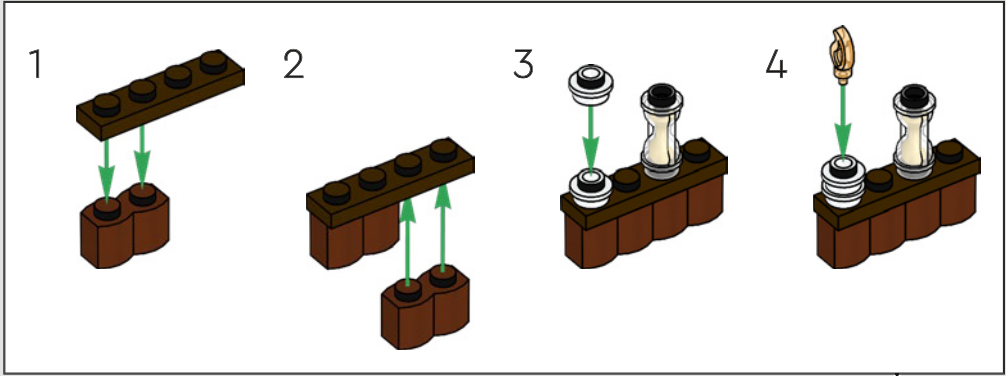

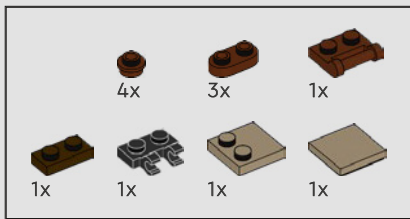

374

1



2

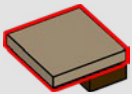

3

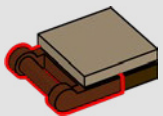

4



5

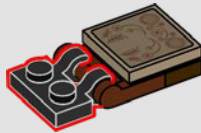

6

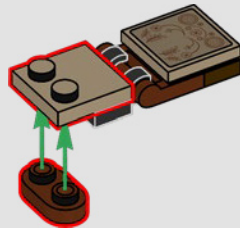

7

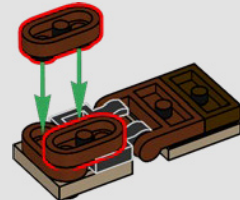

8

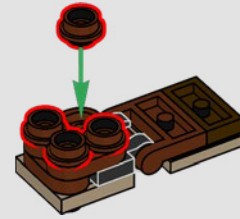

9

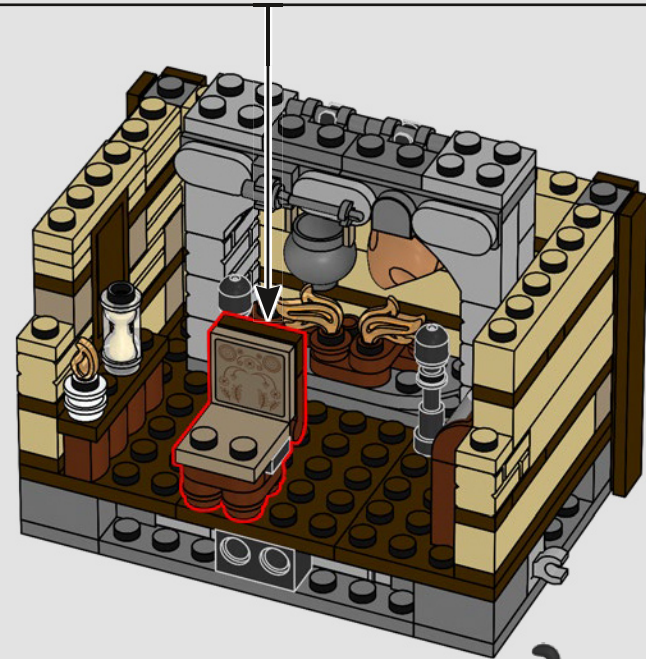
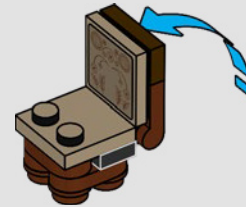

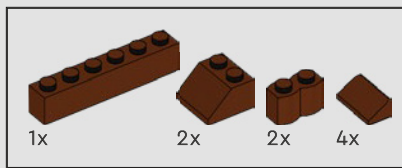

375

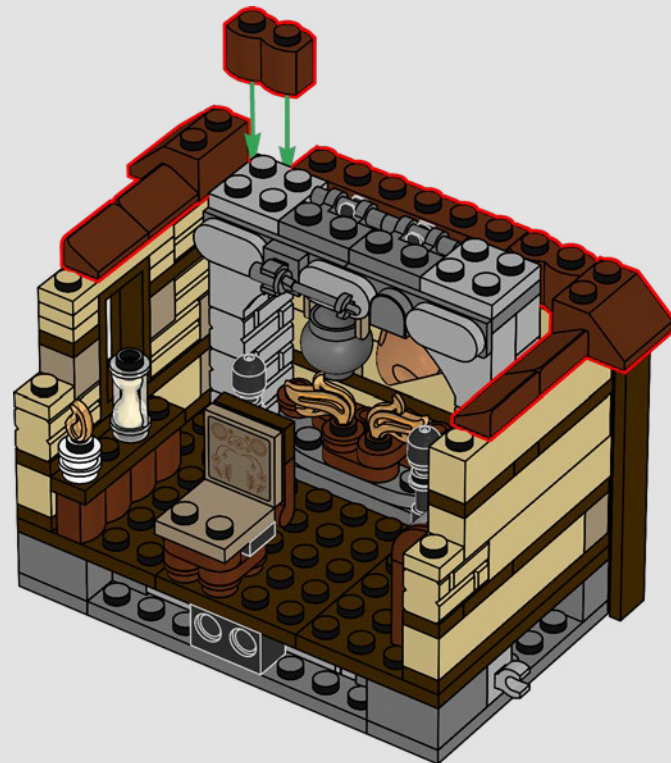
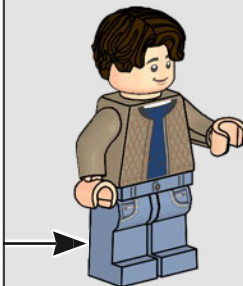
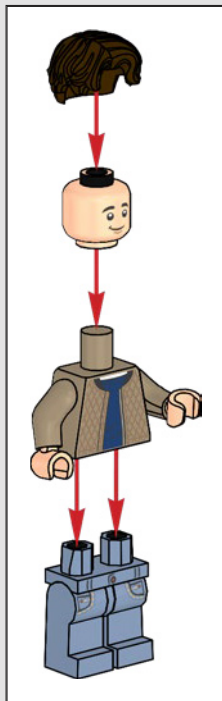

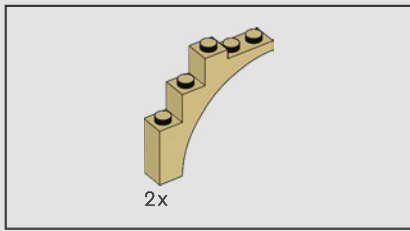

376

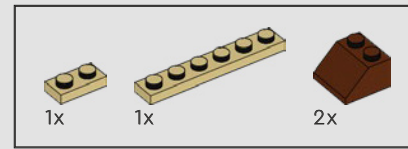
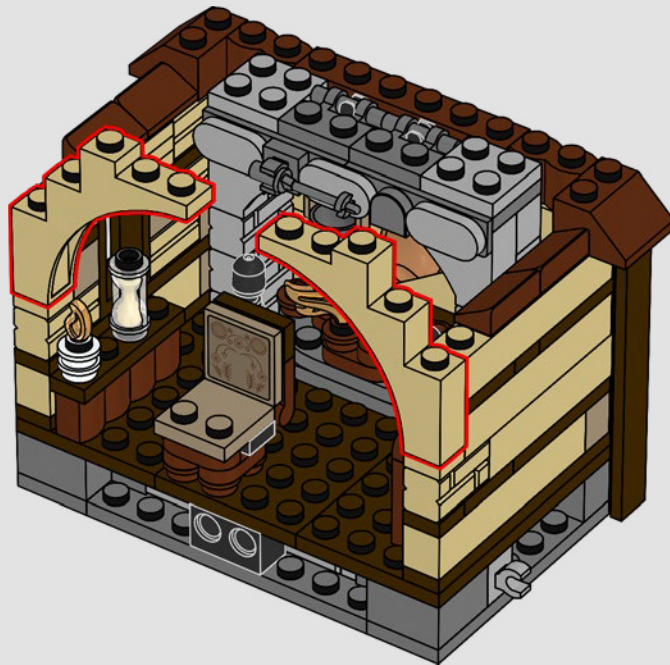

377

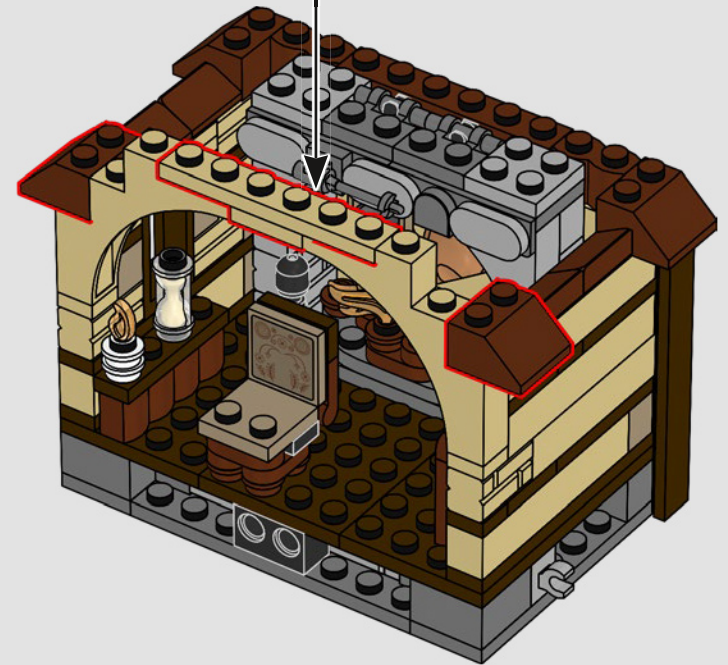
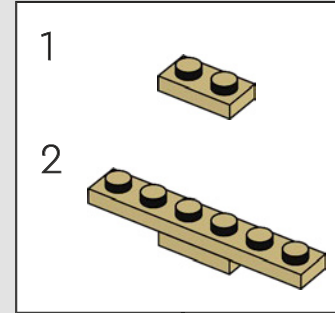

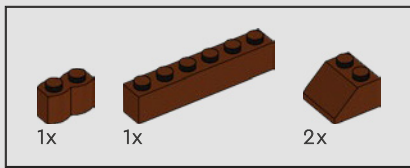

378

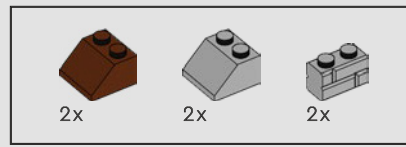
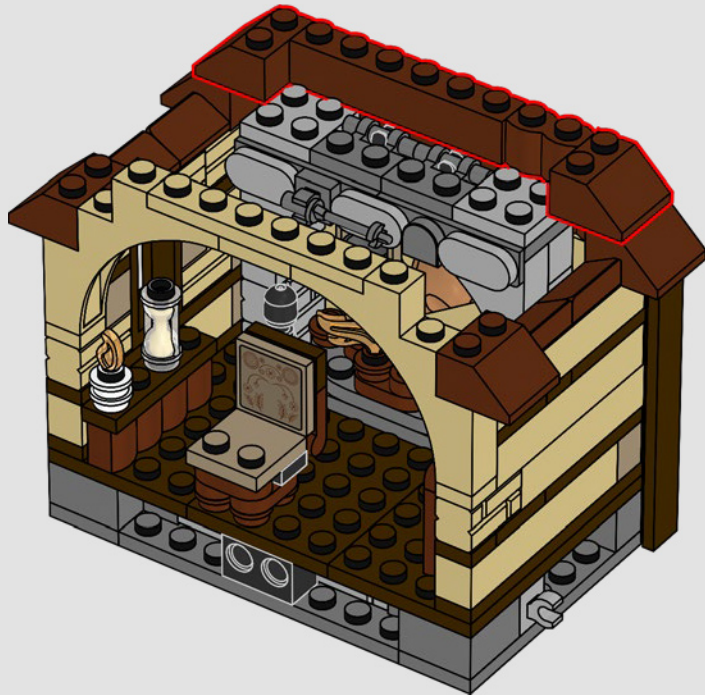

379

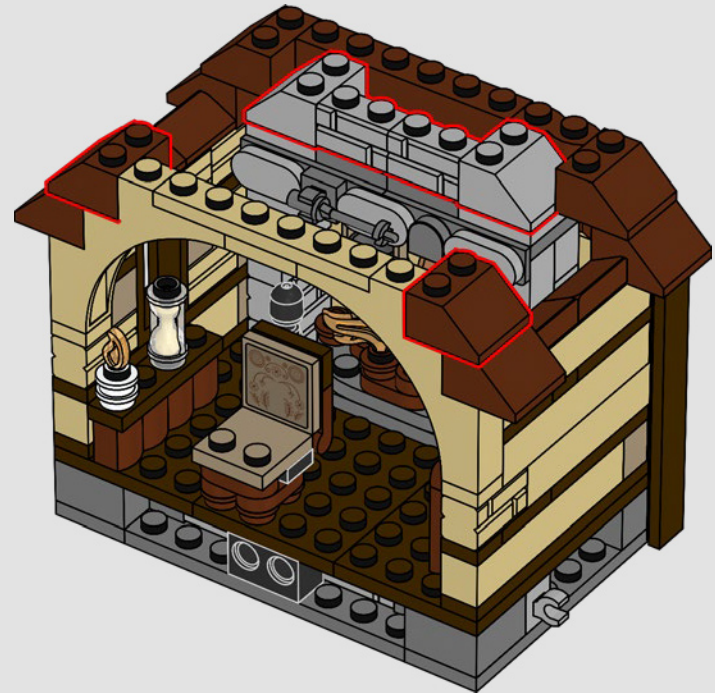

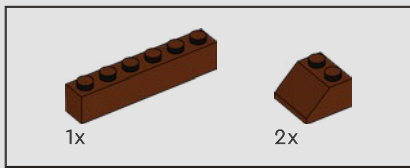

380

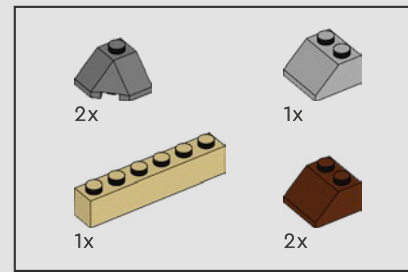
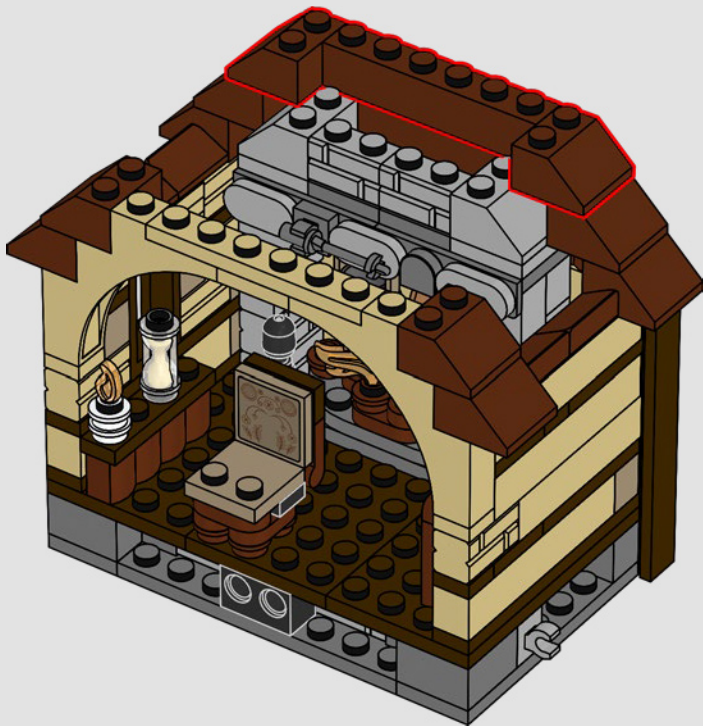

381

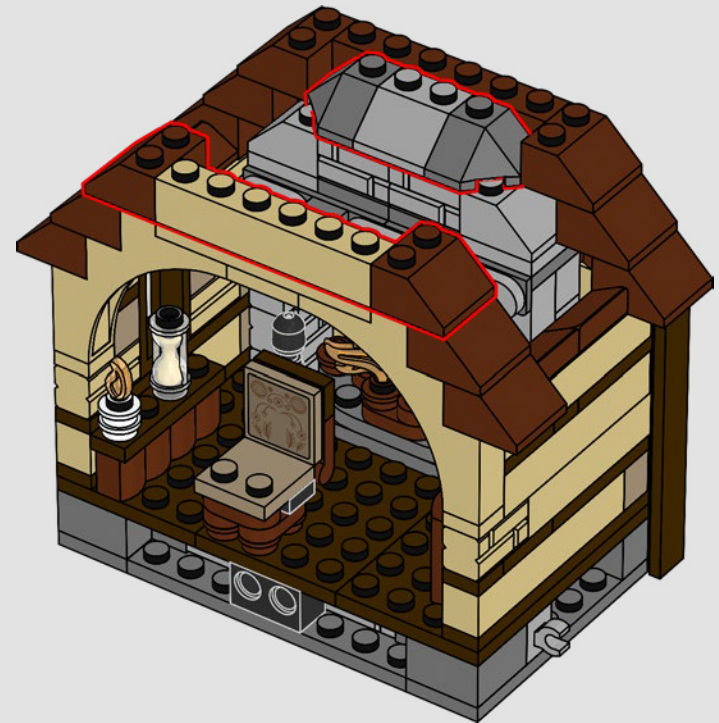

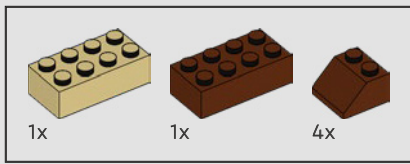

382

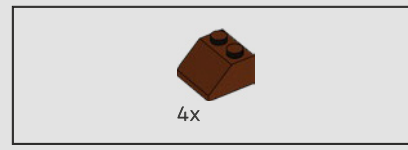
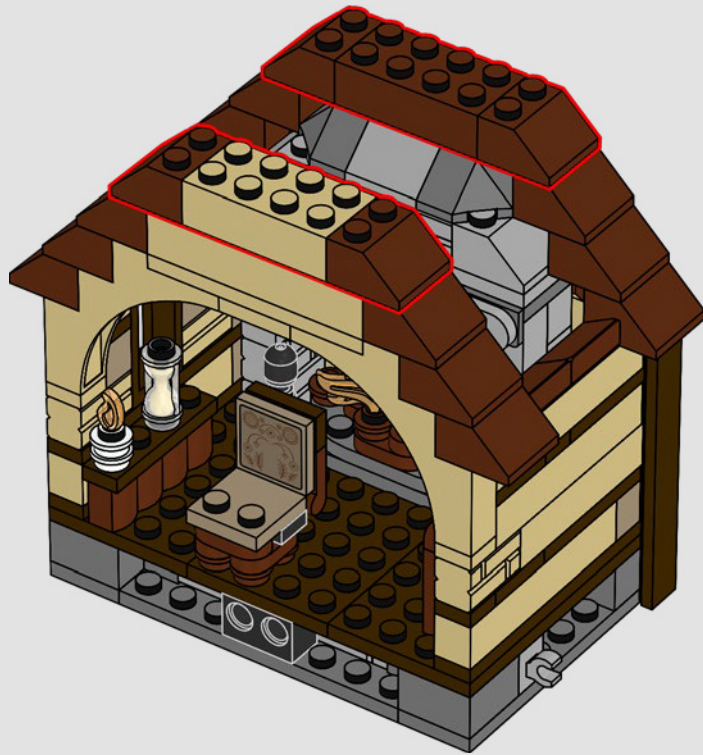

383

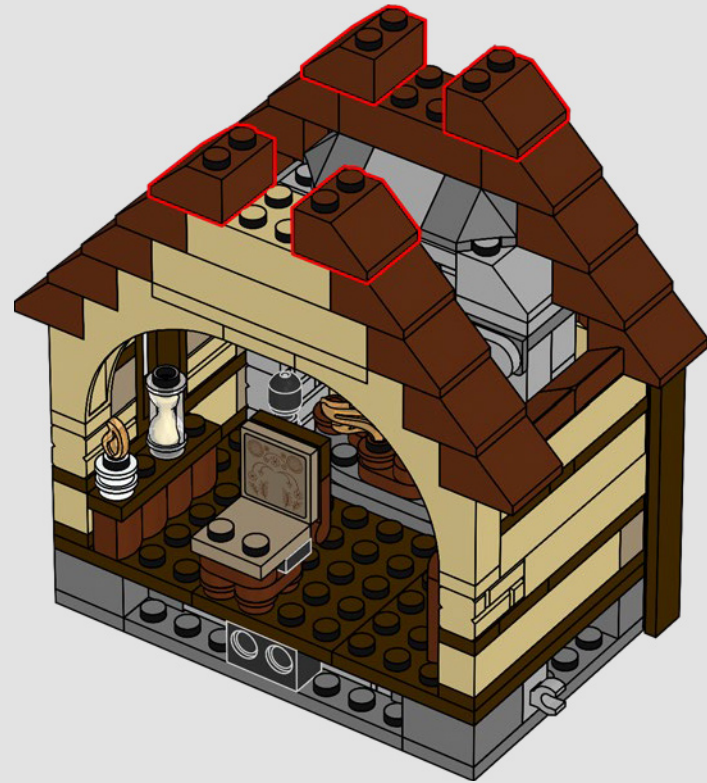

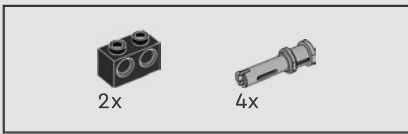

384

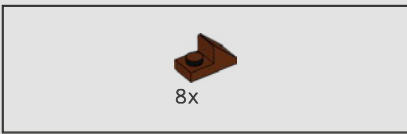
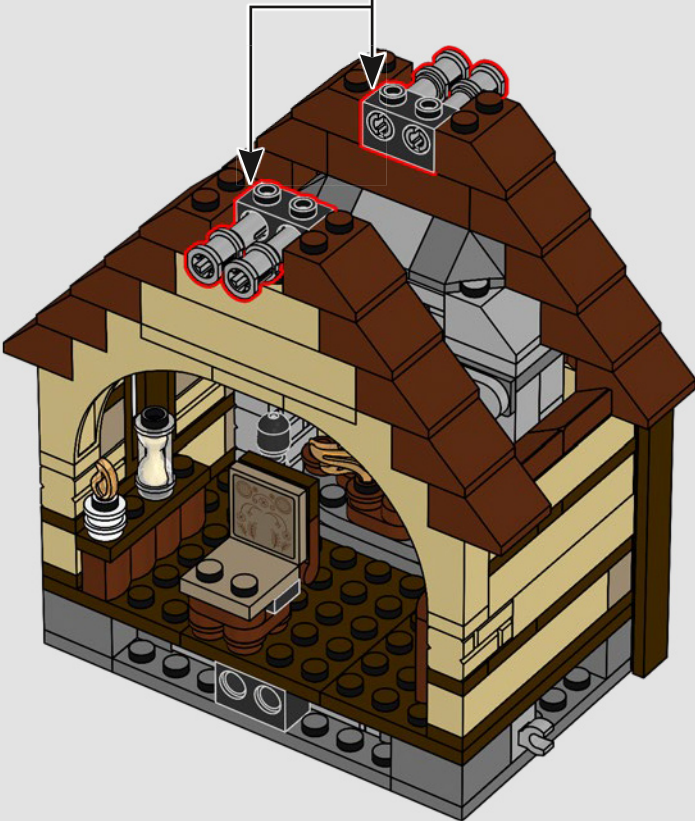
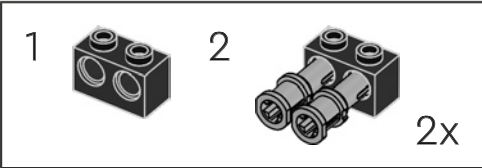

385

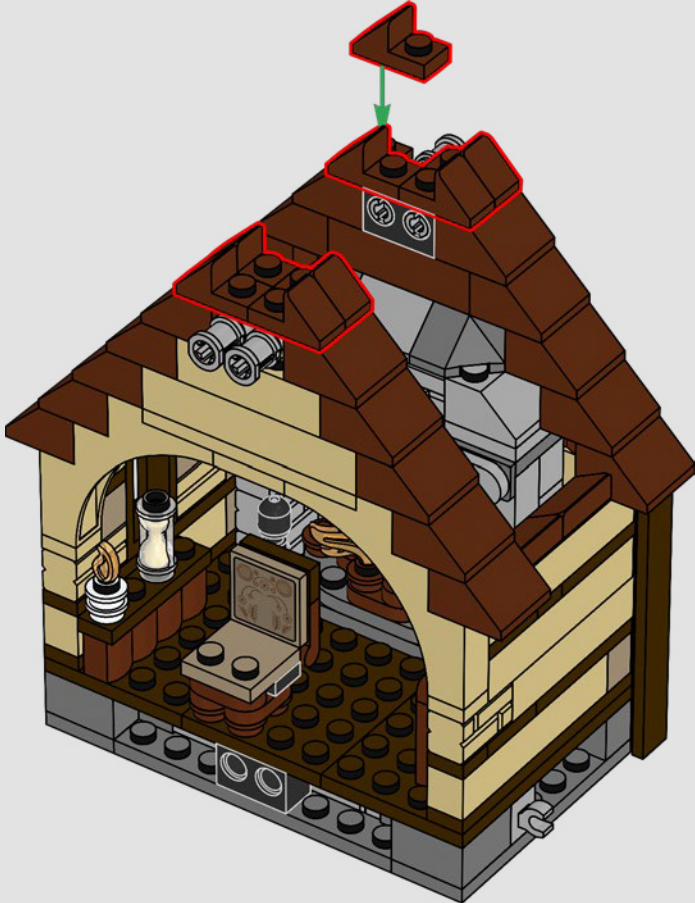

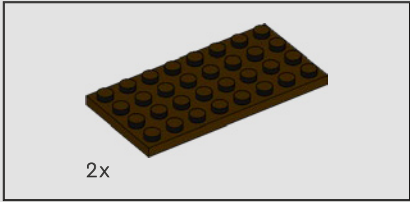
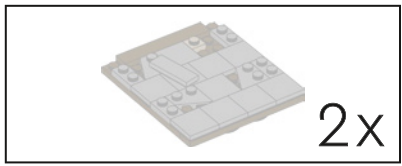

386

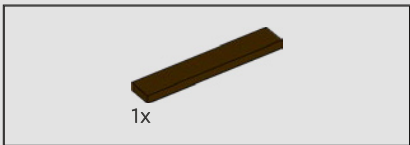
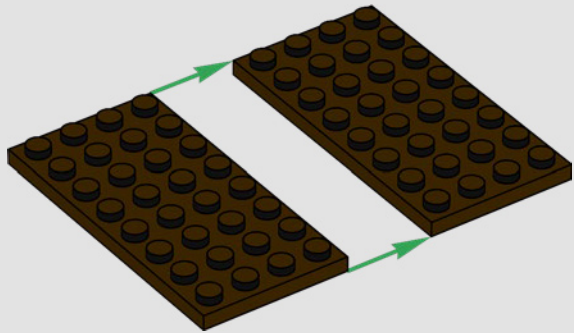

387

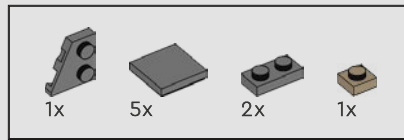
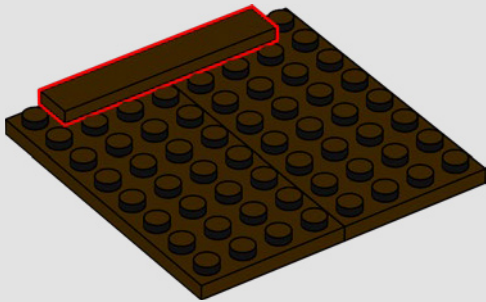

388

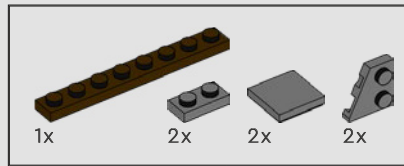
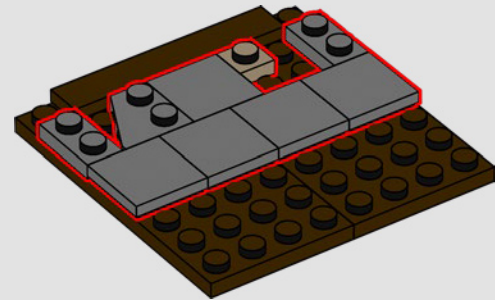

389

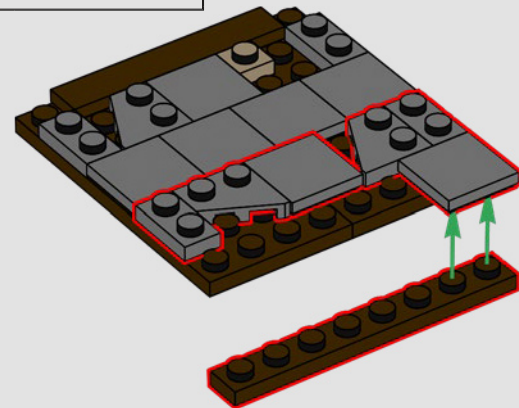

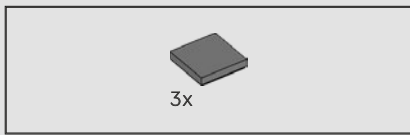

390

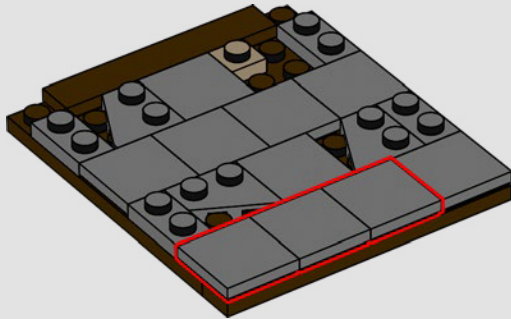

391

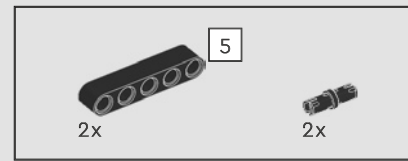
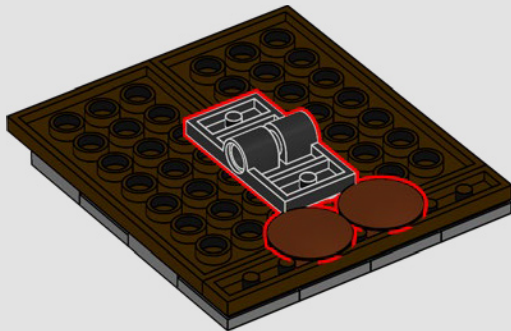

392

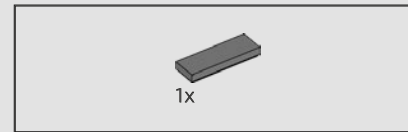
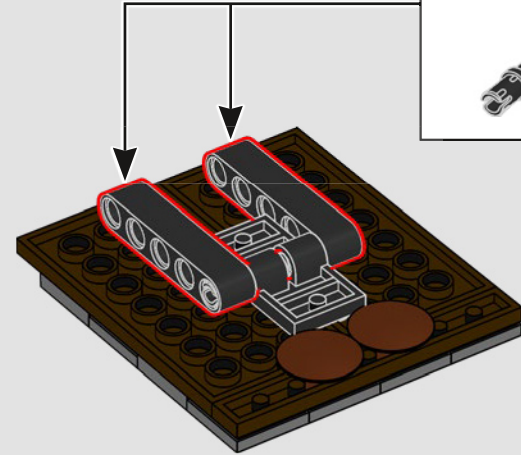
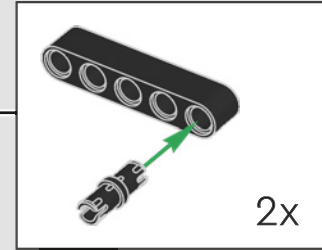

393

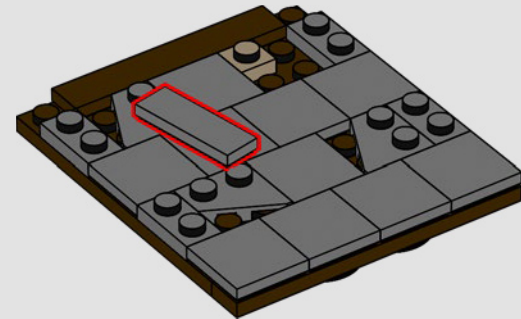

2x



394

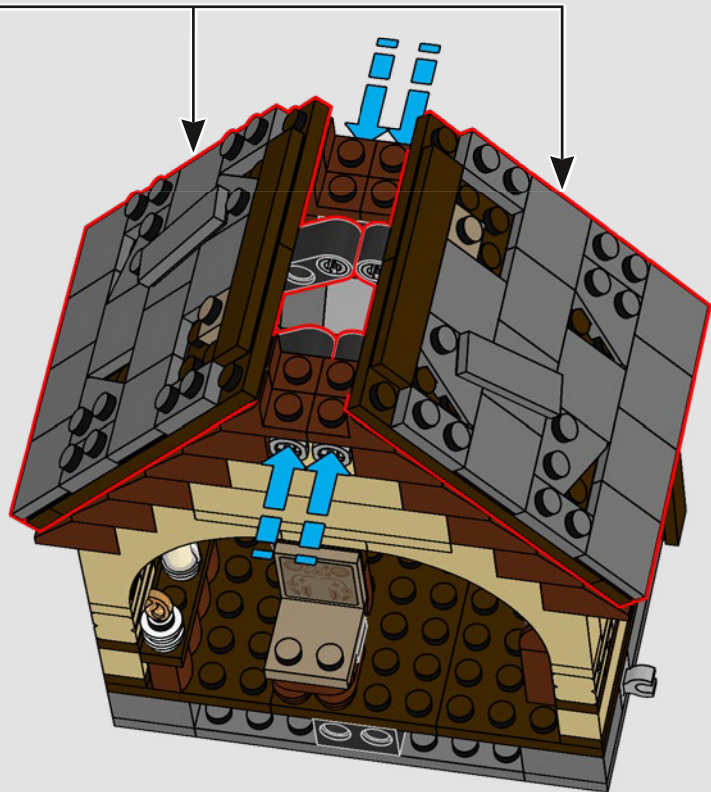

395

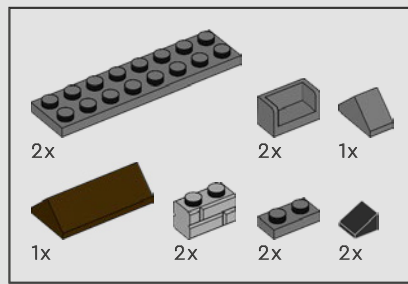

1

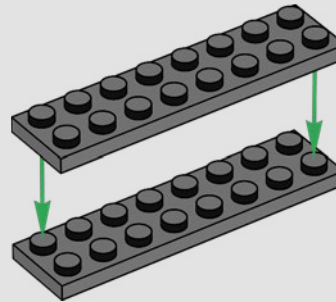

2

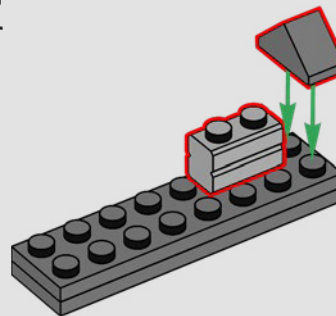

3

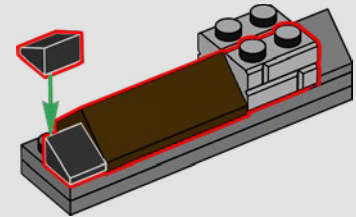

4

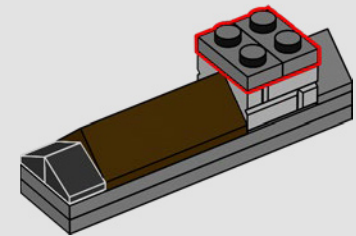

5

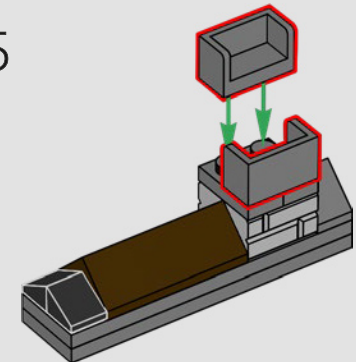

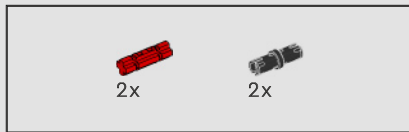

396

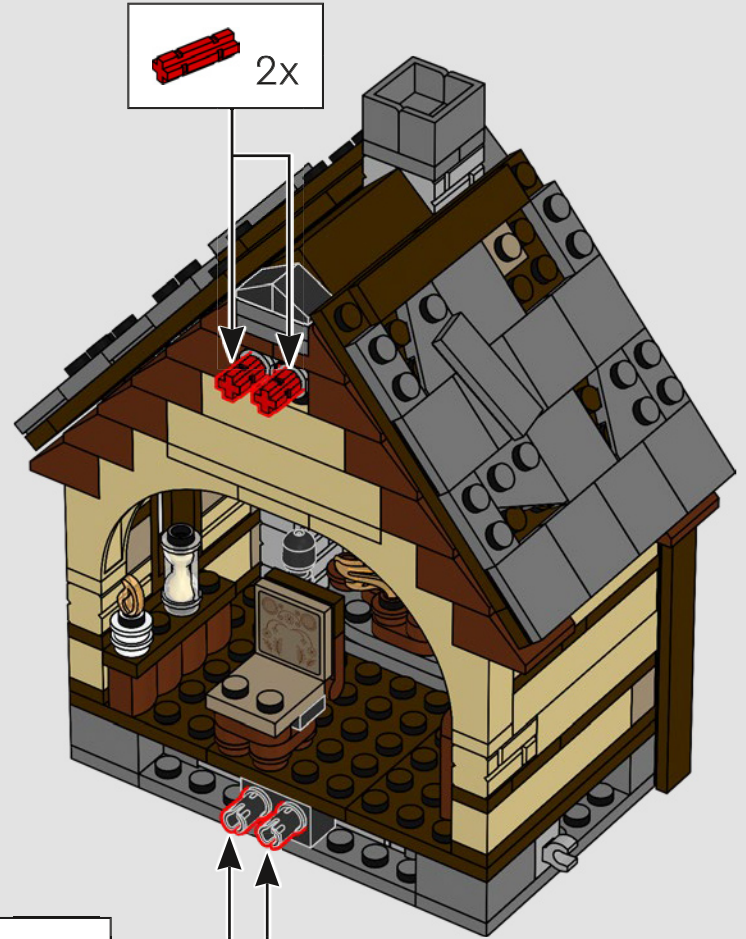
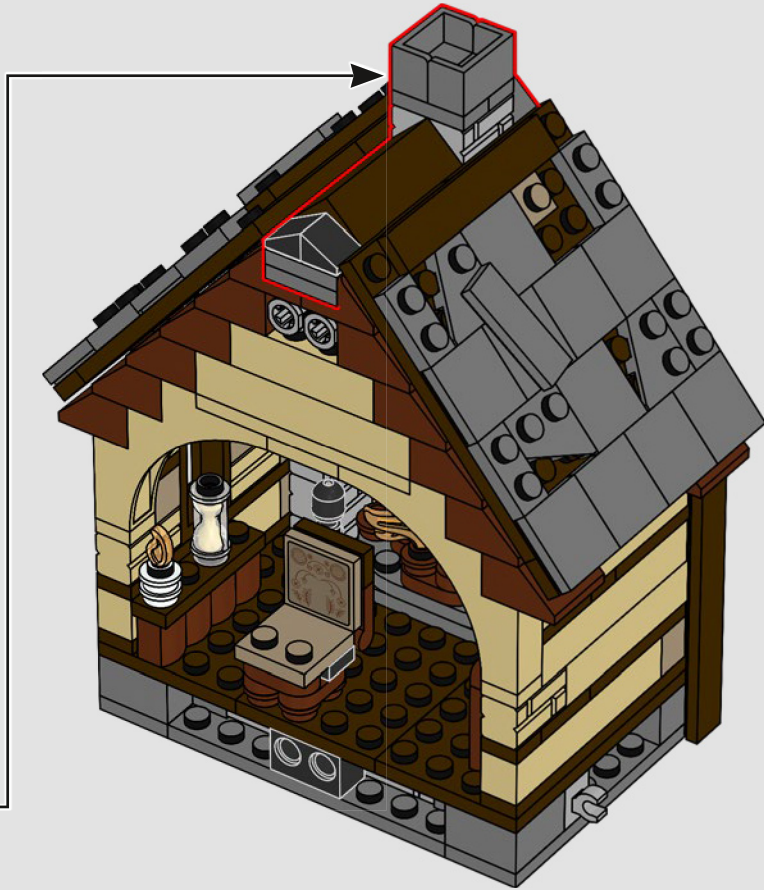

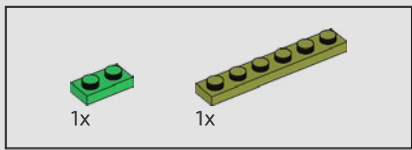

397

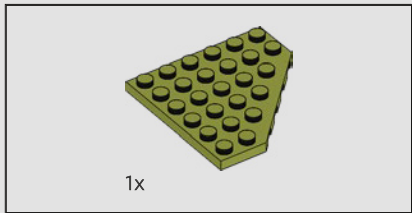
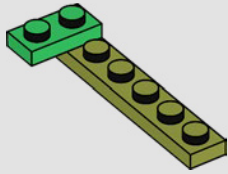

398

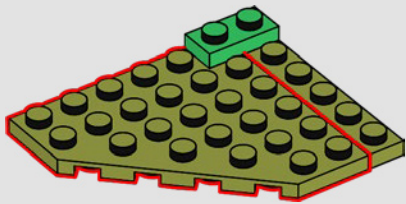

399

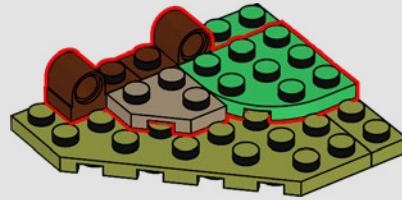

400

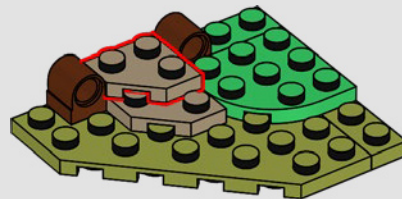

401

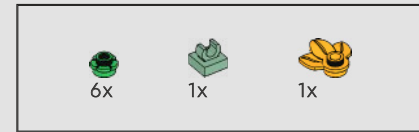
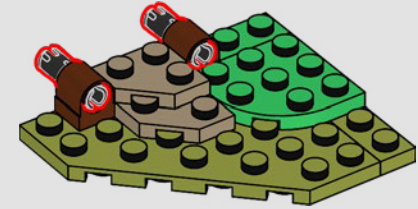

402

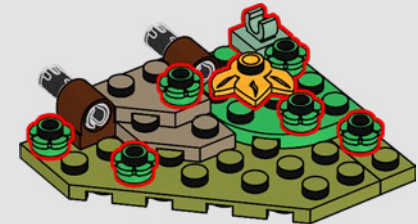

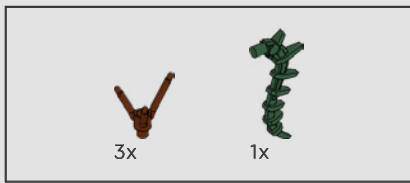

403

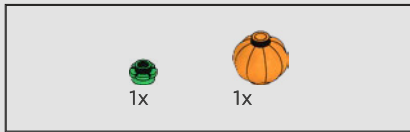
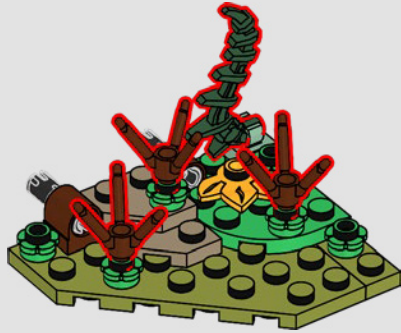

404



405

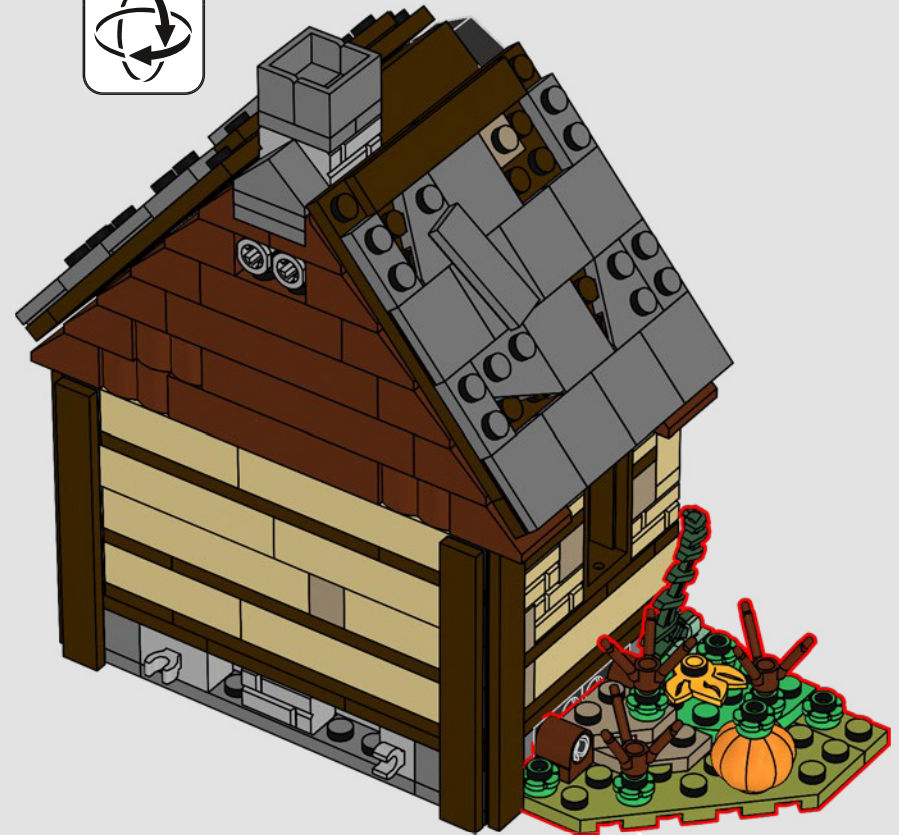

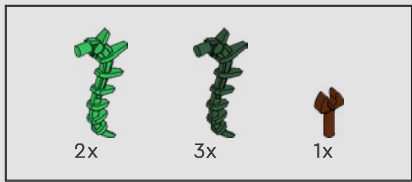

406

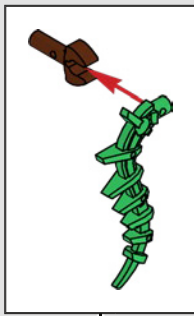

407







IDEAS

SHARE YOUR IDEA
TEILE DEINE IDEE
PARTAGEZ VOTRE IDÉE
CONDIVIDI LA TUA IDEA
COMPARTÉ TU IDEA
PARTILHA A TUA IDEIA
分享创意
PODZIEL SIĘ POMYSŁEM

SDÍLEJTE SVÉ NÁPADY
ZDIEĽAJTE SVOJE NÁPADY
OSZD MEG AZ ÖTLETED!
ÎMPĂRȚĂȘEȘTE IDEEA TA
СПОДЕЛЕТЕ ИДЕИТЕ СИ
PARĂDI SAVU IDEJU
JAGA OMA IDEED
PASIDALINK SAVO IDĚJA

GATHER SUPPORT
HOL DIR UNTERSTÜTZUNG
RECUEILLENZ DES VOTES
CHIEDI DI ESSERE SUPPORTATO
CONSIGUE APOYOS
OBTÉM APOIO
争取支持
ZDOBĄDŹ GŁOSY

ZÍSKEJTE PODPORU
ZÍSKAJTE PODPORU
SZEREZZ TÁMOGATÁST!
CERE SPRIJIN
ПОЛУЧЕТЕ ПОДКРЕПА
IEGŪSTI ATBALSTU
KOGU TOĒTUST
RINK PALAIKYMĄ

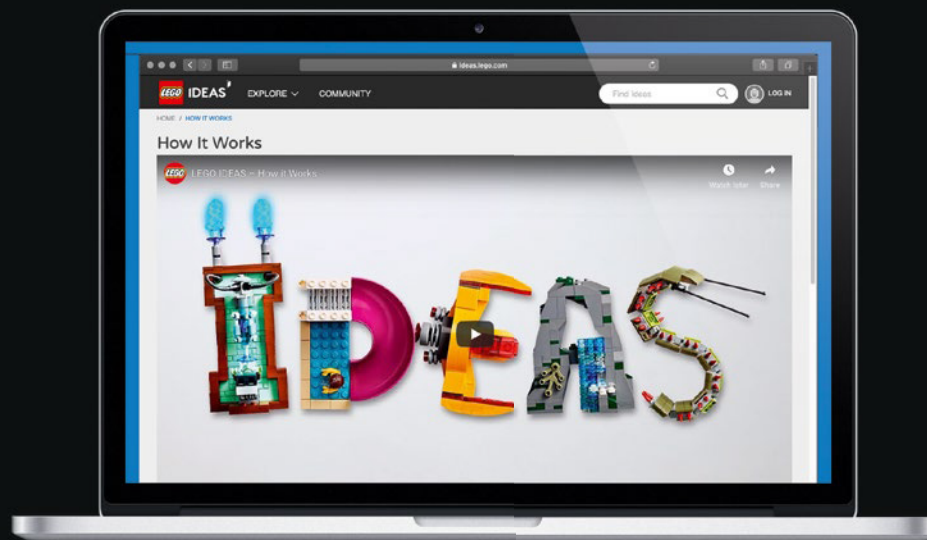
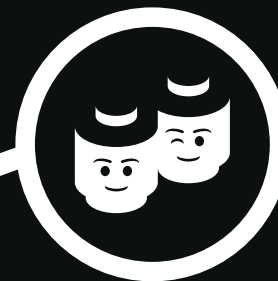
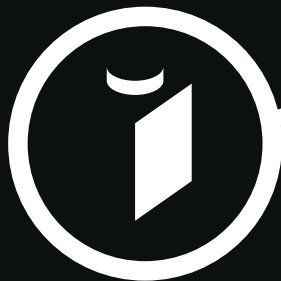

LEGO® REVIEW
LEGO® PRÜFUNG
EXAMEN PAR LEGO®
REVIEW LEGO®
REVISIÓN DE LEGO®
ΑΒΑΛΙΑÇΑO LEGO®
乐高®审核
OCENA LEGO®

OUZENÍ DESIGNÉRY LEGO®
POSÚDENÉ DIZAJNÉRMÍ LEGO®
LEGO® VÉLEMÉNYEZÉS
VERIFICARE LEGO®
ΠΡΕΓΛΕΔ ΗΑ LEGO®
LEGO® RECENZIJA
LEGO® ARVUSTUS
LEGO® APŽVALGA

NEW LEGO® PRODUCT
NEUES LEGO® PRODUKT
NOUVEAU PRODUIT LEGO®
NUOVO PRODOTTO LEGO®
NUEVO PRODUCTO LEGO®
NOVO PRODUTO LEGO®
全新乐高®产品
NOWY PRODUKT LEGO®

NOVÁ STAVEBNICE LEGO®
NOVÁ STAVEBNICA LEGO®
ÚJ LEGO® TERMÉK
PRODUS LEGO® NOU
НОВ ПРОДУКТ LEGO®
JAUNS LEGO® PRODUKTS
UUS LEGO® TOODE
NAUJAS LEGO® PRODUKTAS



ideas.LEGO.com



EN

Important information about batteries

Never use different types of batteries together, or a combination of old and new batteries. Always remove the batteries if the product is not to be used for a long time or if the batteries have run down. Never use damaged batteries. Only use alkaline type batteries. Insert the batteries so that the poles are correctly positioned. Never attempt to recharge non-rechargeable batteries. Never short-circuit the battery holder.

DE

Wichtige Informationen zu Batterien

Benutzen Sie niemals unterschiedliche Arten von Batterien oder alte und neue gleichzeitig. Nehmen Sie stets die Batterien heraus, wenn mit dem Modell längere Zeit nicht gespielt wird oder wenn die Batterien leer sind. Verwenden Sie niemals beschädigte Batterien. Verwenden Sie ausschließlich Alkali-Batterien. Achten Sie beim Einsetzen der Batterien auf die richtige Polung. Versuchen Sie unter keinen Umständen, „normale“ Batterien wieder aufzuladen. Schließen Sie das Batteriefach niemals kurz.

FR

Informations importantes concernant les piles

Ne jamais utiliser un mélange de différents types de piles, ou de piles neuves et de piles anciennes ou déjà utilisées. Toujours retirer les piles si le produit n'est pas utilisé durant une période prolongée ou si les piles sont vides. Ne jamais utiliser de piles endommagées. N'utiliser que des piles alcalines. En insérant les piles, respecter scrupuleusement le sens d'orientation des pôles (+/-). Ne jamais essayer de recharger des piles non rechargeables. Ne jamais court-circuiter le compartiment des piles.

IT

Importanti informazioni sulle batterie

Non usare mai contemporaneamente batterie di tipo diverso o batterie nuove e usate insieme. Rimuovere sempre le batterie qualora il prodotto non venga utilizzato per periodi prolungati, oppure se le batterie sono esauste. Non utilizzare mai batterie danneggiate. Utilizzare solo batterie di tipo alcalino. Inserire le batterie avendo cura che la loro polarità sia corretta. Non tentare mai di ricaricare batterie non ricaricabili. Non cortocircuitare mai il portabatterie.

NL

Belangrijke informatie over batterijen

Gebruik nooit verschillende soorten of een combinatie van oude en nieuwe batterijen tegelijkertijd. Verwijder de batterijen altijd als je het product lange tijd niet wilt gebruiken of als batterijen leeg zijn. Gebruik nooit beschadigde batterijen. Gebruik alleen alkalinebatterijen. Plaats de batterijen met de polen in de juiste richting. Probeer nooit niet-oplaadbare batterijen opnieuw op te laden. Laat de batterijhouder nooit kortsluiten.

ES

Información importante acerca de las pilas

No use pilas de diferentes tipos ni pilas nuevas y antiguas para alimentar el producto. Extraiga las pilas del producto si este va a permanecer sin uso durante un período prolongado de tiempo o aquellas se han agotado. No use pilas dañadas. Use solo pilas alcalinas. Inserte las pilas de modo que los polos queden situados en las posiciones correctas. No trate de cargar pilas no recargables. No cortocircuite el compartimento de las pilas.

DA

Vigtige oplysninger om batterier

Brug aldrig forskellige batterityper sammen eller en kombination af gamle og nye batterier. Fjern altid batterierne, hvis produktet ikke skal bruges i lang tid, eller hvis batterierne er flade. Brug aldrig beskadigede batterier. Brug kun alkaliske batterier. Sæt batterierne i, så polerne vender den rigtige vej. Forsøg aldrig at oplade ikke-genopladelige batterier. Kortslut aldrig batteriholderen.

IS

Mikilvægar upplýsingar um rafhlöður

Aldrei skal nota mismunandi gerðir rafhlaðna samtímis, né nýjar og eldri rafhlöður samtímis. Ef ekki á að nota tækið í lengri tíma eða ef rafhlöðurnar eru orðnar tómar skal fjarlægja rafhlöðurnar. Aldrei skal nota rafhlöður sem hafa skemmt. Eingöngu má nota alkaline-rafhlöður. Setja skal rafhlöðurnar í þannig að plús- og mínusskaut þeirra snúi rétt. Aldrei skal reyna að endurhlaða rafhlöður sem ekki eru endurhlaðanlegar. Aldrei ætti að valda skammhlaupi í rafhlöðuhólfinu.

FI

Tärkeää tietoa paristoista

Älä koskaan käytä erityyppisiä paristoja yhdessä. Älä myöskään käytä samassa laitteessa sekä vanhoja että uusia paristoja. Poista paristot tuotteesta aina, kun se on pitemmän aikaa käyttämättä, tai kun paristot ovat tyhjentyneet. Älä koskaan käytä viallisia paristoja. Käytä vain alkaliparistoja. Aseta paristot siten, että navat osoittavat oikeaan suuntaan. Älä koskaan aiheuta oikosulkuja pariston kosketinten välillä.

SV

Viktig information om batterier

Använd aldrig olika sorters batterier samtidigt, och inte heller en kombination av gamla och nya batterier. Ta alltid ur batterierna om produkten inte ska användas under en längre tid eller om batterierna är slut. Använd aldrig skadade batterier. Använd endast alkaliska batterier. Sätt i batterierna så att polerna hamnar i rätt läge. Försök aldrig ladda icke-laddningsbara batterier. Kortslut aldrig batteriutrymmets kontaktytor.

NO

Viktig informasjon om batterier

Bruk aldri ulike typer batterier sammen og heller aldri gamle og nye batterier sammen. Ta alltid ut batteriene hvis produktet ikke skal brukes på lang tid, eller hvis batteriene er brukt opp. Bruk aldri skadde batterier. Bruk bare alkaliske batterier. Sett inn batteriene med polene vendt riktig vei. Forsøk aldri å lade opp ikke-oppladbare batterier. Kortslett aldri batteriholderen.

PT

Informação importante sobre as pilhas

Nunca use diferentes tipos de pilhas em simultâneo, ou uma combinação de pilhas usadas e novas. Retire sempre as pilhas se o produto não for usado durante muito tempo ou se as pilhas já não tiverem carga. Nunca use pilhas danificadas. Use apenas pilhas alcalinas. Insira as pilhas de forma a que os polos fiquem corretamente posicionados. Nunca tente recarregar pilhas não recarregáveis. Nunca deixe o compartimento das pilhas entrar em curto-circuito.

EL

Σημαντικές πληροφορίες για τις μπαταρίες

Μην χρησιμοποιείτε ποτέ διαφορετικούς τύπους μπαταριών μαζί και μην συνδυάζετε παλιές και καινούργιες μπαταρίες. Αφαιρείτε πάντα τις μπαταρίες αν δεν σκοπεύετε να χρησιμοποιήσετε το προϊόν για αρκετό καιρό ή αν οι μπαταρίες έχουν αδειάσει. Ποτέ μην χρησιμοποιείτε μπαταρίες που έχουν φθορές. Χρησιμοποιείτε μόνο αλκαλικές μπαταρίες. Τοποθετήστε τις μπαταρίες με τους πόλους στη σωστή θέση. Μην επιχειρήσετε ποτέ να επαναφορτίσετε μη επαναφορτιζόμενες μπαταρίες. Ποτέ μην βραχυκυκλώνετε τη θήκη των μπαταριών.

JA

電池取扱いに関する重要事項

異なるタイプの電池や古い電池を混ぜて使用しないでください。商品を長時間使用しないときや電池が切れたときは、電池を必ず取り外してください。不具合のある電池は絶対に使用しないでください。アルカリタイプの電池のみを使用してください。電極を確認して電池を正しい向きに入れてください。充電式ではない電池は絶対に充電しないでください。電池ホルダーをショートさせないでください。

ZH

電池使用注意事項

请勿同时使用不同类型的电池，或把新旧程度不同的电池混合使用。如果产品将有很长时间不会使用，或者电池已经没电，请注意取出电池。切勿使用已破损的电池。仅可使用碱性电池。装入电池时请注意正负极。请勿尝试给非充电电池充电。切勿对电池仓进行短路连接。

KO

배터리 사용 시 주의사항

다른 종류의 배터리를 함께 사용하거나, 새 전지와 오래된 전지를 혼용하지 마세요. 배터리가 방전되었거나 장기간 제품을 작동하지 않을 때에는 반드시 배터리를 분리하세요. 파손된 배터리는 사용하지 마세요. 알칼라인 타입의 배터리만을 사용하세요. 양극과 음극의 위치를 잘 맞춰서 넣으세요. 일반 배터리는 충전해서 사용할 수 없습니다. 배터리 홀더의 접촉부에 배터리를 정확히 끼워서 사용하세요.

RU

Необходимая информация об элементах питания

Ни в коем случае не используйте одновременно элементы питания различных типов, а также элементы питания с разным сроком годности. В обязательном порядке вынимайте элементы питания из терминалов в случае, если вы не пользуетесь прибором в течение долгого времени, либо в случае, если в элементах питания закончился заряд. Ни в коем случае не используйте поврежденные элементы питания. Используйте только элементы питания щелочного типа. Установите элементы питания, соблюдая указанную полярность. Ни в коем случае не пытайтесь подзаряжать перезаряжаемые элементы питания. Ни в коем случае не пытайтесь замкнуть полюса в устройстве для элементов питания.

PL

Ważne informacje dotyczące baterii

Nigdy nie należy stosować razem różnych rodzajów baterii ani stosować równocześnie starych i nowych baterii. Jeżeli produkt nie jest używany przez dłuższy czas lub jeżeli baterie się wyczerpały, należy wyjąć baterie. Nigdy nie należy stosować uszkodzonych baterii. Należy używać wyłącznie baterii alkalicznych. Przy wkładaniu baterii należy zwrócić uwagę na właściwe położenie biegunów. Nigdy nie należy próbować ładowania baterii jednorazowych. Nigdy nie należy doprowadzać do zwarcia w gnieździe baterii.

CZ

Důležitá informace o bateriích

Nikdy nepoužívejte najednou různé typy baterií nebo kombinaci starých a nových baterií. Nebude-li se výrobek delší dobu používat nebo jsou-li baterie vybité, vždy je vyjměte z výrobku. Nikdy nepoužívejte poškozené baterie. Používejte pouze alkalické baterie. Baterie instalujte se správnou orientací pólů. Nikdy se nesnažte nabíjet baterie, které nejsou nabíjetelné. Nikdy nezkratujte kontakty v prostoru pro baterie.

SK

Dôležitá informácia o batériách

Nikdy nepoužívajte naraz odlišné typy batérií ani nekombinujte staré batérie s novými. Batérie vždy vyberte, ak sa výrobok nebude dlhšie používať, alebo ak sa batérie vybili. Nikdy nepoužívajte poškodené batérie. Používajte iba alkalické batérie. Batérie vkladajte so správnou orientáciou pólov. Nikdy sa nesnažte nabíjať batérie, ktoré nie sú nabíjateľné. Nikdy neskratuje kontakty v priestore pre batérie.

HU

Fontos tudnivalók az elemekről

Soha ne használjon különböző típusú elemeket, illetve ne használjon vegyesen új és használt elemeket. Mindig távolítsa el az elemeket, ha a készüléket előre láthatóan hosszabb ideig nem fogják használni, vagy ha az elemek lemerültek. Soha ne használjon megrongálódott elemeket. Csak alkáli elemeket használjon! Az elemeket helyesen helyezze be, a polaritásuknak megfelelően. Soha ne próbálja meg feltölteni a nem tölthető elemeket. Soha ne hozzon létre rövidzárlatot az elemtartó kivezetésain.

UA

Необхідна інформація про батарейки

Ніколи не використовуйте одночасно батарейки різних типів або батарейки з різним терміном придатності. Обов'язково вилучайте батарейки з приладу, якщо довго не користуєтесь ним, або якщо в батарейках уже скінчився заряд. Ніколи не використовуйте пошкоджені батарейки. Використовуйте лише лужні батарейки. Вставляйте батарейки, враховуючи задану полярність. У будь-якому випадку не намагайтеся підзарядити батарейки, що не підлягають підзарядці. У будь-якому випадку не намагайтеся зробити коротке замикання в приладі для батарей.

HR

Važne obavijesti o bateriji

Nikada nemoj koristiti različite vrste baterija zajedno, isto tako ni kombinaciju starih i novih baterija. Uvijek izvadite baterije ako dugo nećeš koristiti proizvod ili ako su one potrošene. Nikada nemoj koristiti oštećene baterije. Upotrebļjavajte samo alkalne baterije. Umetni baterije pazeđi da dobro okreneš polove. Nikada ne pokušavaj puniti baterije koje nisu predviđene za punjenje. Nikada ne izazivaj kratki spoj u držaču baterija.

SR

Важне информације о батеријама

Никада не користите различите типове батерија заједно нити комбинацију старих и нових батерија. Увек извадите батерије уколико производ нећете дуже време користити или уколико су батерије празне. Никада не користите оштећене батерије. Користите само алкалне батерије. Ставите батерије тако да су полови правилно позиционирани. Никада не покушавајте да пуните батерије које не могу да се пуне. Никада не изазивајте кратак спој у кућишту за батерије.

МК

Важни информации за батериите

Никогаш не користете различни типови батерии заедно или комбинација од стари и нови батерии. Секогаш отстранувајте ги батериите доколку не го користите производот подолго време или доколку се потрошиле. Никогаш не користете оштетени батерии. Користете само алкални батерии. Вметнете ги батериите така што точно ќе ги наместите половите. Никогаш не обидувајте се да ги полните батериите за еднократна употреба. Никогаш не предизвикувајте краток спој на држачот за батерии.

SL

Pomembne informacije o baterijah

Nikoli ne uporabljajte skupaj različnih baterij ali kombinacije starih in novih baterij. Vedno odstranite baterije, če izdelka dlje časa ne boste uporabljali ali če so iztrošene. Nikoli ne uporabljajte poškodovanih baterij. Uporabljajte le alkalne baterije. Baterije vstavite tako, da so njihovi polji pravilno obrnjeni. Nikoli ne poskušajte polniti baterij, ki niso akumulatorske. Pazite, da ležišč za baterije ne boste spravili v kratak stik.

RO

Informații importante despre baterii

Nu folosiți niciodată împreună tipuri diferite de baterii, sau o combinație de baterii vechi și noi. Îndepărtați întotdeauna bateriile dacă produsul nu este folosit timp îndelungat sau dacă bateriile s-au epuizat. Nu folosiți niciodată baterii deteriorate. Utilizați numai baterii de tip alcalin. Introduceți bateriile astfel ca polii să fie poziționați corect. Nu încercați niciodată să reîncărcați baterii nereîncărcabile.

Nu scurtcircuitați niciodată suportul bateriei.

BG

Важна информация за батериите

Никога не използвайте едновременно различни типове батери или комбинация от стари и нови батерии. Винаги изваждайте батериите, ако изделието няма да се използва продължително време или ако батериите са се изтозили. Никога не използвайте повредени батерии. Използвайте само алкални батерии. Поставяйте батериите така, че полюсите да са разположени правилно. Никога не опитвайте да зареждате батерии, които не са акумулаторни. Никога не свързвайте на късо контактите на отделението за батериите.

LV

Svarīga informācija par baterijām

Nekad vienlaikus nelietojiet dažādu tipu, kā arī vecas un jaunas baterijas. Vienmēr izņemiet baterijas, ja tās ir izlādējušās vai ja produkts ilgāku laiku netiek lietots. Nekad nelietojiet bojātas baterijas. Izmantojiet tikai sārma tipa baterijas. Ievietojot baterijas, ievērojiet pareizu polaritāti. Nekad nemēģiniet uzlādēt baterijas, kas nav uzlādējamās. Nepieļaujiet issavienojumu bateriju nodalījumā.

ET

Oluline teave patareide kohta

Ära kunagi kasuta koos erinevat tüüpi patareisid, samuti vanu ja uusi patareisid. Kui mänguasja ei kasutata pika aja jooksul, võta patarei sellest välja. Ära kunagi kasuta kahjustatud patareisid. Kasuta ainult leelispatareisid. Pane patareid mänguasja sisse nii, et pluss- ja miinusklemmi asend oleks õige. Ära kunagi proovi akulaadijaga laadida tavalisi patareisid. Patareipesa klemmide vahel ei tohi tekkida lühist.

LT

Svarbi informacija apie elementus

Vienu metu nenaudokite skirtingų elementų, taip pat su naujais elementais nenaudokite senų. Jei nenaudosite gaminio ilgesnį laiką arba jei elementai išseko, visuomet išimkite juos iš gaminio. Niekada nenaudokite pažeistų elementų. Naudokite tik šarminius elementus. Elementus dėkite atsižvelgdami į jų poliškumą. Niekada nebandykite įkrauti vienkartinį elementų. Saugokitės, kad elementų įdėkle nesukeltumėte trumpojo jungimo.

TR

Piller hakkında önemli bilgiler

Hiçbir zaman farklı tipte pilleri ya da eski pillerle yeni pilleri bir arada kullanmayın. Ürün uzun süre kullanılmayacaksa ya da piller bitmişse, pilleri ürünün içinden çıkarın. Hiçbir zaman zedelenmiş piller kullanmayın. Sadece alkalin piller kullanın. Pilleri kutupları doğru konumda olacak şekilde yerleştirin. Hiçbir zaman, sarj edilebilir olmayan pilleri sarj etmeye çalışmayın. Hiçbir zaman pil kutusuna kısa devre yaptırmayın.

AR

معلومات مهمة عن البطاريات

يحظر استخدام أنواع مختلفة من البطاريات معا أو مزيج من البطاريات القديمة و الجديدة. أحرص دائما على نزع البطاريات في حال عدم استخدام المنتج لفترة طويلة أو إذا نفذت طاقة البطاريات. تجنب استخدام البطاريات التالفة. لا تستخدم إلا البطاريات القلوية فقط. قم بتكيب البطاريات بحيث تكون الأقطاب في موضعها الصحيح. يحظر إعادة شحن البطاريات غير القابلة لإعادة الشحن. تجنب إحداث دائرة قصر في حامل البطارية.

ID

Informasi penting tentang baterai

Jangan gunakan baterai yang jenisnya berlainan, atau mencampur baterai lama dan baterai baru. Lepas baterai jika produk tidak akan digunakan untuk waktu lama atau jika baterai sudah lemah. Jangan gunakan baterai yang rusak. Gunakan hanya baterai alkali. Masukkan baterai dengan posisi kutub yang tepat. Jangan pernah coba mengisi ulang baterai biasa. Jangan pernah membuat arus pendek pada dudukan baterai.

MS

Maklumat penting tentang bateri

Jangan guna jenis bateri yang berbeza bersama-sama, atau gabungan bateri baharu dan lama. Tanggalkan bateri jika produk tidak akan digunakan untuk tempoh masa yang lama atau jika bateri telah kehabisan kuasa. Jangan guna bateri yang rosak. Guna bateri jenis alkali sahaja. Selitkan bateri supaya paksi berada pada kedudukan yang betul. Jangan cuba untuk mengecas semula bateri yang tidak boleh dicalaskan semula. Jangan pintas litar pemegang bateri.

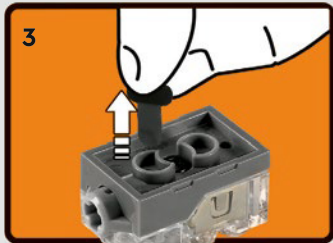

1:1
2x LR 41 1.5V



EN

WARNING: This product contains a Button or Coin Cell Battery.

A swallowed Button or Coin Cell battery can cause internal chemical burns in as little as two hours and lead to death. Dispose of used batteries immediately. Keep new and used batteries away from children. If you think batteries might have been swallowed or placed inside any part of the body, seek immediate medical attention.

DE

ACHTUNG: Dieses Produkt enthält eine Knopfzellenbatterie.

Eine verschluckte Knopfzellenbatterie kann innere chemische Verbrennungen verursachen und in weniger als zwei Stunden zum Tod führen. Entsorge umgehend gebrauchte Batterien. Halte neue und gebrauchte Batterien von Kindern fern. Wenn du glaubst, dass Batterien verschluckt wurden oder sich in einem Körperteil befinden, hole umgehend medizinische Hilfe.

FR

AVERTISSEMENT : Ce produit contient une pile bouton.

L'ingestion d'une pile bouton peut provoquer des brûlures chimiques internes en seulement deux heures et provoquer la mort. Jeter immédiatement les piles usagées. Conserver les piles neuves et usagées hors de portée des enfants. Si vous suspectez l'ingestion d'une pile ou sa présence où que ce soit à l'intérieur du corps, consultez immédiatement un médecin.

IT

ATTENZIONE: questo prodotto contiene una batteria a bottone.

Se inghiottita, una batteria a bottone può causare ustioni chimiche interne in sole due ore, con possibile morte. Smaltire immediatamente le batterie usate. Tenere le batterie nuove e usate lontano dai bambini. Se si pensa che una batteria sia stata inghiottita o inserita in una parte del corpo, rivolgersi immediatamente a un medico.

NL

WAARSCHUWING: dit product bevat een knoopcelbatterij.

Als een knoopcelbatterij wordt ingeslikt, kan deze binnen twee uur chemische brandwonden veroorzaken in het lichaam. Het inslikken van een dergelijke batterij kan zelfs leiden tot overlijden. Gooi gebruikte batterijen onmiddellijk weg. Bewaar nieuwe en gebruikte batterijen buiten bereik van kinderen. Als je denkt dat een kind batterijen heeft ingeslikt of ze in een lichaamsopening heeft gestopt, raadpleeg je direct een arts.

ES

ADVERTENCIA: Este producto contiene una pila de botón.

Ingerir una pila de botón puede dar lugar a quemaduras químicas internas en tan sólo dos horas y provocar la muerte. Las pilas usadas deben desecharse inmediatamente. Mantenga las pilas nuevas y usadas fuera del alcance de los niños. Si sospecha de la ingestión o la introducción de pilas en cualquier parte del cuerpo, busque atención médica inmediatamente.

DA

ADVARSEL: Dette produkt indeholder et knap- eller møntcellebatteri.

Hvis et knap- eller møntcellebatteri sluges, kan det forårsage indvendige ætsninger på blot to timer og medføre døden. Bortskaf brugte batterier omgående. Hold både nye og brugte batterier uden for børns rækkevidde. Hvis du har mistanke om, at batterierne kan være blevet slugt eller kommet ind i nogen del af kroppen, skal du omgående søge lægehjælp.

IS

VIÐVÖRUN: Þessi vara inniheldur hnapparahlöðu eða flata rafhlöðu.

Ef hnapparahlöða eða flöt rafhlöða er gleypt getur hún valdið innvortis efnabruna á innan við tveimur klukkustundum og leitt til dauða. Fargaðu notuðum rafhlöðum tafarlaust. Geymdu nýjar og notaðar rafhlöður þar sem börn ná ekki til. Ef þú telur að rafhlöður hafi verið gleyptar eða á annan hátt komist inn í einhverjum hluta líkamans skaltu tafarlaust leita lækniástoðar.

FI

VAROITUS: Tämä tuote sisältää pienen tai isokokaisen nappipariston.

Nieltynä pieni tai isokokoinen nappiparisto voi aiheuttaa sisäisiä kemiallisia palovammoja jo kahden tunnin kuluessa ja johtaa kuolemaan. Käytetyt paristot on toimitettava heti keräyspisteeseen. Pidä uudet ja käytetyt paristot poissa lasten ulottuvilta. Jos epäilet jonkun nieleisseen pariston tai laittaneensa pariston kehoonsa, vie hänet välittömästi lääkäriin.

SV

VARNING: Denna produkt innehåller ett knapp- eller myntcellsbatteeri.

Förtäring av ett knapp- eller myntcellsbatteeri kan orsaka inre kemiska brännskador på så kort tid som två timmar och leda till döden. Kassaera förbrukade batterier omedelbart. Förvara nya och använda batterier utom räckhåll för barn. Om du tror att batterierna kan ha svalts eller placerats inuti någon del av kroppen, sök omedelbart läkarvård.

NO

ADVARSEL: Dette produktet inneholder et knapp- eller myntcellebatteri.

Ved svelging kan knapp- eller myntcellebatterier gi kjemisk brannskade innvendig på bare to timer og føre til død. Brukte batterier skal avhendes øyeblikkelig. Nye og brukte batterier skal oppbevares utilgjengelig for barn. Hvis du tror at batterier har blitt svelget eller puttet inn andre steder i kroppen, må du kontakte lege øyeblikkelig.

PT

AVISO: Este produto contém uma pilha tipo botão ou moeda.

Uma pilha tipo botão ou moeda que tenha sido engolidas pode provocar queimaduras químicas internas em menos de duas horas e levar à morte. Elimine as pilhas usadas imediatamente. Mantenha as pilhas novas e usadas fora do alcance das crianças. Se pensa que as pilhas podem ter sido engolidas ou colocadas no interior de alguma parte do corpo, procure de imediato assistência médica.

EL

ΠΡΟΕΙΔΟΠΟΙΗΣΗ: Αυτό το προϊόν περιέχει μία Στρογγυλή Μπαταρία Μεγέθους Κουμπιού ή Κέρματος.

Η κατάποση μιας Στρογγυλής Μπαταρίας Μεγέθους Κουμπιού ή Κέρματος μπορεί να προκαλέσει εσωτερικά χημικά εγκαύματα σε μόλις δύο ώρες και να οδηγήσει σε θάνατο. Πετάξτε αμέσως τις χρησιμοποιημένες μπαταρίες. Κρατήστε τις καινούργιες και τις χρησιμοποιημένες μπαταρίες μακριά από τα παιδιά. Εάν νομίζετε ότι κάποια μπαταρία έχει καταποθεί ή τοποθετηθεί εντός οποιουδήποτε μέρους του σώματος, ζητήστε αμέσως ιατρική βοήθεια.

JA

警告: 本製品には、ボタン型またはコイン型の電池が使用されています。ボタン型またはコイン型電池は誤飲すると2時間以内に体内で科学火傷を起こし、死に至る恐れがあります。使用済みの電池は直ちに廃棄してください。新しい電池および使用済み電池は、どちらもお子様の手の届かないところに保管してください。電池を誤飲した恐れがある、または電池が身体のとこかに入った恐れがある場合は、直ちに医師の診察を受けてください。



ZH

警告: 本品内含一颗纽扣电池。



吞咽的纽扣电池仅在两小时内就会引起体内化学灼伤并导致死亡! 请立即处理使用过的电池。请将新、旧电池放置到儿童接触不到的地方。如果电池被不慎吞下, 或被置入身体的任何一个部位, 请立即就医!

KO

경고: 이 제품에는 버튼 또는 코인 셀 배터리가 포함되어 있습니다.

코인 셀 배터리를 삼킬 경우, 빠르면 2시간 이내에 체내에서 화학적 화상이 일어나고 심하면 사망에 이를 수 있습니다. 다 쓴 배터리는 즉시 폐기하십시오. 배터리를 어린이의 손에 닿지 않는 곳에 보관하십시오. 배터리를 삼켰거나 신체 어느 부위에든 들어간 것으로 판단될 경우, 즉각 의사의 도움을 구하십시오.

RU

ПРЕДОСТЕРЕЖЕНИЕ. Эта игрушка работает от батарейки таблеточного или кнопочного типа.

Проглатывание батарейки таблеточного или кнопочного типа может (в течение двух часов) вызвать химические ожоги внутренних органов и привести к летальному исходу. Своевременно утилизируйте использованные батарейки. Храните новые и использованные батарейки в местах, недоступных для детей. Если у вас есть основания полагать, что ребенок проглотил батарейку или она попала внутрь какой-либо части его тела, немедленно обратитесь за медицинской помощью.

PL

OSTRZEŻENIE: w tym produkcie znajduje się płaska okrągła bateria. Połknięcie takiej baterii może spowodować chemiczne oparzenia wewnętrzne już po dwóch godzinach, a także doprowadzić do śmierci. Gdy bateria się zużyje, należy ją natychmiast zutylizować. Nowe i używane baterie należy przechowywać z dala od dzieci. W przypadku stwierdzenia, że baterie mogły zostać połknięte lub inaczej trafić do organizmu, należy natychmiast poszukać pomocy lekarskiej.

CZ

VAROVÁNÍ: Tento výrobek obsahuje knoflíkovou nebo mincovou baterii. Spolknutí knoflíkové nebo mincové baterie může během pouhých 2 hodin způsobit vnitřní poleptání sliznice a v některých případech mít za následek smrt. Použité baterie ihned vyjměte a zlikvidujte. Nové i použité baterie uchovávejte mimo dosah dětí. V případě spolknutí či uvlnutí baterie v některé části těla okamžitě vyhledejte lékařskou pomoc.

SK

UPOZORNENIE: Tento produkt obsahuje gombíkovú alebo mincovú batériu. Prehltnutie gombíkovej alebo mincovej batérie môže spôsobiť vnútorné chemické popáleniny už do dvoch hodín a viesť k úmrtiu. Použité batérie ihneď vyhod'te. Nové aj použité batérie uchováajte mimo dosahu detí. Ak si myslíte, že mohlo dôjsť k prehltnutiu batérie alebo sa batéria mohla dostať do vnútra ktorejkoľvek časti tela, okamžite vyhľadajte lekársku pomoc.

HU

FIGYELMEZTETÉS: Ez a termék gombelemet illetve lapos gombelemet tartalmaz!

A lenyelt gombelem vagy lapos gombelem akár két óra alatt is belső vegyi sérüléseket okozhat, ami halálhoz vezethet. Az elhasznált elemeket azonnal dobja ki! Az új és a használt elemeket ne adja gyermeknek kezébe! Ha úgy gondolja, hogy valaki lenyelt egy elemet, vagy bekerült valakinek valamely testrészébe, akkor azonnal kérjen orvosi segítséget!

UA

ОБЕРЕЖНО. Продукт містить мініатюрну батарейку типу «таблетка». Якщо проковтнути мініатюрну батарейку, вона може спричинити внутрішні хімічні опіки протягом двох годин і призвести до смерті. Негайно утилізуйте використані батарейки. Зберігайте нові та використані батарейки недосяжними для дітей. Якщо вам здається, що дитина проковтнула батарейку чи вона опинилася в будь-якій частині тіла дитини, негайно зверніться до лікаря.

HR

UPOZORENJE: Ovaj proizvod sadrži gumbastu bateriju ili bateriju oblika kovanice.

Ako se gumbasta baterija ili baterija oblika kovanice proguta, za samo dva sata može uzrokovati unutarnje kemijske opekline i izazvati smrt. Iskorištene baterije odmah odložite u otpad. Čuvajte nove i stare baterije dalje od djece. Ako mislite da je baterija progutana ili je dospjela u bilo koji dijel tijela, odmah zatražite liječničku pomoć.

SR

УПОЗОРЕЊЕ: Овај производ садржи дугмасту батерију.

Прогутања дугмаста батерија може да доведе до интерних хемијских опекотина већ за два сата и доводи до смрти. Одмах одложите искоришћене батерије у отпад. Чувајте нове и искоришћене батерије ван домаћаја дече. Ако мислите да је дошло до гутања батерија или стављања у било који део тела, одмах потражите помоћ лекара.

МК

ПРЕДУПРЕДУВАЊЕ: Овој производ садржи батерија тип копче или тип монета.

Проголтувањето на батерија тип копче или тип монета може да предизвика внатрешно хемиско горење во рок од два часа и да доведе до смрт. Исфрлете ги веднаш искористените батерији. Држете ги новите и користените батерији подалеку од деца. Ако мислите дека е можно батериите да се проглотани или поставени во кој било дел на телото, веднаш побарајте медицинска помош.

SL

OPAZORILLO: Ta izdelek vsebuje gumbasto baterijo.

Če oseba požre gumbasto baterijo, lahko to povzroči kemične opekline notranjih organov že v dveh urah po zaužitju. Tovrstne poškodbe lahko vodijo v smrt. Iztrošene baterije takoj zavržite. Pazite, da nove ali iztrošene baterije ne bodo v dosegu otrok. Če menite, da je oseba zaužila baterijo ali si jo vstavila v kateri koli del telesa, takoj poiščite zdravniško pomoč.

RO

AVERTIZARE: Acest produs conține o baterie de tip pastilă.

Înghițirea unei baterii de tip pastilă poate cauza arsuri chimice interne în doar două ore, ducând la deces. Debarasați-vă imediat de bateriile uzate. Nu lăsați bateriile noi și uzate la îndemâna copiilor. Dacă credeți că bateriile ar fi putut fi înghițite sau ar fi putut ajunge în interiorul oricărei părți a corpului, solicitați imediat asistență medicală.

BG

ПРЕДУПРЕЖДЕНИЕ: Този продукт съдържа батерия тип „копче“ или „монета“.

При поглъщане батериите тип „копче“ или „монета“ могат да предизвикат вътрешни химически изгаряния в рамките на по-малко от два часа и да доведат до смърт. Незабавно изхвърляйте използваните батерији. Дръжте новите и стари батерији далеч от деца. Ако смятате, че е възможно батериите да са били поглънати или да са попаднали където и да е вътре в тялото, потърсете незабавно медицинска помощ.



LV
BRĪDINĀJUMS. Šim produktam ir pogas jeb monētas tipa akumulators.
Ja pogas jeb monētas tipa akumulators tiek norīts, tas jau divu stundu laikā var izraisīt iekšējus ķīmiskus apdegumus un izraisīt nāvi. Nekavējoties izlietotos akumulatorus. Jaunus un lietotus akumulatorus glabājiet bērniem nepieejamā vietā. Ja uzskatāt, ka akumulators varētu būt norīts vai ievietots kādā ķermeņa daļā, nekavējoties vērsieties pēc medicīniskās palīdzības.

ET
HOIATUS! See toode sisaldab nõõp- või müntpatareid.
Alla neelatud nõõp- või müntpatarei võib tekitada sisemisi keemilisi põletusi kõigest kahe tunniga ning põhjustada surma. Kõrvaldage kasutatud patareid viivitamatult. Hoidke uusi ja kasutatud patareisid lastele kättesaamatus kohas. Kui arvate, et keegi on patareid alla neelanud või need on sattunud mõnda kehaosasse, pöörduge kohe arsti poole.

LT
ĮSPĖJIMAS. Šiame gaminyje yra sagos arba monetos formos baterija.
Praryta sagos arba monetos formos baterija gali sukelti vidinius cheminius nudeginimus greičiau nei per dvi valandas ir galiausiai sukelti mirtį.
Panaudotas baterijas nedelsiant utilizuokite. Naujas ir panaudotas baterijas laikykite atokiau nuo vaikų. Jei manote, kad vaikas galėjo praryti arba įsprausti bateriją sau į kūną, nedelsdami kreipkitės medicininės pagalbos.

TR
UYARI: Bu ürün bir düğme pil içerir.
Yutulmuş düğme pil, iki saat gibi kısa bir sürede iç kimyasal yanıklara neden olabilir ve ölüme yol açabilir. Kullanılmış pilleri derhal atın. Yeni ve kullanılmıř pilleri çocuklardan uzak tutun. Pillerin yutulmuř ya da vücudun bařka bir yerine sokulmuř olabileceđini dűřünüyorsanız derhal doktora bařvurun.

AR
تحذير: يحتوي هذا المنتج على بطارية خلايا قرضية أو بطارية خلايا على شكل عملة. قد يؤدي ابتلاع بطارية خلايا قرضية أو بطارية خلايا على شكل عملة إلى حدوث حروق كيميائية داخلية خلال فترة قصيرة لا تتجاوز ساعتين وقد يؤدي إلى الوفاة. يرجى التخلص من البطاريات المستعملة على الفور. مع الاحتفاظ بالبطاريات الجديدة والمستعملة بعيداً عن متناول الأطفال. إذا كنت تعتقد أن البطاريات تم ابتلاعها أو إدخالها إلى أي جزء من أجزاء الجسم، فاطلب المساعدة الطبية على الفور.

ID
PERINGATAN: Produk ini berisi Baterai Sel Kancing.
Baterai Sel Kancing yang tertelan dapat mengakibatkan Luka bakar kimiawi dalam tubuh minimal setelah dua jam dan dapat mengakibatkan kematian. Segera buang baterai yang sudah tidak digunakan. Jauhkan baterai baru maupun bekas dari jangkauan anak-anak. Jika Anda curiga baterai telah tertelan atau masuk ke dalam tubuh, segeralah minta bantuan dokter.

MS
AMARAN: Produk ini mengandungi Bateri Sel Butang atau Syiling.
Tertelan bateri Sel Butang atau Syiling boleh mengakibatkan lecuran kimia dalaman dalam tempoh sekurang-kurangnya dua jam dan menyebabkan kematian. Buang bateri terpakai dengan serta-merta. Jauhkan bateri baharu dan terpakai daripada kanak-kanak. Jika anda mendapati bateri mungkin telah ditelan atau termasuk ke dalam mana-mana bahagian badan, dapatkan rawatan perubatan dengan segera.

EN Please retain the leaflet and packaging as they contain important information
DE Broschüre und Verpackung bitte aufbewahren, sie enthalten wichtige Informationen
FR Veuillez conserver le dépliant et l'emballage, car ils contiennent des informations importantes
IT Conserva l'opuscolo e la confezione in quanto contengono informazioni importanti
NL Bewaar a.u.b. de folder en verpakking: die bevatten belangrijke informatie
ES Conserve el folleto y el embalaje; contienen información importante
DA Gem hæftet og emballagen, da de indeholder vigtige oplysninger
IS Geymið bæklinginn og umbúðirnar þar sem þau innihalda mikilvæggar upplýsingar
FI Säilytä esite ja pakkaus, koska ne sisältävät tärkeää tietoa
SV Spara broschyren och förpackningen eftersom de innehåller viktig information
NO Heftet og emballasjen inneholder viktig informasjon og skal beholdes
PT Por favor guarde o folheto e a embalagem, pois contém informação importante
EL Κρατήστε το φυλλάδιο και τη συσκευασία γιατί περιέχουν σημαντικές πληροφορίες
JA 説明書とパッケージには重要な情報が含まれていますので保管しておいてください
ZH 说明书和包装均包含重要信息, 请妥善保管
KO 중요한 정보가 담겨 있으므로 리플릿과 포장을 보관해주세요
RU Пожалуйста, сохраните эту брошюру и упаковку, поскольку они содержат важную информацию
PL Prosimy zachować ulotkę i opakowanie, ponieważ zawierają one ważne informacje
CZ Ponechte si prosím leták i obal, neboť obsahují důležité informace
SK Ponechajte si prosím leták aj obal, pretože obsahujú dôležité informácie
HU Kérjük, őrizze meg a szórólapot és a csomagolást, mert fontos tudnivalókat tartalmaznak
UA Будь ласка, зберігайте вкладиш та упаковку, оскільки вони містять важливу інформацію
HR Spremite letak i ambalažu jer sadrže važne obavijesti
SR Молимо да сачувате путство и паковање јер се на њима налазе важне информације
MK Чувајте ги брошурата и амбалажата бидејќи содржат важна информација
SL Prosimo, da brošurico in embalažo shranite, saj vključujeta pomembne informacije
RO Vă rugăm să păstrați prospectul și ambalajul întrucât conțin informații importante
BG Запазете листовката и опаковката, тъй като съдържат важна информация
LV Lūdzu, saglabājiēt bukletu un iepakojumu, jo uz tā ir norādīta svarīga informācija
ET Hoidke infoleht ja pakend alles, sest nendele on märgitud oluline teave
LT Išsaugokite informacinį lapelį ir pakuotę, nes ant jų pateikiama svarbi informacija
TR Önemli bilgiler içerdіđi için brořurü ve ambalajı saklayın
AR الرجاء الاحتفاظ بالبنشرة والغلاف لاحتوائهما على معلومات هامة
ID Harap simpan brosur dan kemasan ini karena berisi informasi penting
MS Sila simpan risalah dan pembungkusan kerana ia mengandungi maklumat penting

LEGO System A/S
Aastvej 1
DK-7190 Billund



EN

Protect the environment by not disposing of this product with your household waste.
Check with your local authority for recycling advice and facilities. Penalties may apply for improper disposal.

DE

Schützen Sie die Umwelt und entsorgen Sie dieses Produkt nicht mit Ihrem Hausmüll.
Informationen zu Recycling-Möglichkeiten erhalten Sie bei den örtlichen Behörden. Bei unsachgemäßer Entsorgung können Strafen verhängt werden.

FR

Protégez l'environnement : ne jetez pas ce produit avec vos autres déchets ménagers.
Contactez les autorités locales pour obtenir des informations sur le recyclage et connaître les points de collecte. Des sanctions peuvent être appliquées en cas d'élimination inappropriée.



IT

Proteggi l'ambiente! Non smaltire questo prodotto con i rifiuti domestici.
Per consulenza sul riciclaggio dei rifiuti e le strutture di riciclaggio, rivolgersi alle proprie autorità locali. Uno smaltimento improprio può comportare sanzioni.

NL

Bescherm het milieu: gooi dit product niet samen met het andere huisvuil weg.
Raadpleeg de plaatselijke instanties voor locaties van milieustations en advies over hergebruik. In geval van onjuiste verwijdering kunnen boetes worden opgelegd.

ES

Proteja el medio ambiente no deshaciéndose de este producto junto con sus residuos domésticos.
Solicite asesoramiento e información sobre instalaciones de reciclaje a las autoridades locales. La eliminación inadecuada puede ser objeto de sanciones.

DA

Beskyt miljøet! Smid ikke dette produkt ud sammen med husholdningsaffaldet.
Få vejledning om genbrug og genbrugsstationer hos din kommune. Ukorrekt bortskaffelse kan medføre bøde eller straf.

IS

Stuðlið að umhverfisvernd með því að farga þessari vöru ekki með heimilissorpi.
Leitið upplýsinga um endurvinnslu- og förgunarstaði hjá yfirvöldum á hverjum stað. Viðurlögum kann að vera beitt ef förgun er ekki með réttum hætti.

FI

Tämä tuote on hävitettävä ympäristöystävällisesti ja erillään muusta talousjätteestä.
Tietoja kierrätyksestä ja keräyspisteiden sijainnista saat paikkakuntasi teknisestä virastosta. Epäasianmukaisesta hävittämisestä saattaa aiheutua seuraamuksia.

SV

Skydda miljön genom att inte kasta denna produkt bland ditt hushållsavfall.
Kontakta din kommun för frågor om återvinning och miljöstationer. Påföljder kan tillkomma för felaktigt avyttring.

NO

Beskytt miljøet. Ikke kast dette produktet i husholdningsavfallet.
Kontakt kommunen for veiledning om gjenbruk og miljøstasjoner. Feil avfallshåndtering kan være straffbart.

PT

Proteja o ambiente não eliminando este produto com o seu lixo doméstico.
Consulte as autoridades locais para informação sobre reciclagem e sistemas de recolha. Podem ser aplicadas coimas por eliminação inadequada.

EL

Προστατέψτε το περιβάλλον. Μην πετάτε αυτό το προϊόν μαζί με τα συνηθισμένα οικιακά απορρίμματα.
Επικοινωνήστε με τις τοπικές αρχές σχετικά με συμβουλές και εγκαταστάσεις ανακύκλωσης. Ενδέχεται να επιβάλλονται κυρώσεις για ακατάλληλη διάθεση απορριμμάτων.

JA

環境保護のため、本製品は家庭ごみとは別に処分してください。
リサイクルに関する指示や施設については、お住まいの地方自治体にお問い合わせください。不適切な廃棄を行った場合、罰則が適用されることがあります。

ZH

注意保护环境，请勿将本产品与生活垃圾一起丢弃处理。
请咨询当地相关部门，了解与回收相关的设施与建议。
处理不当可能会导致处罚。

KO

환경 보호를 위해 이 제품을 생활폐기물과 함께 버리지 마십시오.
재활용 방법 및 시설에 관한 사항은 현지 관계 당국에 문의하십시오. 부적절하게 폐기할 경우 벌칙이 부과될 수 있습니다.

RU

Позаботьтесь об окружающей среде: не утилизируйте этот продукт вместе с бытовым мусором.
Узнайте в органах местного самоуправления правила вторичной переработки и утилизации таких отходов.
В случае ненадлежащей утилизации могут быть наложены штрафы.



PL

Aby chronić środowisko naturalne, nie należy wyrzucać tego produktu wraz z odpadkami z gospodarstwa domowego. W celu uzyskania wskazówek dotyczących recyklingu oraz adresów zakładów należy skontaktować się z lokalnym urzędem. Za nieprzestrzeganie zasad związanych z utylizacją odpadów grożą kary.

CZ

Nevyhazujte tento produkt do domácího odpadu, chráňte životní prostředí. Zjistěte si prosím u místních úřadů možnosti recyklace a dostupná zařízení. Nesprávná likvidace může být pokutována.

SK

Nevyhadzujte tento produkt do domáceho odpadu, chráňte životné prostredie. Zistite si na miestnych úradoch možnosti recyklácie a dostupné zariadenia. Za nesprávnu likvidáciu môžu byť uložené sankcie.

HU

Környezetét óvja, ha ettől a terméktől nem a háztartási hulladékkal együtt válik meg. Érdéklődjék a lakóhelyéhez közel eső hatóságnál az újrahasznosítás módjáról és lehetőségeiről. A nem megfelelő hulladékelhelyezésért büntetés járhat.

UA

Допоможіть захистити довкілля: не утилізуйте цей виріб разом із побутовим сміттям. Вказівки з утилізації та відомості про пункти прийому з'ясуєте в місцевих компетентних органах. У разі неналежної утилізації можуть застосовуватися штрафи.

HR

Zaštitite okoliš tako da ovaj proizvod ne odložite u otpad zajedno s kućanskim otpadom. Od lokalnih vlasti zatražite savjet ili informacije o pogonima za recikliranje. Moguća je kazna za nepropisno zbrinjavanje.

SR

Zaštitite životnu sredinu tako što nećete da odlažete ovaj proizvod sa kućnim otpadom. Raspitajte se kod lokalnog nadležnog organa o načinu reciklaže i o sabirnom centru. U slučaju nepravilnog odlaganja u otpad, mogu biti izrečene kazne.

МК

Zaštitete ja okolinata tako što nema da se oslobodite od proizvodot so domashniot otpad. Konsultirajte se so lokalnite vlasti za da doznaete za sovetite i objektite za recikliranje. Vozmožno e da bidat primeneti kazni za nepravilno isflanje.

SL

Zaščitite okolje! Okolje varujte tako, da tega izdelka ne zavržete skupaj z gospodinjanskimi odpadki. Pri krajevni upravi preverite, kakšne možnosti in kateri obrati za recikliranje obstajajo v vaši okolici. Za nepravilno odlaganje odpadkov vas lahko doleti kazen.

RO

Protejați mediul înconjurător și nu vă debarașiți de acest produs împreună cu deșeurile menajere. Consultați autoritățile locale pentru îndrumări și facilități de reciclare. Dezafectarea necorespunzătoare poate atrage sancțiuni.

BG

Защитете околната среда и не изхвърляйте този продукт заедно с битовите си отпадъци. Свържете се с местните власти относно съвети и съоръжения за рециклиране. Възможно е да има глоби за неправилно изхвърляне.

LV

Lai saudzētu vidi, neizmetiet šo izstrādājumu kopā ar sadzīves atkritumiem. Vērsieties vietējās varas iestādēs, lai noskaidrotu, kur un kā tas nododams pārstrādei. Par neatbilstošu likvidēšanu var tikt piemērots sods.

ET

Keskkonda saate kaitsta nii, et ei kõrvalda seda toodet koos olmejäätmetega. Nõuandeid toote taaskasutusse võtmise ja ümbertöötlemispunktide kohta saate asjaomaselt kohalikult asutuselt. Nõuetele mittevastav kasutuselt kõrvaldamine võib kaasa tuua trahvid.

LT

Saugokite aplinką: nemeskite šio produkto kartu su buitinėmis atliekomis. Atsižvelkite į savo vietos valdžios rekomendacijas dėl pakartotinio panaudojimo ir sąlygas. Už netinkamą šalinimą gali būti taikomos baudos.

TR

Bu ürünü, evsel atıklarla birlikte atmayarak çevreyi koruyun. Geri dönüşüm tavsiyeleri ve tesisler hakkında bilgi için yerel yönetimle iletişimi kurun. Uygunsuz atılması durumunda cezalar uygulanabilir.

AR













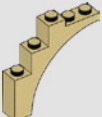













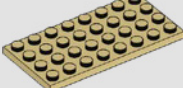

احم البيئة بعدم التخلص من هذا المنتج مع المخلفات المنزلية. استشر السلطة المحلية لديك للحصول على نصيحه بخصوص إعادة تدوير المخلفات ومراقبه. قد يتم تطبيق عقوبات على التخلص غير السليم.

ID

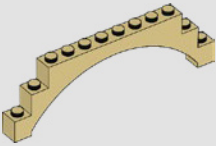
Jagalah lingkungan dengan tidak membuang produk ini bersama sampah rumah tangga Anda. Periksa peraturan pemerintah setempat tentang saran dan fasilitas daur ulang. Pembuangan yang tidak sesuai ketentuan dapat dikenakan denda.

MS

Lindungi alam sekitar dengan tidak melupuskan produk ini bersama sisa isi rumah anda. Rujuk pihak berkuasa tempatan anda tentang nasihat dan kemudahan kitar semula. Penalti boleh dikenakan untuk pelupusan yang tidak wajar.

| | | | | | | | | | |
|----------------|---|----------------|---|--|---|---|---|---|---|
| 10x 6341465 |  | 5x 6360037 |  |  |  |  |  |  |  |
| 6x 6240495 |  | 2x 6355727 | 2x 4288513 | 7x 6075057 | 6x 6348148 | 3x 6296799 | 2x 6308000 | 12x 6310268 | 16x 6116604 |
| 1x 6284572 |  | 2x 4624086 | 1x 6374166 |  | 1x 6332580 | 1x 6356406 | 2x 6196548 | 1x 6359881 | 3x 302126 |
| 1x 6440382 |  | 2x 4666579 | 4x 4114077 | 37x 4112982 | 4x 6378120 | 3x 6282140 | 21x 6279875 | 2x 4106513 | 1x 383926 |
| 13x 6168642 |  | 2x 6236425 | 1x 4114306 |  | 1x 4504379 | 2x 6284699 | 1x 452926 | 1x 4140588 | 1x 6018805 |
| 1x 6276148 |  | 11x 4113917 | 1x 4114084 | 3x 4124067 | 4x 307021 | 1x 6227901 | 2x 403226 | 1x 6234806 | 4x 6018805 |
| 1x 6298930 |  | 55x 6148262 | 1x 6321305 | 1x 4114324 | 3x 4142865 | 2x 4504382 | 2x 4109810 | 1x 6093525 | 1x 243126 |
| 4x 4651445 |  | 1x 6440383 | 1x 6450348 | 1x 4114324 | 1x 6336210 | 1x 302426 | 1x 6195325 | 2x 6336989 | 1x 371026 |
| 2x 307001 |  | 1x 6368620 | 1x 6300317 | 1x 4113988 | 1x 302321 | 2x 4504382 | 2x 4512363 | 1x 6093525 | 1x 6167800 |
| 1x 4161326 |  | 13x 6057517 | 3x 6024495 |  | 1x 6450369 | 1x 4623113 | 7x 3200026 | 1x 6425507 | 1x 6174917 |
| 1x 4160857 |  | 30x 4159553 | 4x 6383295 | 1x 4509897 | 1x 6129995 | 2x 6380236 | 2x 300426 | 1x 368026 | 1x 4525078 |
| 6x 6252200 |  | 1x 6360078 | 1x 6251252 | 2x 6267489 | 1x 6156462 | 1x 6245281 | 2x 6092585 | 2x 4124096 | 1x 4124096 |
| 4x 4547489 |  | 2x 4125253 | 1x 4114026 | 2x 6058093 |  | 1x 6305110 | 1x 4144024 | 1x 6089119 | 6x 6194233 |
| 1x 306901 |  | 1x 4112980 | 1x 4113916 | 1x 6246845 | 2x 6156462 | 2x 6290456 | 1x 306926 | 2x 4180087 | 4x 4142135 |
| 1x 6232029 |  | 2x 4112980 | 5x 4113233 | 2x 6058093 | 2x 6156462 | 2x 473326 | 4x 6313116 | 3x 362326 | 2x 6328408 |
| |  | 1x 6342671 | 1x 4113233 | 13x 4113916 | 1x 6246845 | 2x 4505757 | 1x 6443327 | 1x 6089119 | 2x 6328408 |
| |  | | 1x 4113233 | 1x 6246845 | 1x 6403046 | 2x 6174075 | 2x 4538456 | 1x 408326 | 2x 370626 |
| |  | | 1x 4113233 | 1x 6246845 | 1x 4206482 | 20x 6315887 | 2x 6330086 | 2x 6435928 | 9x 366626 |
| |  | | 1x 4113233 | 1x 6246845 | 1x 4504381 | 6x 6168646 | 1x 6016172 | | |

4

5

6

- 4x 663626
- 2x 6101857
- 1x 303426
- 4x 4645732
- 3x 4514845
- 2x 246526
- 1x 428226
- 18x 6135287
- 4x 6270055
- 2x 6269971
- 1x 306928

- 1x 302328
- 2x 6047426
- 1x 6440388
- 1x 4542391
- 1x 6116259
- 1x 6450235
- 1x 6062166
- 2x 371028
- 2x 6133852
- 16x 303428
- 1x 6443328
- 1x 6455389
- 1x 6353089
- 1x 6247798

- 1x 6447576
- 1x 6245206
- 1x 6306748
- 2x 6254552
- 1x 6278710
- 1x 6239418
- 1x 6337639
- 2x 6254256
- 2x 6251295
- 1x 6247793
- 1x 6337597
- 1x 6238674
- 1x 6447567
- 2x 6267125

- 1x 6240515
- 1x 6254564
- 1x 6411773
- 5x 6061678
- 1x 6435720
- 1x 4624381
- 4x 4537251
- 1x 4164037
- 4x 4220632
- 1x 6422924
- 1x 6395622
- 4x 6099364
- 1x 6337632
- 1x 6319295

- 3x 6300322
- 9x 6040126
- 56x 6001824
- 20x 4549436
- 1x 6245275
- 1x 6388214
- 1x 6338985
- 1x 6328445
- 1x 6132790
- 6x 4530678
- 10x 6092591
- 2x 6228921
- 6x 6310836
- 1x 6002851

- 1x 6002849
- 1x 6028018
- 1x 6028022
- 5x 6396392
- 4x 6331865
- 1x 4255416
- 2x 4507045
- 1x 6450260
- 2x 6329820
- 1x 6344040

- 1x 4626904
- 1x 6001822
- 2x 6164288
- 1x 6254772
- 2x 6035326
- 2x 4507047
- 2x 6156492
- 2x 4251796
- 1x 4595709
- 1x 6096215
- 1x 6114515

- 1x 4528981
- 4x 6055171
- 3x 4504375
- 1x 4648340
- 1x 6214291
- 17x 6400754
- 18x 6369999
- 2x 4260493
- 1x 6454361
- 1x 6341975
- 10x 6348059
- 2x 6223913
- 4x 4550169

- 1x 4539090
- 1x 6450240
- 2x 6117418
- 21x 6357747
- 1x 6172233
- 1x 6323033
- 4x 6245265
- 2x 6314353
- 10x 6378797
- 5x 6422088
- 14x 6341968
- 7x 6215659
- 4x 6060731
- 4x 6186673
- 1x 6439053
- 6x 4221744

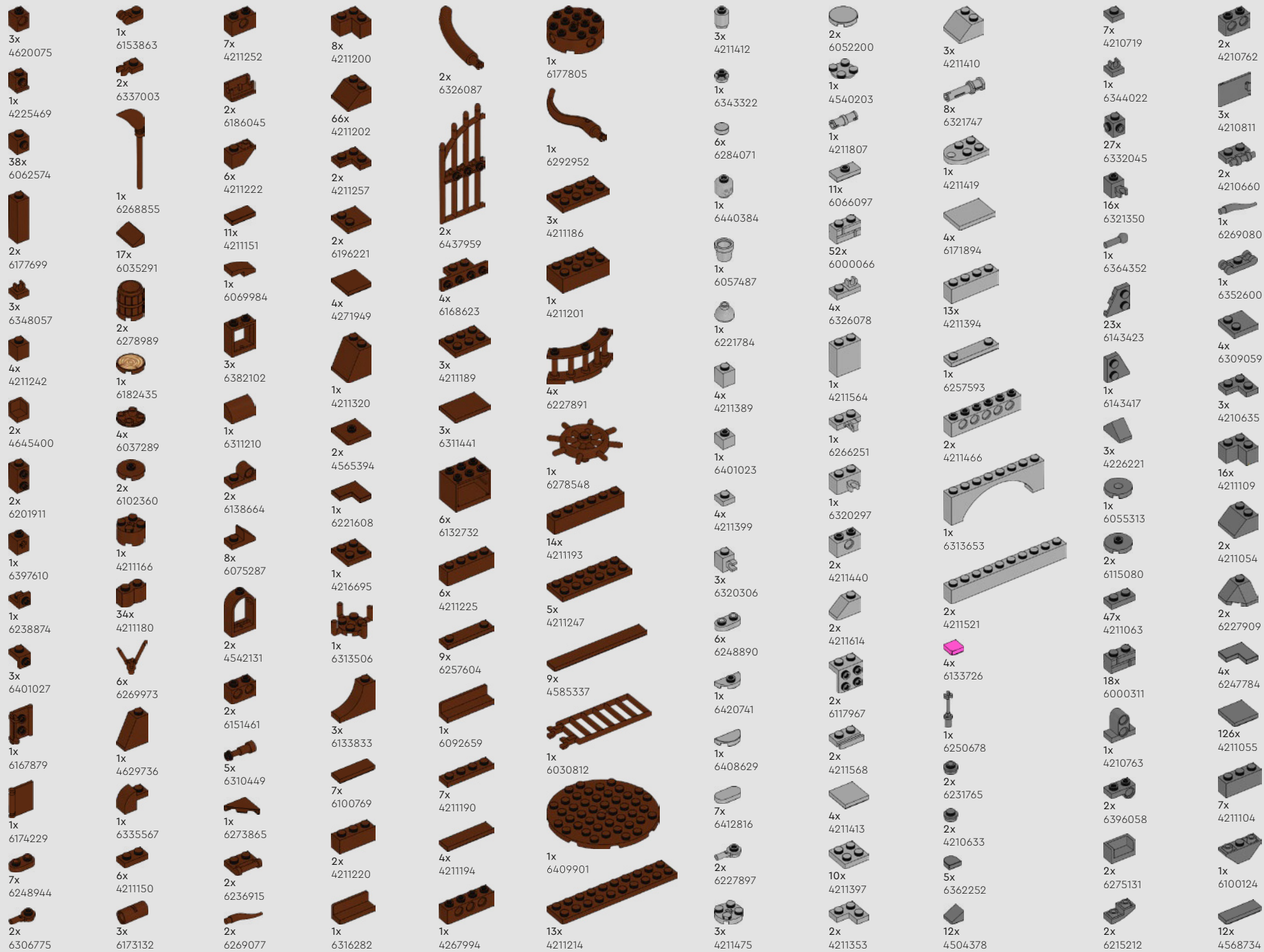

- 1x 4211045
- 2x 6271127
- 4x 6378143
- 1x 6083620
- 11x 4211103
- 1x 4211001
- 4x 4211053
- 2x 4211065
- 1x 6413109
- 1x 6388294
- 2x 4211100
- 1x 6266298
- 3x 6186825
- 2x 4667977
- 4x 4210998
- 1x 6266299
- 13x 4210997
- 4x 4211061

- 1x 6440397
- 1x 6435521
- 1x 6440394
- 1x 6454362
- 1x 6440386
- 1x 6440392
- 1x 6440389
- 1x 6364557
- 1x 6252374
- 1x 6236271
- 2x 6447569
- 1x 6337455
- 1x 6455546
- 1x 6237120

- 2x 6398008
- 1x 6408049
- 1x 6278089
- 3x 6272101
- 1x 6378168
- 11x 6209691
- 6x 6186672
- 3x 6295686
- 18x 4541873
- 1x 6404610
- 2x 6326425
- 1x 6138068
- 1x 4538126
- 3x 6323688

- 1x 6315780
- 2x 6380013
- 1x 6332586
- 39x 6194729
- 10x 6226437
- 2x 6259071
- 1x 6436364
- 1x 6278987
- 3x 4623298
- 41x 6058221
- 3x 6382784
- 4x 6468357
- 3x 6378109
- 2x 6331950

- 20x 6252667
- 9x 6328181
- 4x 6313874
- 1x 6337282
- 6x 6447568
- 7x 6226792
- 19x 6295366
- 32x 4519946
- 17x 6447565
- 14x 6447571
- 8x 6447573

- 2x 6447572
- 2x 6400315
- 4x 6177146
- 1x 6076674
- 1x 6413079
- 7x 6292154
- 1x 6440391
- 2x 6365746
- 1x 6360055
- 4x 6343854
- 1x 6429472
- 1x 6363146
- 1x 6450245
- 4x 6426723

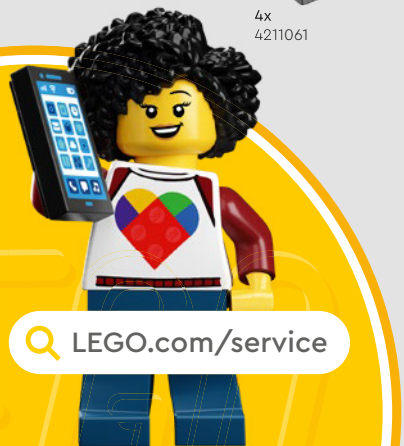

 [LEGO.com/service](https://www.LEGO.com/service)

4



YOU COULD WIN



YOU COULD WIN

Your feedback will help shape the future development of this product series.

Visit:

DU KÖNNTEST GEWINNEN

Dein Feedback trägt zur Weiterentwicklung dieser Produktreihe bei.

Geh auf:

VOUS POURRIEZ GAGNER

Vos commentaires nous aideront à concevoir les futurs produits de cette gamme.

Visitez :

POTRESTI VINCERE TU

La tua opinione ci aiuterà a migliorare la creazione futura di questa linea di prodotti.

Visita:

PUEDES GANAR

Tu opinión contribuirá al futuro de esta serie de productos.

Visita:

轻松获奖

您的反馈将有助于我们在今后改进本产品系列。

请访问:

[LEGO.com/productfeedback](https://www.lego.com/productfeedback)

You also have the chance to win a LEGO® set.

Terms and conditions apply.*

Außerdem hast du die Chance, ein LEGO® Set zu gewinnen.

Es gelten die Teilnahmebedingungen.*

Vous pourriez également gagner un ensemble LEGO®.

Des conditions s'appliquent.*

Hai anche la possibilità di vincere un set LEGO®.

Termini e condizioni sono applicabili.*

También tienes la oportunidad de ganar un set LEGO®.

Aplican términos y condiciones.*

您还有机会赢取乐高®套装。

条款和条件适用。*

*[LEGO.com/productfeedback-terms](https://www.lego.com/productfeedback-terms)

Disney
HOCUS
POCUS

LEGO and the LEGO logo are trademarks of the LEGO Group. ©2023 The LEGO Group.
©Disney

6500755