



Friends



3188

1

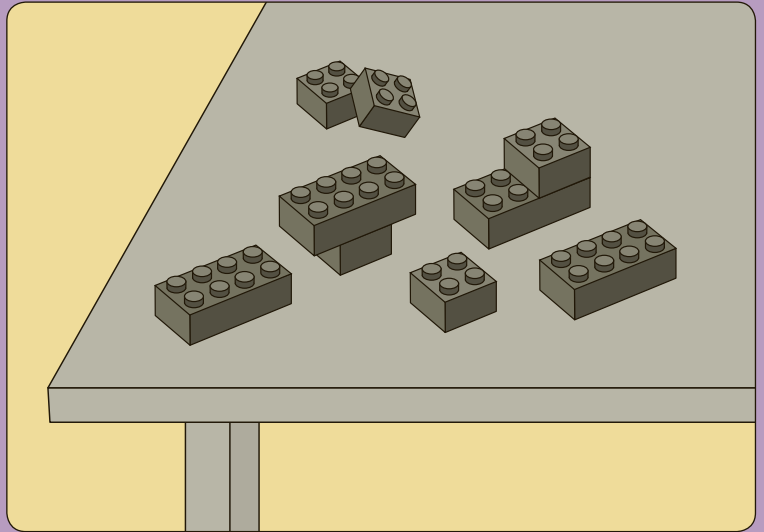
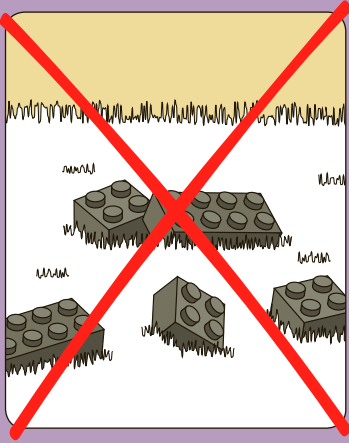

2



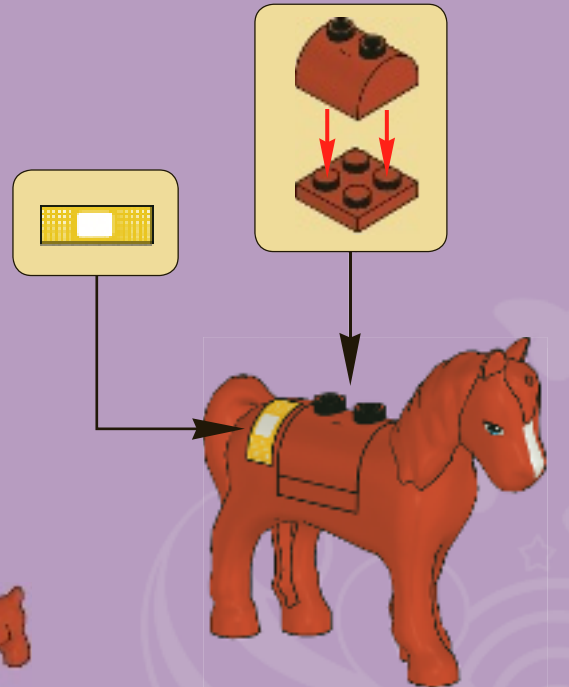
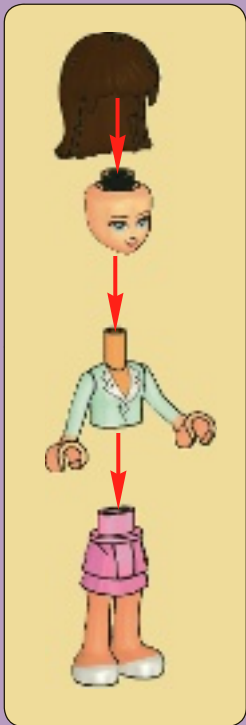
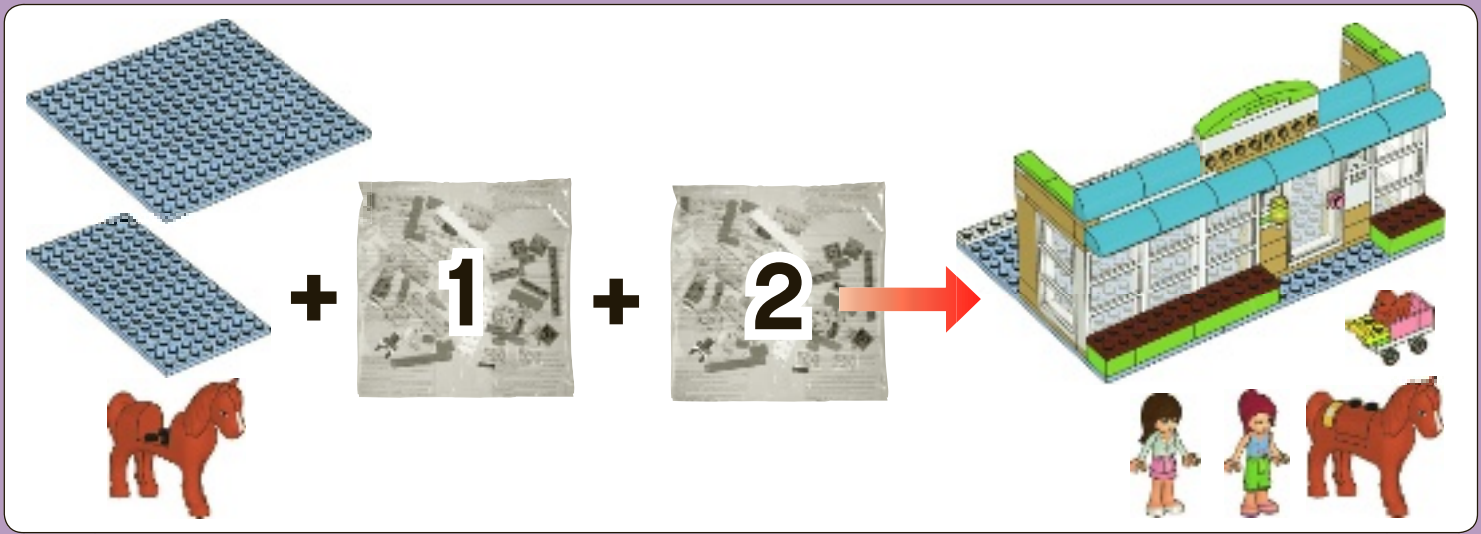



1



2

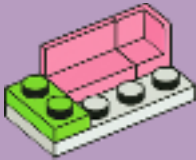

3

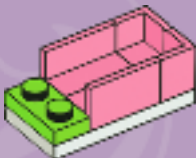

4

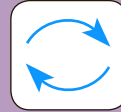
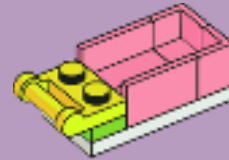

5



6

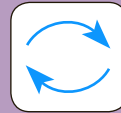
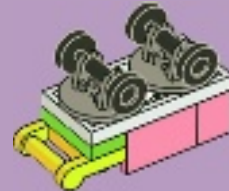

7



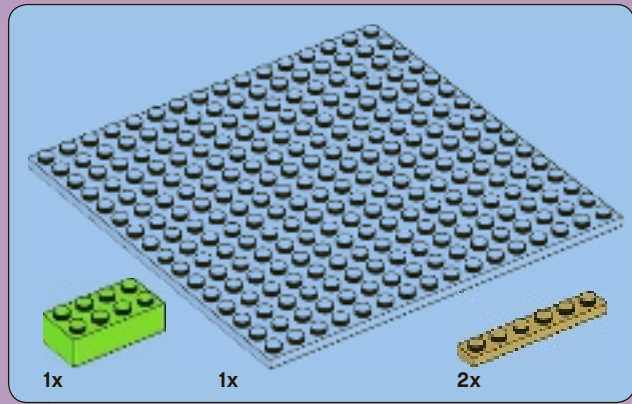
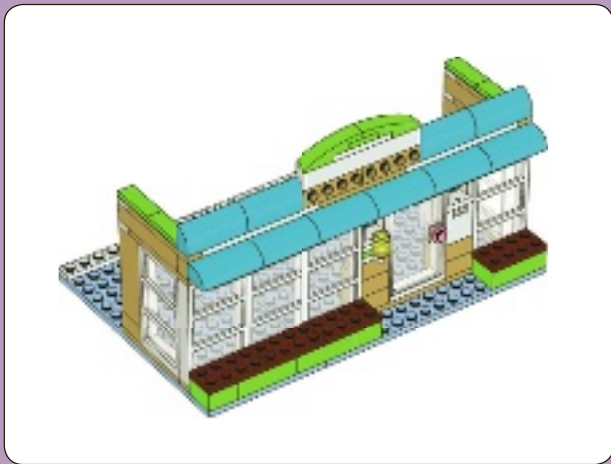

1

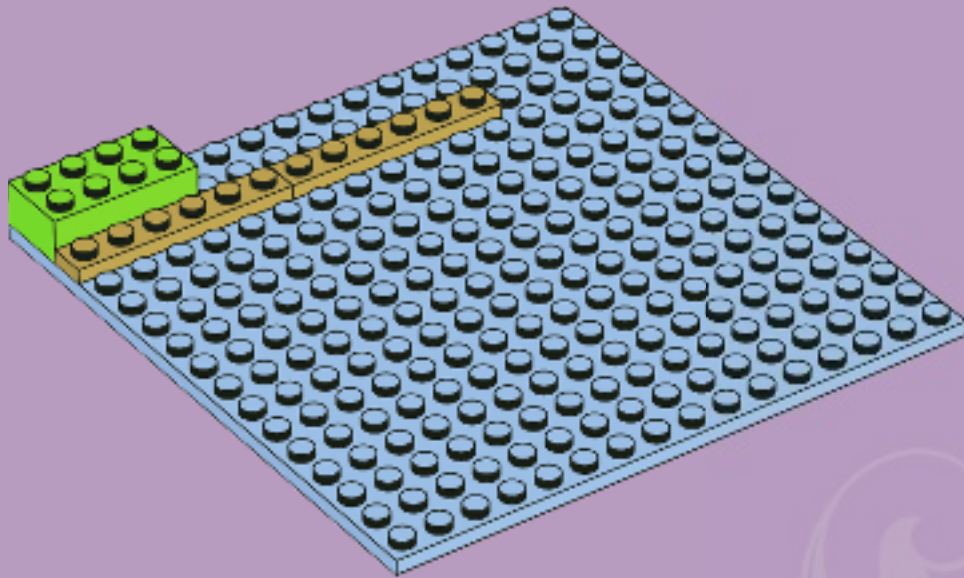

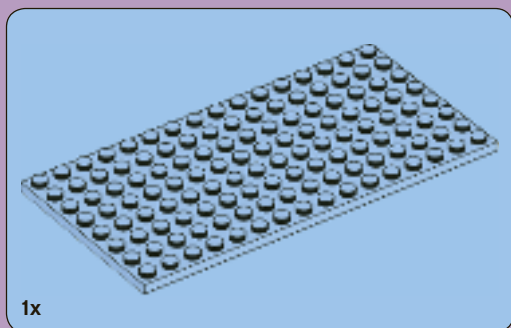

2

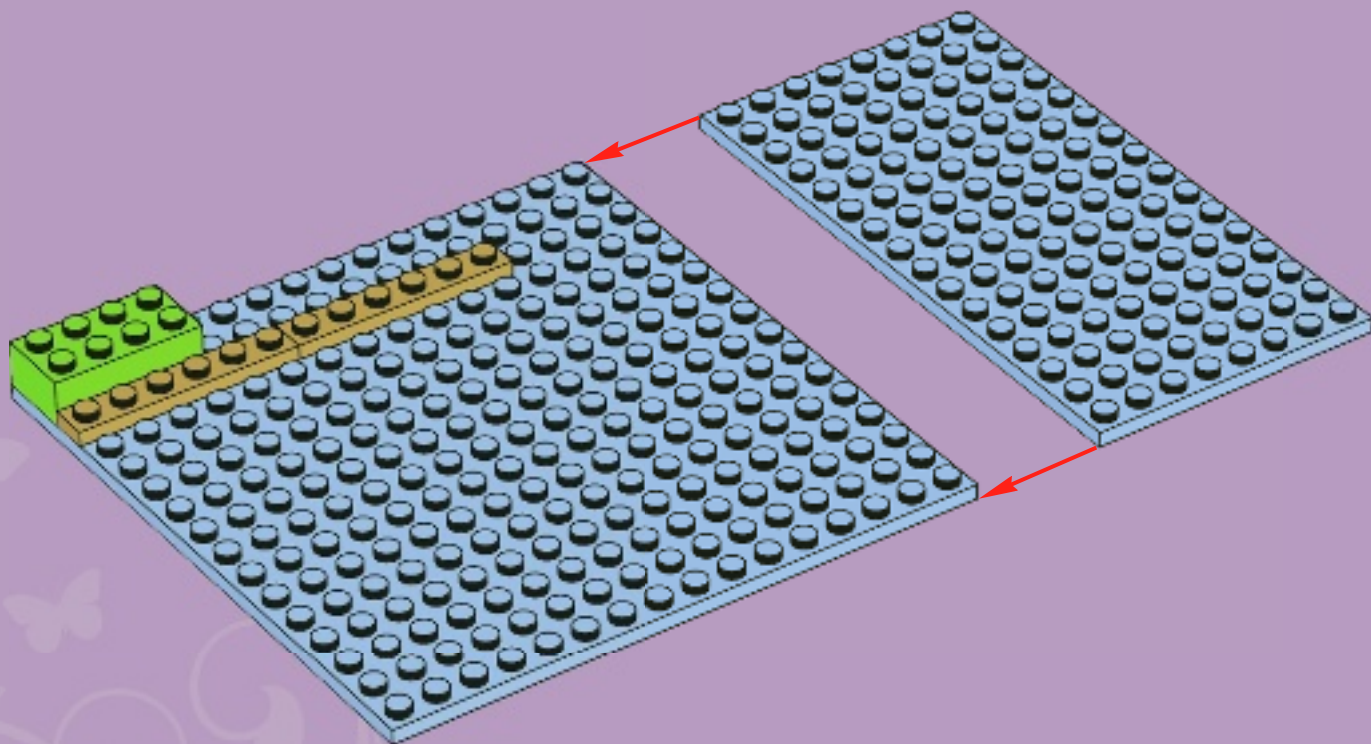

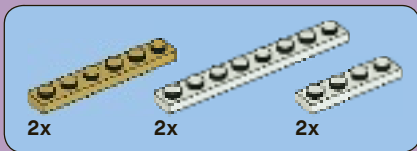

3

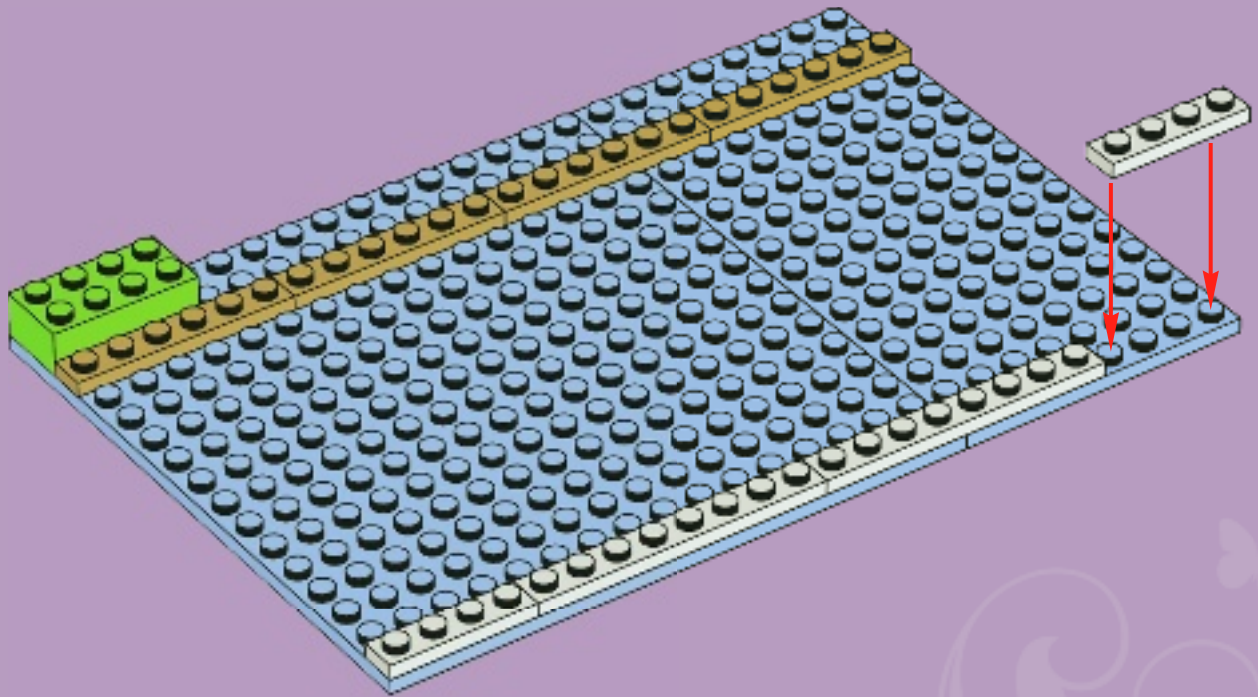

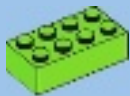

2x



2x

4

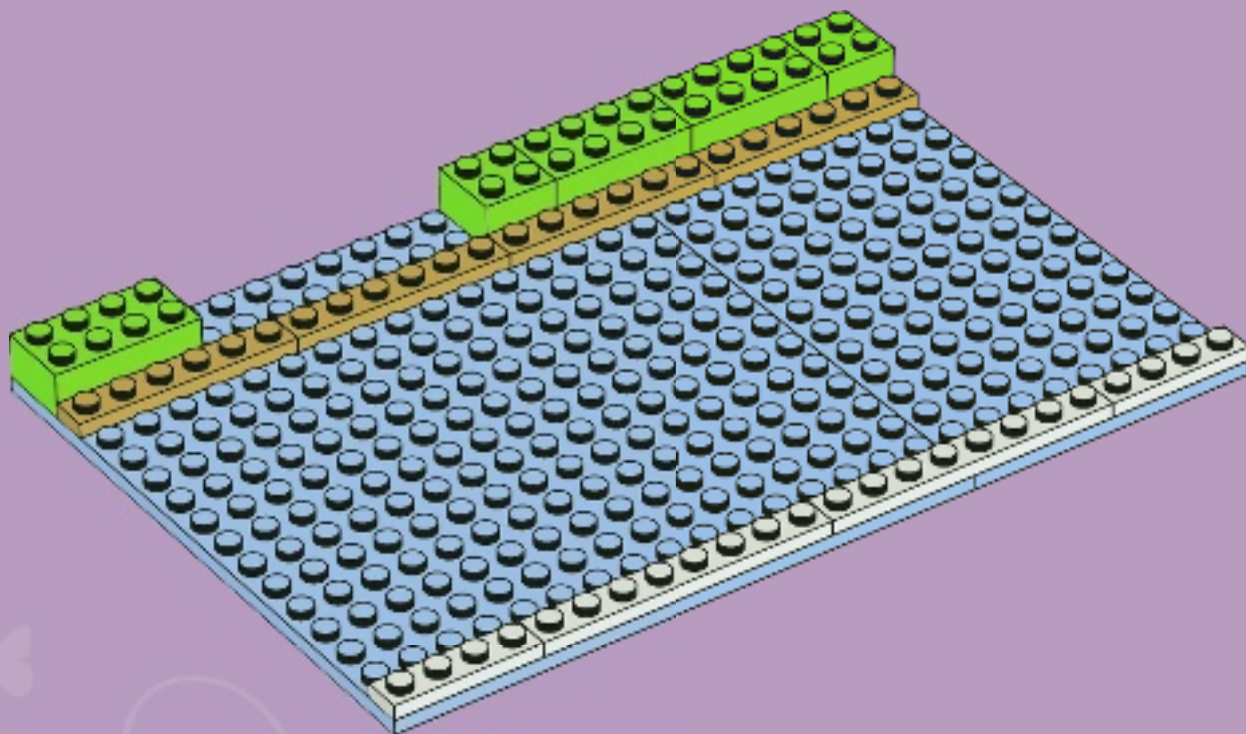

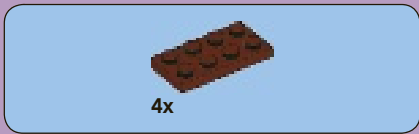

5

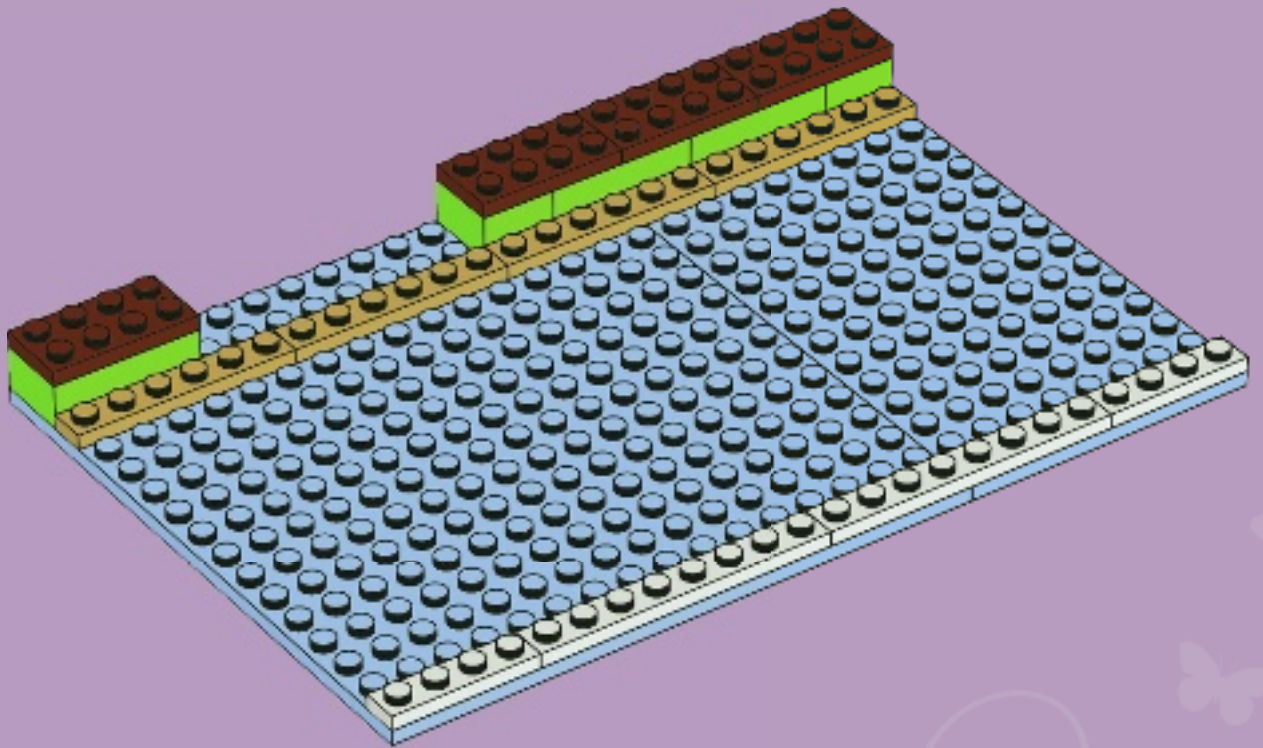

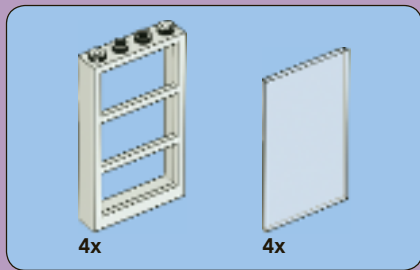

6

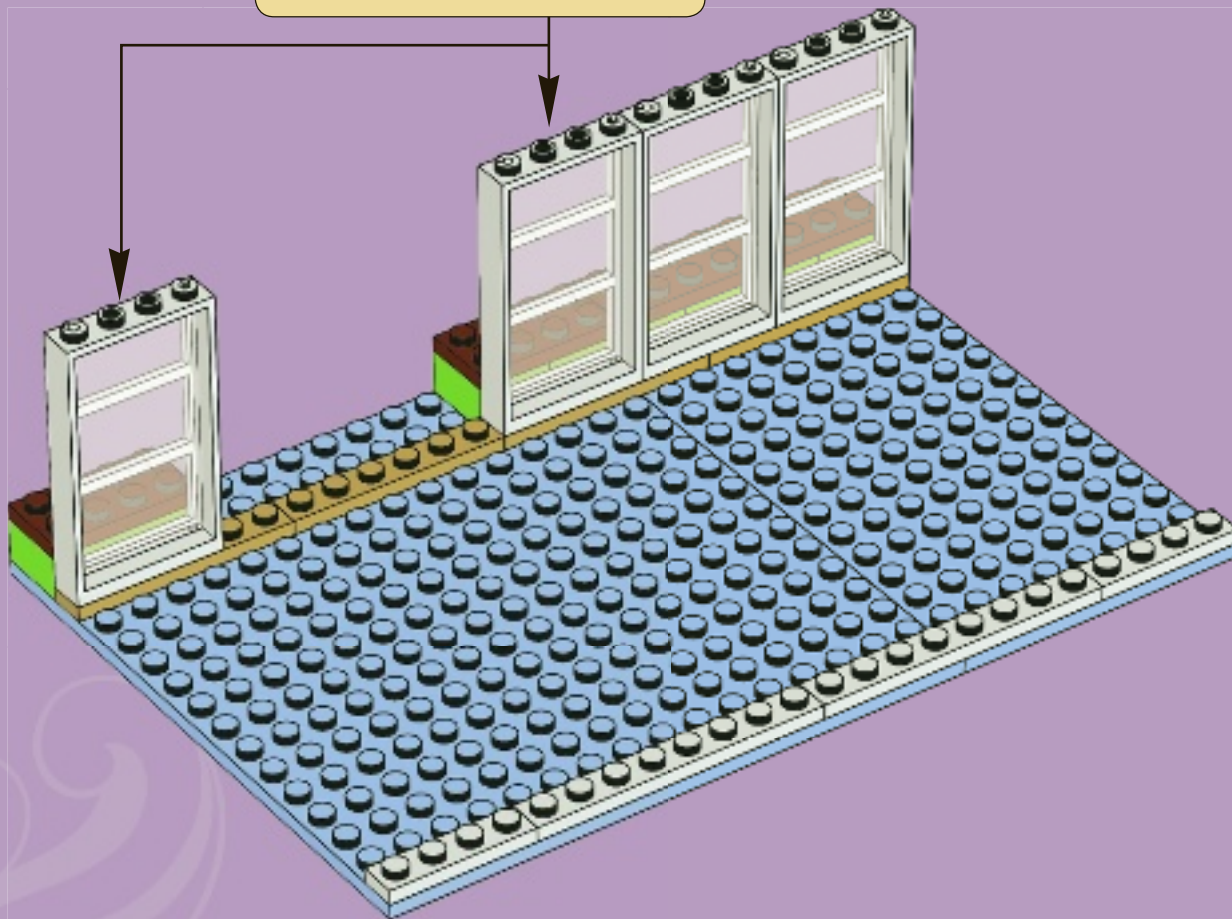
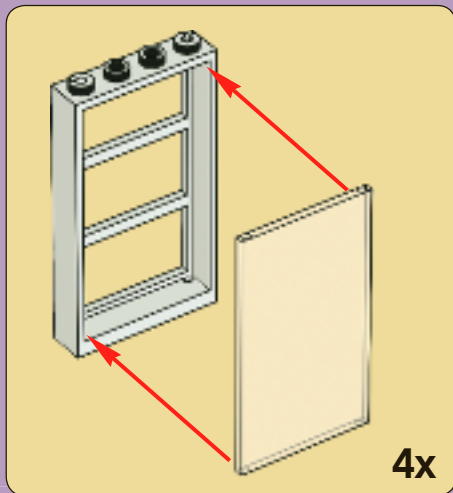



7

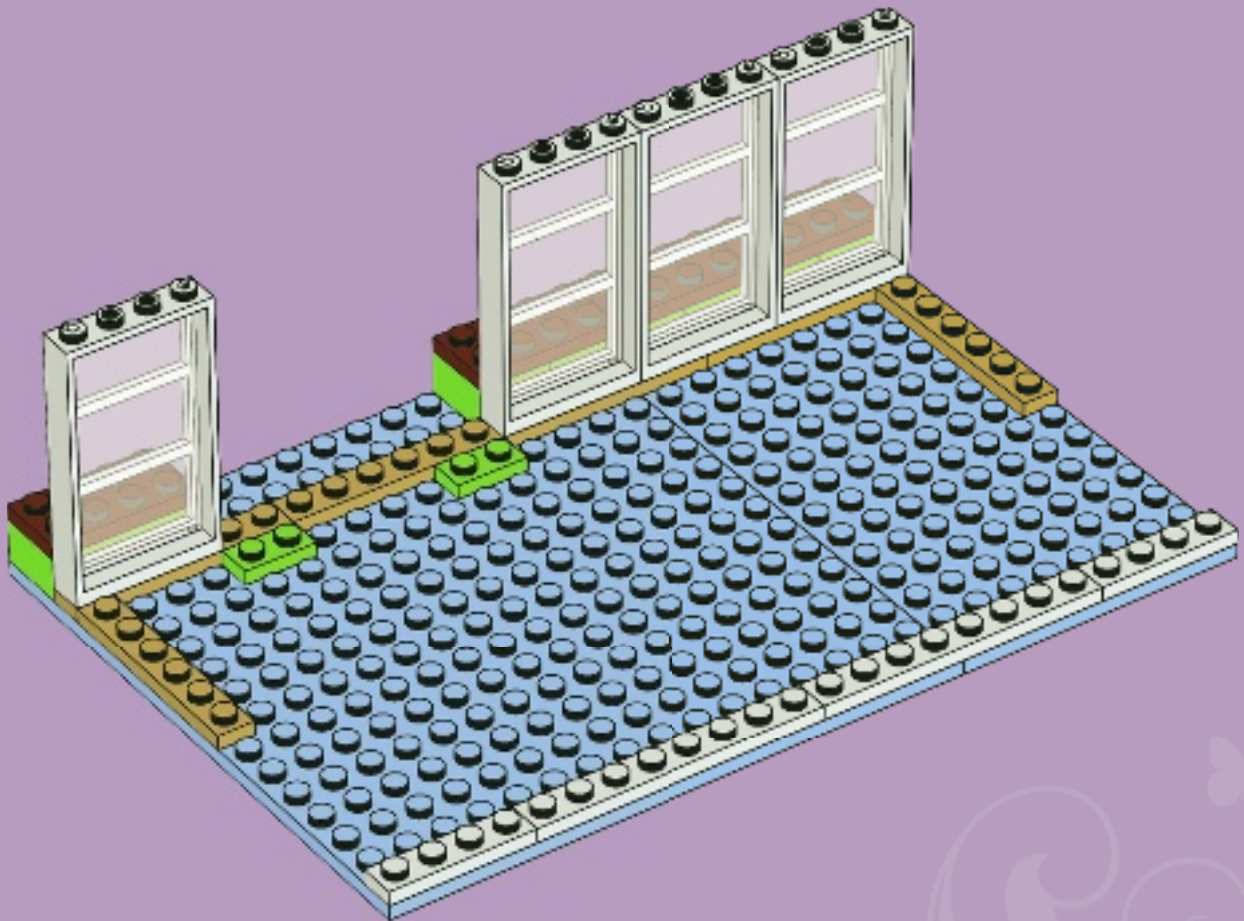



4x

8

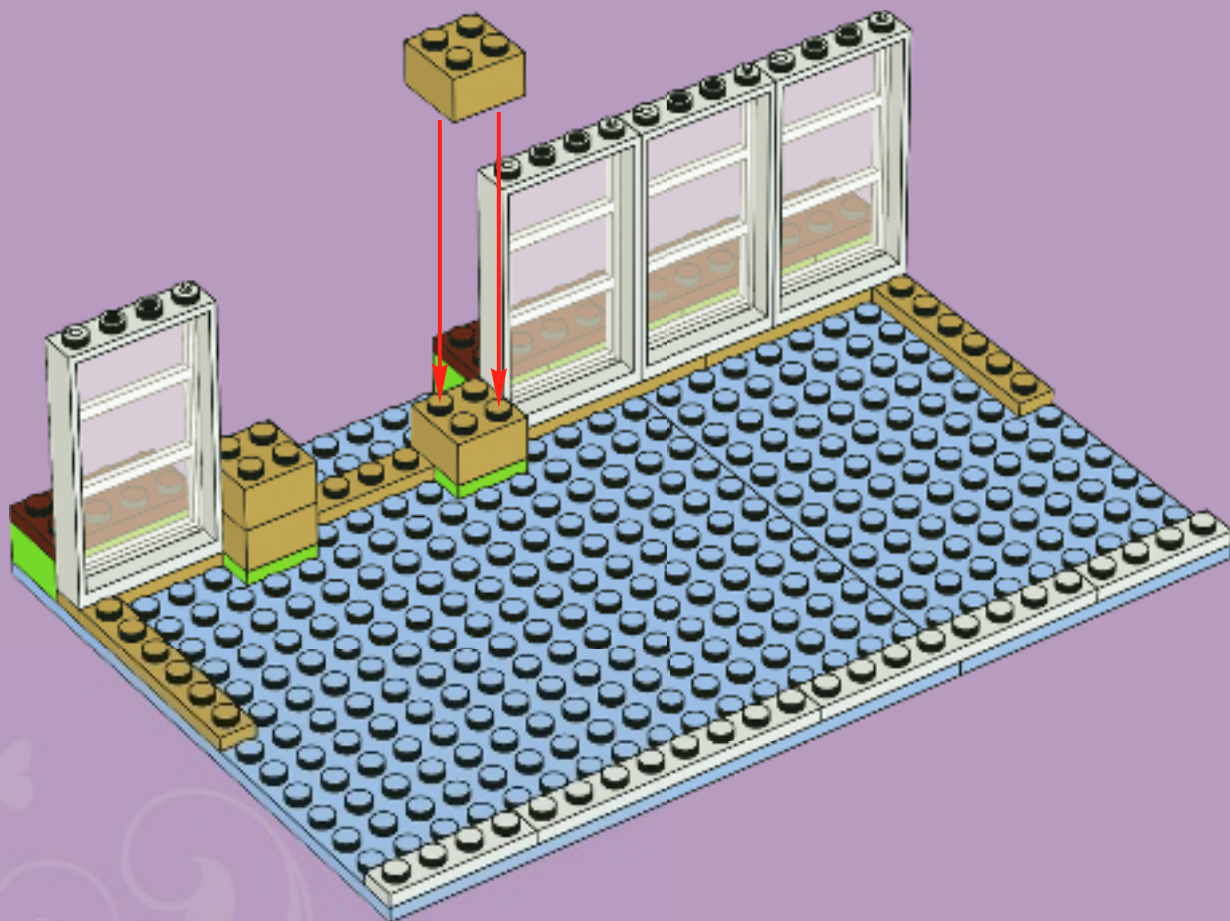

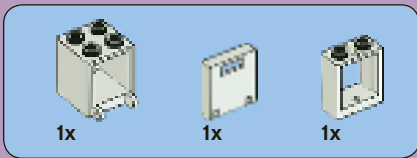

9

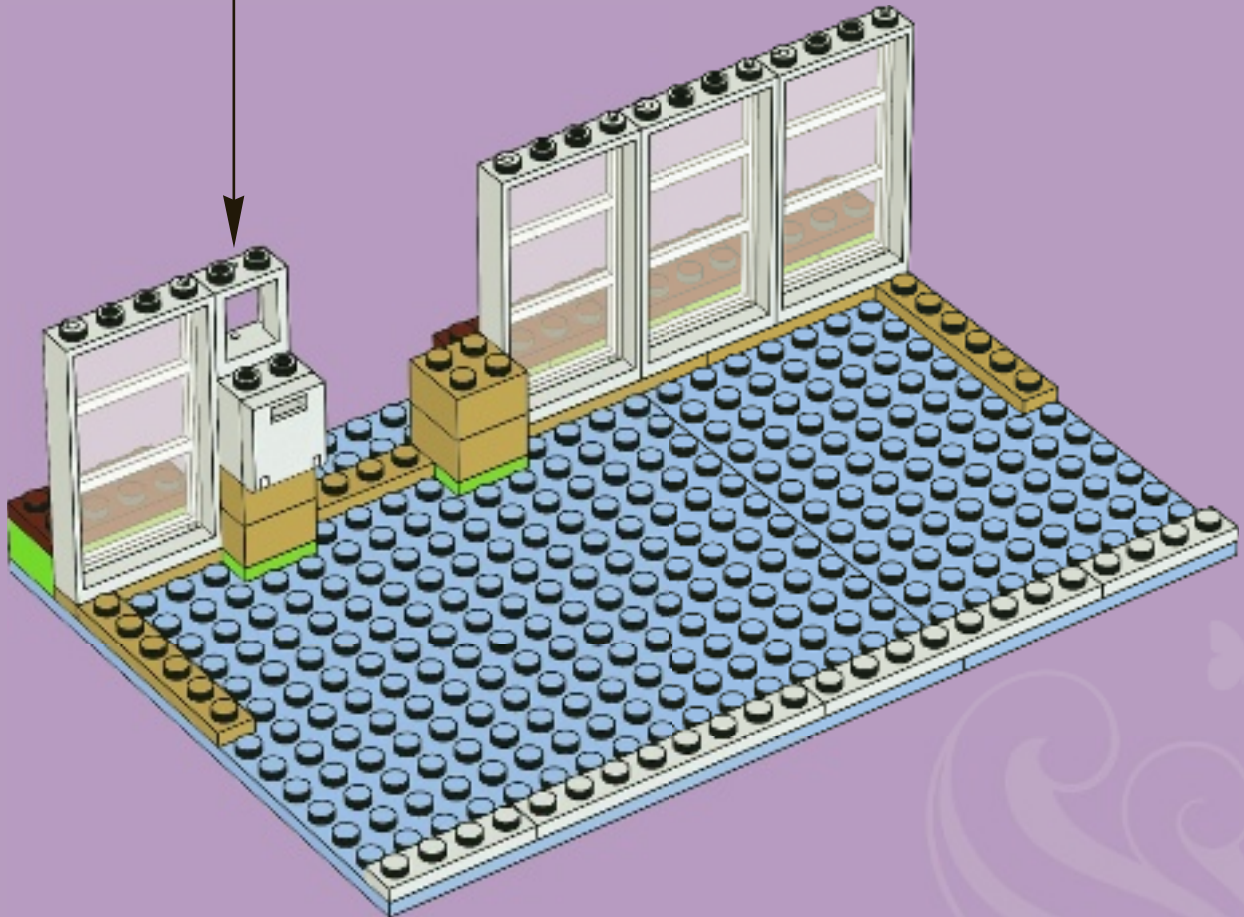
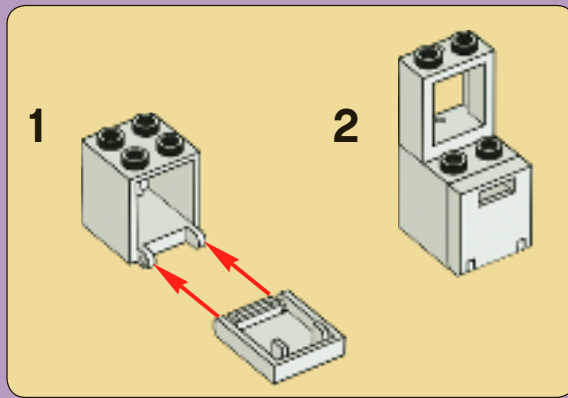

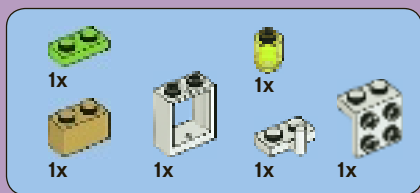

10

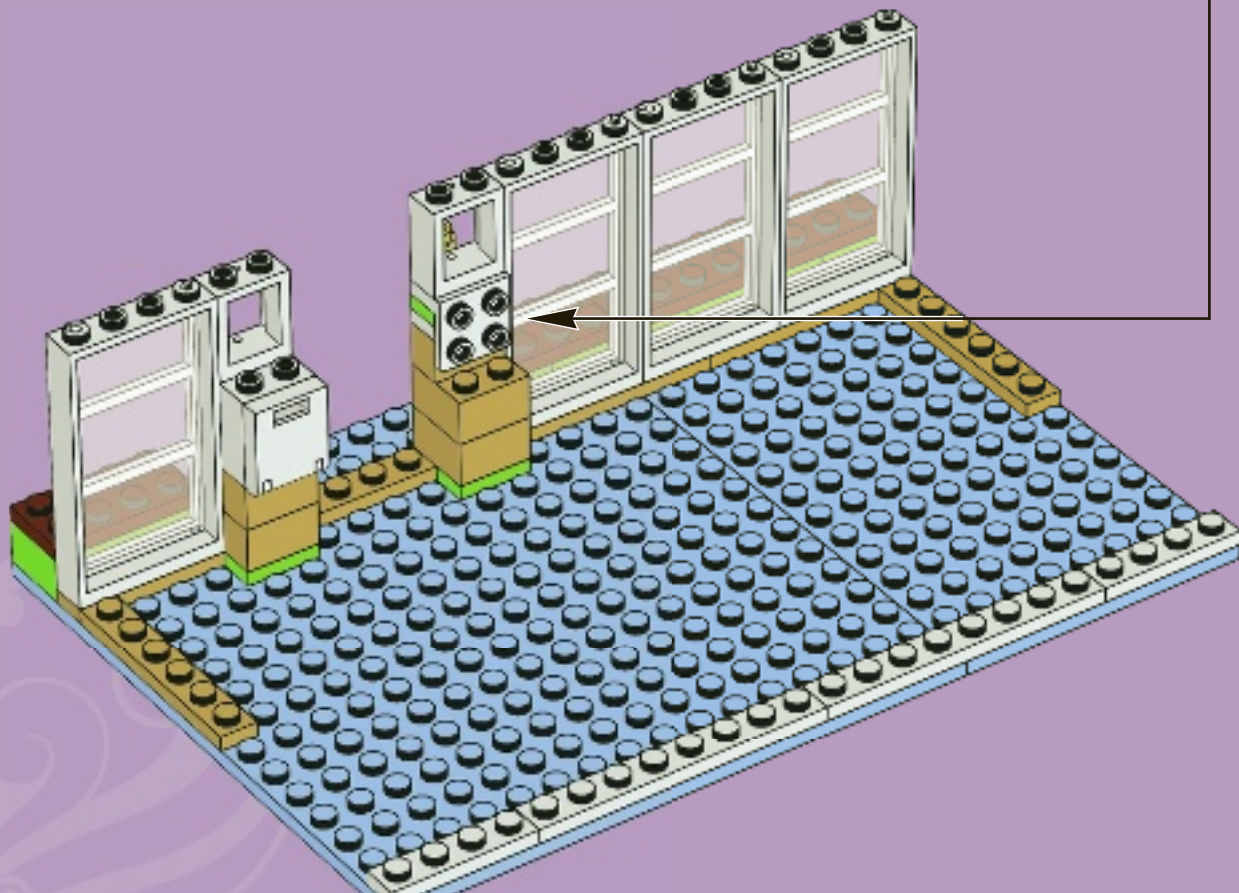
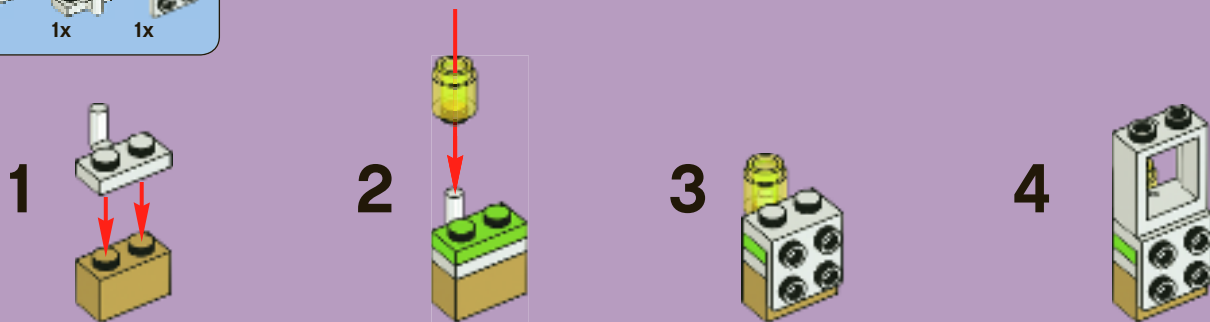

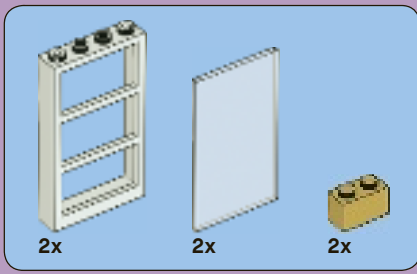

11

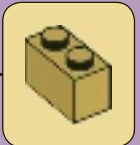
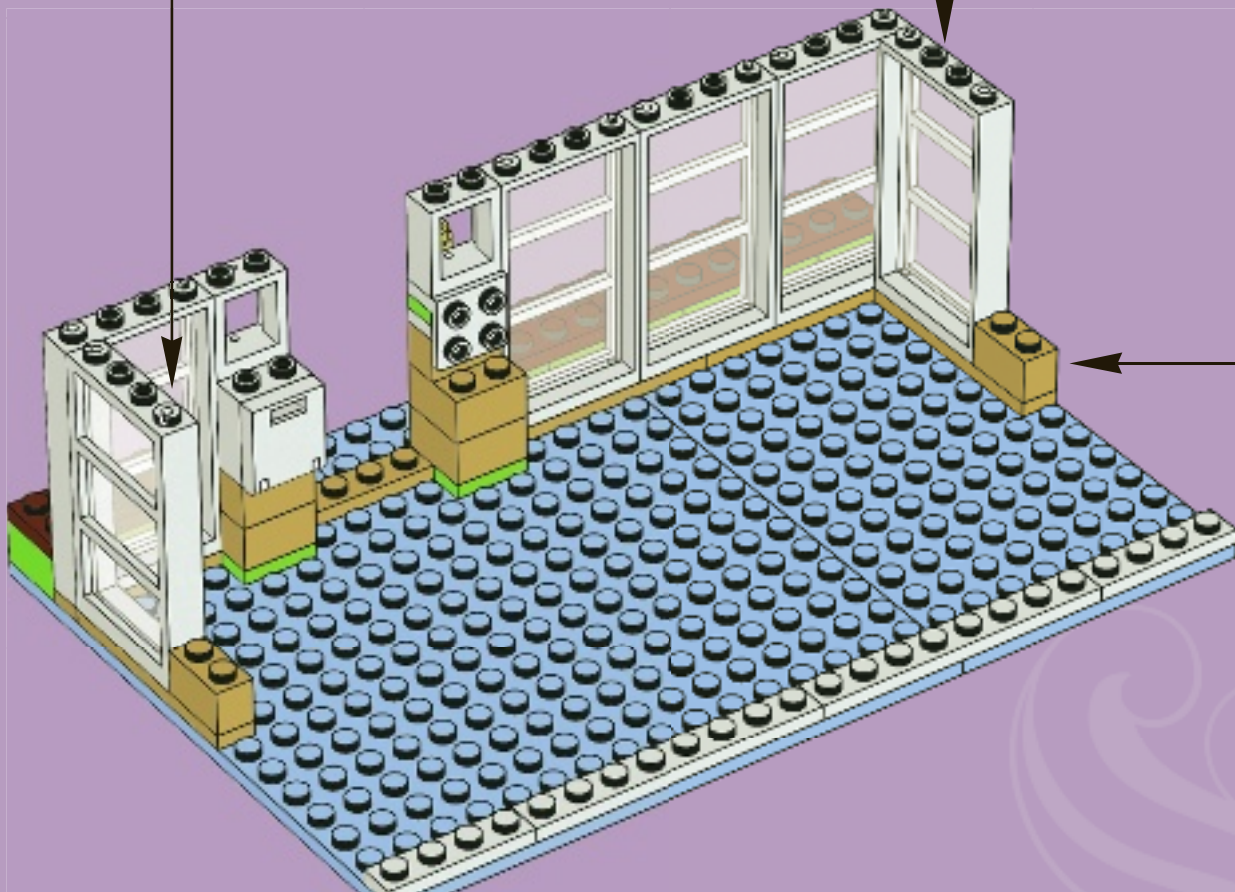
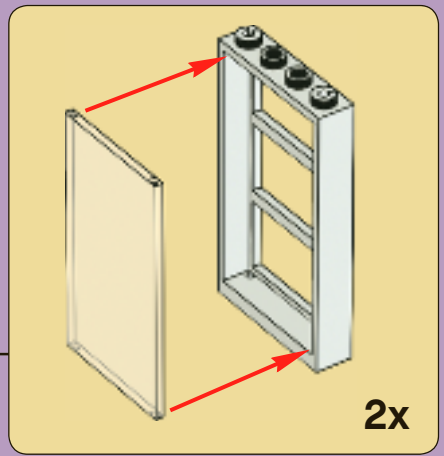

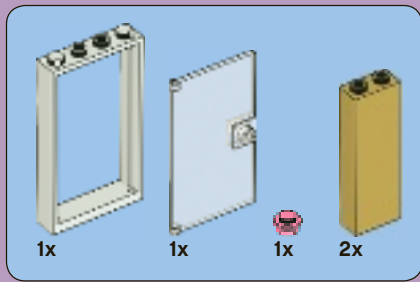

12

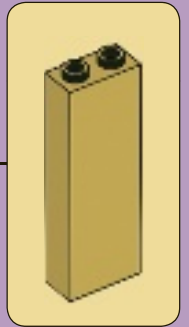
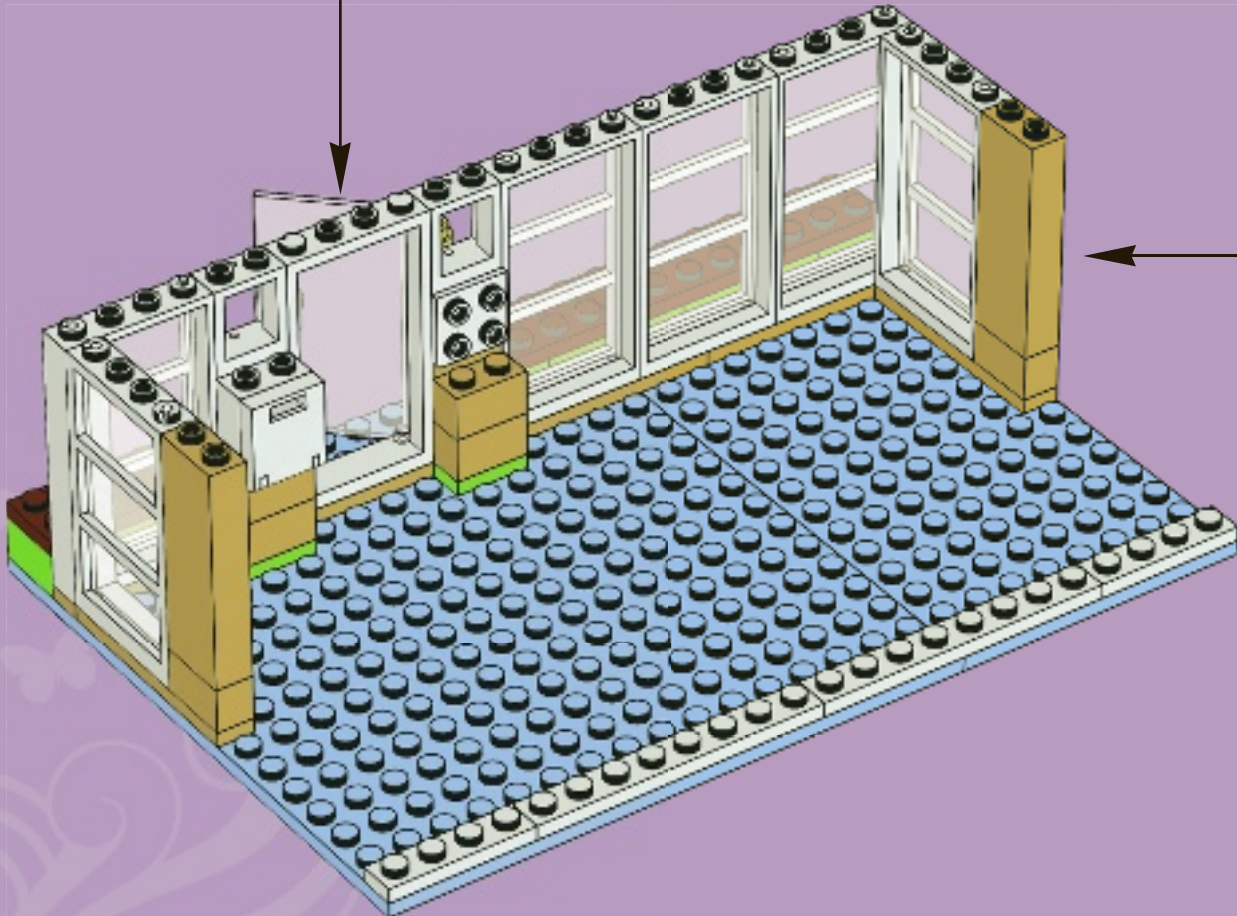
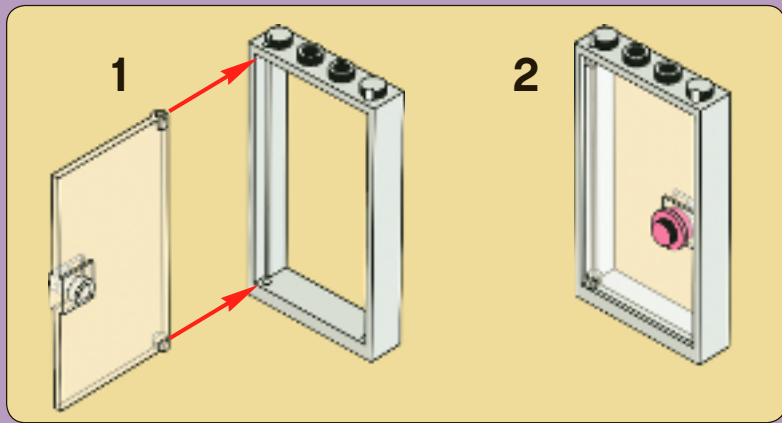

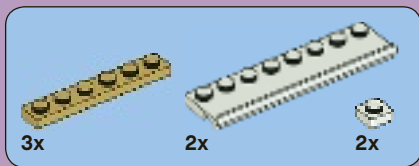

13

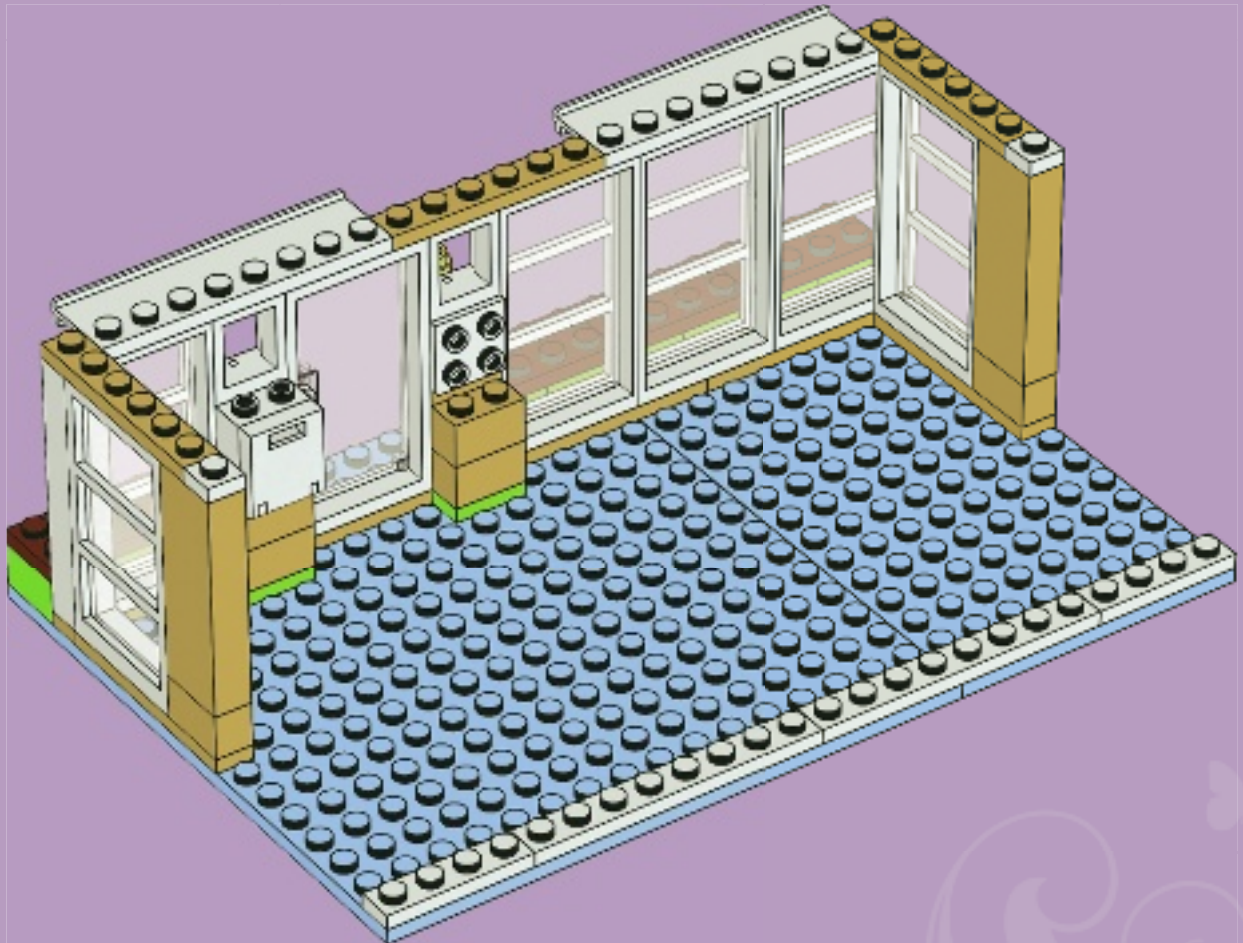



14

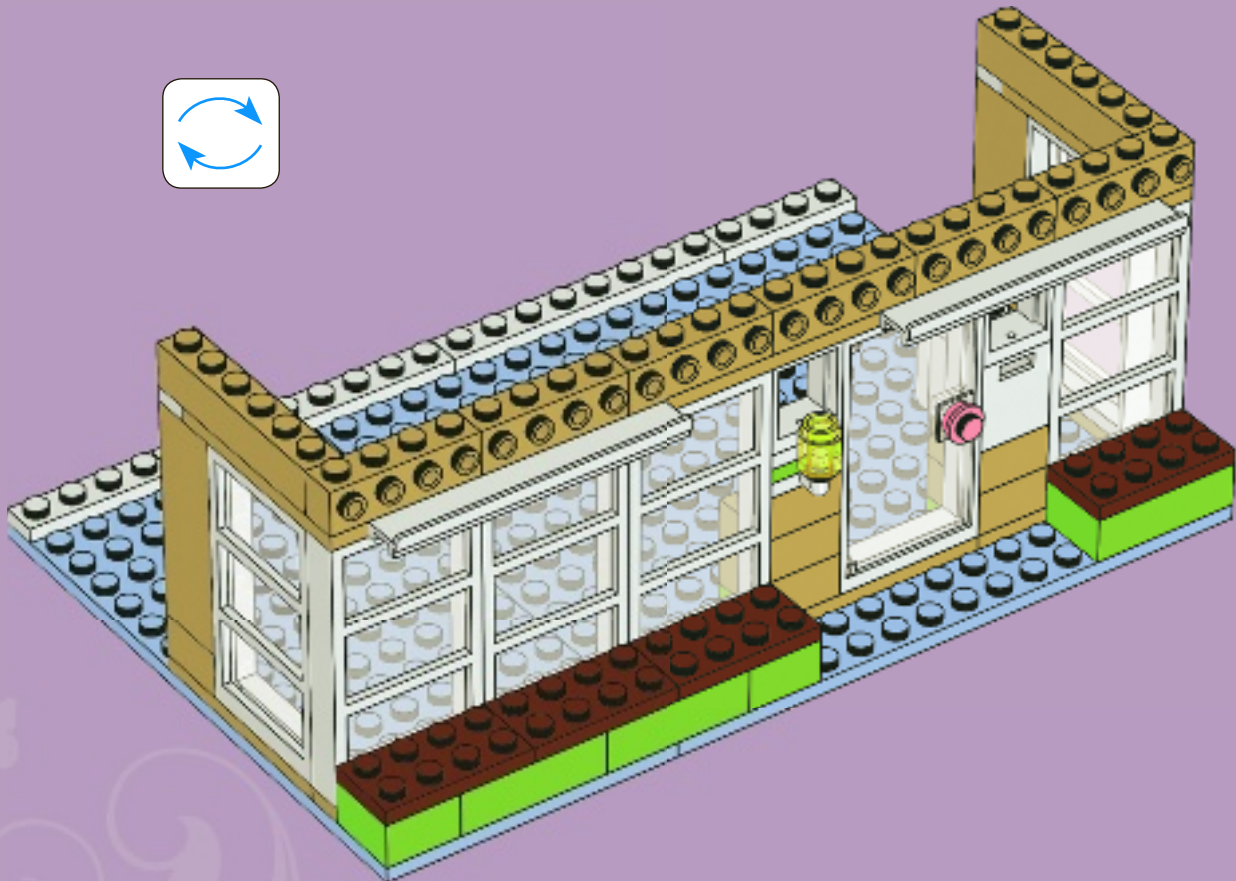
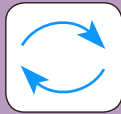



15

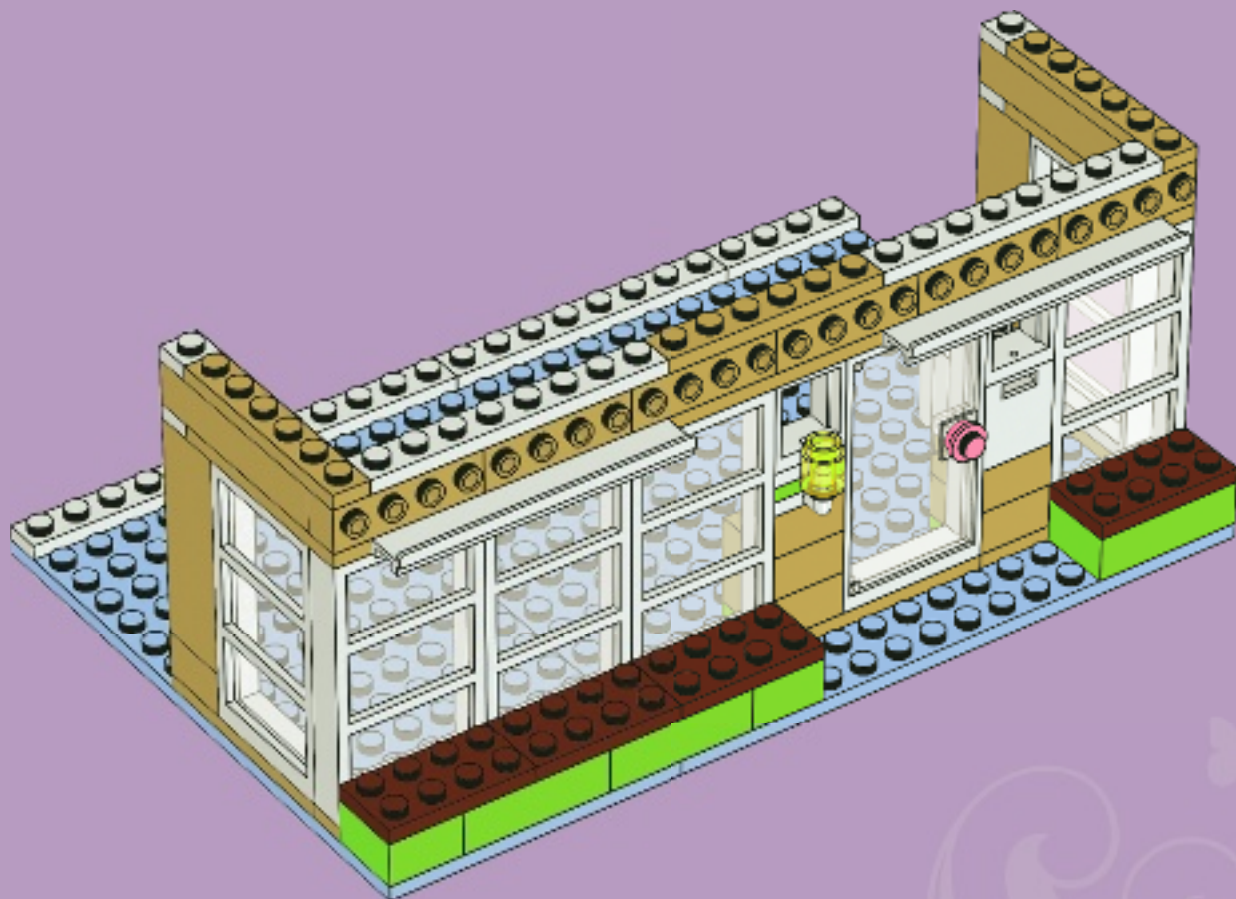

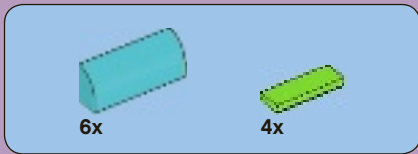

16

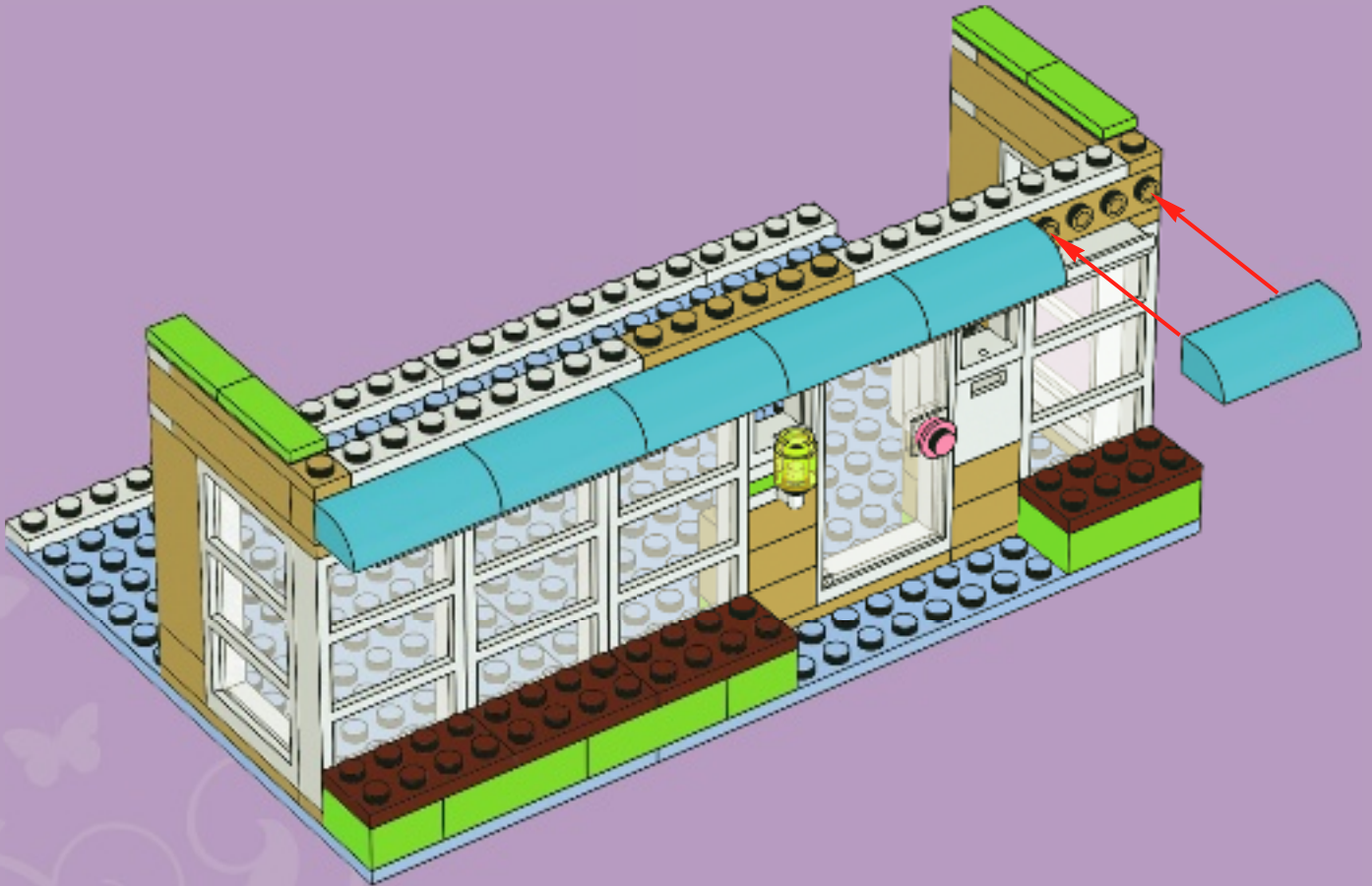

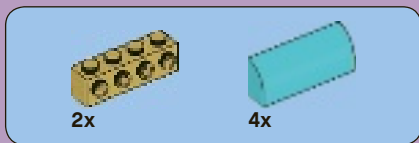

17

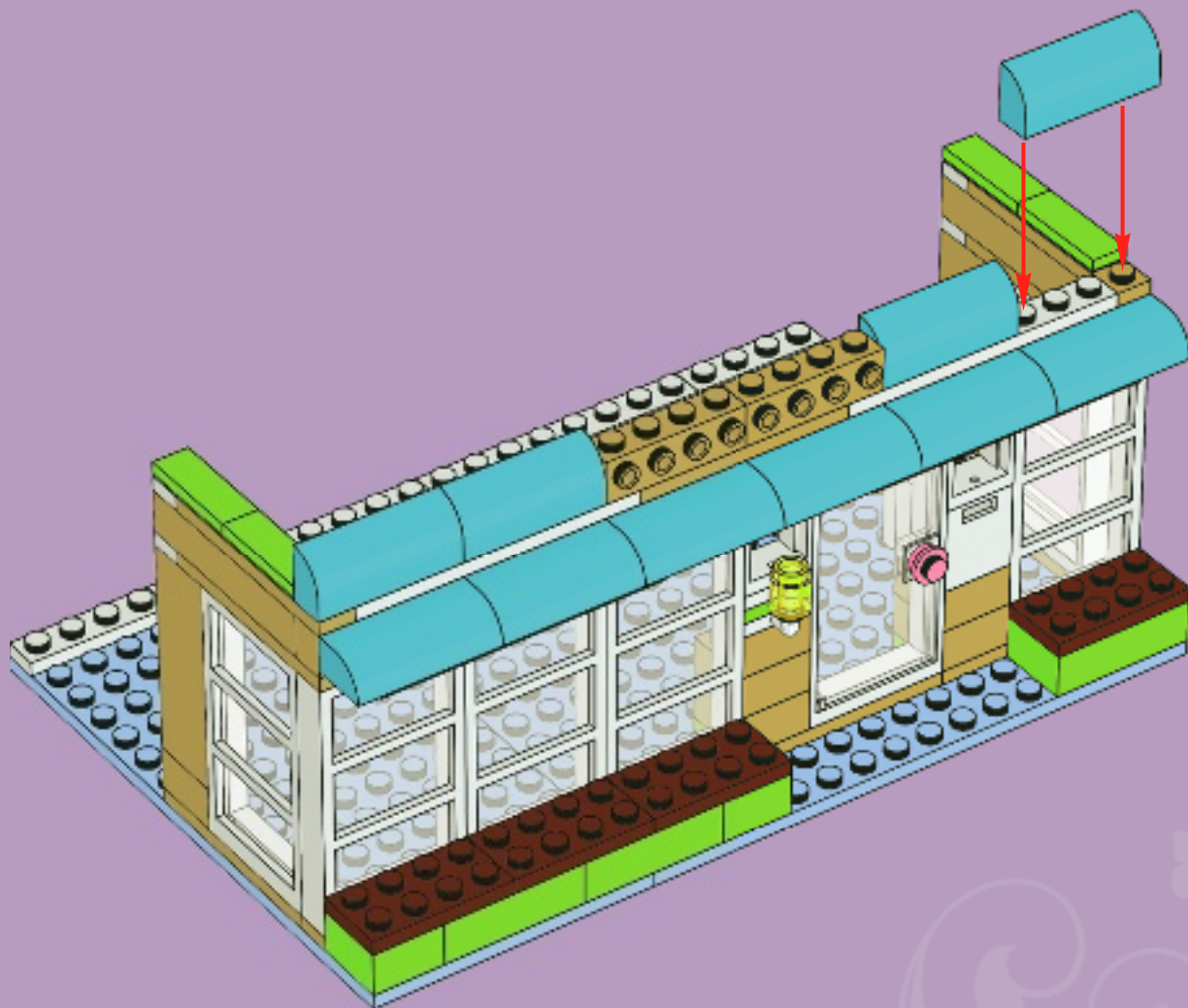

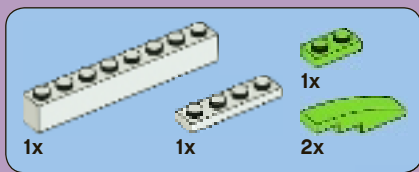

18

1

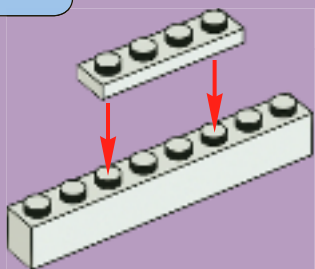

2

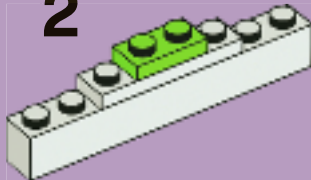

3

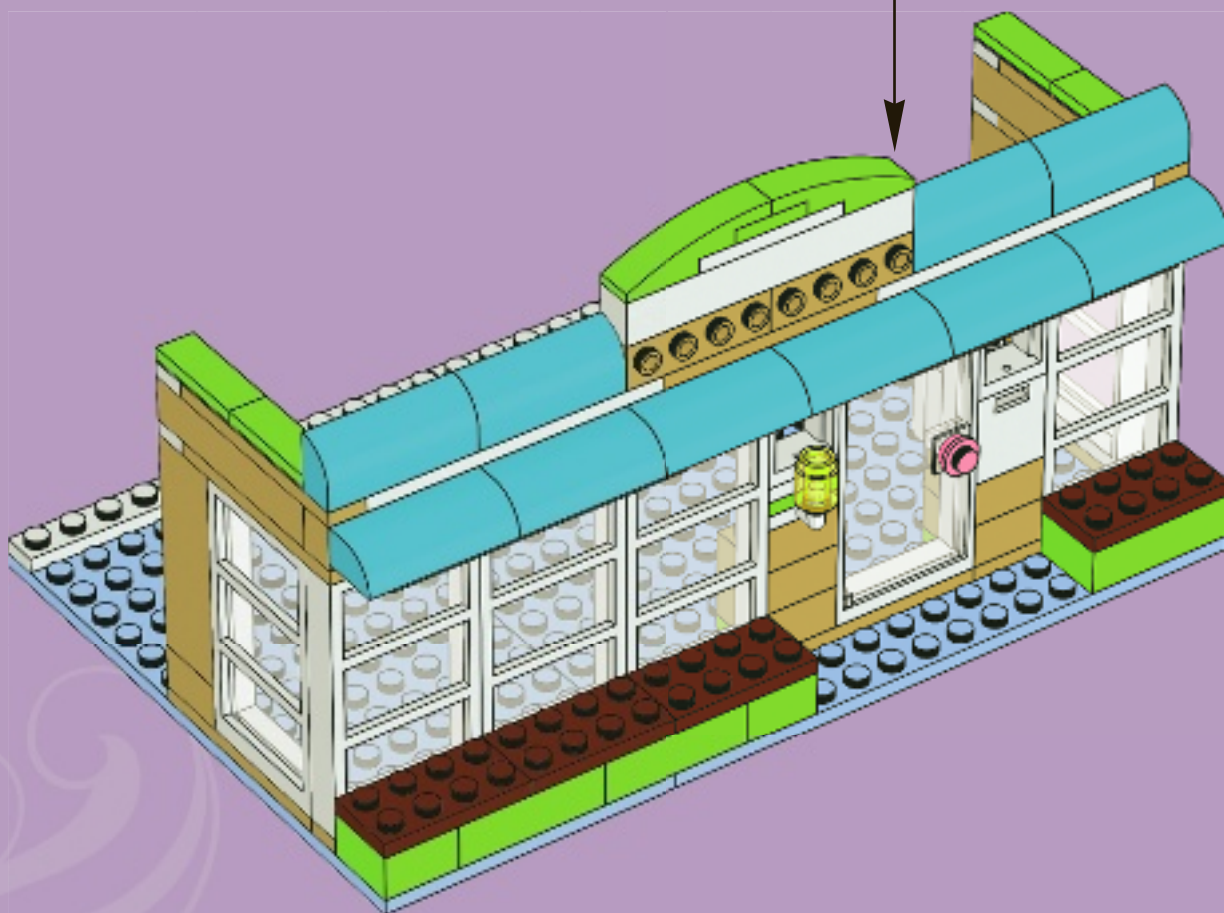
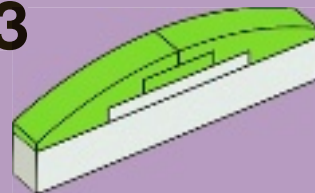

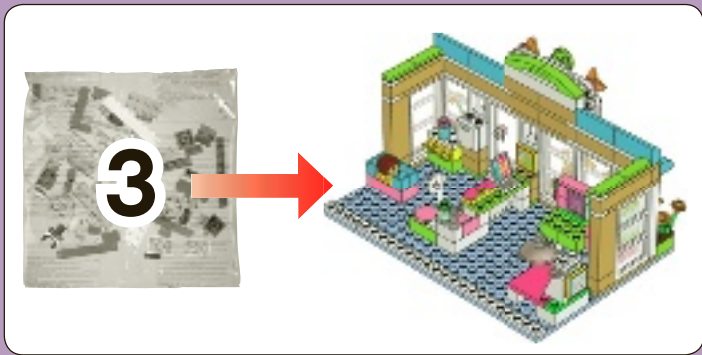

1

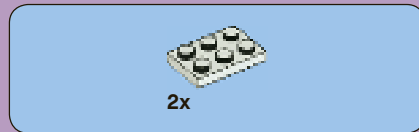
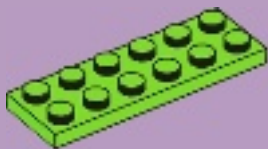

2

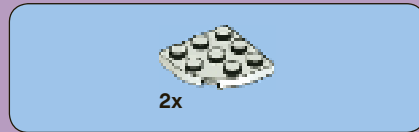
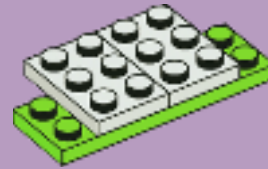

3

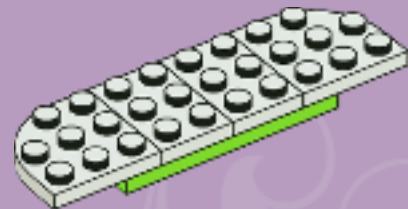



2x

4

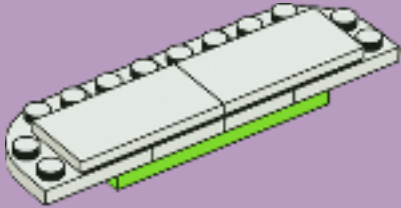

2x



1x

5

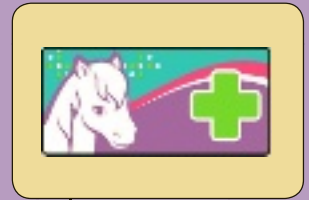
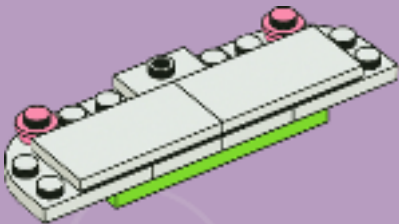

6

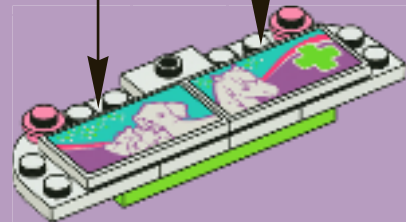



7

19

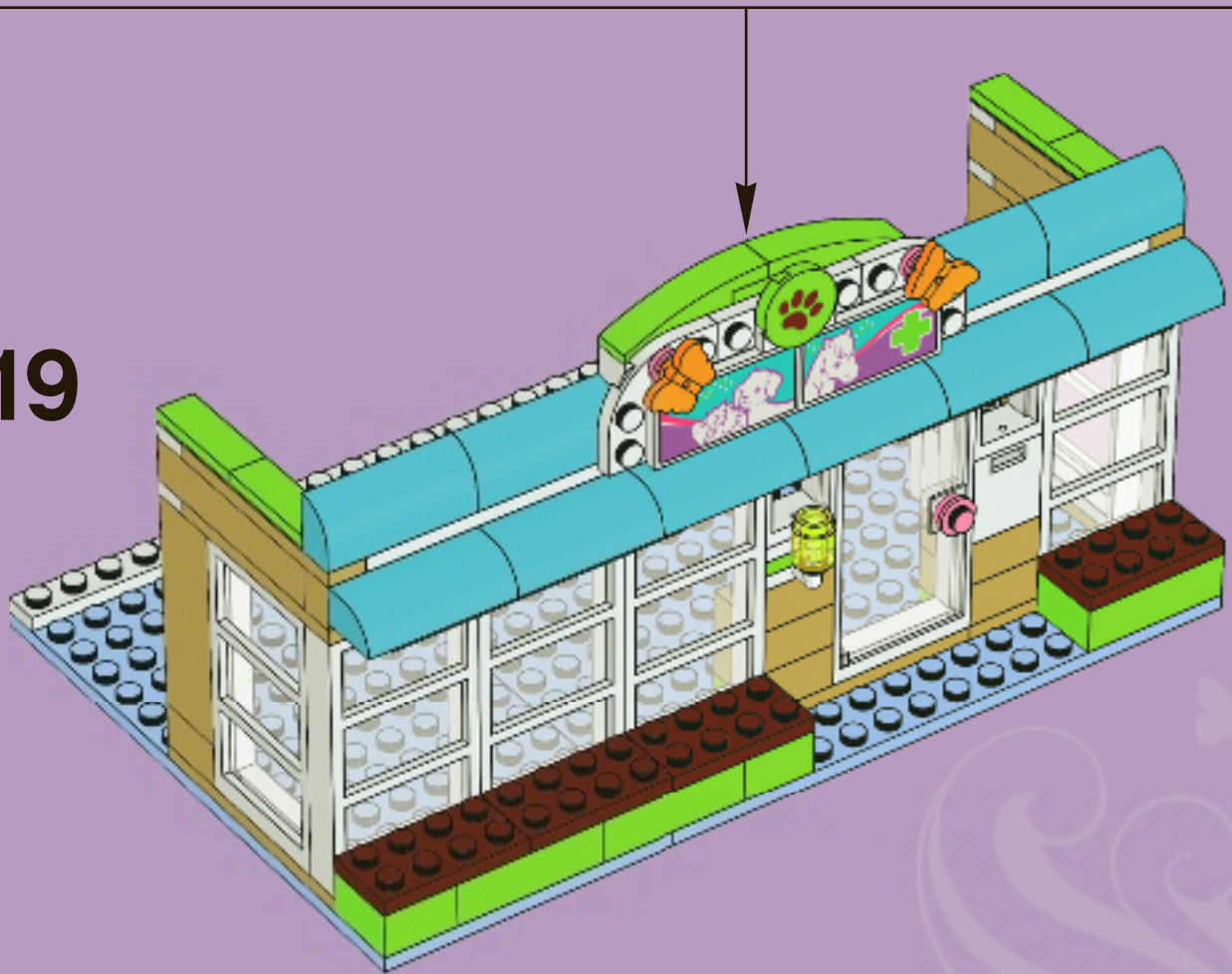



4x



2x

20

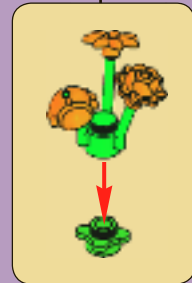
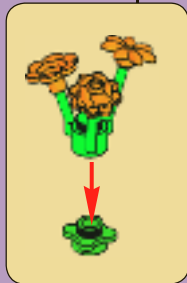
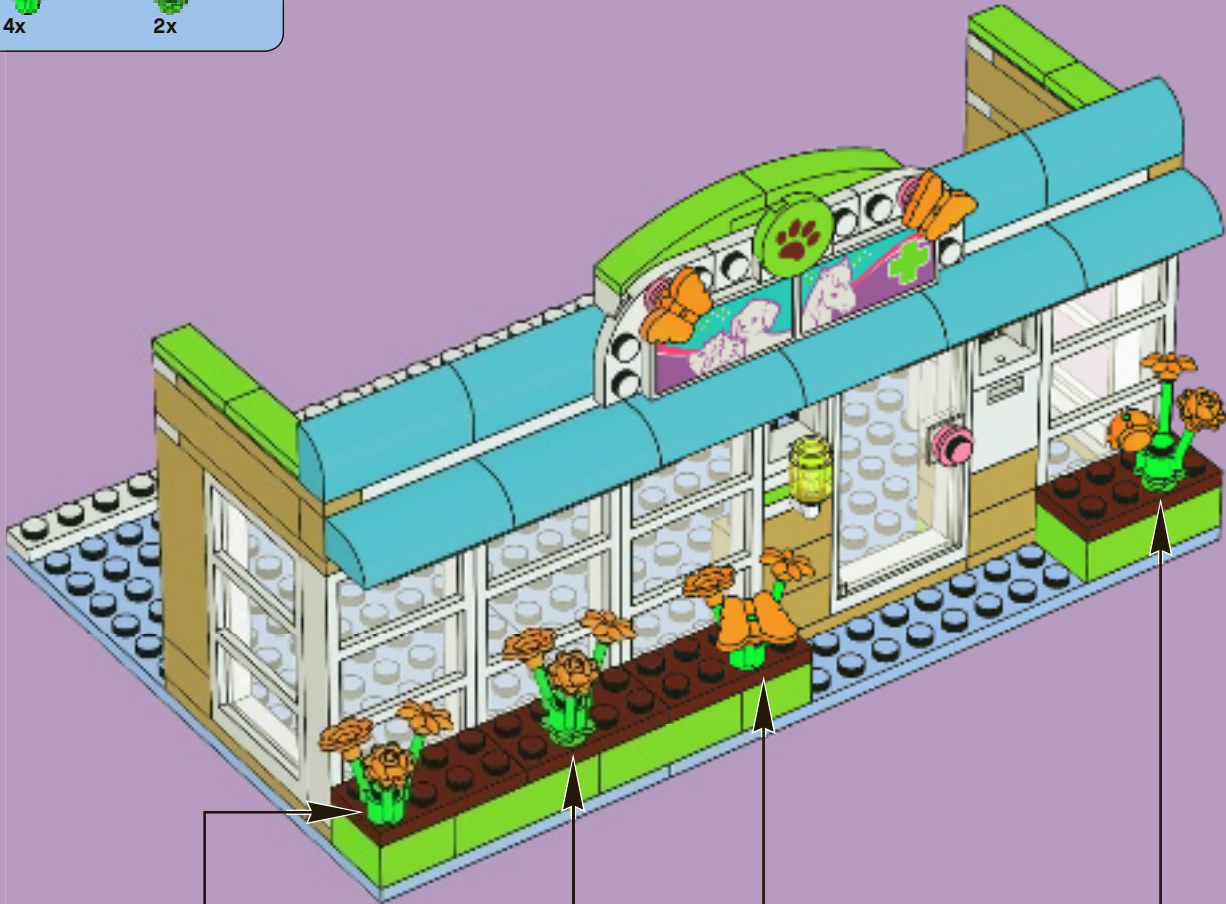

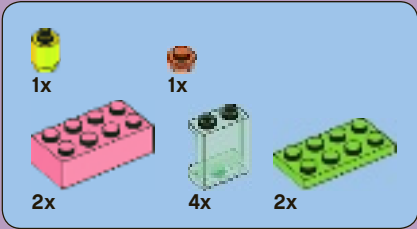

21

1

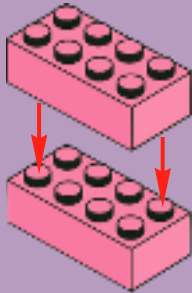

2

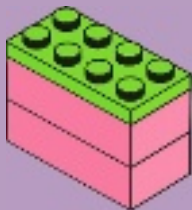

3

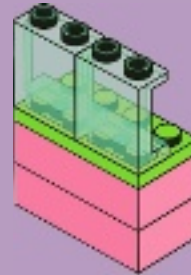

4

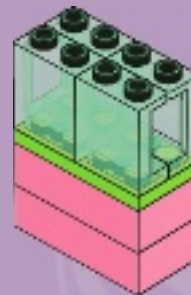

5



7

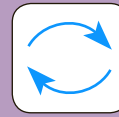

6



8





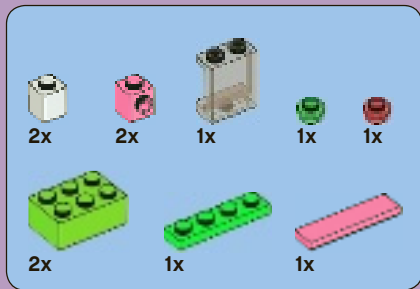

22

1

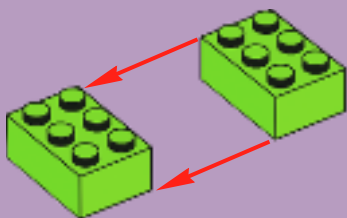

2

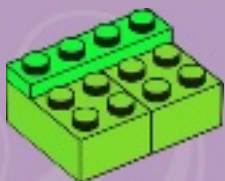

3

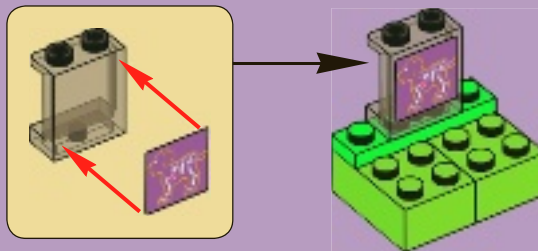

4

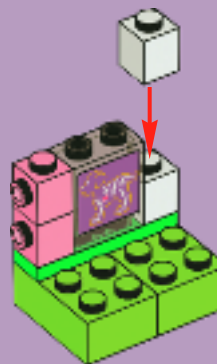

5





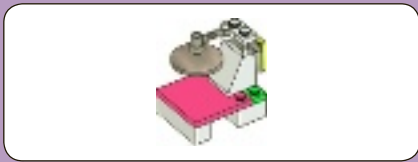

1

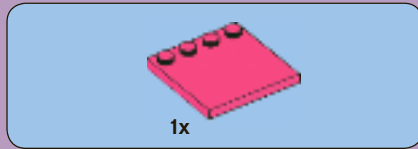
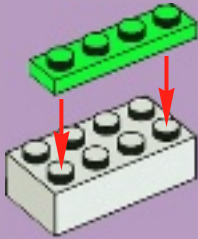

2



3

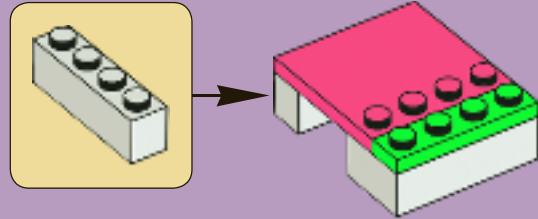

4

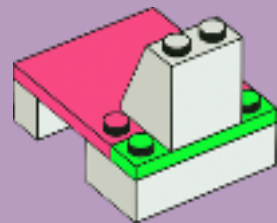



1x

5

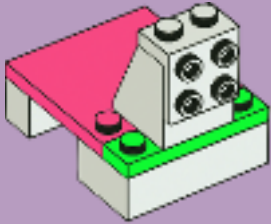

1x



1x

6

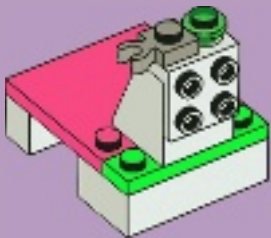

1x

7

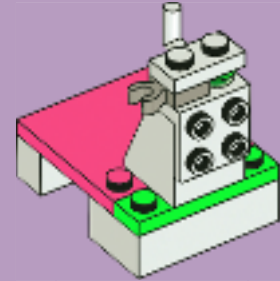

1x

8

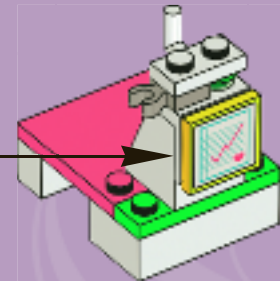
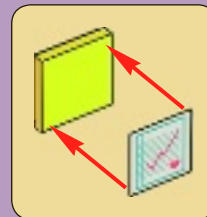

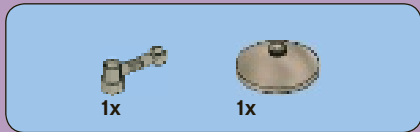

9

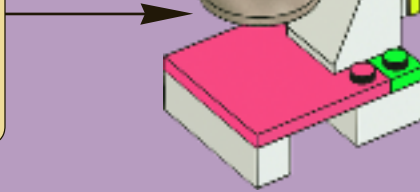
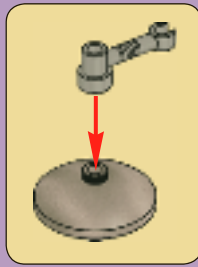

23





1x



1x

24

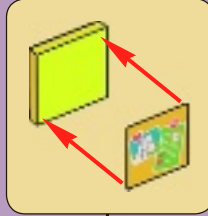

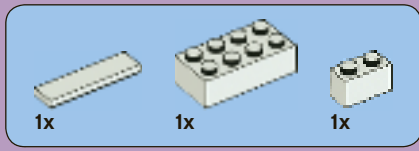

25





3x



2x

26





27

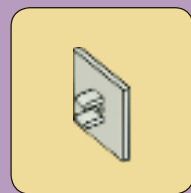
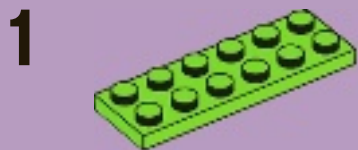





1x



1x



1x

28



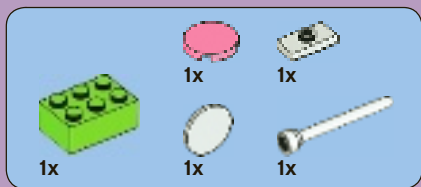

29

1

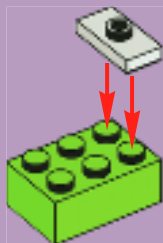

2



3

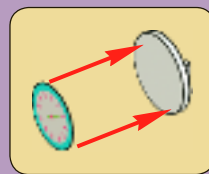



30

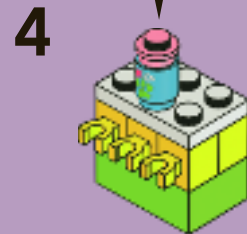
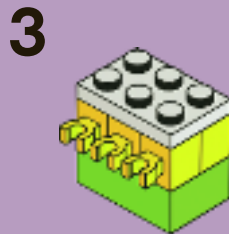
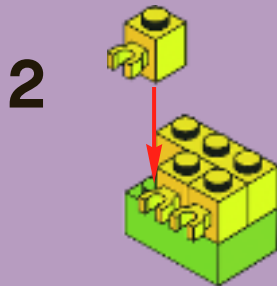
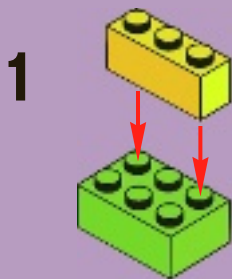

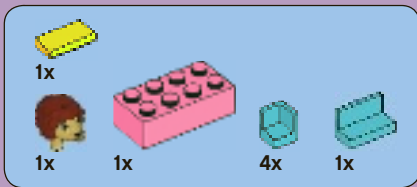

31

1

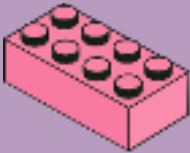

2

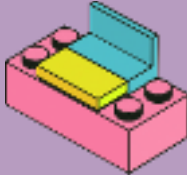

3

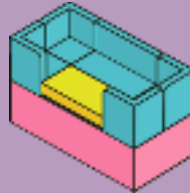

4



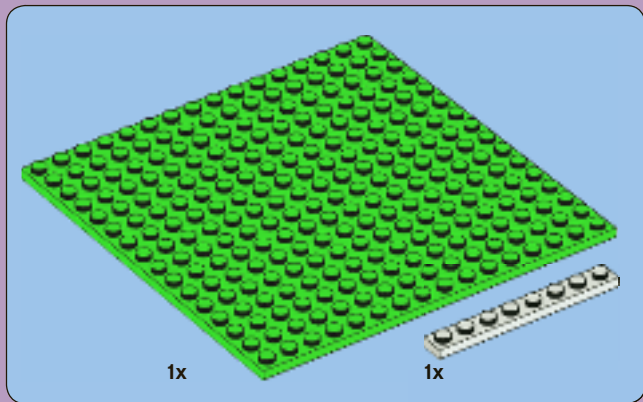
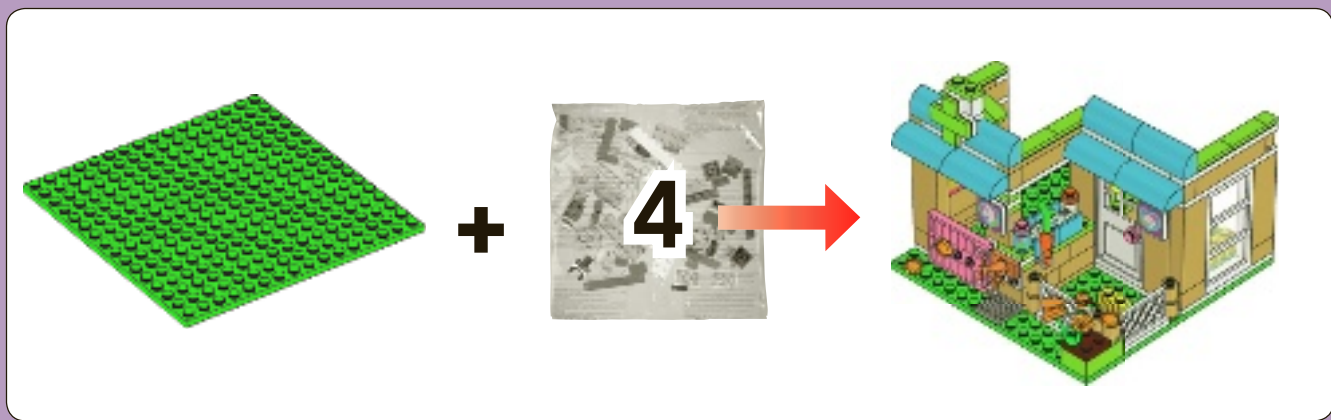

1x

1x

1

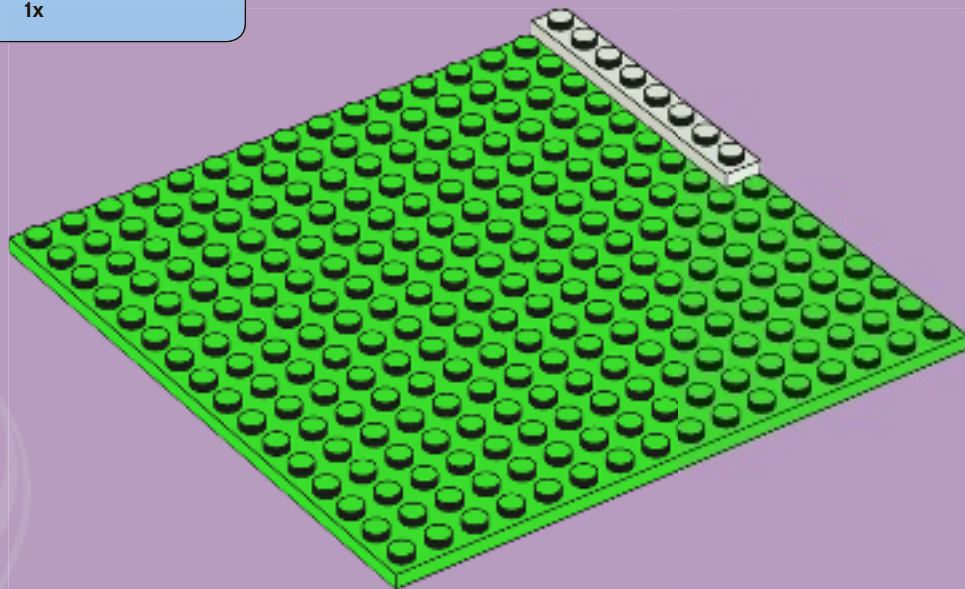

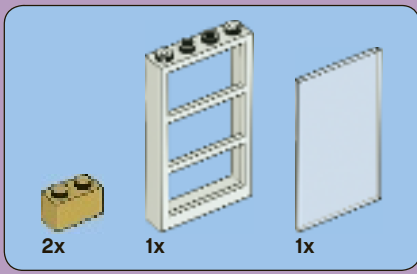

2

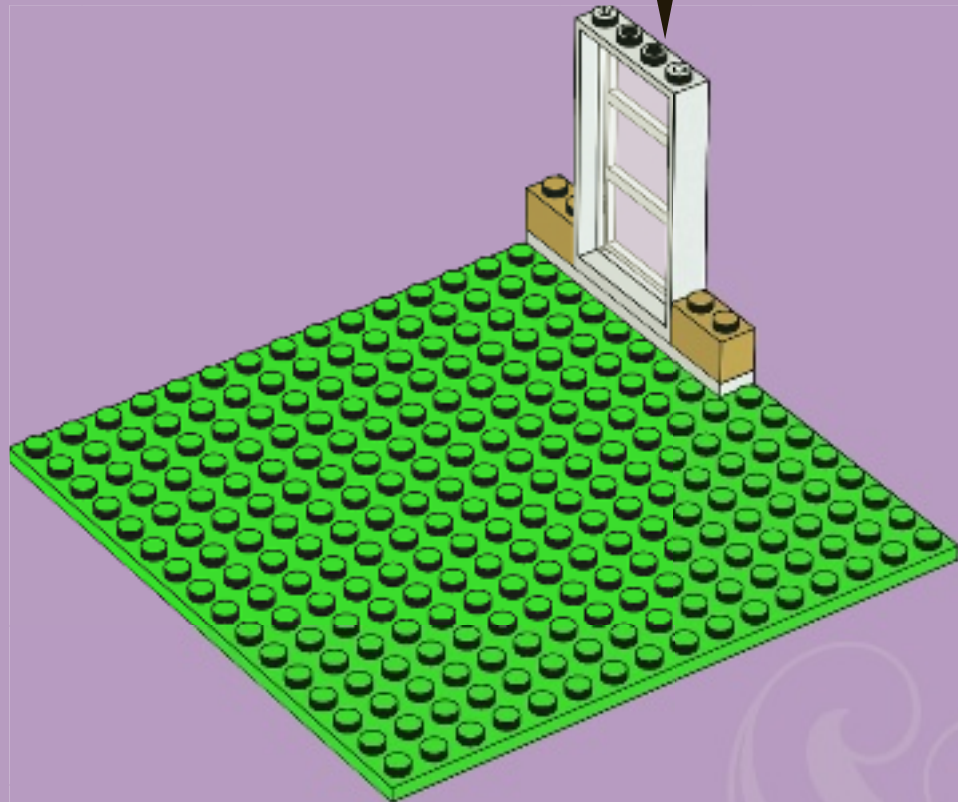
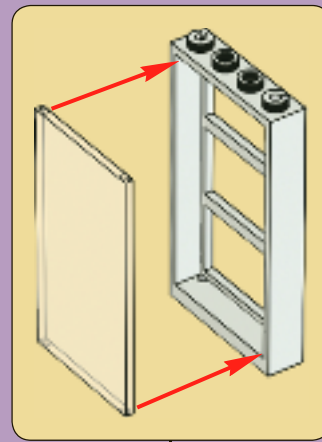

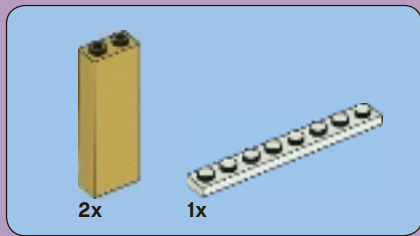

3

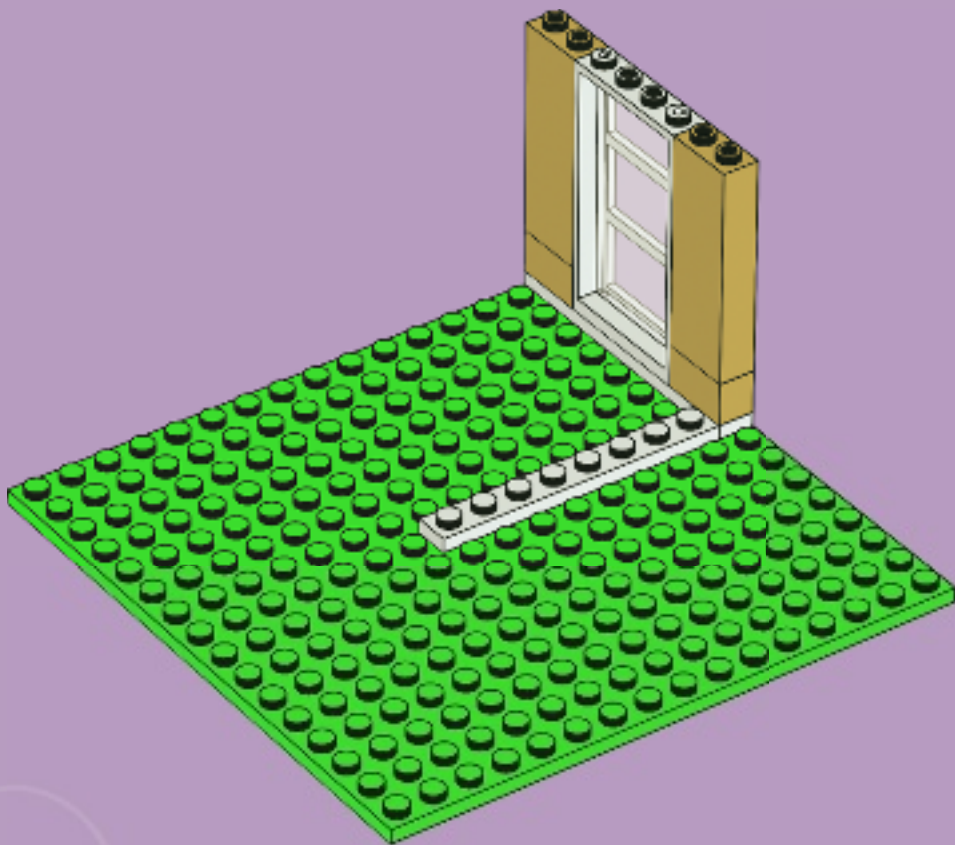

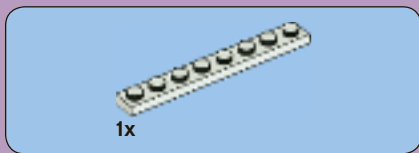

4

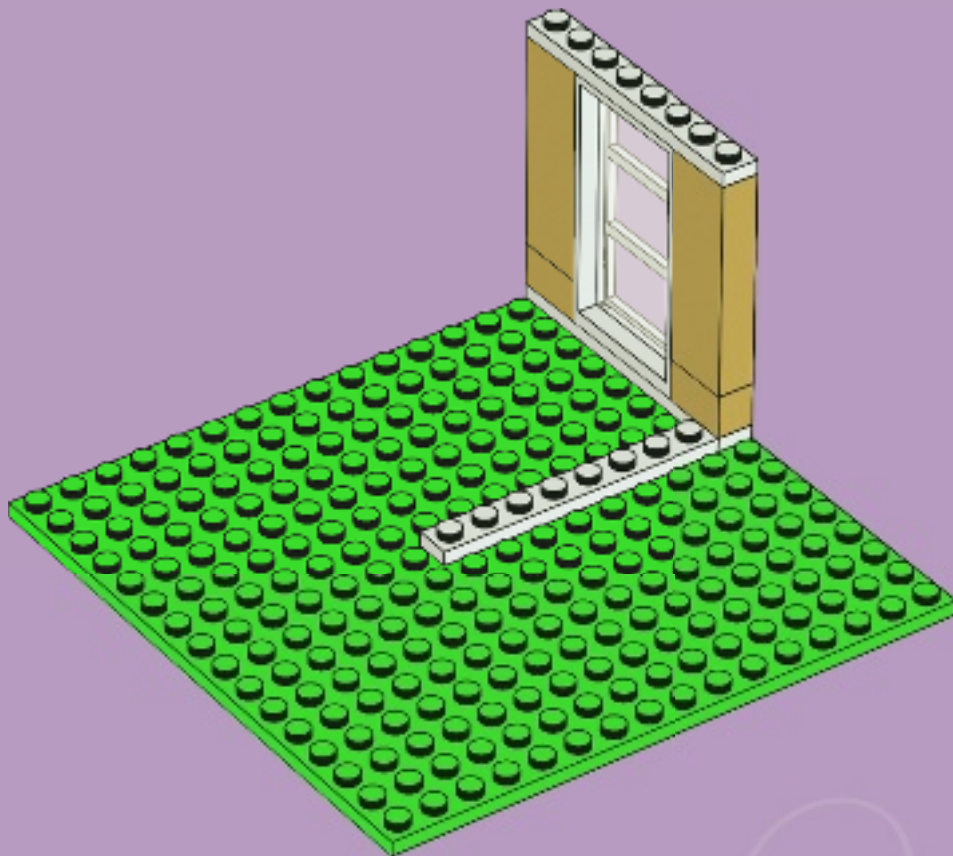

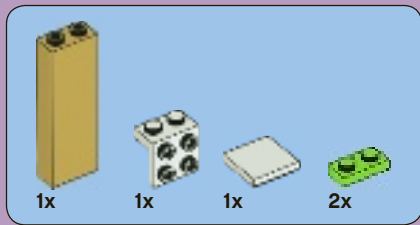

5

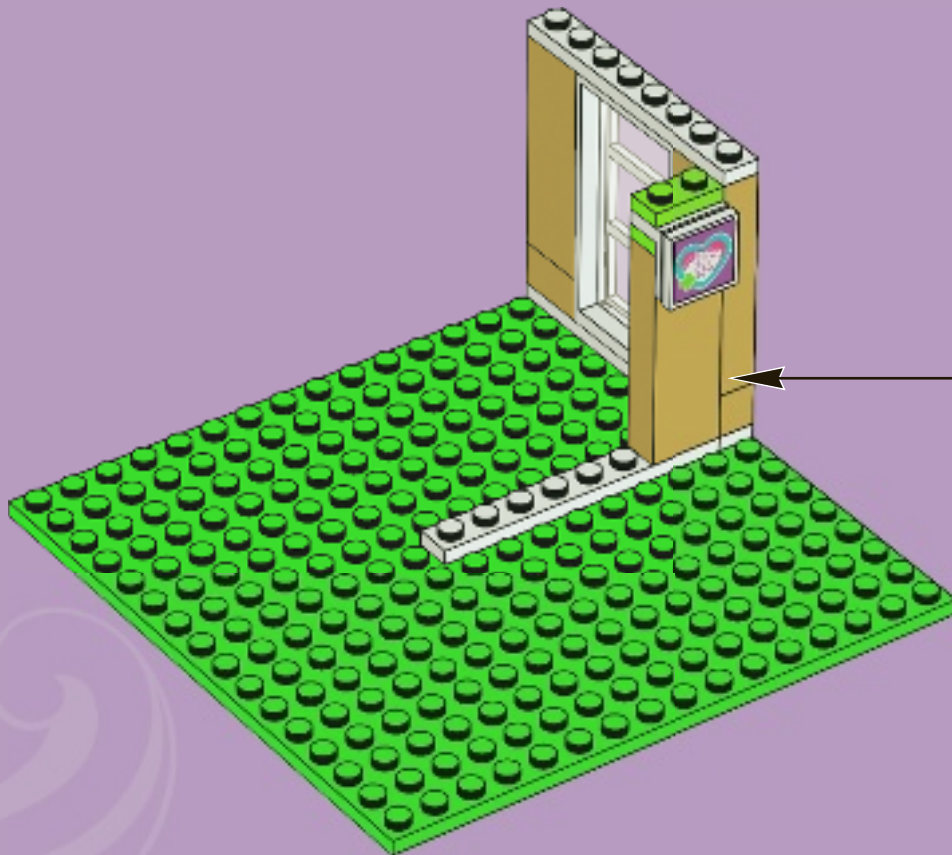
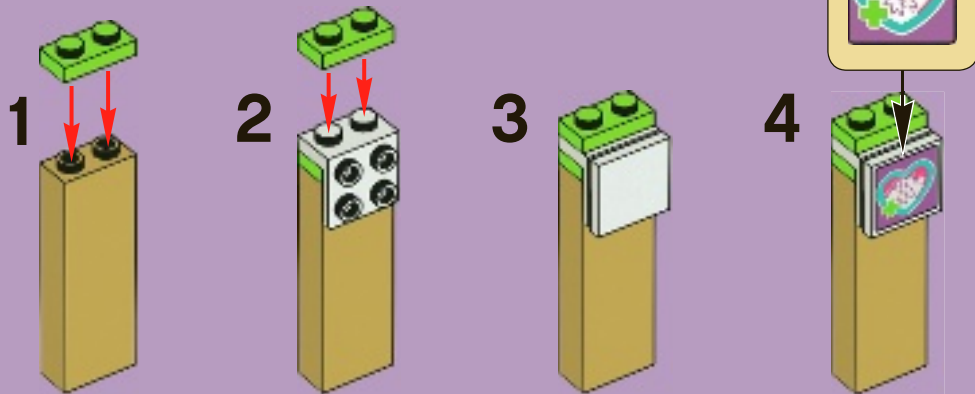



6



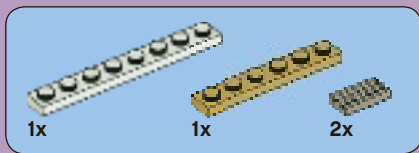

7



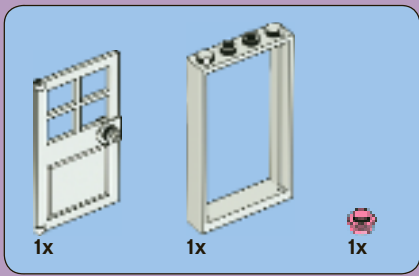

8

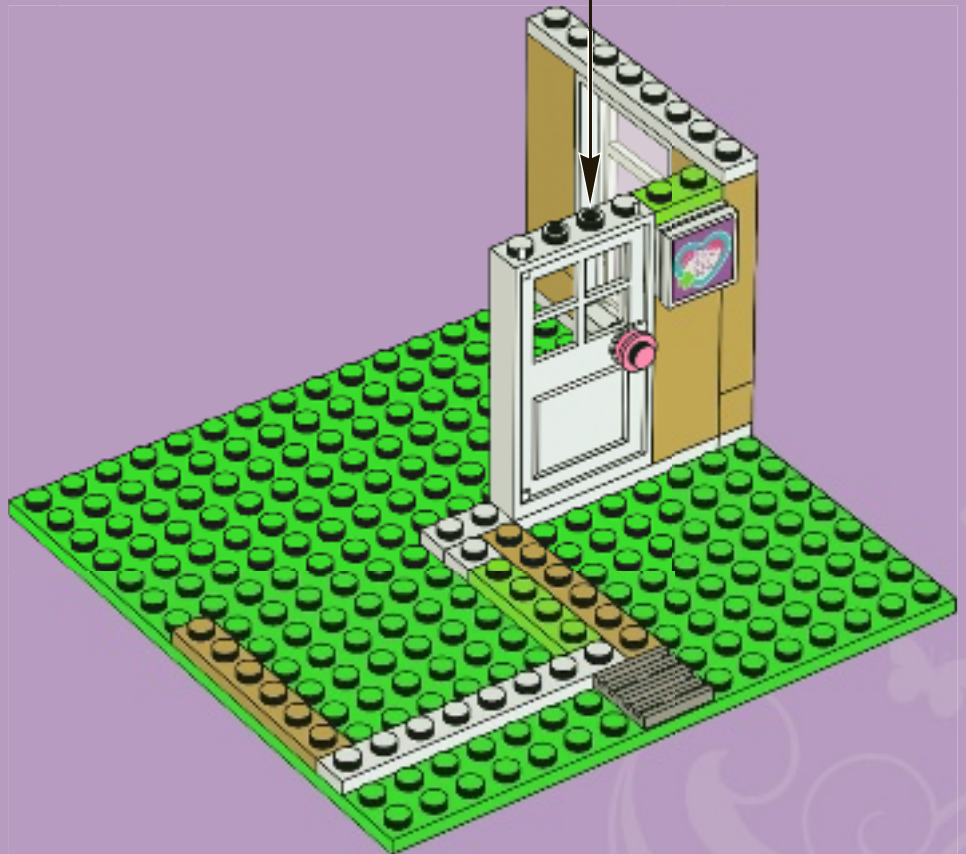
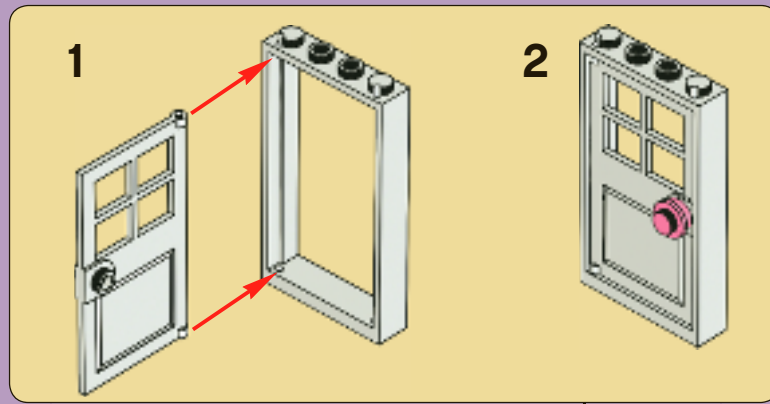

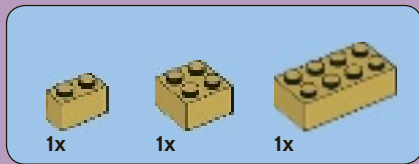

9

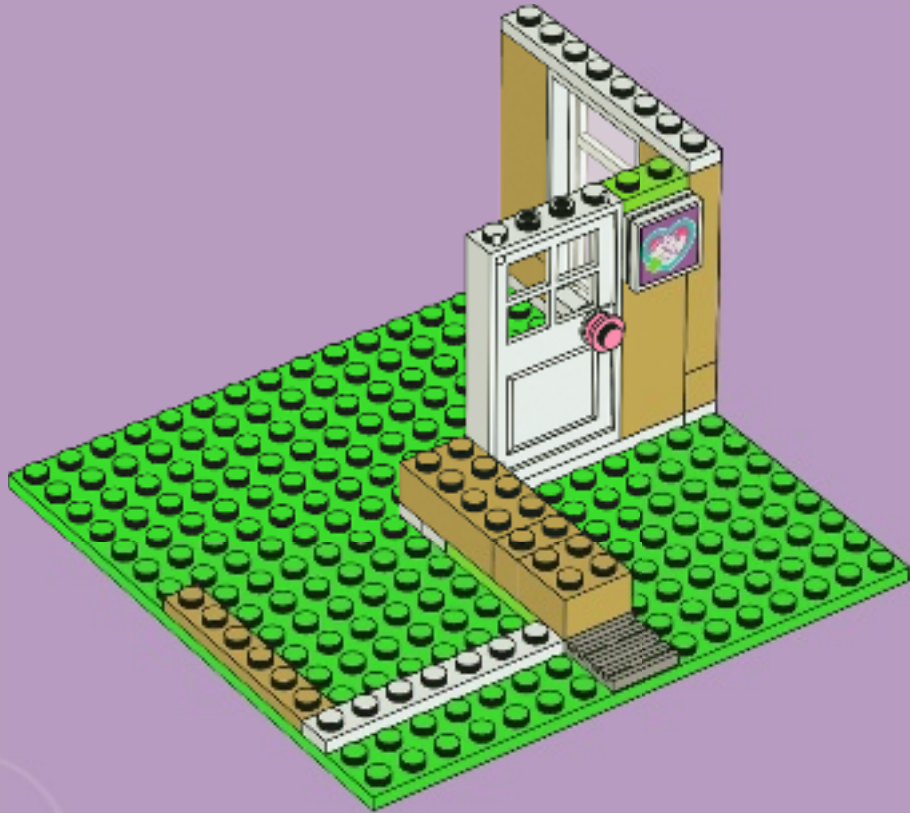

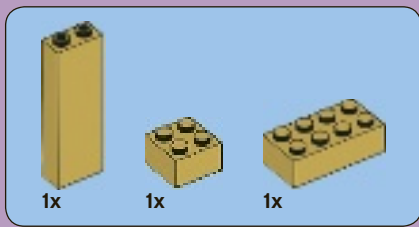

10

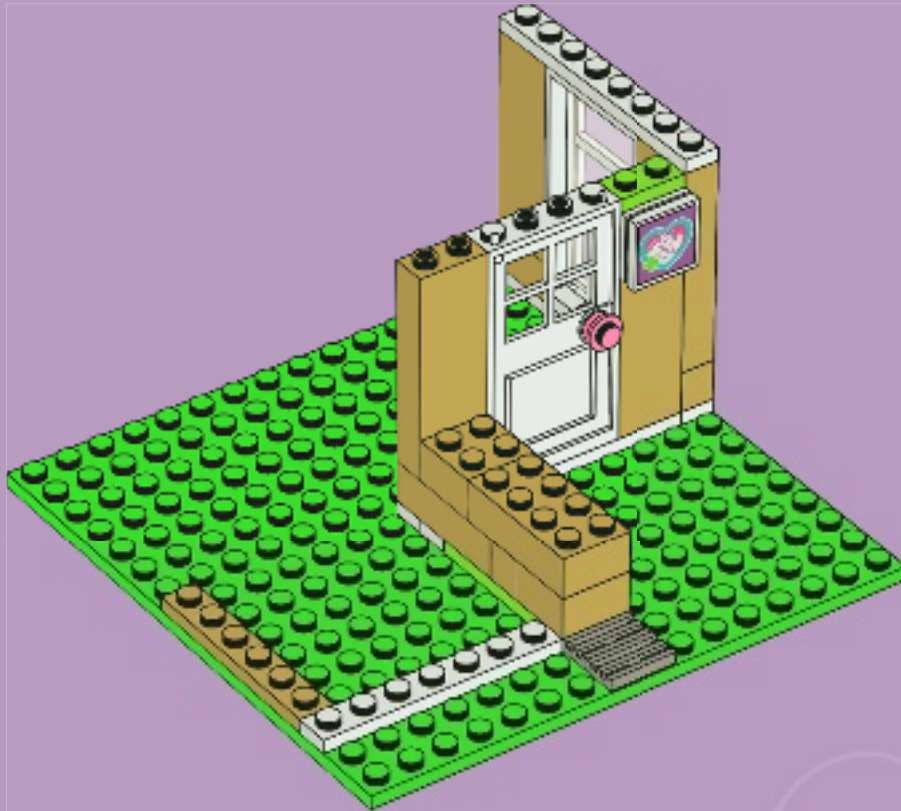



11

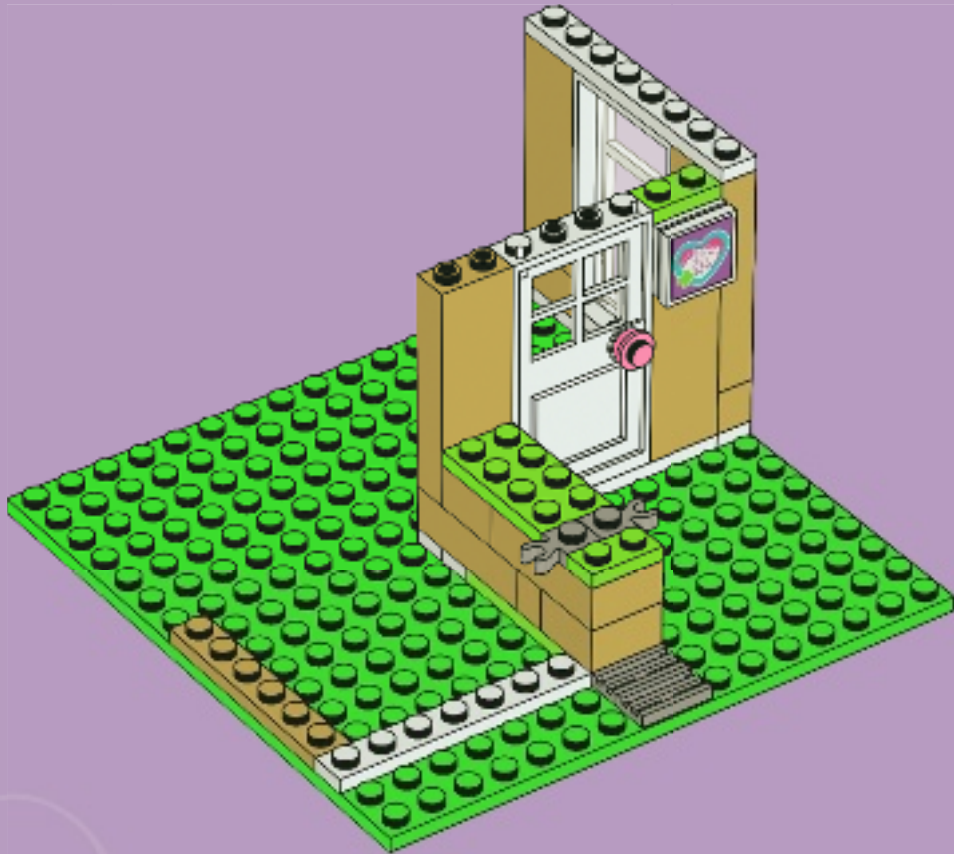

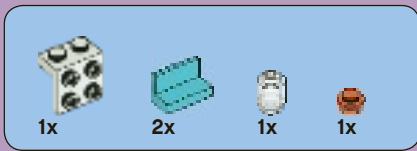

12

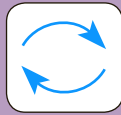



1x



2x



1x

13



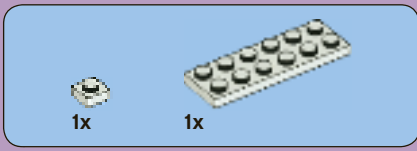

14



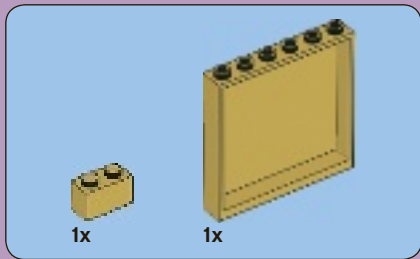

15

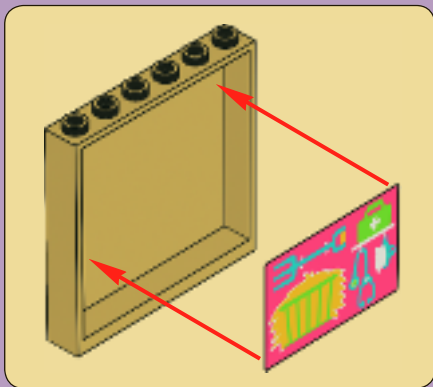

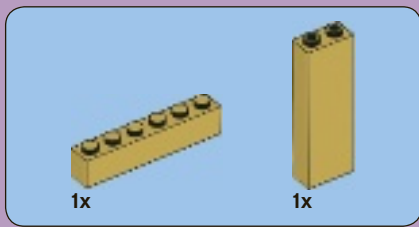

16



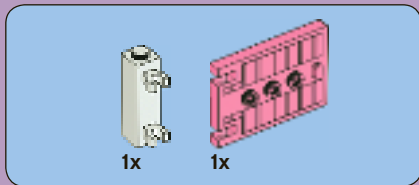

17



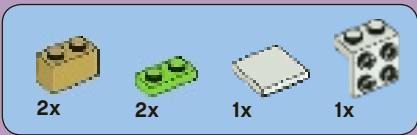

18

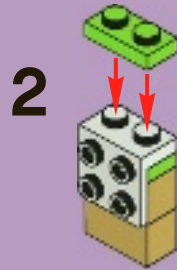
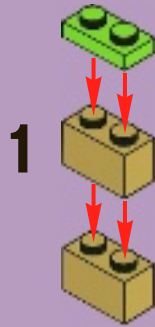

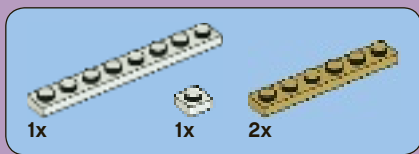

19





20





21



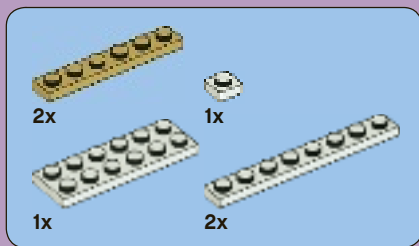

22



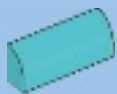

4x

23



1x

6x

24



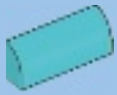

4x

25



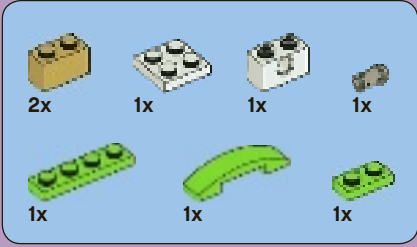

26

1

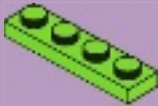

2

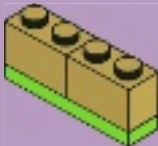

3

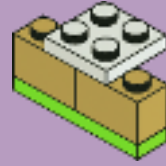

4

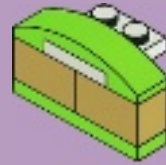

5

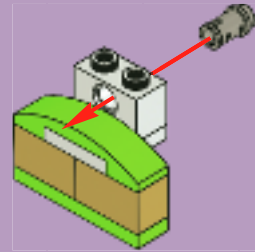

6





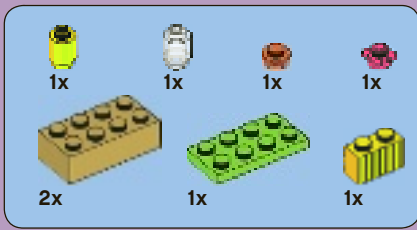

27

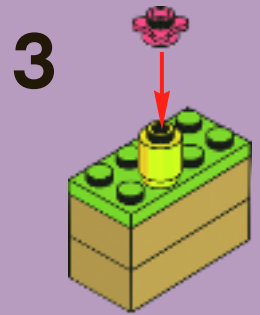
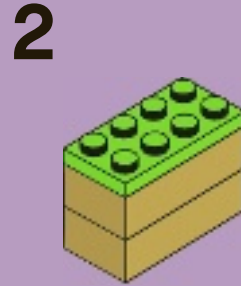
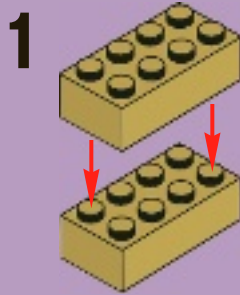

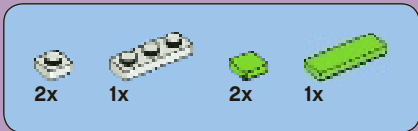

28

1

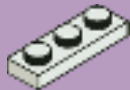

2

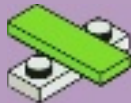

3

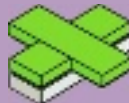

4

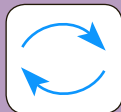
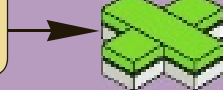



29

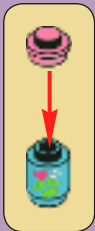



30





4x



1x

31



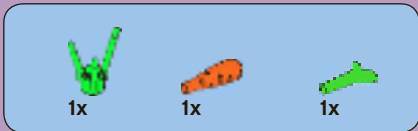

32

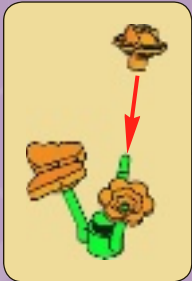
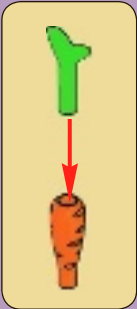

33

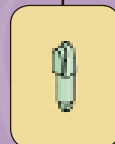
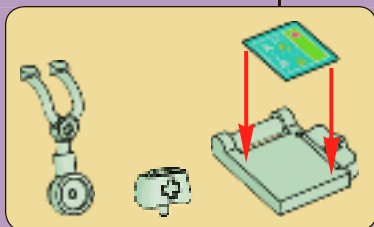

2x
300501

1x
302001

1x
4521943

1x
434601

11x
4109995

2x
3006840

2x
287724

4x
300401

2x
379501

1x
434501

7x
4114064

7x
4639698

2x
306224

1x
301001

11x
346001

1x
243201

6x
4114306

1x
4521504

1x
362324

2x
300101

5x
4615649

2x
4541956

2x
379401

4x
4114319

1x
3005741

1x
306924

1x
300801

2x
306801

7x
4507543

1x
4293350

6x
4112982

1x
4183544

1x
4501232

10x
302401

1x
243101

2x
4587272

1x
4521848

12x
4201062

4x
4640026

2x
306824
1x
362224

1x
302201

2x
4560178

1x
4631596

2x
4611700

7x
4117070

1x
4638658

3x
4515354

1x
362301

2x
4500878

1x
4116816

1x
4563684

18x
4124067

3x
4619599

1x
4296514

3x
302101

2x
4550745

1x
370001

1x
4512688

1x
4119479

2x
3005748

3x
371001

2x
4521210

1x
395701

1x
4234525

3x
4157103

1x
4119478



2x
4220632



1x
4622815



1x
4621315



1x
4657416



2x
371028



1x
4611777



5x
4220631



3x
4537251



2x
249626



1x
3006844



5x
374128

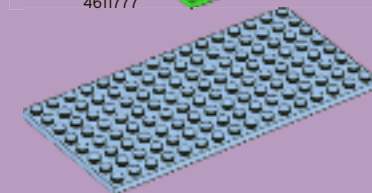

1x
4600612



3x
4165967



1x
4619769



3x
4594238



1x
4657469



2x
4653269

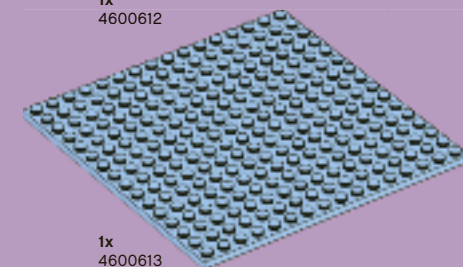

1x
4600613



2x
4537927



1x
4216695



2x
4211350



3x
4520632



18x
4618658



1x
4617069



4x
4211186



1x
4211503



2x
4621554



4x
4618645



11x
4565993



1x
4648076



2x
4211373



1x
4654127



5x
4618647



12x
4164037



1x
4520972



1x
4211644



1x
4621552



1x
4615606



1x
4625279



2x
4187743



1x
4621972



1x
4211483



6x
4517996



1x
4648073



4x
4537936



1x
4600345



1x
4649736



4x
4619591



1x
4615268



2x
4621548



1x
4646911



1x
4216479



2x
4655258



1x
4624987



1x
4644070

Customer Service

Kundenservice

Service Consommateurs

Servicio Al Consumidor

www.lego.com/service or dial



: 00800 5346 5555

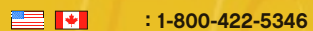

: 1-800-422-5346



3183



3061



3065



3931



3187



3935



3932



3930



3933



3936



3934



3942



3188



3315

Heartlake City



LEGO Friends

LEGO

Friends

LEGOFriends.com



Emma



Olivia



Stephanie



Mia



Andrea

LEGO club
FREE! GRATIS! GRATUIT!



www.LEGOclub.com



LEGO Club Magazine



LEGO Club Email



VISIT THE WORLD'S
BIGGEST LEGO SHOP!

www.LEGOshop.com

00800 5346 5555

1-866-534-6258 • 1-877-518-5346

- * Freephone. Mobile charges may apply.
- * Numéro sans frais. Des frais peuvent s'appliquer avec les téléphones cellulaires.
- * Gebühreentfernt, Kosten für Anrufe aus Mobilfunknetzen können abweichen.
- * Gratis telefonnummer vanaf vaste lijn.
- * Det er et gratis nummer, når du ringer fra fasttelefon.
- * Det är gratis, när du ringer från en fasttelefon.
- * Numéro sans frais. Des frais peuvent s'appliquer avec les téléphones portables.



BI115

YES! I want to join the LEGO® Club FREE! **OUI!** Je veux m'abonner au LEGO® Club GRATUITEMENT !
Ja! Ich möchte Mitglied im kostenlosen LEGO® Club werden. Ja! Ik wil graag GRATIS lid worden van de LEGO® Club.
Ja! Jeg ønsker å melde meg inn i LEGO® Club gratis! Ja! Jag vill gå med i LEGO® Club GRATIS!

First name • Prénom
Vorname • Voornaam
Fornavn • Fornamn

Last name • Nom de famille
Name • Achternaam •
Etternavn • Efternamn

Date of Birth • Date de naissance
Geburstag • Geboortedatum
Fødselsdato • Födelsedatum

Boy • Garçon •
Junge • Jongen •
Gutt • Pojk

Girl • Fille •
Mädchen • Meisje
Jente • Flicka

Street • Adresse
Straße, Hausnr.
Straat, huisnr. • Address

City • Ville
Ort • Woonplaats
Poststed • Postort

State
Prov.
County

Zip/Postcode
Code Postal • PLZ
Postcode
Postnummer

Country
Pays
Land

Email • Courriel
E-Mail • E-post

- Fill in your email address and we will send you a membership confirmation and monthly email newsletters. If you do not wish to receive the newsletters please tick here. Remplis ton adresse e-mail et nous t'enverrons une confirmation d'adhésion ainsi que le bulletin e-mail mensuel. Si tu ne désires pas recevoir le bulletin, coche cette case. Vul je e-mailadres in en we sturen je een bevestiging van je lidmaatschap en maandelijks e-mail nieuwsbrieven. Als je geen e-mail wilt ontvangen, kruis dan dit vakje aan.
- Ich möchte per E-Mail den monatlichen LEGO Club Newsletter erhalten. Ønsker du at vi skal sende en liten hilsen til barnet ditt for å bekrefte medlemskapet, ber vi deg krysses av i feltet, samt oppgi e-postadressen som hilsen skal sendes til. Om du vill att vi ska skicka en bekräftelse på ditt barns medlemskap, ber vi dig sätta ett kryss i rutan och skriva den e-post adress som bekräftelsen ska skickas till.
- If you do not wish to receive additional mailings from the LEGO Club please tick here. Si tu ne désires pas recevoir de courriel supplémentaire du Club LEGO, coche cette case. Als je geen verdere post van de LEGO Club wilt ontvangen, kruis dan dit vakje aan.
- Dersom du ønsker å motta annen informasjon fra LEGO Gruppen, setter du et kryss her.

Mail to: / Poster à: LEGO® Club
P.O. Box 1157
Enfield, CT USA
06083-1157

Per Post an: LEGO® Club
Postfach 14 15
D-36243 Niederaula

Stuur op naar: LEGO® Club
Postbus 40250
3504 AB Utrecht

Poster à: LEGO® Club
21 rue de la banque
75 002 PARIS
FRANCE

Send til: LEGO® Club Norge
Postboks 58
1314 Vøyenenga

Skickas till: LEGO® Club Sverige
Ubox 841
202 29 Malmö

The English language version of the magazine can only be mailed to addresses in the US, Canada, the UK, and Republic of Ireland. Club membership is valid for two years and includes free copies of the LEGO Club Magazine and e-mail newsletters. In the US and Canada please allow up to 6 weeks for delivery of your first magazine. In the UK and Republic of Ireland please allow six to 14 weeks for delivery of your first magazine. By signing this form you consent the LEGO Club to use your child's data for LEGO mailings. The data will only be used for LEGO mailings and will not be sold, rented or otherwise disclosed to any company outside the LEGO Company except for disclosure to companies acting as our agents to help us provide services requested by the child. This coupon is valid for one free membership per person, group or organization. Photocopied coupons are accepted. La version française du magazine peut être postée uniquement au Canada. L'abonnement est valide pour 2 ans et inclut des exemplaires gratuits du Magazine LEGO. Aux É.U. et au Canada, allouer 6 semaines pour la livraison initiale. En remplissant ce formulaire, vous consentez à ce que LEGO utilise les informations de votre enfant pour des envois postaux de LEGO. L'information sera utilisée uniquement pour des envois postaux par LEGO et ne sera en aucun cas, vendue, louée, échangée ou divulguée à d'autres compagnies autres que la compagnie LEGO, à l'exception des compagnies affiliées qui nous procurent des services auxquels l'enfant en a fait la demande. Formulaires photocopiés acceptés. Mit der folgenden Unterschrift erkläre ich, für mein Kind den Beitritt zum kostenlosen LEGO Club, der von der LEGO GmbH D-85676 Grumbach, betrieben wird. Die Mitgliedschaft beinhaltet die Zusendung des LEGO Club Magazines und kann beidseitig jederzeit beendet werden. Mit der Mitgliedschaft im LEGO Club sind keinerlei Verpflichtungen verbunden. Das deutschsprachige LEGO Club Magazin wird nur an Adressen in Deutschland, Österreich und der Schweiz versendet. Eine Anmeldebestätigung kann nur per E-Mail geschickt werden. Das Magazin erscheint fünfmal jährlich. Daher kann die Zustellung des ersten Heftes bis zu drei Monate dauern. Die Mitgliedschaft ist beidseitig jederzeit kündbar, ohne dass Ihnen Kosten entstehen. Sie können der werblichen Nutzung Ihrer Daten jederzeit widersprechen. Kündigung und Widerspruch können Sie telefonisch erklären (00800 / 5346 5555, Anruf gebührenfrei, Kosten für Anrufe aus dem Mobilfunknetz können abweichen) oder an die LEGO GmbH senden. Het Nederlansde LEGO Club Magazine kan alleen worden gestuurd naar adressen in Nederland. Het lidmaatschap is 2 jaar geldig en geeft recht op toezending van het gratis LEGO Club Magazine en LEGO Club e-mails. Het eerste magazine zal binnen 12 tot 14 weken toegestuurd worden. Het lidmaatschap kan op ieder moment opgezegd worden en kan na 2 jaar gratis worden verlengd, tenzij LEGO met deze activiteit stopt. Uw gegevens worden uitsluitend gebruikt voor mailings van LEGO en zullen niet worden verkocht, verhuurd of op welke wijze dan ook verstrekt aan derden buiten de LEGO Groep, uitgezonderd de organisaties die namens ons optreden om de informatie te sturen waarvoor toestemming is verleend. Den norske utgaven av magasinet sendes kun til adresser i Norge. Medlemskap i klubben gjelder i 2 år og inkluderer gratisutgaver av LEGO Club Magazine. Påreg minimum oppitt seks uker leveringstid for første magasin. Ved å undertegne dette skjemaet, gir du ditt samtykke til at LEGO Club kan bruke opplysningene om barnet ditt i LEGO forsendelser. Dataene vil utelukkende bli brukt i LEGO forsendelser og vil ikke bli solgt, utleid eller på annen måte gjøres tilgjengelig for selskaper utenfor LEGO gruppen, unntatt selskaper som er våre agenter og som hjelper oss å tilby tjenestene barnet etterspør. Dette skjemaet gjelder for ett gratis medlemskap per person, gruppe eller organisasjon. Den svenska versionen av tidningen kan endast skickas till adresser i Sverige. Club-medlemskapet är giltigt i 2 år och innefattar gratis exemplar av LEGO Club Magazine. Vänligen räkna med minimum 6 veckor för leverans av din första tidning. Genom att skicka in det här formuläret godkänner du att LEGO Club använder barnets uppgifter för LEGO utskick. Uppgifterna kommer bara att användas för LEGO utskick och kommer inte att säljas, hyras ut eller vidarebefordras till något företag som inte tillhör LEGO Gruppen, med undantag av företag som agerar som våra ombud för att tillhandahålla tjänster som barnet har begärt. Den här kupongen gäller för ett gratis medlemskap per person, grupp eller organisation. En complétant ce bulletin d'adhésion, vous acceptez que LEGO Club utilise les données relatives à votre enfant pour l'envoi de courriers concernant LEGO. Ces données seront uniquement utilisées pour l'envoi d'information concernant LEGO et ne seront ni vendues, ni louées, ni utilisées par d'autres sociétés que le groupe LEGO, à l'exception des sociétés agissant pour le compte de LEGO en tant que sous-traitant de services divers. L'abonnement au LEGO Club est valable pour une période de 2 ans. Il inclut l'envoi par courrier du magazine LEGO Club et par email des newsletters. Un délai de 6 à 14 semaines est à prévoir pour la réception de votre premier magazine. Ce bulletin d'adhésion garantit est valable pour l'inscription d'une seule personne. Les photocopies sont acceptées. ATTENTION! Le bulletin d'adhésion doit être rempli et signé par un parent ou un tuteur.

Parent's signature • Signature d'un parent ou d'un tuteur •
Unterschrift Erziehungsberechtigte/r • Handtekening ouders •
Foreldres/foresattes underskrift • Förälders/förmyndares underskrift

Date
Datum
Date



Win!

Go to www.LEGOsurvey.com/product to fill out a survey for a chance to win a cool LEGO® Product.

No purchase necessary.
Open to all residents where not prohibited.

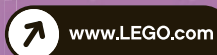

www.LEGOsurvey.com/product

Gewinne! Win!

Nimm an der Umfrage auf www.LEGOsurvey.com/product teil und hab die Chance ein cooles LEGO® Produkt zu gewinnen!

Die Teilnahme am Gewinnspiel führt zu keinerlei Kaufverpflichtungen. Teilnahme in allen nicht ausgeschlossenen Ländern möglich.

Ga naar www.LEGOsurvey.com/product, vul een enquêteformulier in en maak kans op een cool LEGO® product.

Geen aankoopverplichting, iedereen mag deelnemen, uitgezonderd ingezetenden van landen waar een enquêteverbod geldt.

Gagne! 当てよう!

Visite www.LEGOsurvey.com/product pour répondre à un questionnaire et avoir une chance de gagner un produit LEGO® très cool!

Aucune obligation d'achat. Ouvert à tous les résidents des pays autorisés.

www.LEGOsurvey.com/product にアクセスして、アンケートにご記入ください。当選者にはレゴ製品を差し上げます。

お買い上げの必要はありません。
禁止されていない限り、すべての皆様にご利用いただけます。