

Statue of Liberty

3 4 5 0

4183855

1

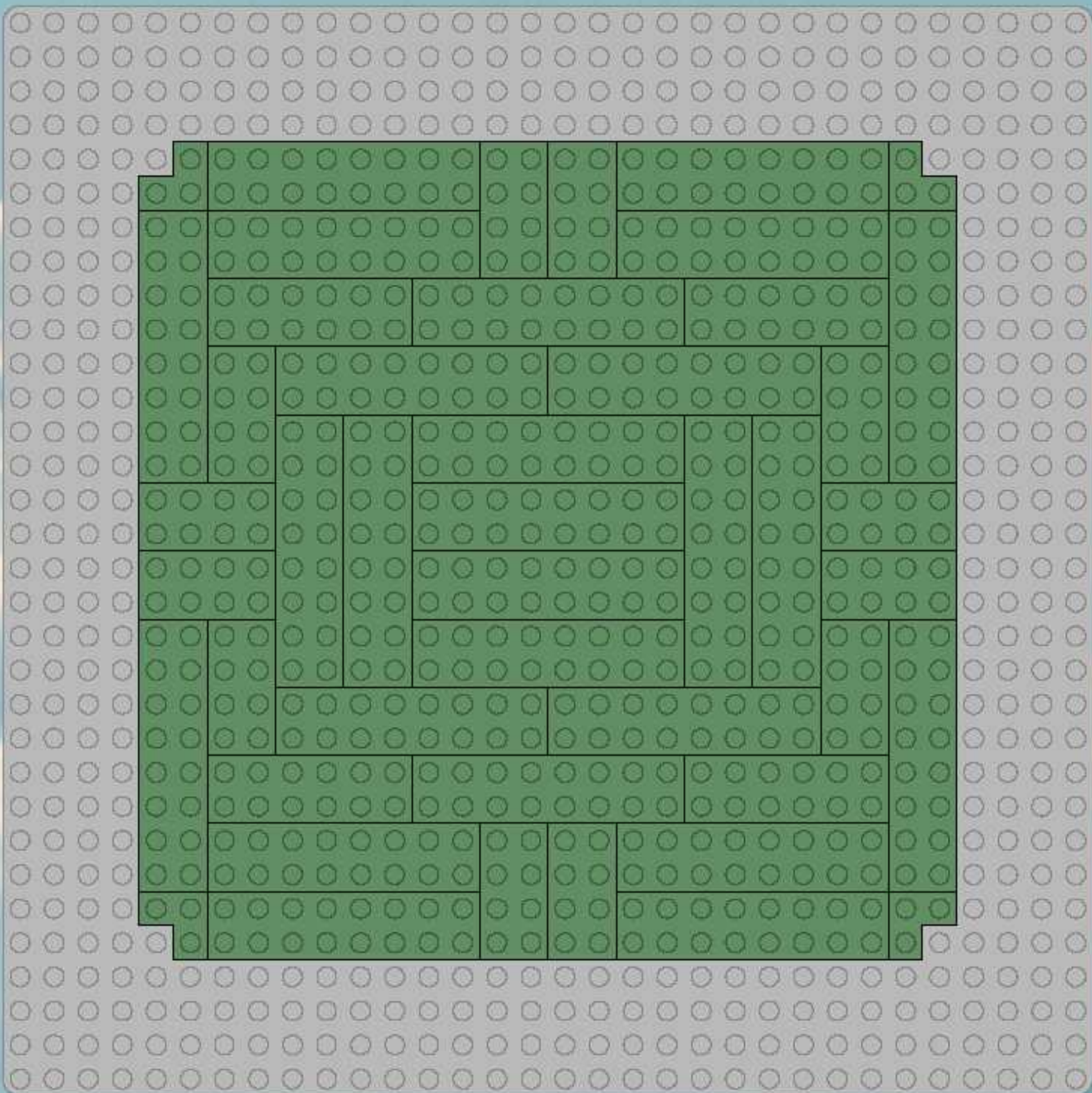
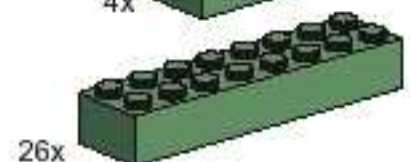
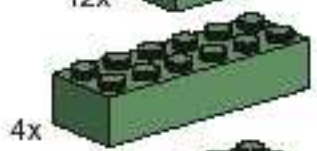

2

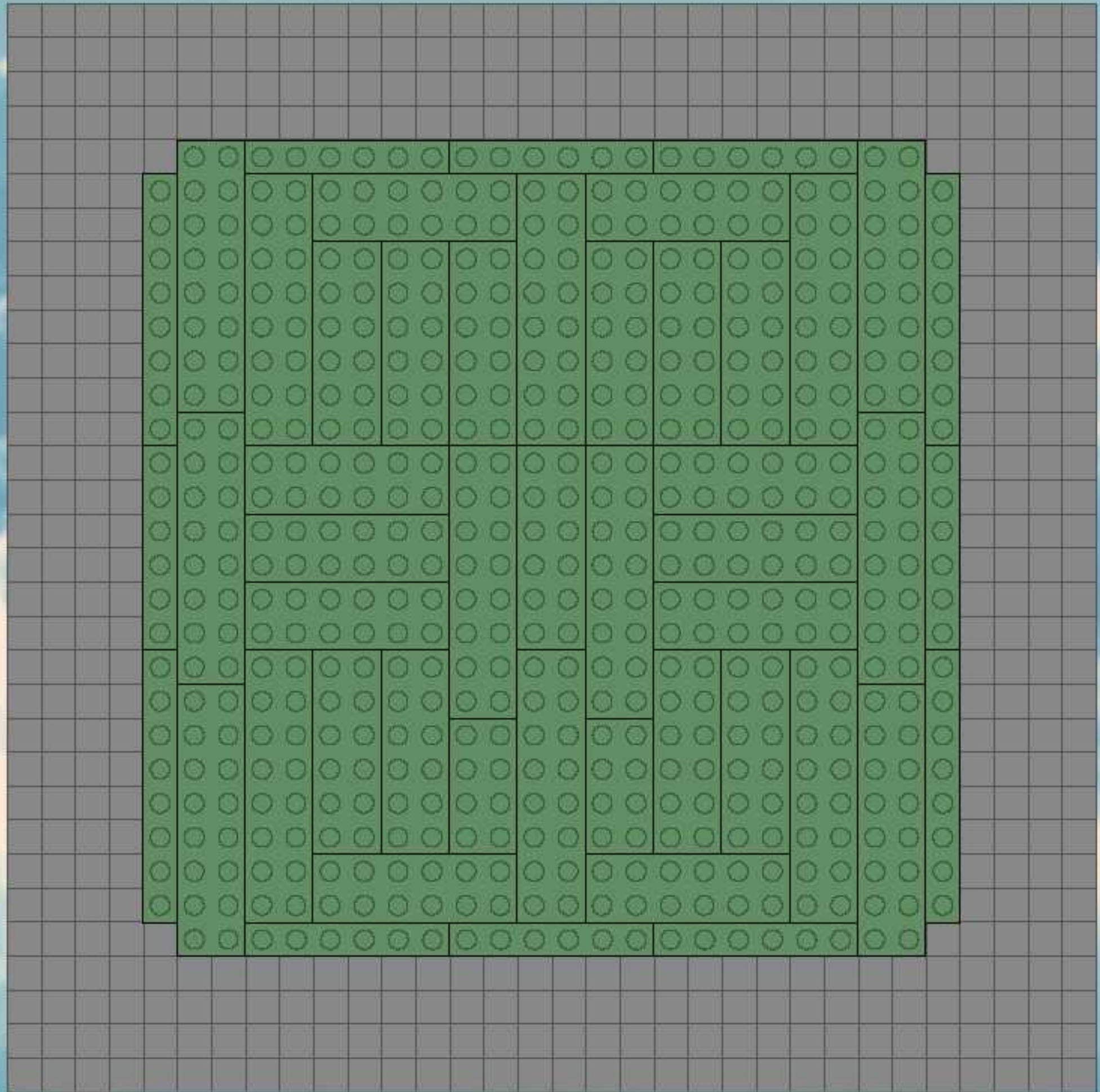
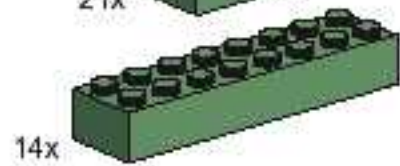
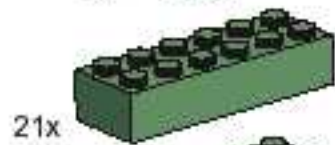
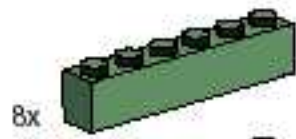

3

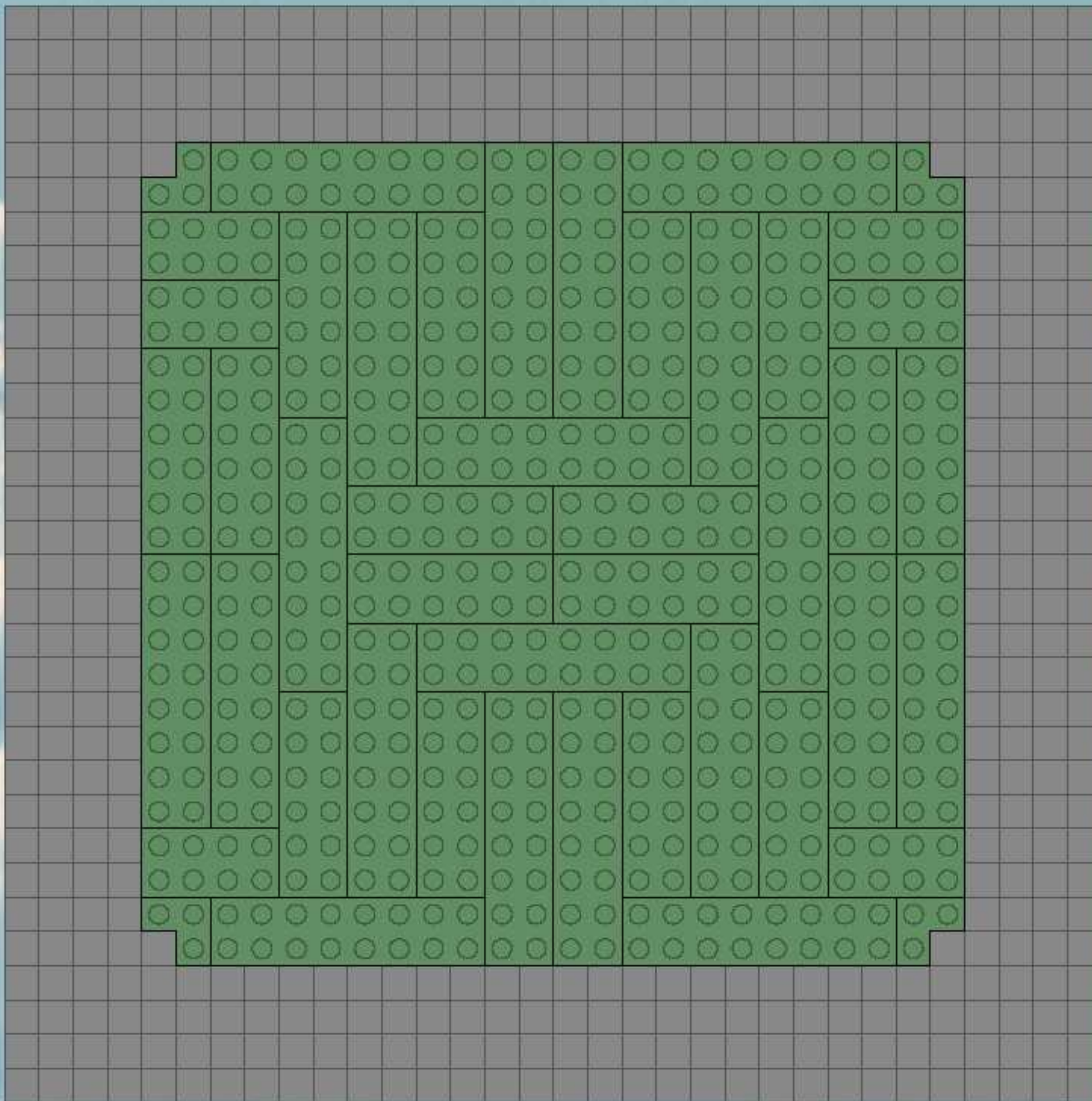
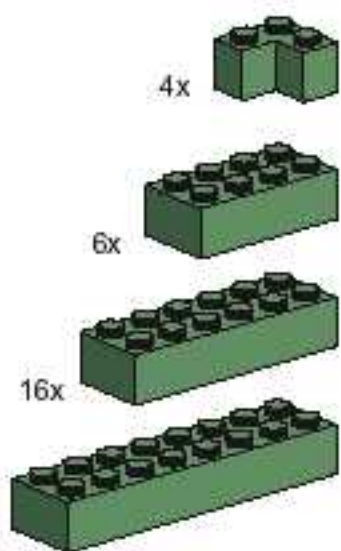

4

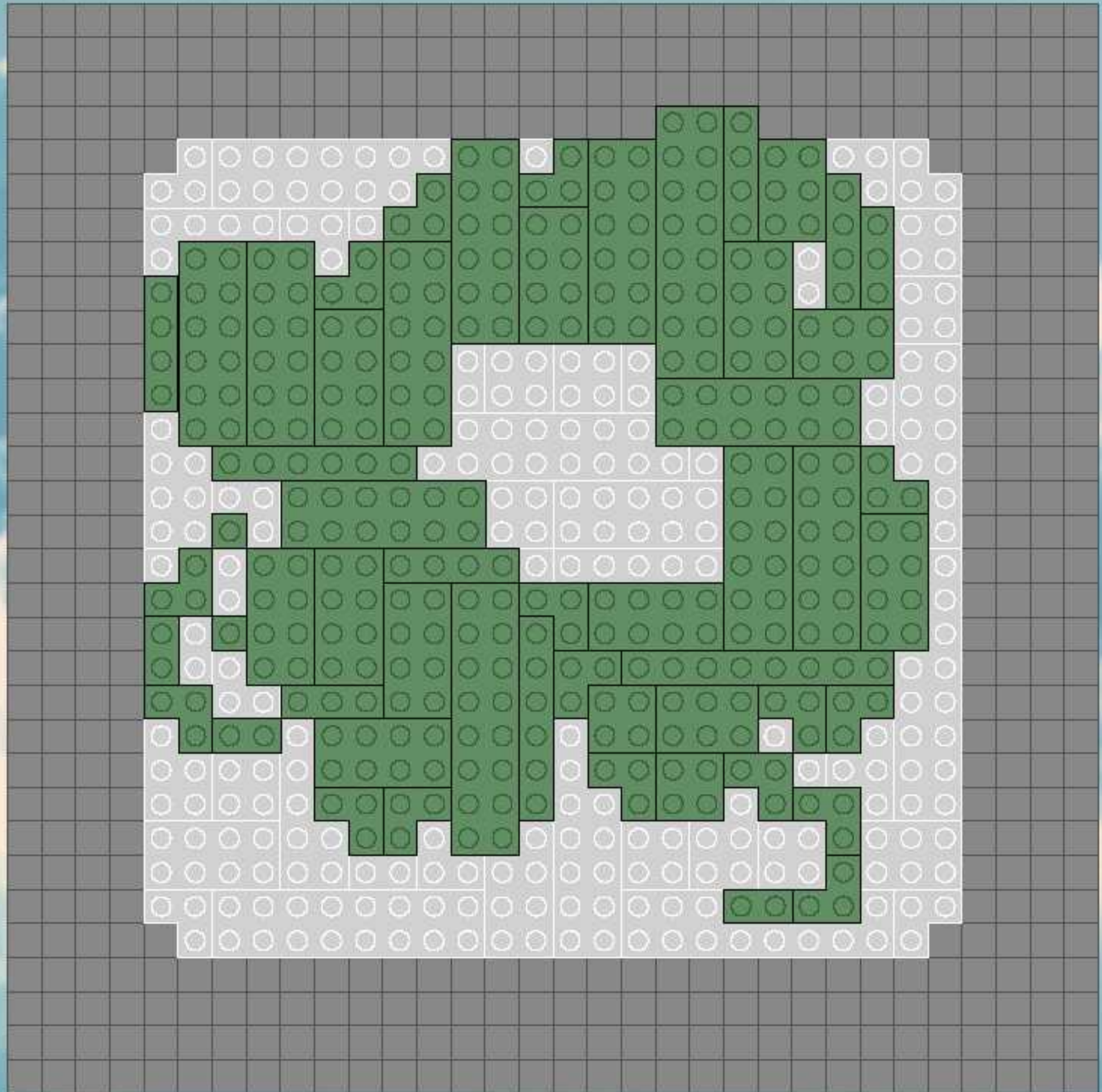
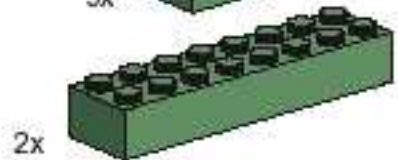
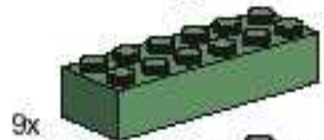
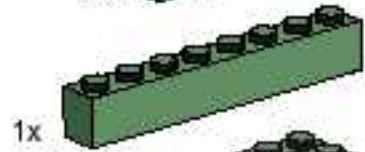
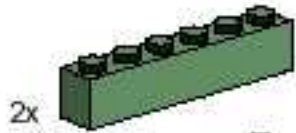

5

- 12x
- 3x
- 4x
- 3x
- 1x
- 2x
- 8x
- 9x
- 7x

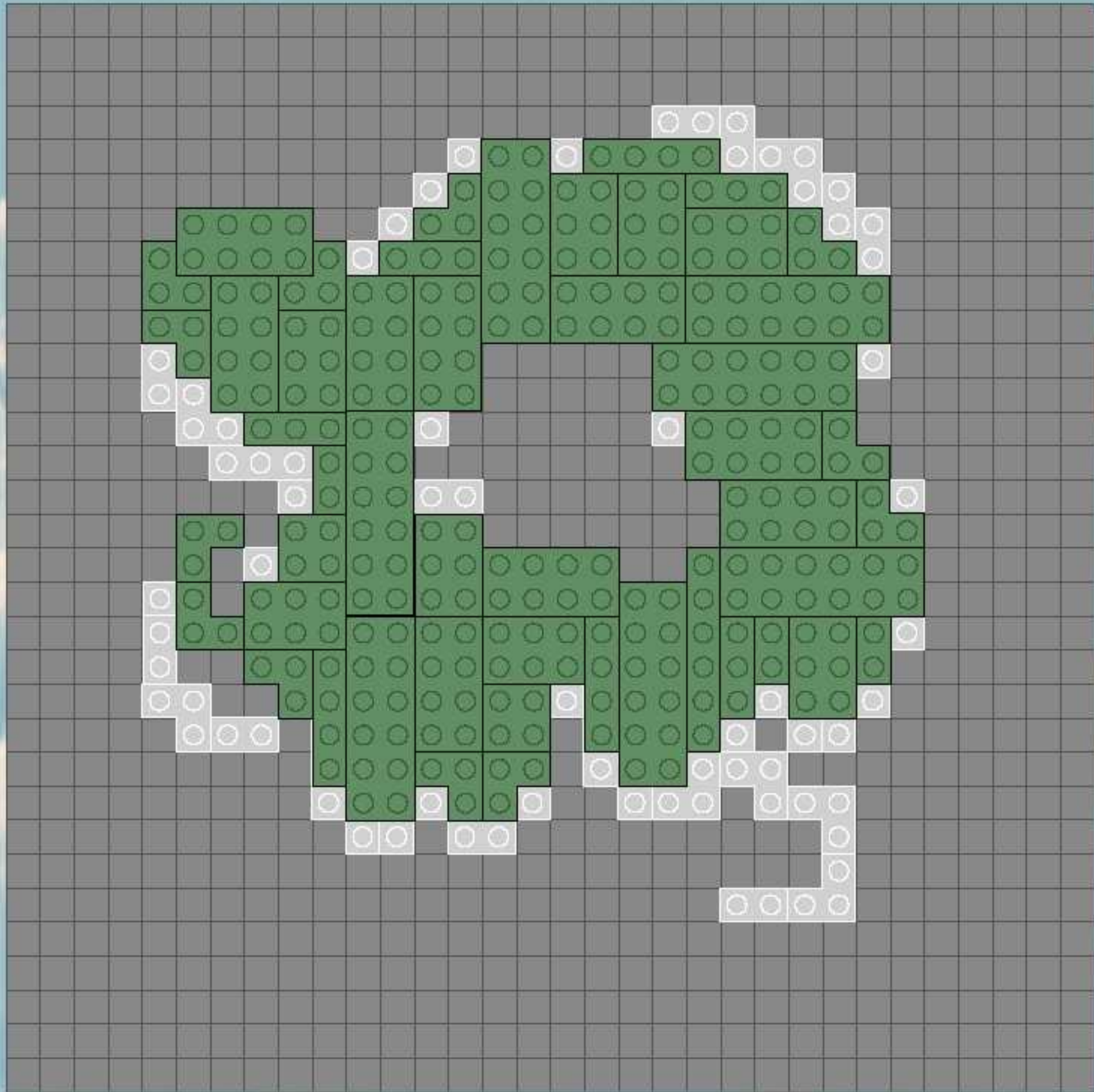





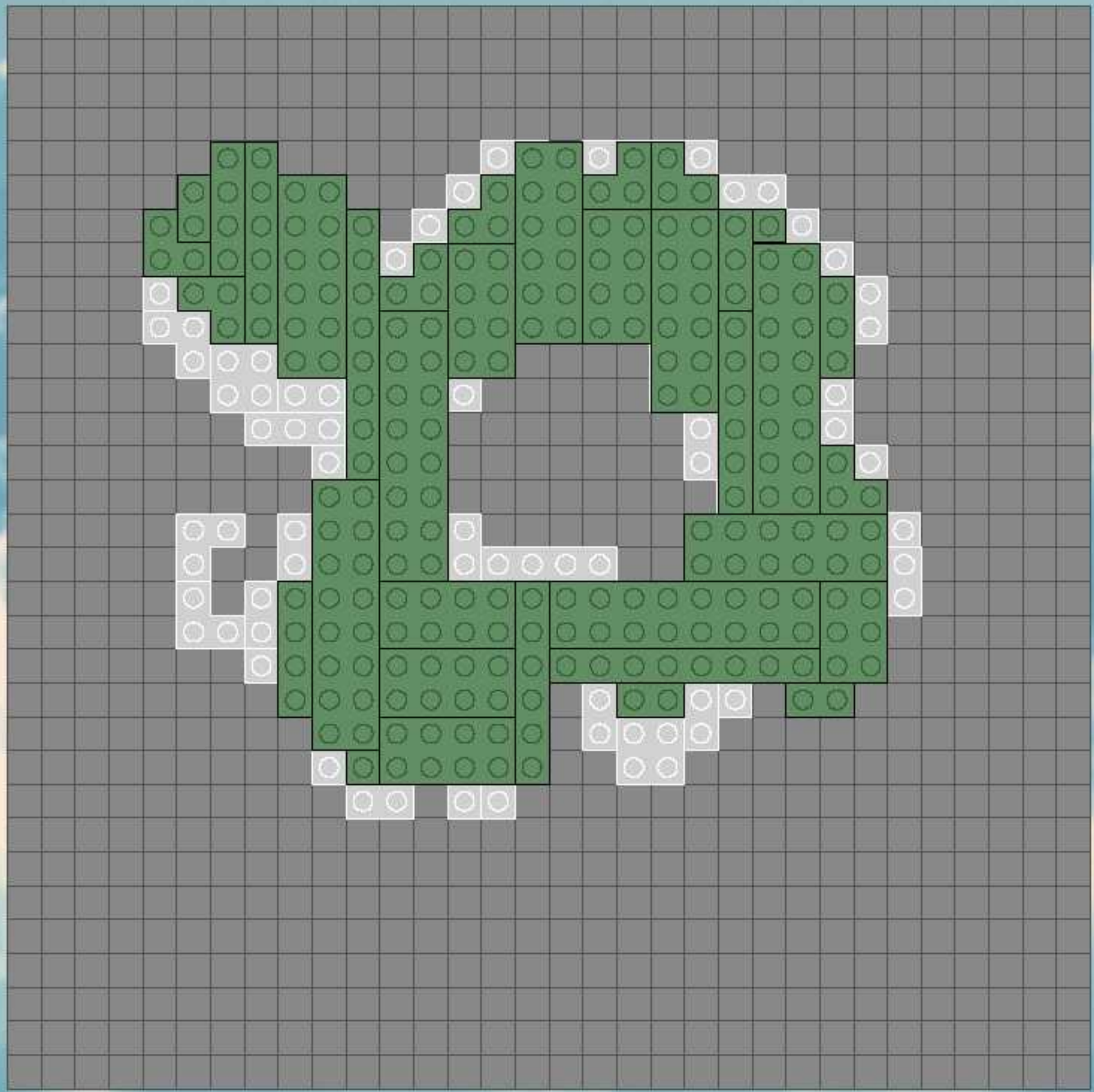



6

- 7x
- 2x
- 3x
- 2x
- 2x
- 3x
- 2x
- 1x
- 5x
- 4x
- 4x



7

- 10x 
- 2x 
- 2x 
- 3x 
- 6x 
- 2x 
- 11x 
- 7x 
- 3x 

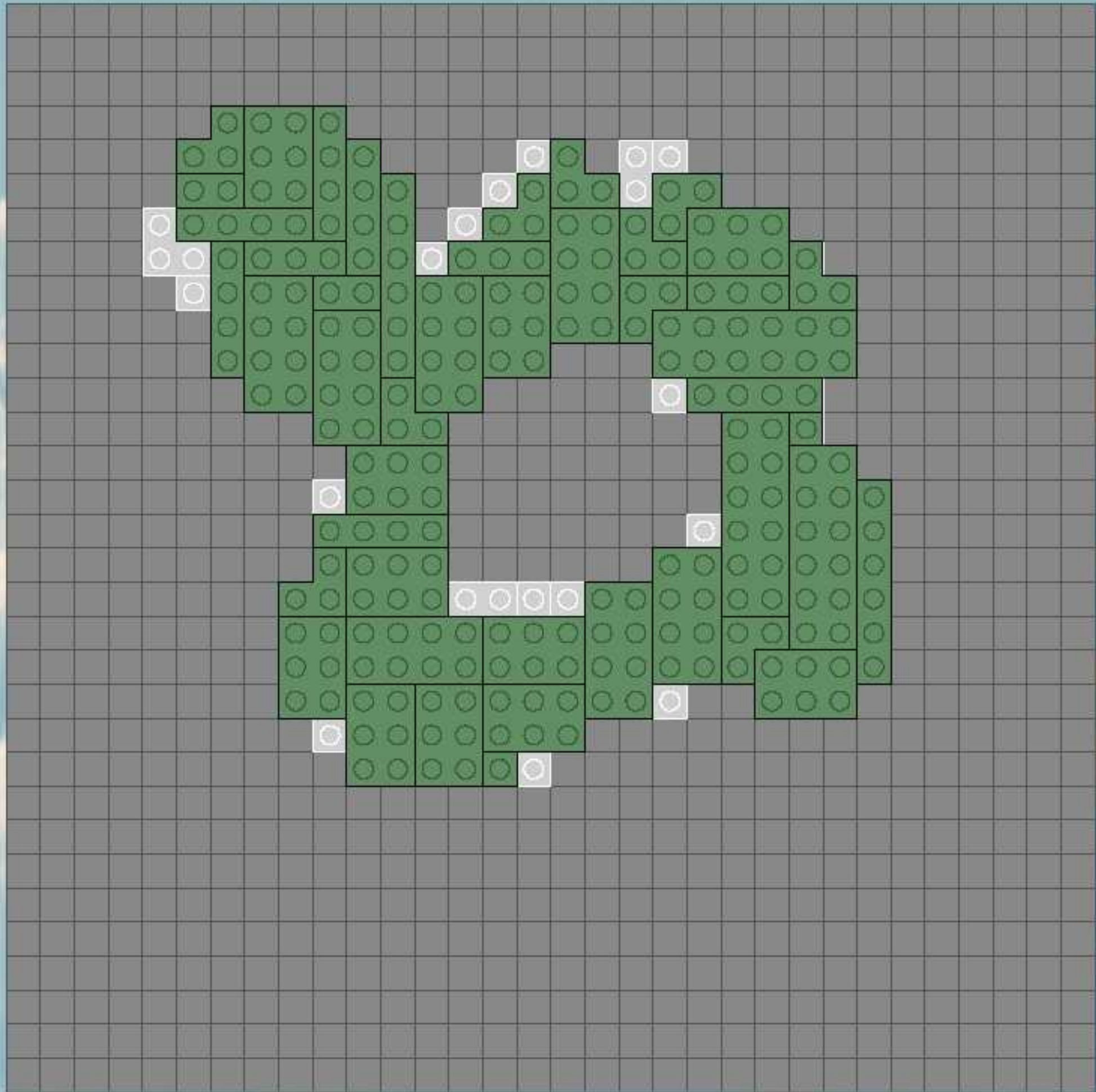

8

- 12x
- 2x
- 2x
- 6x
- 4x
- 4x
- 1x
- 5x
- 2x
- 3x
- 4x

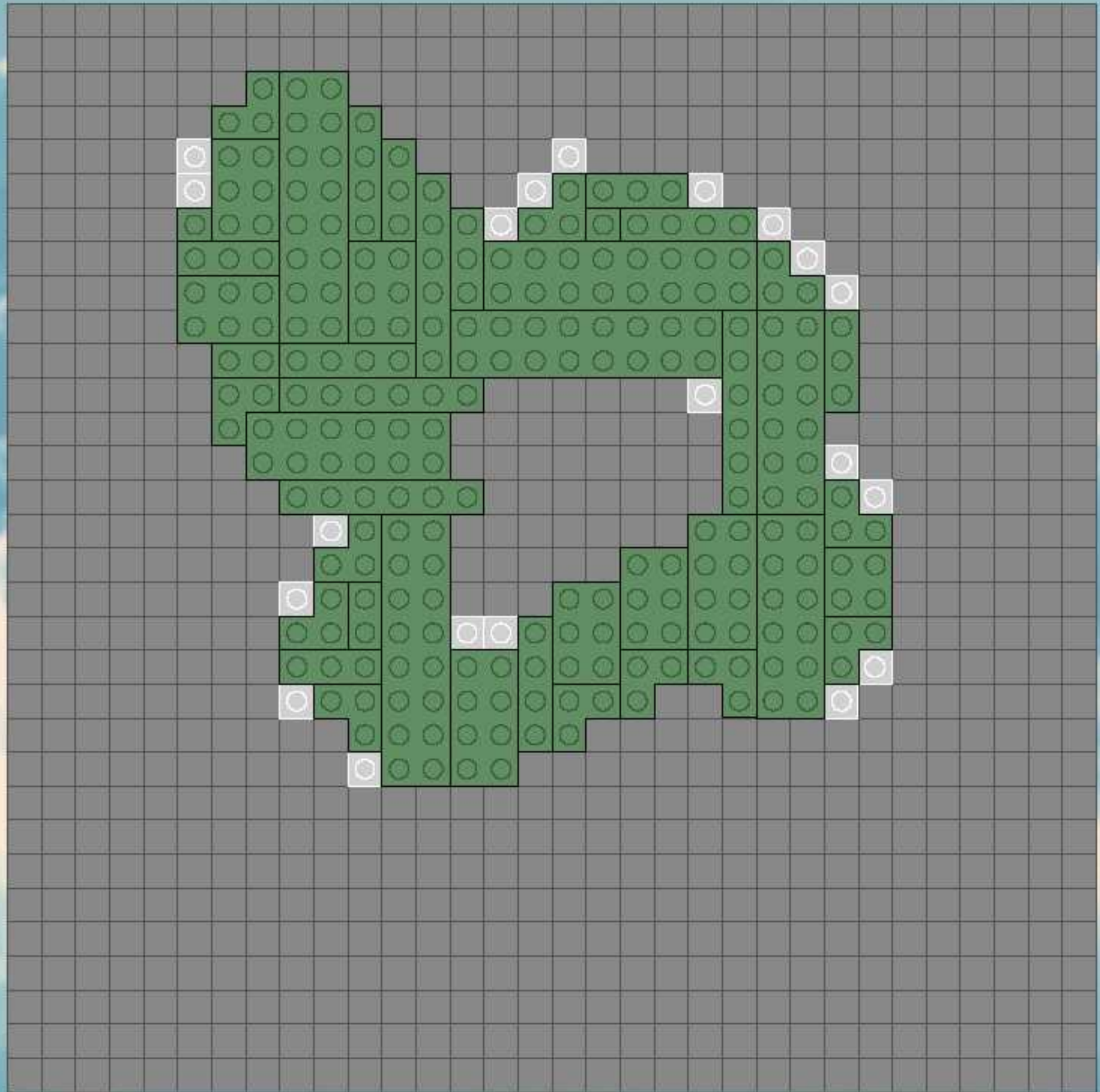

9

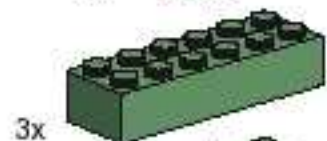
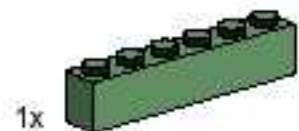
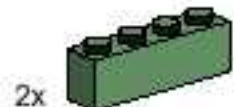

10



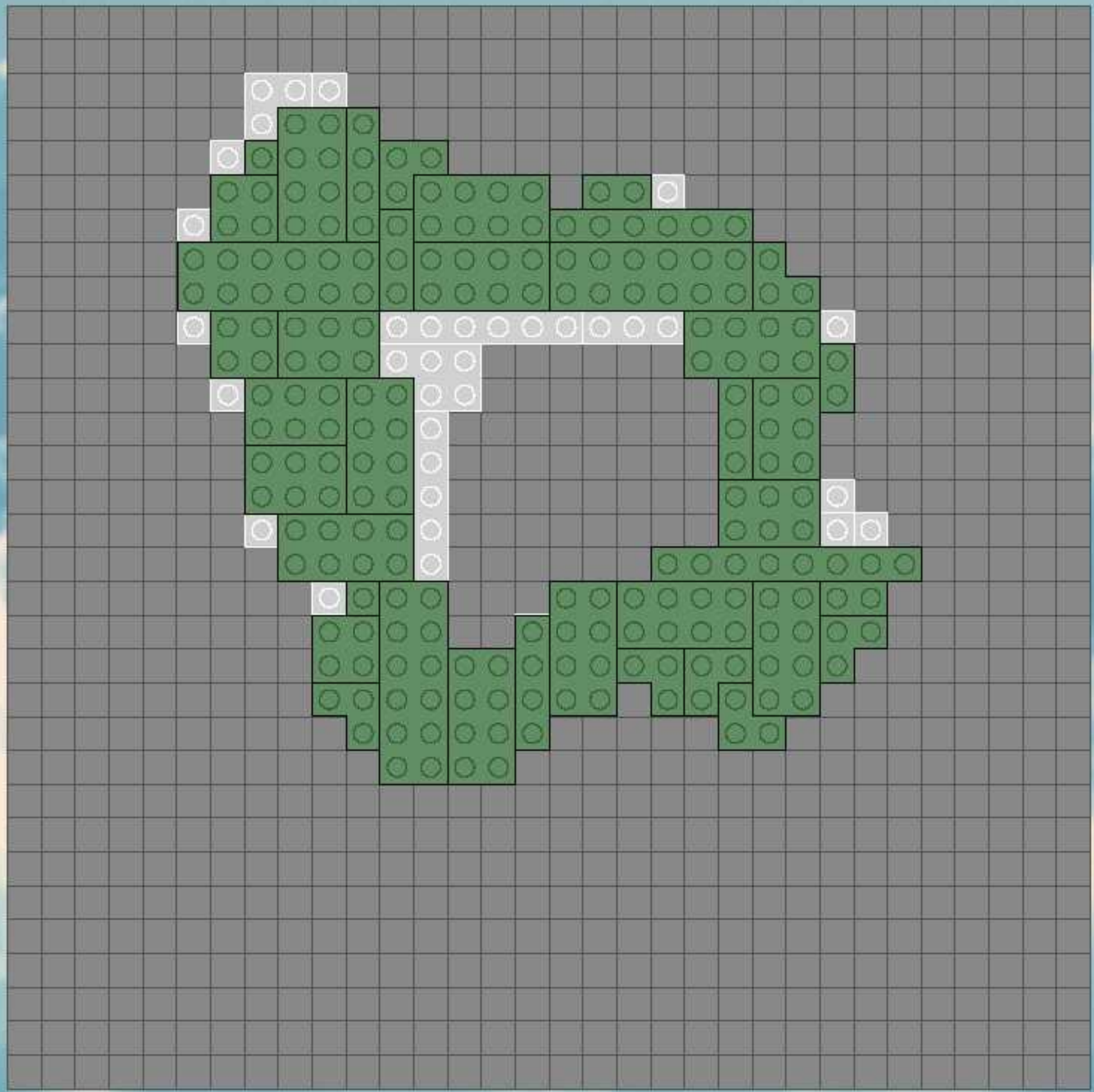



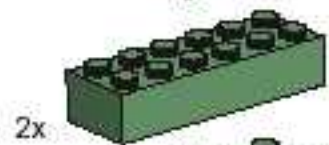

- 7x
- 2x
- 3x
- 2x
- 2x
- 1x
- 1x
- 3x
- 5x
- 10x
- 3x



11



12







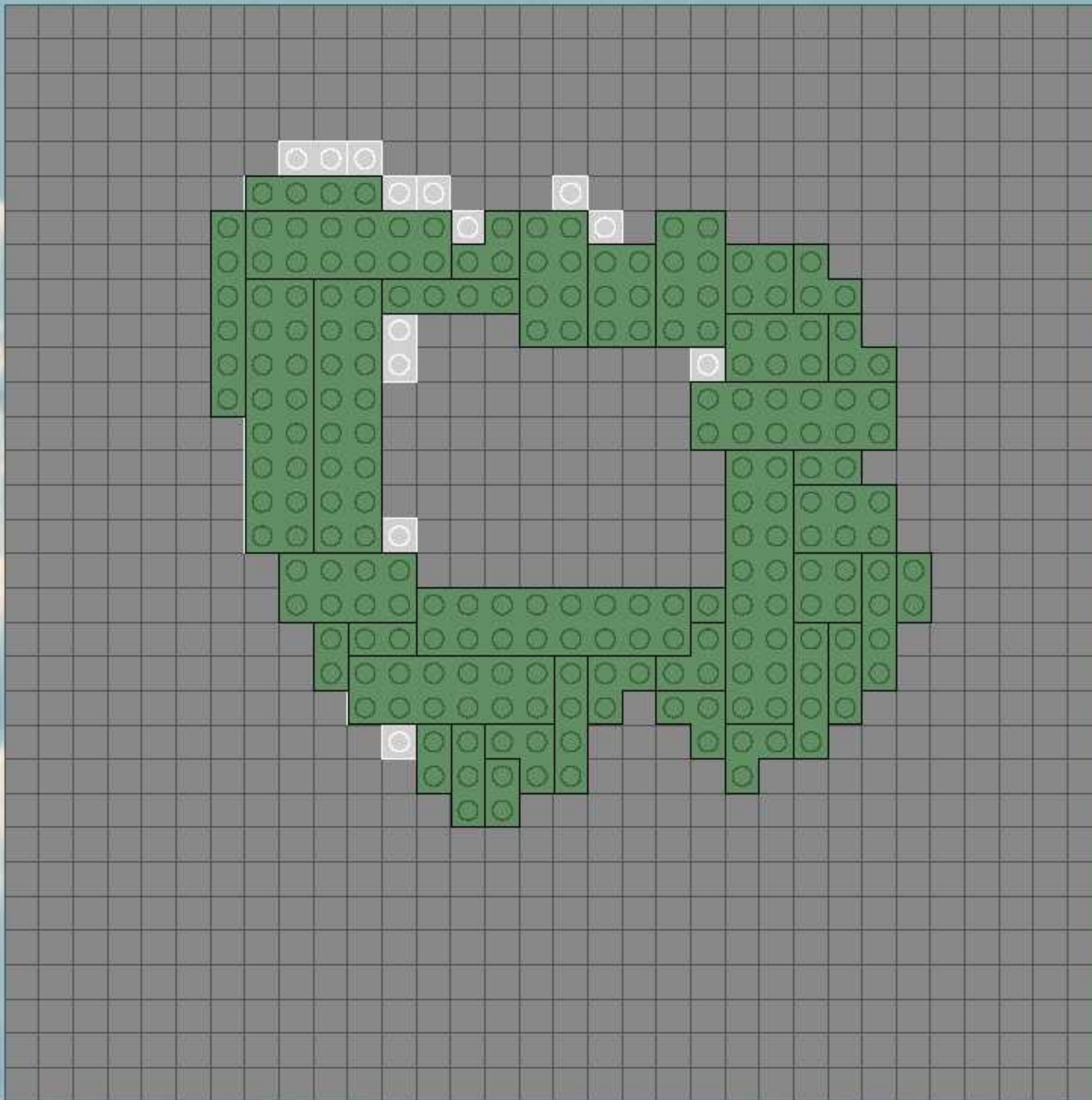
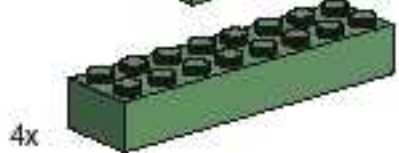
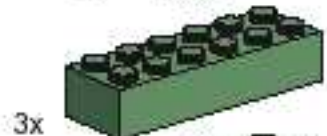
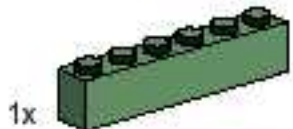

- 11x 
- 3x 
- 1x 
- 4x 
- 4x 
- 2x 
- 8x 
- 6x 
- 4x 



13

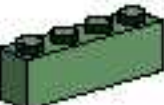

14

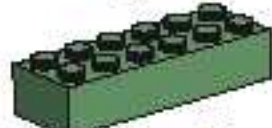
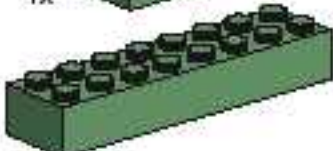





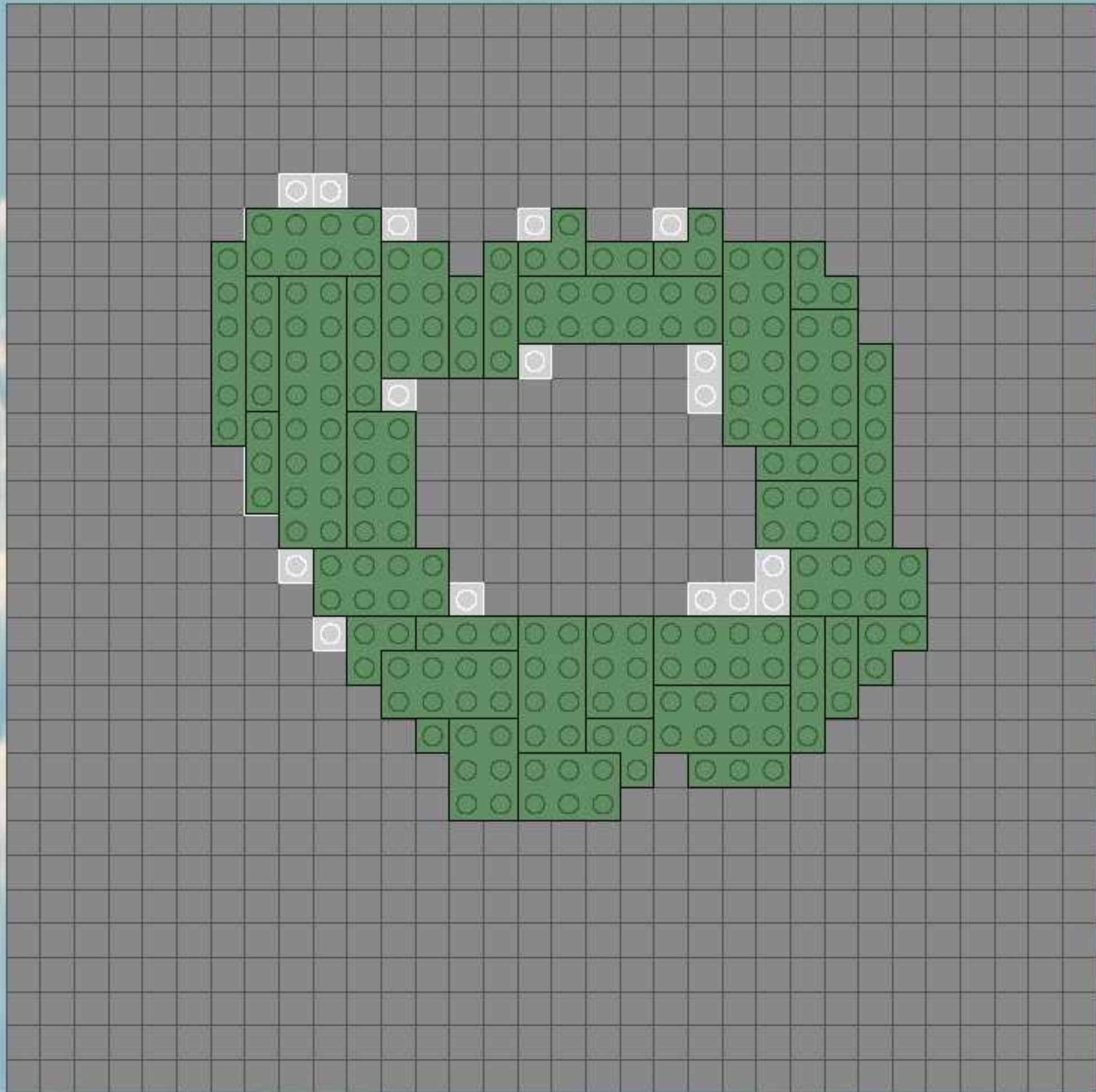
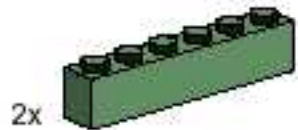
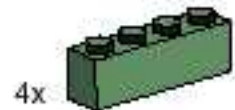

- 4x 
- 2x 
- 8x 
- 4x 
- 2x 
- 1x 
- 5x 
- 7x 
- 4x 
- 2x 



15



16

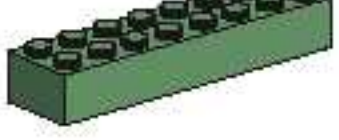

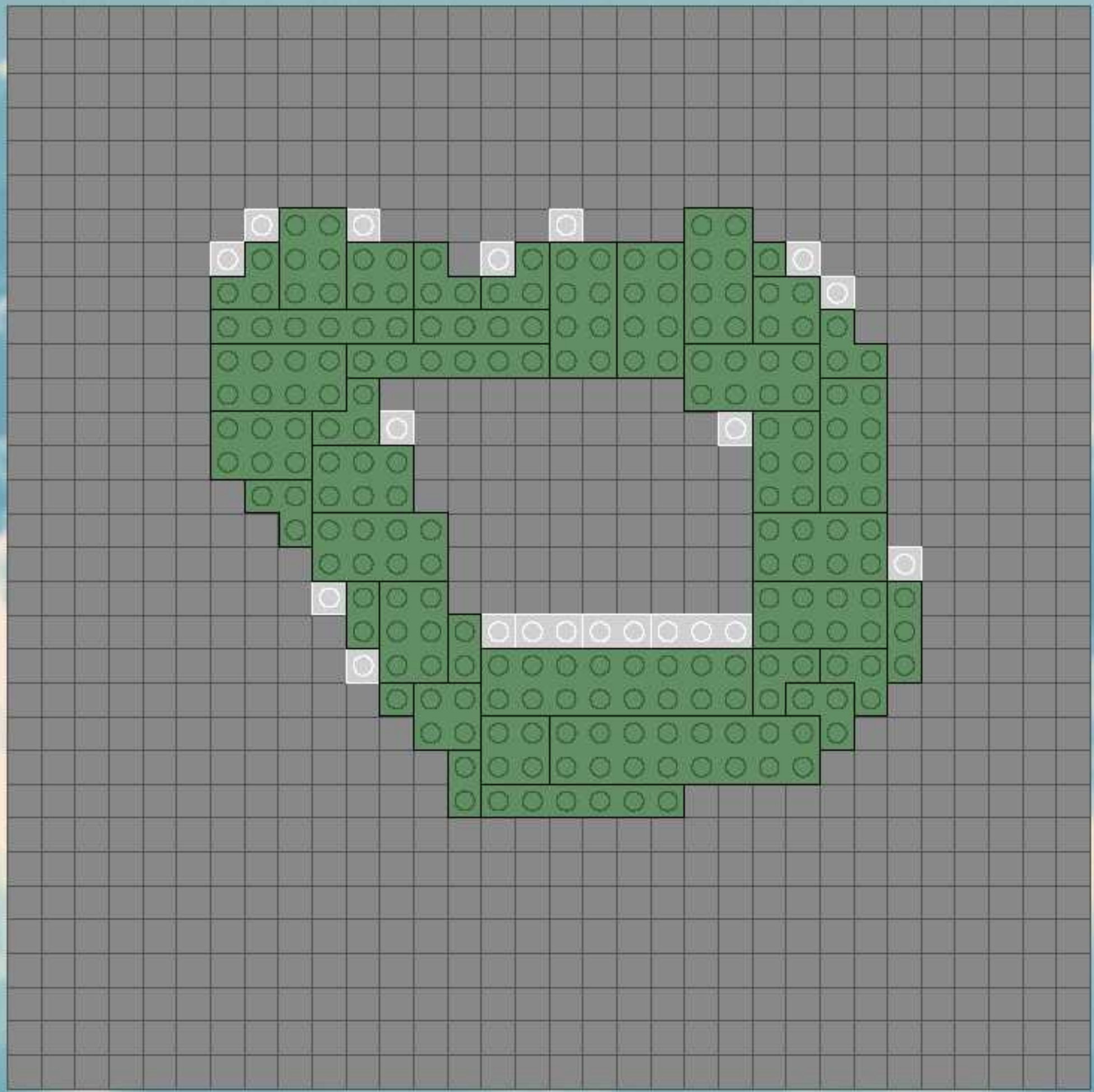

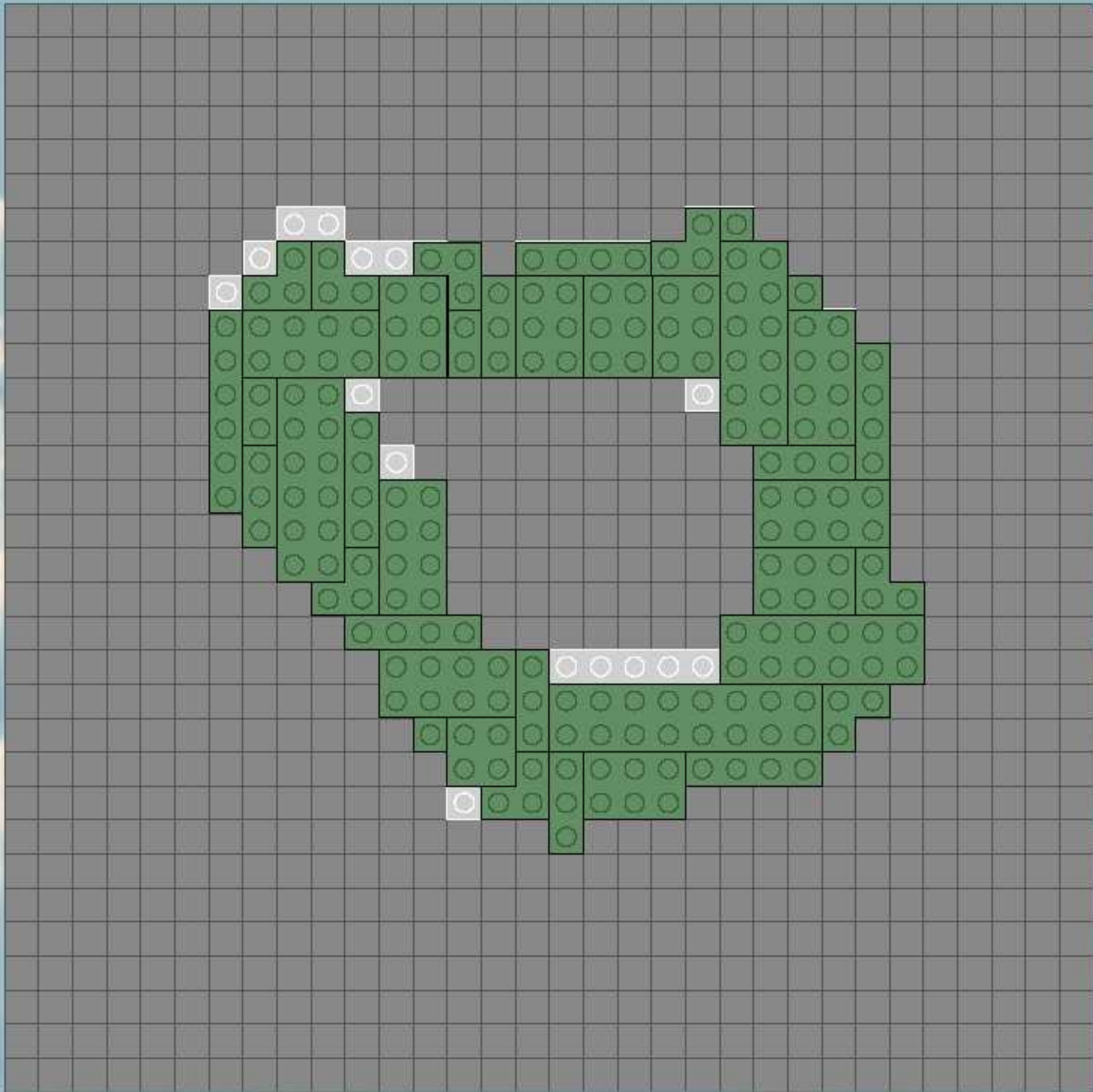
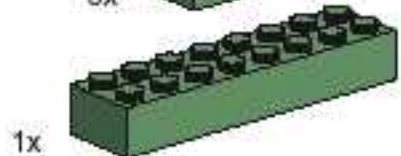
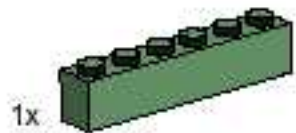
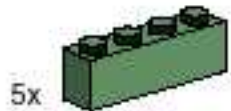

- 9x 
- 2x 
- 3x 
- 1x 
- 1x 
- 3x 
- 4x 
- 5x 
- 9x 
- 2x 



17

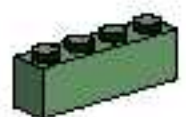
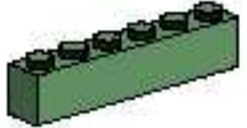

18

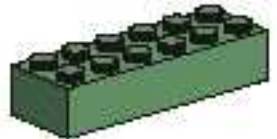
- 10x 
- 3x 
- 3x 
- 5x 
- 3x 
- 1x 
- 8x 
- 7x 
- 1x 



19

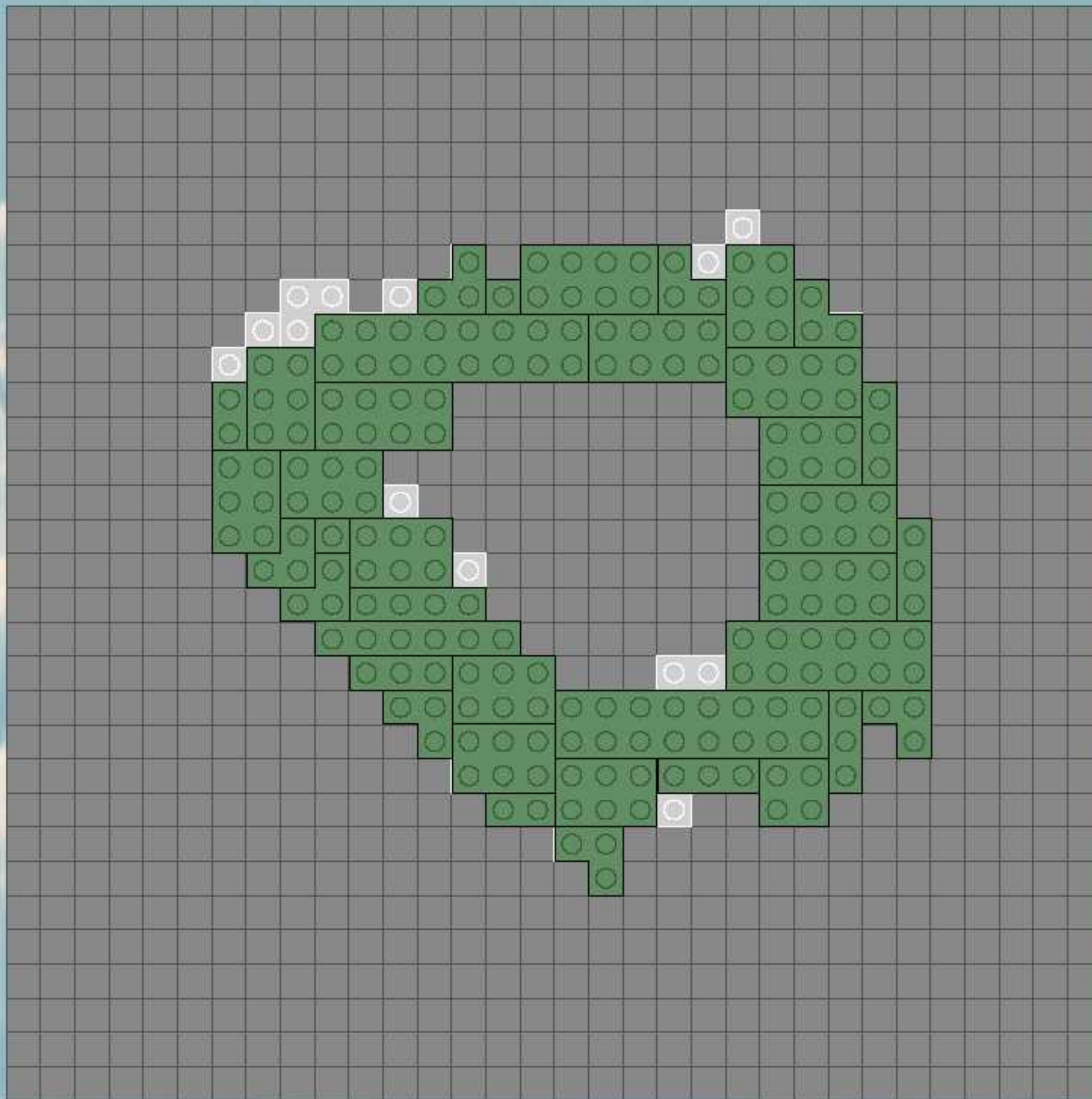
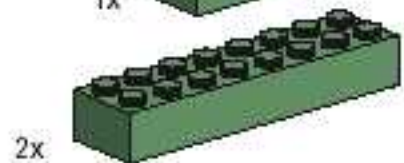
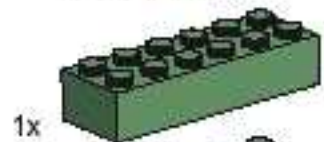
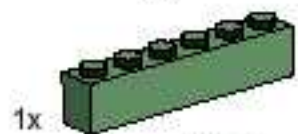
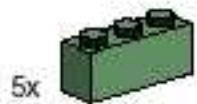

20



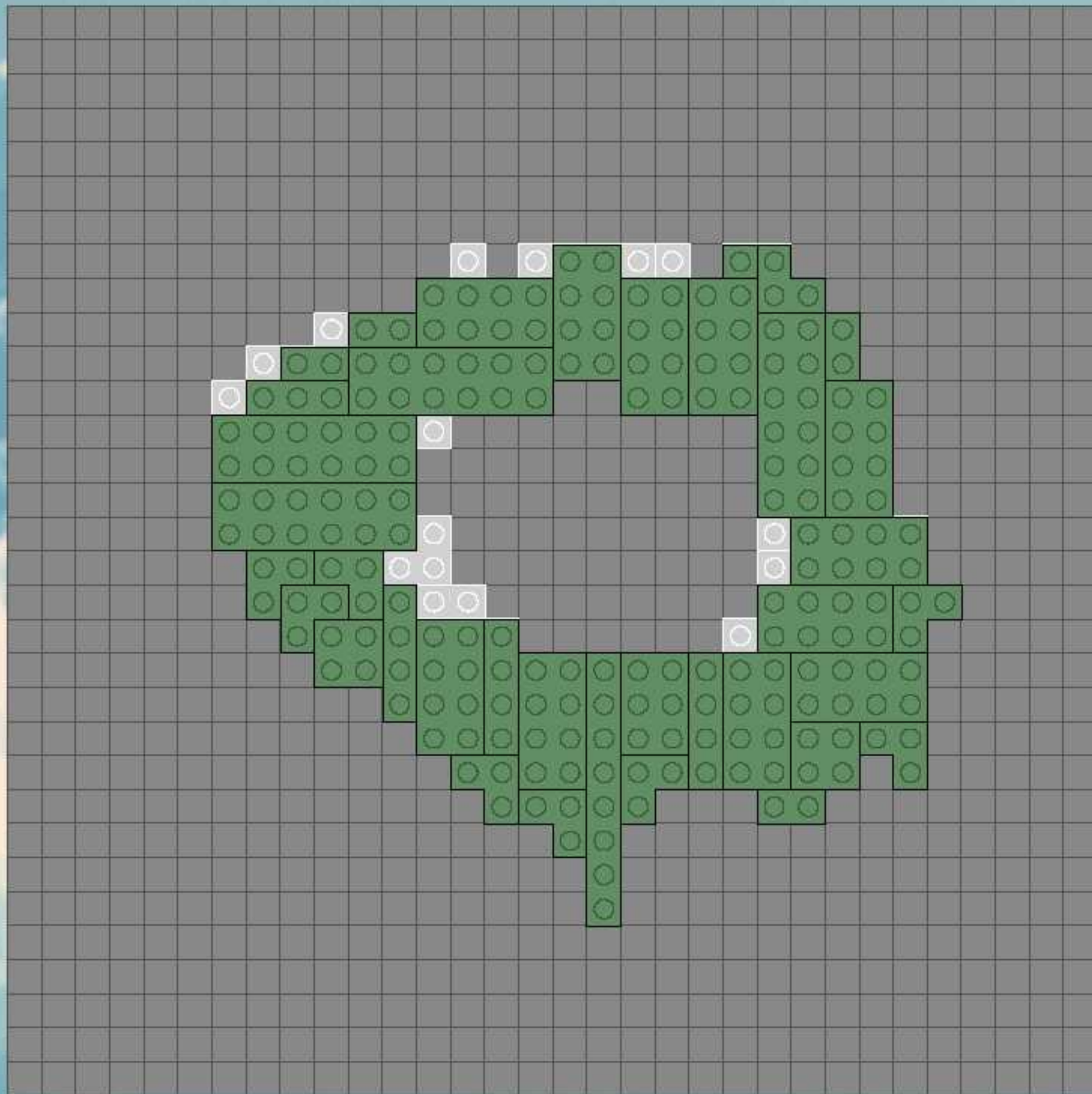

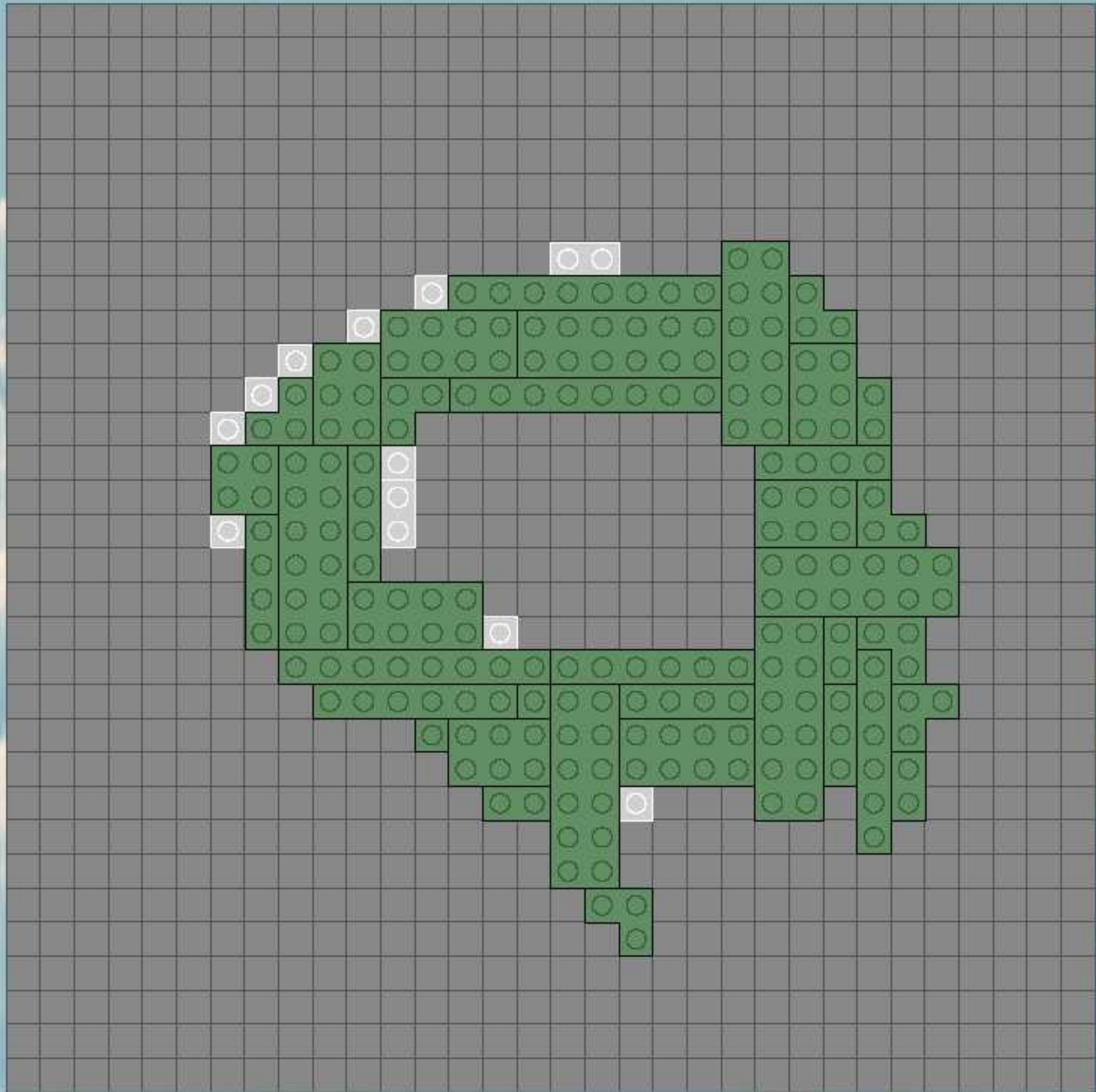
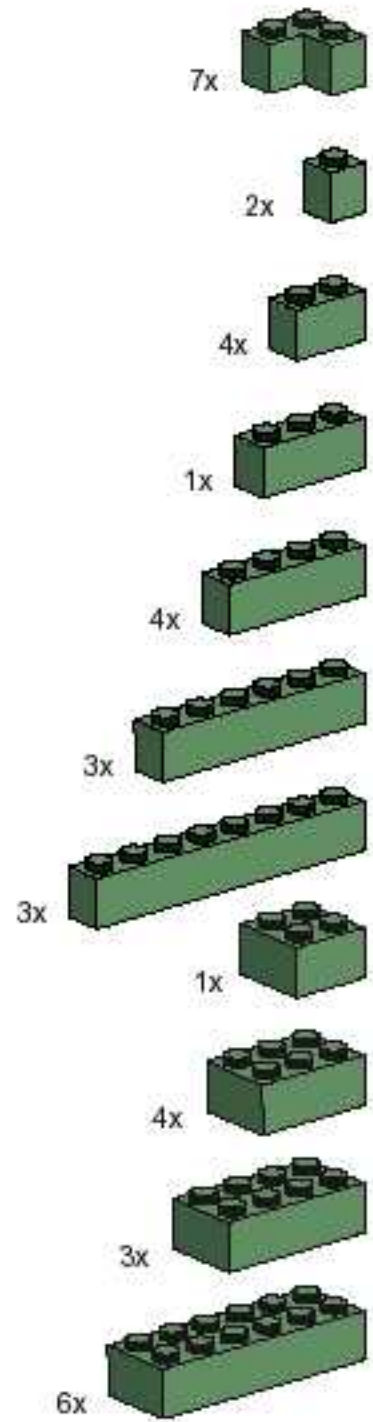

- 9x
- 1x
- 4x
- 1x
- 3x
- 1x
- 2x
- 1x
- 11x
- 4x



21

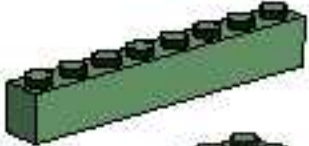

22

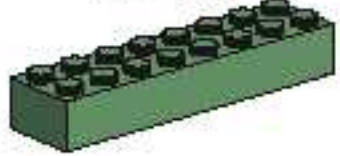

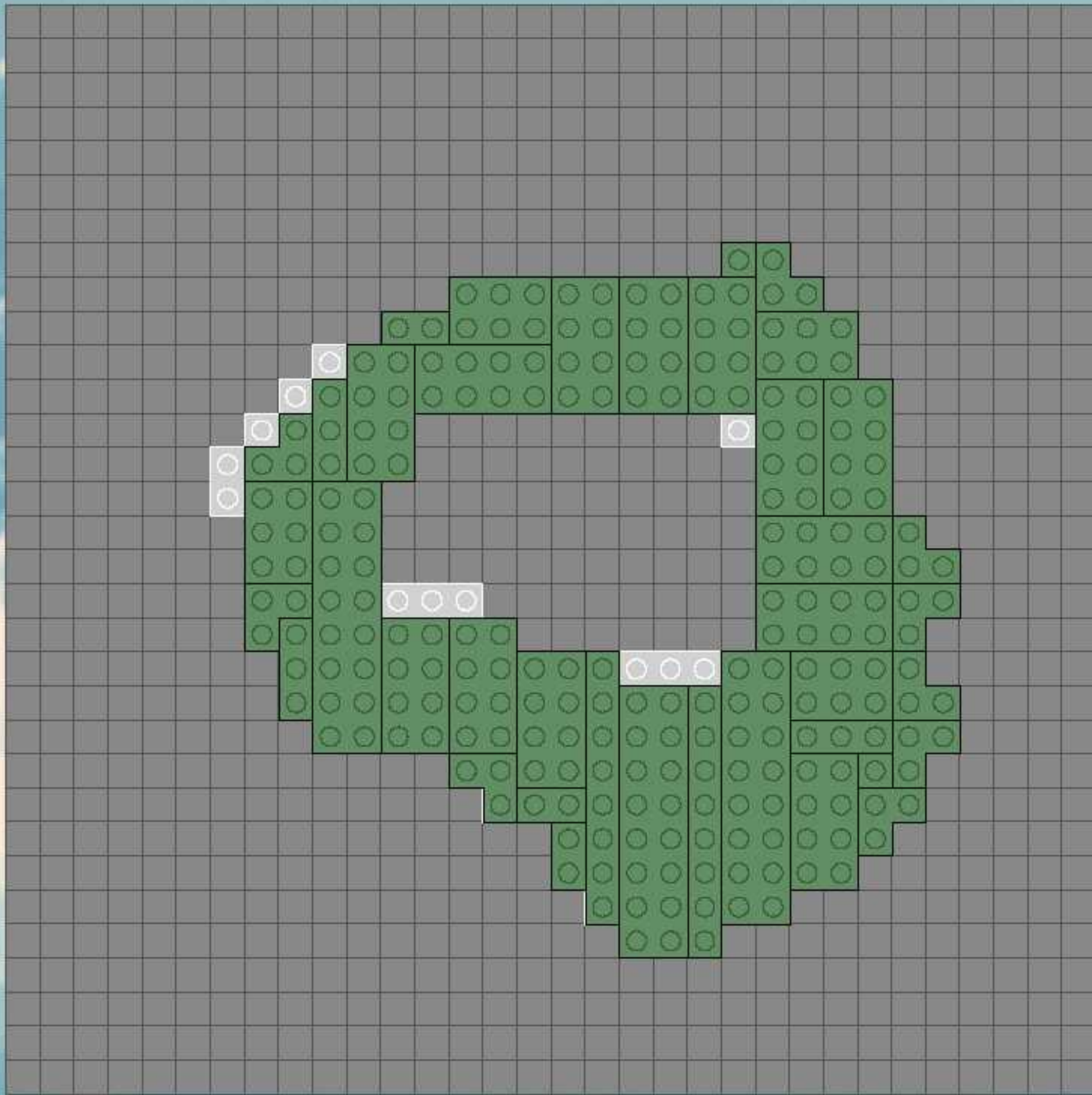



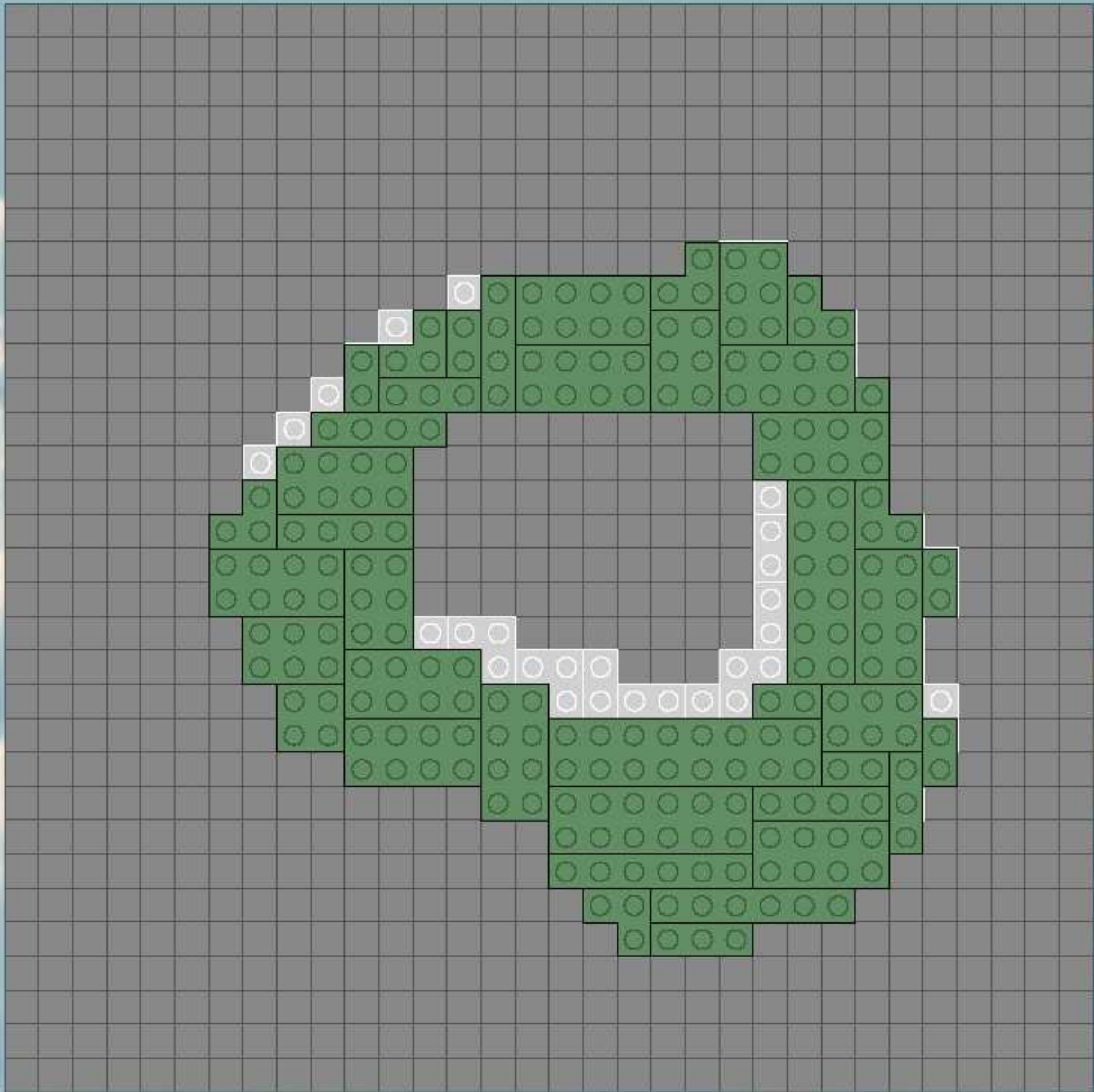
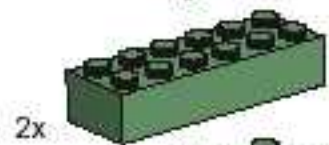
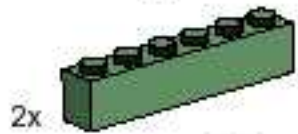
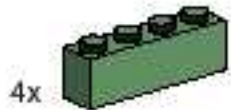

- 9x 
- 2x 
- 3x 
- 3x 
- 2x 
- 4x 
- 13x 
- 3x 



23

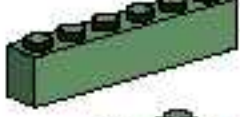

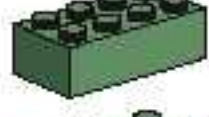



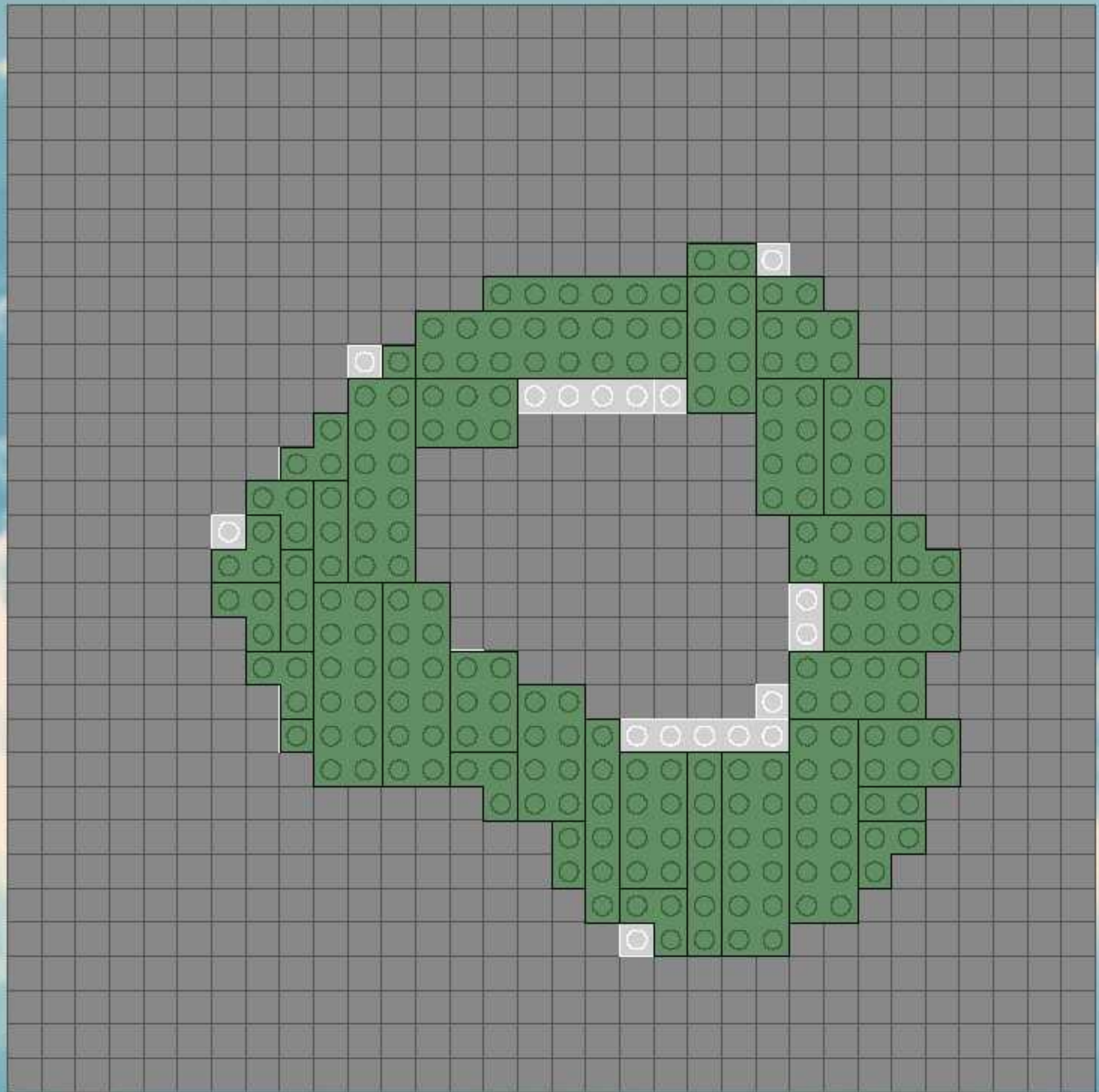



24

- 9x 
- 2x 
- 4x 
- 2x 
- 3x 
- 5x 
- 7x 
- 5x 
- 1x 

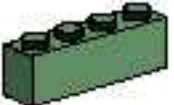

25

- 6x 
- 1x 
- 5x 
- 5x 
- 5x 
- 1x 
- 7x 
- 9x 
- 3x 

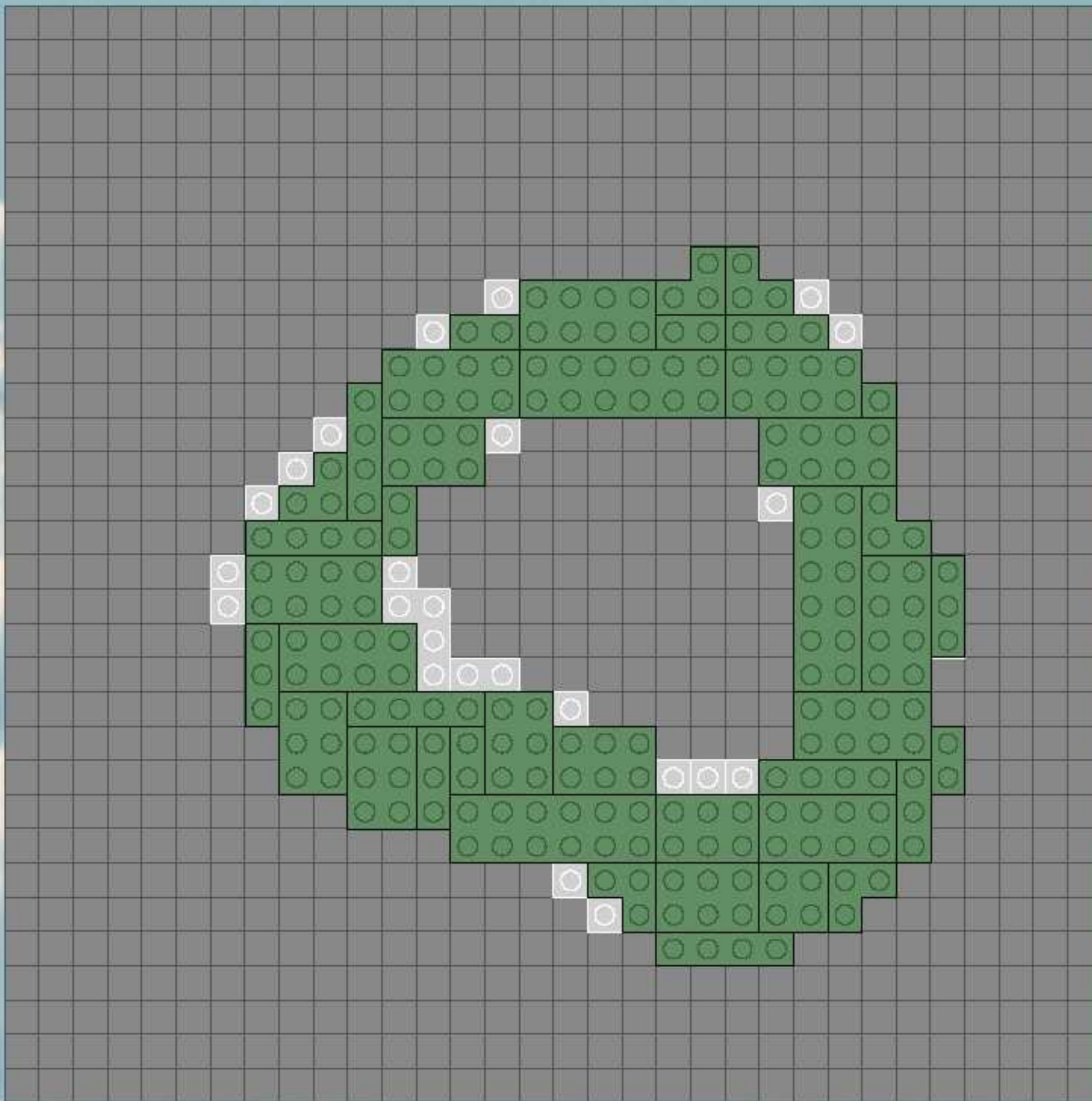

26



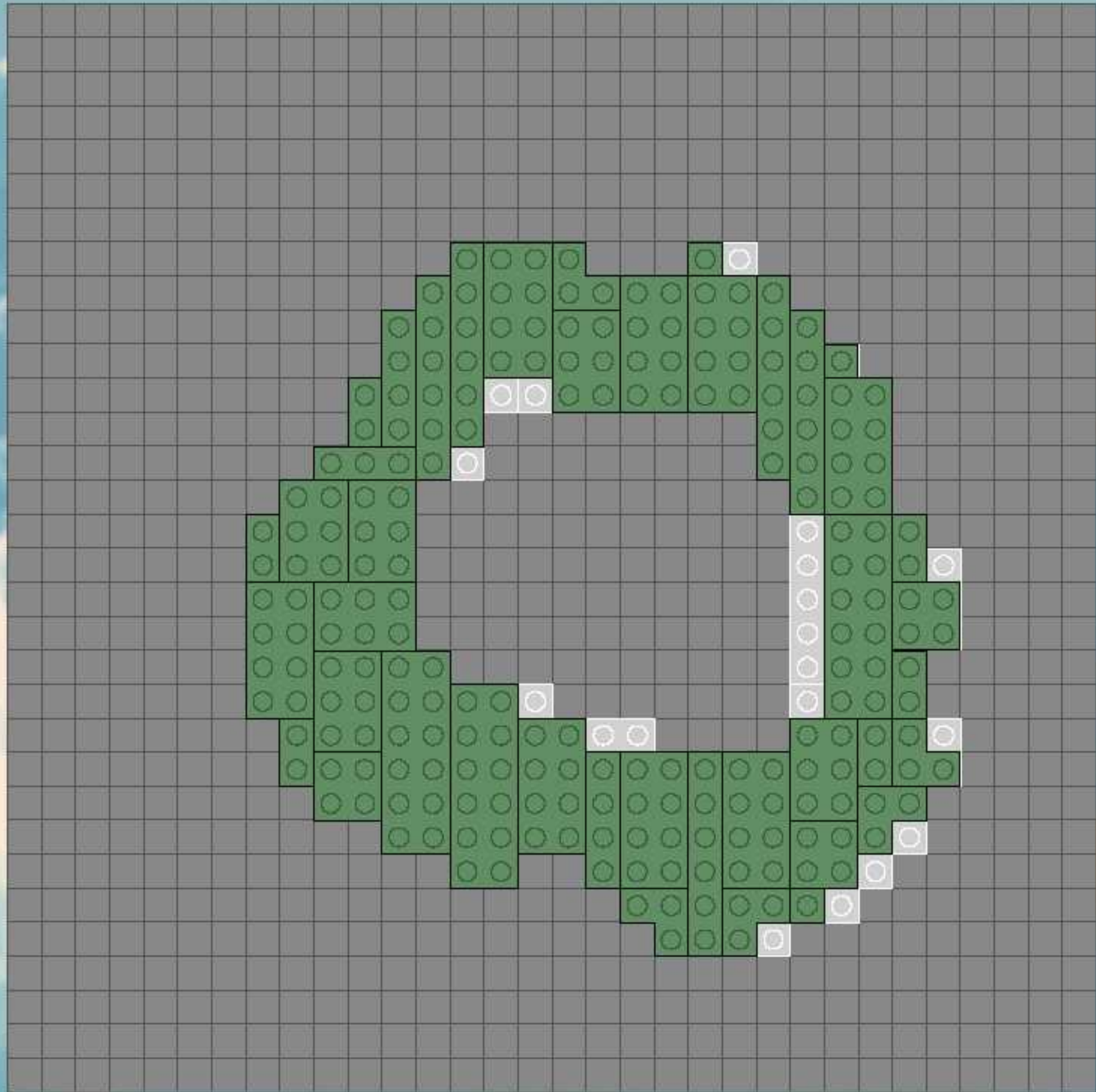



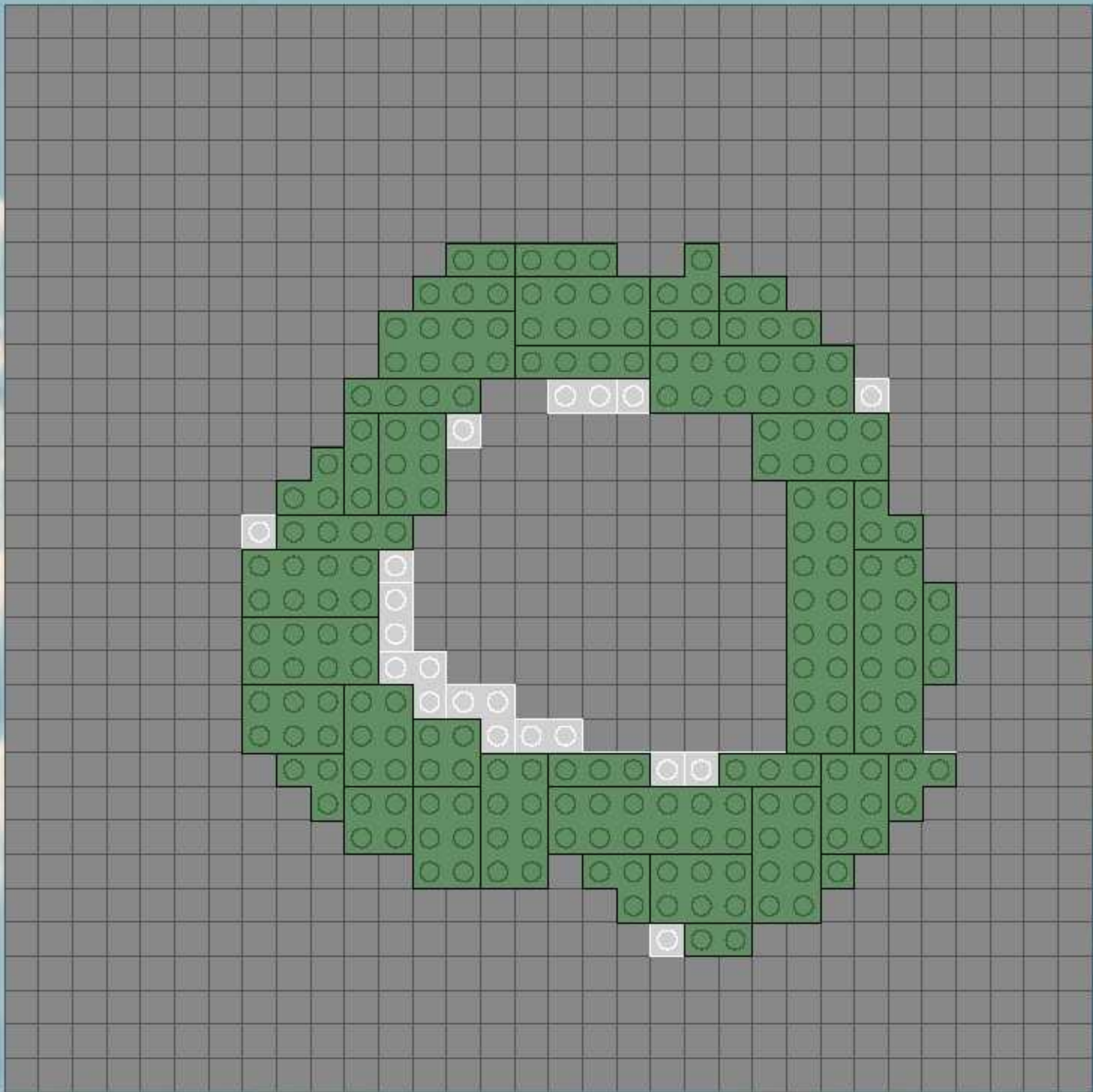
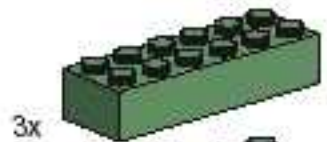



- 5x
- 3x
- 6x
- 1x
- 2x
- 5x
- 3x
- 6x
- 8x
- 3x



27



28

- 11x 
- 1x 
- 1x 
- 5x 
- 4x 
- 2x 
- 2x 
- 5x 
- 10x 
- 1x 

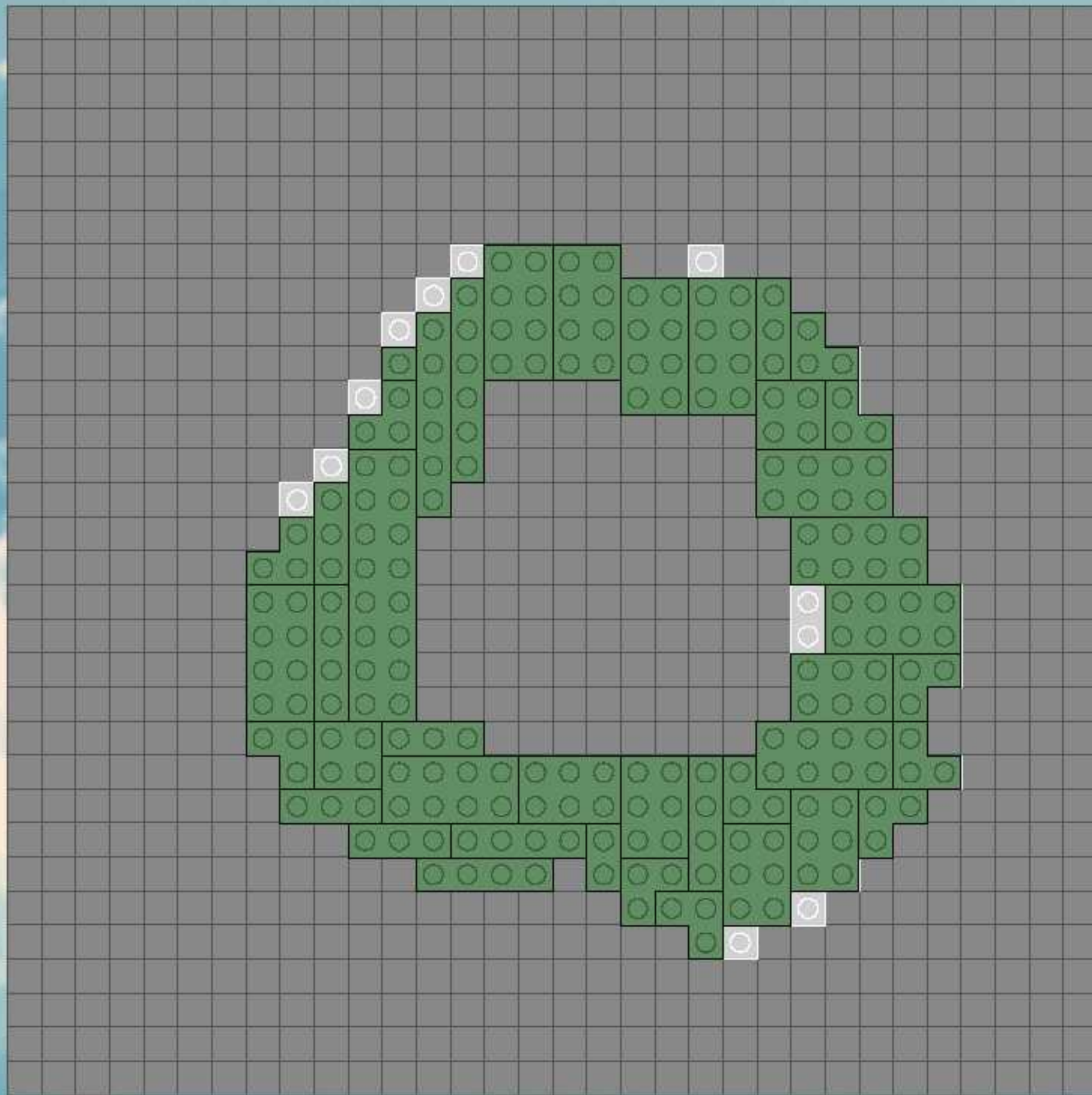

29

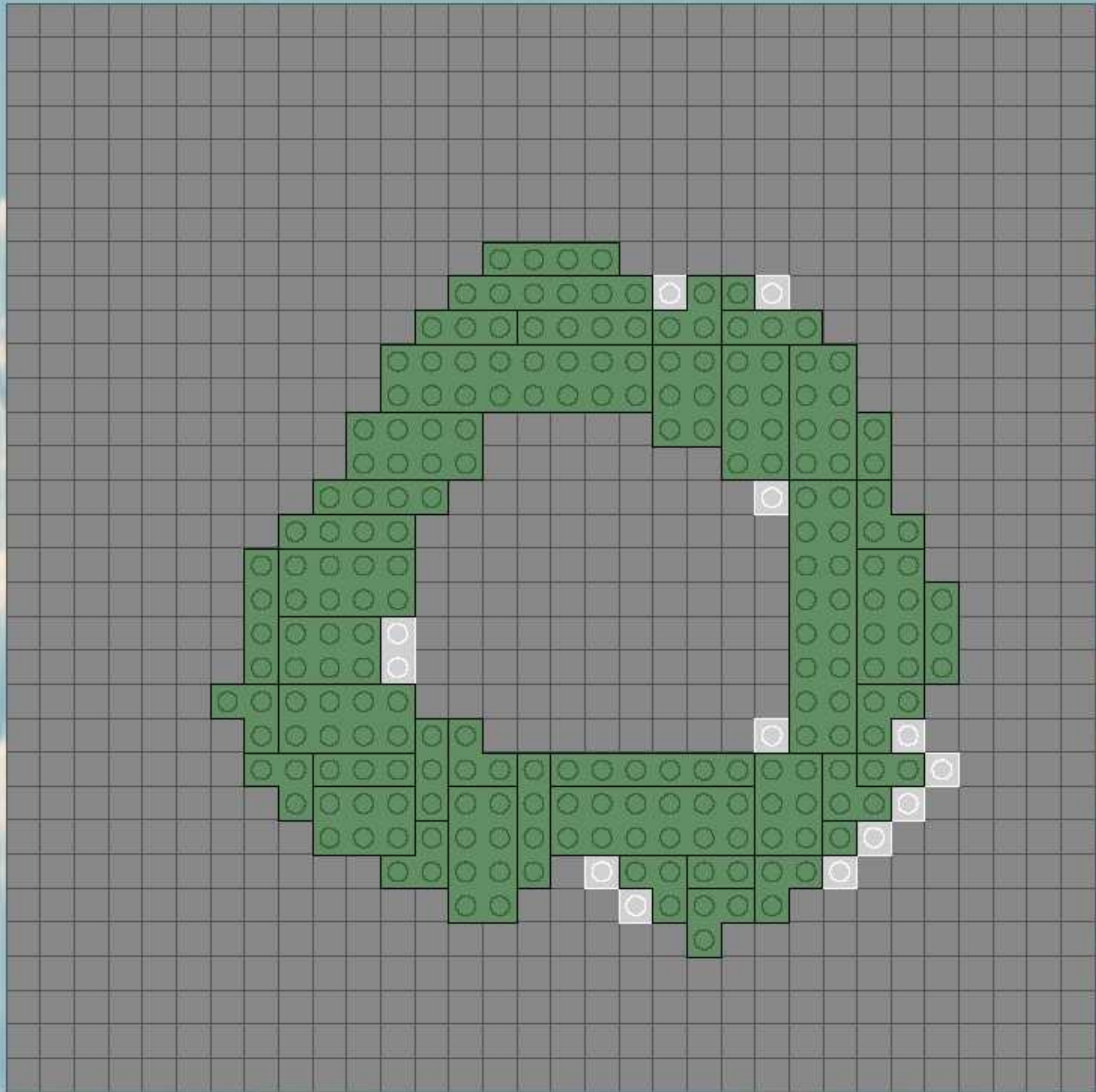
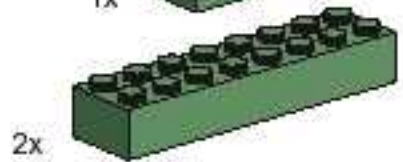
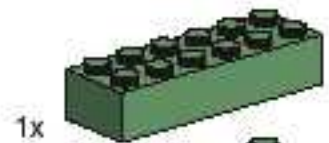
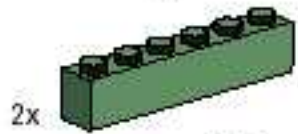
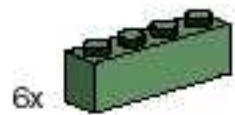

30

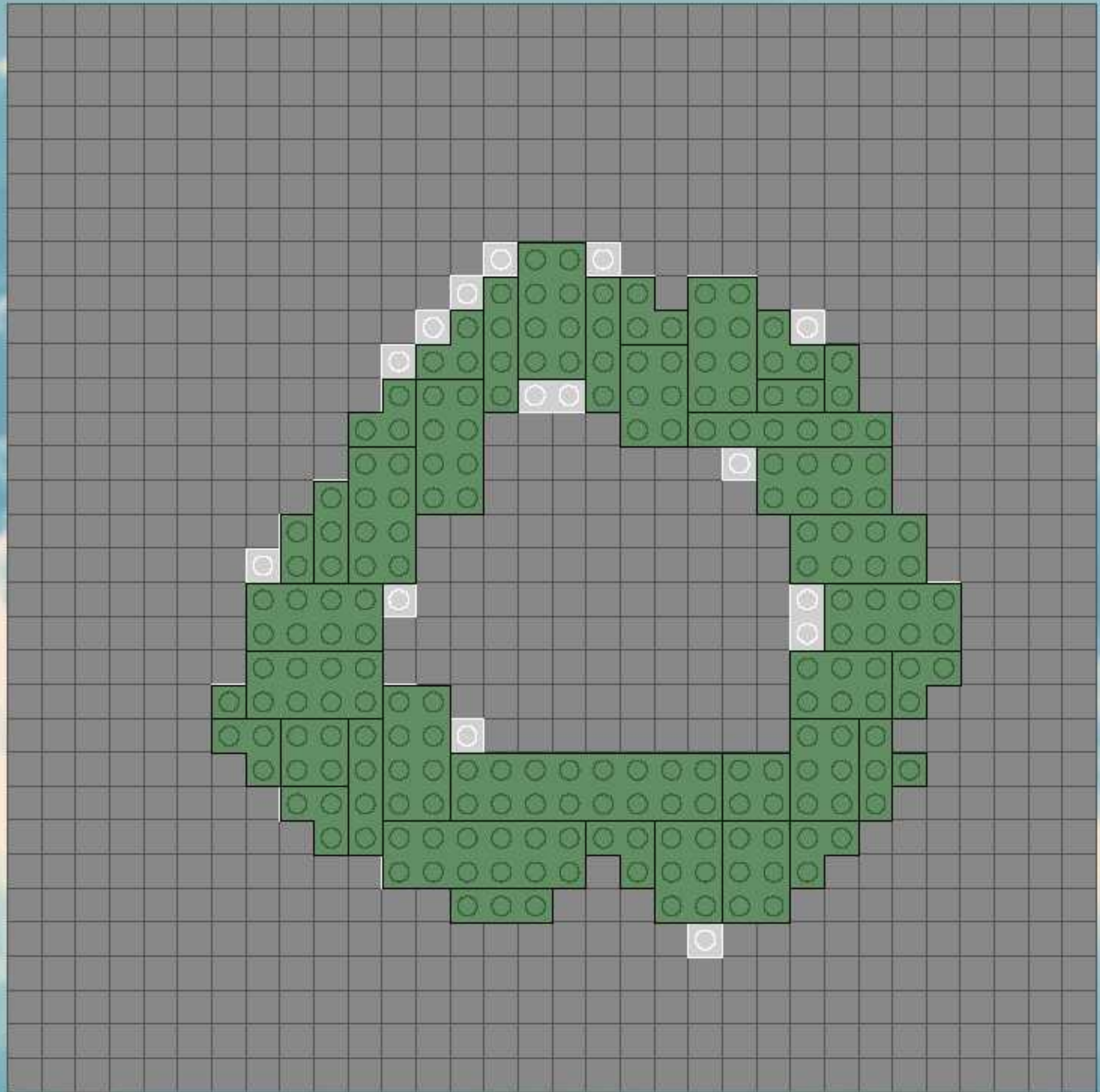
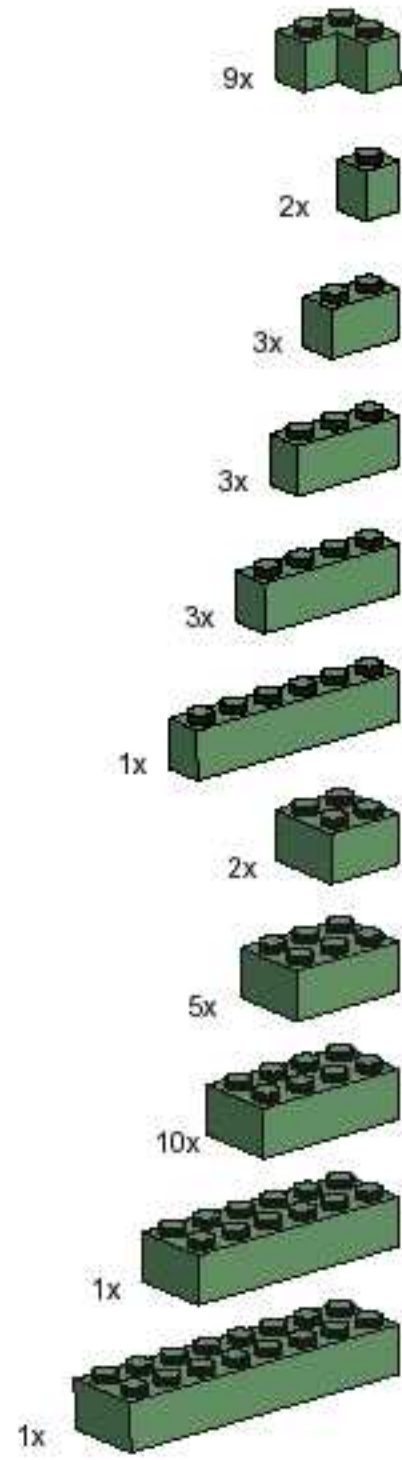

31

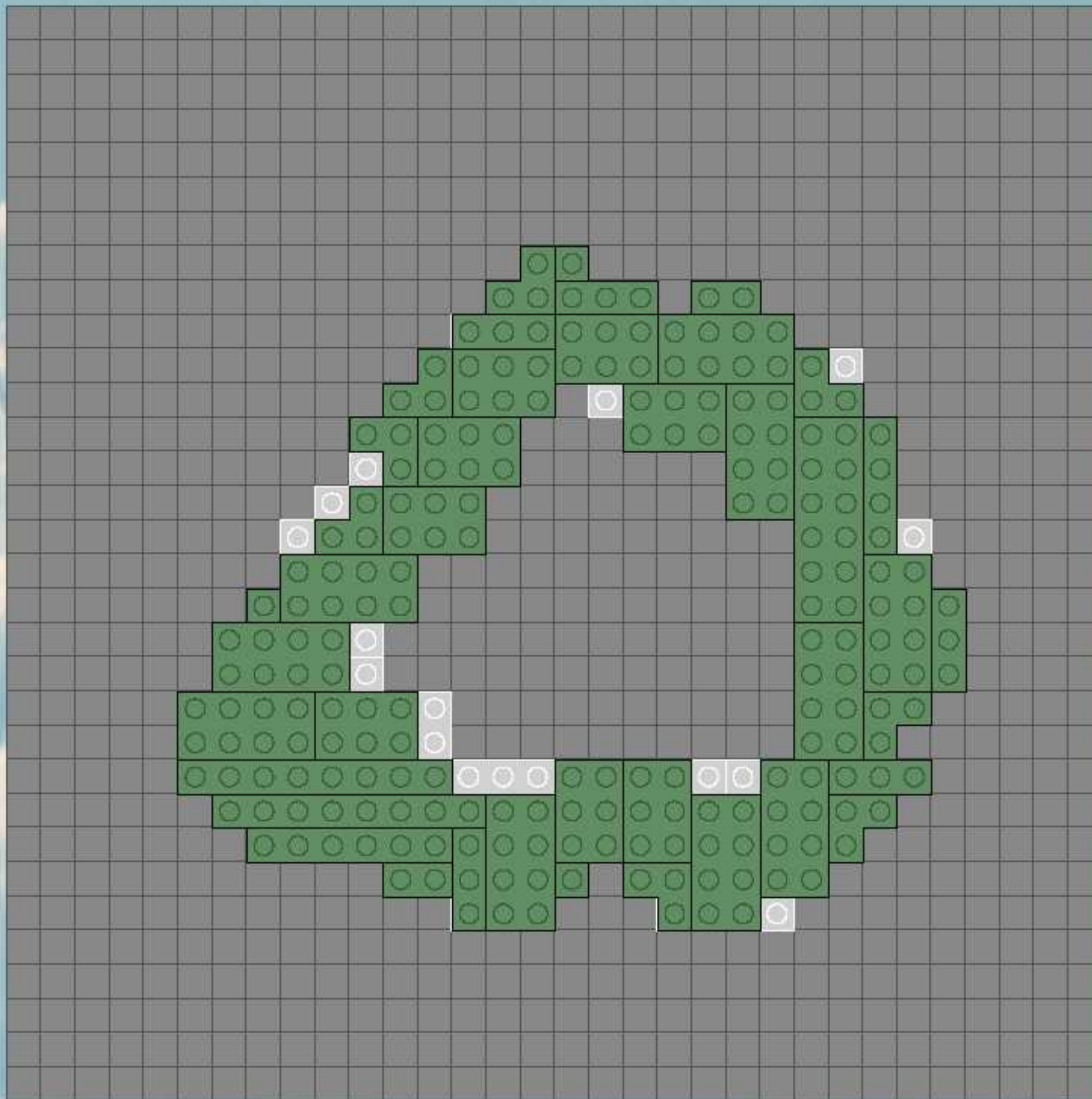
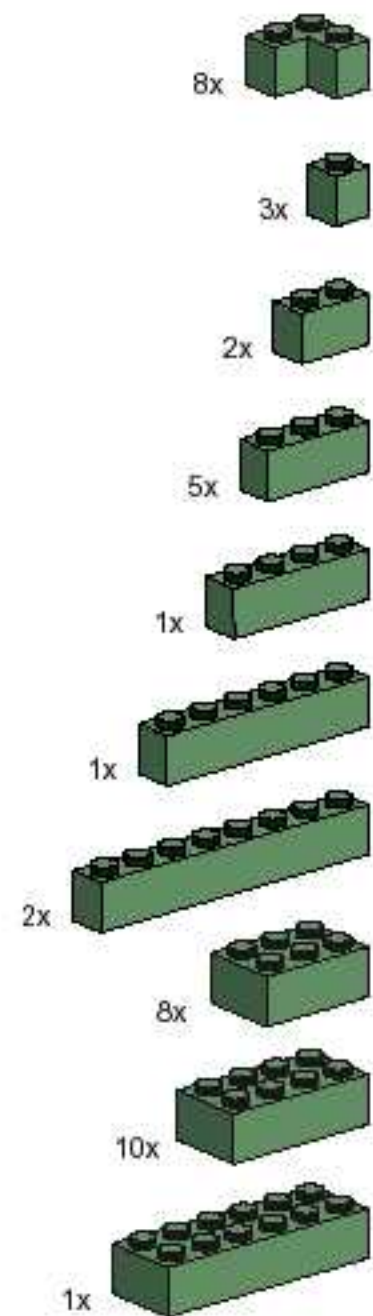

32

- 11x
- 3x
- 4x
- 1x
- 4x
- 1x
- 1x
- 7x
- 9x
- 1x
- 1x

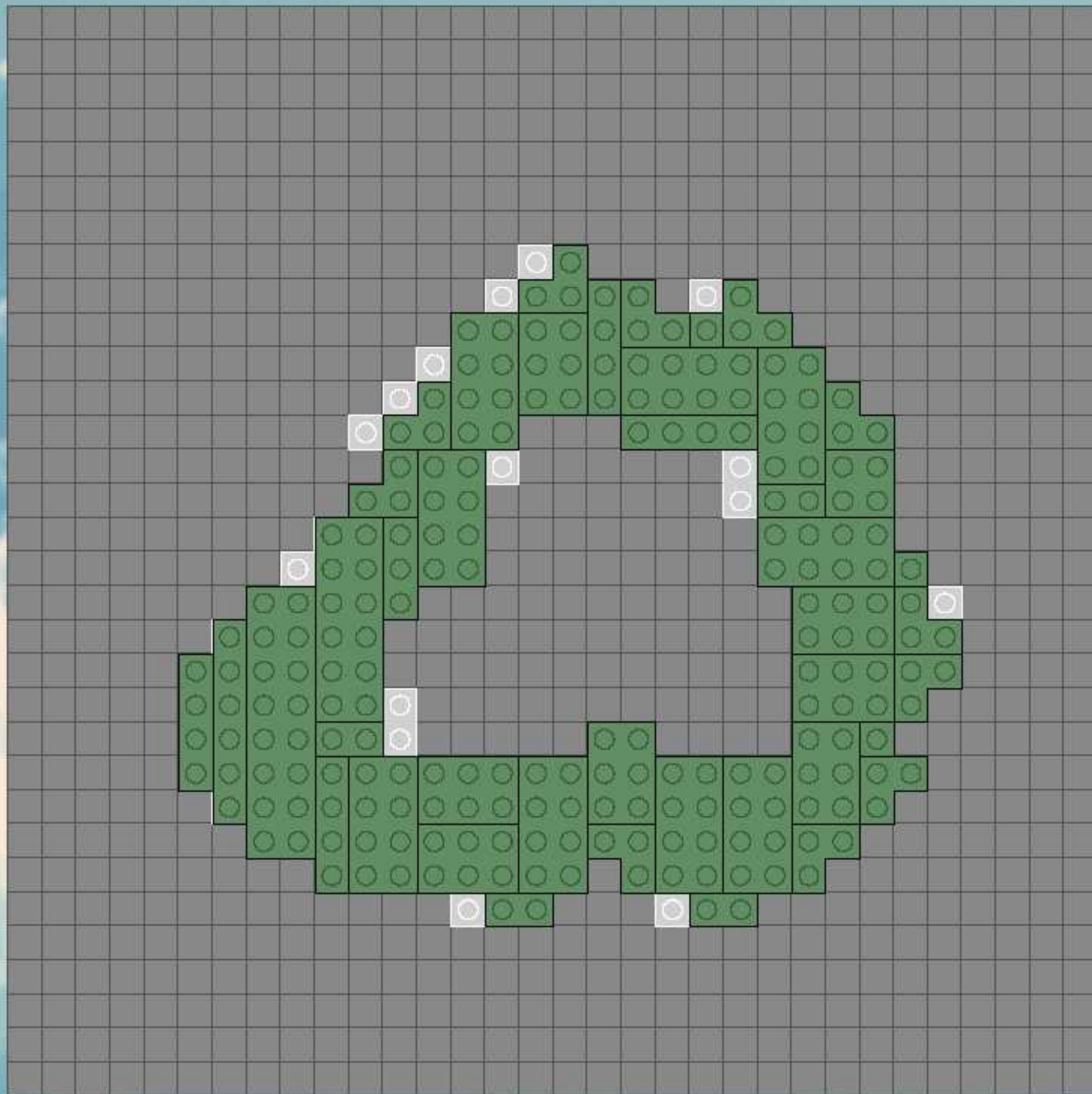

33

1

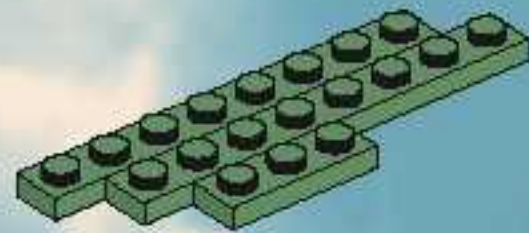

2

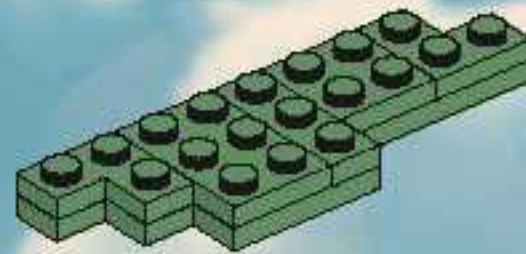

3

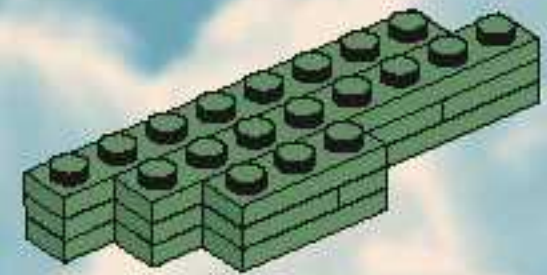

33

- 9x
- 7x
- 2x
- 2x
- 2x
- 2x
- 1x
- 5x
- 9x
- 4x
- 2x

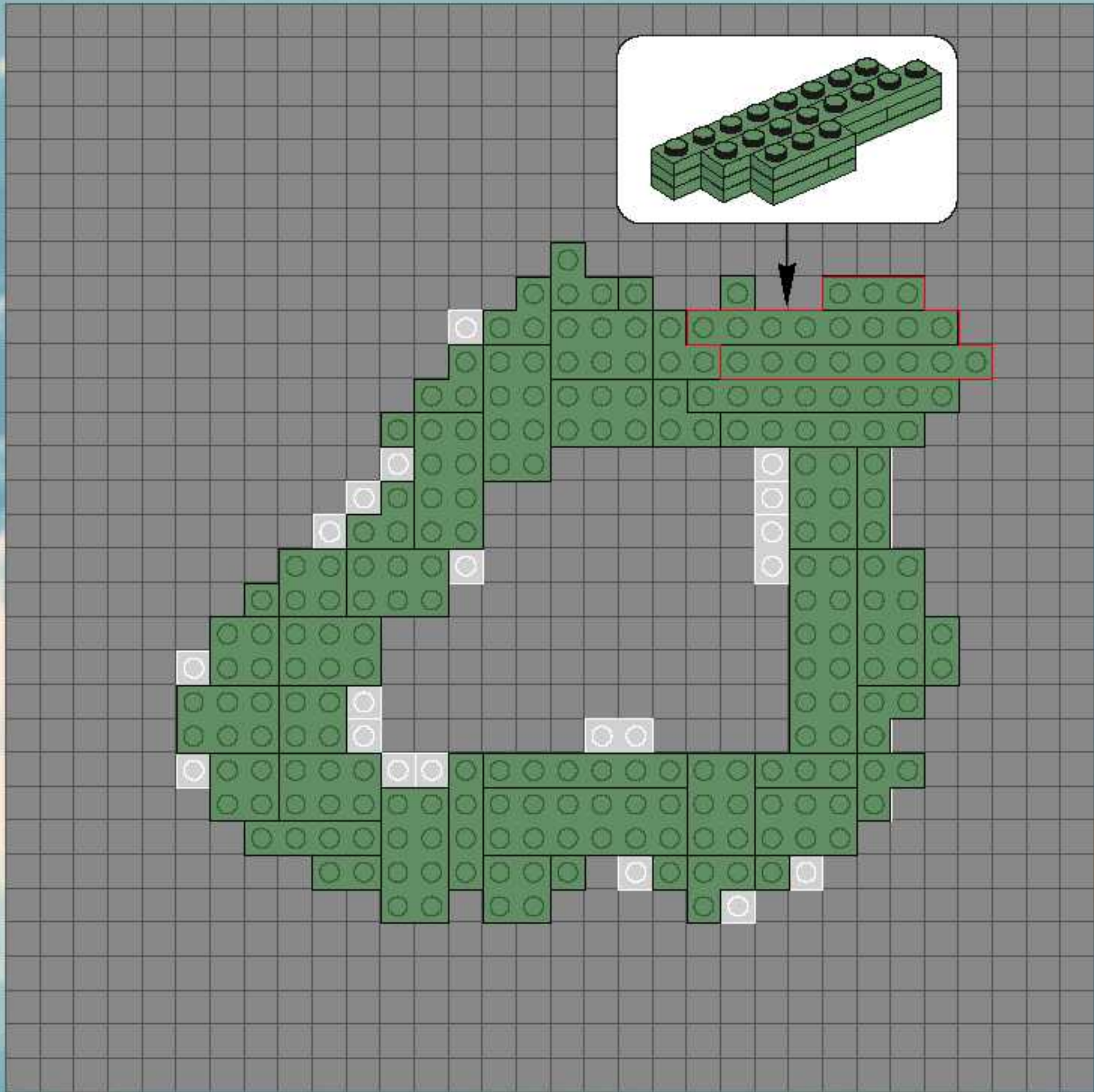

34

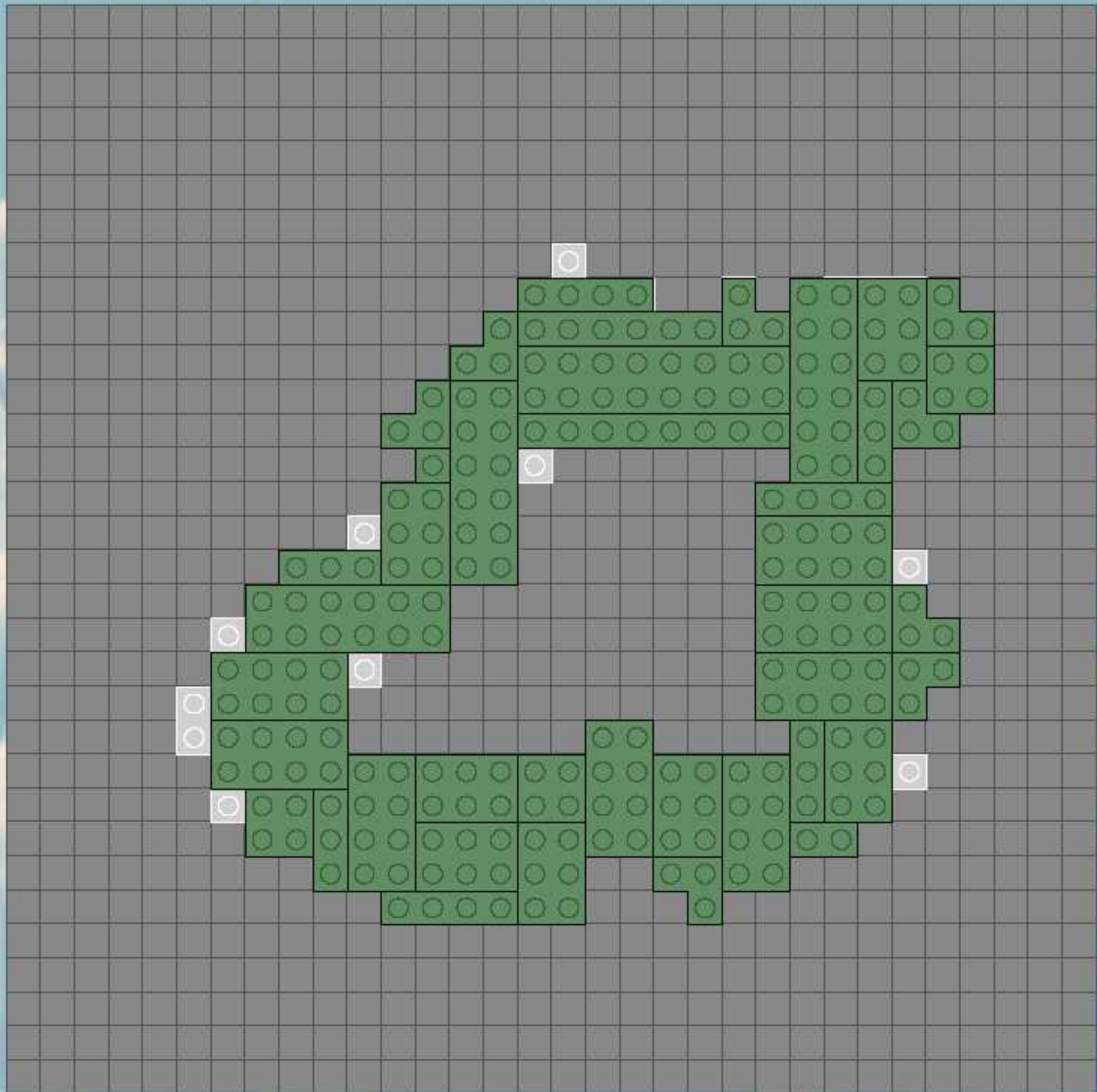
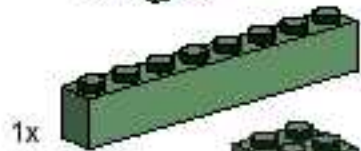
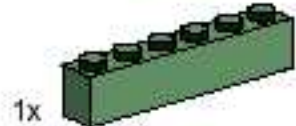
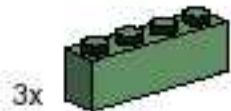

35

- 4x
- 1x
- 4x
- 6x
- 1x
- 1x
- 6x
- 2x
- 5x
- 5x
- 2x

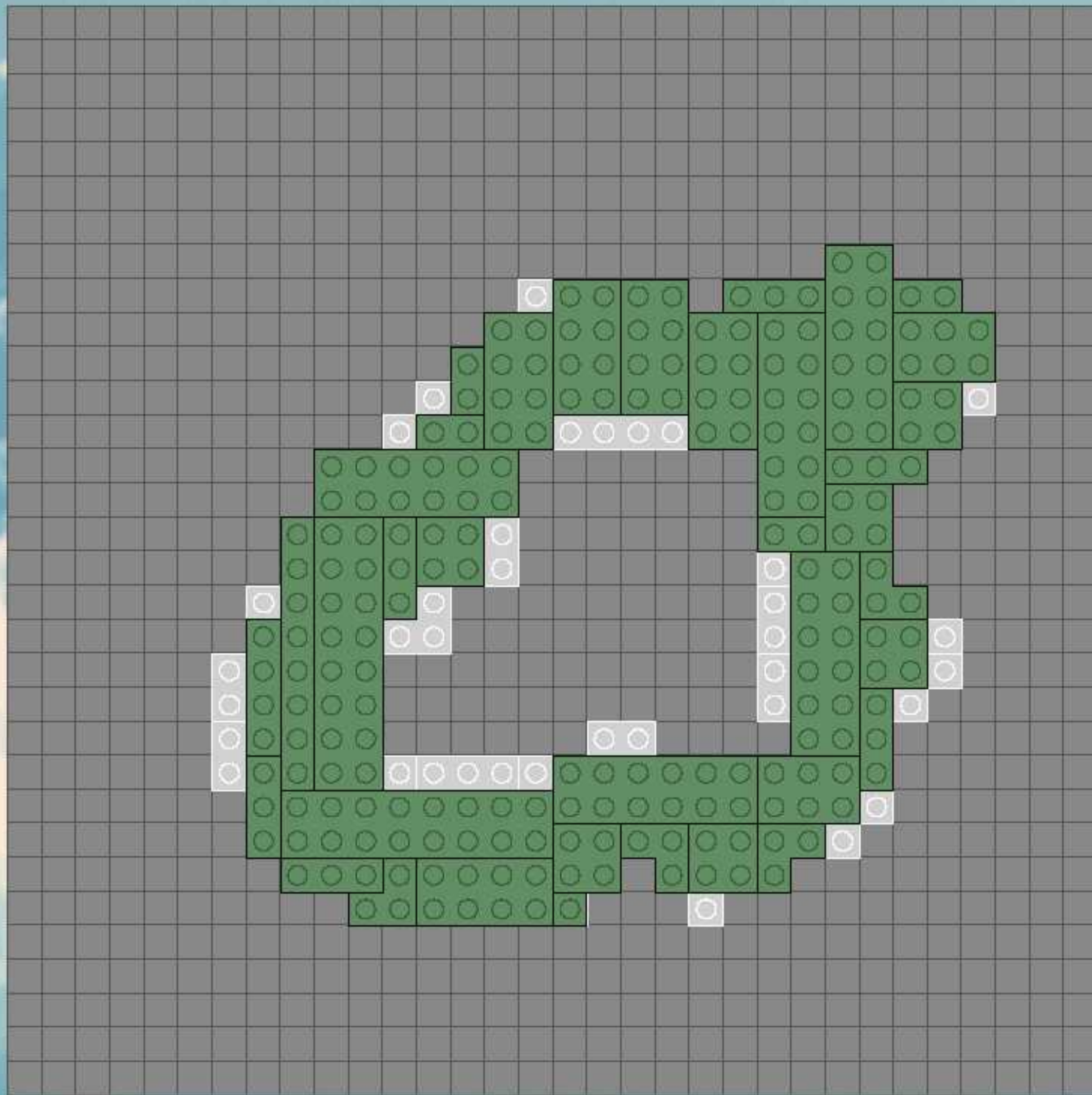

36

- 3x
- 2x
- 4x
- 6x
- 2x
- 1x
- 9x
- 7x
- 4x

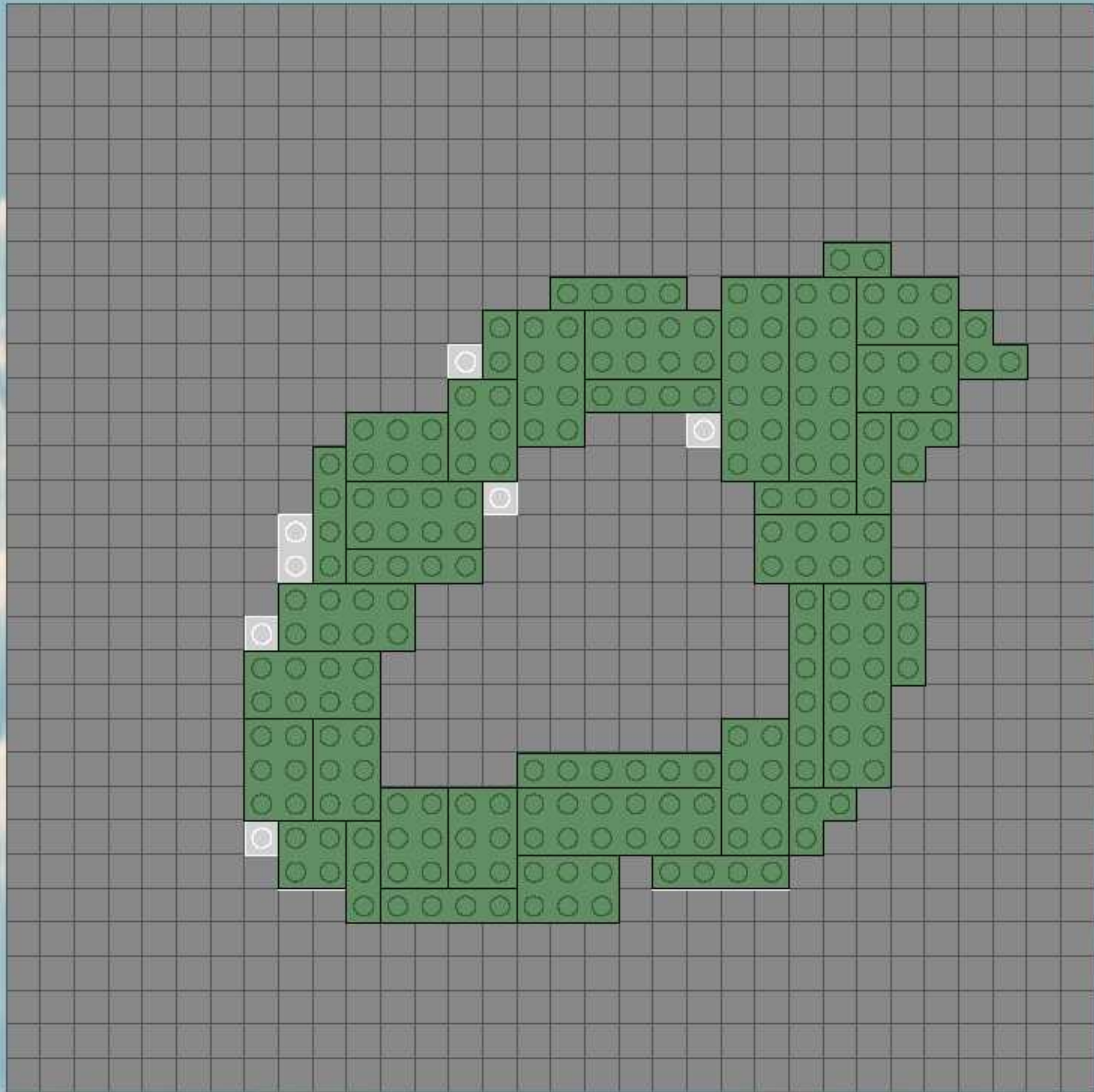

37

- 7x
- 4x
- 4x
- 5x
- 1x
- 2x
- 7x
- 8x
- 2x

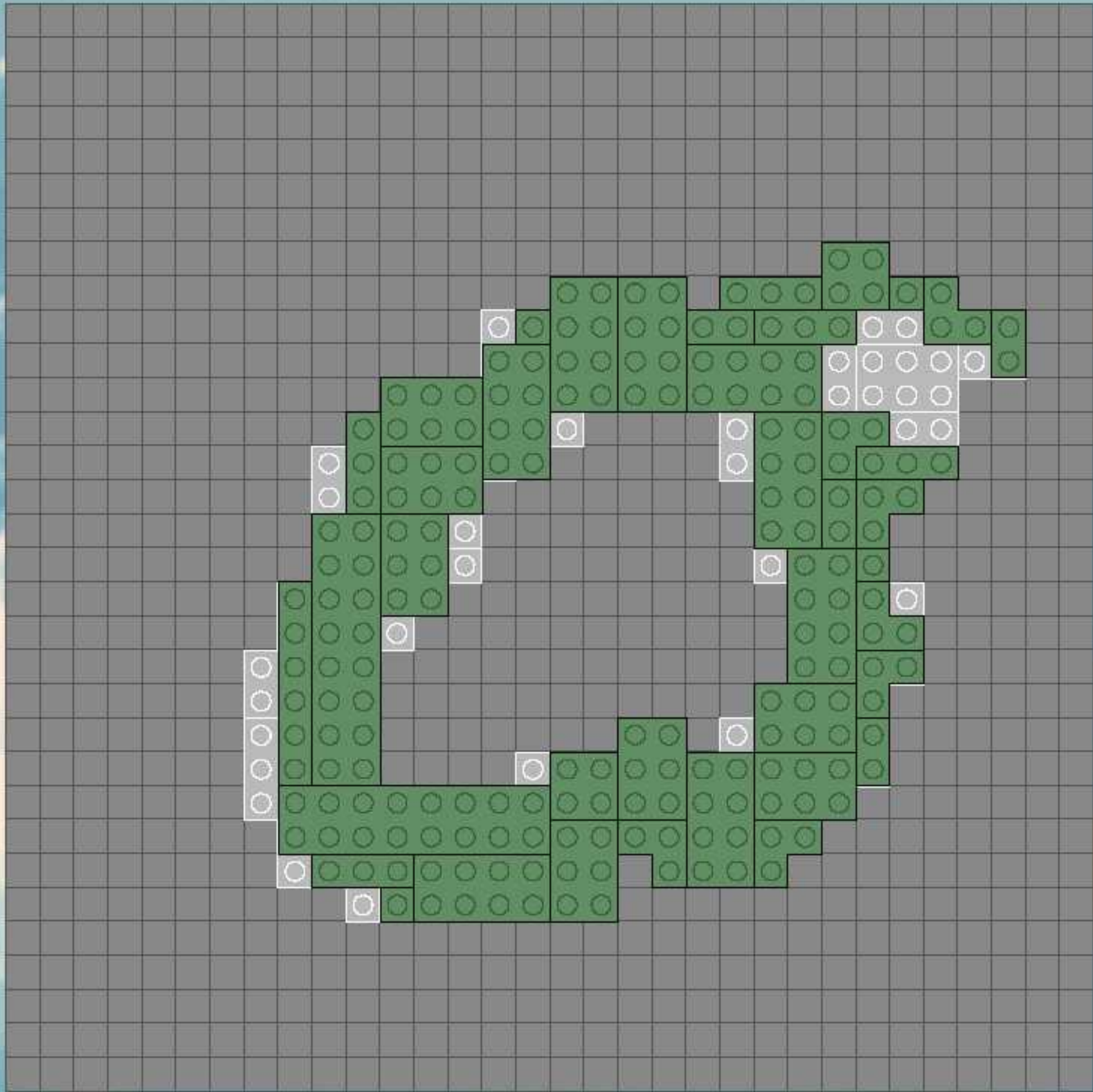





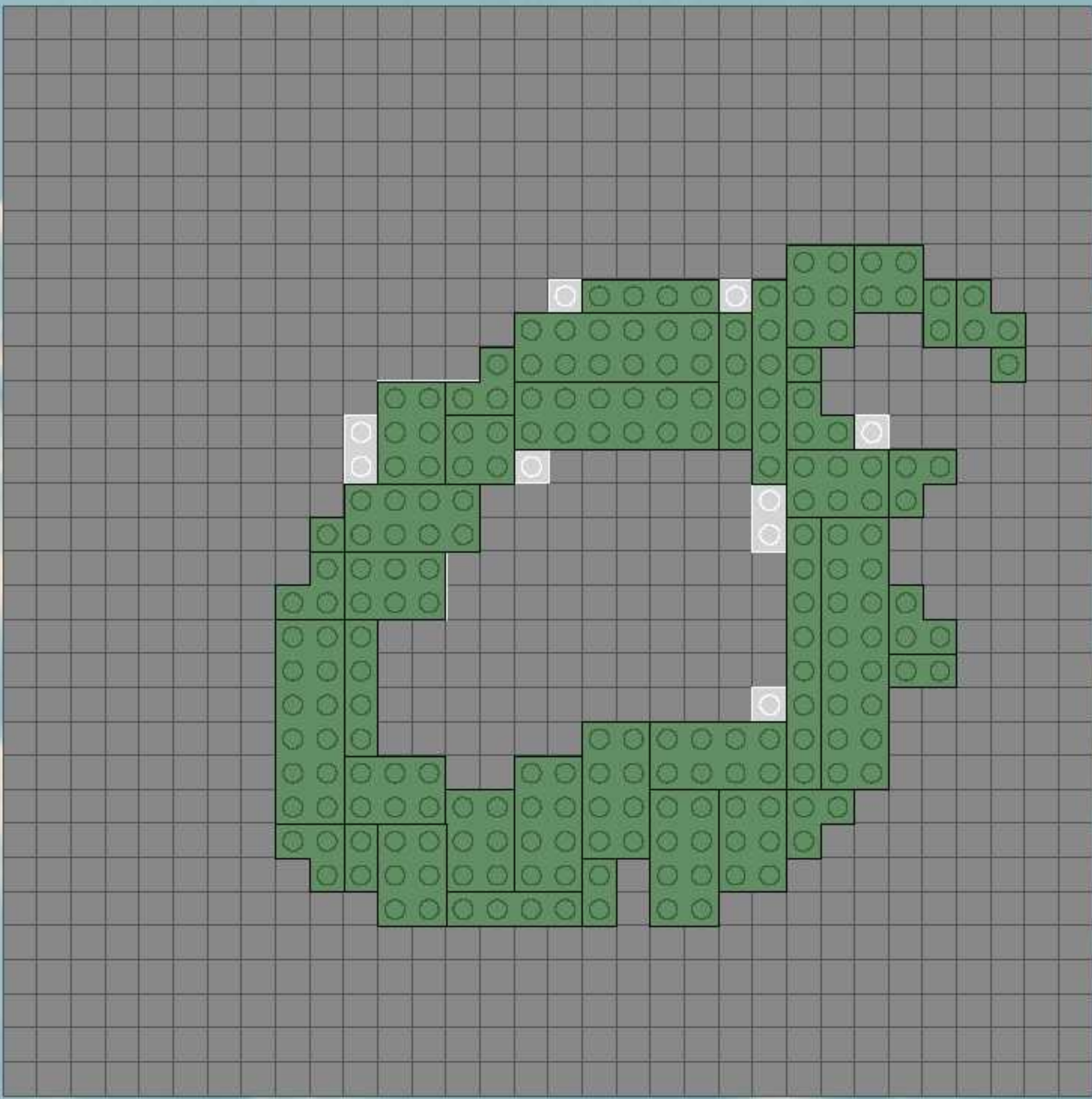





38

- 8x
- 3x
- 4x
- 4x
- 1x
- 1x
- 2x
- 8x
- 5x
- 3x
- 1x



39

- 2x 
- 13x 
- 2x 
- 7x 
- 1x 
- 2x 
- 1x 
- 1x 
- 3x 
- 1x 
- 1x 

1

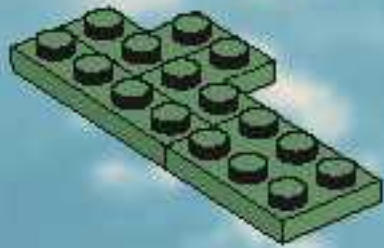

2

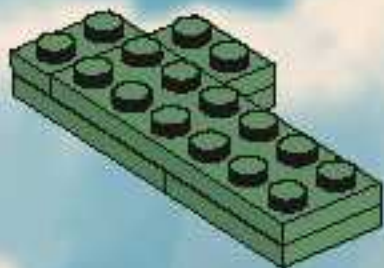

3

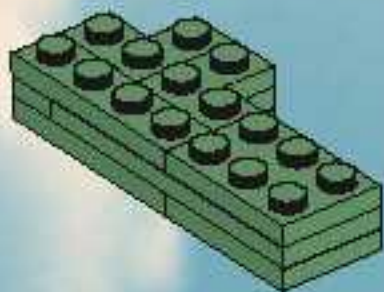

1



2

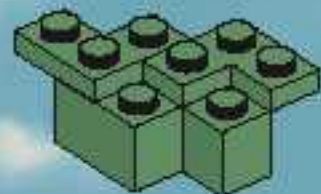

3

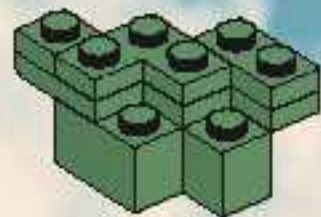

4

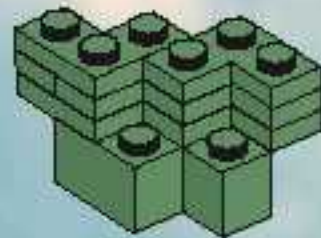

1

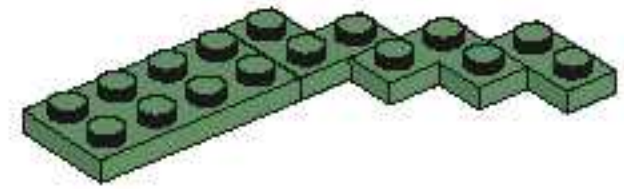

2

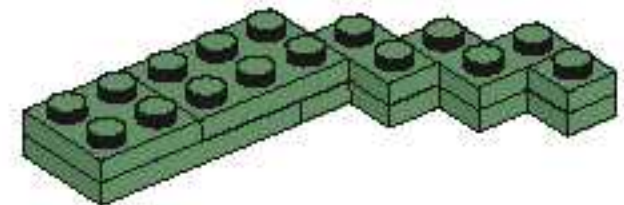

3

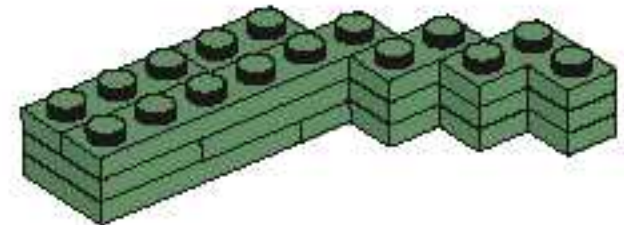

5

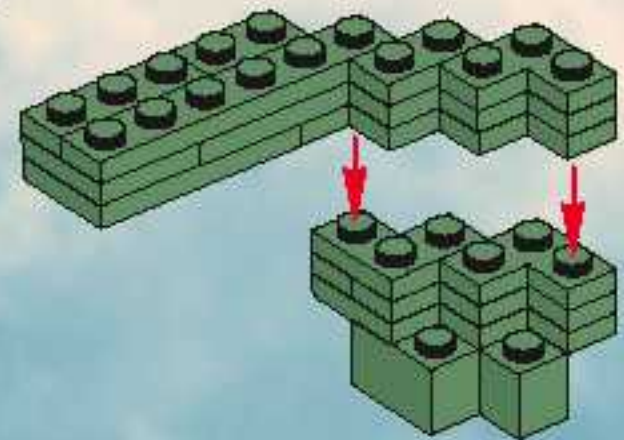

39

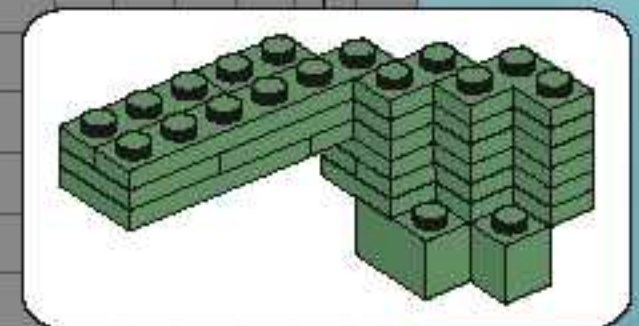
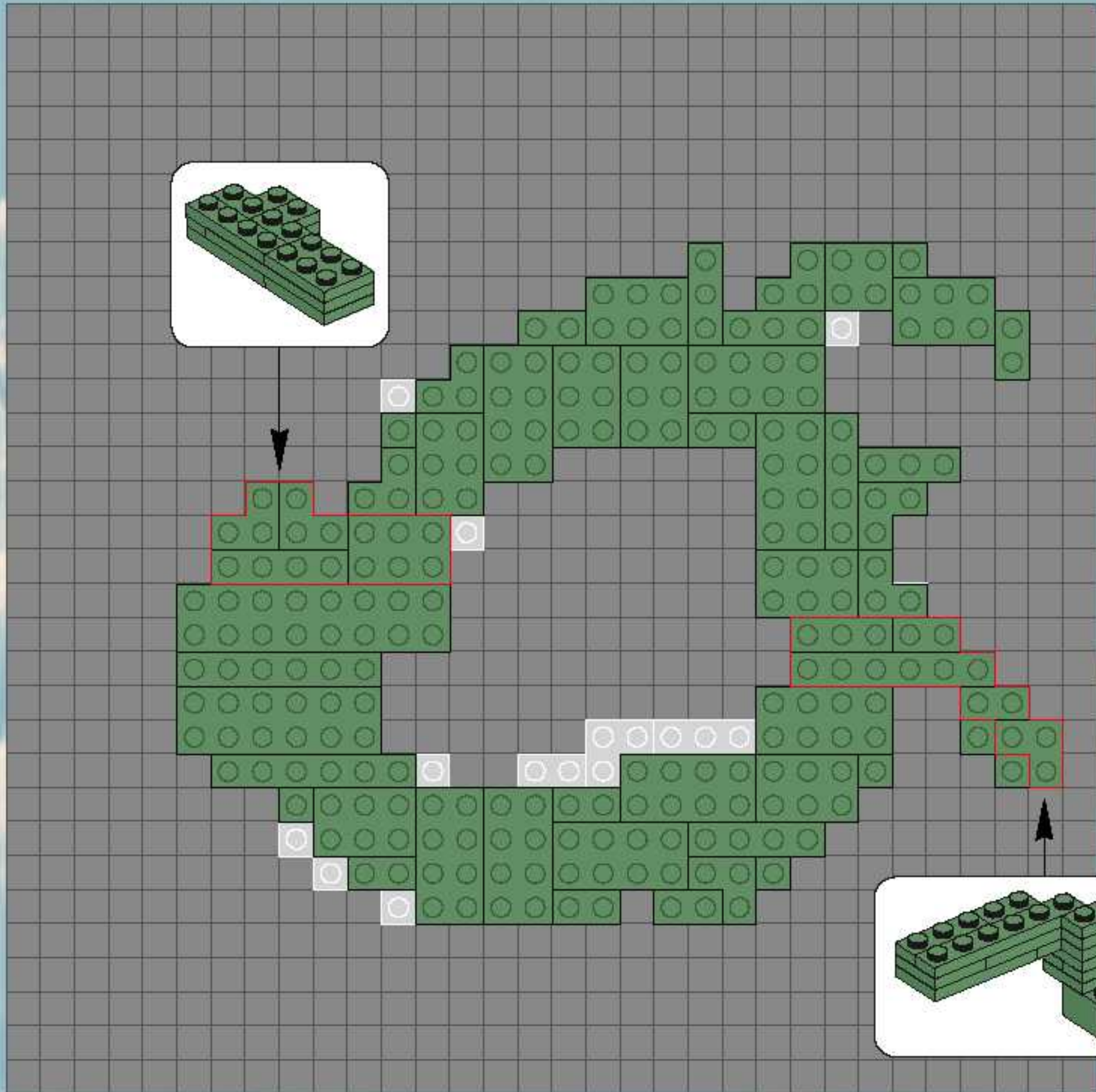
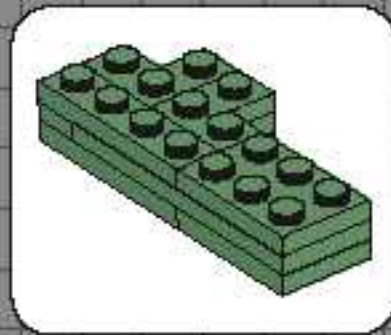
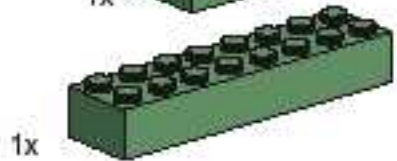
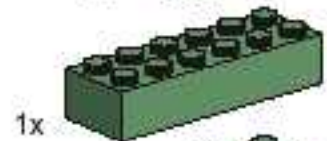
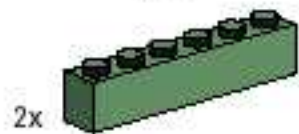

40



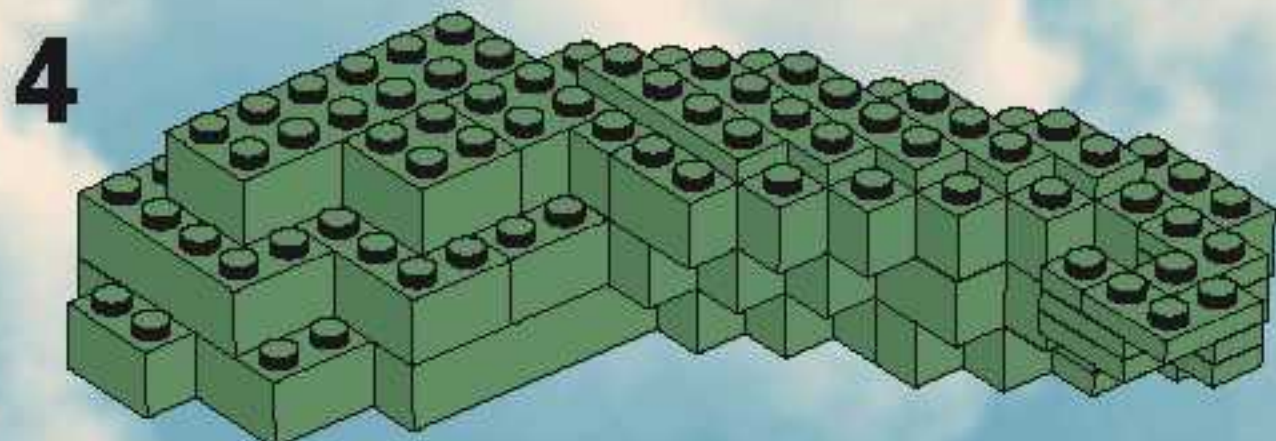
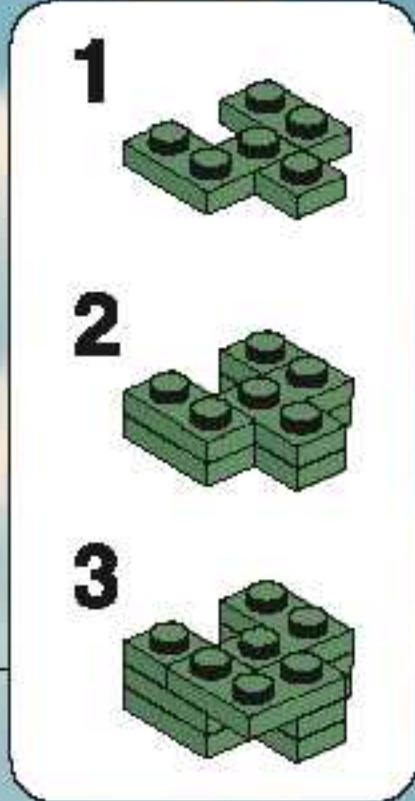
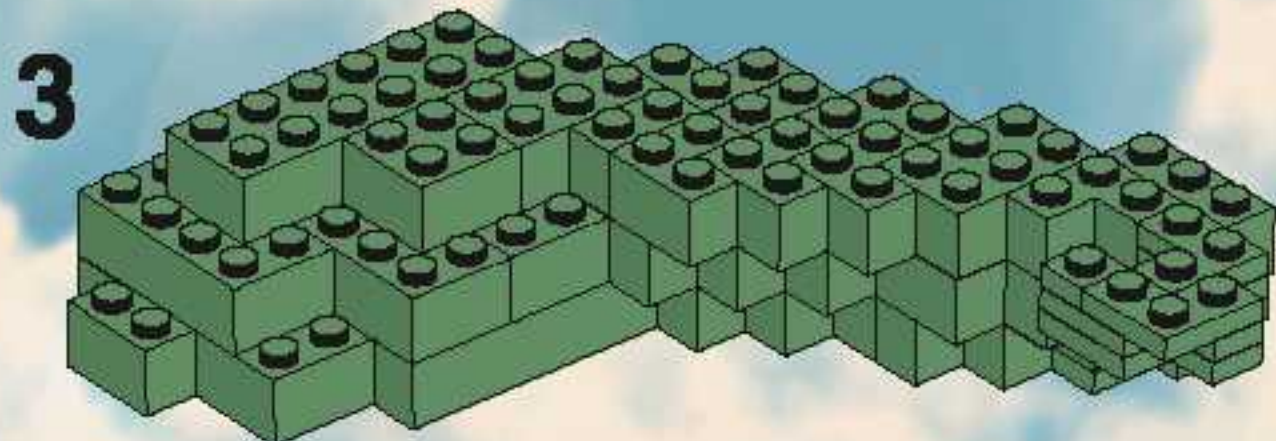
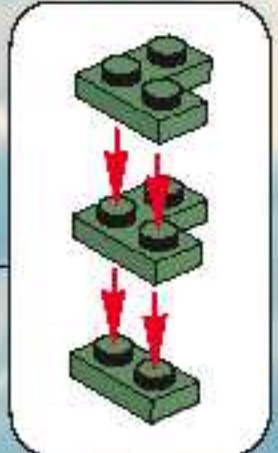
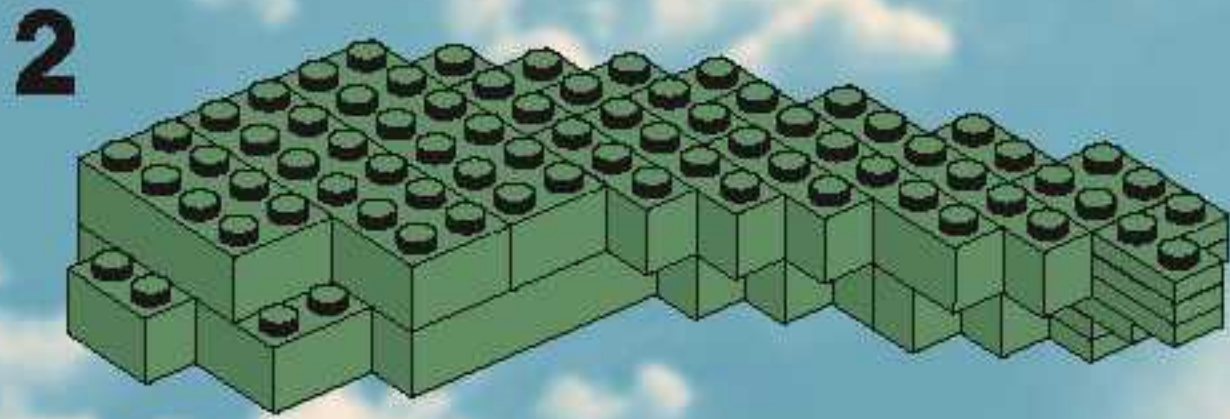
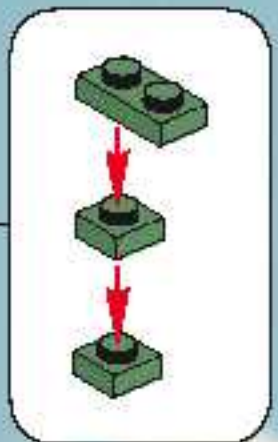
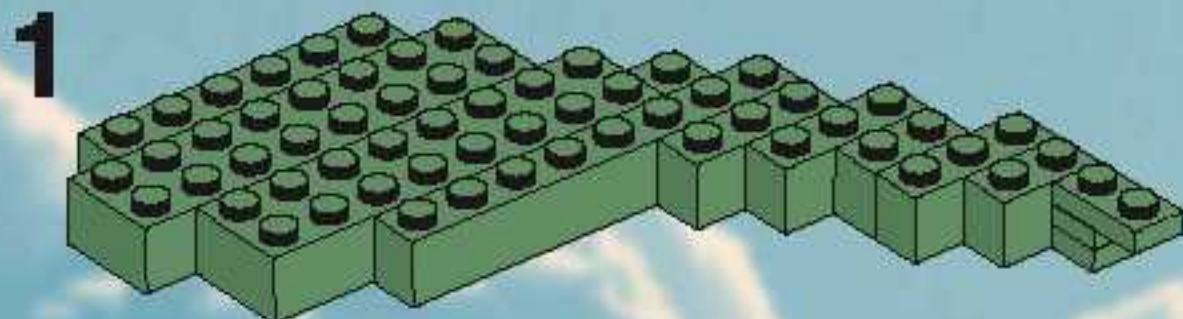

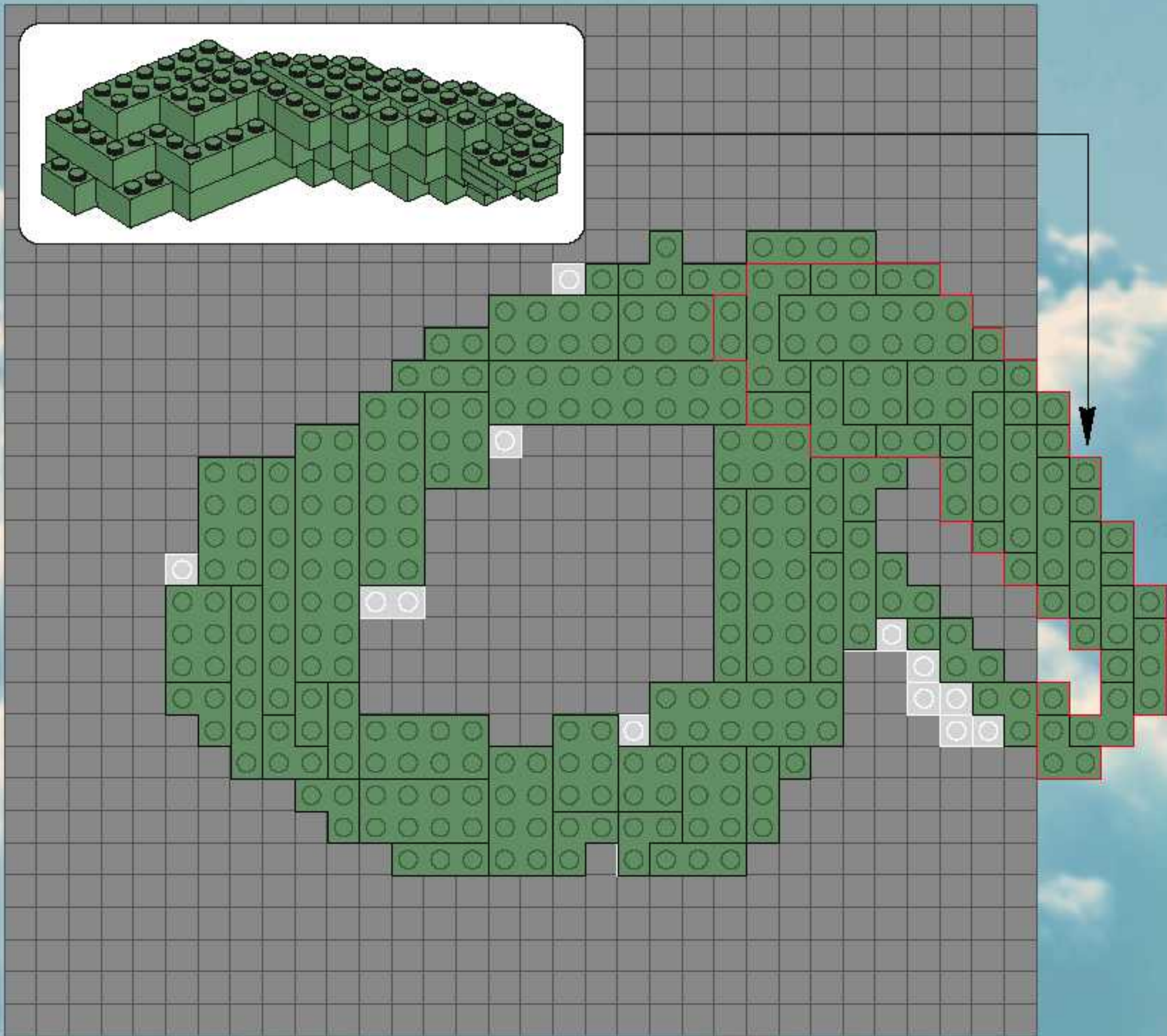
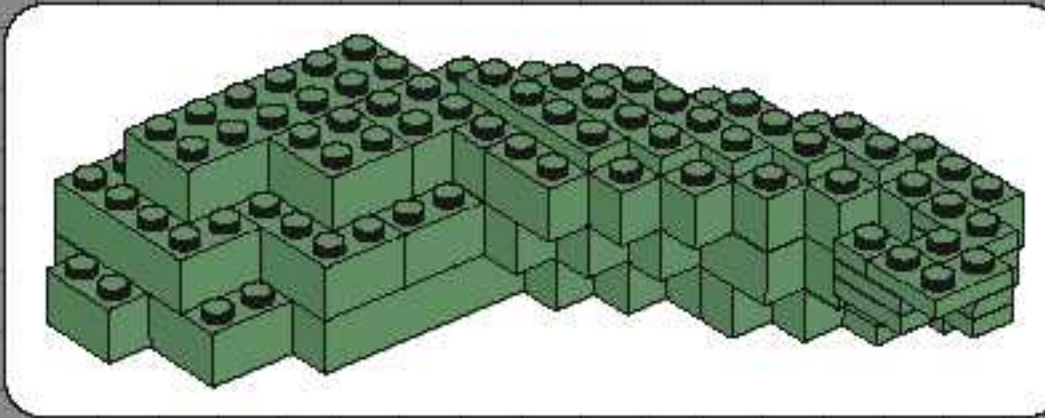
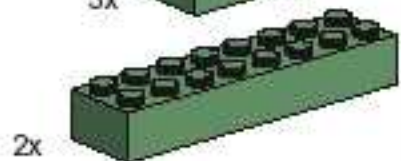
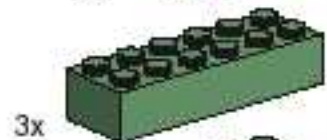
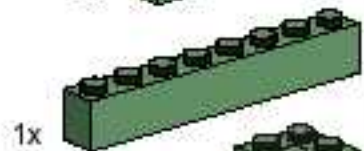
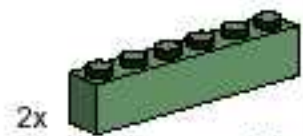
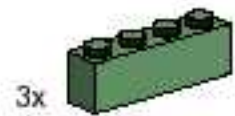

- 8x
- 2x
- 6x
- 6x
- 1x
- 3x
- 1x
- 2x
- 2x
- 2x
- 1x
- 3x
- 2x
- 5x
- 5x
- 1x
- 6x
- 3x



40

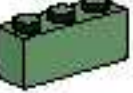
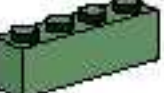

41

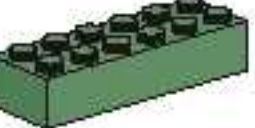
- 9x 
- 2x 
- 5x 
- 4x 
- 2x 
- 2x 
- 8x 
- 11x 
- 2x 



42

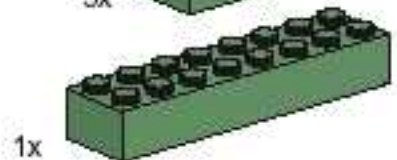
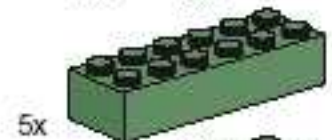
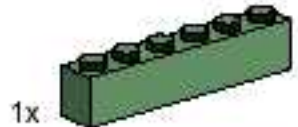

43

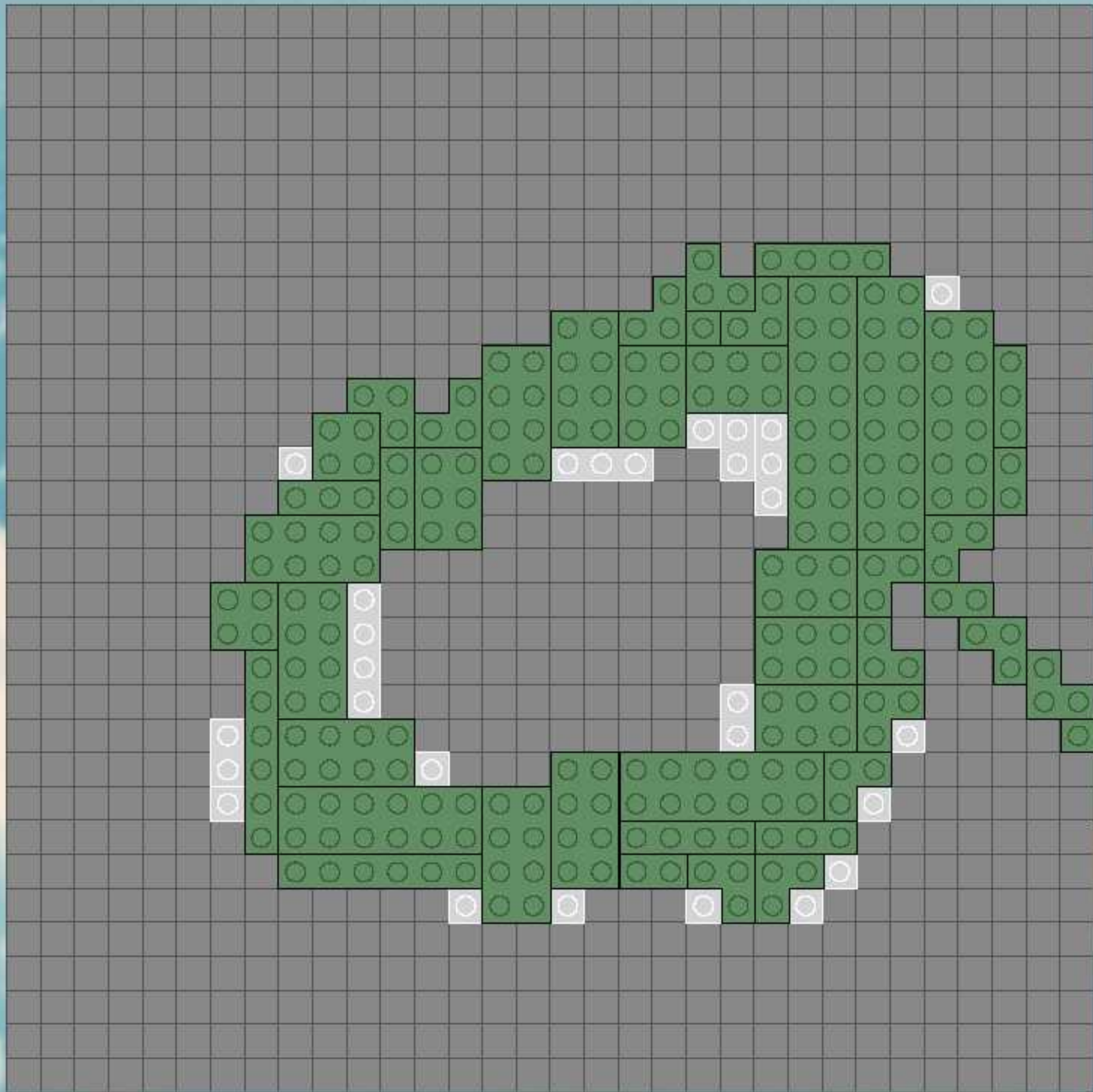
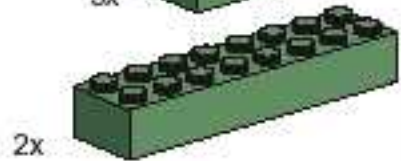
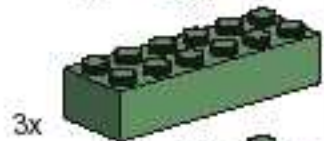
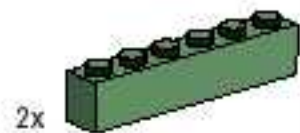

44



1



2

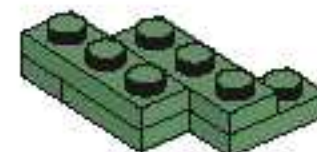

3

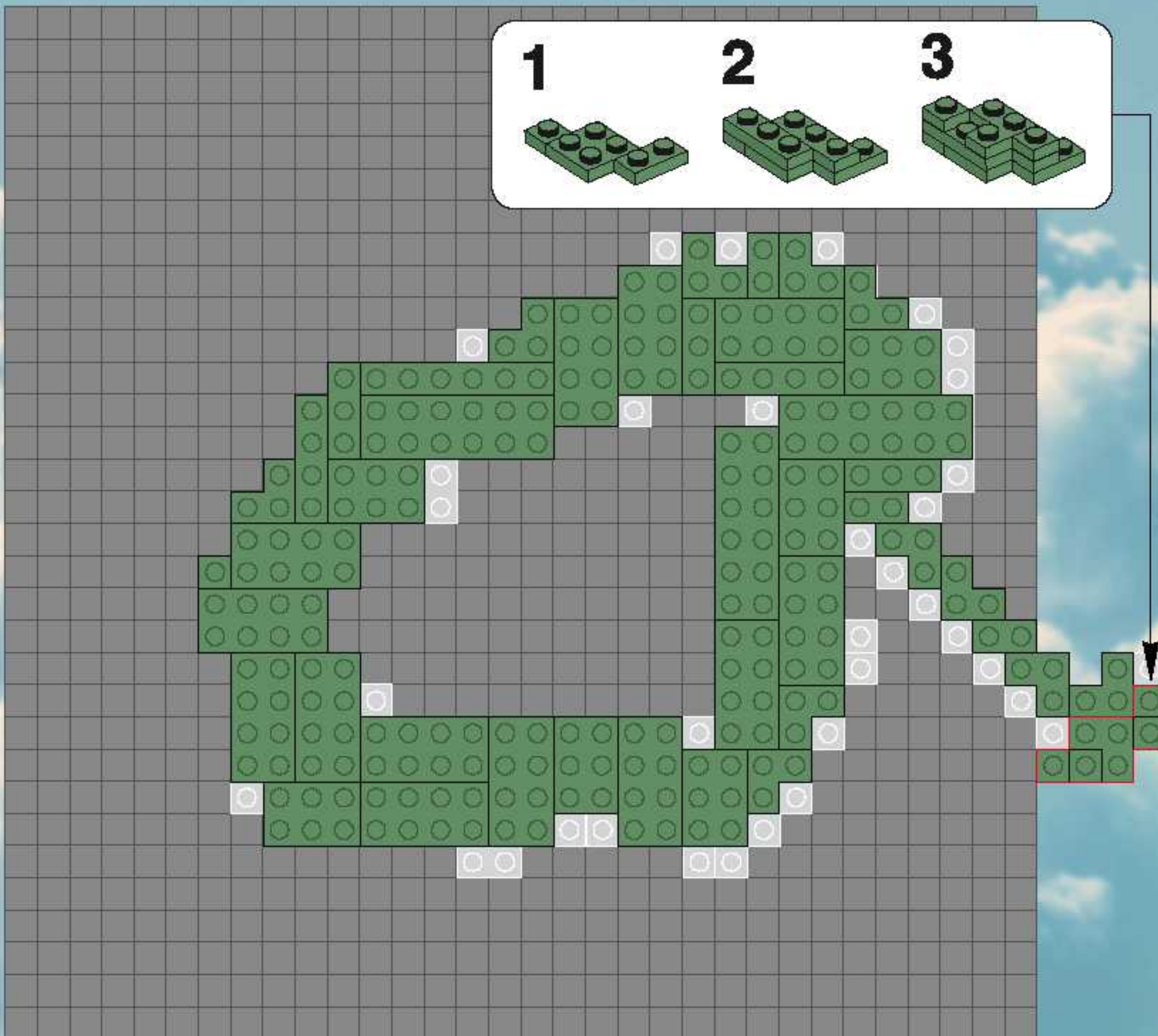

45

- 11x
- 3x
- 9x
- 5x
- 2x
- 1x
- 7x
- 8x
- 3x

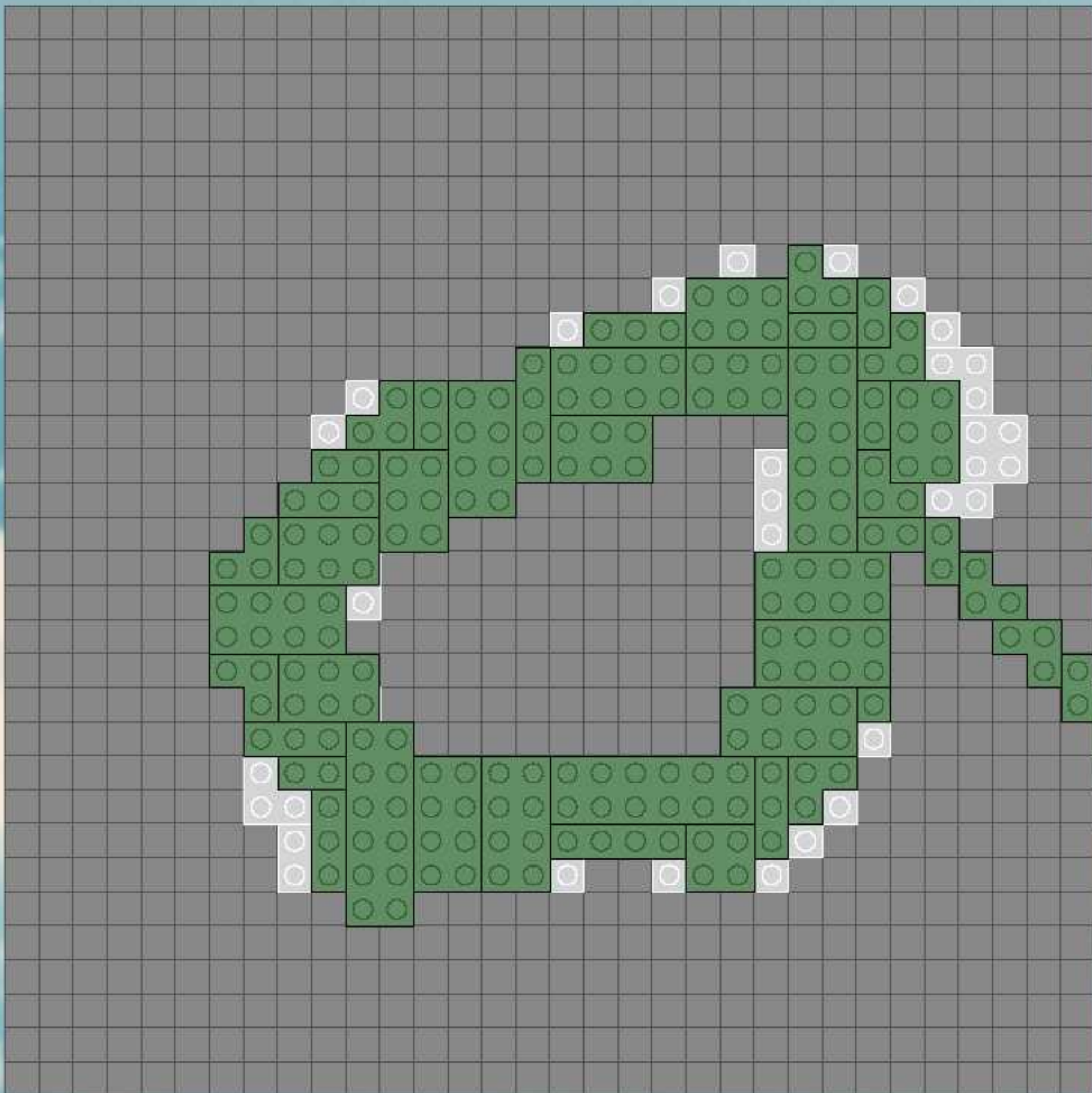

46

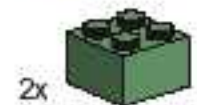
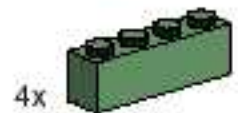
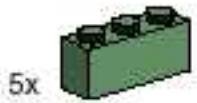

1

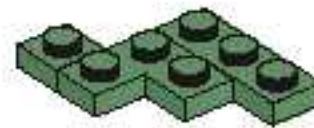

2



3

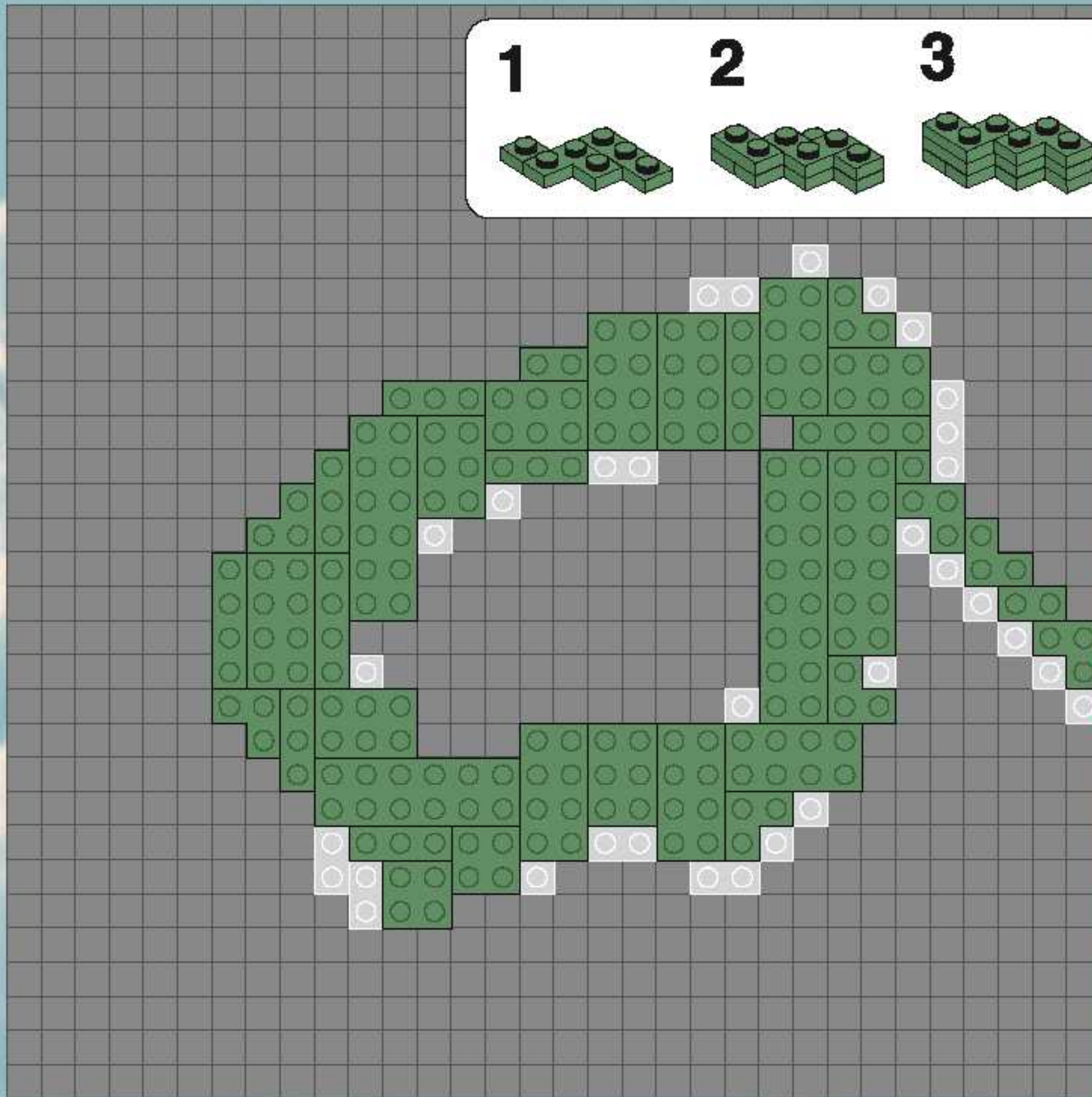
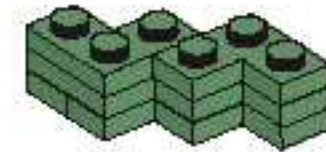

47

- 9x
- 3x
- 3x
- 3x
- 2x
- 2x
- 3x
- 7x
- 5x

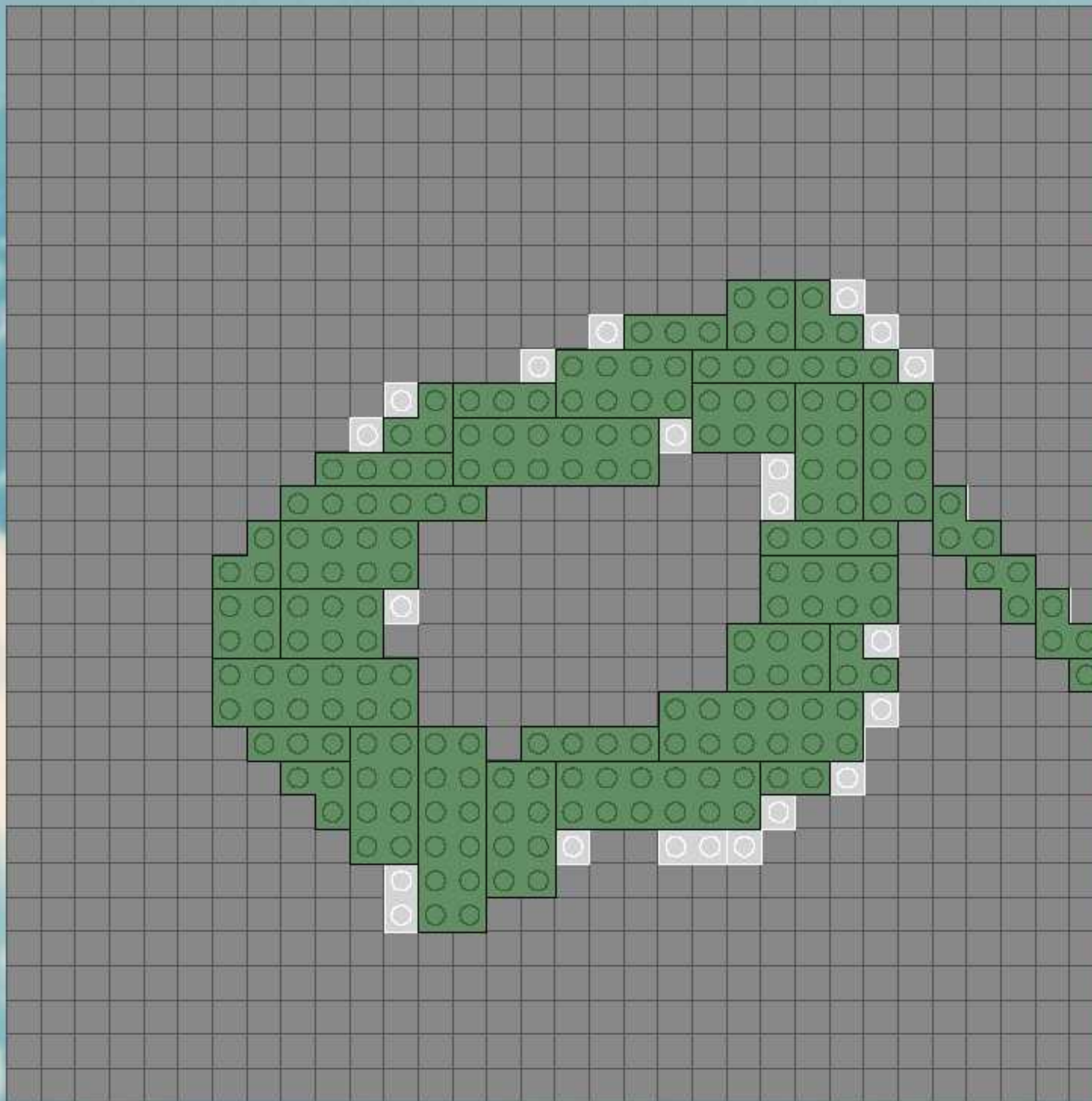

48

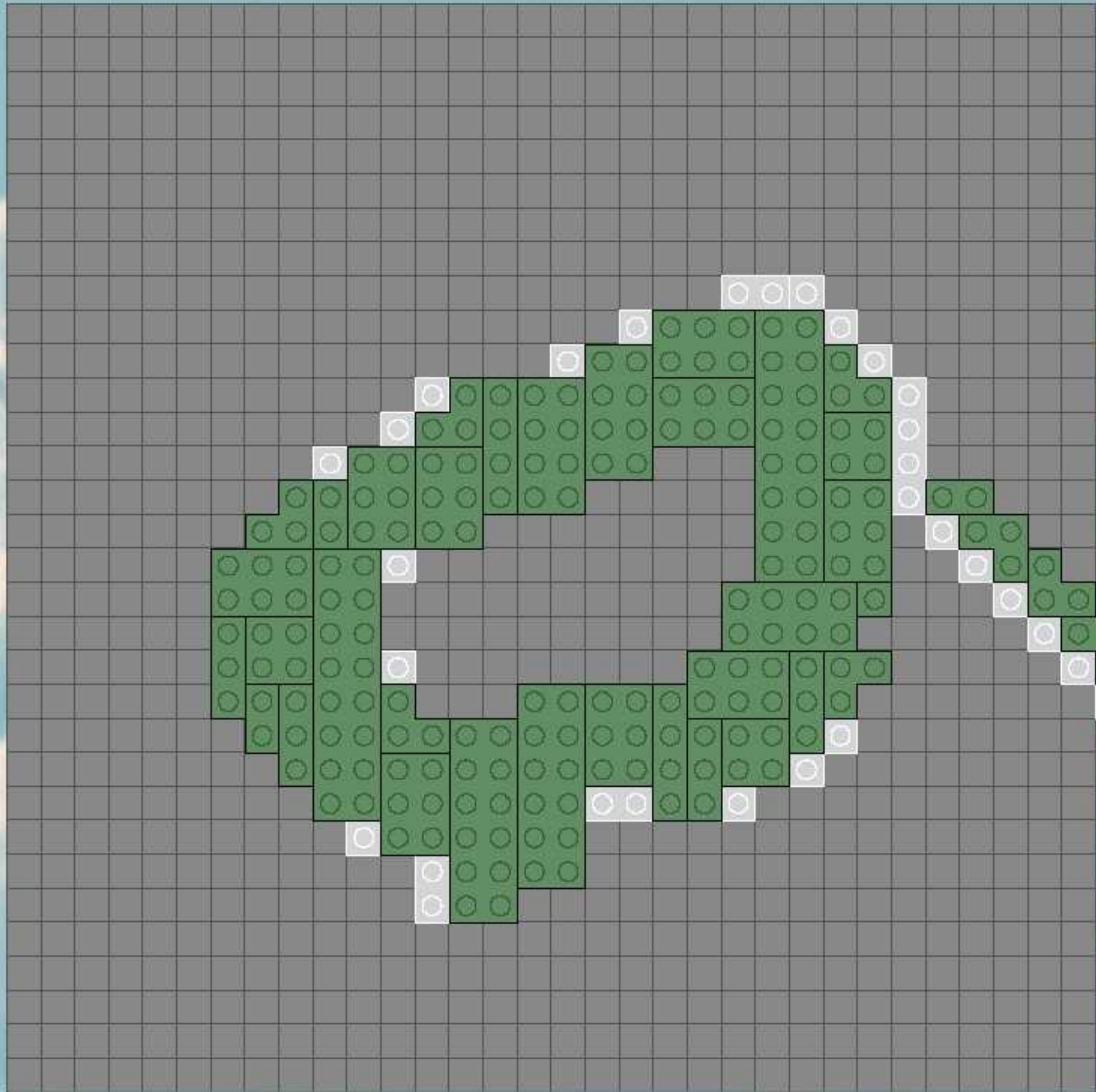
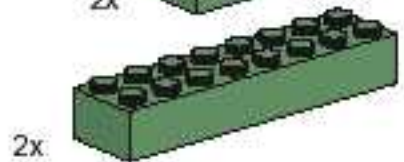

49

- 11x
- 1x
- 3x
- 5x
- 2x
- 1x
- 1x
- 2x
- 3x
- 6x
- 2x

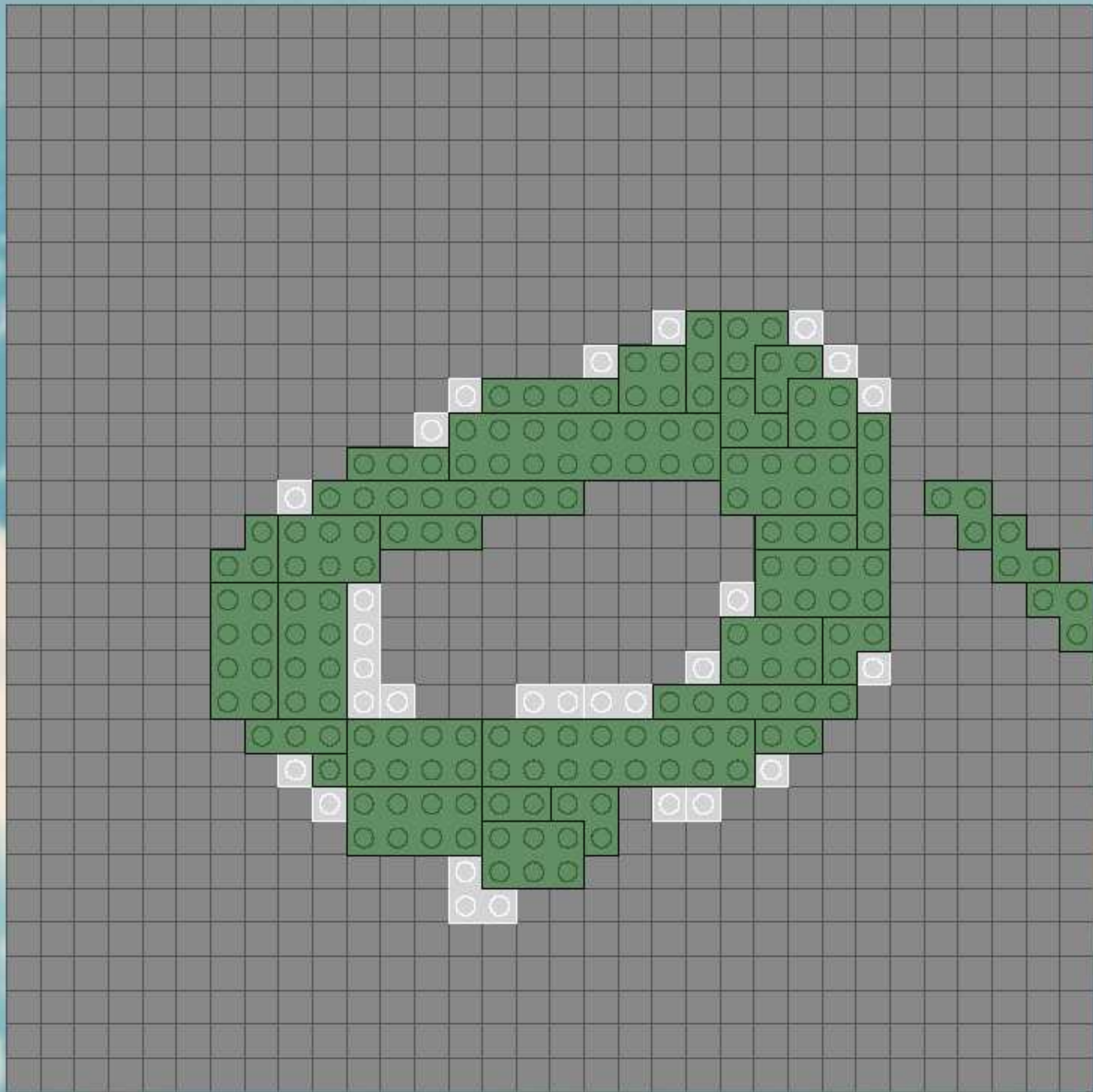

50

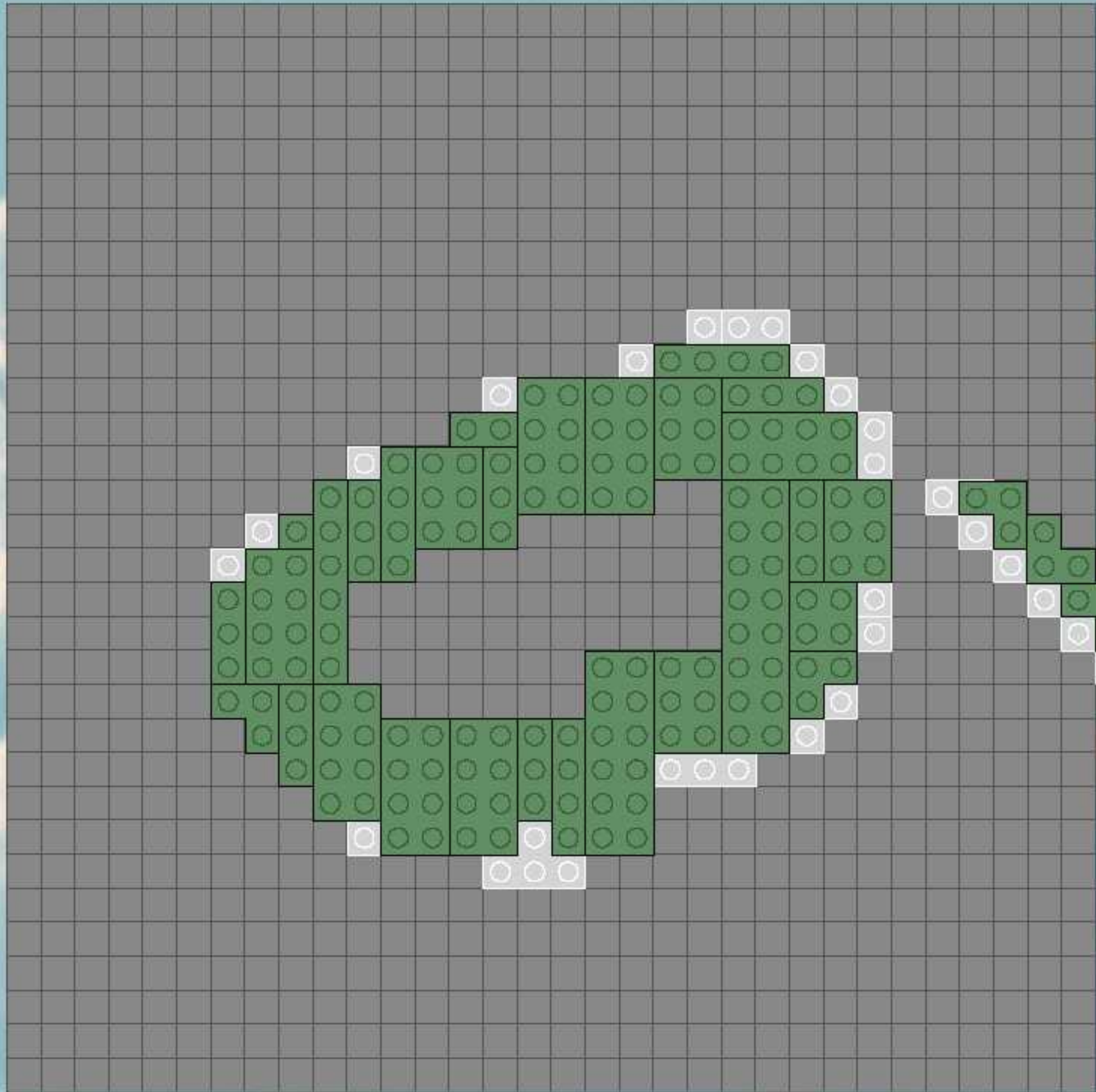
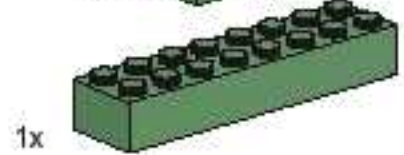
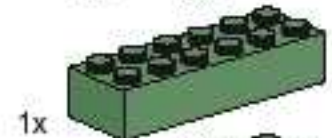
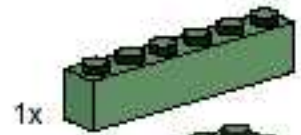
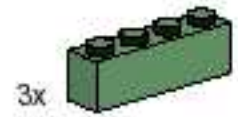

51

- 5x
- 1x
- 3x
- 4x
- 2x
- 1x
- 1x
- 5x
- 5x

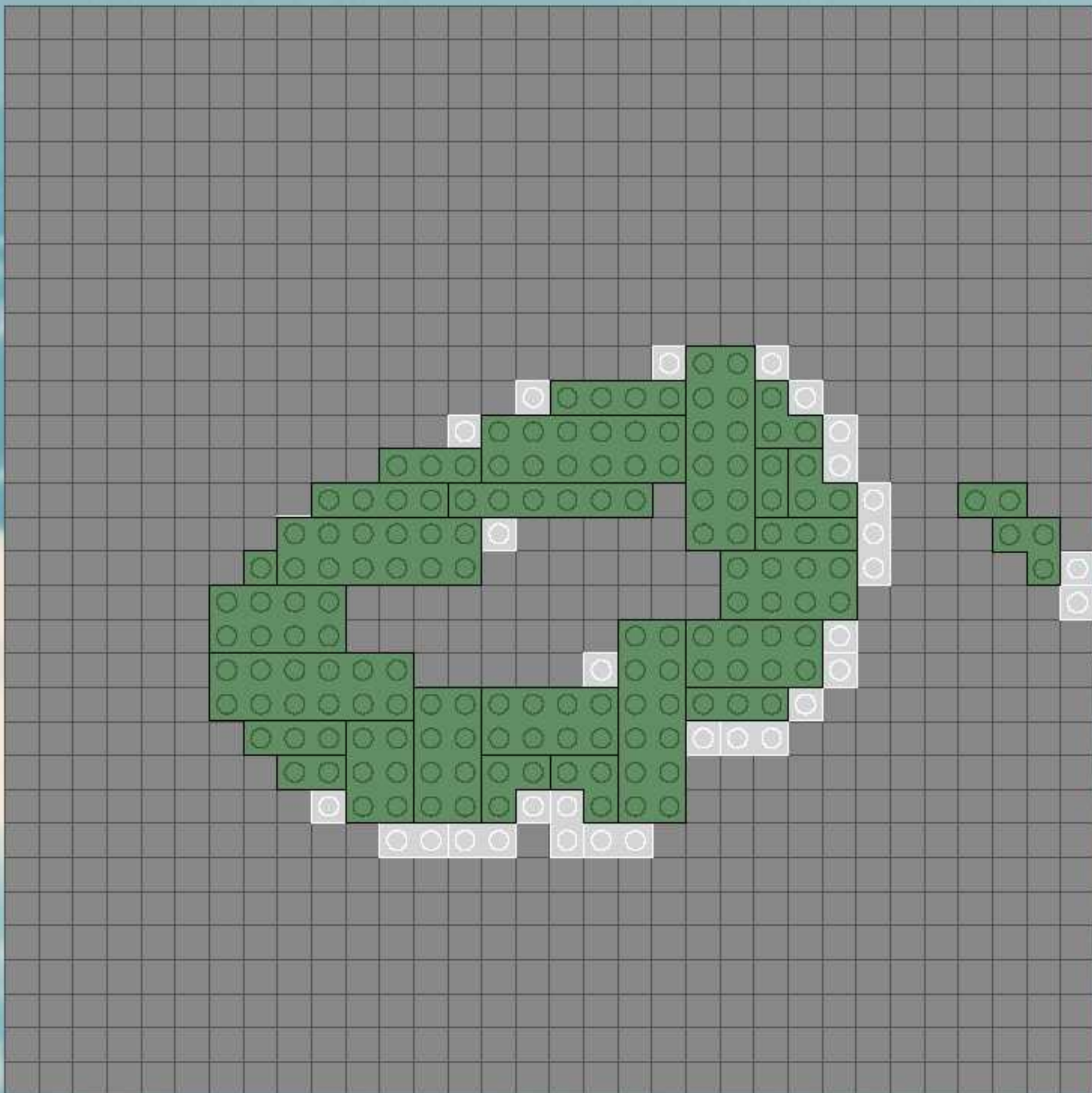

52

- 3x
- 1x
- 1x
- 1x
- 1x
- 8x
- 5x
- 2x

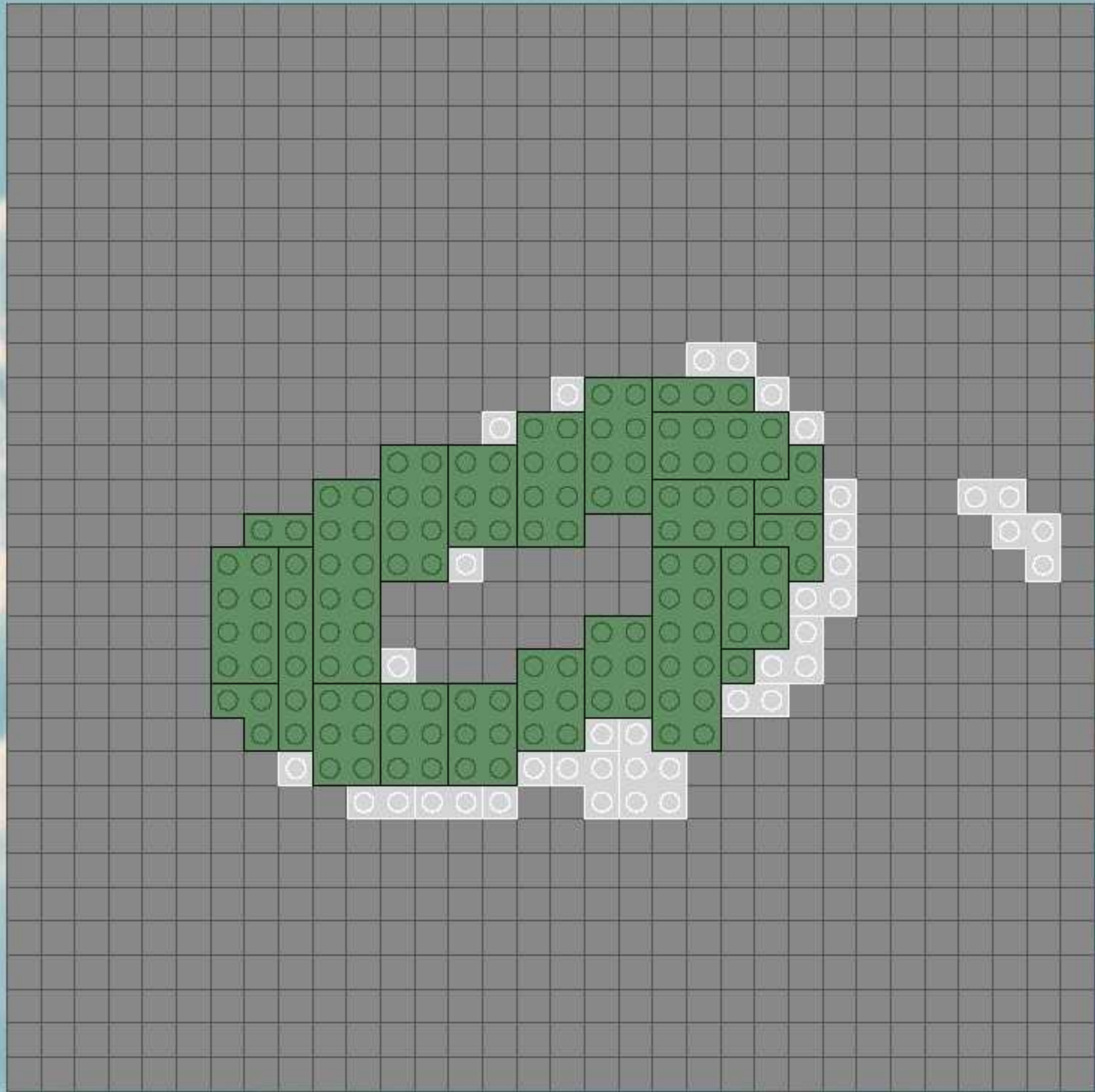

53

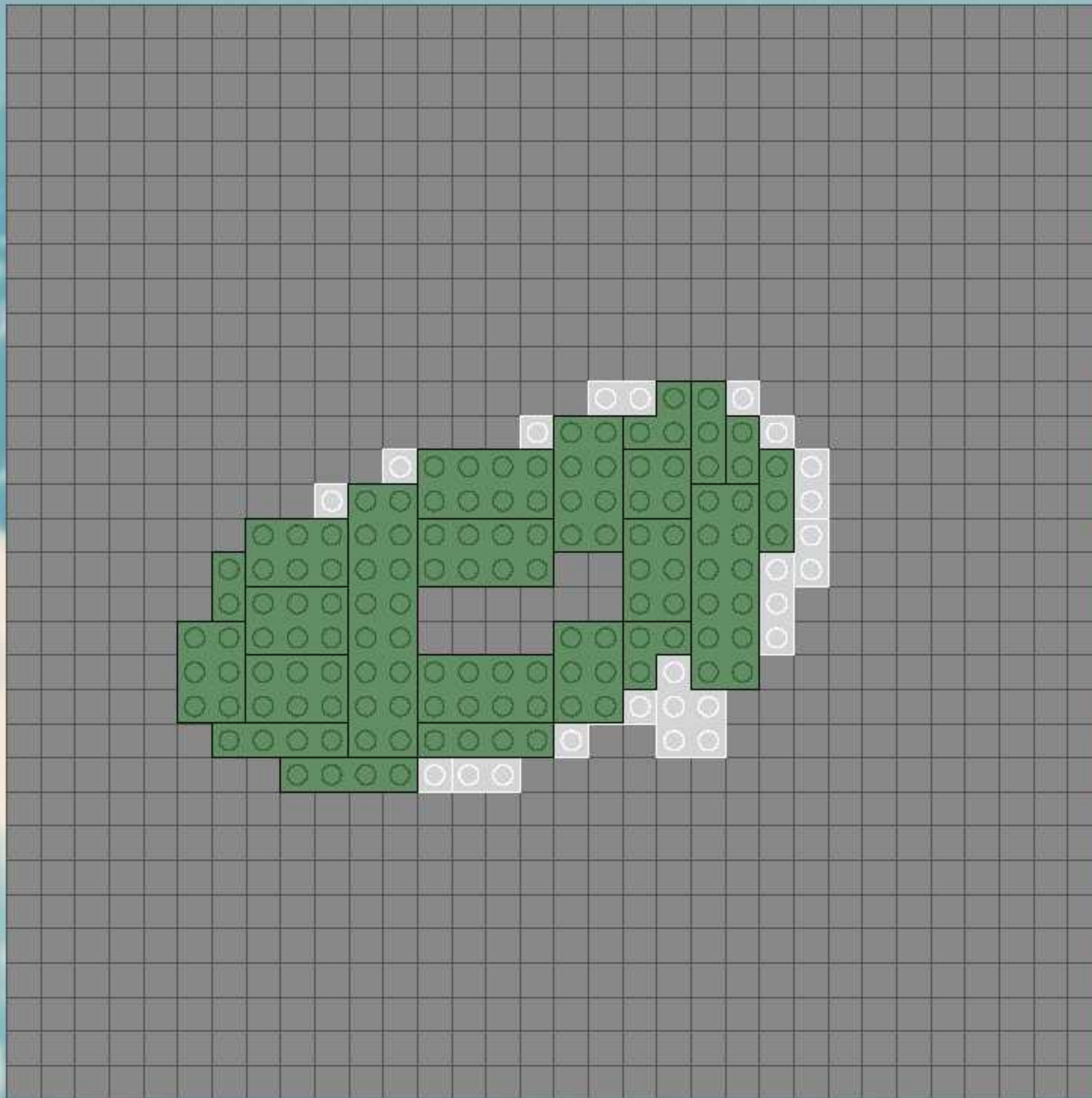

54

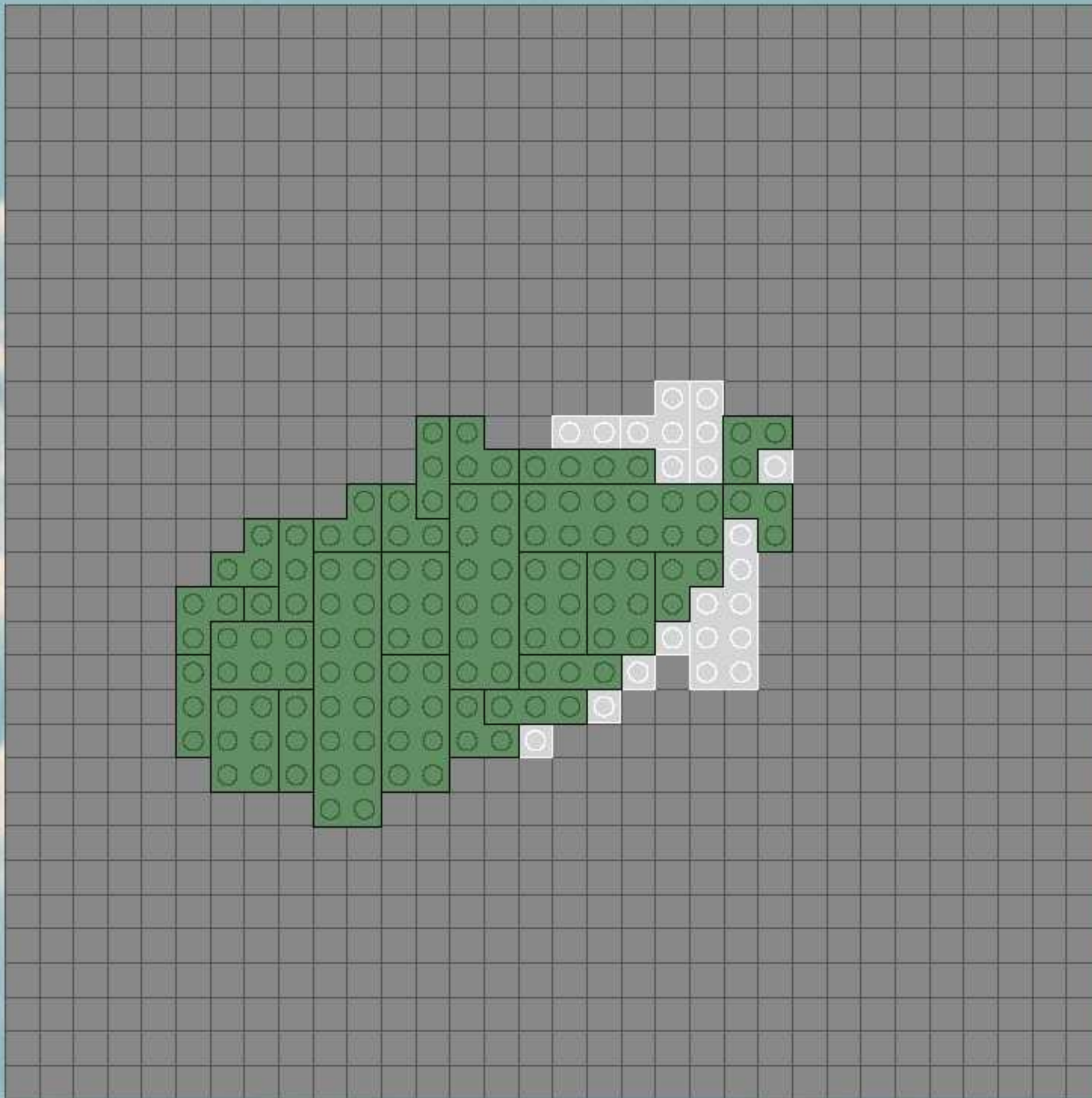
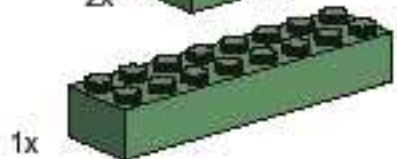
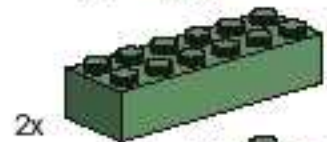

55

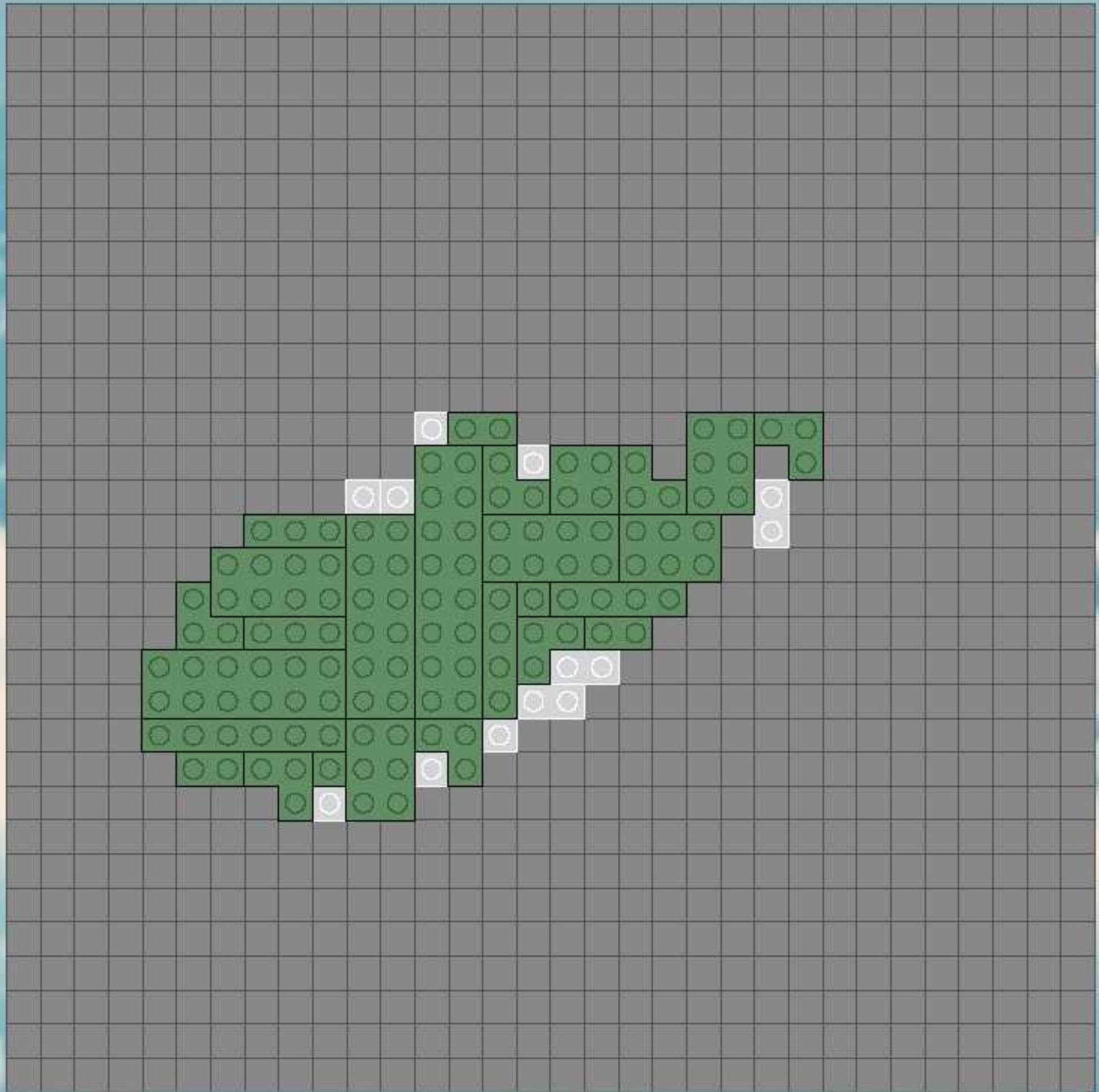
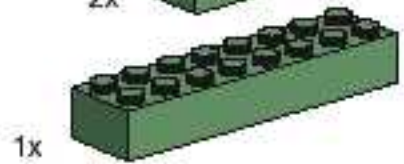
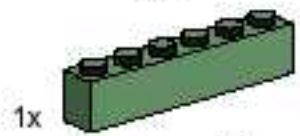
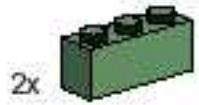

56

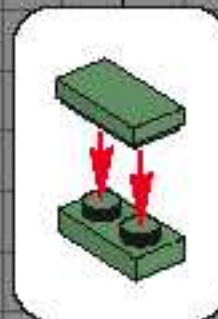
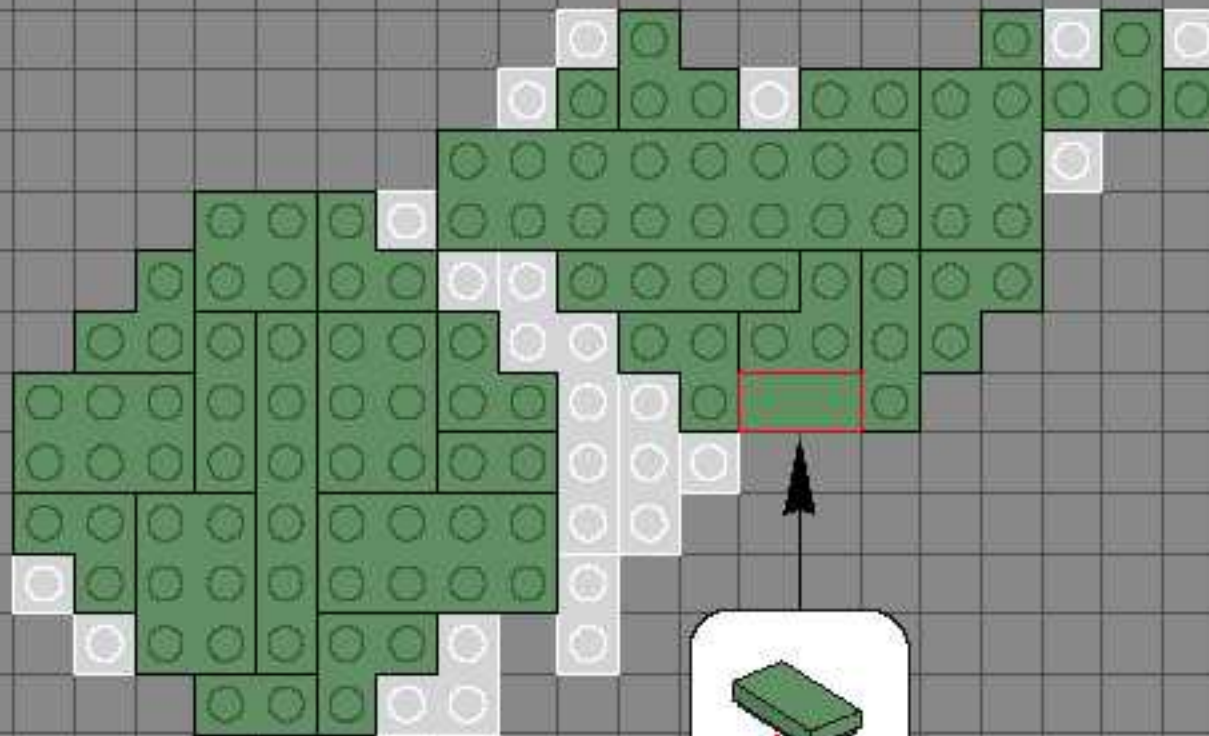
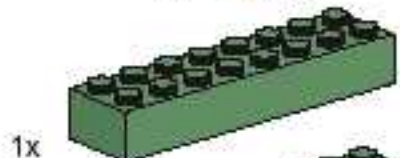
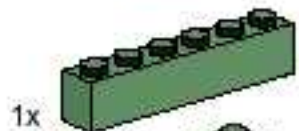
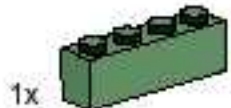





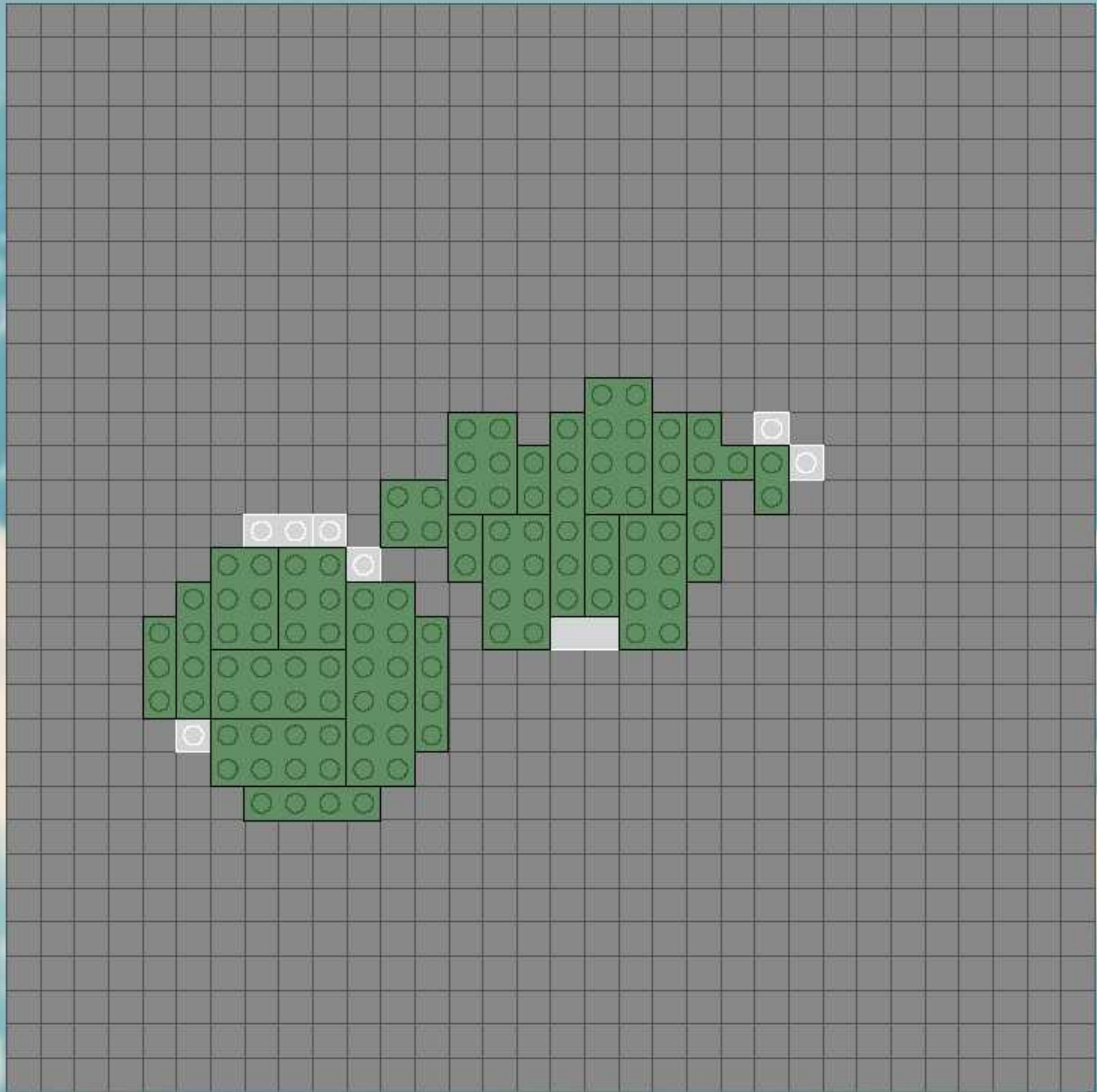

57

- 1x
- 3x
- 4x
- 3x
- 1x
- 1x
- 1x
- 3x
- 5x
- 1x



58

- 1x 
- 2x 
- 4x 
- 4x 
- 1x 
- 1x 
- 2x 

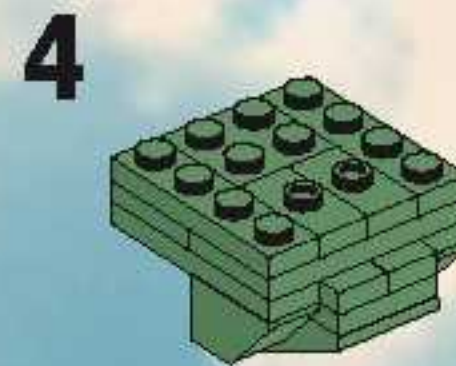
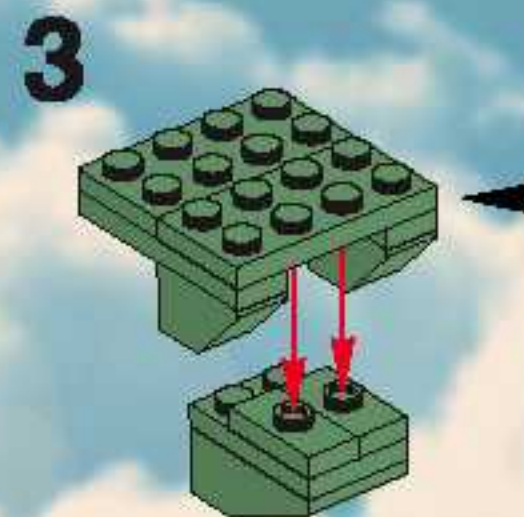
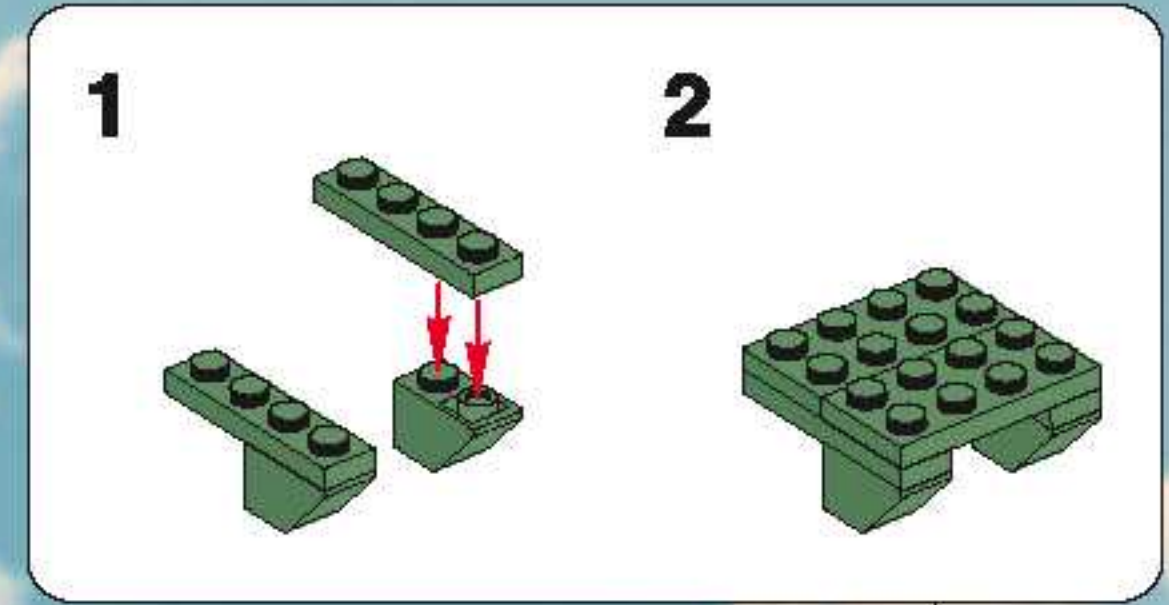
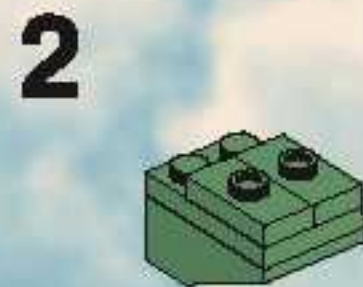
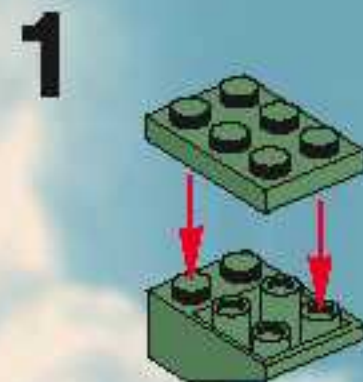

58

- 5x
- 3x
- 4x
- 2x
- 2x
- 5x
- 2x
- 1x

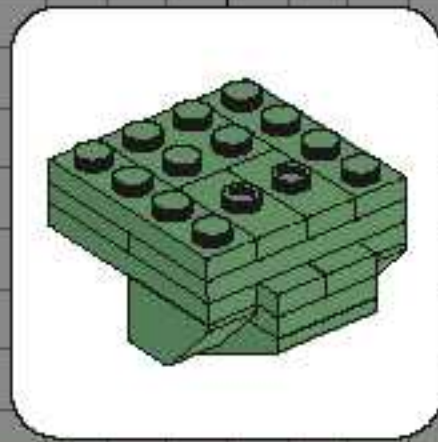
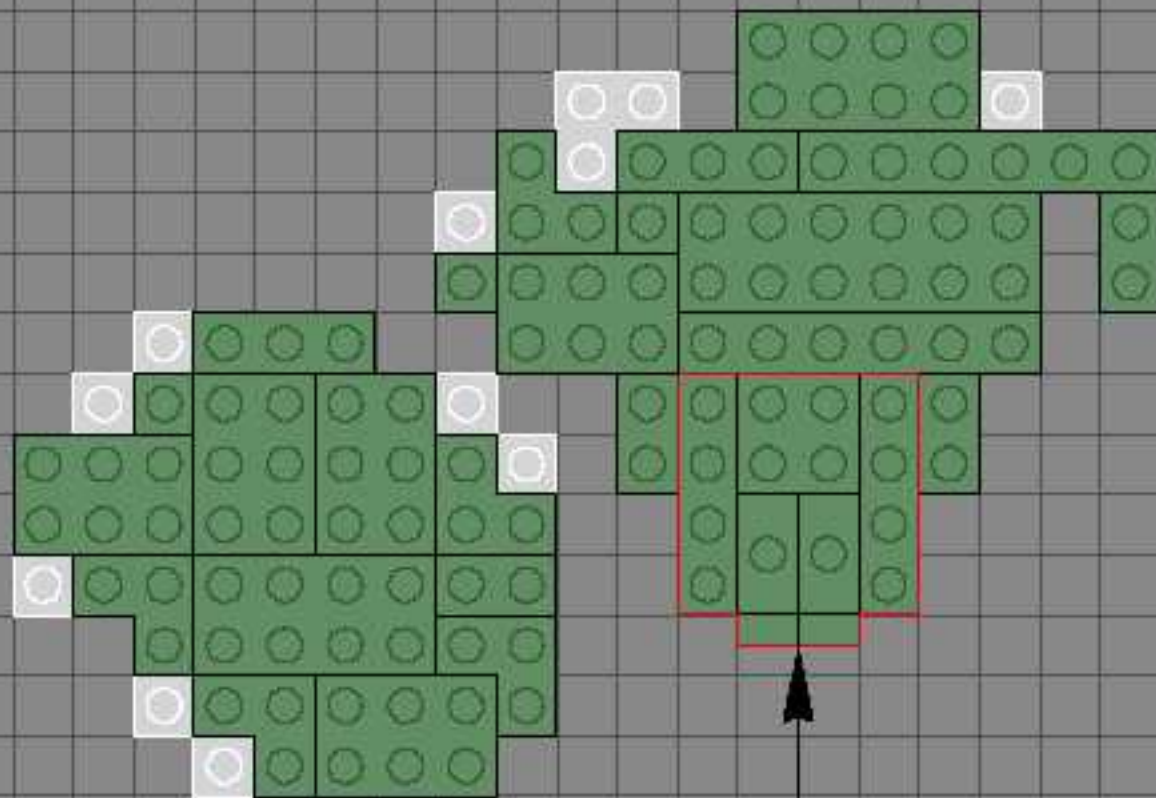

59

- 2x
- 2x
- 6x
- 4x
- 3x
- 2x
- 4x
- 4x
- 2x
- 6x

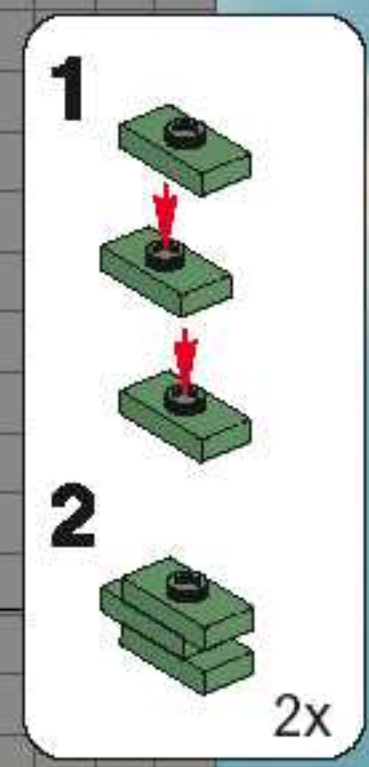
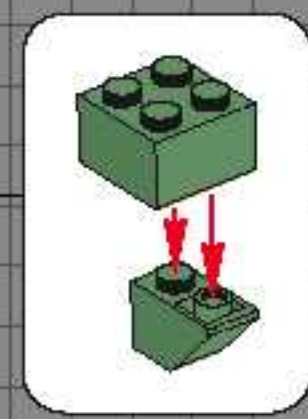
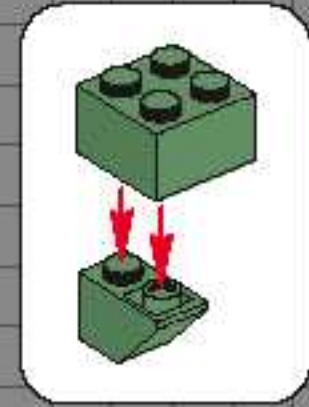
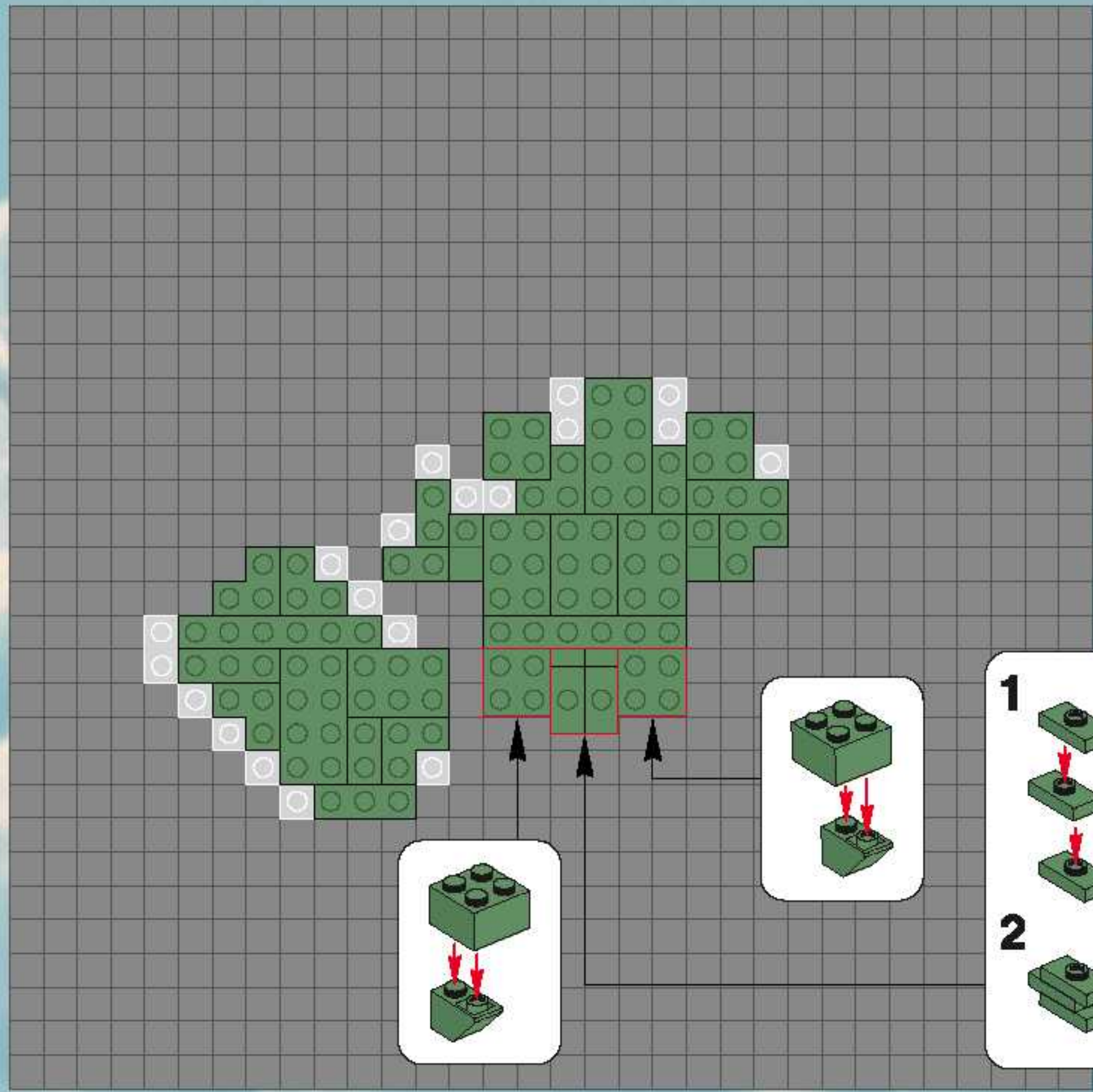

60

- 1x
- 1x
- 3x
- 1x
- 3x
- 1x
- 1x
- 3x
- 5x
- 1x
- 2x
- 2x
- 1x
- 1x
- 2x

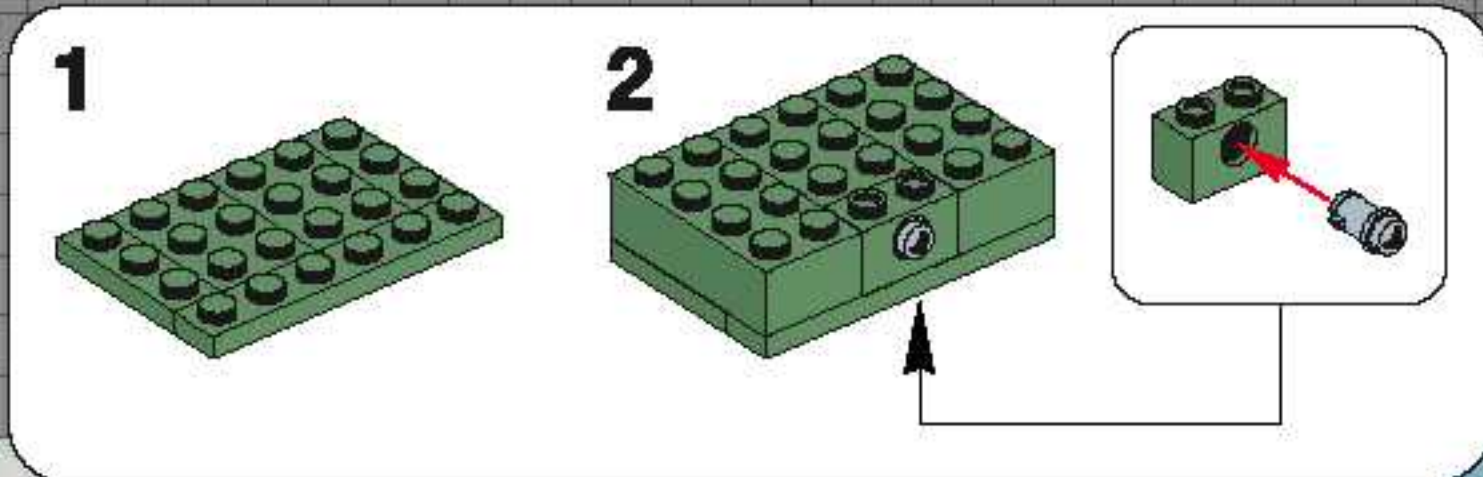
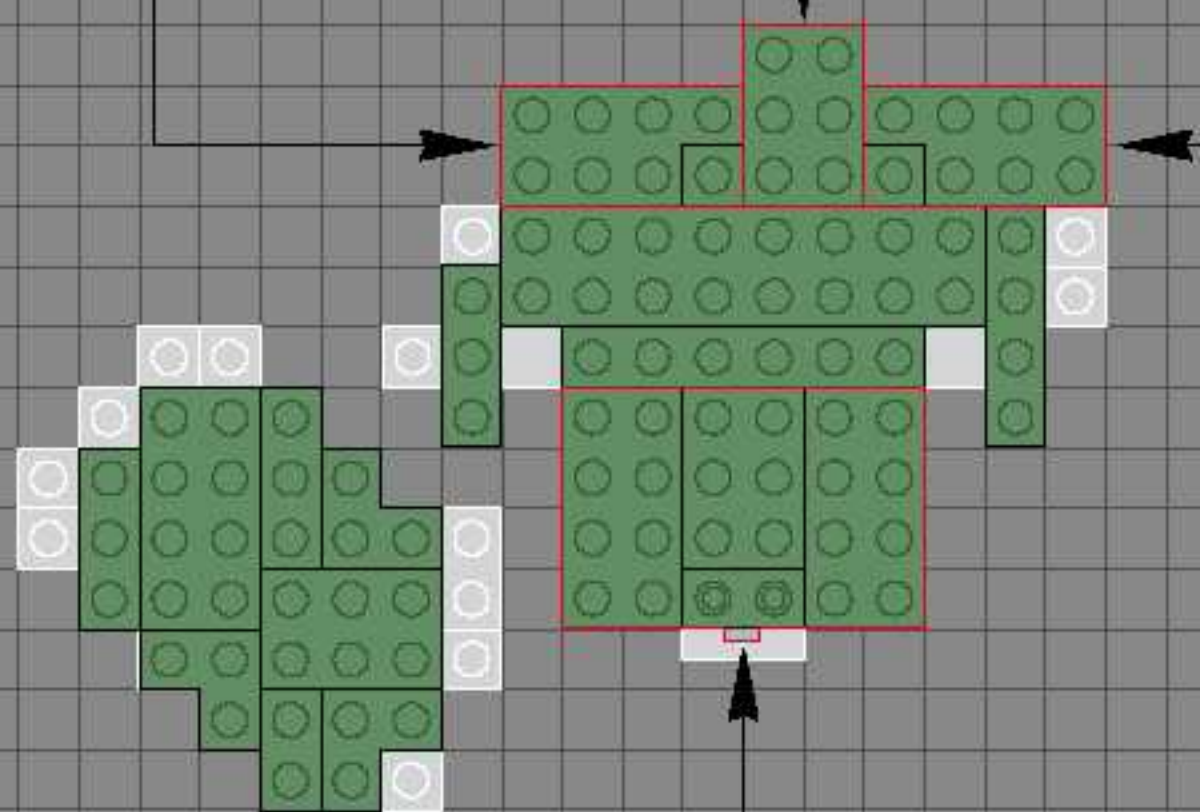
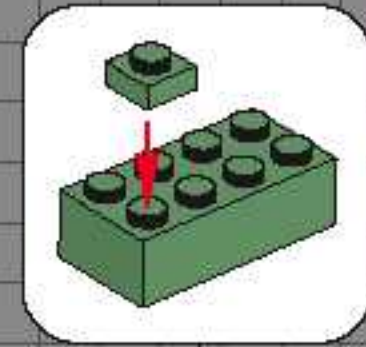
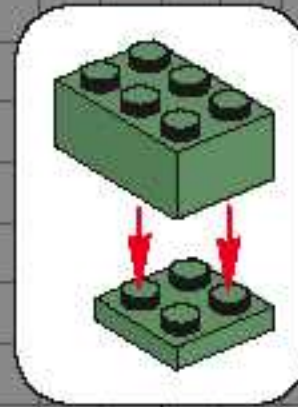
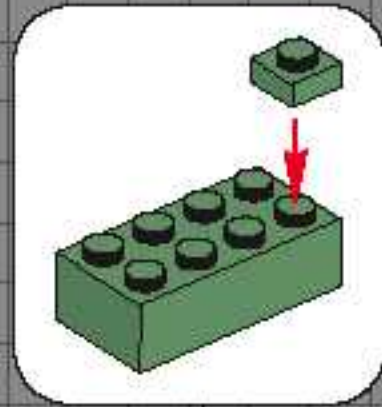

61

- 1x
- 2x
- 5x
- 1x
- 2x
- 1x
- 4x
- 2x
- 8x
- 2x
- 2x
- 1x
- 2x
- 1x
- 1x
- 1x

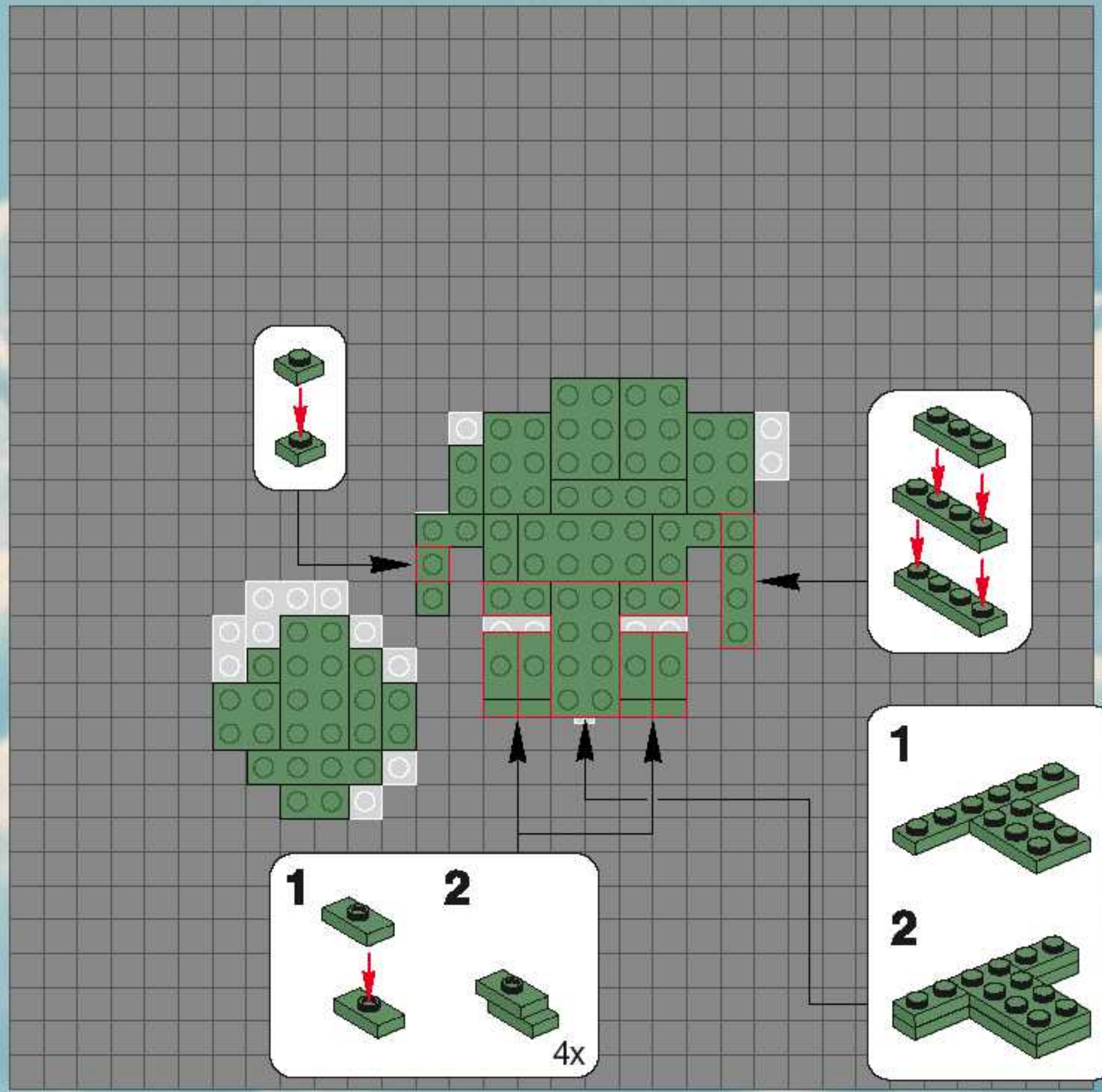

62

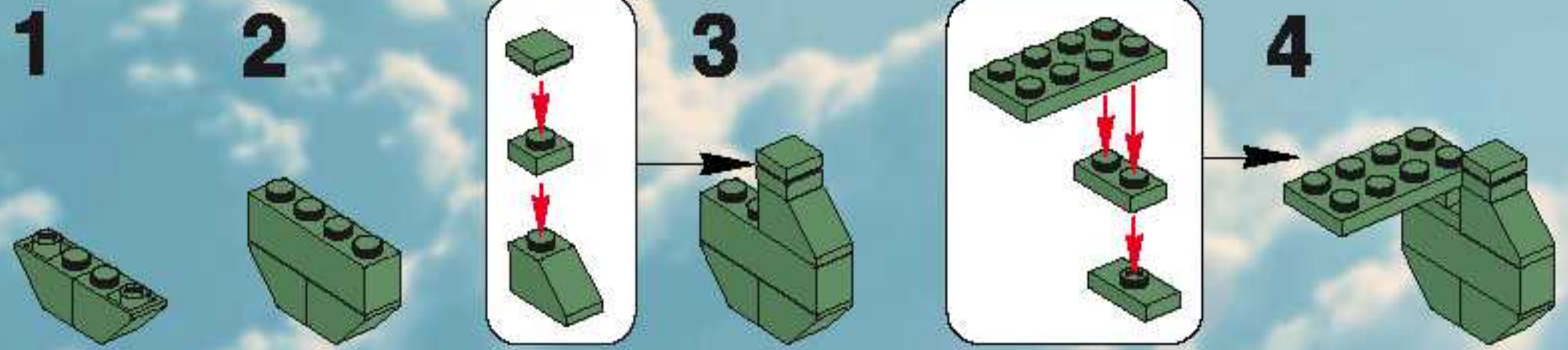

- 2x
- 4x
- 2x
- 2x
- 2x
- 2x
- 2x
- 2x

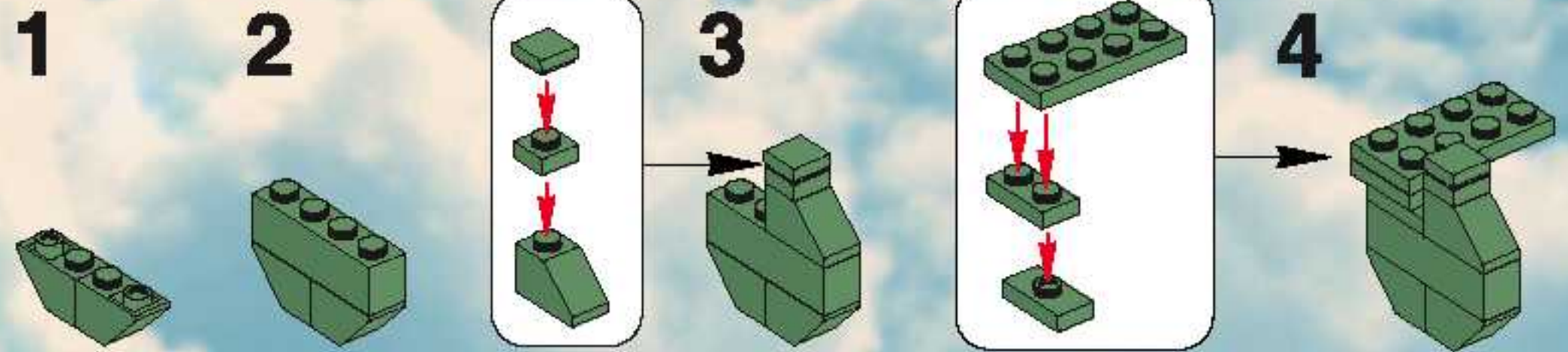





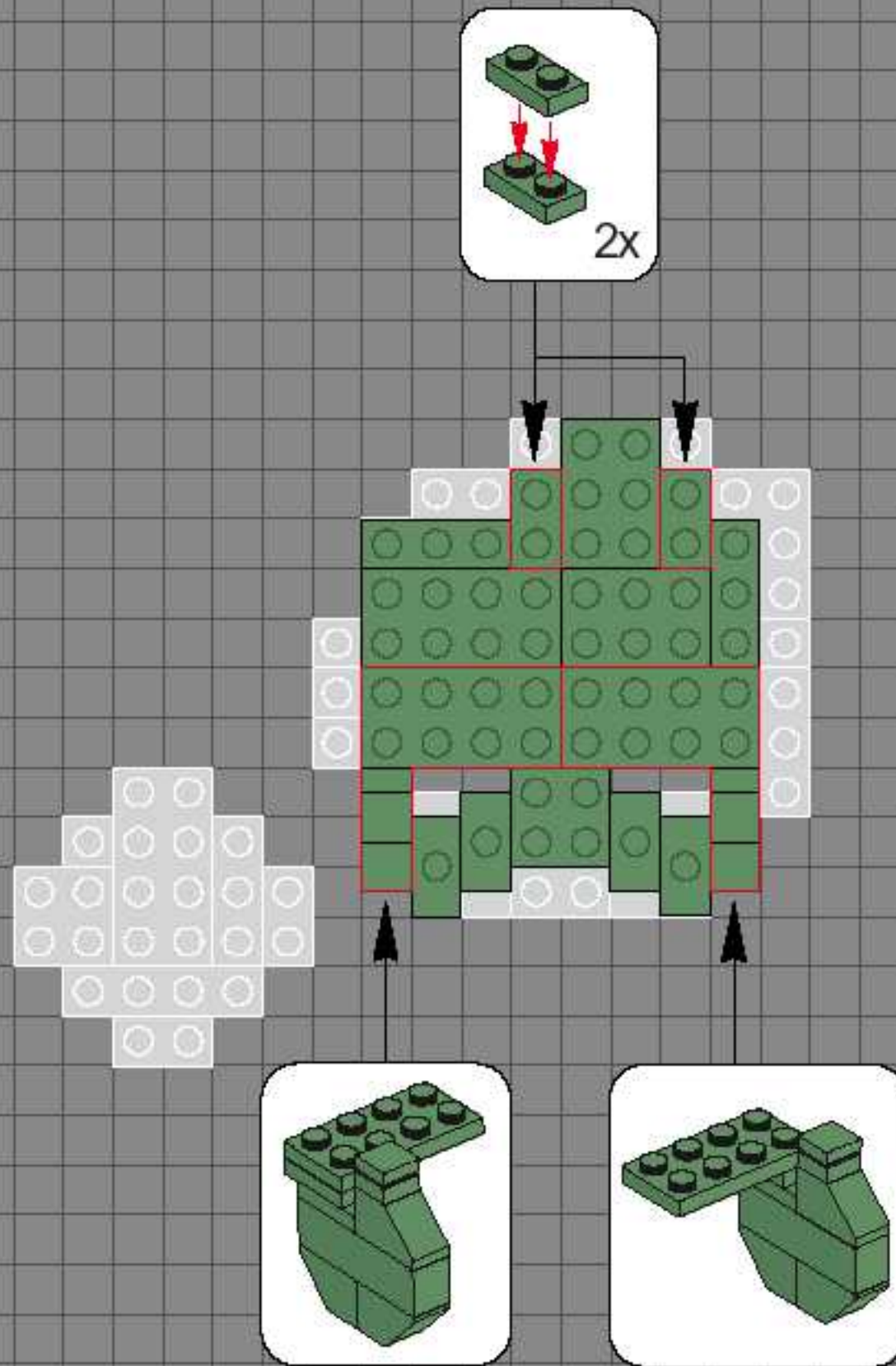





62

- 2x
- 2x
- 1x
- 4x
- 4x
- 1x







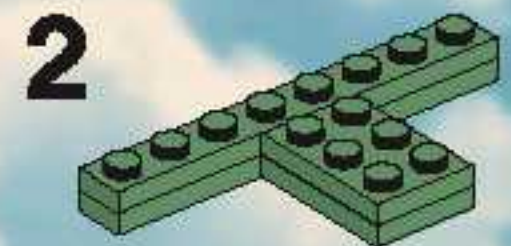
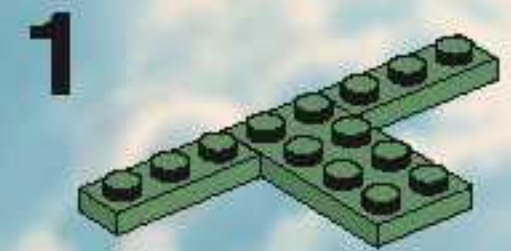
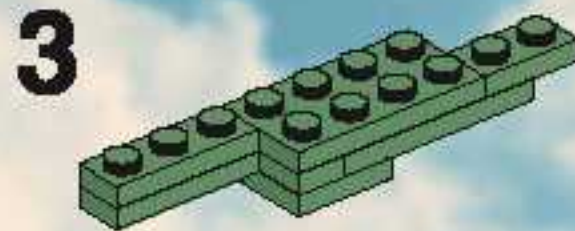
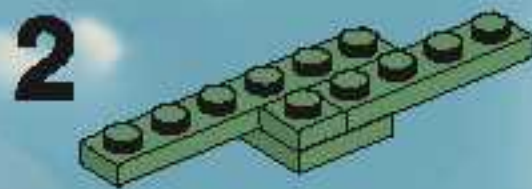
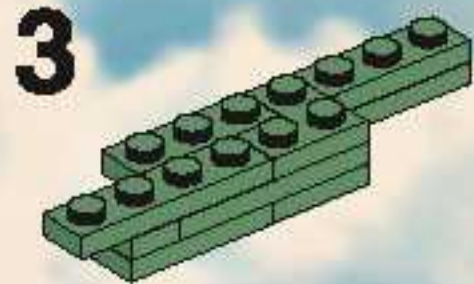
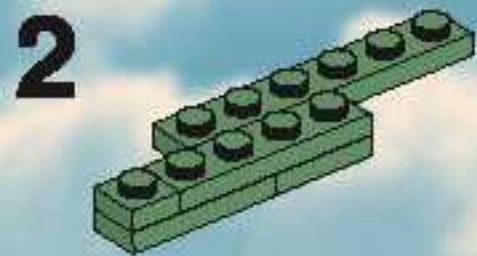
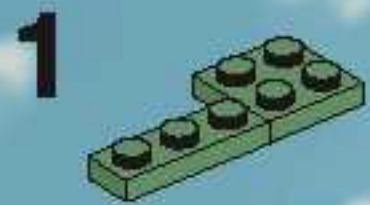



63

- 1x 
- 2x 
- 1x 
- 6x 
- 3x 
- 2x 
- 1x 
- 2x 
- 1x 
- 2x 







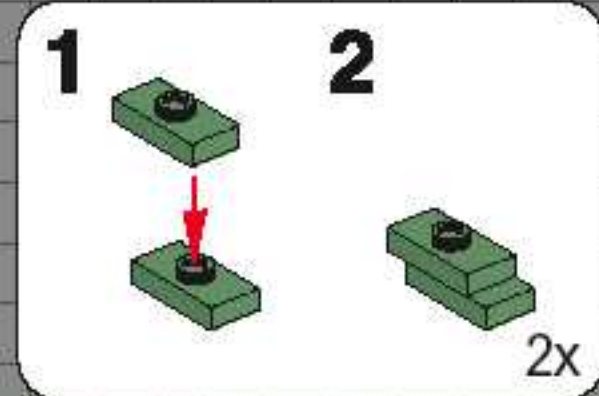
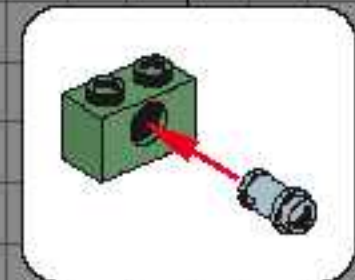
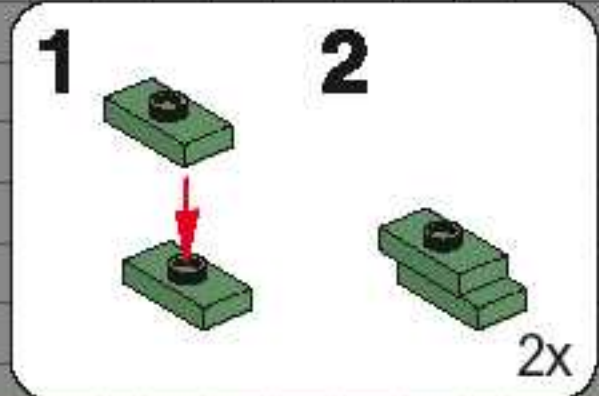
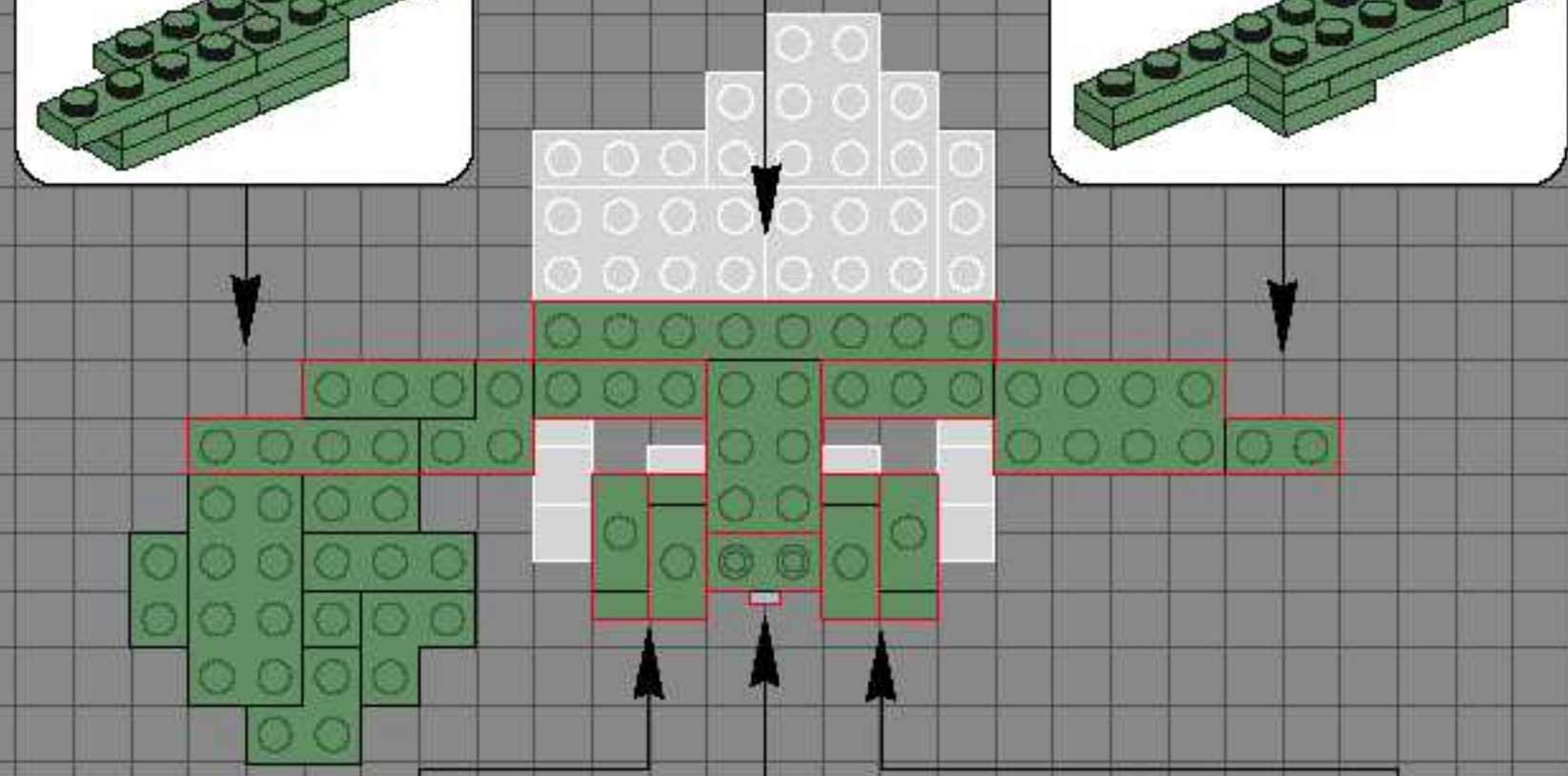
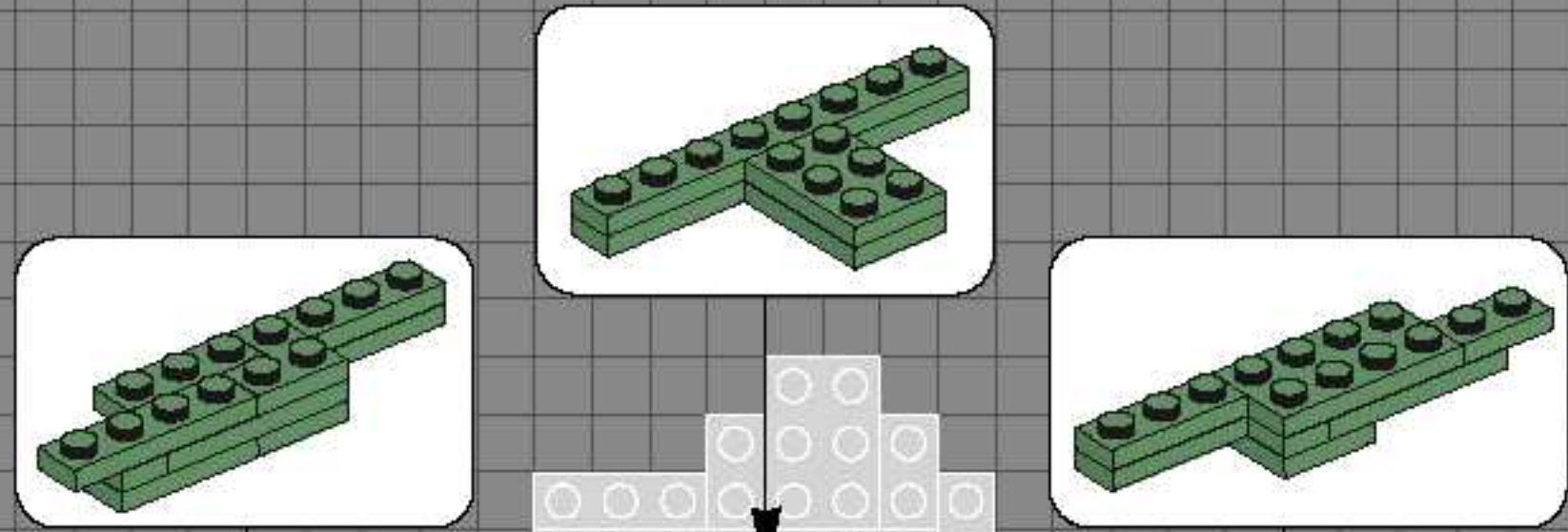

63

- 1x 
- 8x 
- 2x 
- 1x 
- 2x 
- 1x 
- 1x 
- 1x 



64



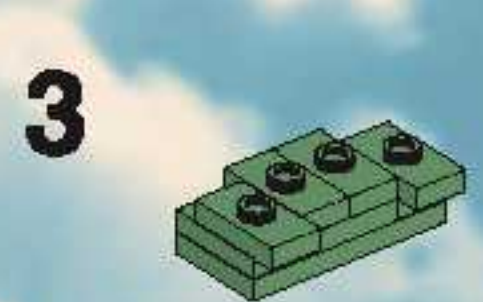
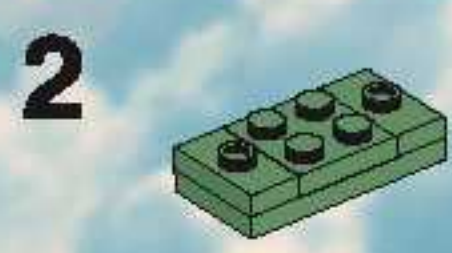
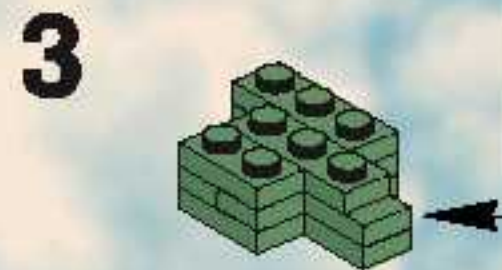
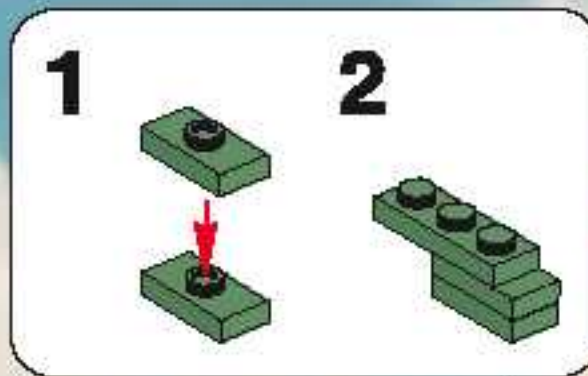
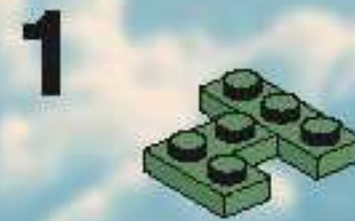
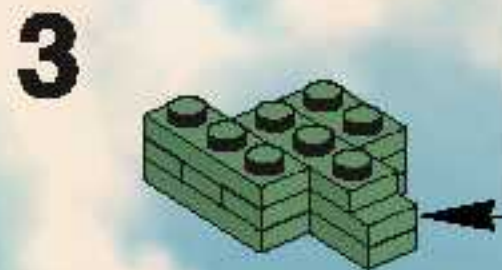
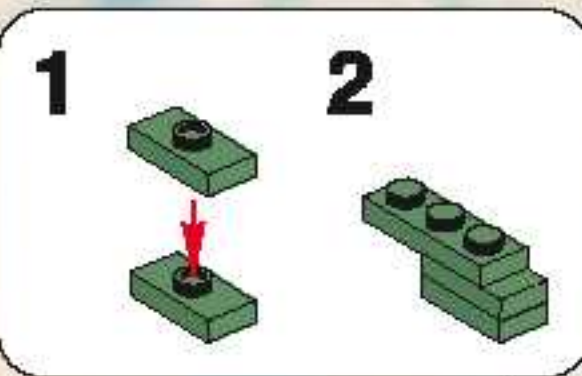
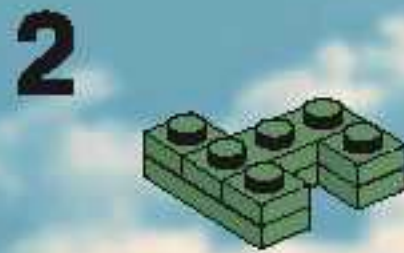
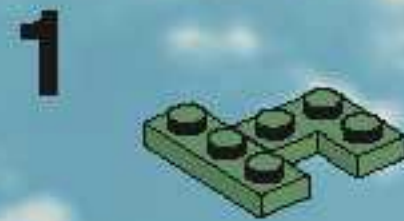



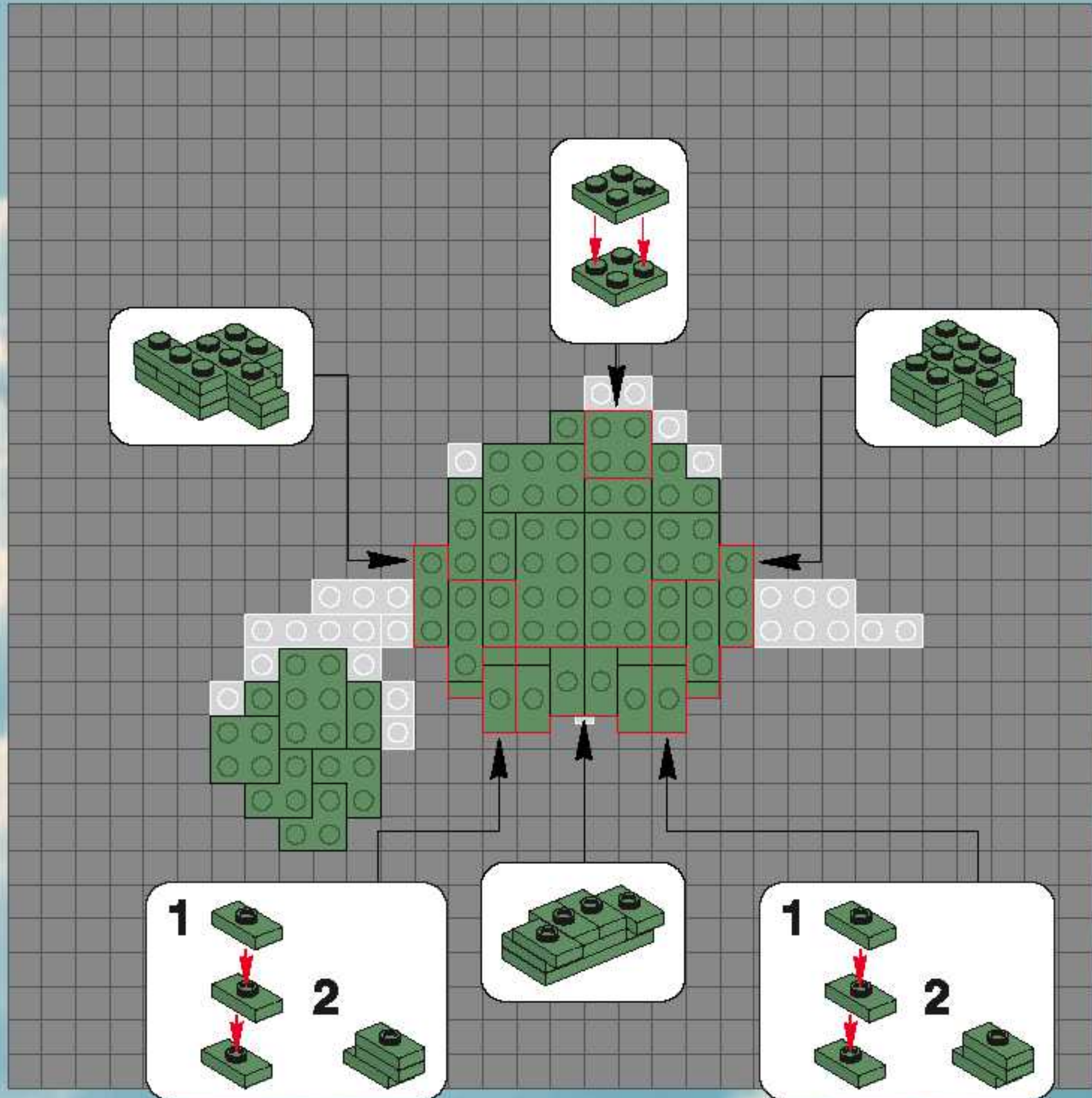

- 10x 
- 2x 
- 6x 
- 2x 
- 8x 
- 1x 
- 1x 



- 6x
- 2x
- 4x
- 2x
- 3x
- 1x
- 2x
- 2x
- 2x





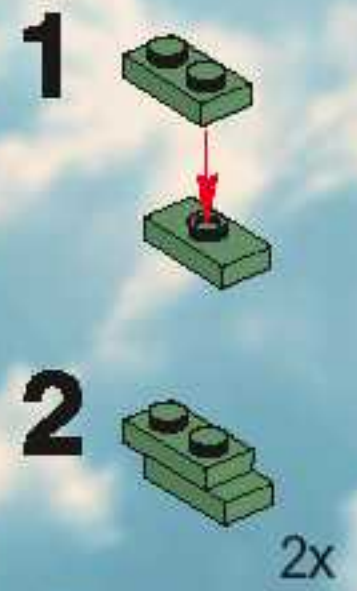
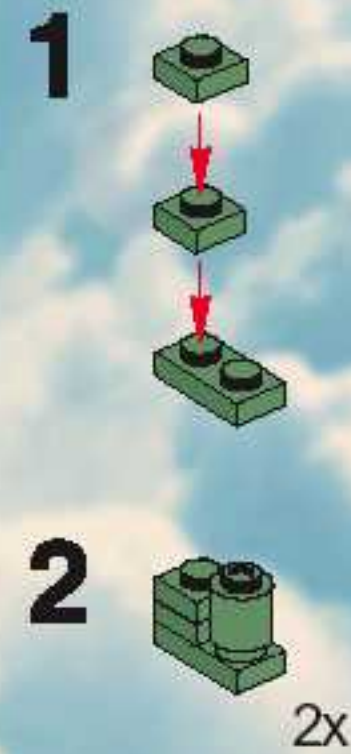
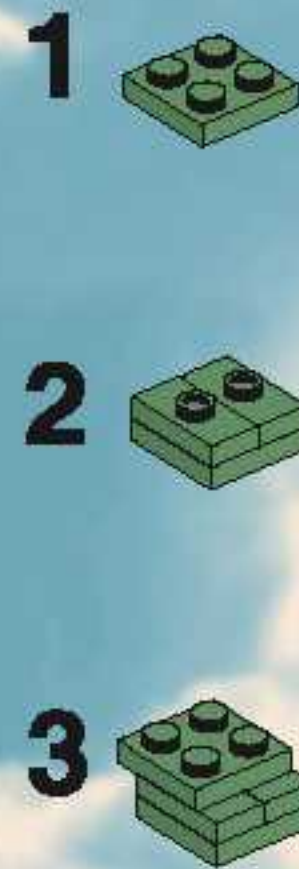
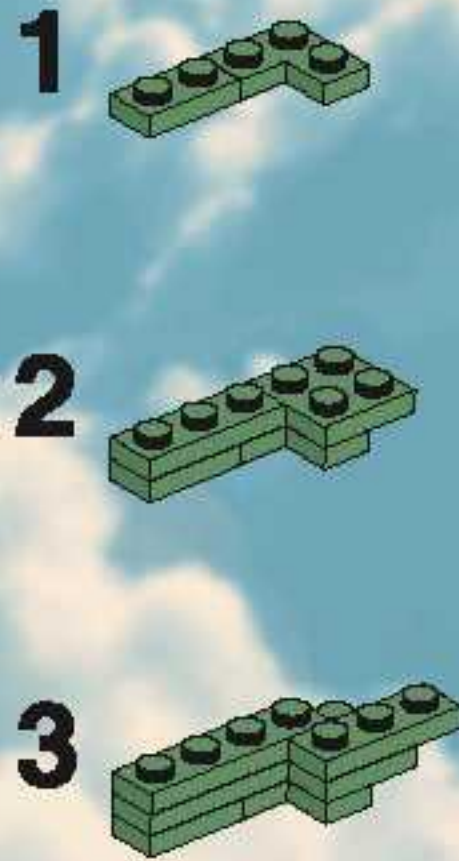
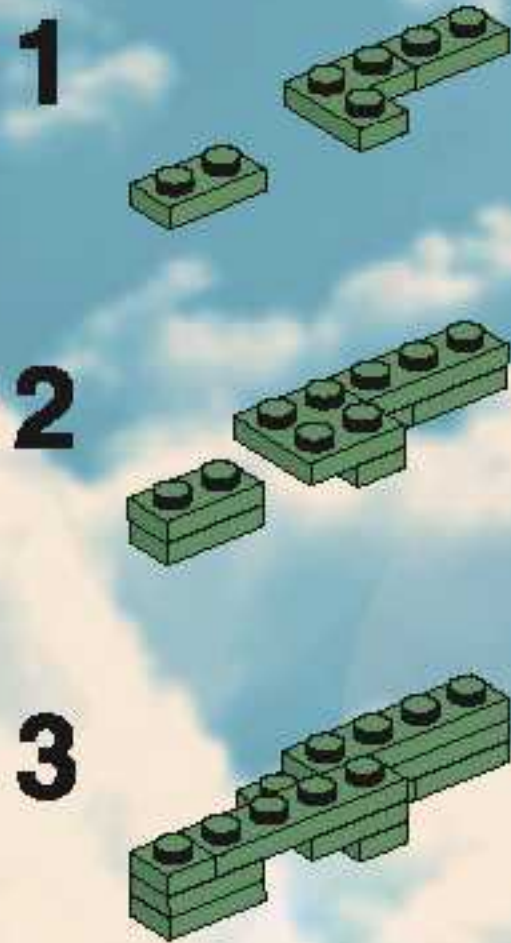

65

- 2x 
- 4x 
- 2x 
- 5x 
- 8x 
- 3x 
- 3x 
- 4x 

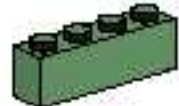

65

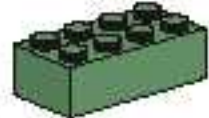
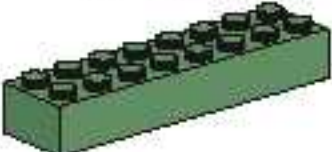
- 2x 
- 2x 
- 5x 
- 2x 
- 1x 
- 1x 
- 1x 

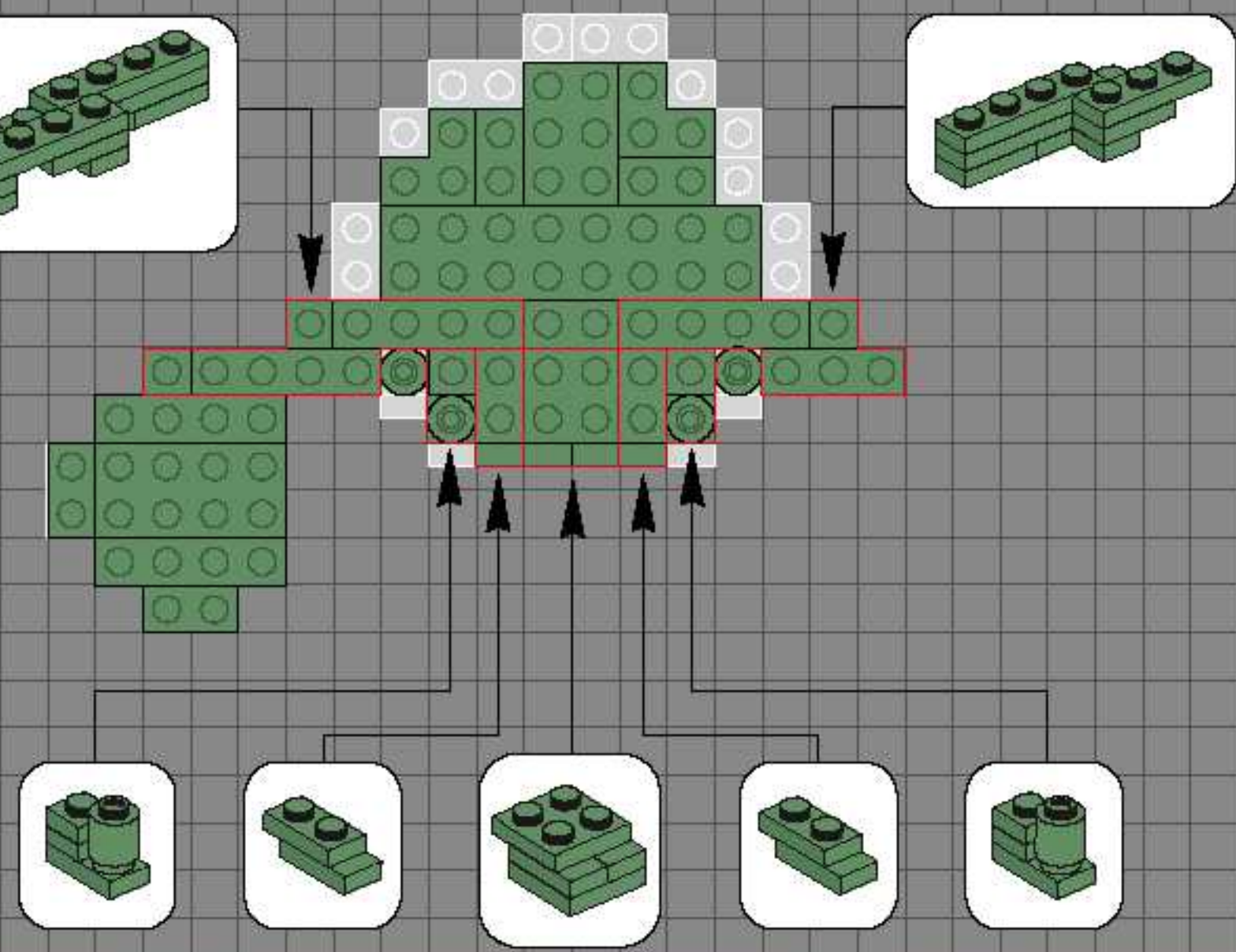
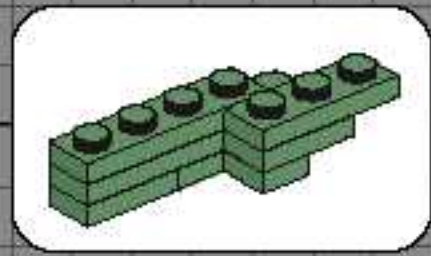
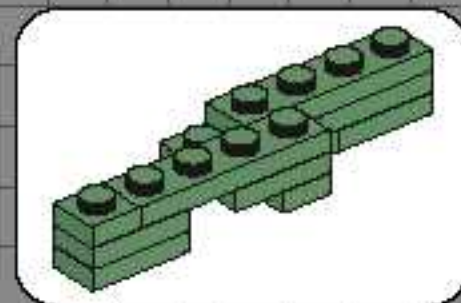

66

- 6x
- 2x
- 4x
- 1x
- 4x
- 3x
- 5x
- 3x
- 1x

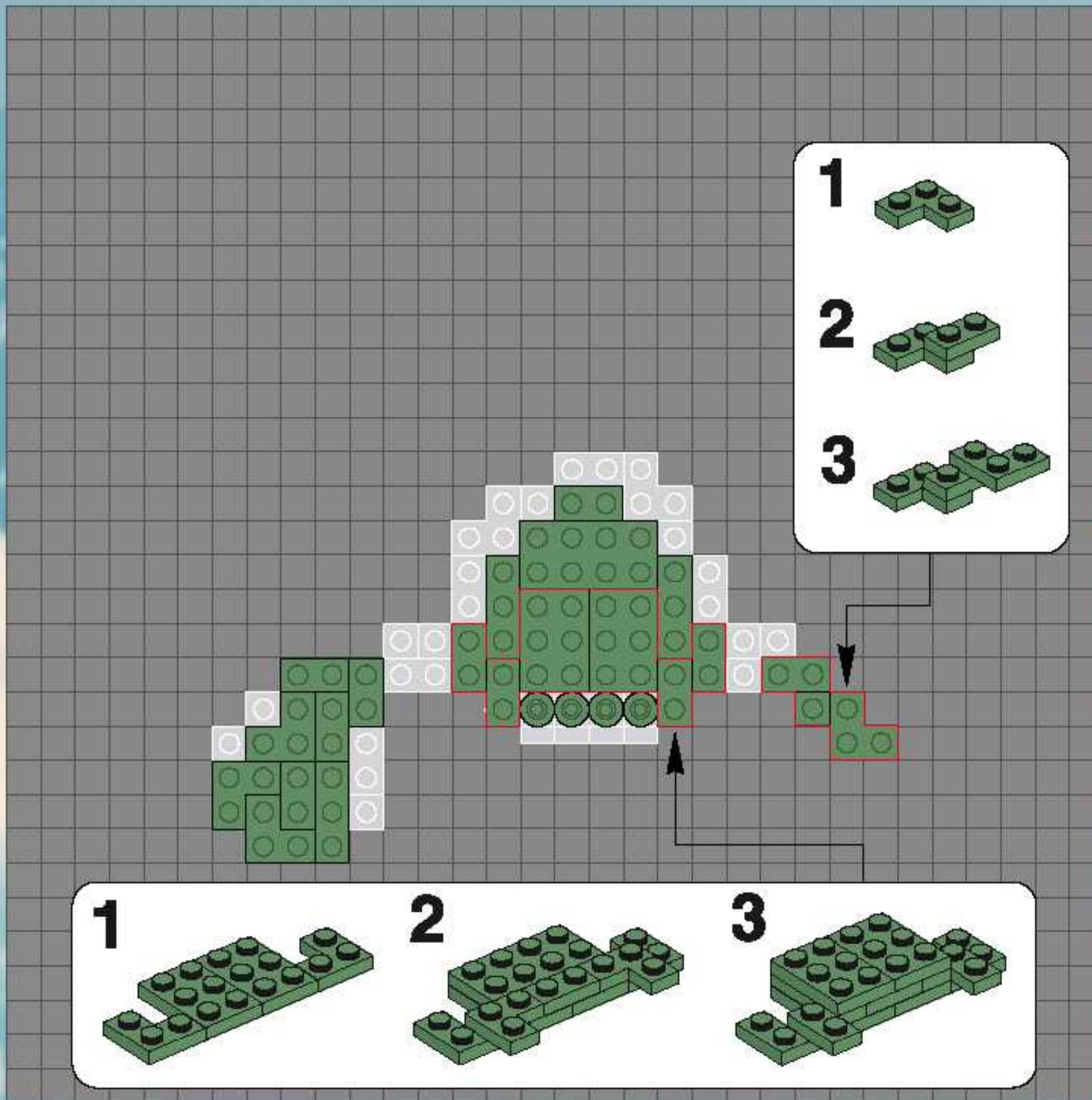

1

2







3







1







2



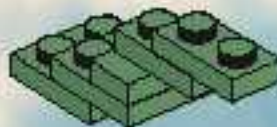

3

67

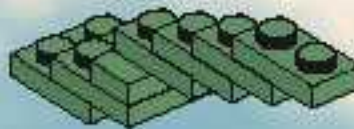
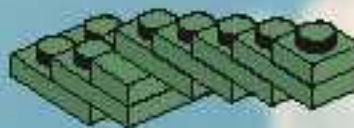

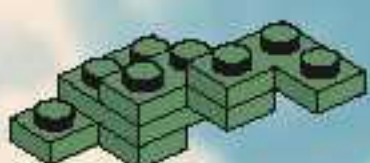

- 1x 
- 4x 
- 5x 
- 6x 
- 2x 
- 4x 

- 1 
- 2 
- 3 
- 4 
- 5 
- 6 

- 1 
- 2 
- 3 
- 4 
- 5 
- 6 
- 7 
- 8 

- 1 
- 2 
- 3 
- 4 
- 5 
- 6 

67

- 3x 
- 1x 
- 1x 
- 1x 

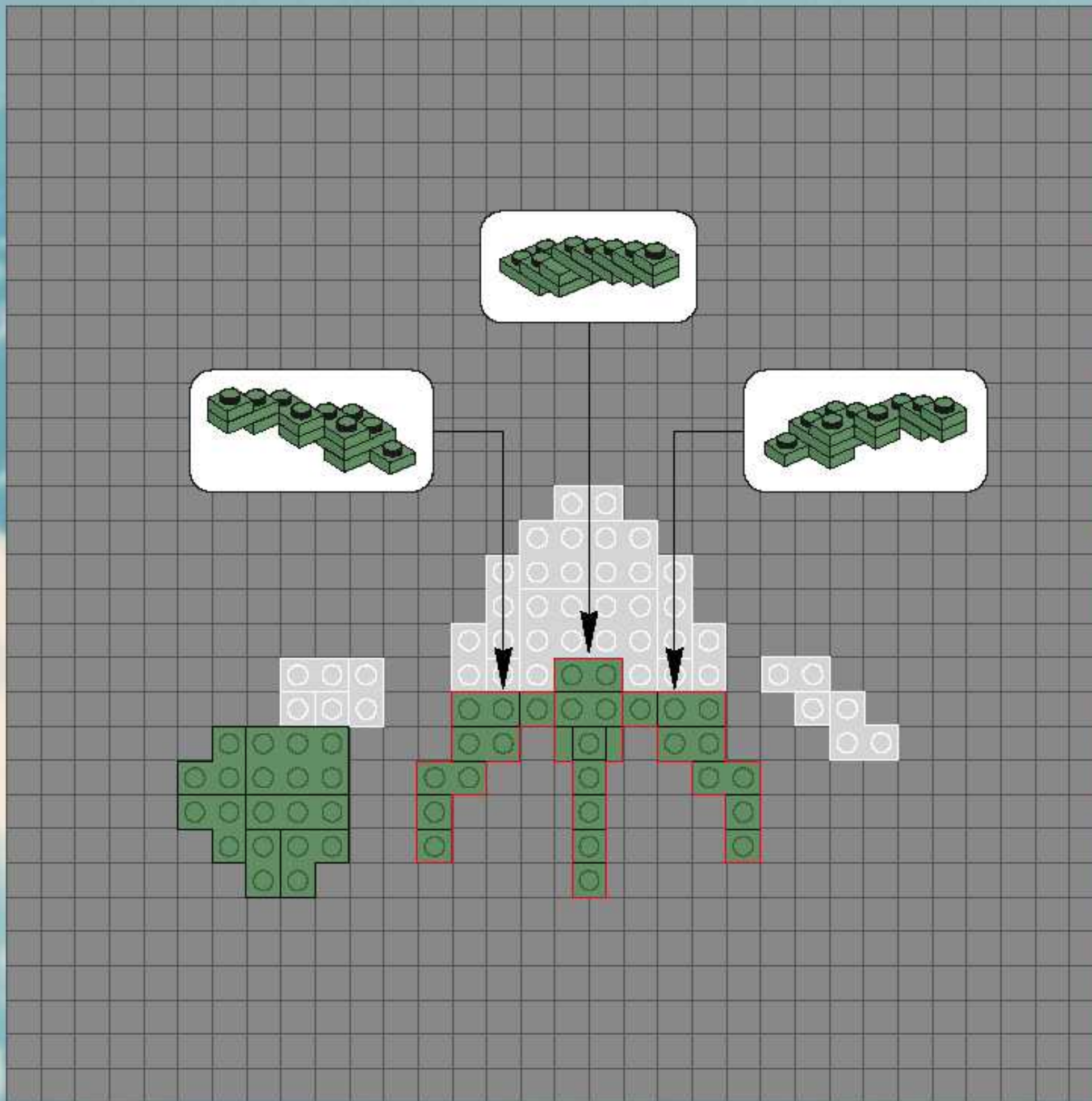

68

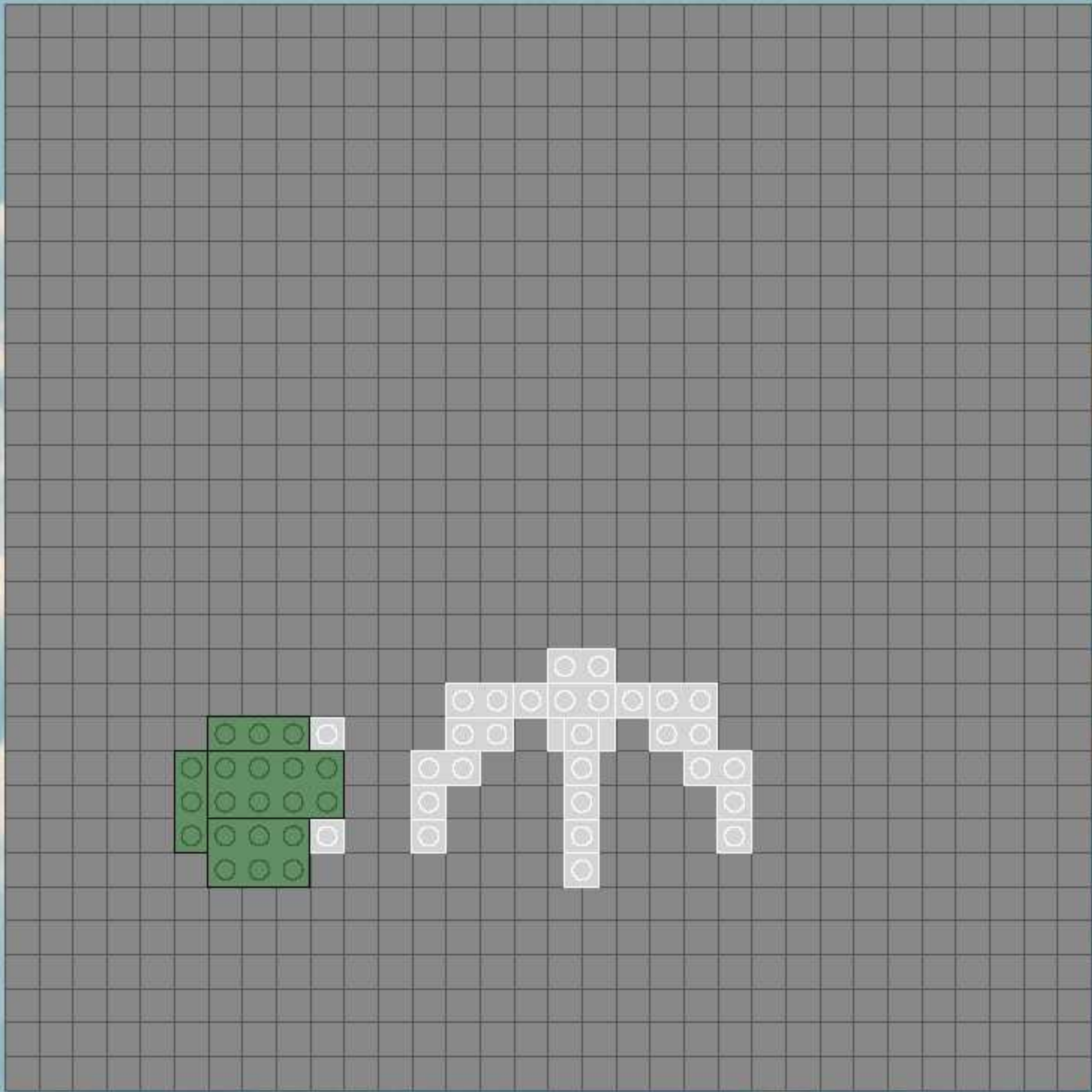
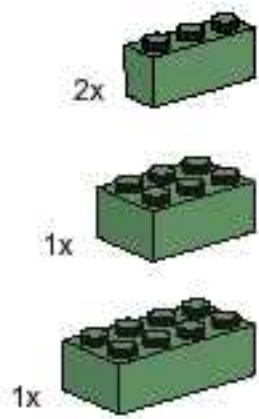

69

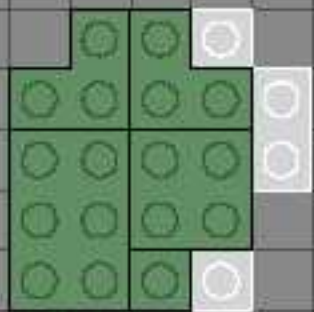
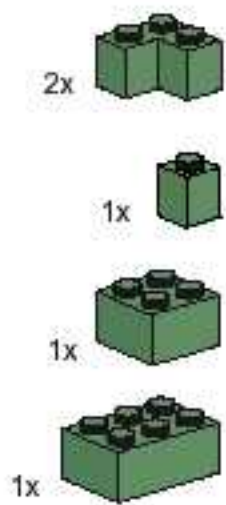

70

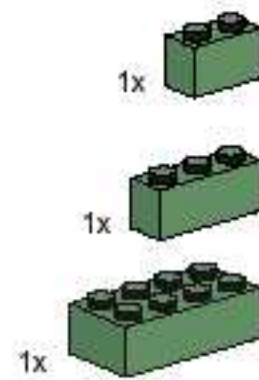

71

4x

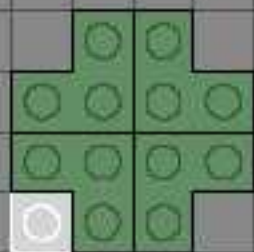

72

1x



2x



73

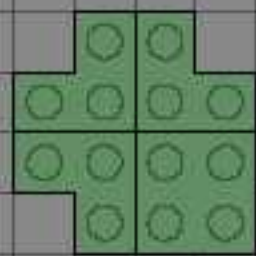
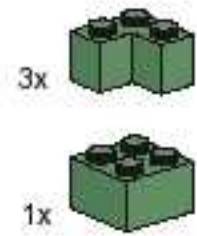

74

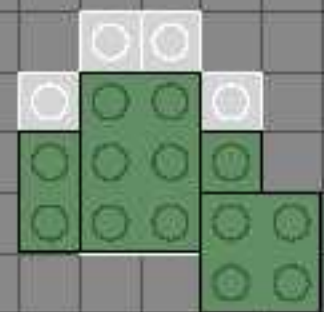
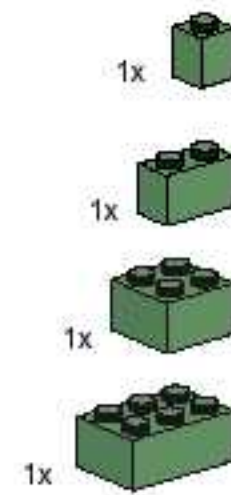

75

- 6x
- 5x
- 4x
- 2x

1

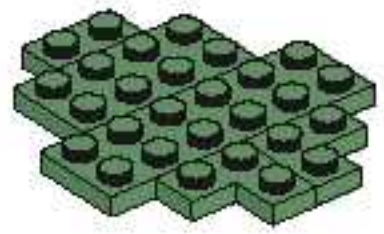

2

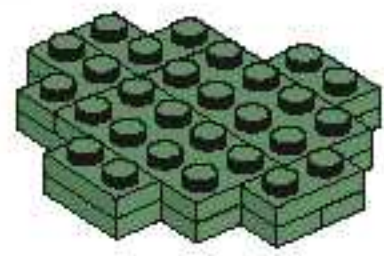

3

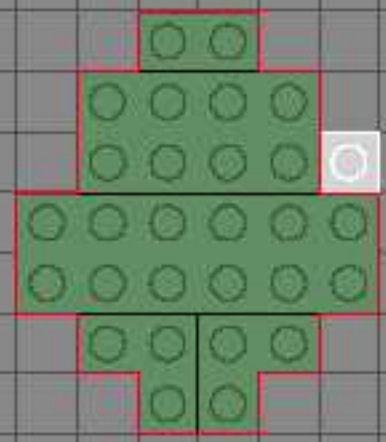
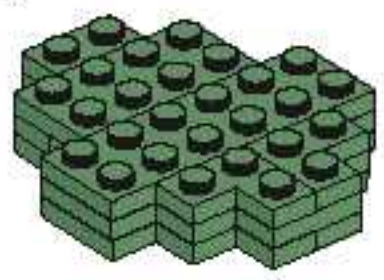

76

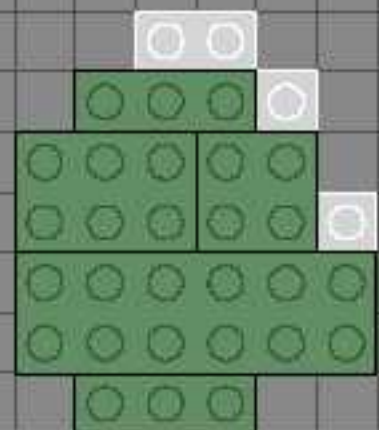
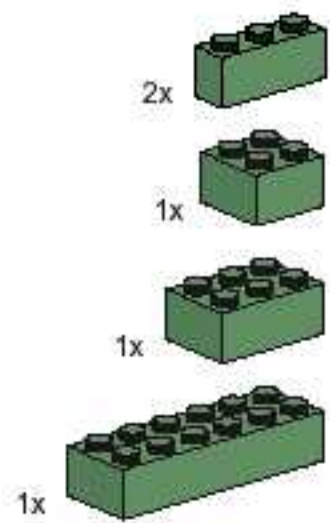

77

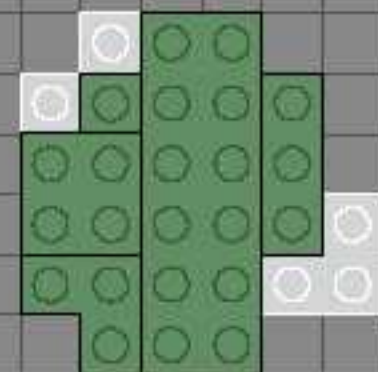
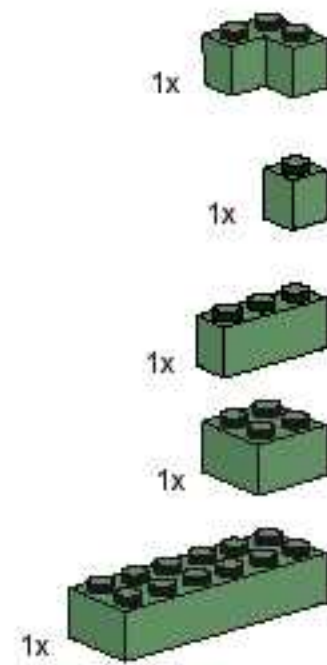

78

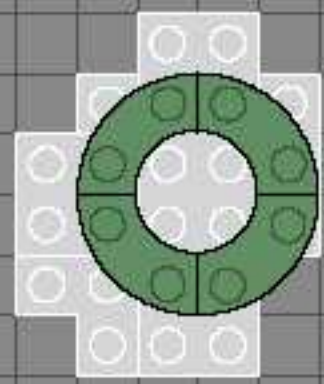

79

- 20x
- 2x
- 4x
- 2x
- 2x
- 2x
- 1x
- 1x
- 16x
- 4x
- 2x
- 2x
- 1x

1

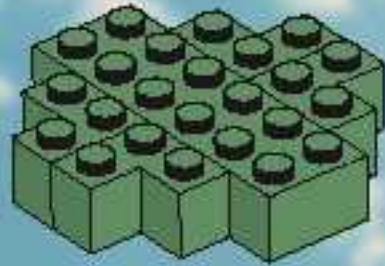

2

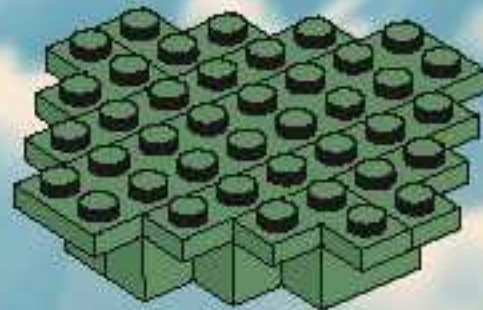

3

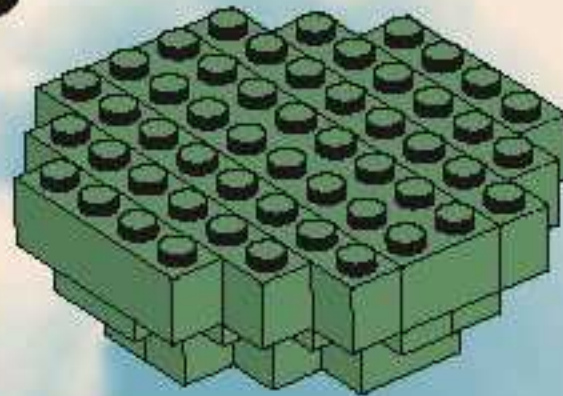

4

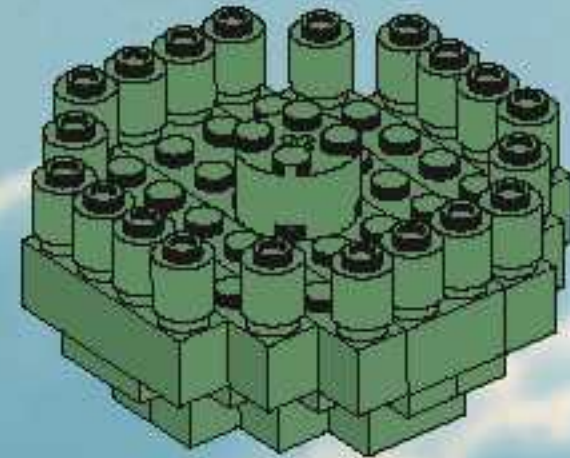

5

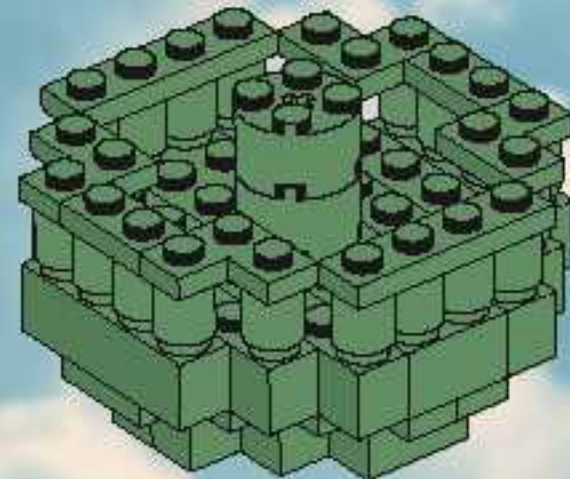



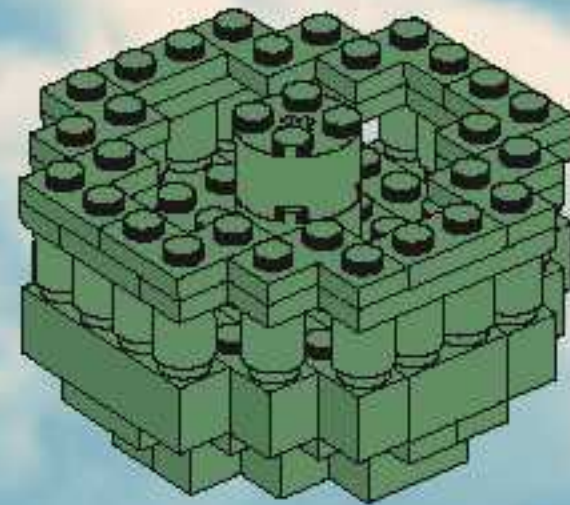



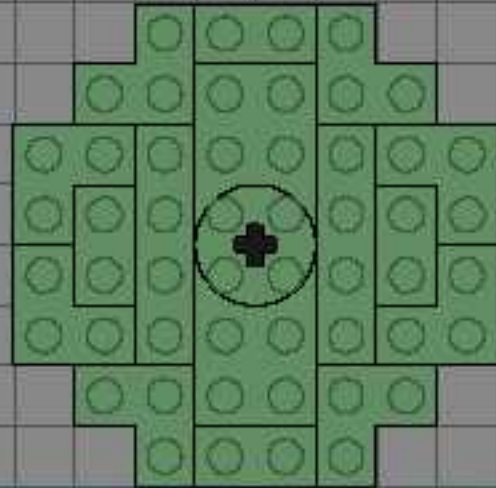
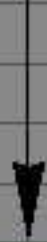
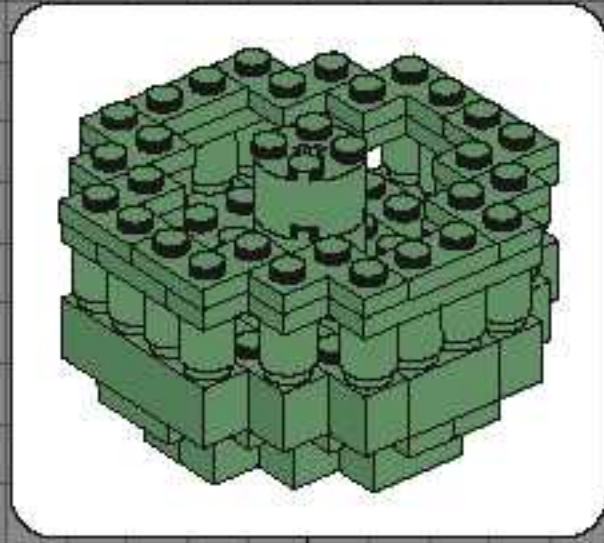

6



79



80

- 4x 
- 1x 
- 9x 
- 2x 
- 6x 
- 2x 
- 2x 
- 1x 
- 4x 

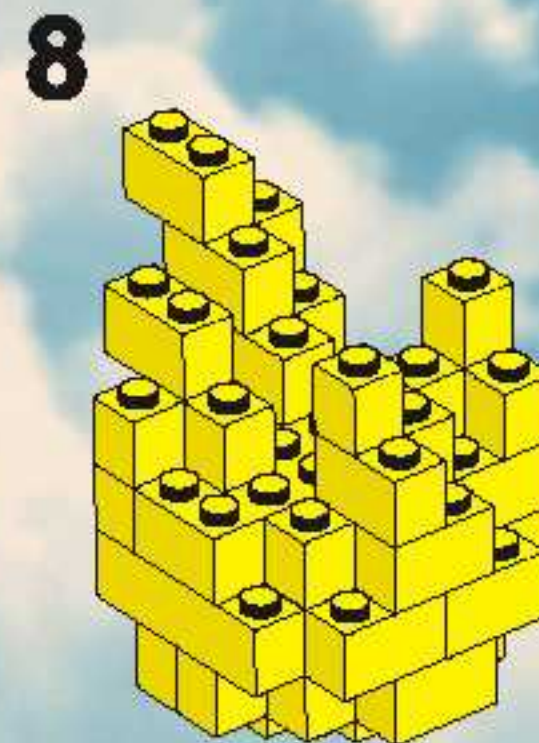
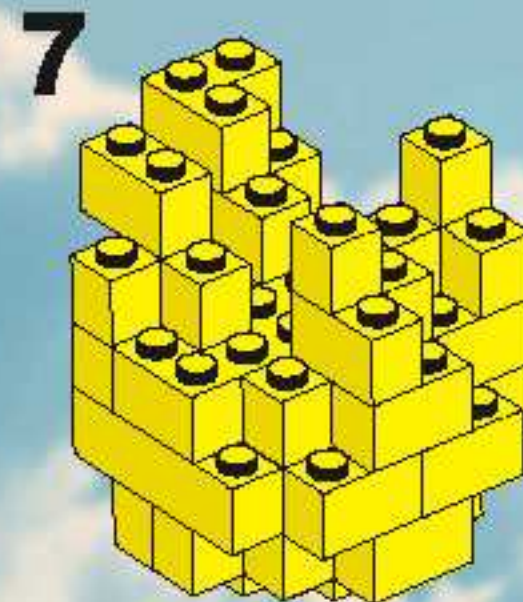
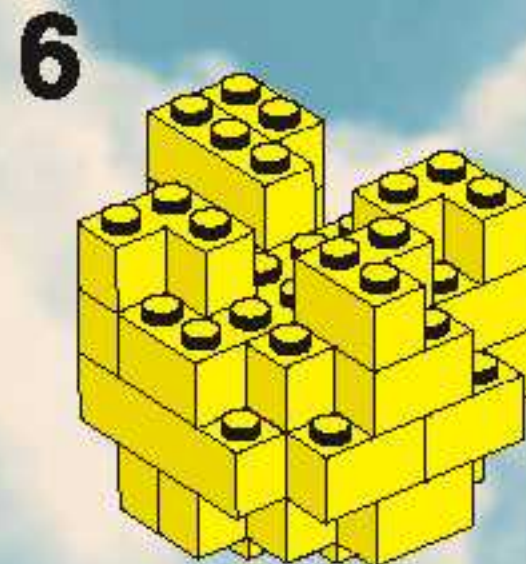
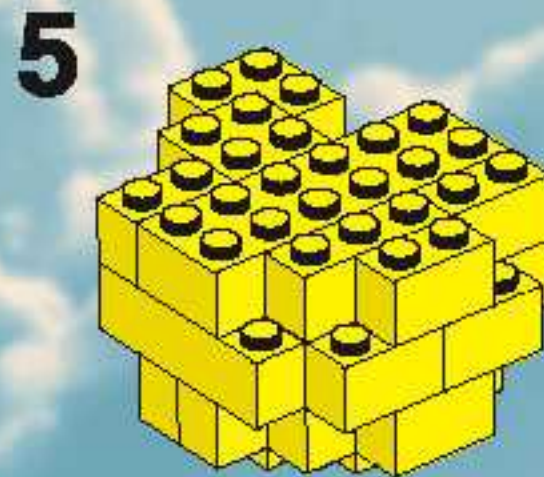
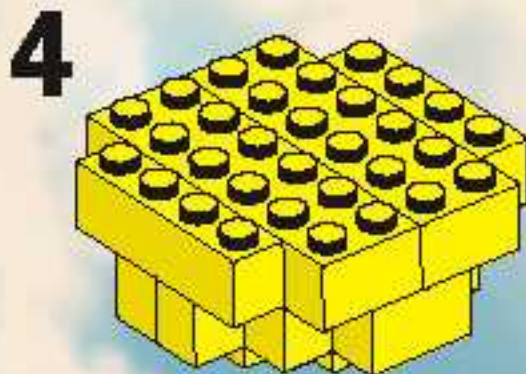
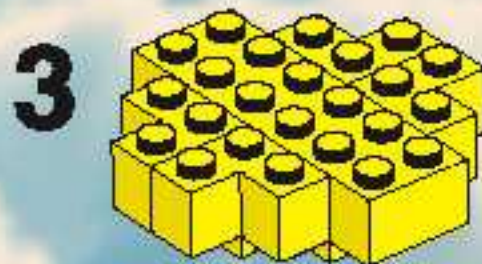

80

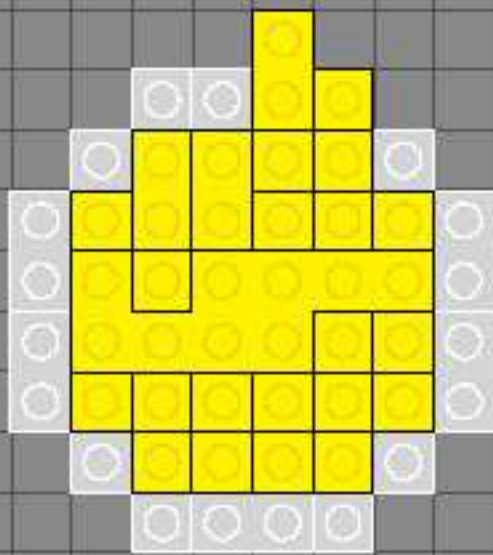
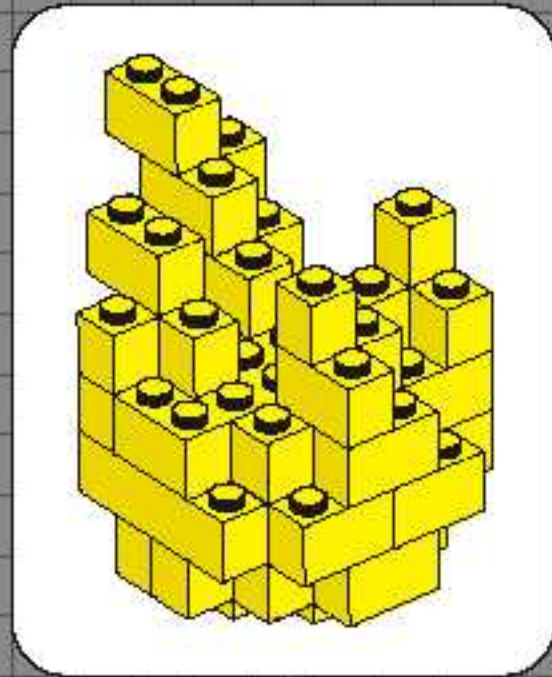

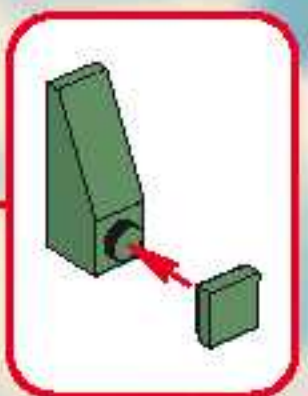
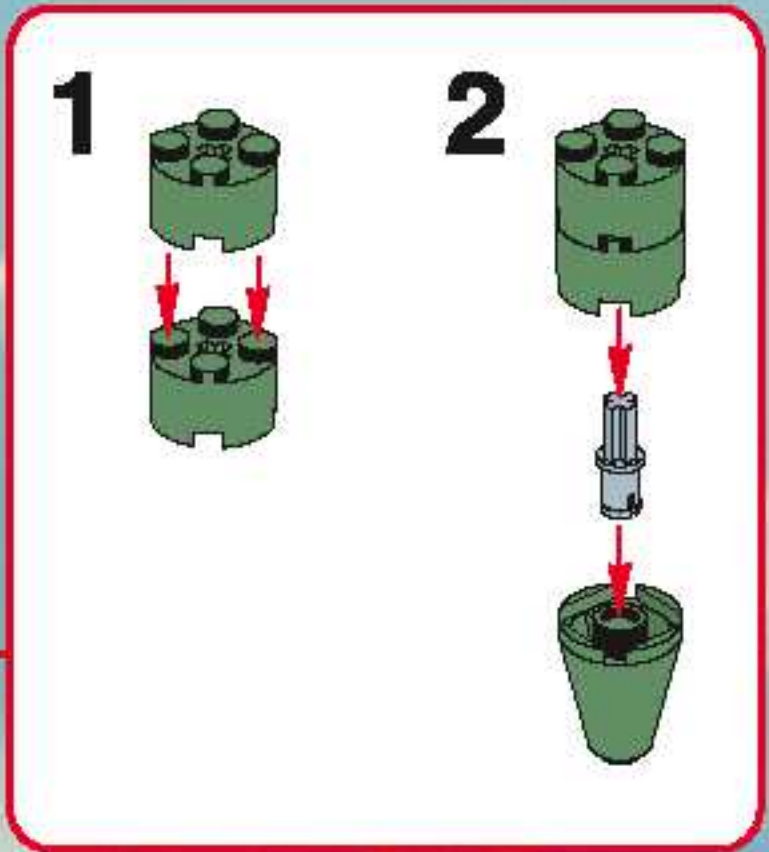
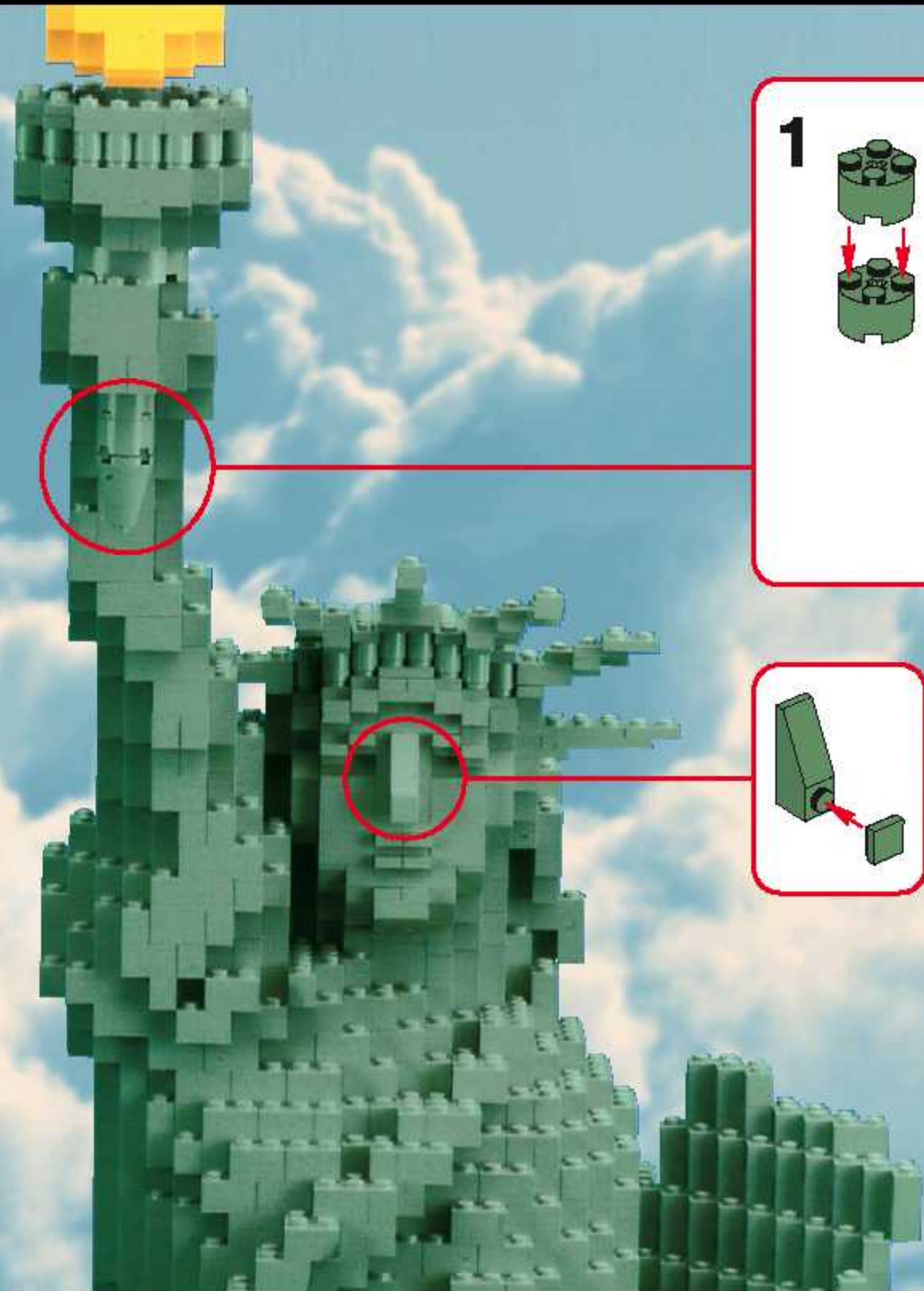



10024

Red Baron





Sopwith Camel

3 4 5 1





just imagine...

