



# BRICK 'HEADZ

40354



 [LEGO.com/brickheadz](https://www.LEGO.com/brickheadz)

BAILARÍN DE LA DANZA DEL DRAGÓN

DANSEUR DRAGON

DRAGON DANCE GUY

80



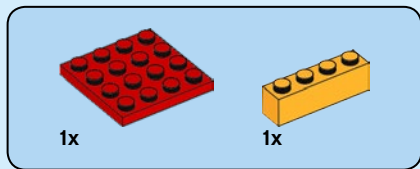

1

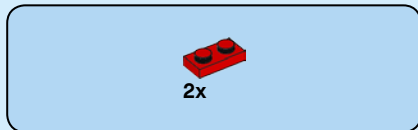
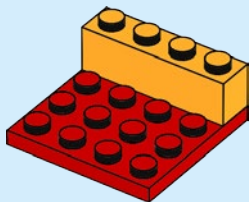

2

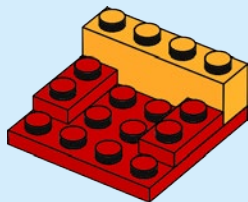

3

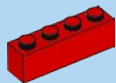

1x



1x

3

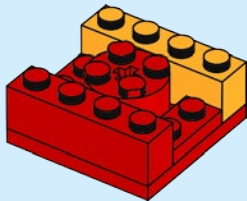

4

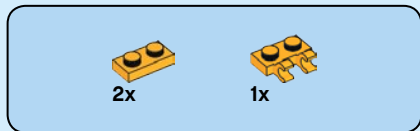

4

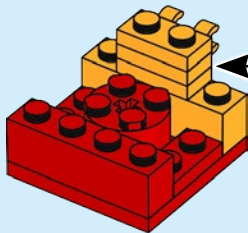
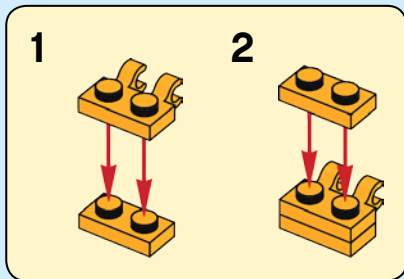



2x



2x

5



2x

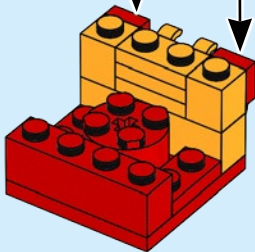

6



2x



1x



2x

6

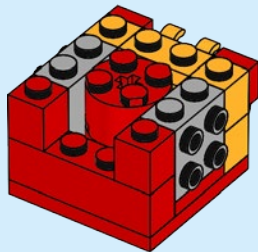

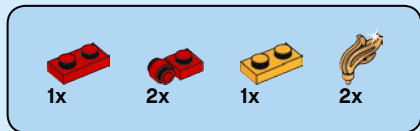

7

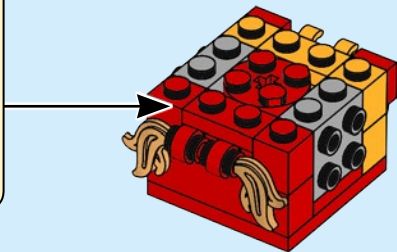
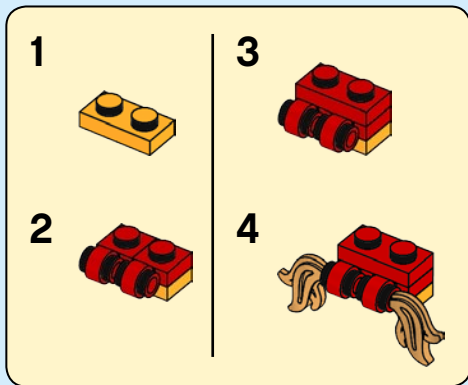



1x



2x

8

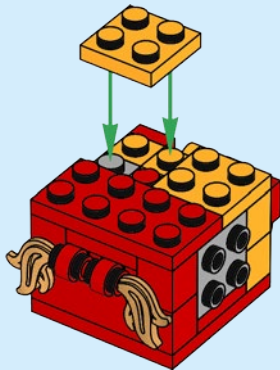

8



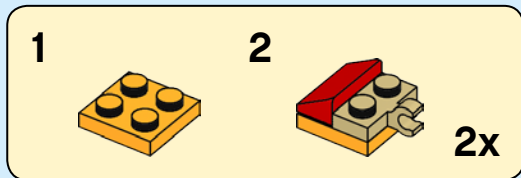

9

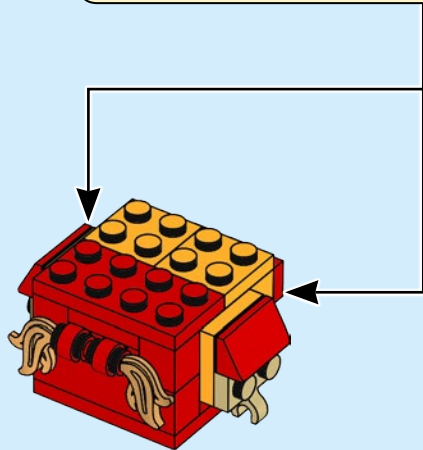



5x



2x

# 10

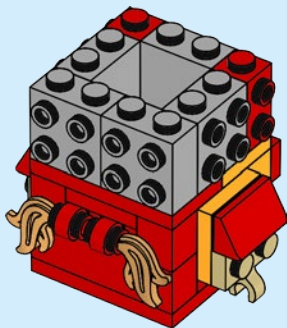

10

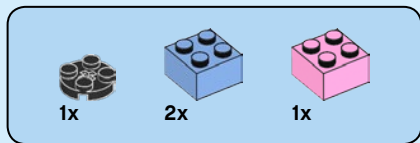

# 11

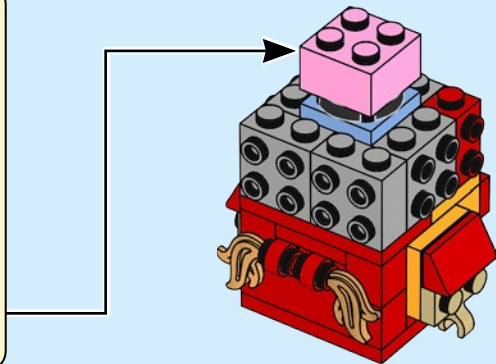
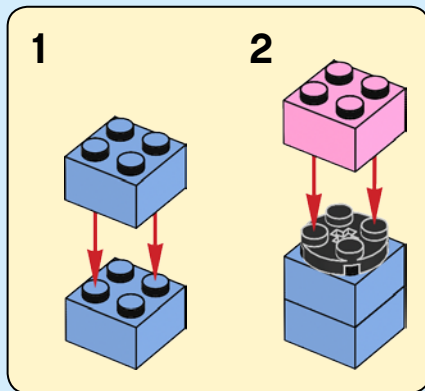



6x

12

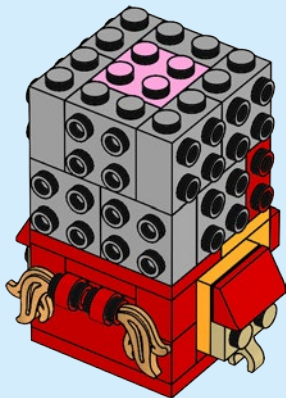

12

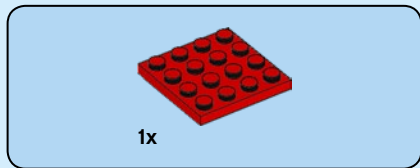

13

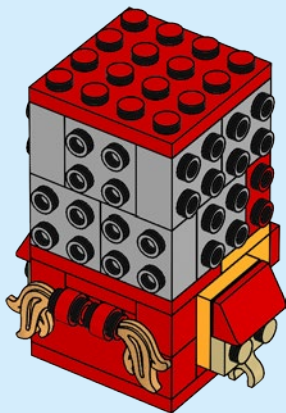



2x

14

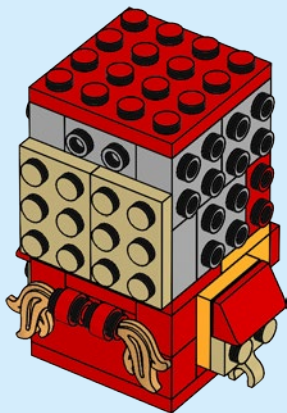

14

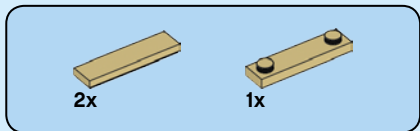

15

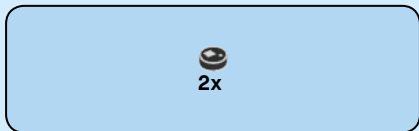
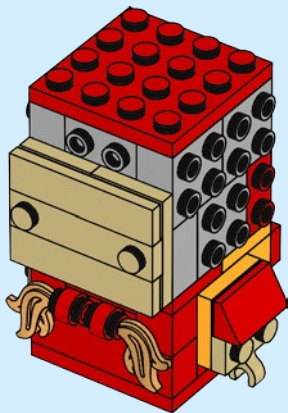

16

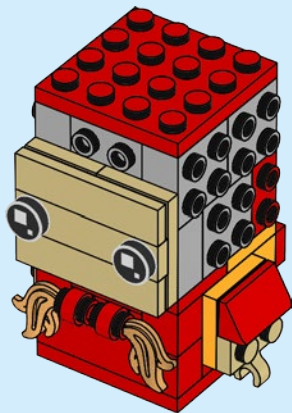



1x



2x



2x

# 17

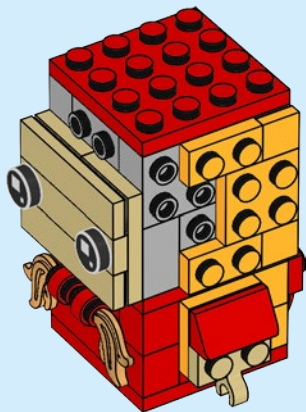





1x



1x

# 18

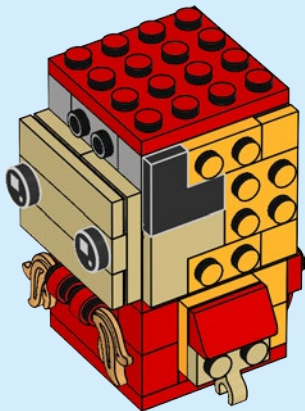

4x



4x

# 19

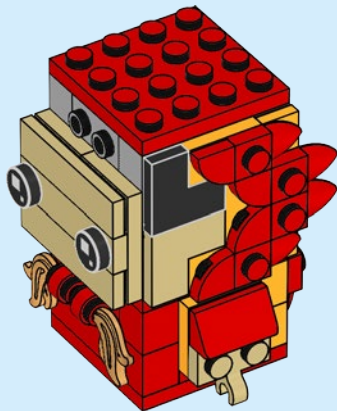



1x



2x



2x

# 20

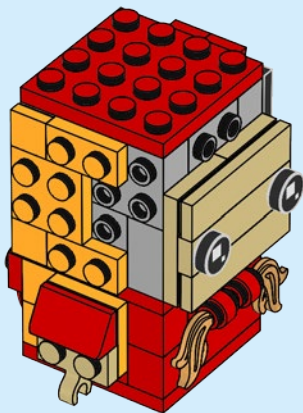
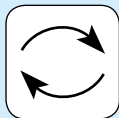



1x



1x

# 21

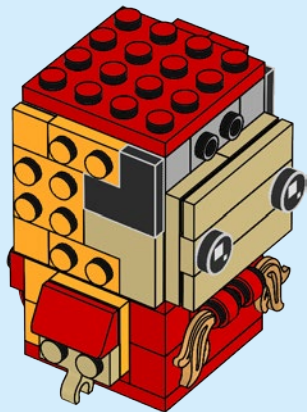



4x



4x

22

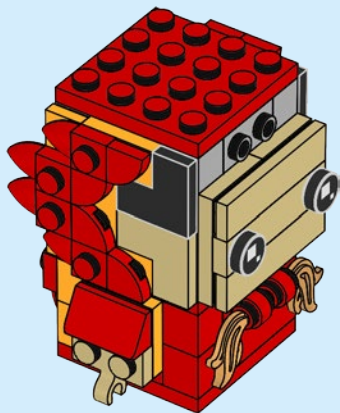

20

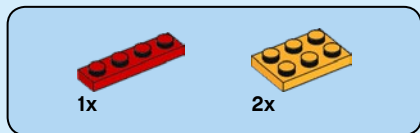

# 23

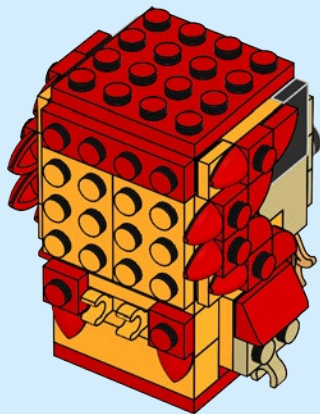
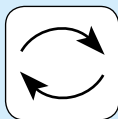

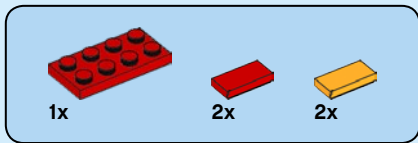

24

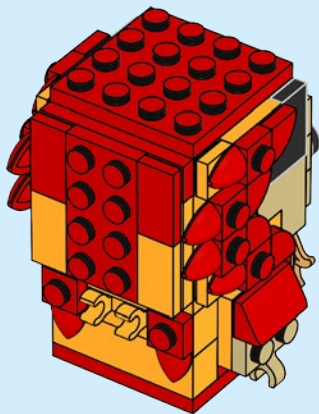



2x

25

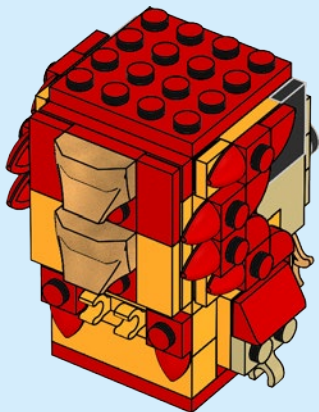



1x



1x



2x



2x

# 26

1

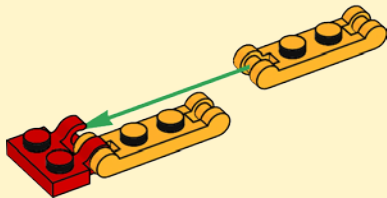

2

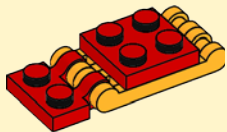

3

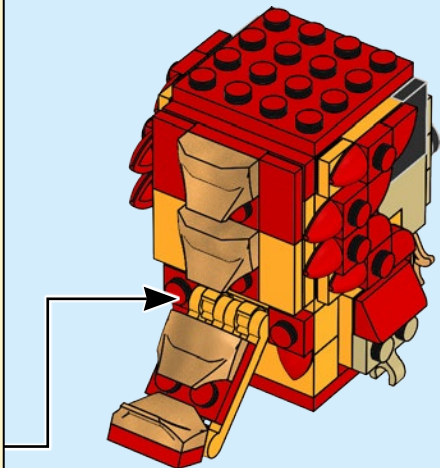



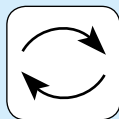
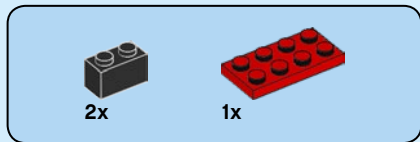

# 27

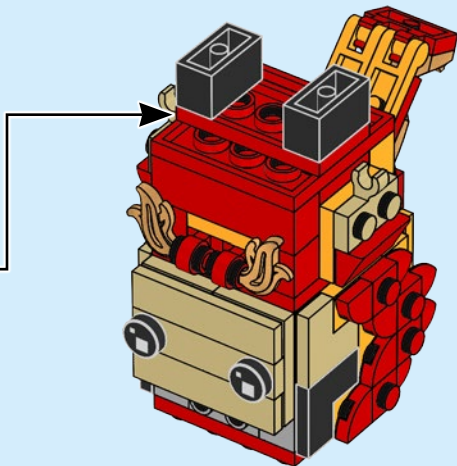
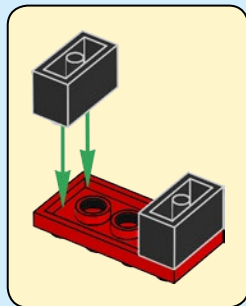



2x



1x



2x

# 28

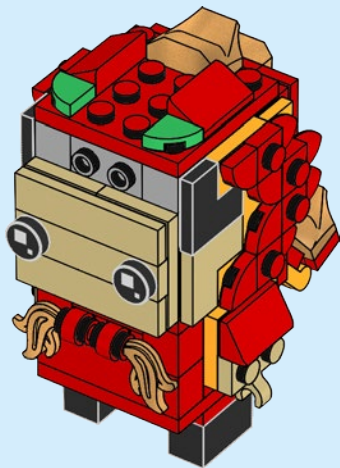
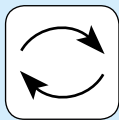

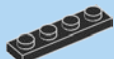

1x

29

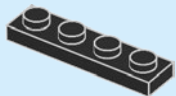

2x



1x

30

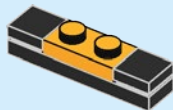



2x

31

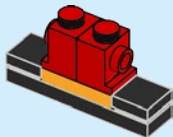

28



2x

32

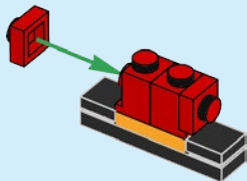



2x

33

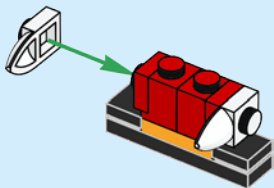

2x

34

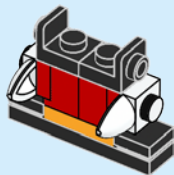



2x



1x

35

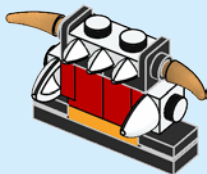

30



1x

36

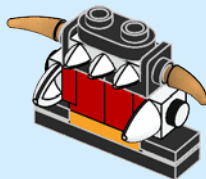

37

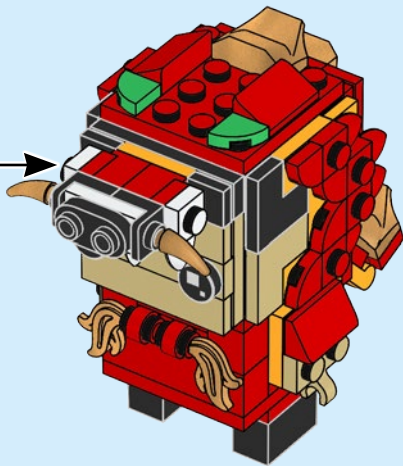



1x



1x

# 38

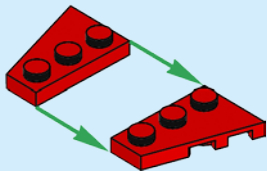

32

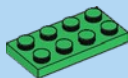

1x

# 39

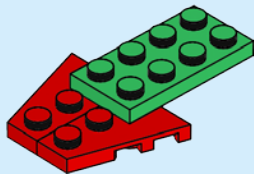





1x

40

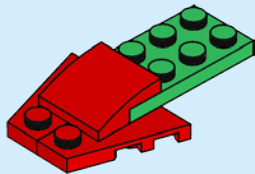

1x



1x

41

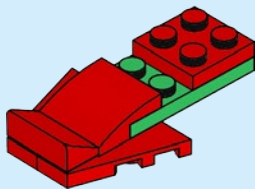



2x

42

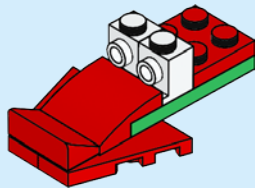

34



2x

43

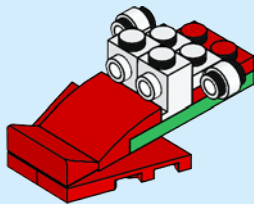



1x

44

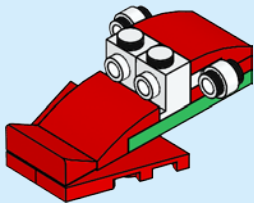

2x



2x

45

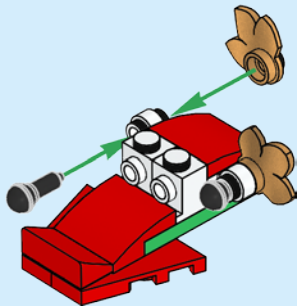



2x

46

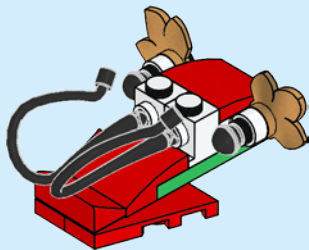

36



1x

47

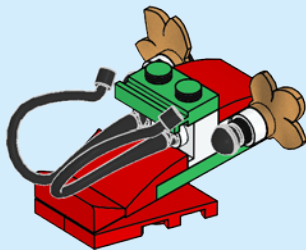

48

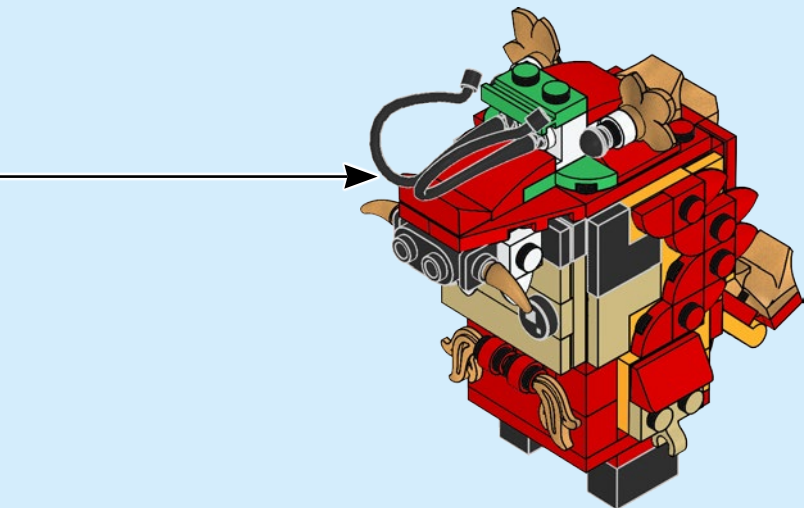

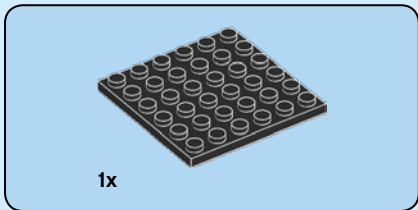
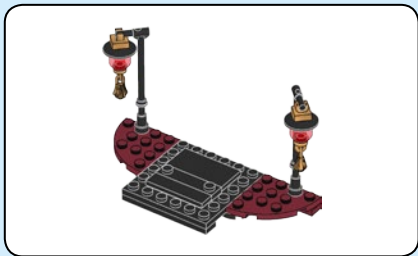

49

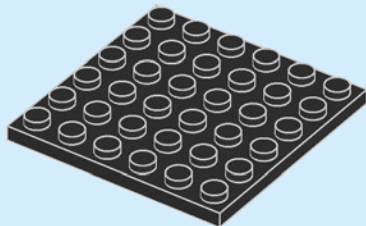

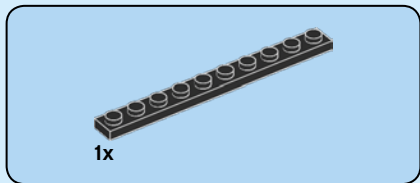

**50**

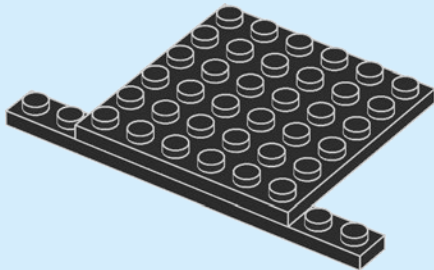



2x

51

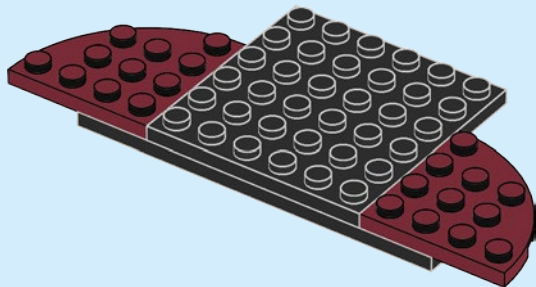

40



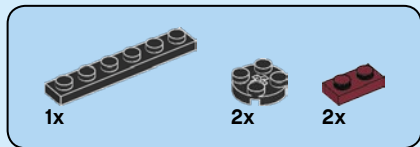

52

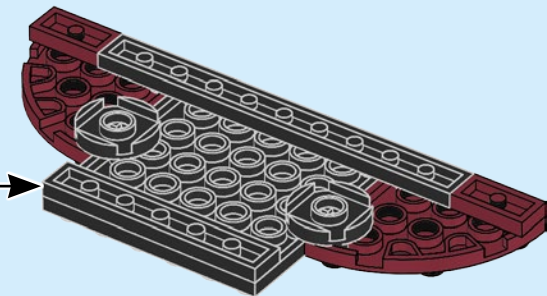
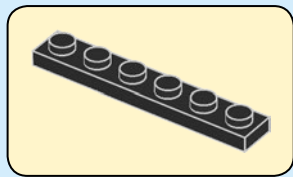
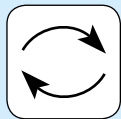

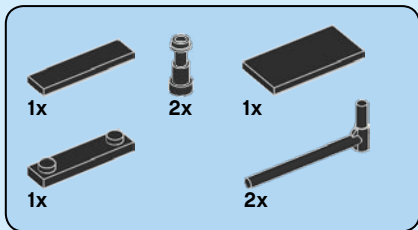

53

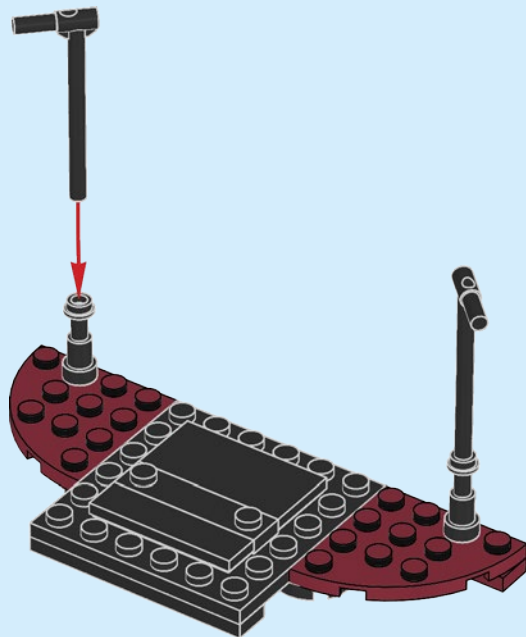
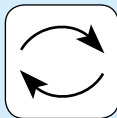

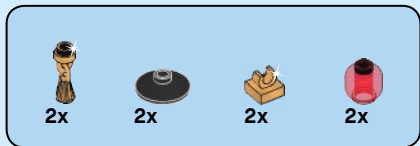

54

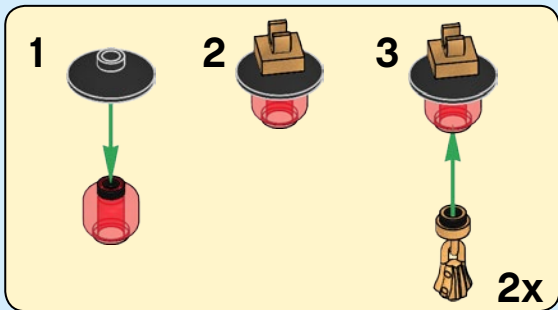
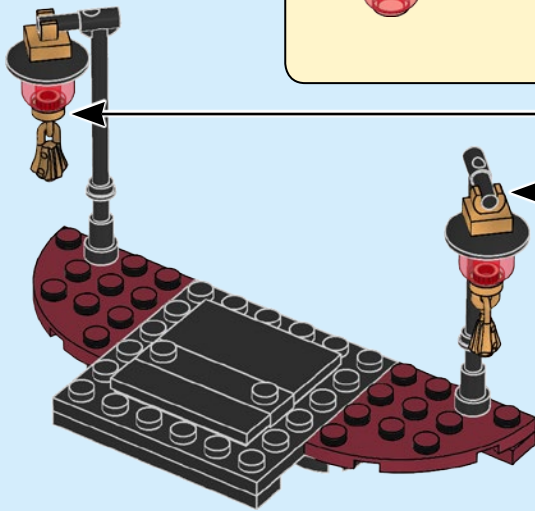

55

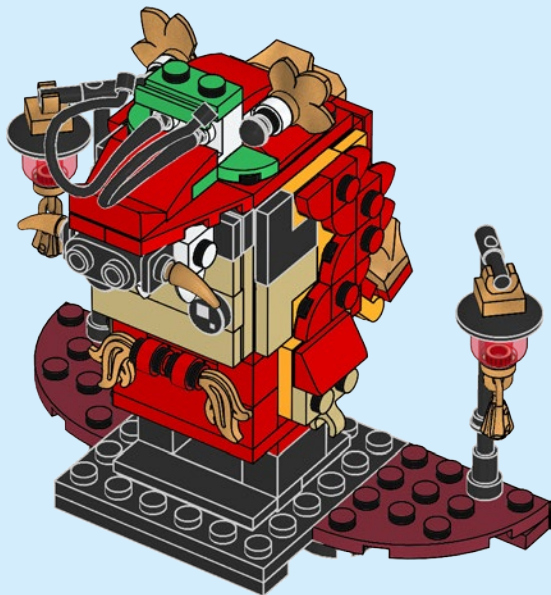

44



# BRICK HEADZ

REMEMBER  
VALENTINE

N'oubliez pas la  
SAINT-VALENTIN

ACUÉRDATE DE  
SAN VALENTÍN



40349

CACHORRITO

CHIOT

PUPPY

81



2x  
407001



2x  
4224792



2x  
4632566



1x  
6046381



2x  
6177314



2x  
6173057



2x  
4118790



1x  
6173056



2x  
4550324



2x  
407021



8x  
6170390



2x  
302421



2x  
6187620



2x  
300521



10x  
6078640



1x  
4180533



1x  
4180504



5x  
4651524



2x  
614321



2x  
4632572



2x  
306921



3x  
302321



1x  
4556153



2x  
6105976



2x  
302221



1x  
371021



1x  
301021



3x  
302021



2x  
4243814



2x  
6088550



2x  
4538456



2x  
6178627



2x  
307026



2x  
6234695



1x  
6210270



2x  
474026



3x  
403226



2x  
300426



2x  
6133722



1x  
243126



1x  
4599499



1x  
371026



1x  
4560182



2x  
4623113



2x  
6092878



1x  
366626

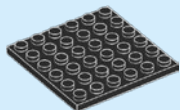

1x  
395826



1x  
447726



2x  
6150607



1x  
4272665



1x  
302028



2x  
6173950



2x  
4201235



2x  
4539097



2x  
4613267



4x  
6065504



2x  
6092035



8x  
6028736



2x  
4622062



1x  
6093459



6x  
6003033



2x  
6174004



2x  
6097503



1x  
6003004



13x  
6123809



1x  
4550359



2x  
6071259



2x  
6196565



2x  
4618195



2x  
6219088



5x  
6114676



2x  
6251548



**Customer Service**

**Kundenservice**

**Service Consommateurs**

**Servicio Al Consumidor**

**LEGO.com/service or dial**



**: 00800 5346 5555**



**: 1-800-422-5346**



# WIN

GO TO [WWW.LEGO.COM/PRODUCTFEEDBACK](http://WWW.LEGO.COM/PRODUCTFEEDBACK) AND  
GIVE US YOUR SHORT **FEEDBACK** ABOUT THIS  
LEGO® SET FOR A CHANCE TO WIN  
A COOL LEGO PRIZE.

Terms & Conditions apply

## [LEGO.com/productfeedback](http://LEGO.com/productfeedback)



### GEWINNE

Erzähle uns auf  
[www.LEGO.com/productfeedback](http://www.LEGO.com/productfeedback)

etwas über die Erfahrungen, die du  
mit diesem LEGO® Set gemacht hast,  
und sichere dir die Chance auf einen  
coolen LEGO Preis!

Es gelten die Teilnahmebedingungen

### GAGNE

Rends-toi sur  
[www.LEGO.com/productfeedback](http://www.LEGO.com/productfeedback)

et donne-nous quelques commen-  
taires sur ce produit LEGO® pour  
avoir une chance de gagner un  
prix LEGO !

Voir Conditions Générales

### GANAN

Visita  
[www.LEGO.com/productfeedback](http://www.LEGO.com/productfeedback)

y envíanos tu opinión acerca de este  
set LEGO®. ¡Participarás en el sorteo  
de un premio LEGO!

Términos y Condiciones aplicables

### 获取奖品

登录  
[www.LEGO.com/productfeedback](http://www.LEGO.com/productfeedback)

给出关于此乐高®套装的简短反馈，  
就有机会获得炫酷乐高奖品

《条款及条件》适用

LEGO and the LEGO logo are trademarks of the/son des marques de commerce du/  
son marcas registradas de LEGO Group. ©2019 The LEGO Group.

6270802