



**BRICK  
HEADZ**

**40752**







1x

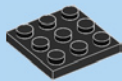

1x

1

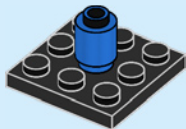

1x

2





2x

3

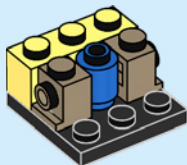

3x

4

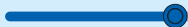
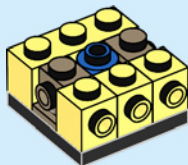



1x

5

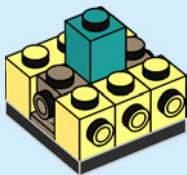

2x



1x

6

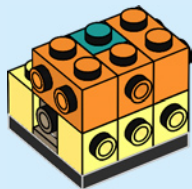



3x

7

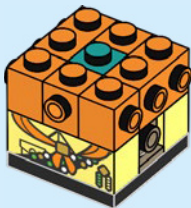

2x

8

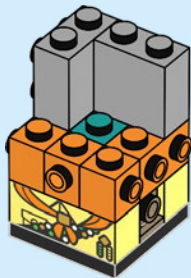



1x



1x



1x

9

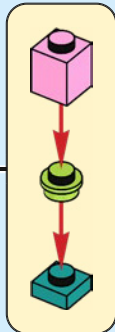
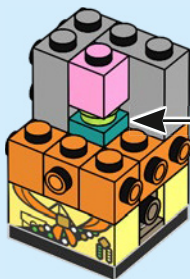

2x

10

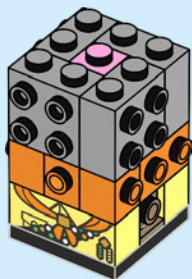



# 11

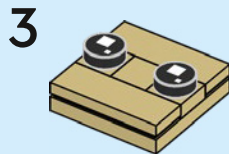
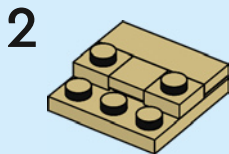
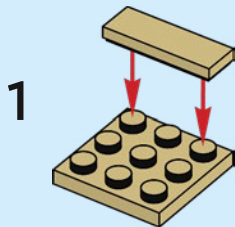



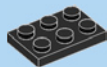

2x

12

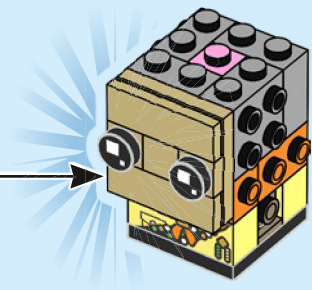



1x

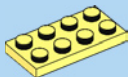

1x

# 13

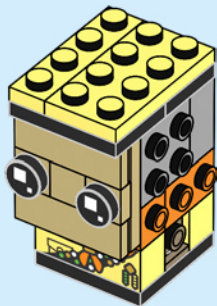

3x

# 14

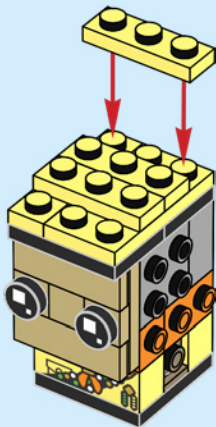



2x



1x

15

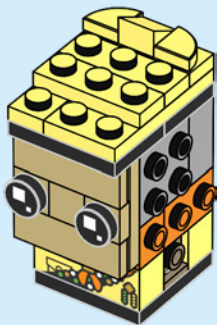

2x



2x

16

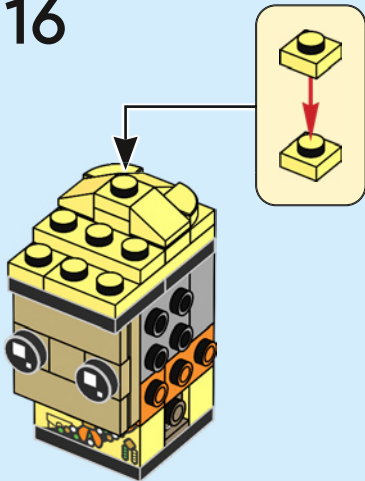



2x



1x

17

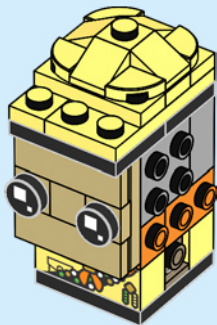

1x



1x



1x

18

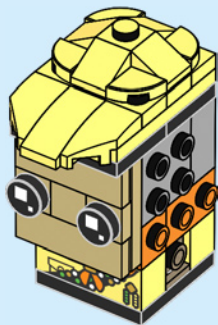





1x



1x

19

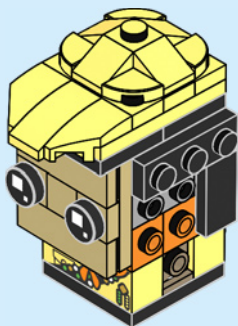

1x



1x

20

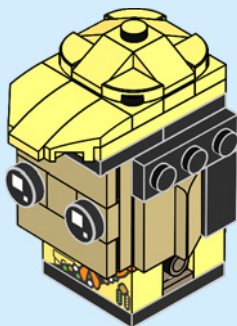



1x



1x

21

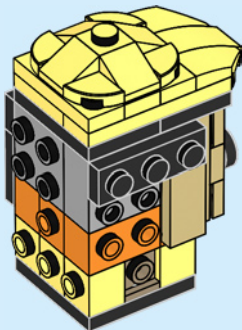

1x



1x

22

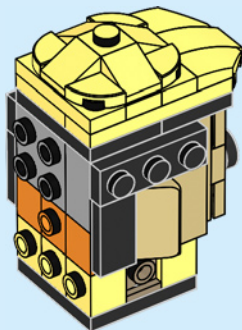

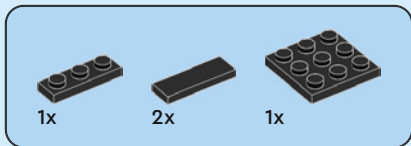

# 23

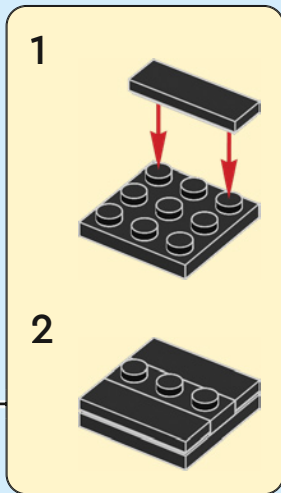
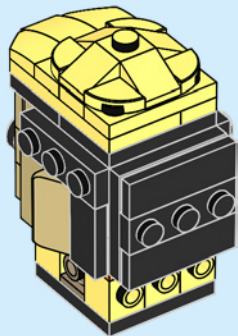





2x



2x



2x

# 24

1

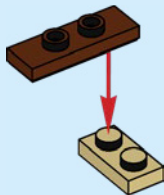

2

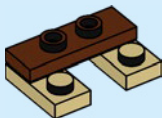

3



4

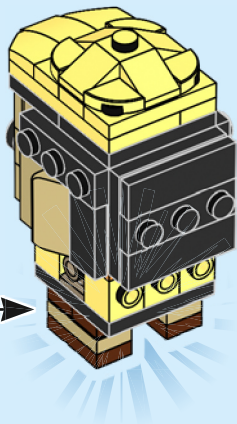
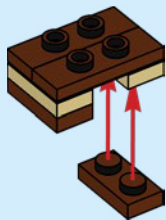



1x



2x



1x

# 25

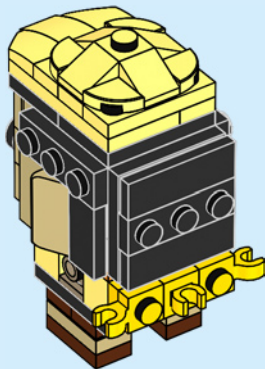

1

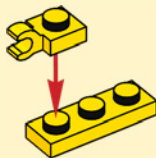

2

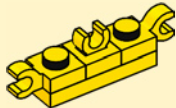

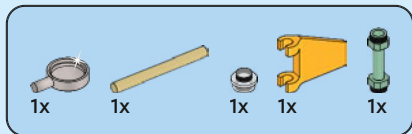

26

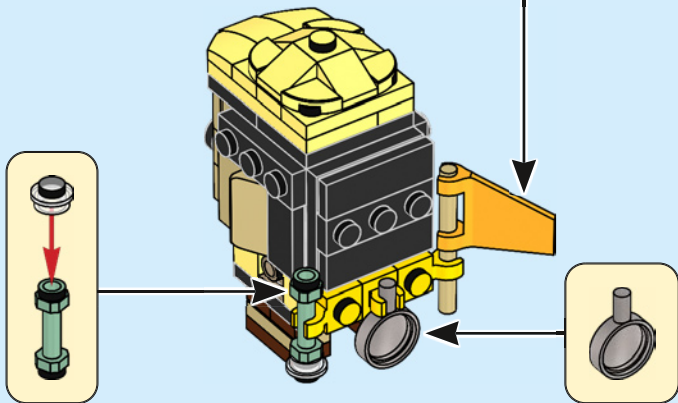
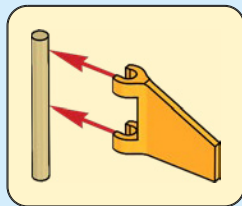



2x



2x

27

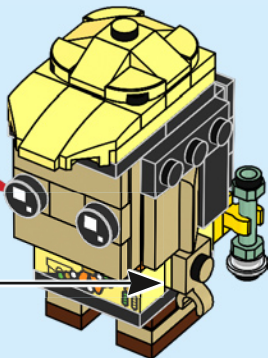
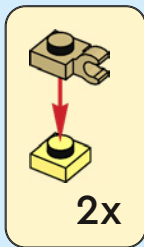

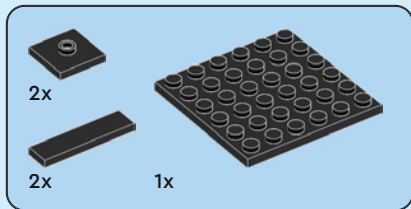

# 28

1

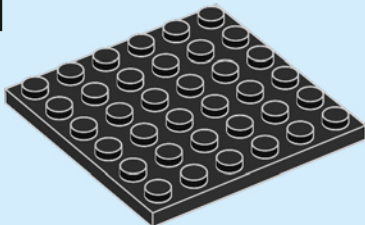

2

