



# Mixels™

## TUNGSTER



41544



7 [LEGO.com](http://LEGO.com)

6126538

1



2

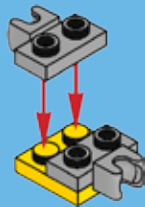

3



4

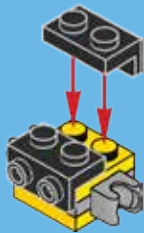

5

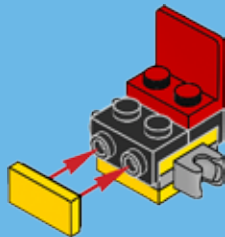

6

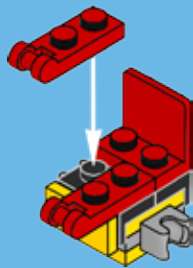

7

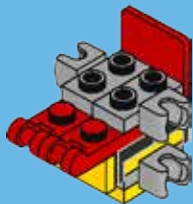

8

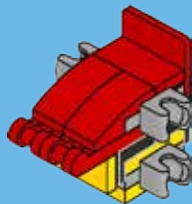

9

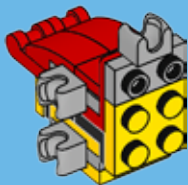

10

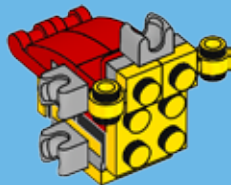

11

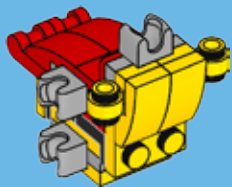

12





13

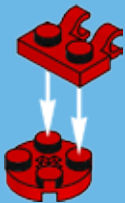

14



15





16

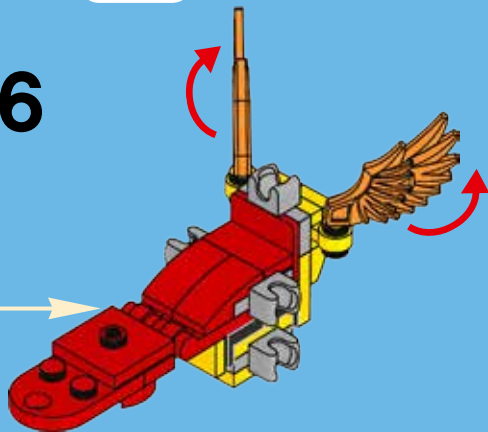



1



2



3



17

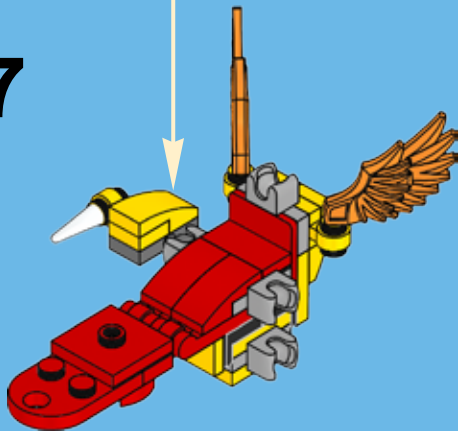

1



2



3



18

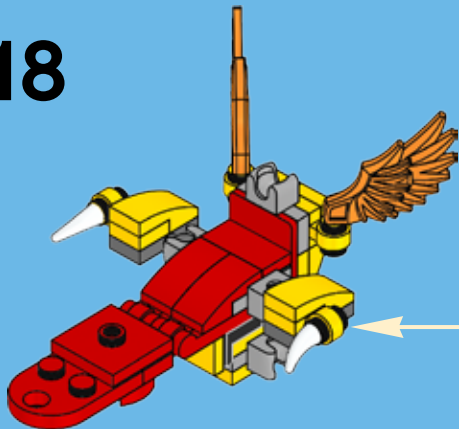



19



20



21

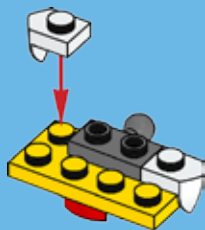

22



23



24



25

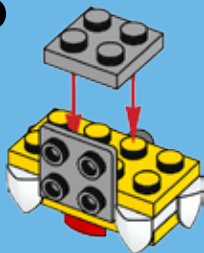

26

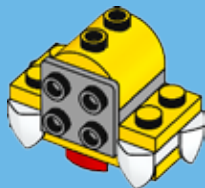

1



2



3



4



27



28

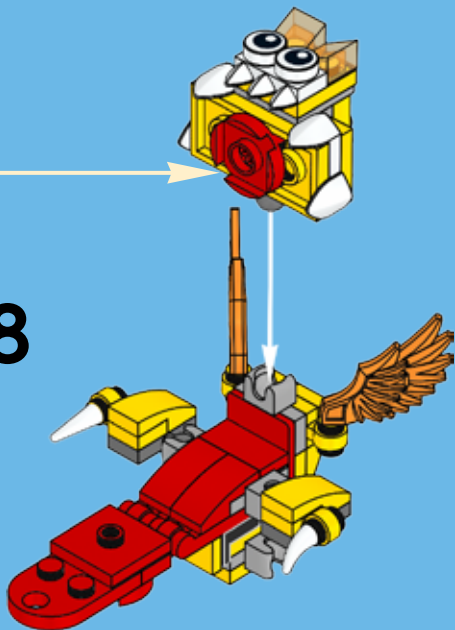

29

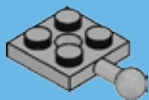

30

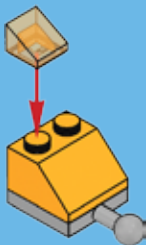

31

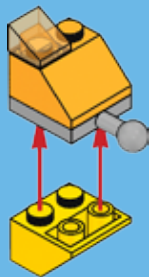



32

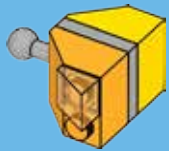

33

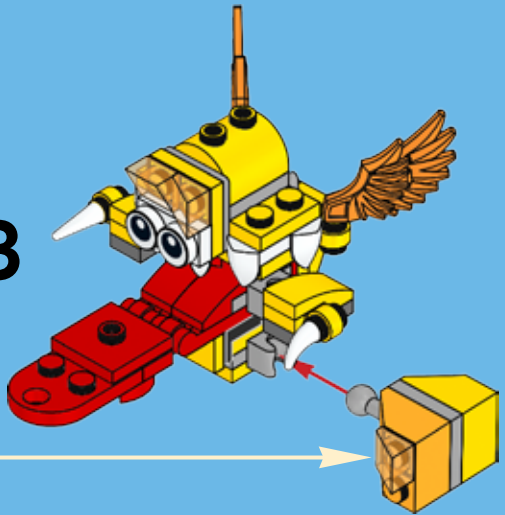

34

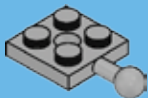

35

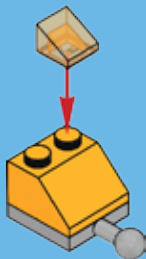

36

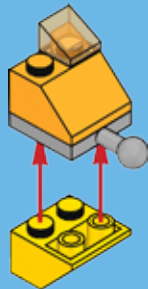

37



38

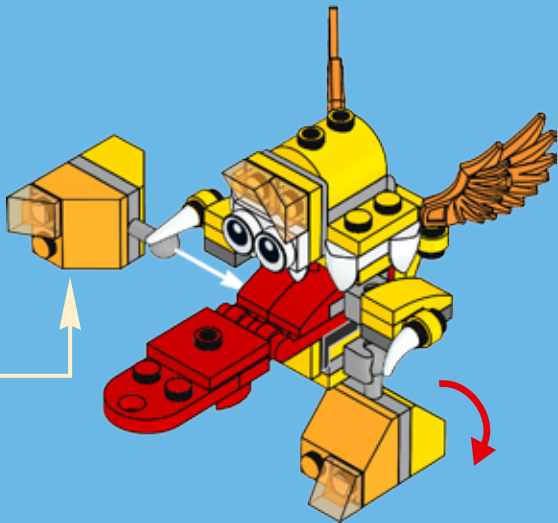



2x  
6057921



4x  
4244369



2x  
6029156



1x  
4211397



2x  
6029946



1x  
4188189



4x  
4632569



2x  
6020181



3x  
6039479



2x  
4568387



5x  
6043656



1x  
306921



2x  
403221



4x  
302224



2x  
6016172



4x  
6046905



1x  
4654580



1x  
4581308



1x  
6001806



2x  
302024



1x  
6046381



2x  
6063611



1x  
4556153



4x  
6029947



2x  
366024



**Customer Service**

**Kundenservice**

**Service Consommateurs**

**Servicio Al Consumidor**

**LEGO.com/service or dial**



**00800 5346 5555 :**



**1-800-422-5346 :**



2x  
4515365



1x  
306924



1x  
4187061



**SPUGG  
41542**



**LIXERS  
MAX!**



**TURG  
41543**



**TUNGSTER  
41544**



[LEGO.com/mixels](http://LEGO.com/mixels)





# Mixels



41536  
GOX



41537  
JINKY



41538  
KAMZO



41539  
KROG



41540  
CHILBO



41541  
SNOOF



41542  
SPUGG



41543  
TURG



41544  
TUNGSTER



[LEGO.com/mixels](http://LEGO.com/mixels)





**YOU CAN BUY THE GAME!  
TU PEUX ACHETER LE JEU!  
¡PUEDES COMPRAR EL JUEGO!**

**VA1KYR1E**

**IN GAME CODE!  
CODE DANS LE JEU!  
¡CÓDIGO PARA EL JUEGO!**



Apple, the Apple logo, iPad, iPhone and iPod touch are trademarks of Apple Inc. Apple, le logo Apple, iPad, iPhone et iPod touch sont des marques de commerce d'Apple Inc.

Apple, el logotipo de Apple, iPad, iPhone e iPod touch son marcas comerciales de Apple Inc.

# Mixels RUSH



Google Play is a trademark of Google Inc.

Google Play est une marque de commerce de Google Inc.

Google Play es una marca comercial de Google Inc.