

**PYRRATZ  
MAX!**



**SHARX  
41566**



**SKULZY  
41567**



**LEWT  
41568**

Warning! Choking hazard. Small parts and small balls.  
Achtung! Erstickungsgefahr. Kleine Teile und kleine Kugeln.  
Attention ! Danger d'étouffement. Petits éléments et petites balles.  
Avvertenza! Rischio di soffocamento. Piccole parti e piccole palle.  
Waarschuwing! Verstikkingsgevaar. Kleine onderdelen en kleine ballen.  
¡Advertencia! Peligro de atragantamiento. Partes pequeñas y bolas pequeñas.  
Advarsel! Kvælningssfare. Små dele og små kugler.  
Viðvörðun! Kófnunarrhætta. Litillir hlutir og litlar kúlur.  
Varoitus! Tukehtumisvaara. Pieniä osia ja pieniä palloja.  
Varning! Kvävningssrisk. Små delar och små bollar.  
Advarsel! Kvelningsfare. Små deler og små baller.  
Atenção! Risco de asfixia. Pequenas partes e pequenas bolas.  
Προειδοποίηση! Κίνδυνος πνιγμού. Μικρά μέρη και μικρές μπίλιες.  
警告! 窒息の危険性。小さな部品および小さなボール。  
警告! 謹防窒息危險。当心小物件和小球体。  
경고! 질식 위험. 작은 부품 및 작은 공 포함.  
Внимание! Риск удушения. Мелкие детали и маленькие шарики.  
Ostrzeżenie! Niebezpieczeństwo udławienia się. Małe części i małe kulki.  
Upozornění! Nebezpečí zalknutí. Malé části a malé koule.  
Upozornenie! Nebezpečenstvo dusenia. Malé časti a malé guľky a loptičky.  
Figyelmeztetés! Fulladásveszély. Kis alkatrészek és kis labdák.  
Обережно! Ризик задухи. Дрібні деталі та маленькі шарики.  
Uprozorenje! Opasnost od gušenja. Mali dijelovi i male loptice.  
Упозорење! Опасност од гушења. Мали делови и мале куглице.  
Предупредување! Опасност од задушвање. Мали делови и мали топчиња.  
Opozorilo! Nevarnost zadušitve zaradi tujka. Majhni deli in majhne krogle.  
Avertisment! Pericol de sufocare internă. Părți mici și mingi mici.  
Внимание! Опасност от задавяне. Малки части и малки топки.  
Brīdinājums! Aizrīšanās risks. Sīkas detaļas un sīkas bumbiņas.  
Hoiatus! Kägistamisoht. Väikesed osad ja väikesed pallid.  
İspējimas! Pavojus užspringti. Smulkios detalės ir maži kamuoliukai.  
Uyarı! Boğulma Tehlikesi (Havasızlıktan). Küçük parçalar ve küçük toplar.  
خذير! خطر الاختناق. أجزاء صغيرة وكرات صغيرة.  
Peringatan! Bahaya tersedak. Bagian kecil dan bola kecil.  
Amaran! Bahaya tercekik. Bahagian kecil dan bola kecil.



**WARNING: CHOKING HAZARD.**  
Toy contains small parts and a small ball.  
Not for children under 3 years.



**AVERTISSEMENT : RISQUE D'ÉTOUFFEMENT.**  
Le jouet contient des petites pièces ainsi qu'une petite boule.  
Il ne convient pas aux enfants de moins de 3 ans.



**ADVERTENCIA: PELIGRO DE ASFIXIA.**  
Juguete que contiene partes pequeñas y una pelota pequeña.  
No recomendado para niños menores de 3 años.

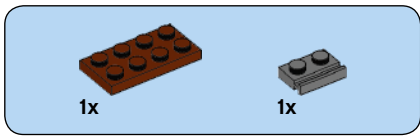

1

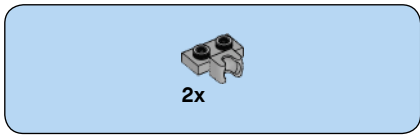
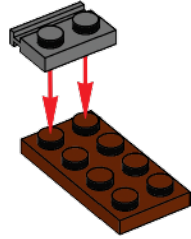

2

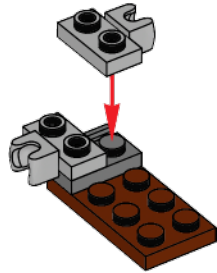

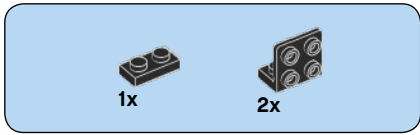

3

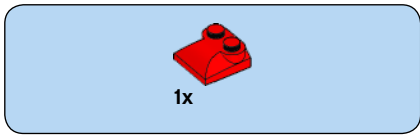
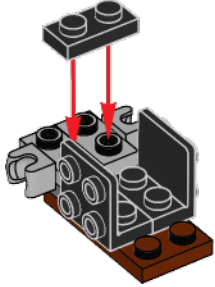

4

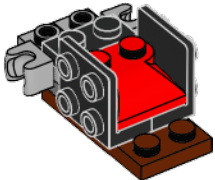

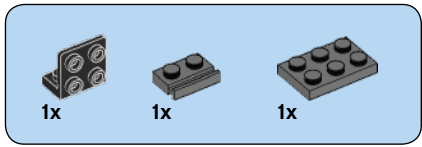

5

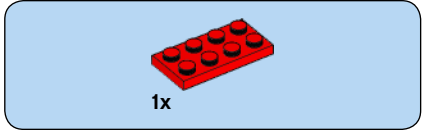
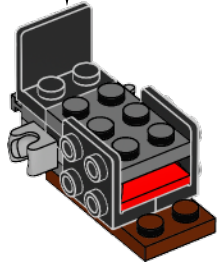
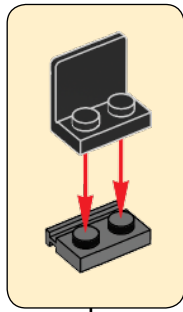

6

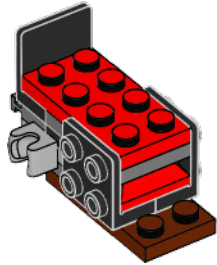

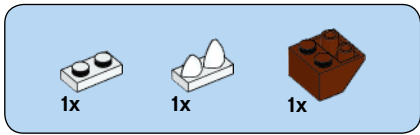

7

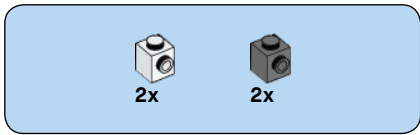
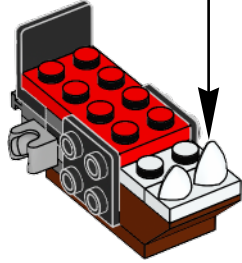
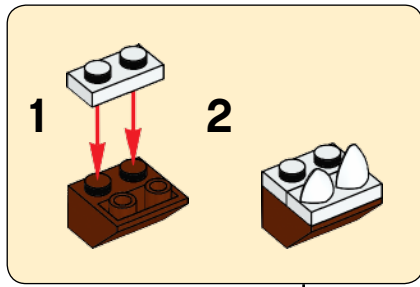

8

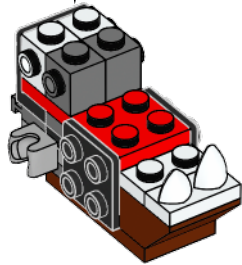
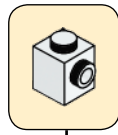

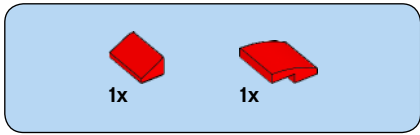

9

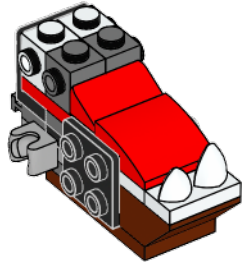

10

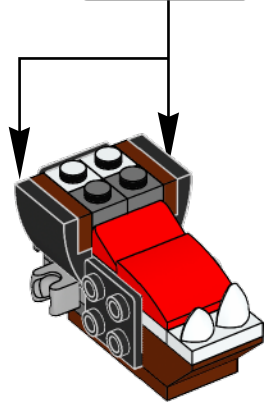
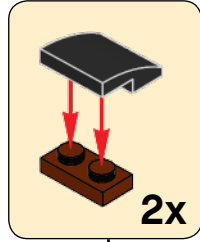



2x

# 11

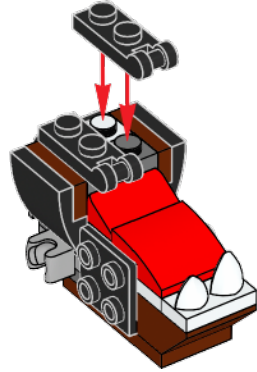

2x

# 12

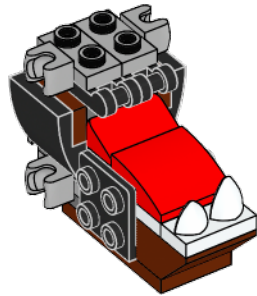



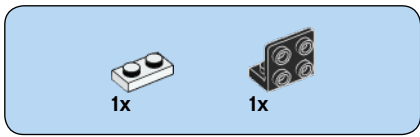

13

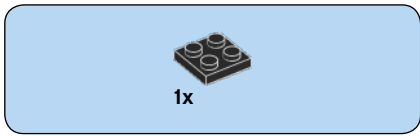
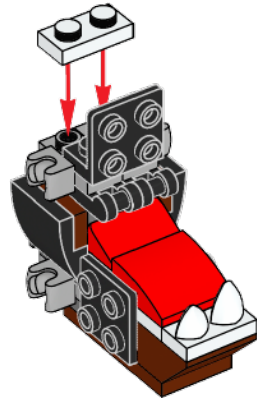

14

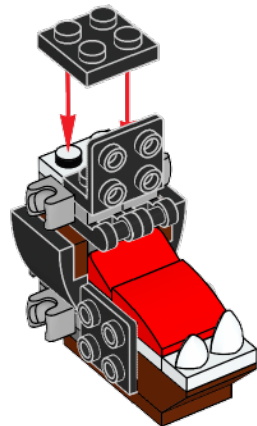

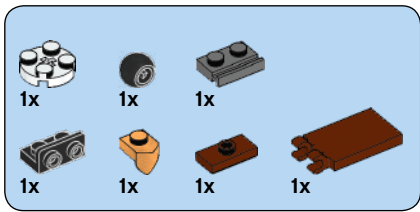

# 15

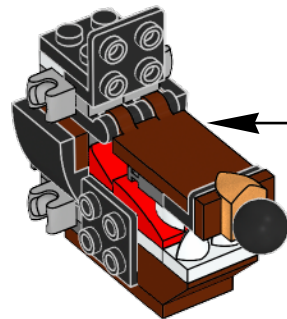
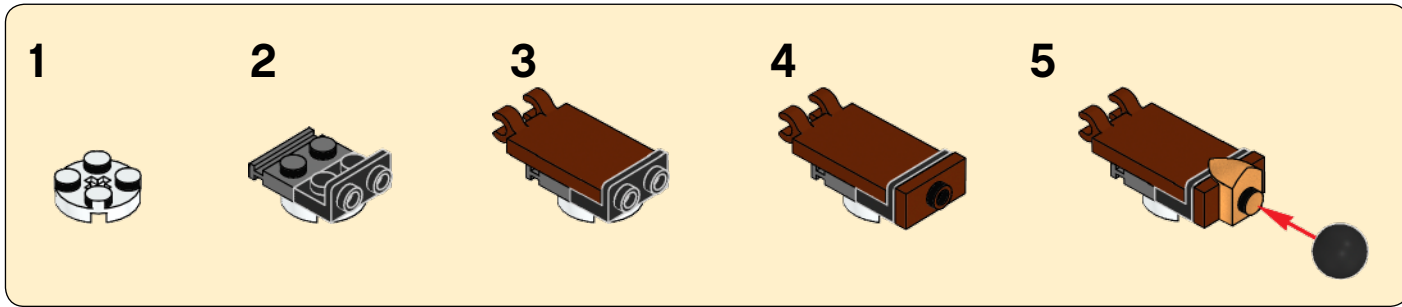

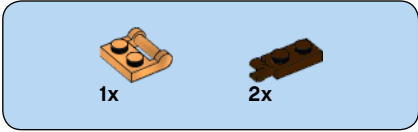

16

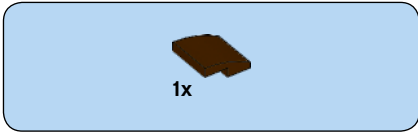
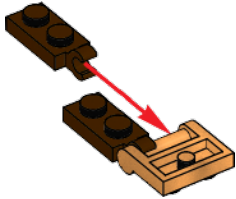

17

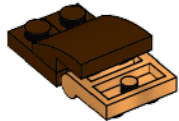

18

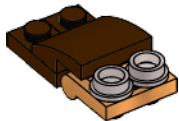



2x

19



2x

20

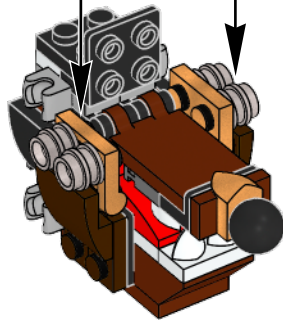

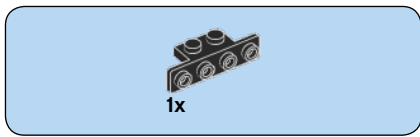

21

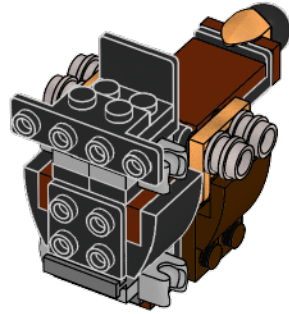
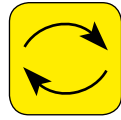

22

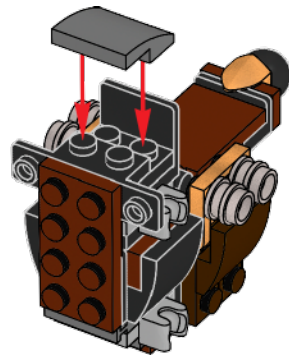



# 23

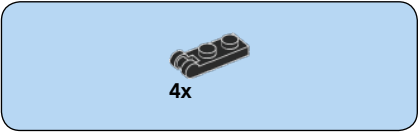
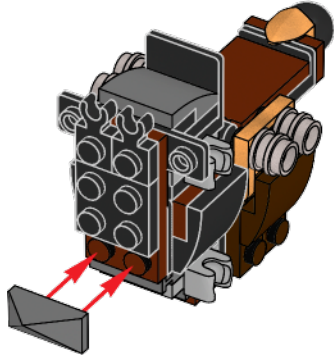

# 24

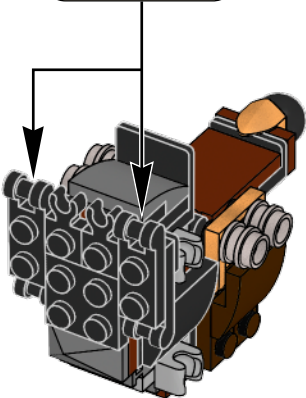
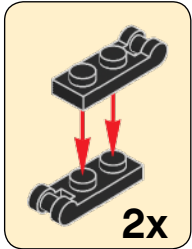

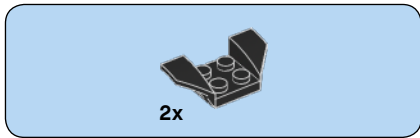

25

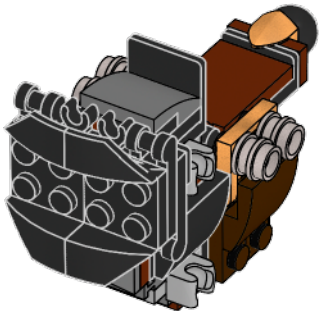

26

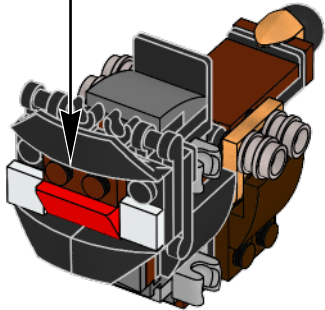

4x

# 27

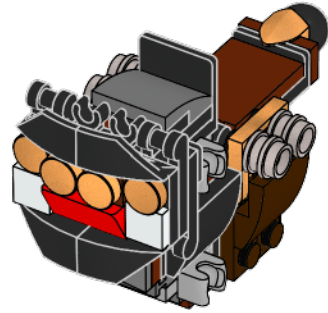

1x

2x

# 28



1



2

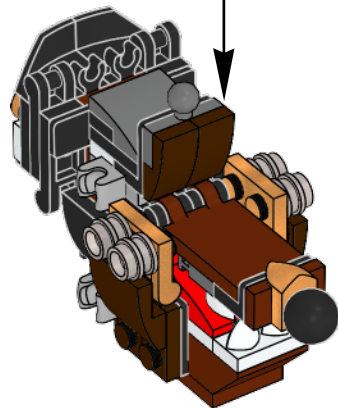
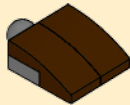



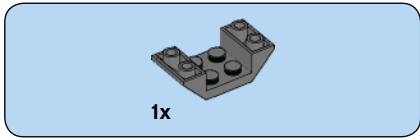
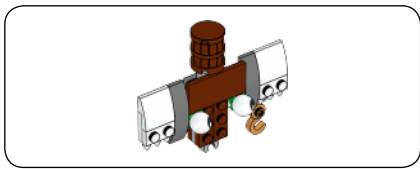

29

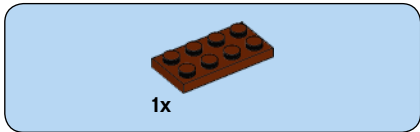
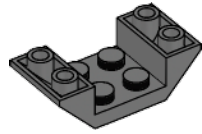

30

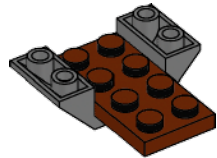

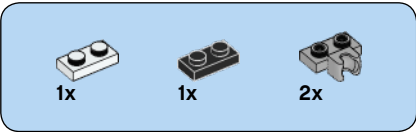

# 31

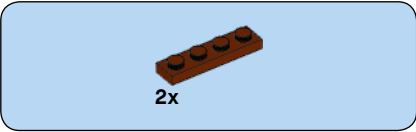
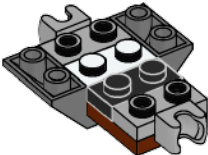

# 32

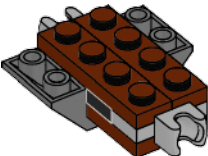

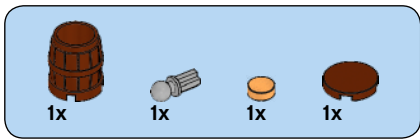

# 33

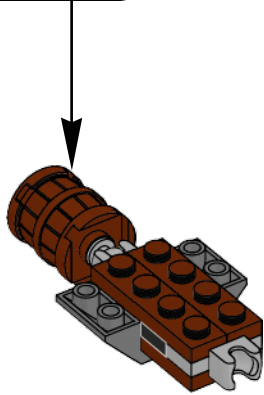
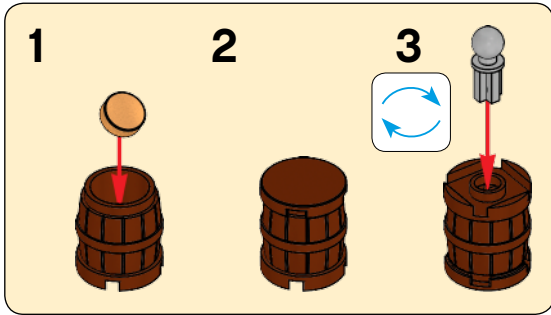

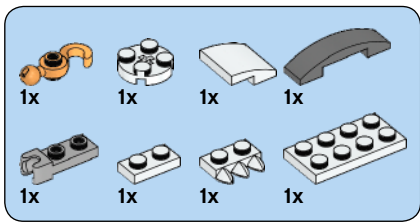

# 34

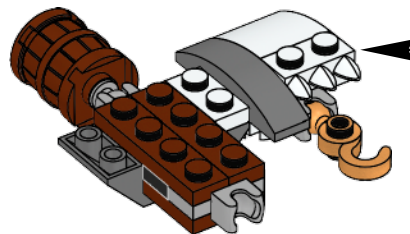
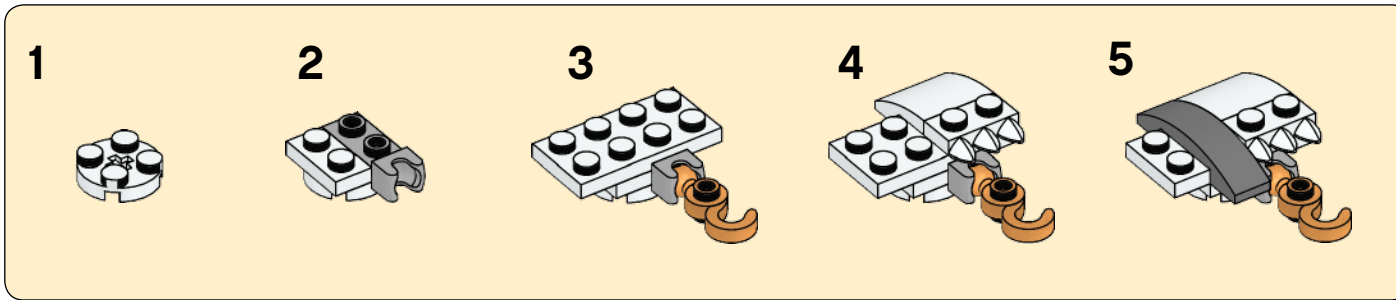

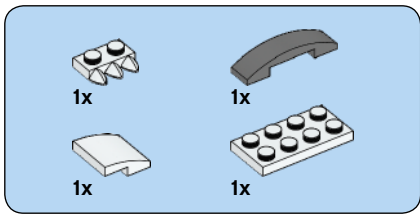

# 35

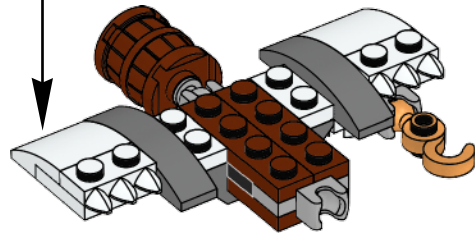
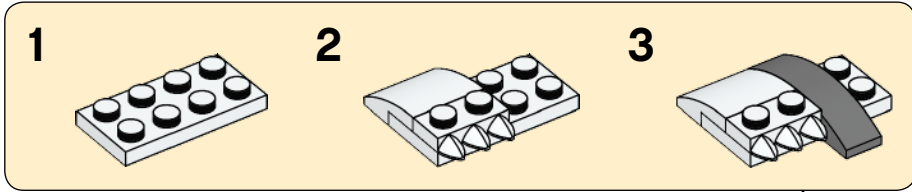

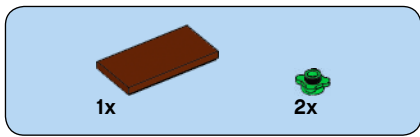

36

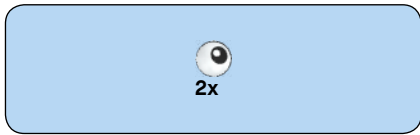
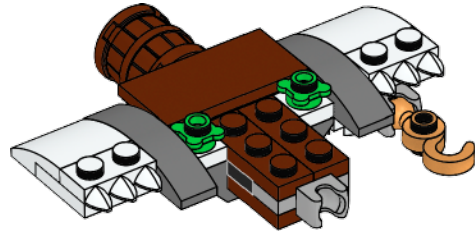

37

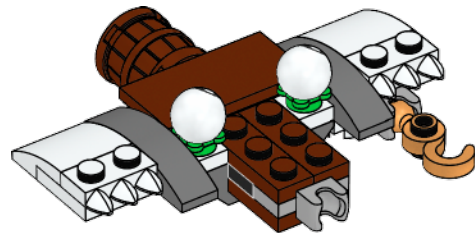

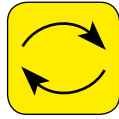

38

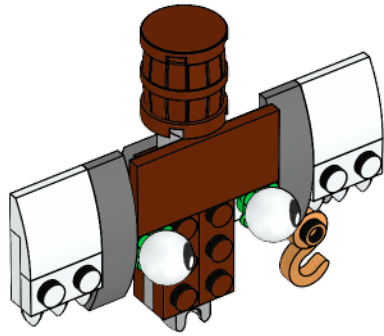

39

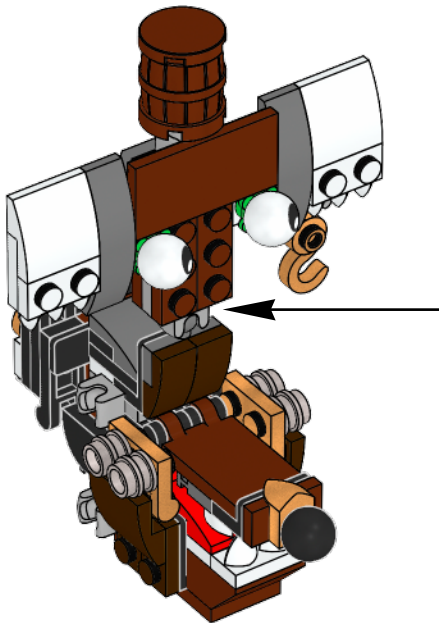

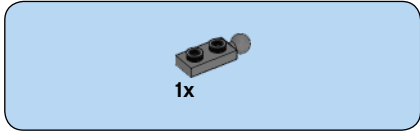
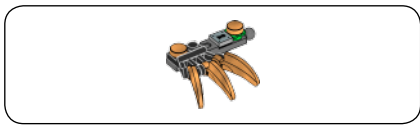

40

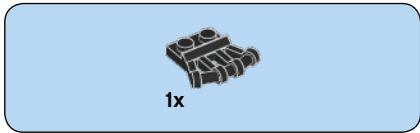
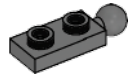

41

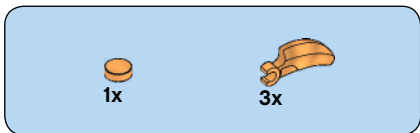

42





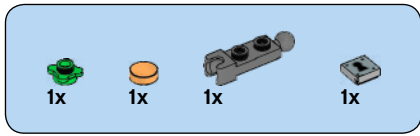

43

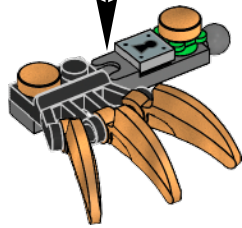
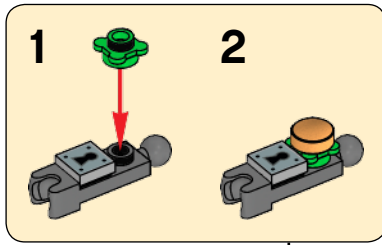

44

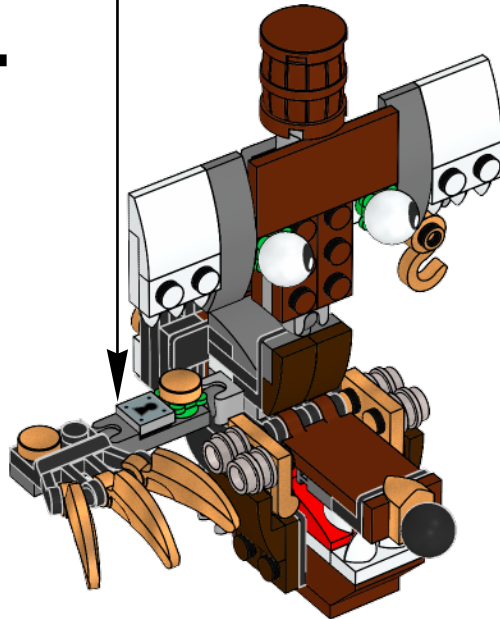

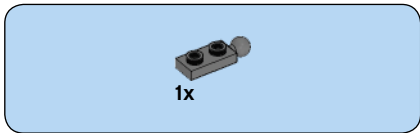
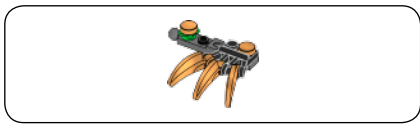

45

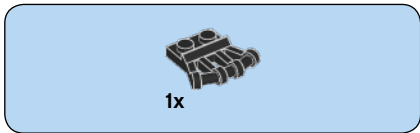

46

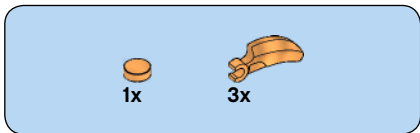

47



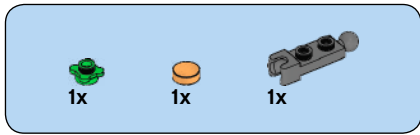

48

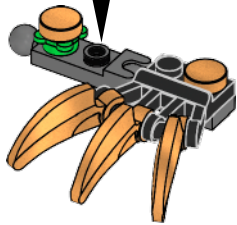
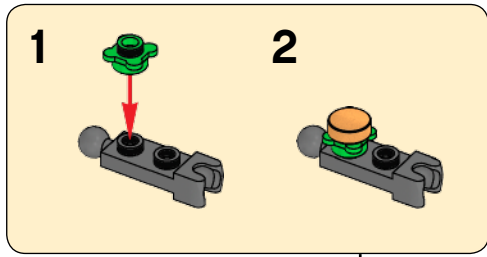

49

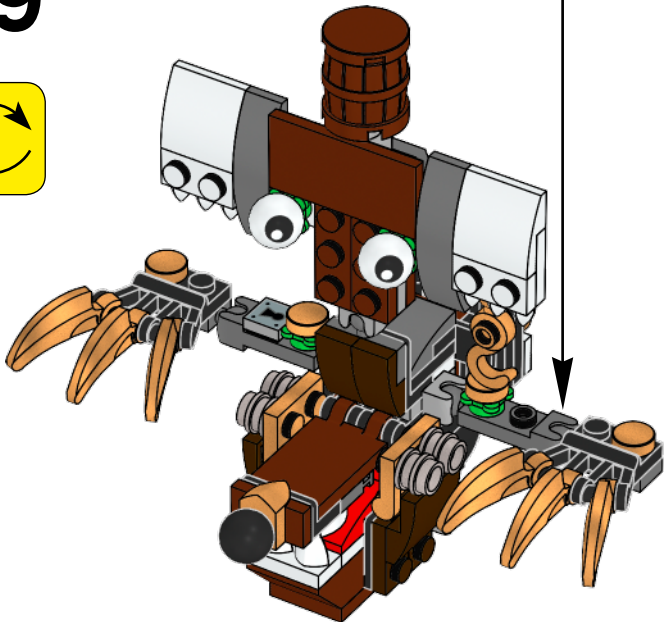
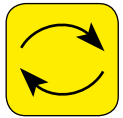



1x

1x

# 50

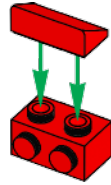

1x

# 51

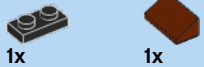
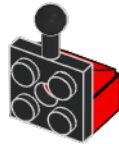

1x

1x

# 52

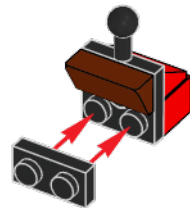

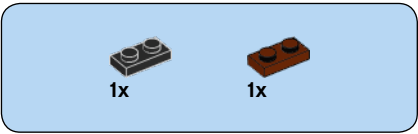

53

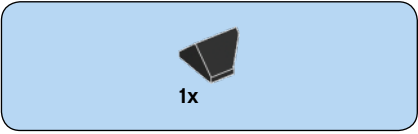
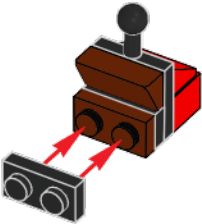

54

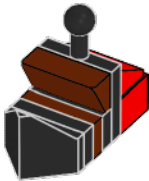

55

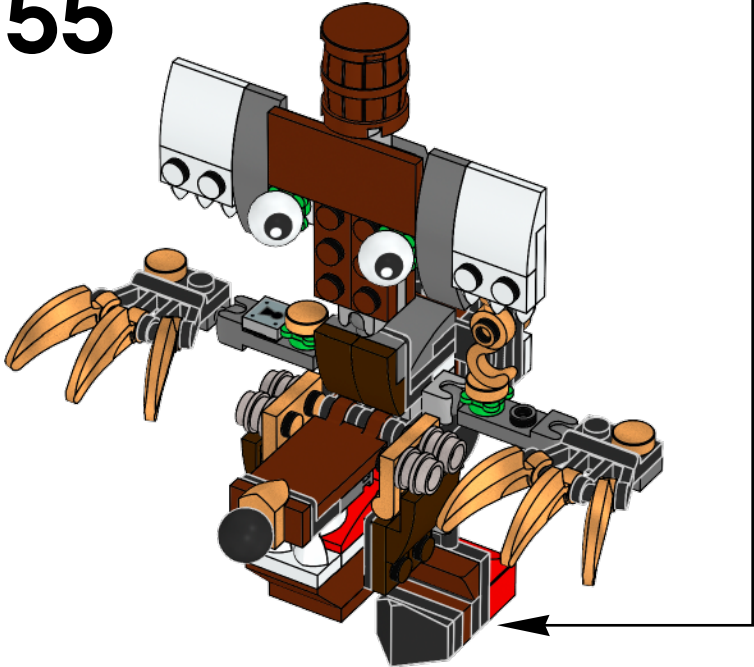

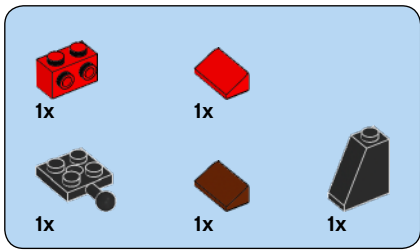

56

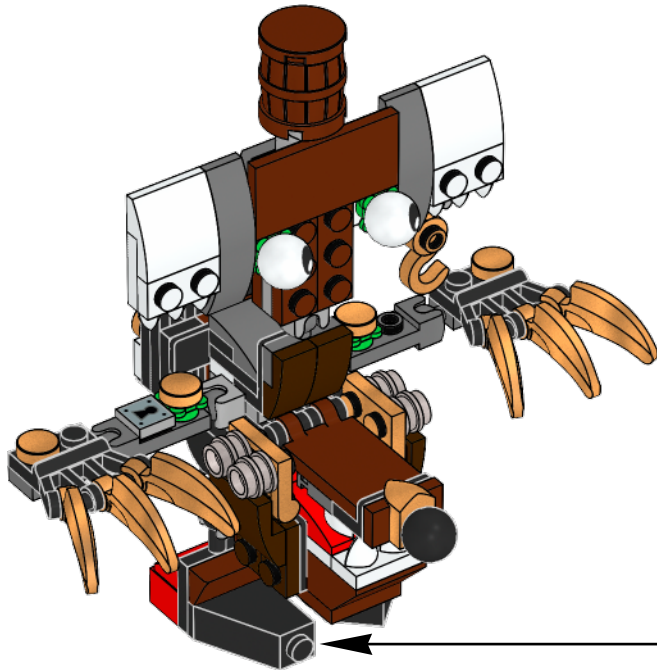
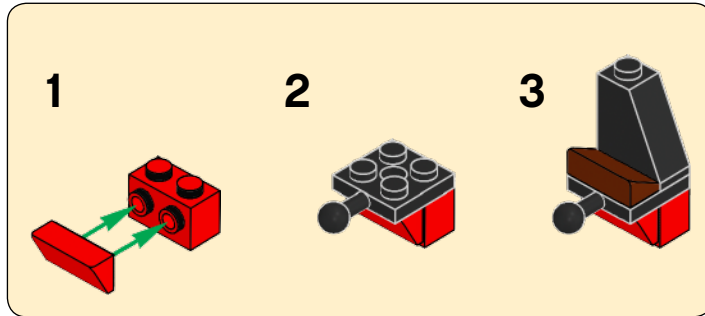

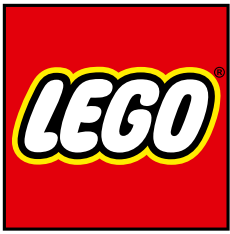

LEGO, the LEGO logo, MIXELS and the MIXELS logo are trademarks and/or copyrights of the/sont des marques de commerce et/ou copyrights du/son marcas registradas, algunas de ellas protegidas por derechos de autor, de LEGO Group.  
©2016 The LEGO Group. All rights reserved/Tous droits réservés/Todos los derechos reservados.