



Friends

41748



1



Get excited about our new packaging!

We're switching from plastic to paper-based packaging. That's why you might find a mix of paper and plastic in our boxes!

Nos nouveaux emballages vous emballeront !

Nous passons des emballages en plastique aux emballages à base de papier. C'est pourquoi vous pourriez trouver un mélange de papier et de plastique dans nos boîtes !

¡Te presentamos nuestros nuevos empaques!

Estamos sustituyendo las bolsas de plástico por bolsas con base de papel. ¡Por eso, puedes encontrar una mezcla de papel y de plástico en nuestras cajas!

[LEGO.com/sustainable-packaging](https://www.lego.com/sustainable-packaging)



BUILDER



Apple and the Apple logo are trademarks of Apple Inc., registered in the U.S. and other countries and regions. App Store is a service mark of Apple Inc. Google Play and the Google Play logo are trademarks of Google LLC. Tencent and the Tencent logo are trademarks of Tencent Inc.

Q [LEGO.com/devicecheck](https://www.lego.com/devicecheck)

EN Ask parents' permission before going online | DE Eltern um Erlaubnis bitten, bevor du online gehst | FR Demande l'autorisation d'un parent avant d'aller en ligne | IT Chiedi il permesso ai tuoi genitori prima di andare online | ES Pídeles permiso a tus papás antes de conectarte a Internet | PT Peça autorização aos pais antes de acederes online | ZH 上网前应先征得父母的同意 | PL Poproś rodziców o zgodę, zanim wejdiesz do Internetu | CS Než půjdeš na internet, požádej rodiče o svolení | SK Skôr než pôjdeš na internet, vyžiď si povolenie od rodičov | HU Kérj szülői engedélyt, mielőtt online csatlakoznál! | RO Cere permisiunea părinților înainte de a te conecta online | BG Поискайте разрешение от родител, преди да влезете онлайн | LV Pirms došanās tiešsaistē palūdz atļauju vecākiem | ET Enne Interneti kasutamist küsi vanematelt luba | LT Prieš prisijungdami prie interneto, atsiklauskite tėvų

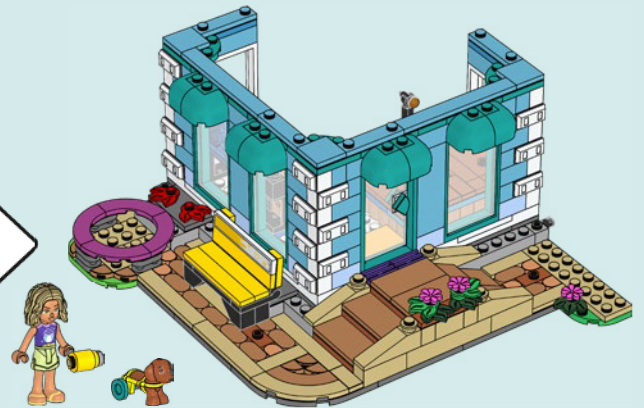
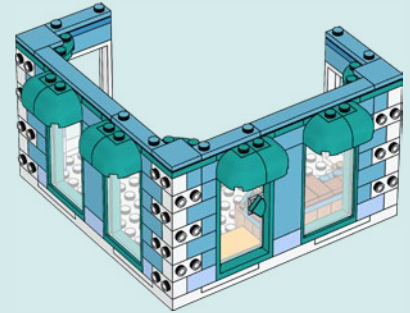
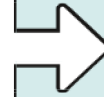
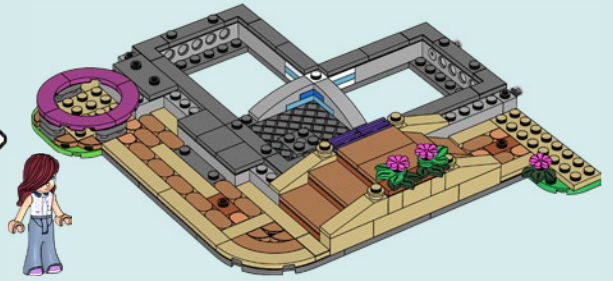
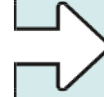
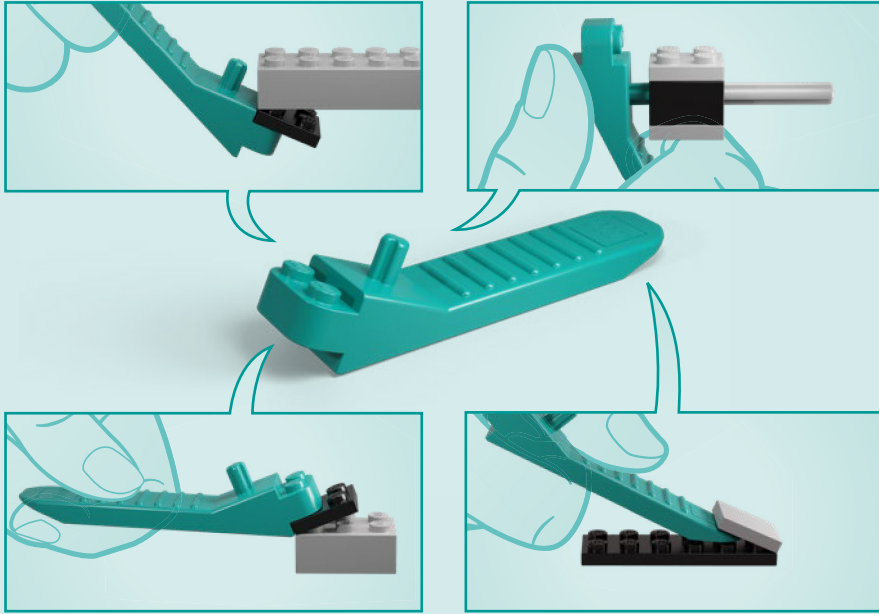



PAISLEY

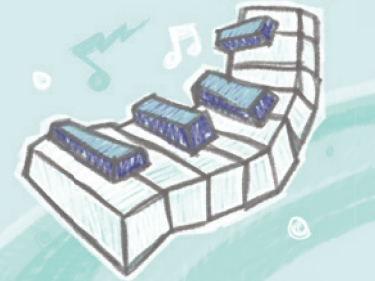
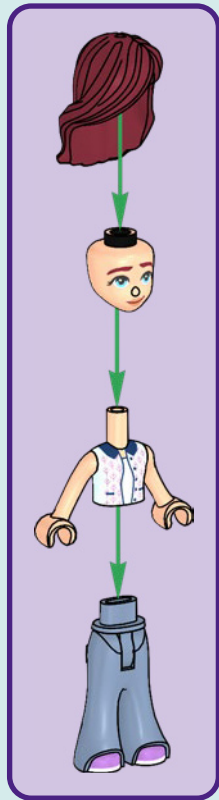



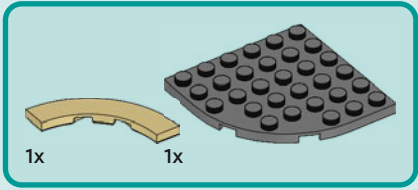
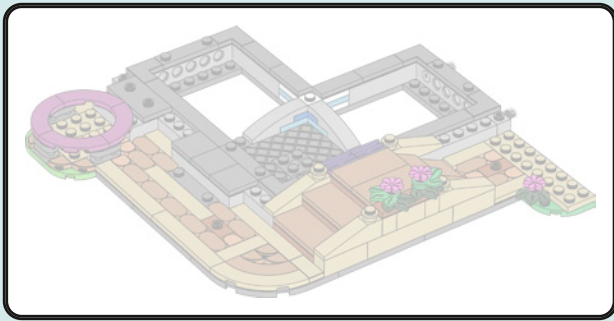

1

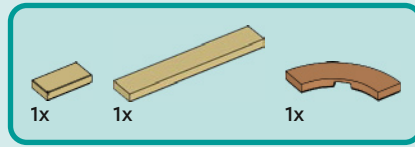
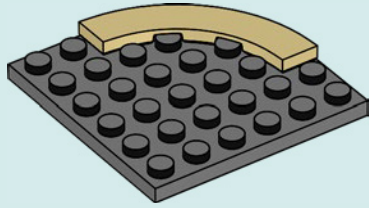

2

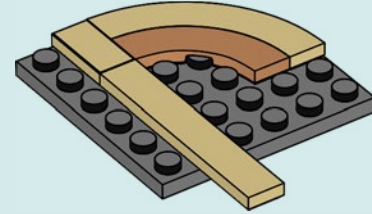

3

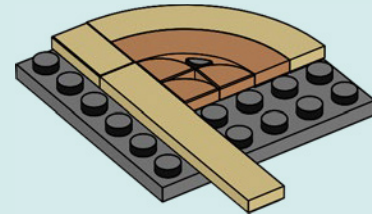

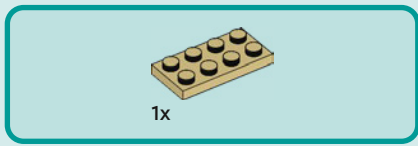

4

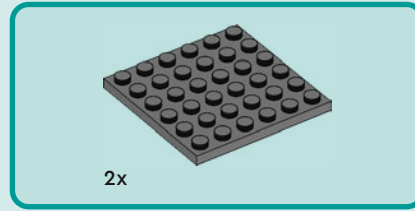
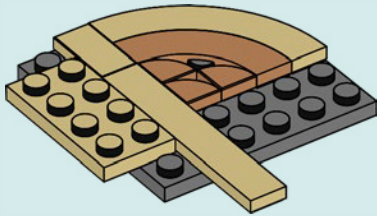

5

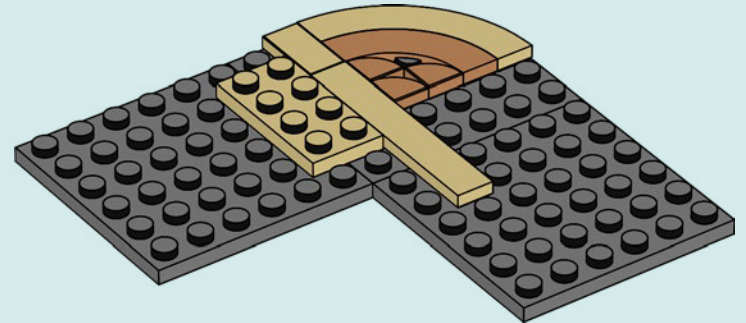

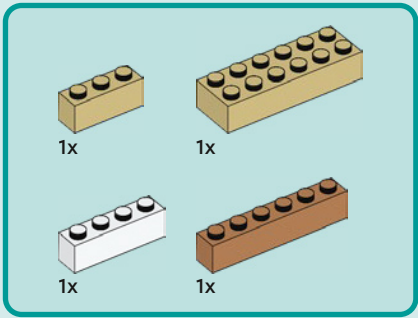

6

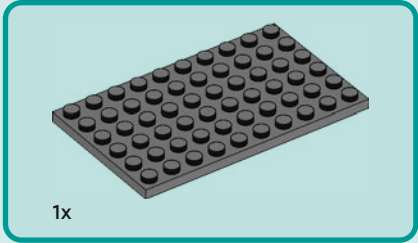
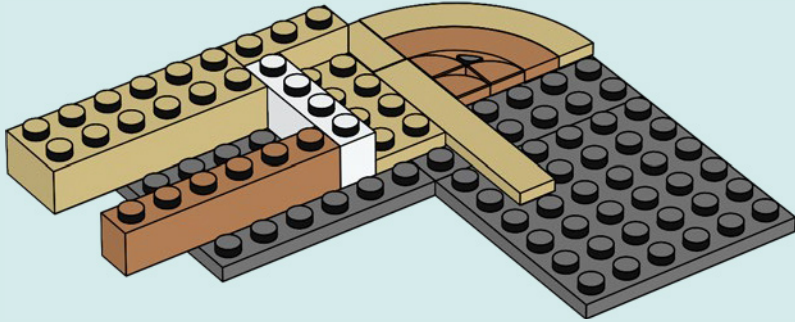

7

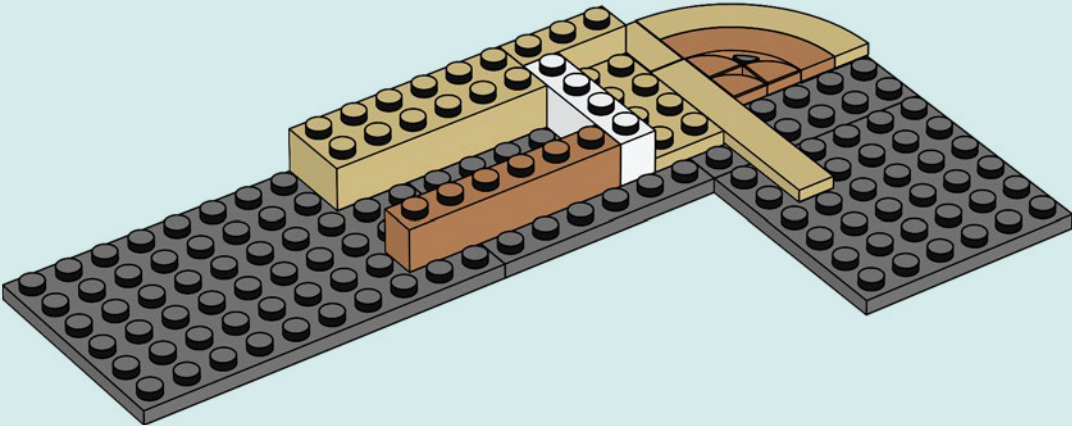

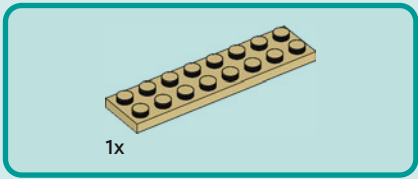

10

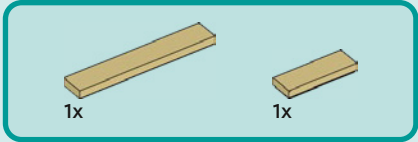
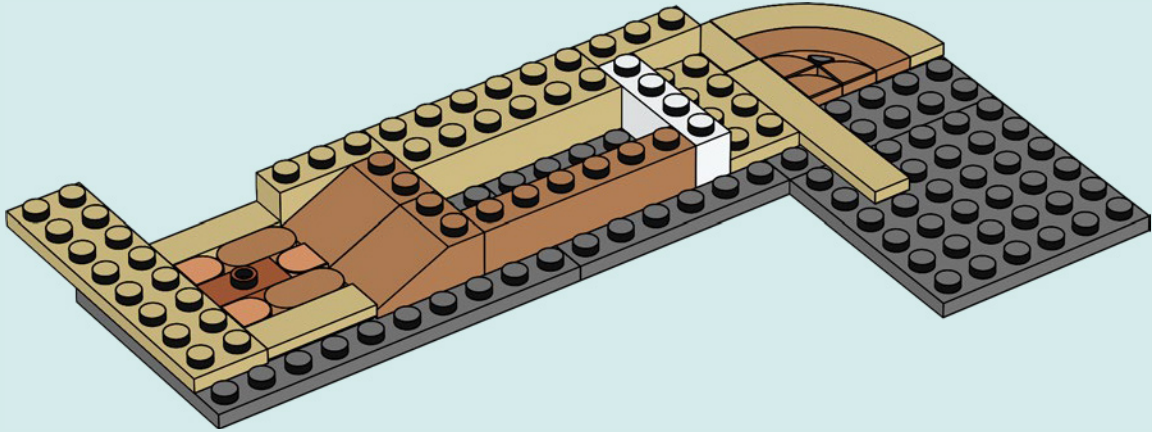

11

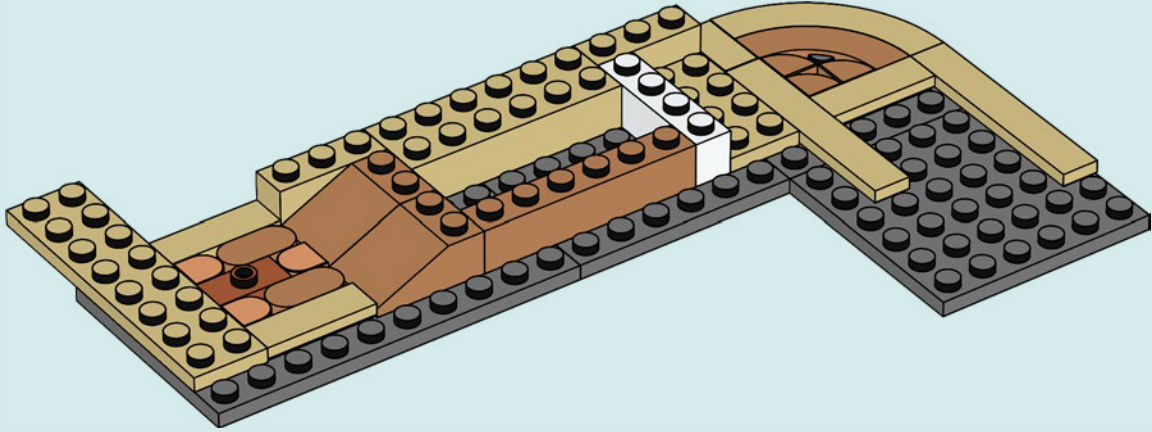

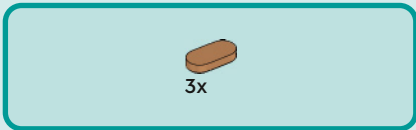

12

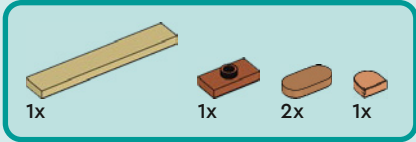
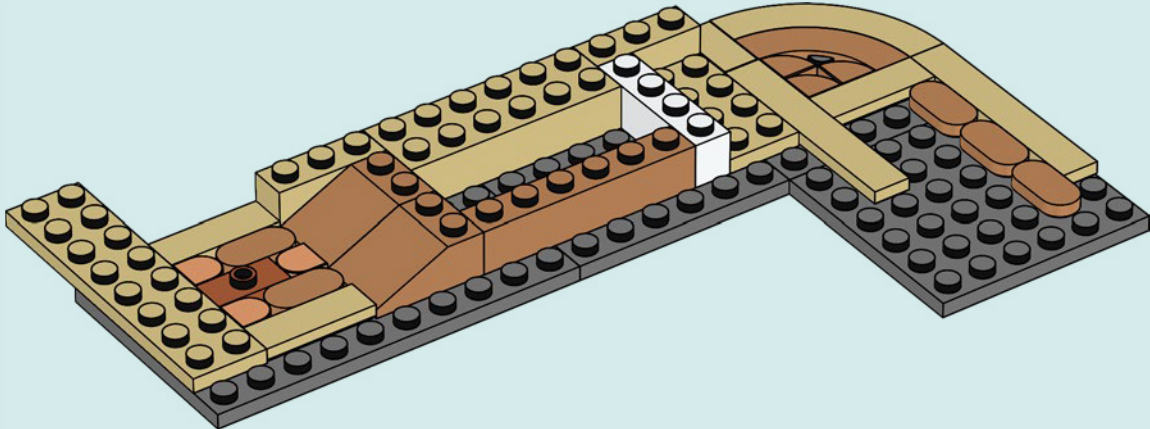

13

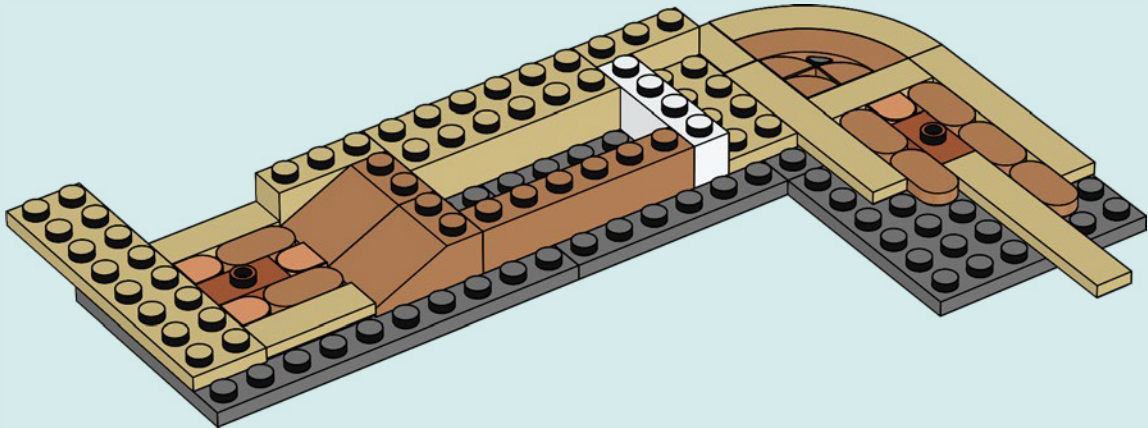

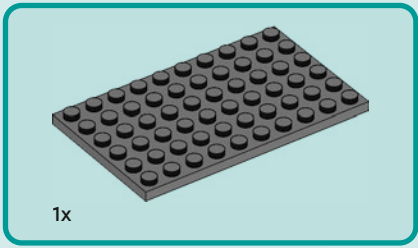

14

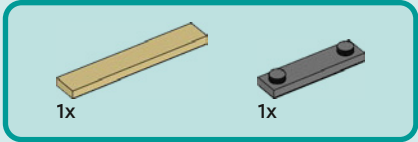
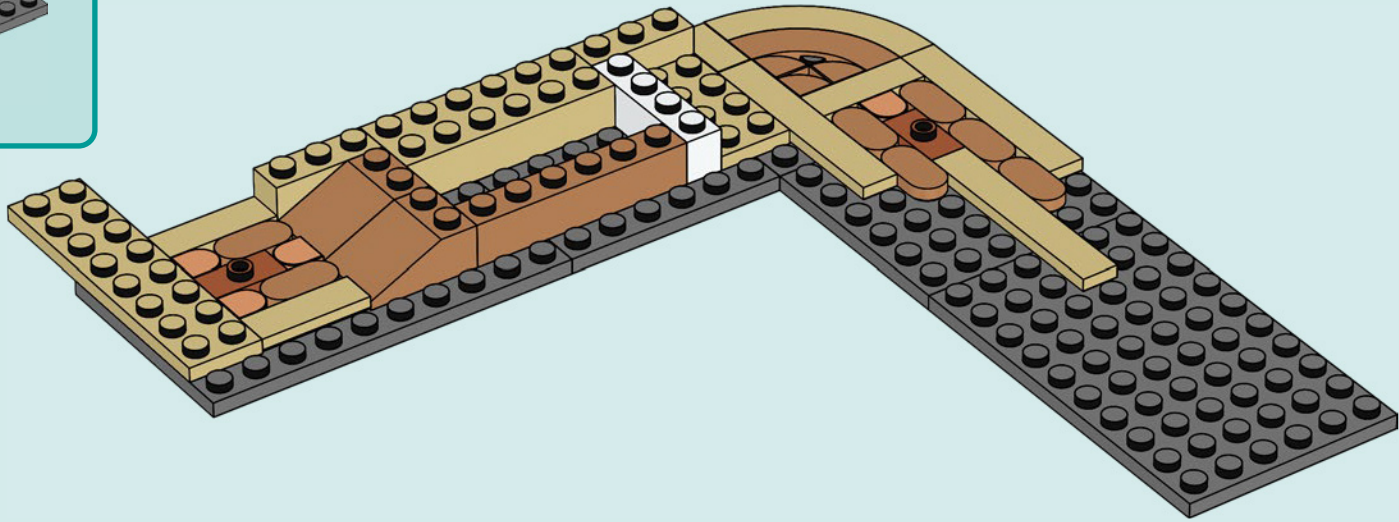

15

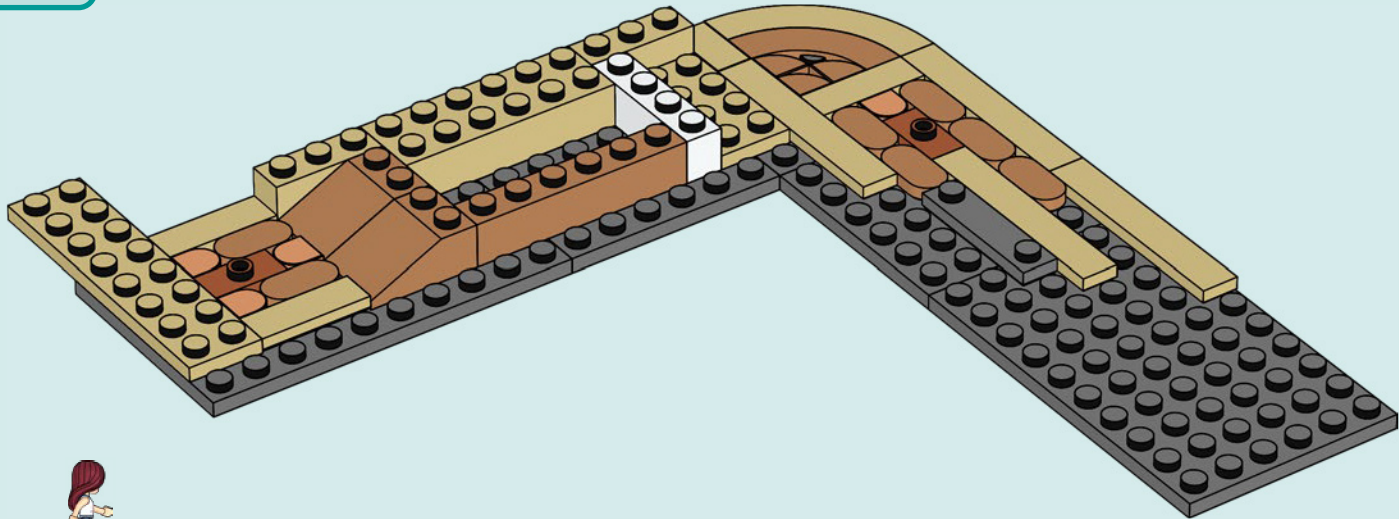

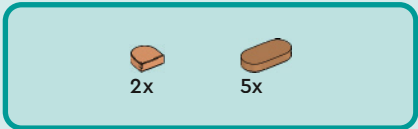

16

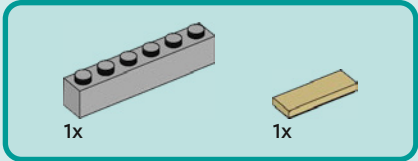
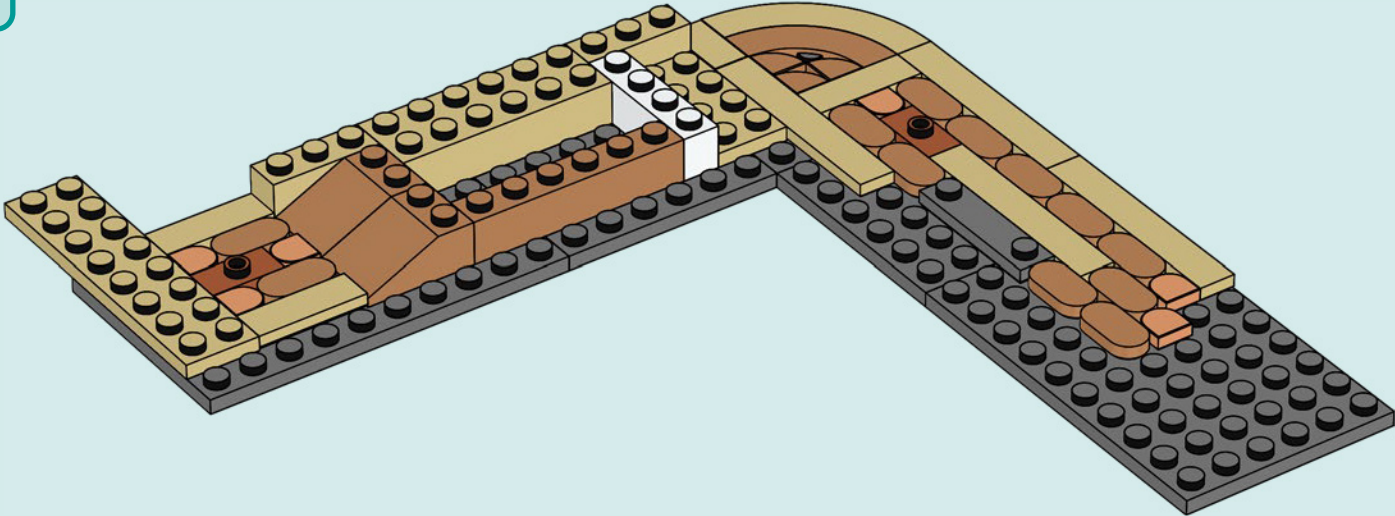

17

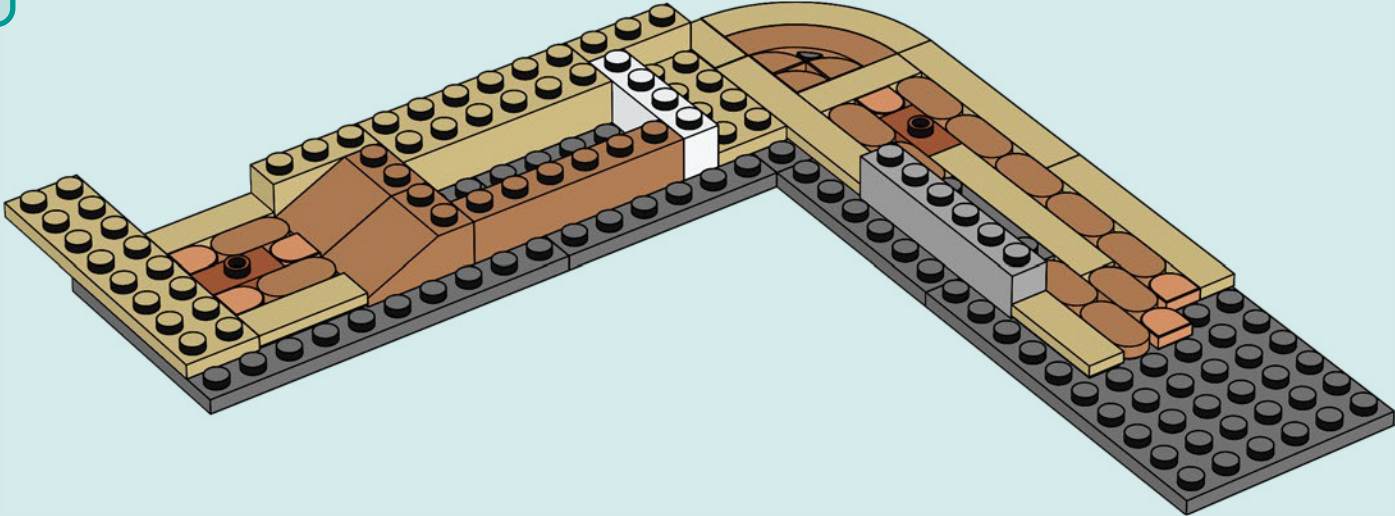



2x



2x

18

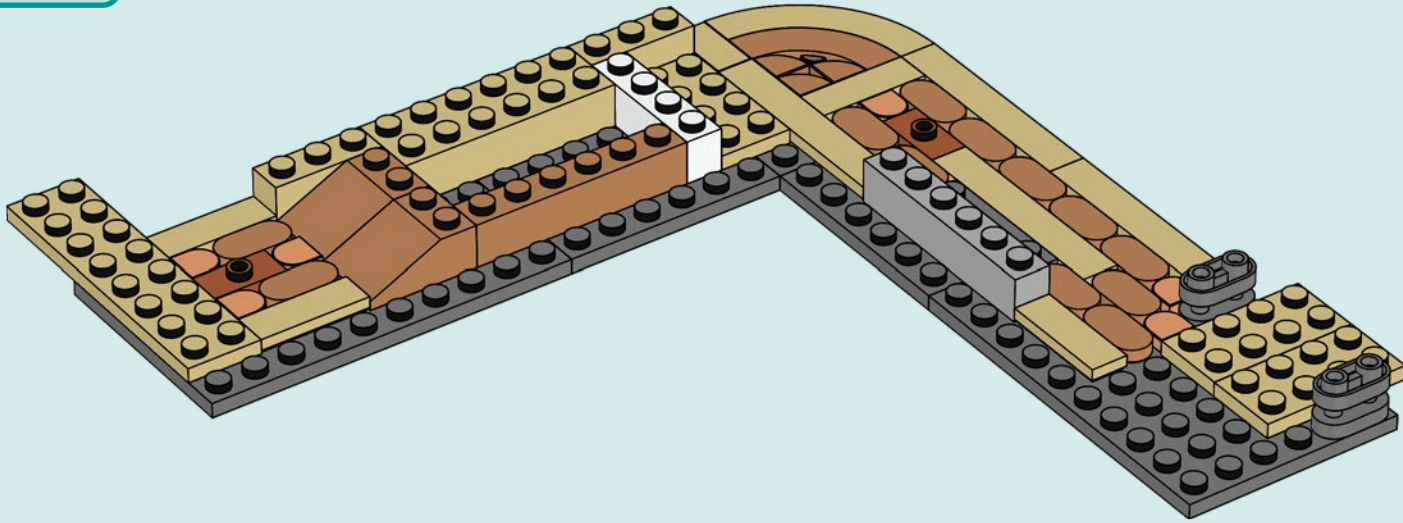

1x



1x

19

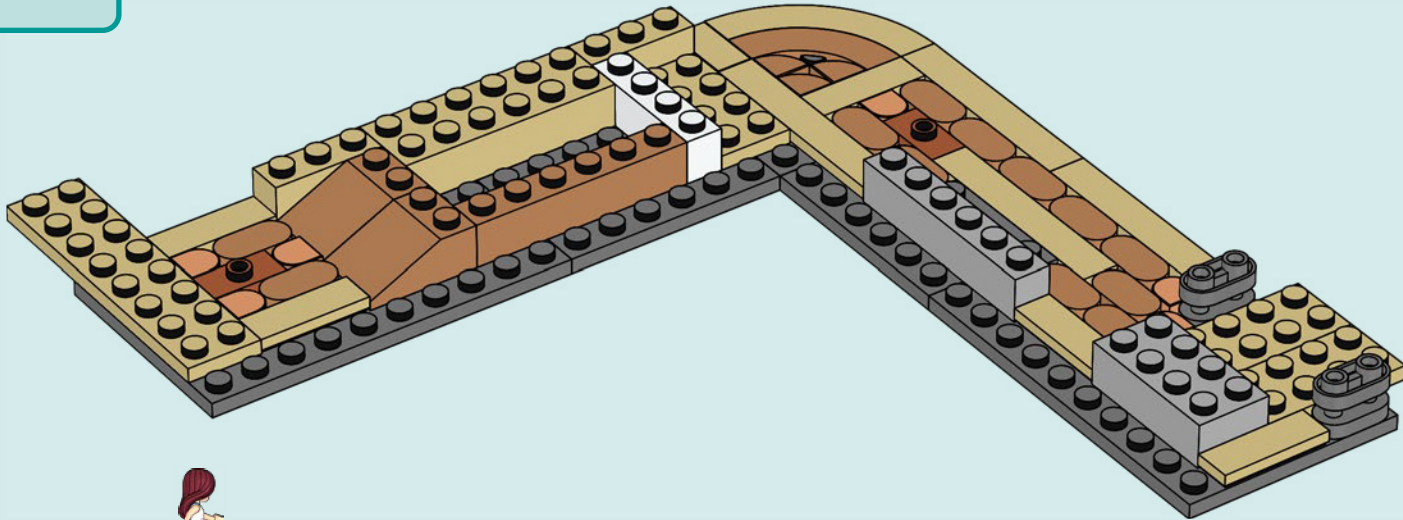

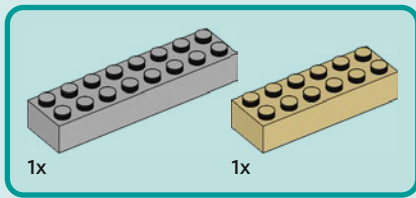

20

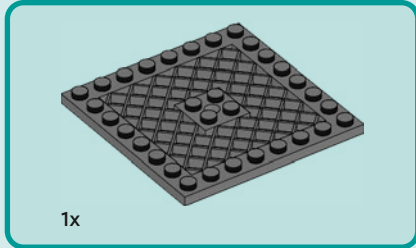
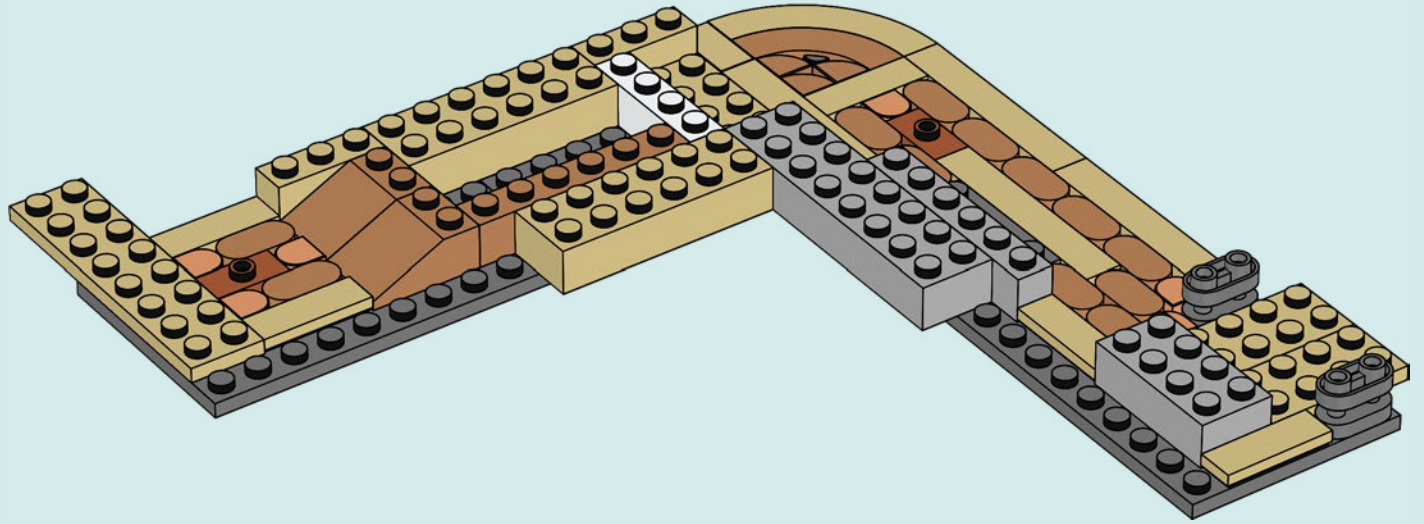

21

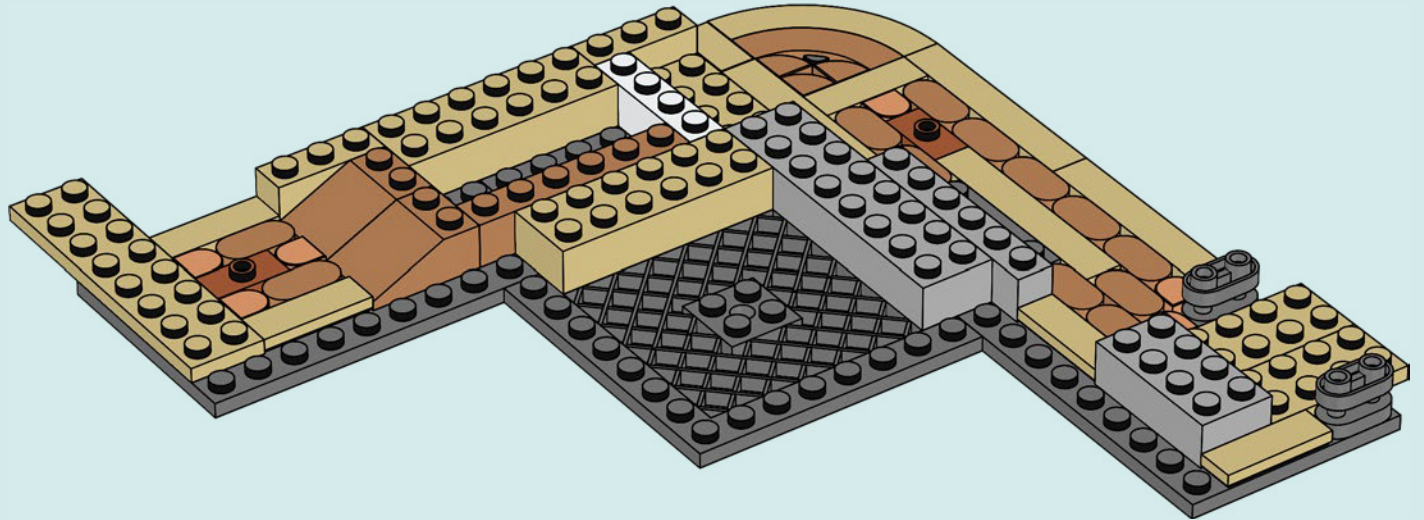

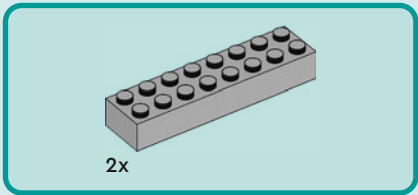

22

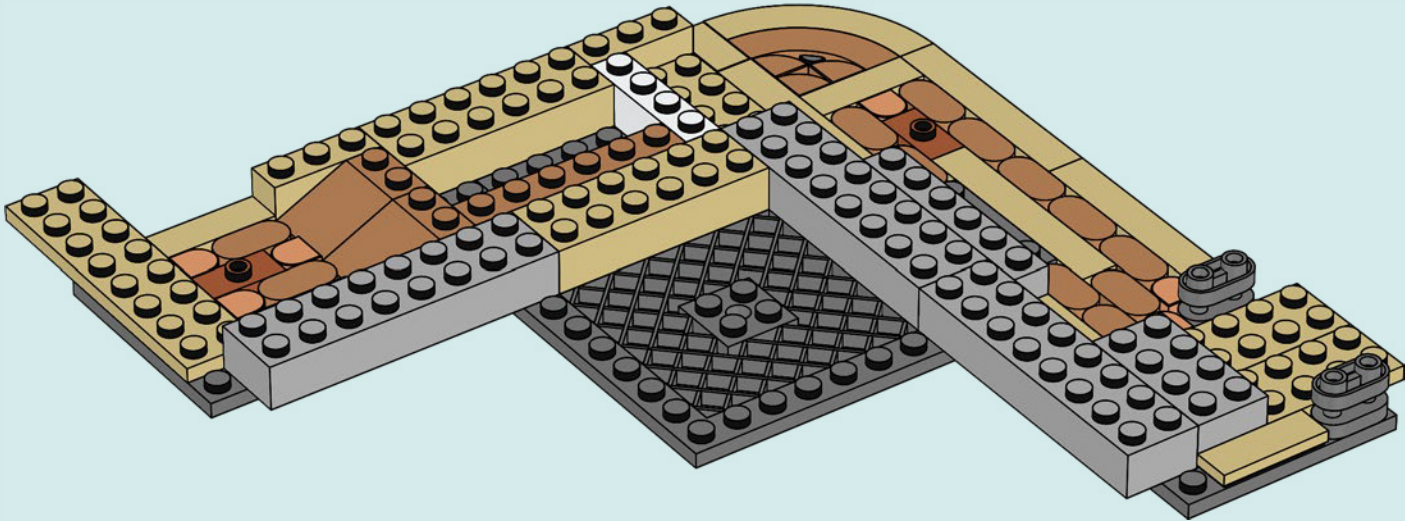

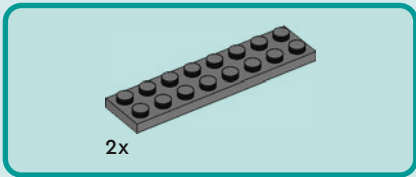

23

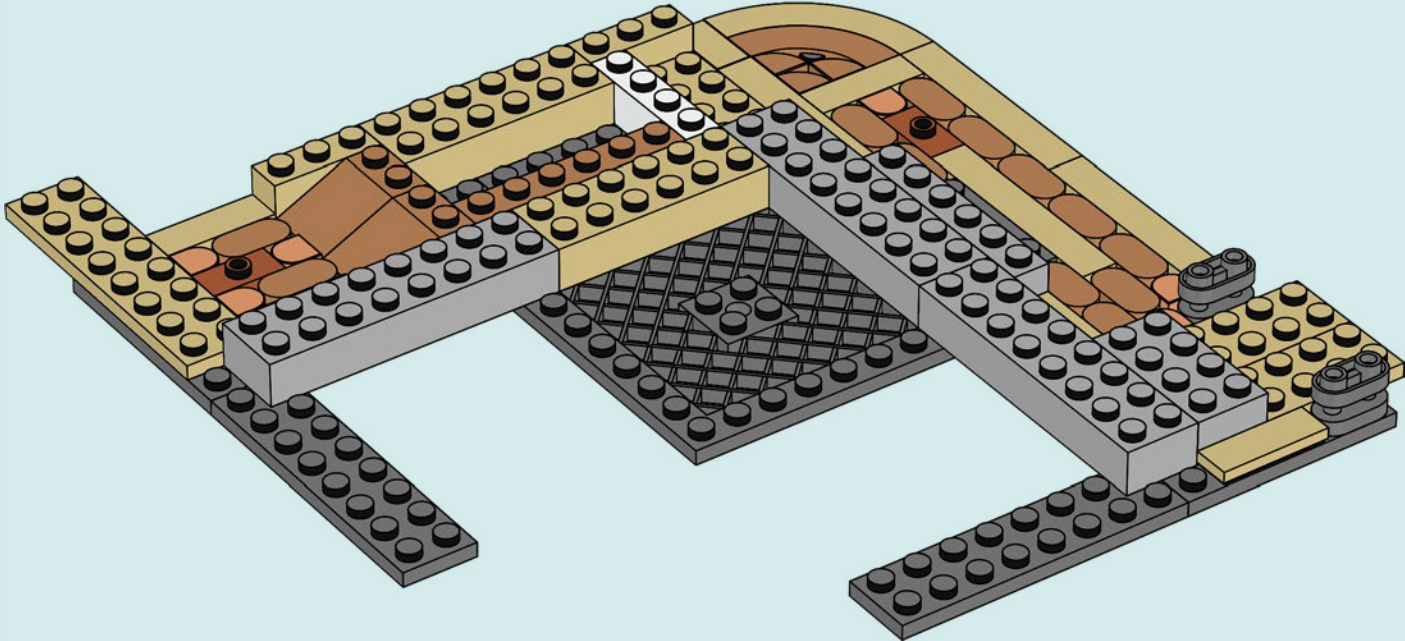

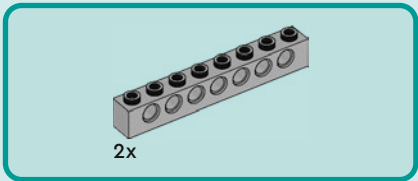

24

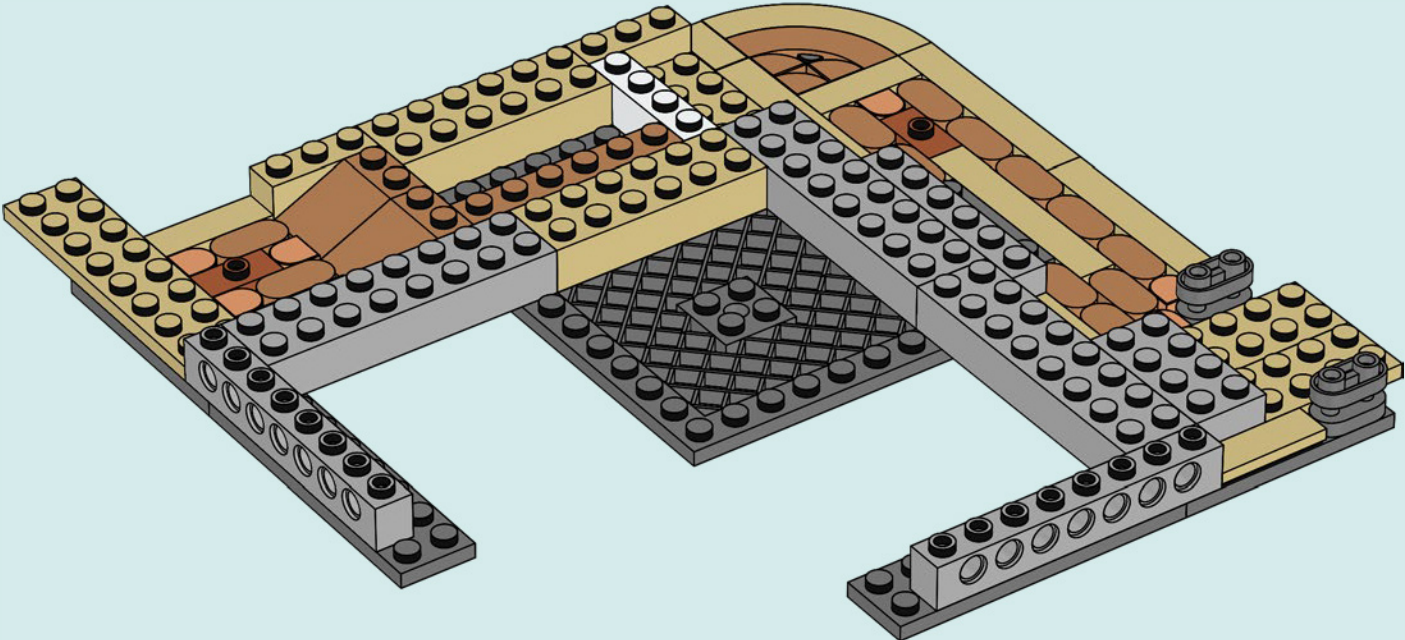

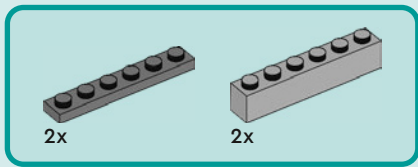

25

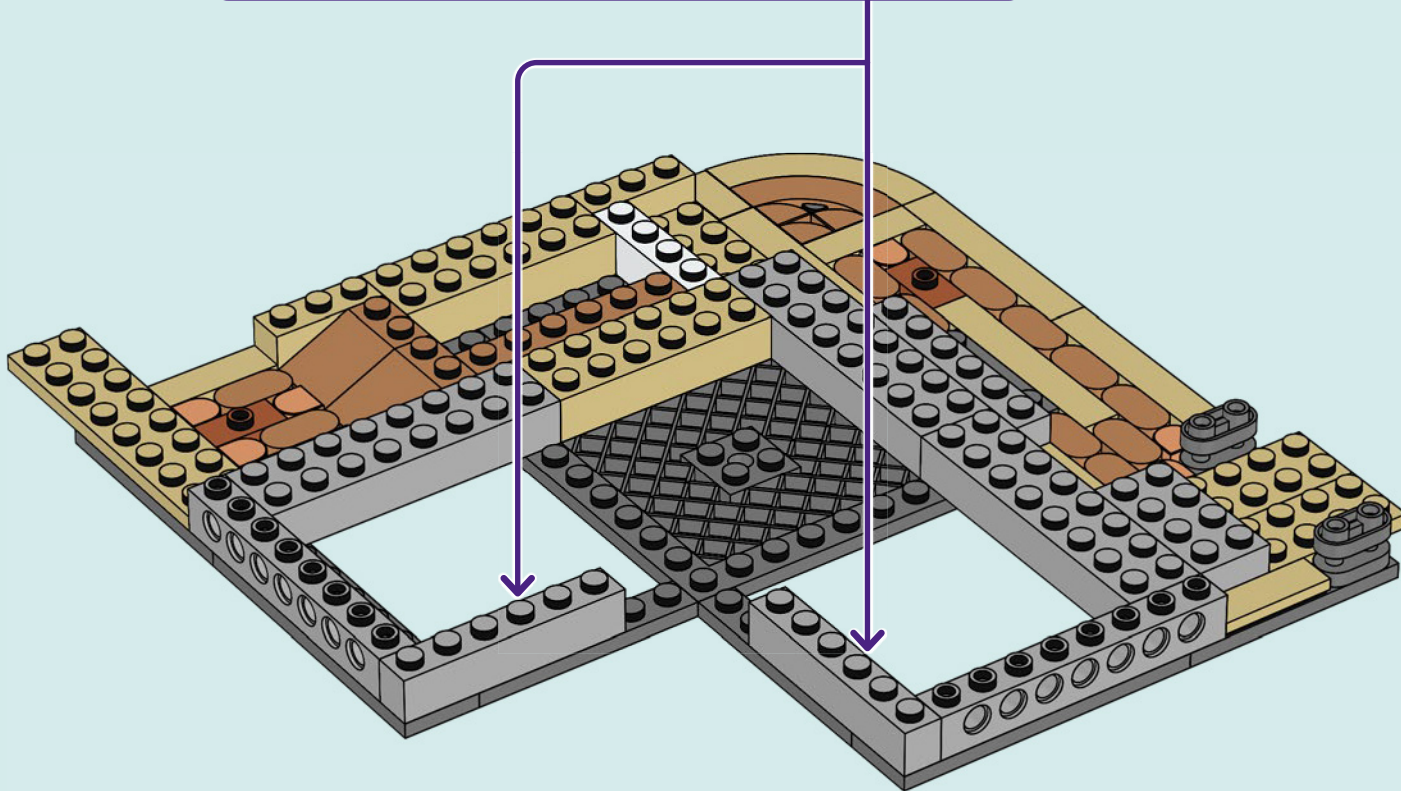
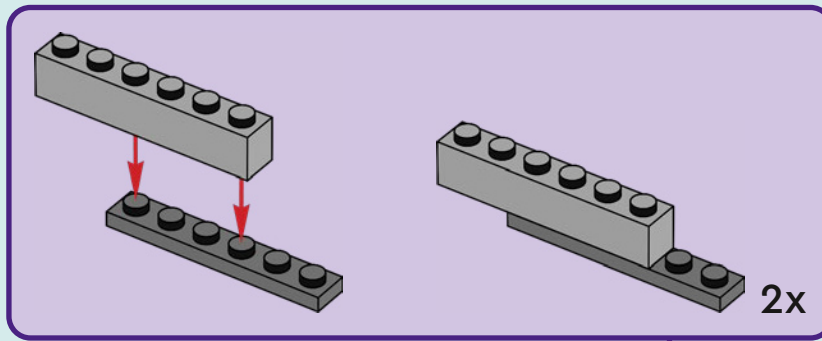



2x



1x

26

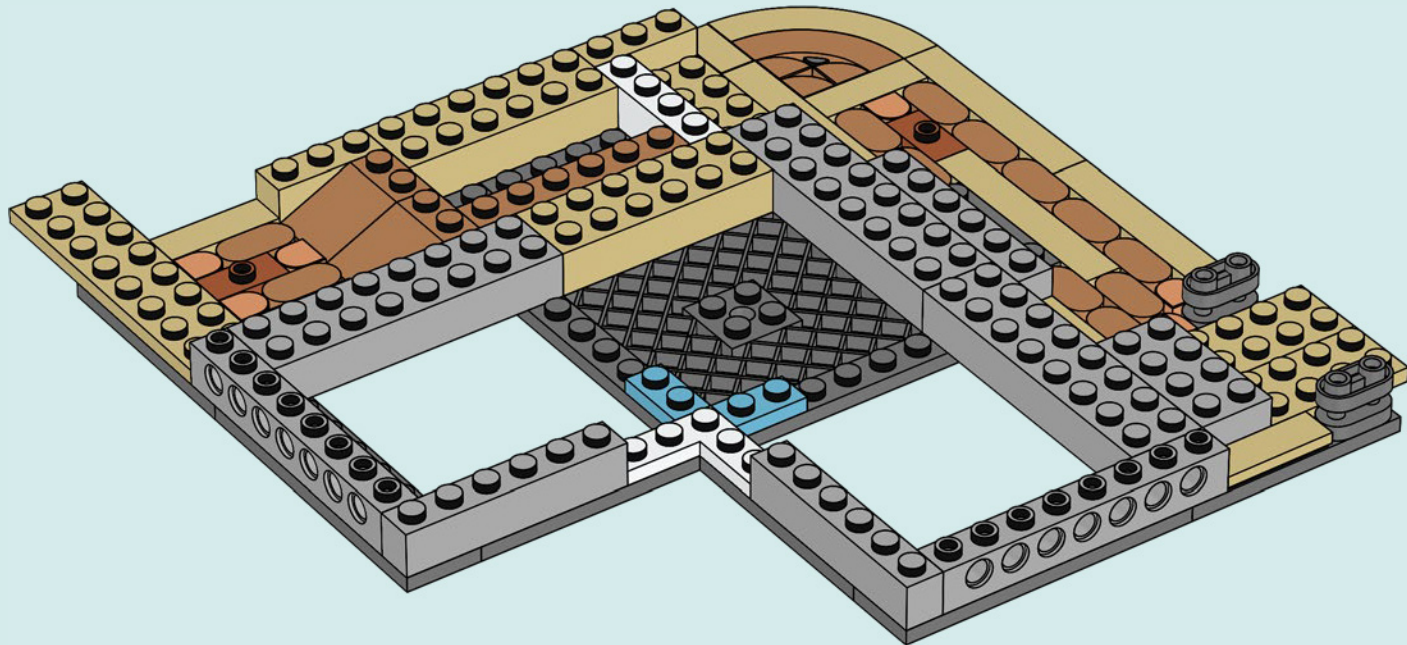



27

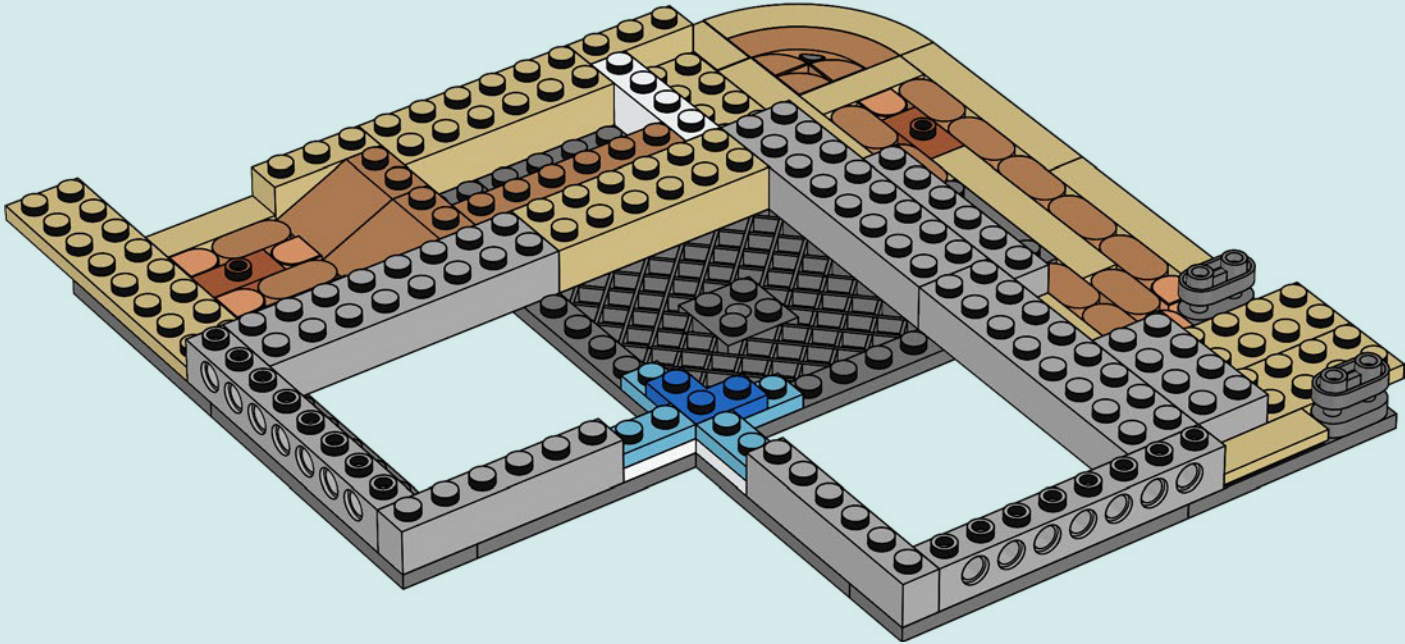

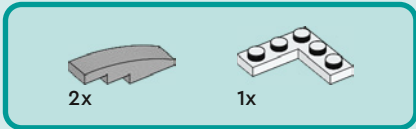

28

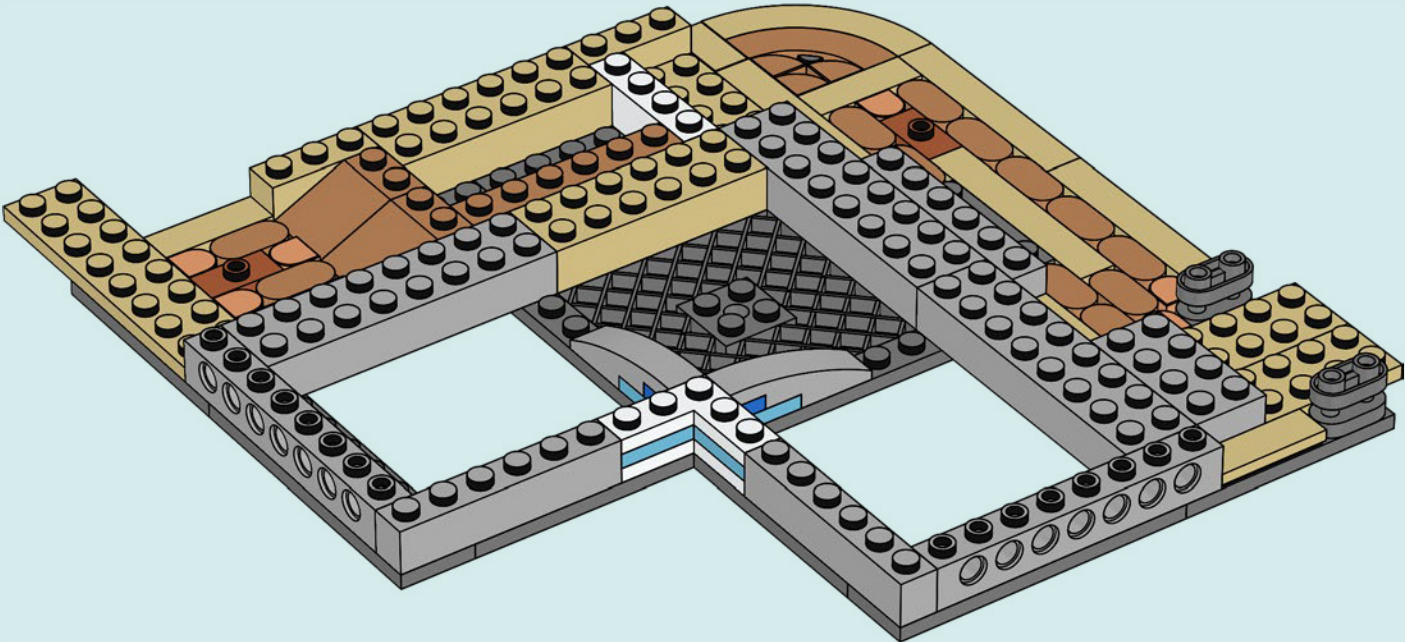

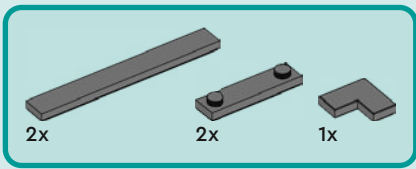

29

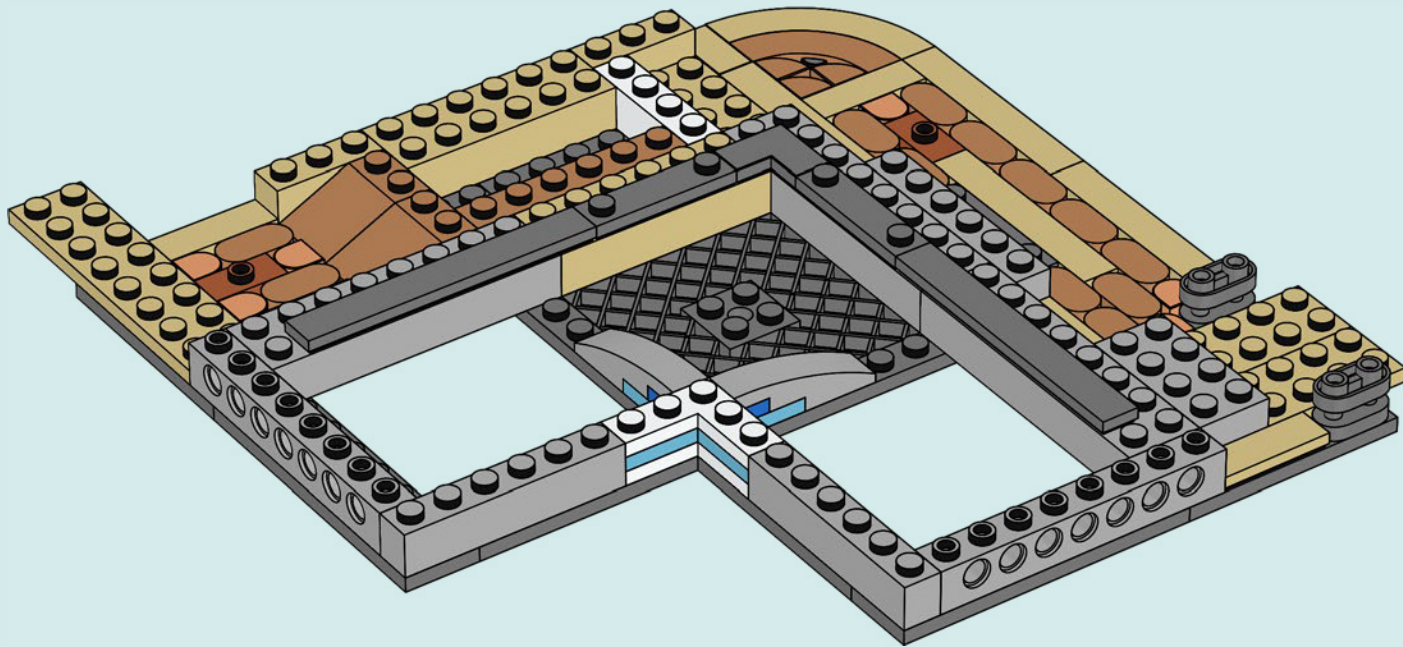



4x



2x

30

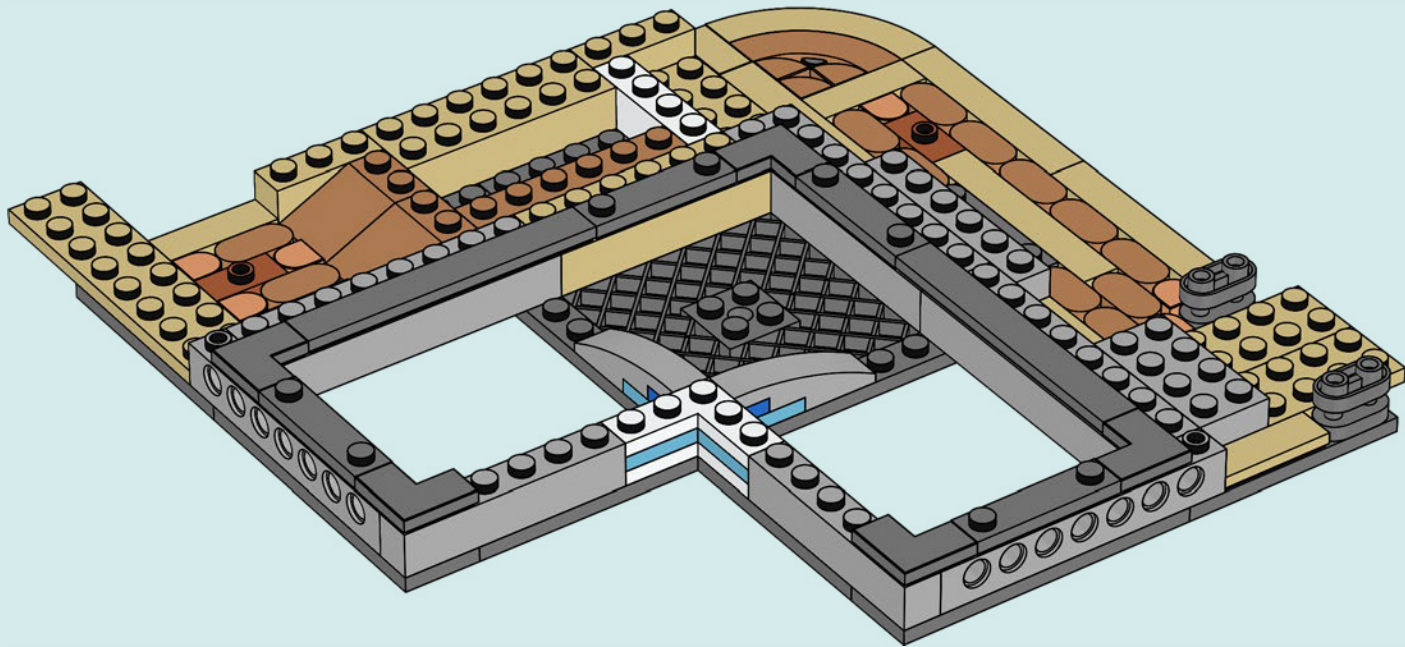

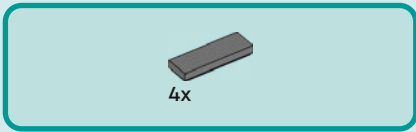

31

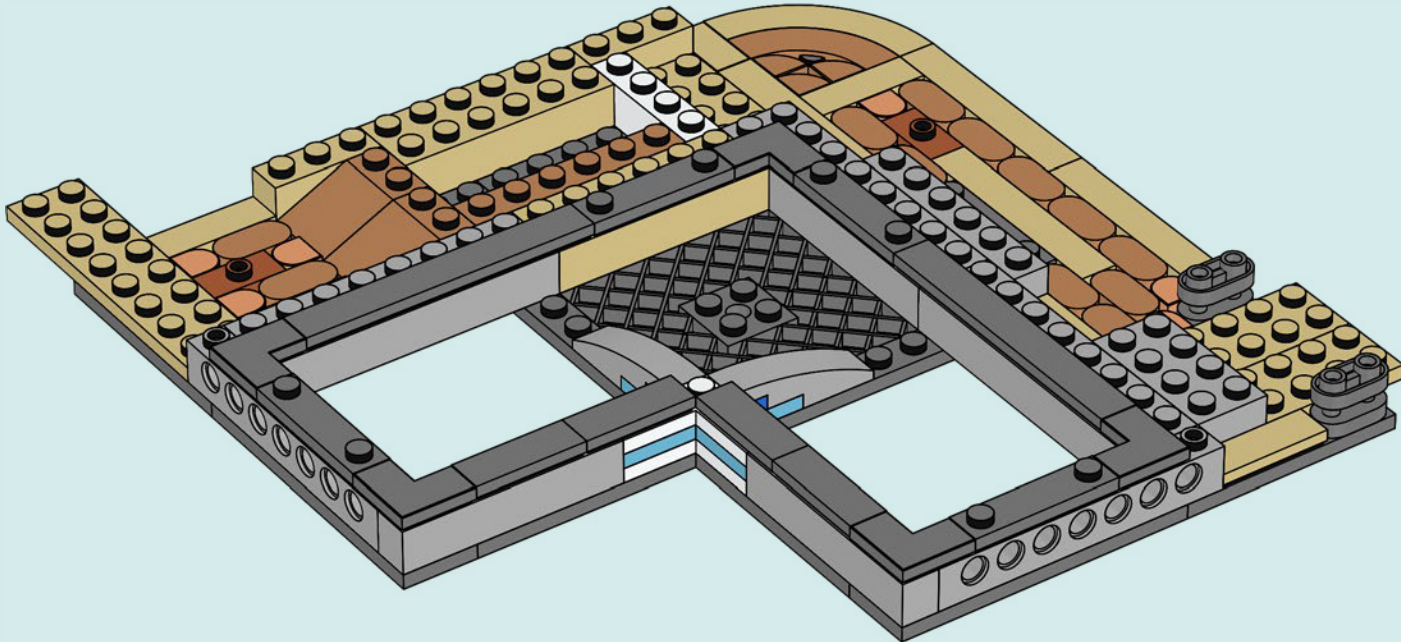



2x

32

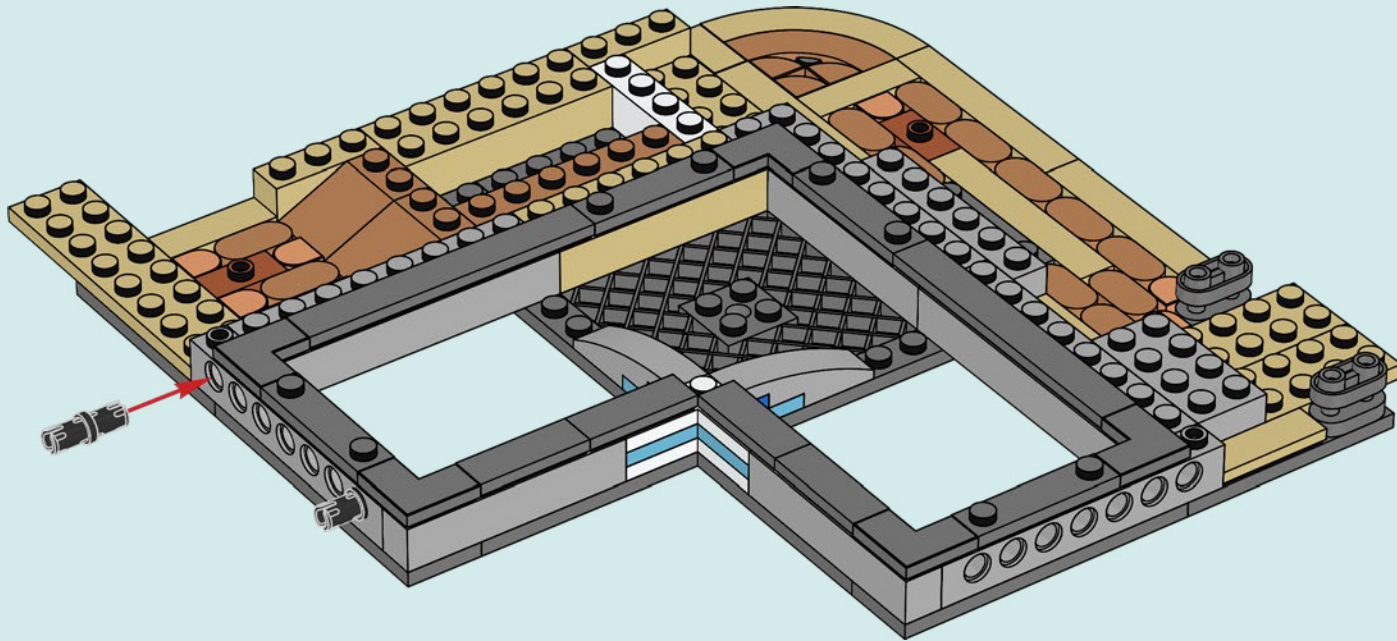

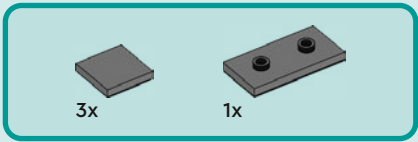

33

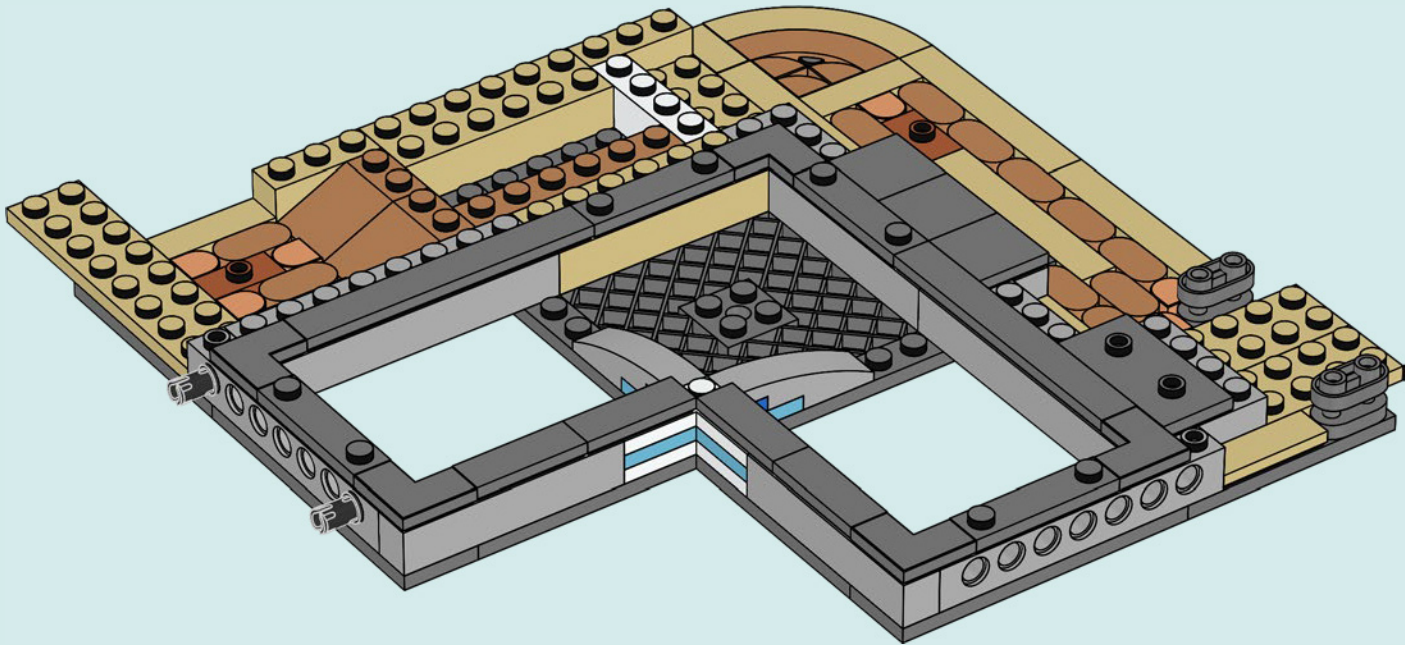



1x

34

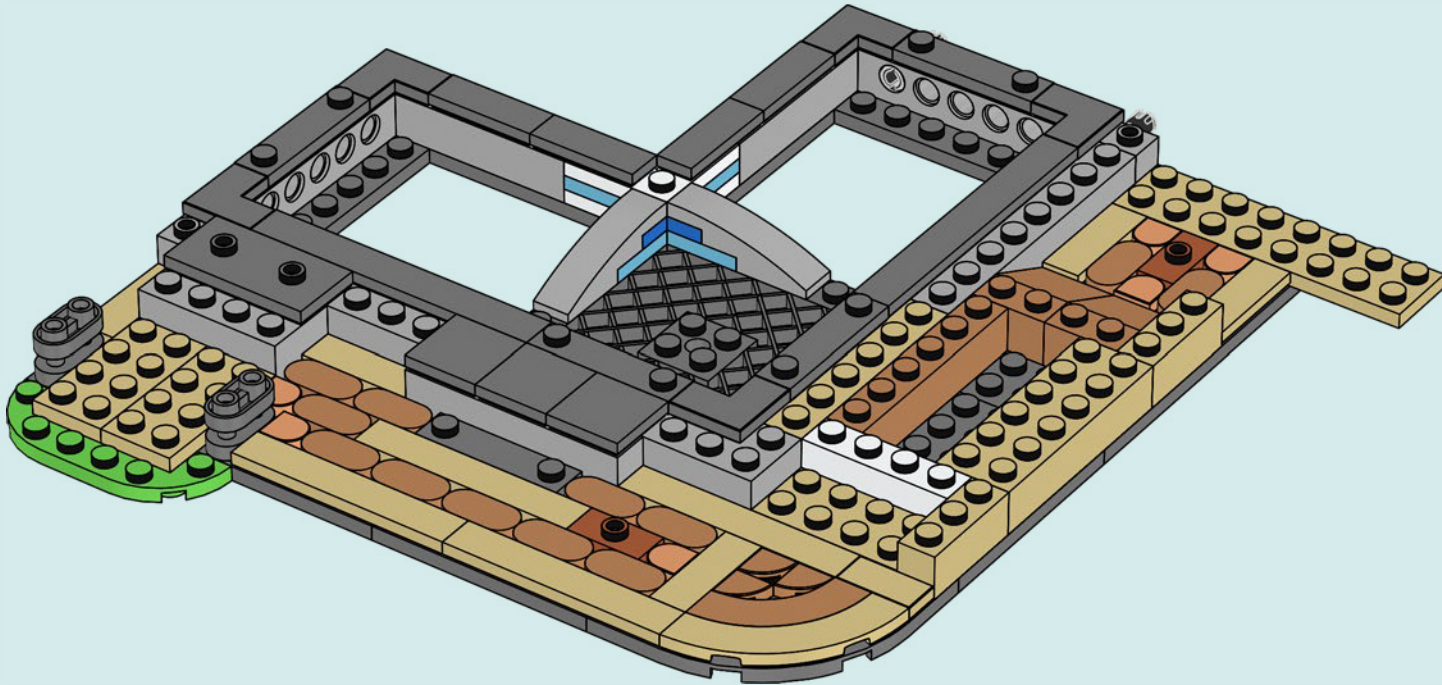

2x

35

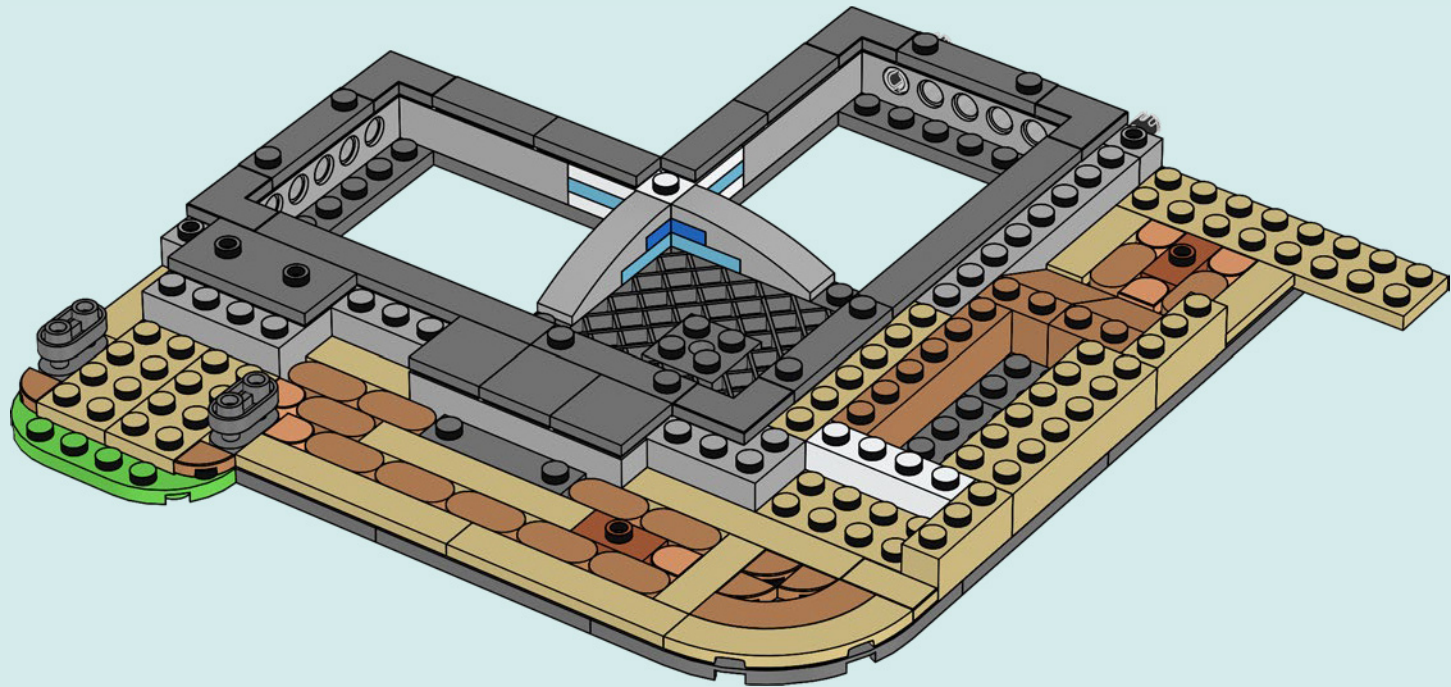

2x

1x

36

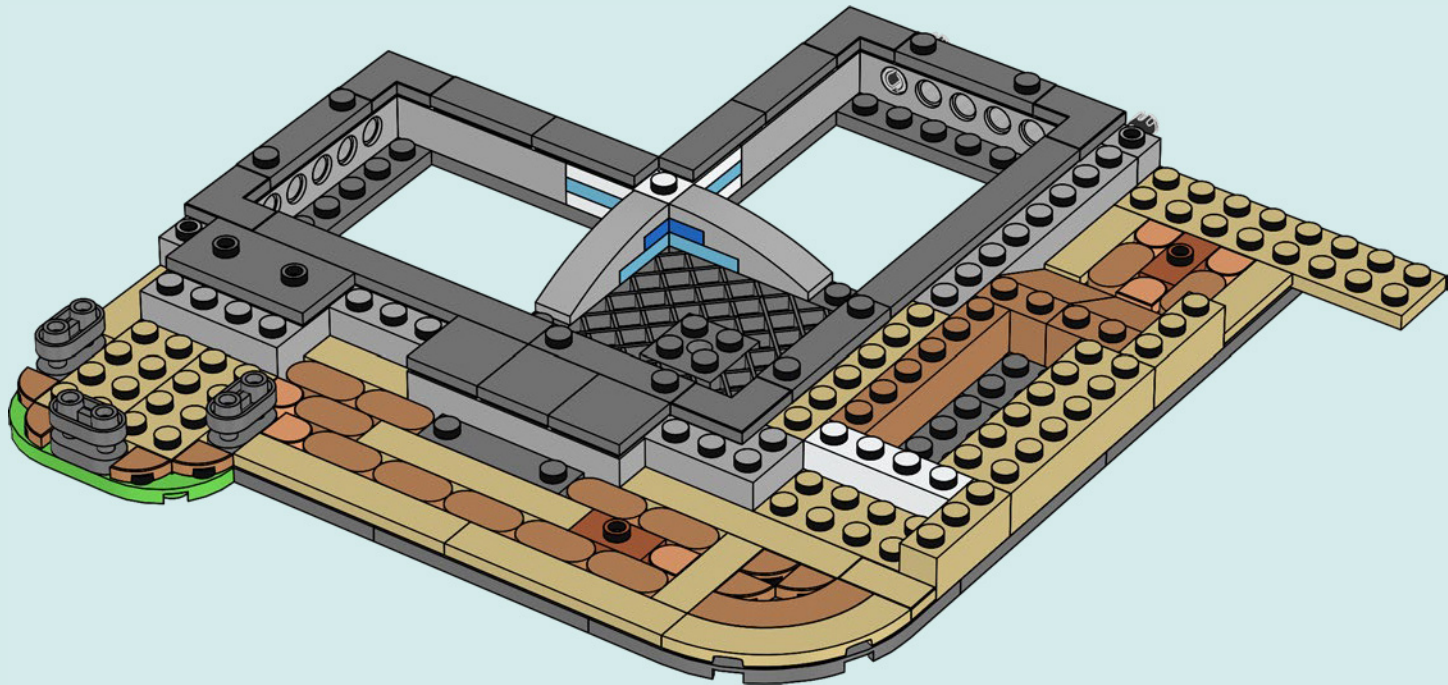

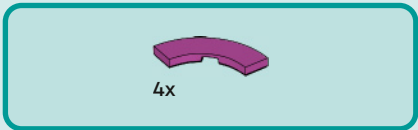

37

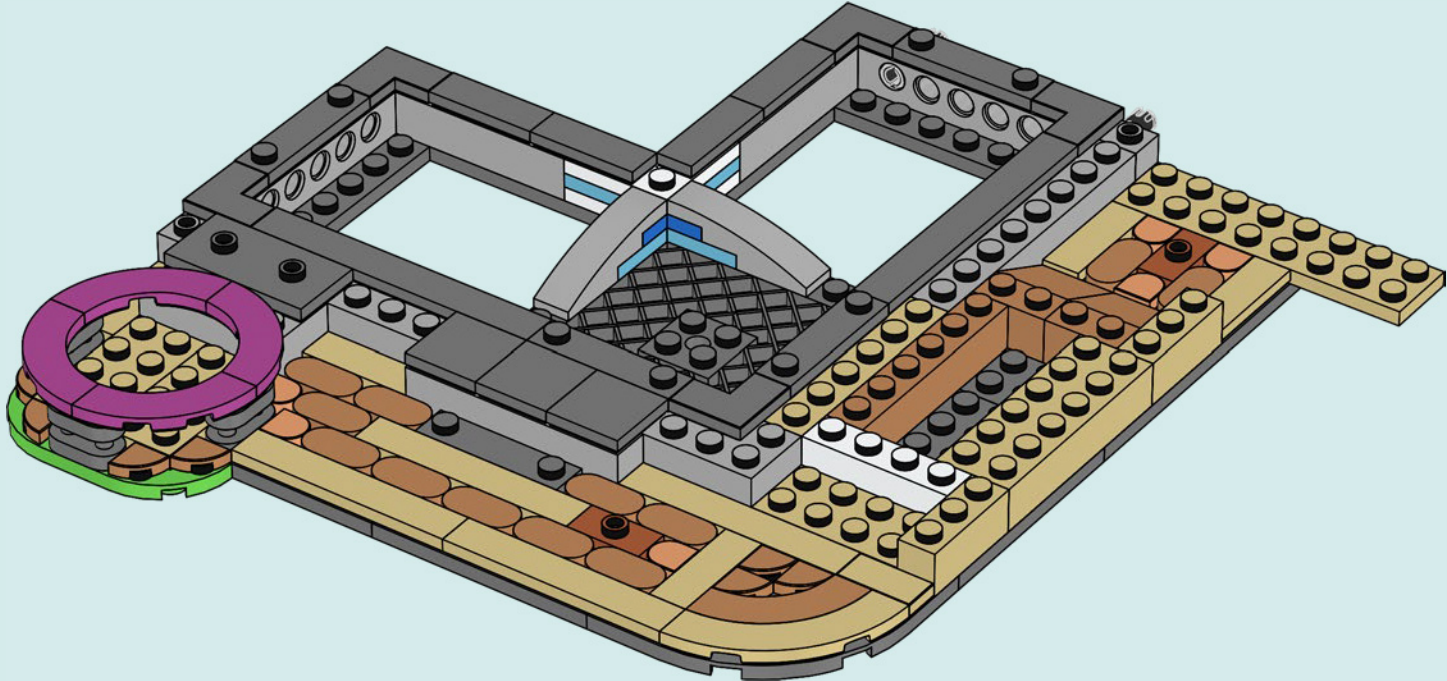

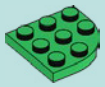

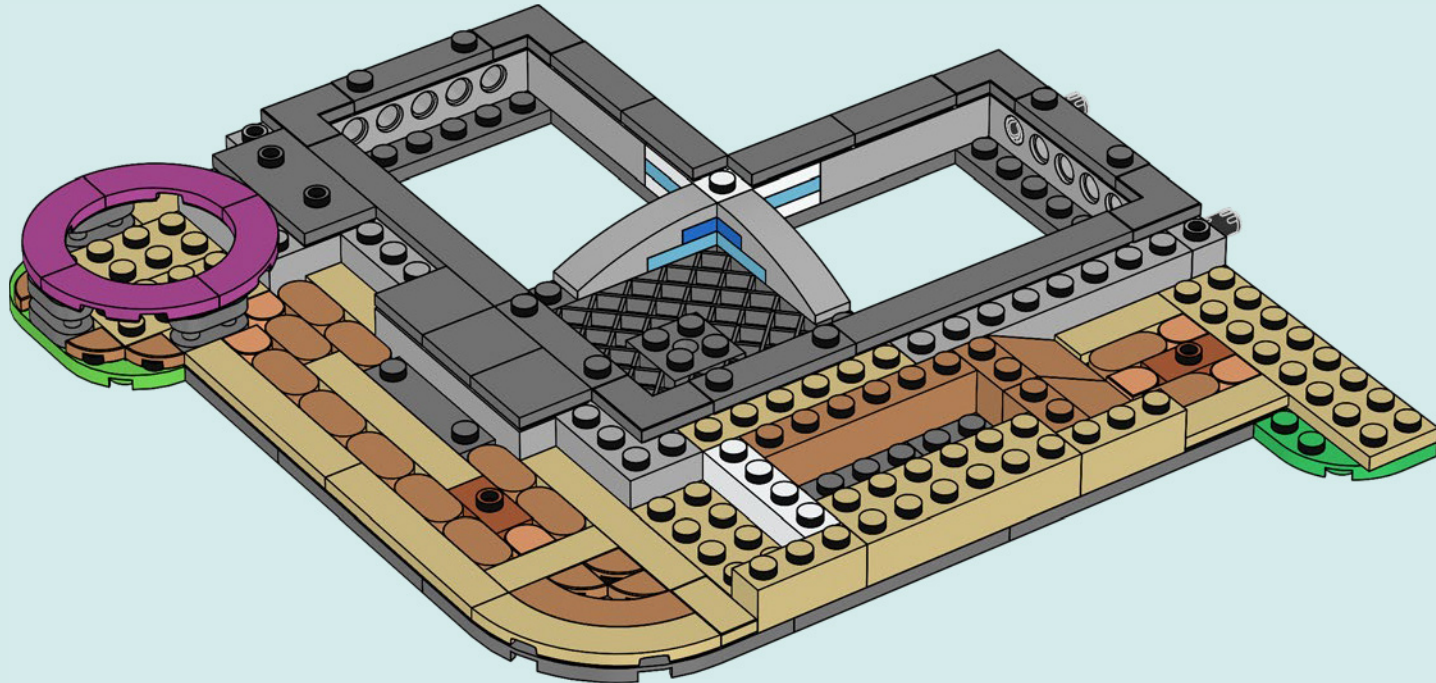

1x

38



1x  1x 

39

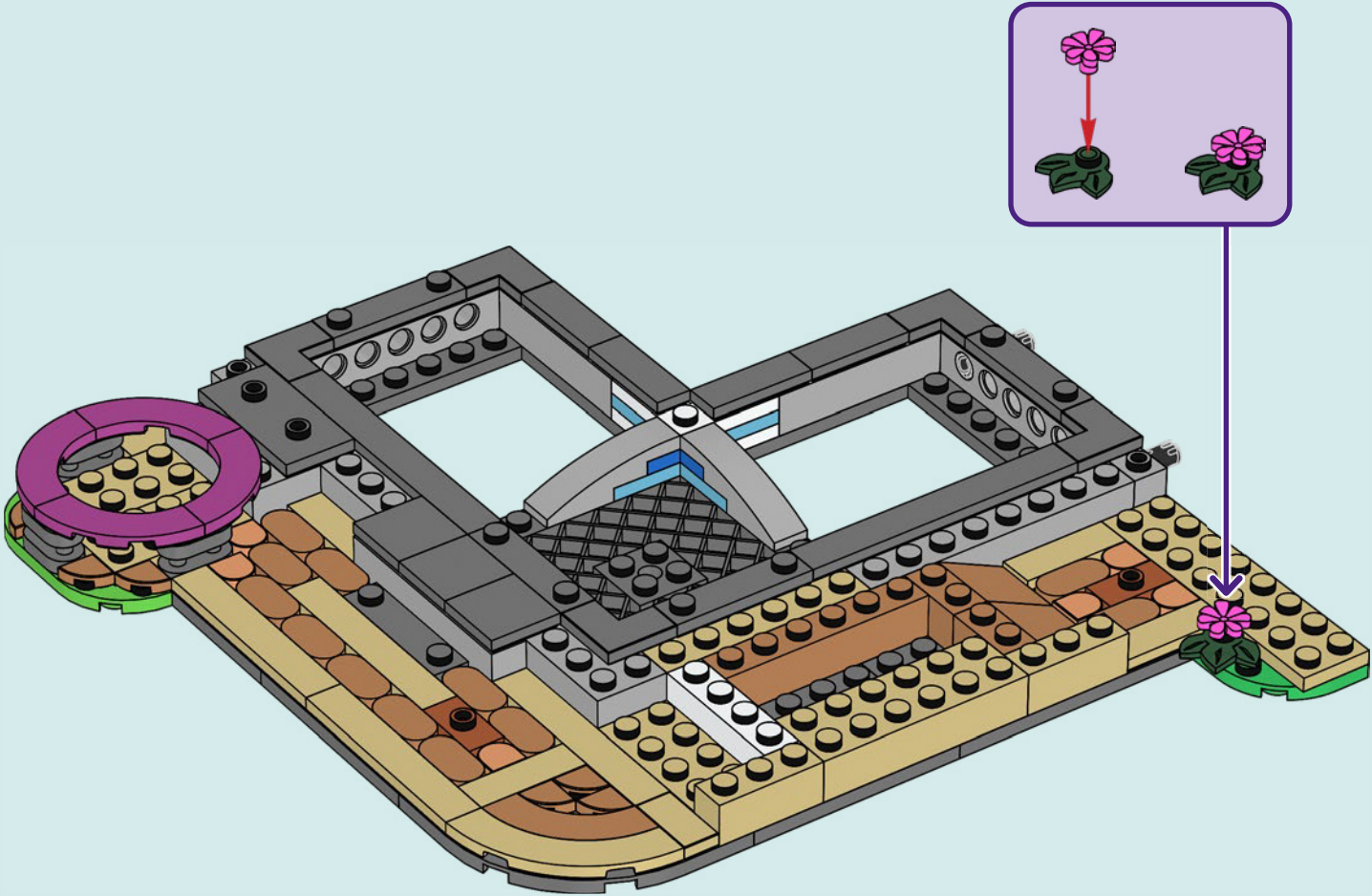



2x

40

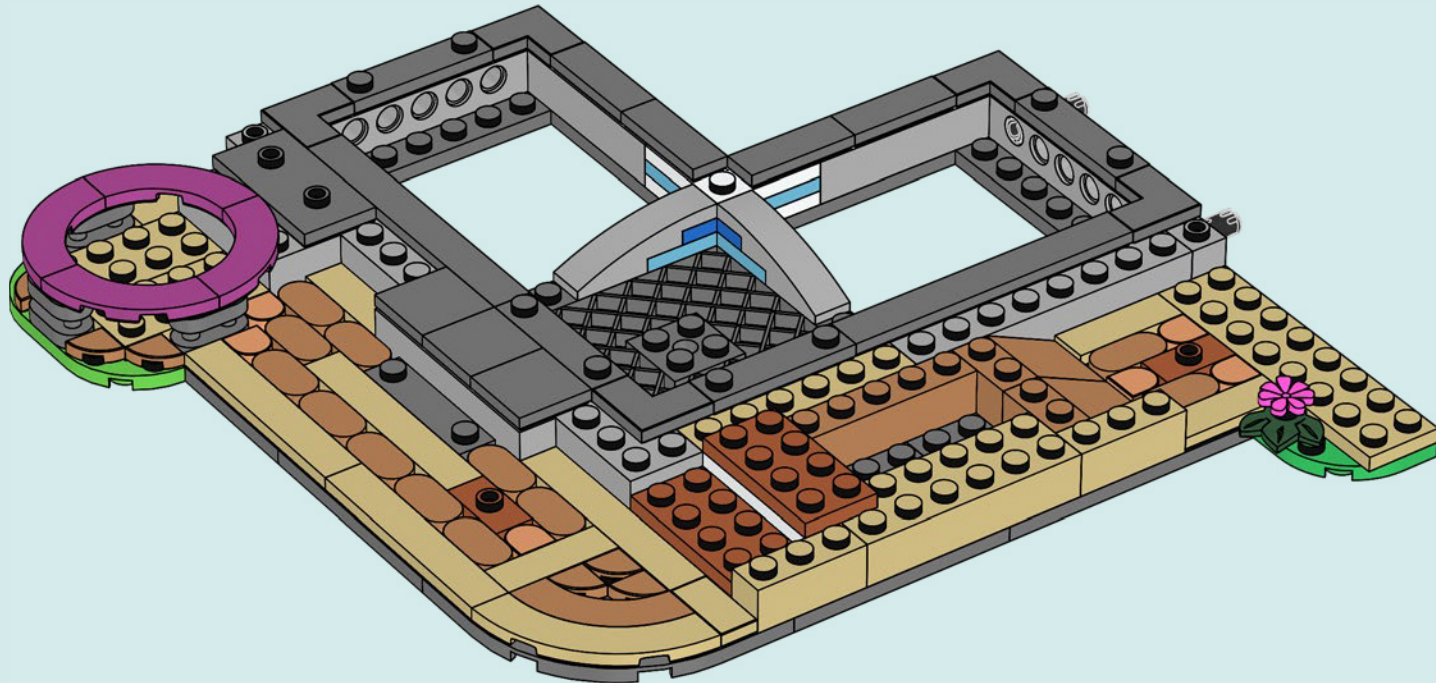

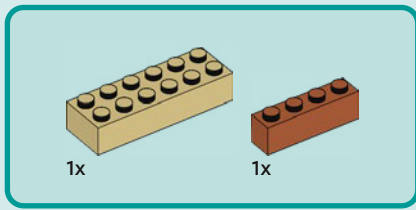

41

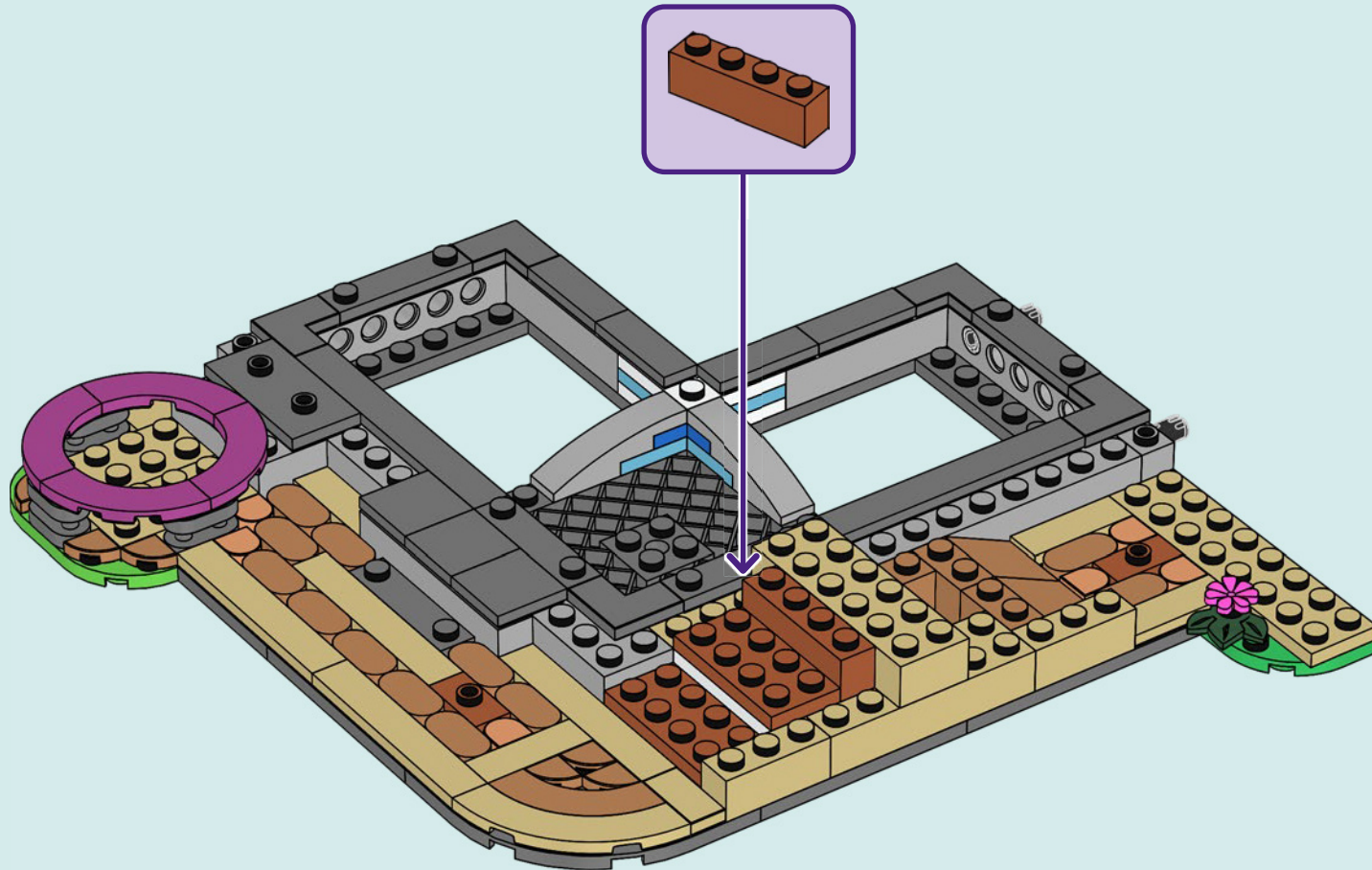

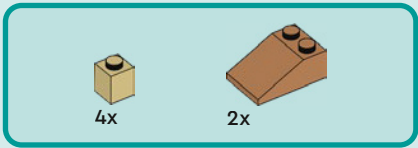

42

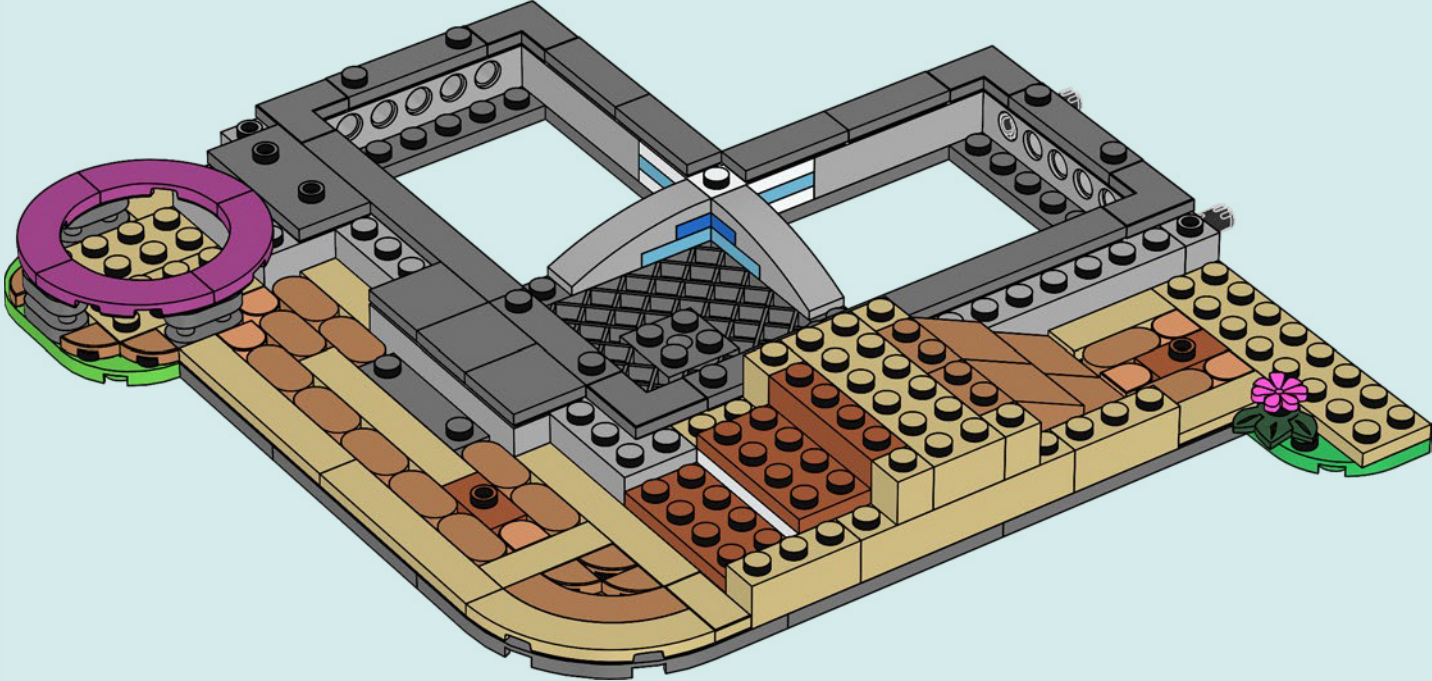

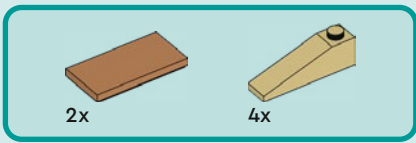

43

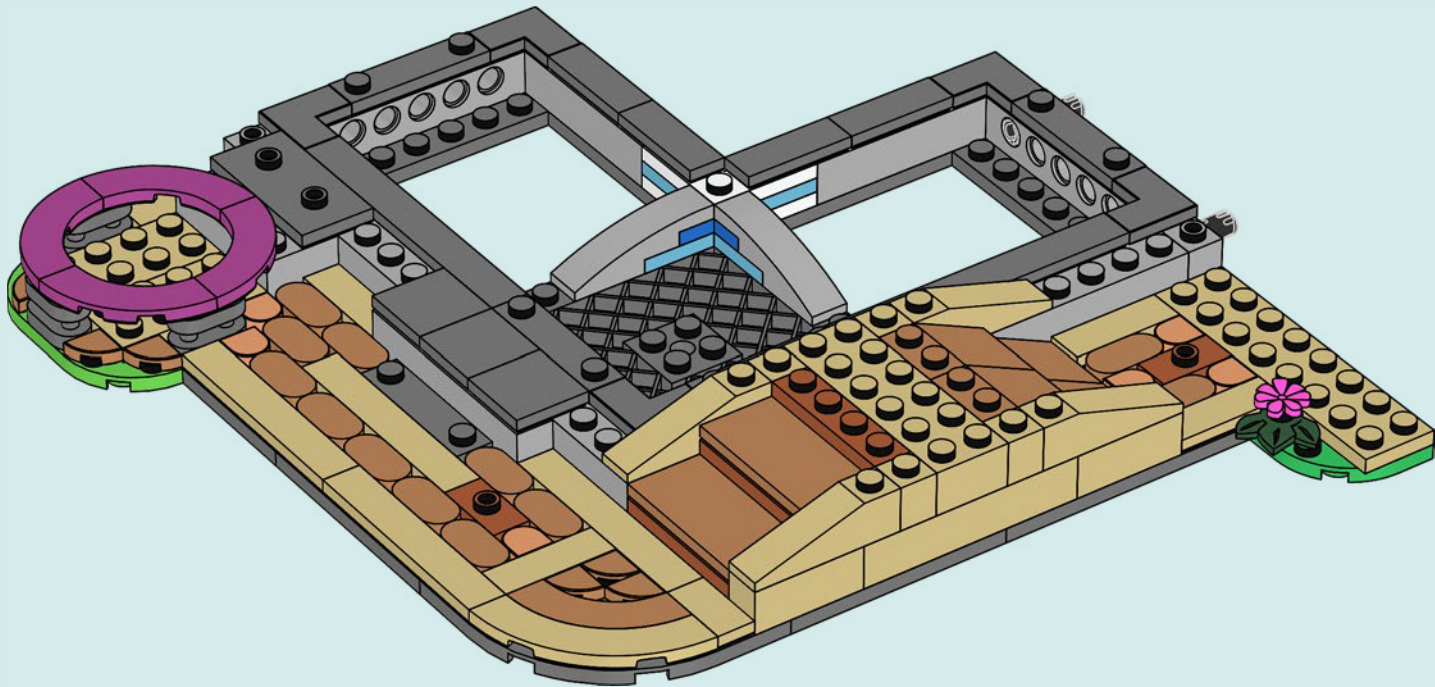

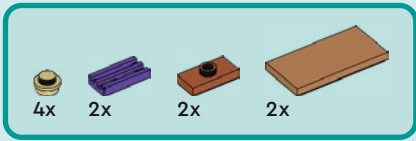

44

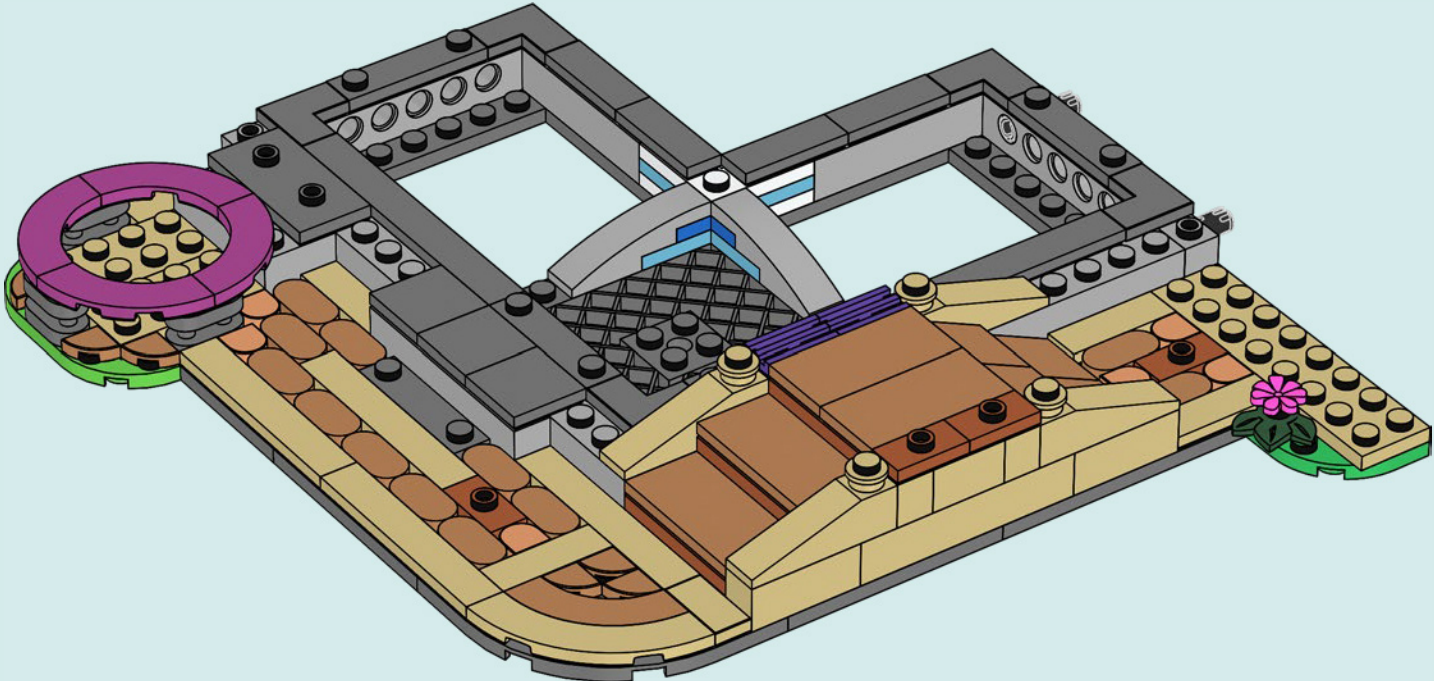



2x

45

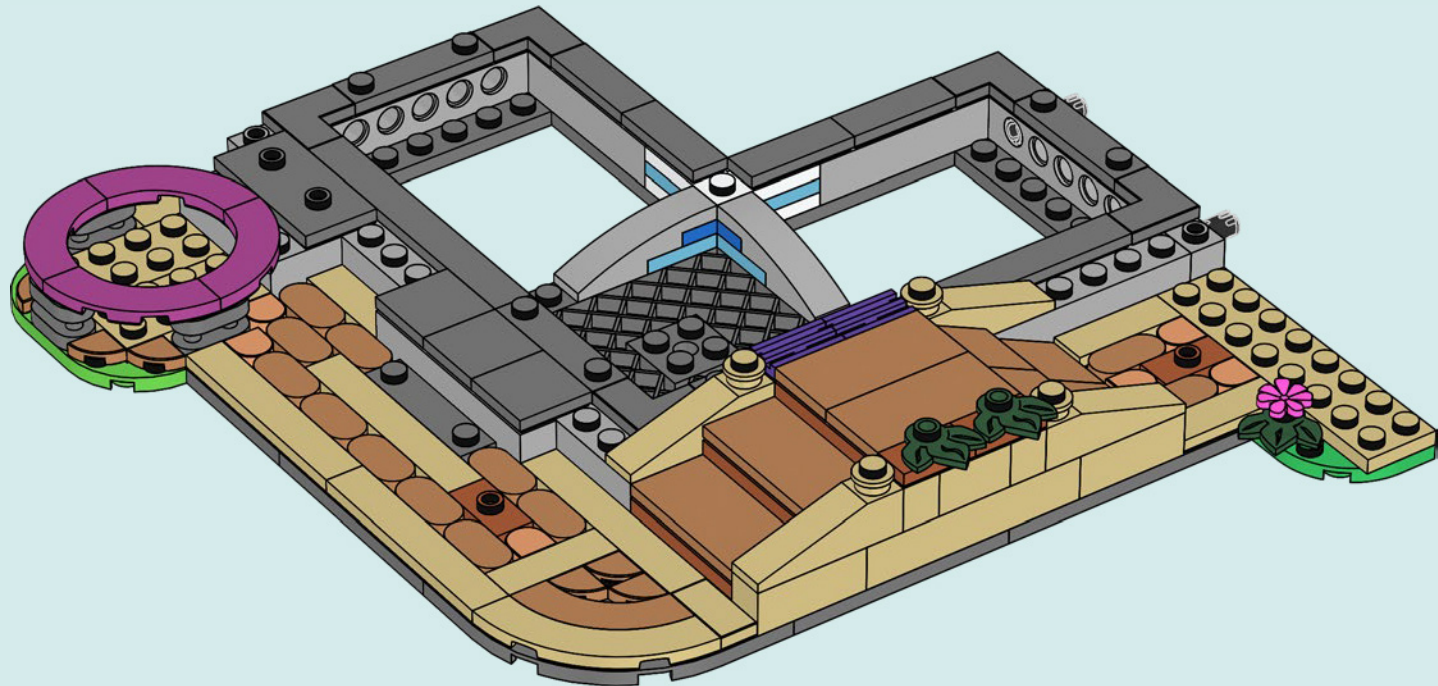



2x



2x

46

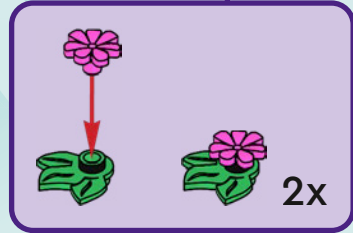

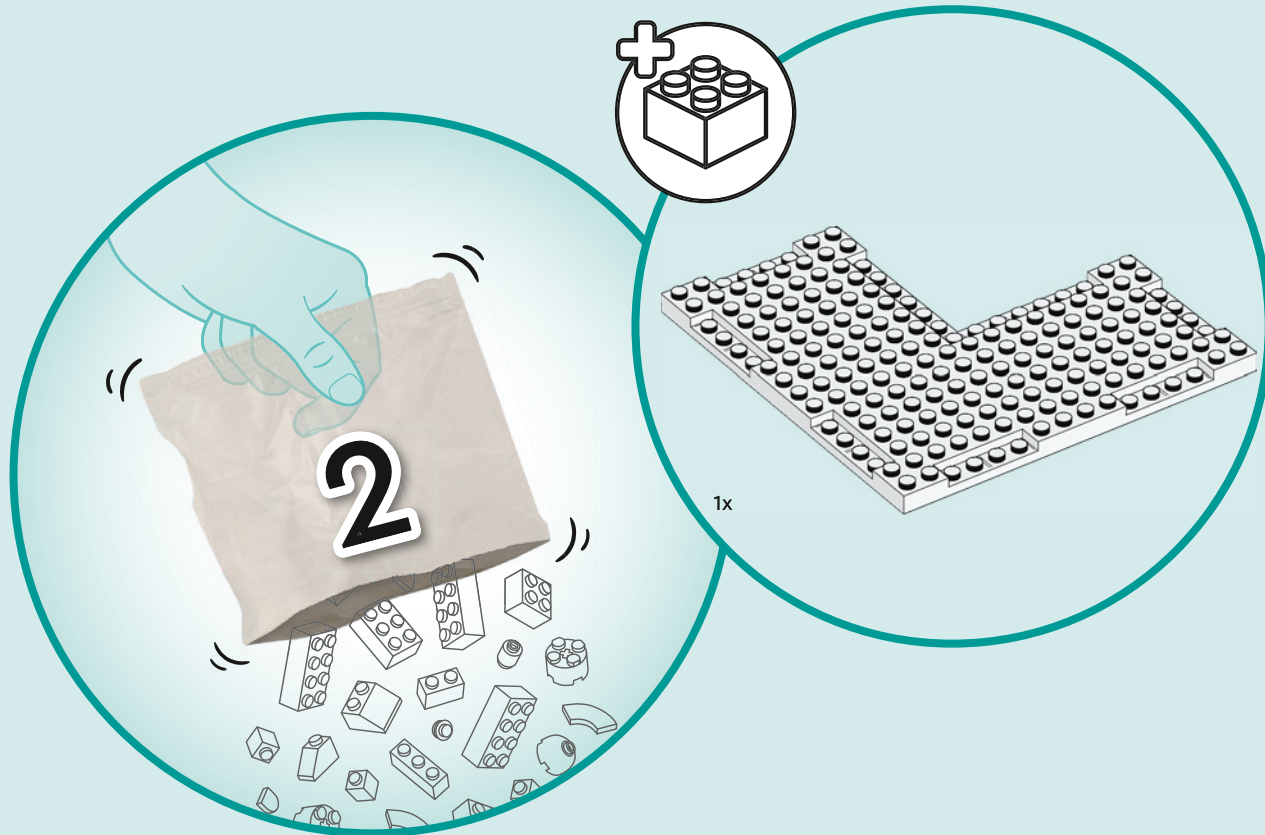

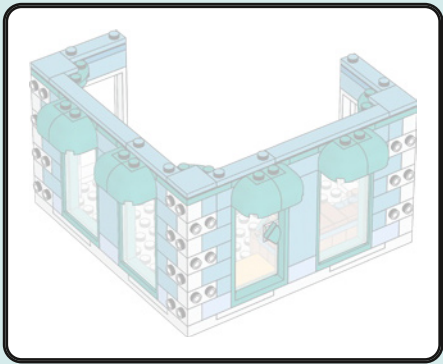

1

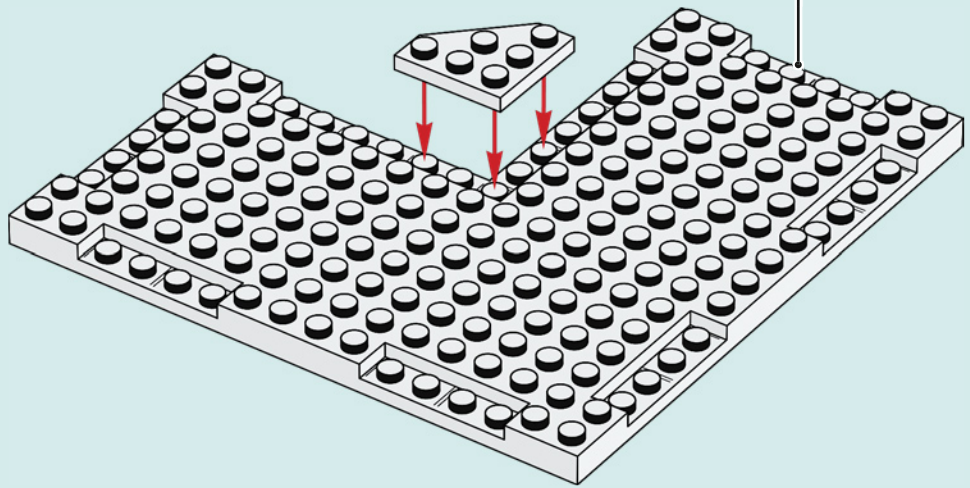
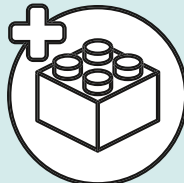

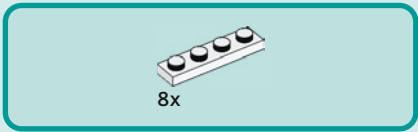

2

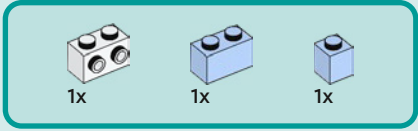
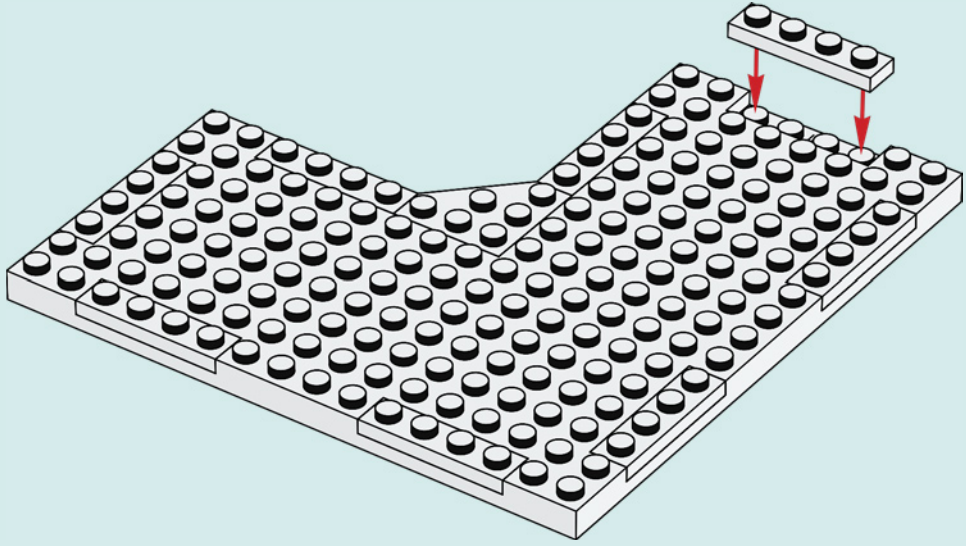

3

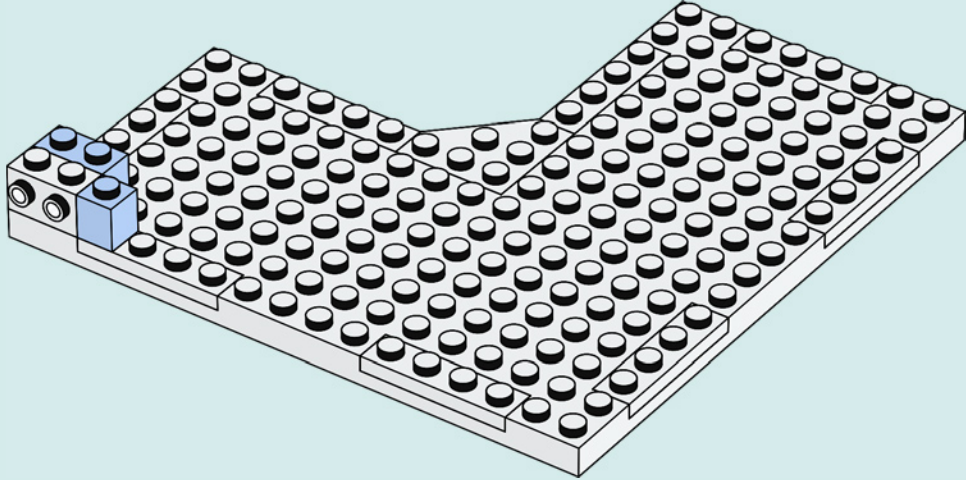



1x



1x

4

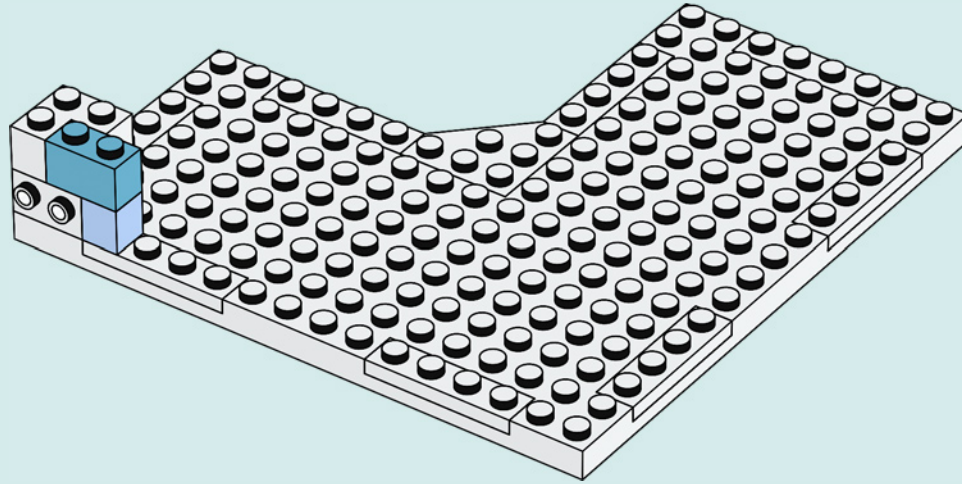

1x



1x



1x

5

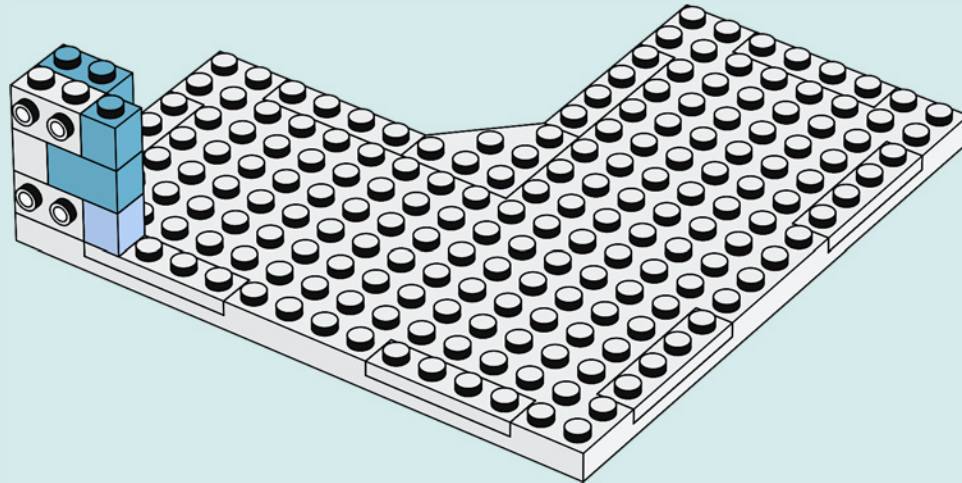

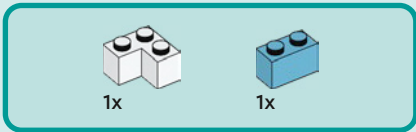

6

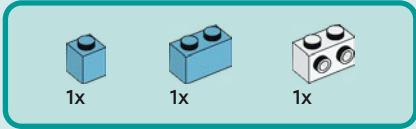
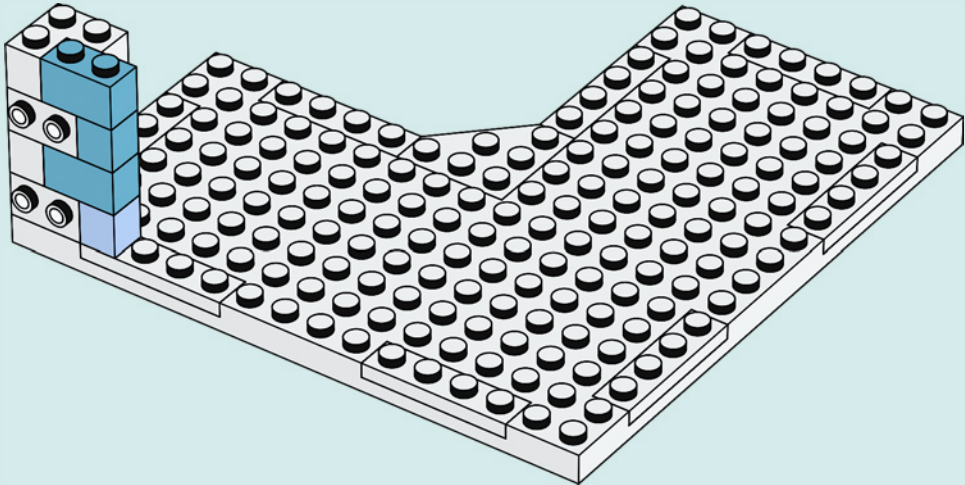

7

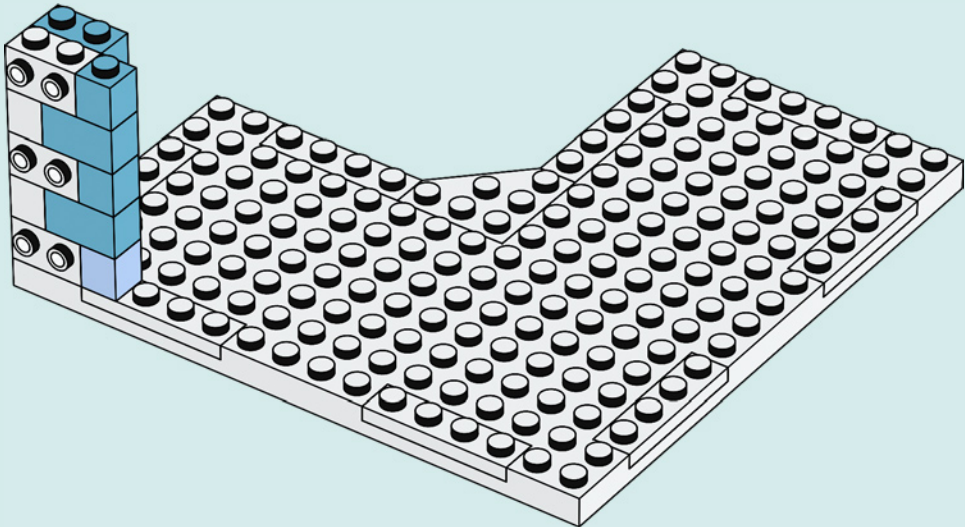

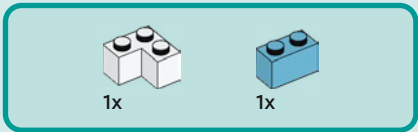

8

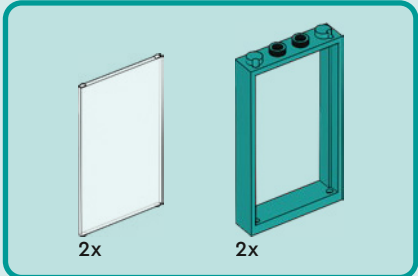
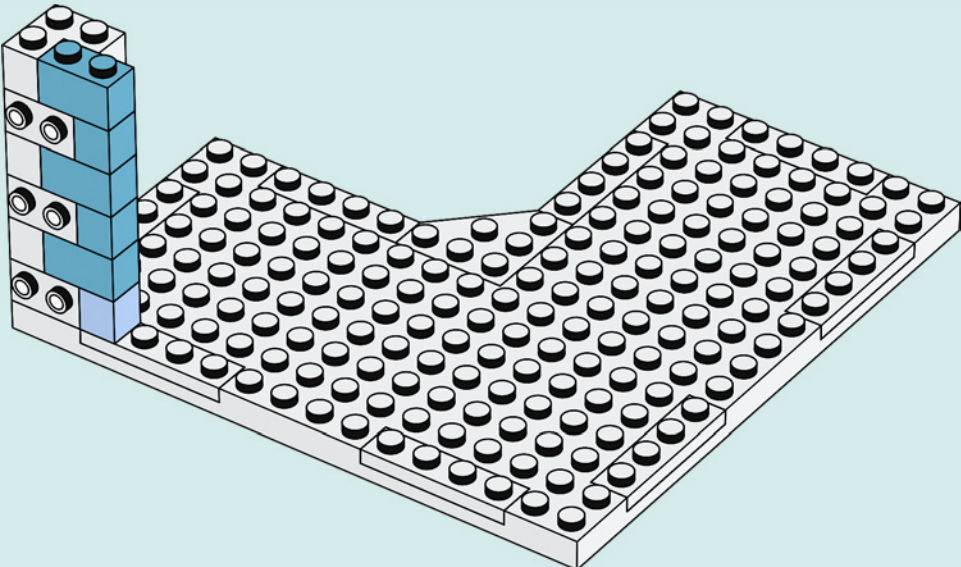

9

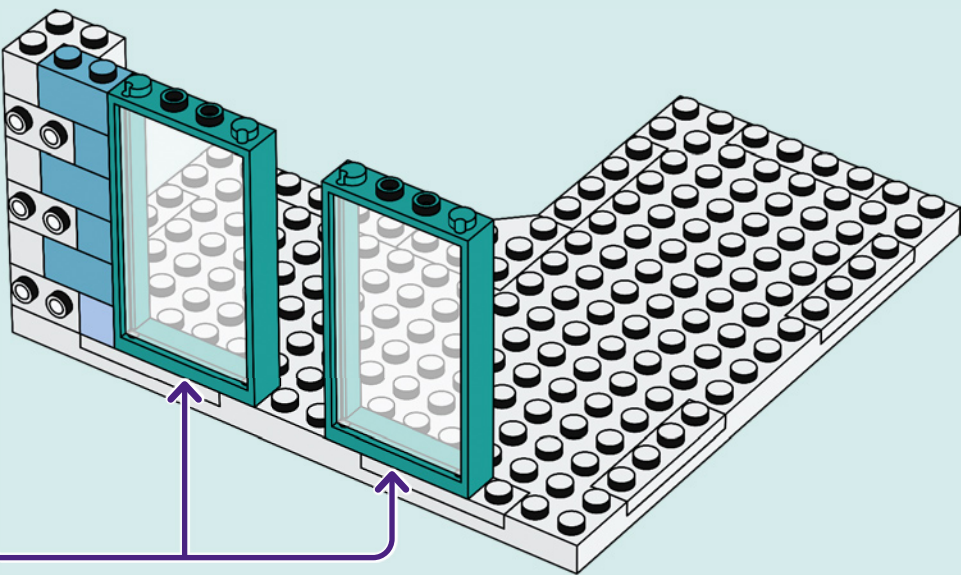
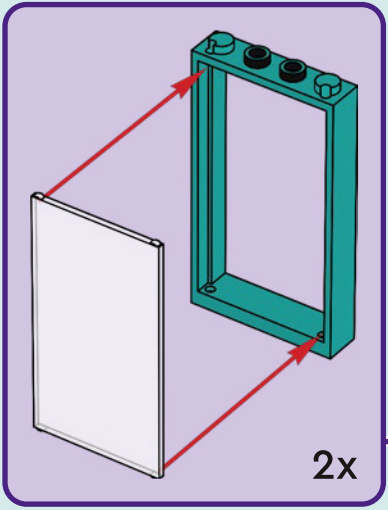

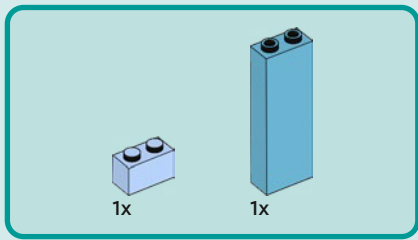

10

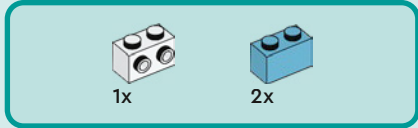
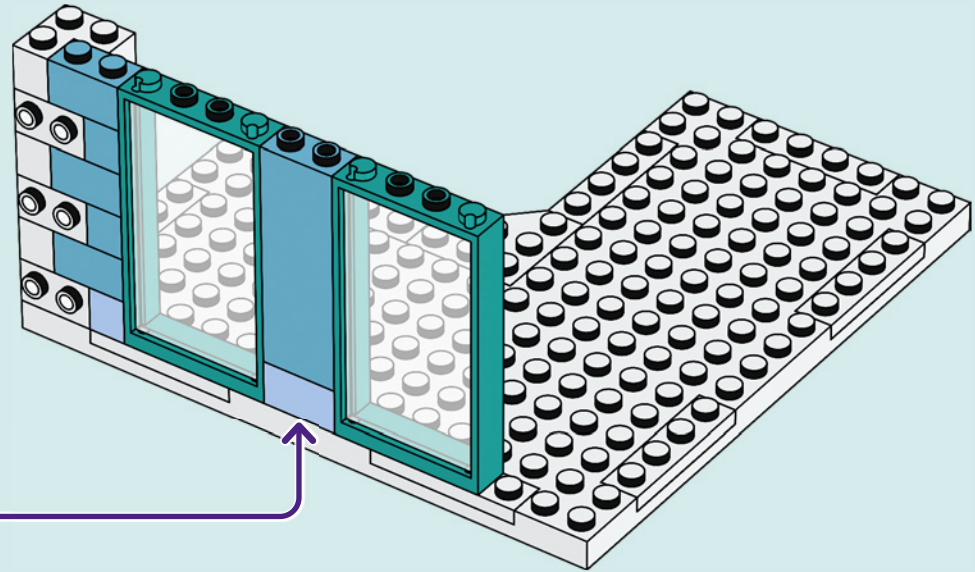
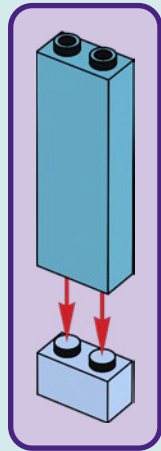

11

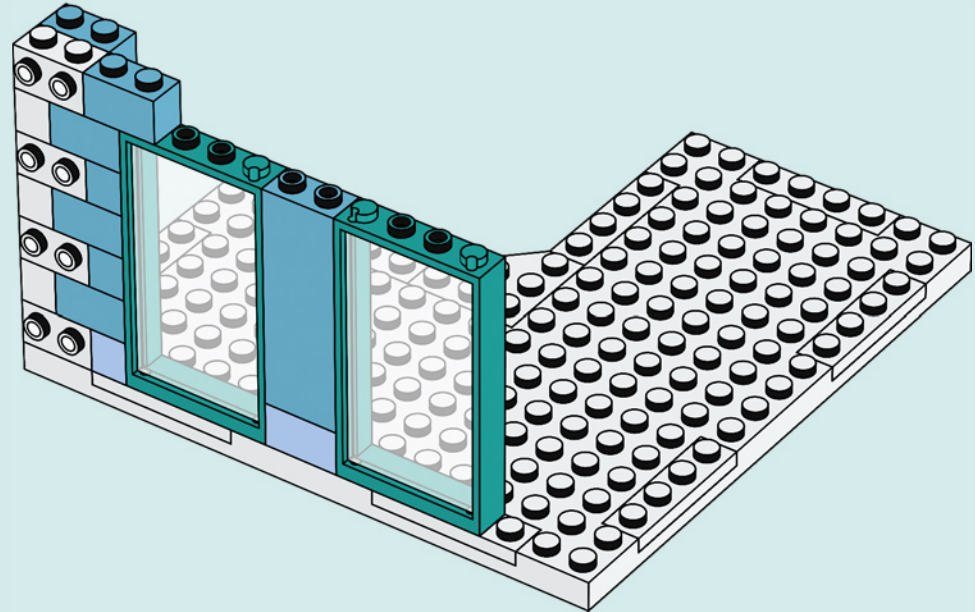

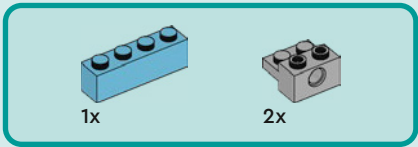

12

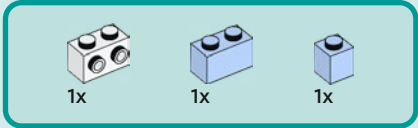
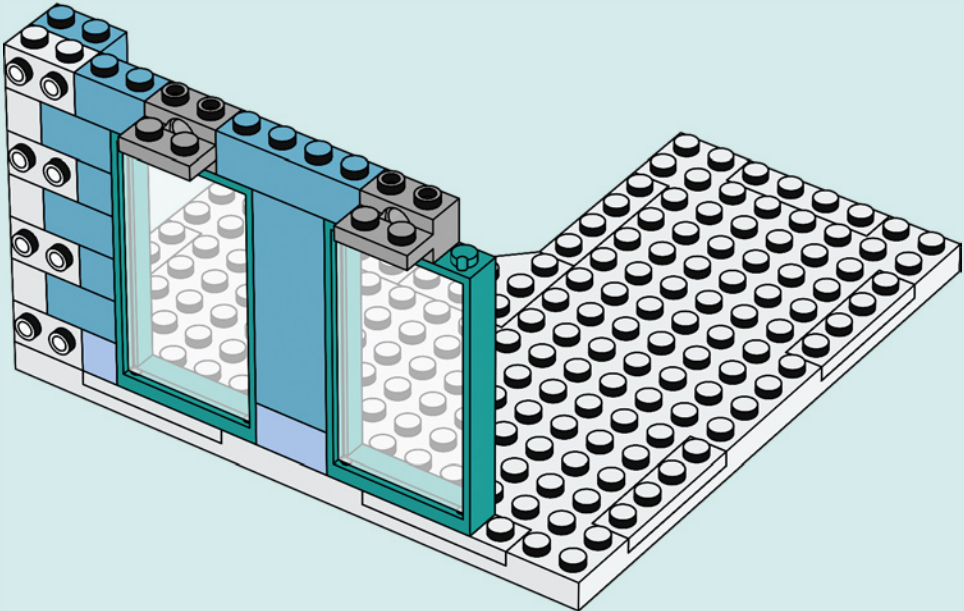

13

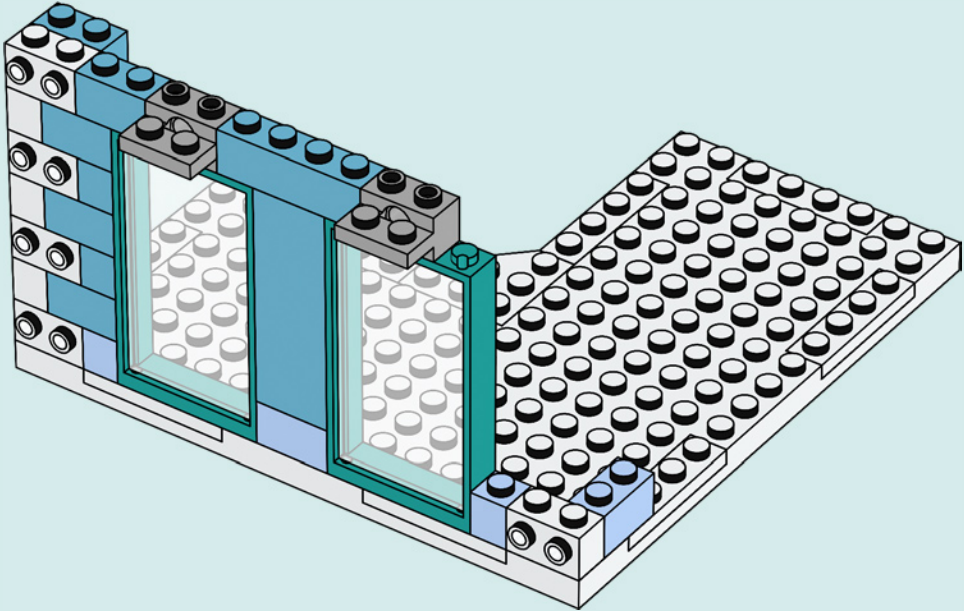

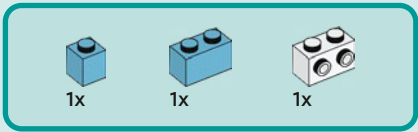

14

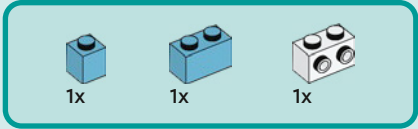
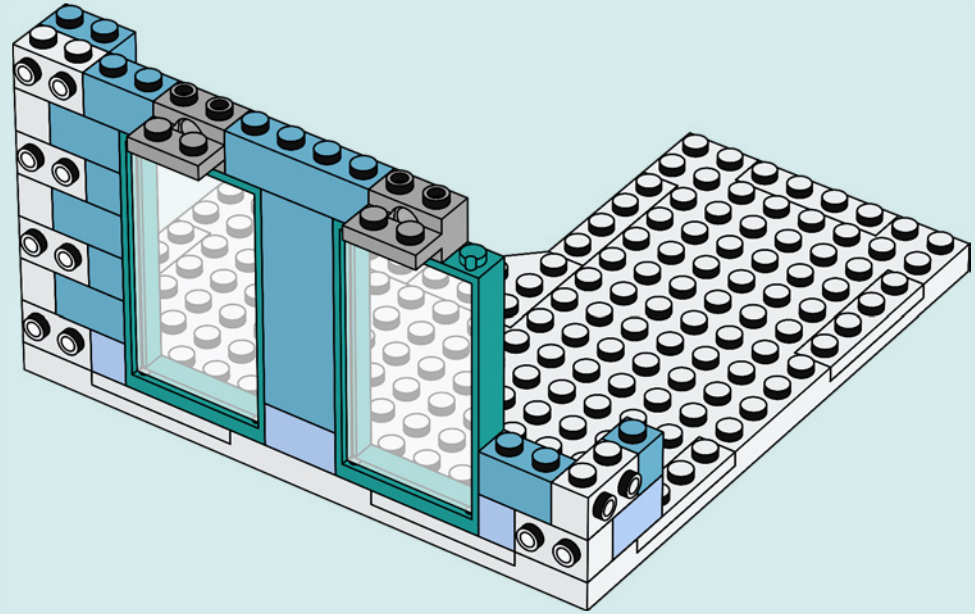

15

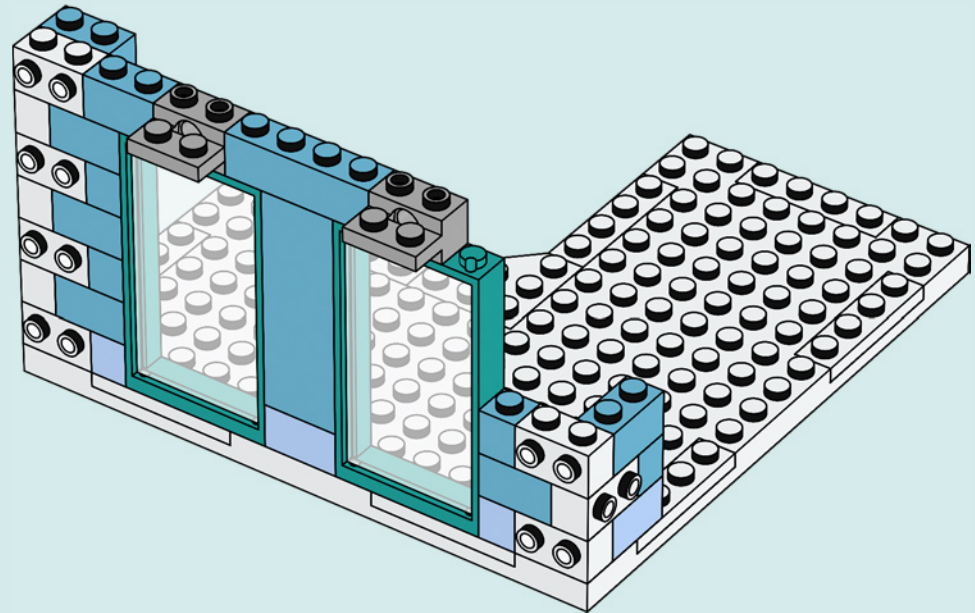

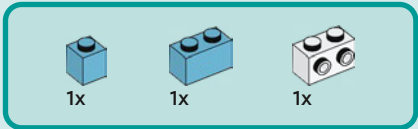

16

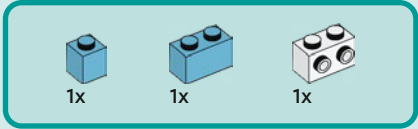
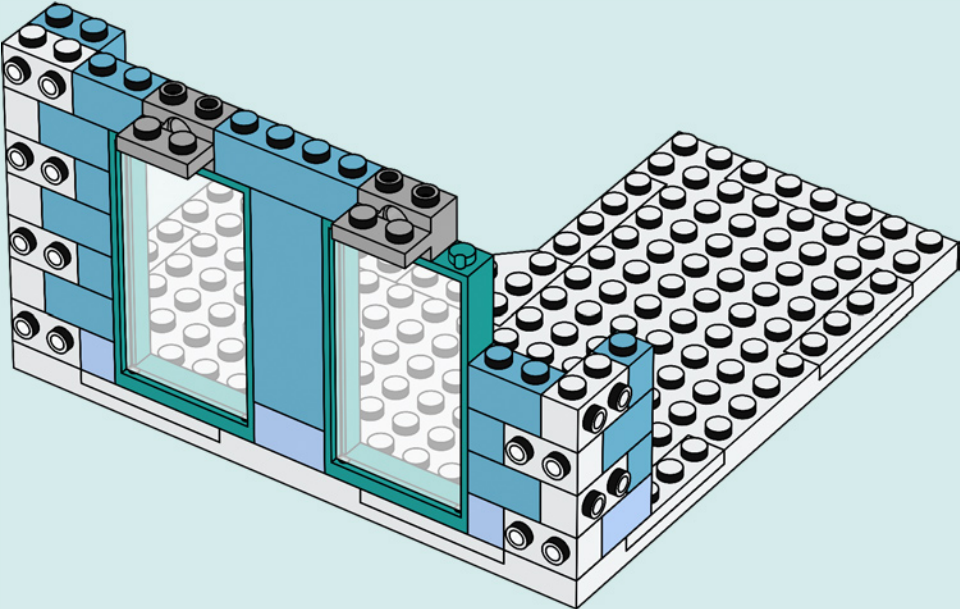

17

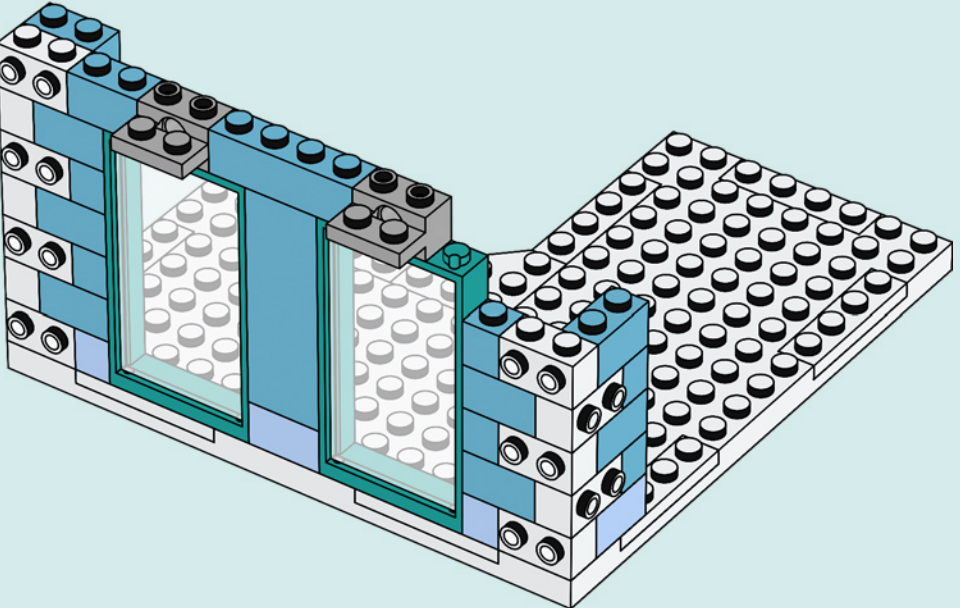

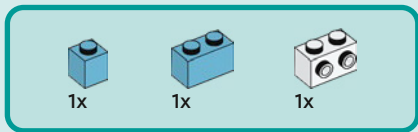

18

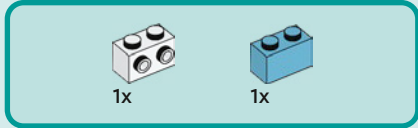
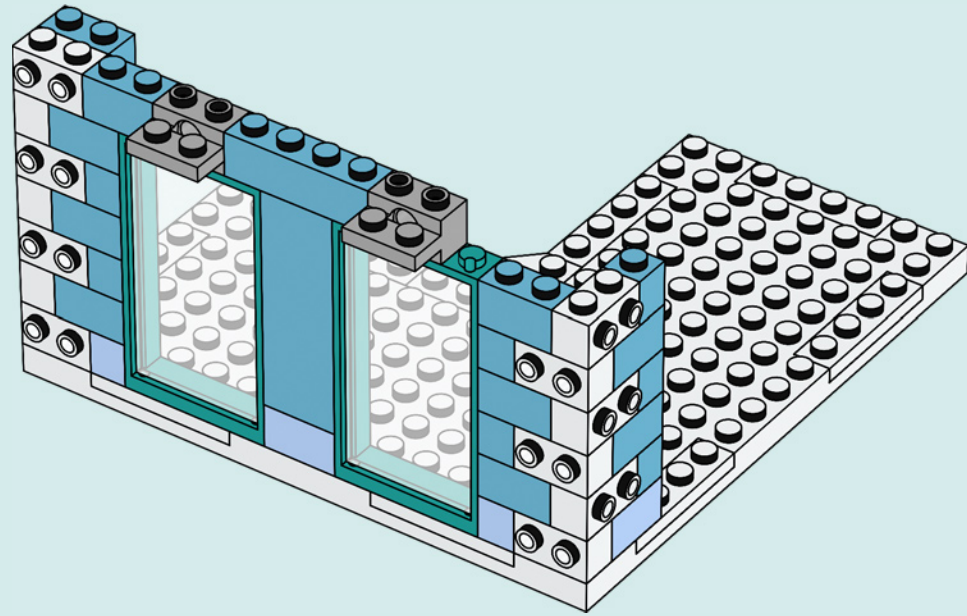

19

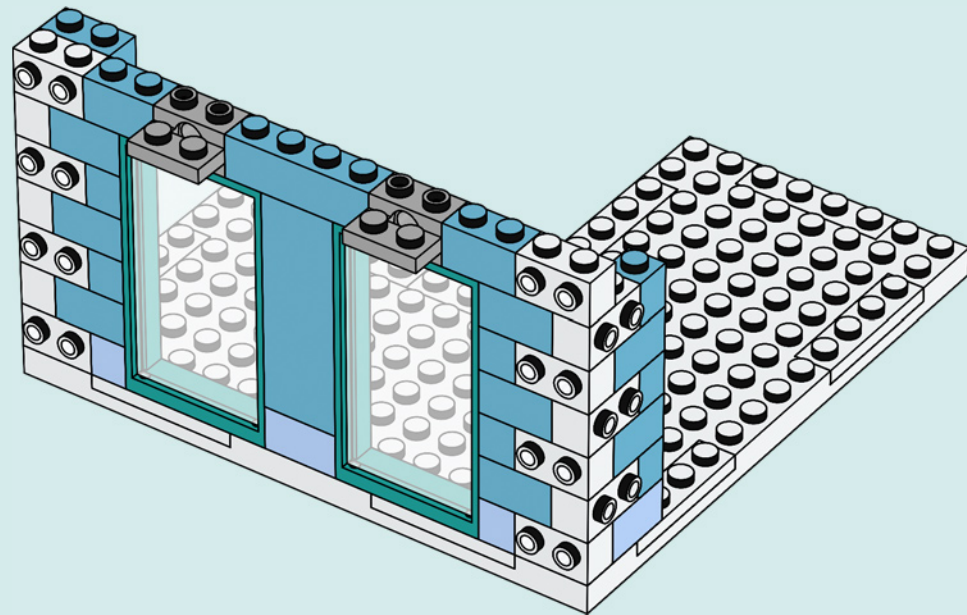



2x

20

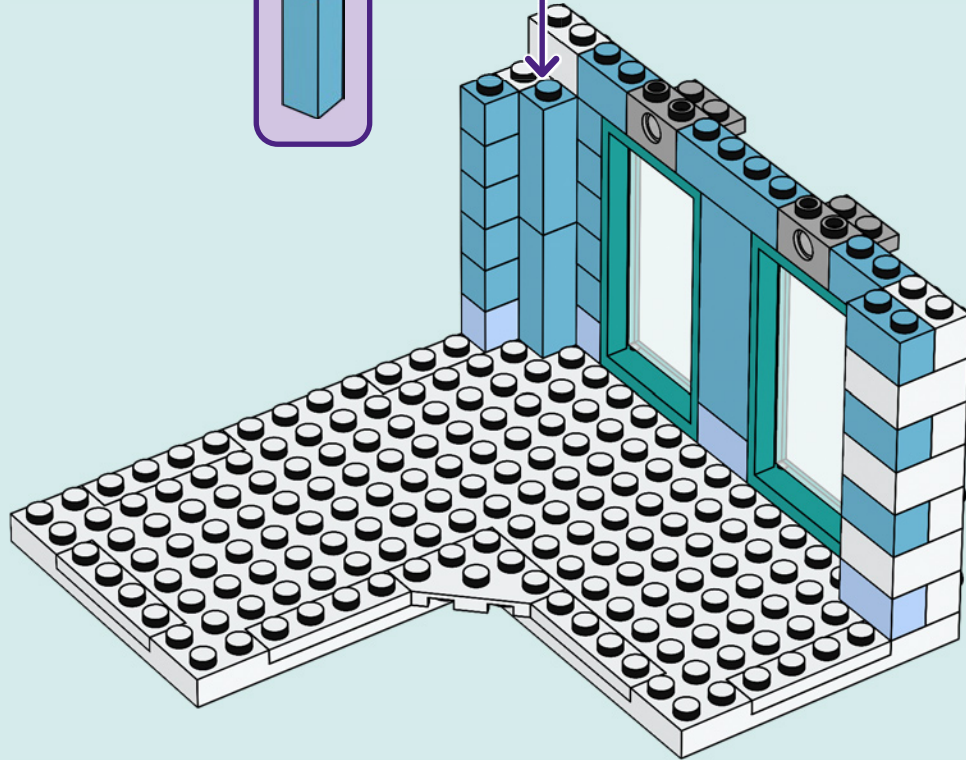
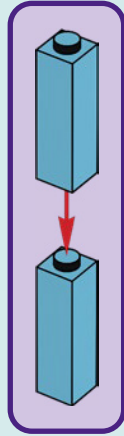

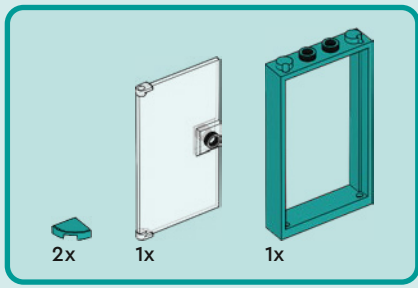

21

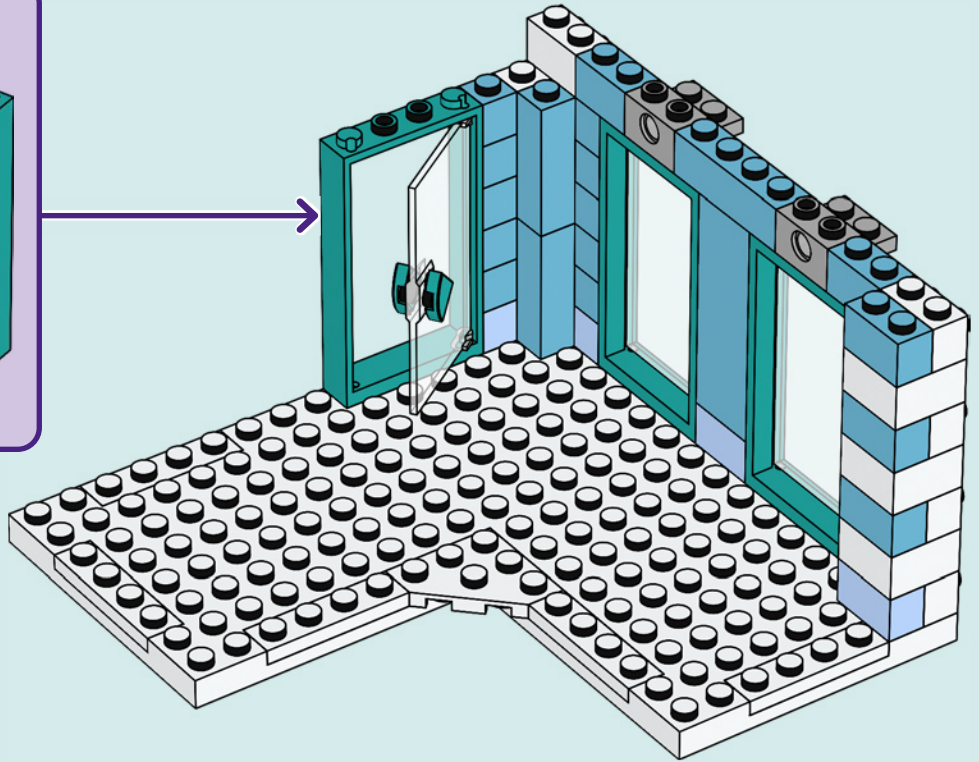
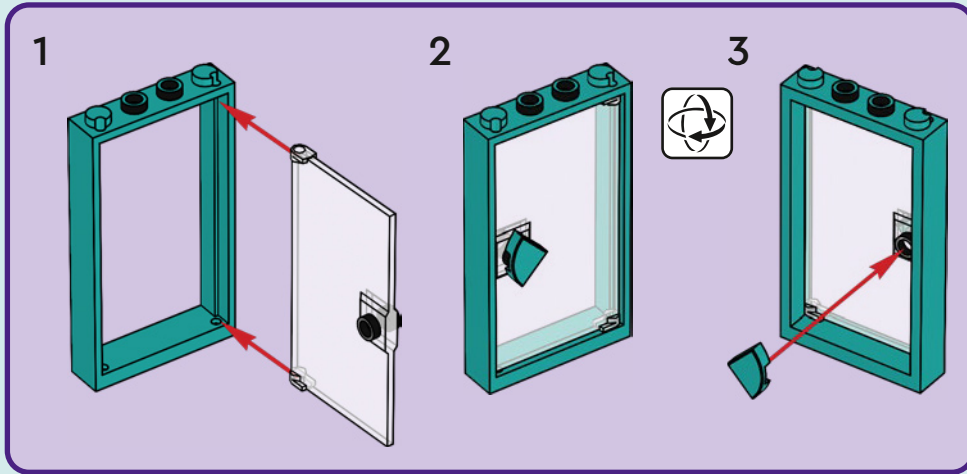

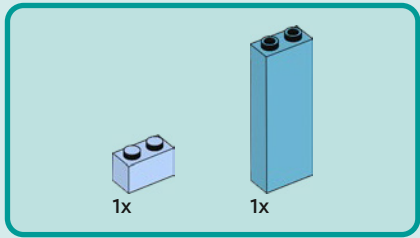

22

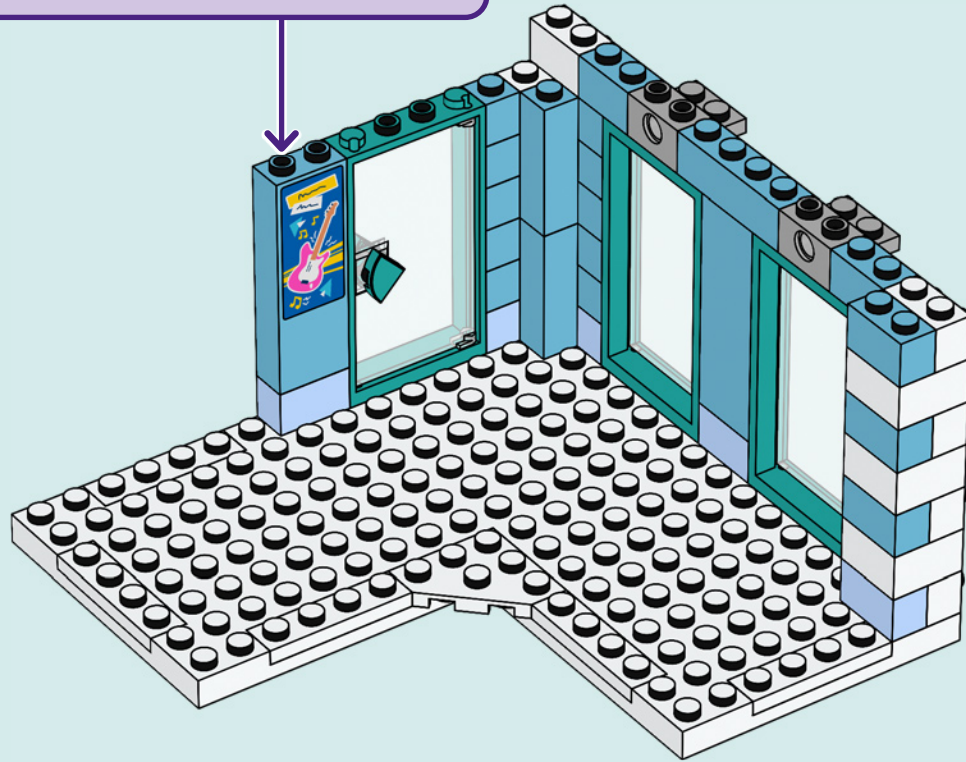
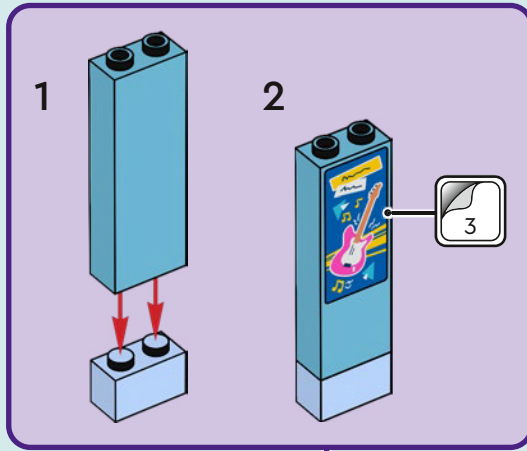

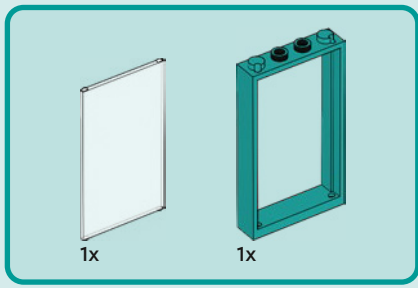

23

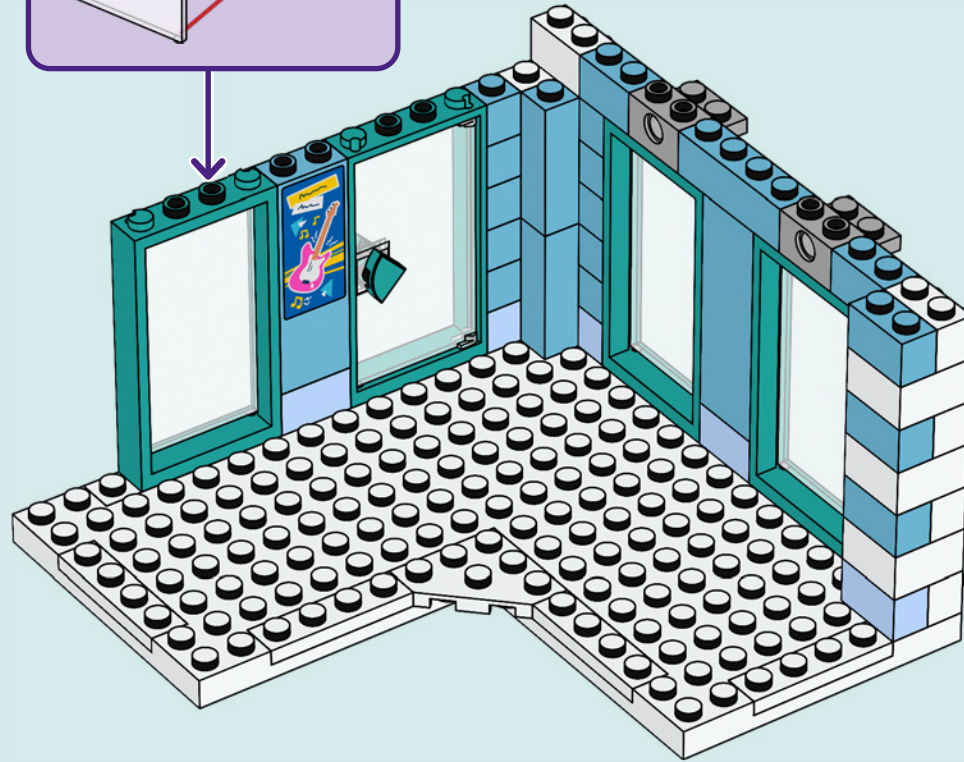
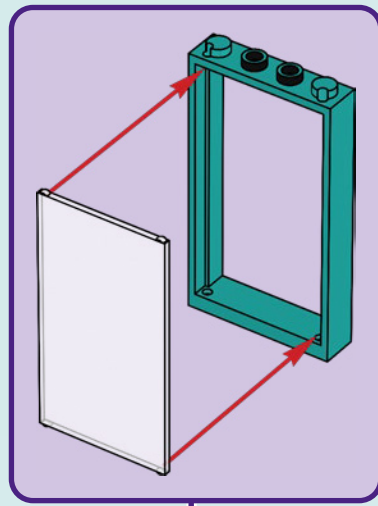

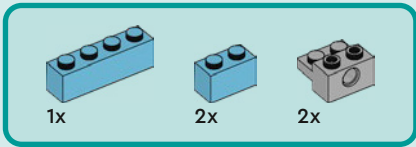

24

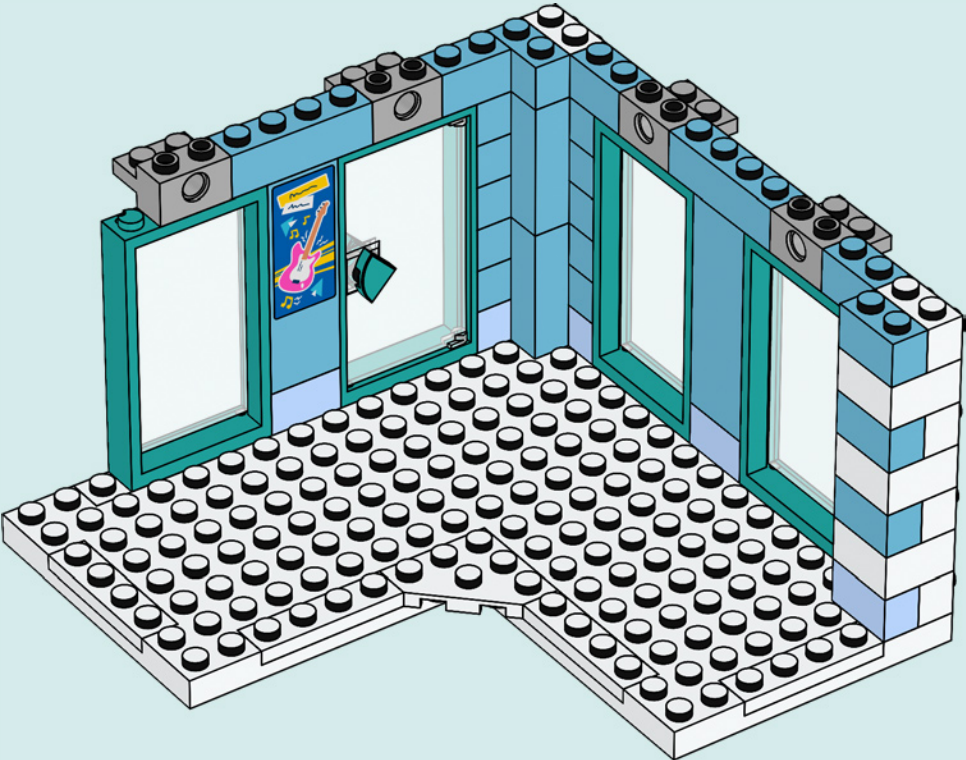

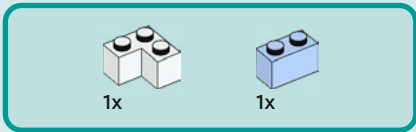

25

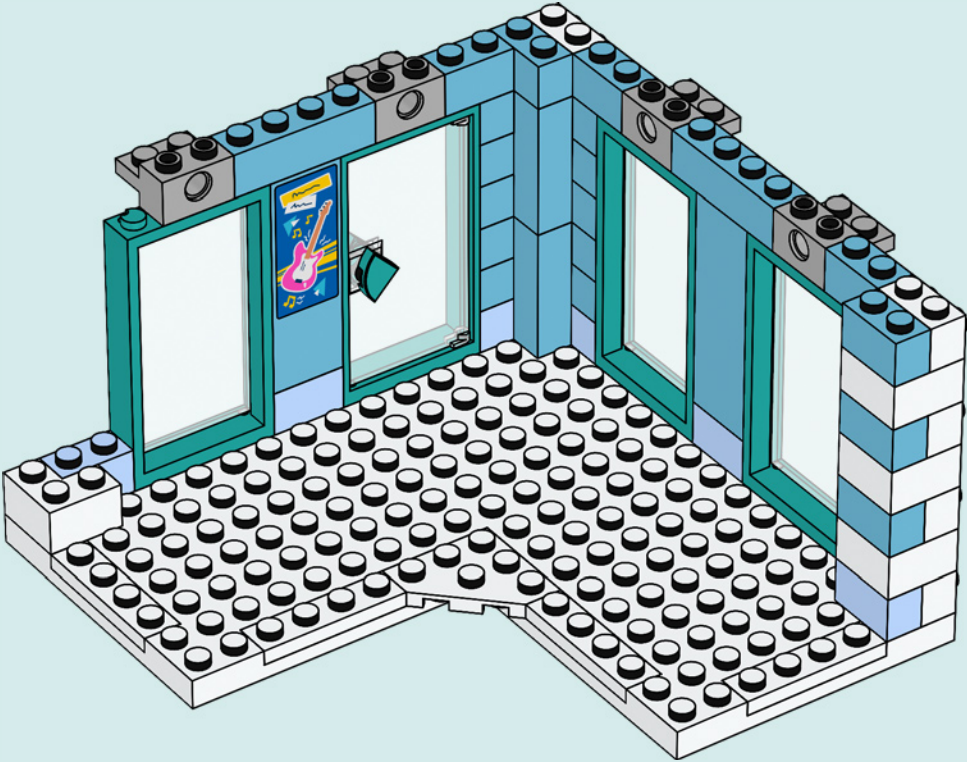

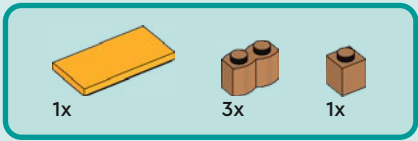

26

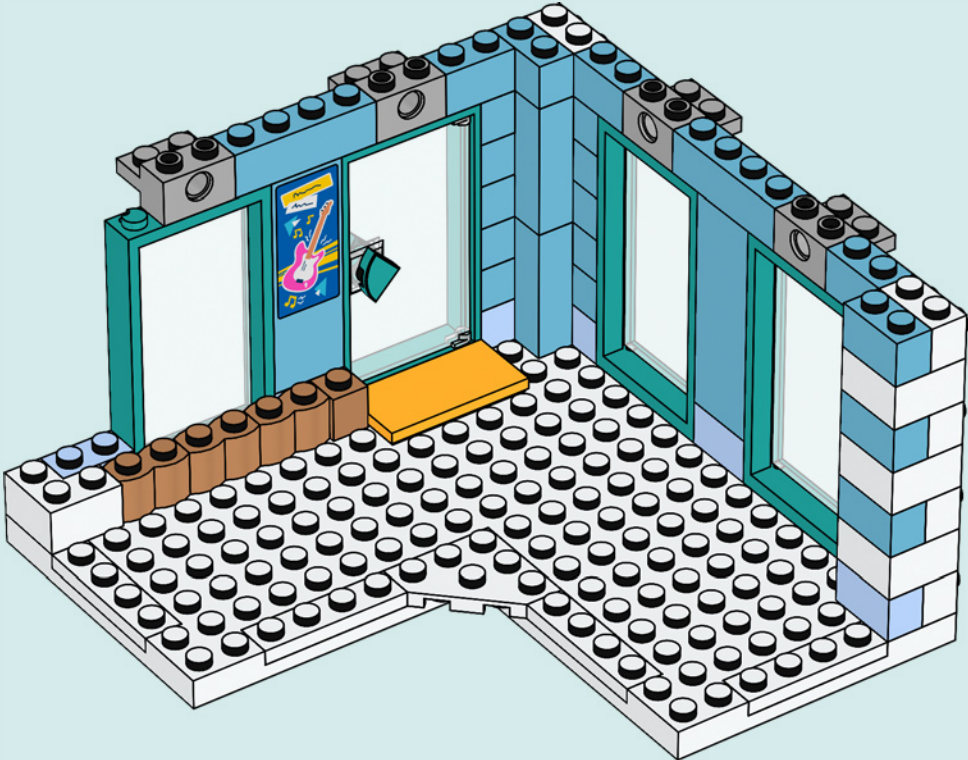



27



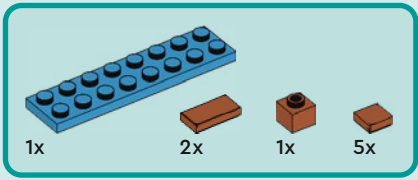

28

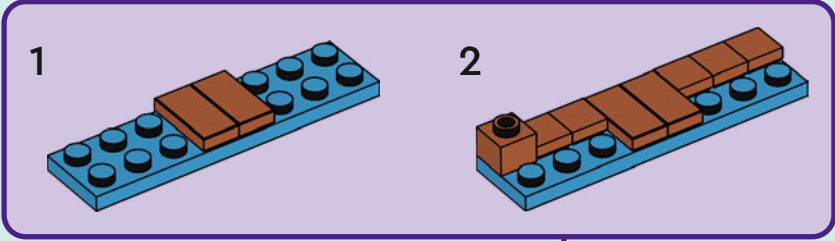

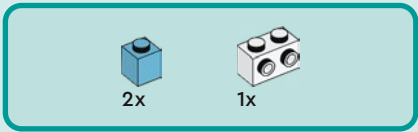

29

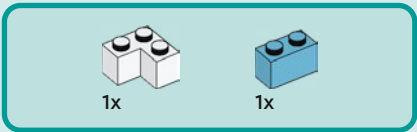
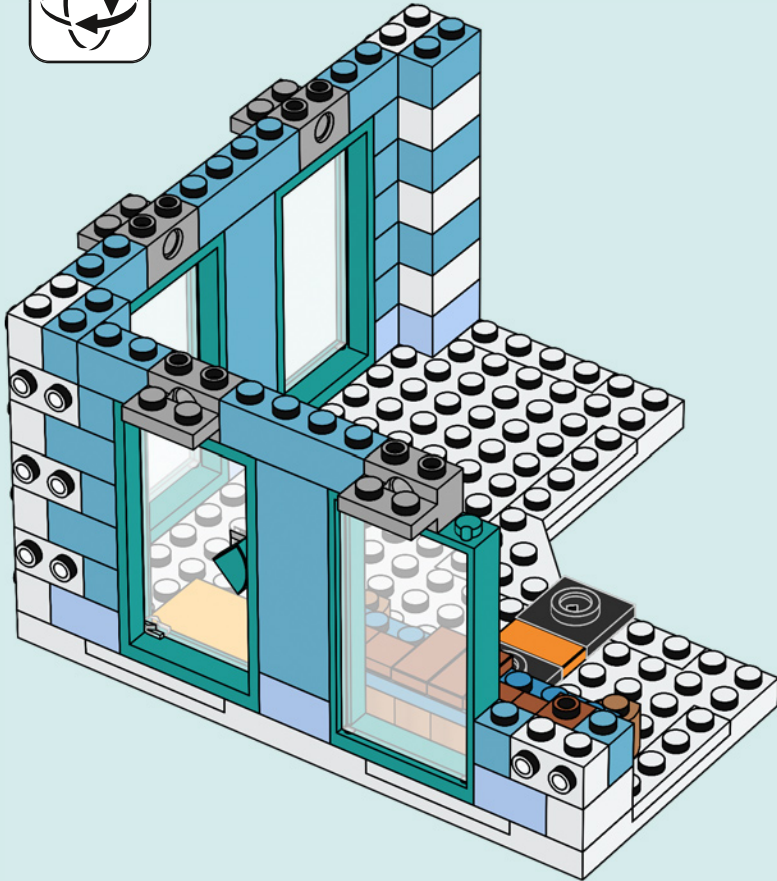

30

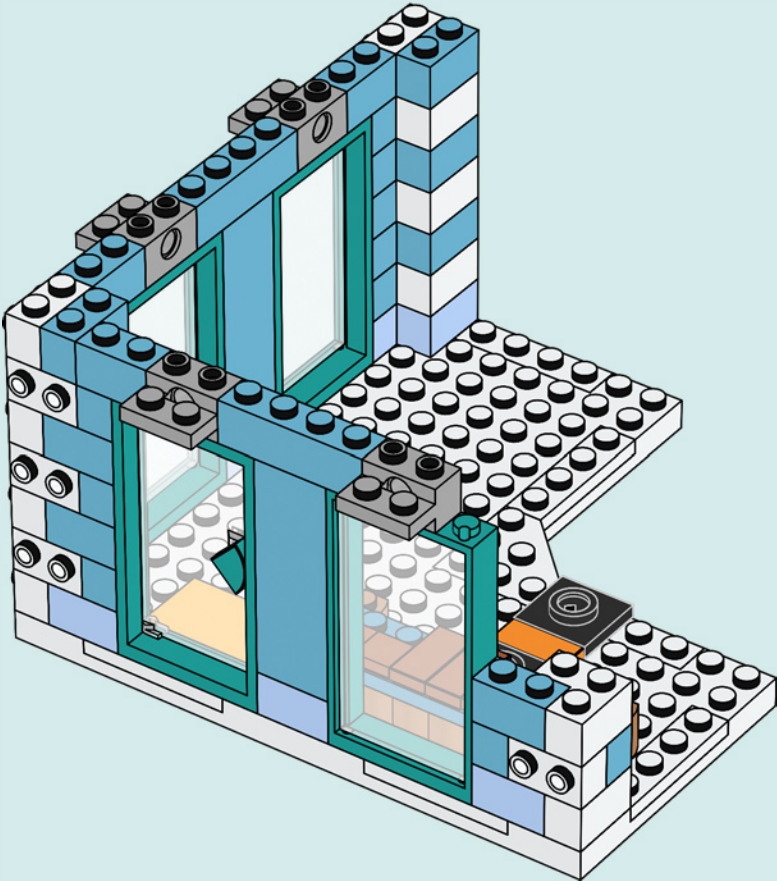

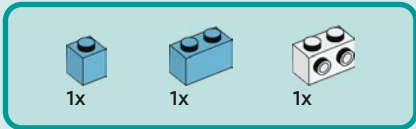

31

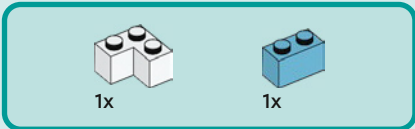
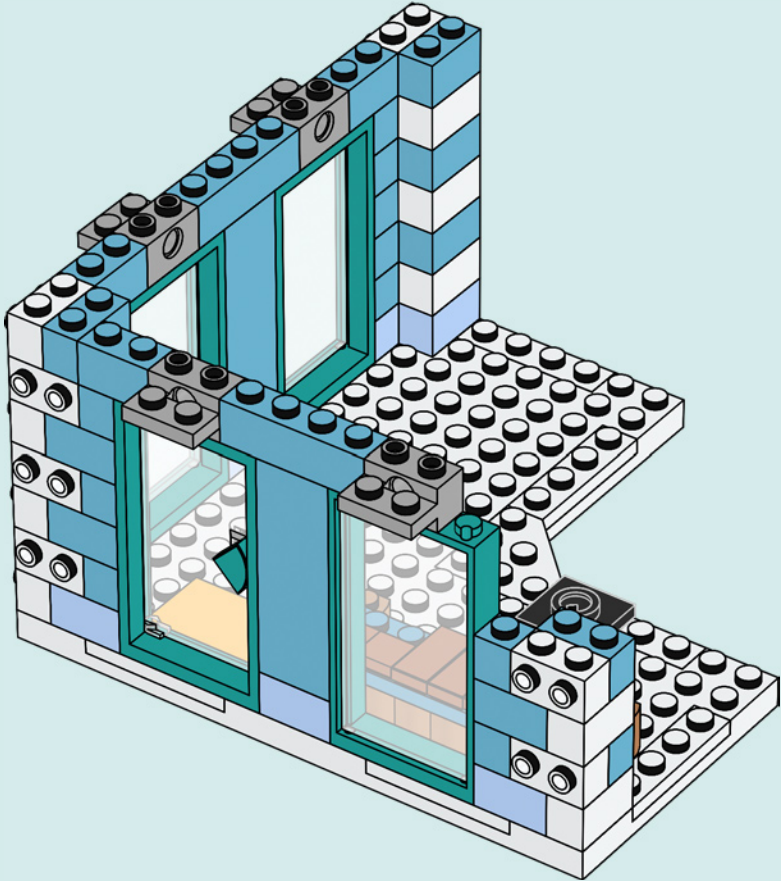

32

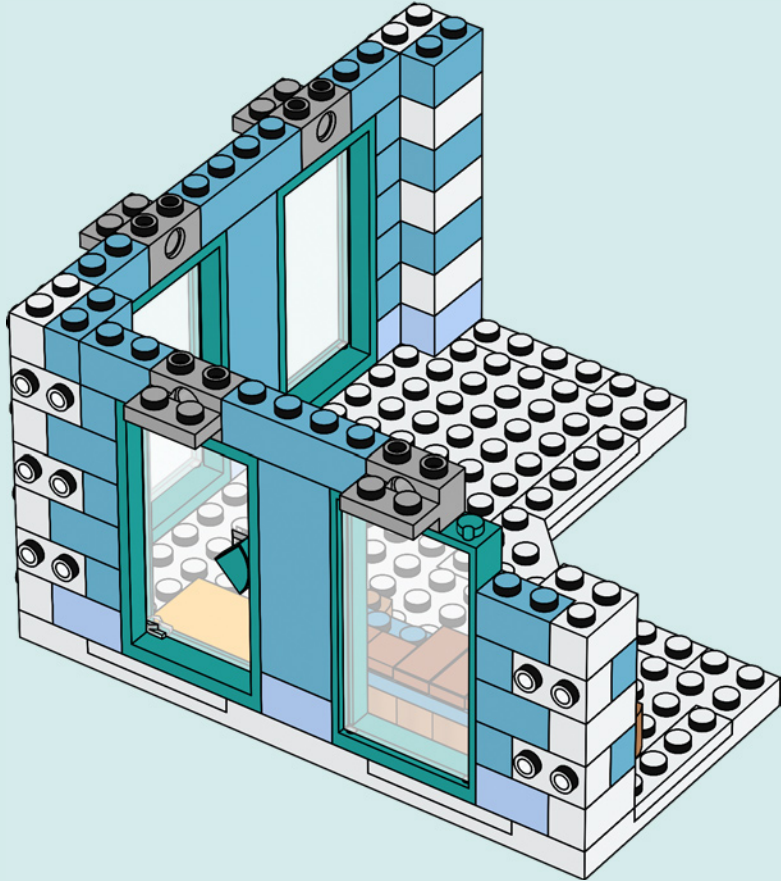

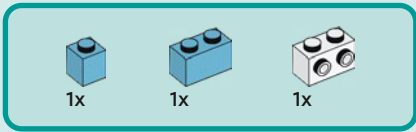

33

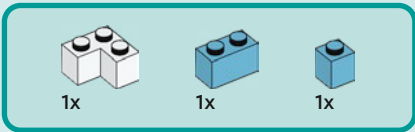
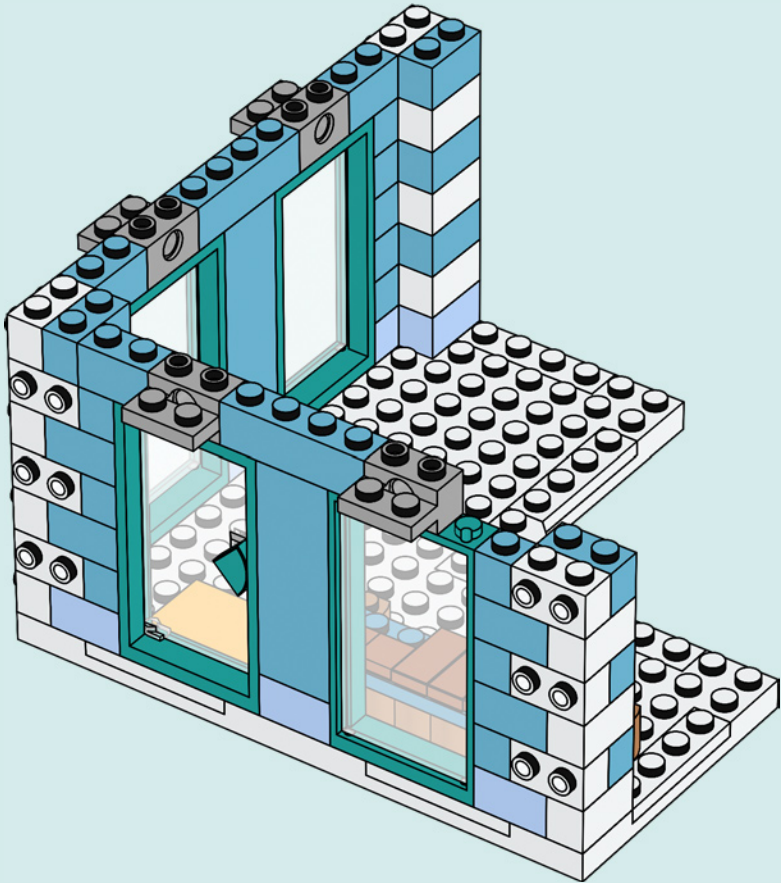

34

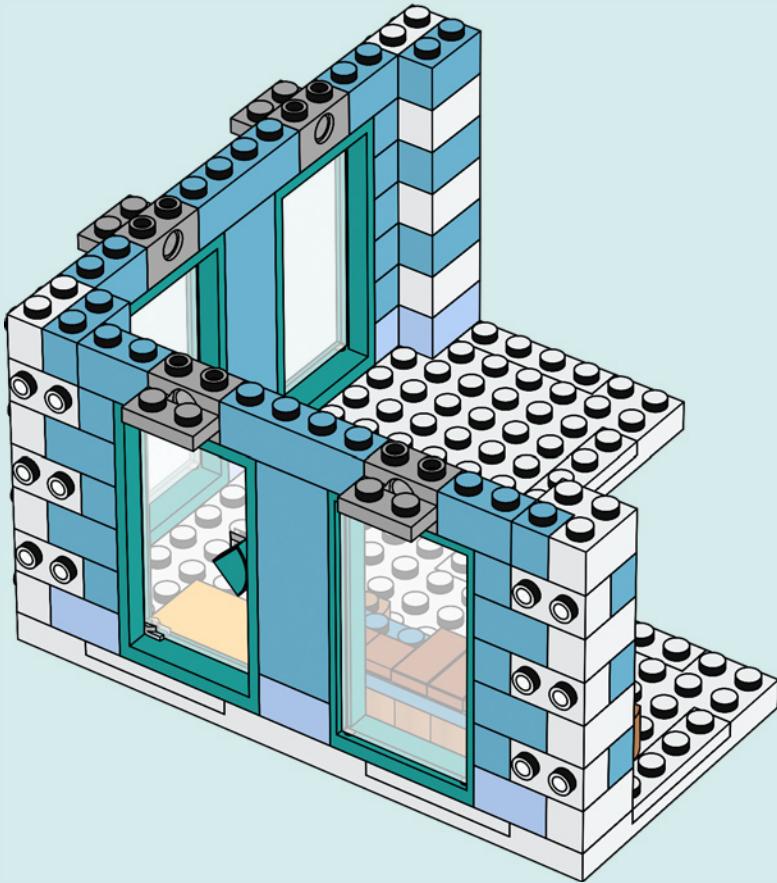

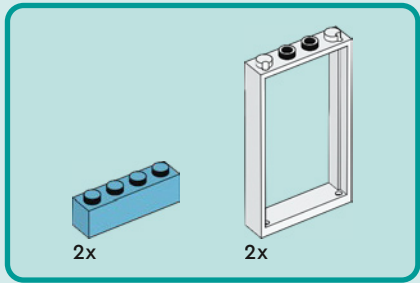

35

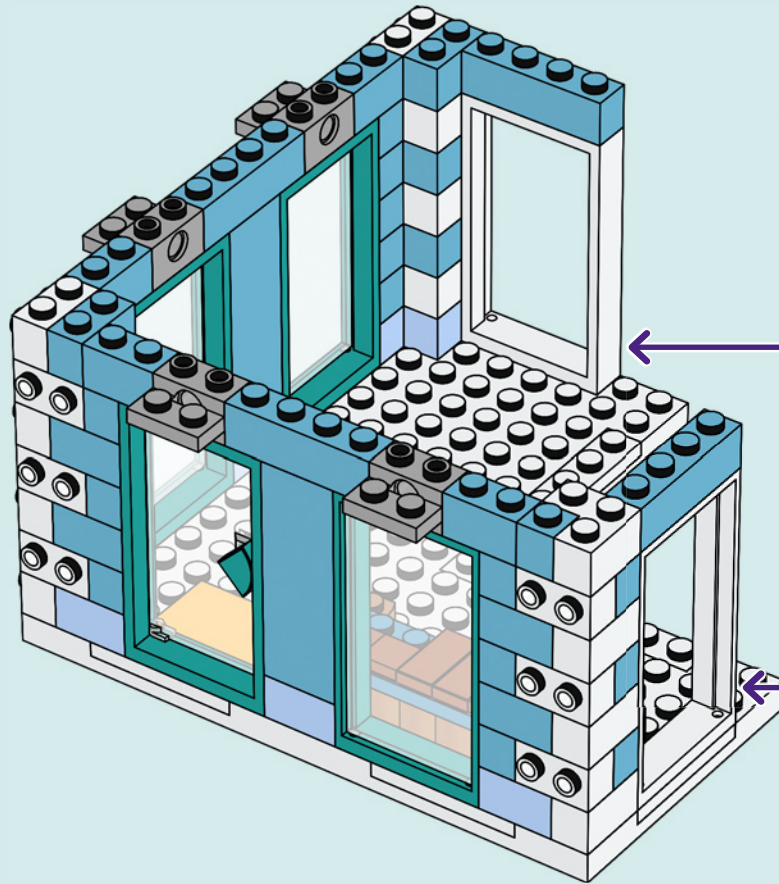
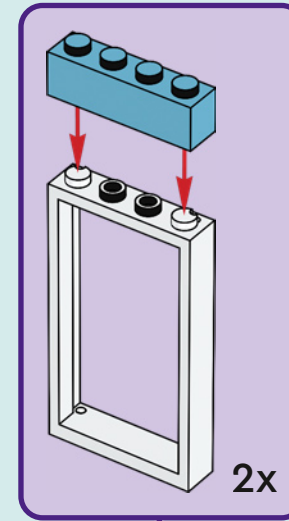

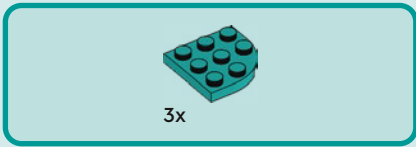

36

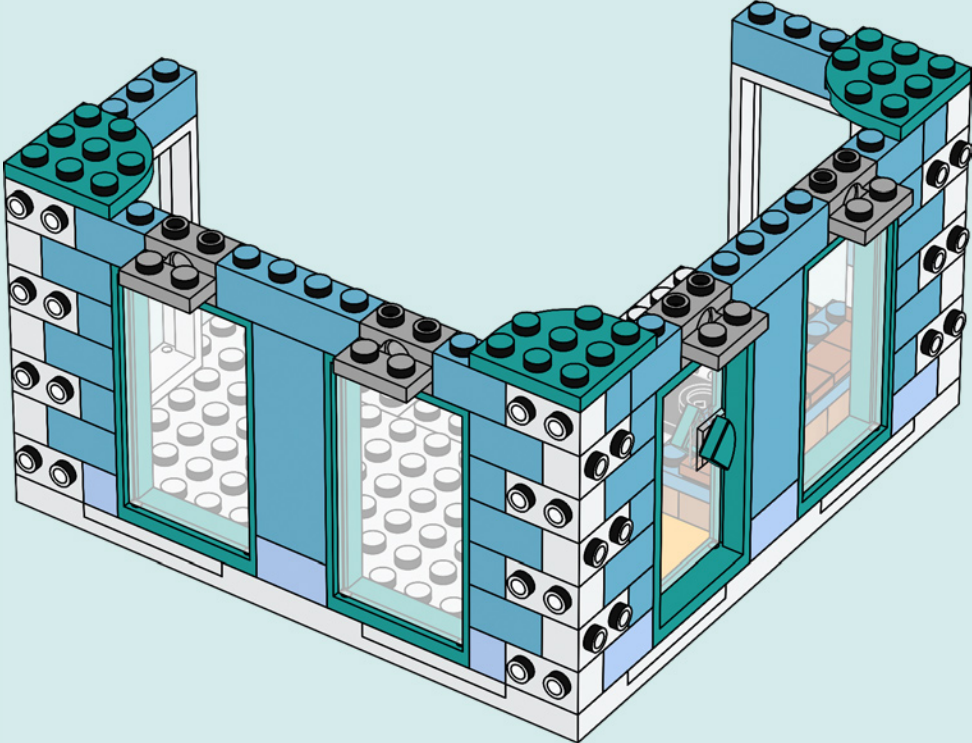



8x

37

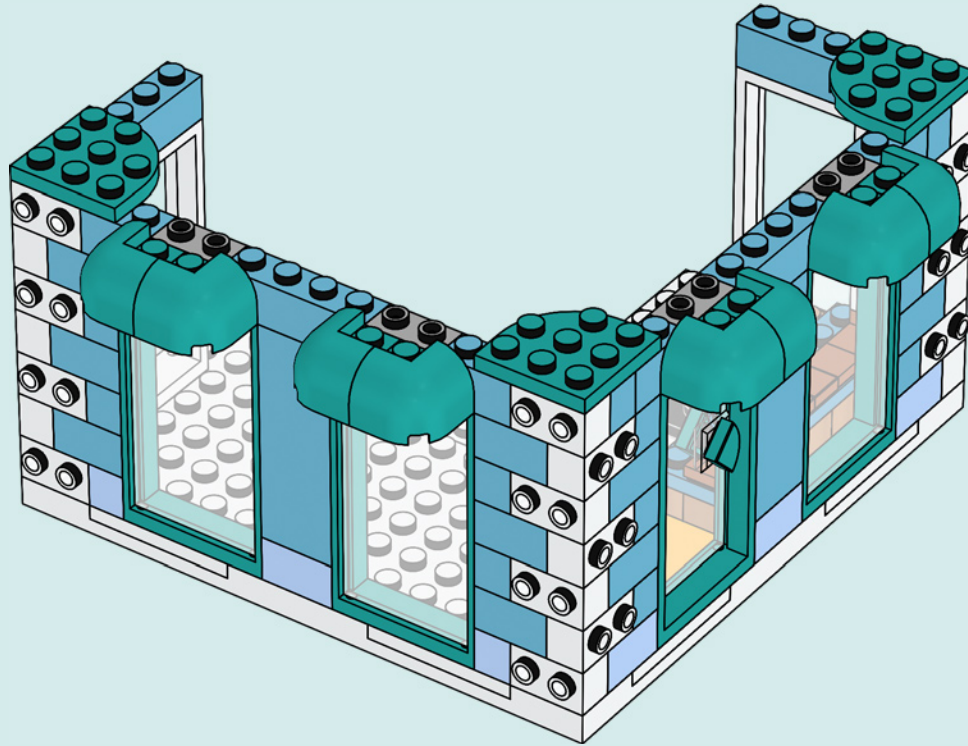



8x

38

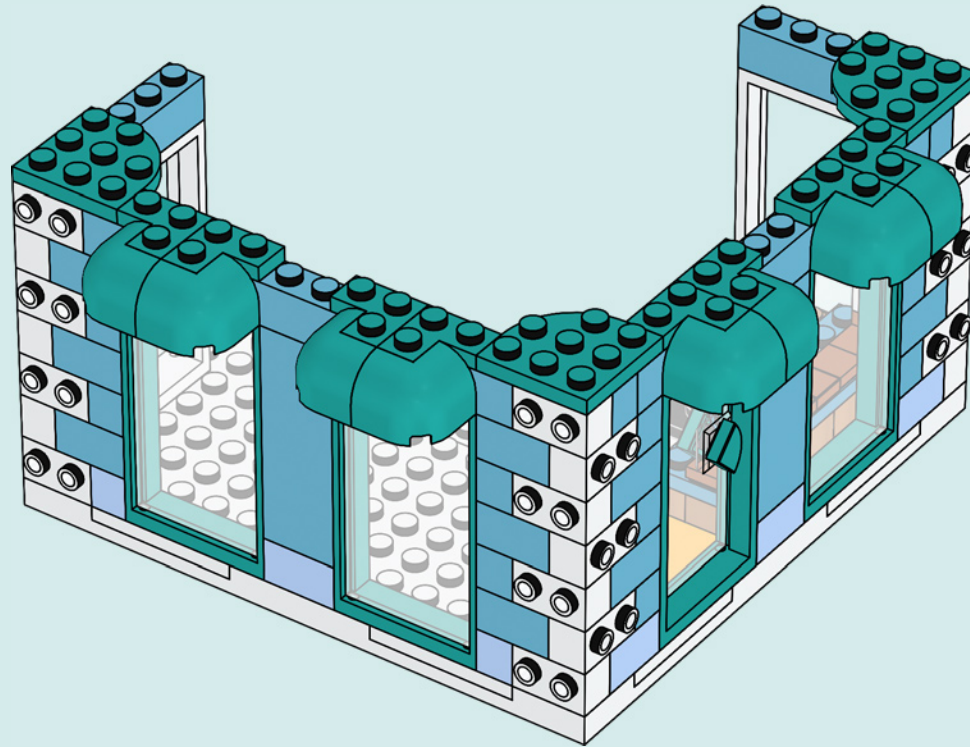



2x



2x

39

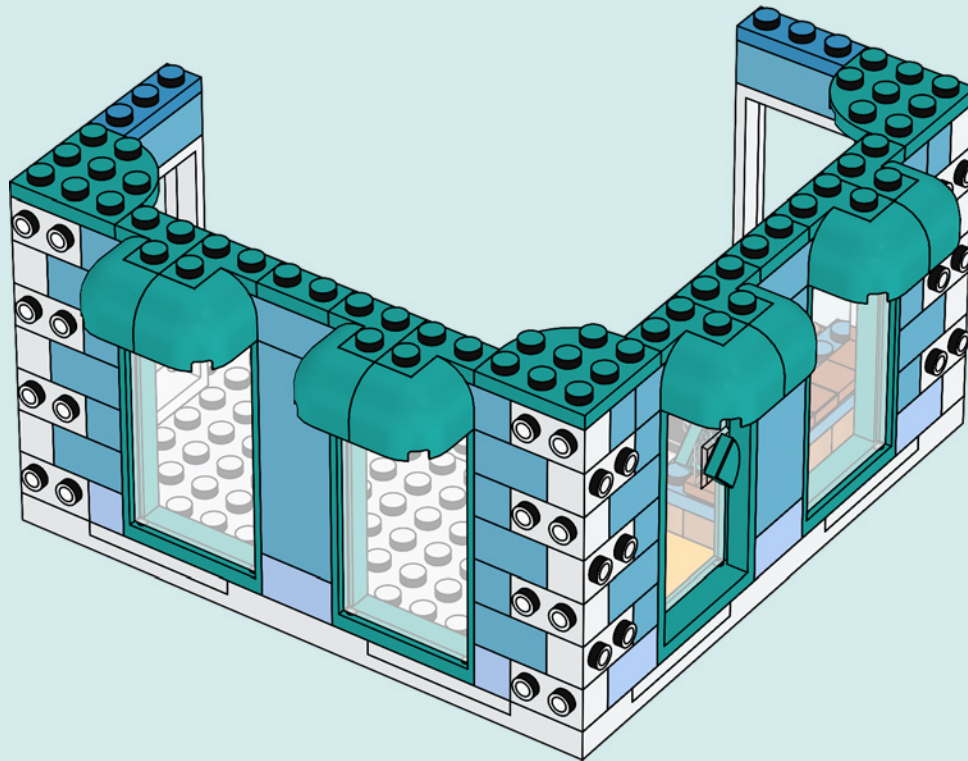

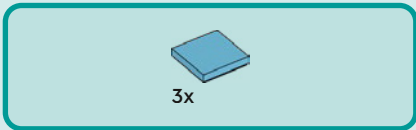

40

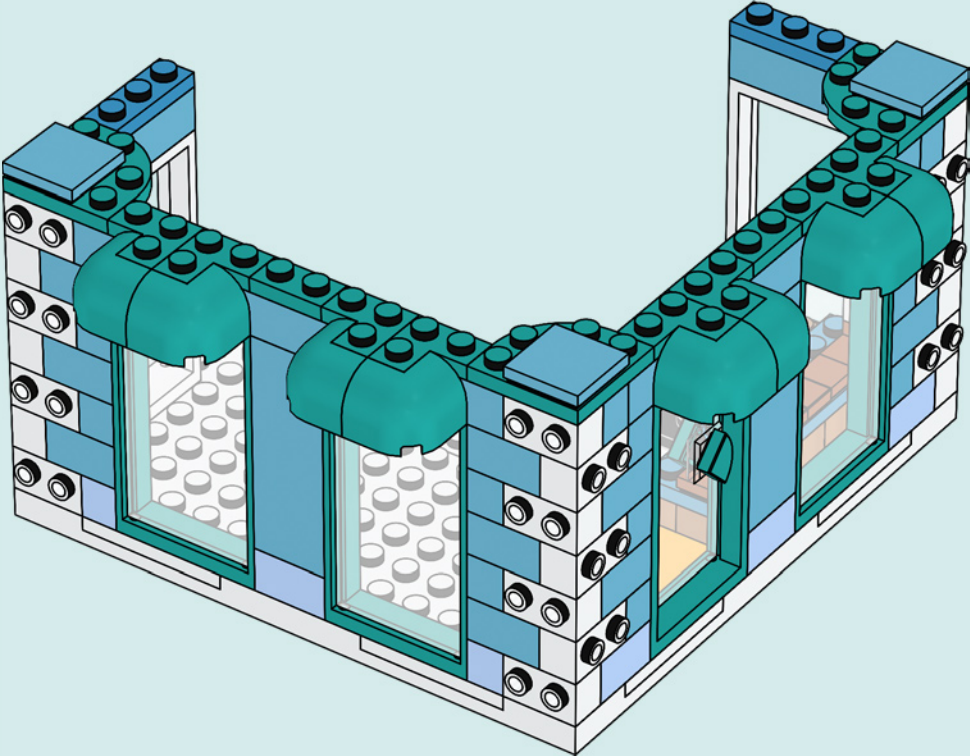

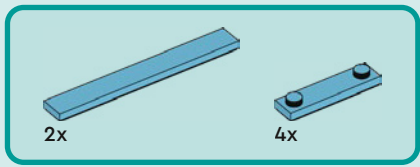

41

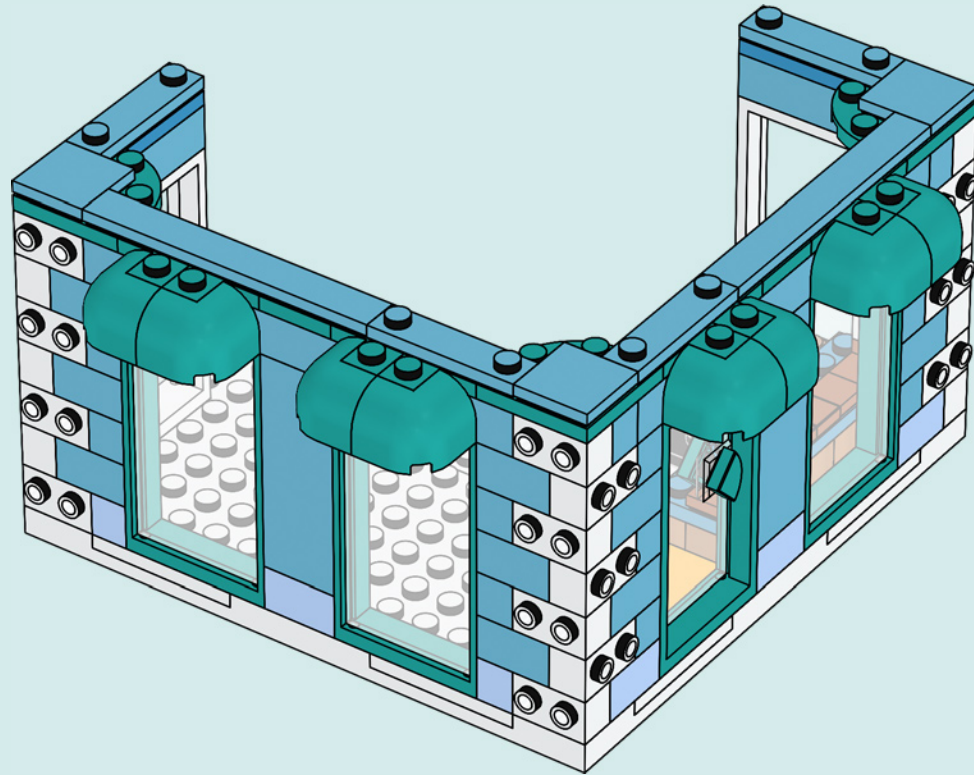



1

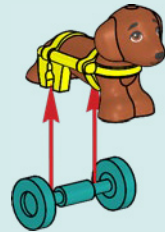

2

PICKLE



NOVA

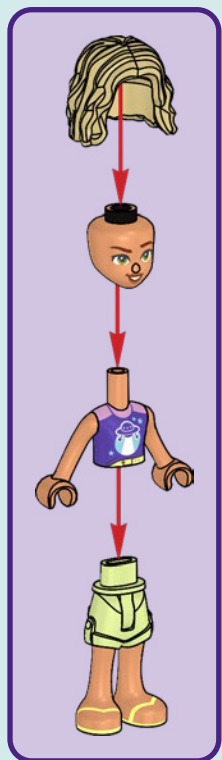

14x

42

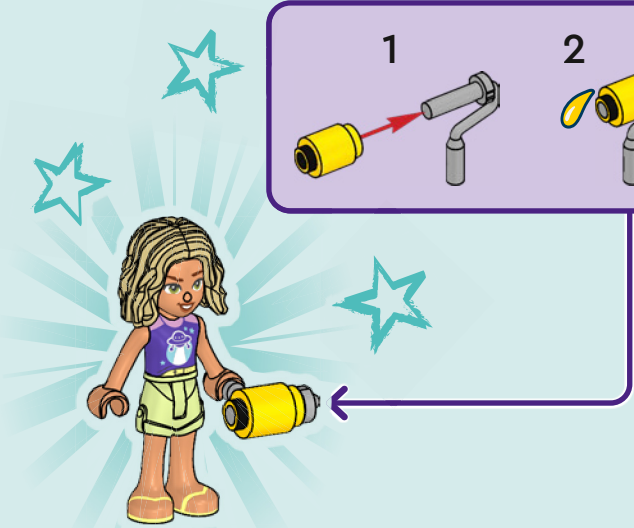
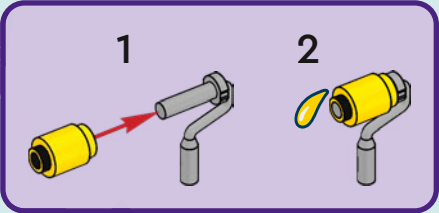
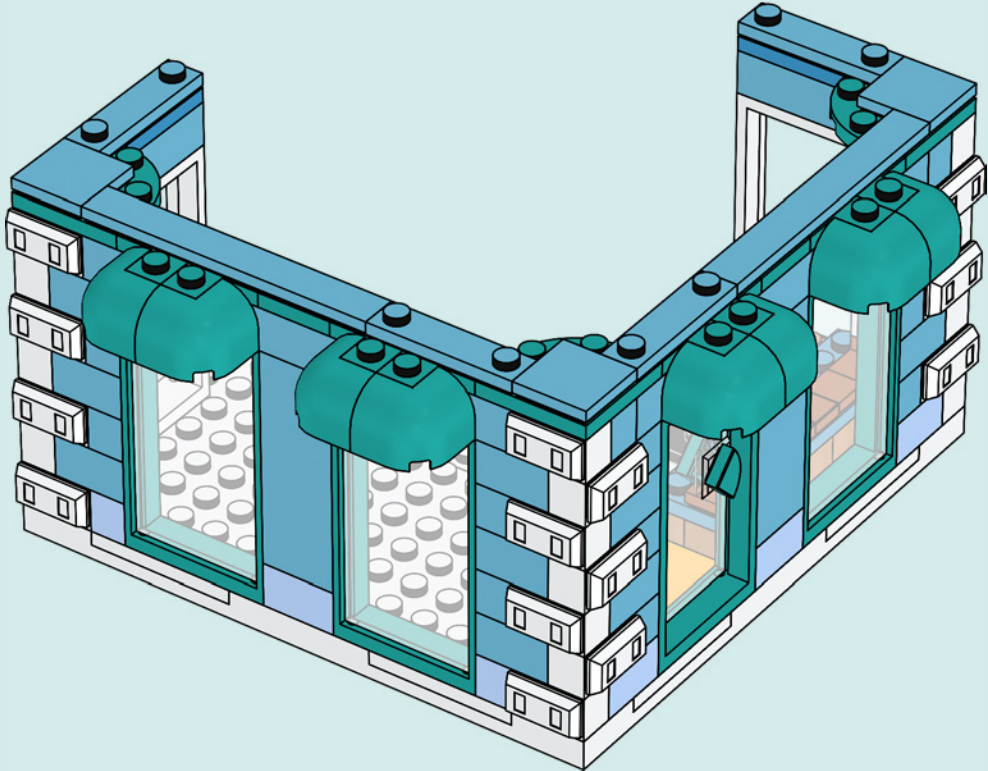



4x

43

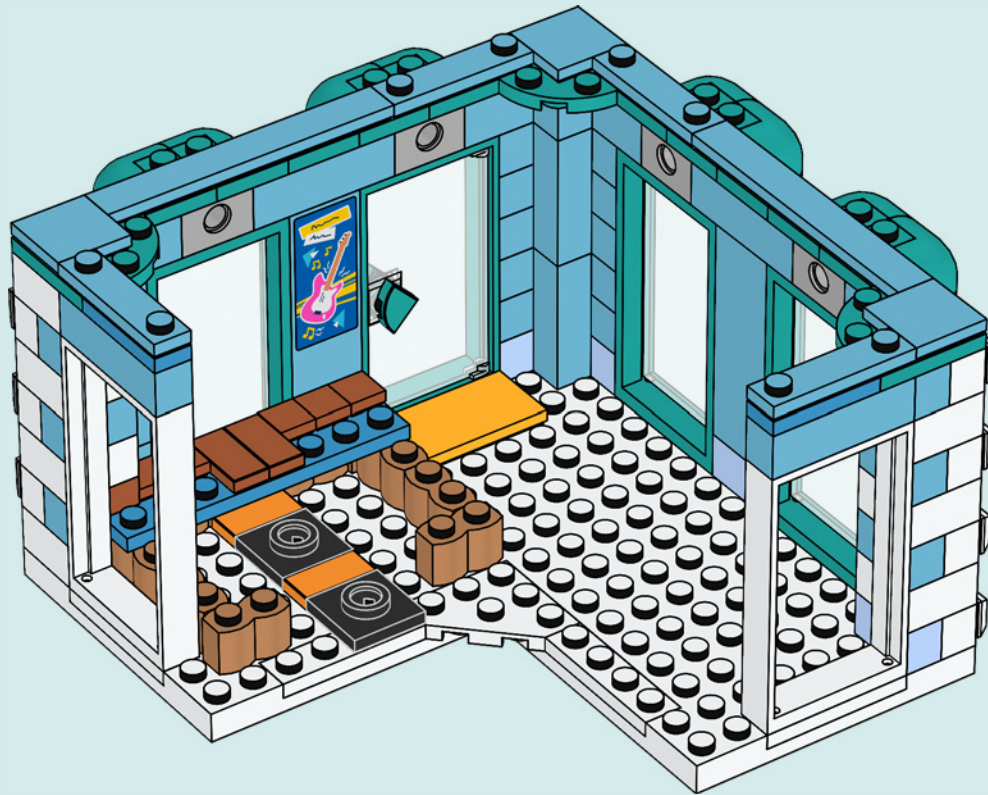



44

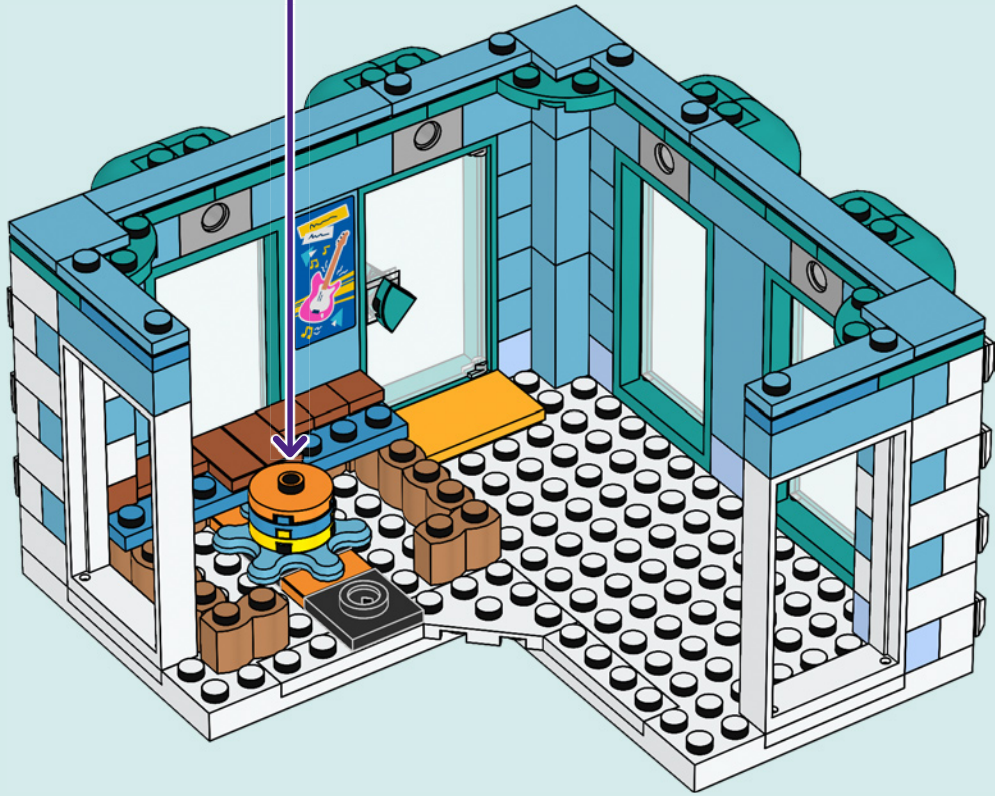
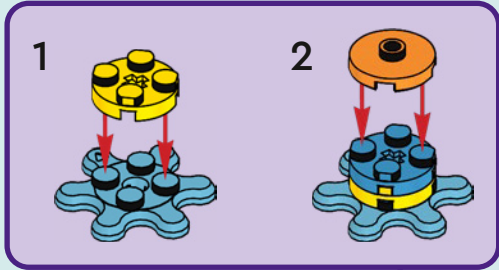



1x



1x

45

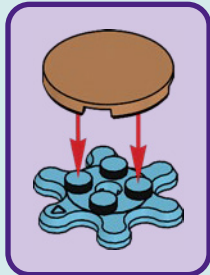
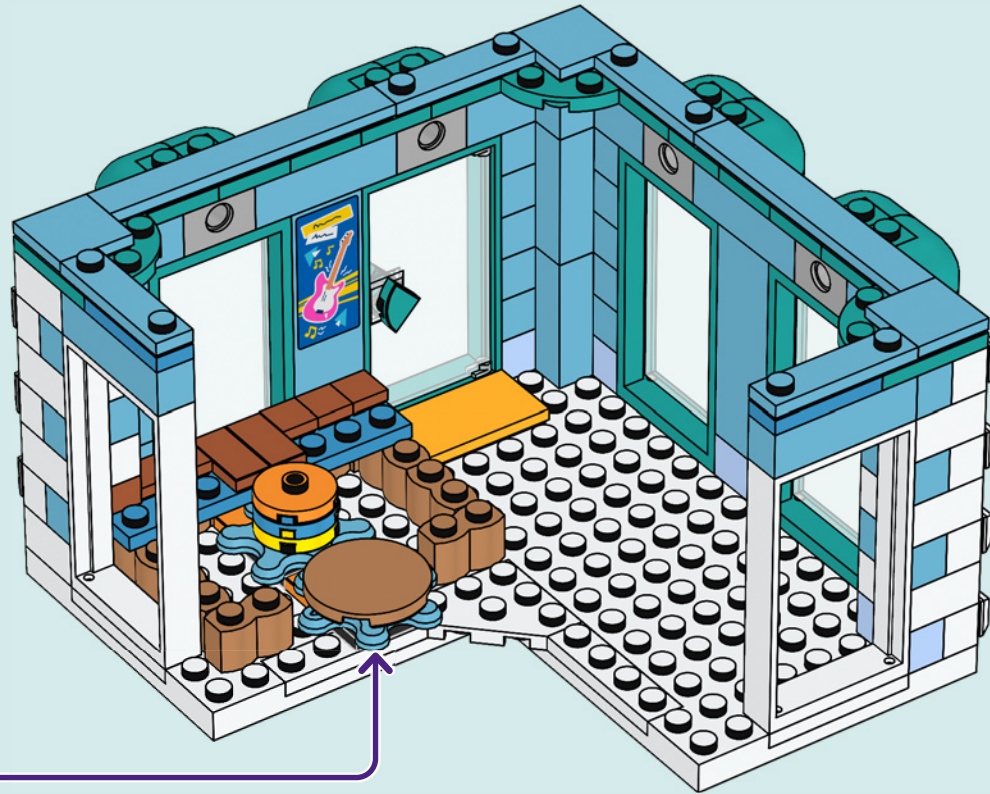

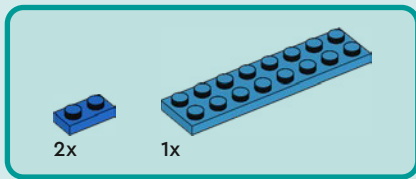

46

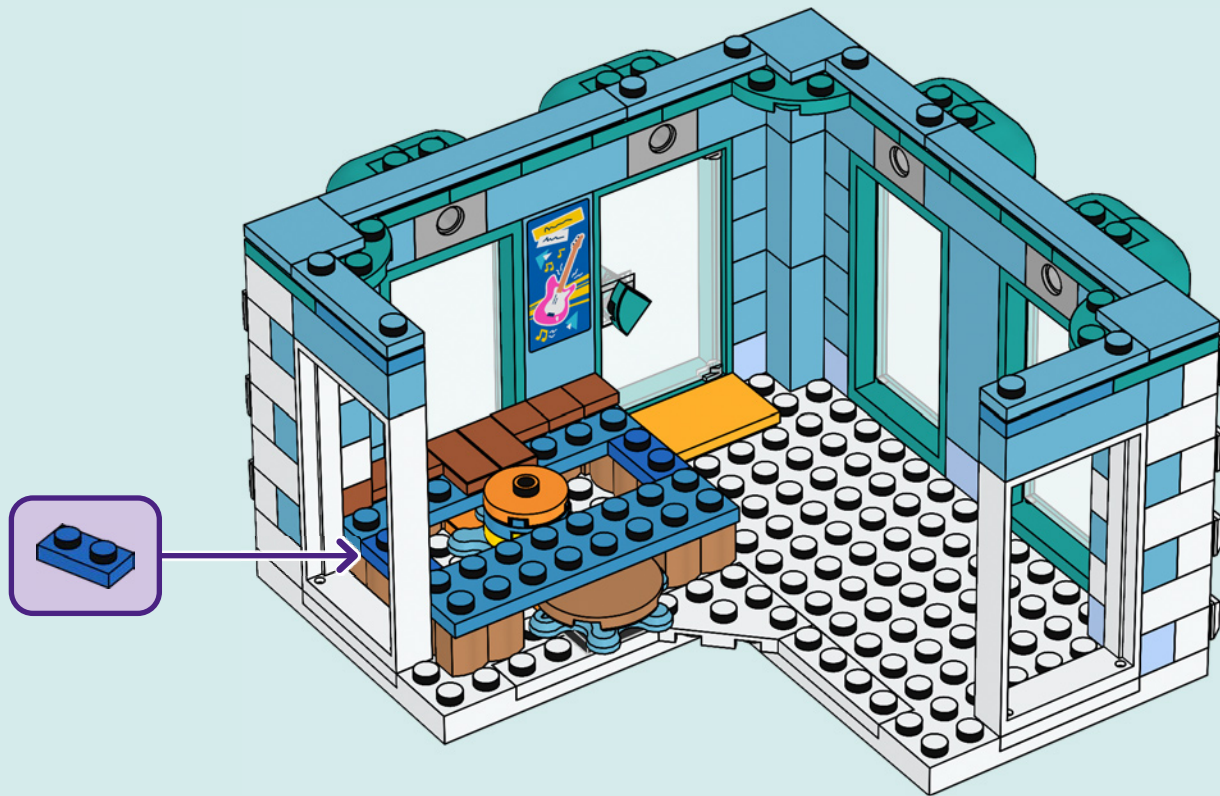

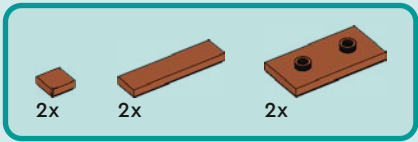

47

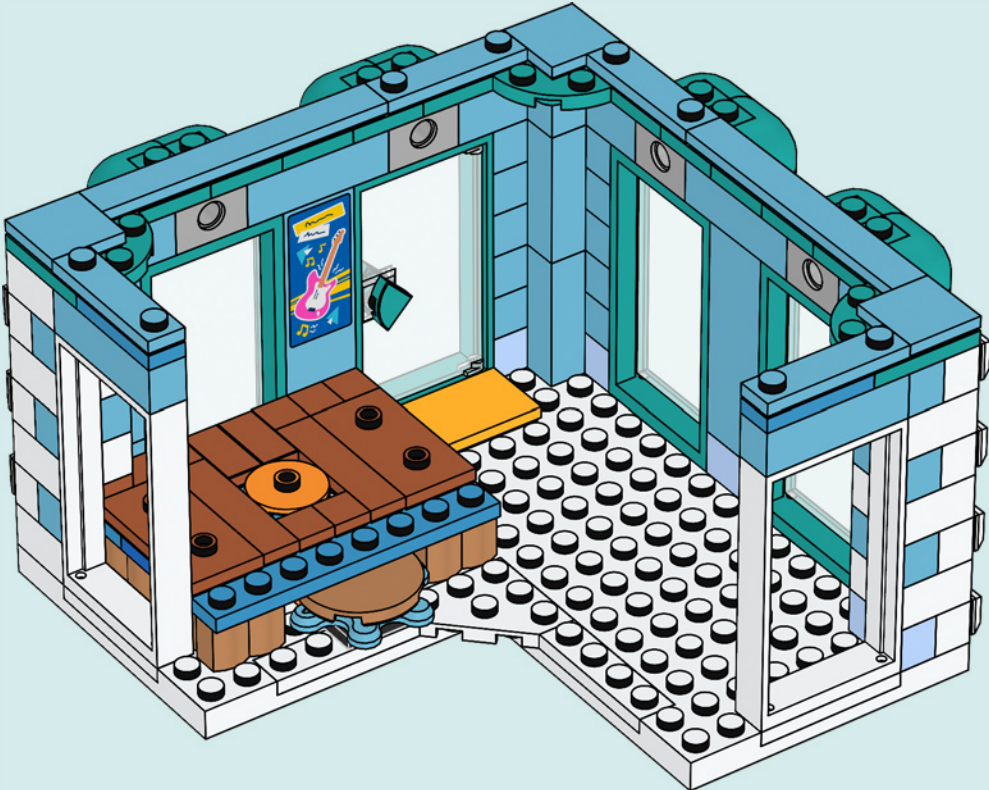



2x



3x

48

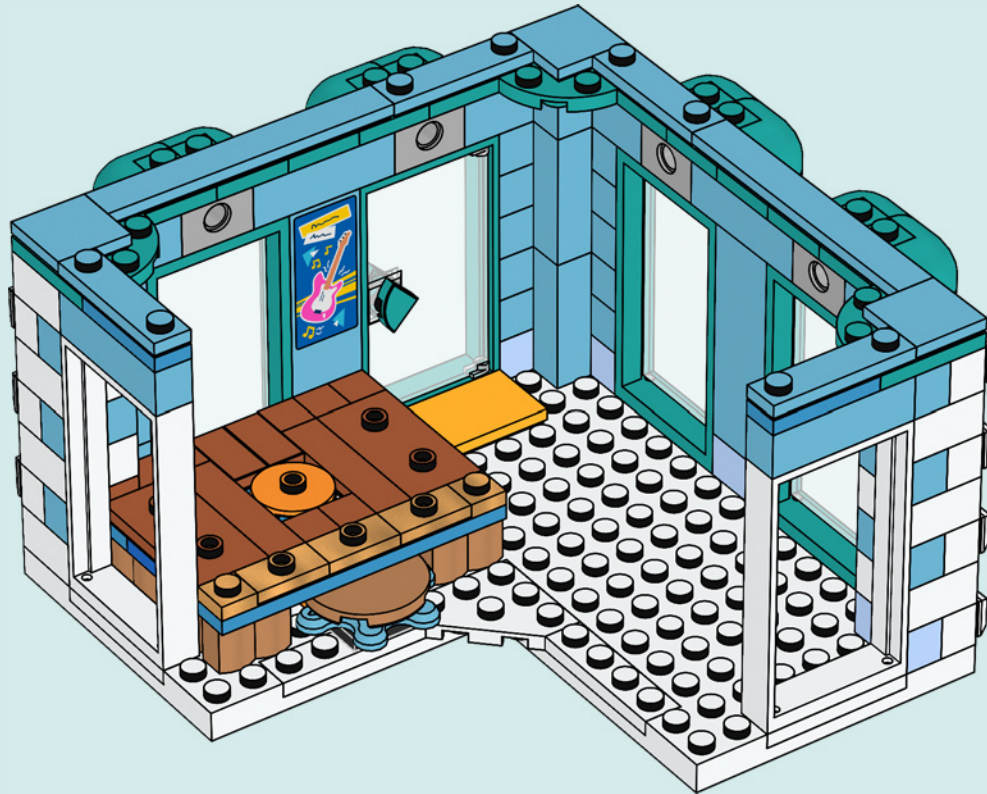



1x



4x

49

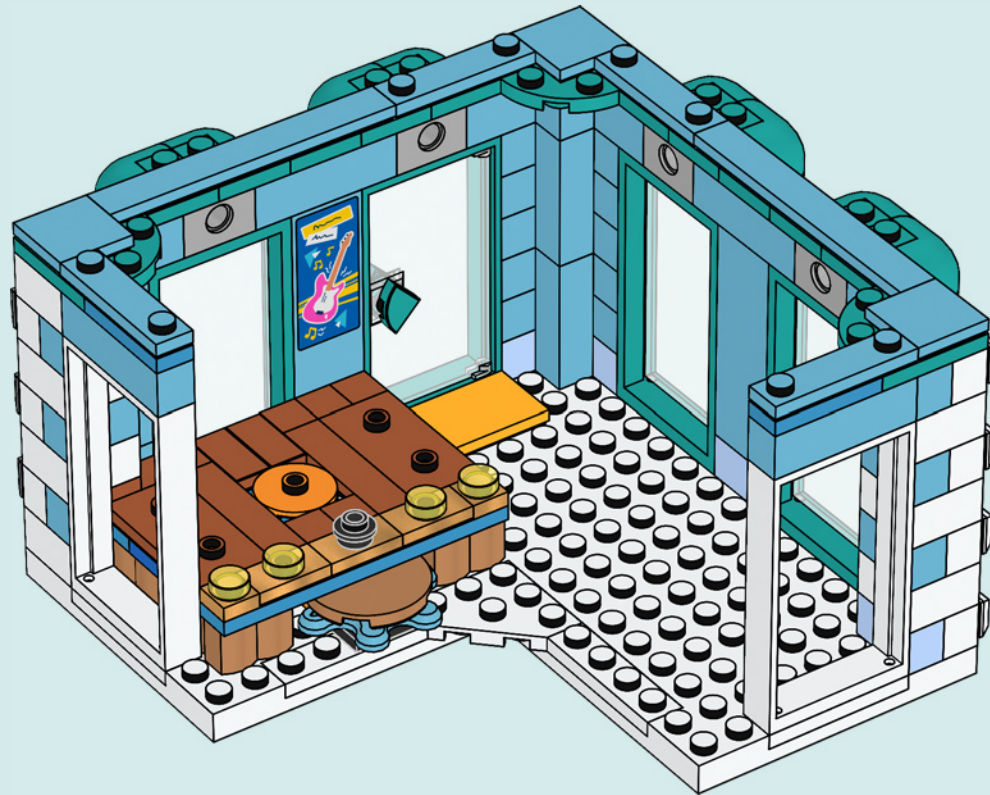

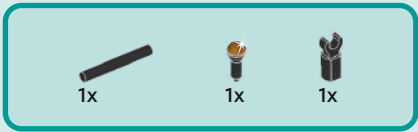

50

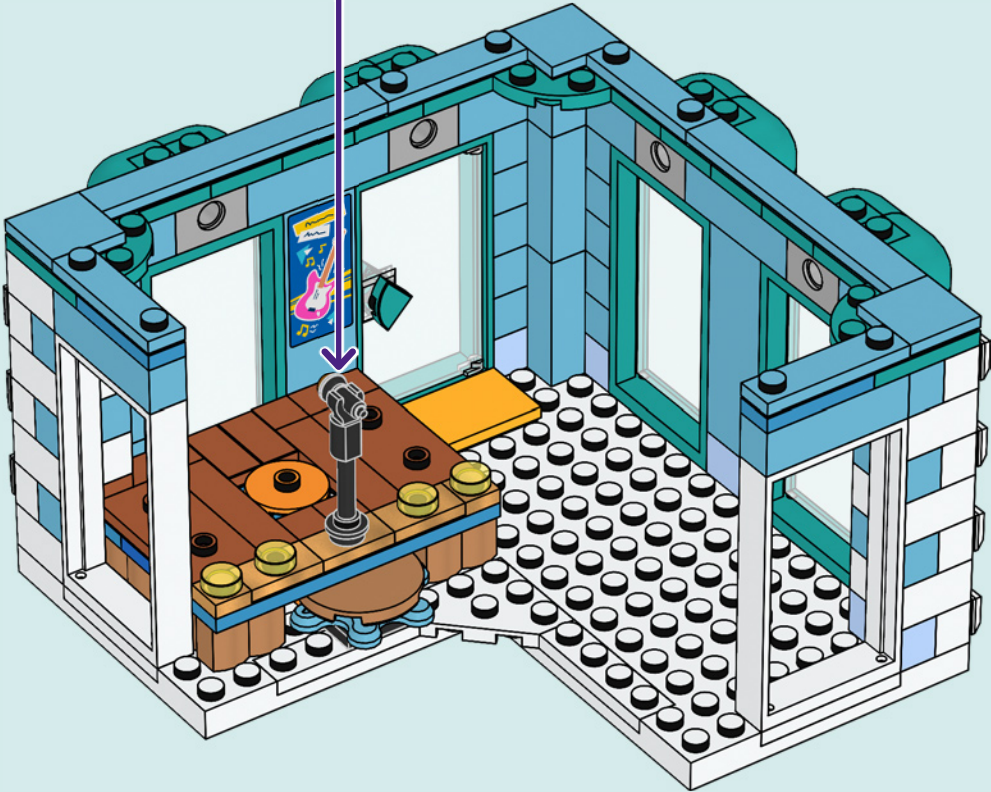
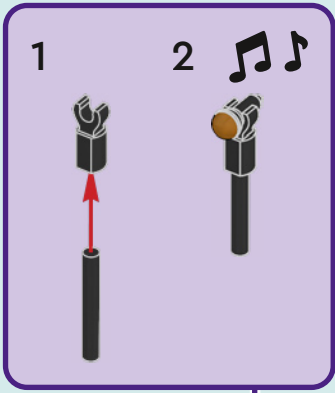

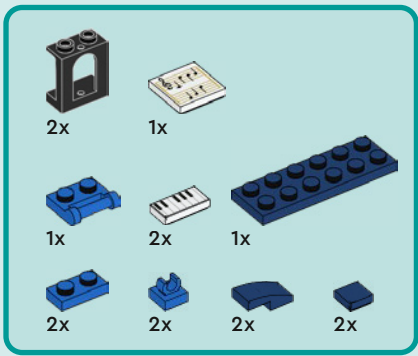

51

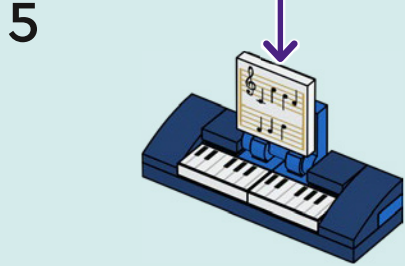
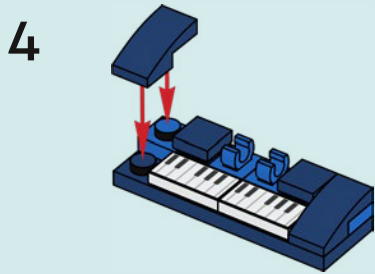
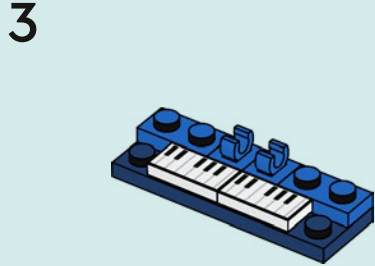
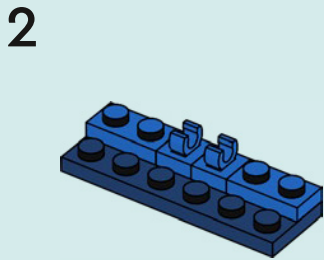
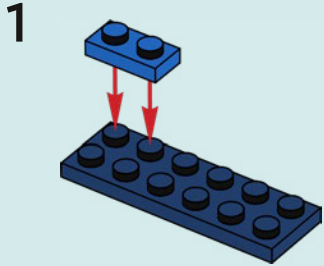





1x



2x

52

1

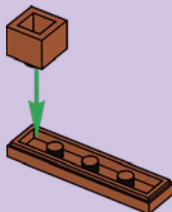

2

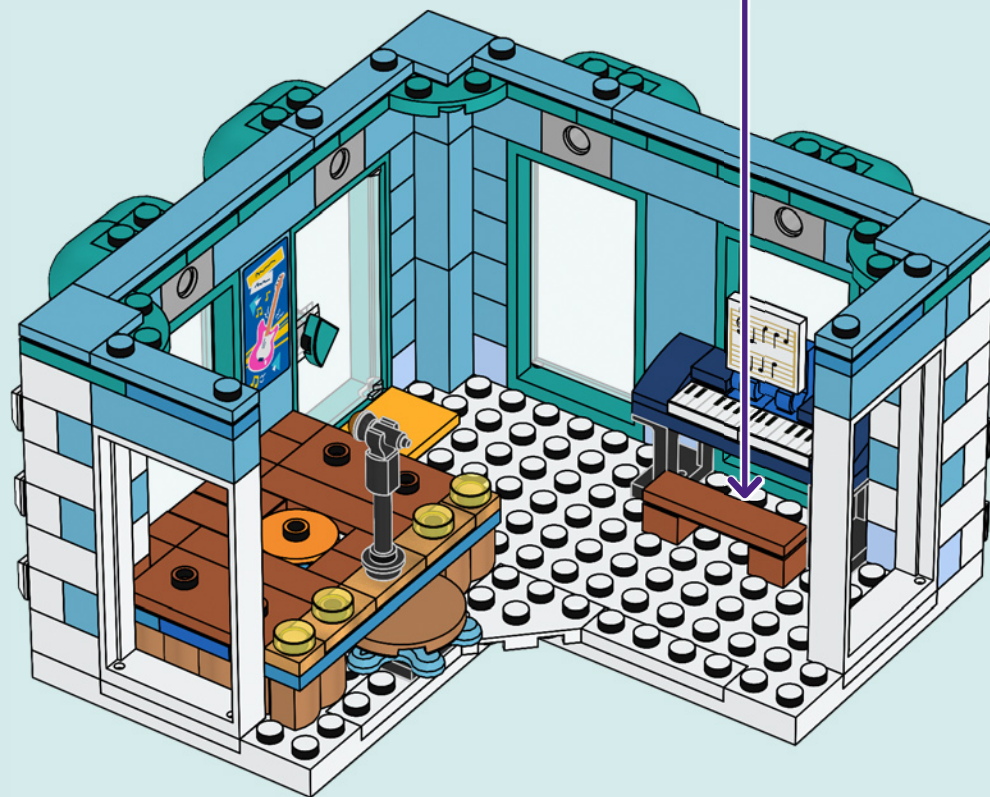
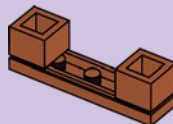

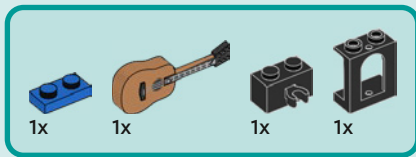

53

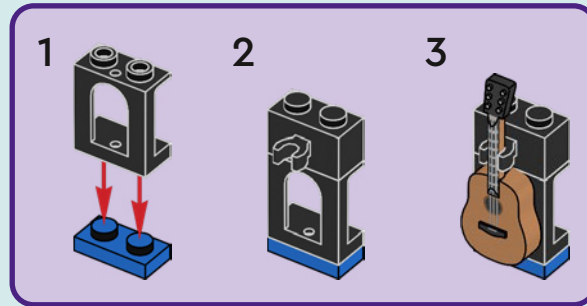

54

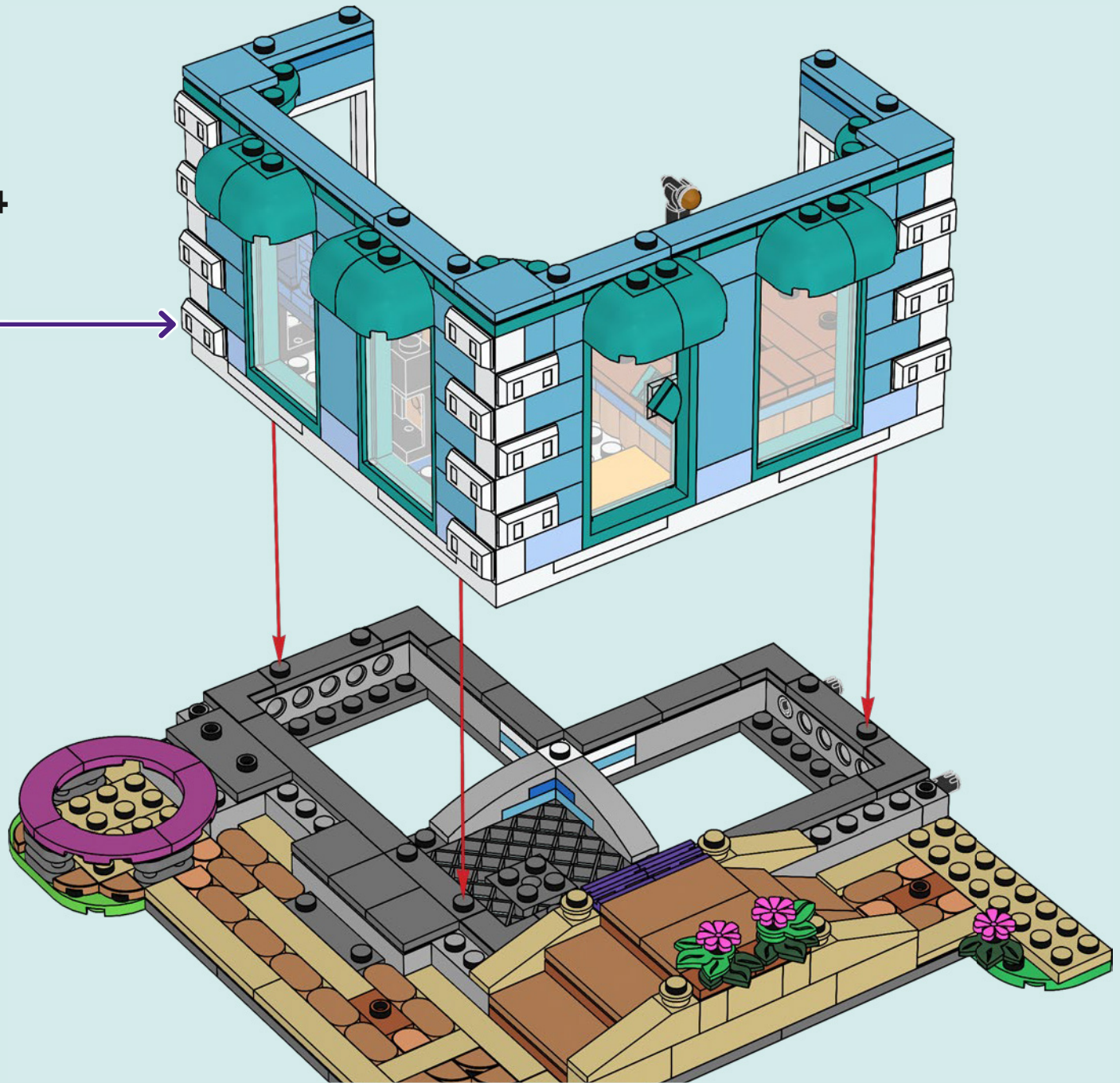



2x

55

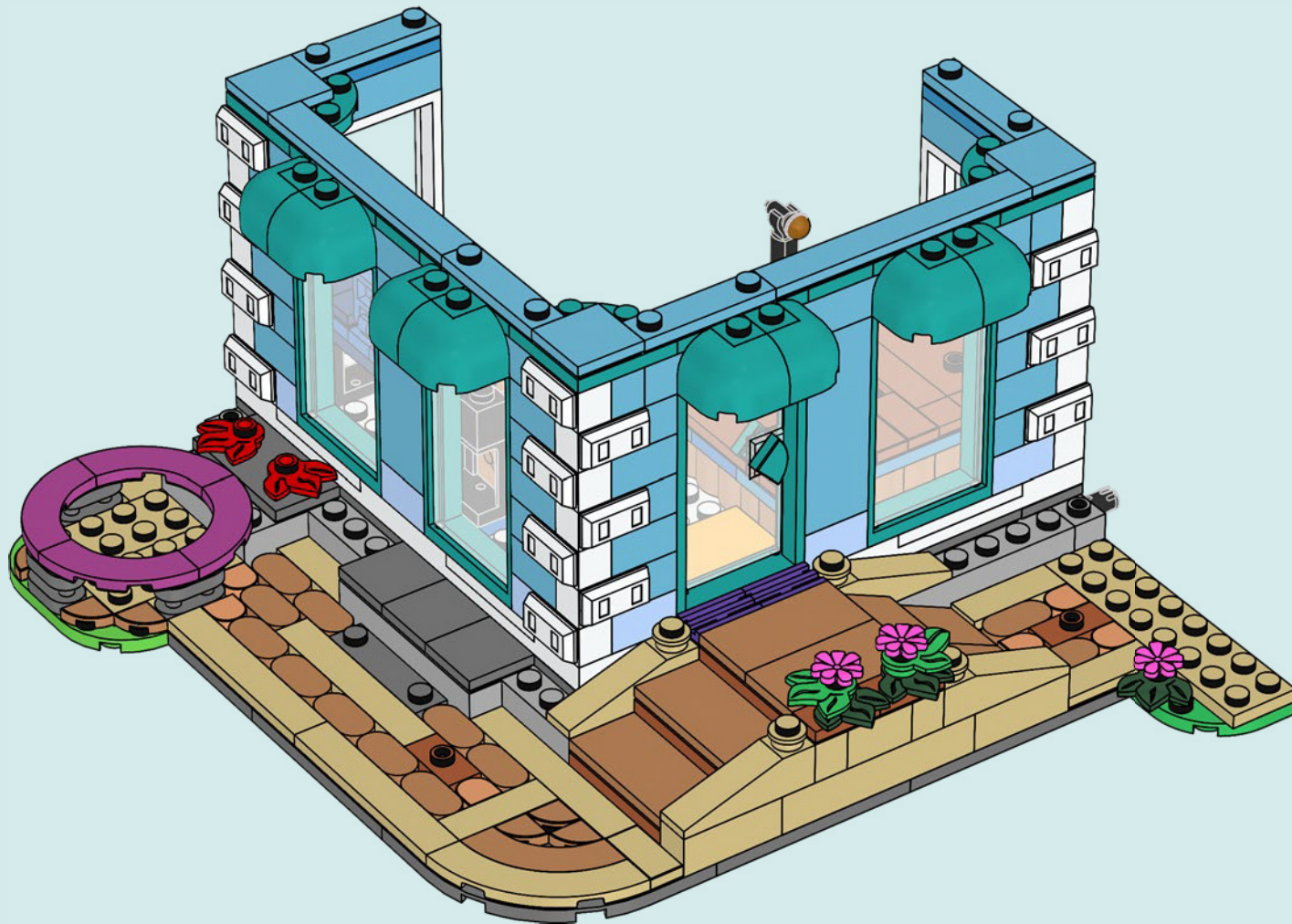

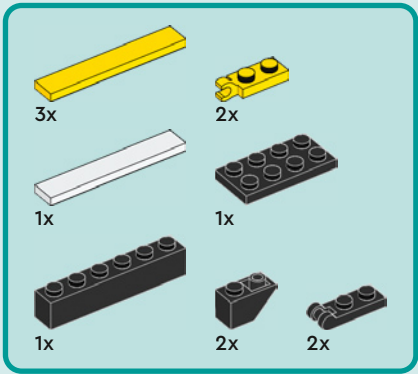

56

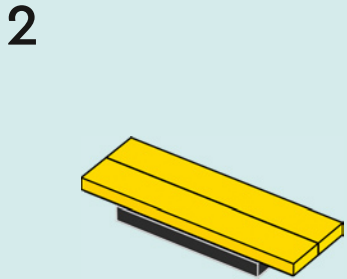
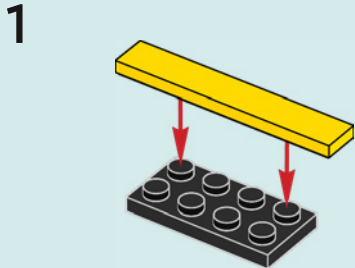

3

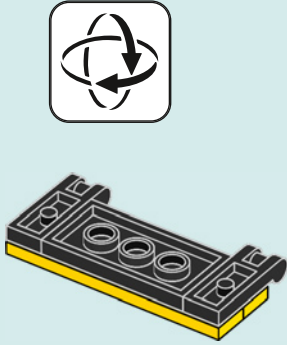

4

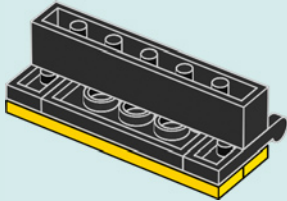

5

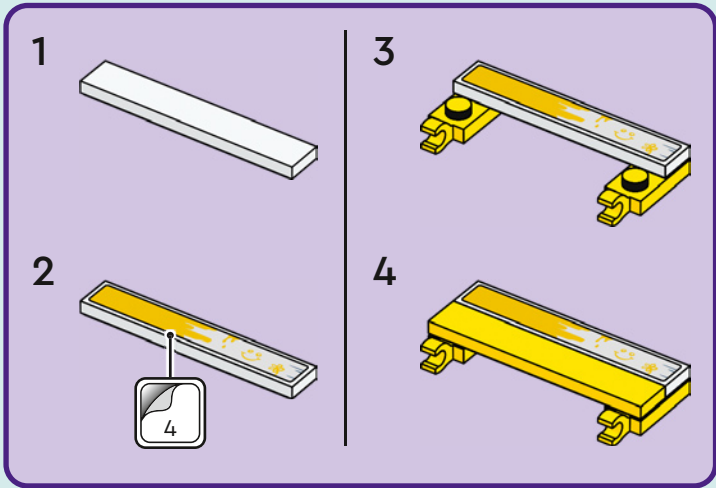
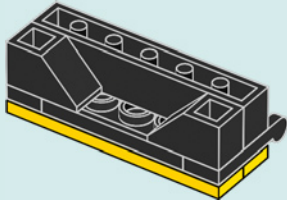

6

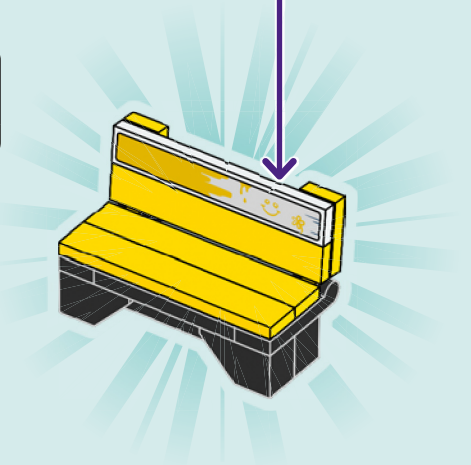

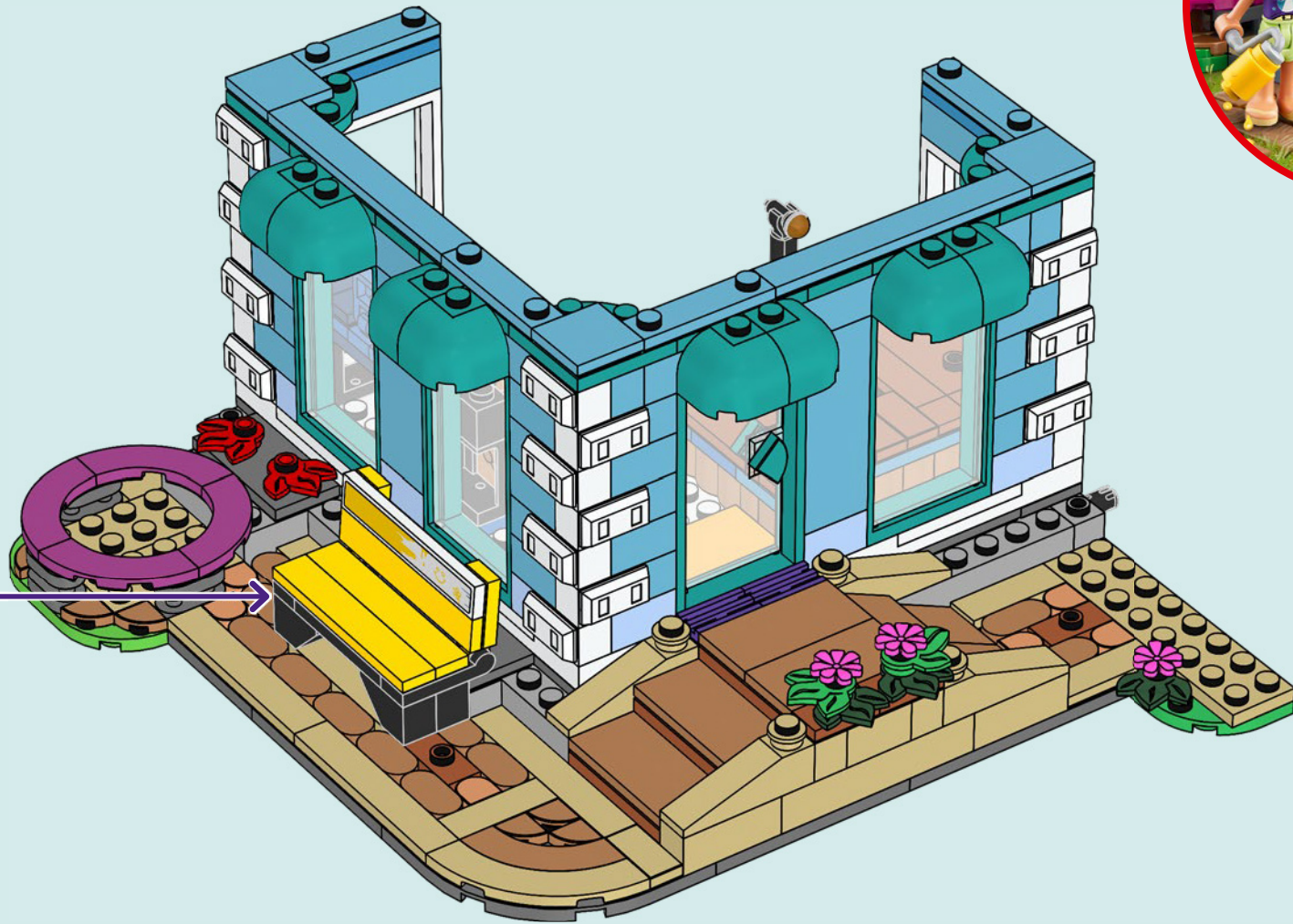

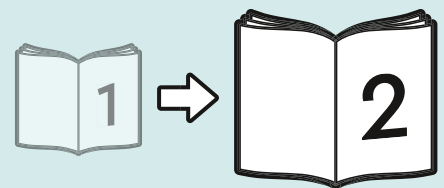
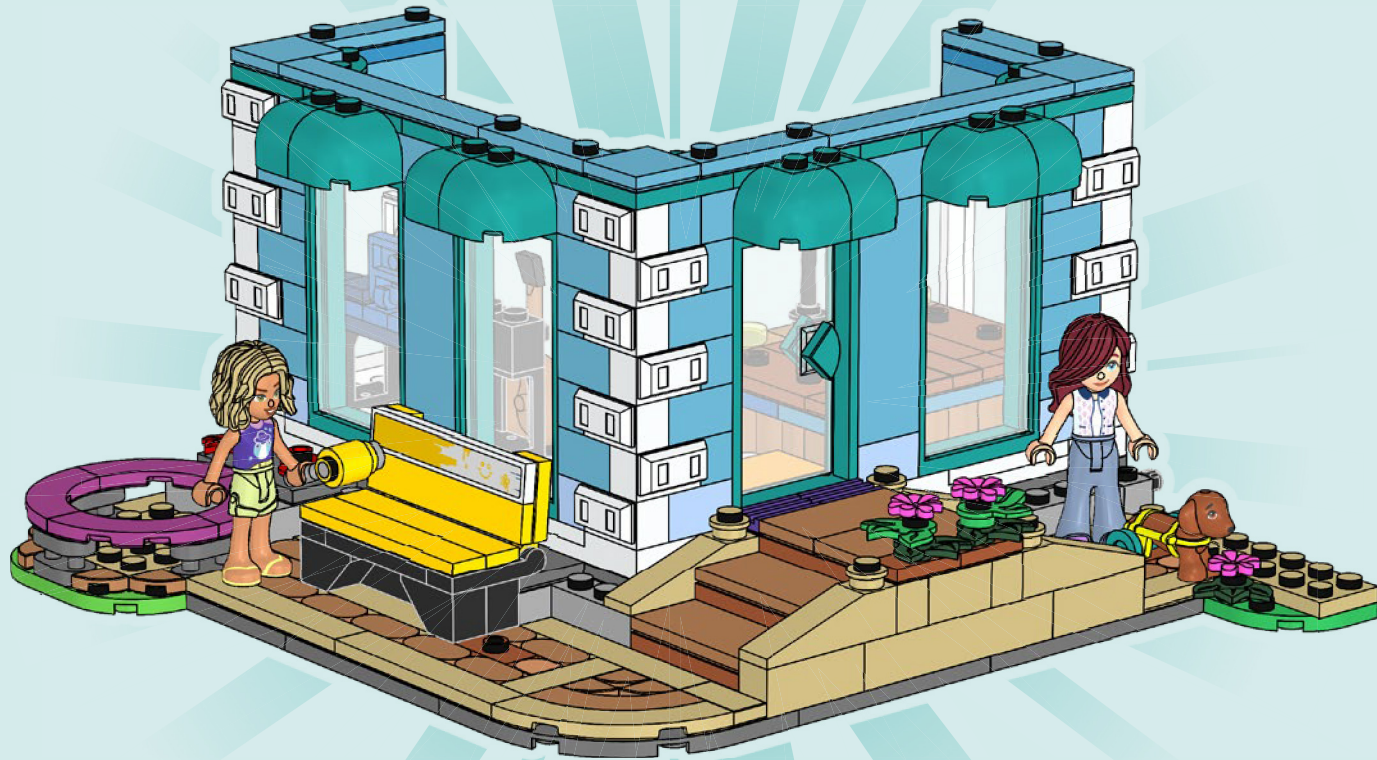



Friends

41745



41747



41744



41749



41748





Friends

AUTUMN

ALTYA

PAISLEY

ZAC



LEO

LIANN

OLLY

NOVA



YOU COULD WIN



Scan this QR code or go to **LEGO.COM/PRODUCTFEEDBACK** and give us your short feedback about this LEGO® set for a chance to win a cool LEGO prize.

Terms and Conditions apply*



EN: YOU COULD WIN. Terms and Conditions apply* **DE: Du könntest GEWINNEN.** Es gelten die Teilnahmebedingungen* **FR: Tu pourrais GAGNER.** Des conditions s'appliquent* **IT: Potresti VINCERE tu.** Termini e condizioni sono applicabili* **ES: Puedes GANAR.** Aplican términos y condiciones* **PT: Poderá GANHAR.** Aplicam-se termos e condições* **ZH: 轻松获奖. 条款和条件适用*** **PL: Szansa na WYGRANĄ.** Obowiązują warunki korzystania* **CS: Máte šanci VYHRÁT.** Platí všeobecné smluvní podmínky* **SK: Máte šancu VYHRAŤ.** Platia všeobecné zmluvné podmienky* **HU: TE IS NYERHETSZ.** Felhasználási feltételek érvényesek* **RO: Ai putea CÂȘTIGA.** Se aplică termeni și condiții* **BG: Можете да СПЕЧЕЛИТЕ.** Има определени правила и условия* **LV: Tu vari LAIMĒT.** Ir spēkā noteikumi un nosacījumi.* **ET: Sul on võimalus VÕITA.** Kehtivad tingimused* **LT: Jūs galite LAIMĖTI.** Taikomos sąlygos*

*[LEGO.com/productfeedback-terms](https://www.lego.com/productfeedback-terms)

LEGO, the LEGO logo and the FRIENDS logo are trademarks of the/son des marques de commerce du/son marcas registradas de LEGO Group. ©2023 The LEGO Group.