



# PIRATES *of the* CARIBBEAN



4181



1

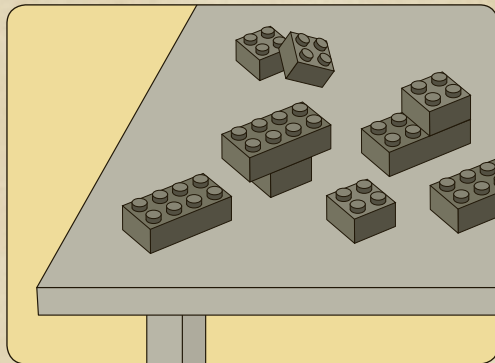
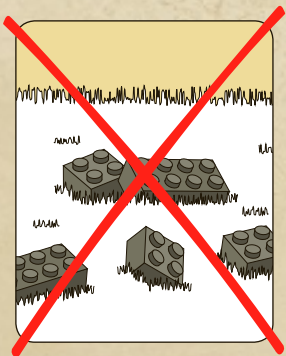

2

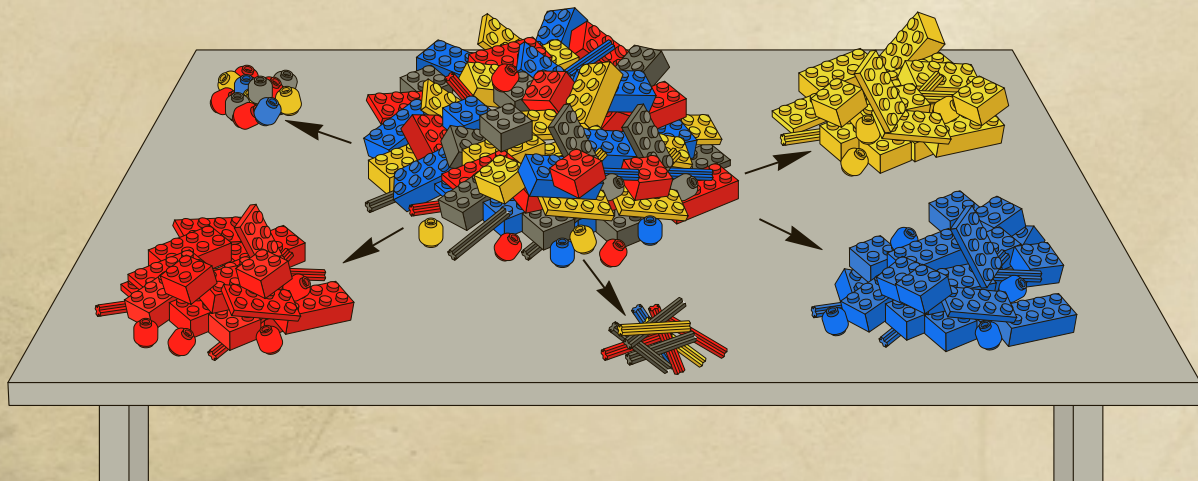

1



2



3



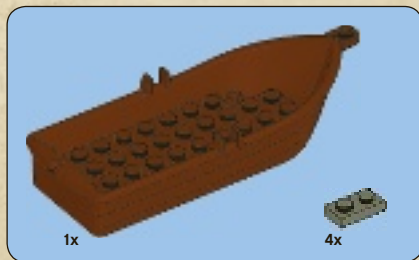

1

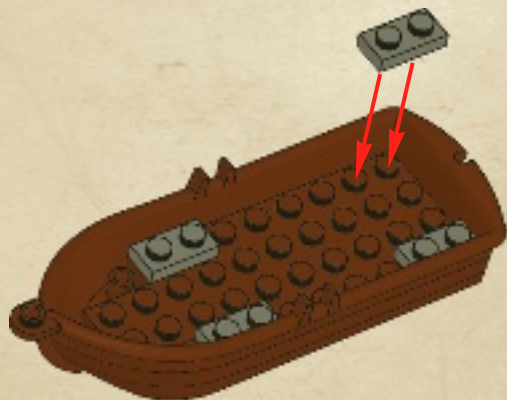



2

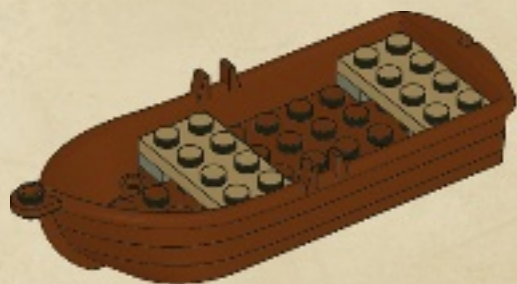

3

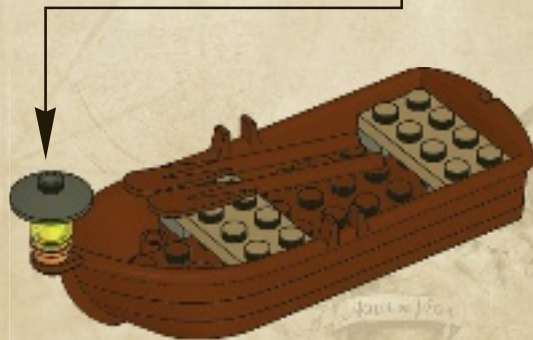



2x

1

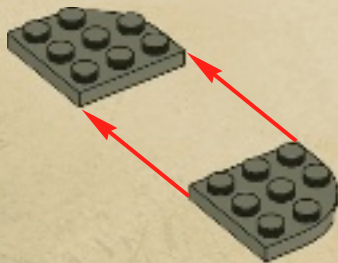

1x



1x

2

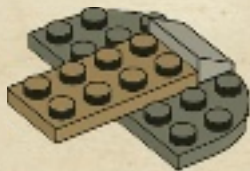



2x

3



2x



1x

4



1x



1x



1x

5

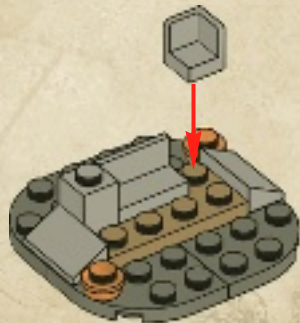



1x



2x

6

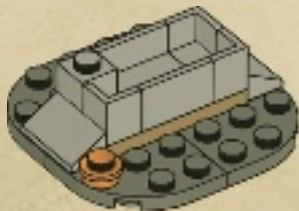

1x



2x



1x

7







1x



1x



1x



2x

# 8

1



2

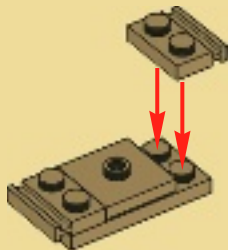

3

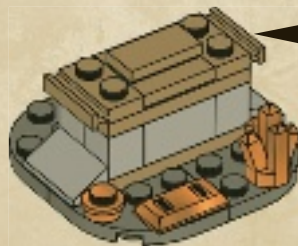
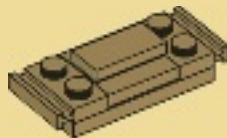

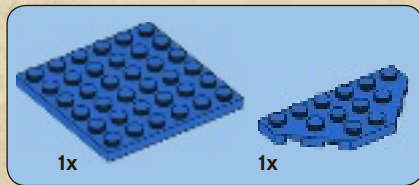

1

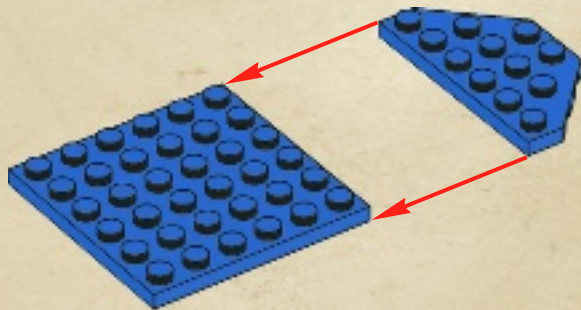



1x



1x



1x

# 2

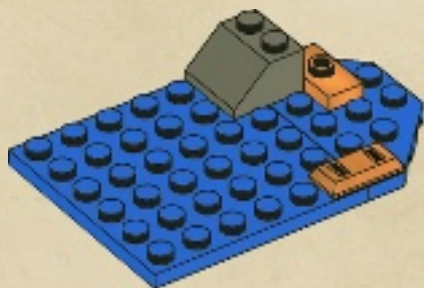

1x



1x

# 3

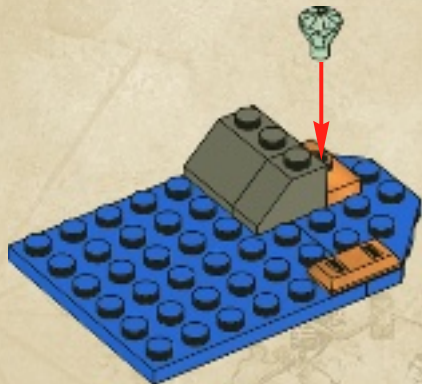



3x

4

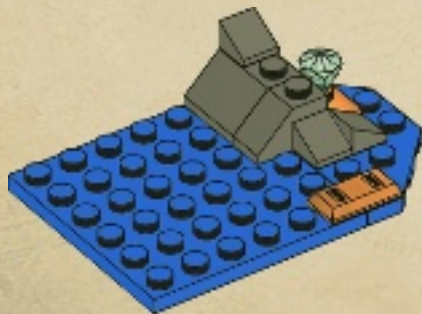

1x

1x

5

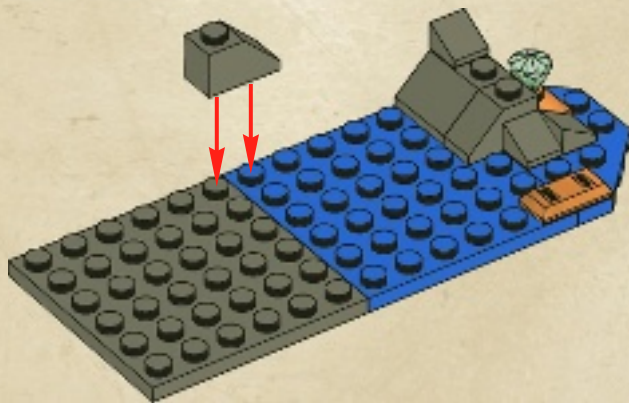



1x



1x

6

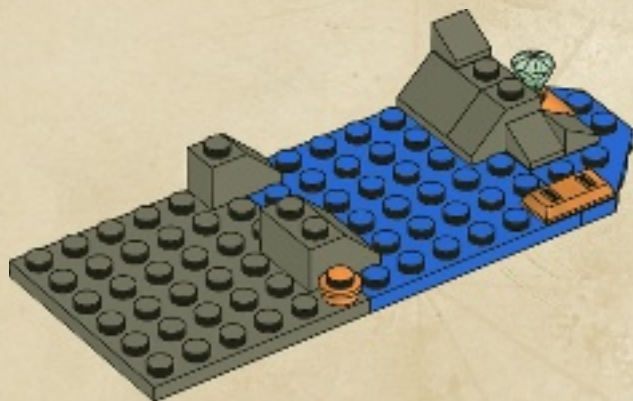

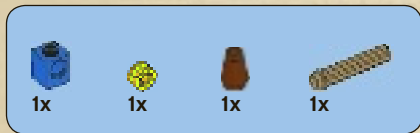

7

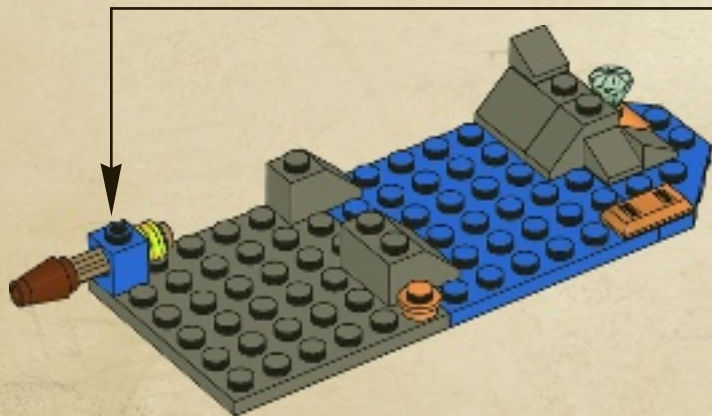
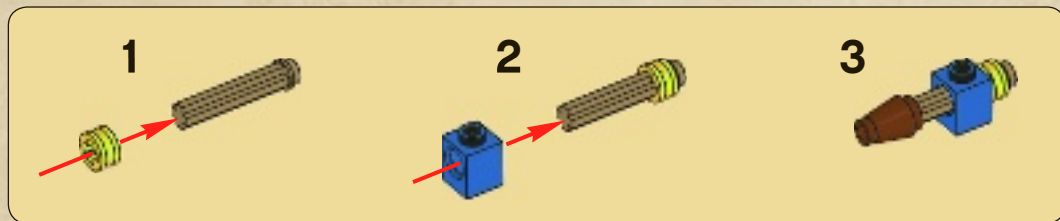

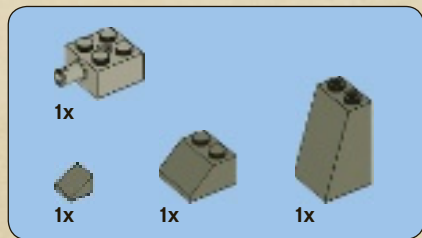

8

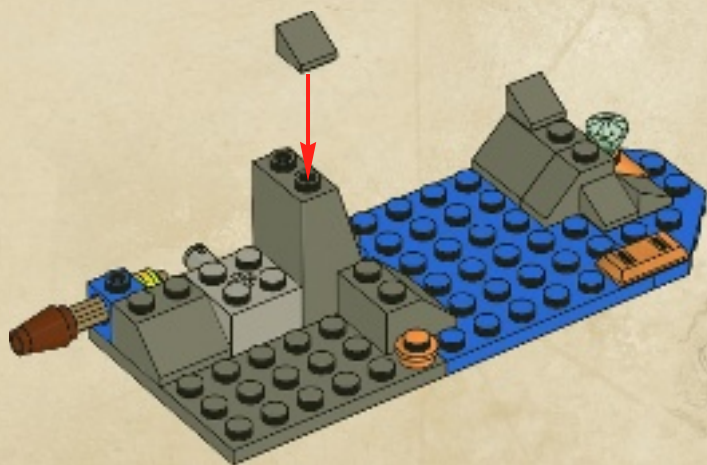

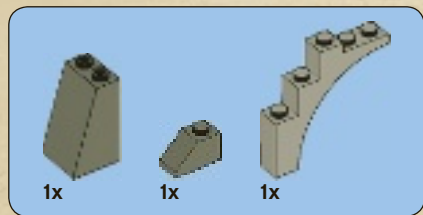

9

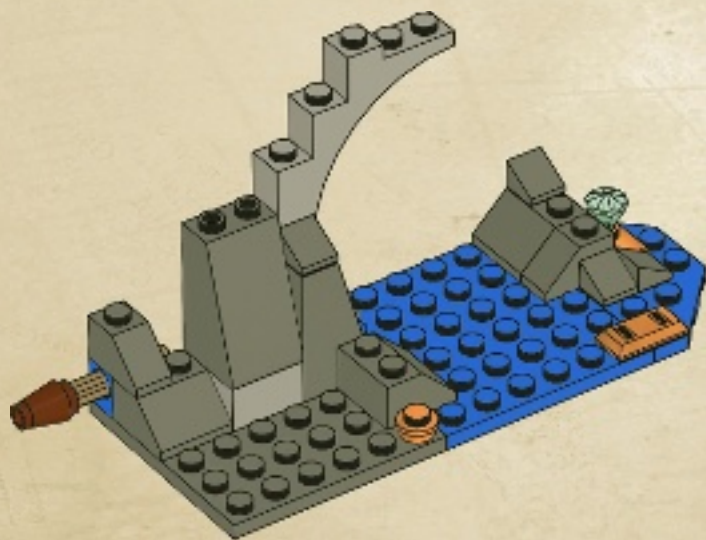





1x



1x

# 10

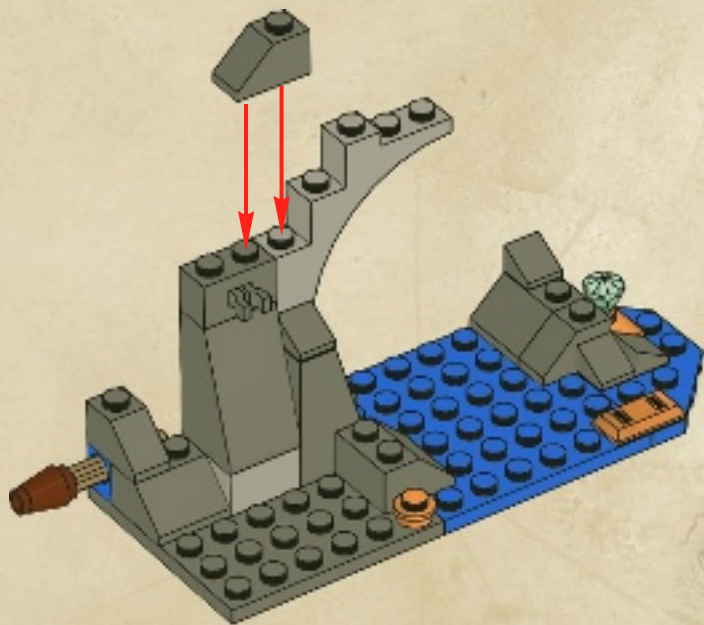



1x



1x



1x

# 11

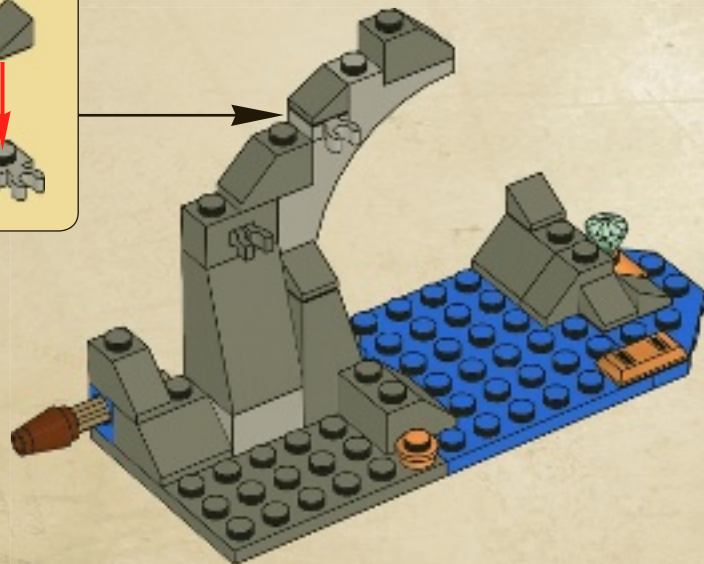
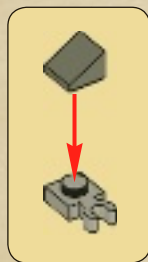



1x



1x



1x



1x

# 12

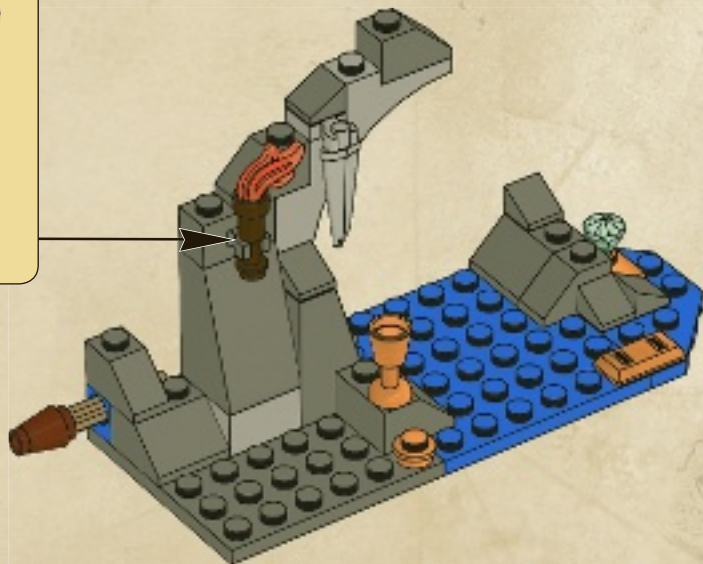

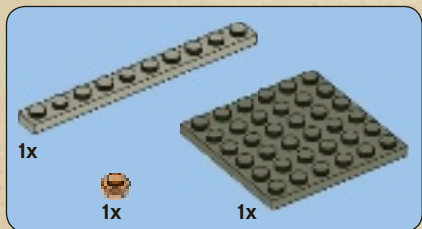

# 13

1



2

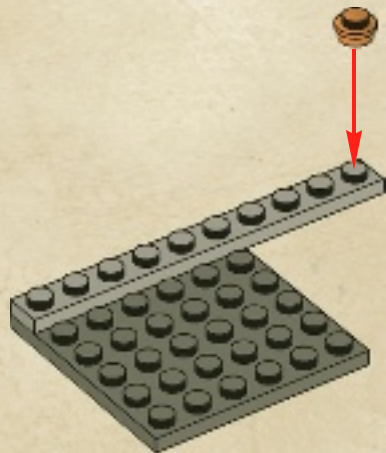

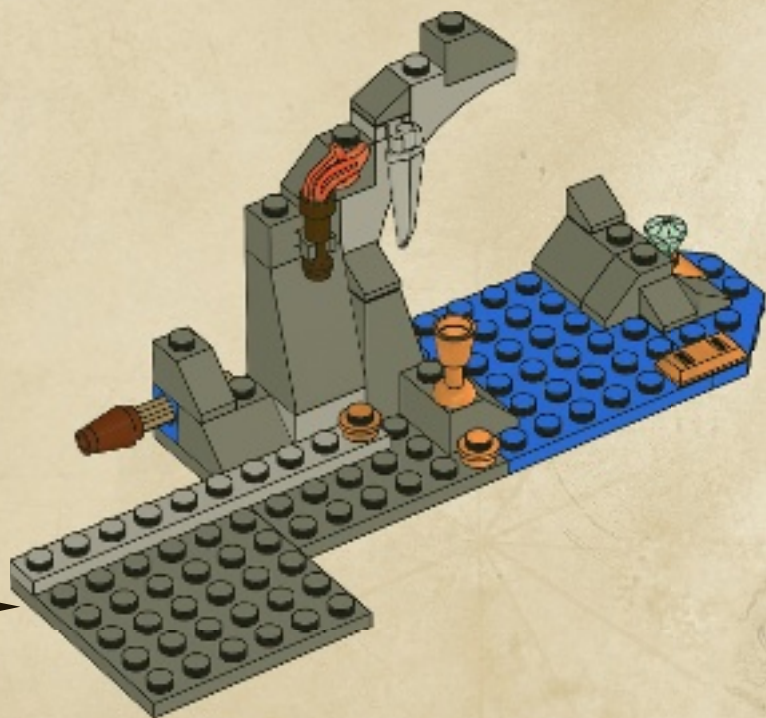



14

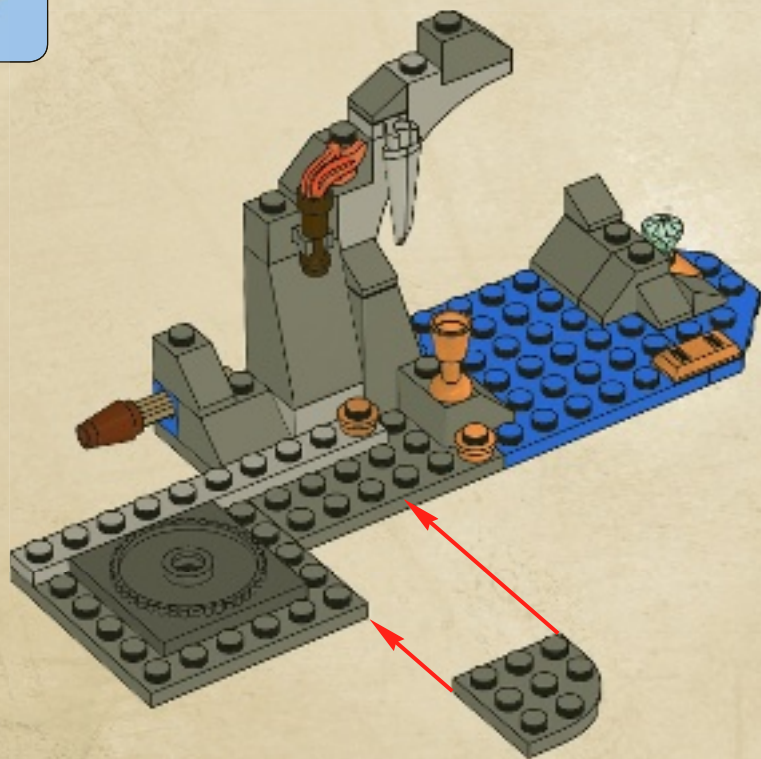



1x



1x

15

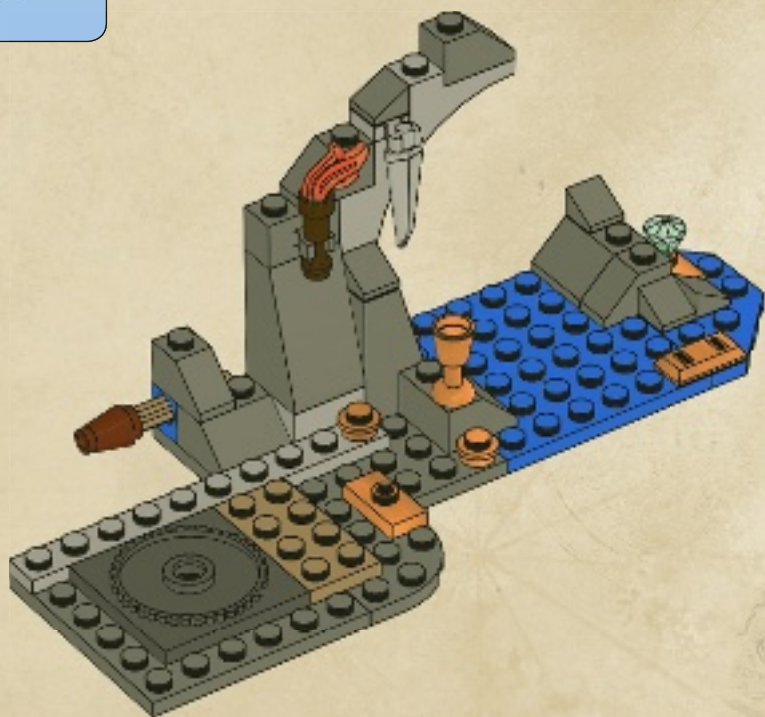



2x

# 16

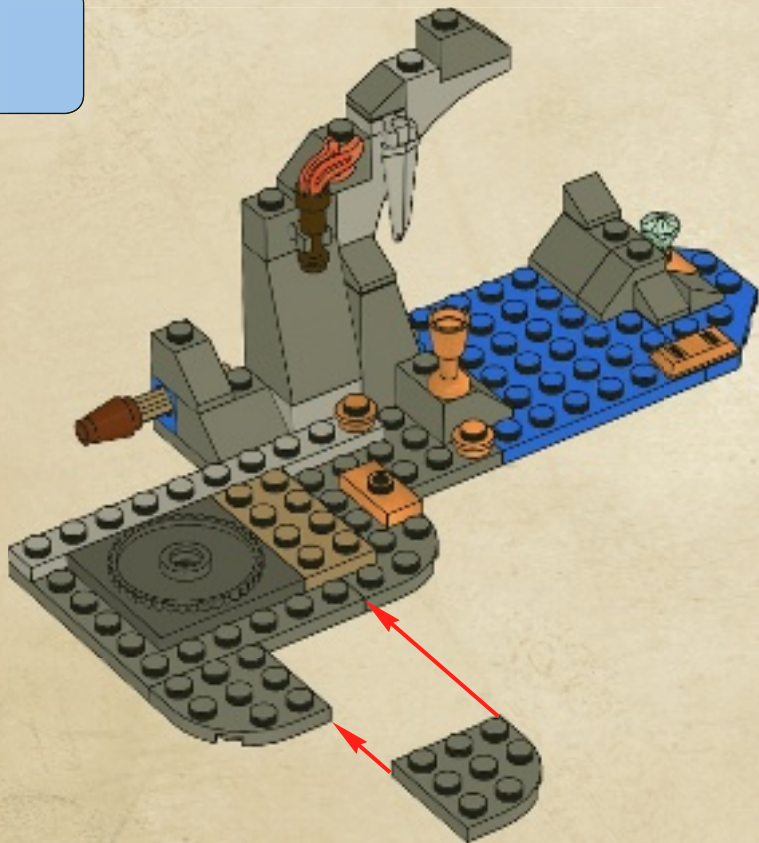





1x



1x

17

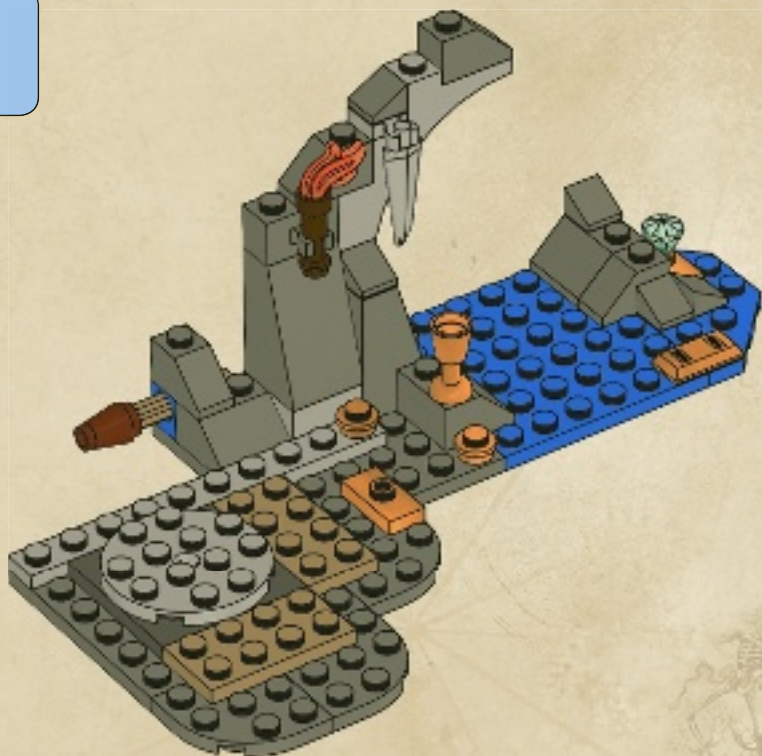



2x

18

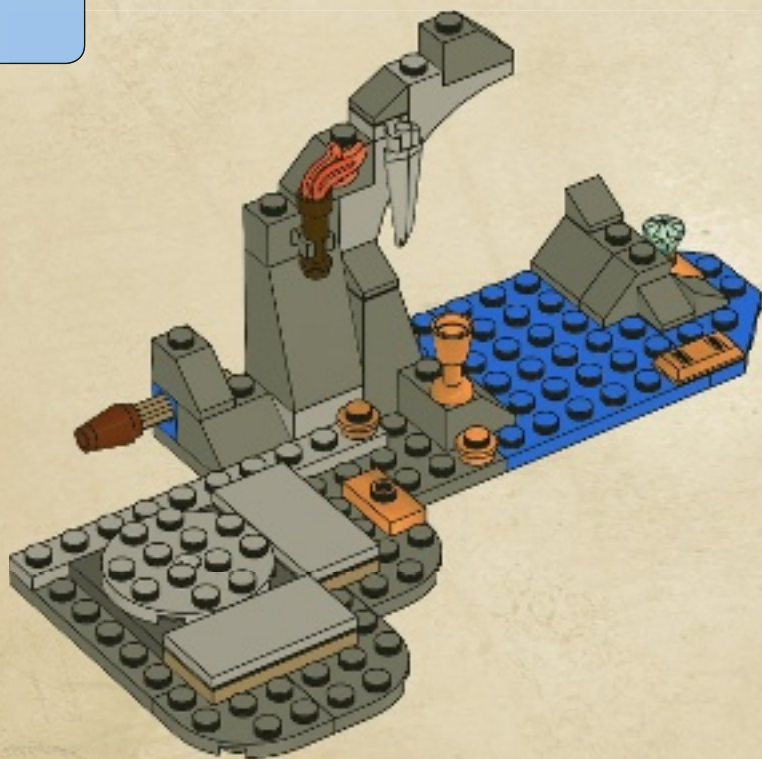



5x

19

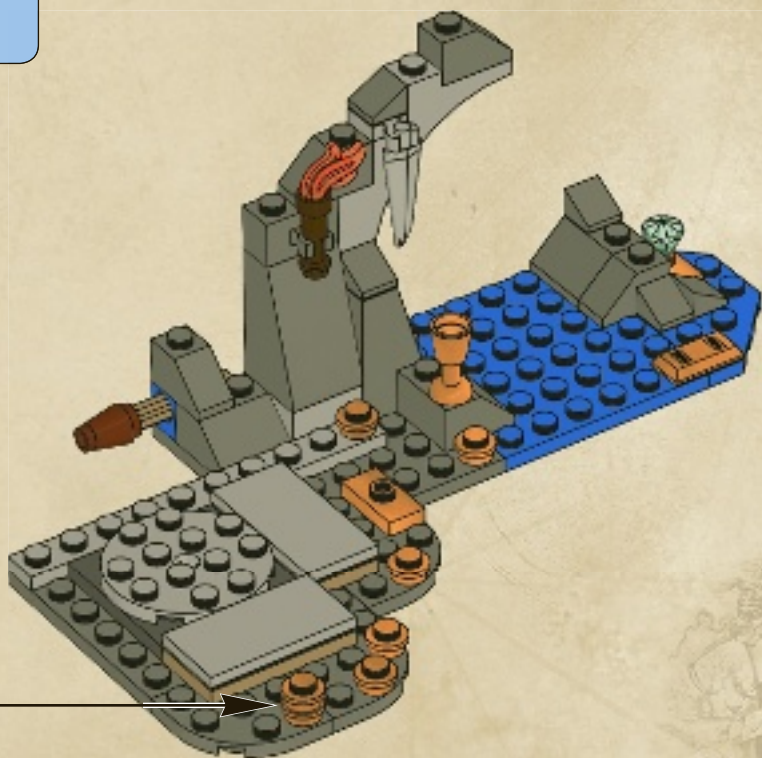
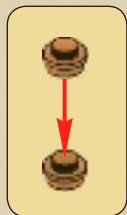



2x

20

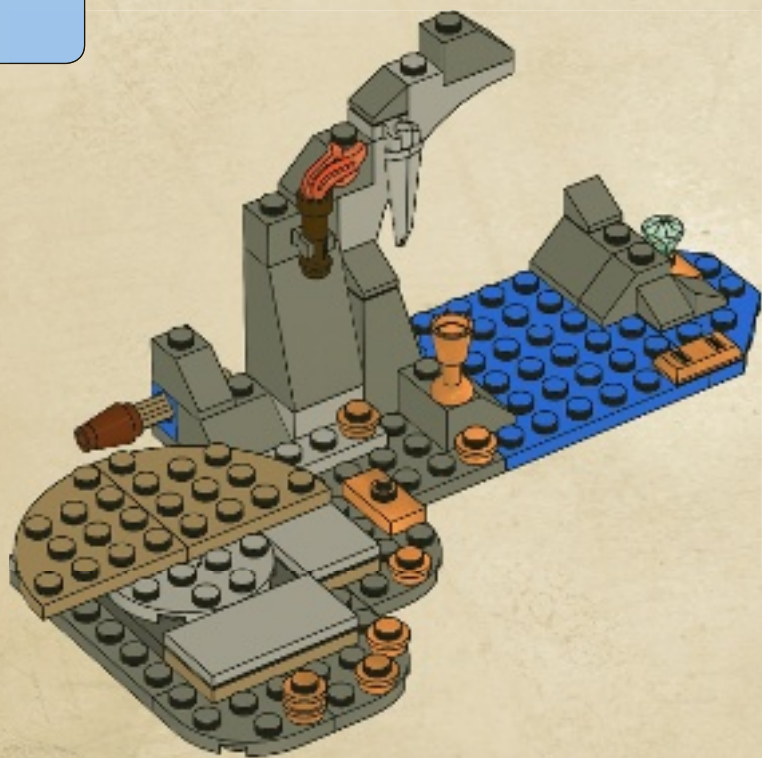



2x

21

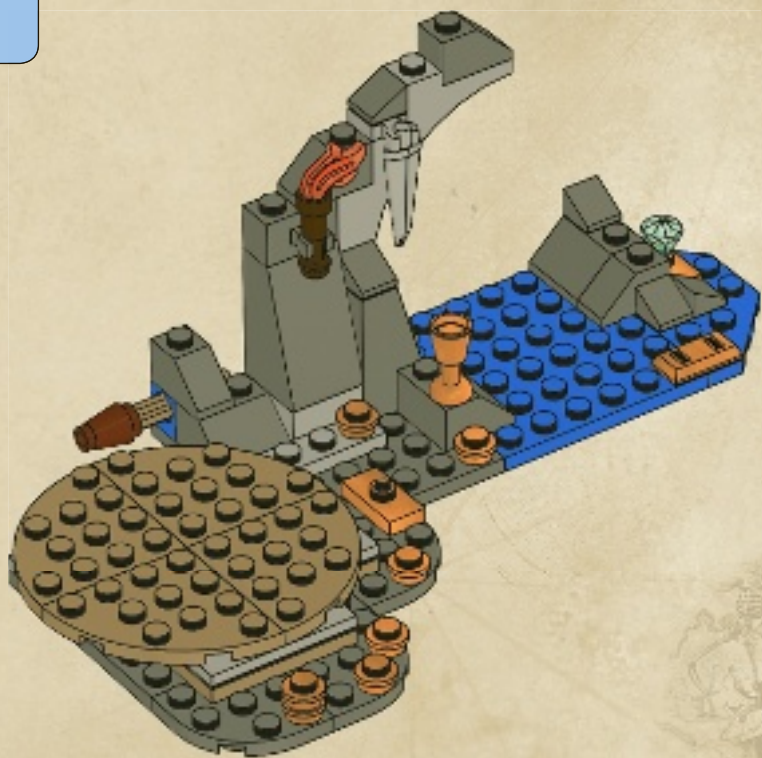



2x

22

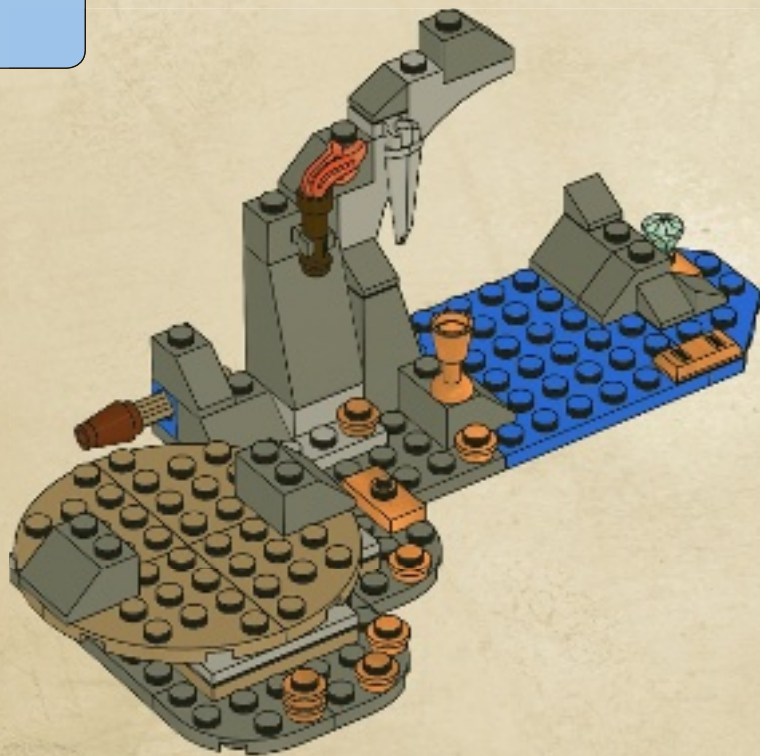



23

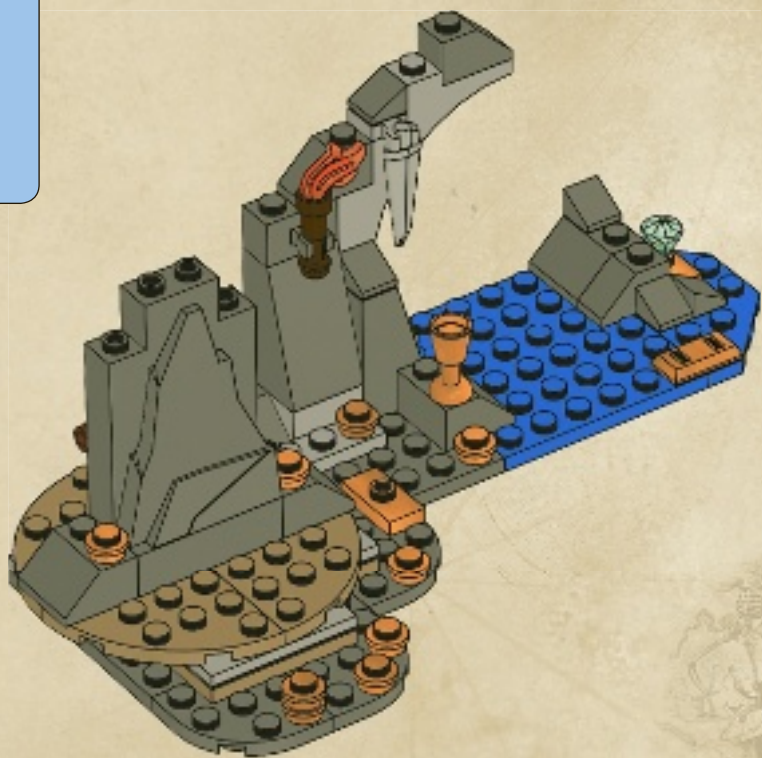



# 24

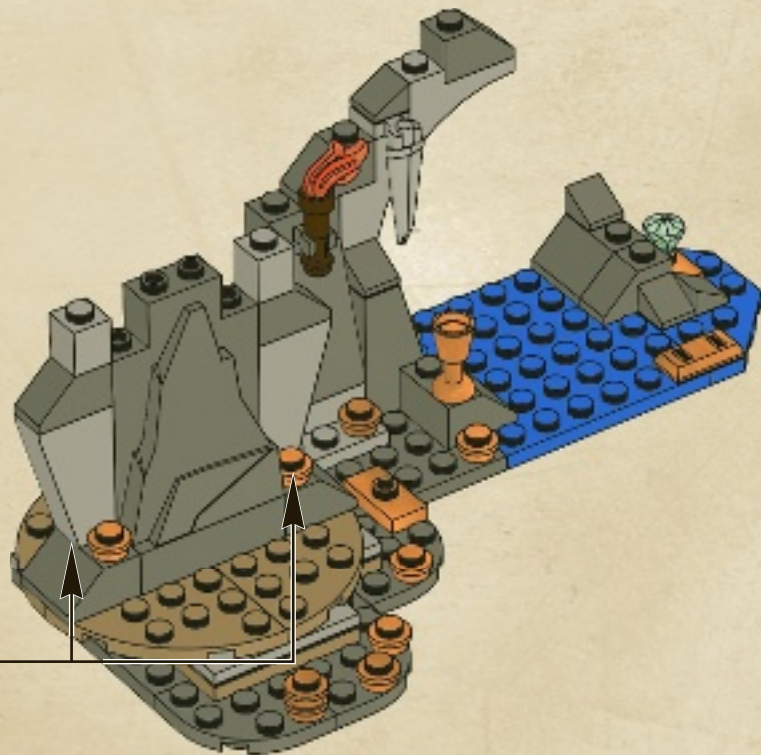
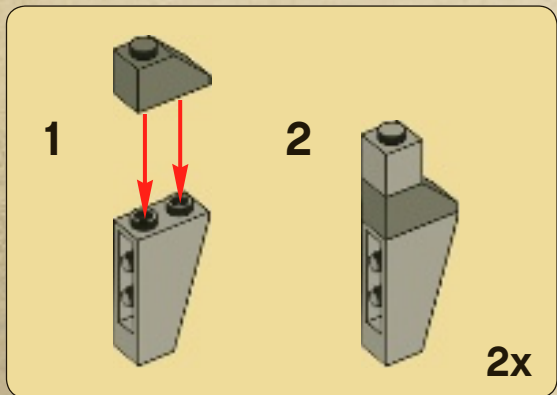





2x

25





# 26

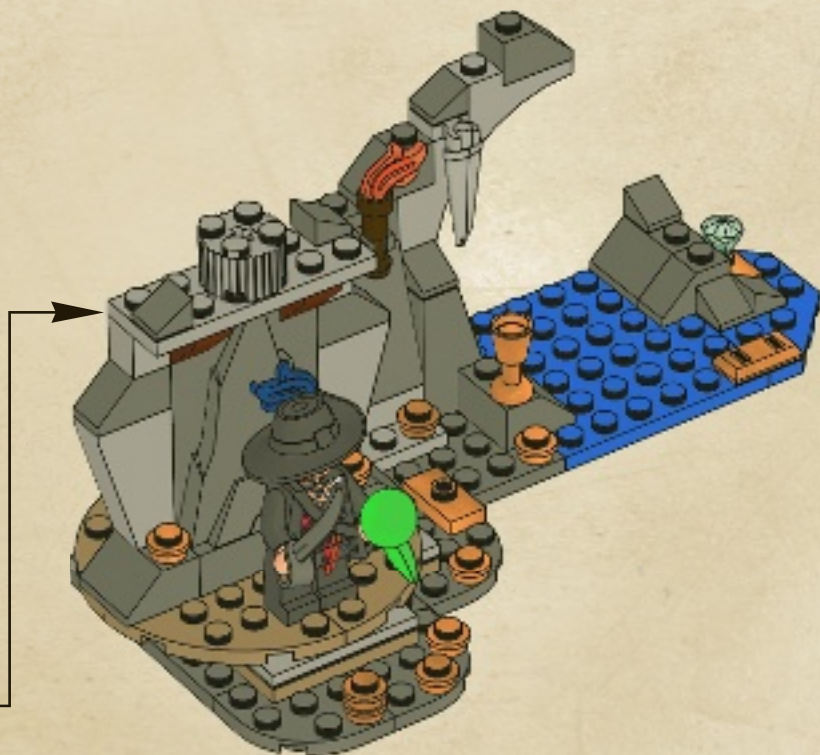
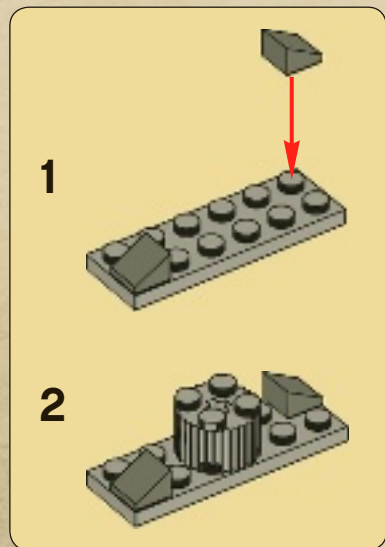



1



2





1x



1x

3



1x



1x

4



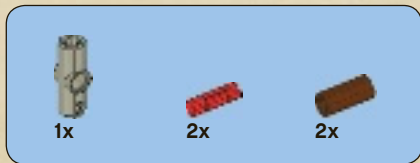

5

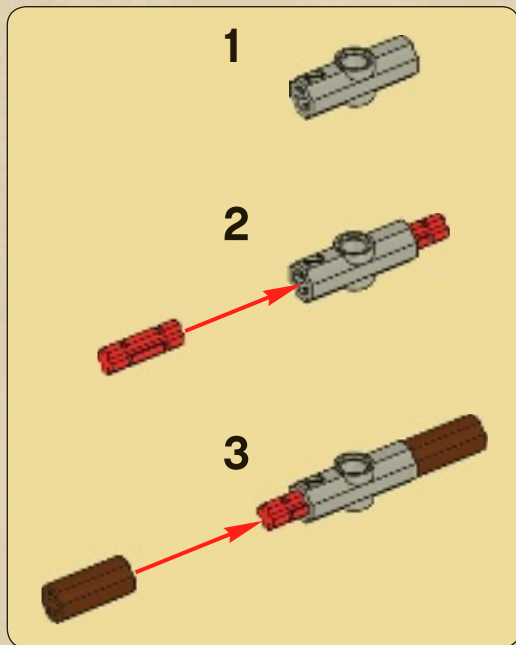



6



7



27

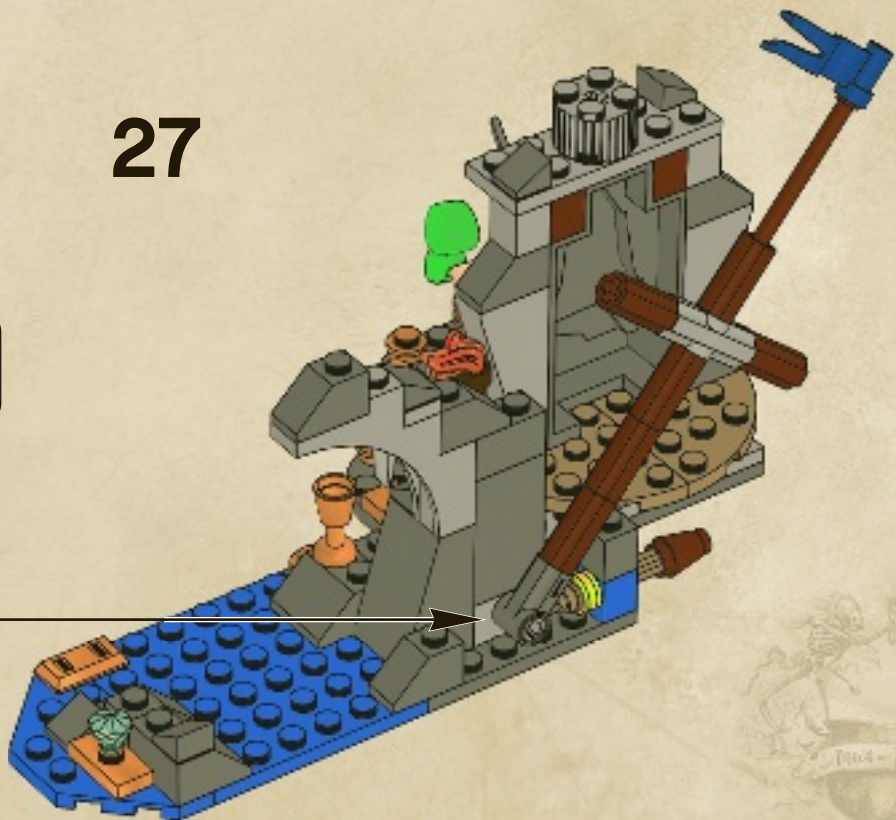

28

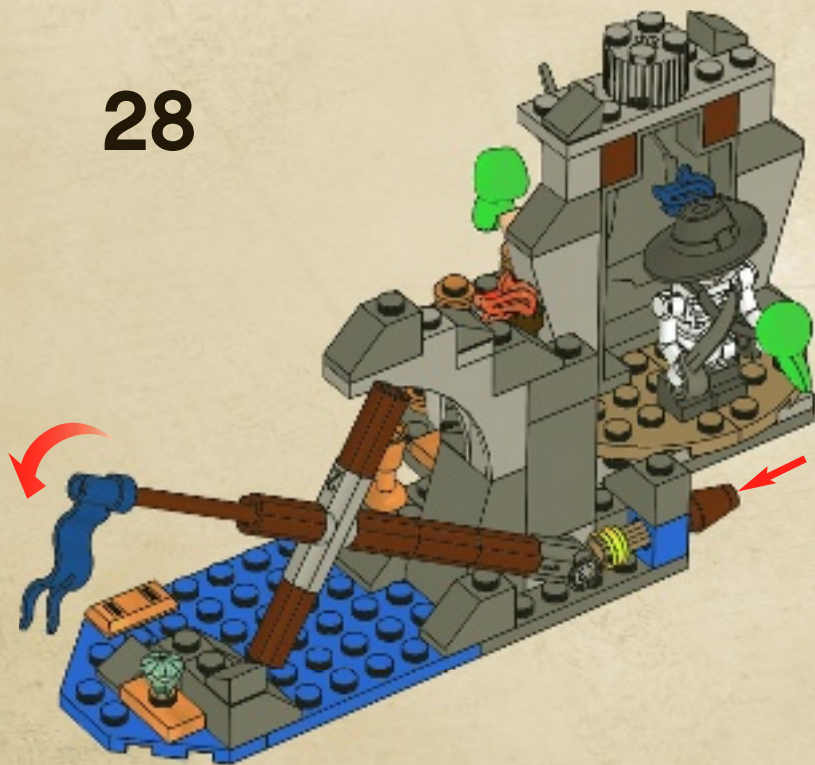



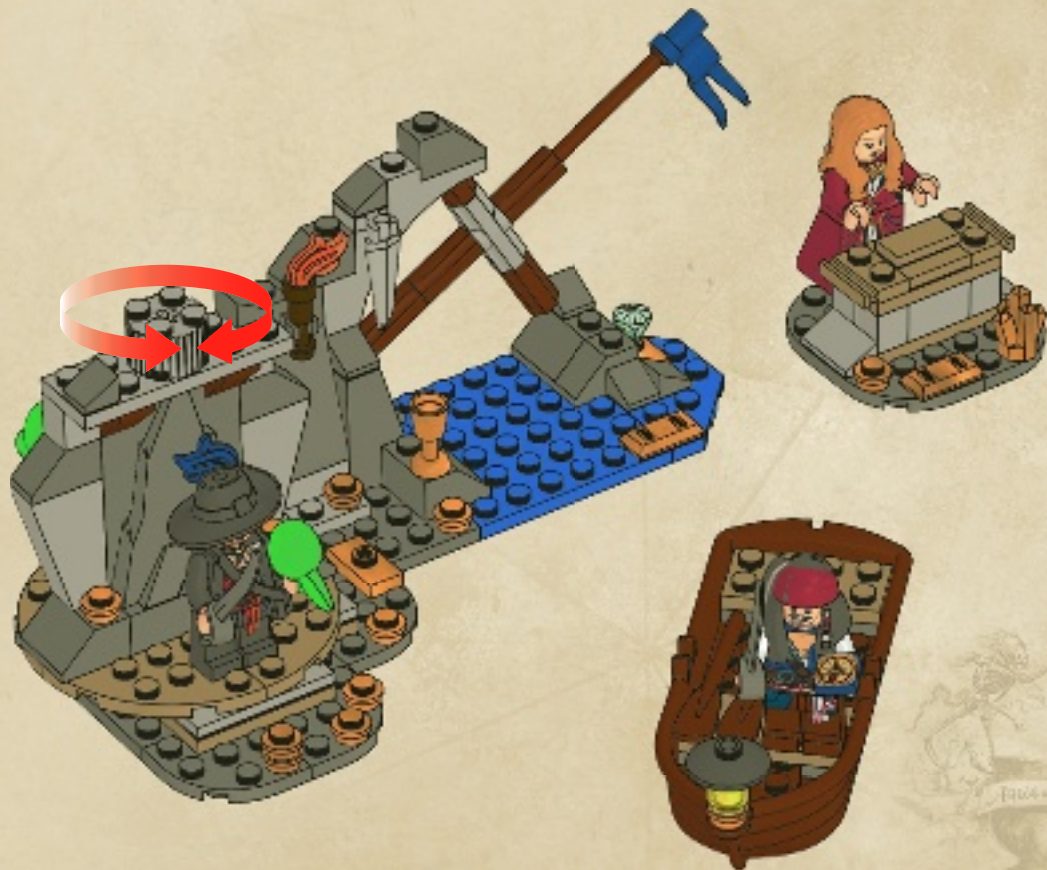

5x  
4142865

1x  
4119014



1x  
4517986

12x  
4523159

1x  
4594238

3x  
4215513

2x  
4609295



1x  
241923

1x  
474026

1x  
4505990

3x  
4211389

2x  
4211515

2x  
4602970



1x  
4199519

1x  
4625580

1x  
4519317

1x  
4211529

1x  
4616840

1x  
4602982

1x  
3006844

1x  
4625322

2x  
4631857

1x  
4610816

1x  
4211567

1x  
4631626

1x  
4540865

2x  
4618269

2x  
4523157

2x  
4216248

1x  
4211815



**Customer Service**  
**Kundenservice**  
**Service Consommateurs**  
**Servicio Al Consumidor**

[www.lego.com/service](http://www.lego.com/service) or dial



00800 5346 5555 :



1-800-422-5346 :



2x  
4626967

1x  
4625304

2x  
4568637

1x  
4515351

1x  
4620193

1x  
4625252

1x  
4519930

1x  
4211452

1x  
4239601

2x  
4560183

1x  
4251149



6x  
4267874



2x  
4616711



1x  
4496699



1x  
4578032



4x  
4570451



1x  
4566927



2x  
4107050



1x  
4625361



1x  
4504647



1x  
4619461



2x  
4548676



1x  
4620206



1x  
4538950



1x  
4119482



1x  
4265794



7x  
4504378



7x  
4211135



2x  
4210696



5x  
4211054



3x  
4210789



1x  
4210658



4x  
4211063



7x  
4212075



2x  
4211134



1x  
4513326



1x  
4625152



1x  
4620052



1x  
4625156



1x  
4529242



2x  
4211222



6x  
4531751



1x  
4619527



2x  
4609635

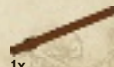

1x  
4538724



1x  
4522012



# PIRATES OF THE CARIBBEAN

ON STRANGER TIDES





# ALIEN CONQUEST



[ALIENCONQUEST.LEGO.COM](http://ALIENCONQUEST.LEGO.COM)



# Disney PIRATES *of the* CARIBBEAN



[videogames.LEGO.com](http://videogames.LEGO.com)



© Disney. LEGO® Pirates of the Caribbean: The Video Game software © 2011 TT Games Publishing Ltd. Produced by TT Games under license from the LEGO Group. LEGO, the LEGO logo, the Brick and the Knob configurations and the Minifigure are trademarks of the LEGO Group. © 2011 The LEGO Group.

© Disney. LEGO® Pirates of the Caribbean : Le logiciel du Jeu Vidéo © 2011 TT Games Publishing Ltd. Produit par TT Games sous licence du Groupe LEGO. LEGO, le logo LEGO, la figurine et les configurations de la brique et du tenon sont des marques de commerce du Groupe LEGO. © 2011 Le Groupe LEGO.





www.LEGOclub.com



LEGO® Club Email



LEGO® Club Magazine

**LEGO** club™

**FREE! GRATIS! GRATUIT!**

**SIGN UP ONLINE!**

**www.LEGOclub.com**



**00800 5346 5555\***



**1-866-534-6258 • 1-877-518-5346**

US & Canada only

One-time enrollment

- \* Freephone. Mobile charges may apply.
- \* Numéro sans frais. Des frais peuvent s'appliquer avec les téléphones cellulaires.
- \* Gebührenfrei. Kosten für Anrufe aus Mobilfunknetzen können abweichen.
- \* Gratis telefonnummer vanaf vaste lijn.
- \* Det er et gratis nummer, når du ringer fra fasttelefon.
- \* Det är gratis, när du ringer från en fast telefon.
- \* Numéro sans frais. Des frais peuvent s'appliquer avec les téléphones portables.



# WIN!

Go to [www.LEGOsurvey.com/product](http://www.LEGOsurvey.com/product) to fill out a survey for a chance to win a cool LEGO® Product.

No purchase necessary.

Open to all residents where not prohibited.



## [www.LEGOsurvey.com/product](http://www.LEGOsurvey.com/product)

### GEWINNE!

Nimm an der Umfrage auf [www.LEGOsurvey.com/product](http://www.LEGOsurvey.com/product) teil und hab die Chance ein cooles LEGO® Produkt zu gewinnen!

Die Teilnahme am Gewinnspiel führt zu keinerlei Kaufverpflichtungen. Teilnahme in allen nicht ausgeschlossenen Ländern möglich.

### WIN!

Ga naar [www.LEGOsurvey.com/product](http://www.LEGOsurvey.com/product), vul een enquêteformulier in en maak kans op een cool LEGO® product.

Geen aankoopverplichting. Iedereen mag deelnemen, uitgezonderd ingezetenden van landen waar een enquêteverbod geldt.

### GAGNE!

Visite [www.LEGOsurvey.com/product](http://www.LEGOsurvey.com/product) pour répondre à un questionnaire et avoir une chance de gagner un produit LEGO® très cool!

Aucune obligation d'achat. Ouvert à tous les résidents des pays autorisés.

### 当てよう!

[www.LEGOsurvey.com/product](http://www.LEGOsurvey.com/product) にアクセスして、アンケートにご記入ください。当選者にはレゴ®製品を差し上げます。

お買い上げの必要はありません。禁止されていない限り、すべての皆様にご利用いただけます。



[www.LEGO.com](http://www.LEGO.com)

4642946

LEGO, the LEGO logo and the Minifigure are trademarks of the LEGO Group. ©2011 The LEGO Group. © Disney Enterprises, Inc. and Jerry Bruckheimer, Inc.