



# Friends

42614



LEGO® Builder



### **Get excited about our new packaging!**

We're switching from plastic to paper-based packaging. That's why you might find a mix of paper and plastic in our boxes!

### **Nos nouveaux emballages vous emballeront !**

Nous passons des emballages en plastique aux emballages à base de papier. C'est pourquoi vous pourriez trouver un mélange de papier et de plastique dans nos boîtes !

### **¡Te presentamos nuestros nuevos empaques!**

Estamos sustituyendo las bolsas de plástico por bolsas con base de papel. ¡Por eso, puedes encontrar una mezcla de papel y de plástico en nuestras cajas!

**[LEGO.com/sustainable-packaging](https://www.lego.com/sustainable-packaging)**



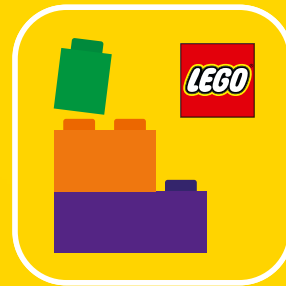

🔍 LEGO® Builder

# BUILDER

Download on the  
App Store

GET IT ON  
Google Play

腾讯应用宝  
安卓应用商店

Apple and the Apple logo are trademarks of Apple Inc., registered in the U.S. and other countries and regions. App Store is a service mark of Apple Inc. Google Play and the Google Play logo are trademarks of Google LLC. Tencent and the Tencent logo are trademarks of Tencent Inc.

🔍 [LEGO.com/devicecheck](https://LEGO.com/devicecheck)

EN Ask parents' permission before going online | DE Eltern um Erlaubnis bitten, bevor du online gehst | FR Demande l'autorisation d'un parent avant d'aller en ligne | IT Chiedi il permesso ai tuoi genitori prima di andare online | ES Pídeles permiso a tus papás antes de conectarte a Internet | PT Pede autorização aos pais antes de acederes online | ZH 上网前应先征得父母的同意 | PL Poproś rodziców o zgodę, zanim wejdiesz do Internetu | CS Než půjdeš na internet, požádej rodiče o svolení | SK Skôr než pôjdeš na internet, vypýtaj si povolenie od rodičov | HU Kérj szülői engedélyt, mielőtt online csatlakoznál! | RO Cere permisiunea părinților înainte de a te conecta online | BG Поискайте разрешение от родител, преди да влезете онлайн | LV Pirms došanās tiešsaistē palūdz atļauju vecākiem | ET Enne Interneti kasutamist küsi vanematelt luba | LT Prieš prisijungdami prie interneto, atsklauskite tėvų

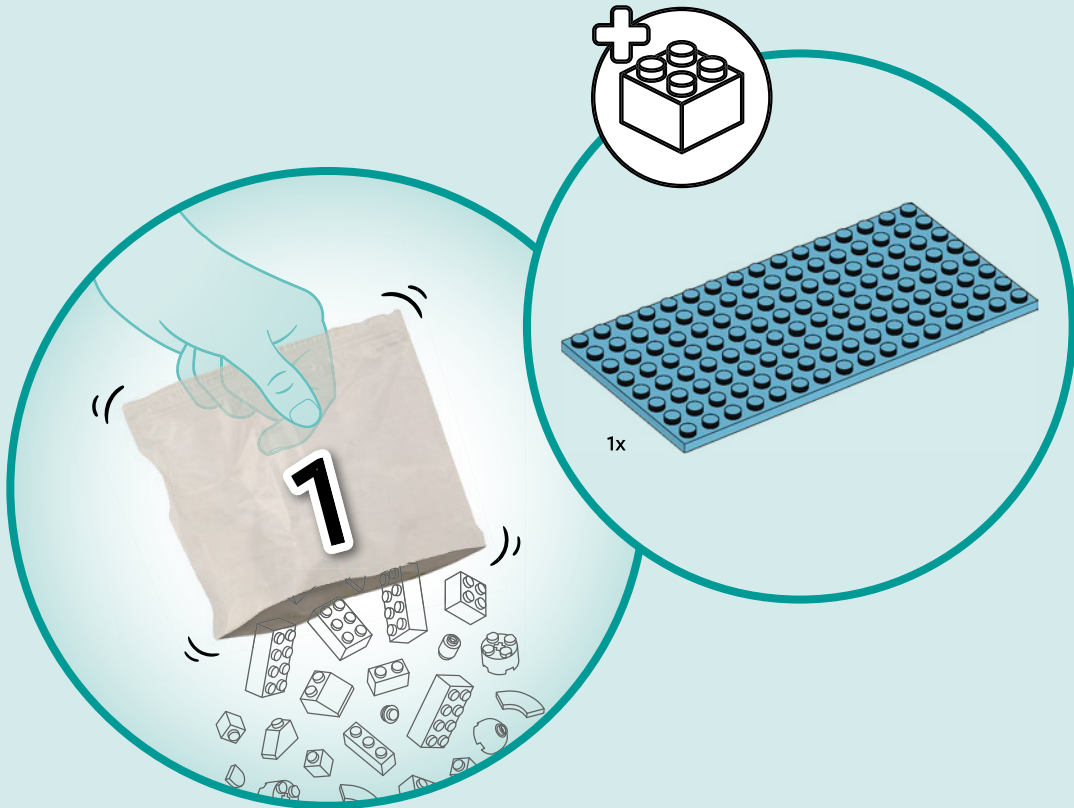

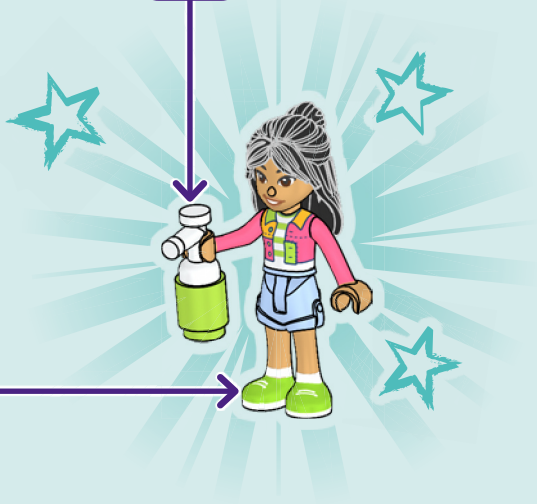
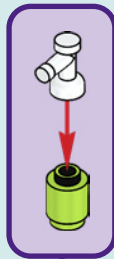
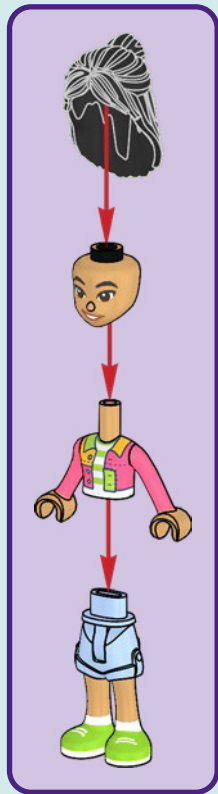



# LIANN

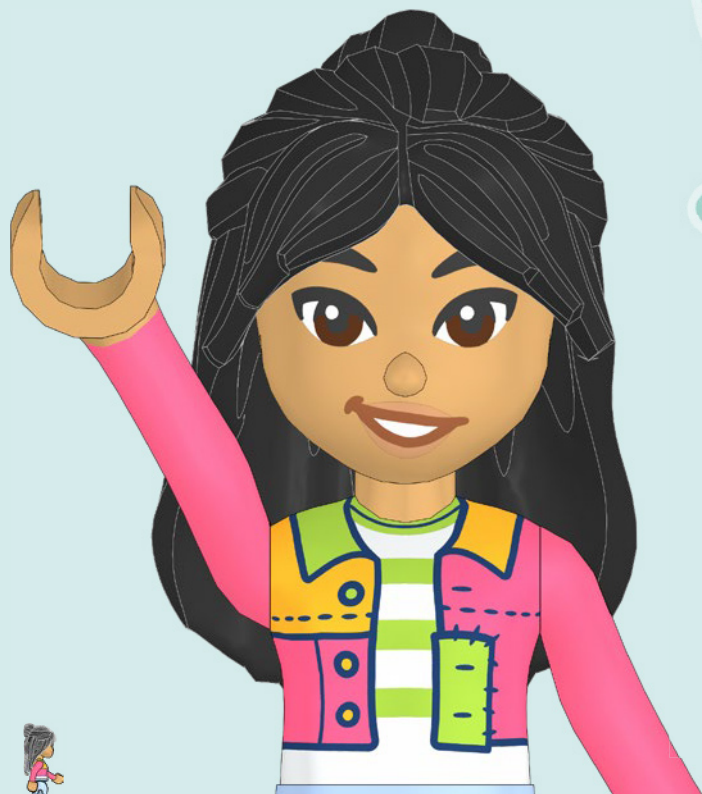



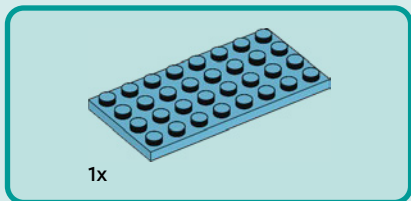
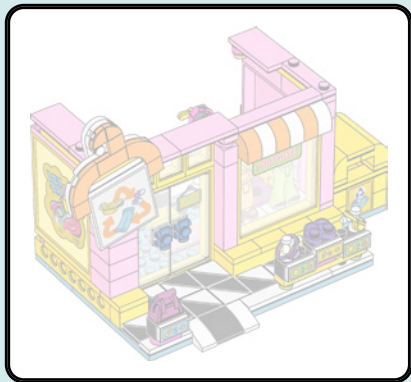

1

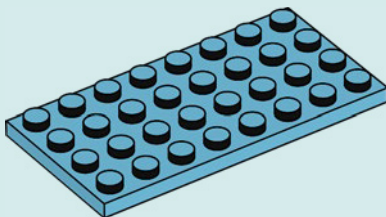



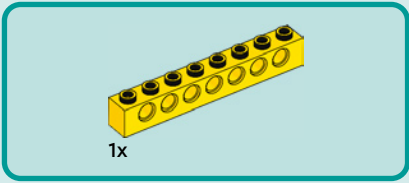

2

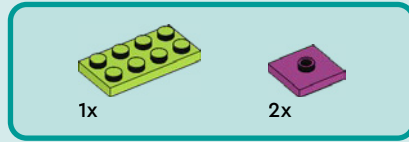
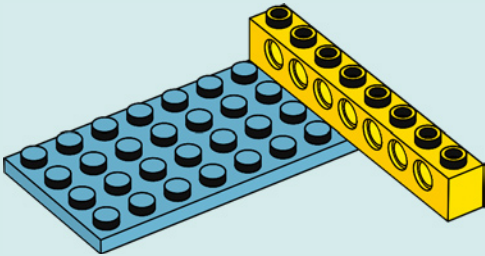

3

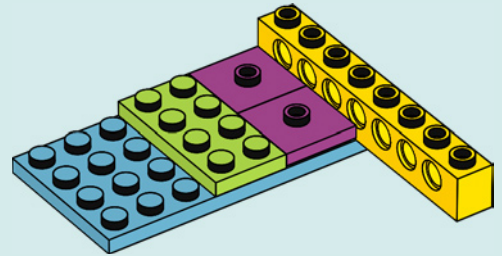

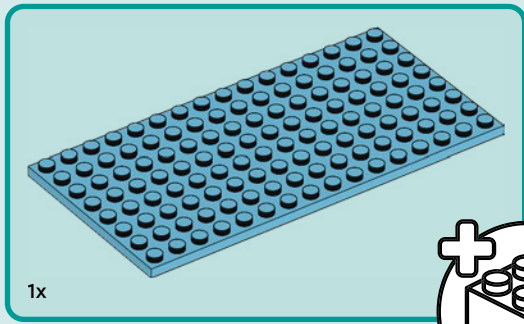

1x

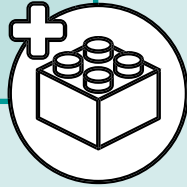

4

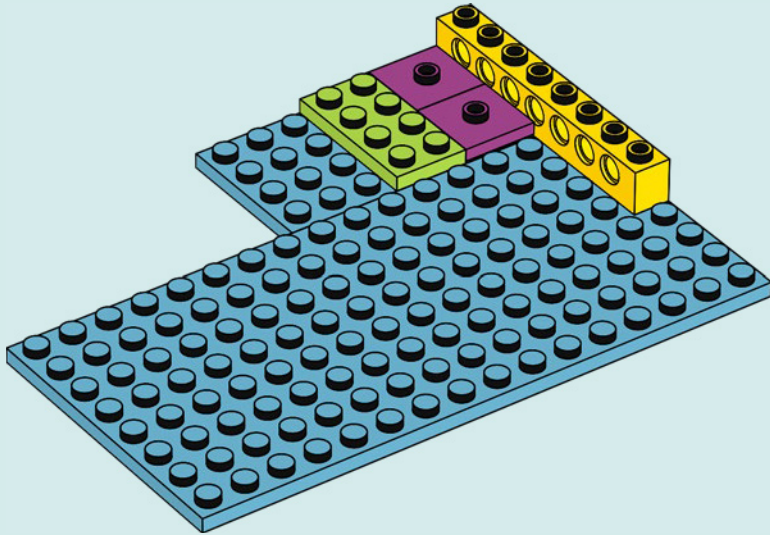

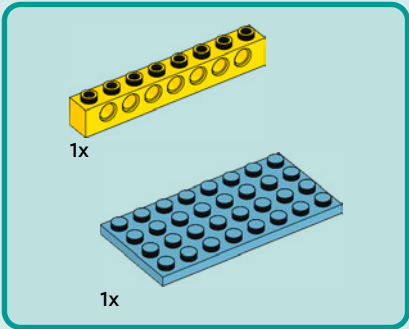

5

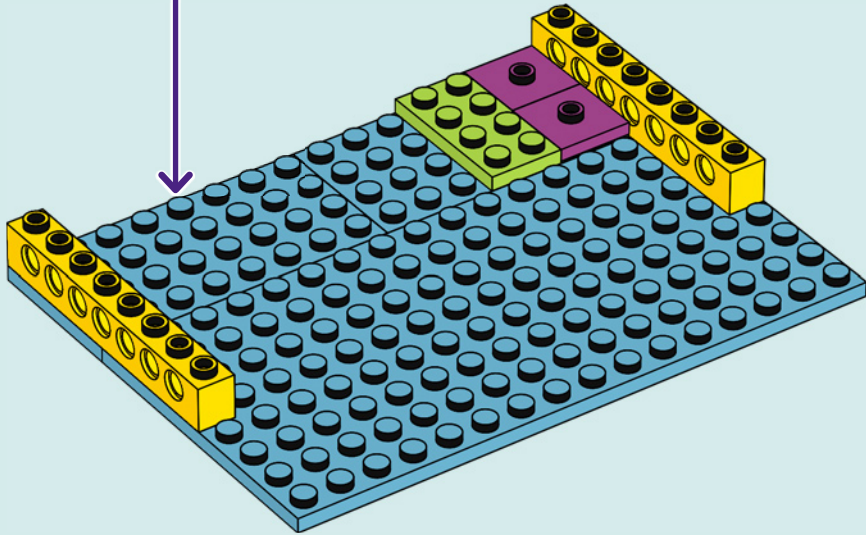
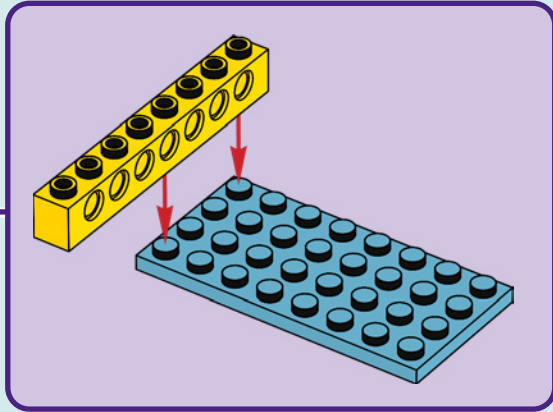



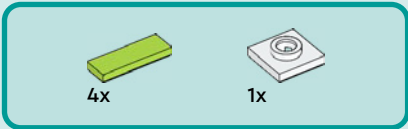

6

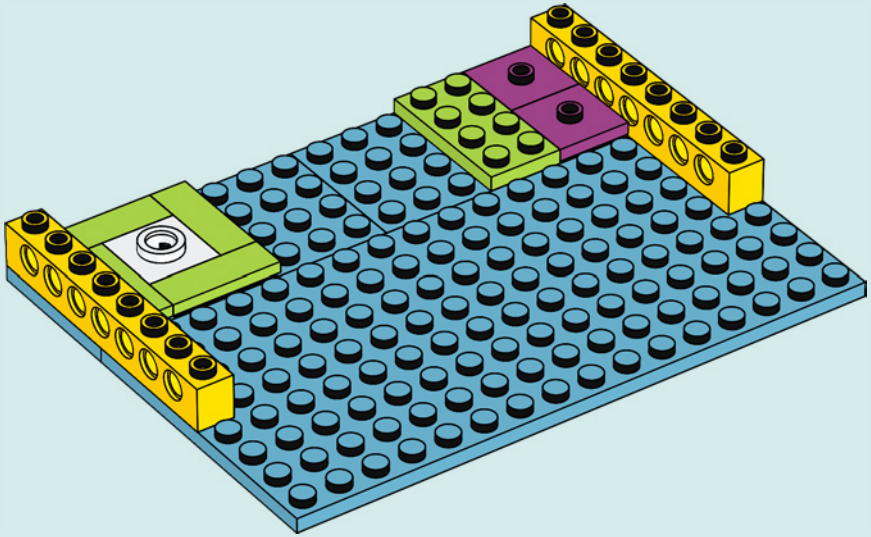



7

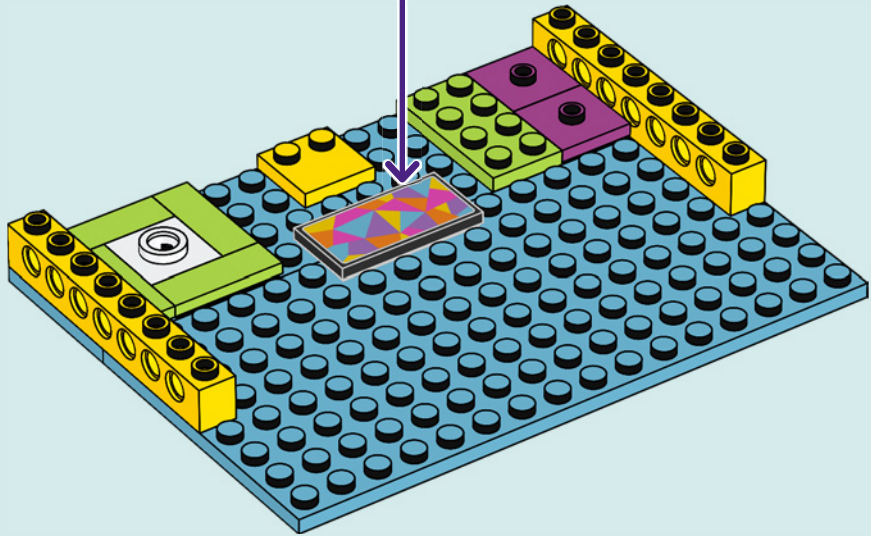
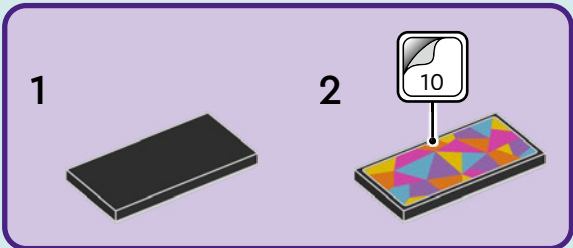





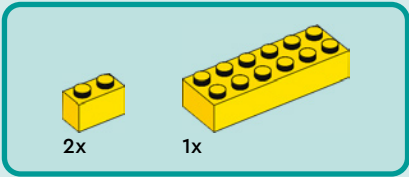

9

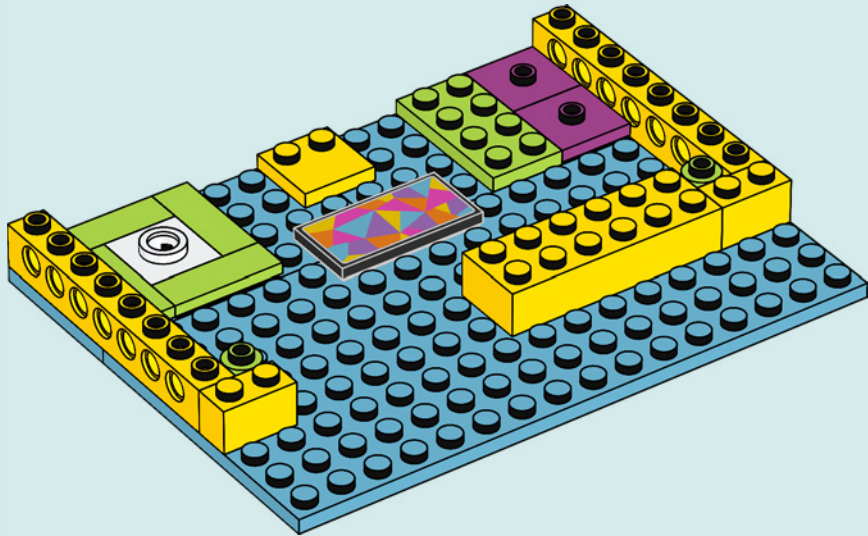



3x



3x

10

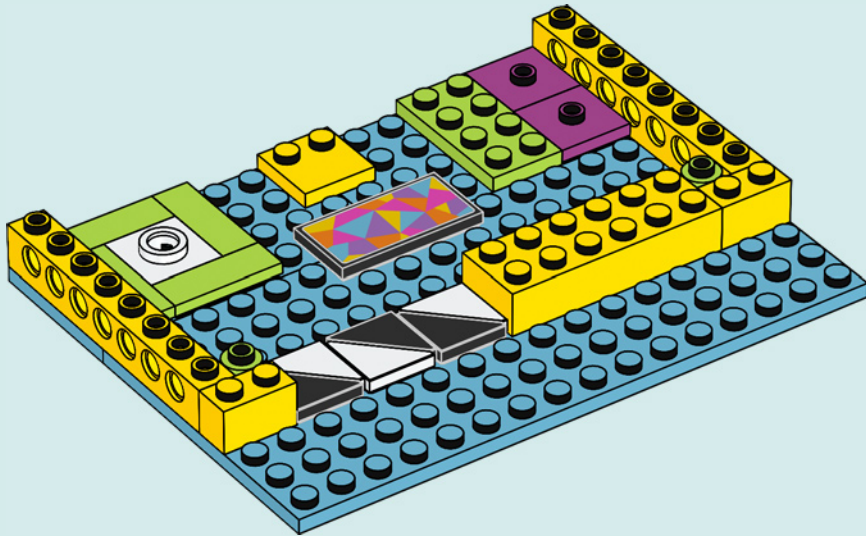



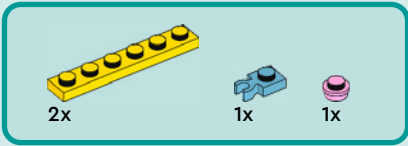

12

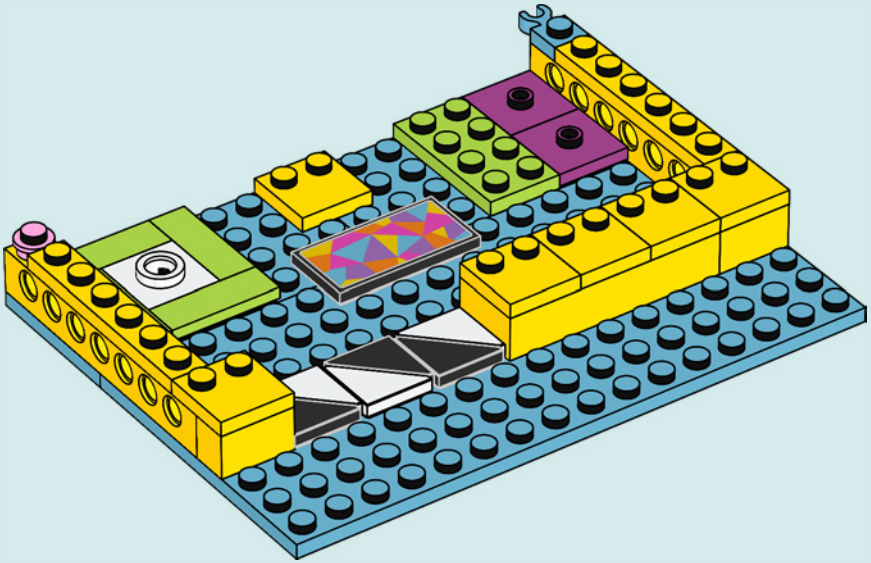







1x



2x

14

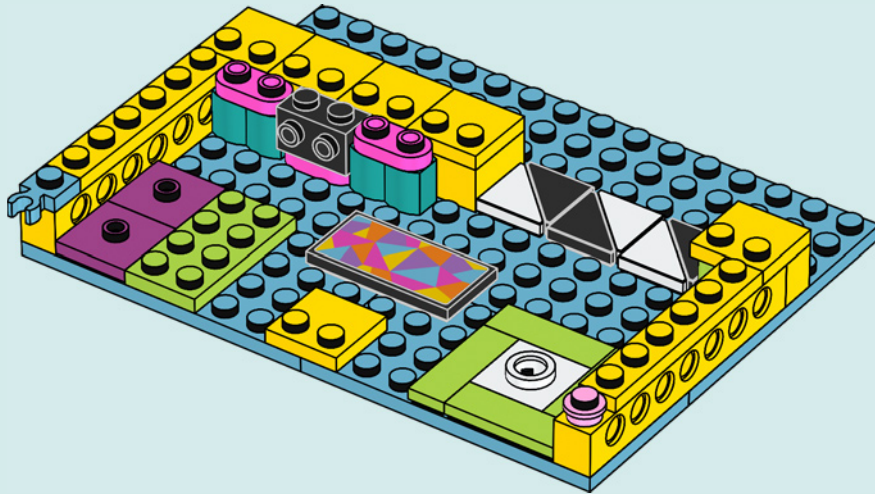



2x



2x

15

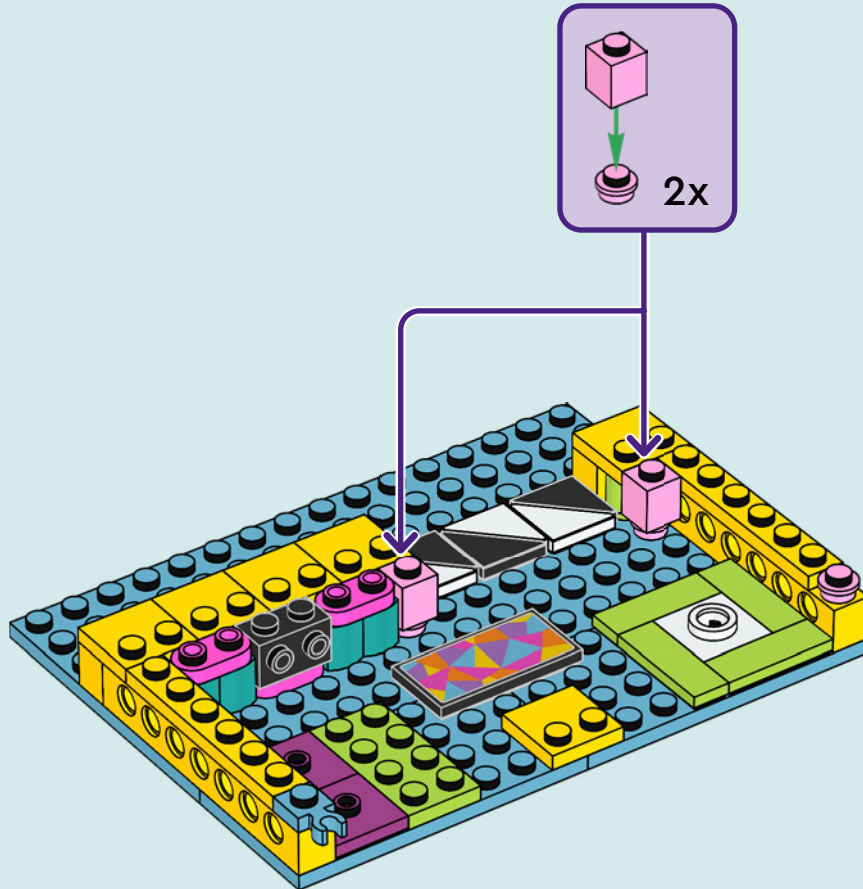



3x

16

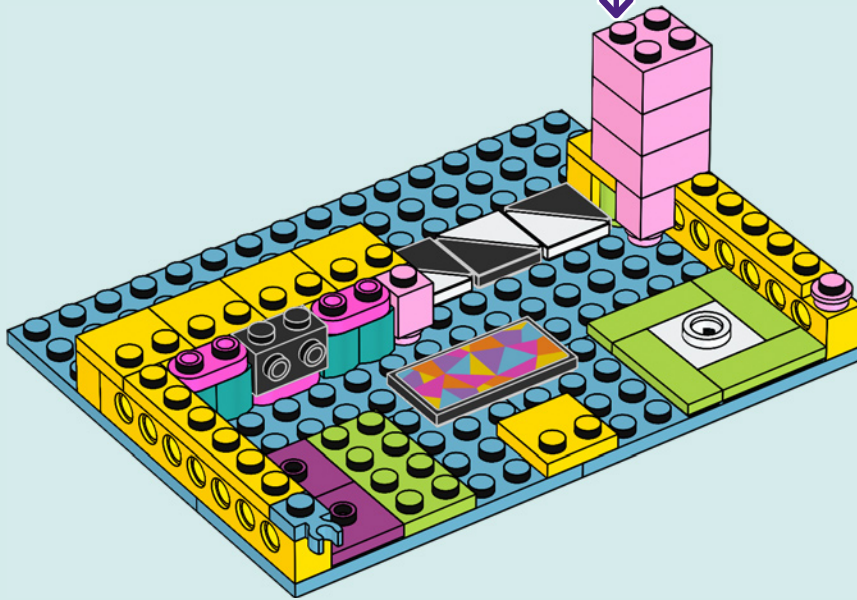
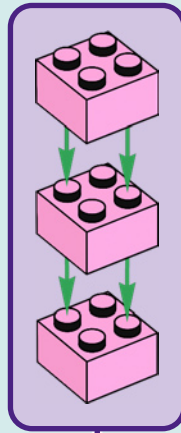

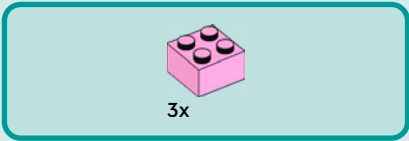

17

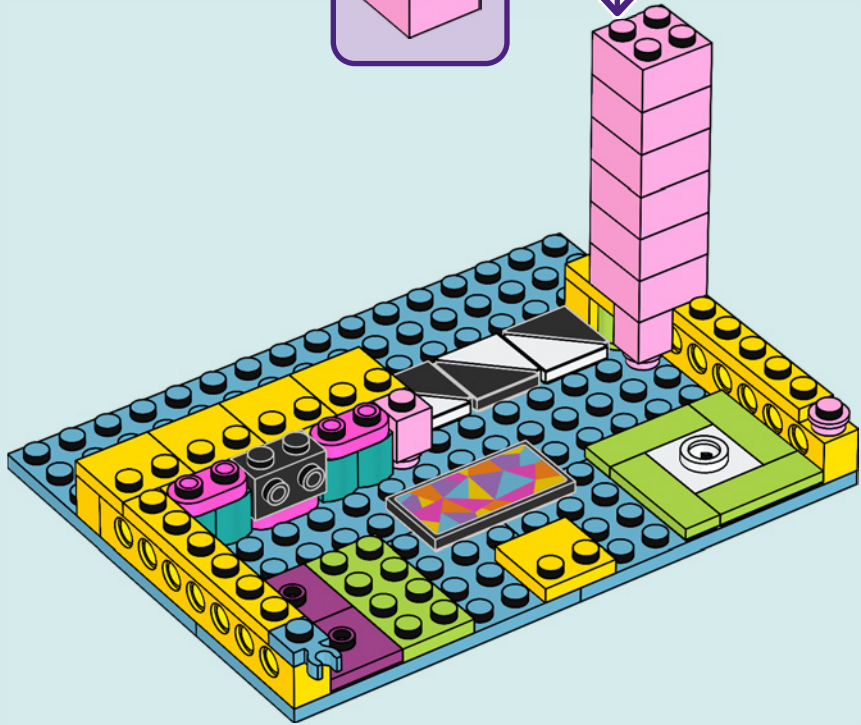
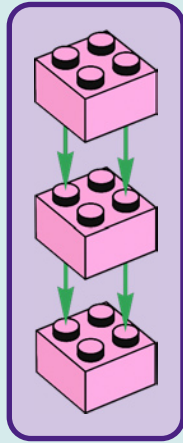

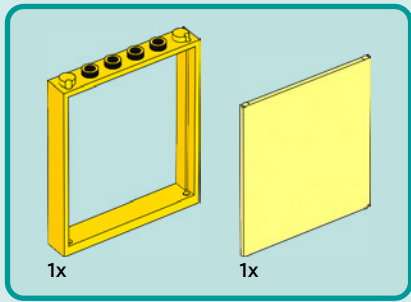

18

1

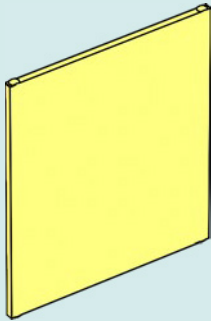

2



3

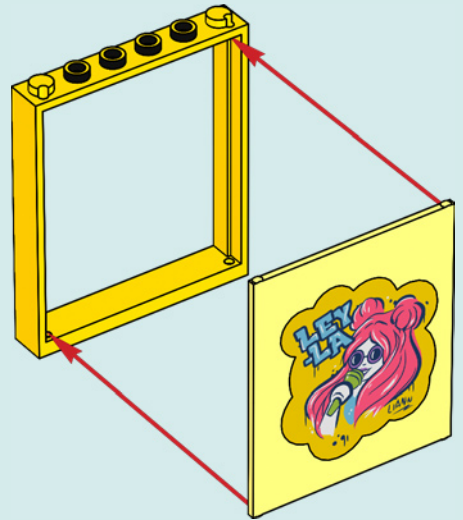



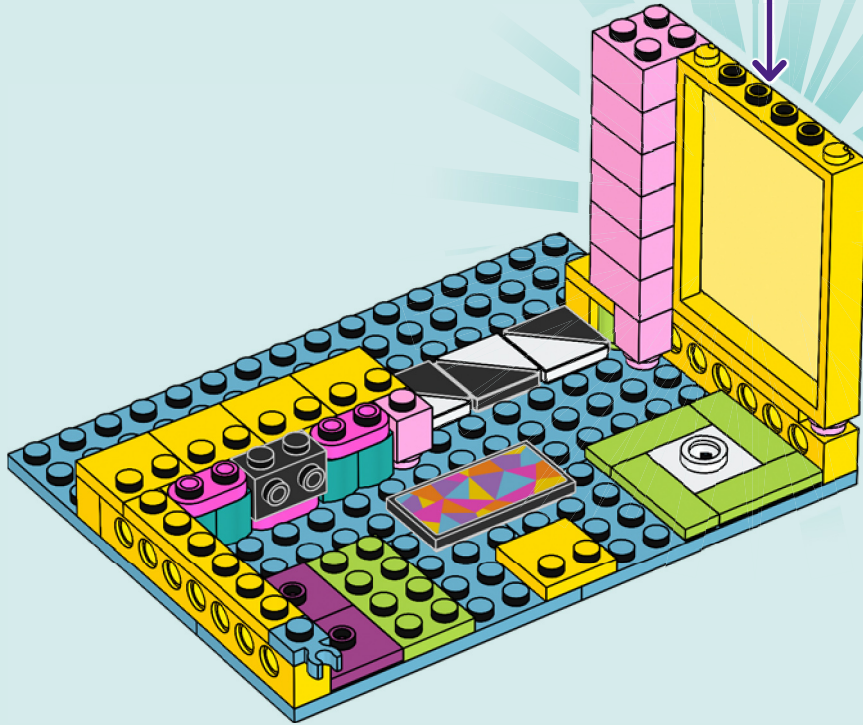

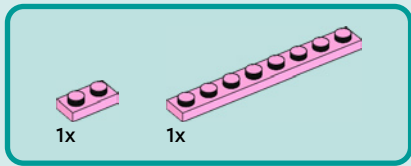

19

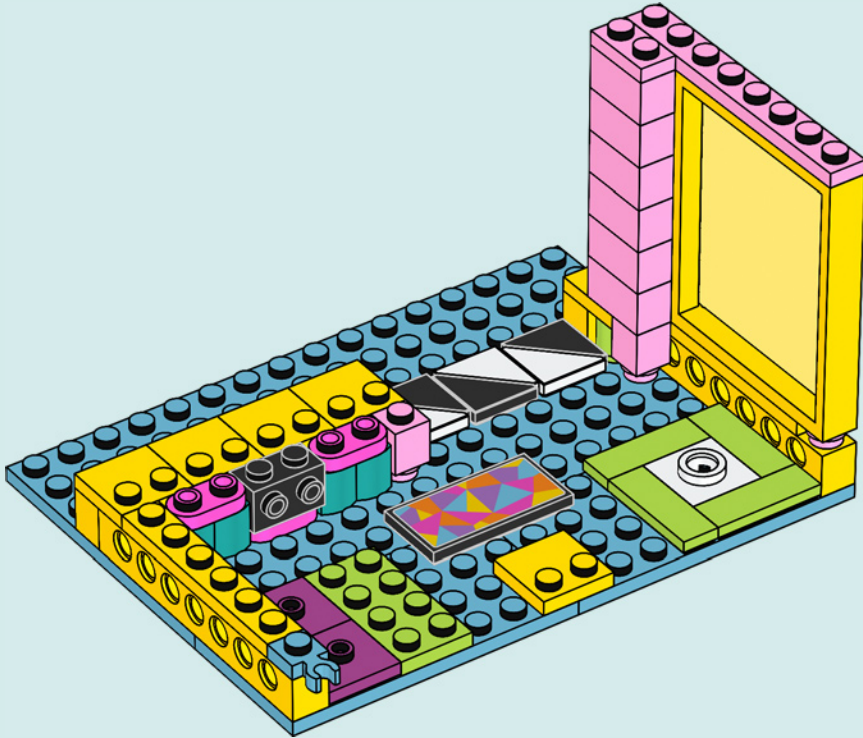

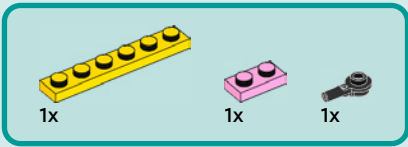

20

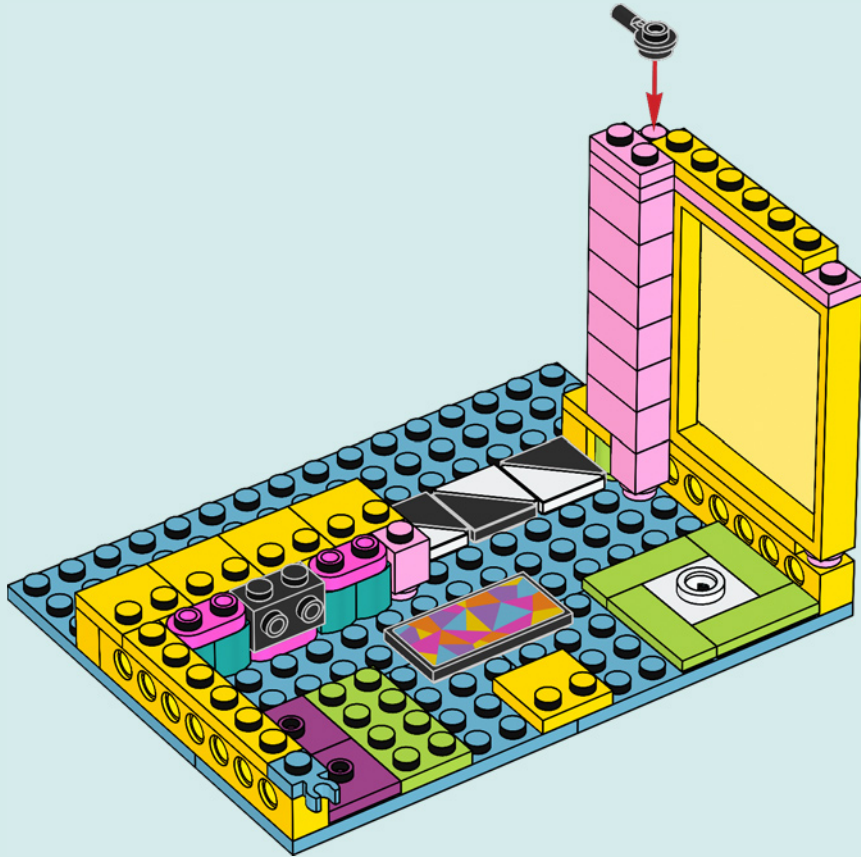



1x



1x

21

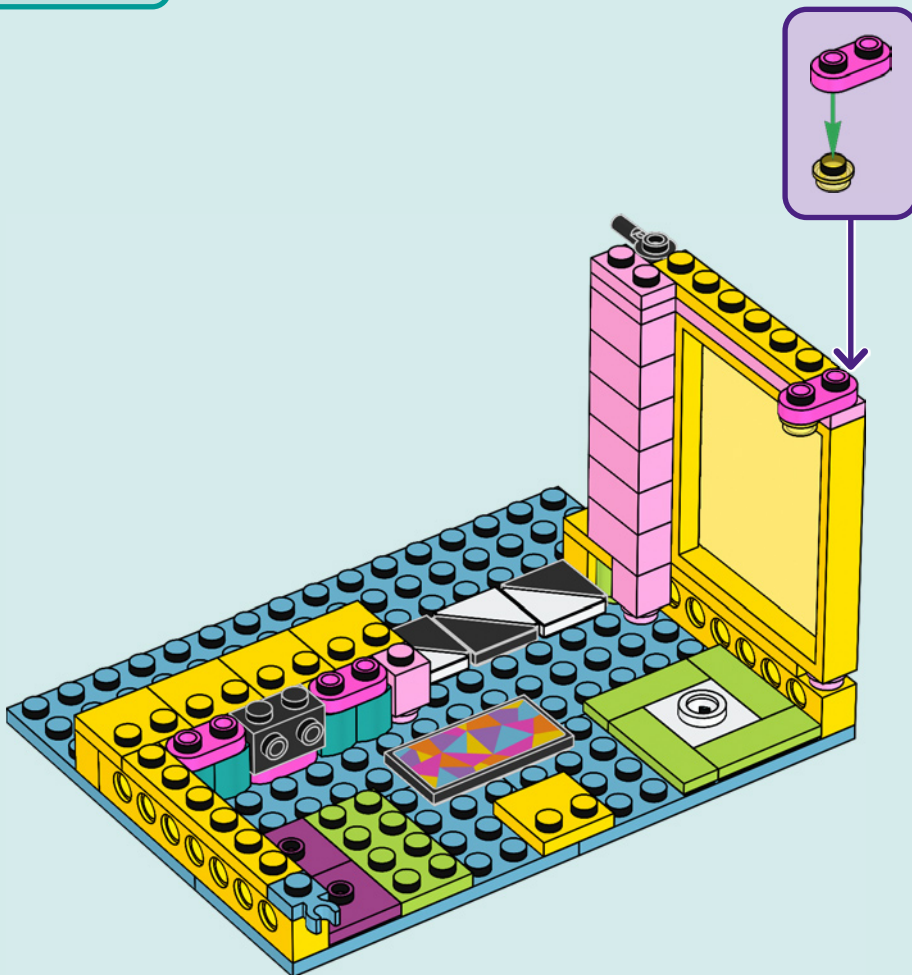

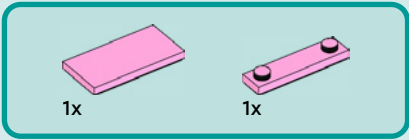

22

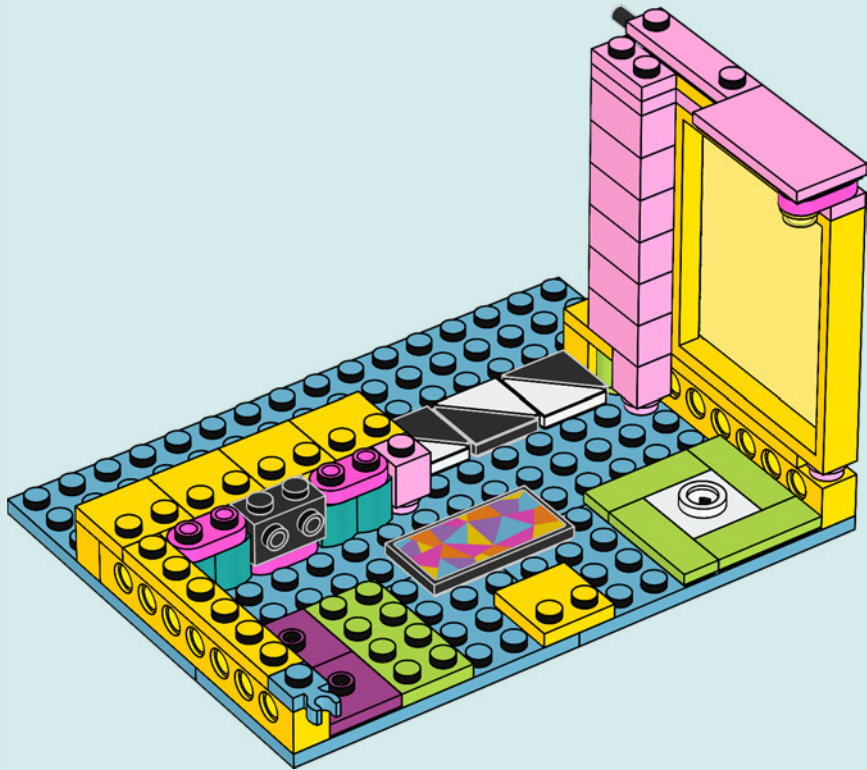

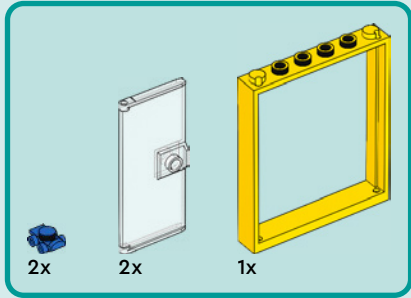
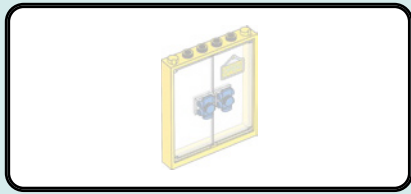

23

1

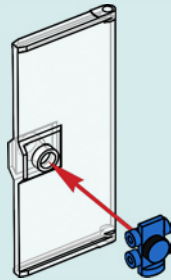

2

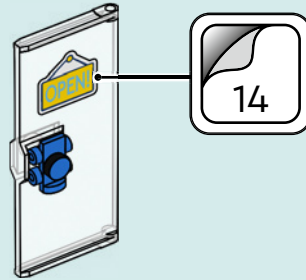



3

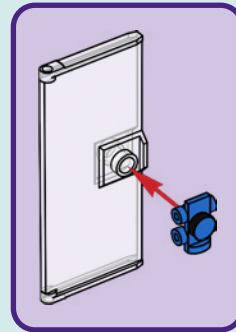
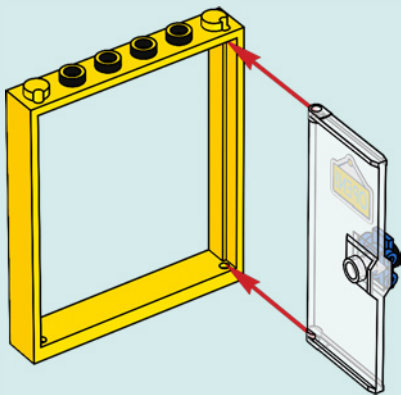

4

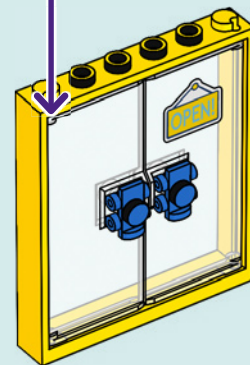

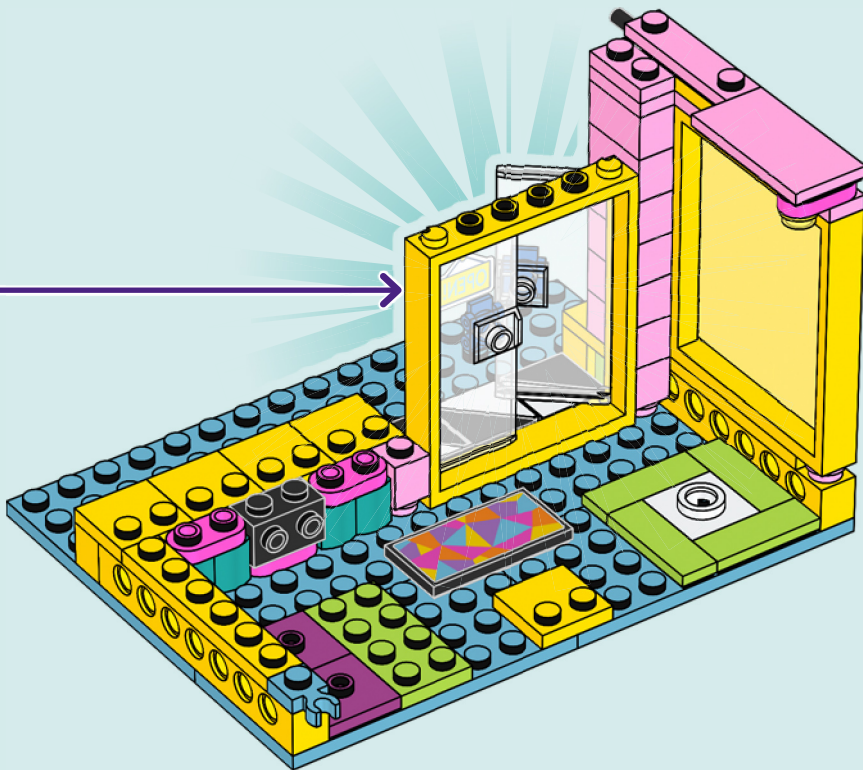

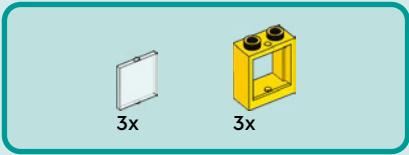

24

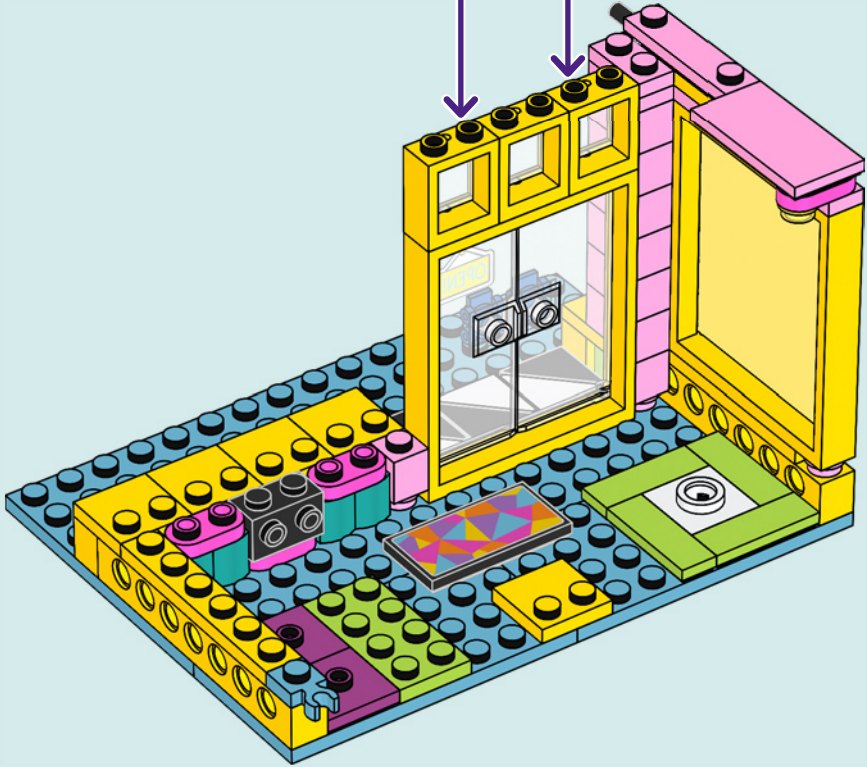
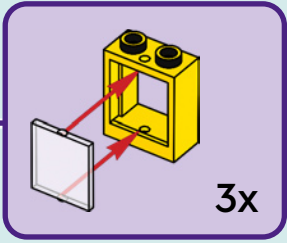



1x

25

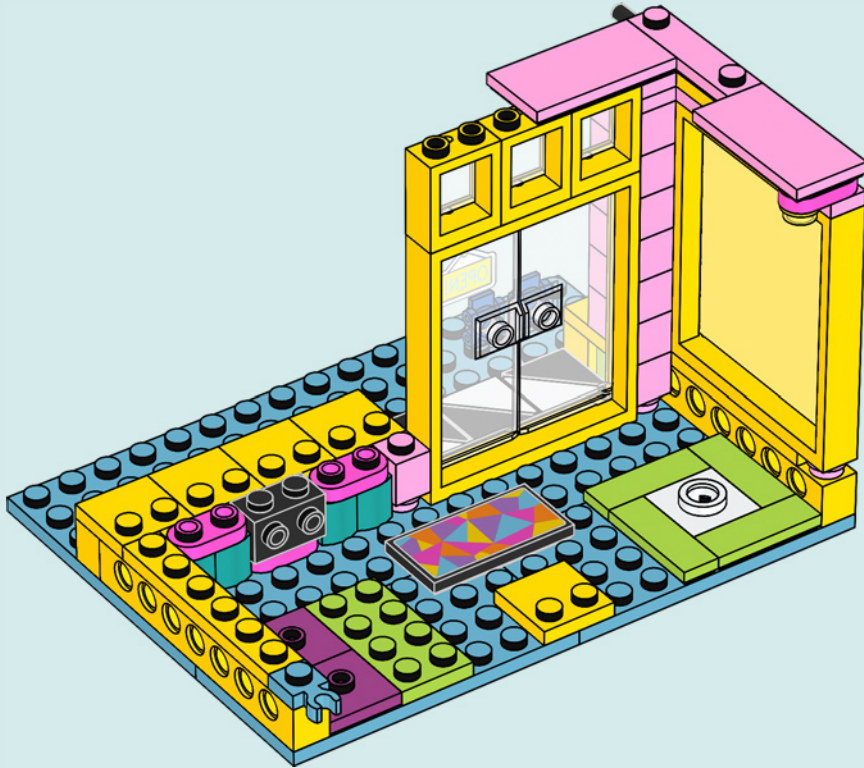

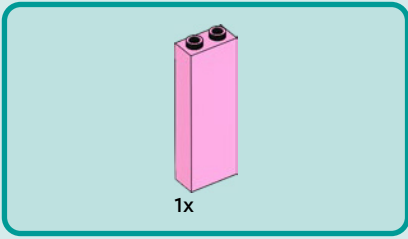

26

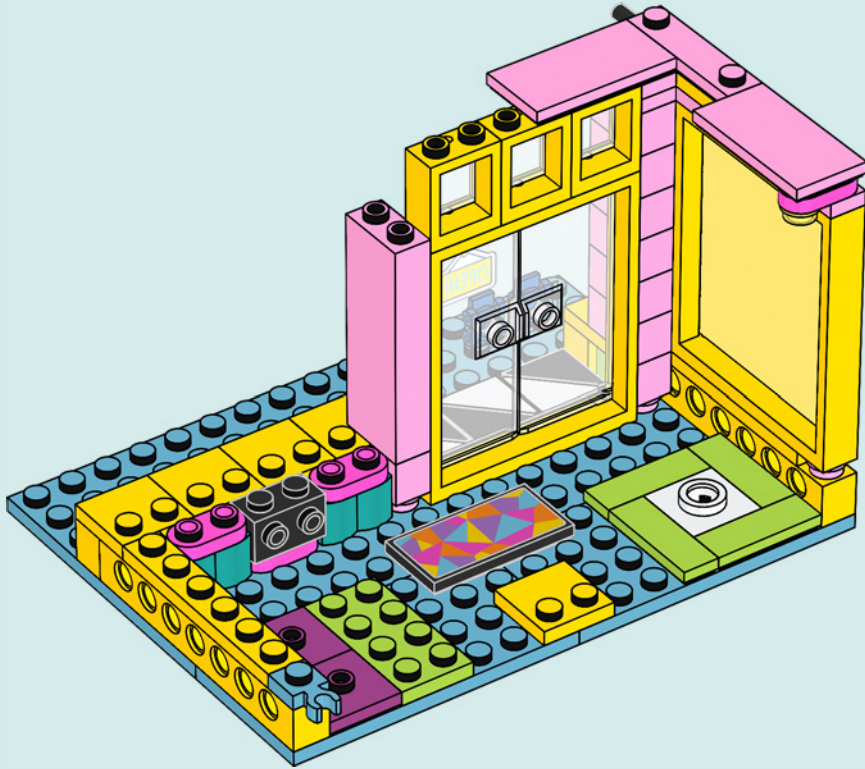



1x



1x

27

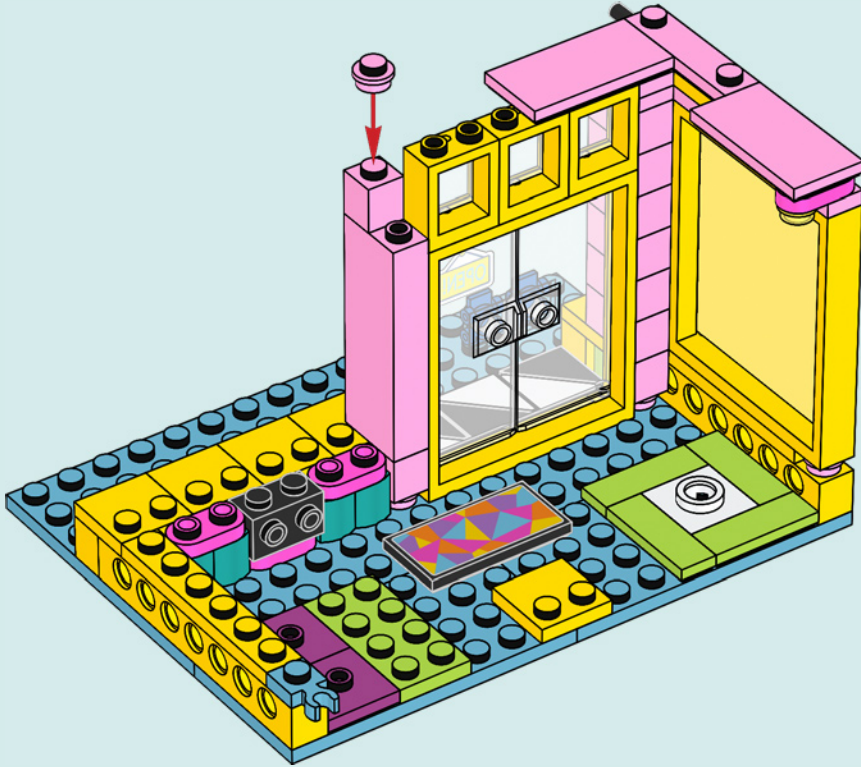



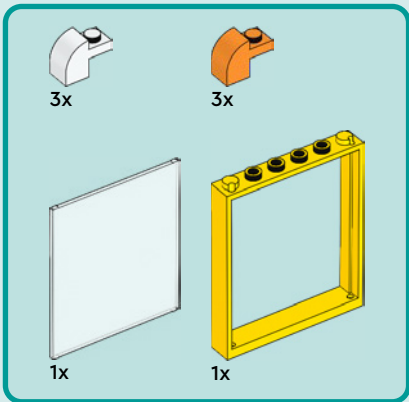
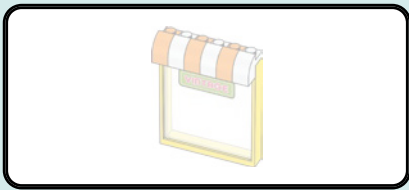

28

1

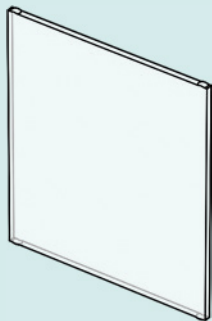

2



3

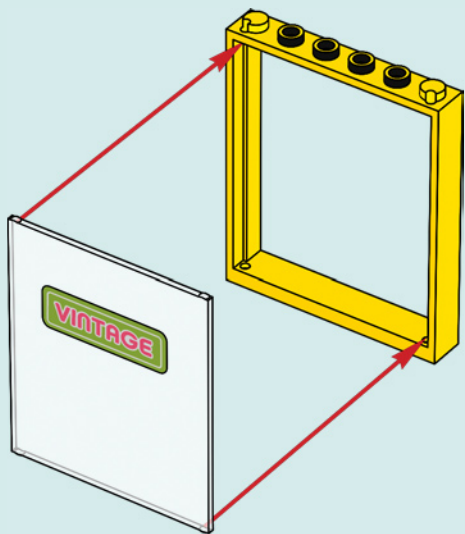

4

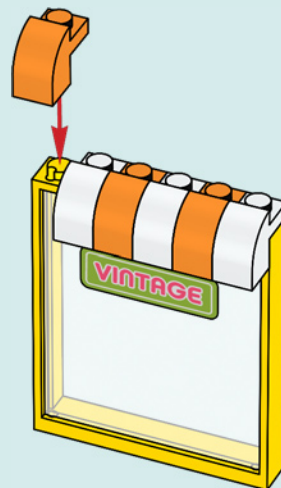

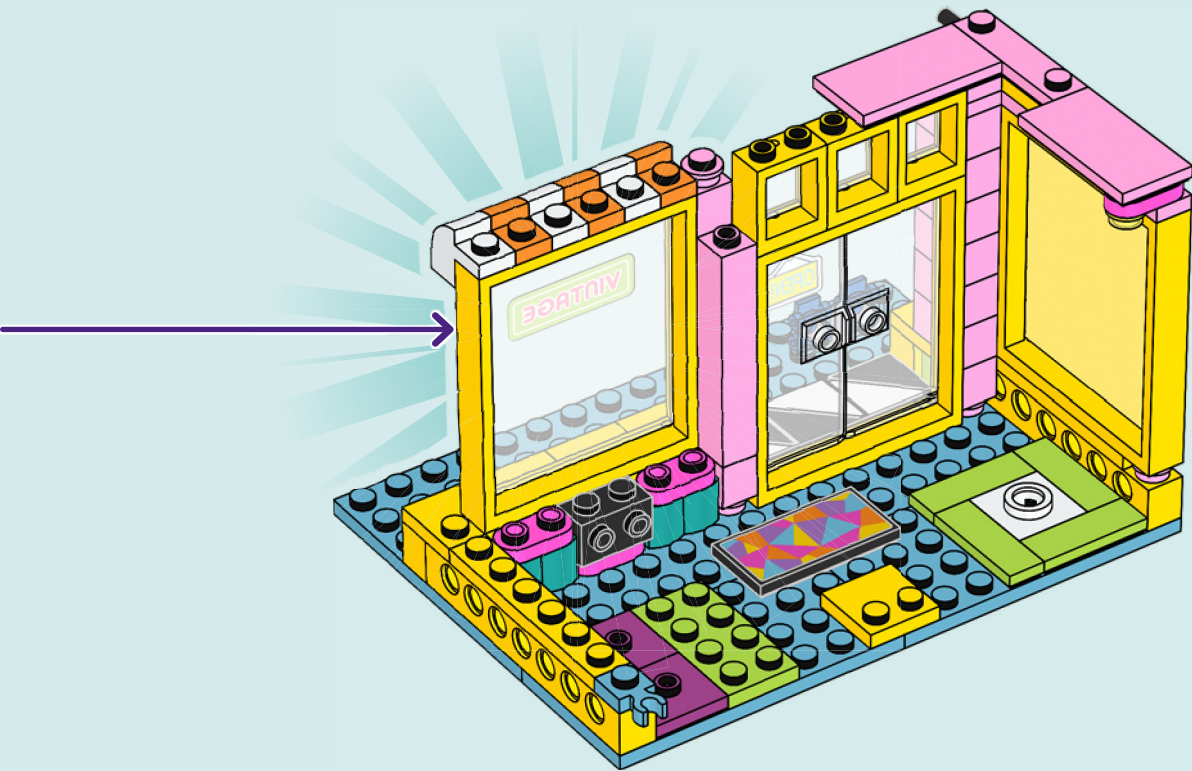

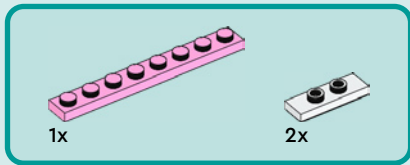

29

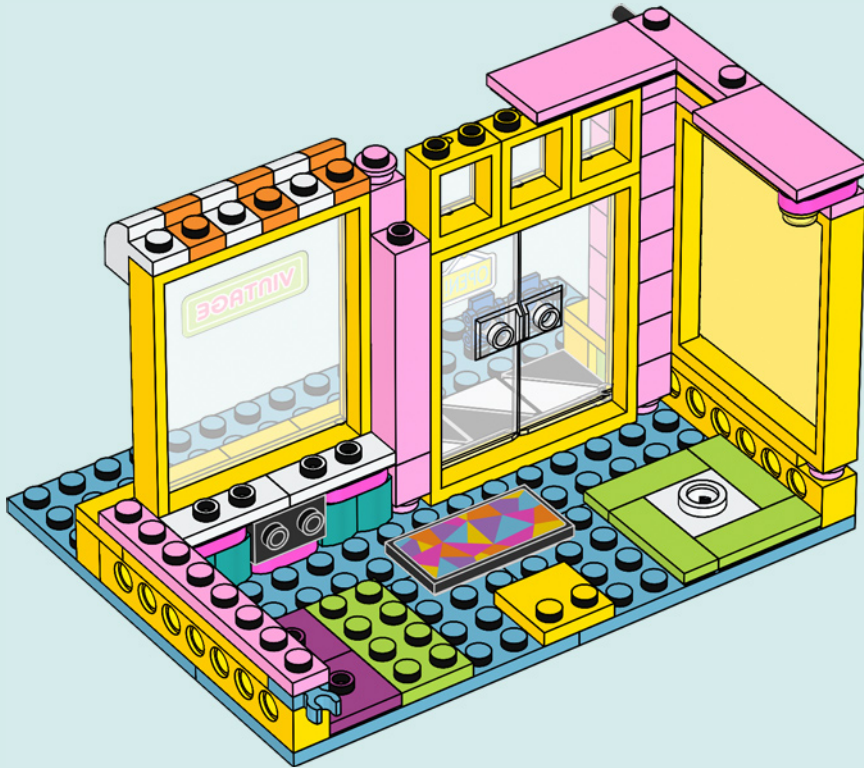

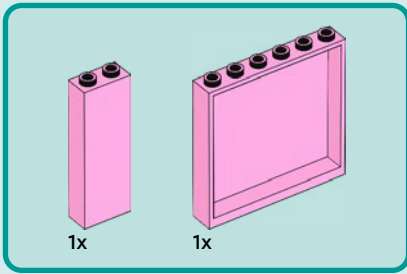

30

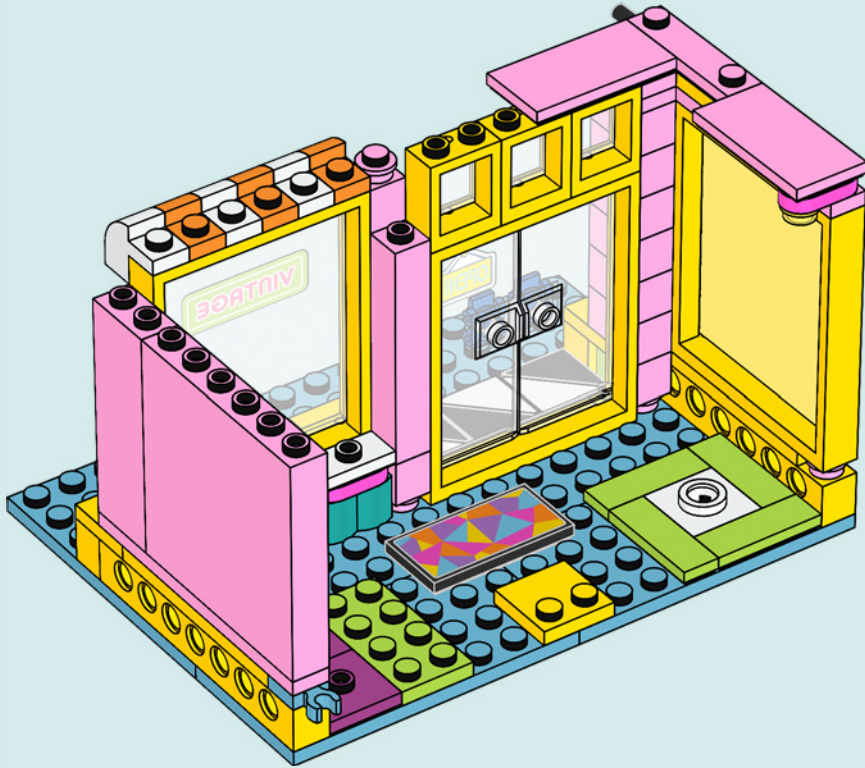

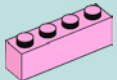

2x

31

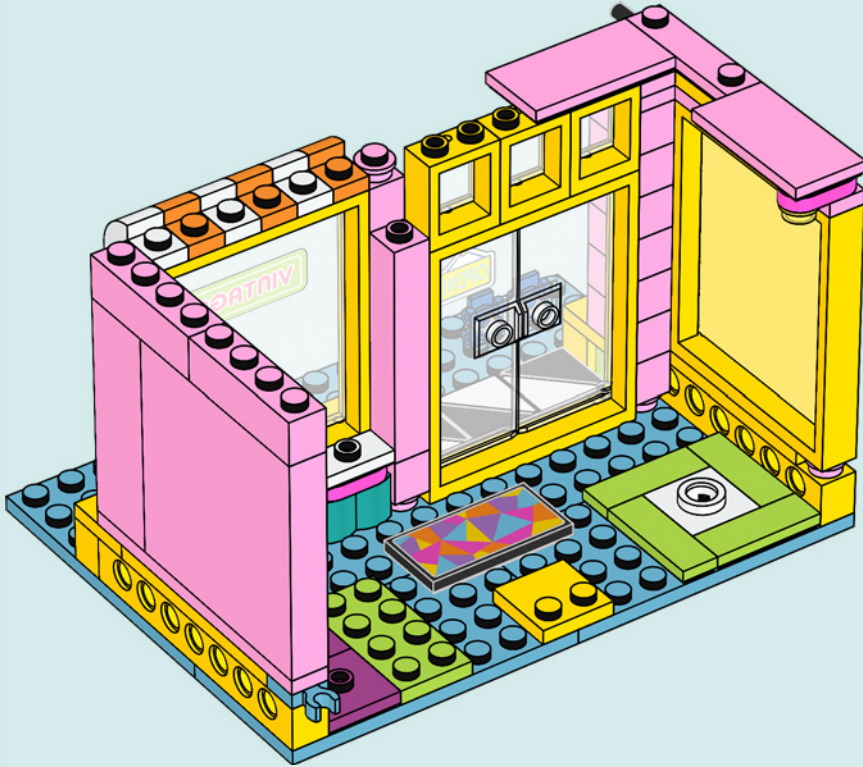



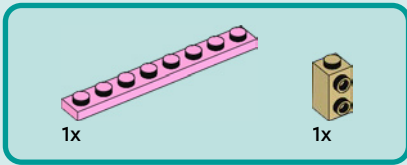

32

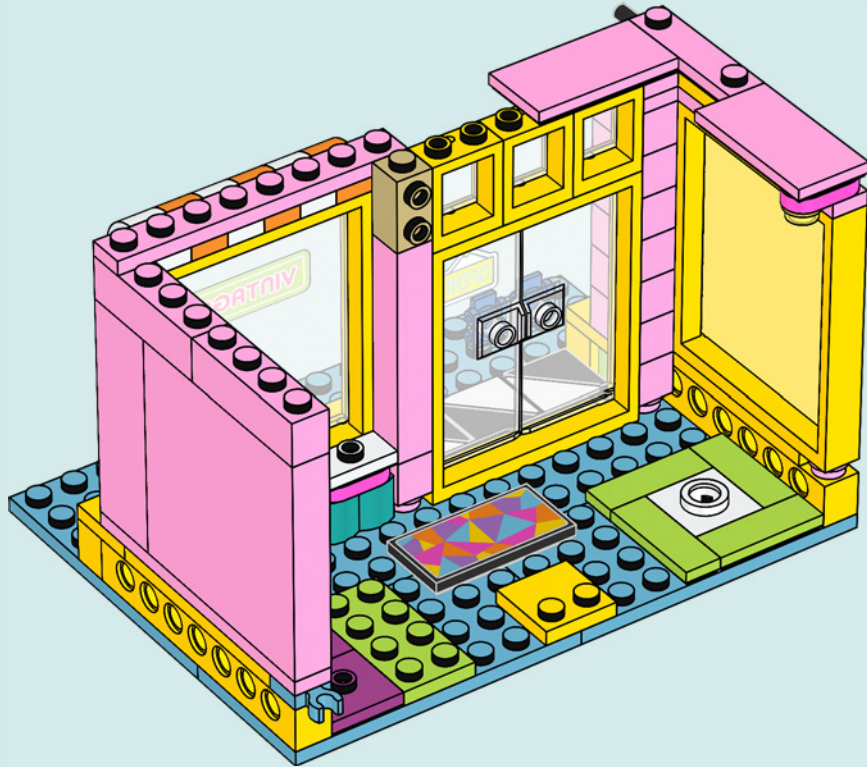

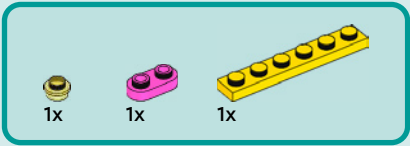

33

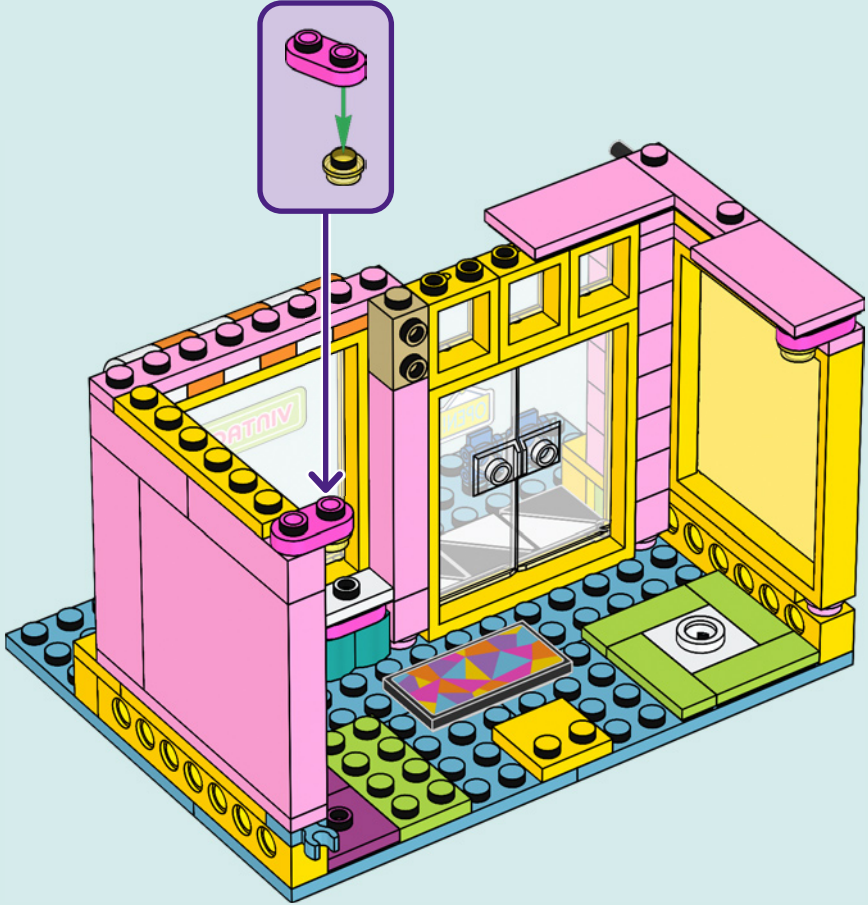

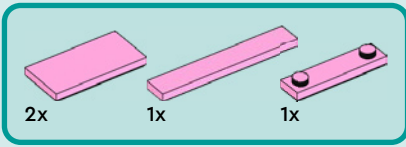

34

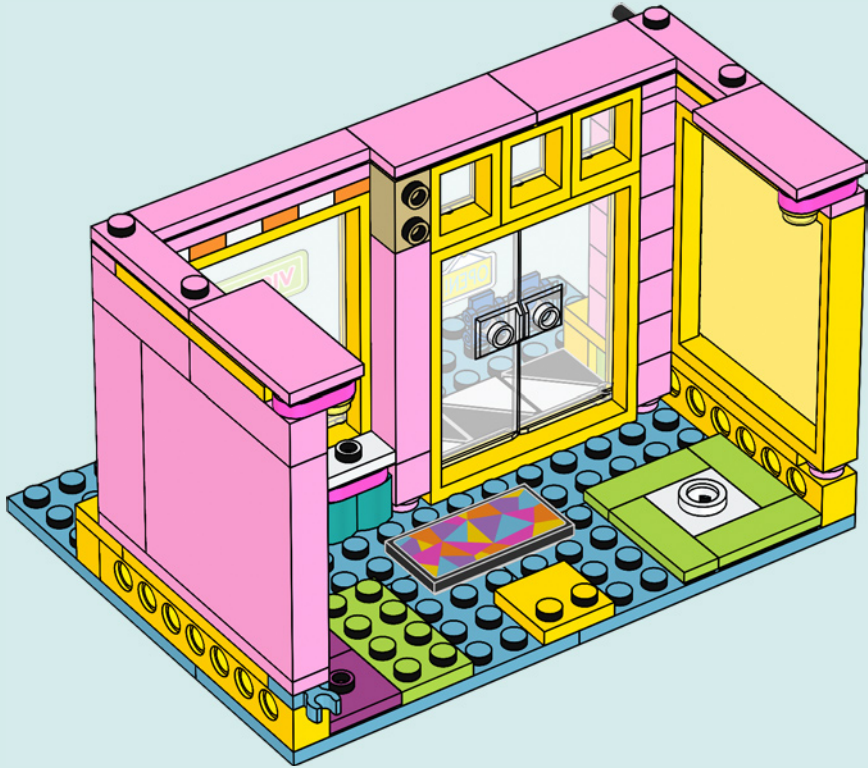





1x



1x

35

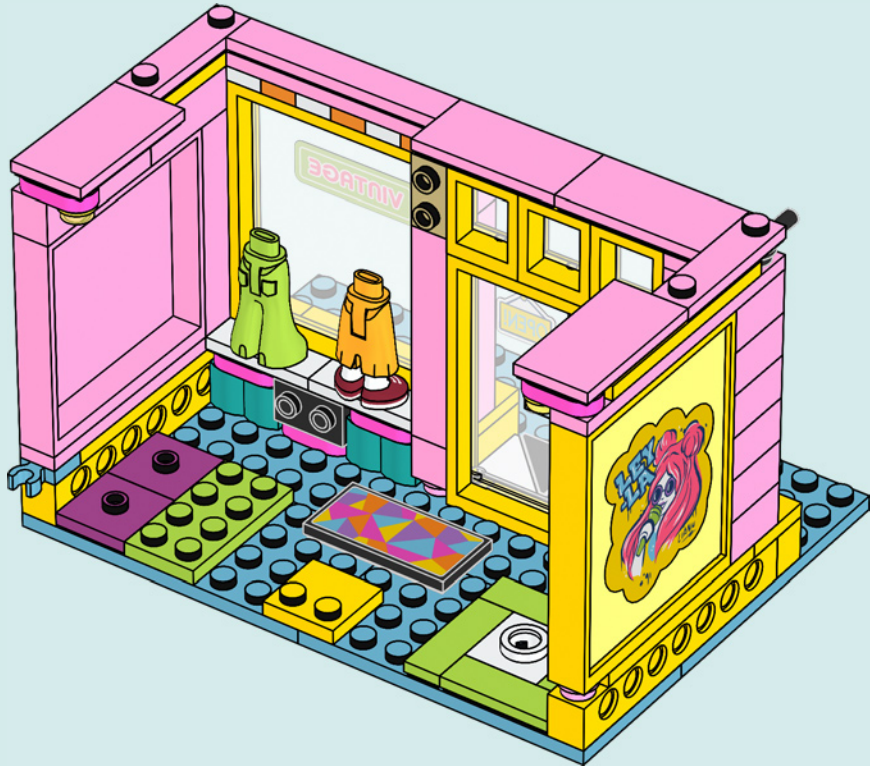



1x

36

1



2

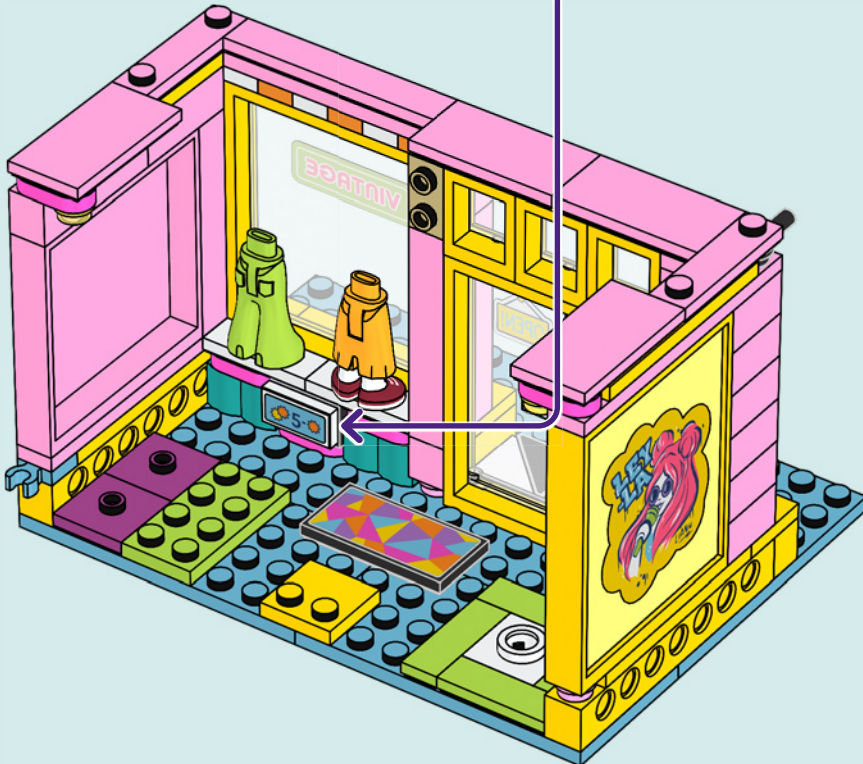



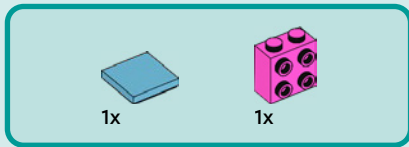

37

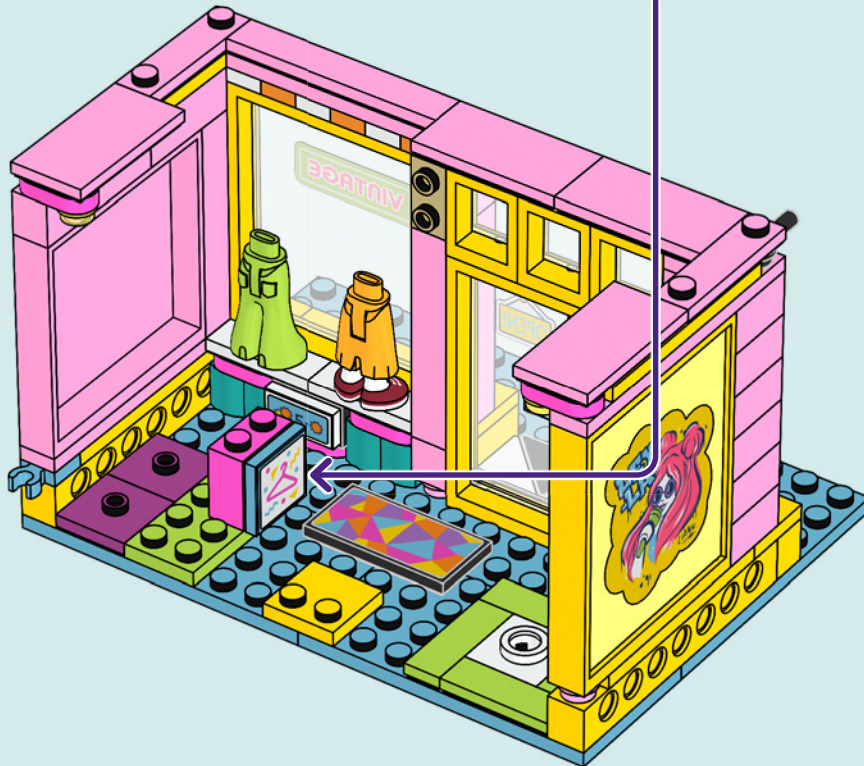
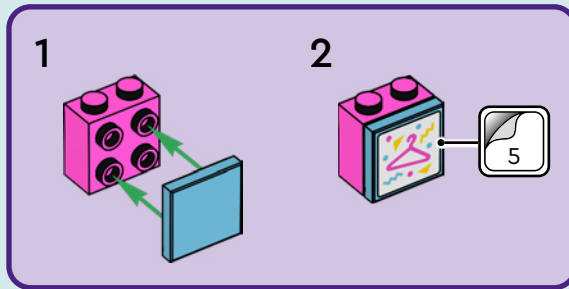



2x

38



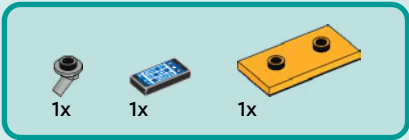

39

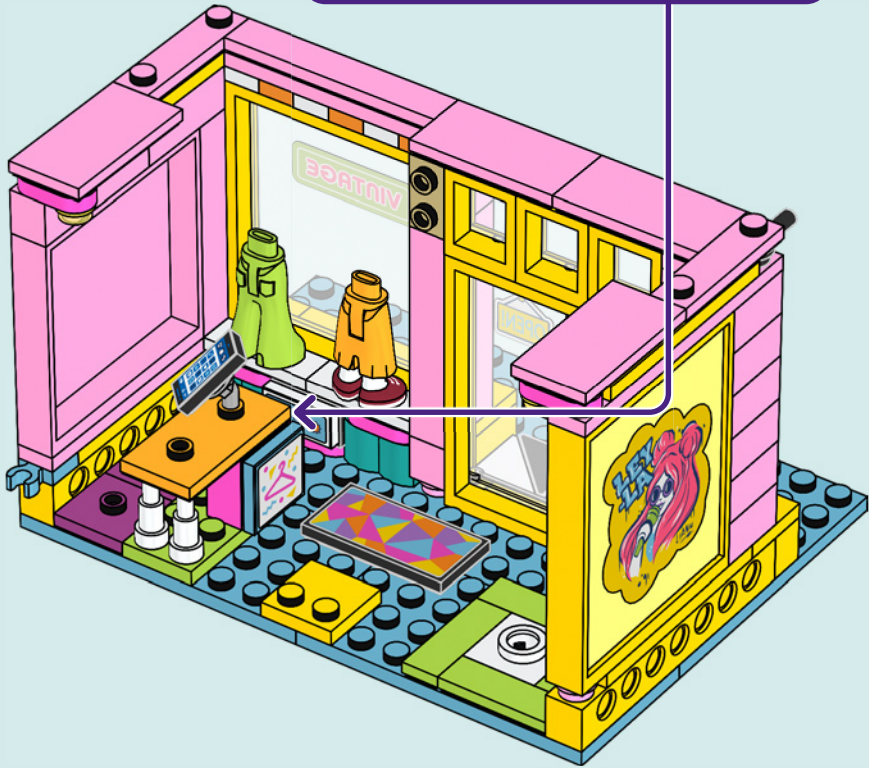
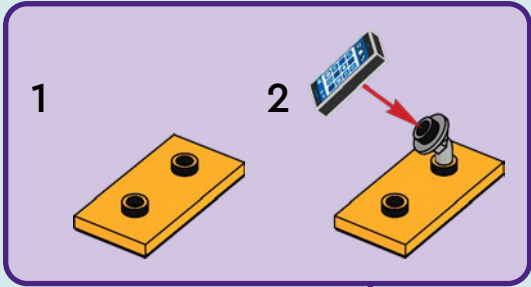

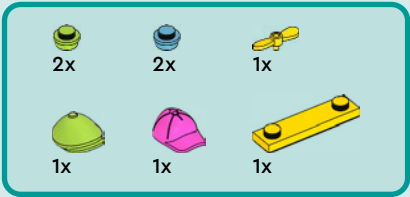

40

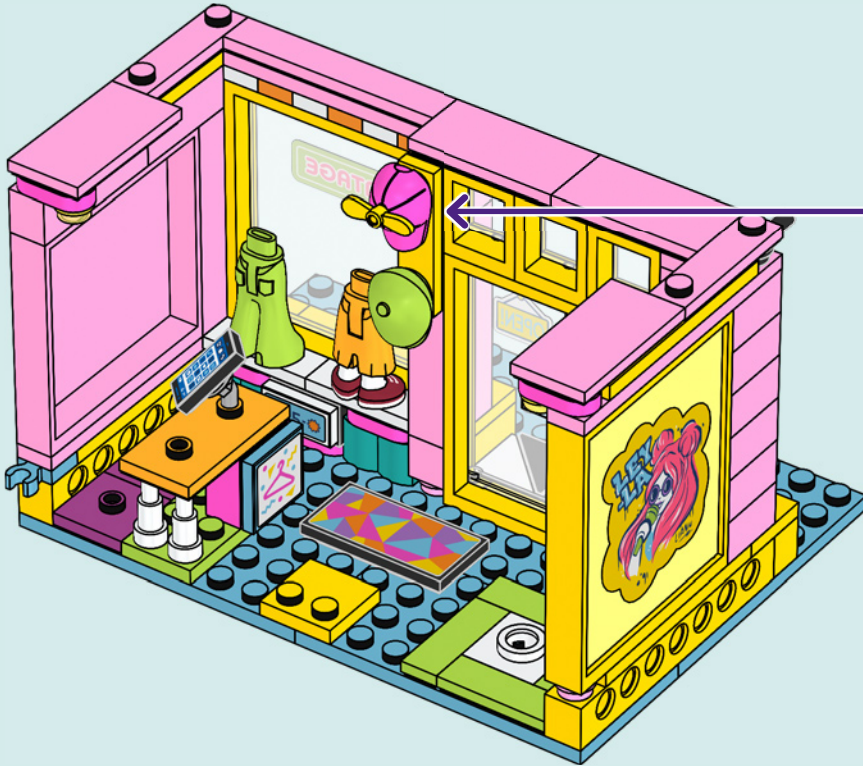
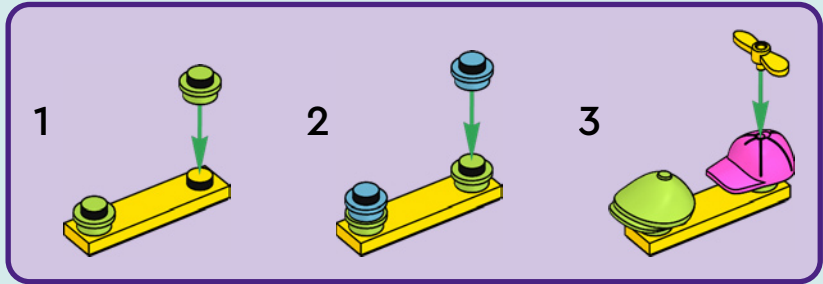

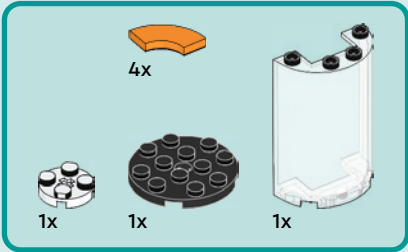

41

1

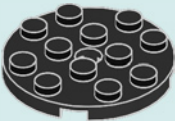

2



3



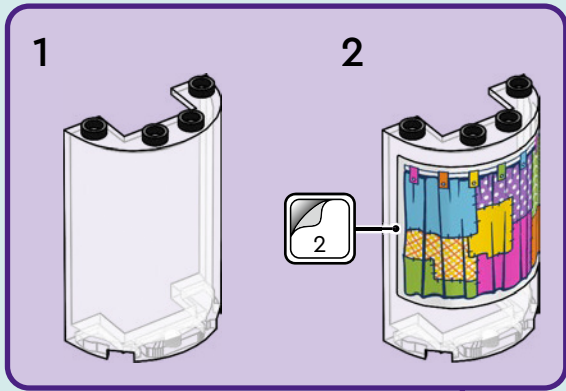



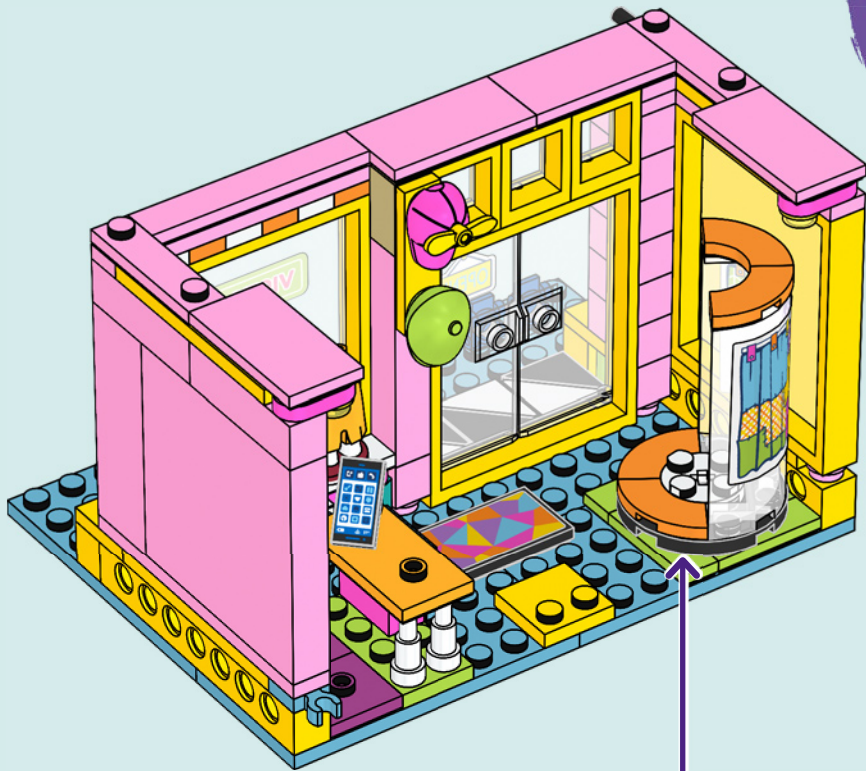



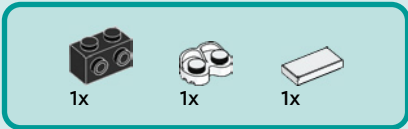

# 42

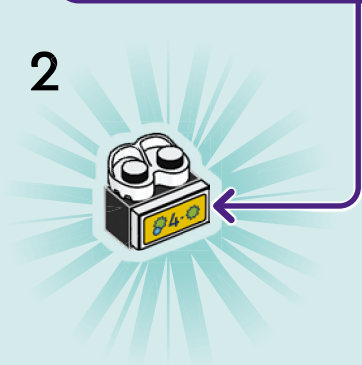
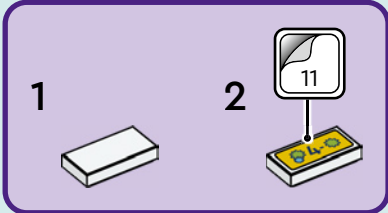
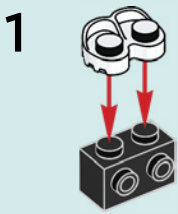





1x

43





8x



8x

44

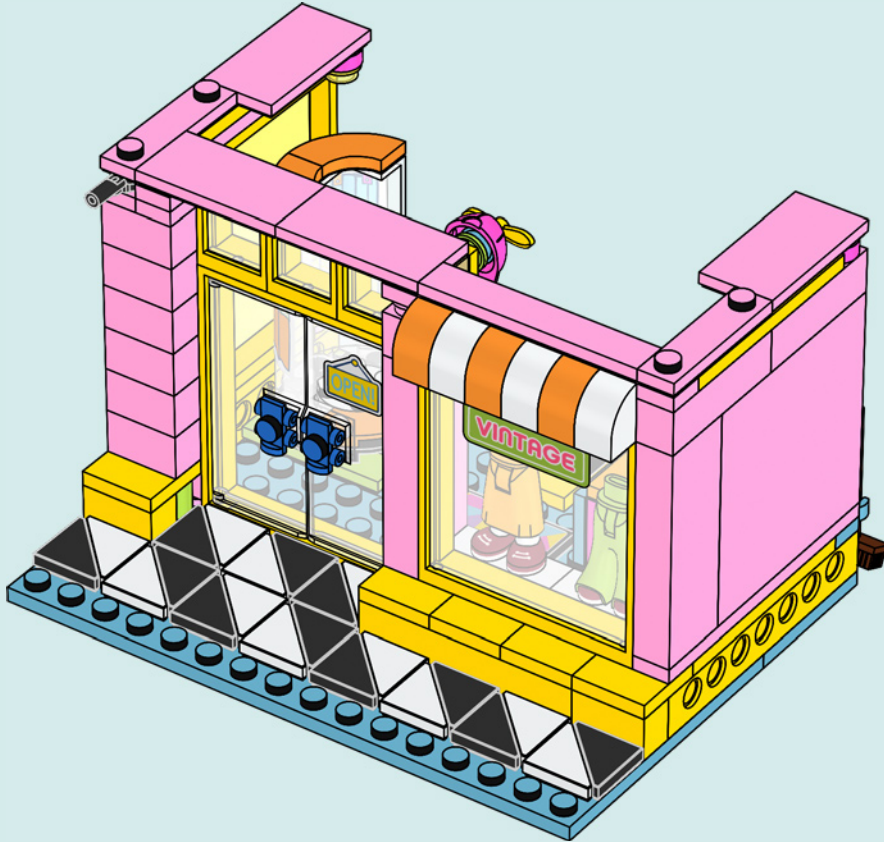

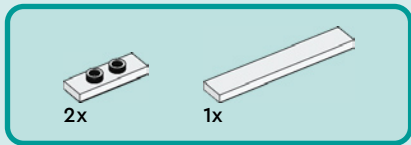

45

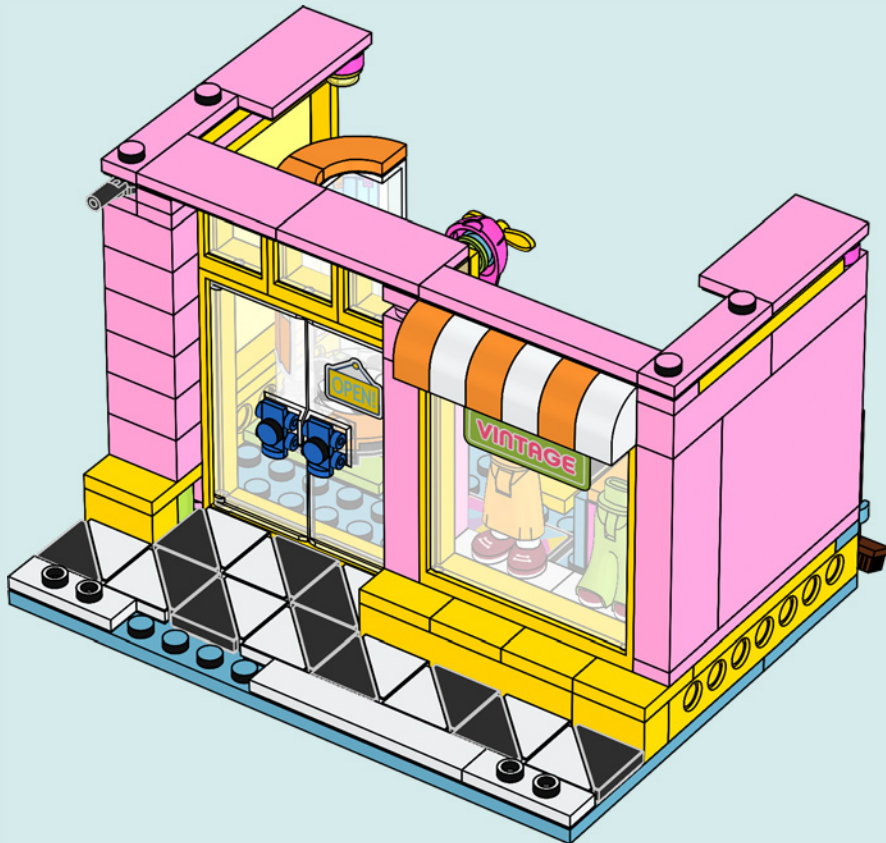



2x



1x

46

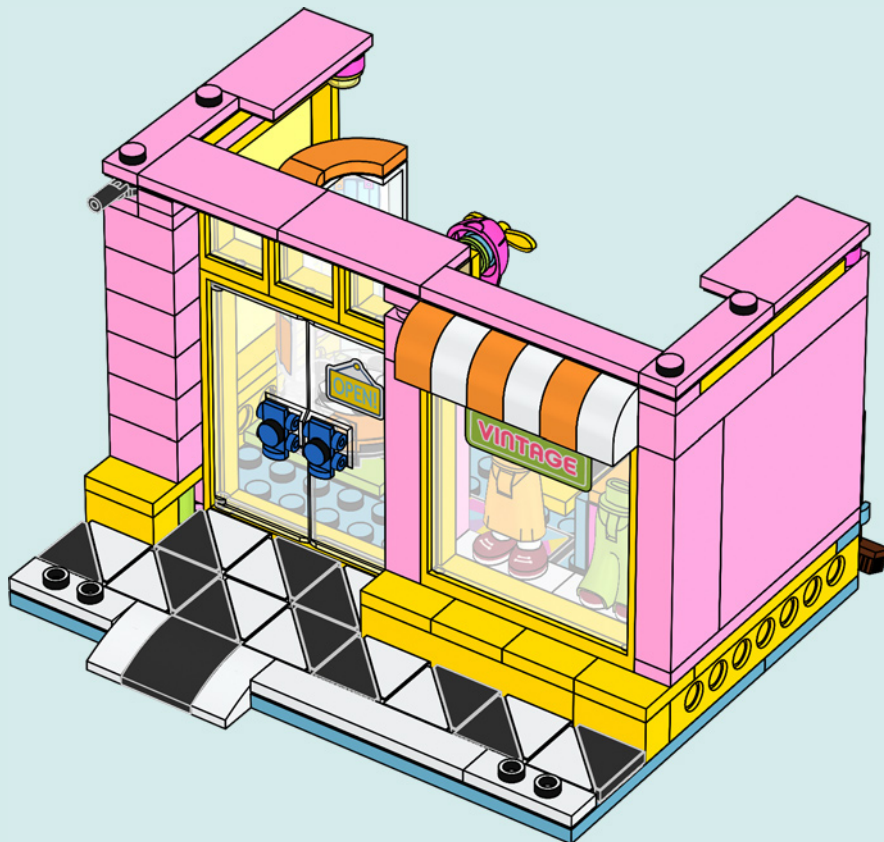

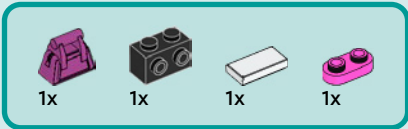

47

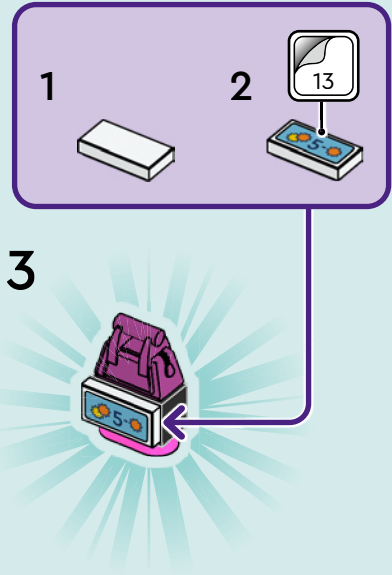
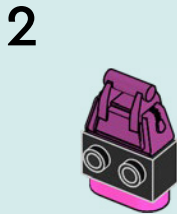
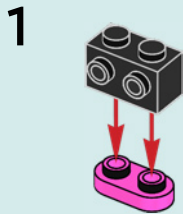



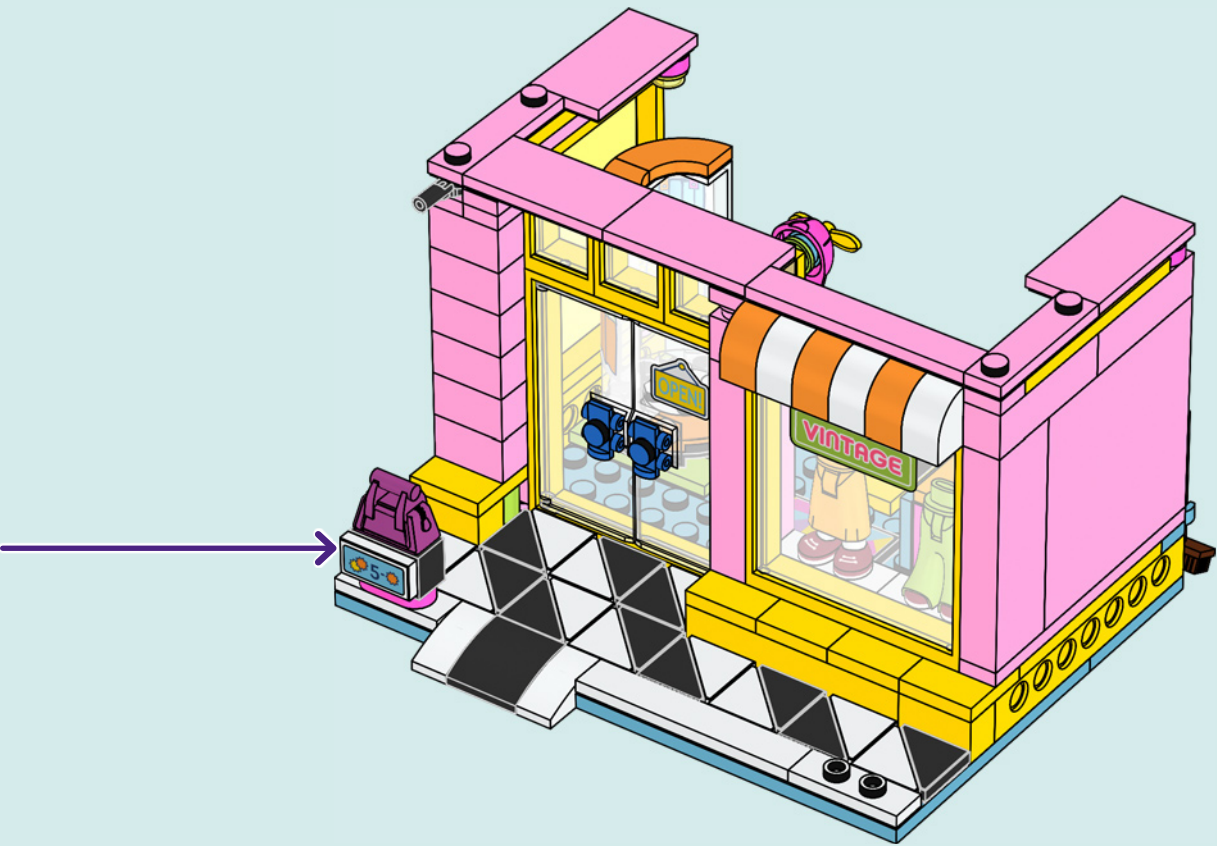

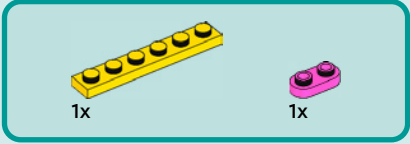

48

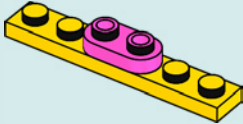

49

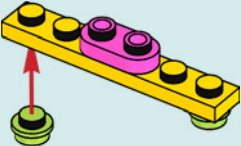



3x

50

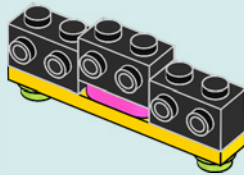

2x

51

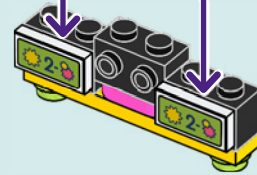
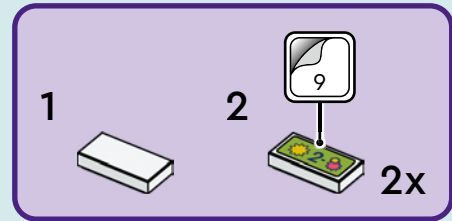



1x

52

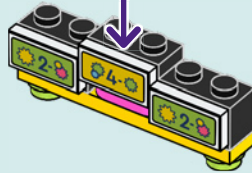
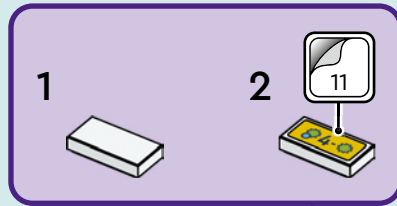



2x



1x

53

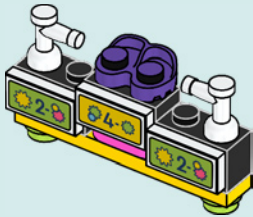

1x



1x

54

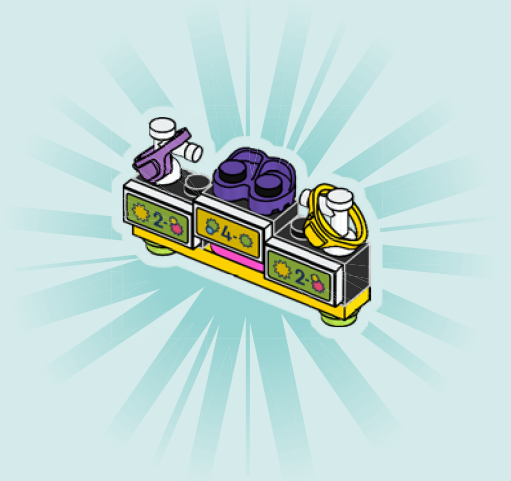

55

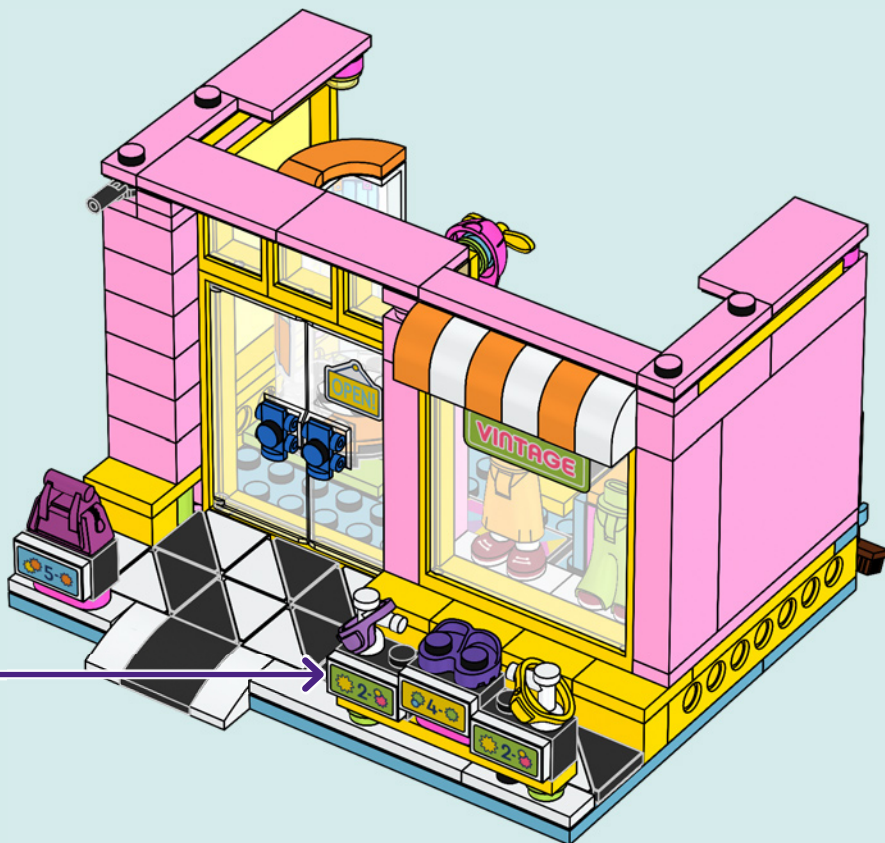

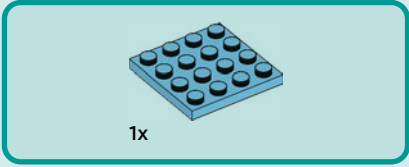
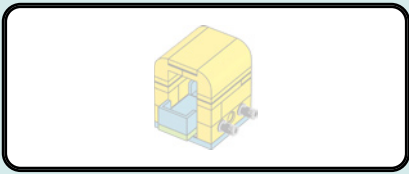

1x

56

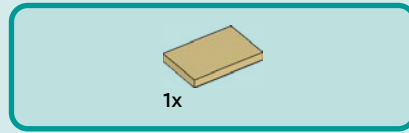
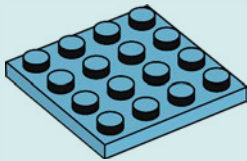

1x

57

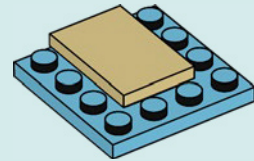



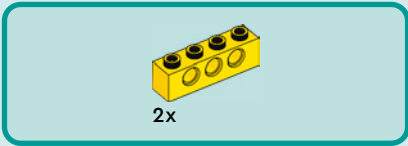

58

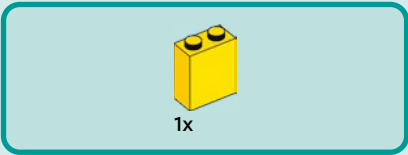
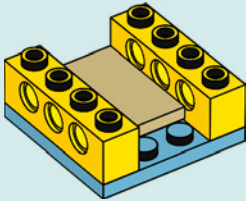

59

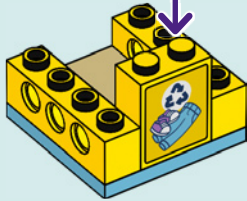
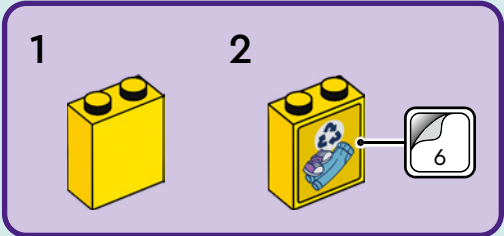

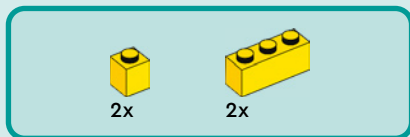

60

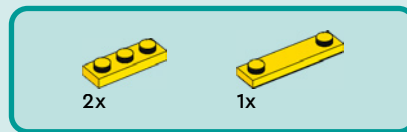
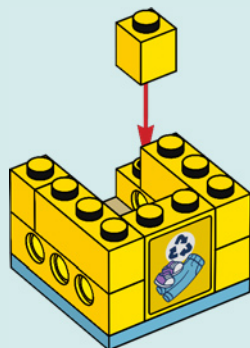

61

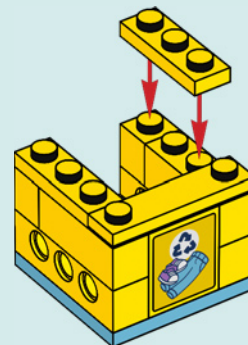



2x

62

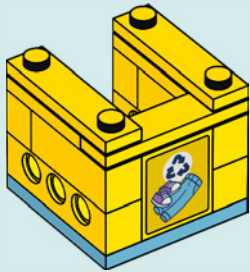

2x

63



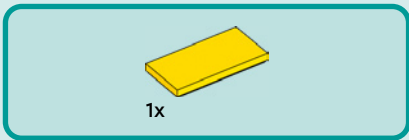

64

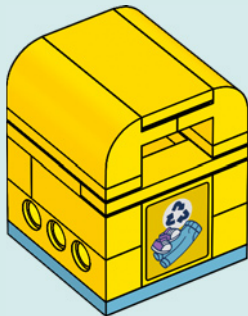

65

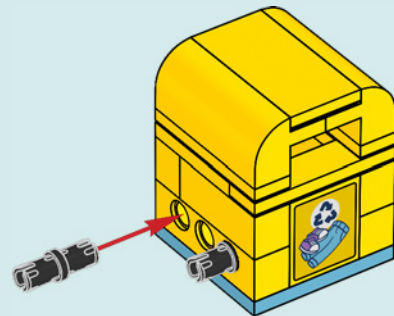

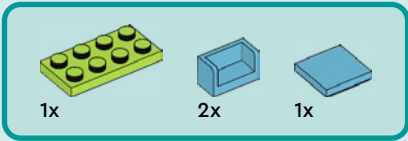

66

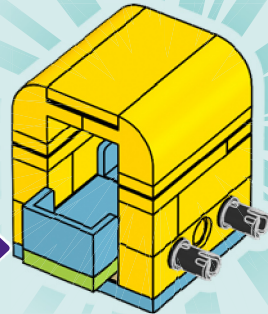
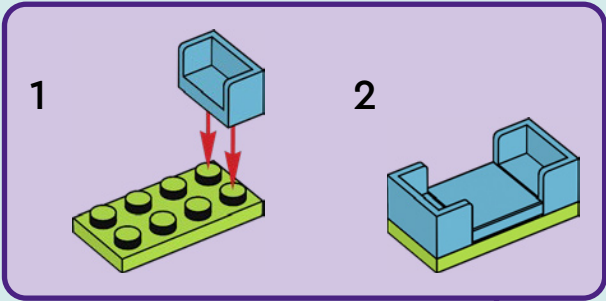

67

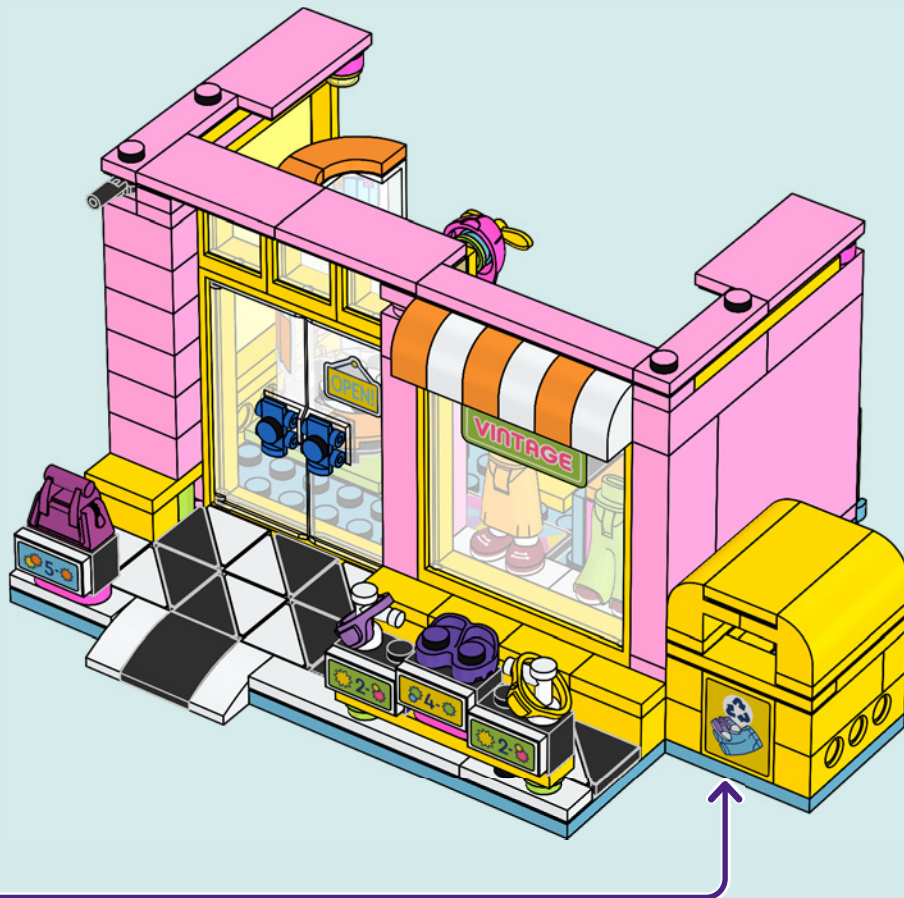

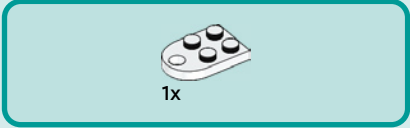
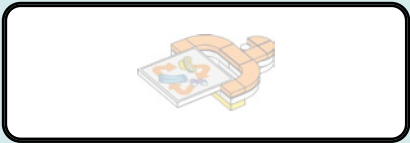

1x

68

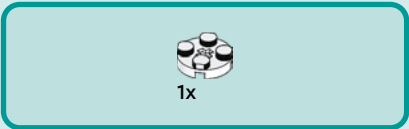

1x

69

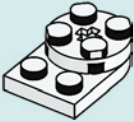



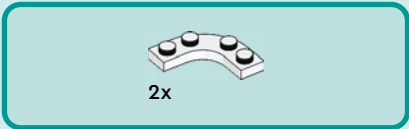

70

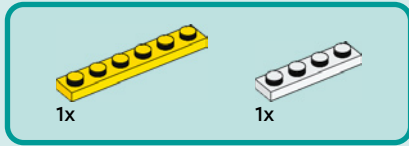
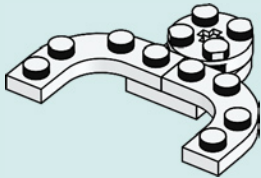

71

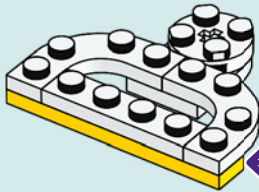
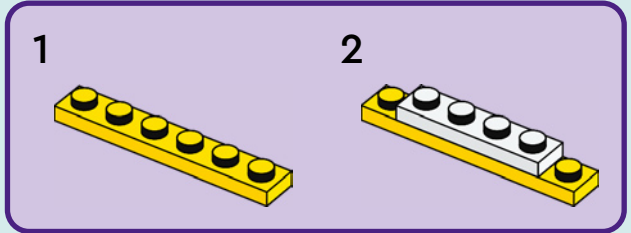

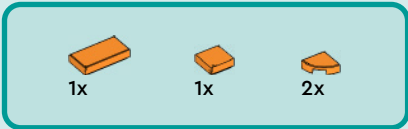

72

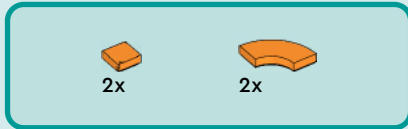
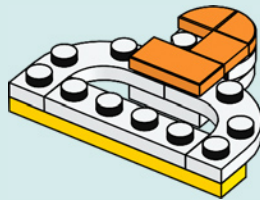

73

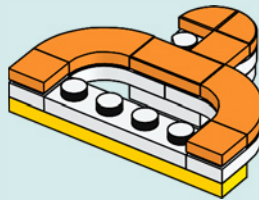

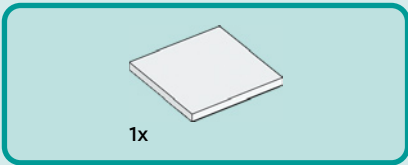

74

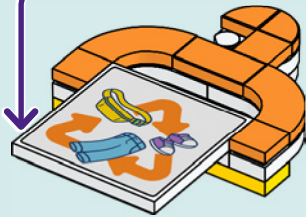
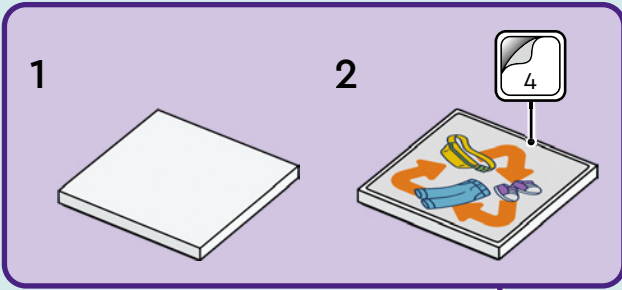

75

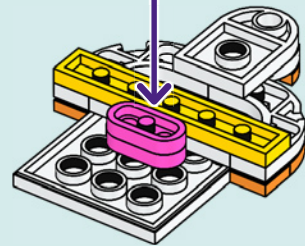
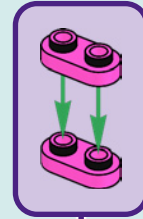
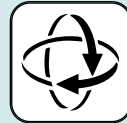

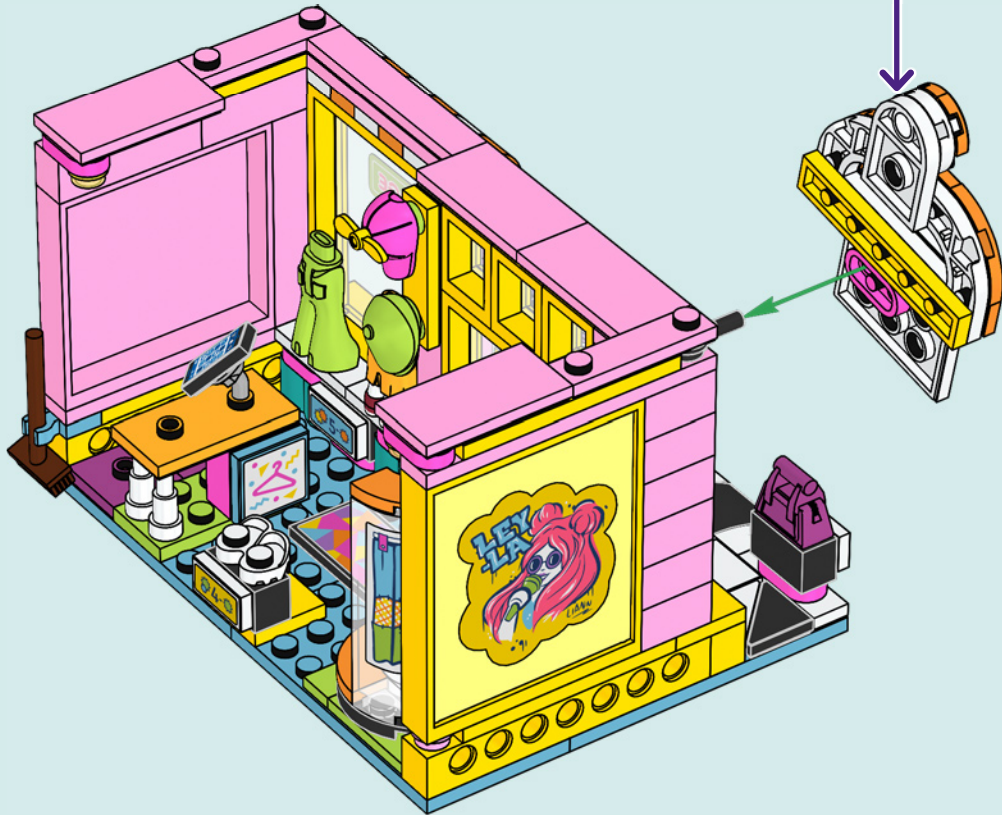

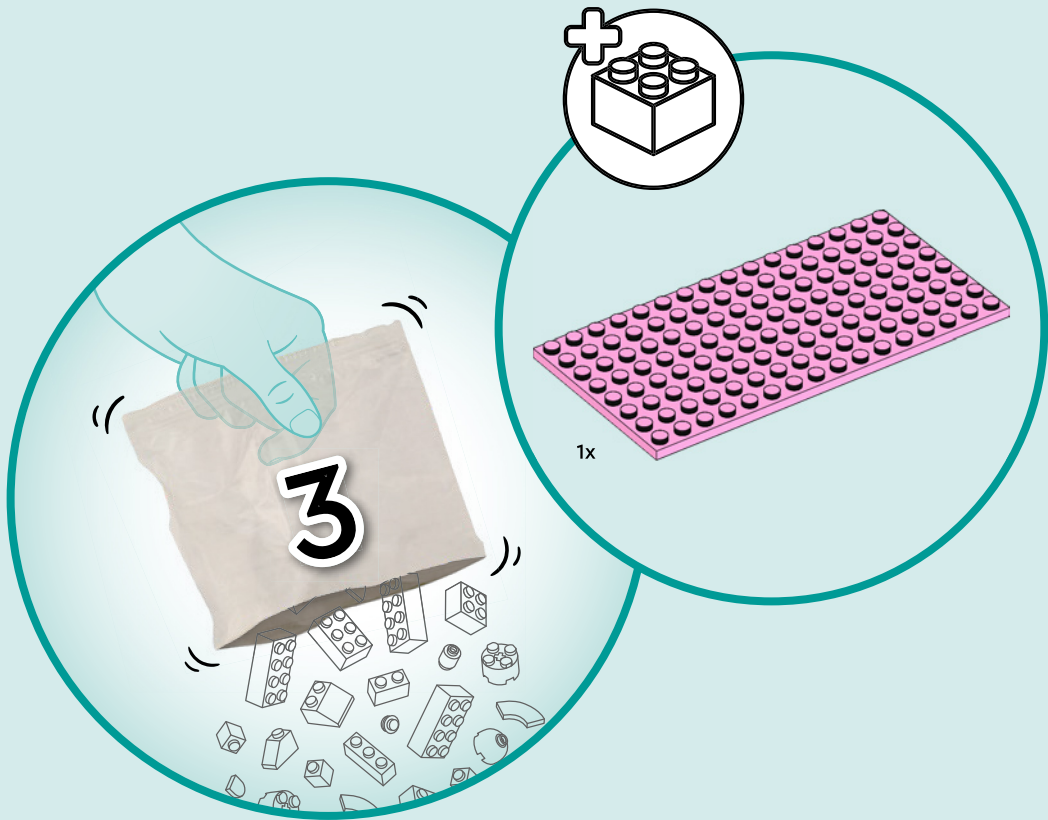



OLLY

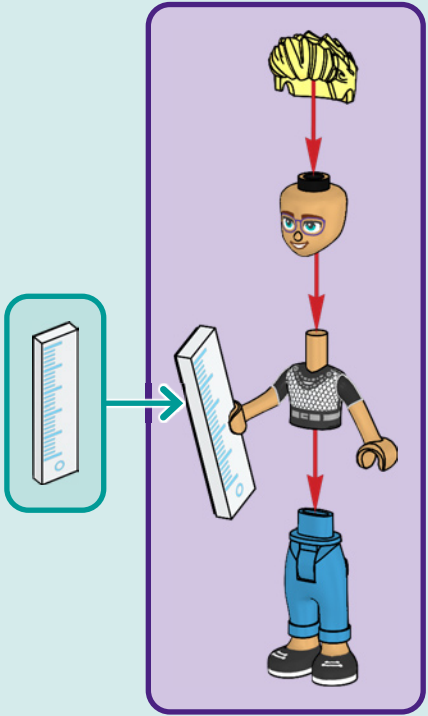





1x

77

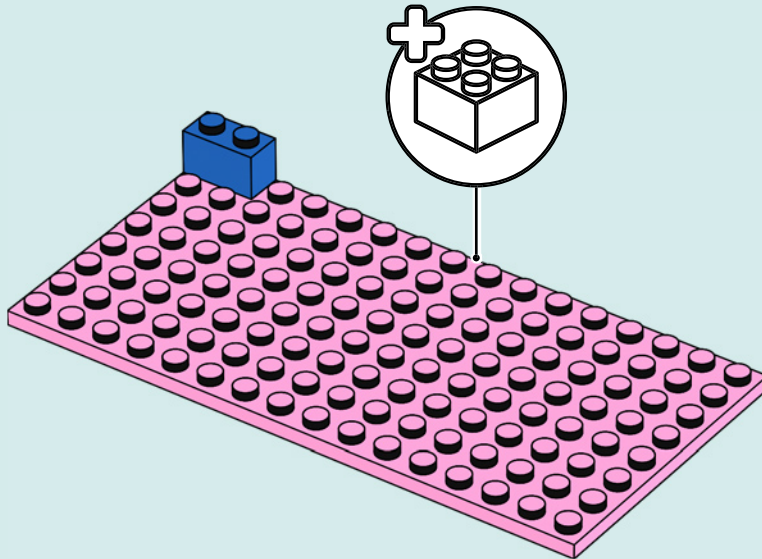

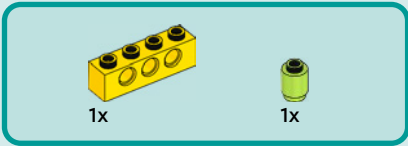

78

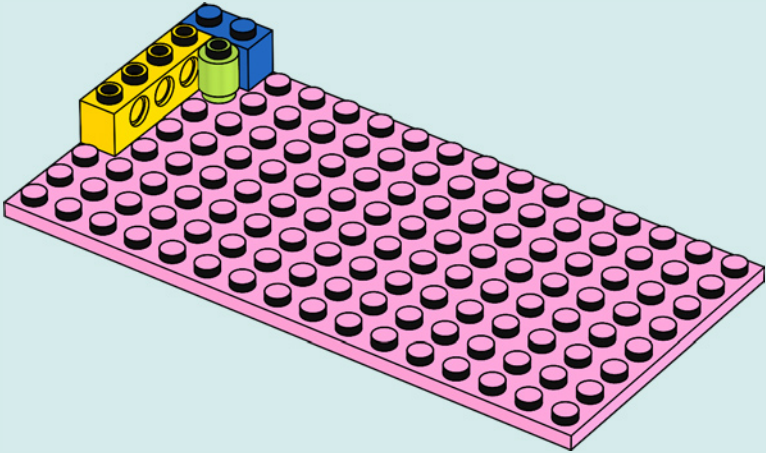

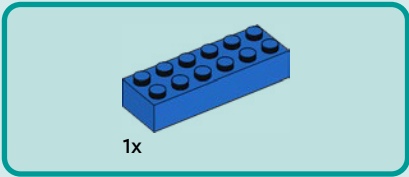

79

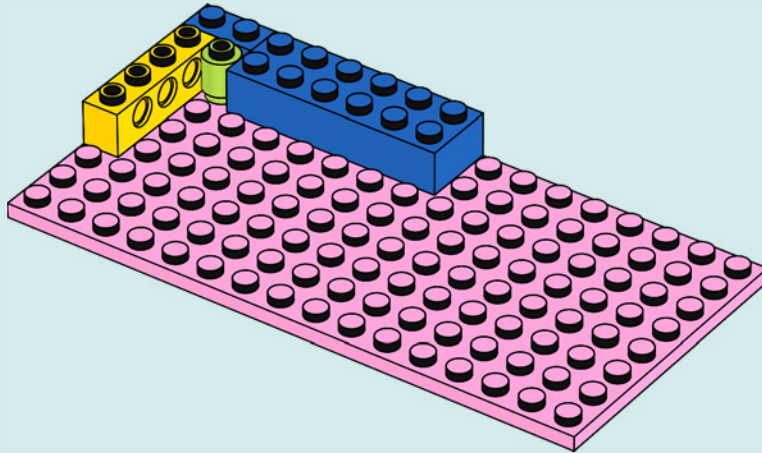

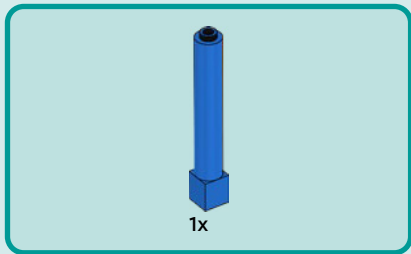

80

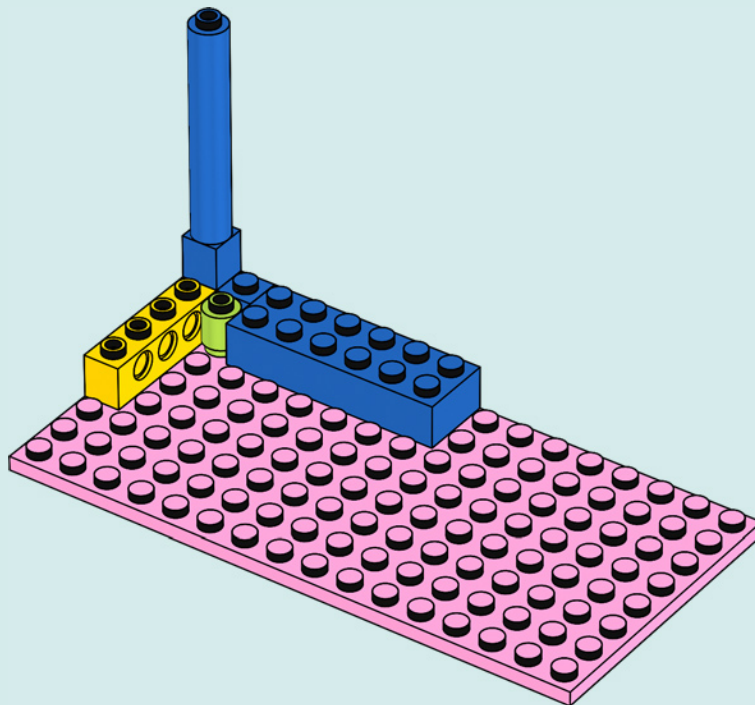

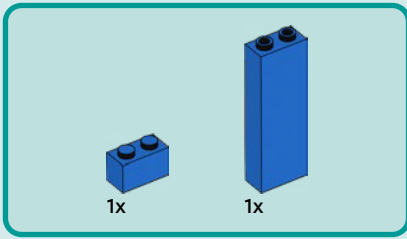

81

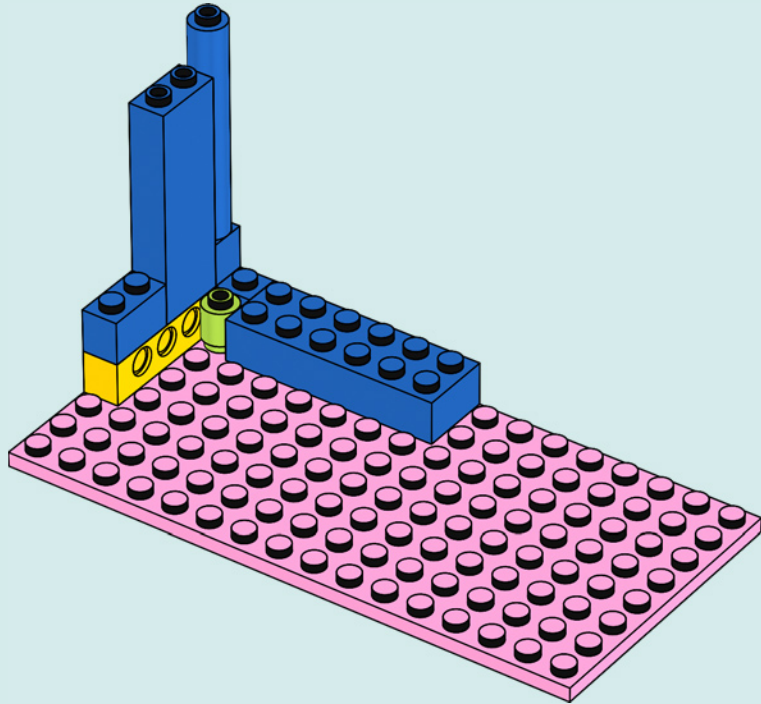

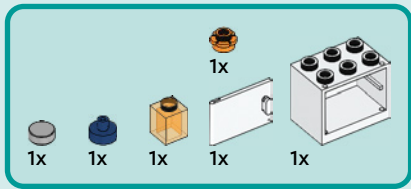

82

1

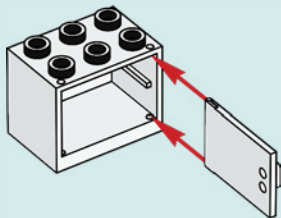

2



3

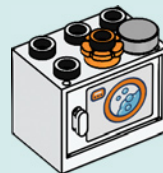







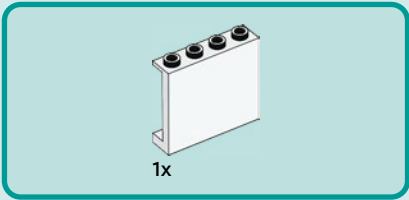

84

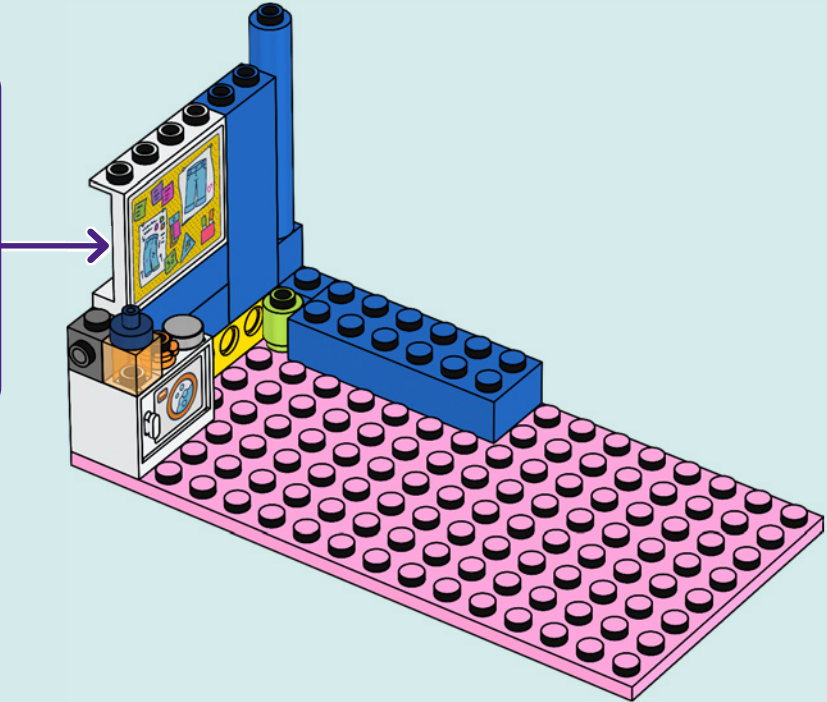
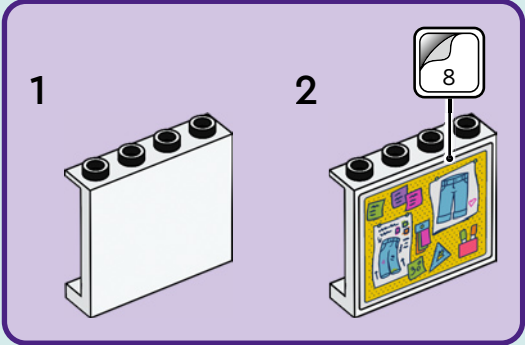



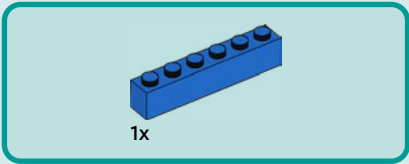

86

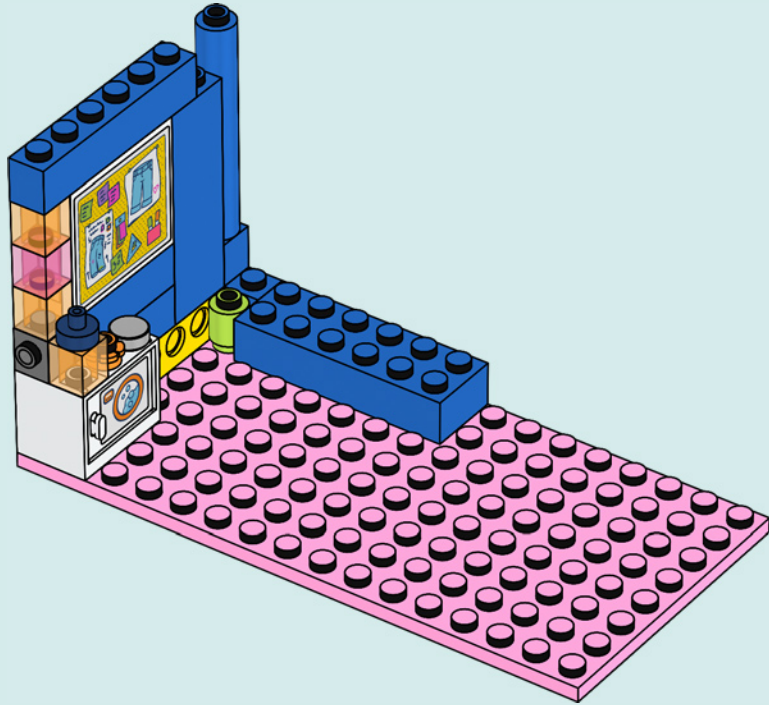





3x



3x

88

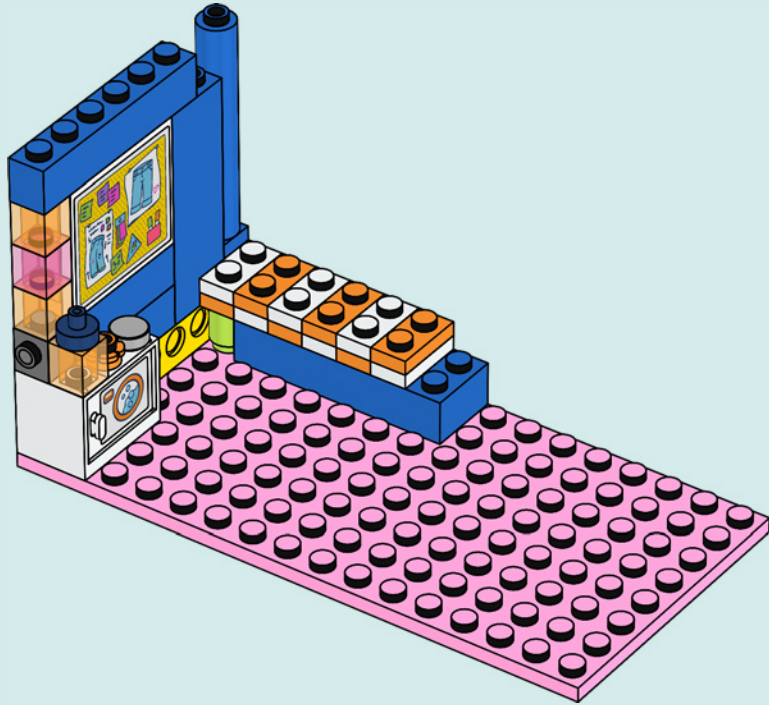





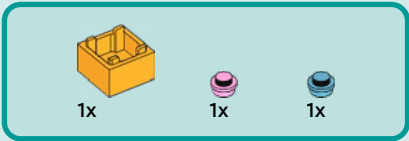

90

1

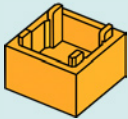

2

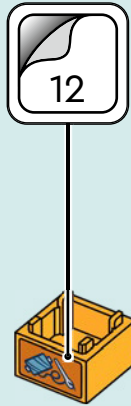

3



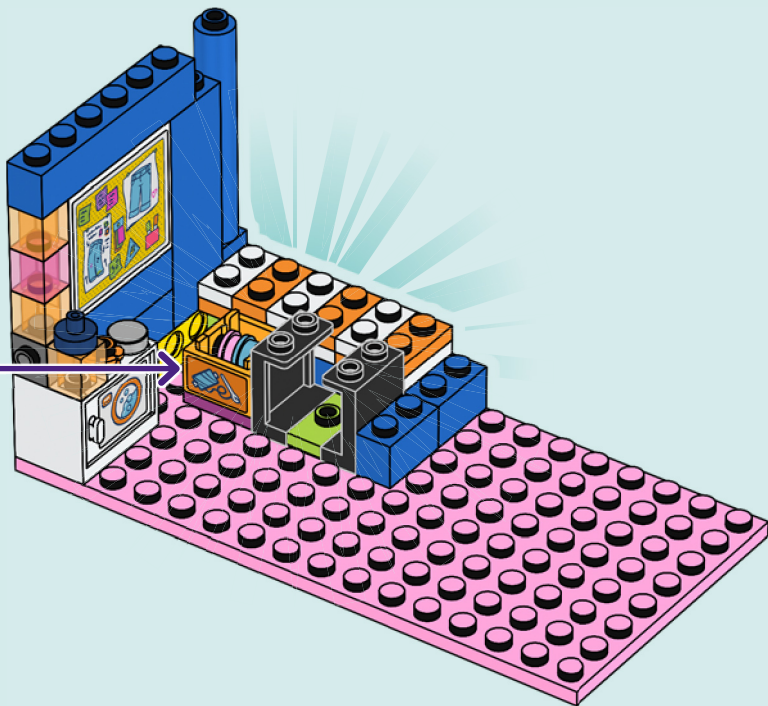

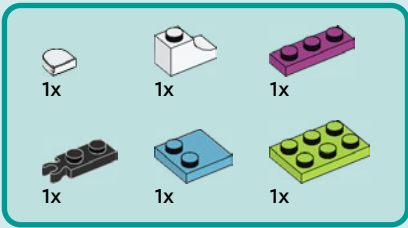

91

1

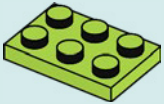

2

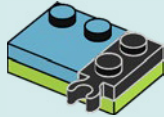

3

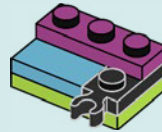

4

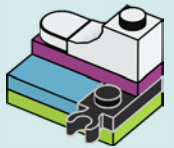

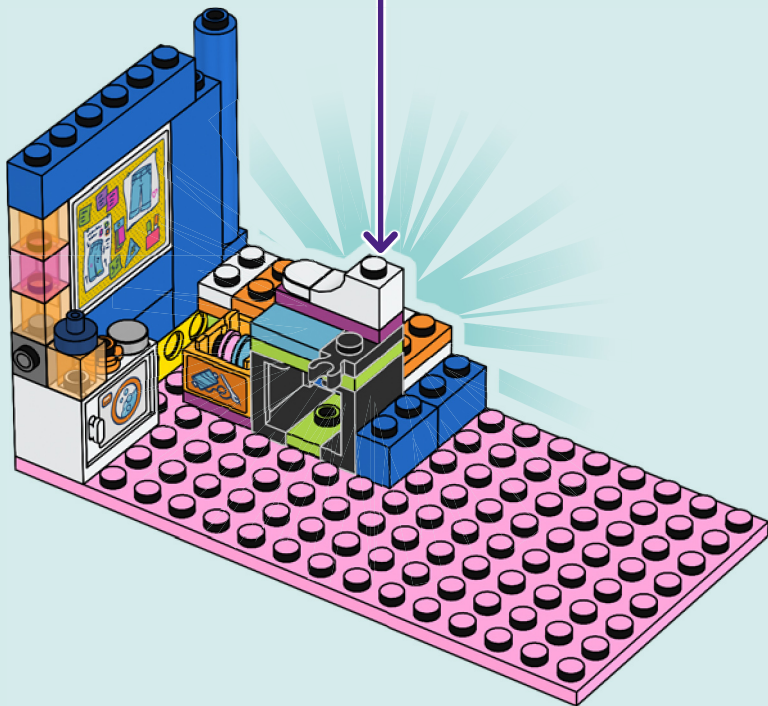

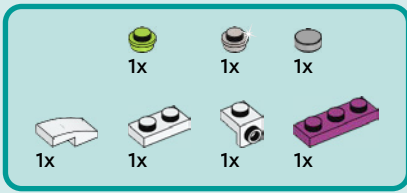

92

1

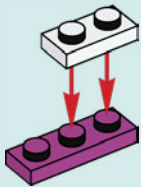

2

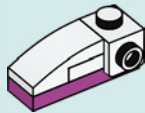

3

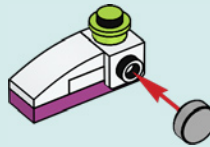

4

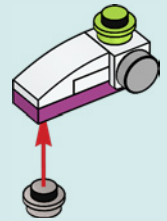

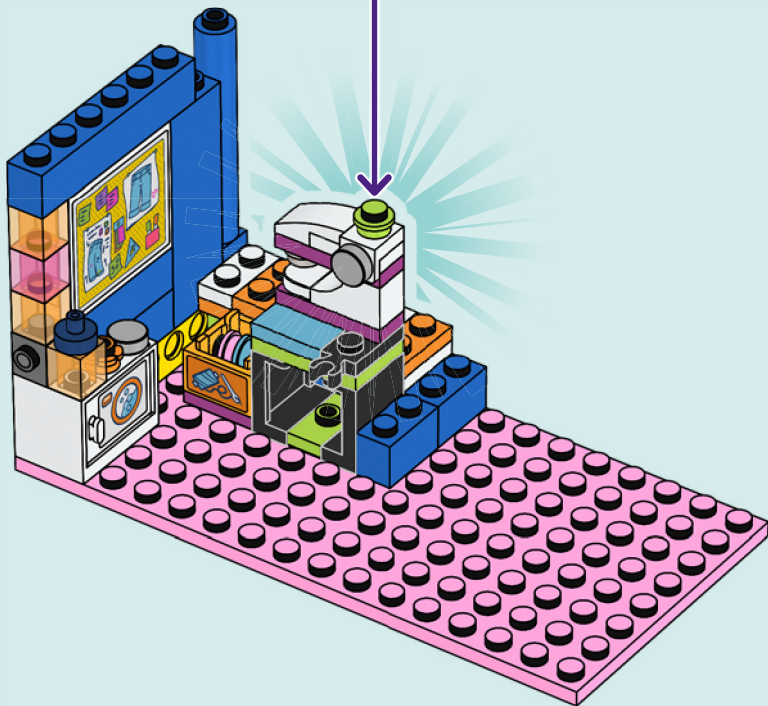





1x

93

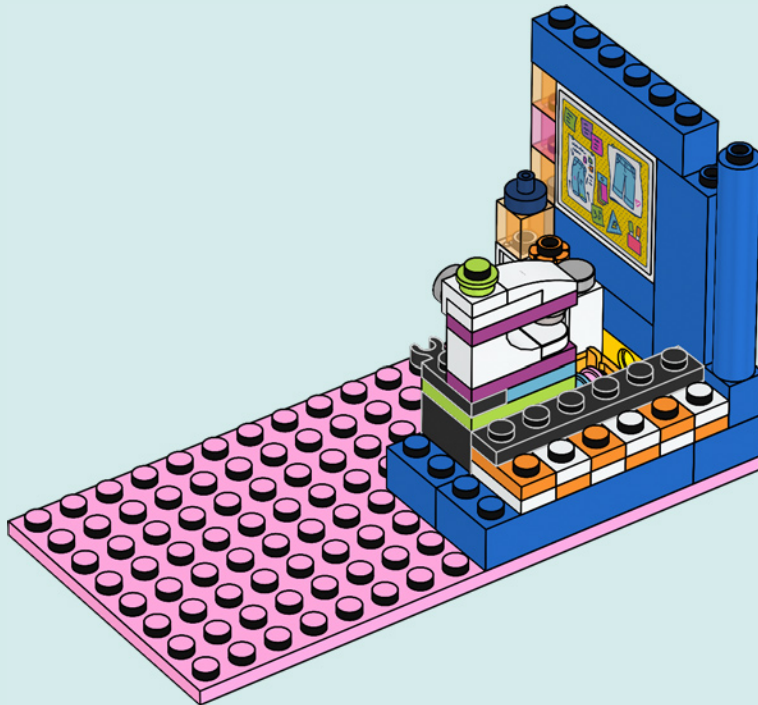



1x



2x

94

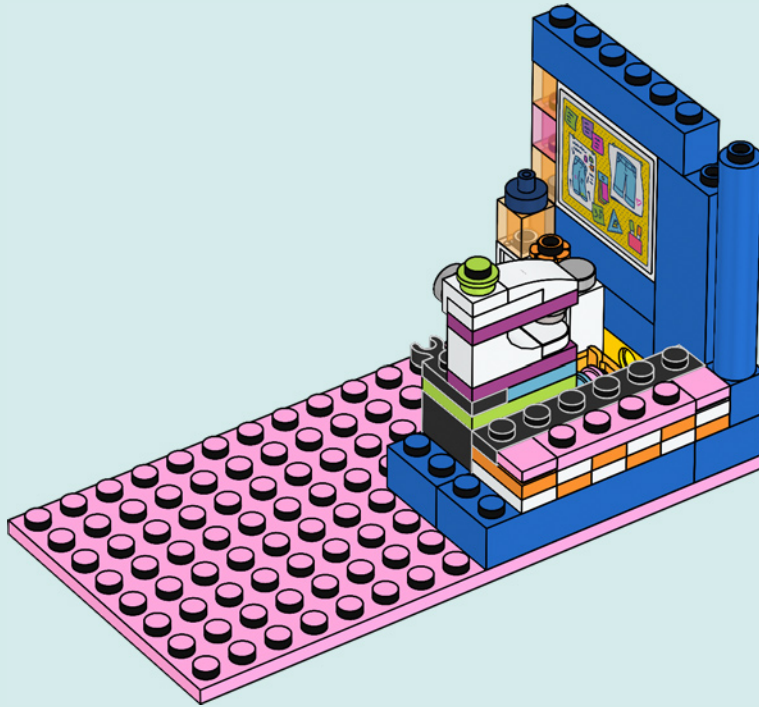



2x



1x

95

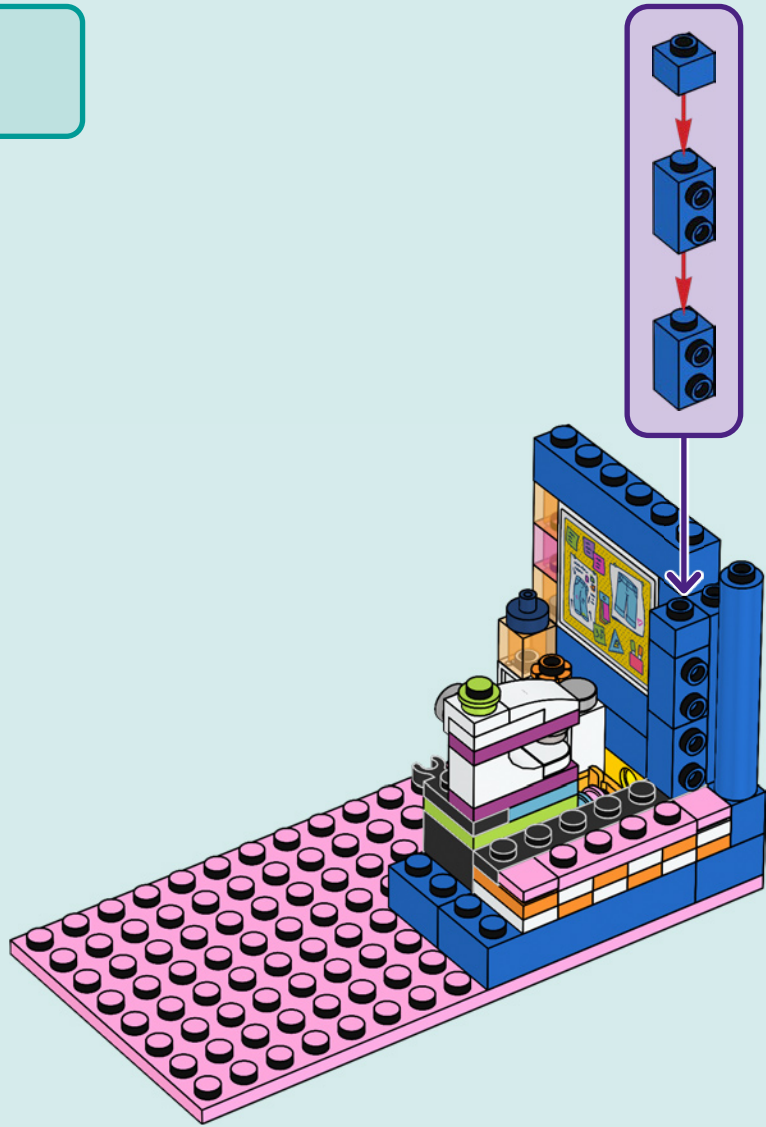

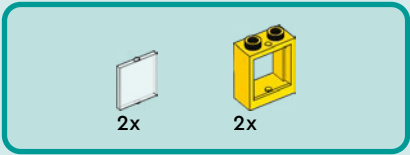

96

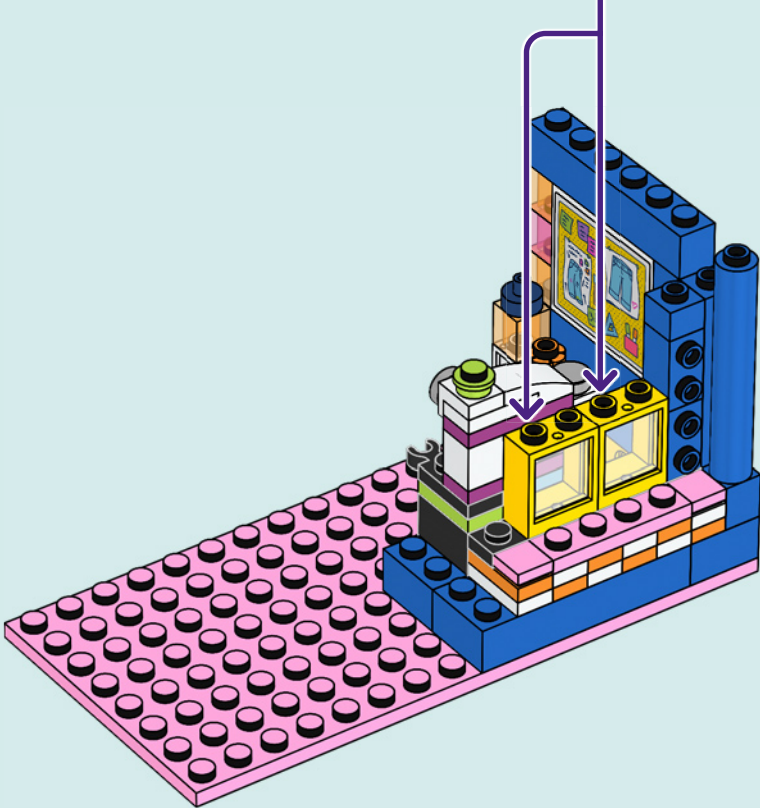
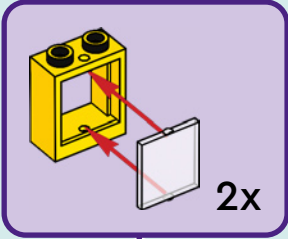

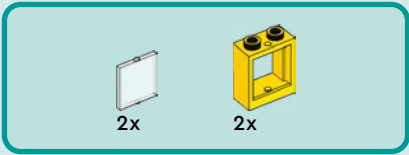

97

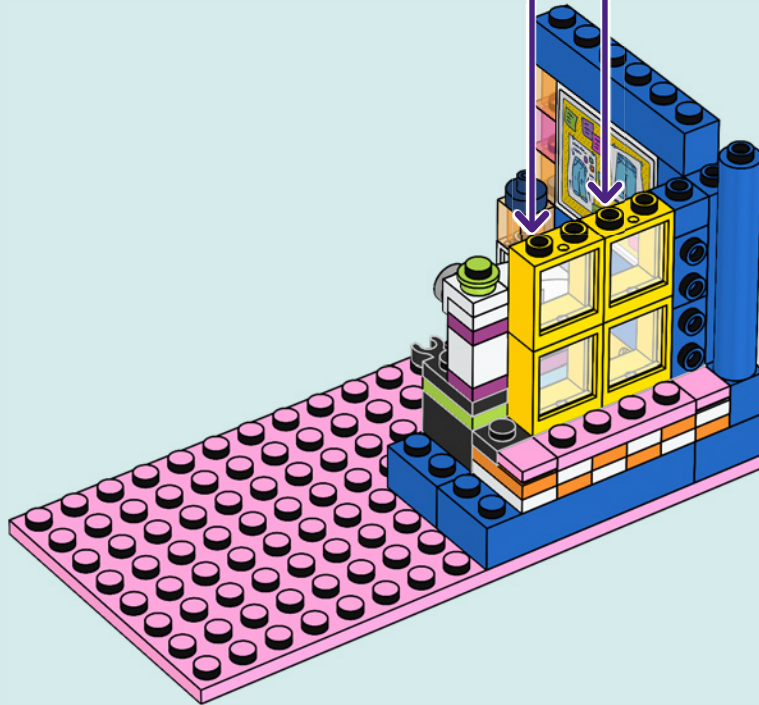
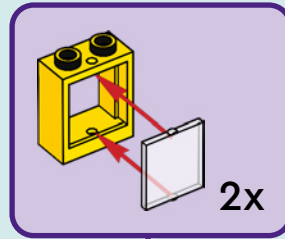



2x



1x

98

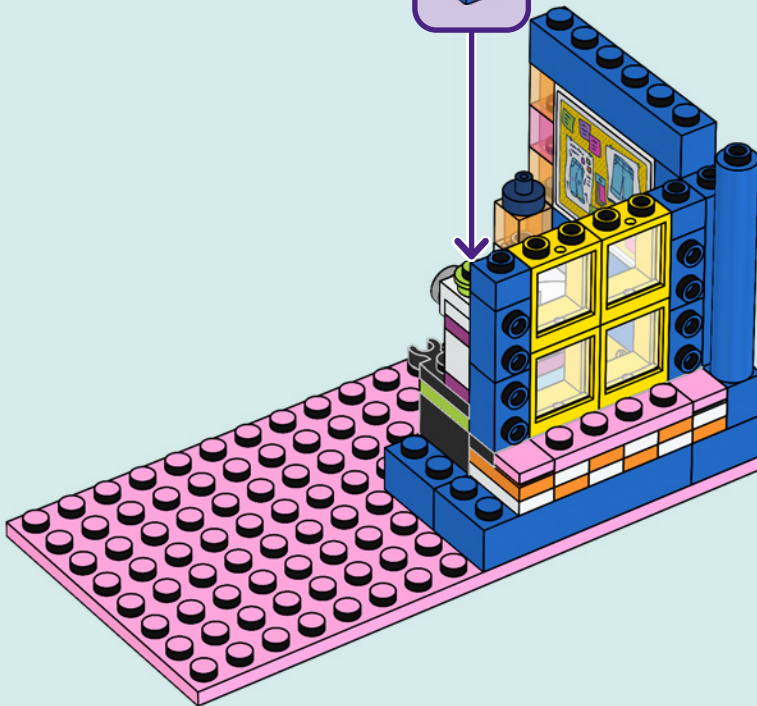
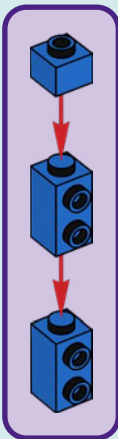



3x

99

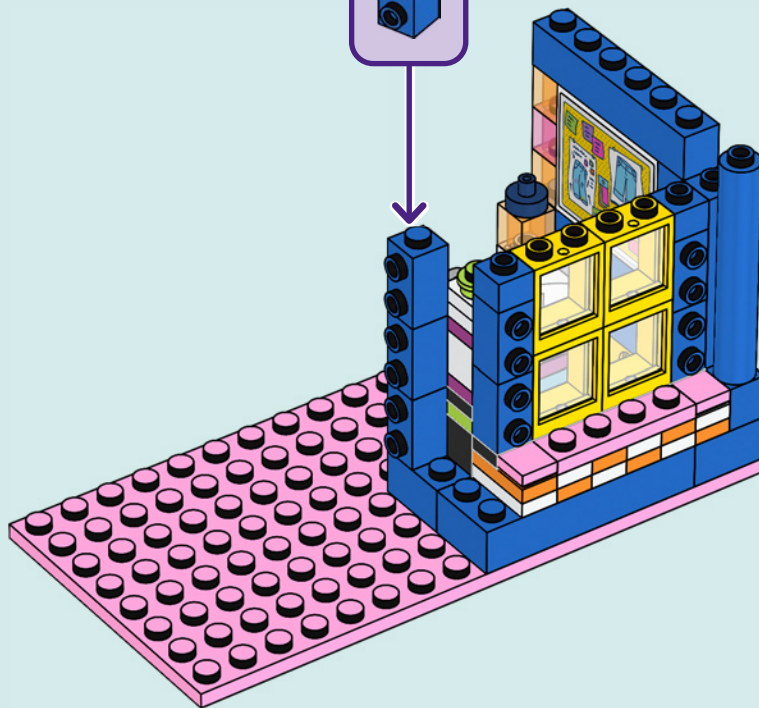
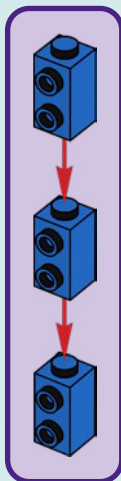



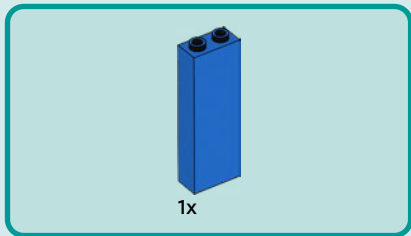

100

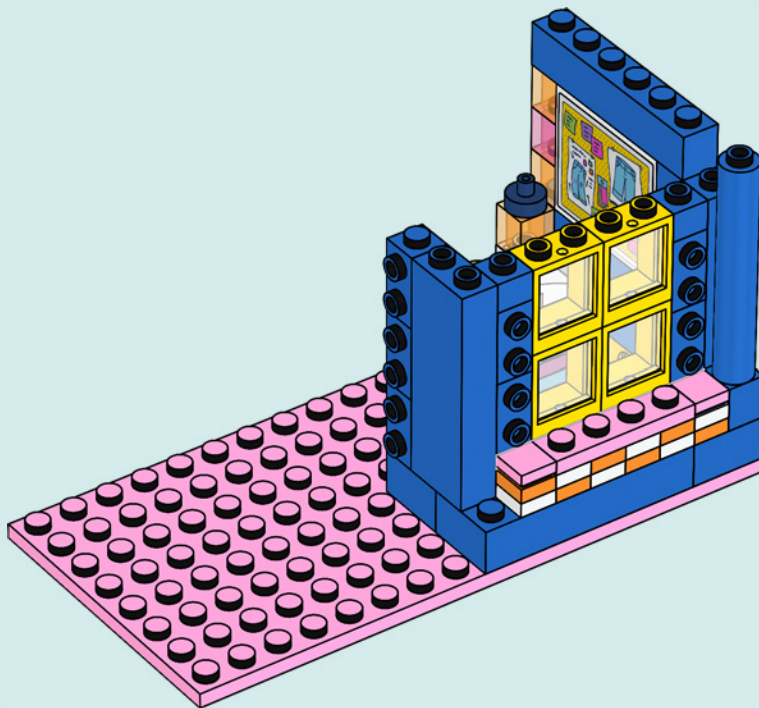

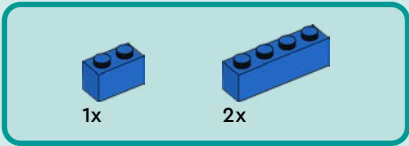

101

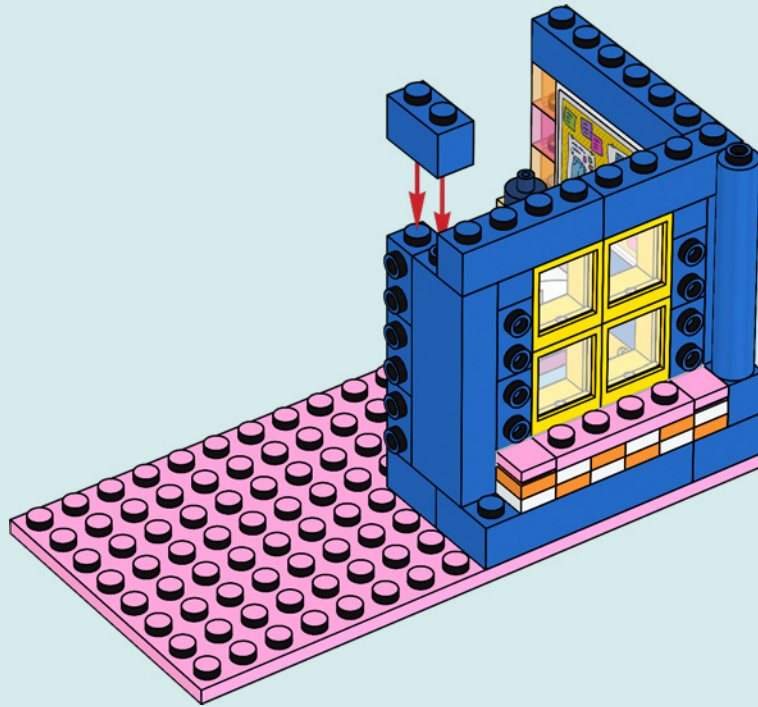

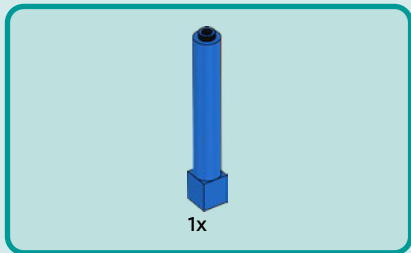

102

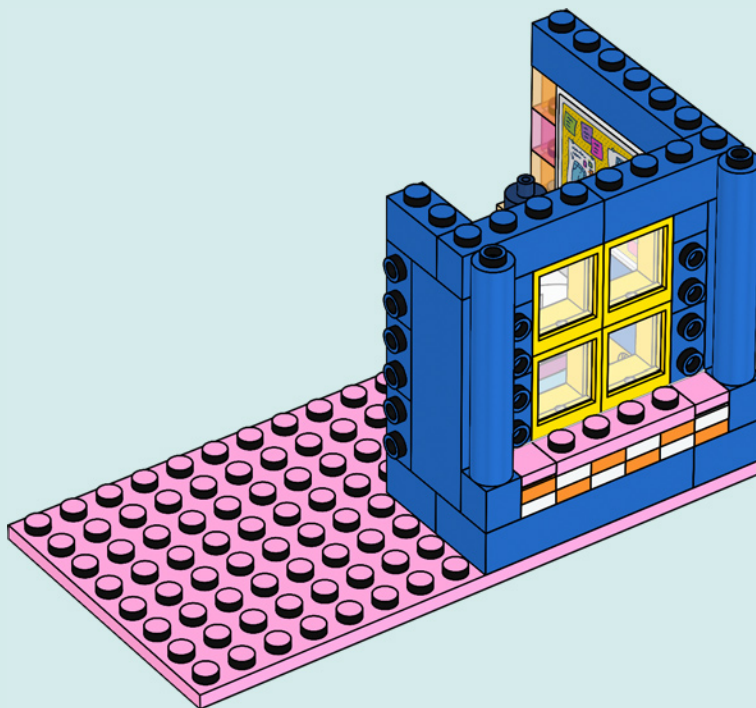

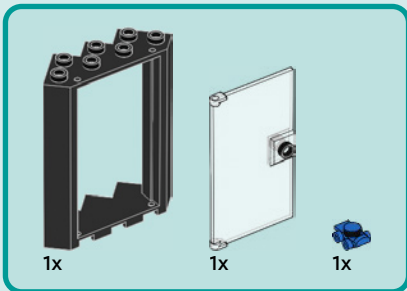

# 103

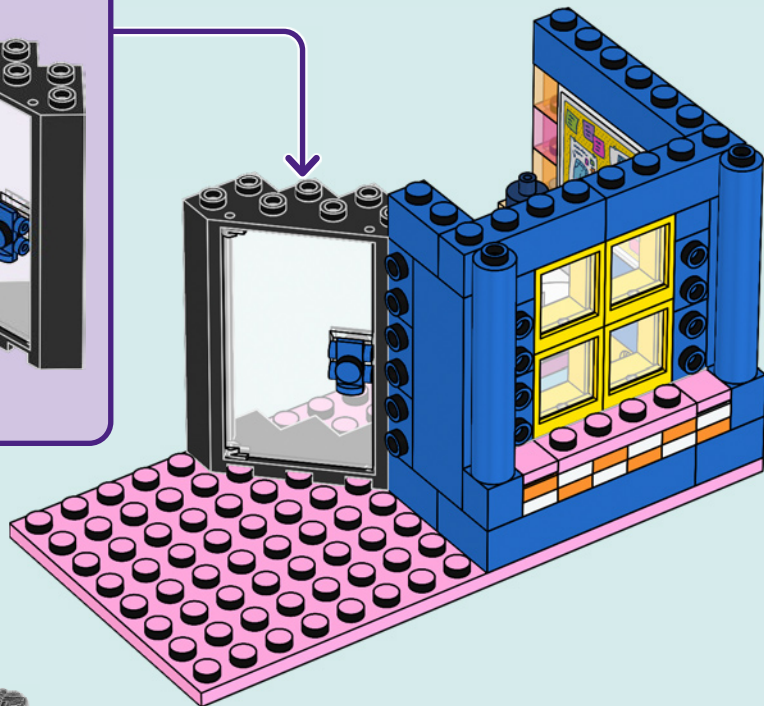
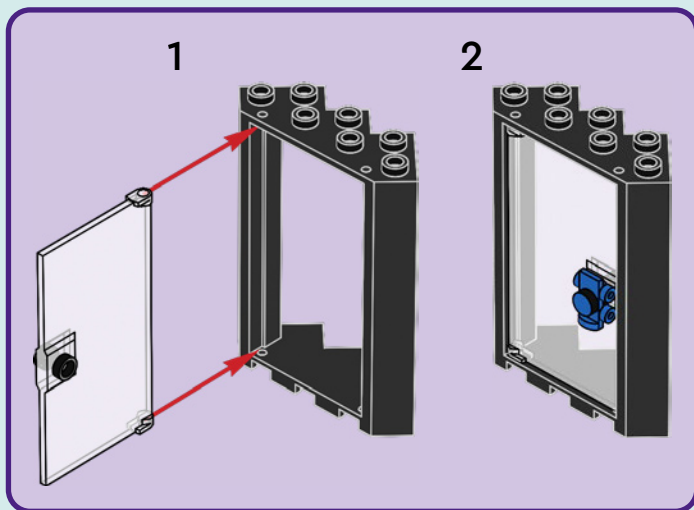

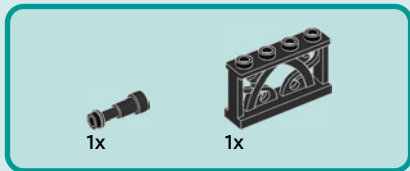

104

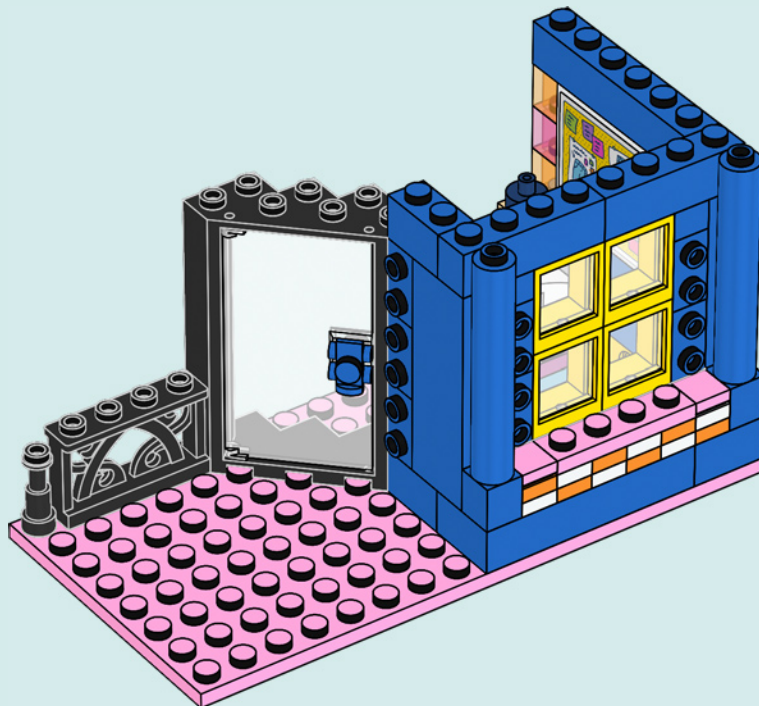

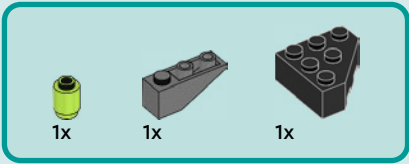

105

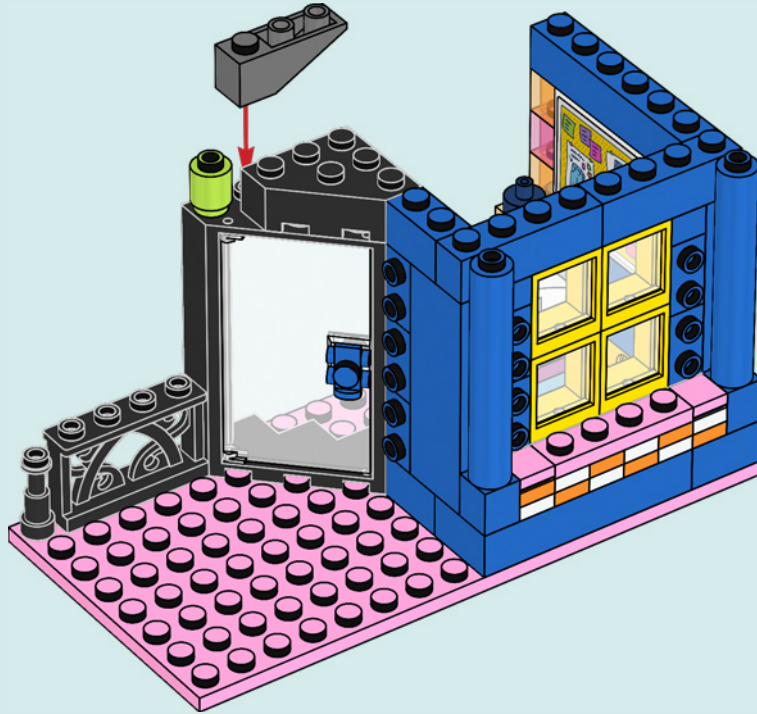

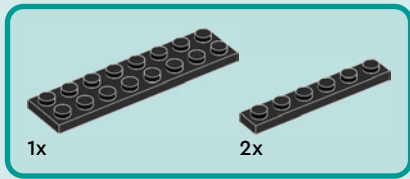

106

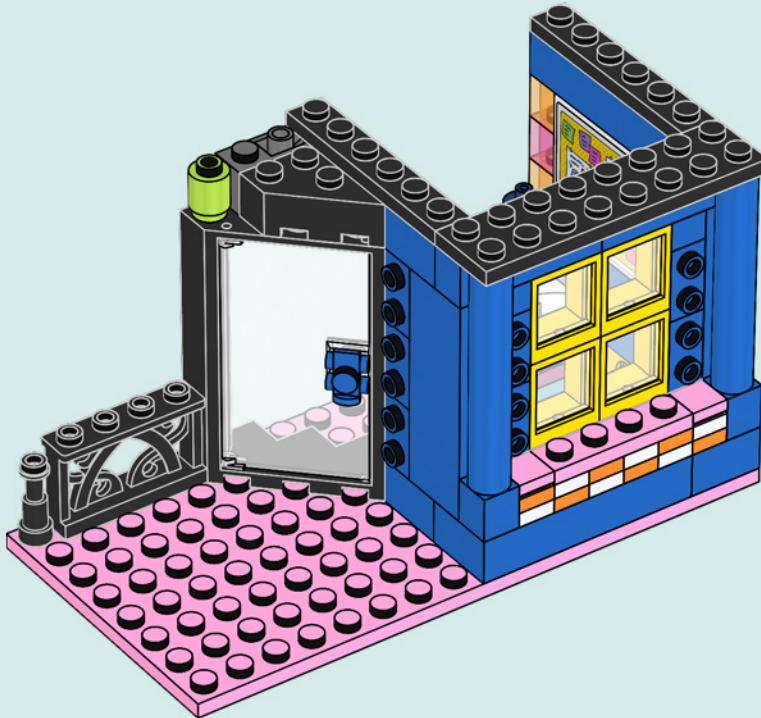



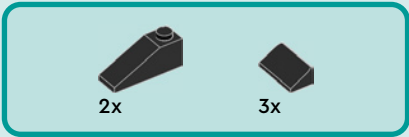

107

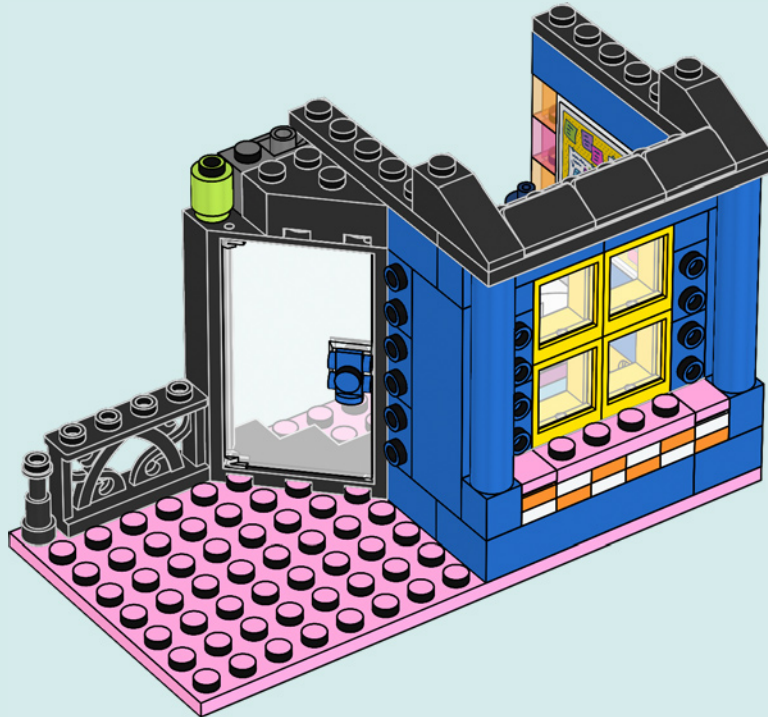

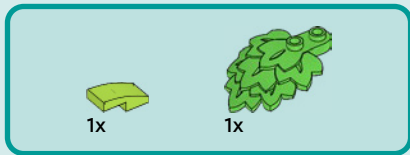

108

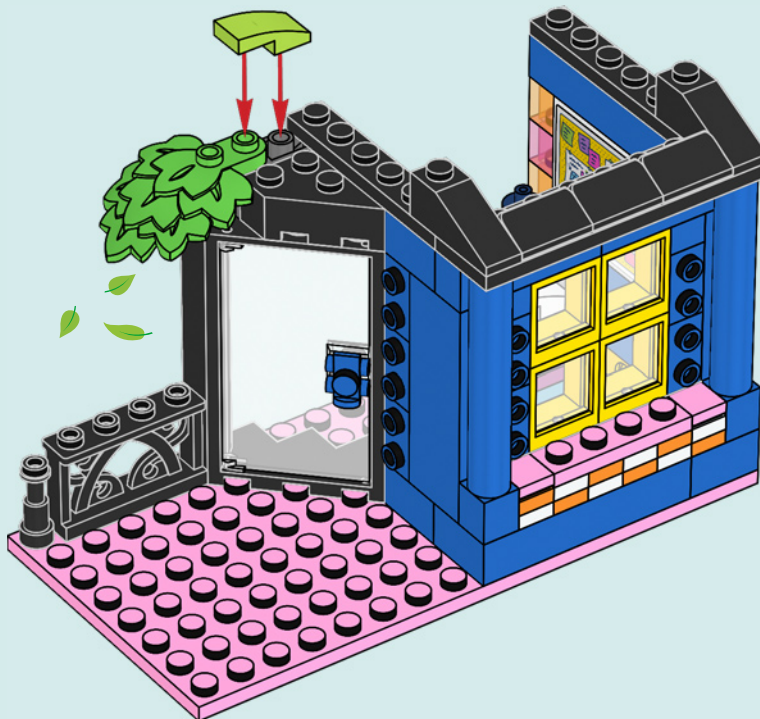



1x

109

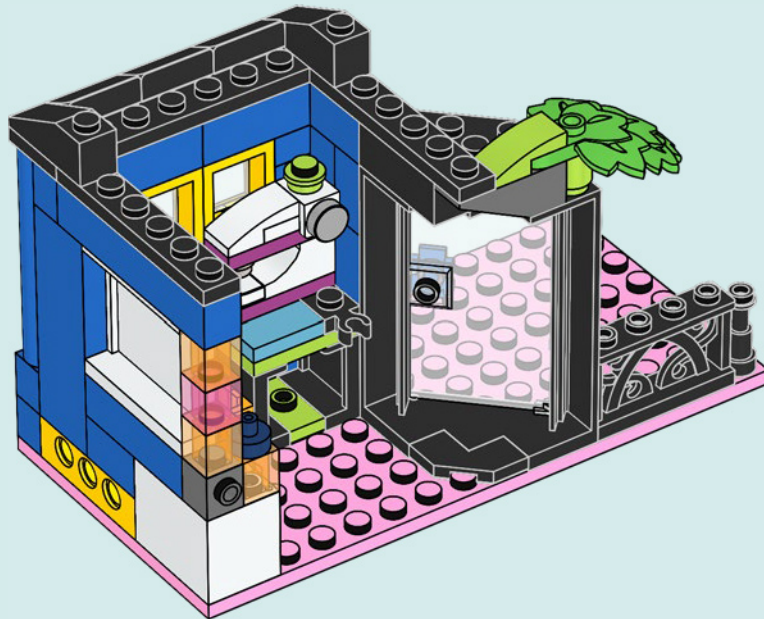



1x

110

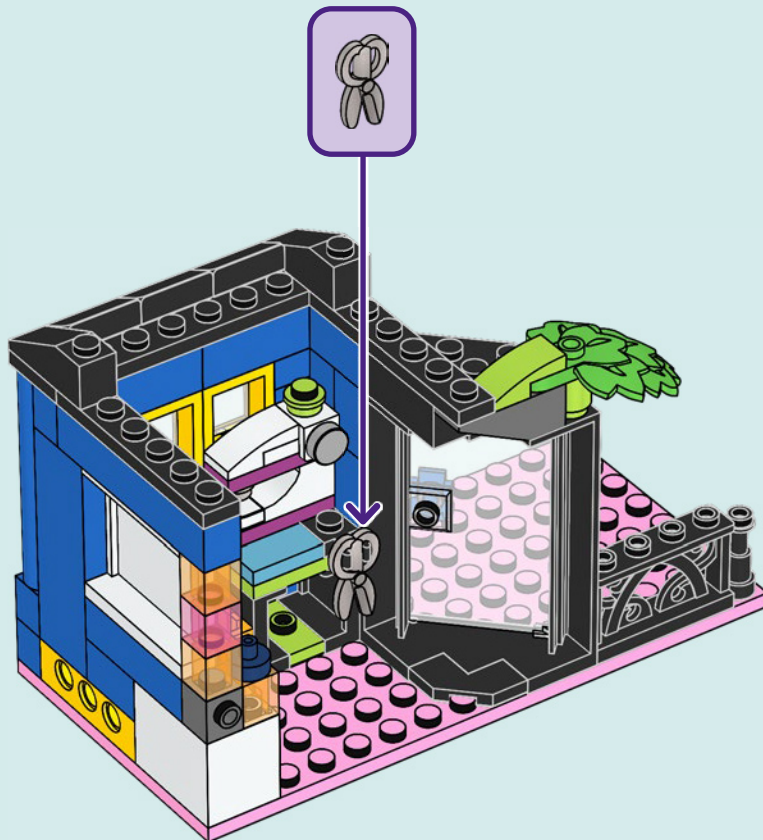



2x

111

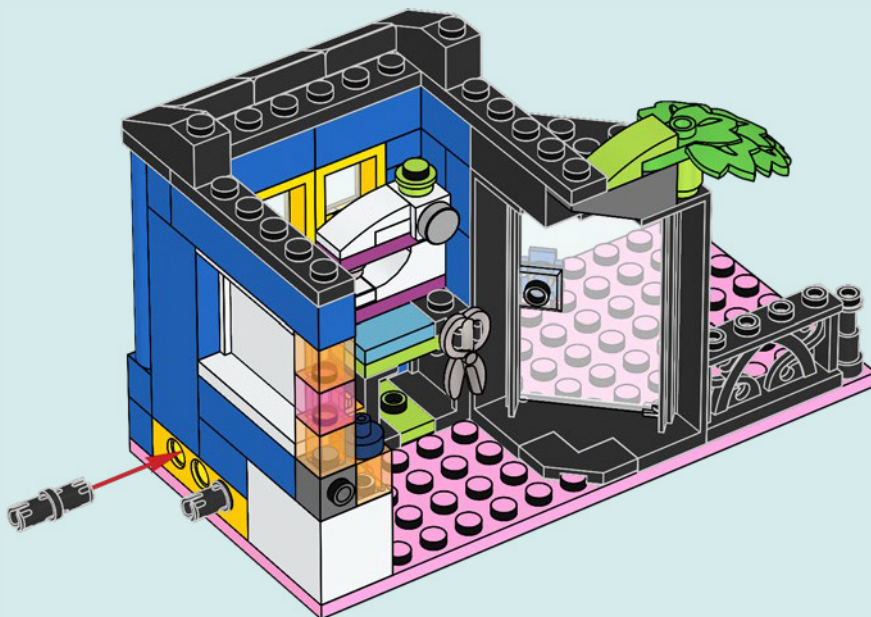

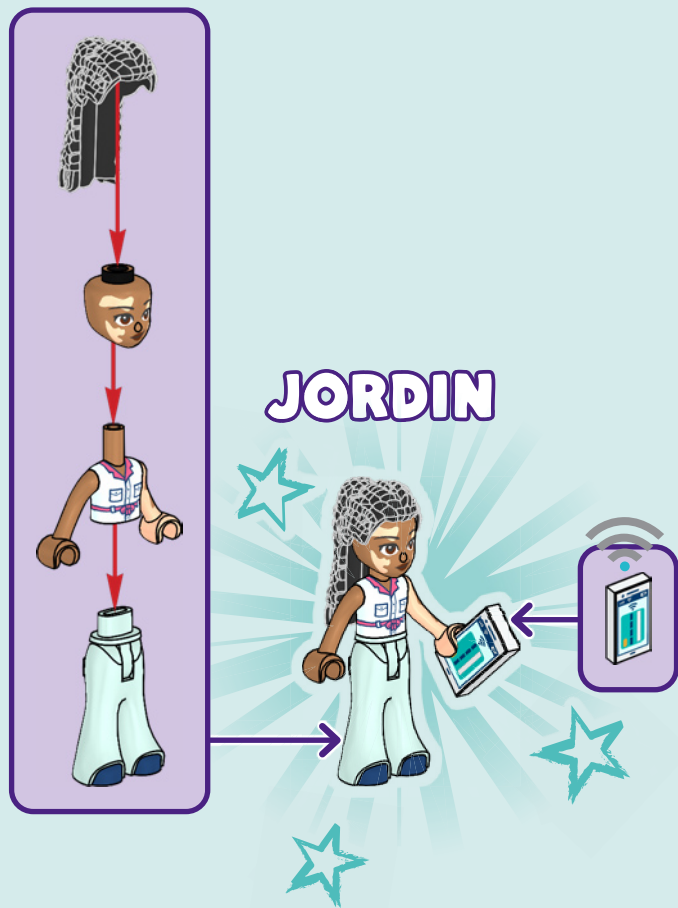



3x

112

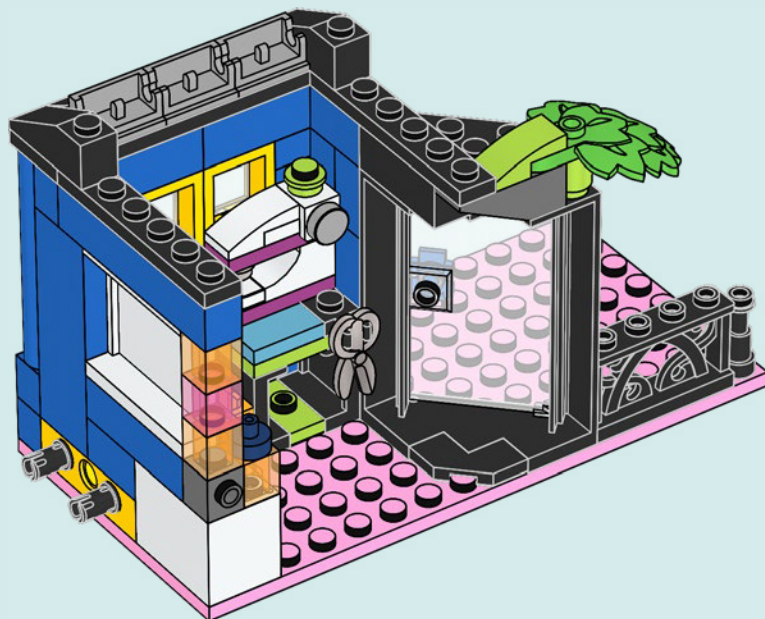





3x

113

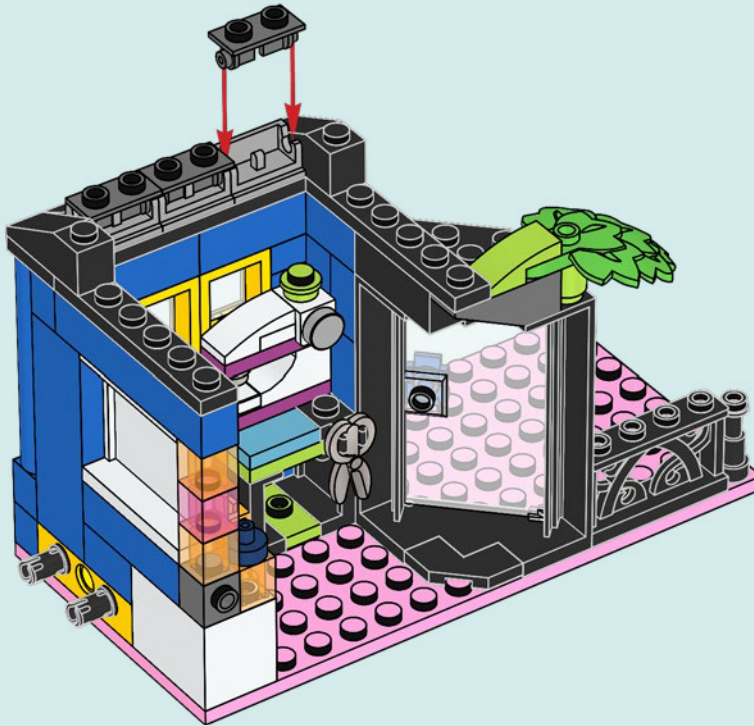

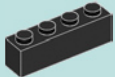

2x



2x

# 114

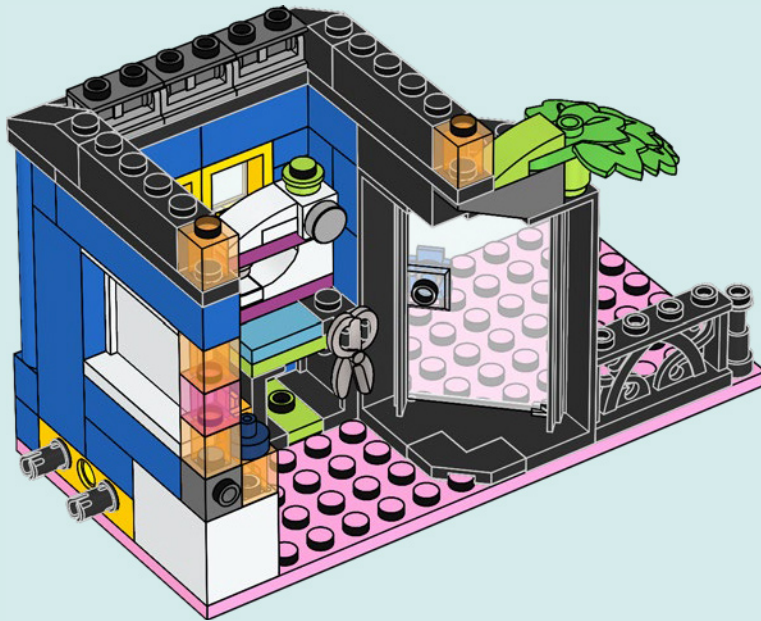



2x



2x



2x

# 115

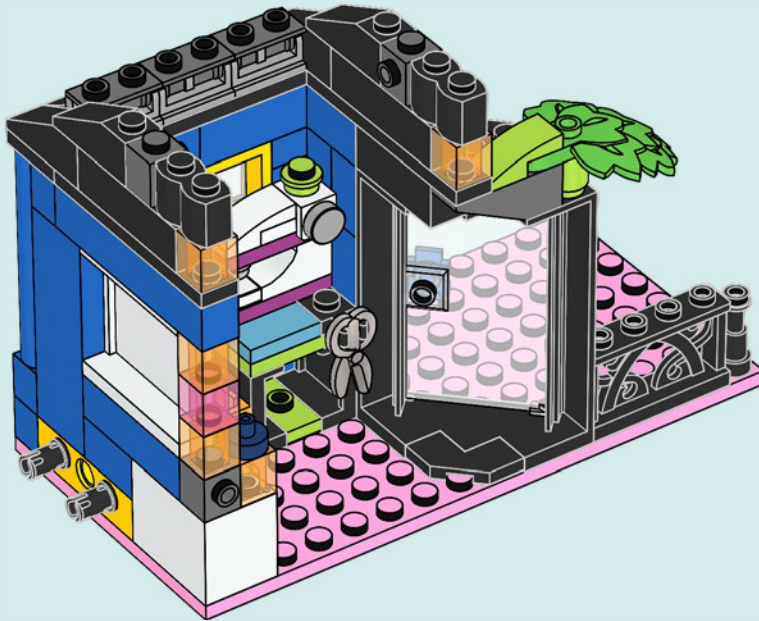



2x



2x

# 116

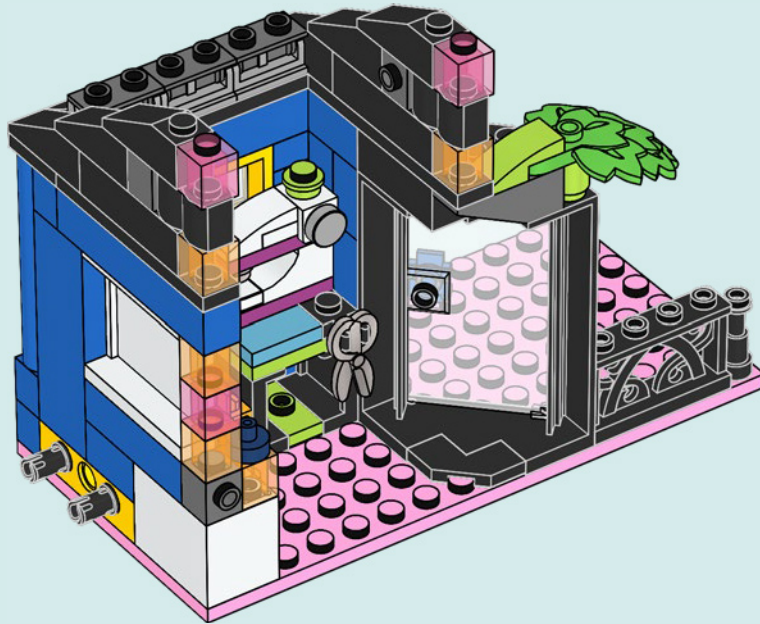

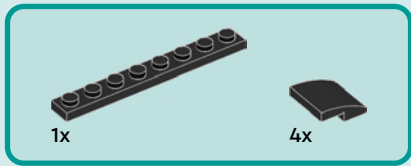

117

1

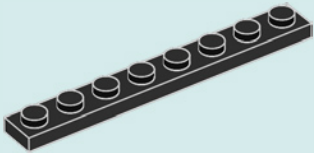

2

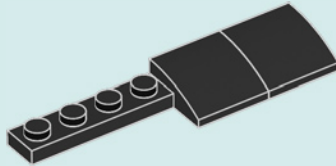

3

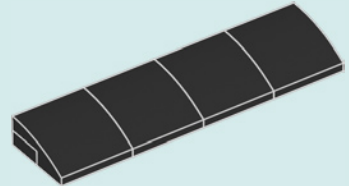

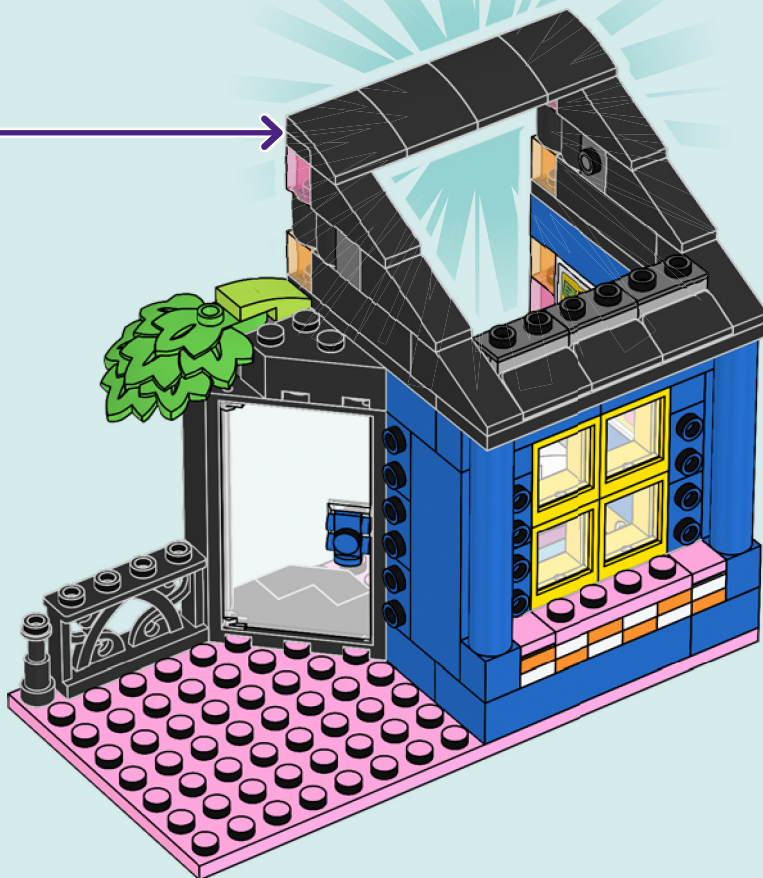



2x

118

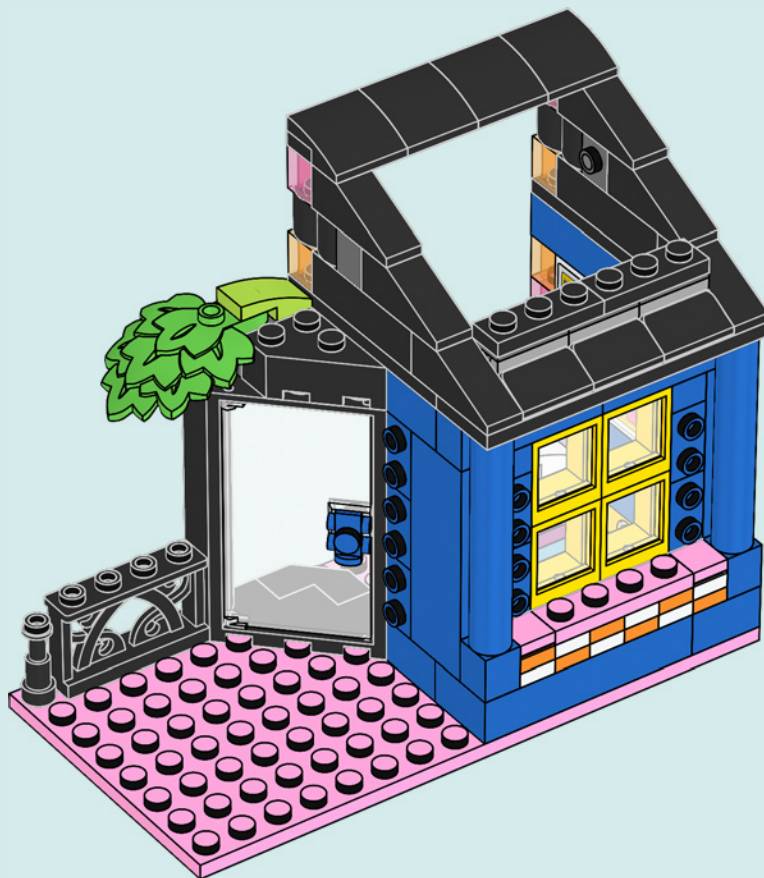

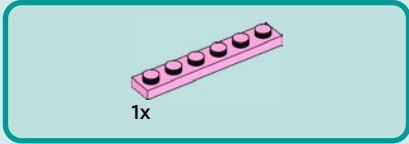
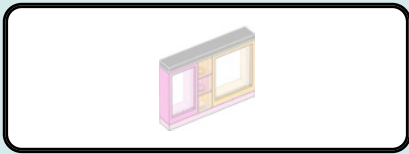

119

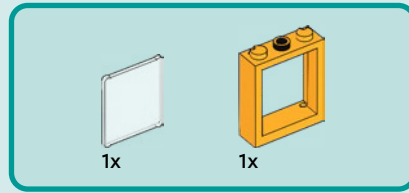
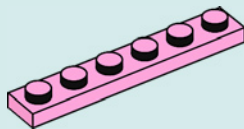

120

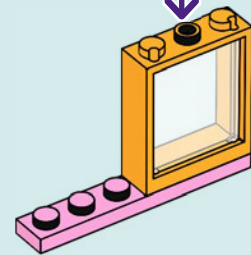
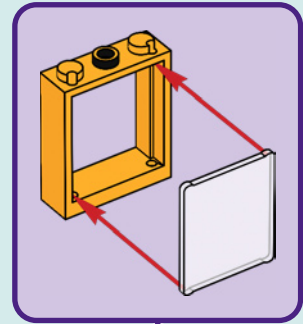





2x



1x

121

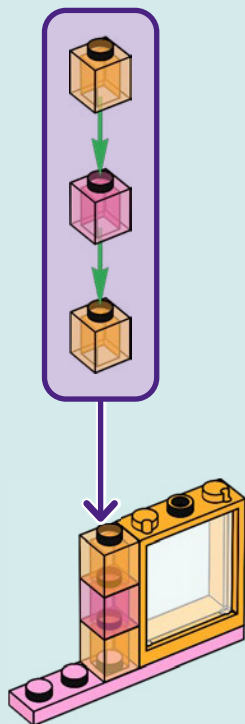

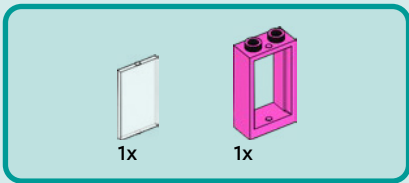

122

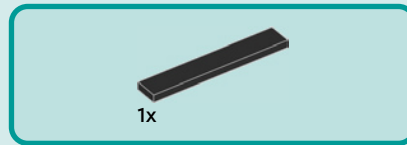
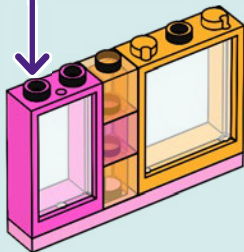
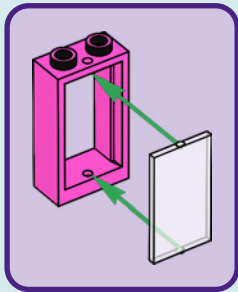

123

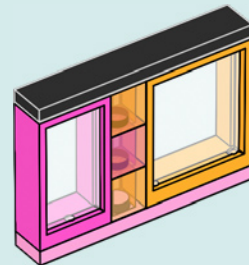

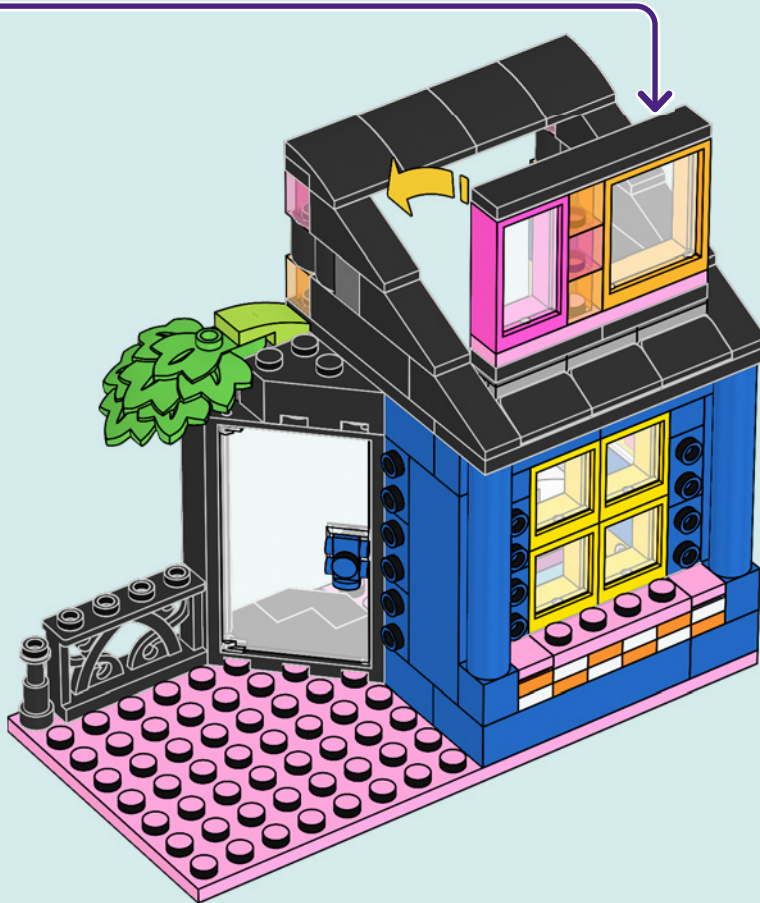



1x



2x

# 125

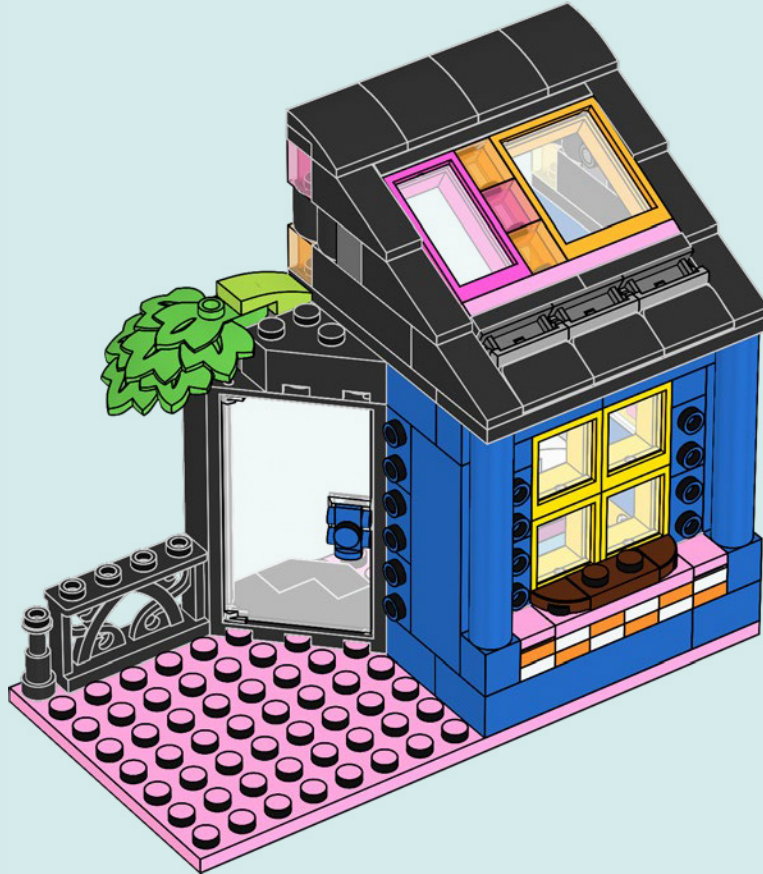



2x



2x

126

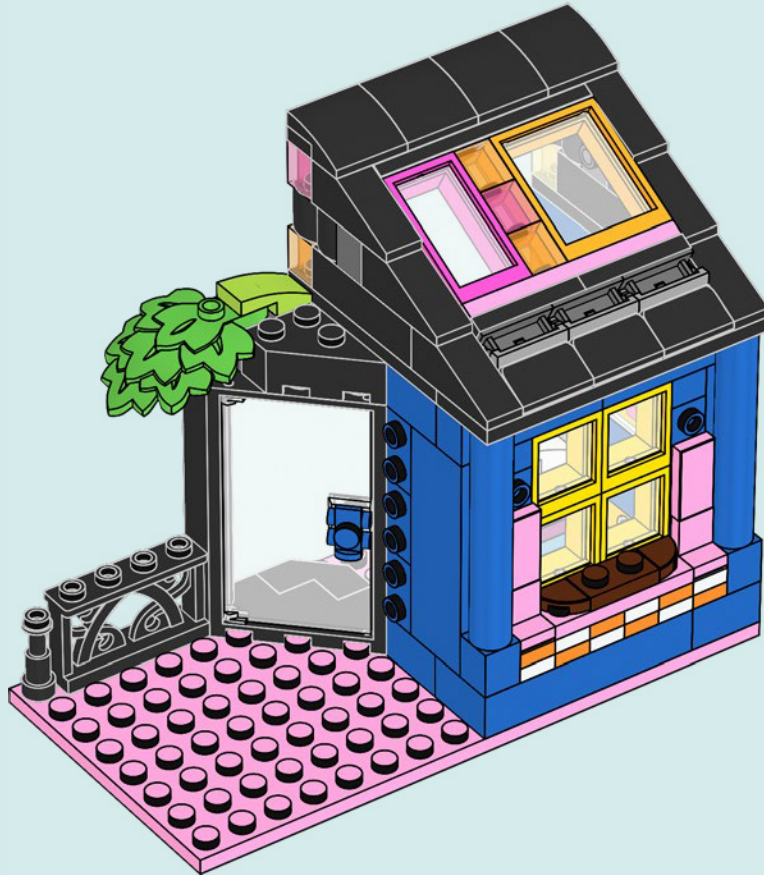



2x



2x

# 127



2x





2x

128







2x



2x



2x

# 129







1x

130





3x

131





2x

132





1x



1x

# 133

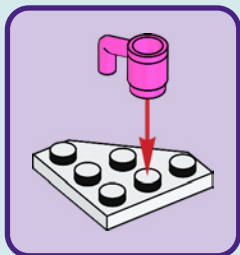



1x



1x

134





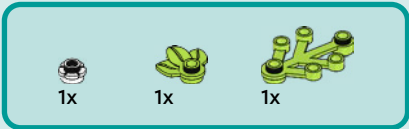

# 135

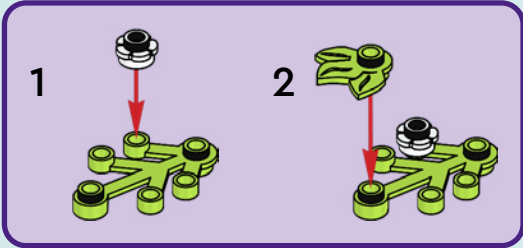



1x

136





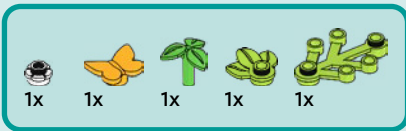

137

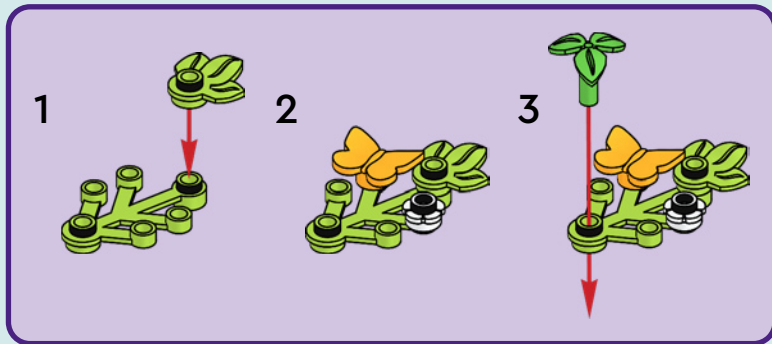



1x



1x



2x

138



139







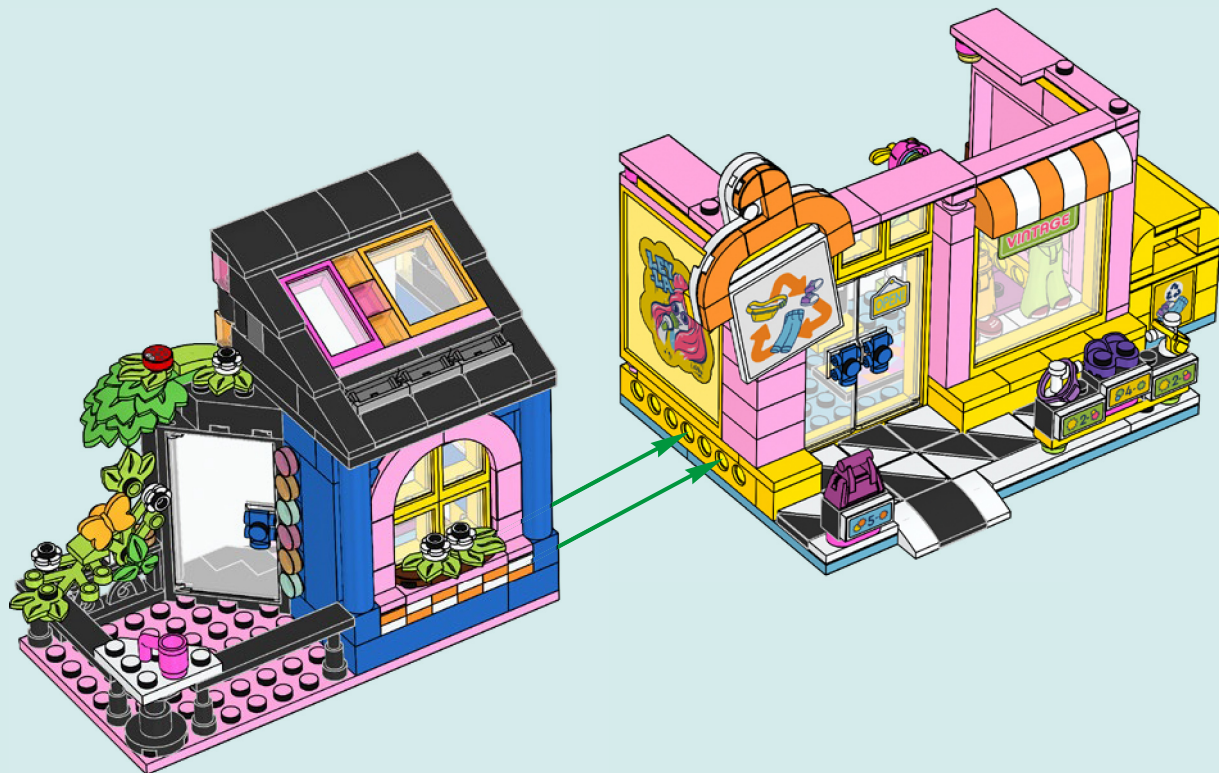











# Friends



42620



42617



42606



42604



42619





# Friends



REGARDEZ  
LA SÉRIE  
EN LIGNE

MIRA  
LA SÉRIE  
EN INTERNET

WATCH  
SERIES  
ONLINE





1x  
6324417



2x  
6240216



1x  
6214234



5x  
6206149



1x  
6250591



1x  
6446788



3x  
459901



1x  
6296132



1x  
6472137



2x  
403201



7x  
302301



1x  
6346616



4x  
6195371



6x  
306901



3x  
6285777



3x  
6034044



1x  
6416469



2x  
6070327



1x  
4261470



11x  
6217875



1x  
6238334



1x  
245001



1x  
6089696



1x  
4619665



1x  
4558208



1x  
371001



1x  
6466346



2x  
6339103



1x  
663601



1x  
6400128



3x  
6267163



2x  
6350345



7x  
6290531



2x  
6432005



4x  
300423



2x  
6055104



3x  
301023



1x  
300923



1x  
4181139



2x  
300524



1x  
6457959



1x  
6265497



2x  
300424



7x  
6424329



1x  
4121625



6x  
6224666



2x  
362224



2x  
362324



3x  
370124



4x  
6257598



2x  
4204625

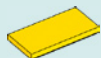

1x  
4560181



6x  
366624

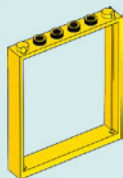

3x  
6424331

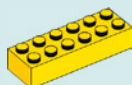

1x  
4181143

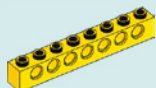

2x  
370224



1x  
6232135



1x  
6175367



1x  
6235080



1x  
6457953



1x  
6416645



1x  
6371960



1x  
6196548



3x  
4548180



4x  
6279875



1x  
6409763



1x  
6106280



2x  
4644456



2x  
4593678



6x  
6138173



1x  
6329698



4x  
4538456



11x  
6214807



1x  
6350725



5x  
6053077



1x  
6166859



6x  
428626



1x  
4159550



2x  
362326



2x  
301026



1x  
6138726



1x  
4515350



1x  
4560182



1x  
6177156



3x  
366626



3x  
663626



1x  
346026



1x  
303426



1x  
6252258



7x  
6254552



1x  
6278710



2x  
6424464



1x  
6247362



1x  
6246876



1x  
6386637

  
3x  
4558595

  
2x  
6173925

  
6x  
4177932

  
3x  
6411362

  
1x  
4188771

  
6x  
6438904

  
5x  
4212454

  
5x  
4183133

  
1x  
6466199

  
1x  
6470918

  
6x  
6286831

  
1x  
6092592

  
2x  
6069006

158

  
4x  
6185307

  
2x  
6268818

  
1x  
6013530

  
2x  
4537936

  
1x  
6395609

  
3x  
6250075

  
2x  
6022048

  
1x  
6429553

  
3x  
6274747

  
7x  
6240550

  
1x  
6428824

  
1x  
4618670

  
2x  
6274745

  
4x  
6240553

  
2x  
6284071

  
1x  
6326748

  
3x  
4211469

  
2x  
6149677

  
1x  
4211157

  
1x  
4211150

  
3x  
4558955

  
3x  
6176400

  
1x  
4211068

  
1x  
6370534

  
1x  
6466782

  
1x  
6439231

  
1x  
6407954

  
1x  
6369683

  
5x  
4517996

  
3x  
4286050

  
2x  
4580010

  
2x  
6143721

  
1x  
6348273

4x  
6251940

2x  
4654128

6x  
4550359

2x  
6253655

2x  
4518890

1x  
6002148

2x  
6468509

4x  
6106713

1x  
6403189

1x  
6058222

3x  
6143789

1x  
6453953

1x  
6409759

1x  
6458990

1x  
6470980

1x  
6466342

1x  
4633691

1x  
6096993

1x  
6430919

3x  
6102986

1x  
6445843

2x  
6248486

1x  
6357615

2x  
6060857

9x  
6271374

1x  
6388194

1x  
6132426

1x  
6468370

1x  
6416494

1x  
6466138

2x  
6299900

1x  
6416639

1x  
6416546

1x  
6471104

1x  
6467217

2x  
6325980

1x  
6445346

1x  
6141594

2x  
6104130

1x  
6022010



 [LEGO.com/service](https://www.LEGO.com/service)



YOU COULD **WIN**

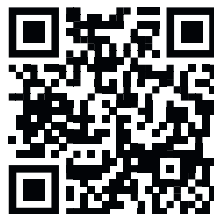

Scan this QR code or go to  
**LEGO.COM/PRODUCTFEEDBACK** and give us  
your short feedback about this LEGO® set for a  
chance to win a cool LEGO prize.

Terms and Conditions apply\*

**EN: YOU COULD WIN.** Terms and Conditions apply\* **DE: Du könntest GEWINNEN.** Es gelten die Teilnahmebedingungen\* **FR: Tu pourrais GAGNER.** Des conditions s'appliquent\* **IT: Potresti VINCERE tu.** Termini e condizioni sono applicabili\* **ES: Puedes GANAR.** Aplican términos y condiciones\* **PT: Poderá GANHAR.** Aplicam-se termos e condições\* **ZH: 轻松获奖. 条款和条件适用\*** **PL: Szansa na WYGRANĄ.** Obowiązują warunki korzystania\* **CS: Máte šanci VYHRÁT.** Platí všeobecné smluvní podmínky\* **SK: Máte šancu VYHRAŤ.** Platia všeobecné zmluvné podmienky\* **HU: TE IS NYERHETSZ.** Felhasználási feltételek érvényesek\* **RO: Ai putea CÂȘTIGA.** Se aplică termeni și condiții\* **BG: Можете да СПЕЧЕЛИТЕ.** Има определени правила и условия\* **LV: Tu vari LAIMĒT.** Ir spēkā noteikumi un nosacījumi.\* **ET: Sul on võimalus VÕITA.** Kehtivad tingimused\* **LT: Jūs galite LAIMĖTI.** Taikomos sąlygos\*

\*[LEGO.com/productfeedback-terms](https://lego.com/productfeedback-terms)

LEGO, the LEGO logo and the FRIENDS logo are trademarks of the/son des marques de commerce du/son marcas registradas de LEGO Group. ©2024 The LEGO Group.

6493653