



Friends

42617







LEGO® Builder



LEGO.com/sustainable-packaging



 **FR**
DONNEZ
OU
RECYCLEZ

 OU  OU 

ASSOCIATION MAGASIN DÉCHÈTERIE

Adresses sur quefairedemesdechets.fr

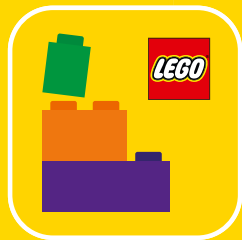

Q LEGO® Builder

BUILDER



Apple and the Apple logo are trademarks of Apple Inc., registered in the U.S. and other countries and regions. App Store is a service mark of Apple Inc. Google Play and the Google Play logo are trademarks of Google LLC. Tencent and the Tencent logo are trademarks of Tencent Inc.

Q LEGO.com/devicecheck

EN Ask parents' permission before going online | **DE** Eltern um Erlaubnis bitten, bevor du online gehst | **FR** Demande l'autorisation d'un parent avant d'aller en ligne | **IT** Chiedi il permesso ai tuoi genitori prima di andare online | **ES** Pídeles permiso a tus papás antes de conectarte a Internet | **PT** Pede autorização aos pais antes de acederes online | **ZH** 上网前应先征得父母的同意 | **PL** Poproś rodziców o zgodę, zanim wejdiesz do Internetu | **CS** Než půjdeš na internet, požádej rodiče o svolení | **SK** Skôr než pôjdeš na internet, vypýtaj si povolenie od rodičov | **HU** Kérj szülői engedélyt, mielőtt online csatlakoznál! | **RO** Cere permisiunea părinților înainte de a te conecta online | **BG** Поискайте разрешение от родител, преди да влезете онлайн | **LV** Pirms došanās tiešsaistē palūdz atļauju vecākiem | **ET** Enne Interneti kasutamist küsi vanematelt luba | **LT** Prieš prisijungdami prie interneto, atsiklauskite tėvų



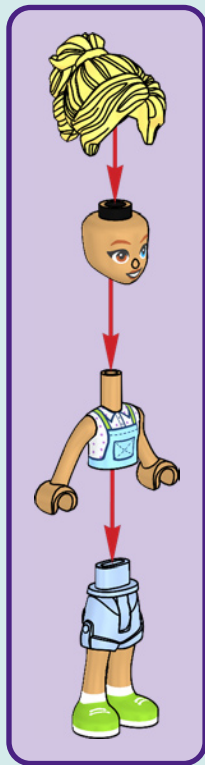

KAYA



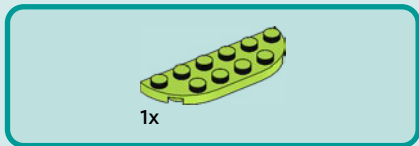
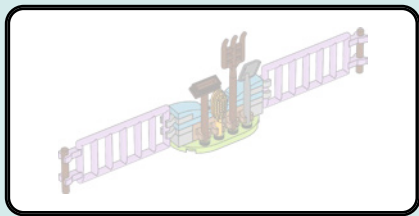

1x

1





4x

2

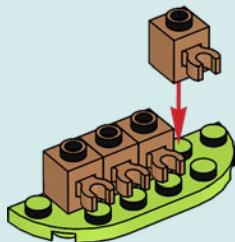

2x

3

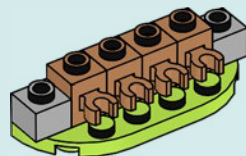



2x

4

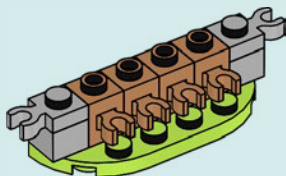

8



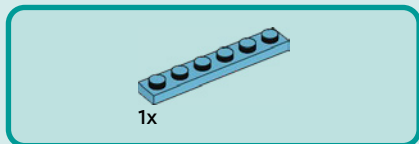

5

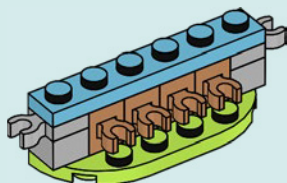

6

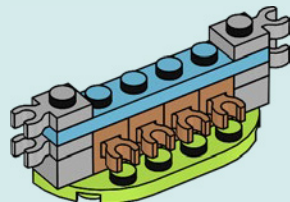



2x

7

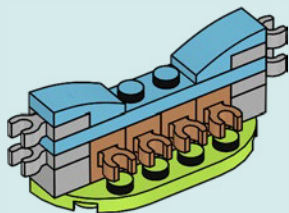

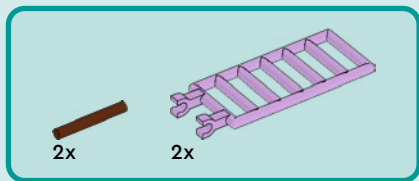

8

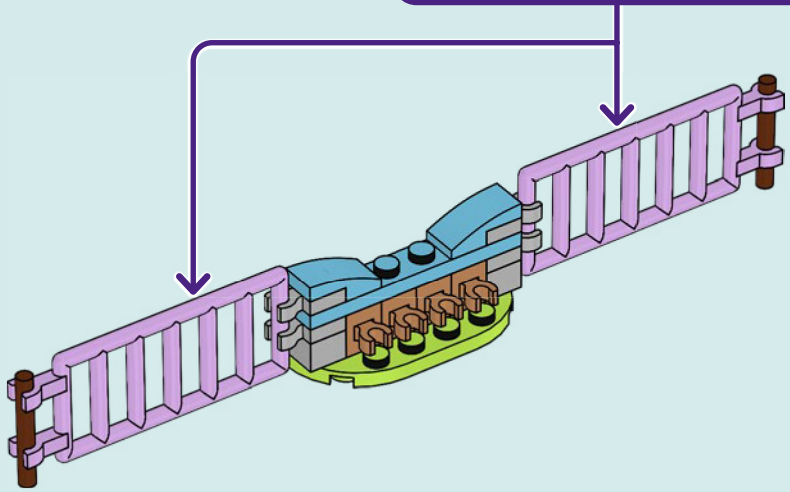
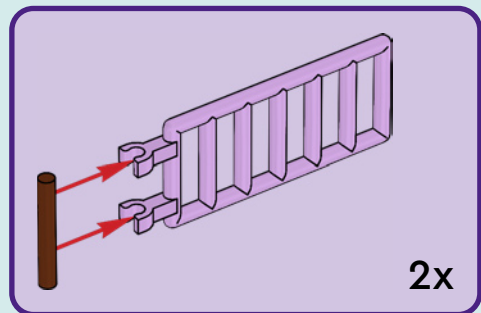

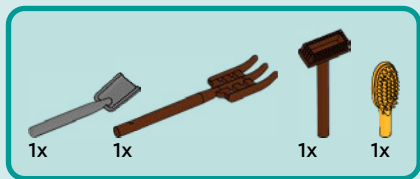

9

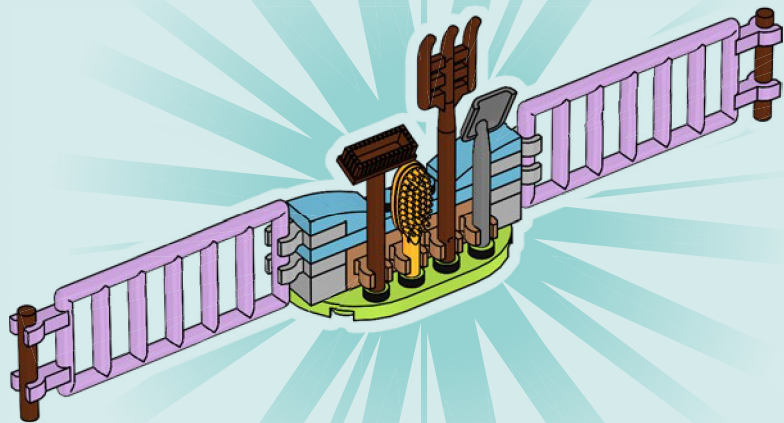

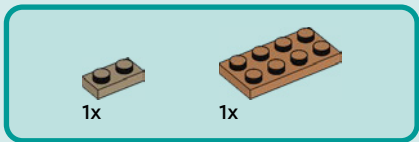

1

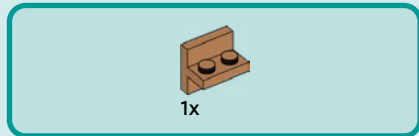
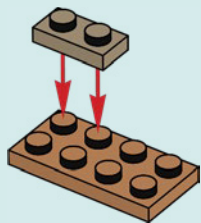

2

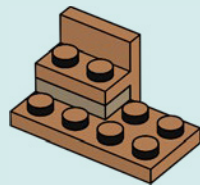



1x

3

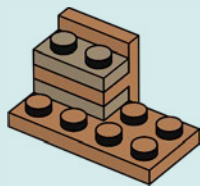



1x

4

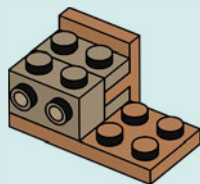

2x

5

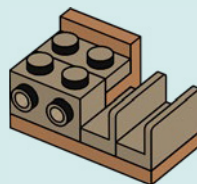



1x

6

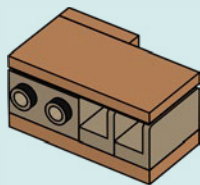



1x

7

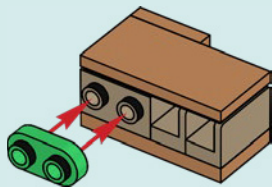

1x



1x

8

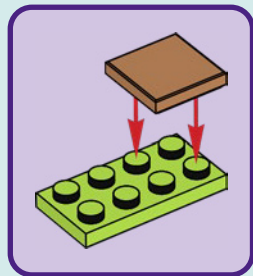
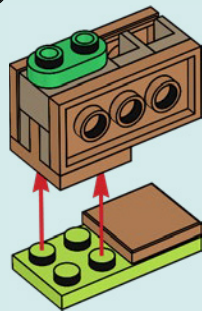



9

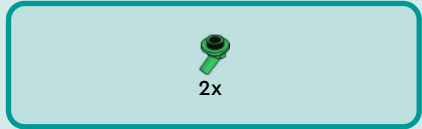
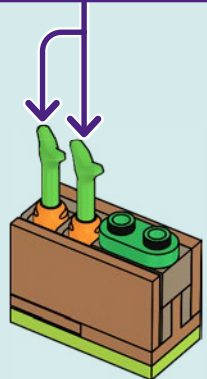
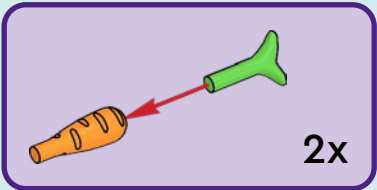

10

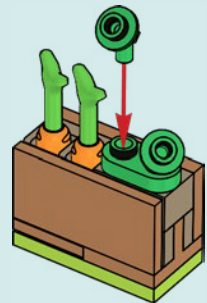



2x



2x

11

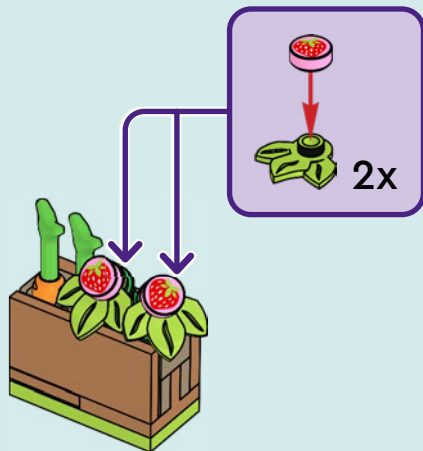

1x

12



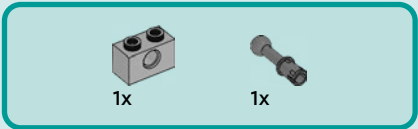

1

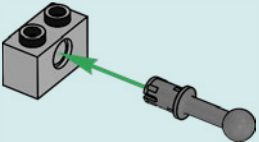

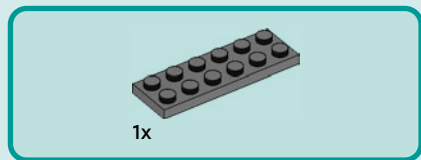

2

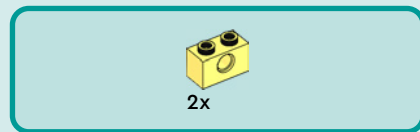
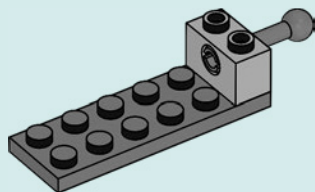

3

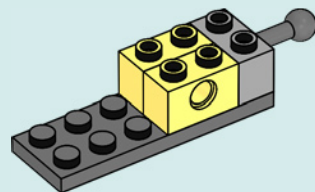



2x

4

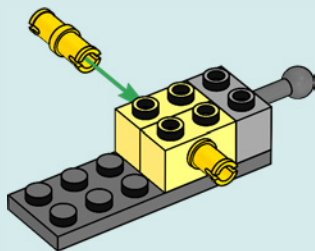

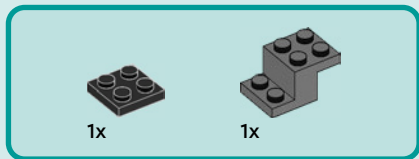

5

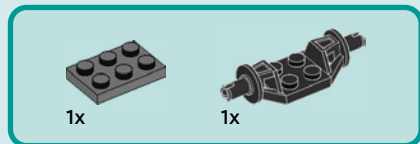
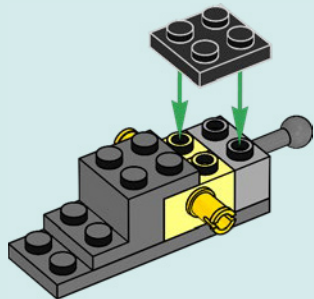

6

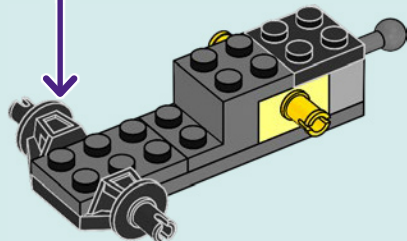
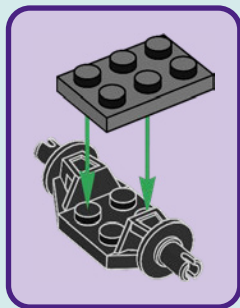



1x

7

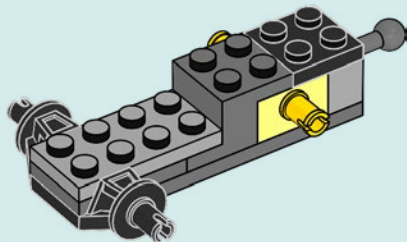

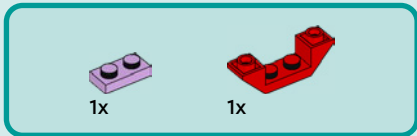

8

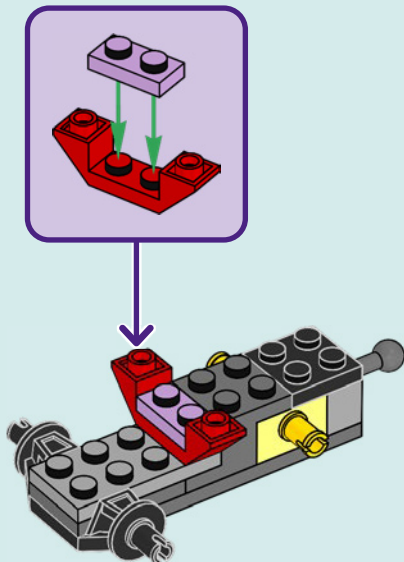



9

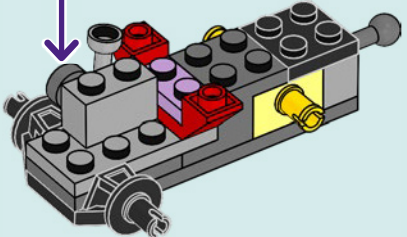
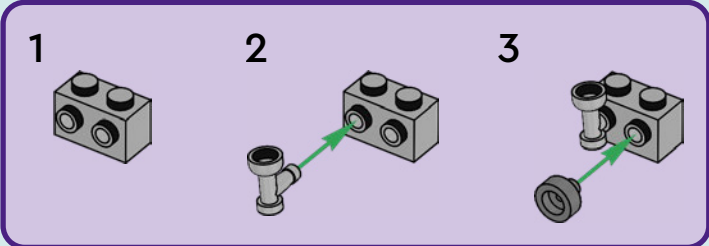



1x



1x

10

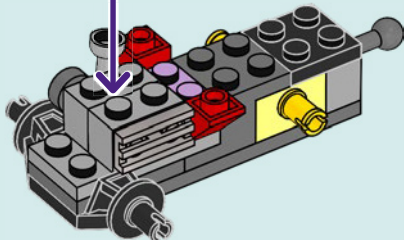
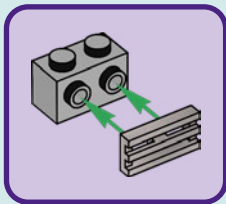

2x

11

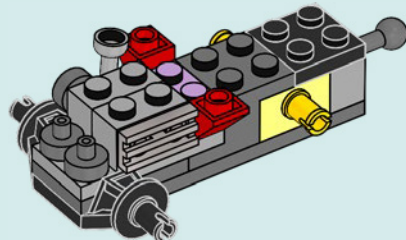

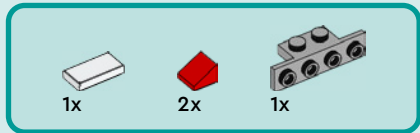

12

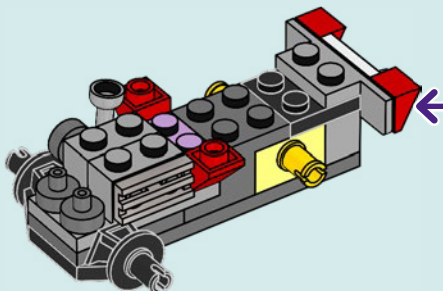
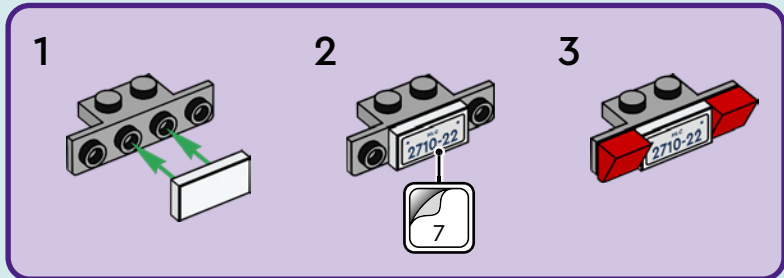



1x

13

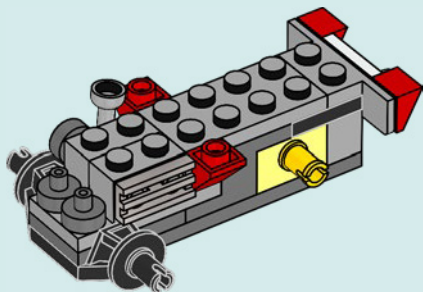

1x



1x



1x

14

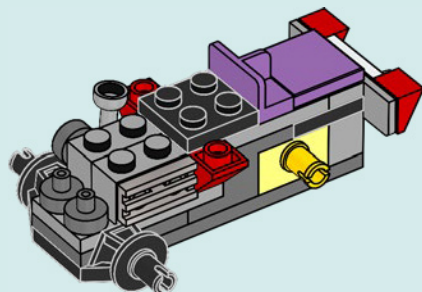



1x

15

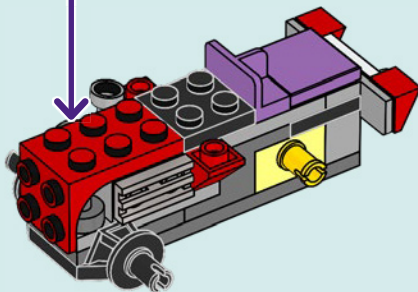
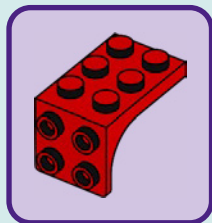

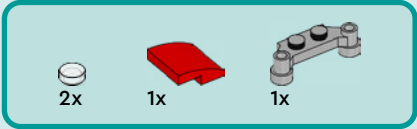

16

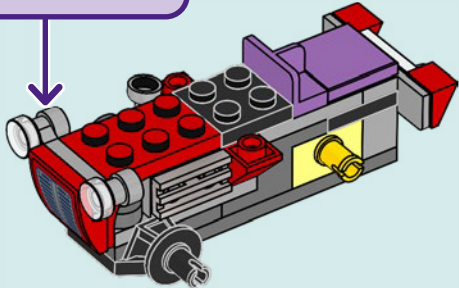
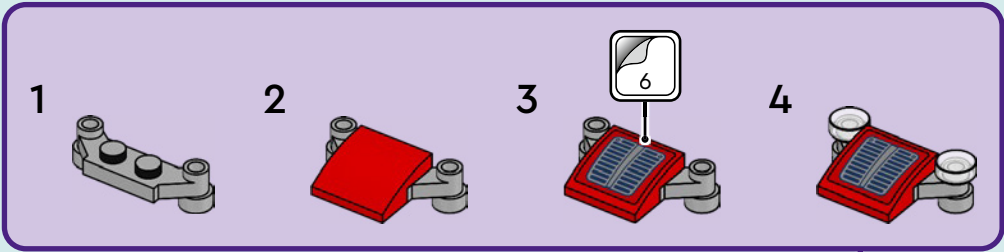



1x

17

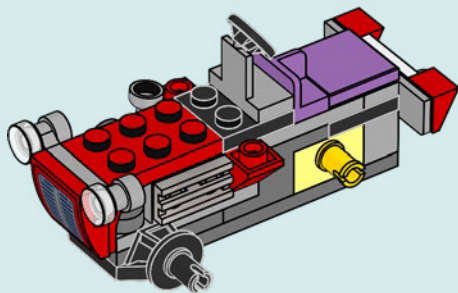

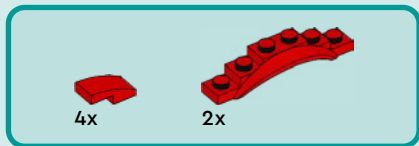

18

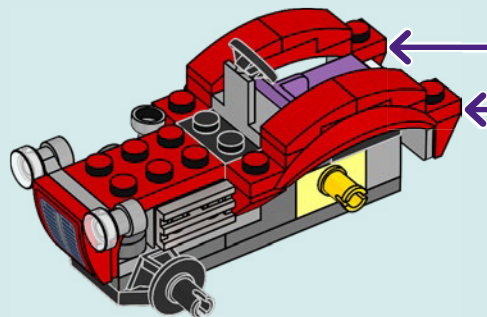
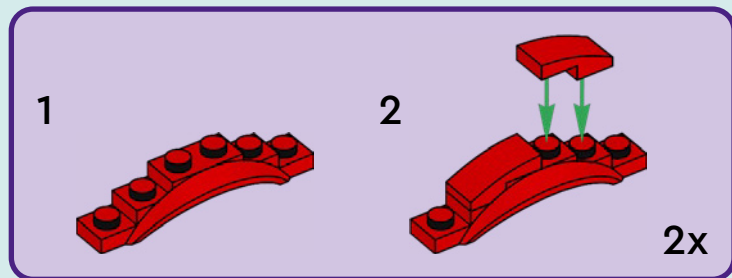



2x

19

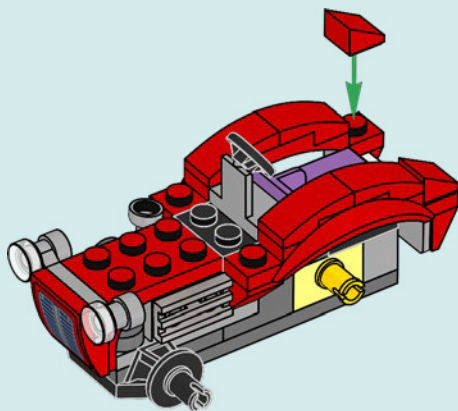



2x

20

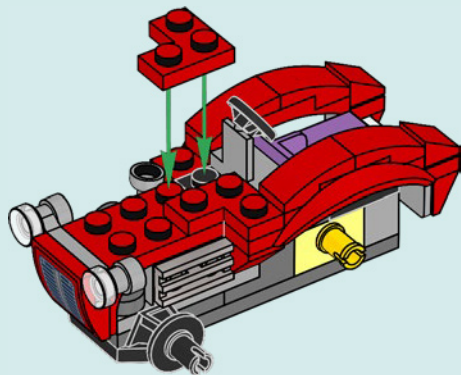

1x

21

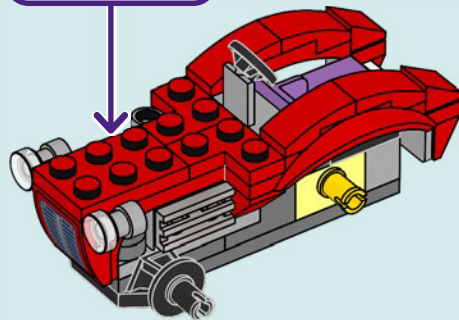



1x

22

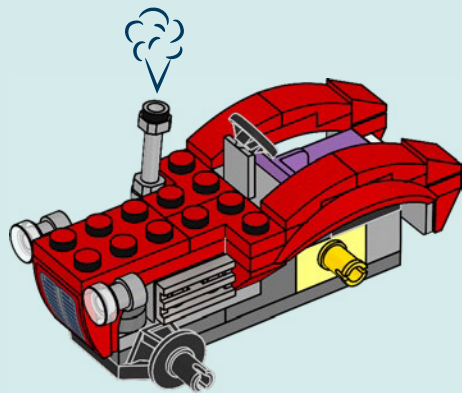

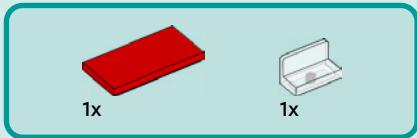

23

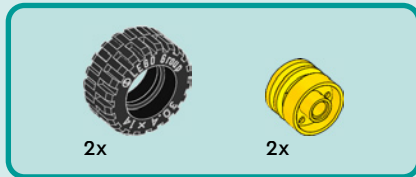
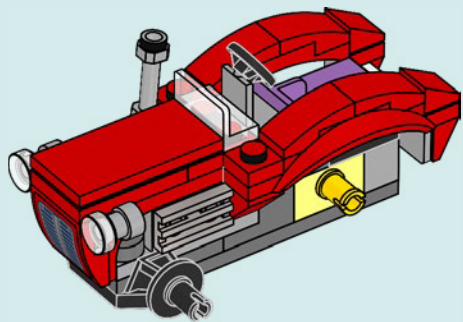

24

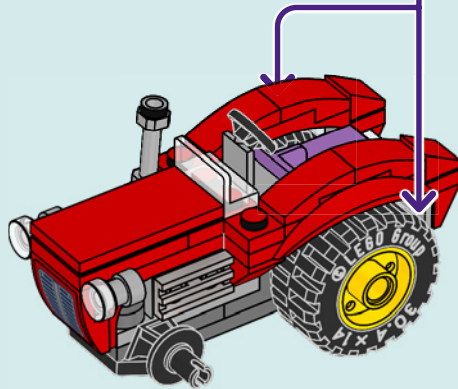
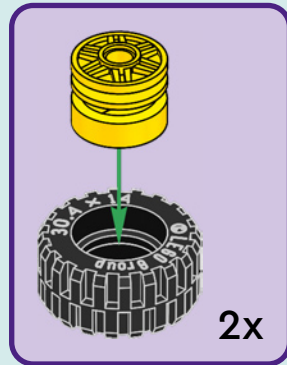



25

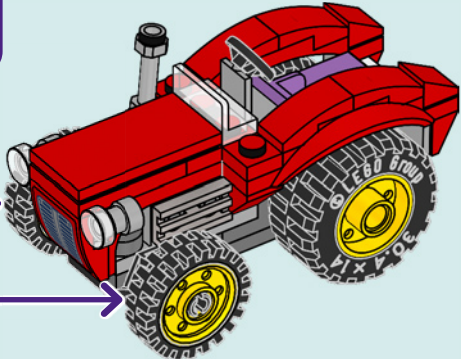
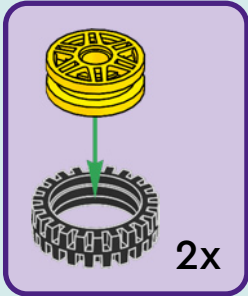

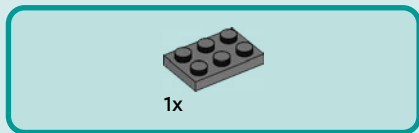
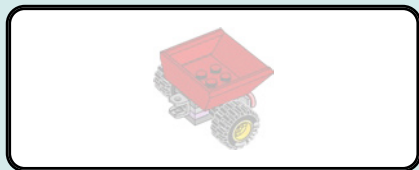

26

1x

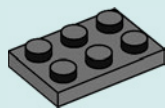

2x

27

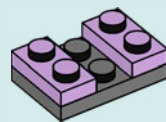



1x

28

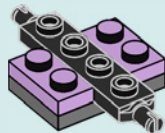

2x

1x

1x

29

1

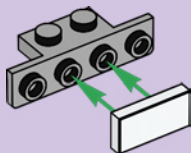

2

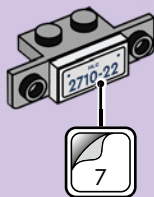

3

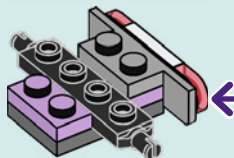



1x

30

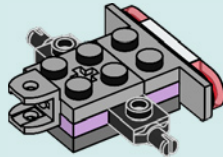



1x

31

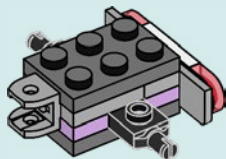

1x

32

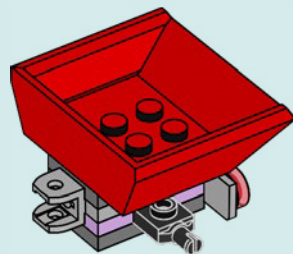



2x



2x

33

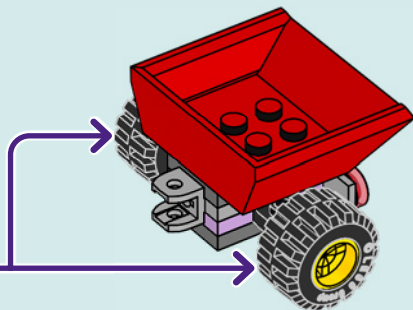
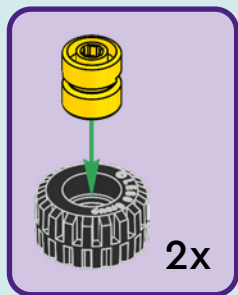

34

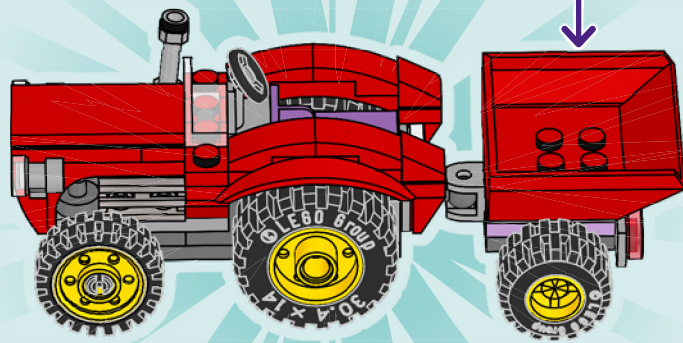







Rebuild
the
world™

