



# Friends

42617



3

4

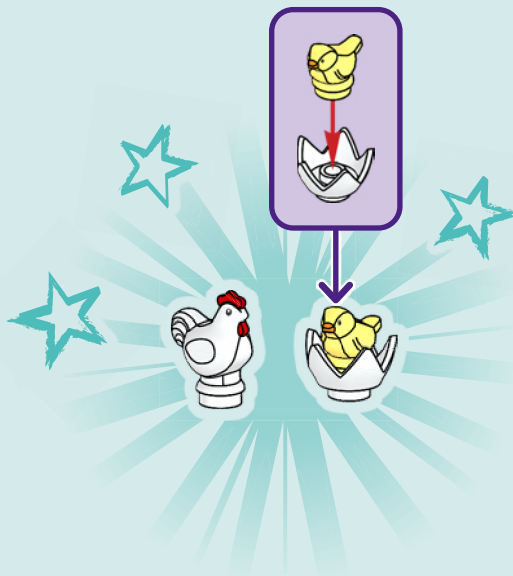

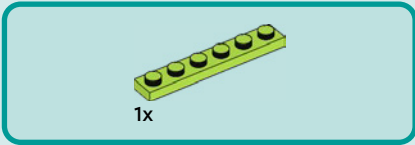
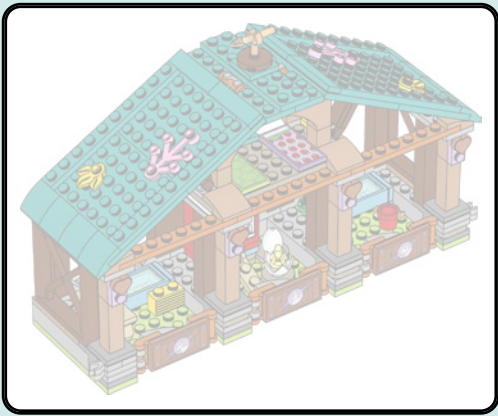

1

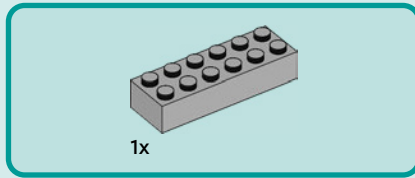
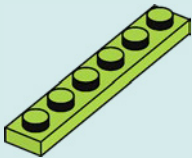

2

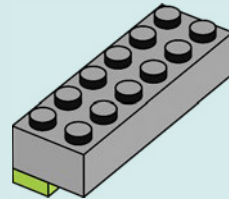

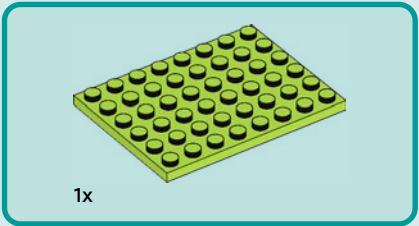

3

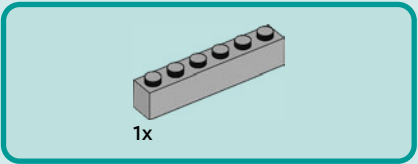
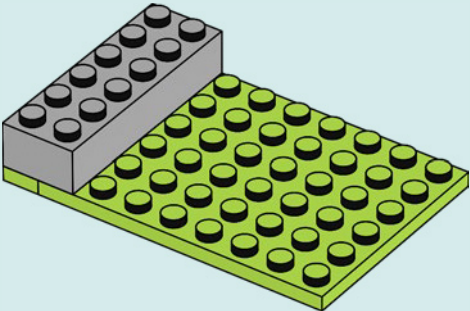

4

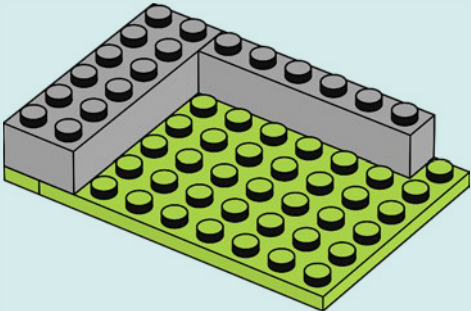

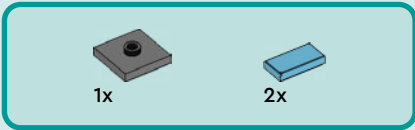

5

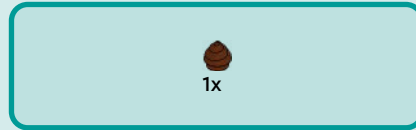
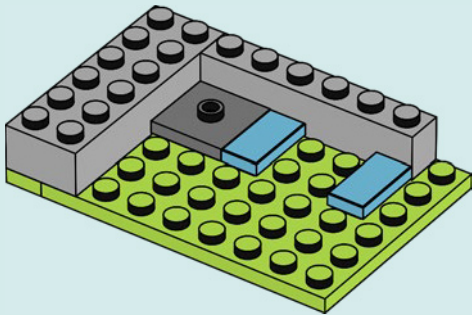

6

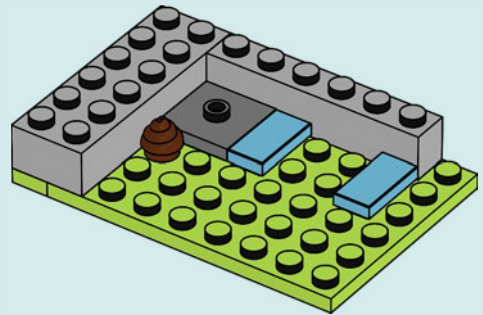

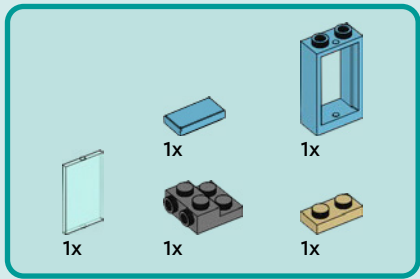

7

1

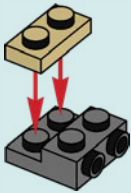

2

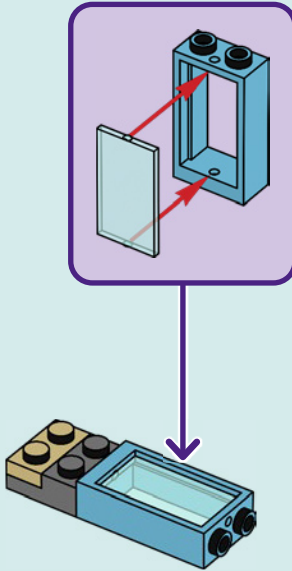

3

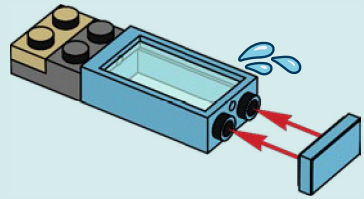

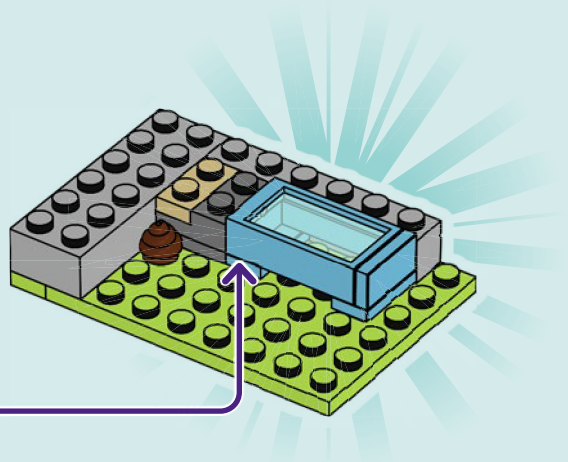



1x



2x

8

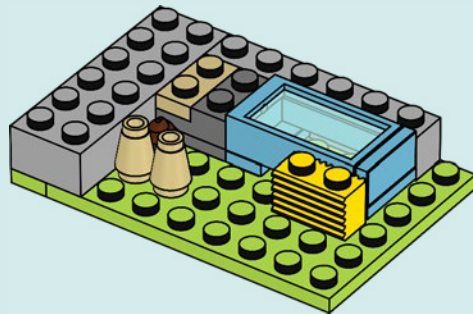



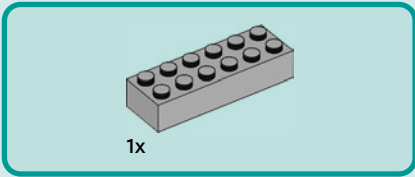

9

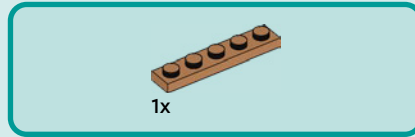
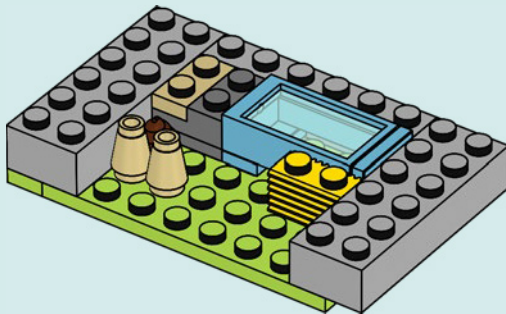

10

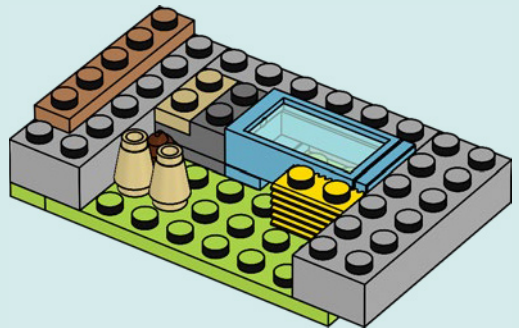

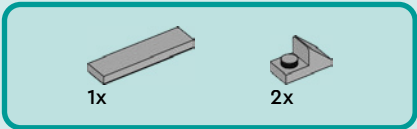

11

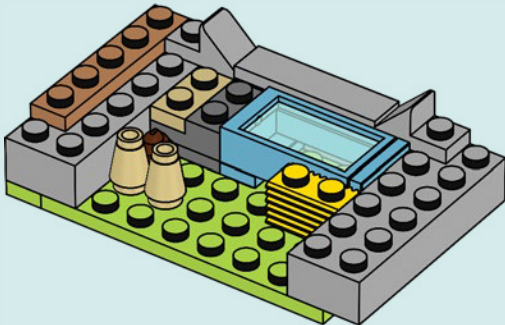

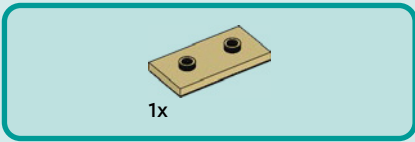

12

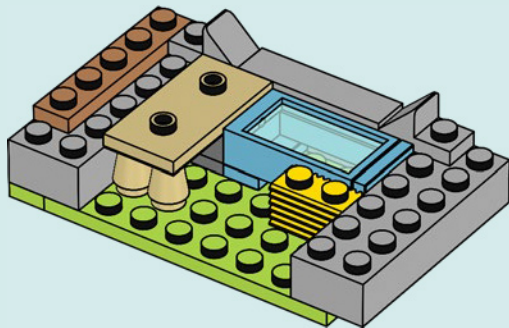

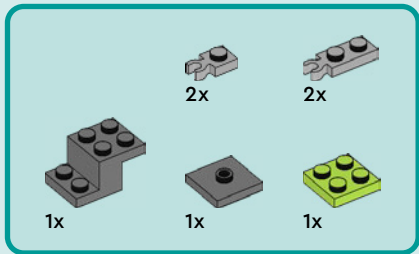

# 13

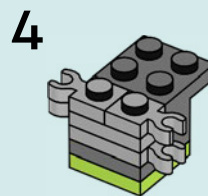
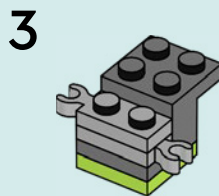
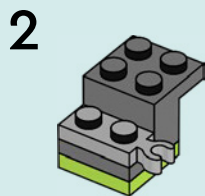
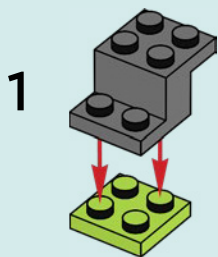

5

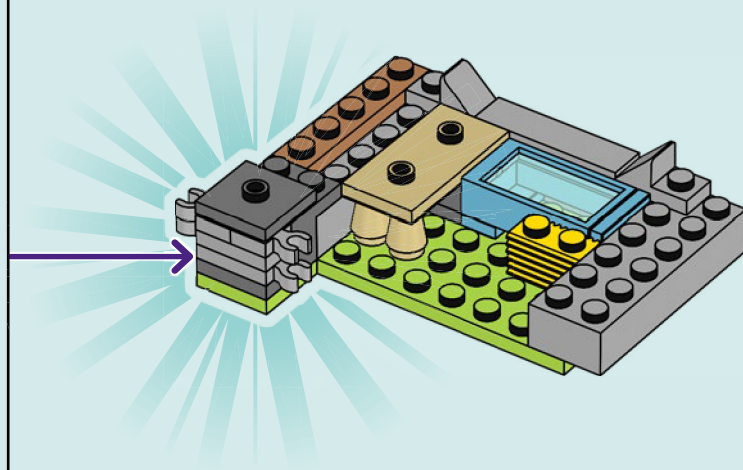
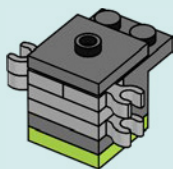

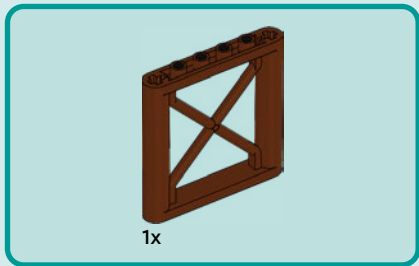

14

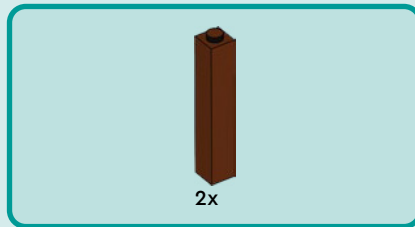
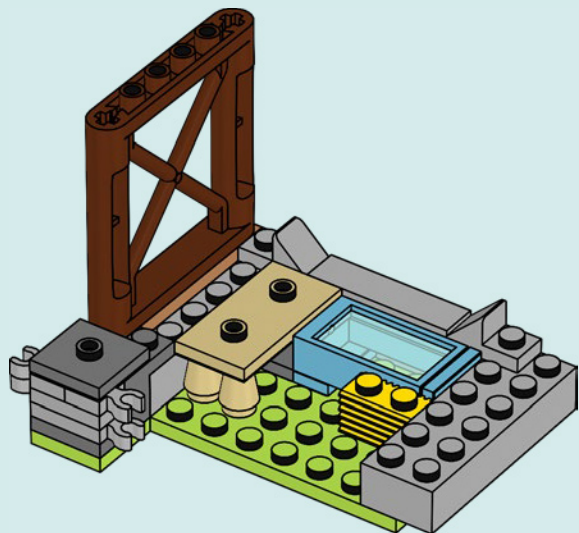

15

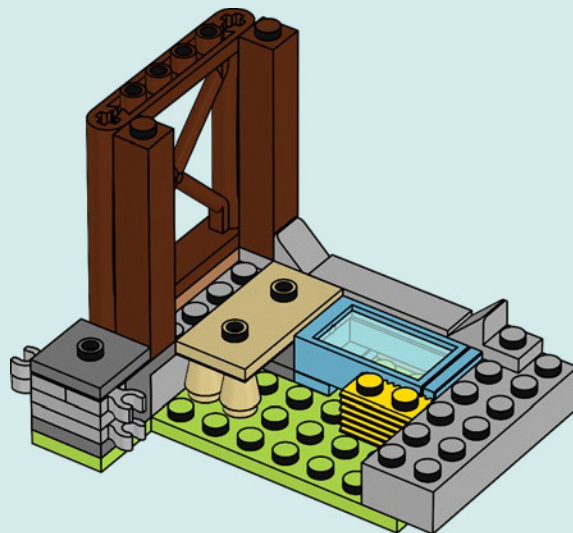

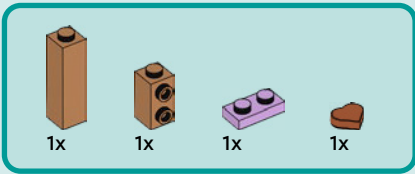

16

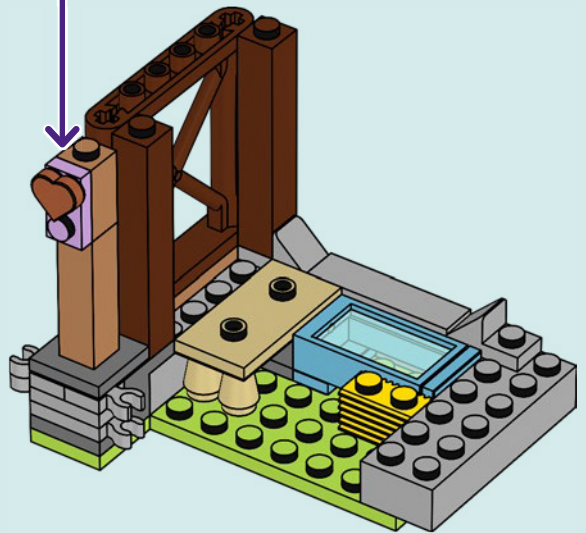
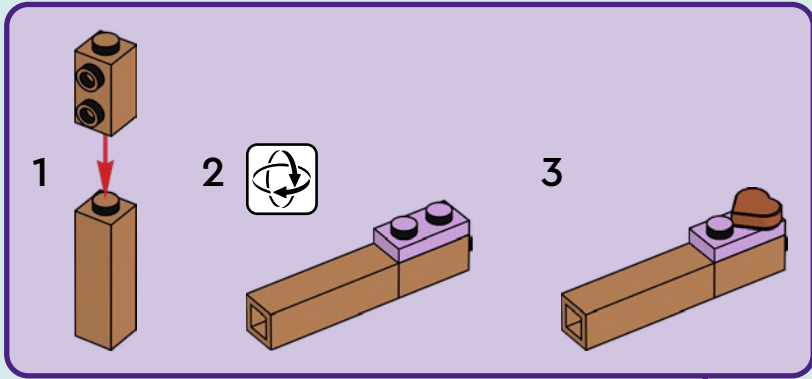

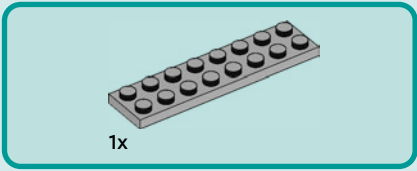

17

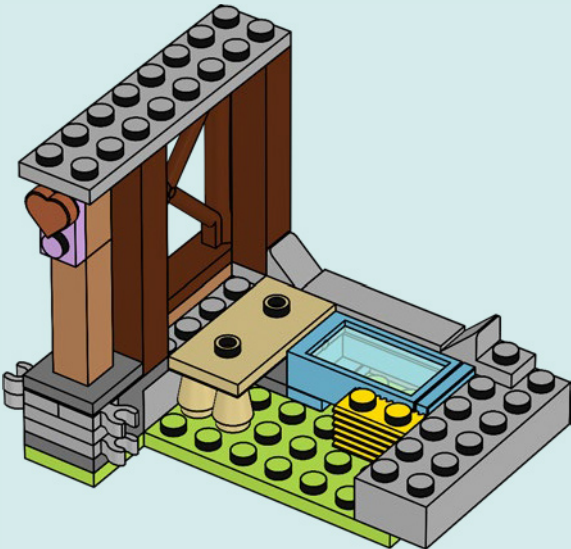



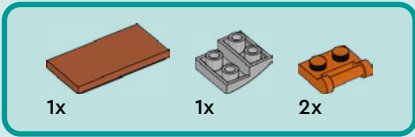

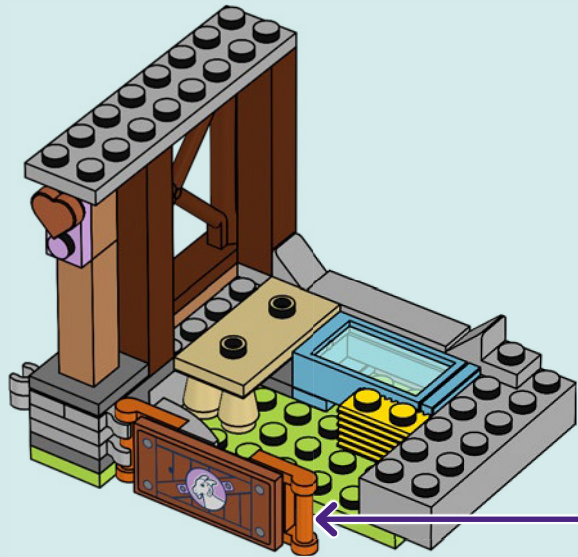
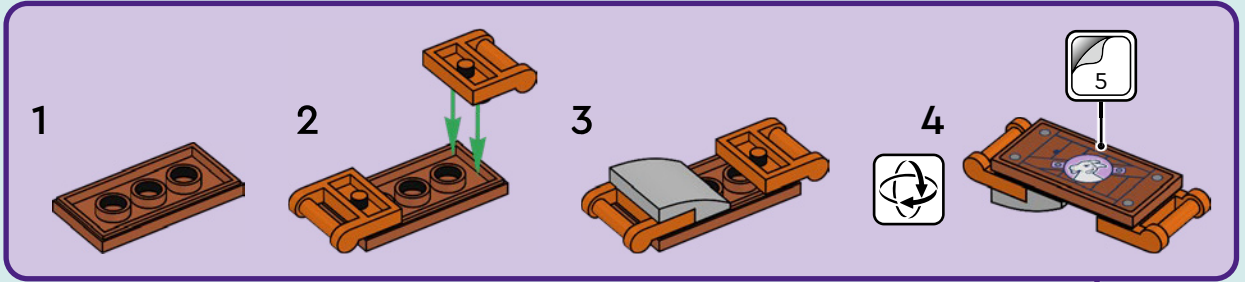

18

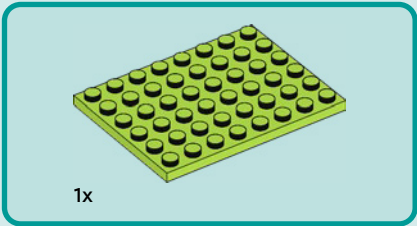



19



 2x	 1x
--	--

20



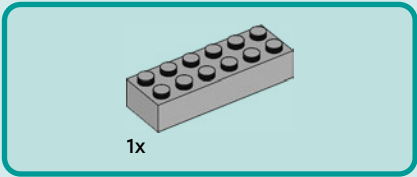

21

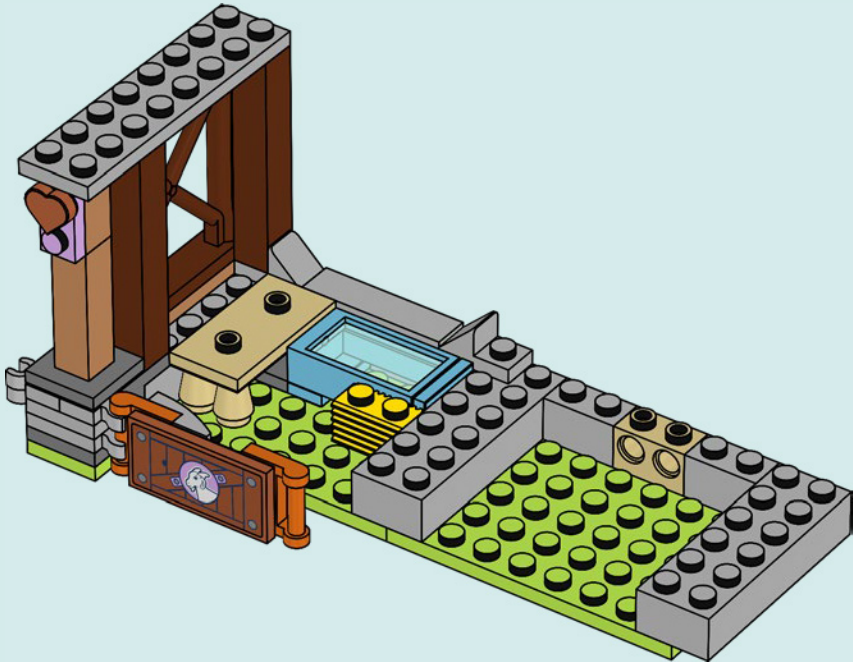

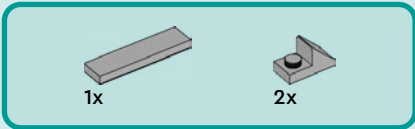

22

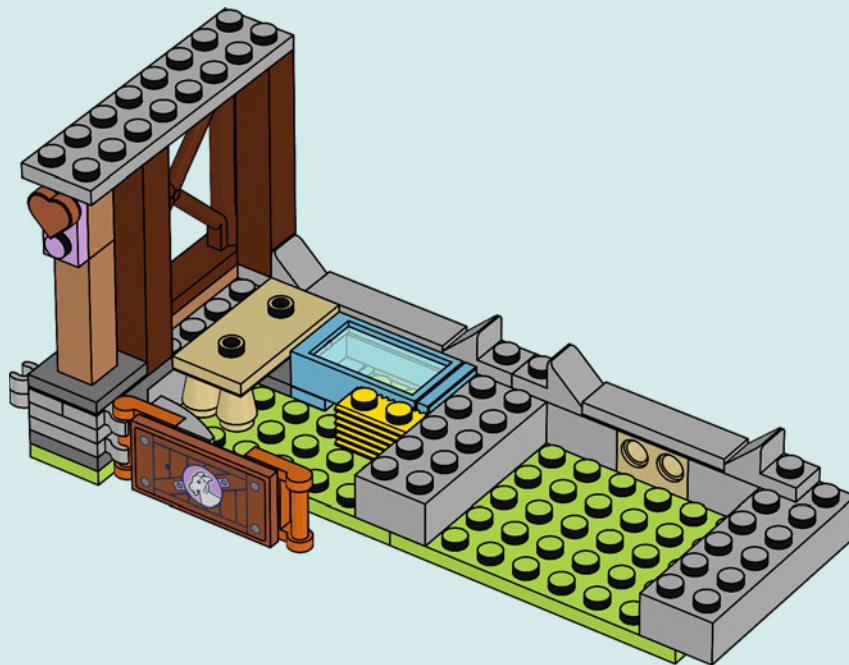



4x

23

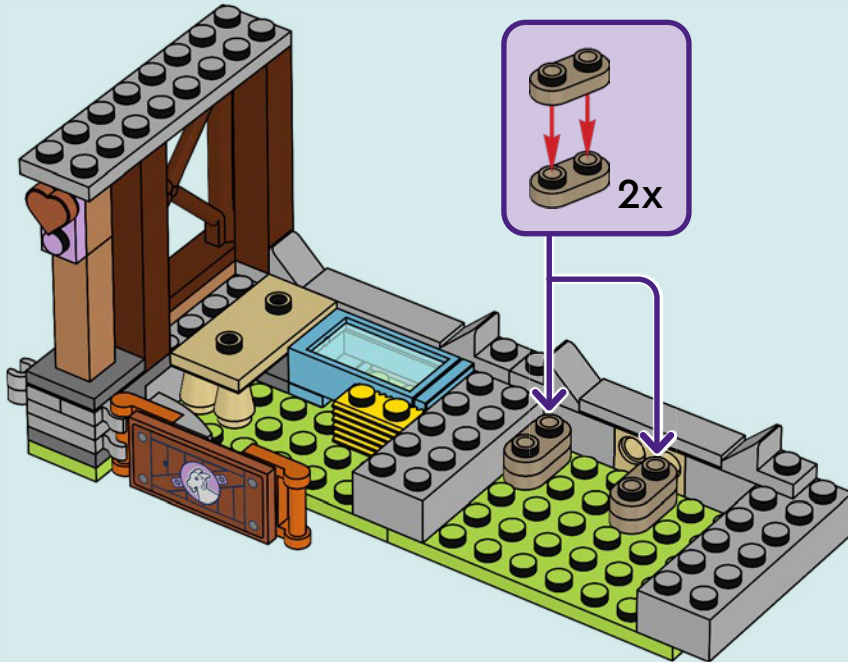



2x

24

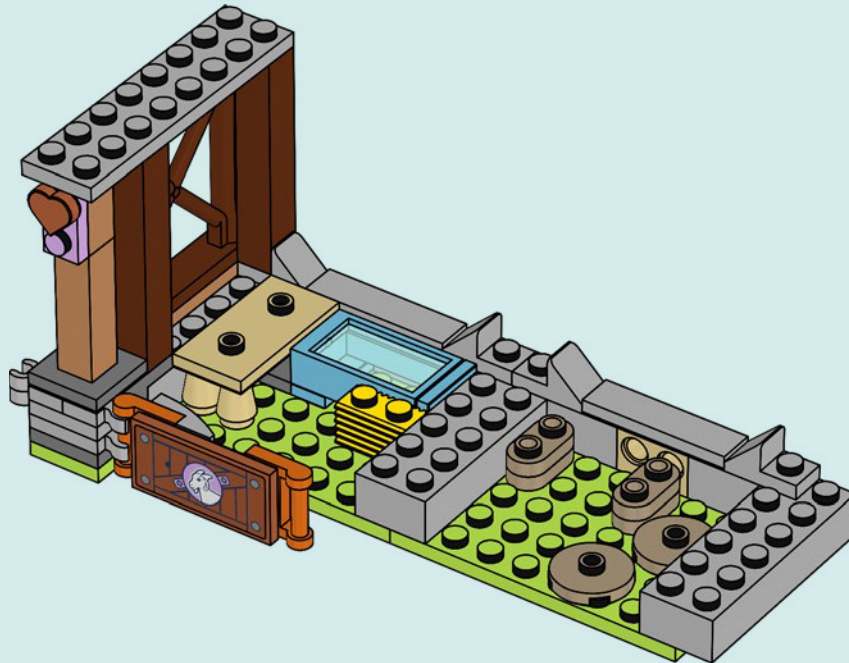

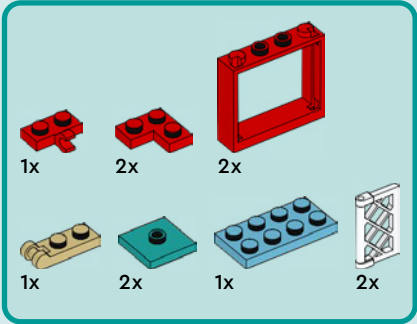
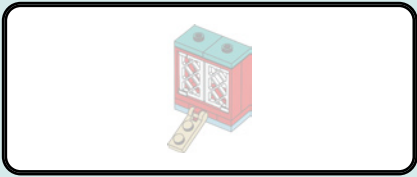

# 25

1

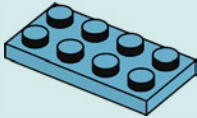

2

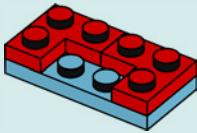

3

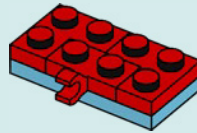



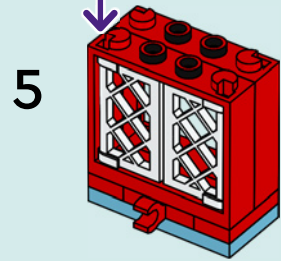
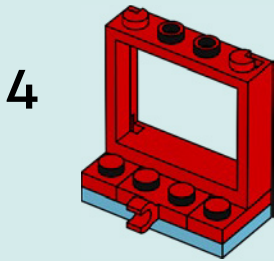
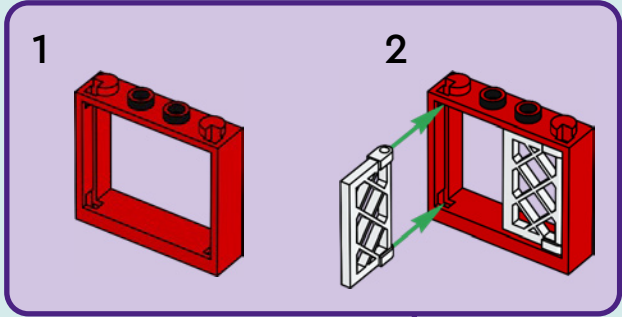

6

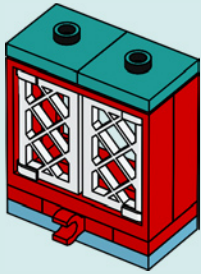

7

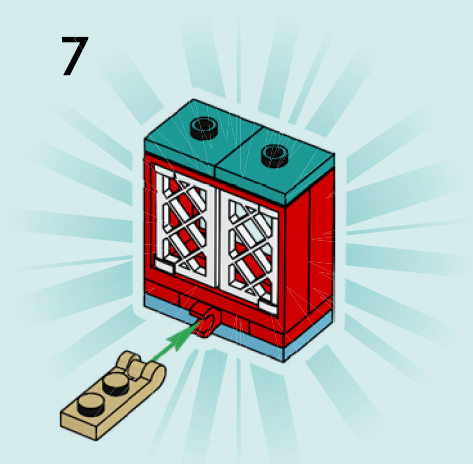

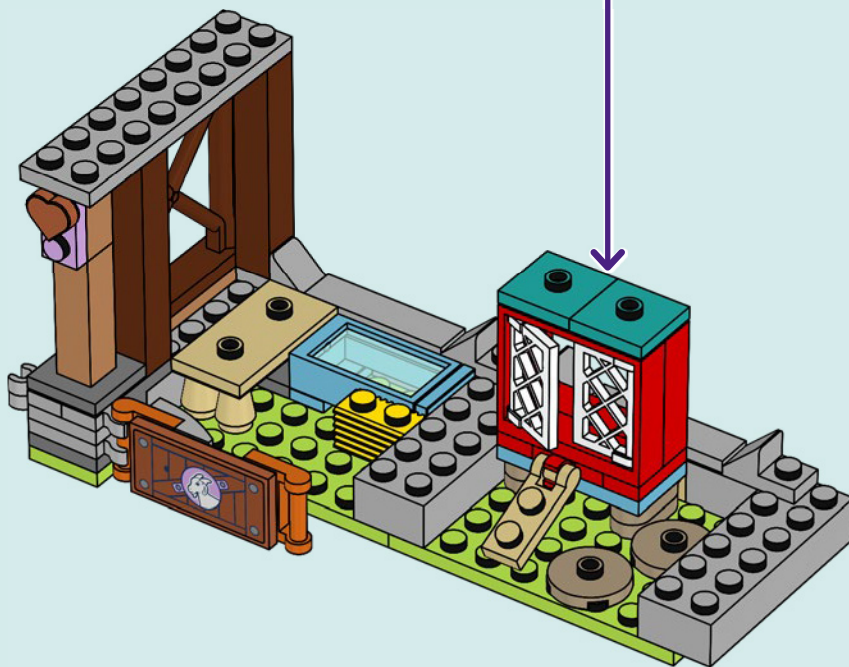



26

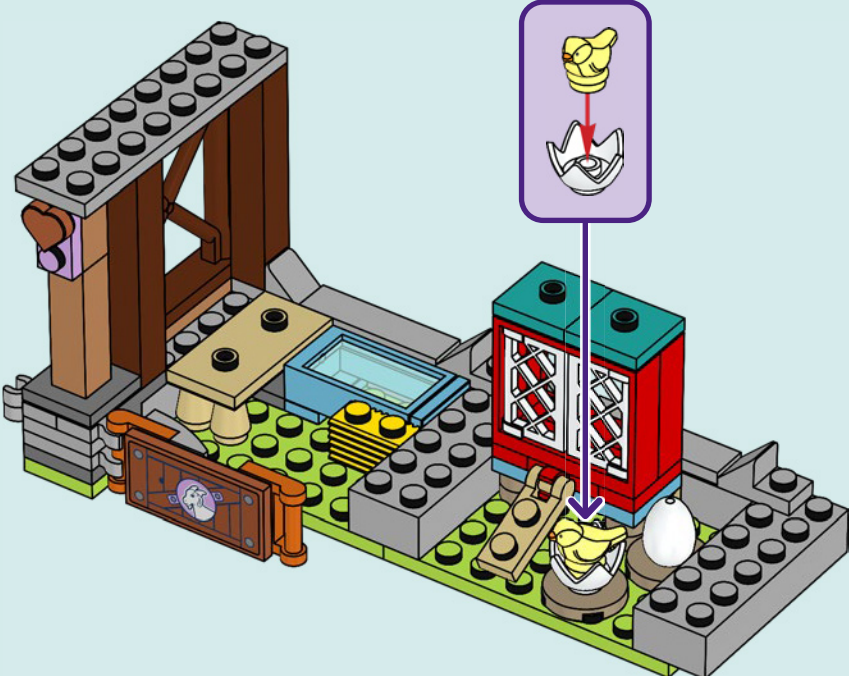

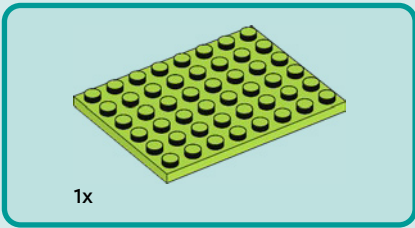

27

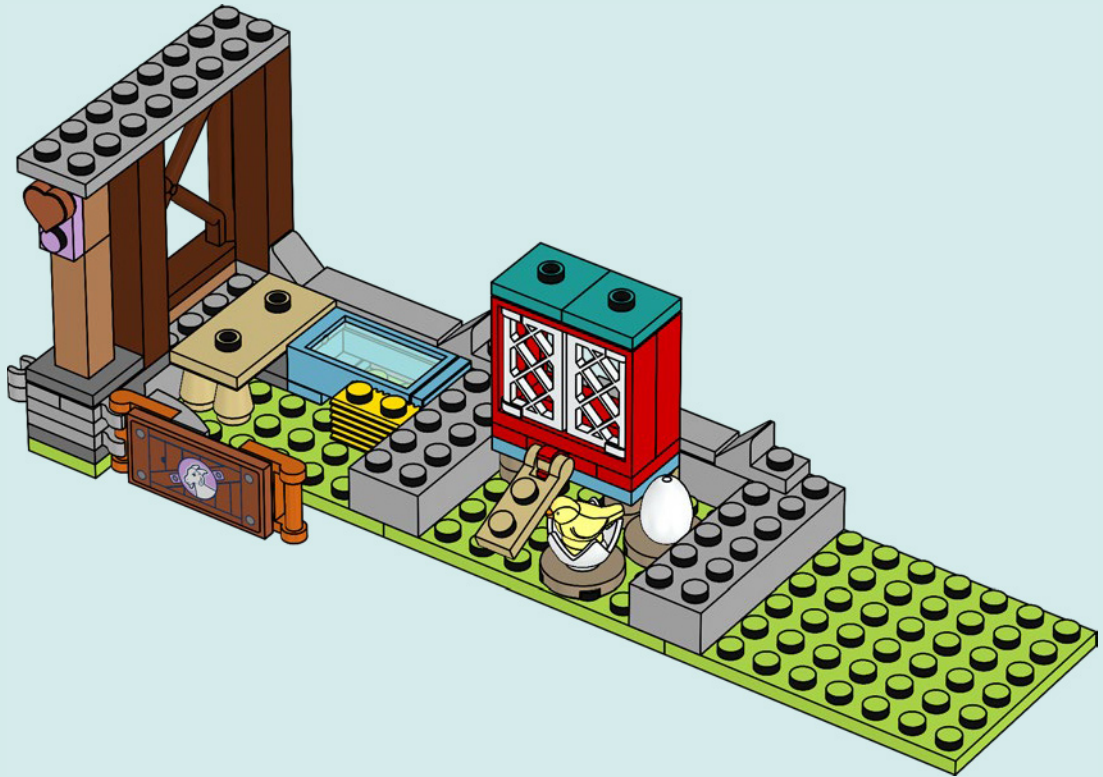

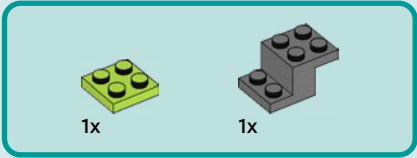
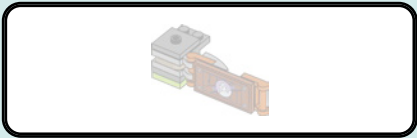

28

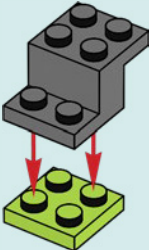

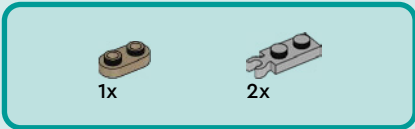

29

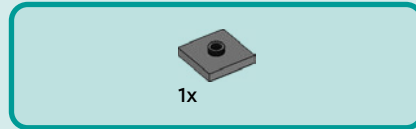
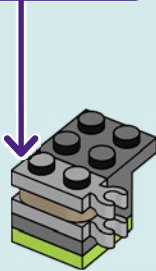
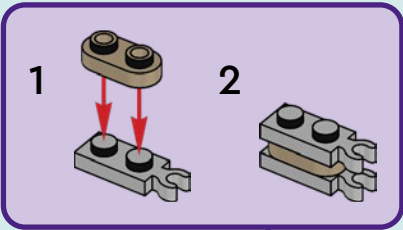

30

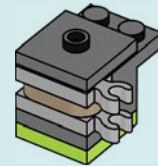

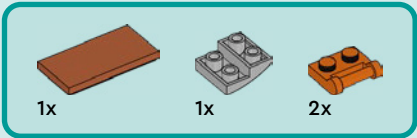

31

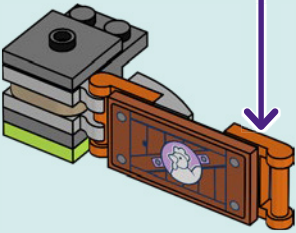
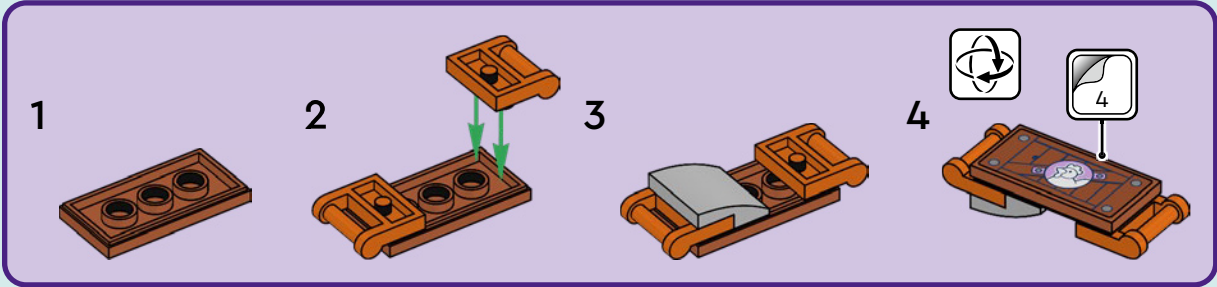



32

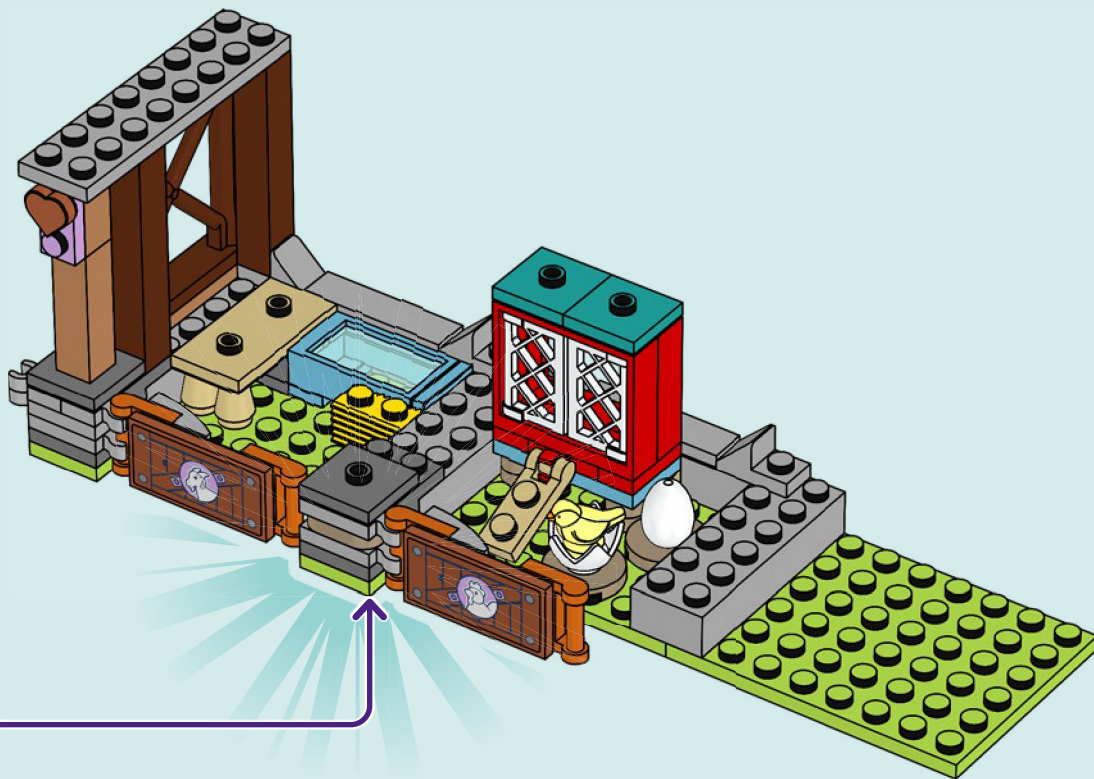

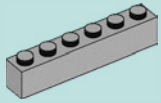

1x

33

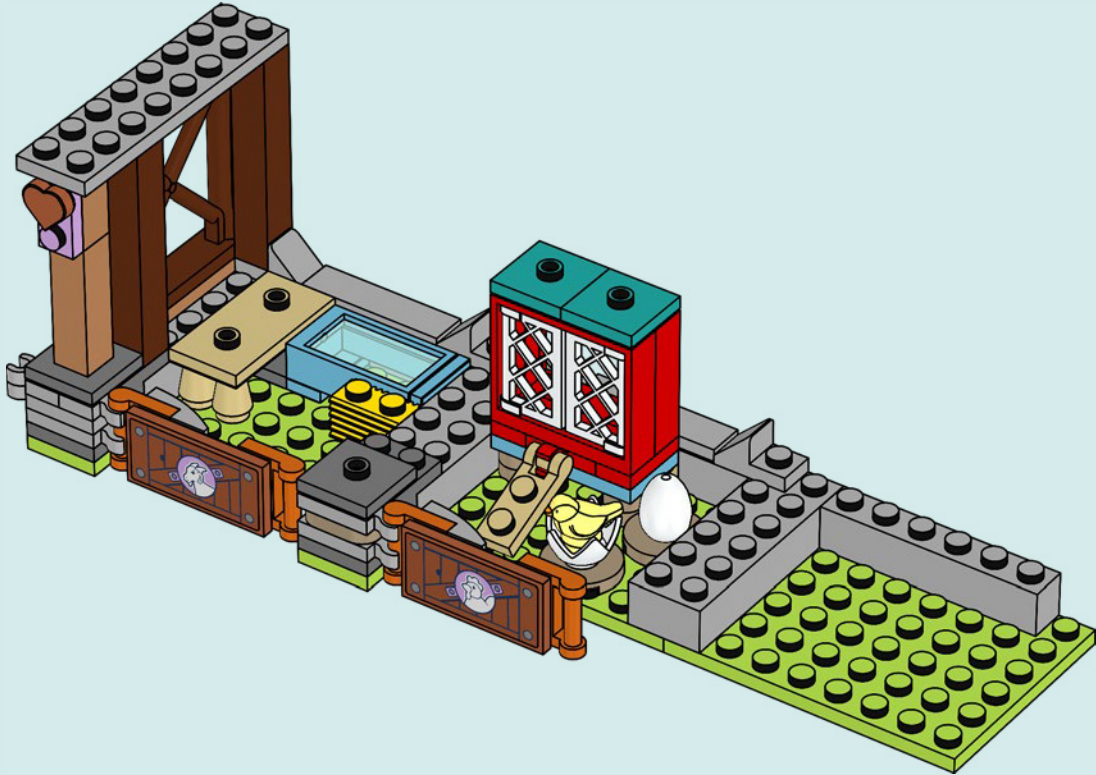

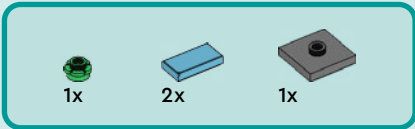

34

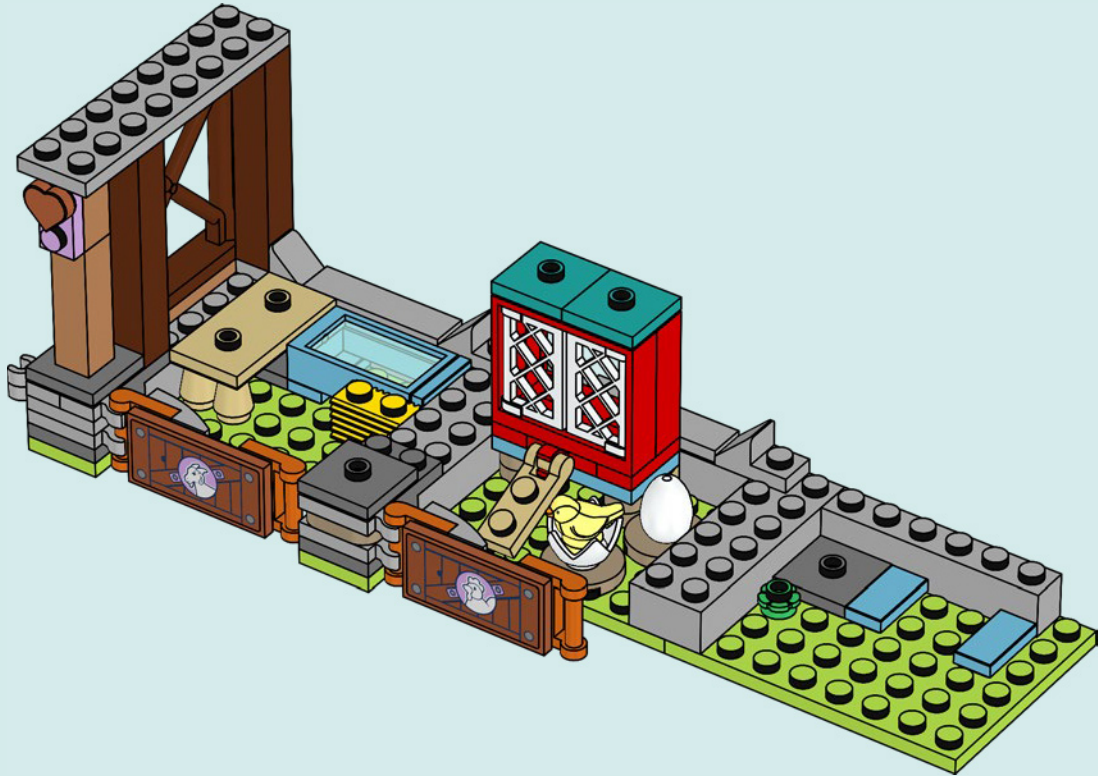



1x



1x

35

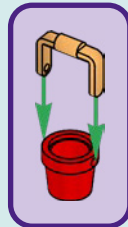

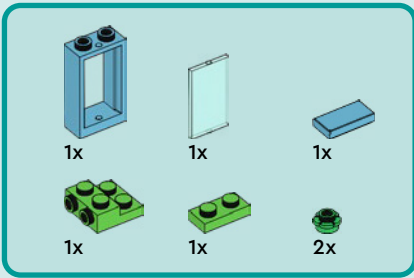

36

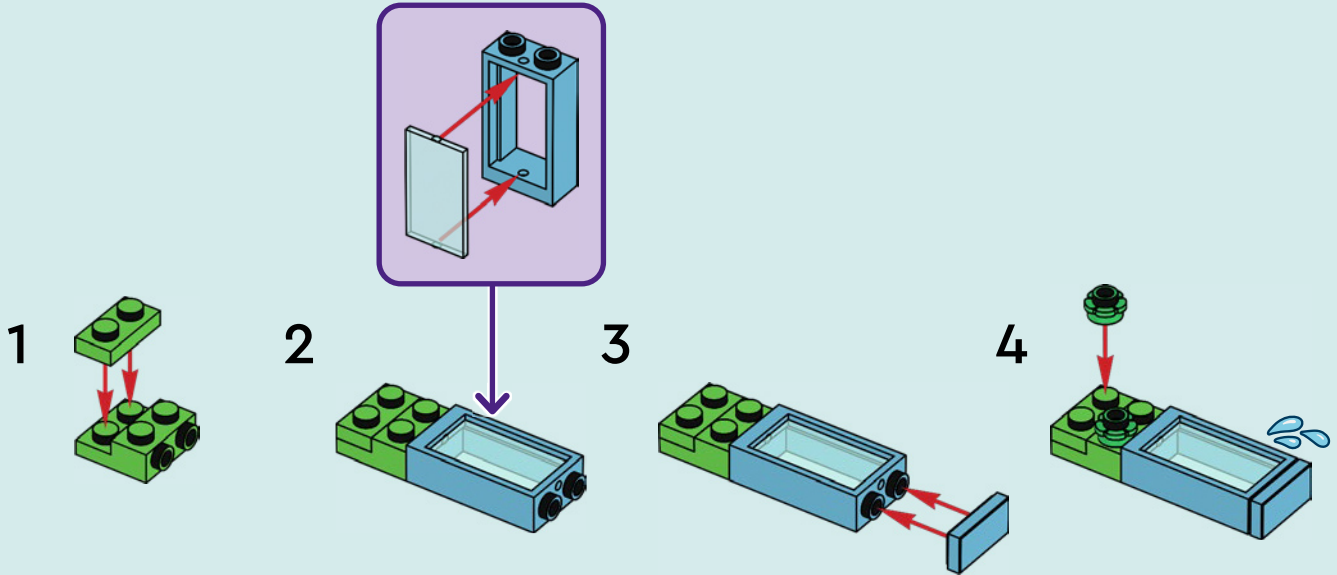

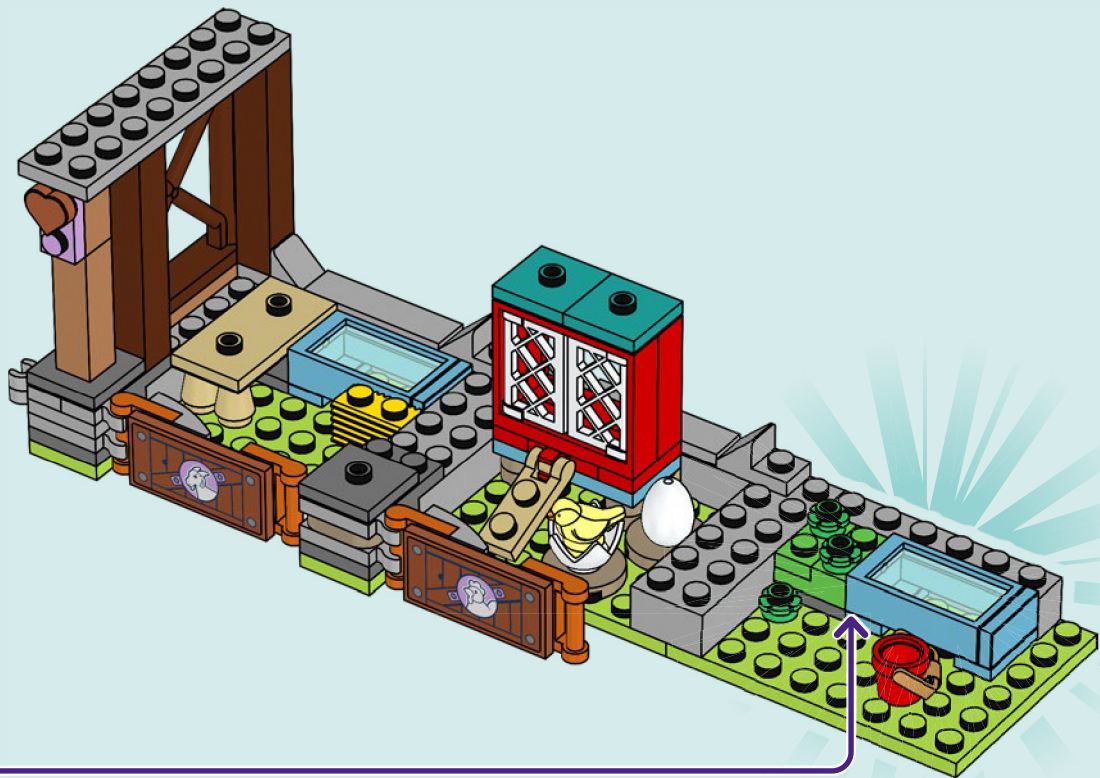

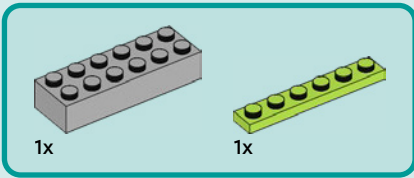

37

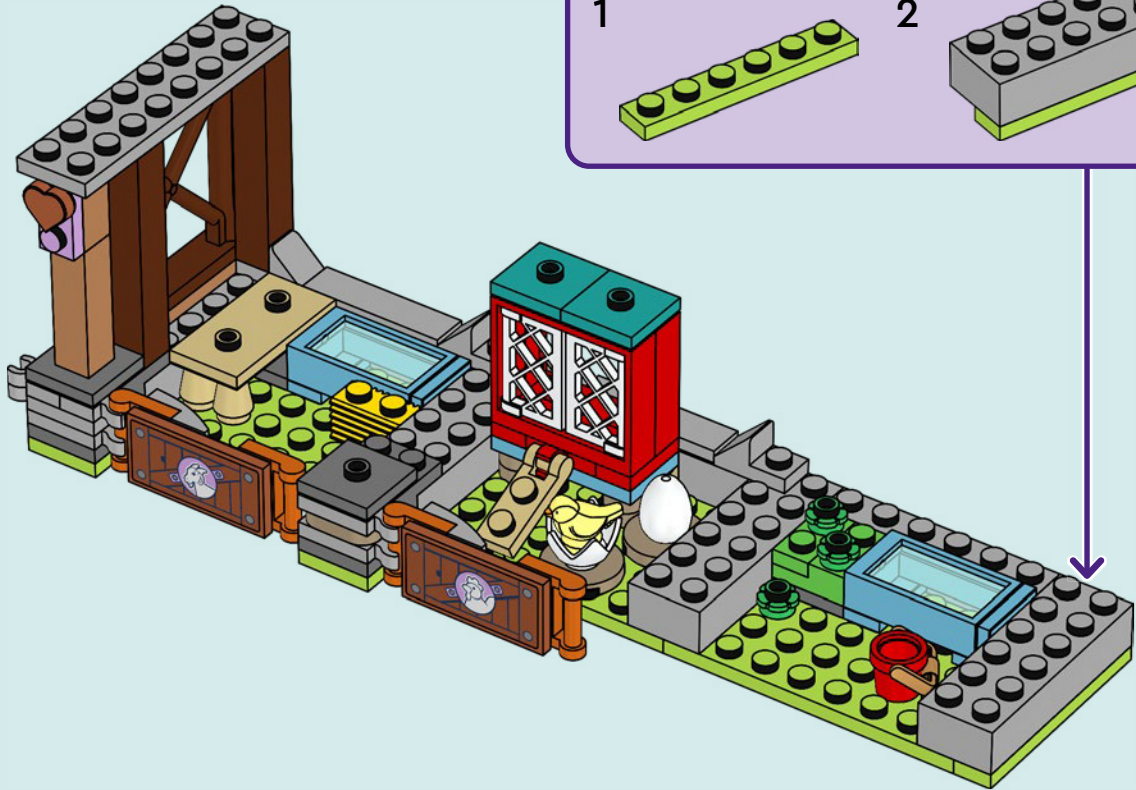

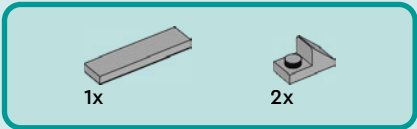

38

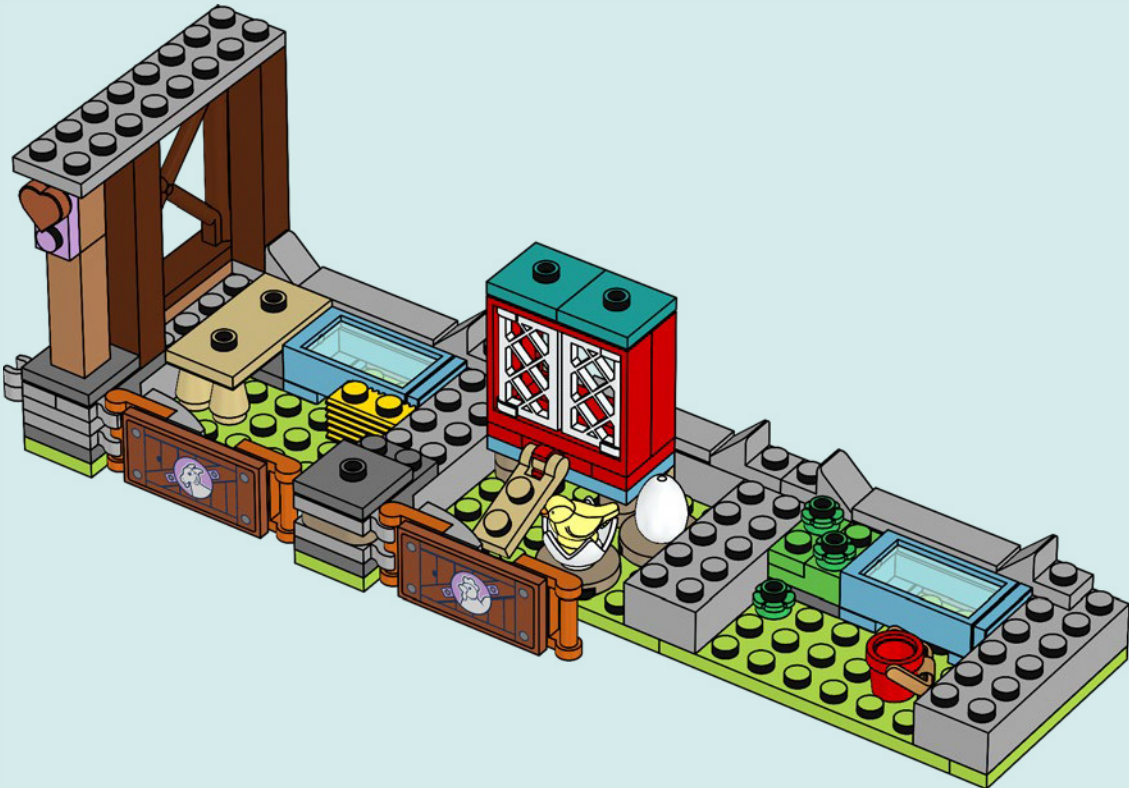





1x

39

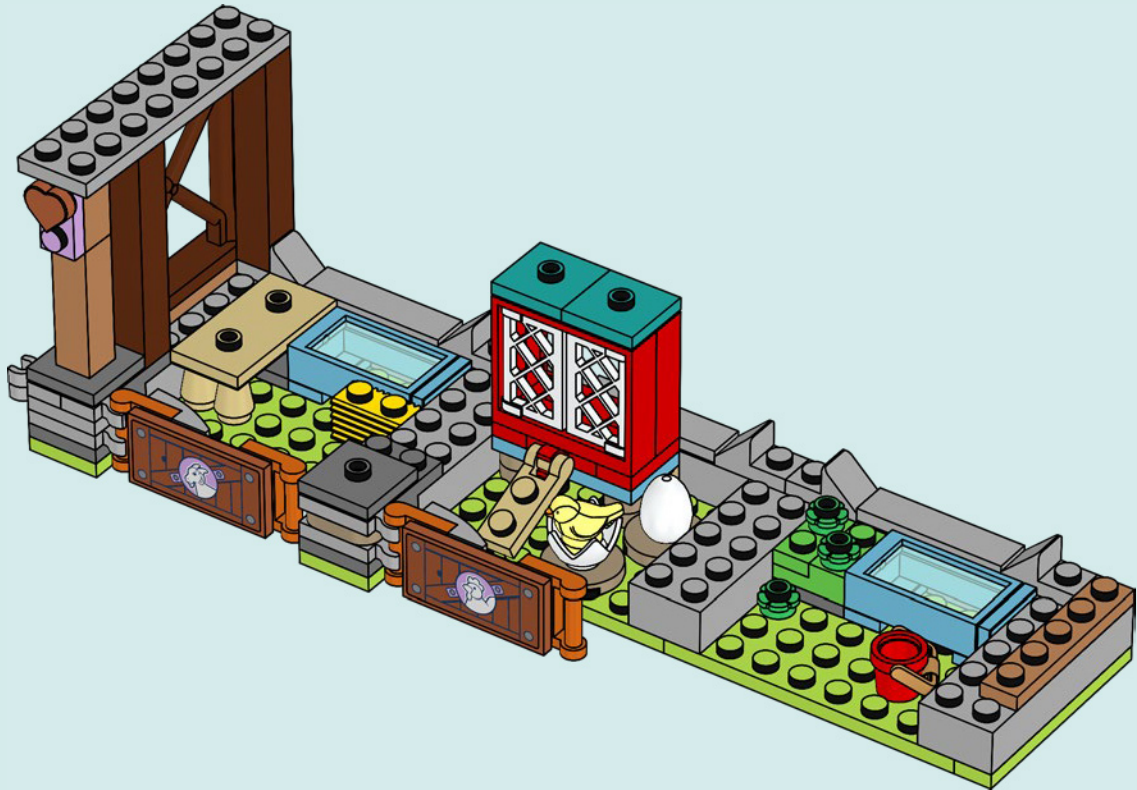

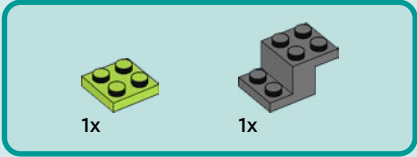
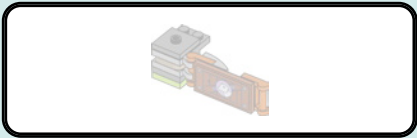

40

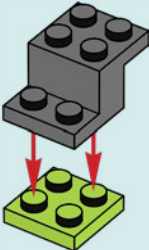

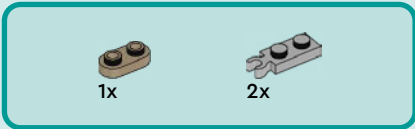

41

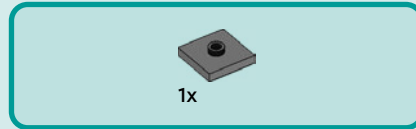
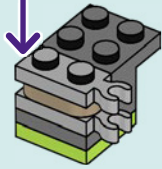
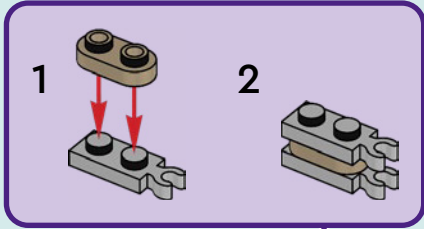

42

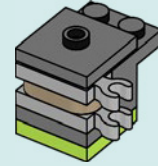

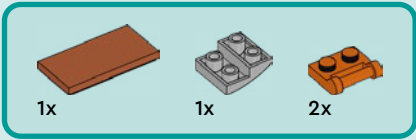

43

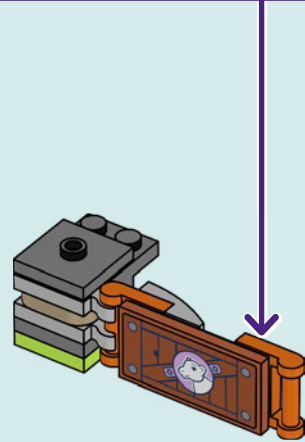
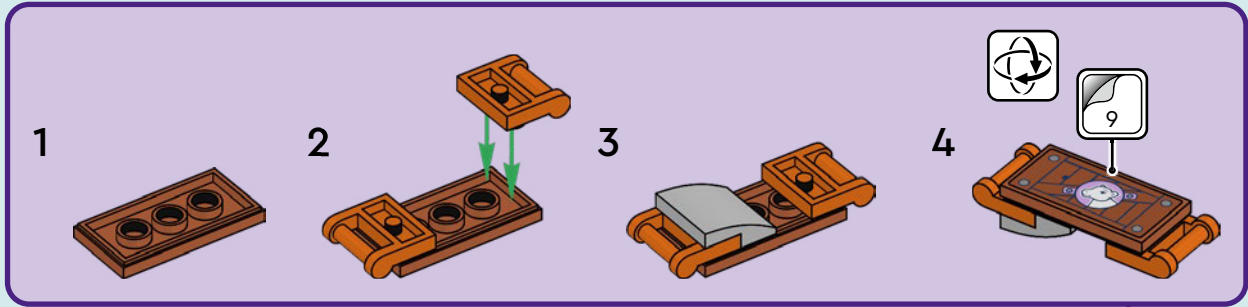

44

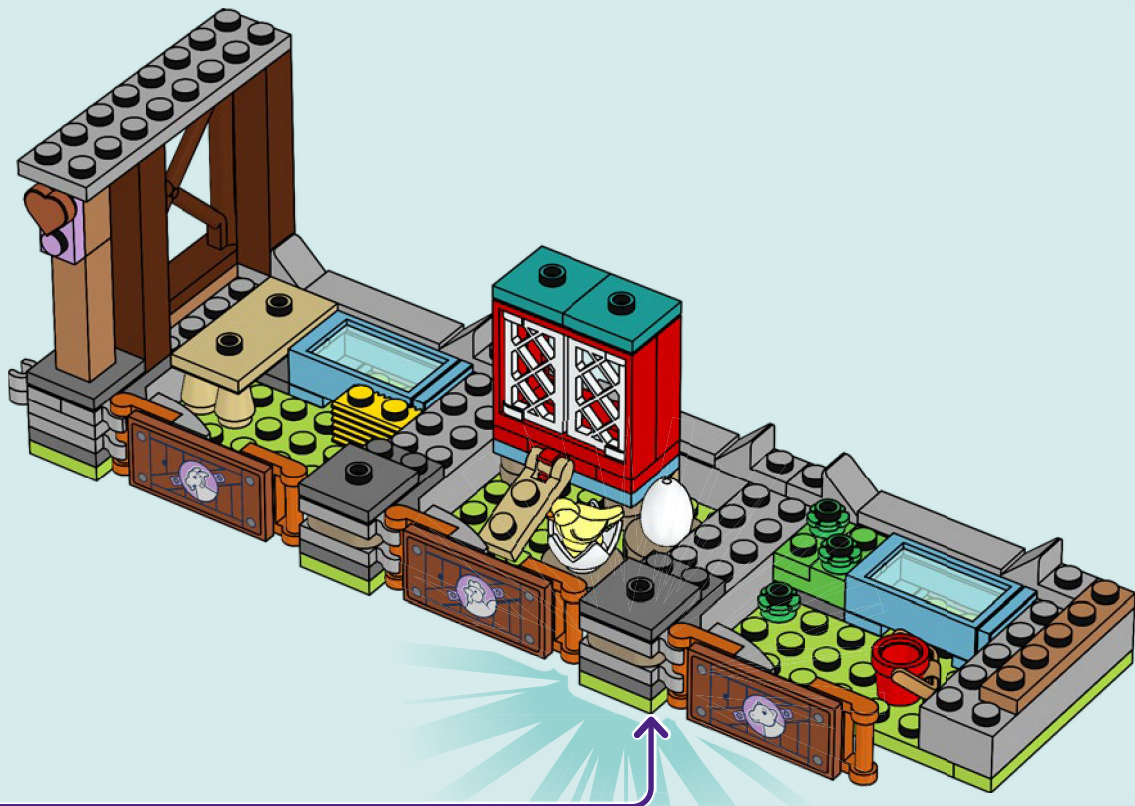

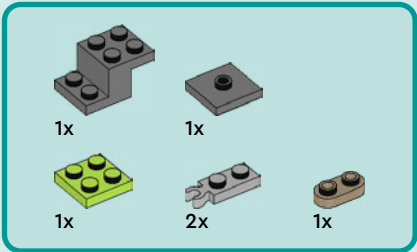

# 45

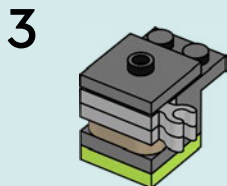
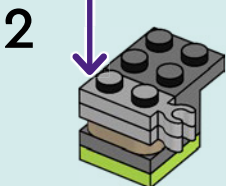
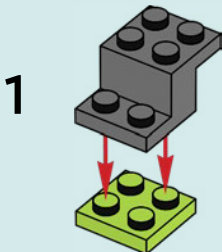
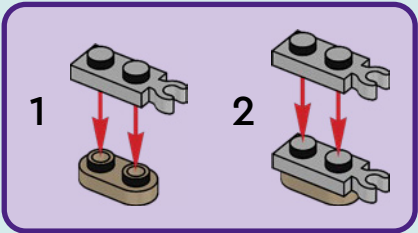

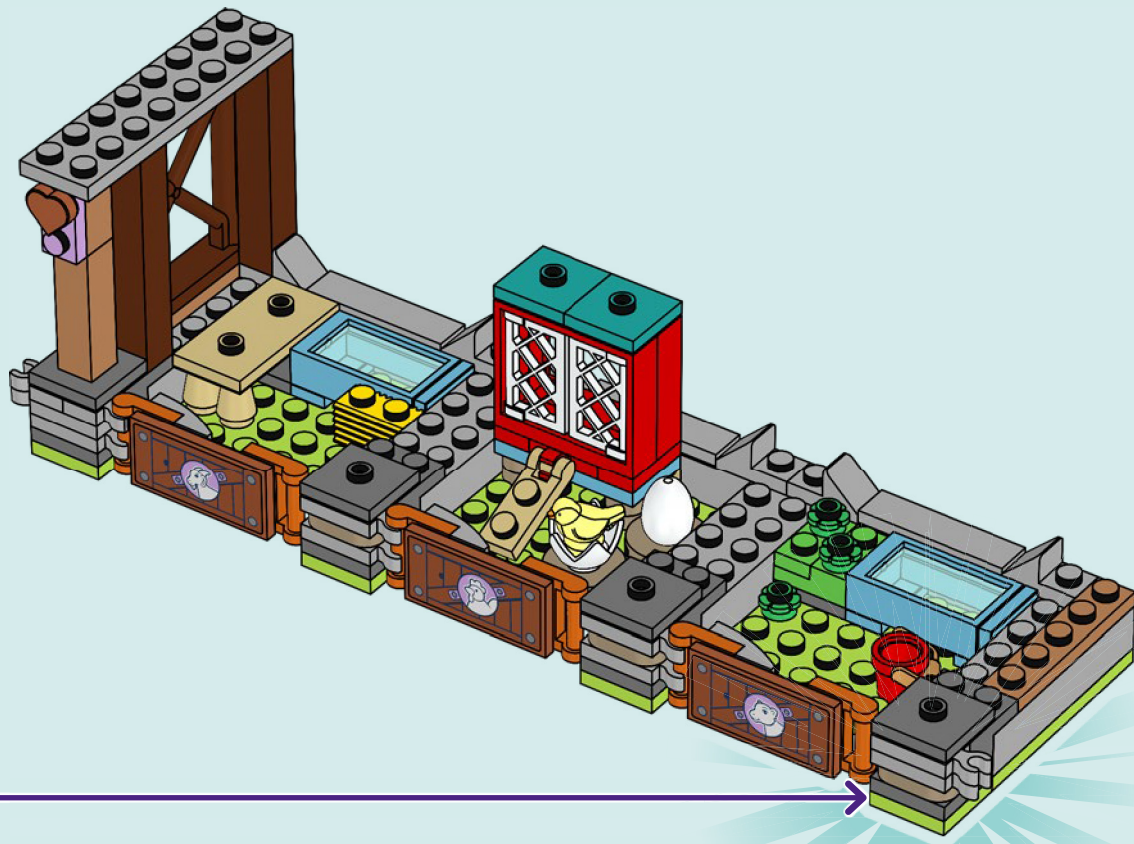

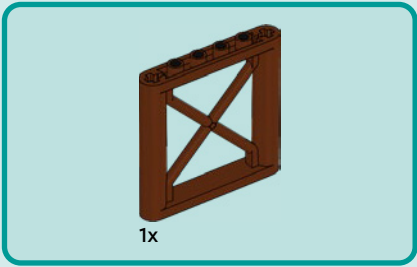

46





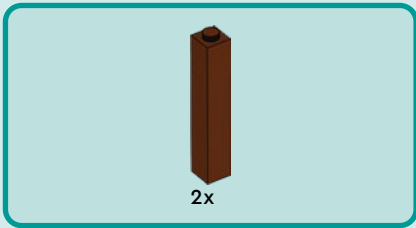

47

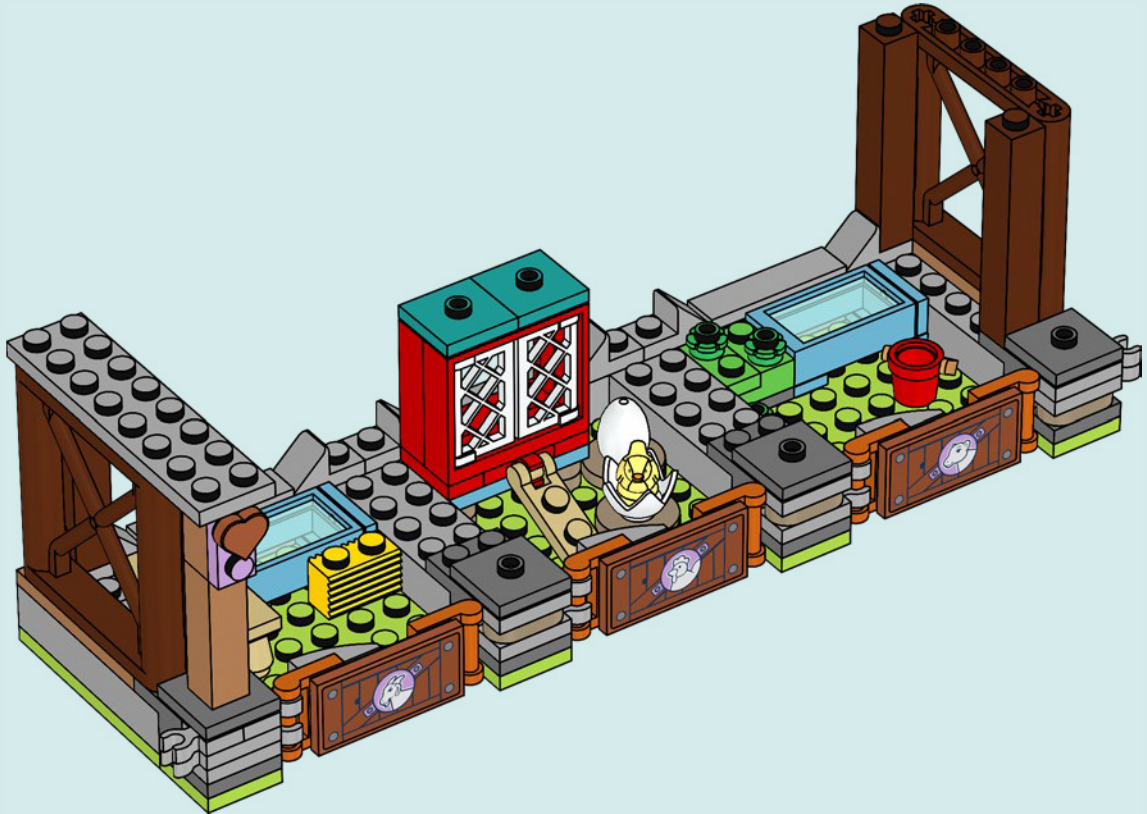

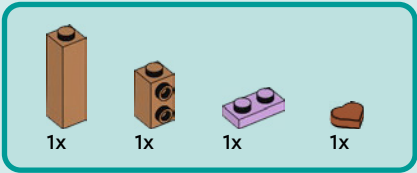

48

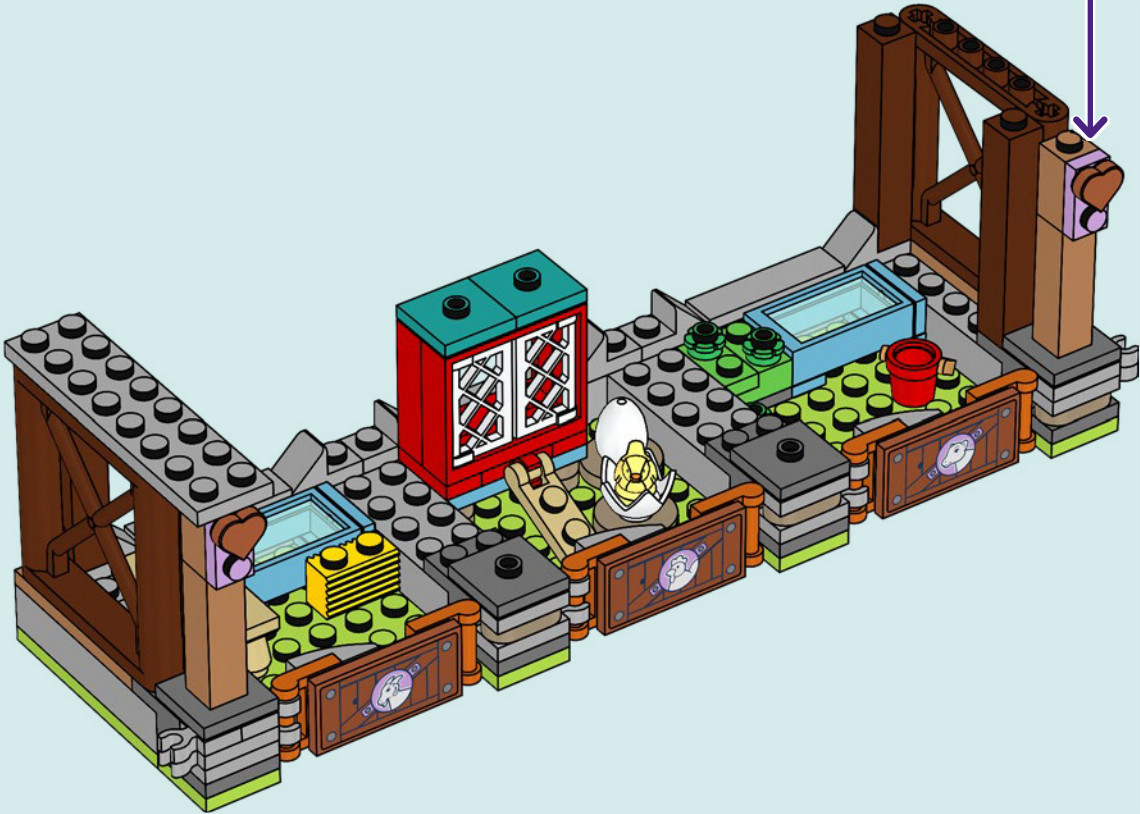
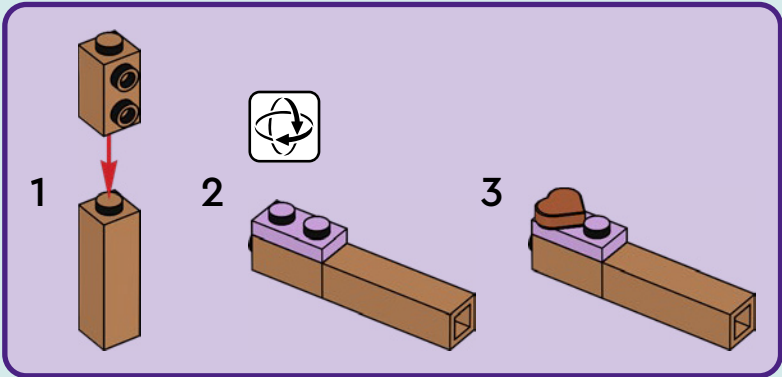

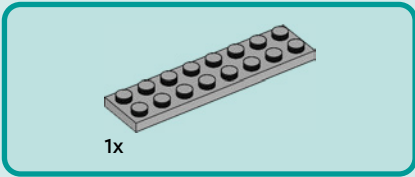

49

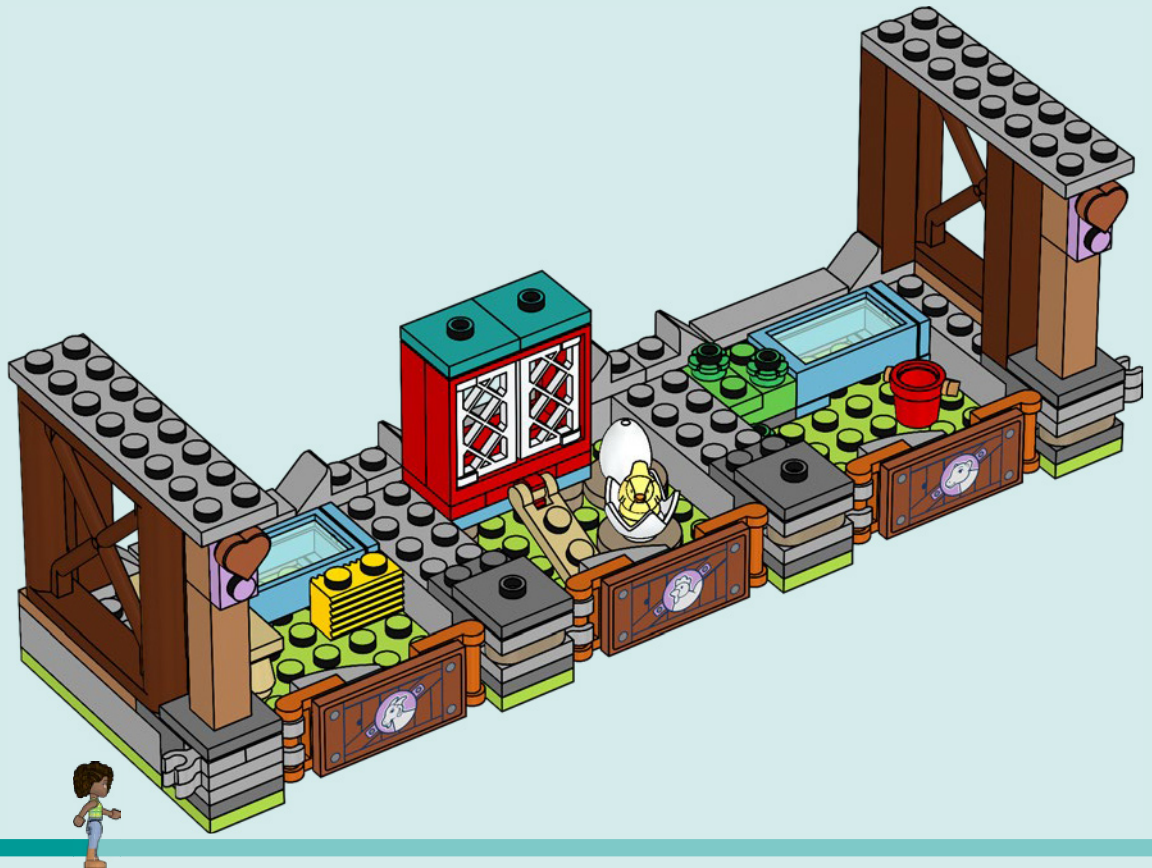

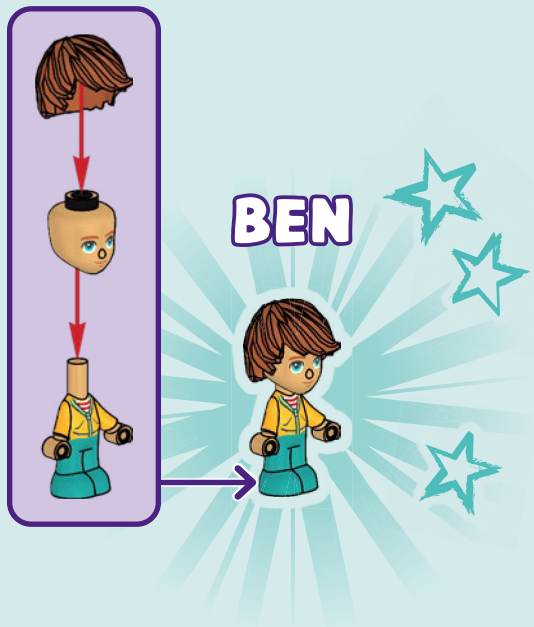

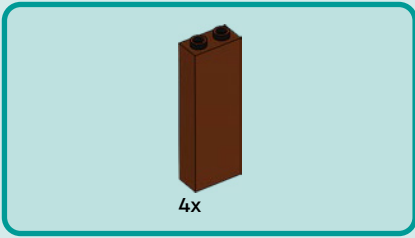

50

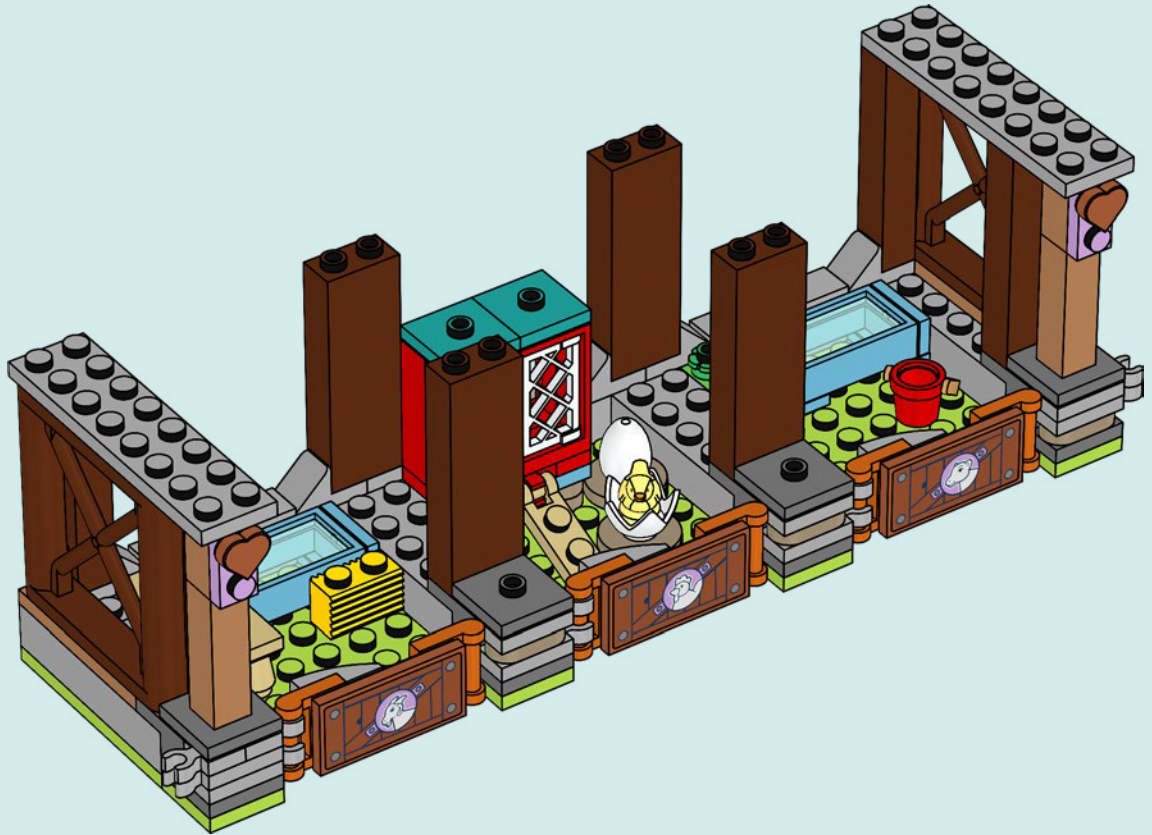

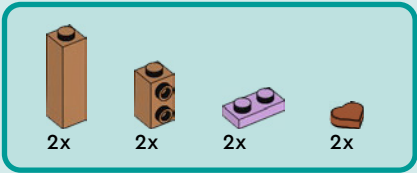

51

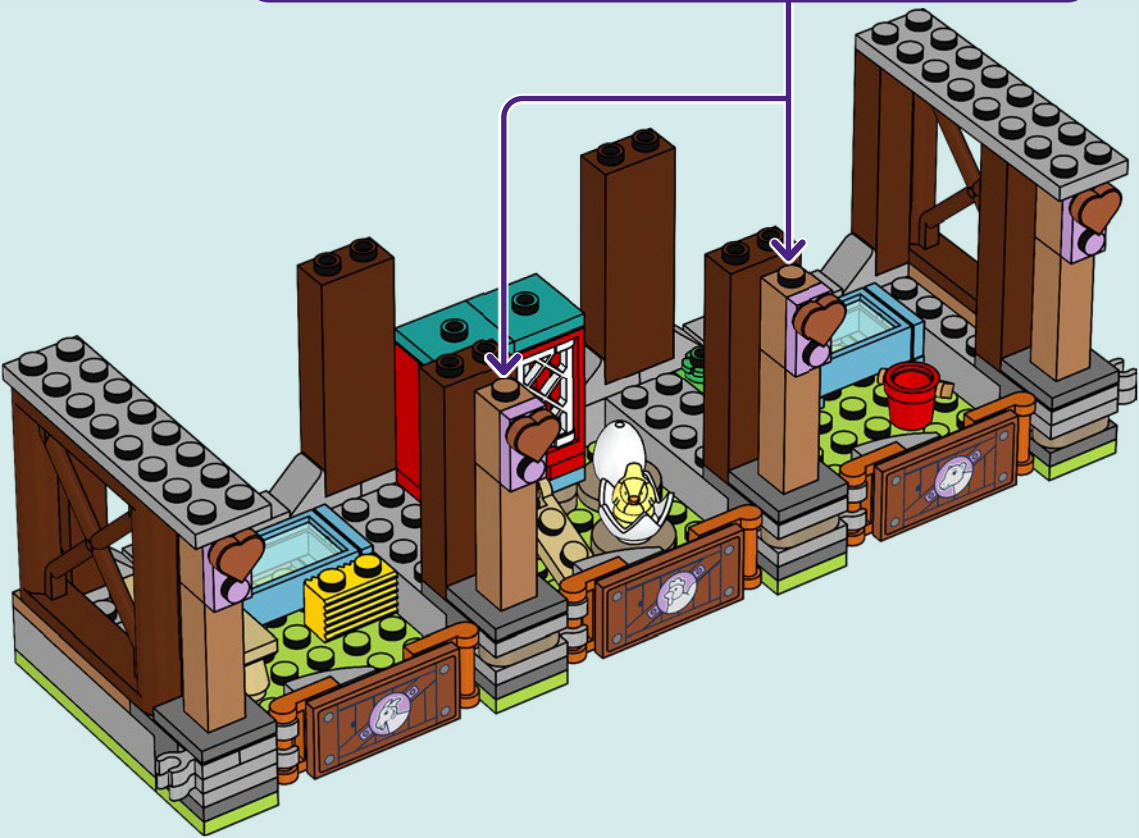
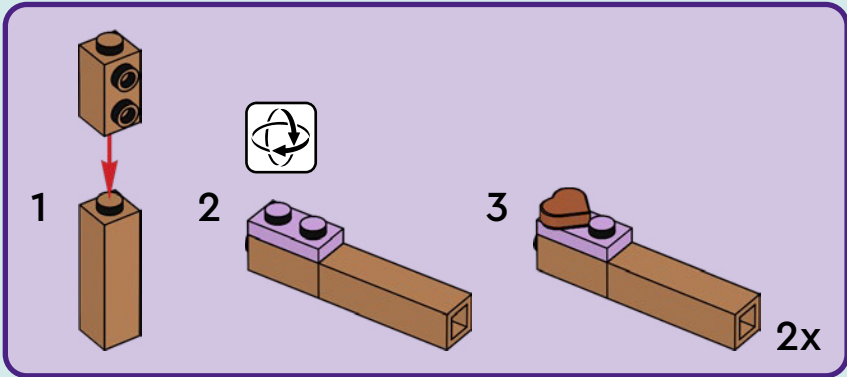



2x

52

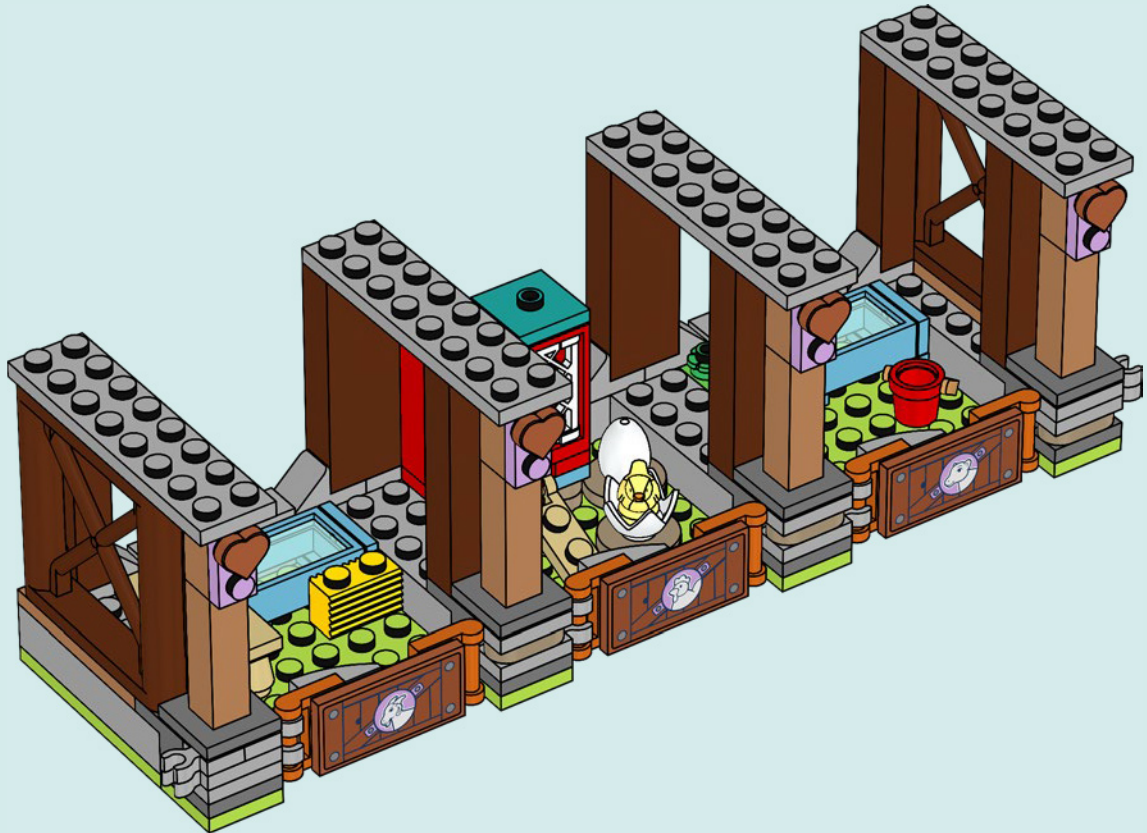

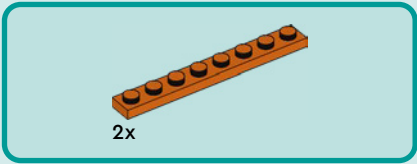

53

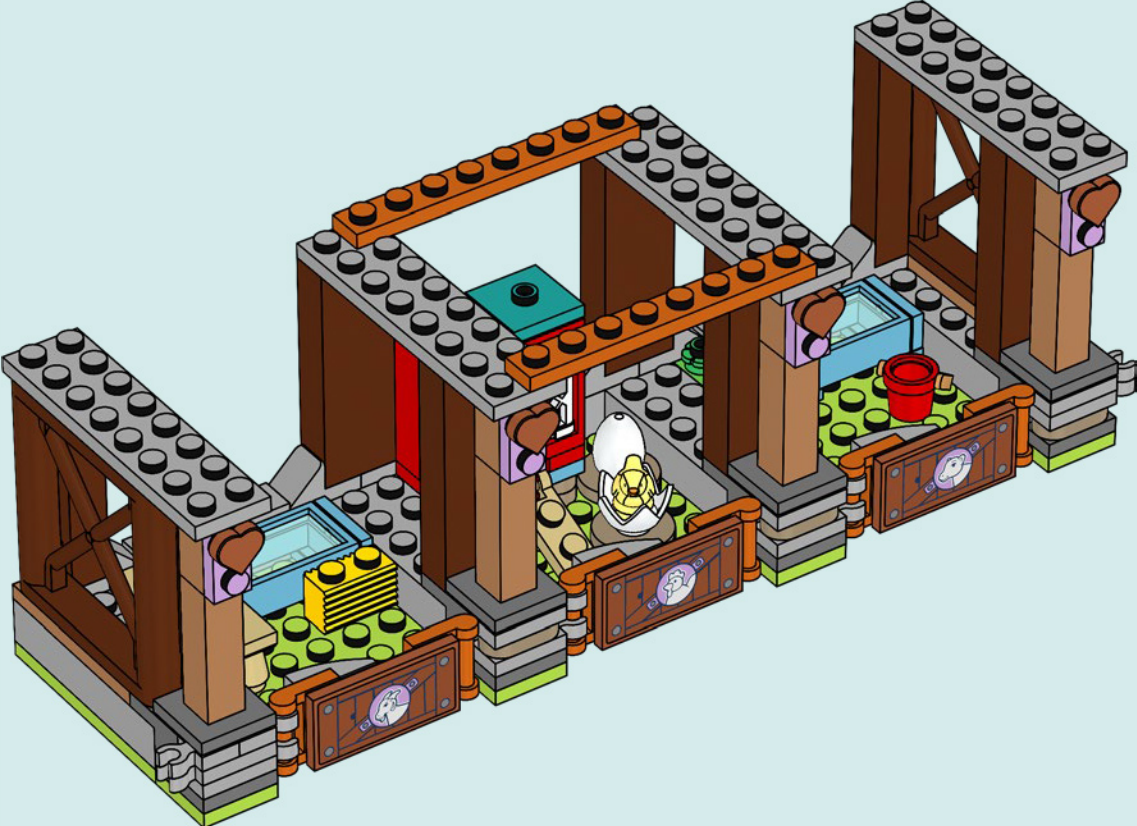



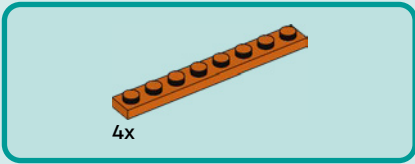

54

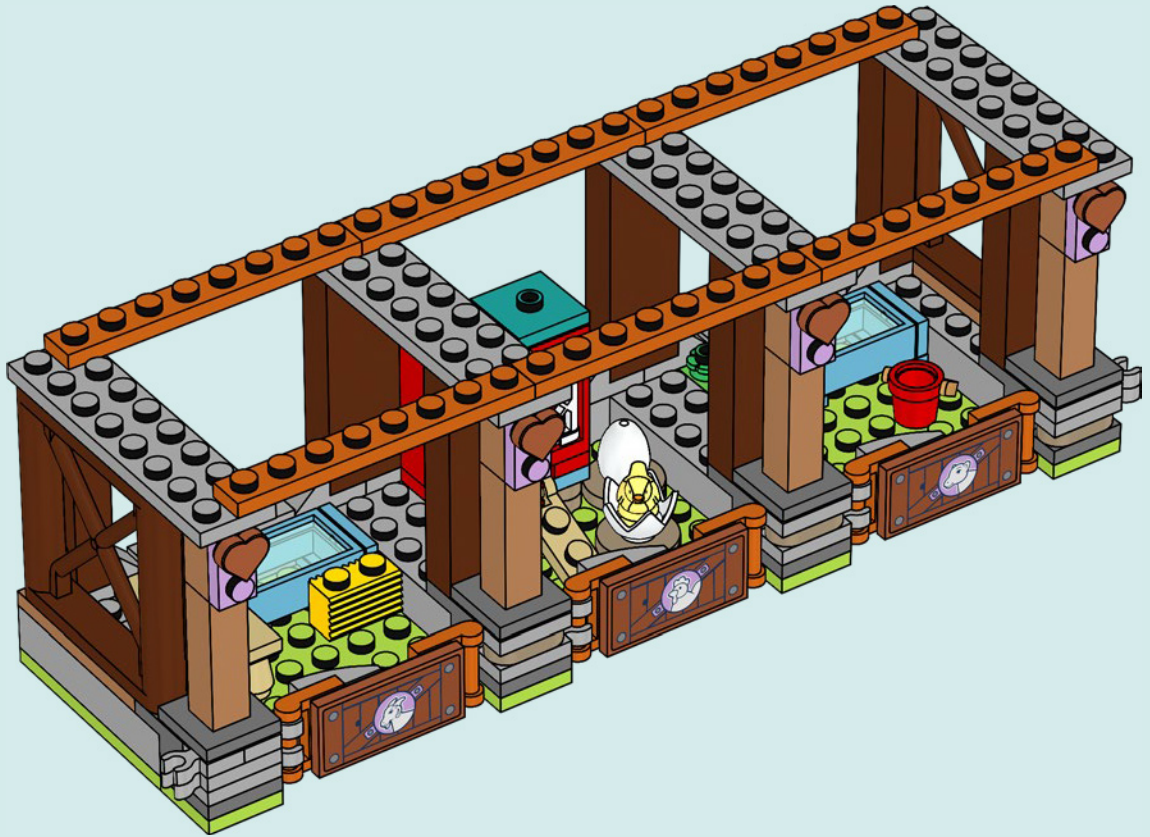



4x

55

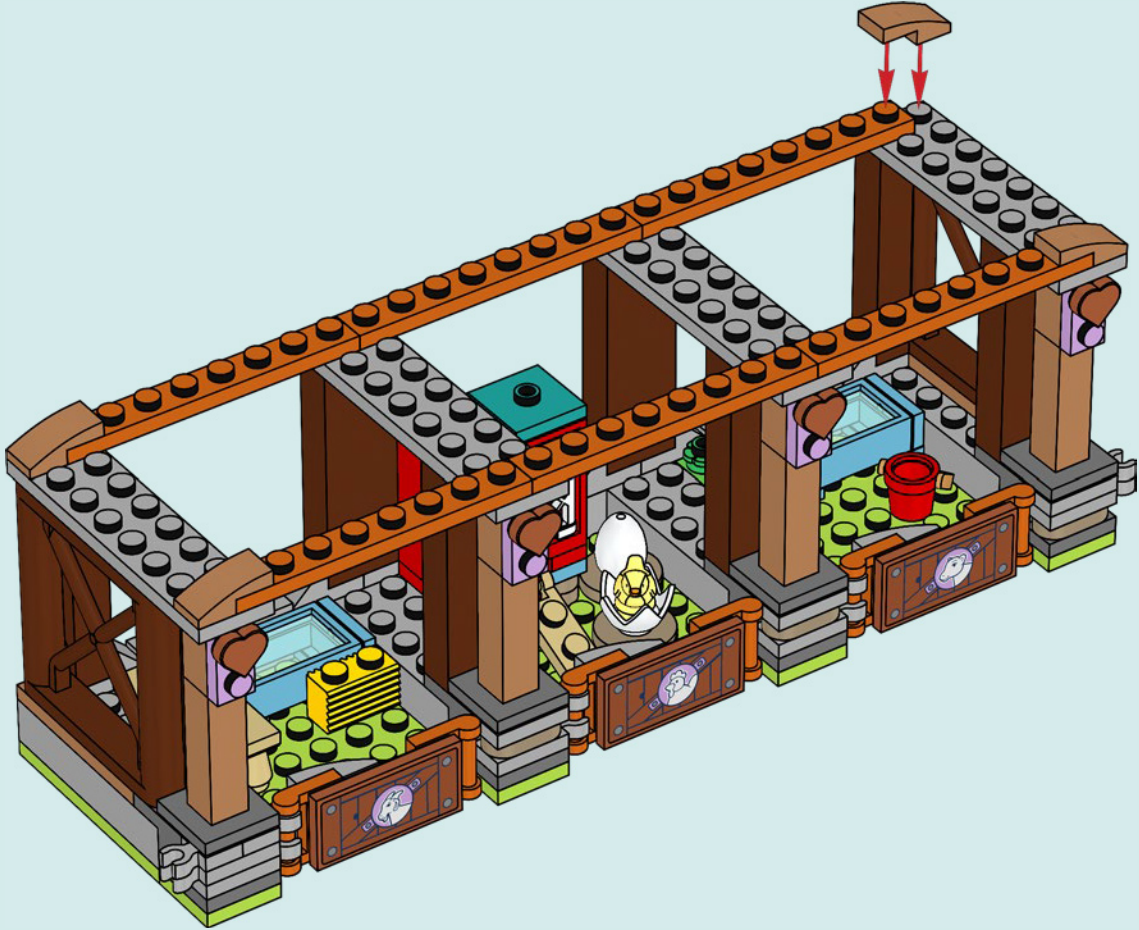

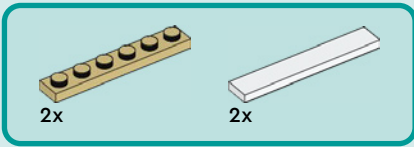

56

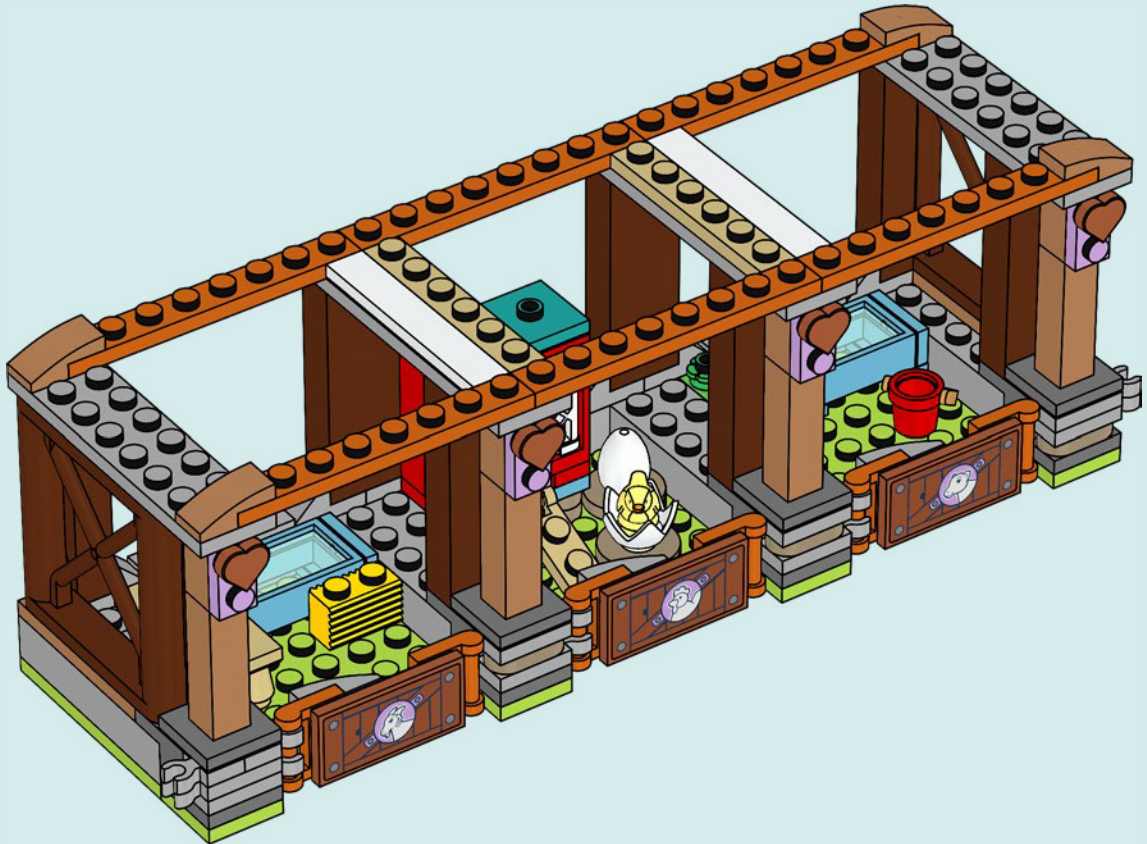

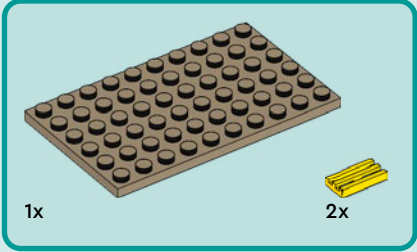
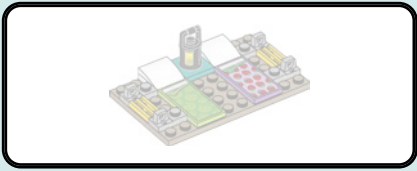

57

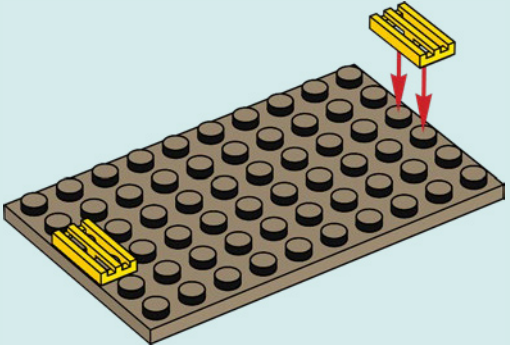



4x

58

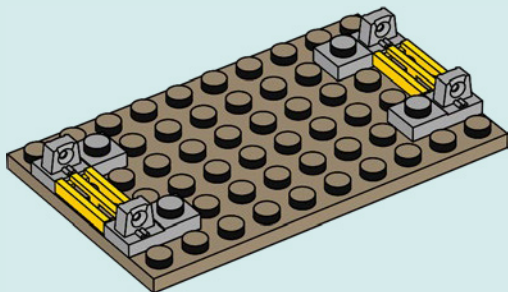

2x



1x

59

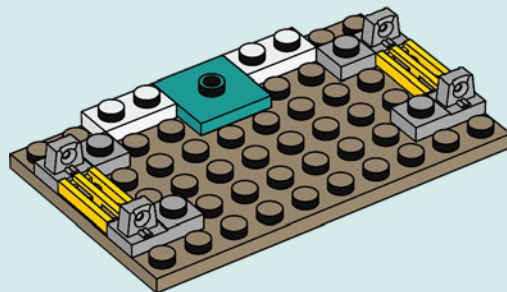



2x

60

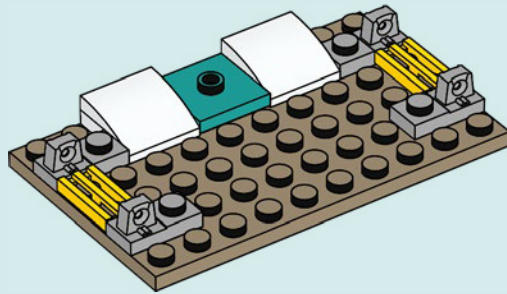

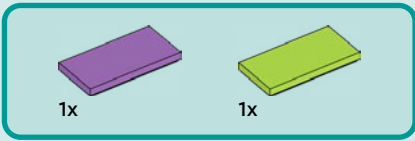

61

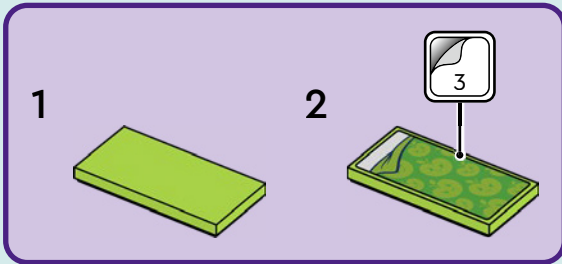
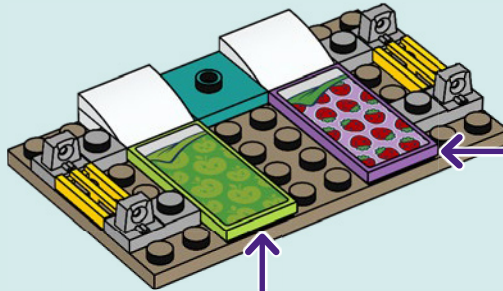
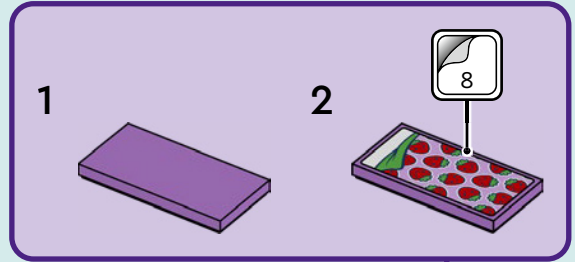



1x



1x

62

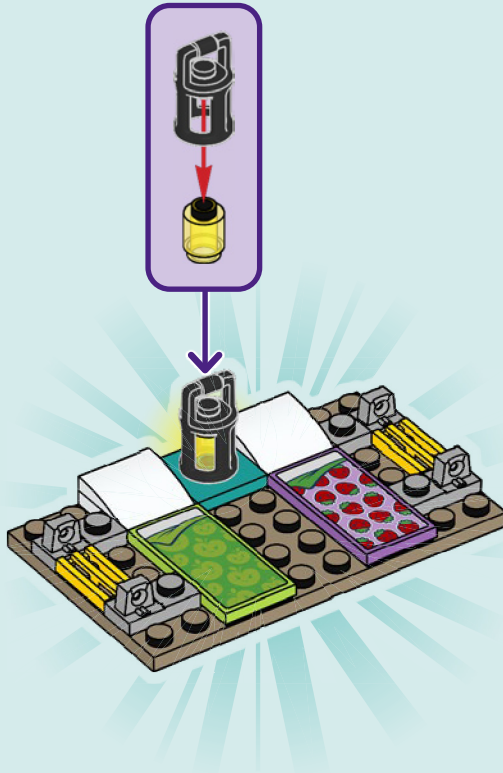



63





4x

64

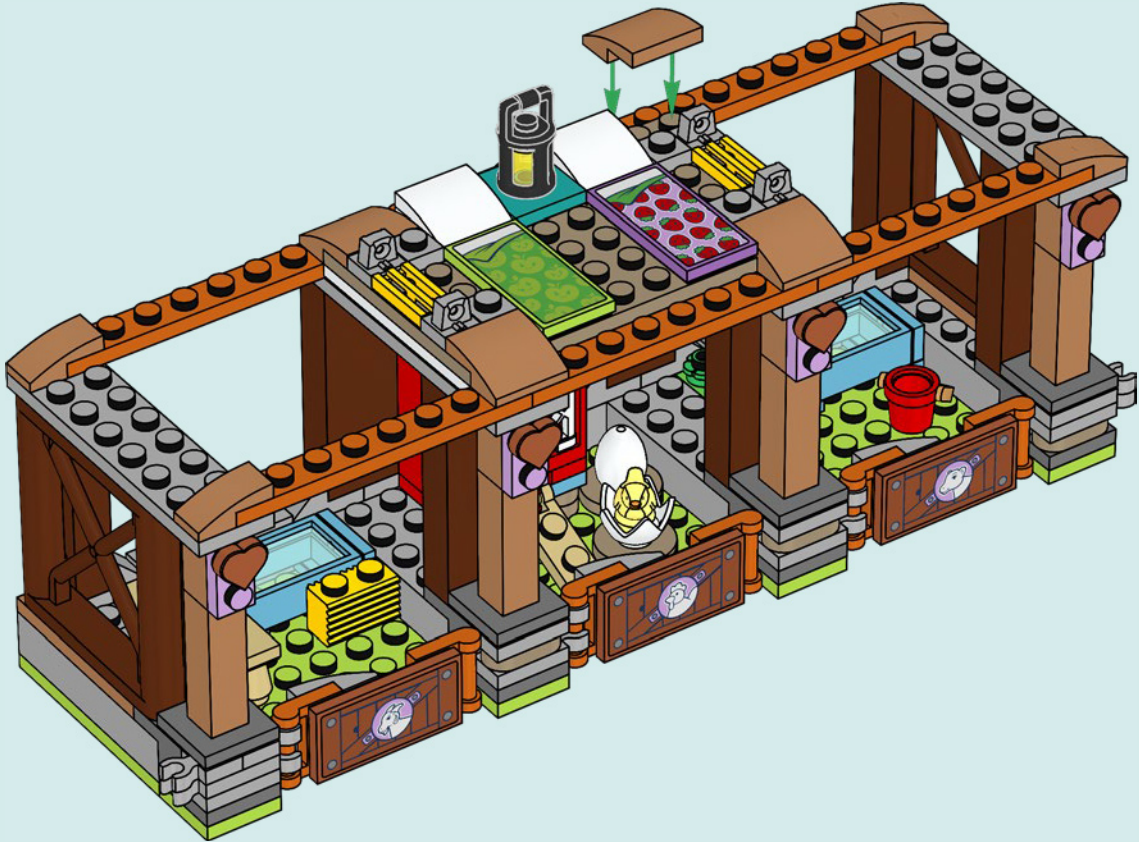



4x

65

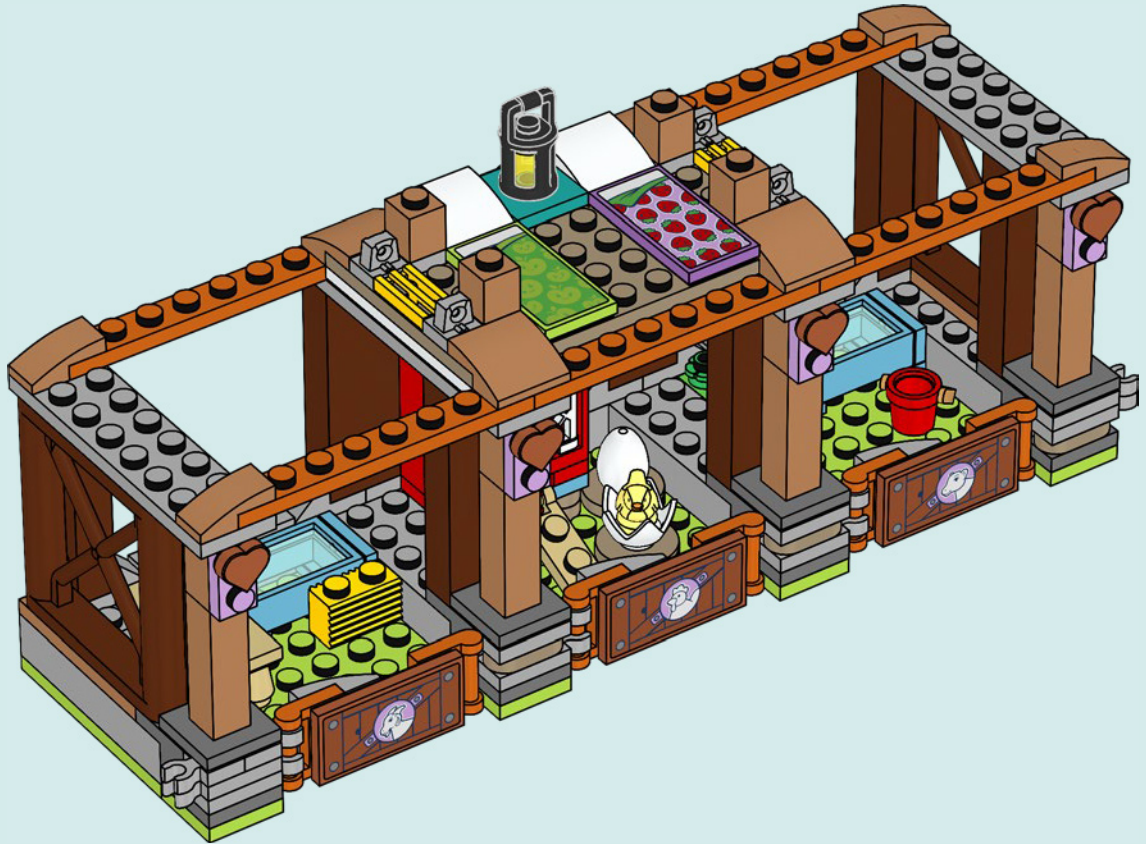

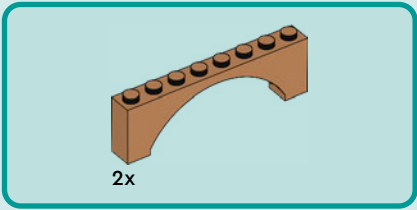

66

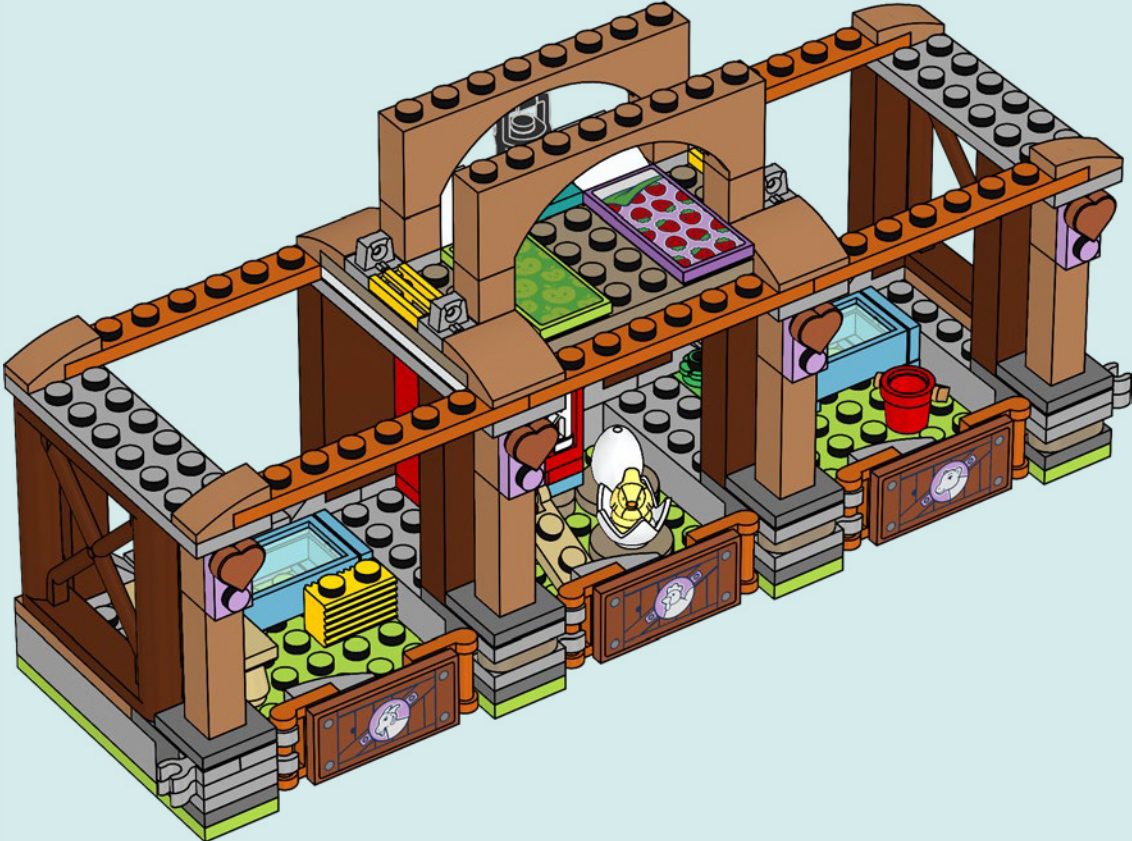



1x

67

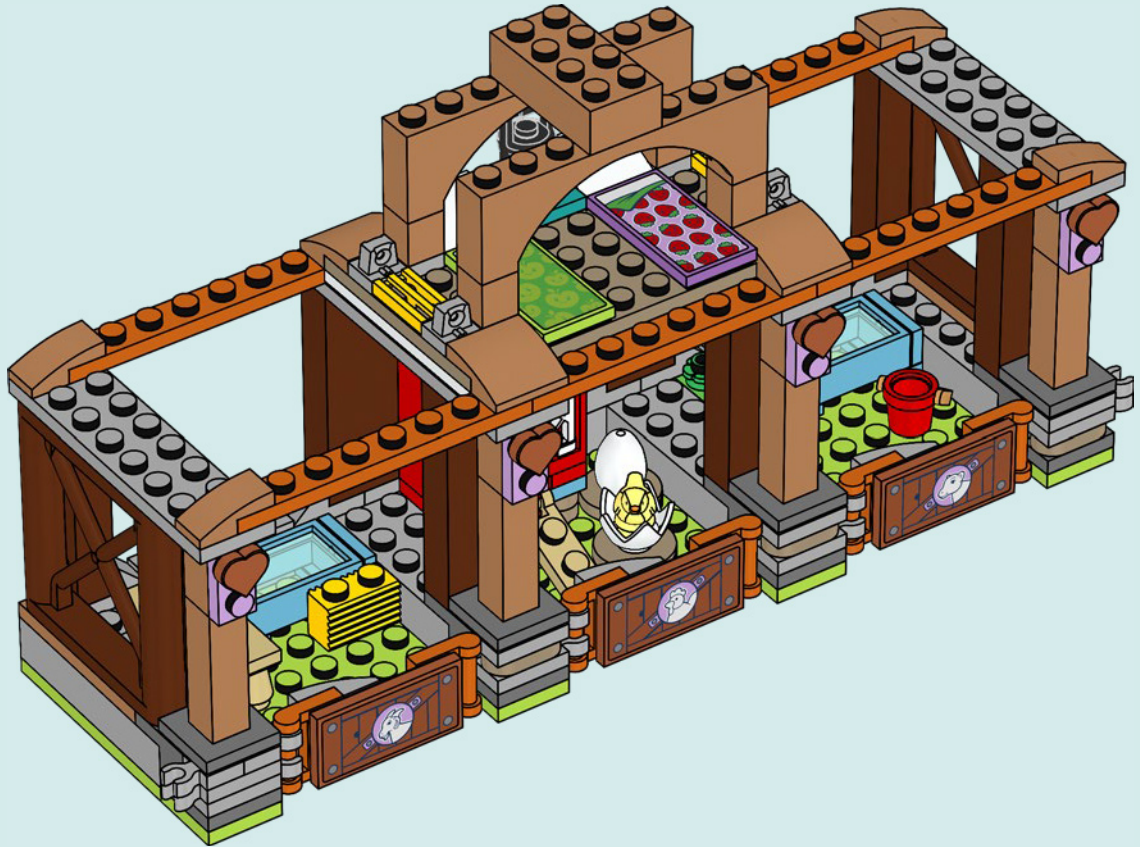

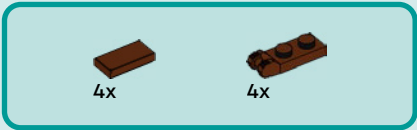

68

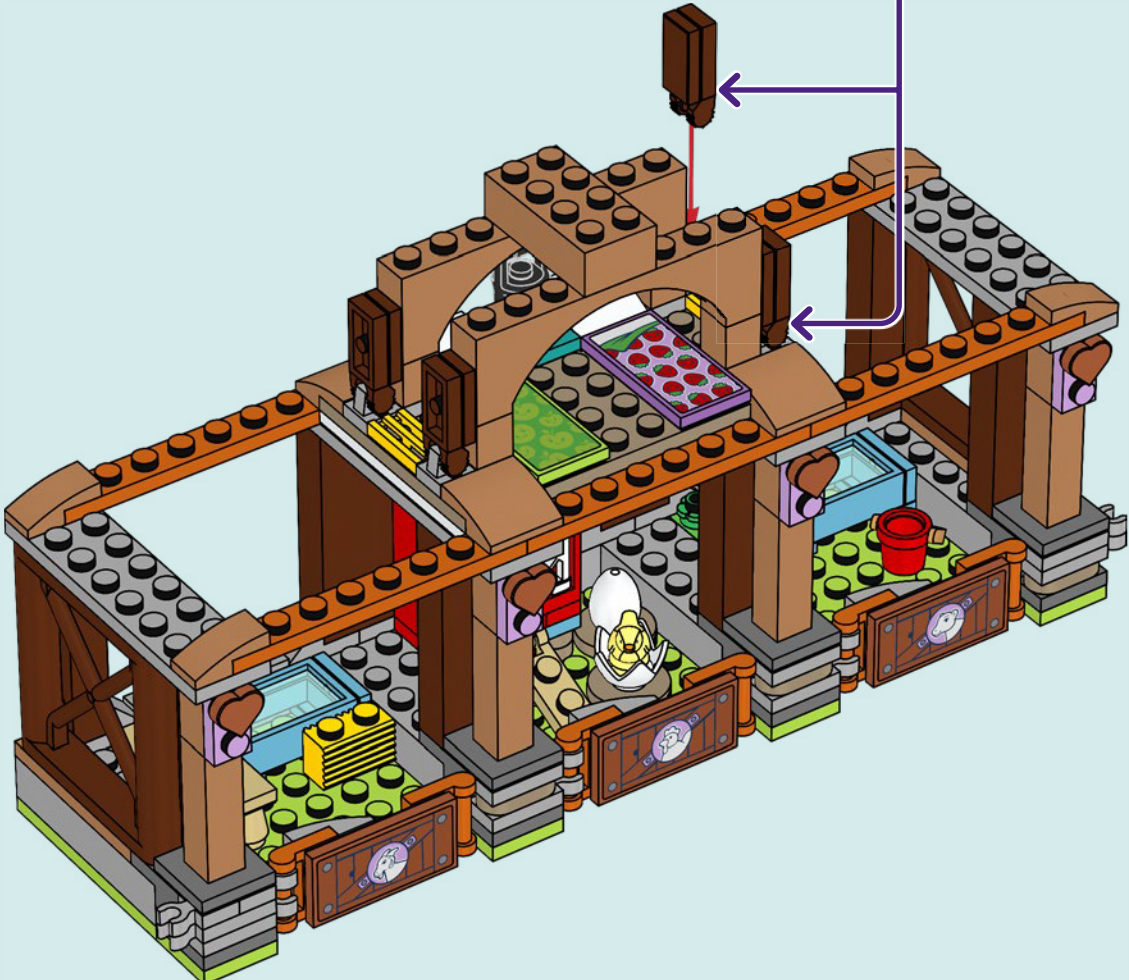
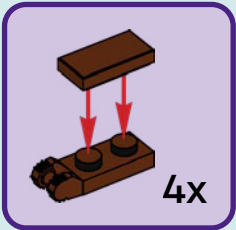





4x

70

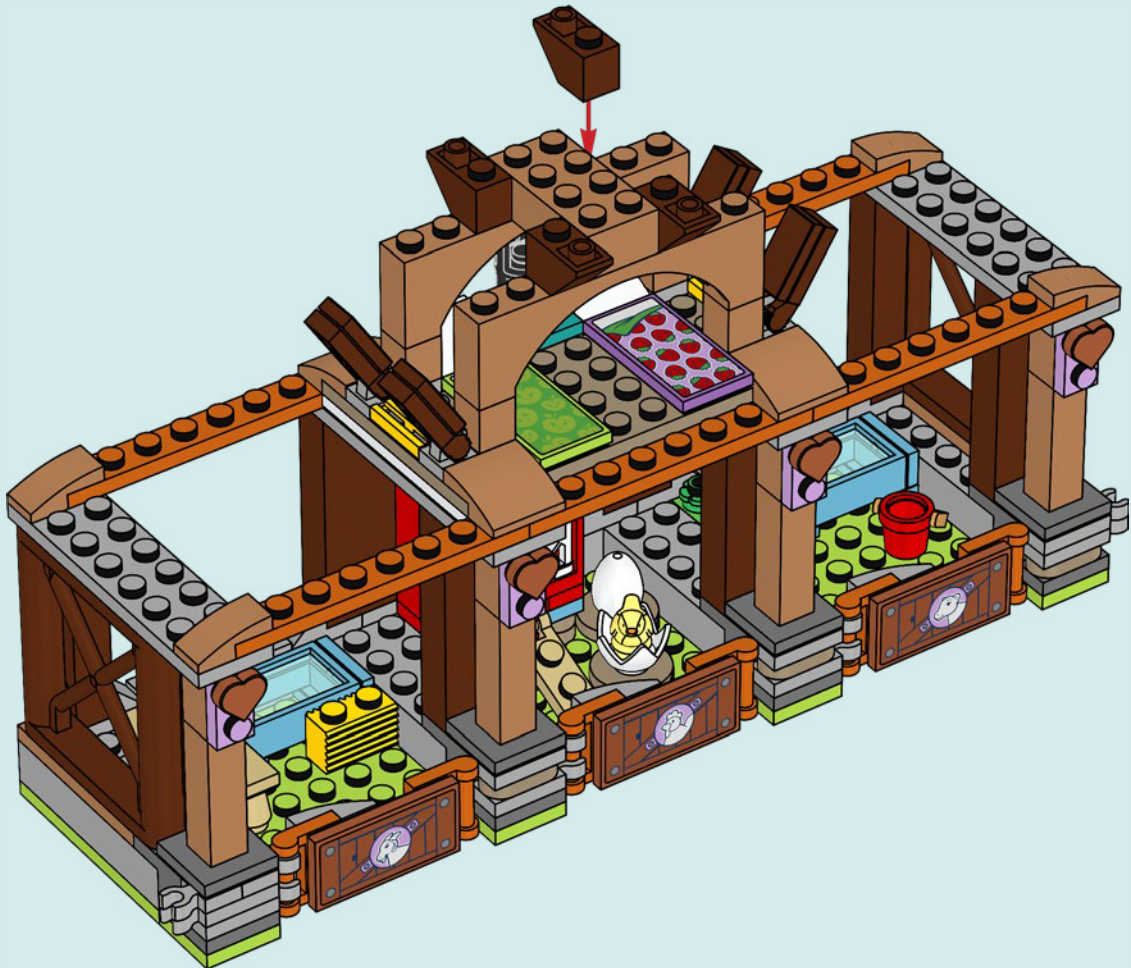





2x

71





4x

72

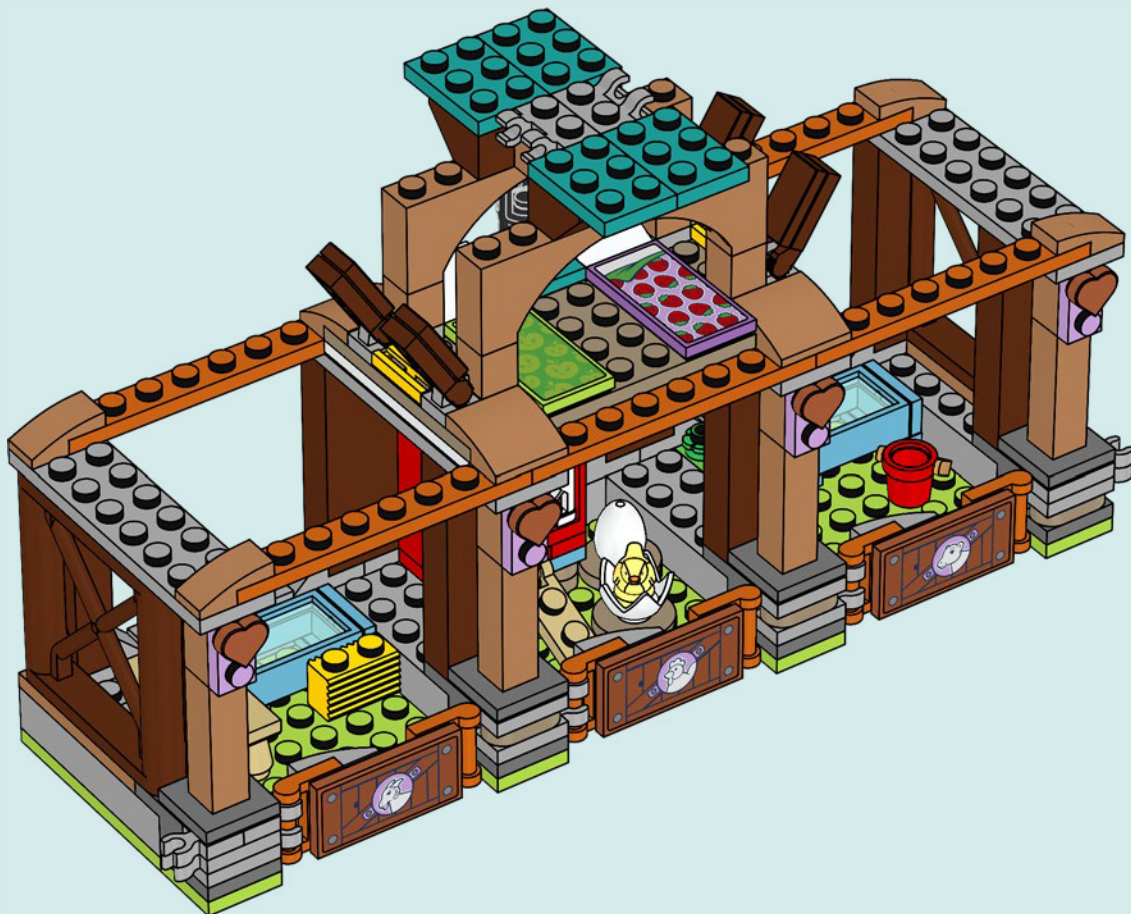

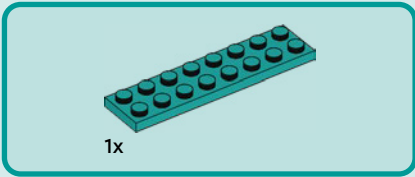

73

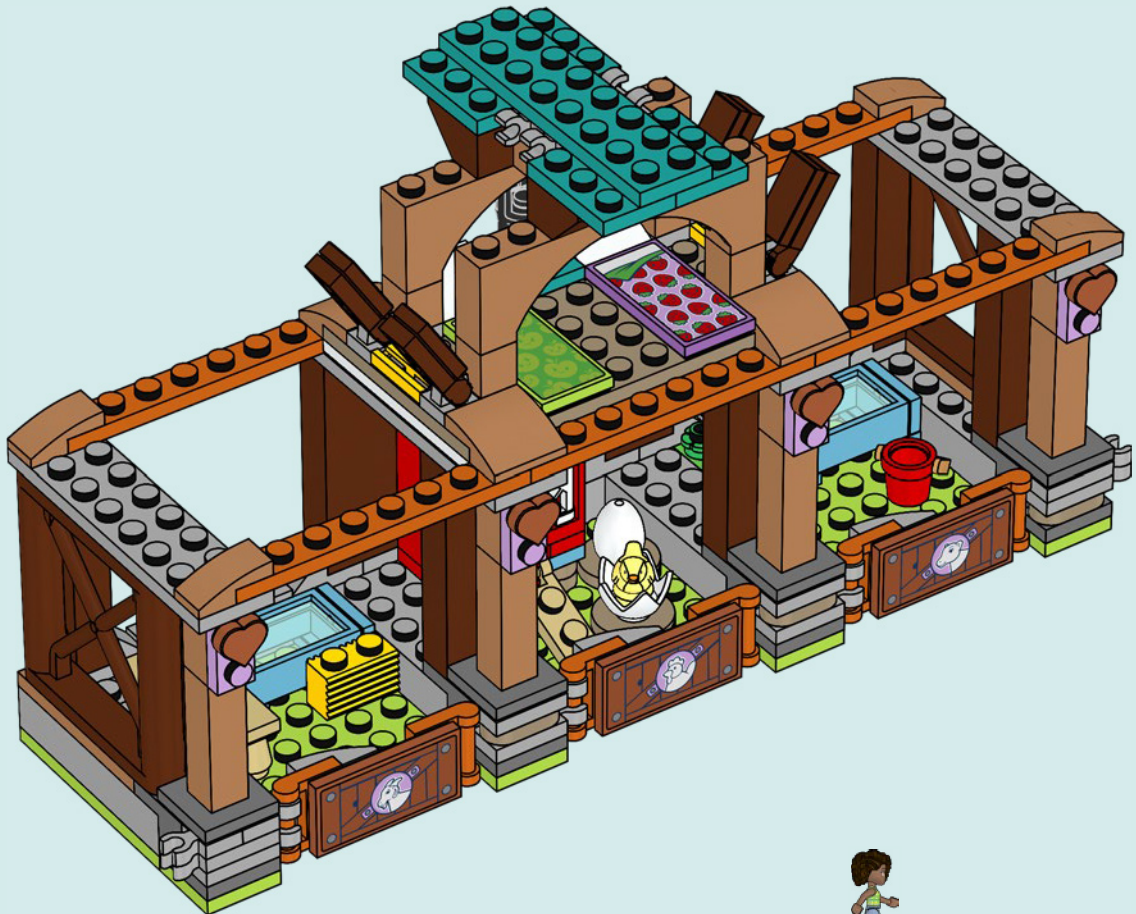

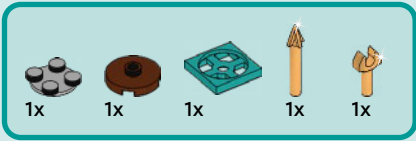

74

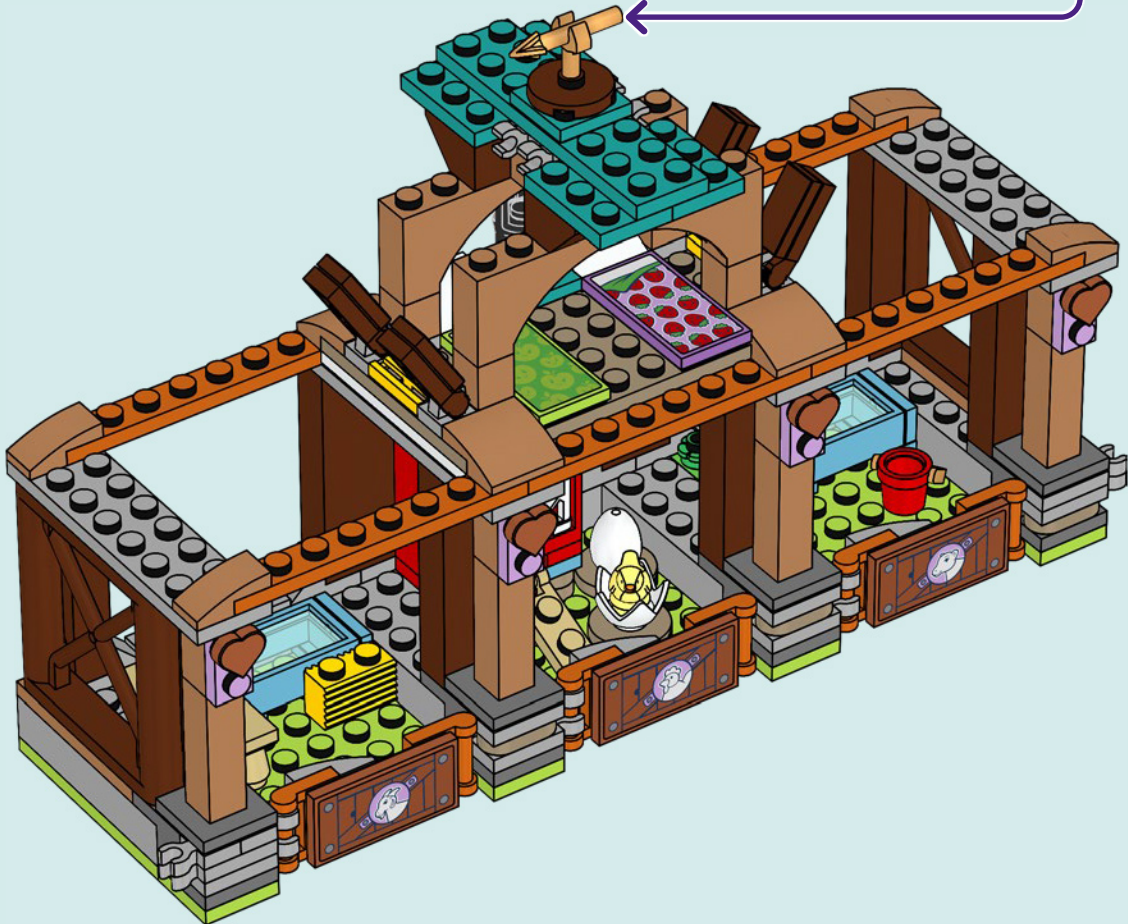
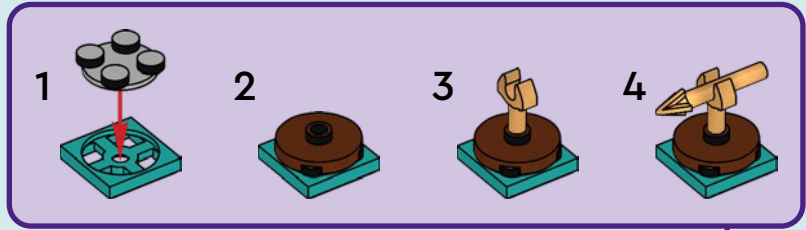

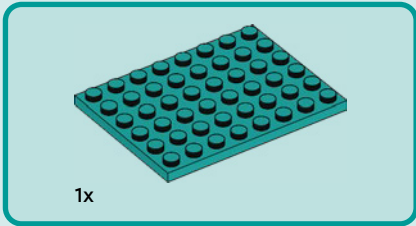
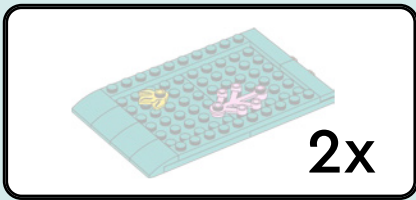

75

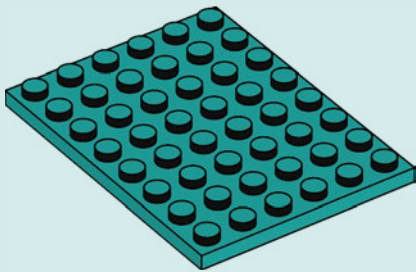

76

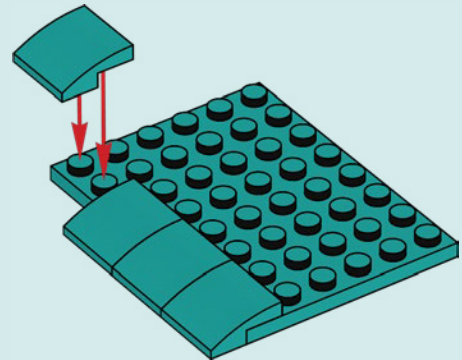

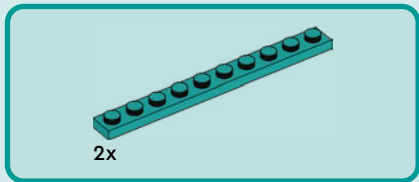

77

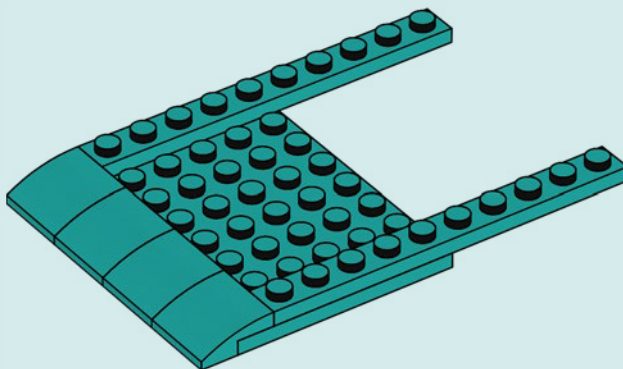

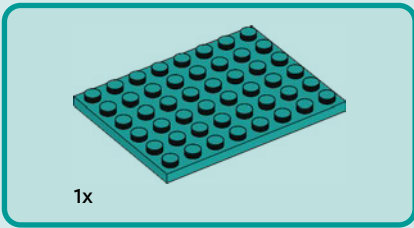

78

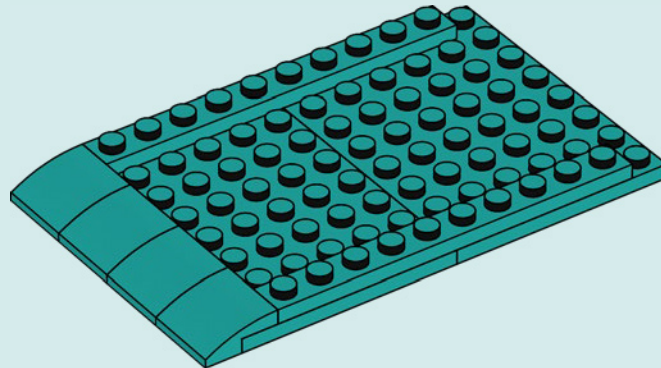



2x

79

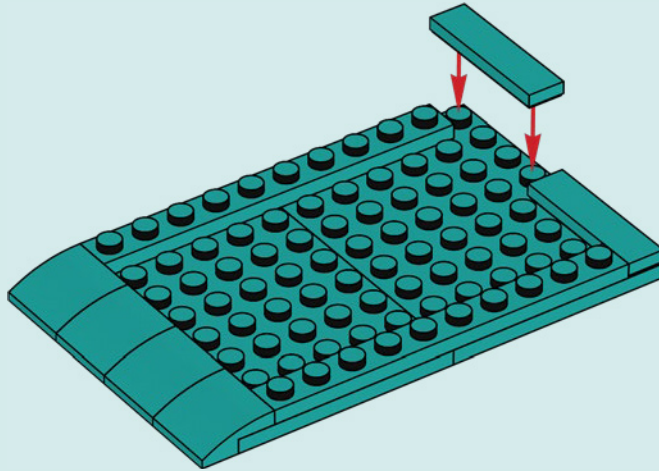





1x



1x

80

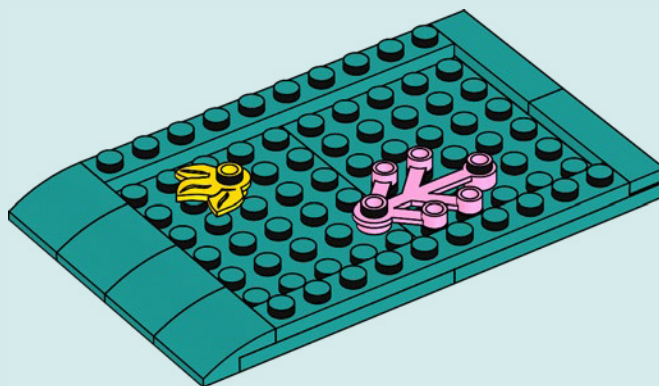



1x

81

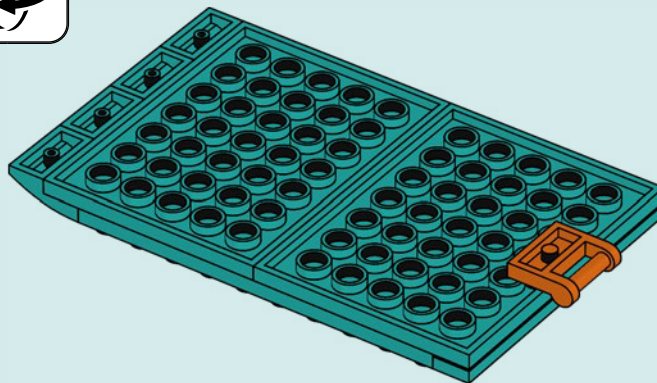



1x



2x

82

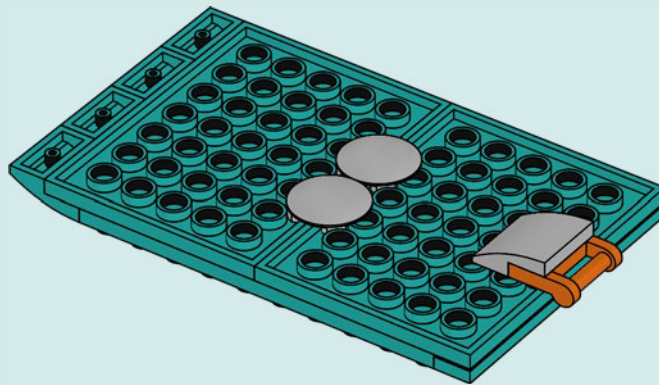

2x



83

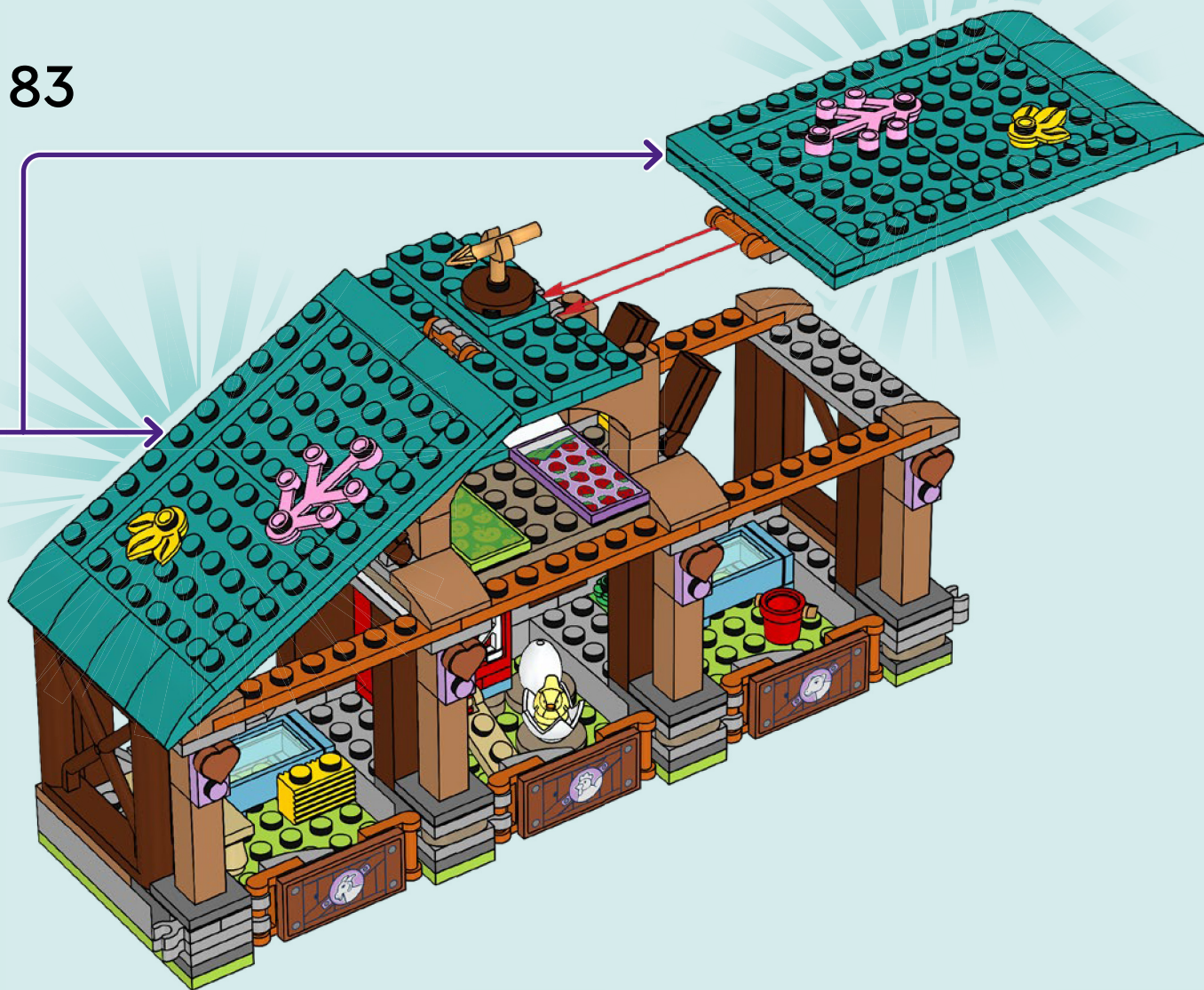







# Friends



WATCH  
SERIES  
ONLINE



Watch series online / Schau dir die Serie online an / Regarde la série en ligne / Guarda la serie online /  
Mira la serie en Internet / Assistir à série online / 在线观看 / Oglądaj serial w internecie /  
Sleduj seriál online / Pozri si seriál online / Nézd a sorozatot online / Vizionează serialul online /  
Гледайте сериала онлайн / Skaties seriālu tiešsaistē / Vaata sarja veebist / Žiūrėk serialą internetu

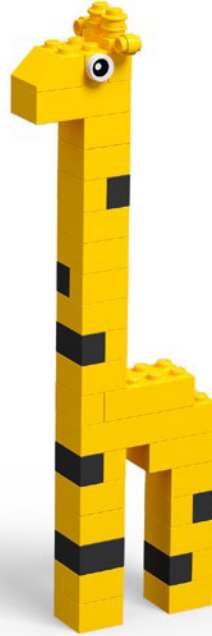
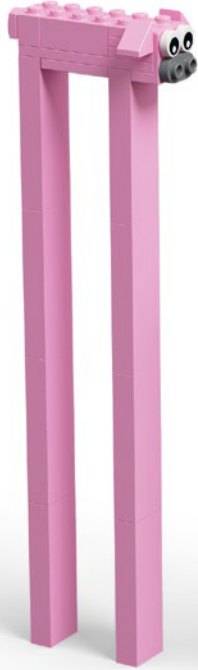

Rebuild  
the  
world™





1x  
6143595



1x  
6440114



2x  
6316757



2x  
6259700



2x  
302301



2x  
306901



2x  
6047220



2x  
663601



2x  
4529237



1x  
4113917



1x  
4523145



1x  
6211975

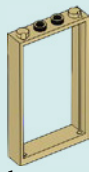

1x  
6262949



1x  
6294227



2x  
4124067



1x  
6003001



4x  
4504379



1x  
6313120



4x  
6029946



4x  
242021



1x  
6105976



1x  
302121



1x  
6369674



2x  
6138800



1x  
6431120



1x  
4560179



2x  
6476008



1x  
6470026



2x  
6299813



2x  
6286830



2x  
4170460



1x  
4169960



2x  
6331822



1x  
287724



2x  
241224



2x  
6468918



2x  
6109681



1x  
6390255



1x  
6227901



1x  
4226995



3x  
302226



2x  
4568644



2x  
4541455



1x  
6466339



1x  
4187209



2x  
4619323



1x  
6338416



1x  
6354604



1x  
416226



1x  
4286009



2x  
6382575



1x  
6210271



2x  
4119479



1x  
6343326



1x  
6469464



6x  
6467786



1x  
6093518



3x  
6058089



2x  
6274738



4x  
6223655



1x  
6246888



6x  
6238673



2x  
6264033



1x  
6238674



2x  
6244907



2x  
6424015



1x  
6293265



3x  
6290269



8x  
6223665



1x  
6466772



4x  
6249417



4x  
6442379



4x  
6292786



1x  
6257063



4x  
6433414



4x  
6424456

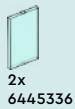

2x  
6445336



2x  
6286831



1x  
6361353



4x  
4537937



2x  
6013530

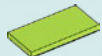

1x  
6212989



2x  
4537936



2x  
6173012



2x  
4529160



2x  
6133225

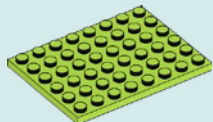

3x  
6100914

90



9x  
6231386



2x  
6132767



2x  
6146234



1x  
6310835



2x  
4528604



2x  
6093038

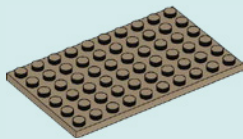

1x  
6096215



2x  
4521948



2x  
6075623



1x  
6407809



2x  
6100234



1x  
6465579



1x  
6467072



1x  
6438899



4x  
4226966



1x  
4211157



1x  
6102360



6x  
4211222



4x  
4211151



6x  
4277016



4x  
6428805



4x  
6452013



1x  
4211279



2x  
4538252



2x  
6470025



1x  
6278548



1x  
6270119



1x  
6436420



1x  
4211503



4x  
6401023



10x  
6296894



4x  
4278273



1x  
4540203



1x  
6395349



6x  
6093859



4x  
6265694



4x  
4211388



2x  
6015344



1x  
4211440



2x  
6000066



2x  
6337268



12x  
6354568



5x  
6185676



1x  
6273227



1x  
6302648



2x  
6168615



1x  
6466340



3x  
4211356



3x  
4211395



2x  
4211393



4x  
4211795



4x  
4211406



2x  
6467807



2x  
6465604



1x  
6162580



1x  
6453281



1x  
6245278



2x  
6133832



1x  
6409768



3x  
6287844



2x  
6329957

3x  
6271752

1x  
6365695

1x  
4210636

2x  
6146225

2x  
6275131

8x  
6126083

2x  
4211000

1x  
6469463

5x  
6395363

3x  
4211043

1x  
4211006

1x  
4211002

4x  
6057986

4x  
6360035

6x  
6422082

6x  
6378362

4x  
6356566

1x  
4569382

2x  
6313132

1x  
6313599

4x  
6312473

1x  
6102990

2x  
6292145

2x  
6365746

1x  
6167700

1x  
6135191

1x  
6093494

1x  
6218359

2x  
6343854

1x  
6468917

2x  
6313662

1x  
6226644

1x  
6412881

1x  
6416663

1x  
6414568

6x  
4649741

2x  
6468358

2x  
6071246

1x  
4655256

1x  
6292824

1x  
4625036

1x  
6177197

1x  
6173813

1x  
4651902

1x  
6329604

1x  
4619636

1x  
6167576

1x  
6428824

1x  
6295242

1x  
6475152

1x  
6466204

8x  
6470072

8x  
6468361

7x  
6467485

3x  
6135287

1x  
4243668

1x  
4569836

7x  
6322820

9x  
6099190

4x  
6471272



 [LEGO.com/service](https://www.LEGO.com/service)

YOU COULD **WIN**



Scan this QR code or go to  
**LEGO.COM/PRODUCTFEEDBACK** and give us  
your short feedback about this LEGO® set for a  
chance to win a cool LEGO prize.

Terms and Conditions apply\*

**EN: YOU COULD WIN.** Terms and Conditions apply\* **DE: Du könntest GEWINNEN.** Es gelten die Teilnahmebedingungen\* **FR: Tu pourrais GAGNER.** Des conditions s'appliquent\* **IT: Potresti VINCERE tu.** Termini e condizioni sono applicabili\* **ES: Puedes GANAR.** Aplican términos y condiciones\* **PT: Poderá GANHAR.** Aplicam-se termos e condições\* **ZH: 轻松获奖. 条款和条件适用\*** **PL: Szansa na WYGRANĄ.** Obowiązują warunki korzystania\* **CS: Máte šanci VYHRÁT.** Platí všeobecné smluvní podmínky\* **SK: Máte šancu VYHRAŤ.** Platia všeobecné zmluvné podmienky\* **HU: TE IS NYERHETSZ.** Felhasználási feltételek érvényesek\* **RO: Ai putea CÂȘTIGA.** Se aplică termeni și condiții\* **BG: Можете да СПЕЧЕЛИТЕ.** Има определени правила и условия\* **LV: Tu vari LAIMĒT.** Ir spēkā noteikumi un nosacījumi.\* **ET: Sul on võimalus VÕITA.** Kehtivad tingimused\* **LT: Jūs galite LAIMĖTI.** Taikomos sąlygos\*

\*[LEGO.com/productfeedback-terms](https://www.lego.com/productfeedback-terms)