



# Friends

42624



LEGO® Builder



LEGO.com/sustainable-packaging



FR  
**DONNEZ**  
OU  
**RECYCLEZ**



OU



OU



ASSOCIATION

MAGASIN

DÉCHÈTERIE

Adresses sur [quefairedemesdechets.fr](http://quefairedemesdechets.fr)

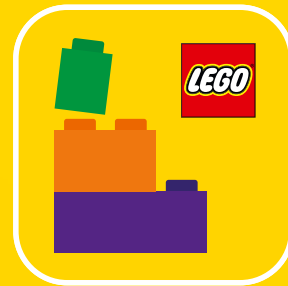

Q LEGO® Builder

# BUILDER



Apple and the Apple logo are trademarks of Apple Inc., registered in the U.S. and other countries and regions. App Store is a service mark of Apple Inc. Google Play and the Google Play logo are trademarks of Google LLC. Tencent and the Tencent logo are trademarks of Tencent Inc.

Q [LEGO.com/devicecheck](https://LEGO.com/devicecheck)

EN Ask parents' permission before going online | DE Eltern um Erlaubnis bitten, bevor du online gehst | FR Demande l'autorisation d'un parent avant d'aller en ligne | IT Chiedi il permesso ai tuoi genitori prima di andare online | ES Pídeles permiso a tus papás antes de conectarte a Internet | PT pede autorização aos pais antes de acederes online | ZH 上网前应先征得父母的同意 | PL Poproś rodziców o zgodę, zanim wejdiesz do Internetu | CS Než půjdeš na internet, požádej rodiče o svolení | SK Skôr než pôjdeš na internet, vypýtaj si povolenie od rodičov | HU Kérj szülői engedélyt, mielőtt online csatlakoznál! | RO Cere permisiunea părinților înainte de a te conecta online | BG Поискайте разрешение от родител, преди да влезете онлайн | LV Pirms došanās tiešsaistē palūdz atļauju vecākiem | ET Enne Interneti kasutamist küsi vanematelt luba | LT Prieš prisijungdami prie interneto, atsislaukite tėvų



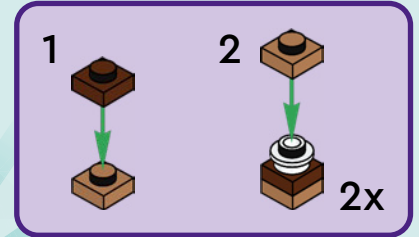
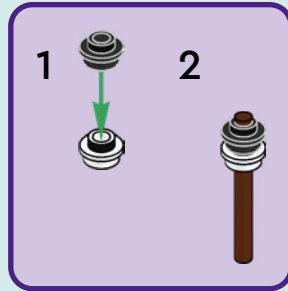
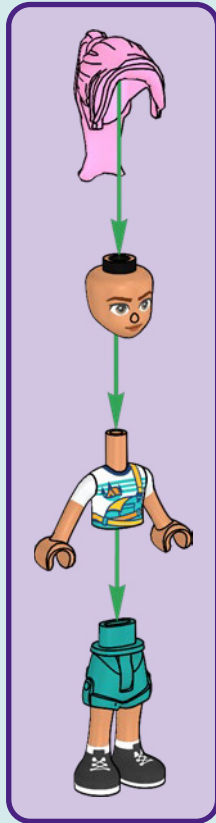

SKY

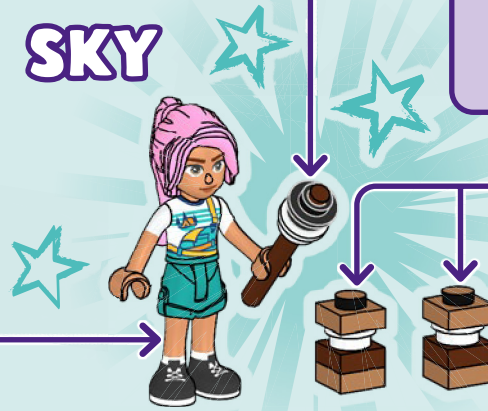

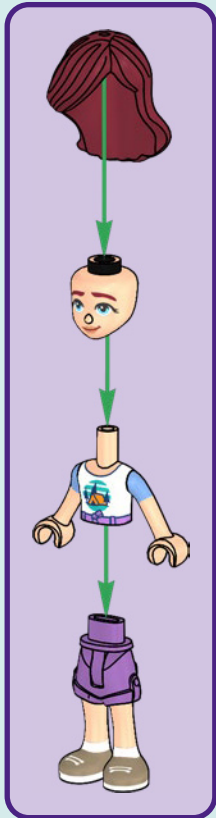

# PAISLEY





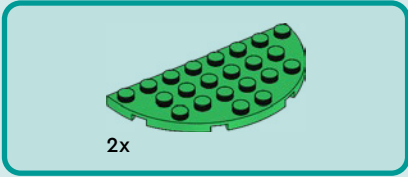

1

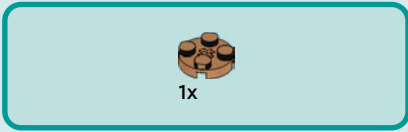
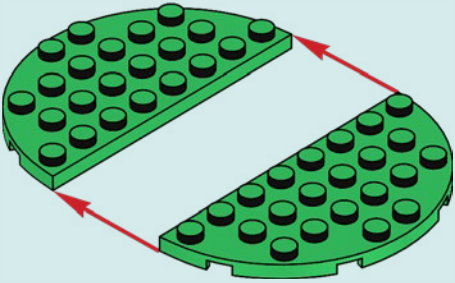

2

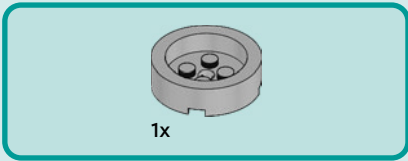
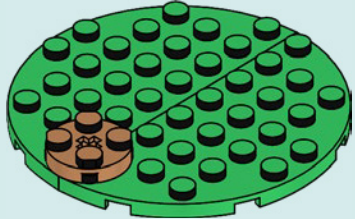

3

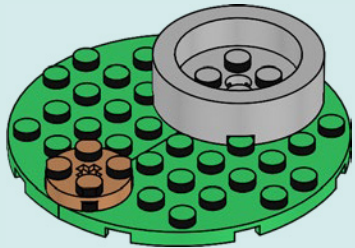





2x

4

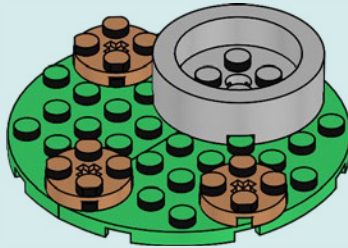

2x



3x

5

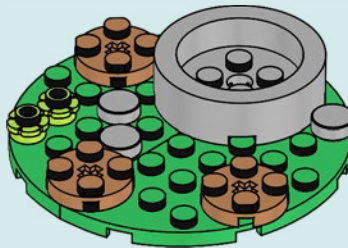



6

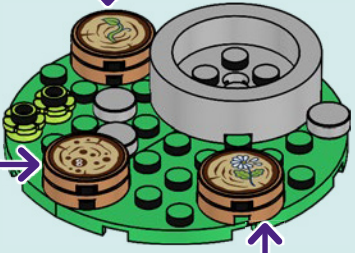
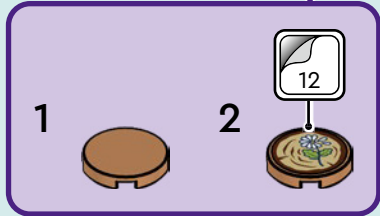

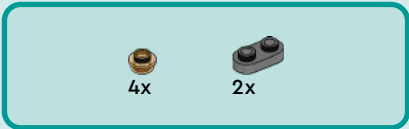

7

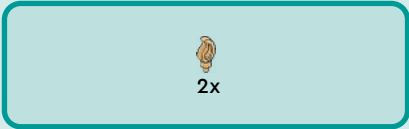
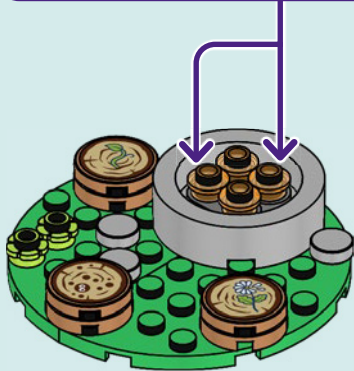
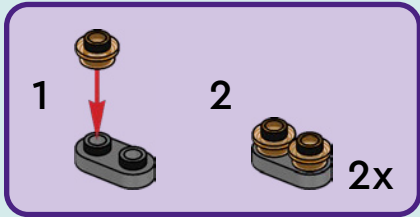

8

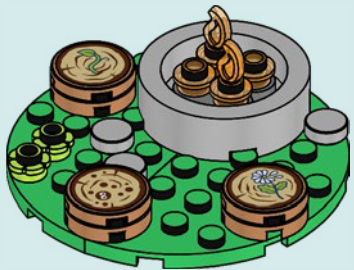



2x

9

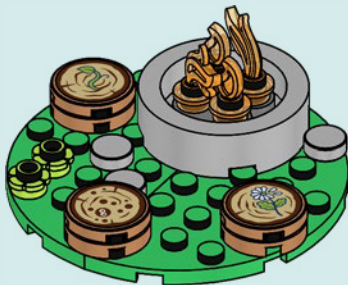

2x



4x

10

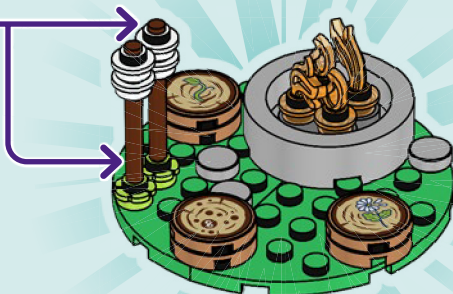
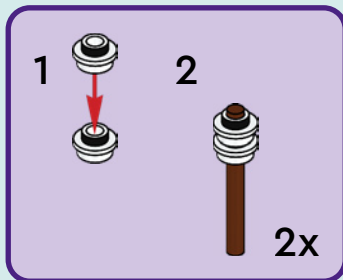



1x

11



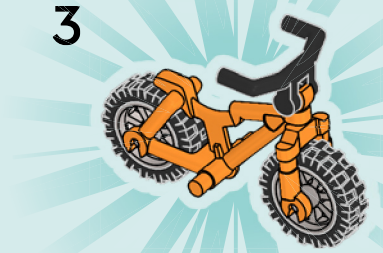
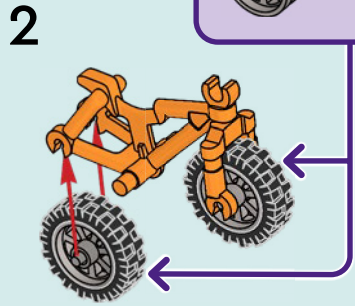
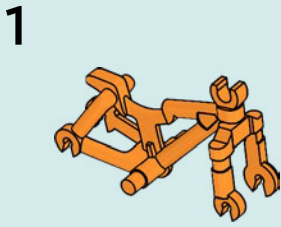
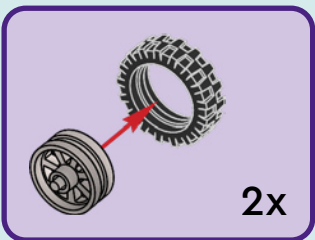
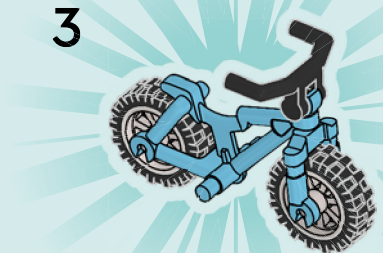
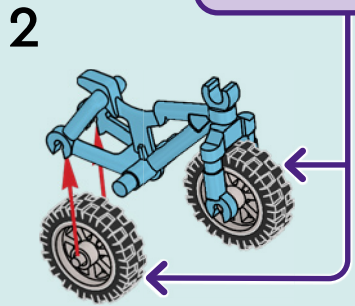
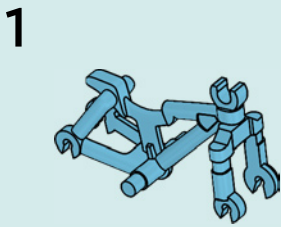
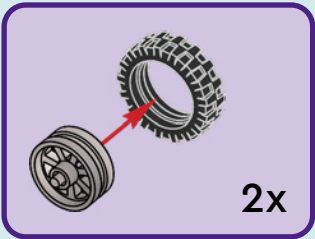
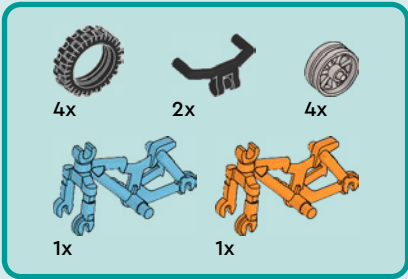

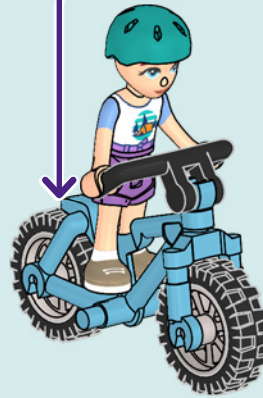
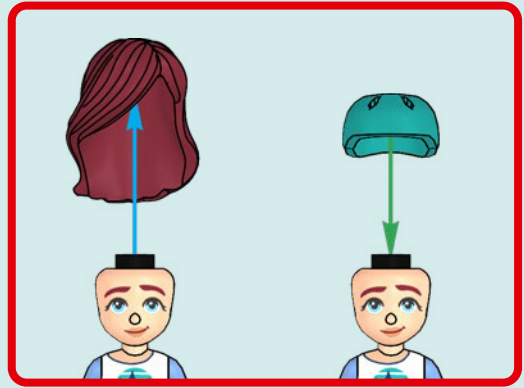
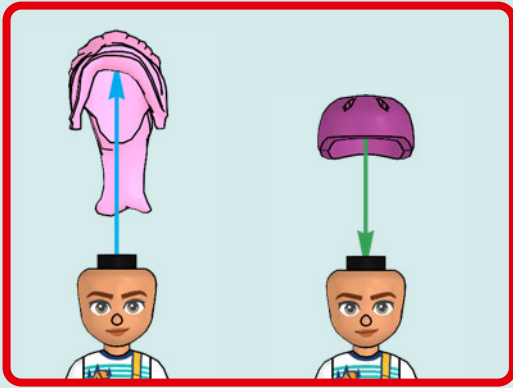

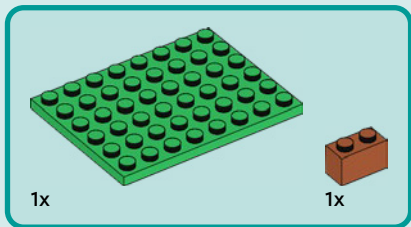
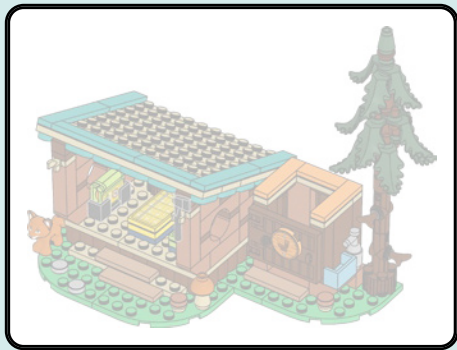

1

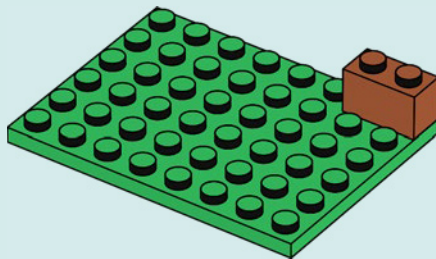



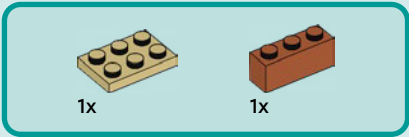

2

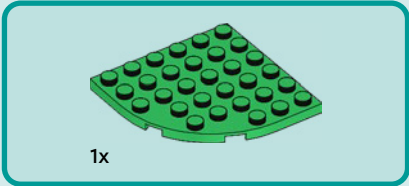
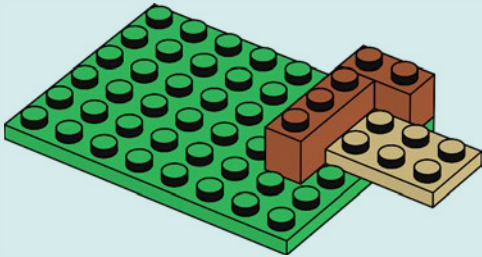

3

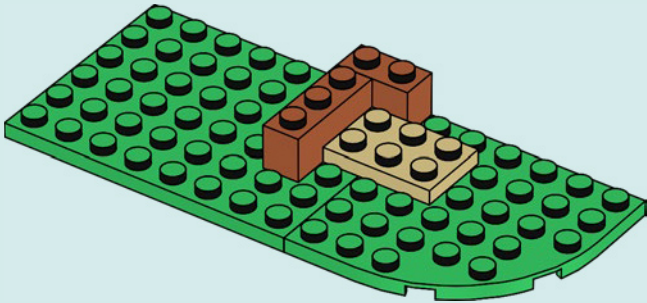



1x

4

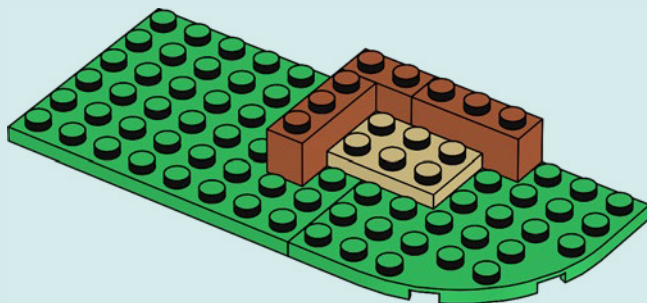

1x



1x

5

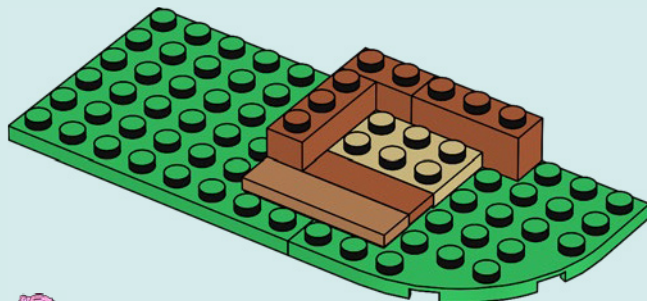

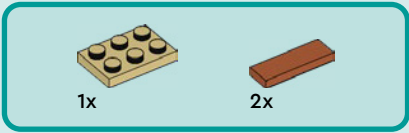

6

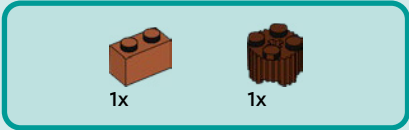
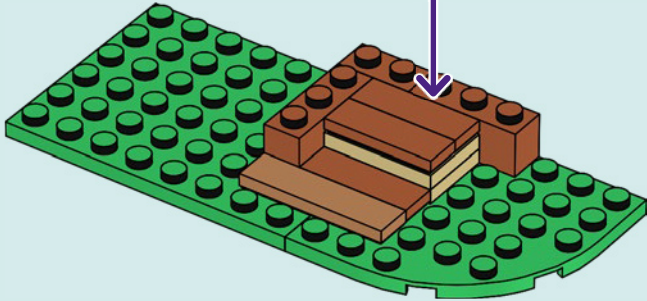
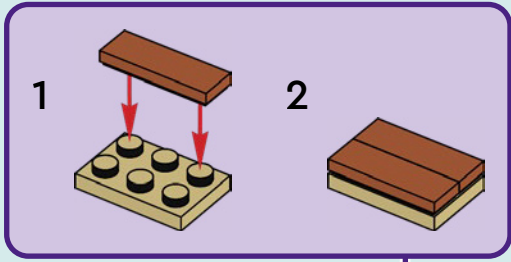

7

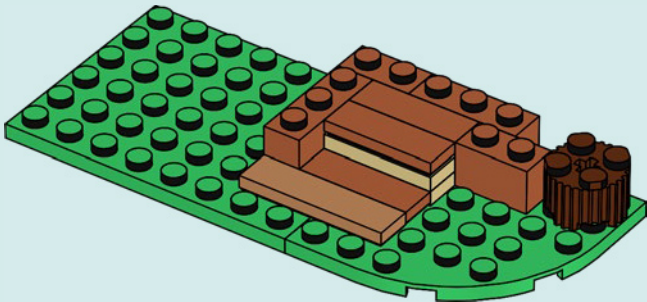



1x

8

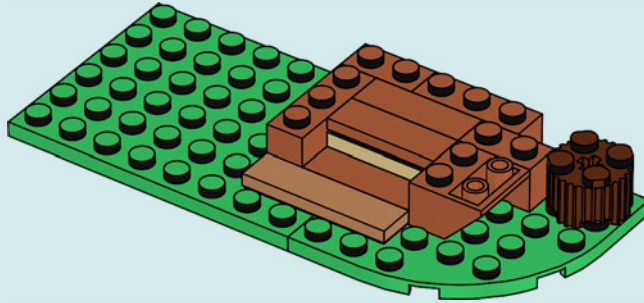

2x



2x

9

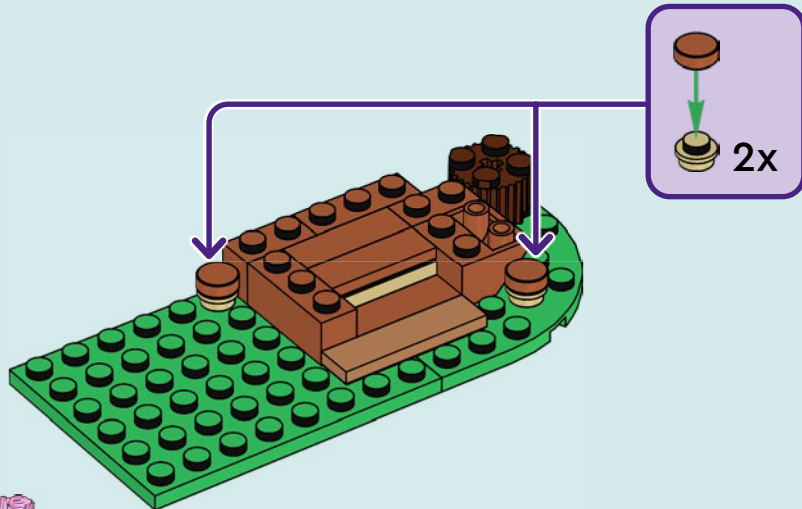

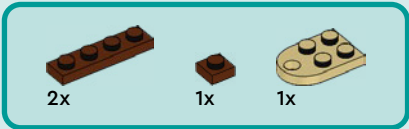

10

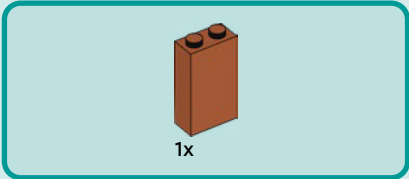
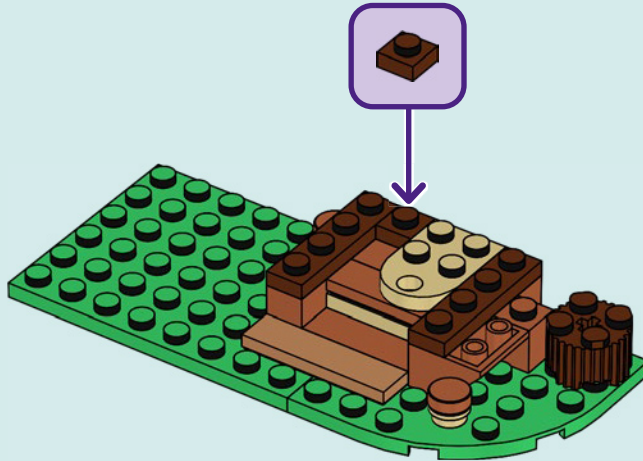

11

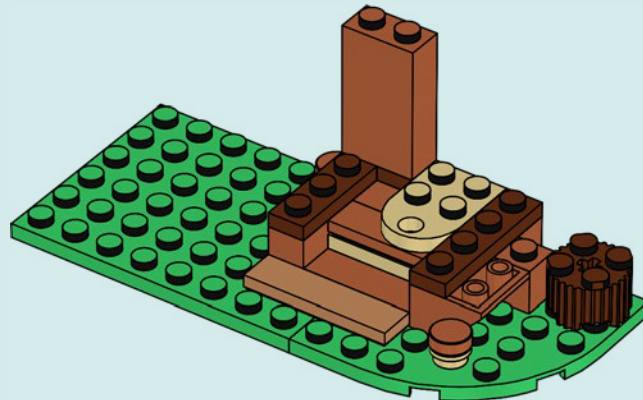

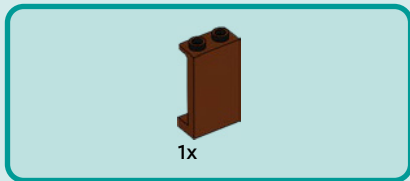

12

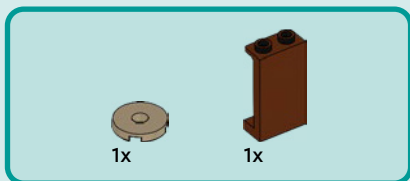
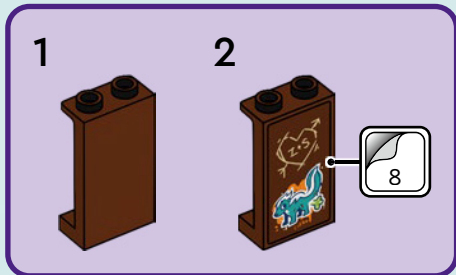
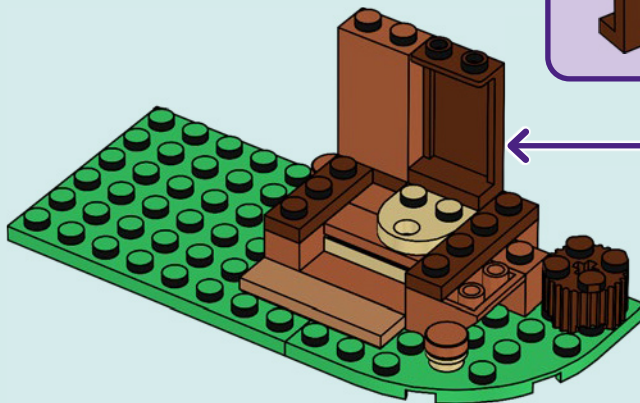

13

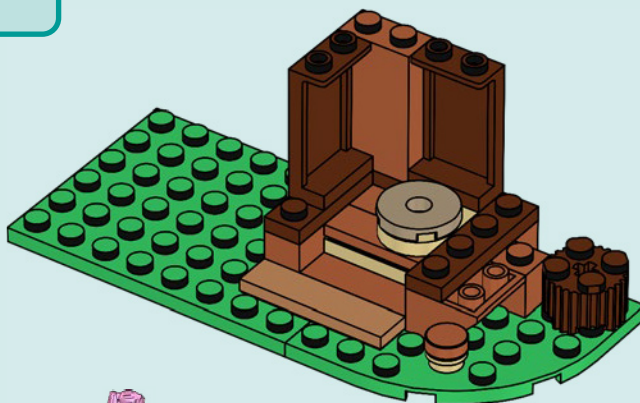

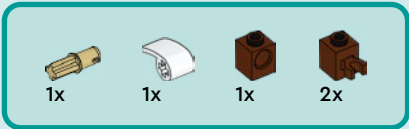

# 14

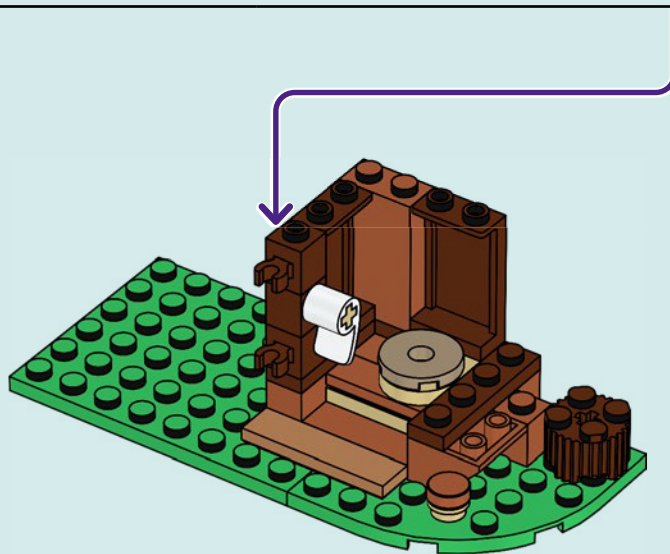
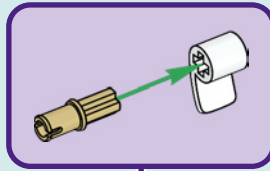
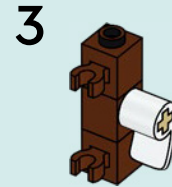
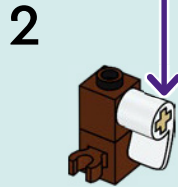
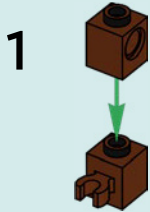



2x



1x

15

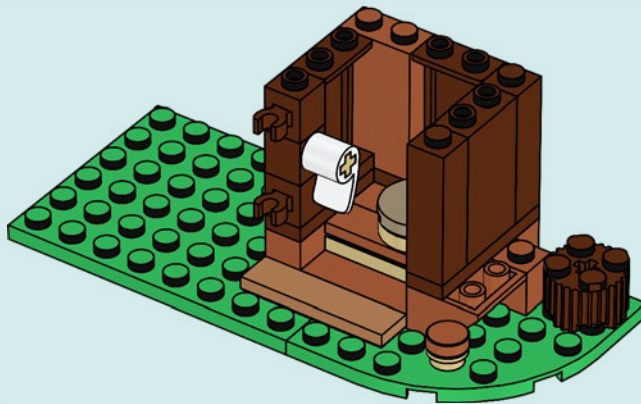



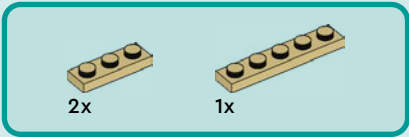

16

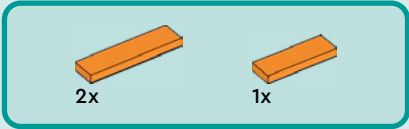
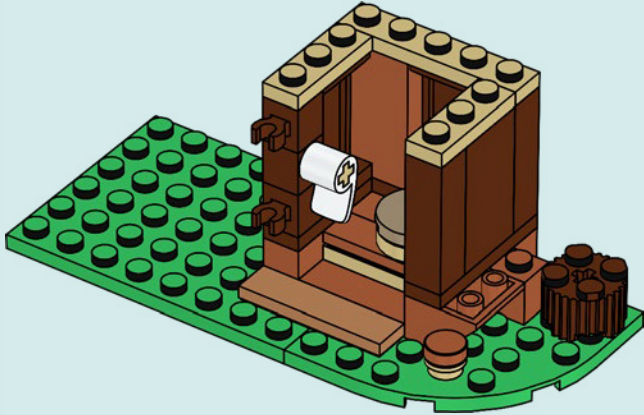

17

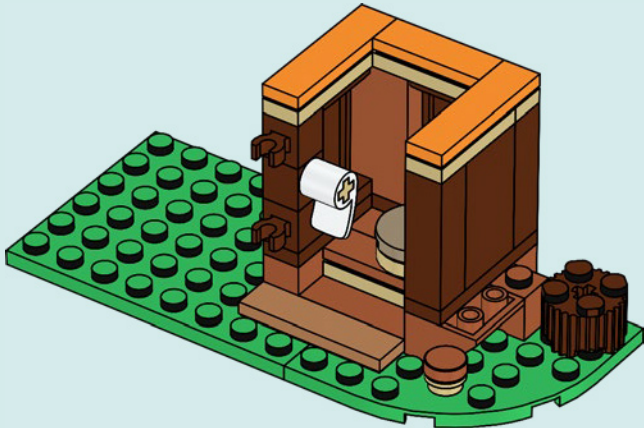

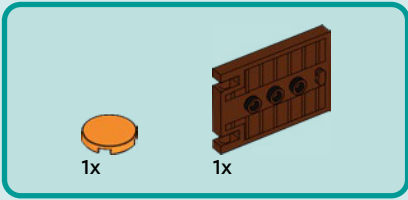

18

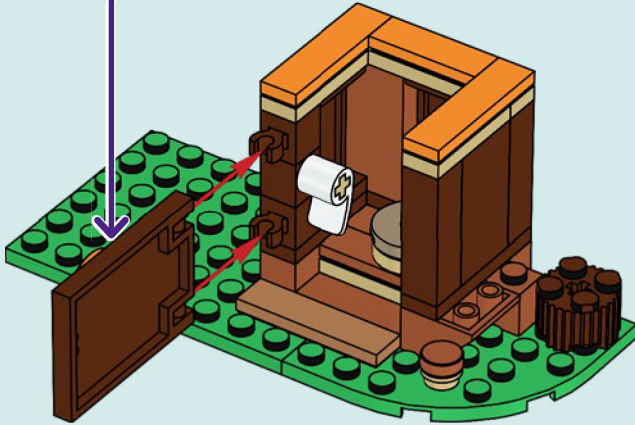
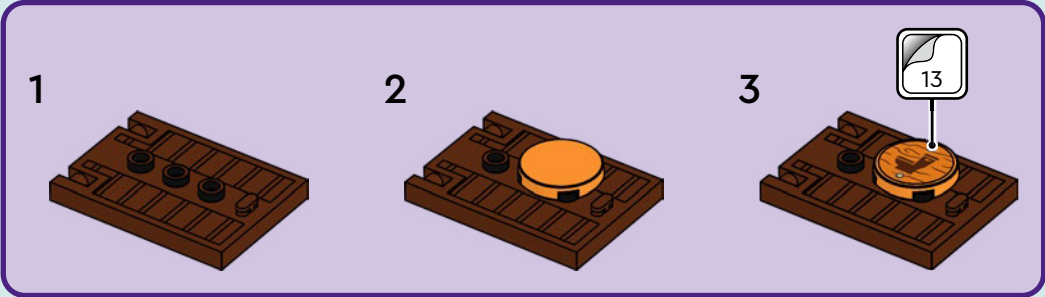



1x

19

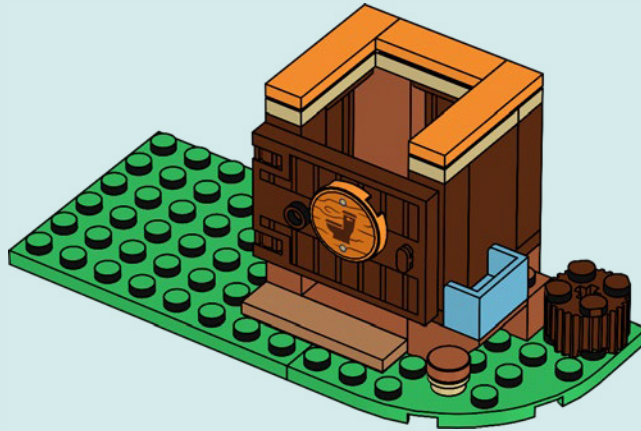

1x



1x

20

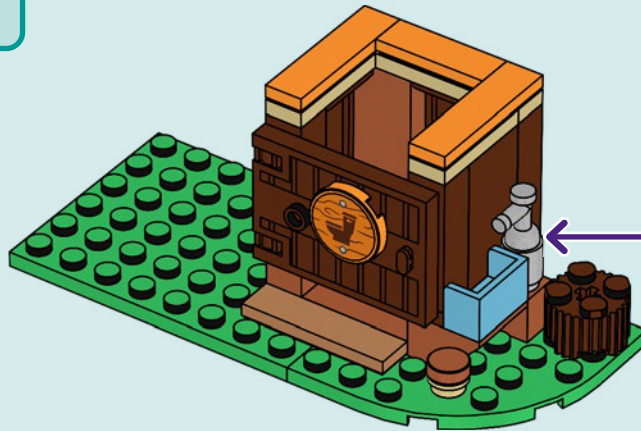

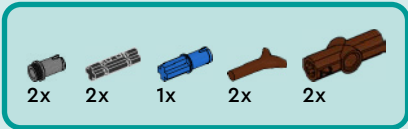

# 21

1

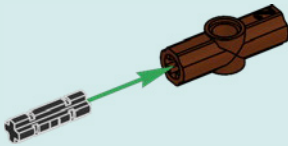

2

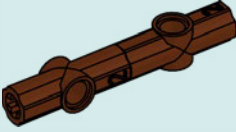

3

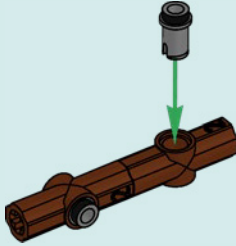

4

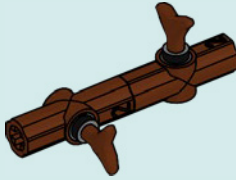

5

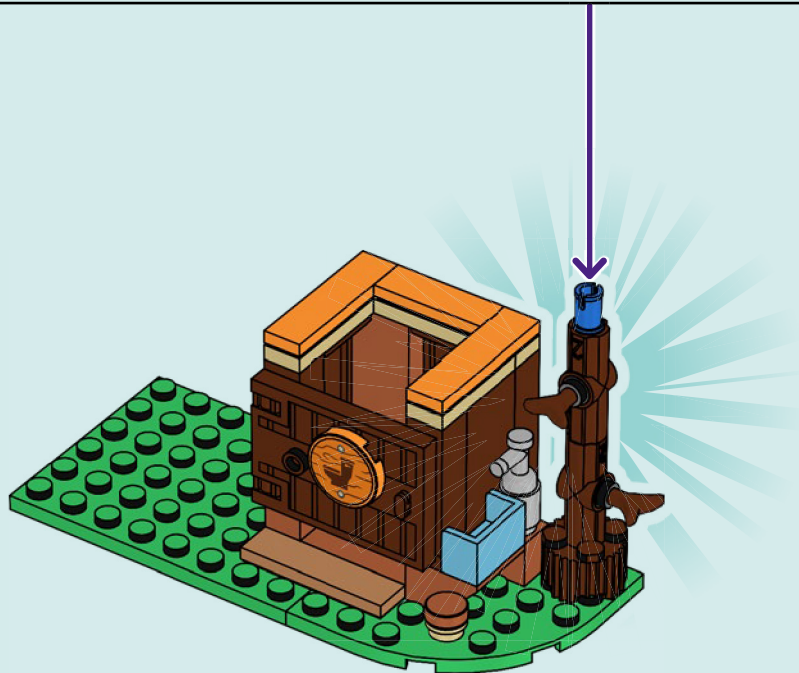
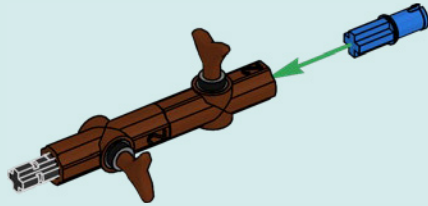



1x



1x

22

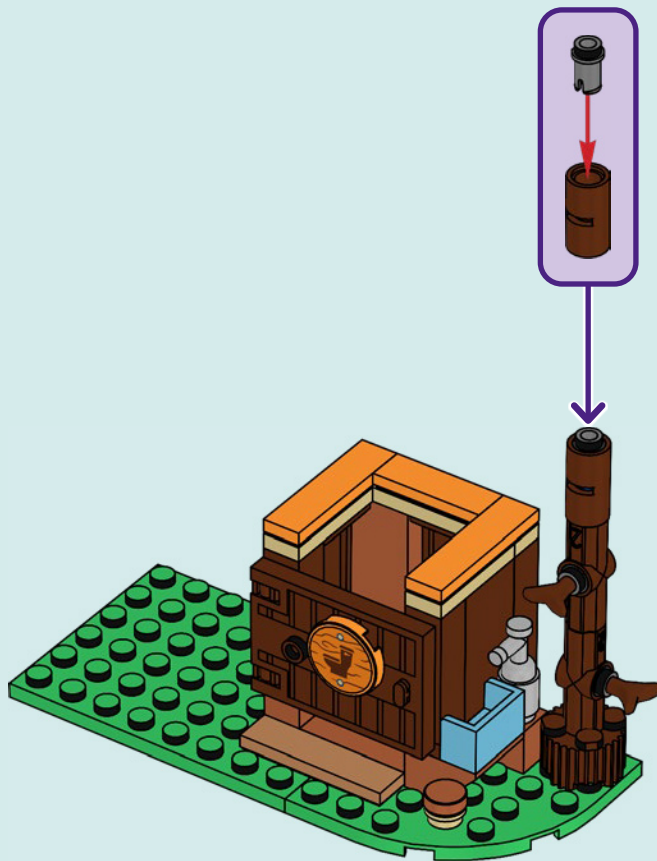

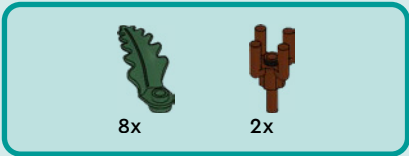

23

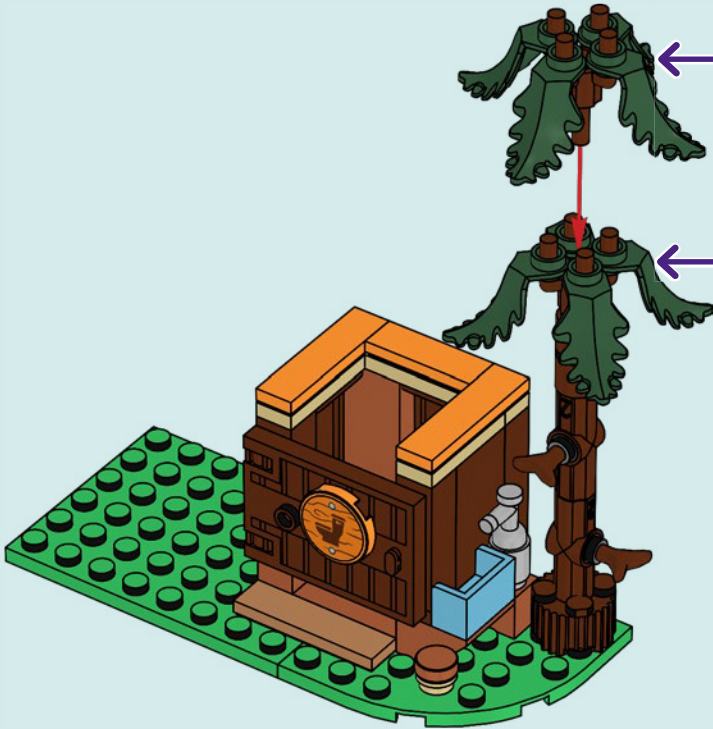
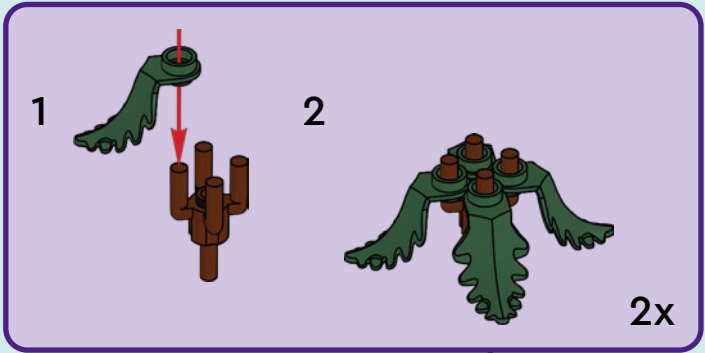

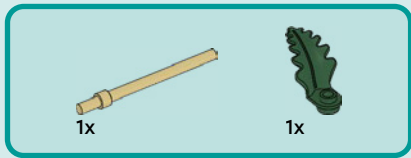

24

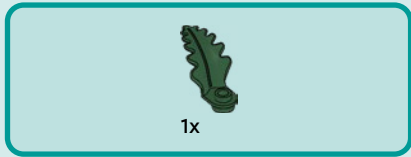
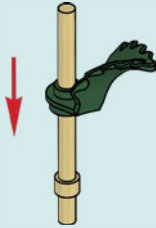

25

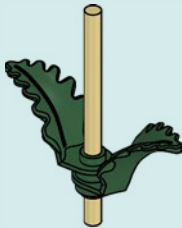

26

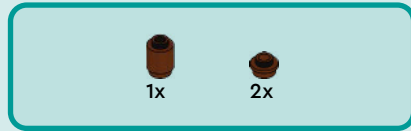
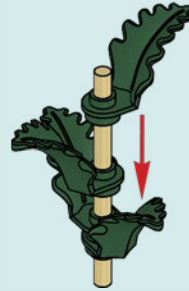

27

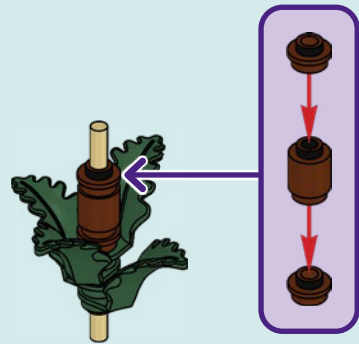



28



29





1x



1x

30

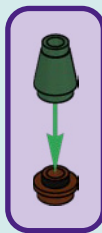



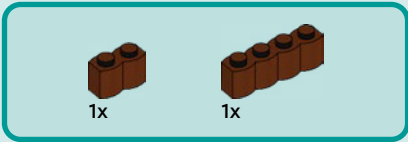

31



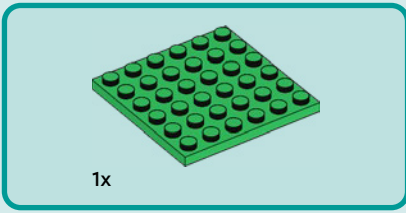

32





1x

33



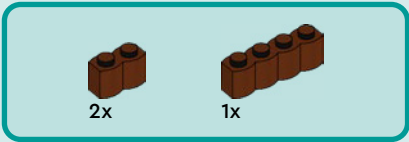

34



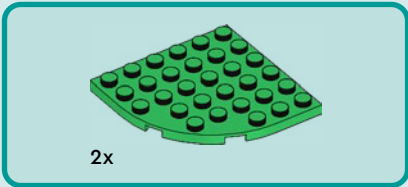

35





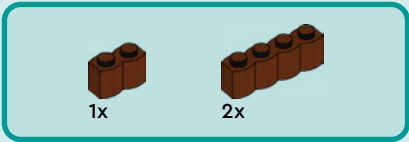

36





2x

37



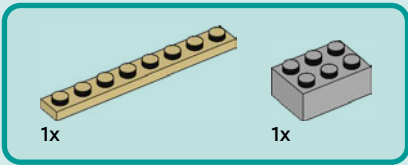

38



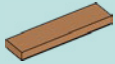

2x

39



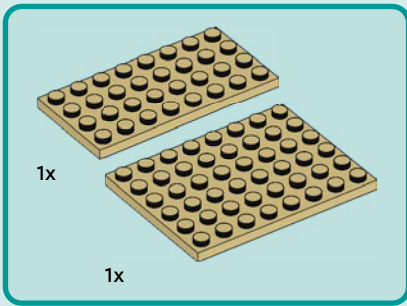

40





1x



1x

41





3x



2x



1x

42

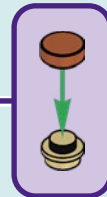
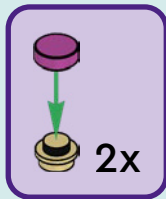

2x

43





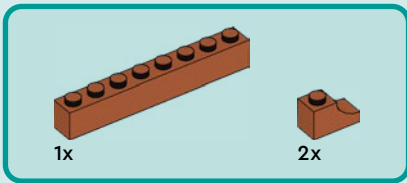

44





2x

45





2x



2x

46



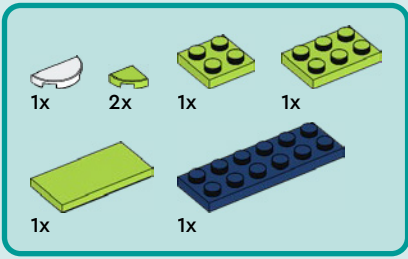

47

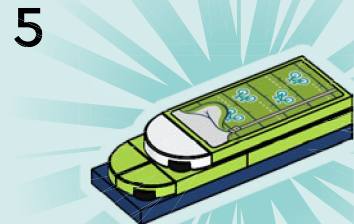
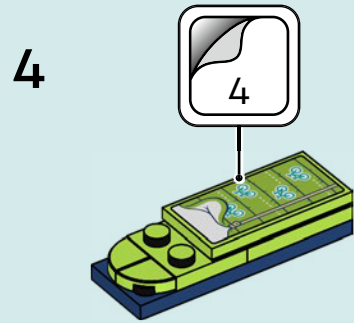
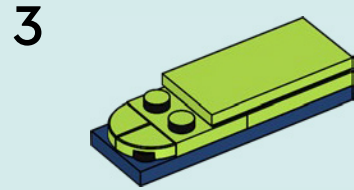
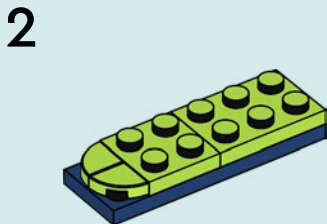
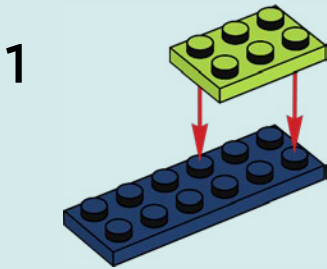



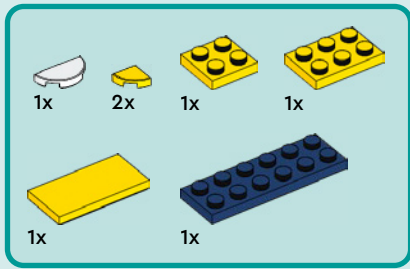

48

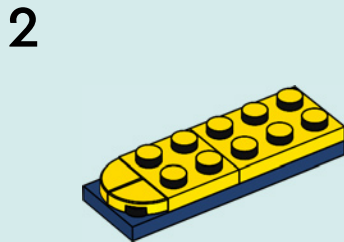
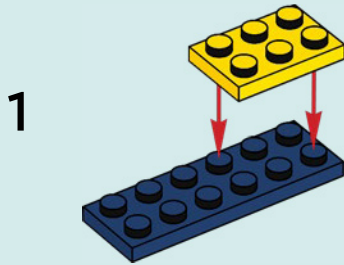

3

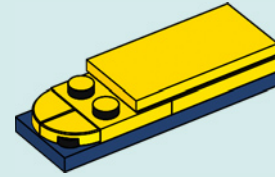

4

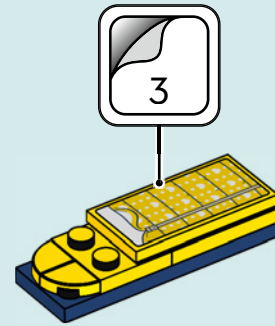

5







49





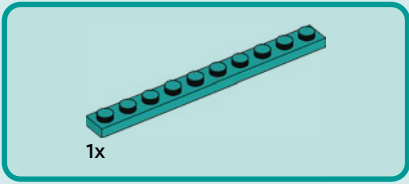

50





2x

51



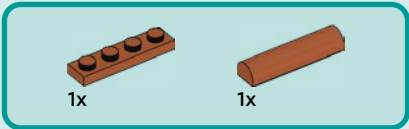

52

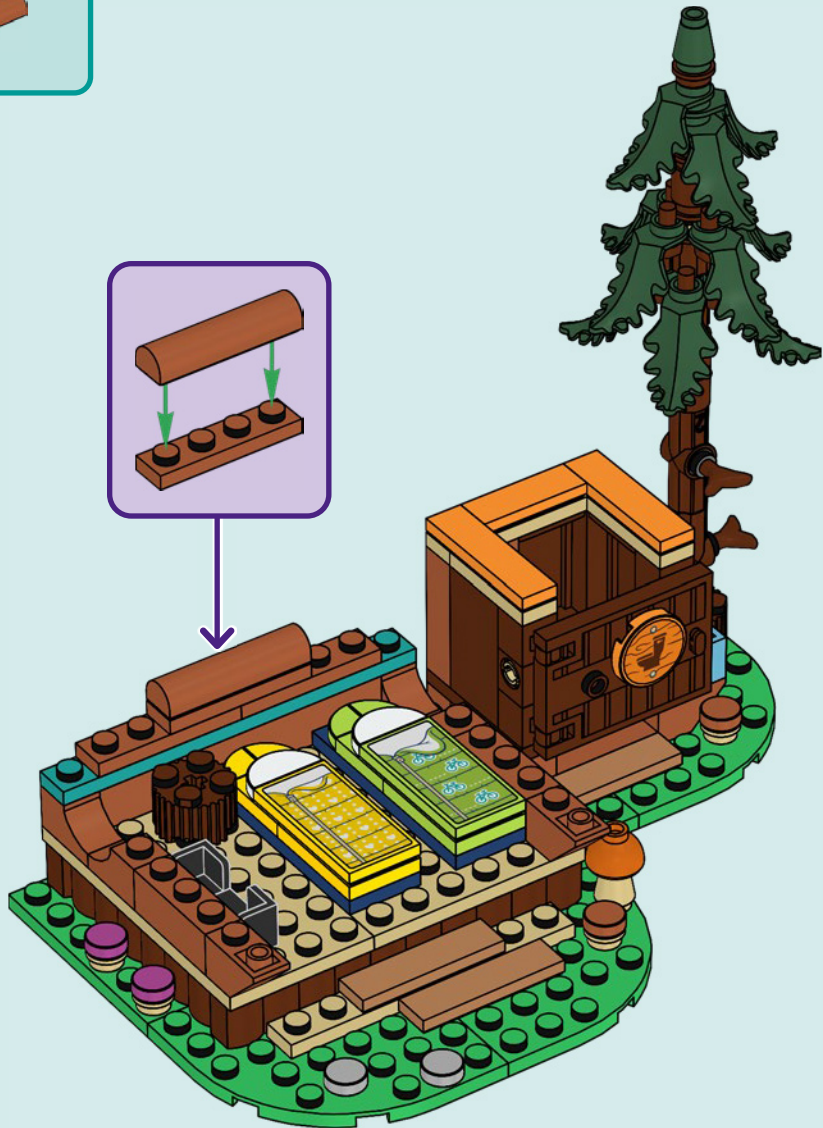



4x

53





2x



1x

# 54





2x

55





4x

56



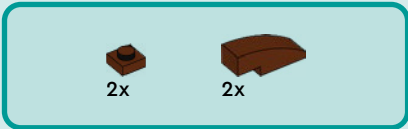

57

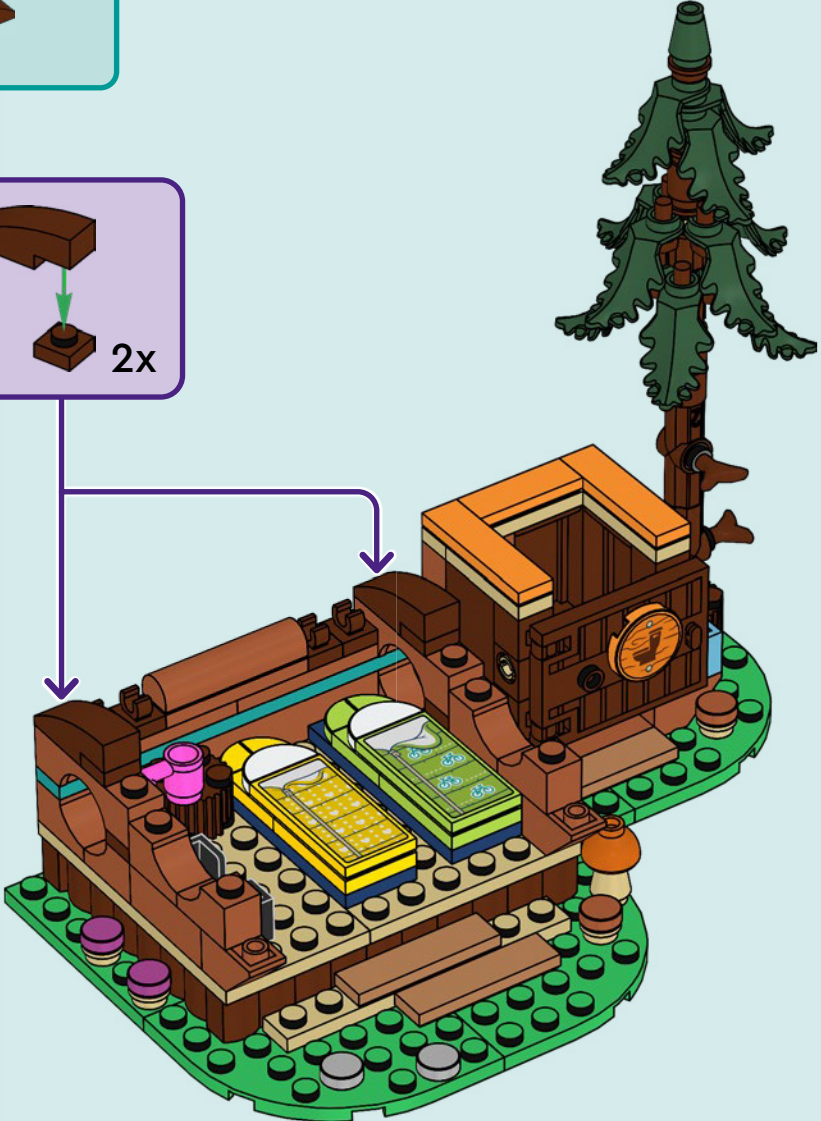
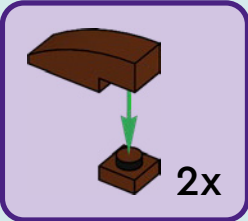





2x

58



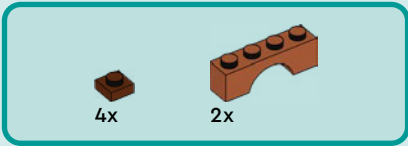

# 59

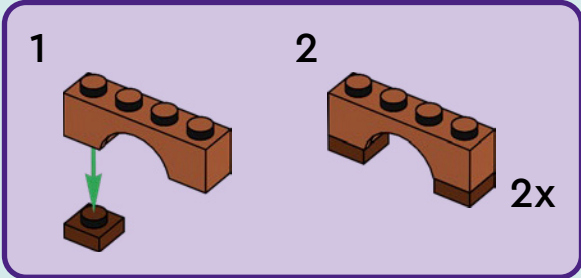



2x



2x

60

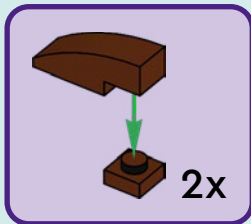



2x

61



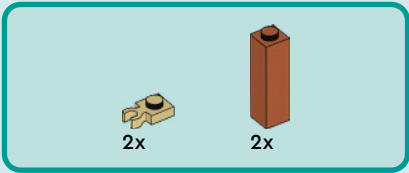

62

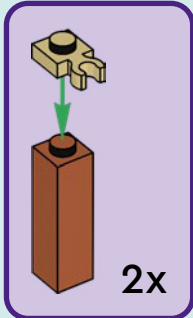



2x



2x

63

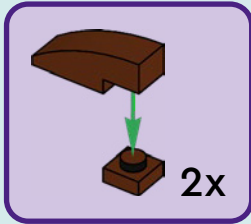

2x

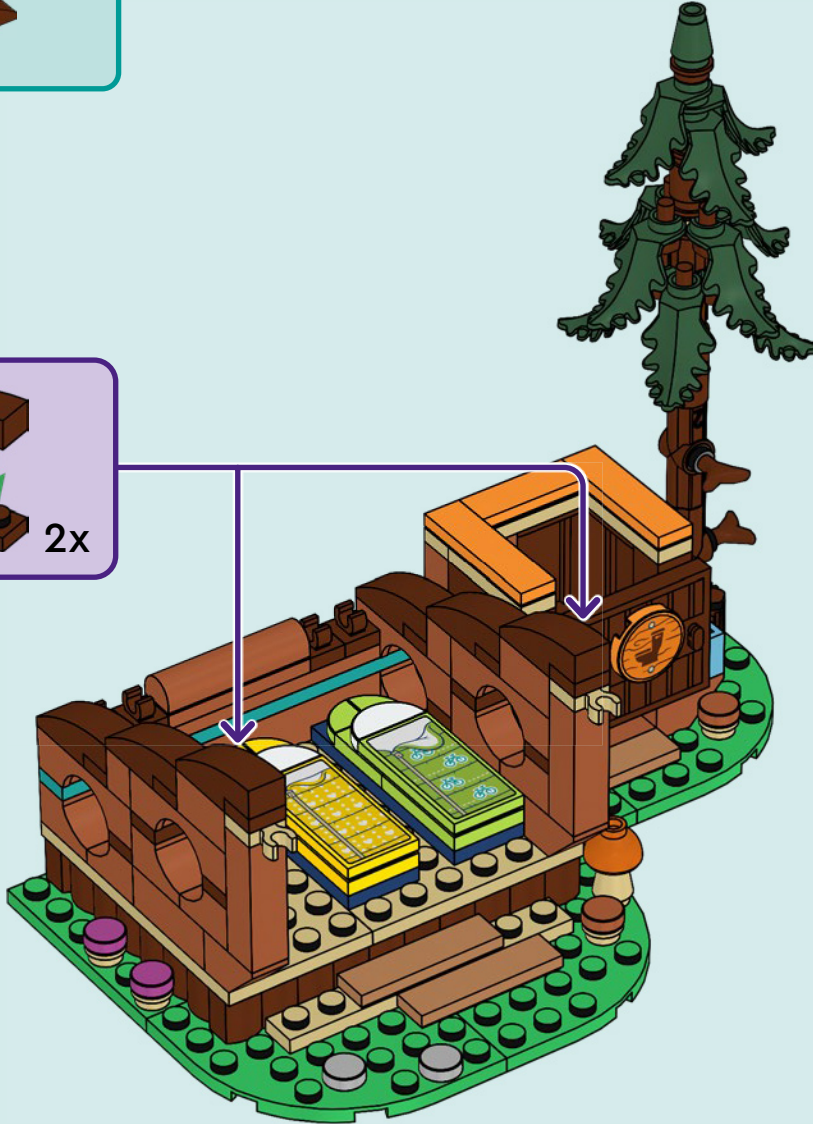

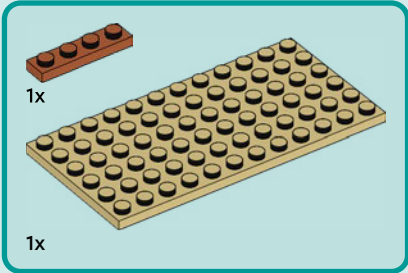
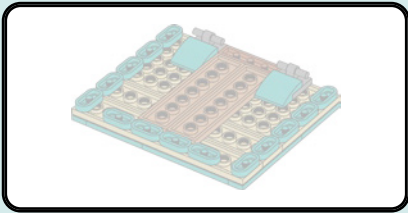

64

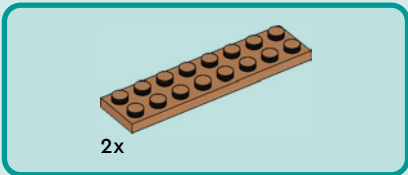
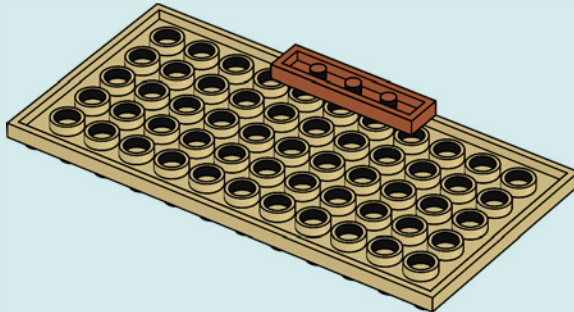

65

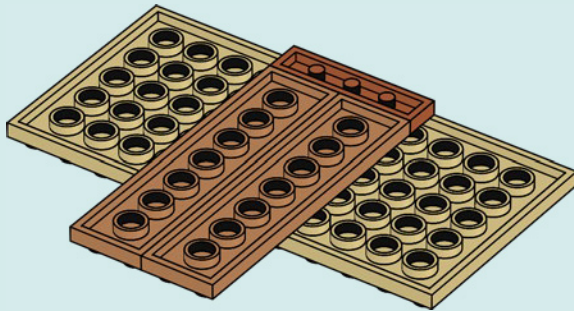

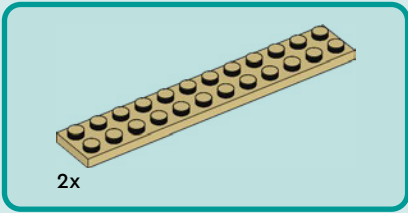

66

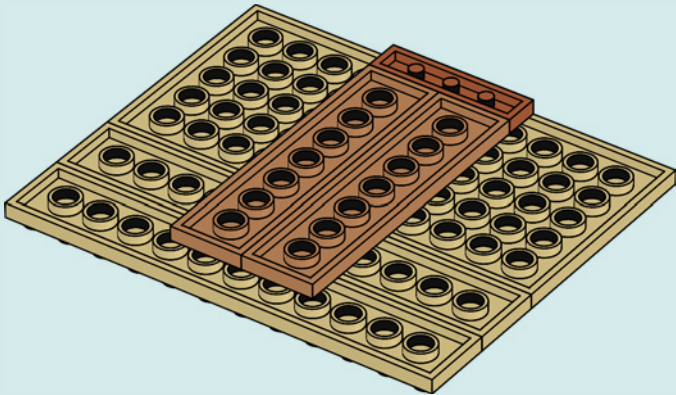

67

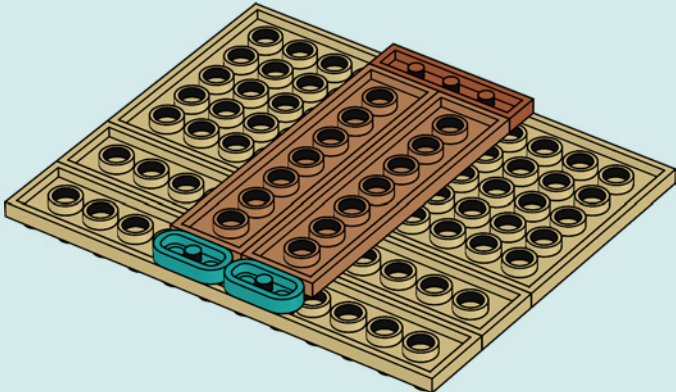





10x

68

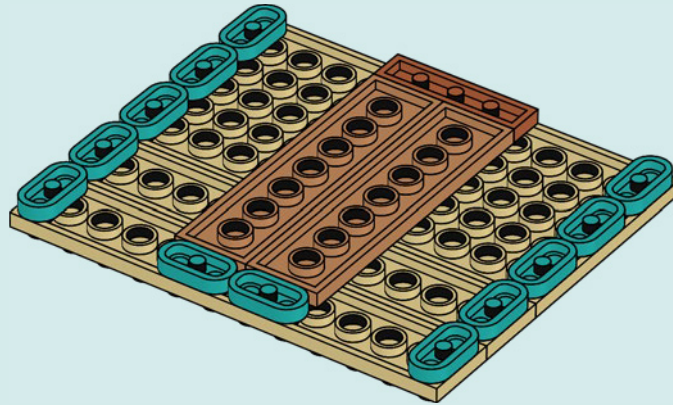

2x

69

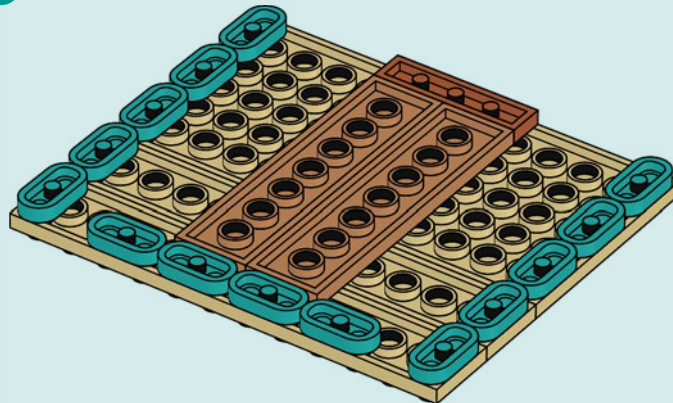

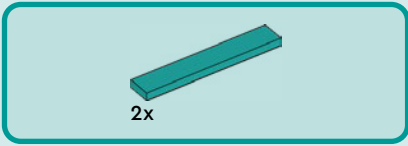

70

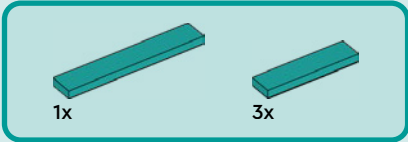
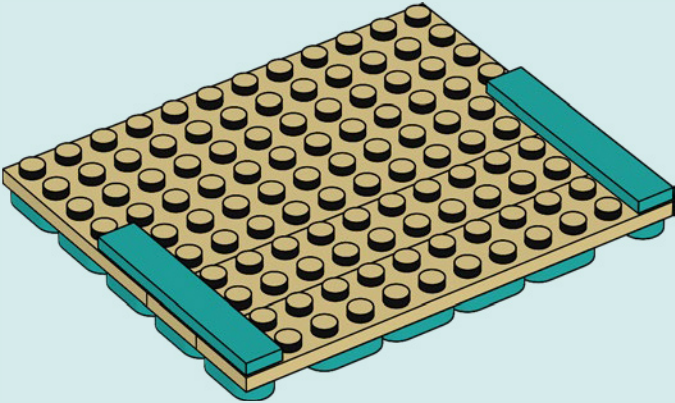

71

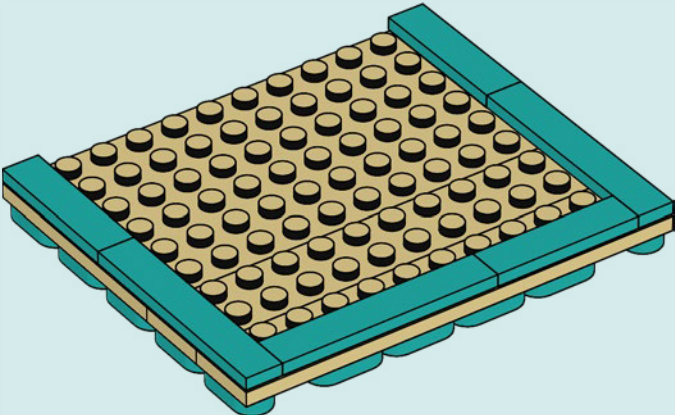



2x

72

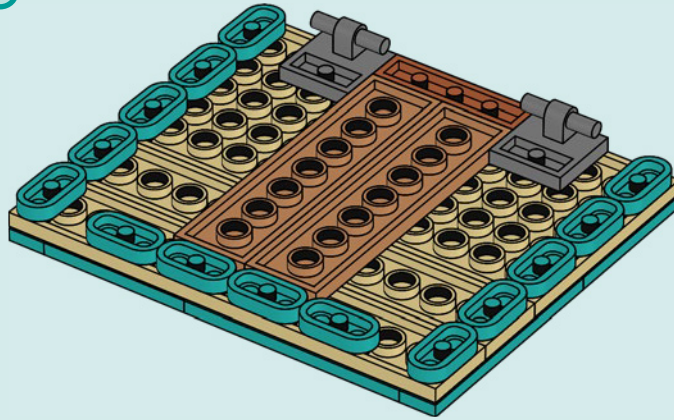

2x

73

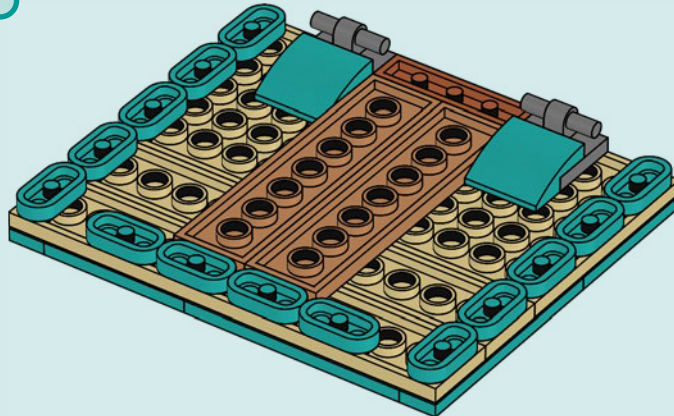

74

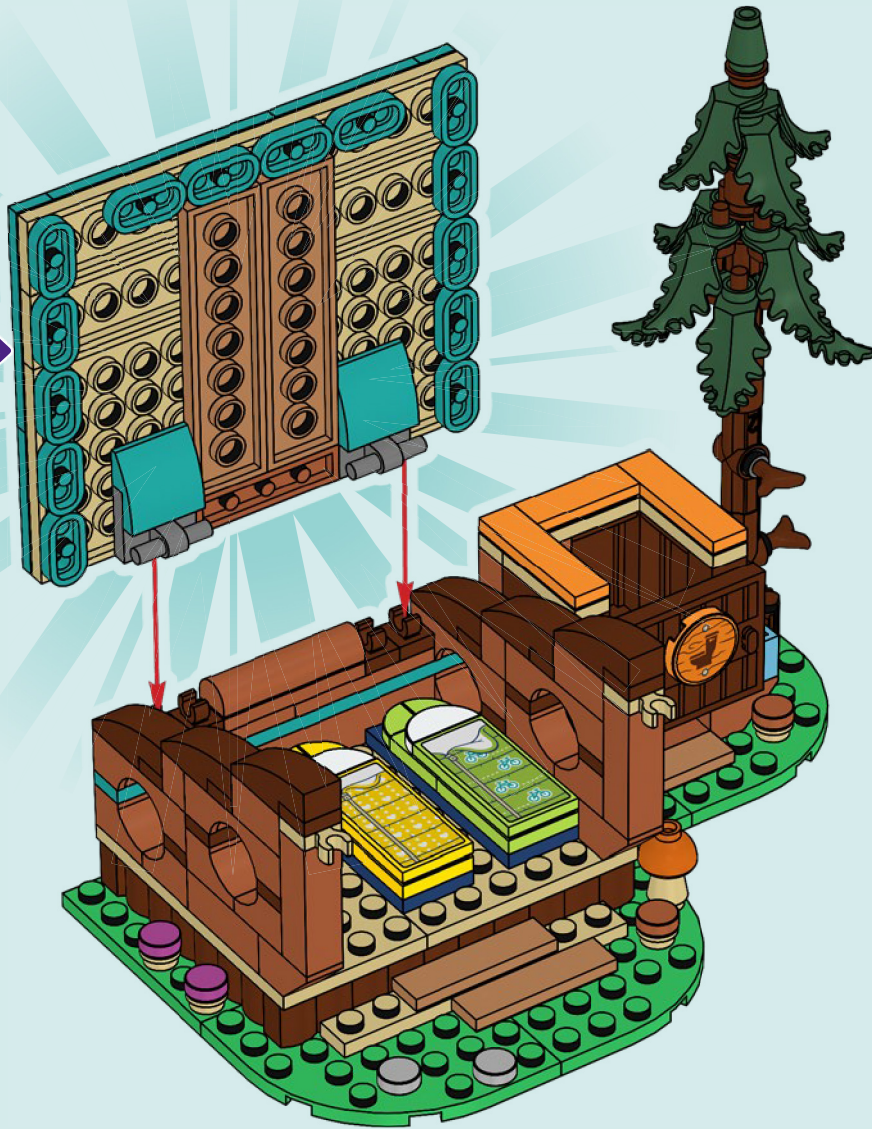

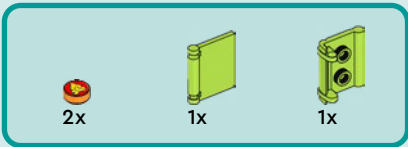

75

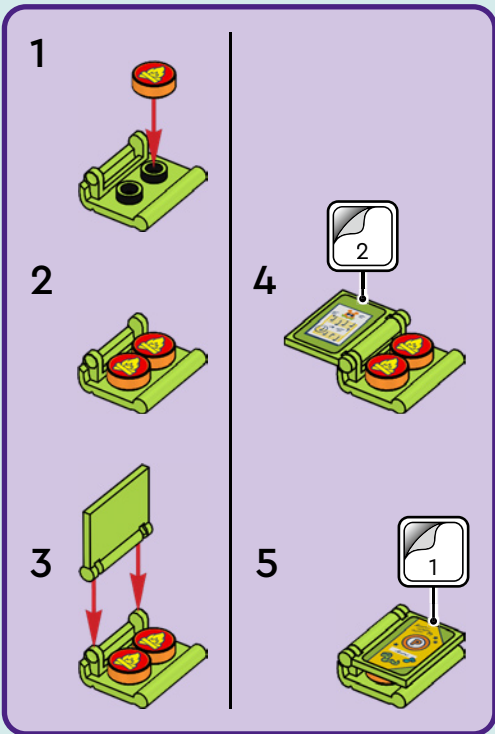



1x



1x

76





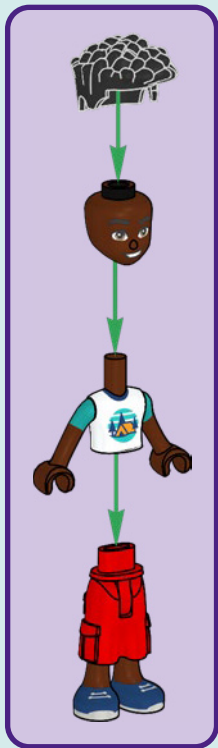

ZAC





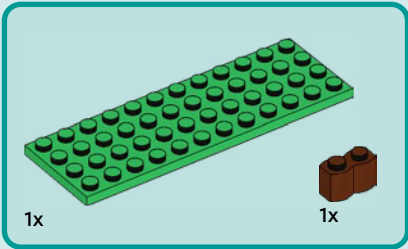
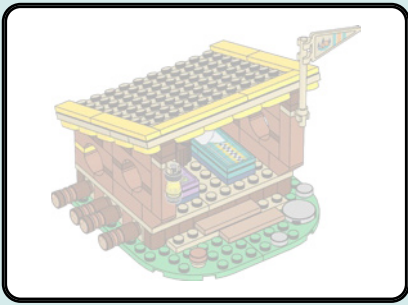

1

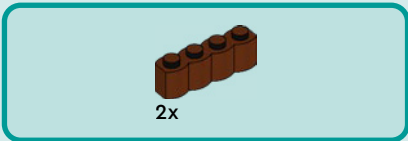
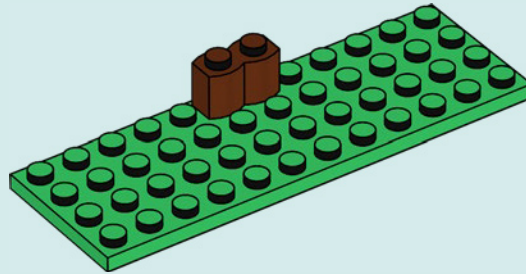

2

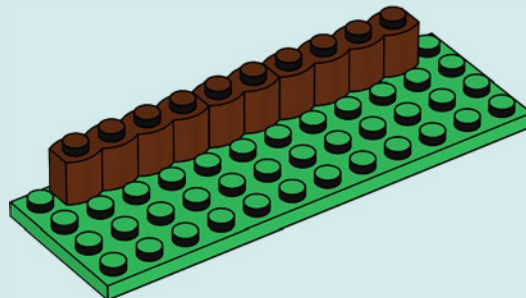



1x

3

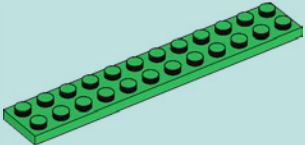
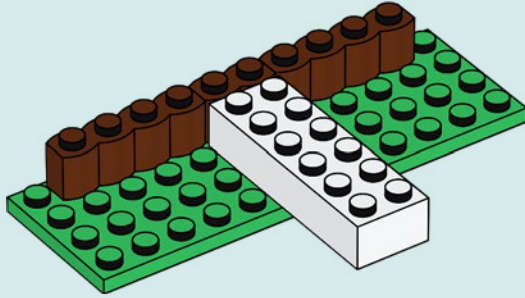

1x

4

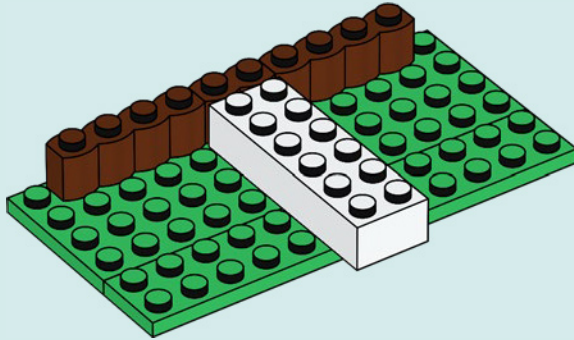

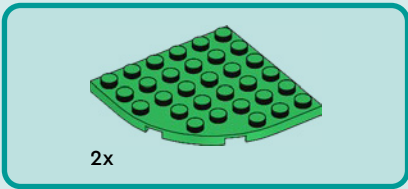

5

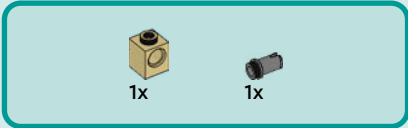
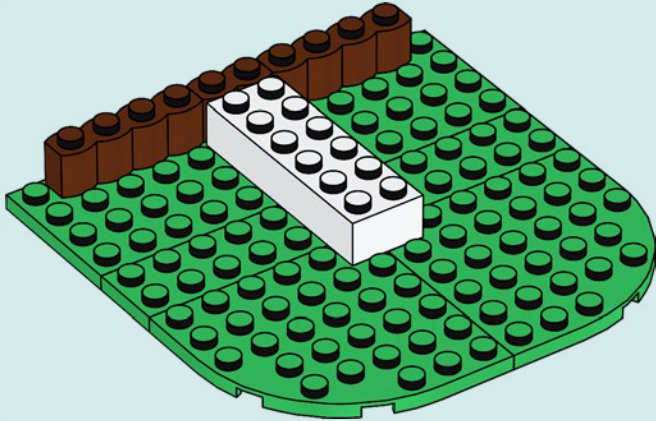

6

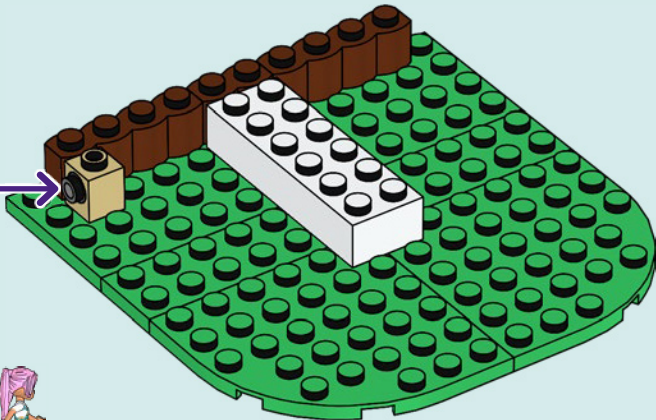
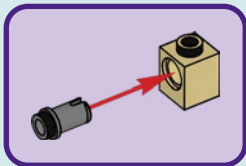



1x



1x

7

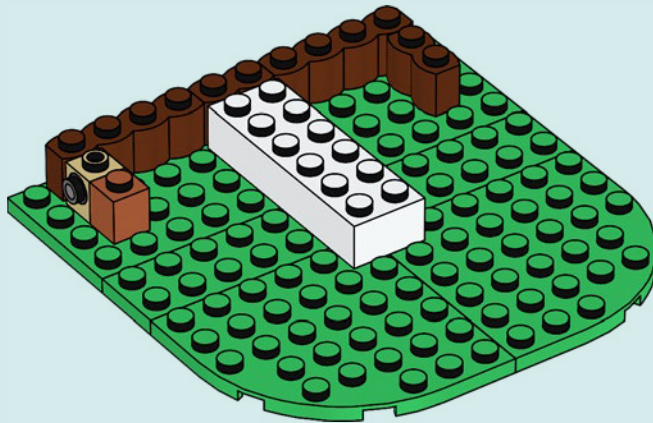

1x



2x

8

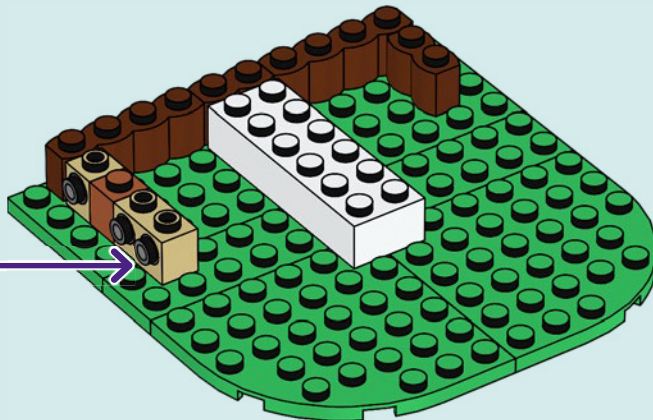
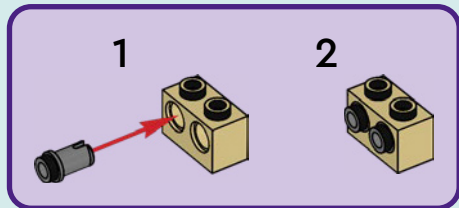

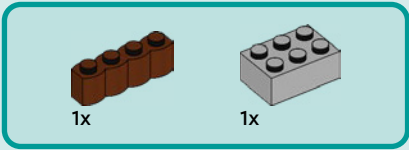

9

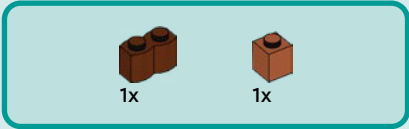
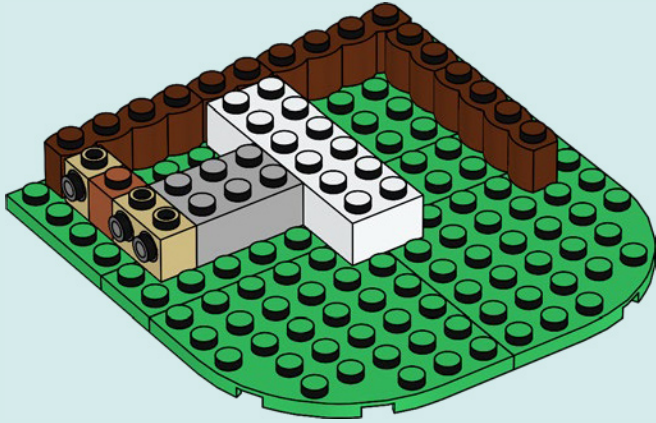

10

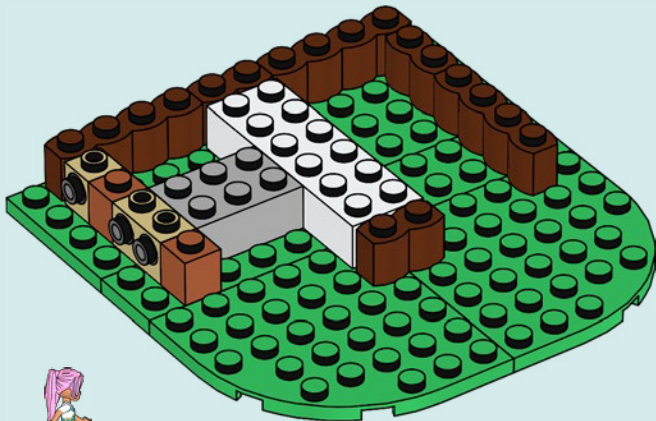



1x



1x

11

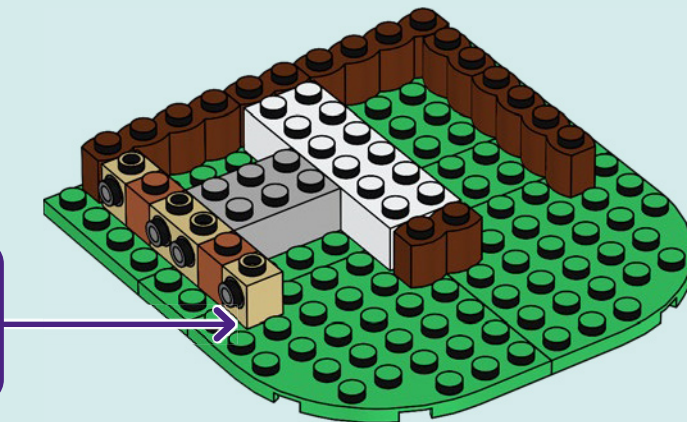
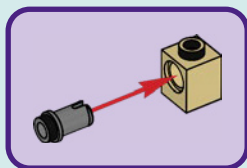

2x

12

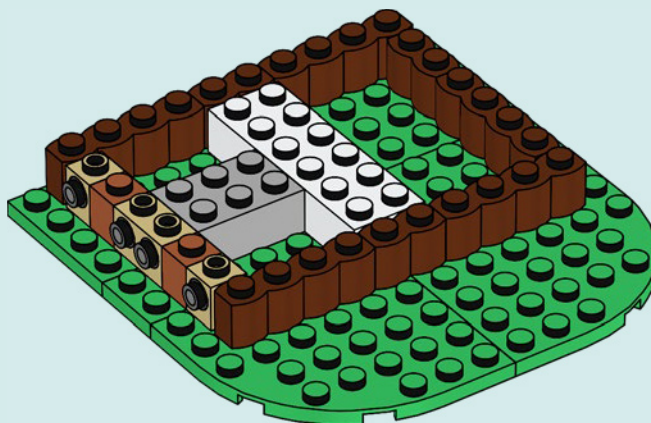

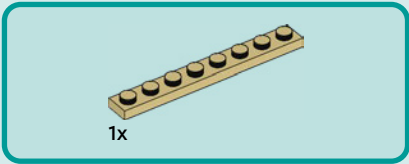

13

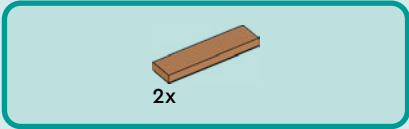
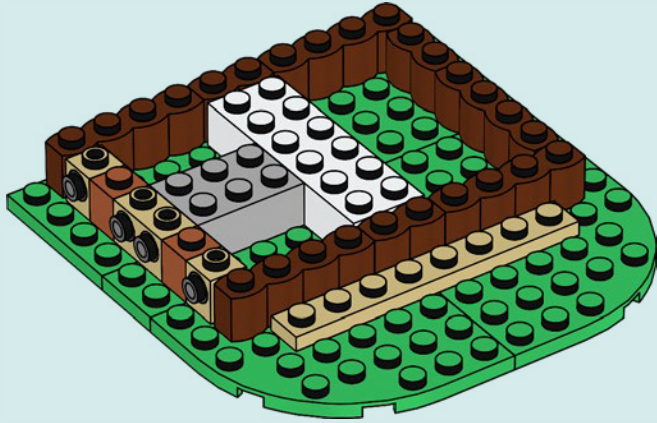

14

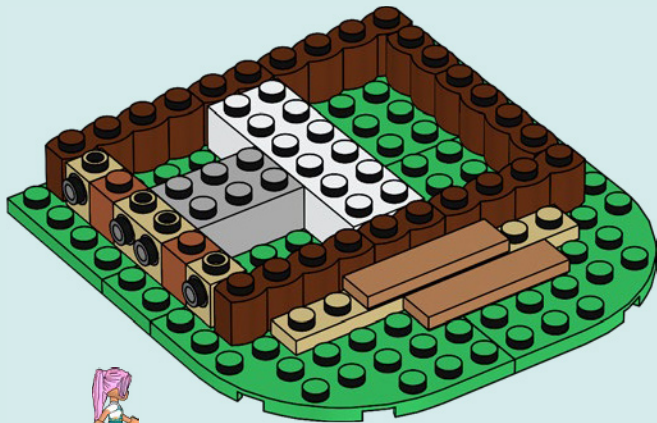

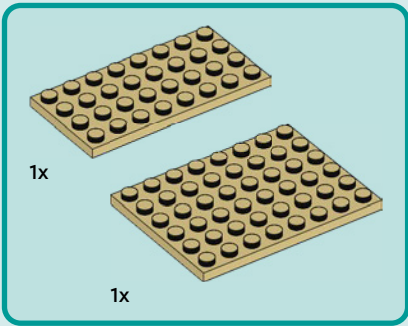

15

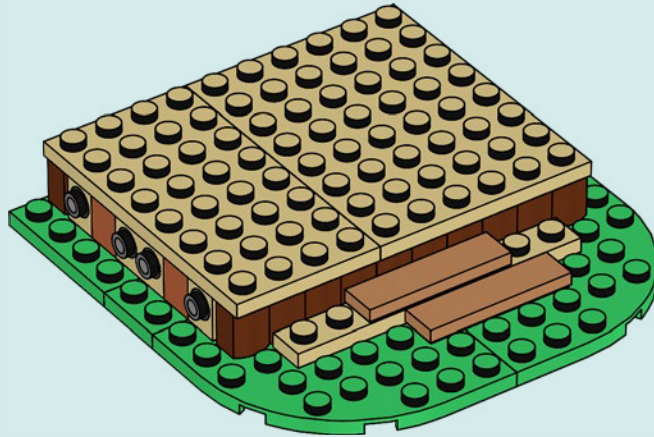

16

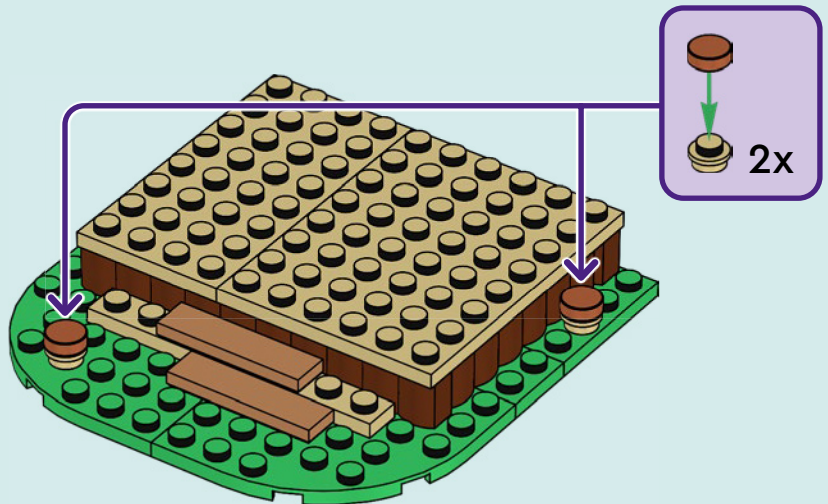





1x



1x

17

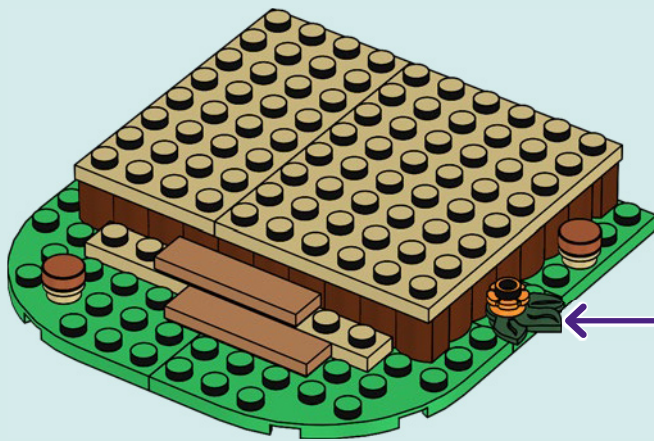

1x



2x

18

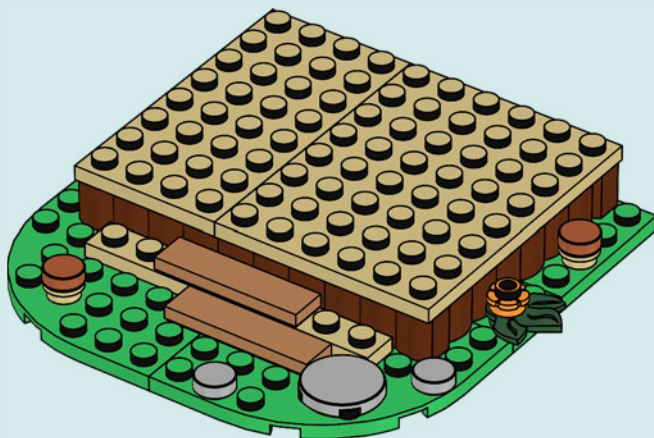

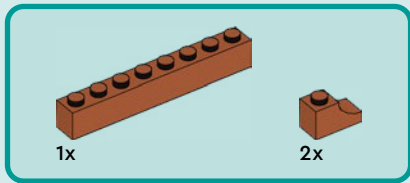

19

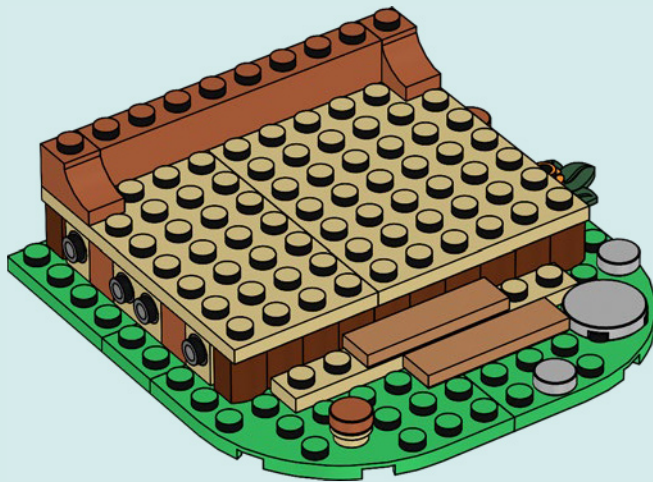



2x

20

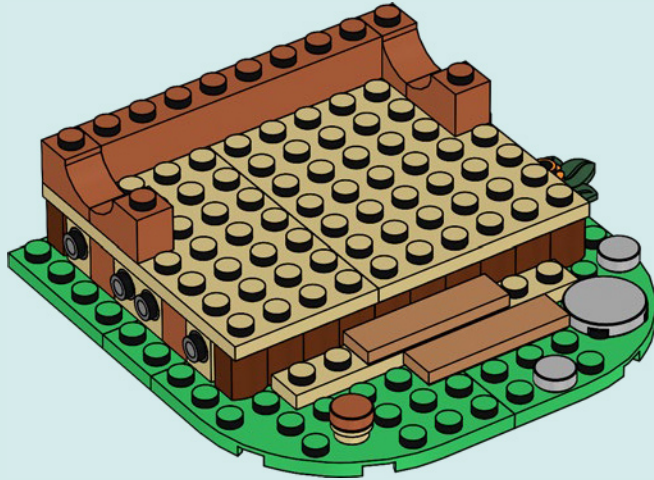

2x



2x

21

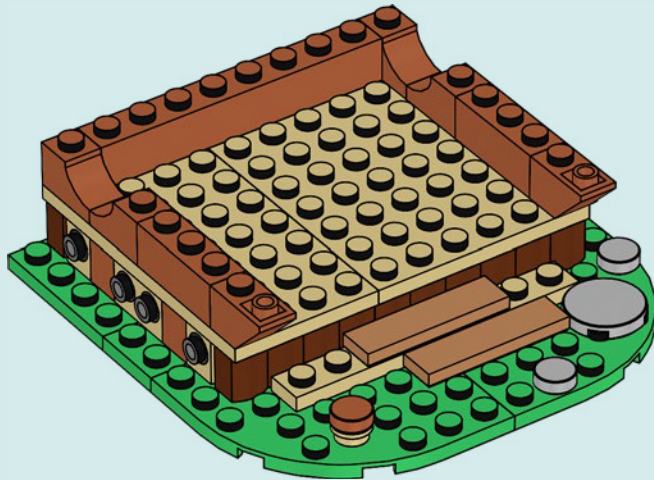

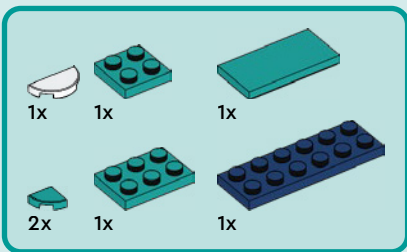

# 22

1

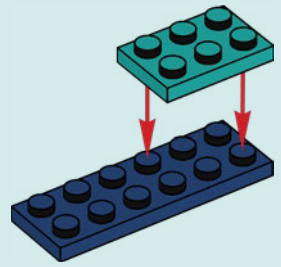

2

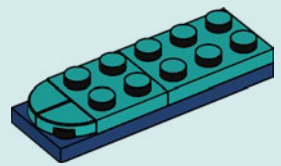

3

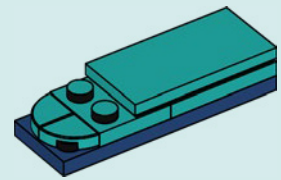

4

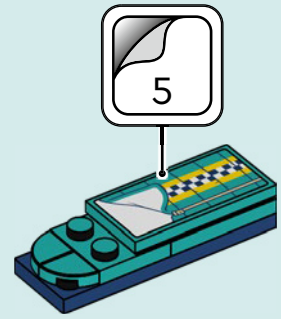

5

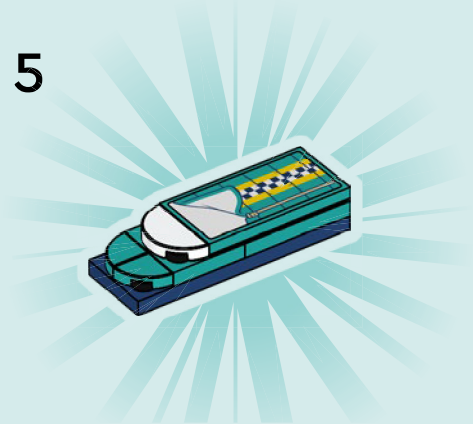

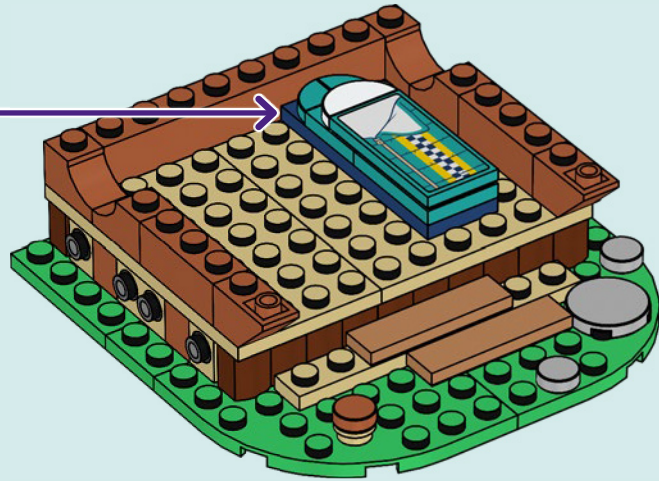

1x

23

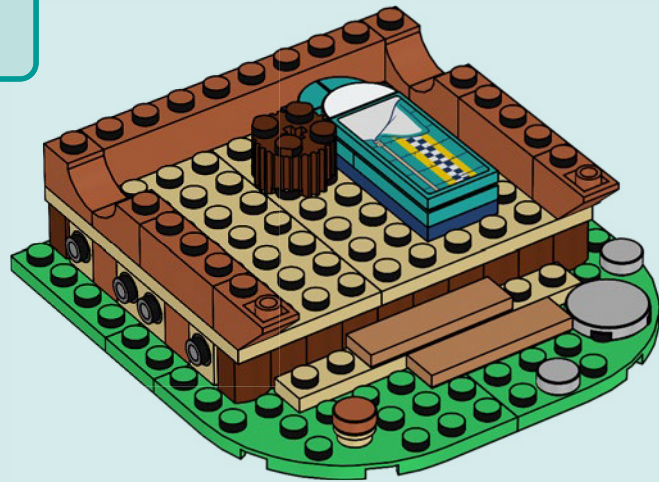

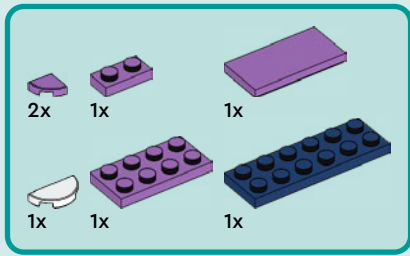

24

1

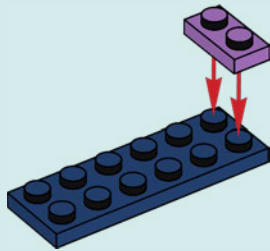

2

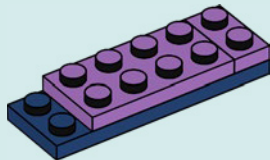

3

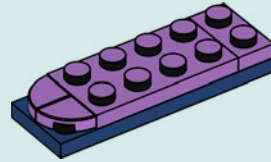

4

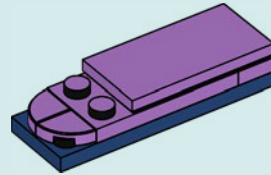

5

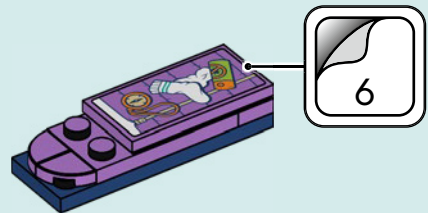

6

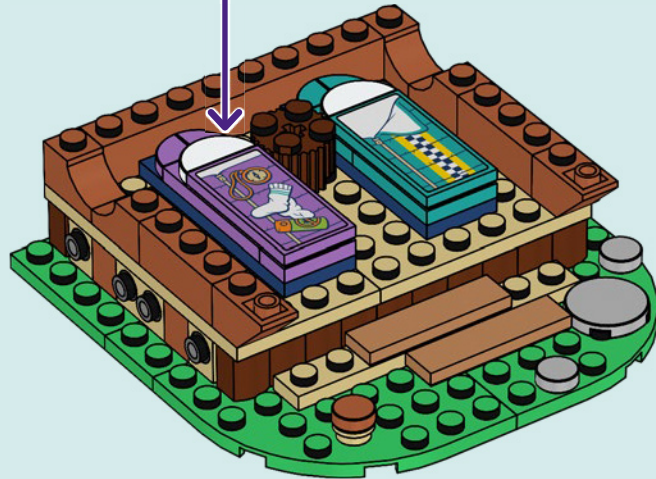

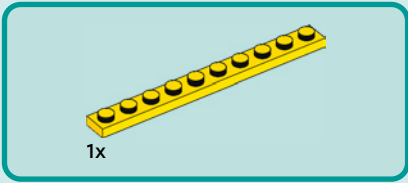

25

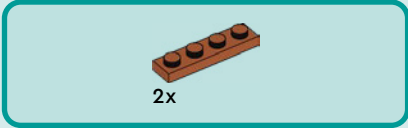

26





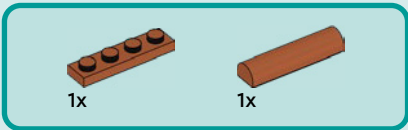

27

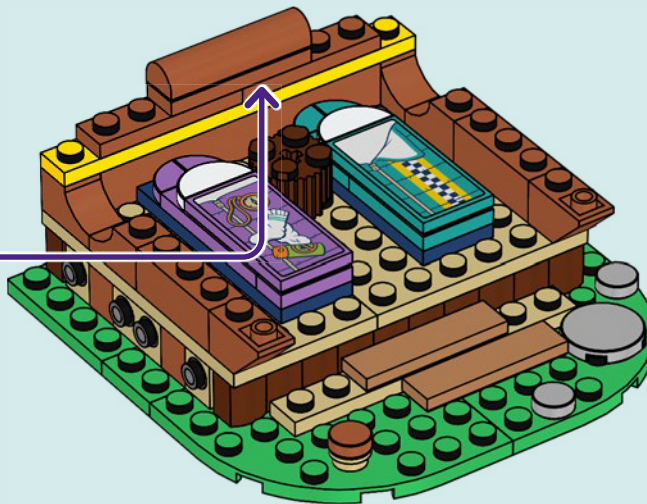
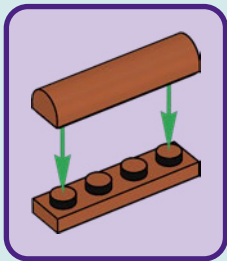

28





2x

29

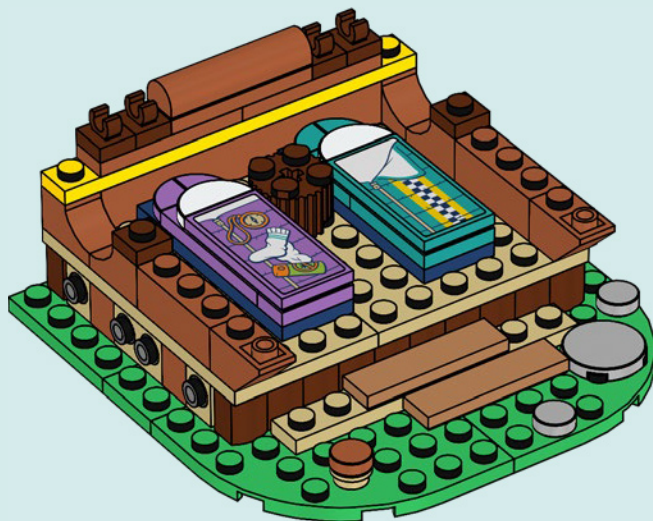

2x

30

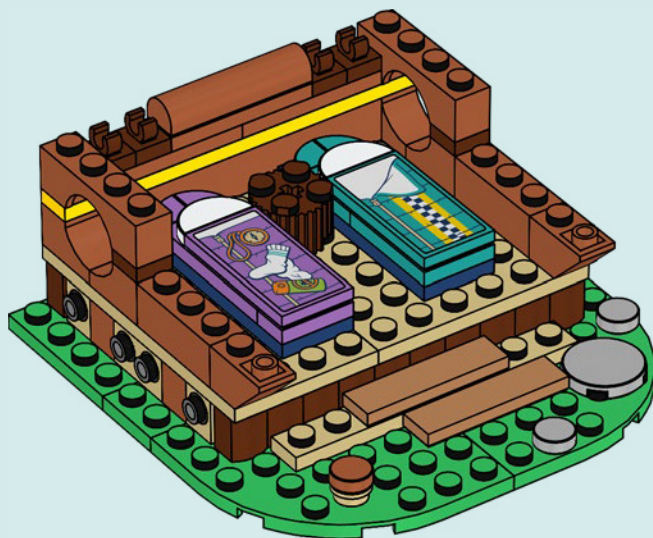



4x

31

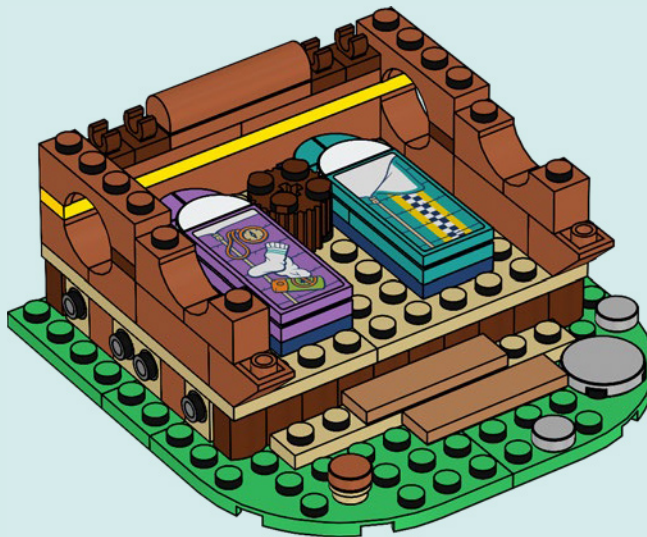

2x



2x

32

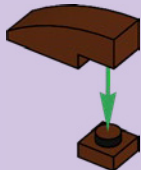
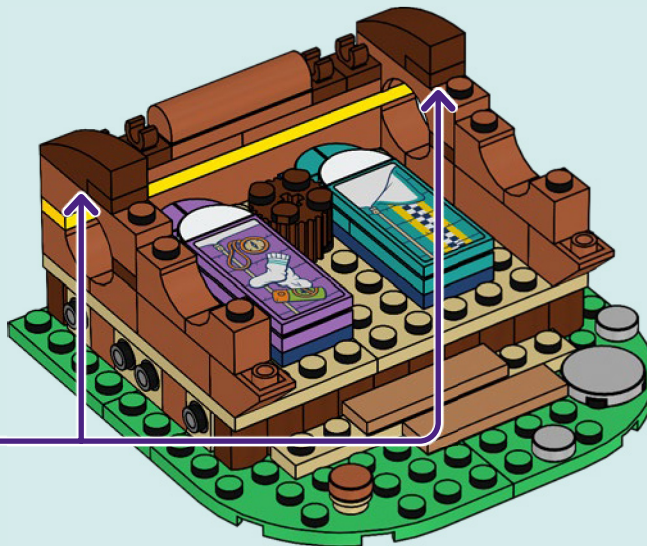

2x





2x

33

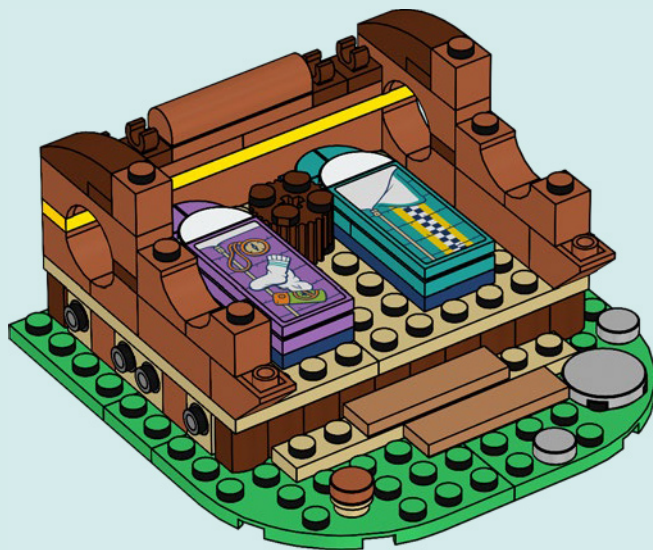

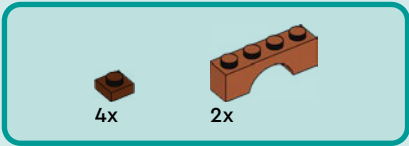

34

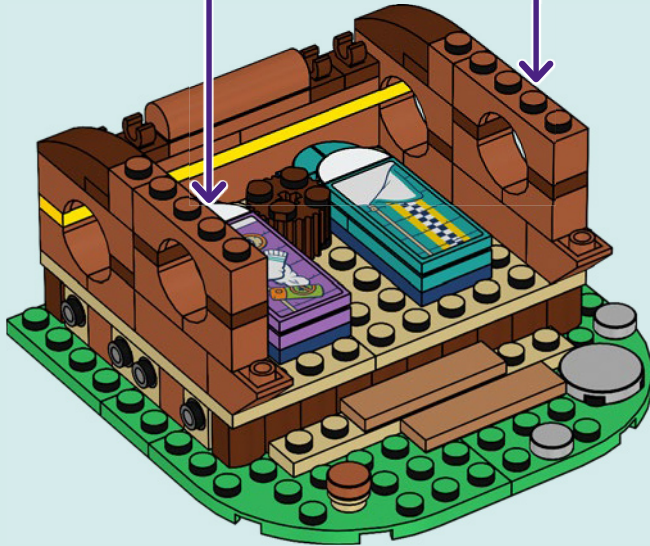
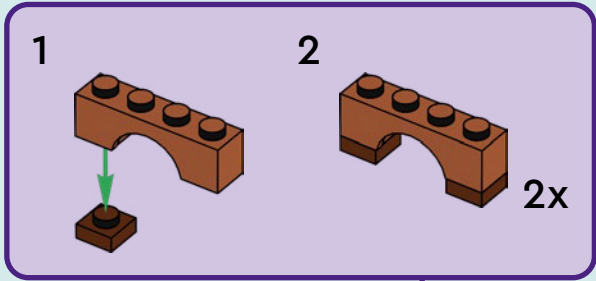



2x



2x

35

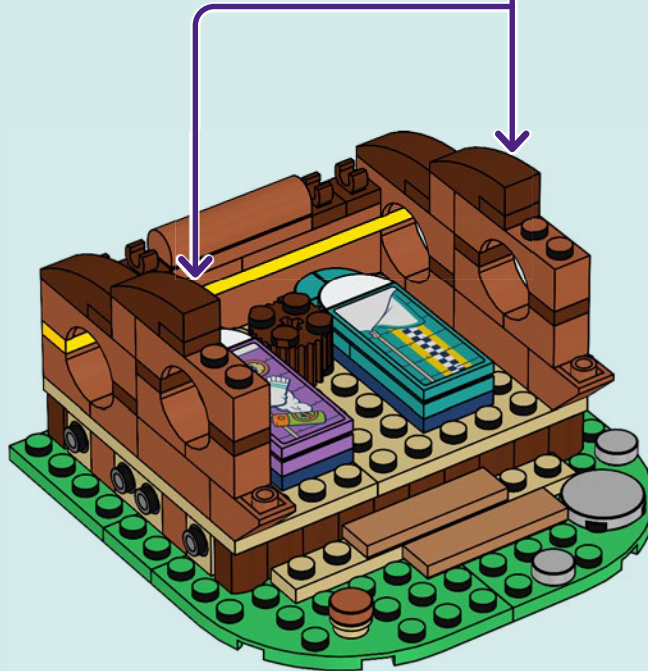
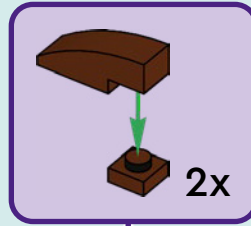



2x

36

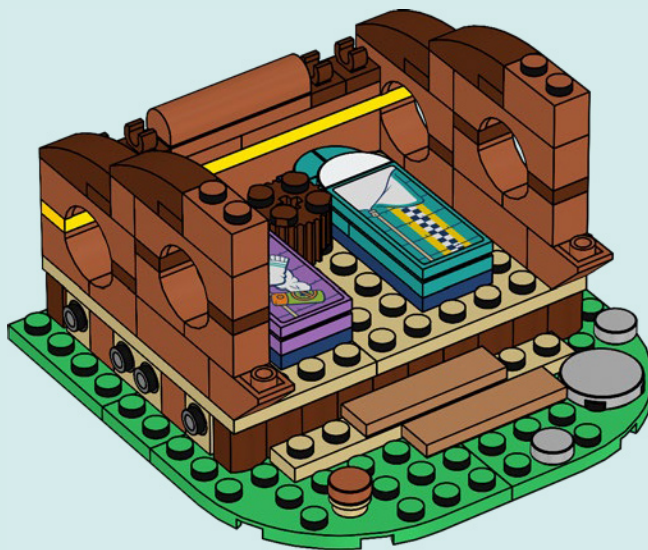

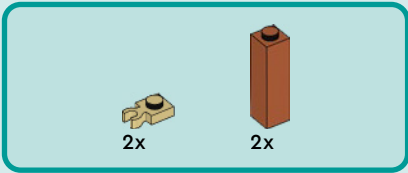

37

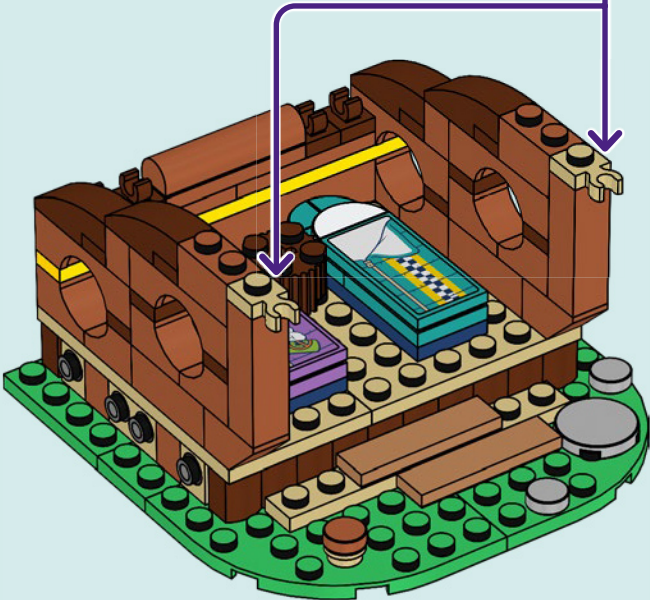
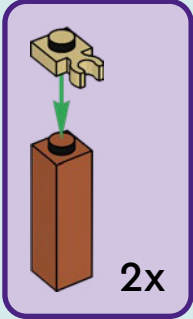





2x



2x

38

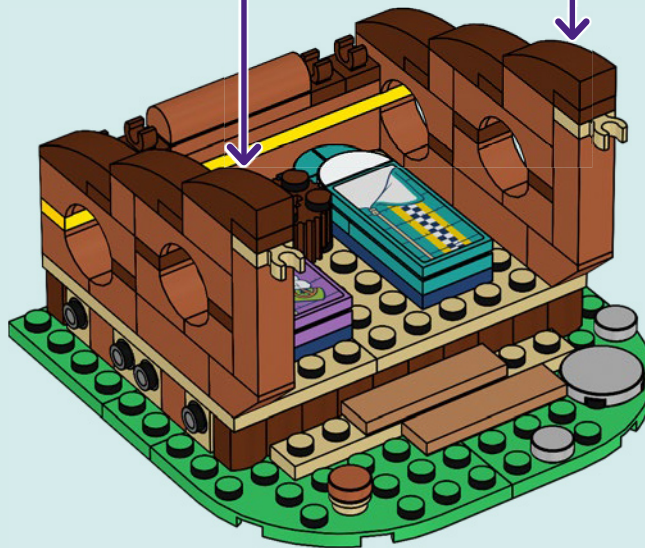
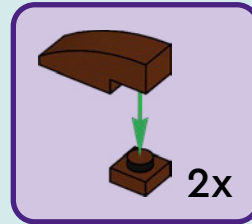

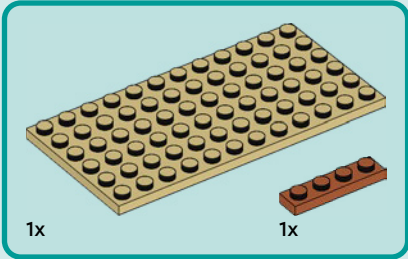
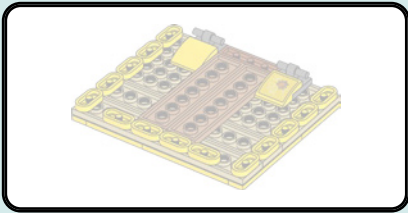

39

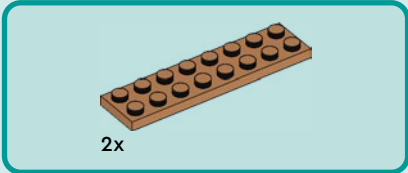
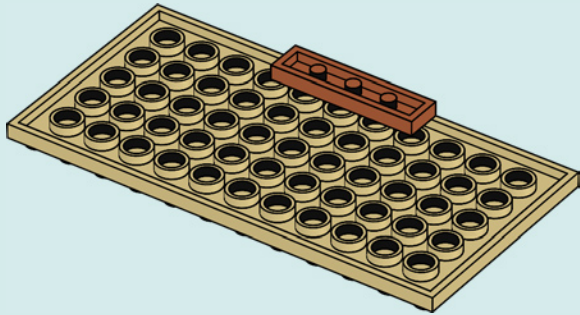

40

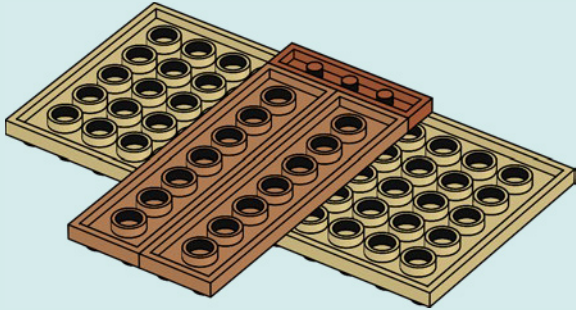

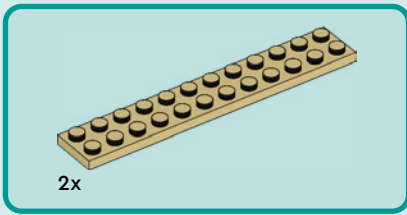

41

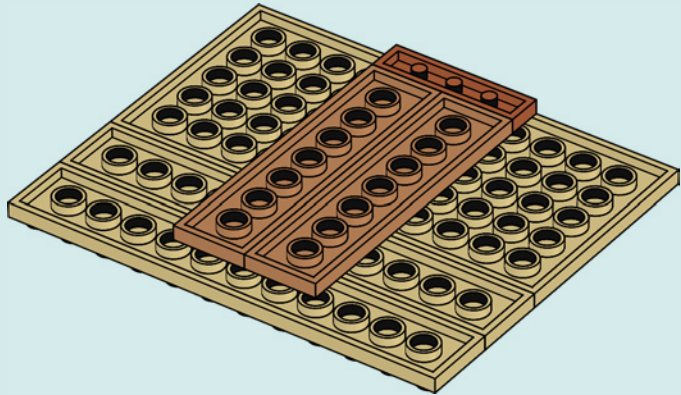

42

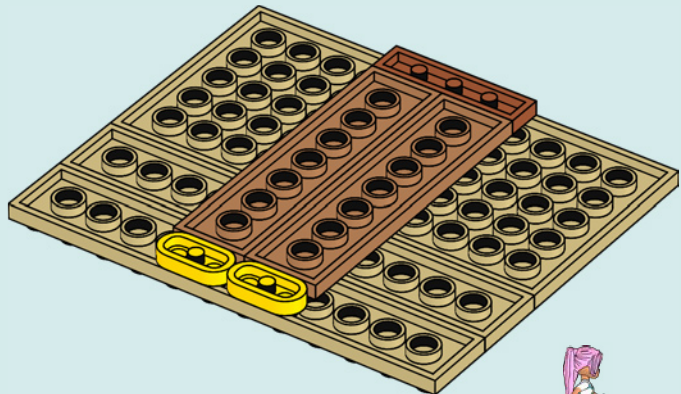



10x

43

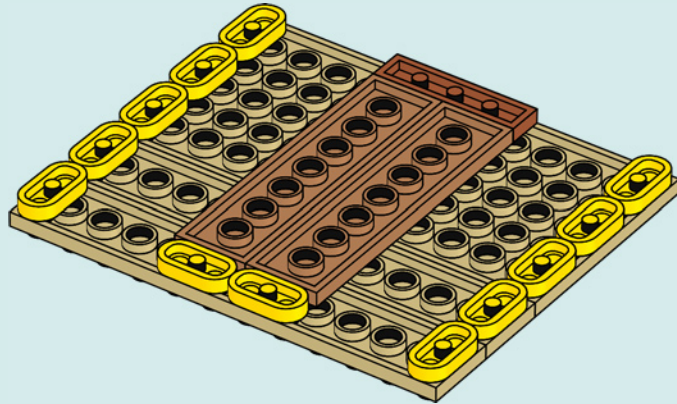

2x

44

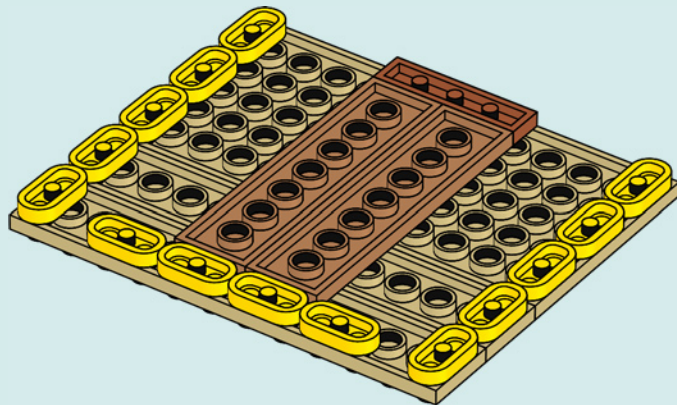

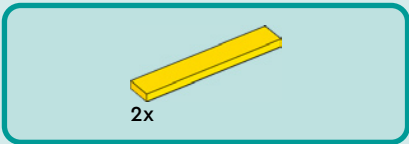

45

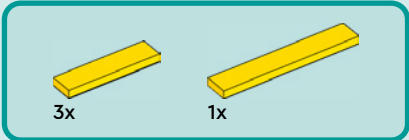
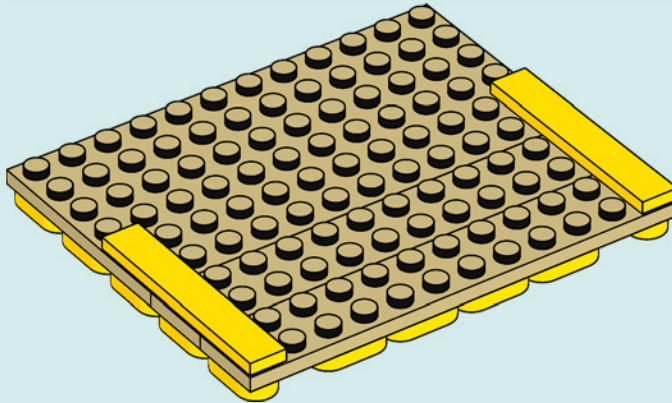
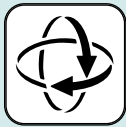

46

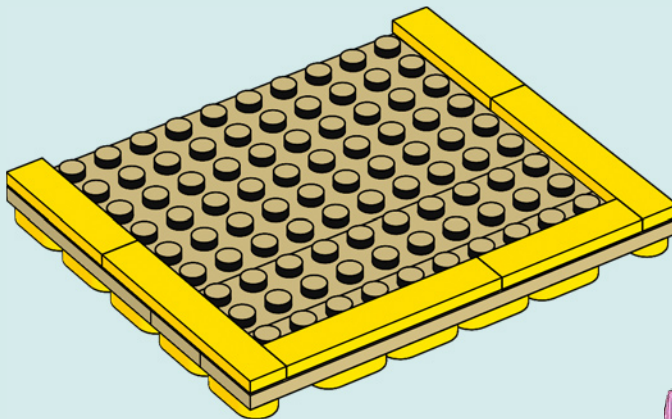



2x

47

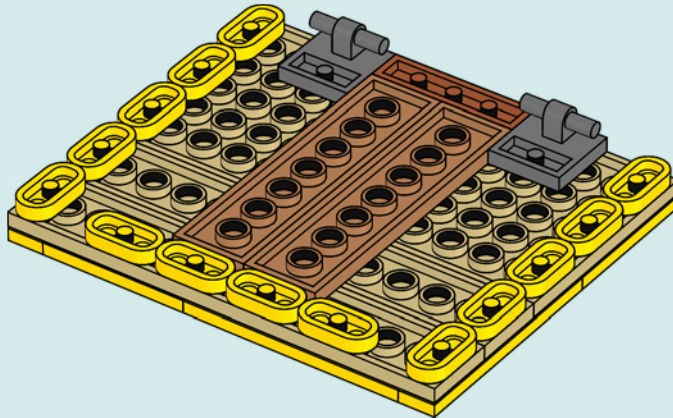



2x

48

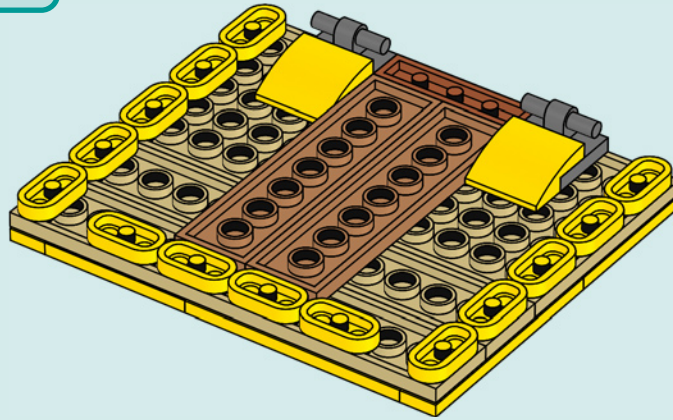

49

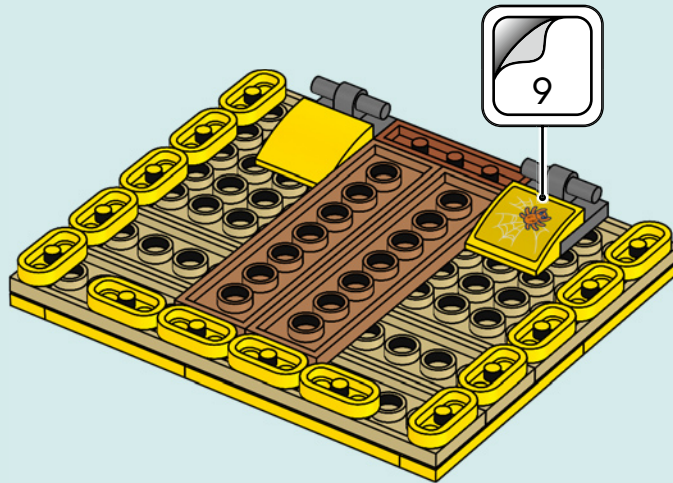

50

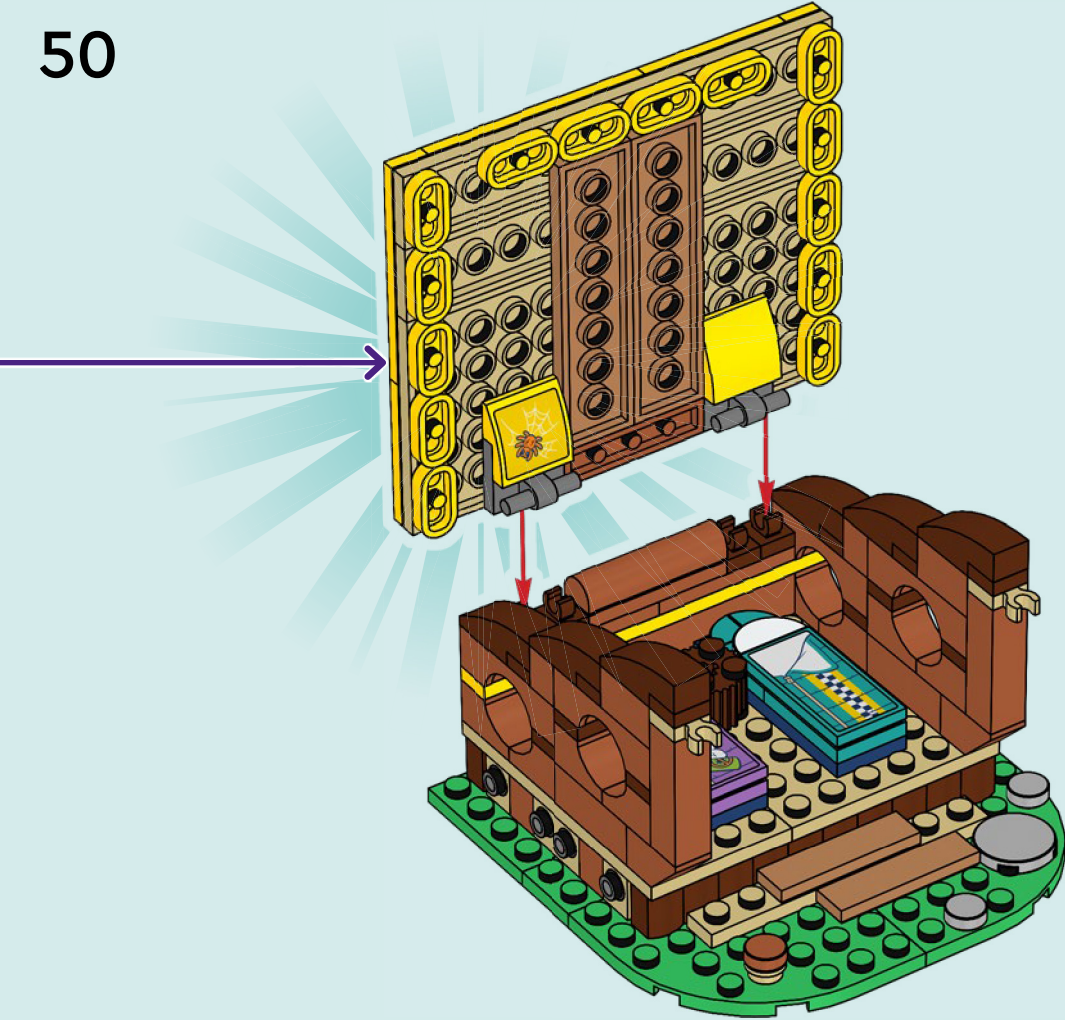



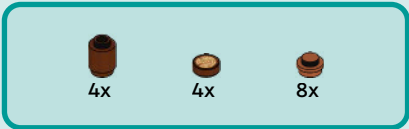

51

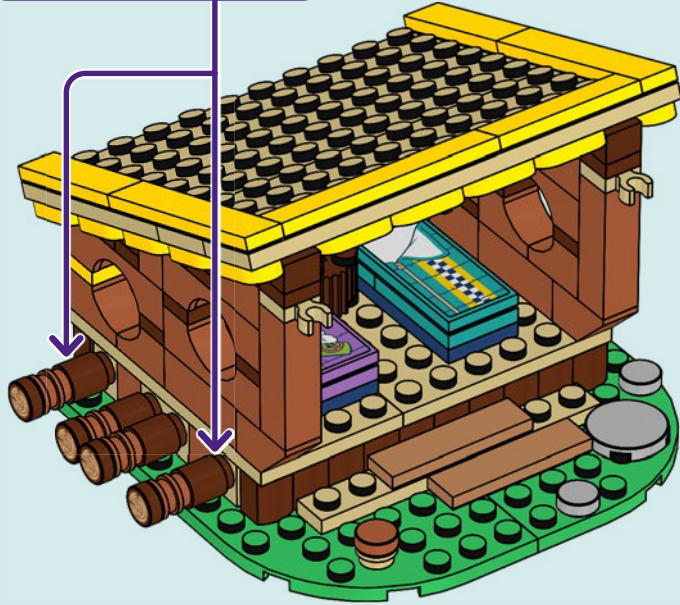
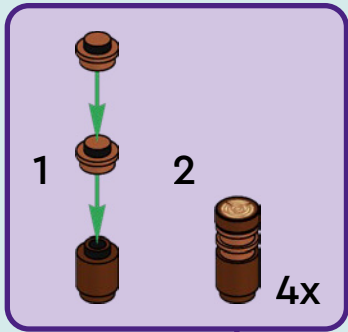



1x



1x



1x

# 52

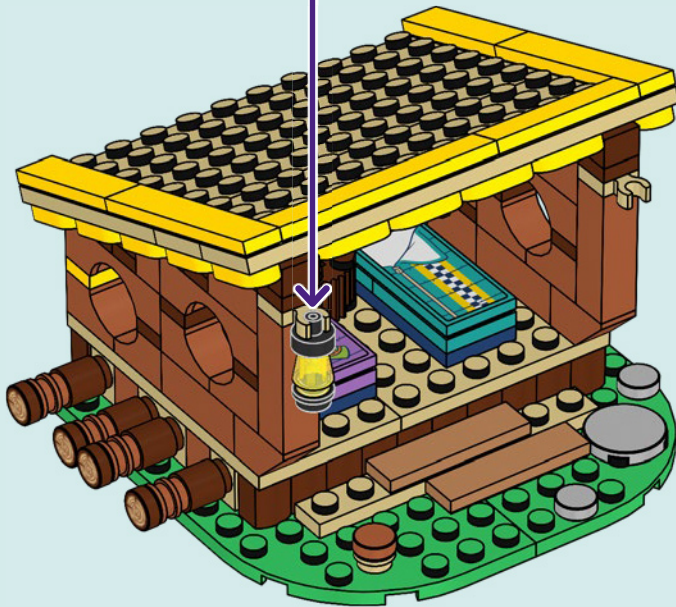
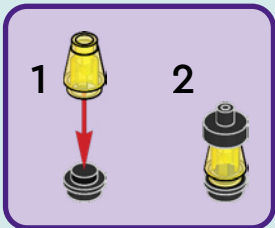



53

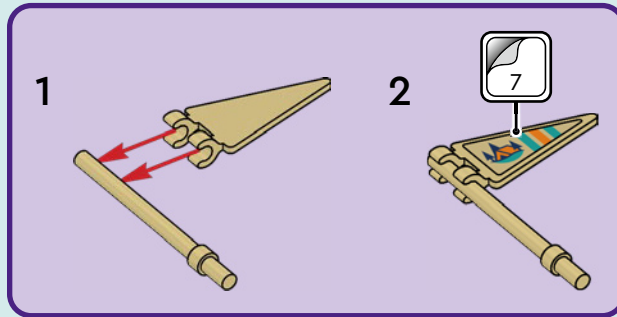





# Friends

## WATCH SERIES ONLINE



WATCH SERIES ONLINE  
SCHAU DIR DIE SERIE ONLINE AN  
REGARDE LA SÉRIE EN LIGNE  
GUARDA LA SERIE ONLINE  
MIRA LA SERIE EN INTERNET  
ASSISTIR À SÉRIE ONLINE  
在线观看剧  
OGLĄDAJ SERIAL W INTERECIE

SLEDUJ SERIÁL ONLINE  
POZRI SI SERIÁL ONLINE  
NÉZD A SOROZATOT ONLINE  
VIZIONEAZĂ SERIALUL ONLINE  
ГЛЕДАЙТЕ СЕРИАЛА ОНЛАЙН  
SKATIES SERIĀLU TIEŠSAISTĒ  
VAATA SARJA VEEBIST  
ŽIŪRĒK SERIALĄ INTERNETU

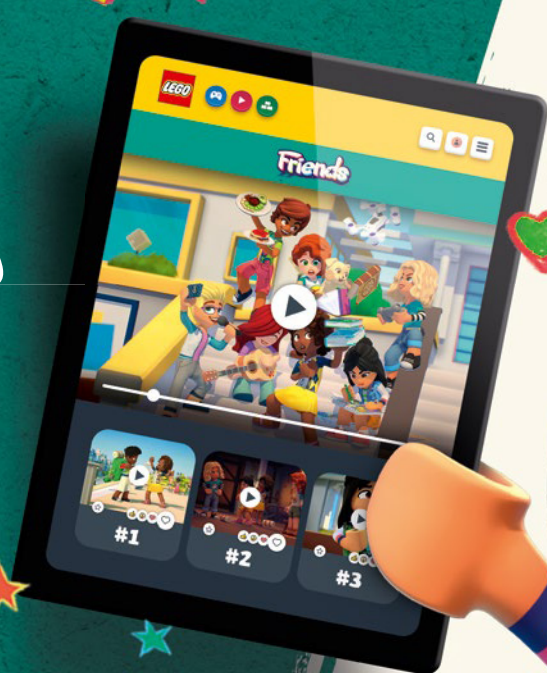

7x  
6168642

4x  
6400114

1x  
6434569

2x  
4181142

7x  
4161734

1x  
4529237

2x  
4179771

4x  
6352222

1x  
4666579

1x  
4523145

2x  
4121921

1x  
6170776

2x  
4118790

1x  
6475813

1x  
6351905

2x  
6254770

2x  
4114324

2x  
4509897

2x  
6070501

4x  
6093864

2x  
6185313

1x  
6478255

1x  
6486016

1x  
6429941

1x  
4206482

2x  
6195183

14x  
6248971

1x  
302224

2x  
6411332

1x  
302124

3x  
243124

1x  
4560181

3x  
663624

1x  
6079138

1x  
614126

1x  
6186675

1x  
6168646

2x  
4106347

1x  
307026

2x  
4109810

1x  
6409770

4x  
6064174

2x  
6078610

1x  
383526

2x  
6133767

1x  
6097194

5x  
6021999

1x  
4507311

1x  
6218146

1x  
4279059

8x  
6315782

5x  
6322840

6x  
6254484

4x  
6397875

16x  
6482692

6x  
4579659

4x  
6482689

1x  
6315191

1x  
6187575

6x  
6263221

3x  
6340118

8x  
6074892

2x  
6439724

8x  
6441766

2x  
6264069

1x  
6337597

1x  
6214234

2x  
6484357

1x  
6092770

1x  
4620693

2x  
4160593

1x  
6475812

2x  
6240467  
1x  
6469022  
1x  
6483118  
14x  
6482693  
1x  
6249390  
2x  
6222950  
1x  
6249417  
3x  
6292786  
1x  
6223065  
3x  
6264986  
1x  
6433414  
2x  
6209692  
2x  
6211875  
1x  
6258352

1x  
6258353  
1x  
4537937  
1x  
6013530  
1x  
6212989  
2x  
6322816  
1x  
6138657  
1x  
6132790  
4x  
6097420  
1x  
6411591  
1x  
6400754  
12x  
6447541  
1x  
6409769  
2x  
6357747  
4x  
6174023

2x  
6314353  
5x  
4211183  
4x  
6285623  
3x  
6215659  
1x  
6416487  
27x  
4221744  
8x  
6348057  
2x  
6177699  
1x  
4620075  
2x  
6483392  
2x  
6325717  
3x  
6036503  
7x  
4211180  
2x  
6078605

1x  
6173132  
3x  
6398342  
1x  
6484671  
2x  
6333110  
12x  
6325975  
3x  
6116613  
11x  
4211181  
2x  
4211190  
1x  
6438484  
7x  
6284071  
1x  
4211412  
1x  
4211503  
1x  
6052200

2x  
4211386  
1x  
6303438  
7x  
6395635  
2x  
6221607  
4x  
6457961  
4x  
6215606  
3x  
6167643  
3x  
6368592  
1x  
6371952  
5x  
6102998  
4x  
6226644

1x  
6482272  
1x  
6478257  
1x  
4618670  
4x  
6413492  
1x  
6400762  
1x  
6248486  
1x  
6495221

1x  
6416490  
1x  
6484662  
2x  
6199893  
1x  
6484627  
1x  
4619512  
1x  
4619516  
1x  
4651902



 [LEGO.com/service](https://www.LEGO.com/service)

YOU COULD **WIN**



Scan this QR code or go to  
**LEGO.COM/PRODUCTFEEDBACK** and give us  
your short feedback about this LEGO® set for a  
chance to win a cool LEGO prize.

Terms and Conditions apply\*

**EN: YOU COULD WIN.** Terms and Conditions apply\* **DE: Du könntest GEWINNEN.** Es gelten die Teilnahmebedingungen\* **FR: Tu pourrais GAGNER.** Des conditions s'appliquent\* **IT: Potresti VINCERE tu.** Termini e condizioni sono applicabili\* **ES: Puedes GANAR.** Aplican términos y condiciones\* **PT: Poderá GANHAR.** Aplicam-se termos e condições\* **ZH: 轻松获奖. 条款和条件适用\*** **PL: Szansa na WYGRANĄ.** Obowiązują warunki korzystania\* **CS: Máte šanci VYHRÁT.** Platí všeobecné smluvní podmínky\* **SK: Máte šancu VYHRAŤ.** Platia všeobecné zmluvné podmienky\* **HU: TE IS NYERHETSZ.** Felhasználási feltételek érvényesek\* **RO: Ai putea CÂȘTIGA.** Se aplică termeni și condiții\* **BG: Можете да СПЕЧЕЛИТЕ.** Има определени правила и условия\* **LV: Tu vari LAIMĒT.** Ir spēkā noteikumi un nosacījumi.\* **ET: Sul on võimalus VÕITA.** Kehtivad tingimused\* **LT: Jūs galite LAIMĖTI.** Taikomos sąlygos\*

\*[LEGO.com/productfeedback-terms](https://www.lego.com/productfeedback-terms)

LEGO, the LEGO logo and the Friends LOGO are trademarks of the LEGO Group. ©2024 The LEGO Group.

6521567