



education™



45821



**SUPER
POWERED™**



WARNING: CHOKING HAZARD.
Toy contains small parts and a small ball.
Not for children under 3 years.

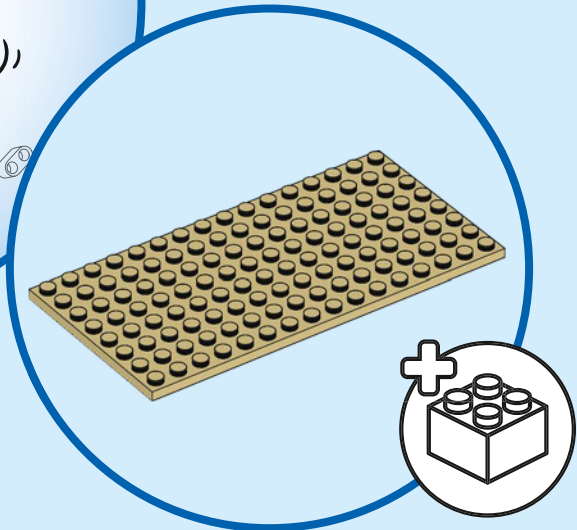
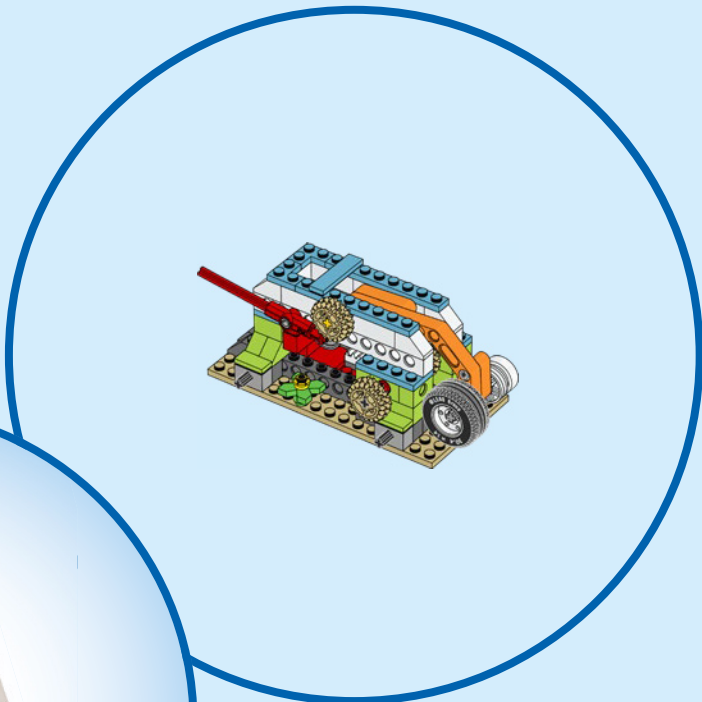

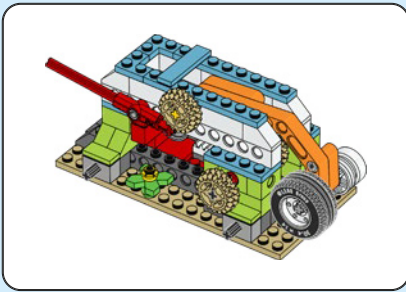

AVERTISSEMENT : RISQUE D'ÉTOUFFEMENT.
Le jouet contient des petites pièces ainsi qu'une petite boule.
Il ne convient pas aux enfants de moins de 3 ans.



ADVERTENCIA: PELIGRO DE ASFIXIA.
Juguete que contiene partes pequeñas y una pelota pequeña.
No recomendado para niños menores de 3 años.

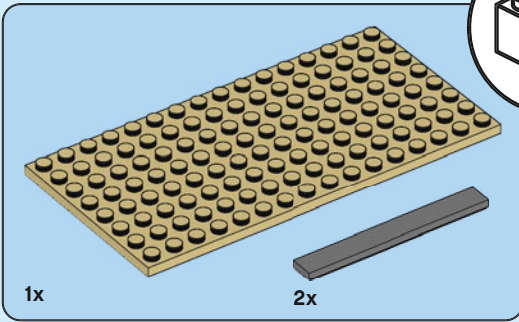
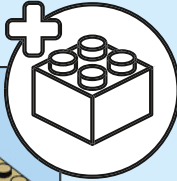

1

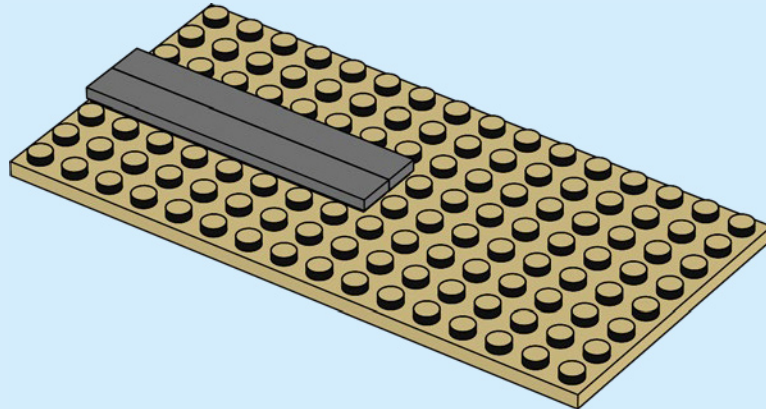

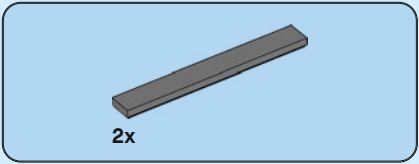

2

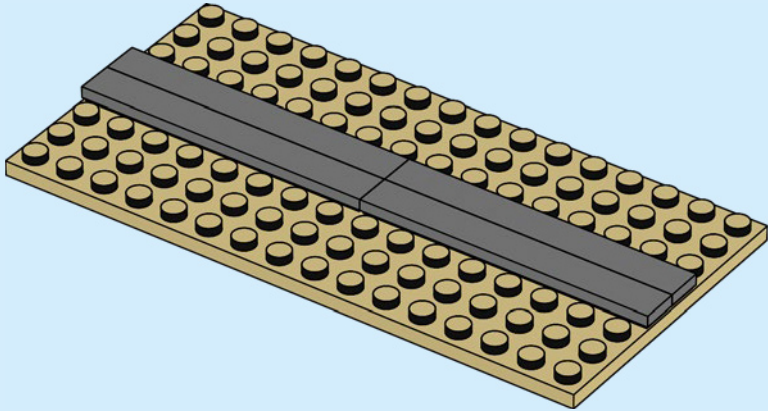

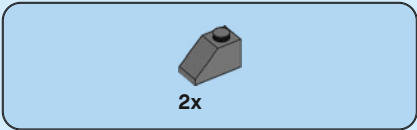

3

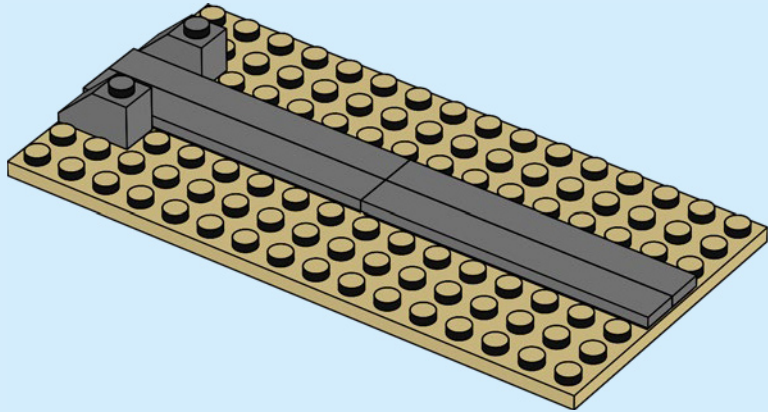

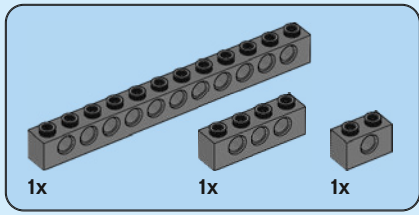

4

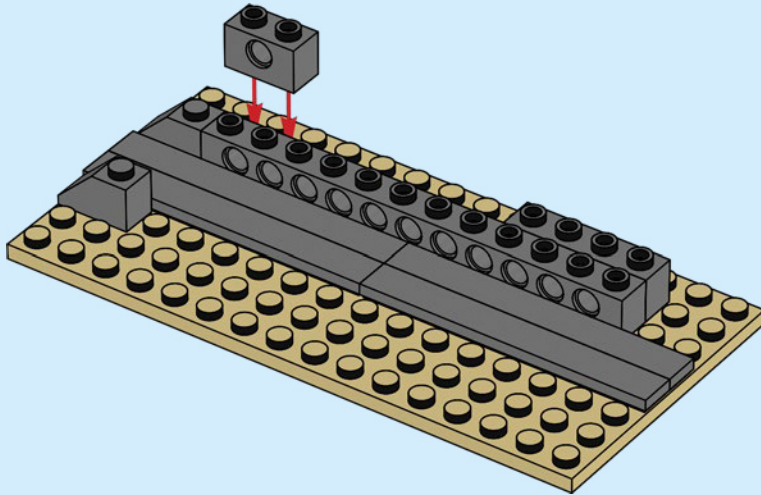

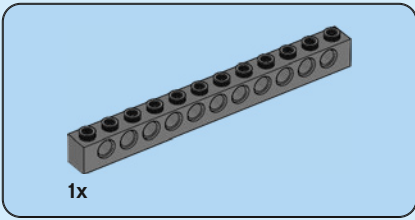

5

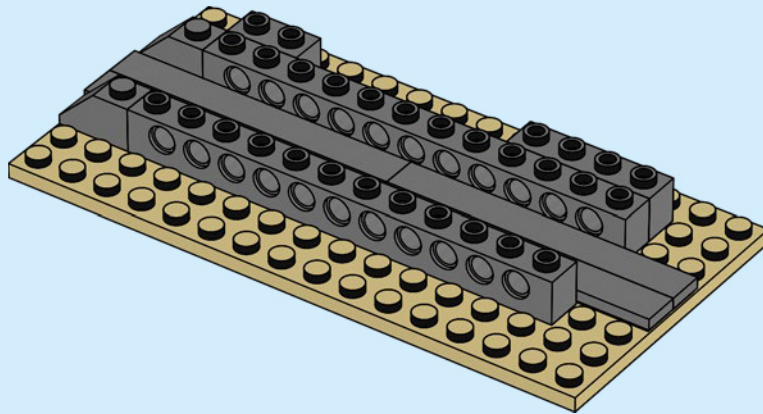

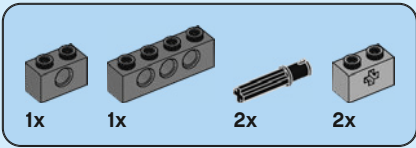

6

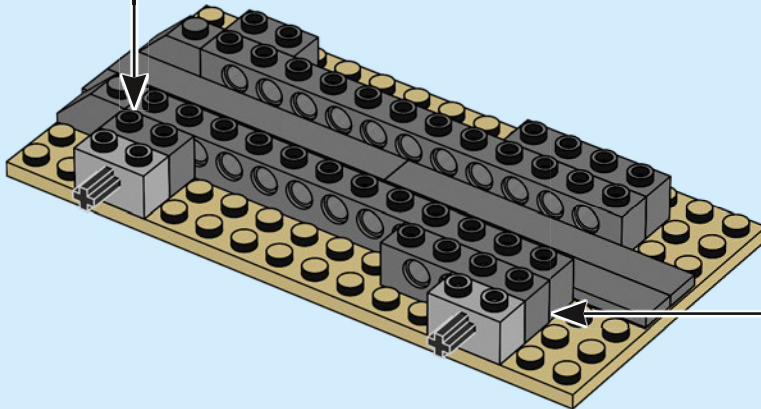
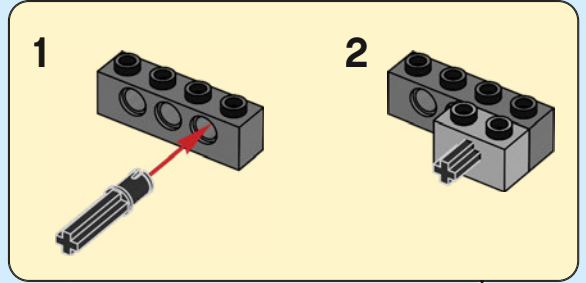
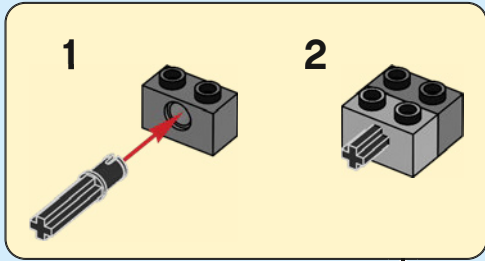

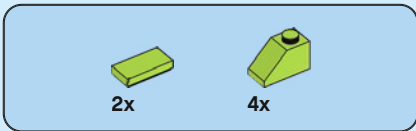

7

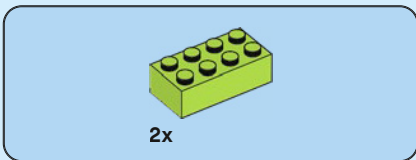
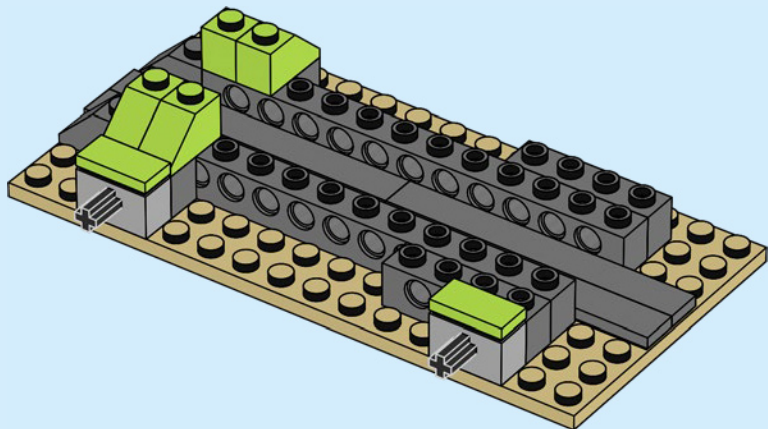

8

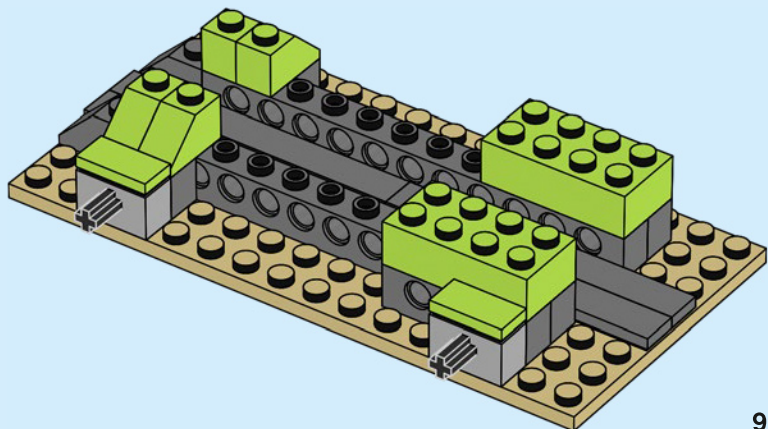



2x

9

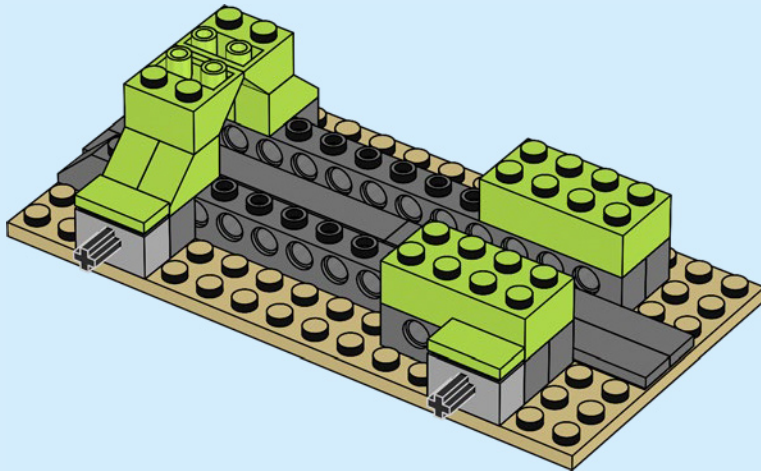



10

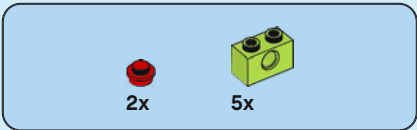
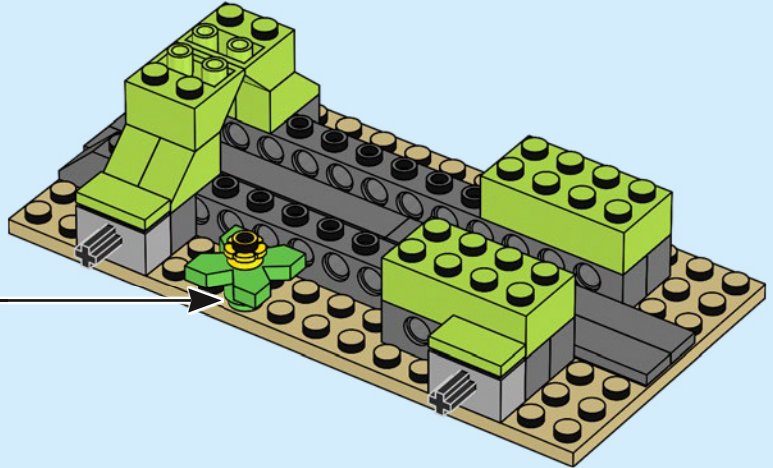
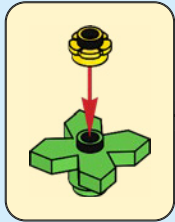

11

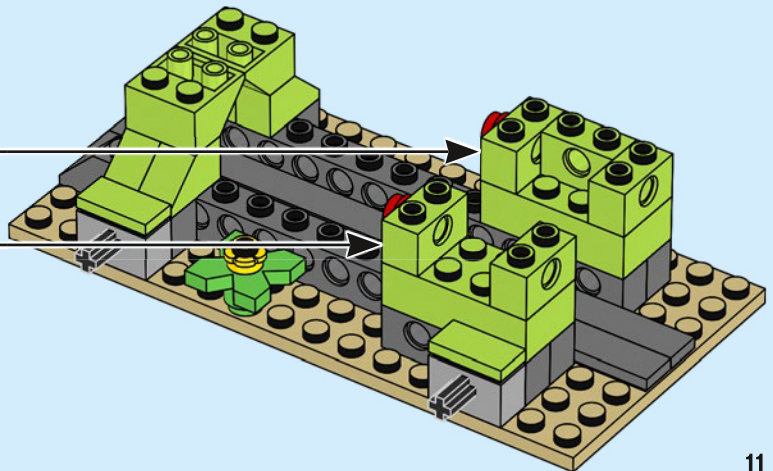
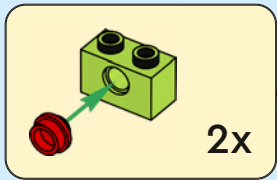

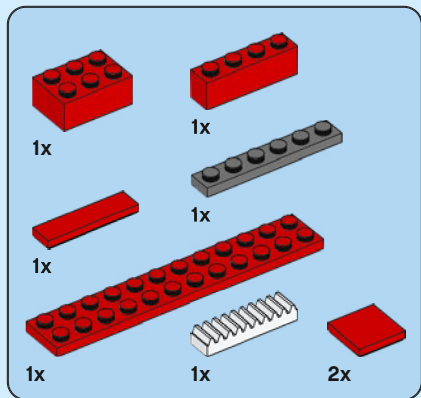

12

1

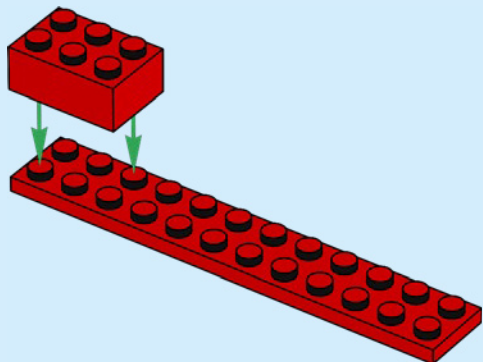

2

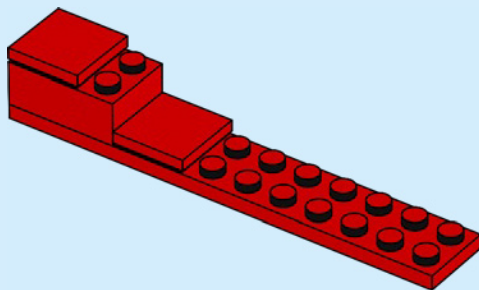

3

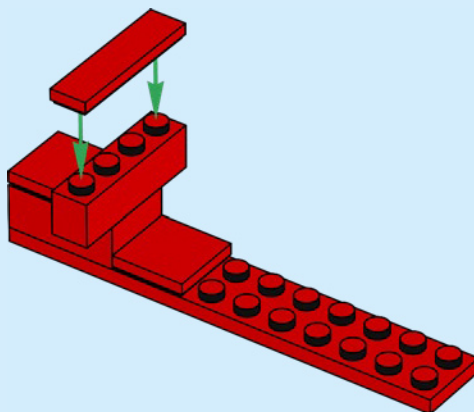

4

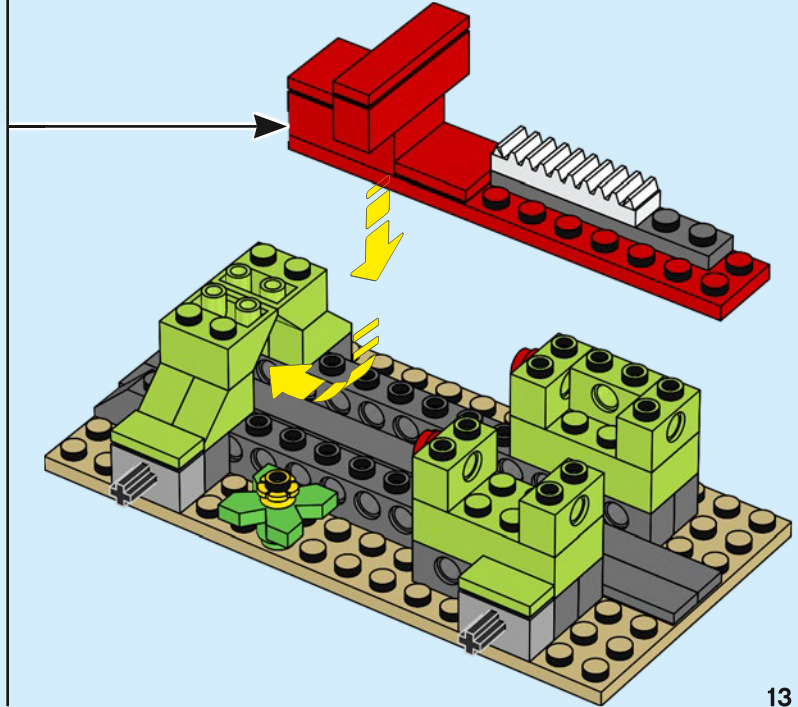
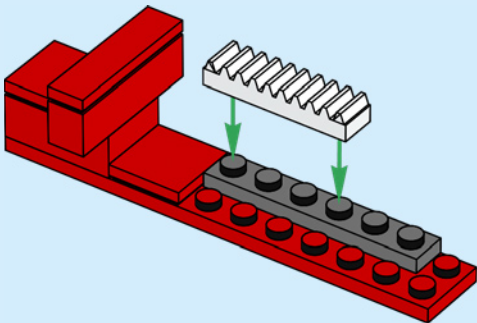

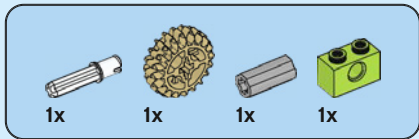

13

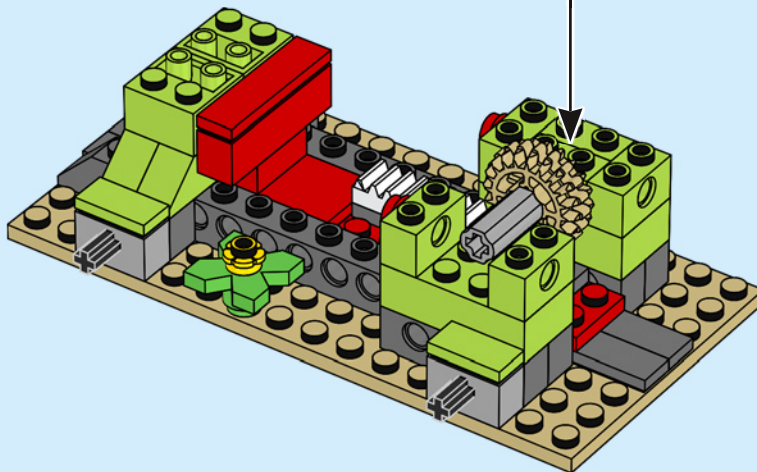
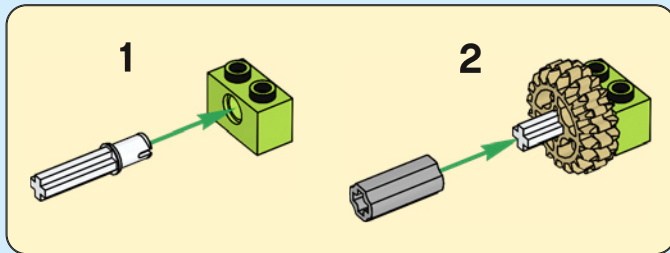



1x

14

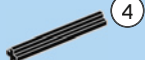
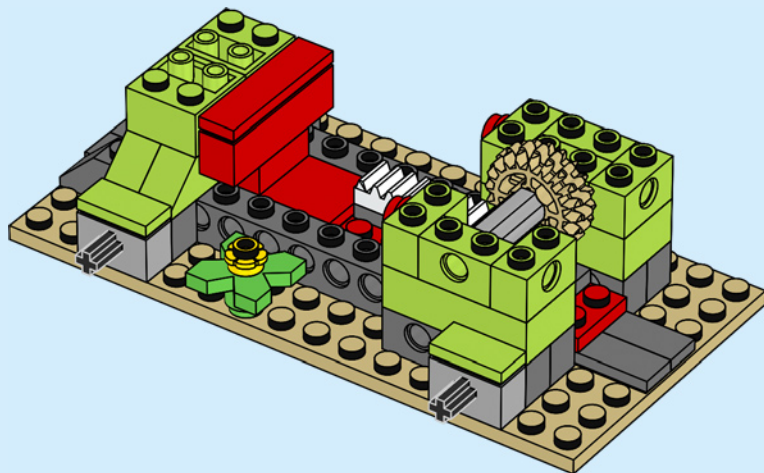

1x



1x



4

1:1

15

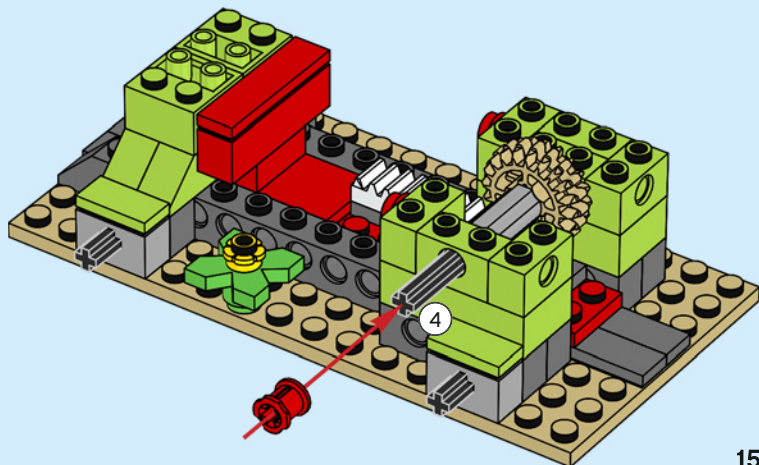



1x

16

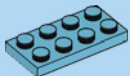
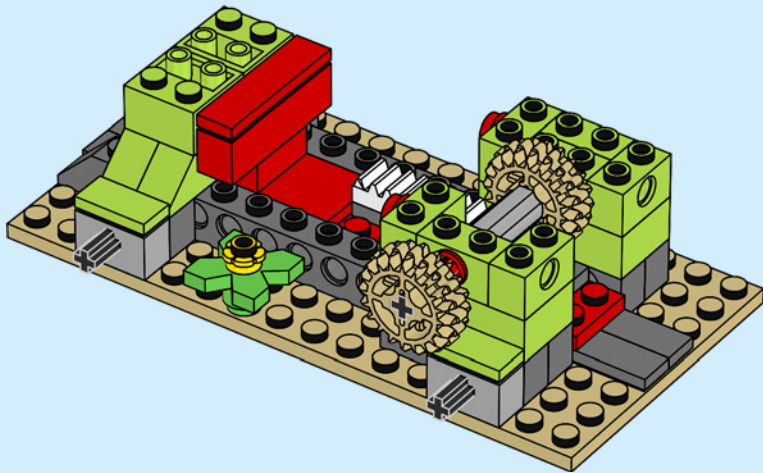

3x

17

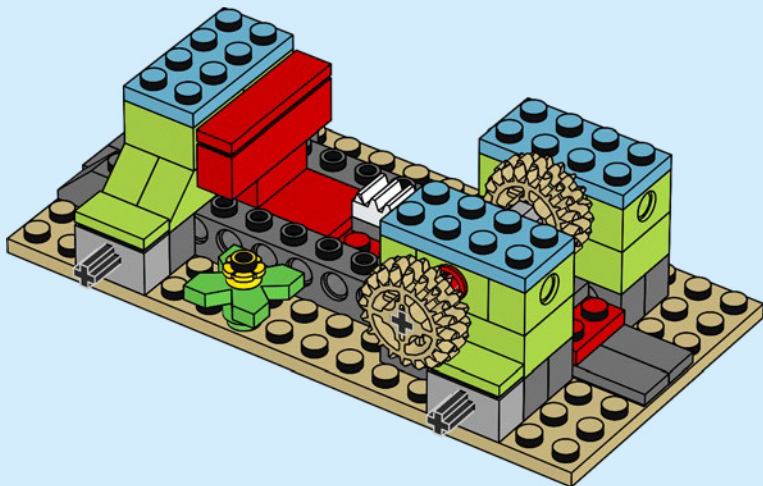

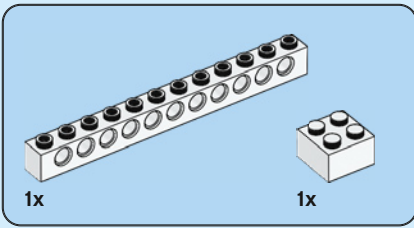

18

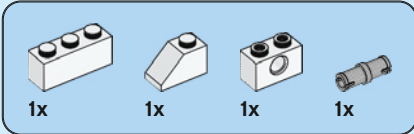
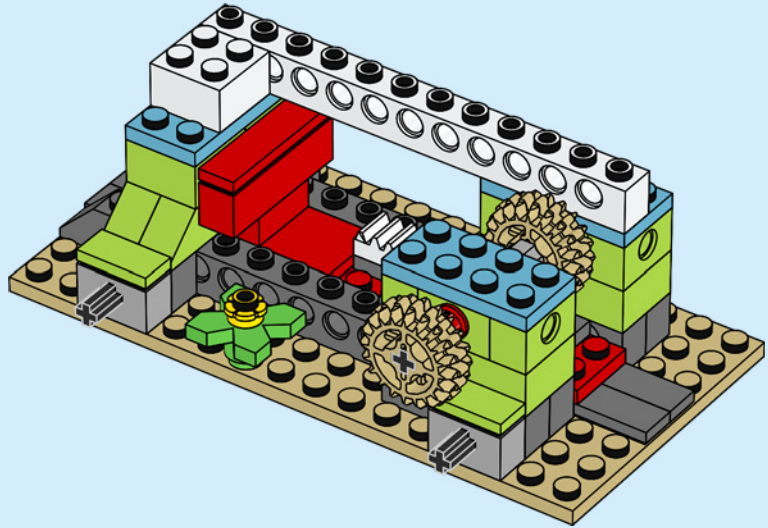

19

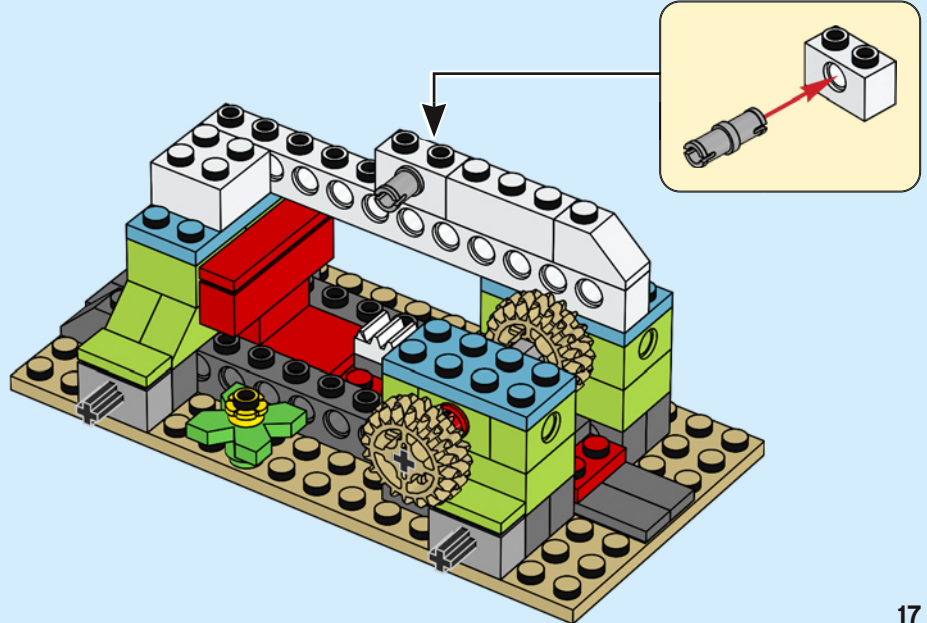

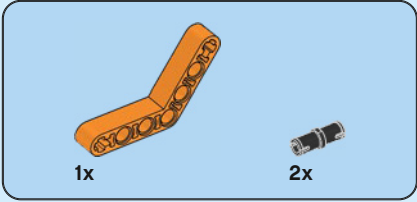
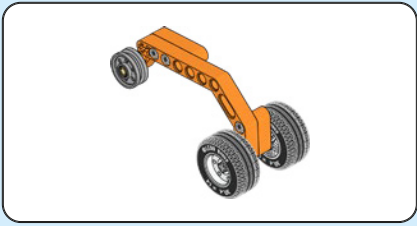

20

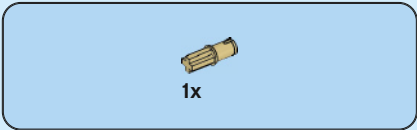
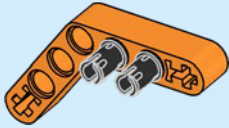

21

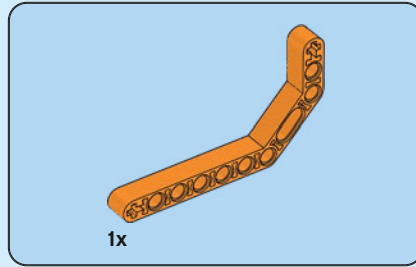
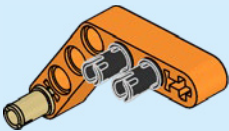

22

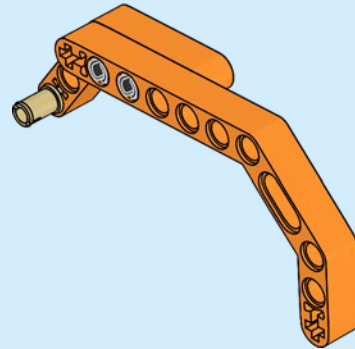



1x

23

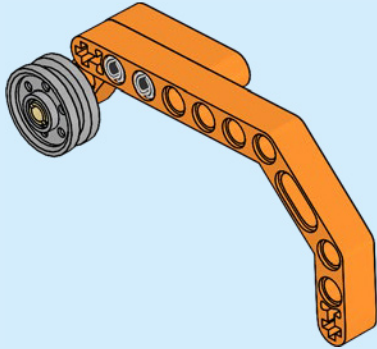

2x

24

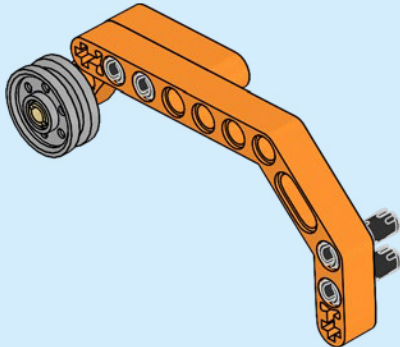

1x

25

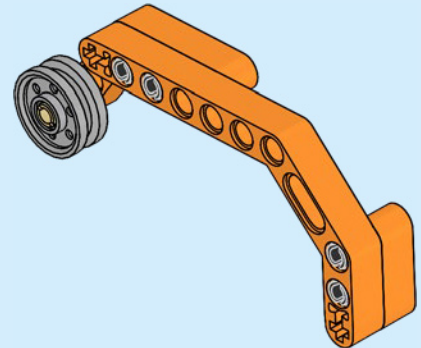

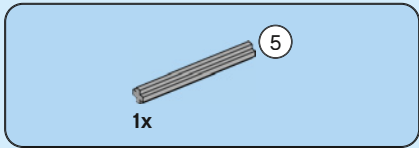

26

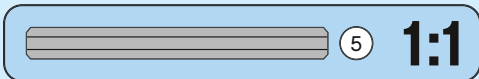
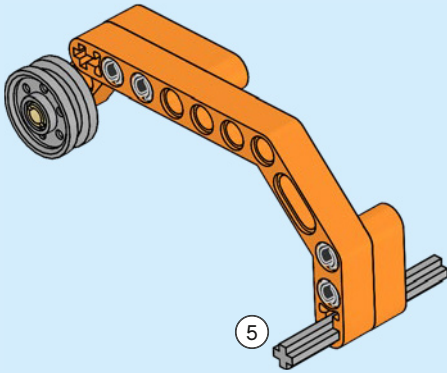

20

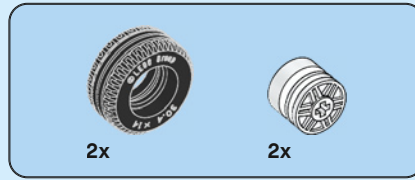

27

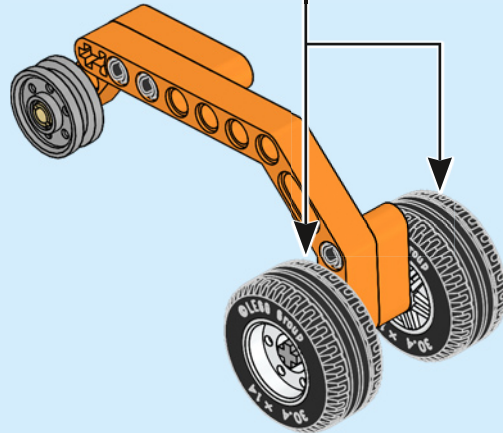
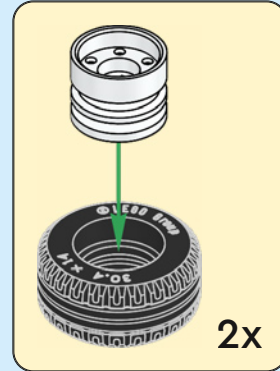

28

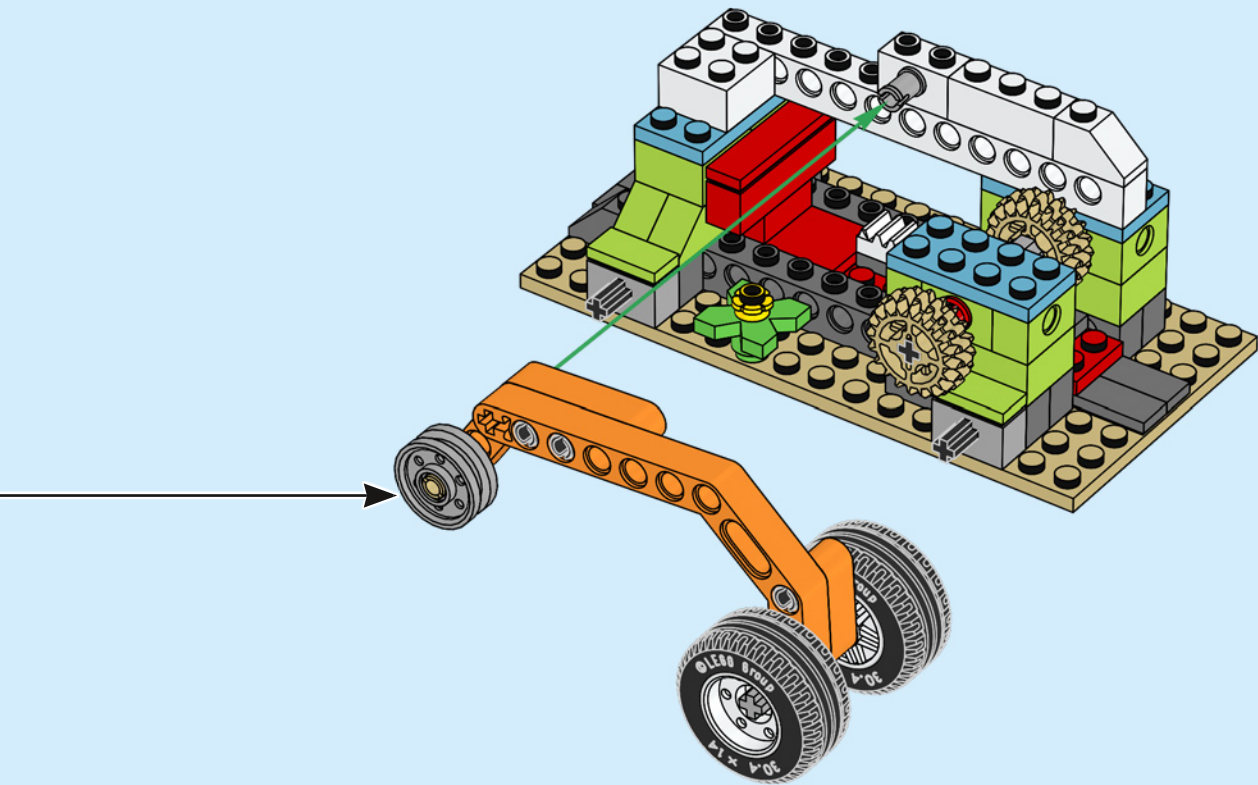

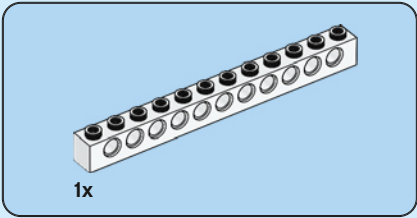

29

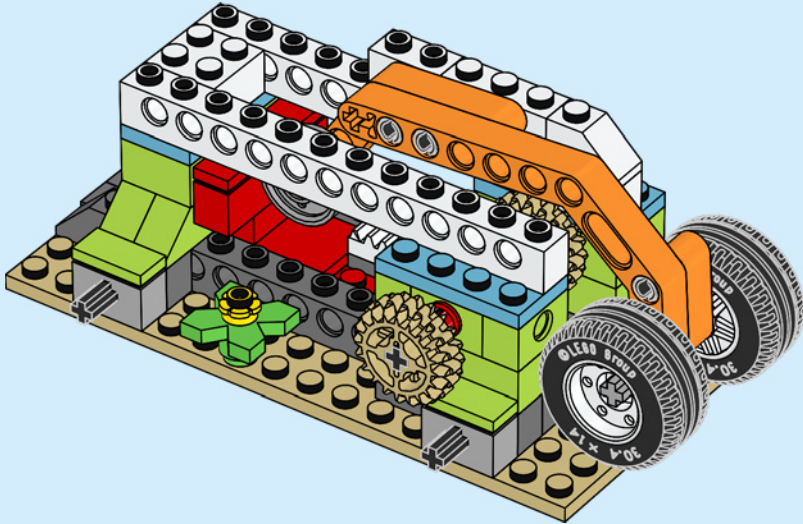

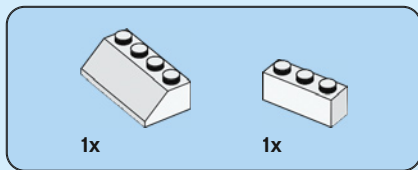

30

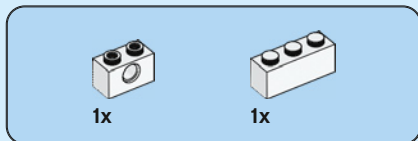
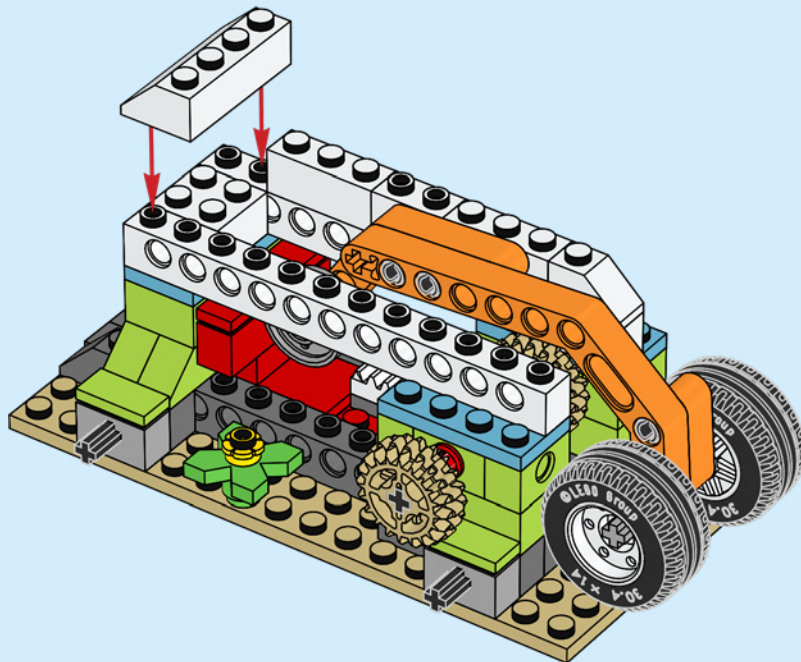

31

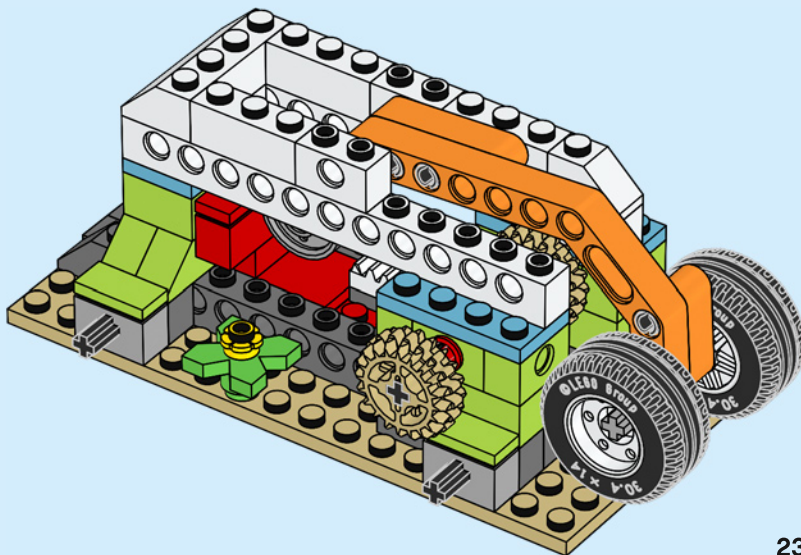

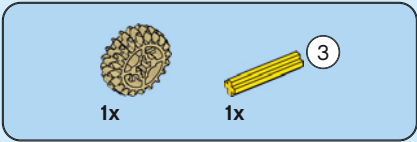

32

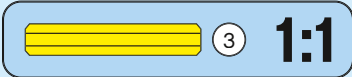
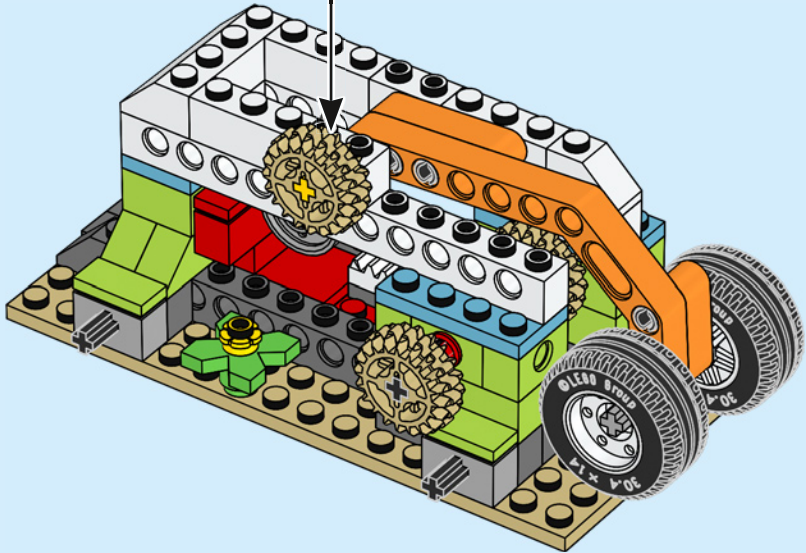
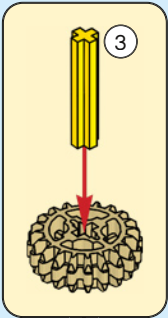

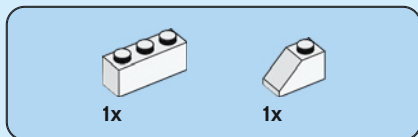

33

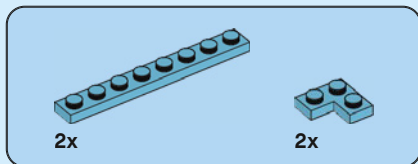
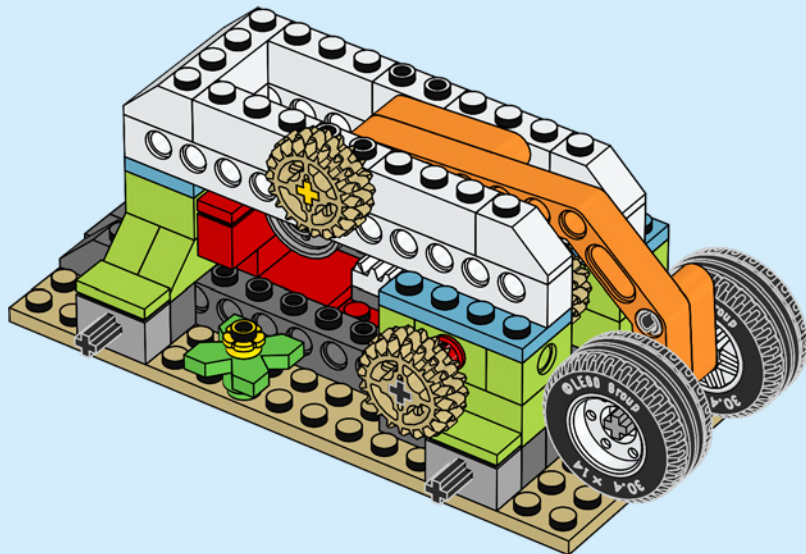

34

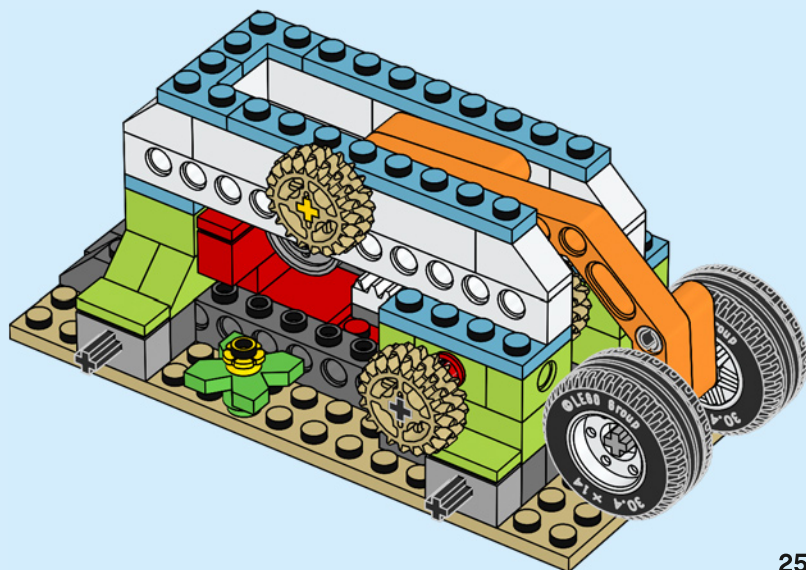

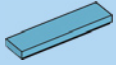

1x

35

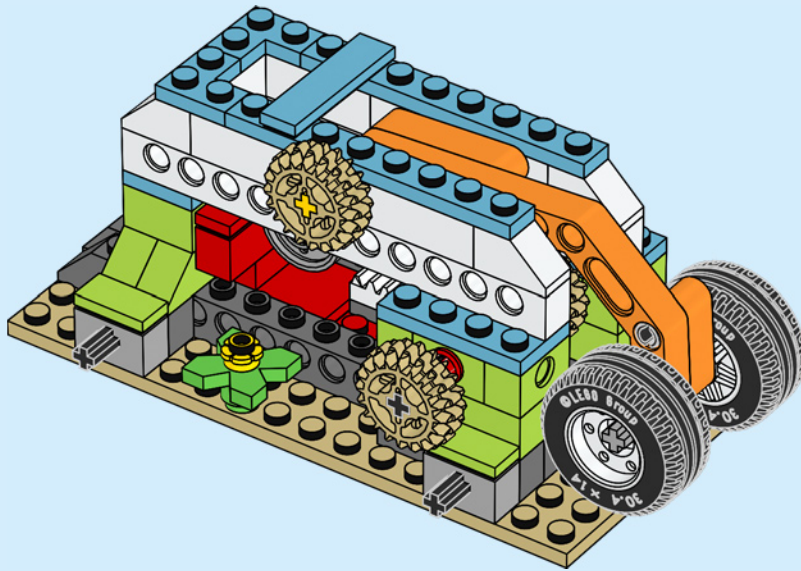

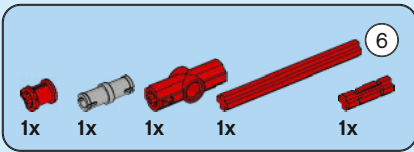

36

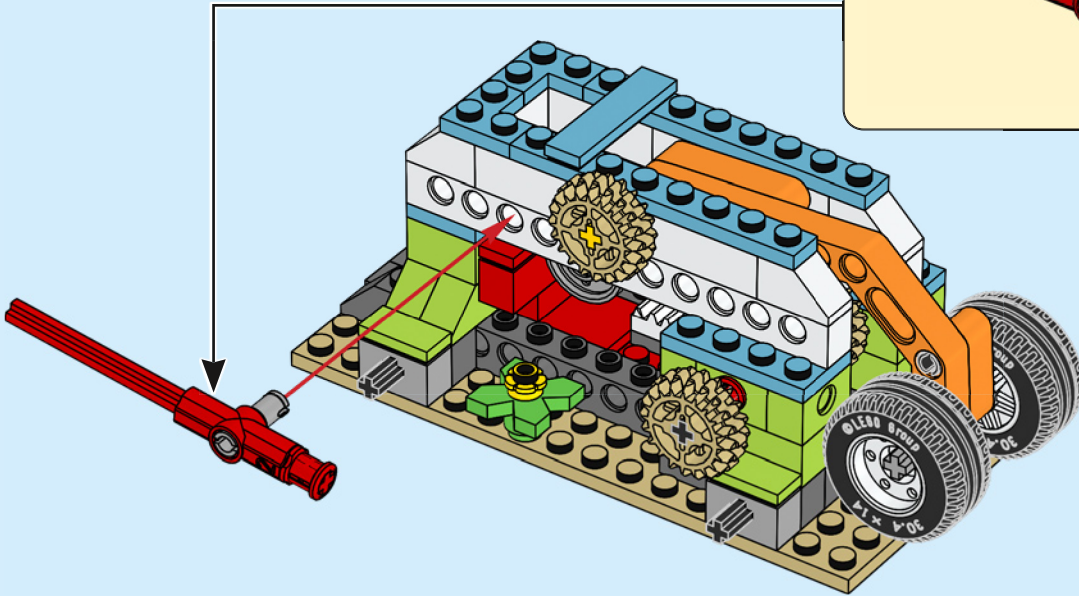
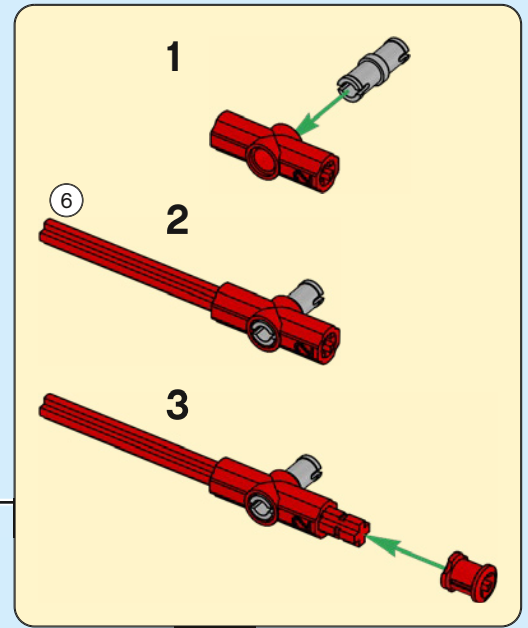

LEGO and the LEGO logo are trademarks of the/sont des marques de commerce du/son marcas registradas de LEGO Group.

©2022 The LEGO Group. 6424373

FIRST[®] is a registered trademark of For Inspiration and Recognition of Science and Technology (*FIRST*). LEGO[®] is a registered trademark of the LEGO Group. *FIRST*[®] LEGO[®] League and SUPERPOWERED[™] are jointly held trademarks of *FIRST* and the LEGO Group.

©2022 *FIRST* and the LEGO Group. All rights reserved.