



6+

4883

Designer Set



Ideas



Instructions



Quick Build  
 Schnellbaumodelle  
 Construction rapide  
 Costruzione rapida  
 Snel bouwen  
 Construcción rápida  
 Byg hurtigt  
 Nopeaan rakentamiseen  
 Bygg snabbt  
 Construção Rápida  
**Γρήγορες Κατασκευές**  
 Kísérletezőknek



Experienced Build  
 Könnnermodelle  
 Construction normale  
 Costruzione esperta  
 Bouwen voor gevorderden  
 Construcción experta  
 Byg videre  
 Kokeneelle rakentajalle  
 Bygg mer  
 Construção para Experimentados  
**Επιδέξιες Κατασκευές**  
 Haladóknak



Advanced Build  
 Profimodelle  
 Construction avancée  
 Costruzione avanzata  
 Geavanceerd bouwen  
 Construcción avanzada  
 Byg avanceret  
 Taitavalle rakentajalle  
 Bygg avancerat  
 Construção Avançada  
**Εξελιγμένες Κατασκευές**  
 Profiknak







1



2



3

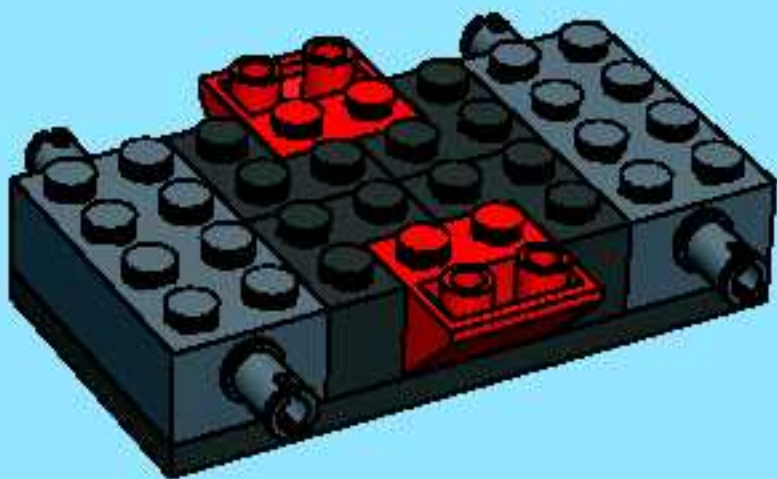

4

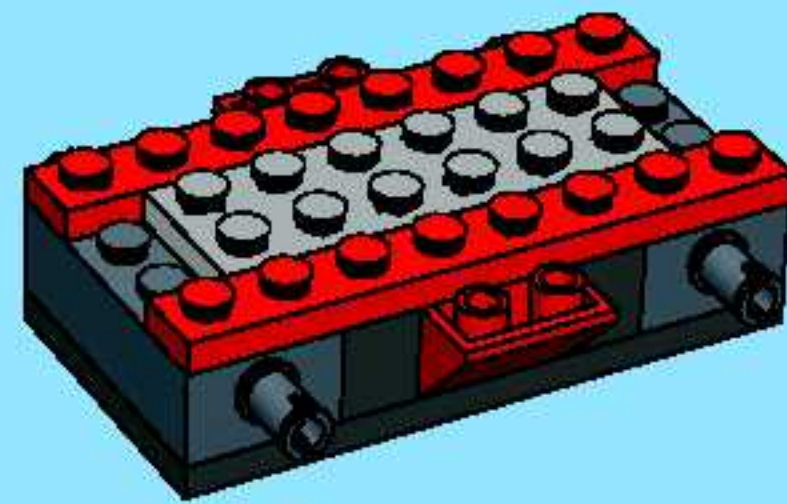

1



2

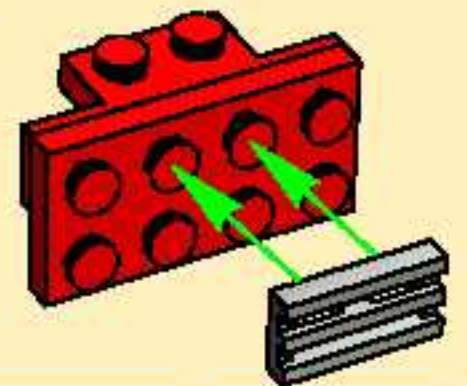

5

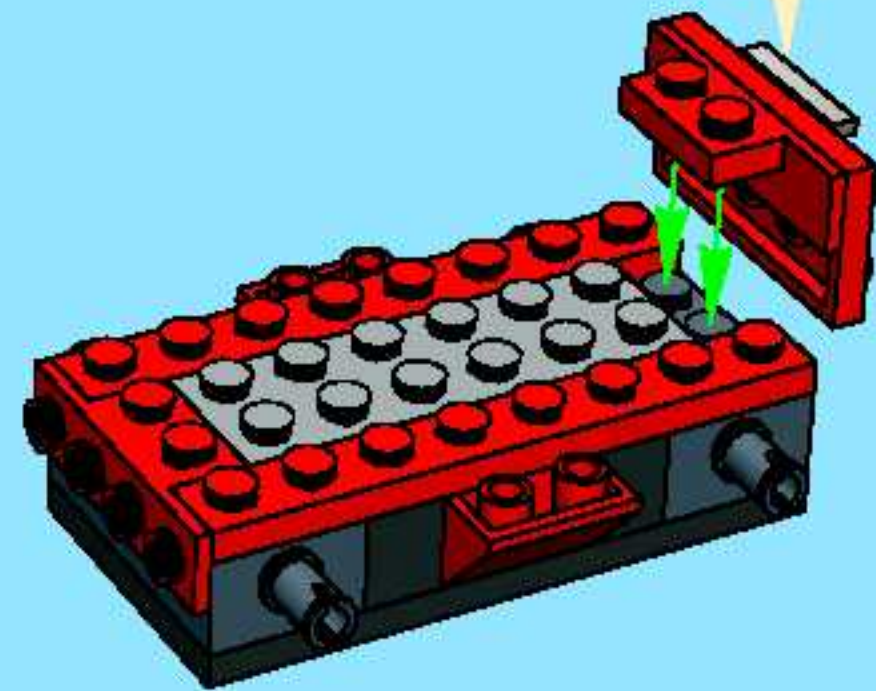

1



2



3



6

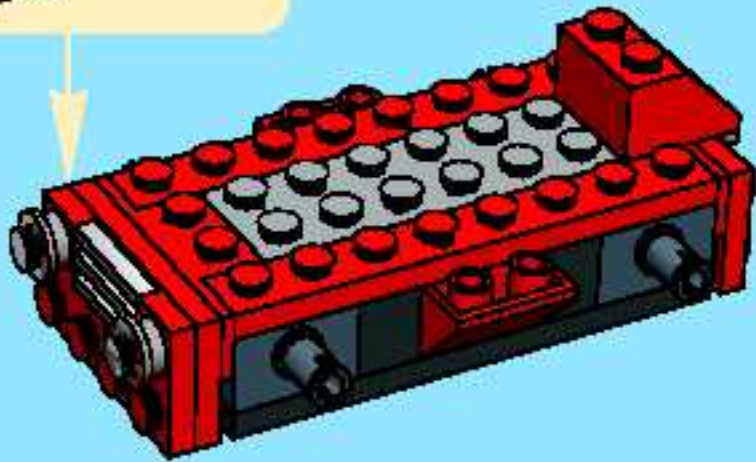

7

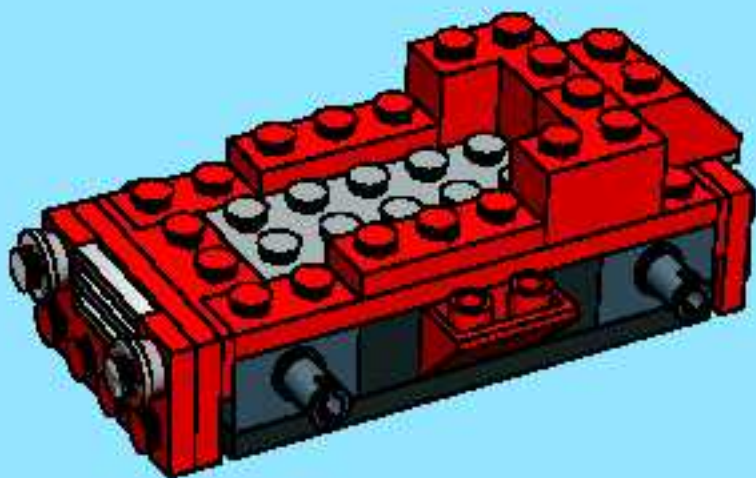

8

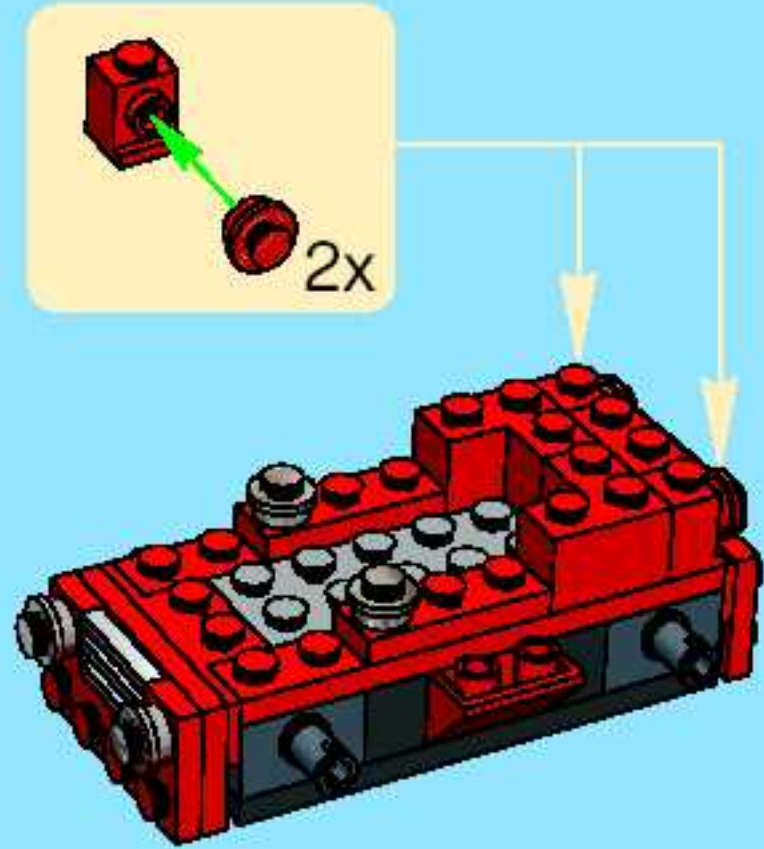

9

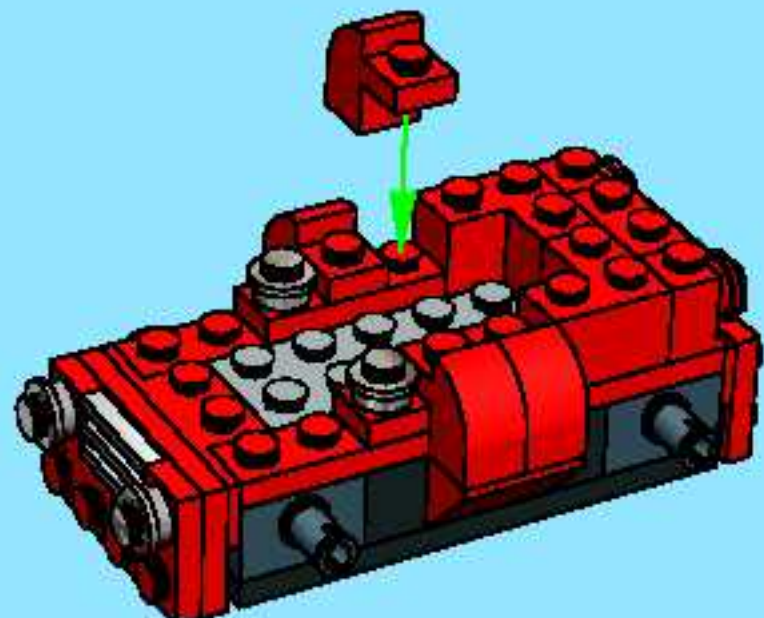

10

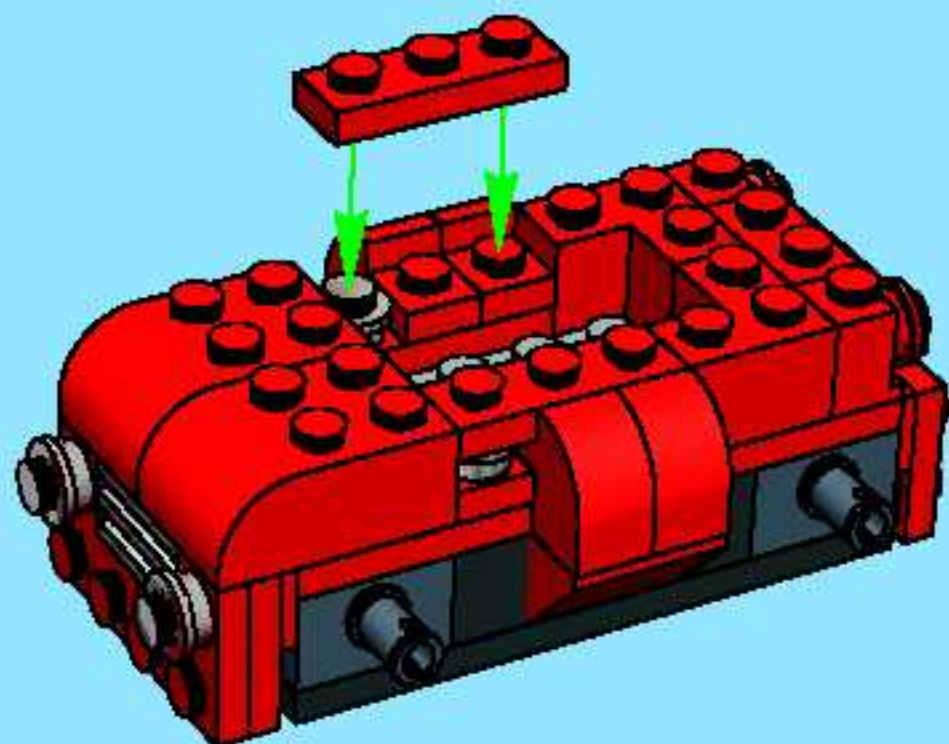

11

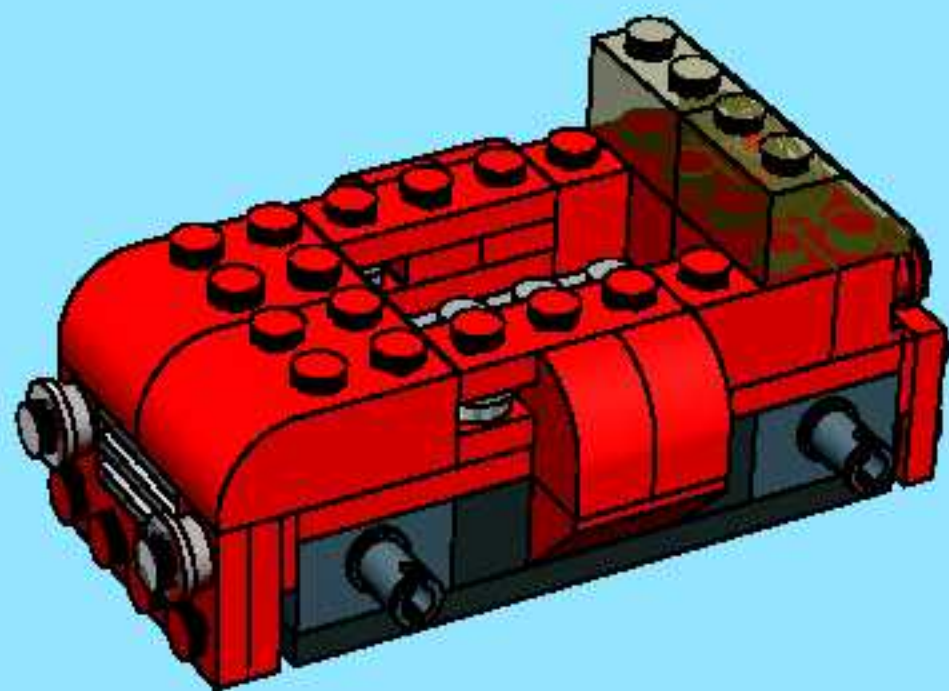

12

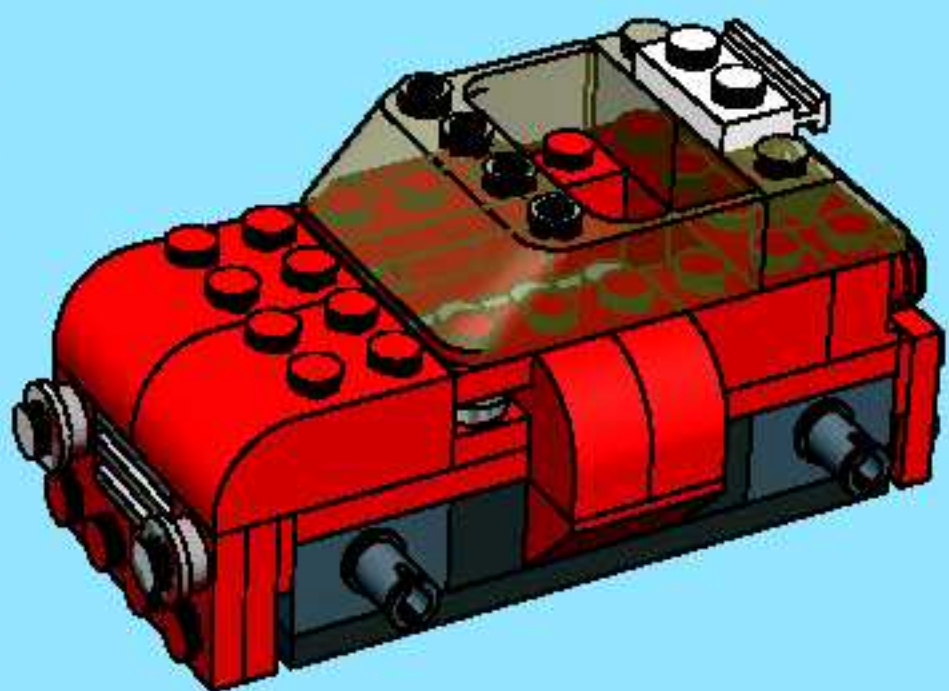

13

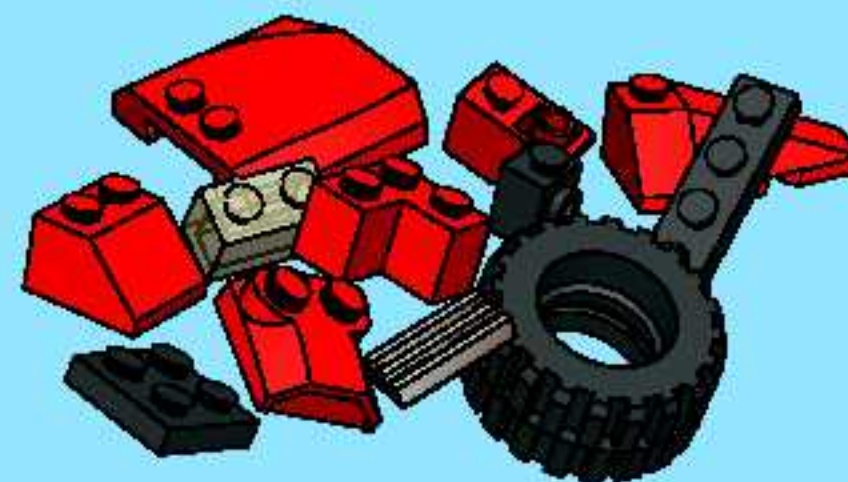
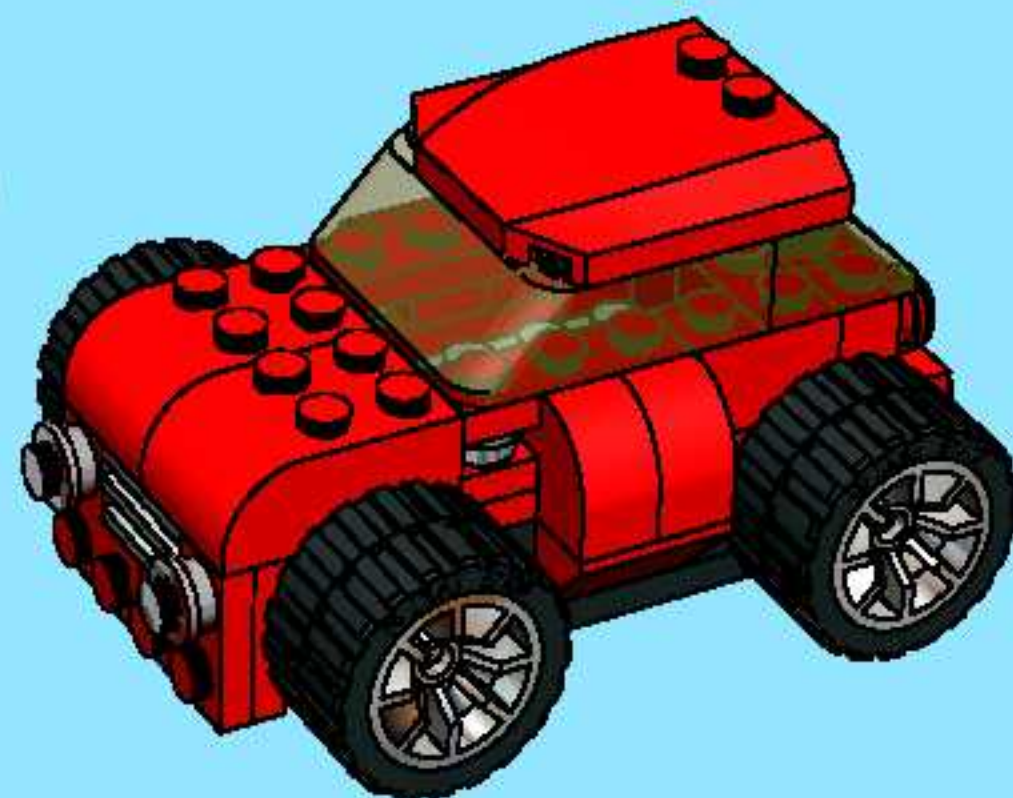

=





1



2



3

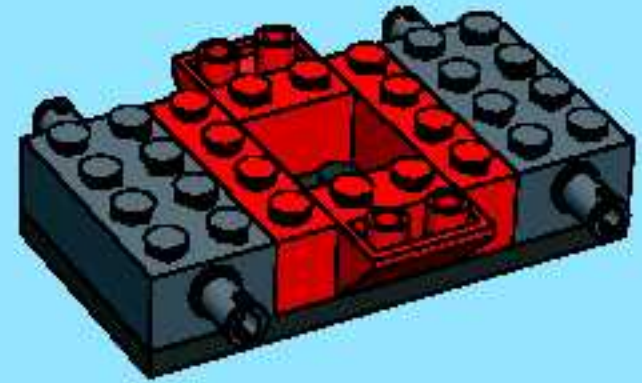

4

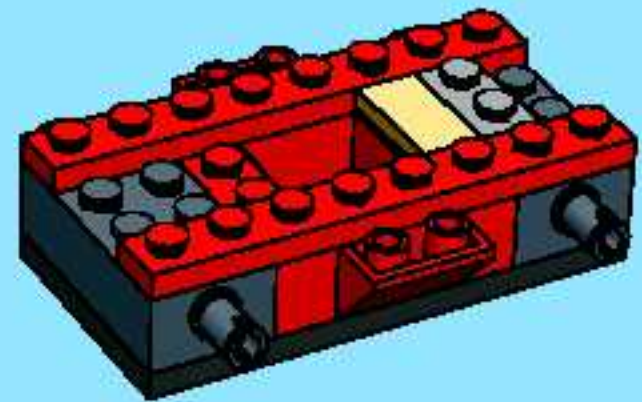



5

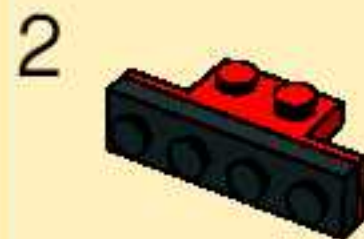
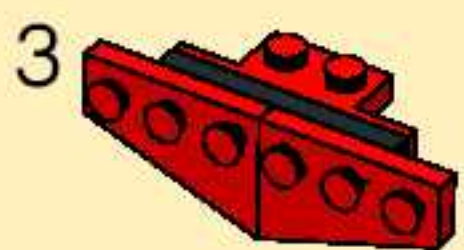
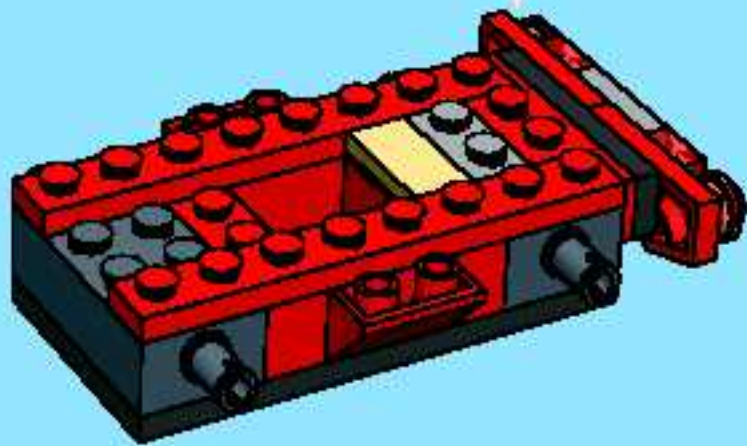

6

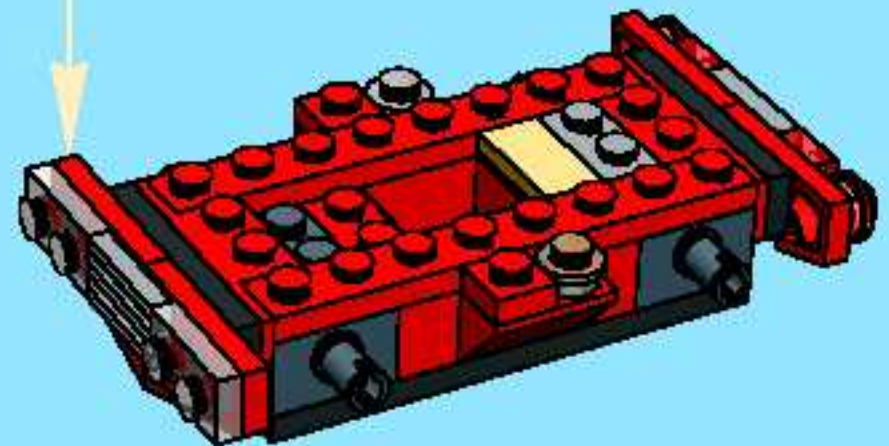



7

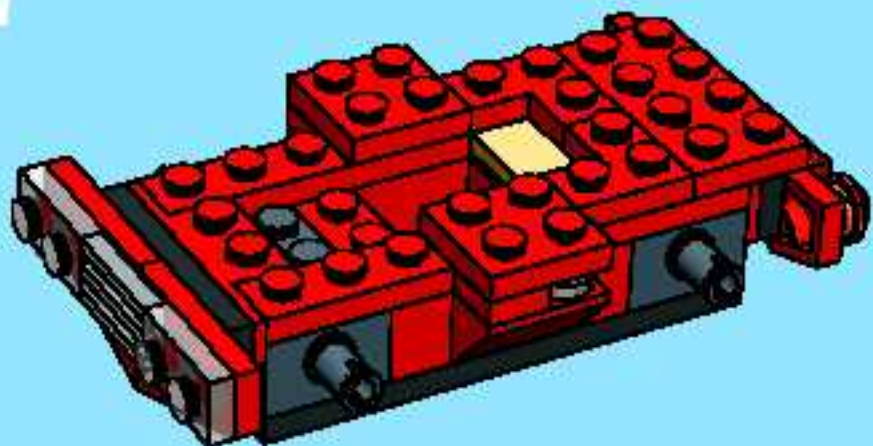

8

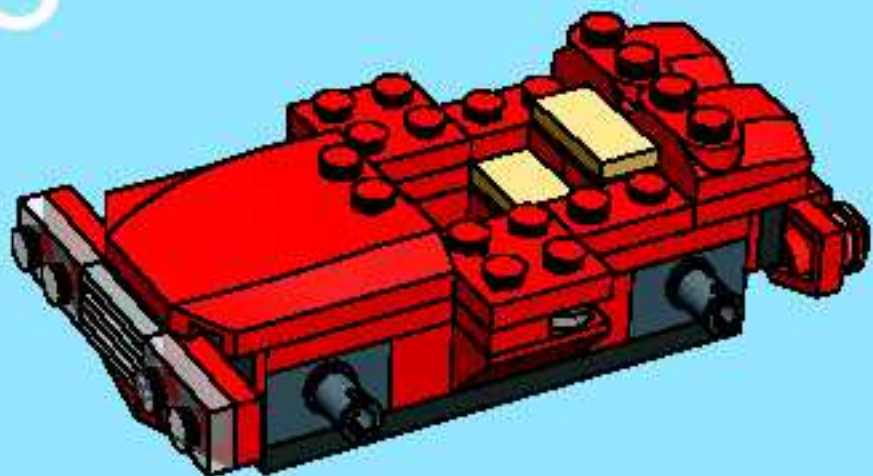

9

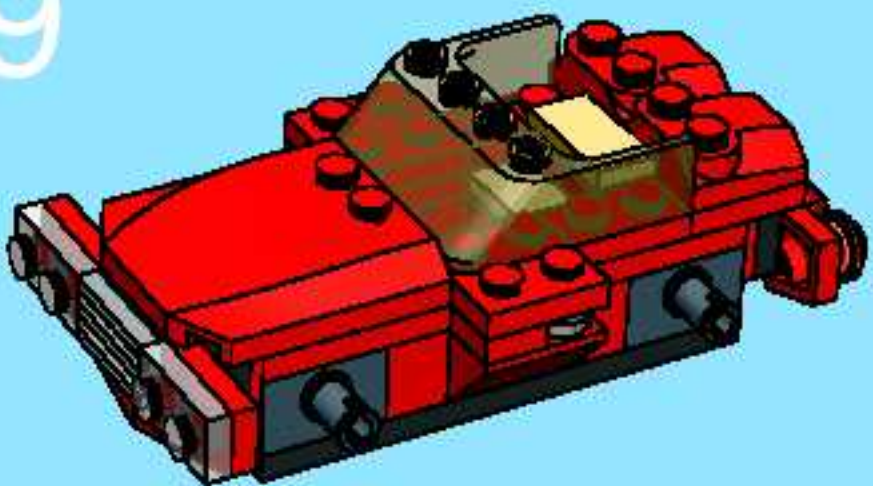

10

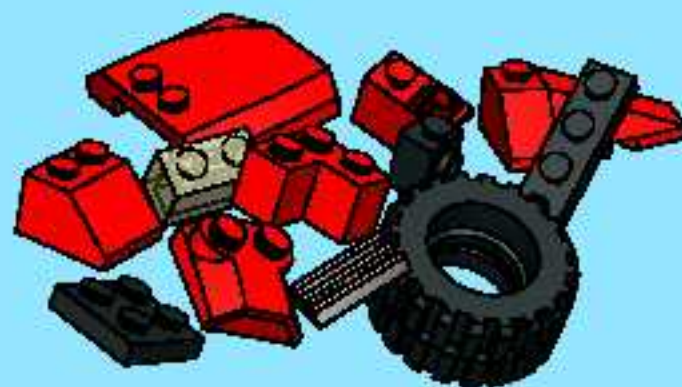
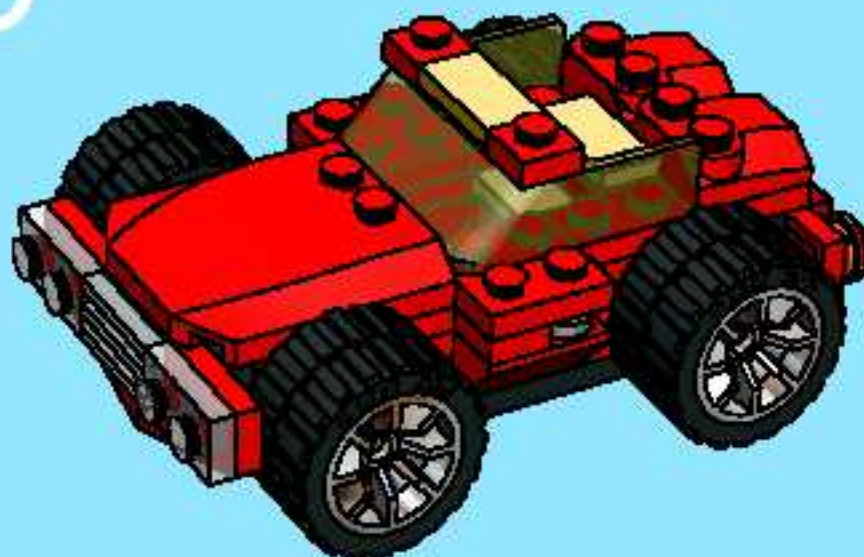

=



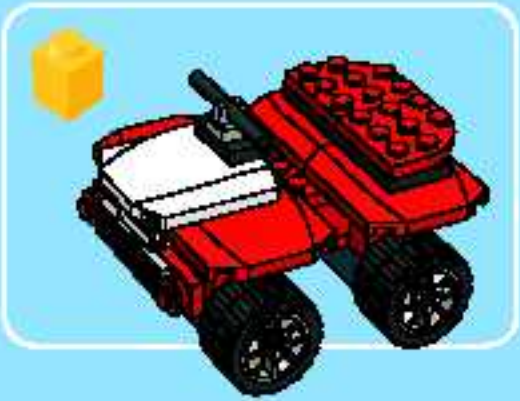

1

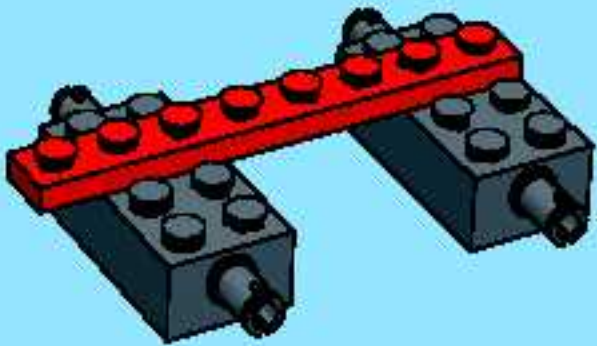

2

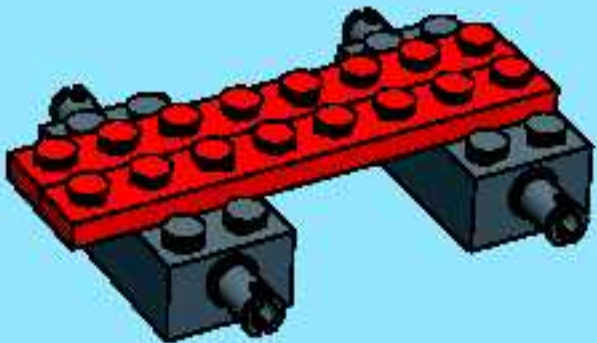

3

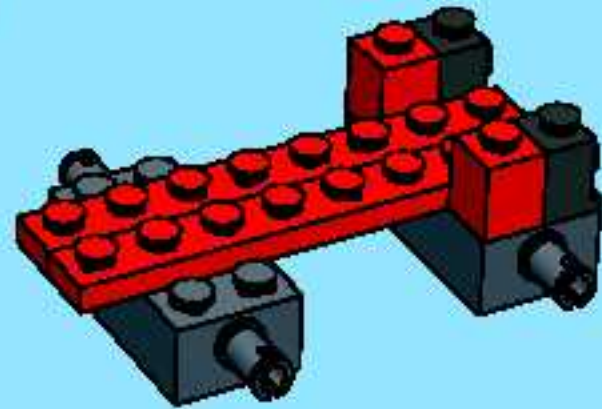

4

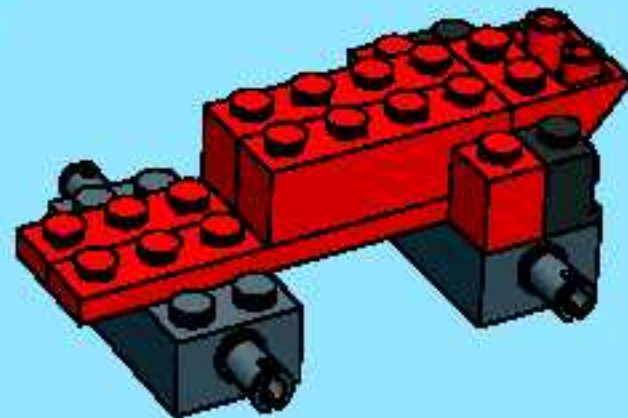

5

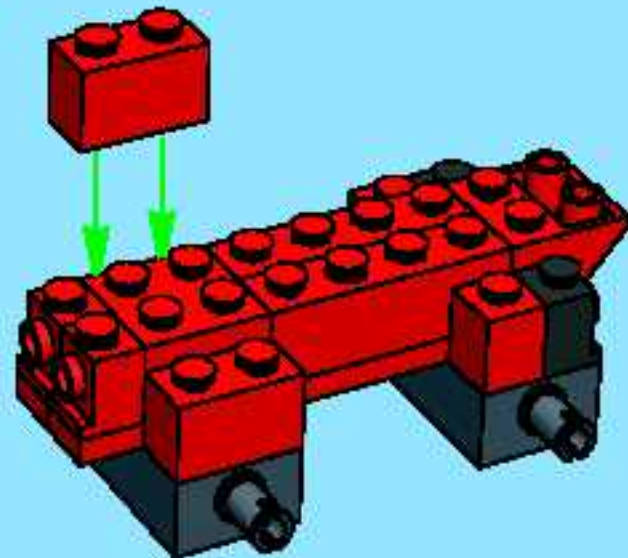

6

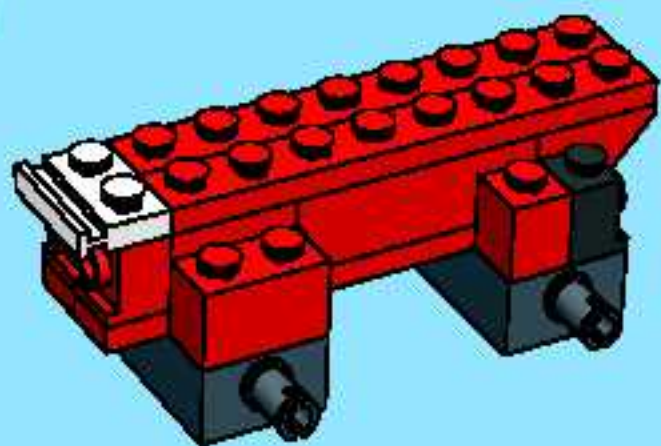

1

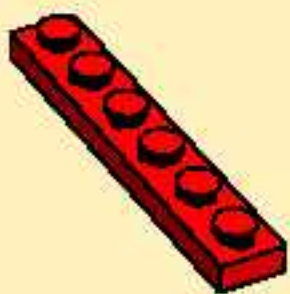

2



7

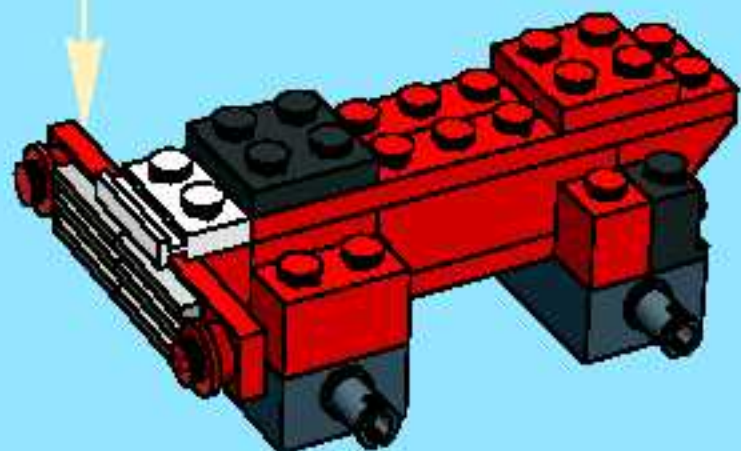

8

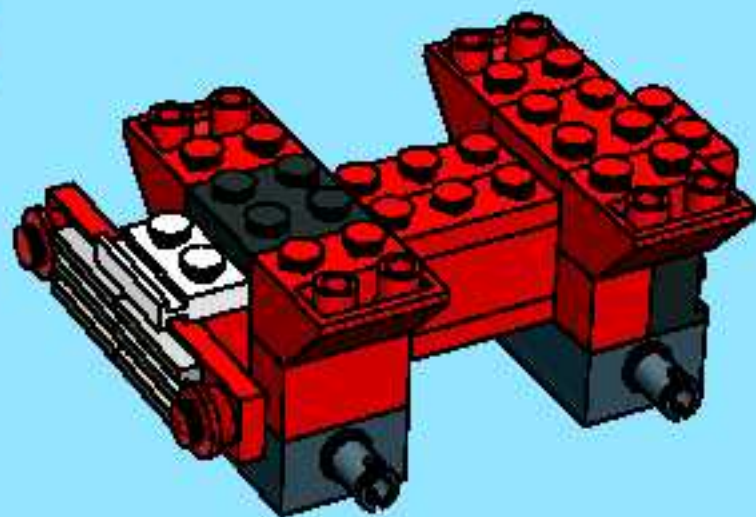

9

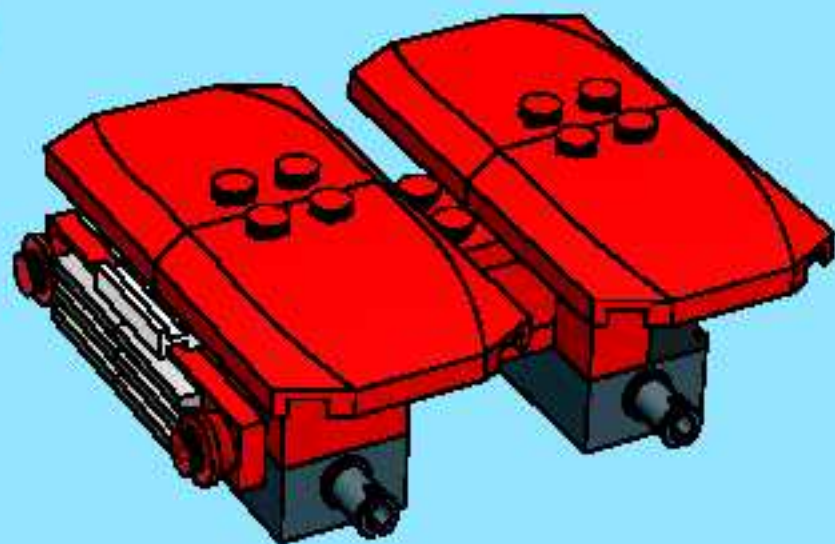

10

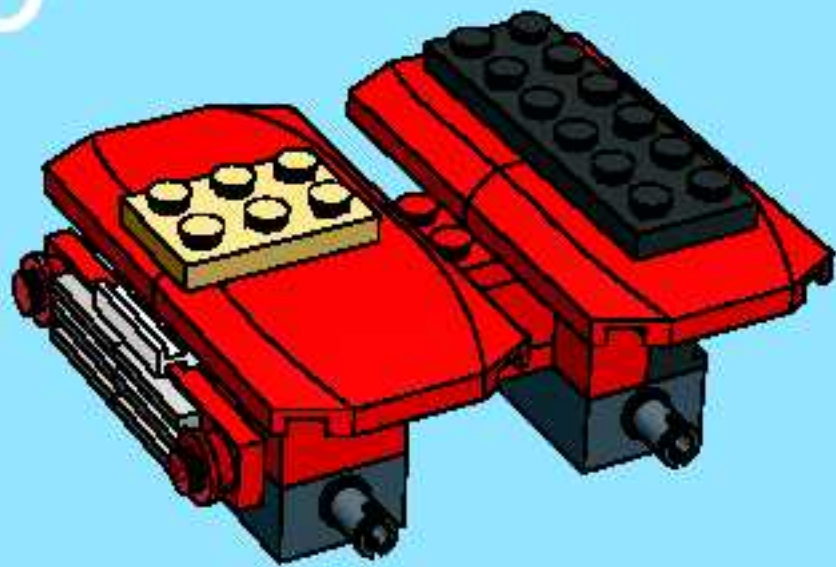

12

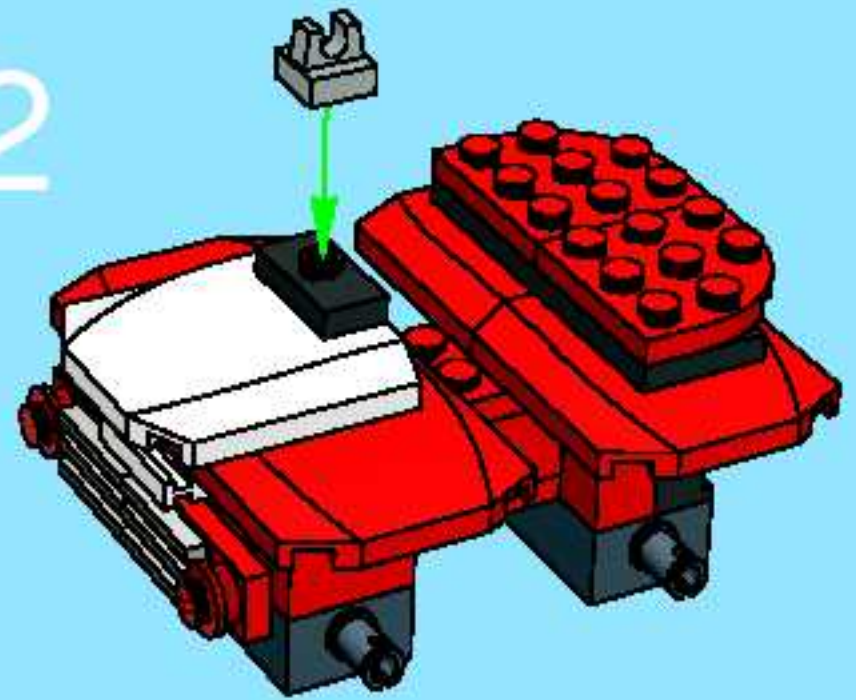

11

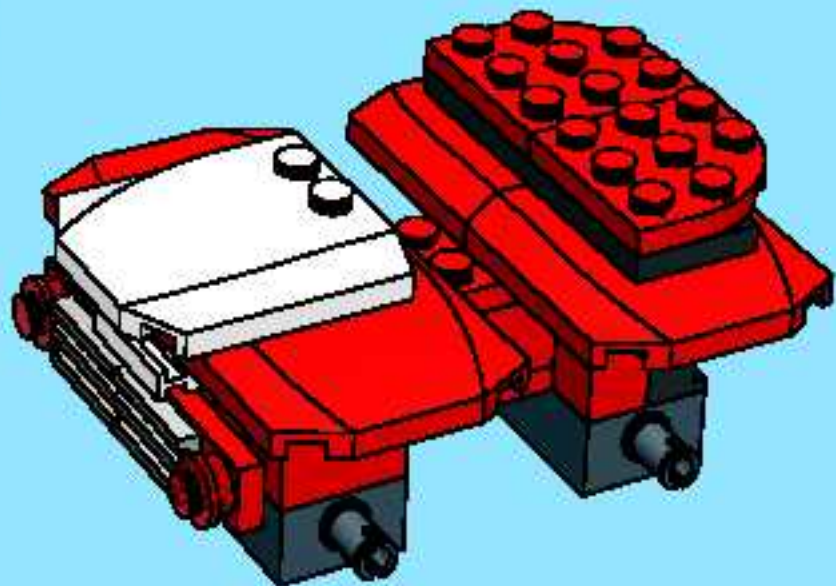

13

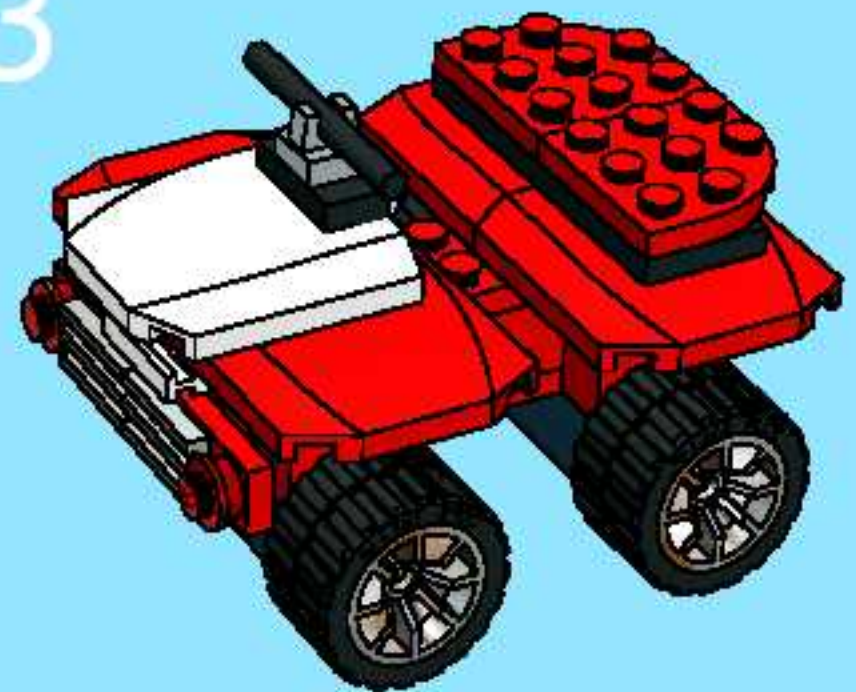



1

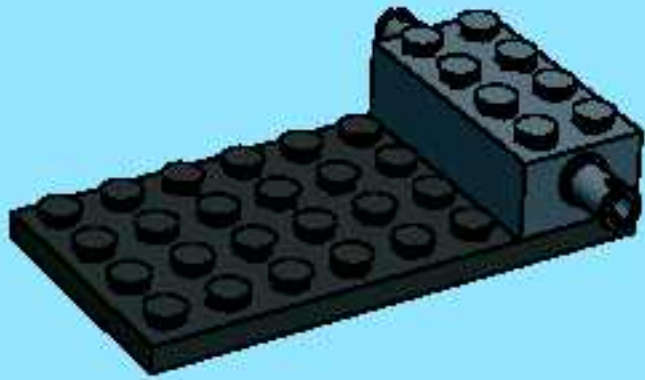

2



3

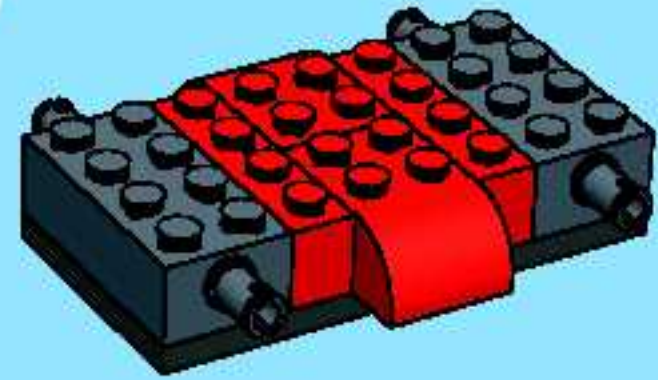

1



2



4

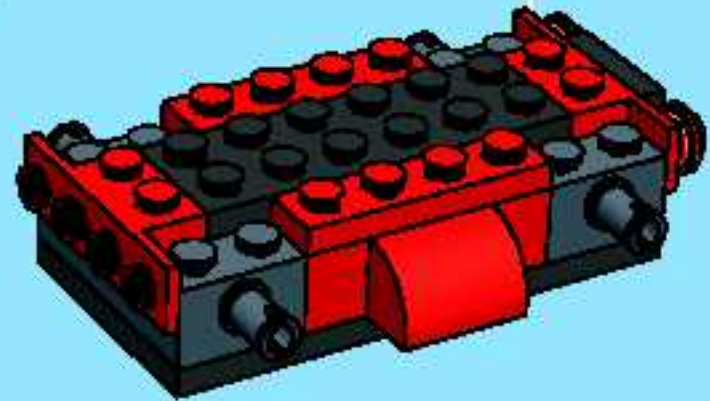

5

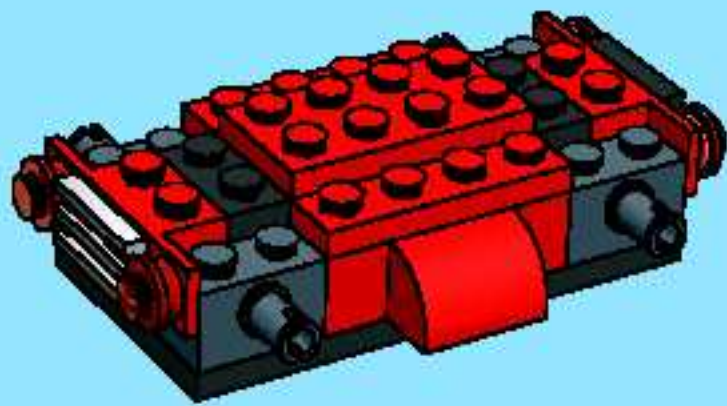

6

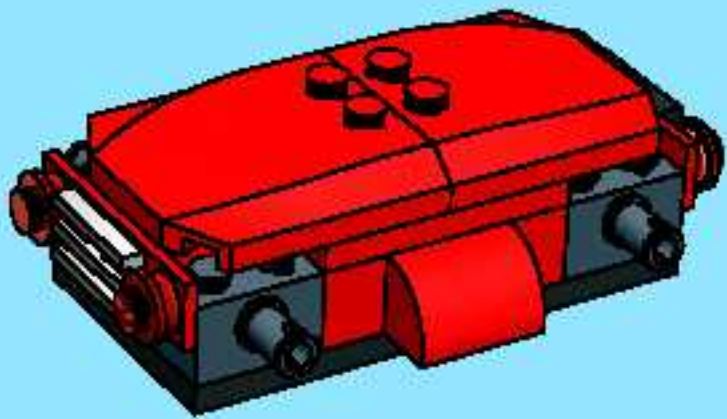

7

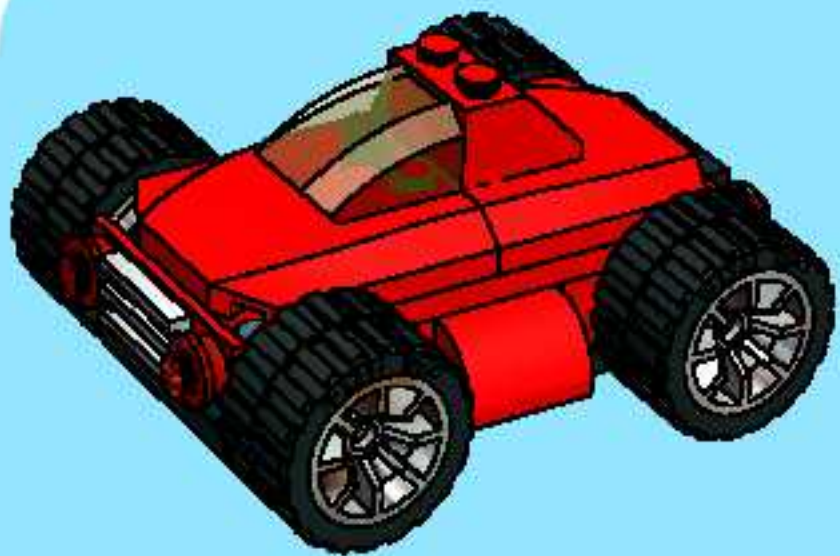

1



2



3



1



2



4

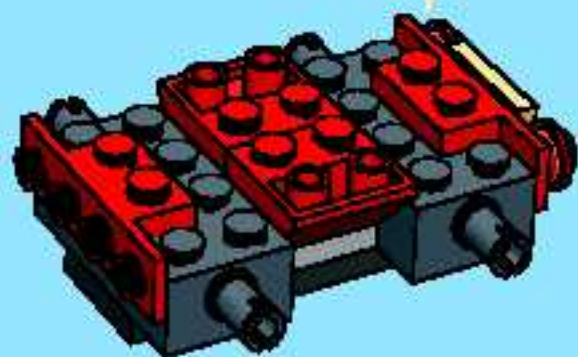

5

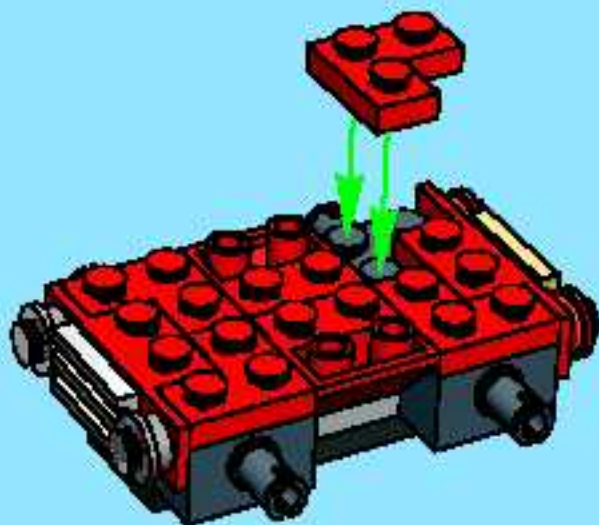

6

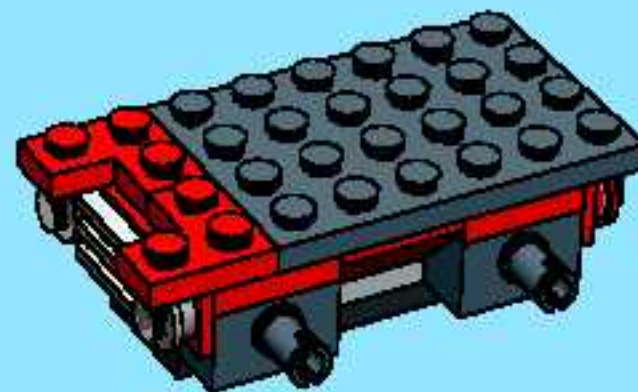

7

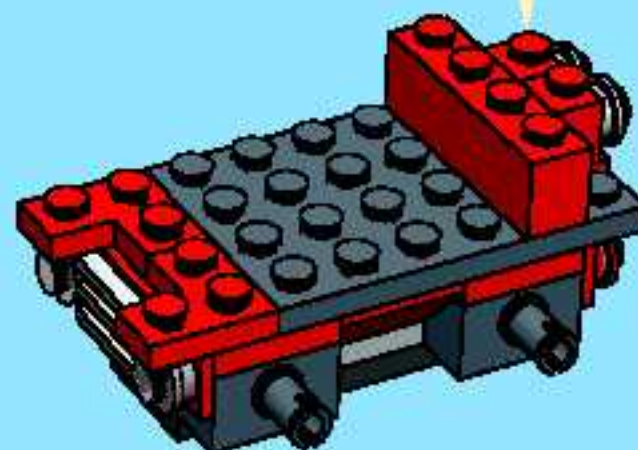
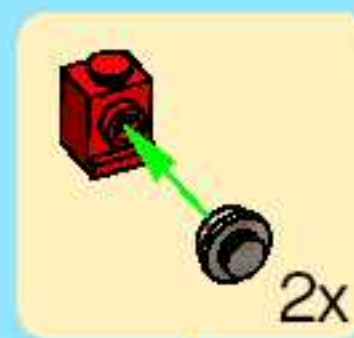

8



9



10

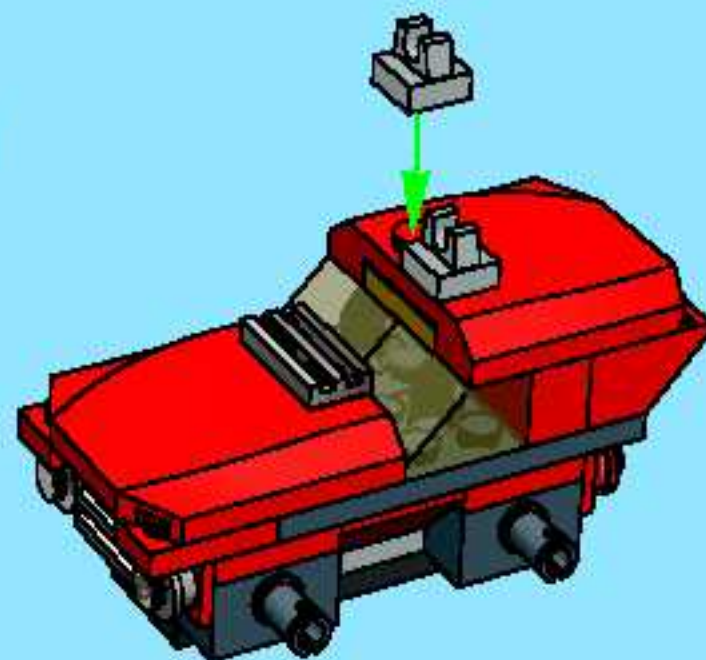

11







1



2

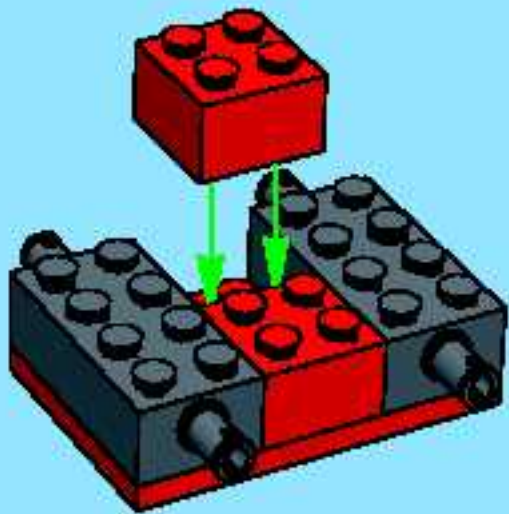

3



1



2

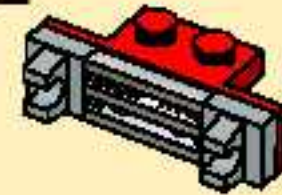

3



4

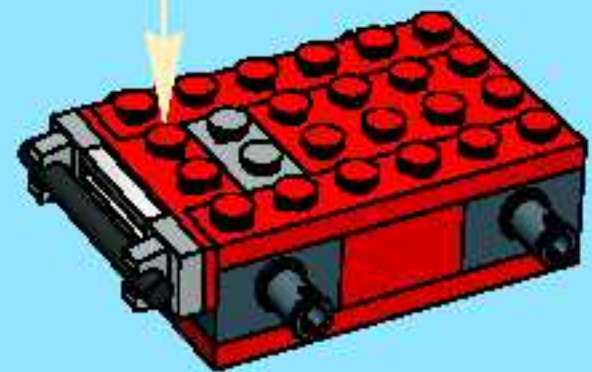

5

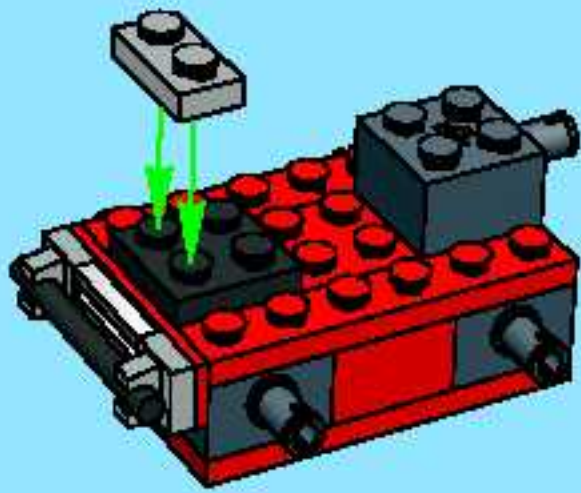

6

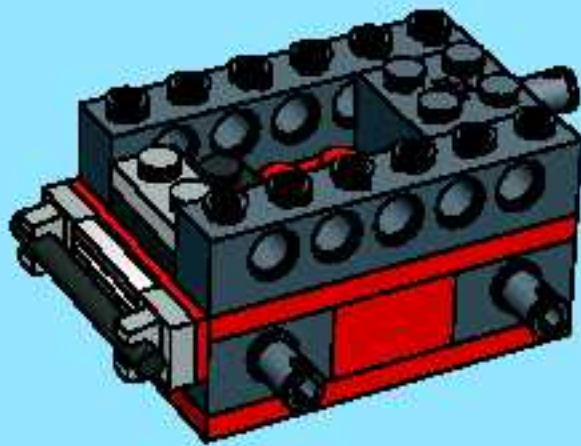

1

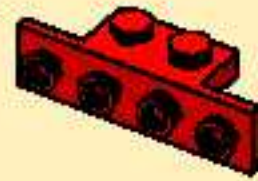

2



7

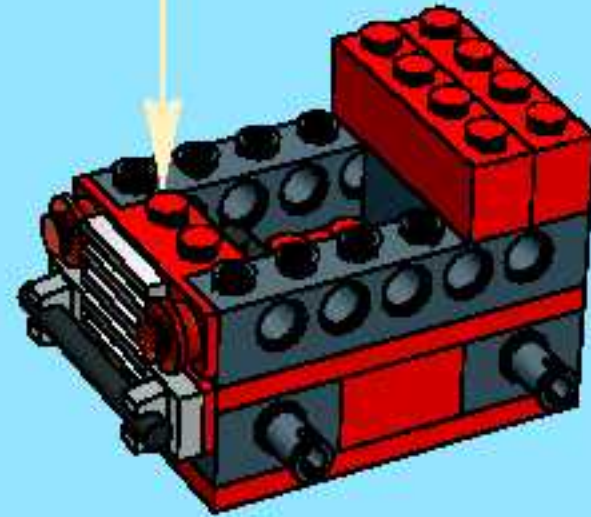

8

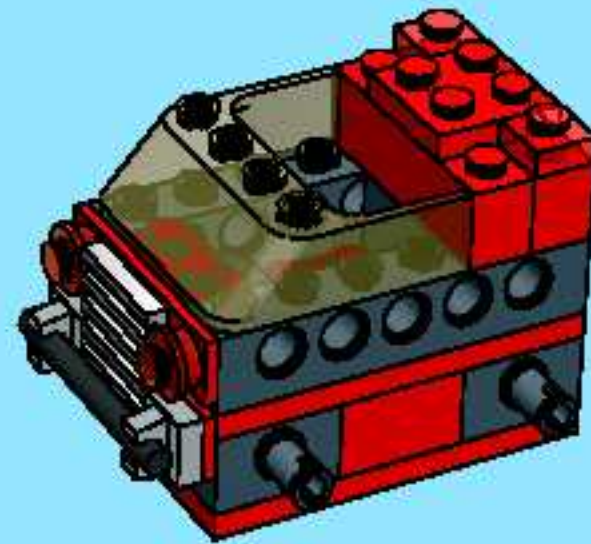

9

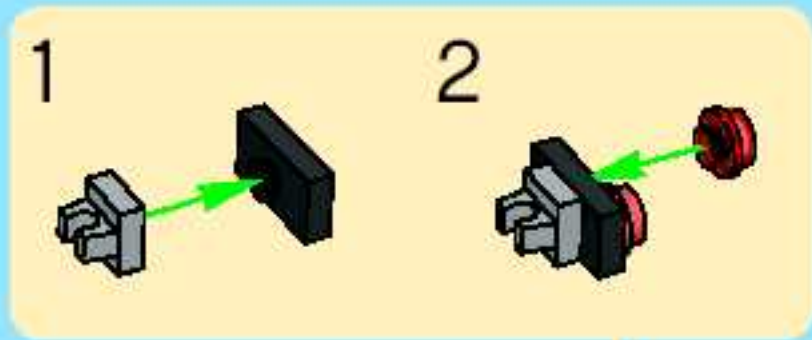

10

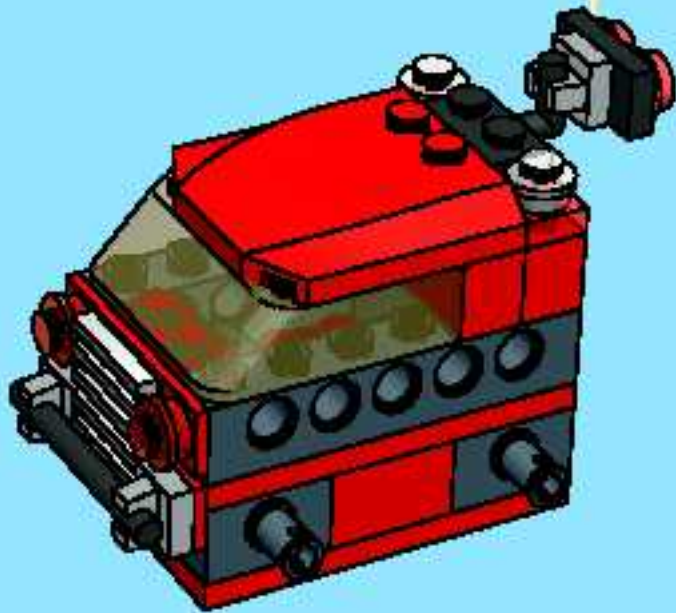

11

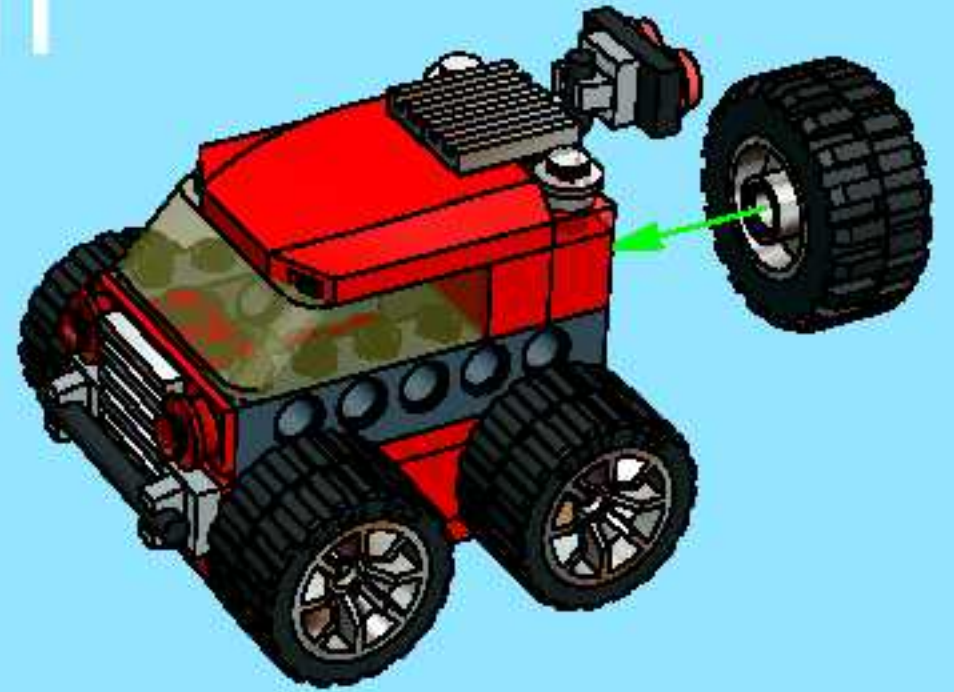



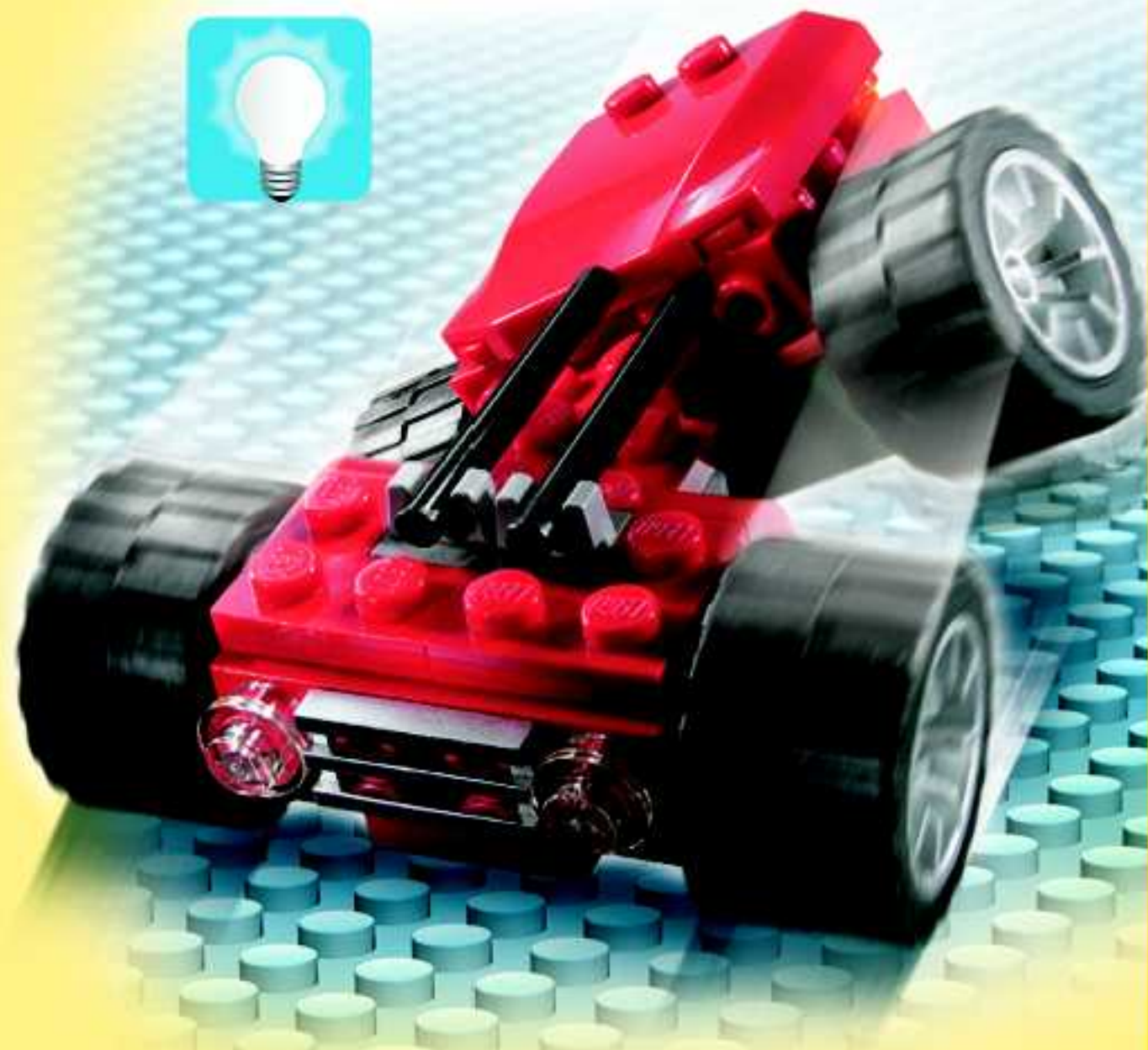



1

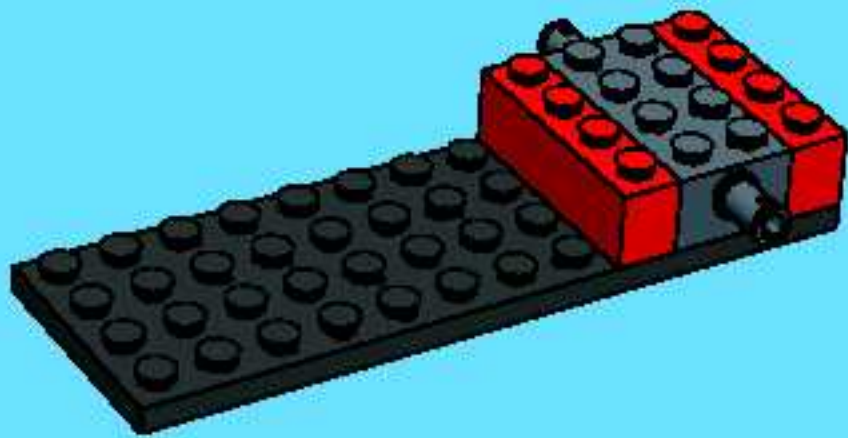

2

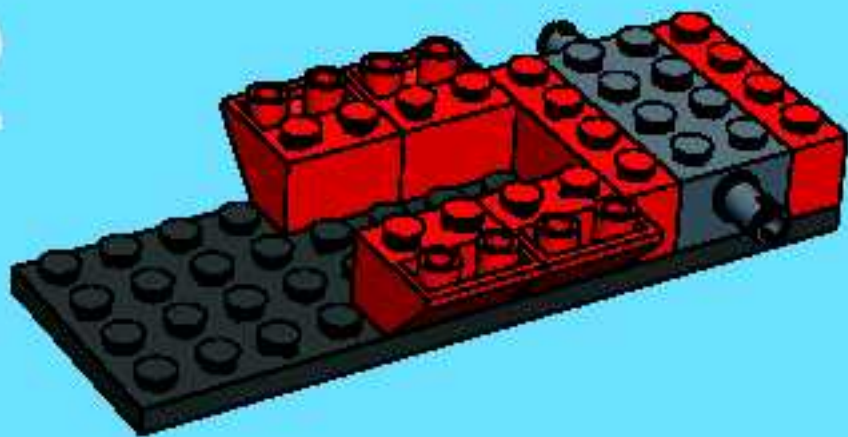

1



2



3



4



5



3



4



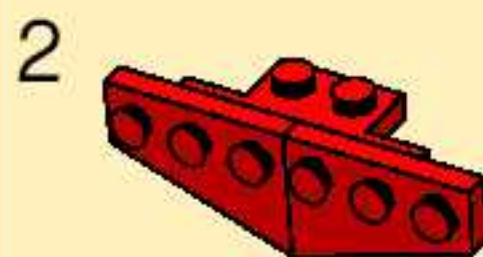
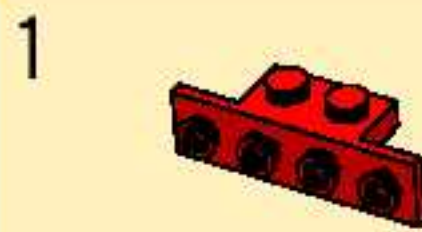
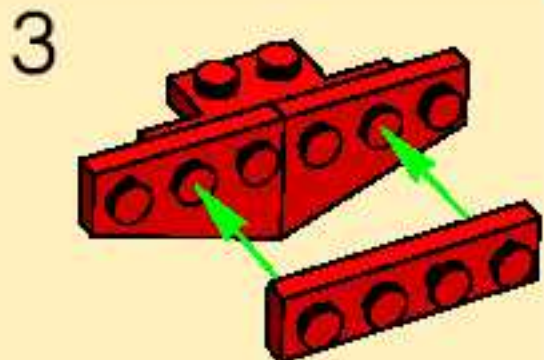

5

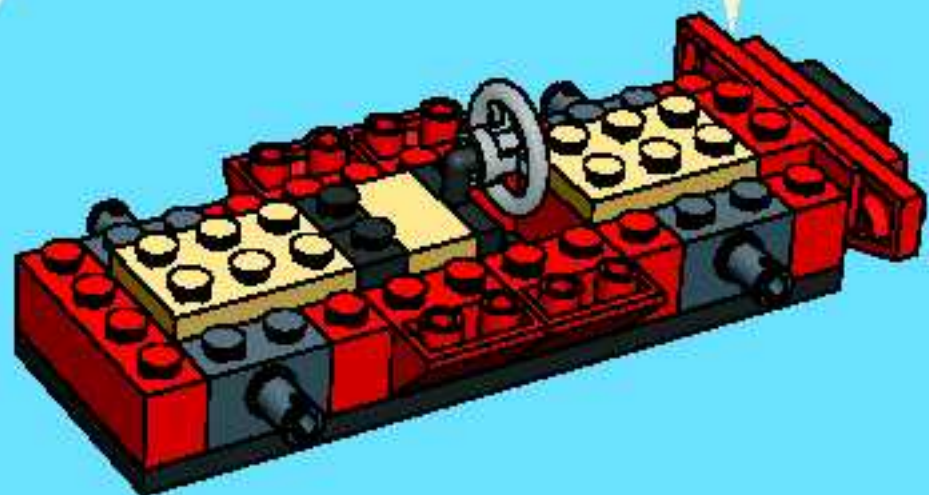

6

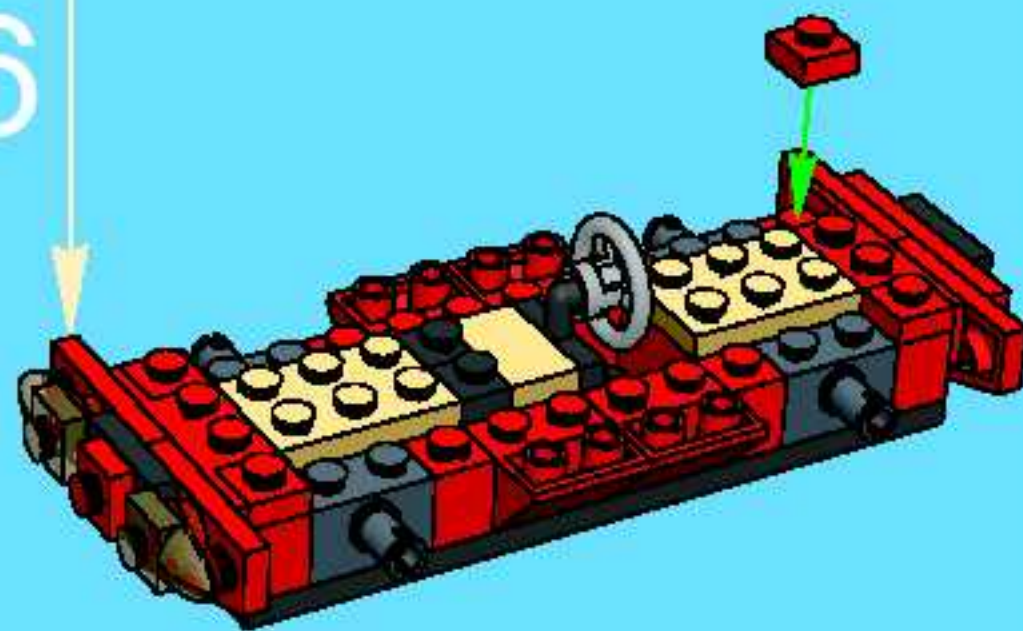

7

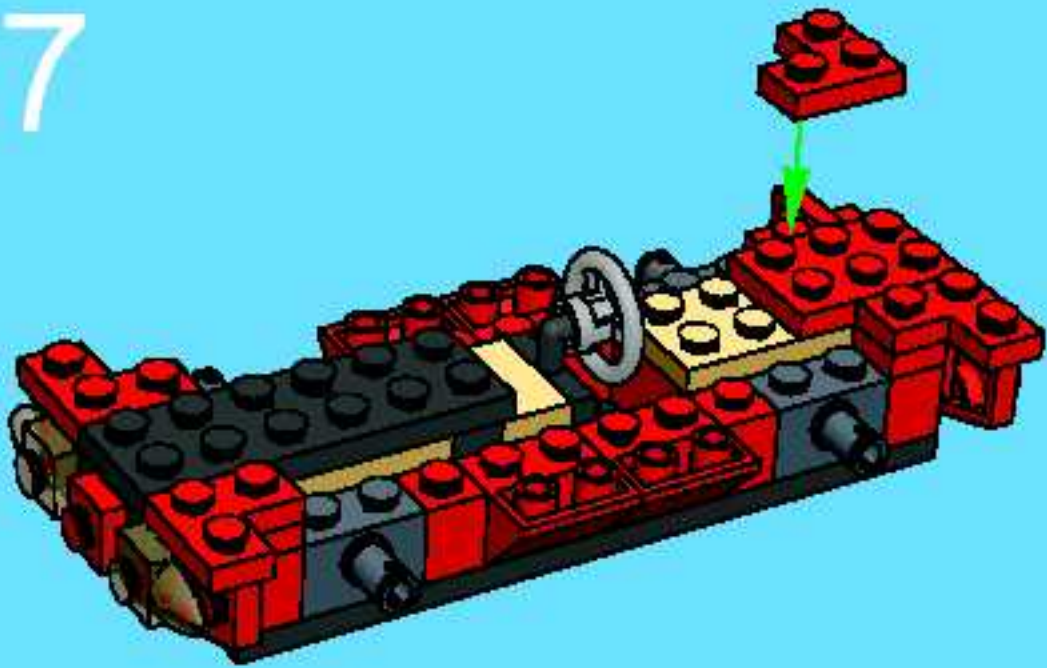

8

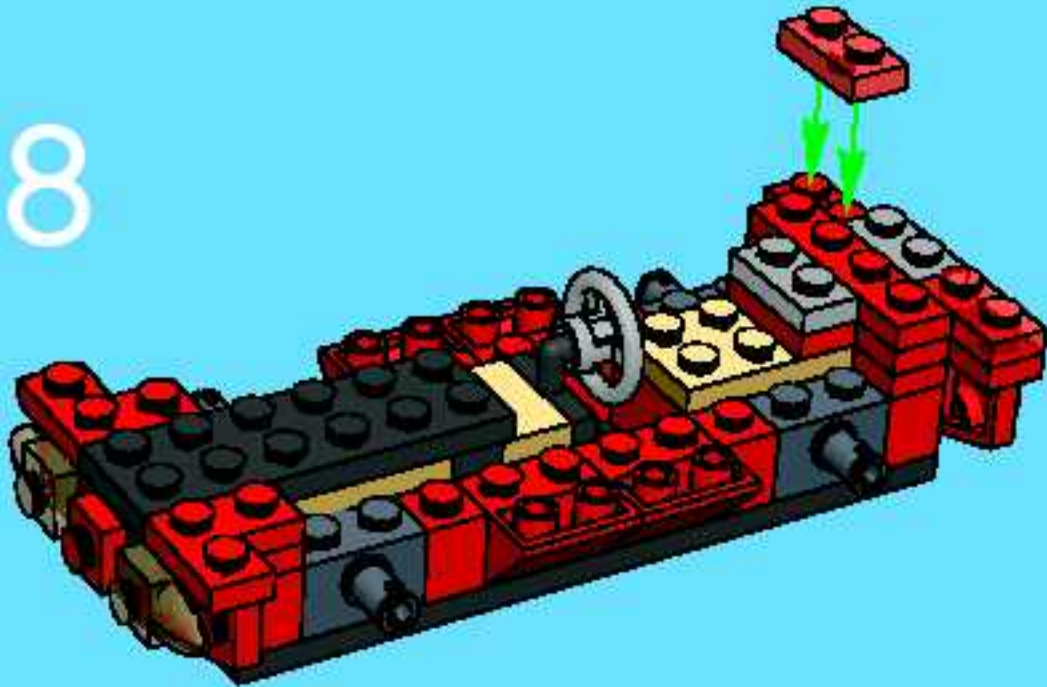

9

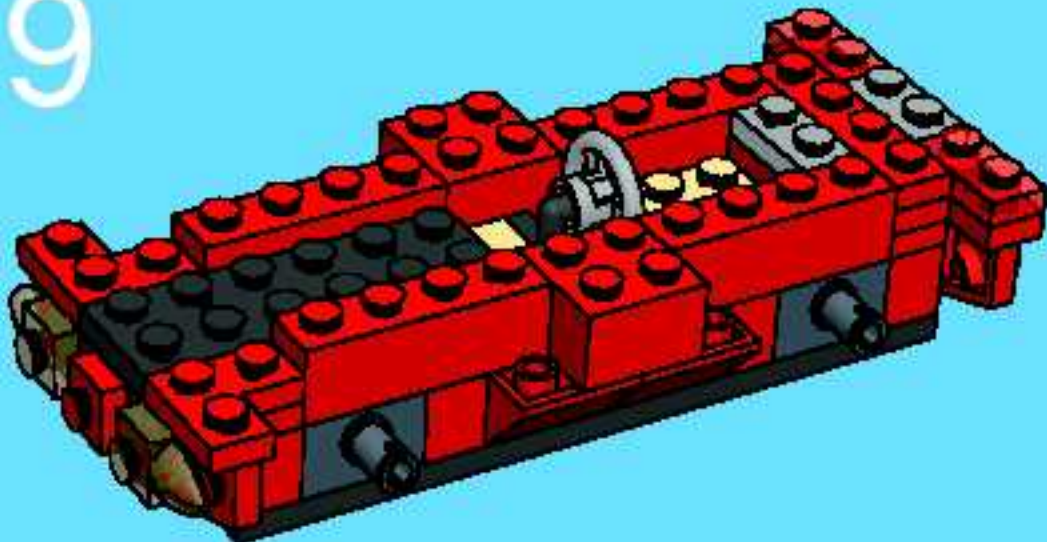

10

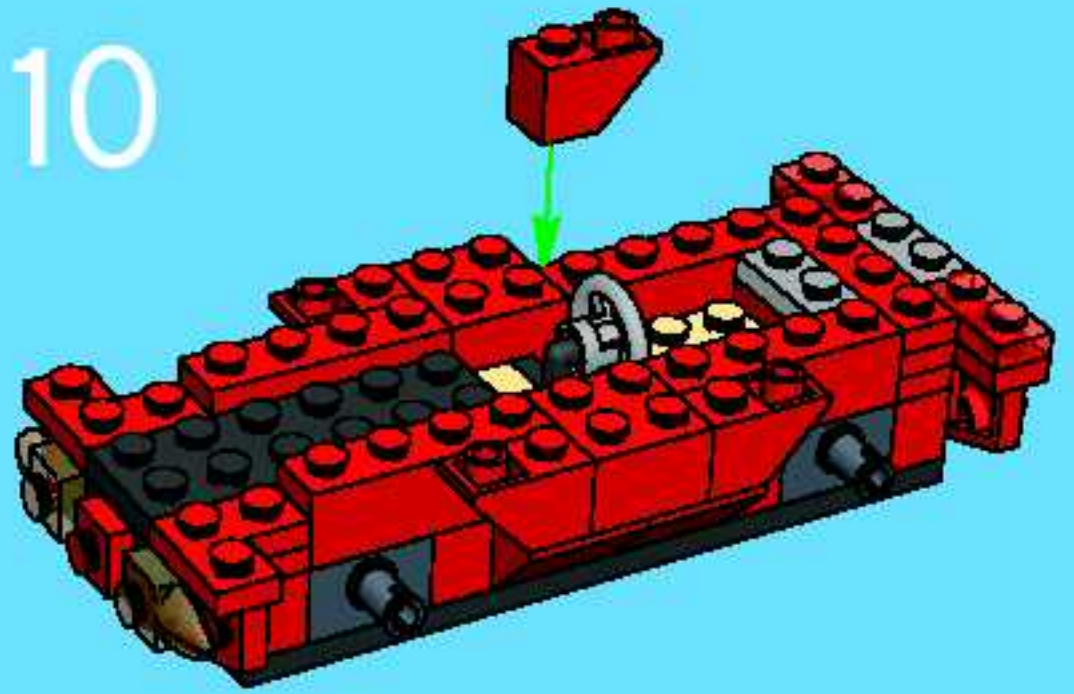

11

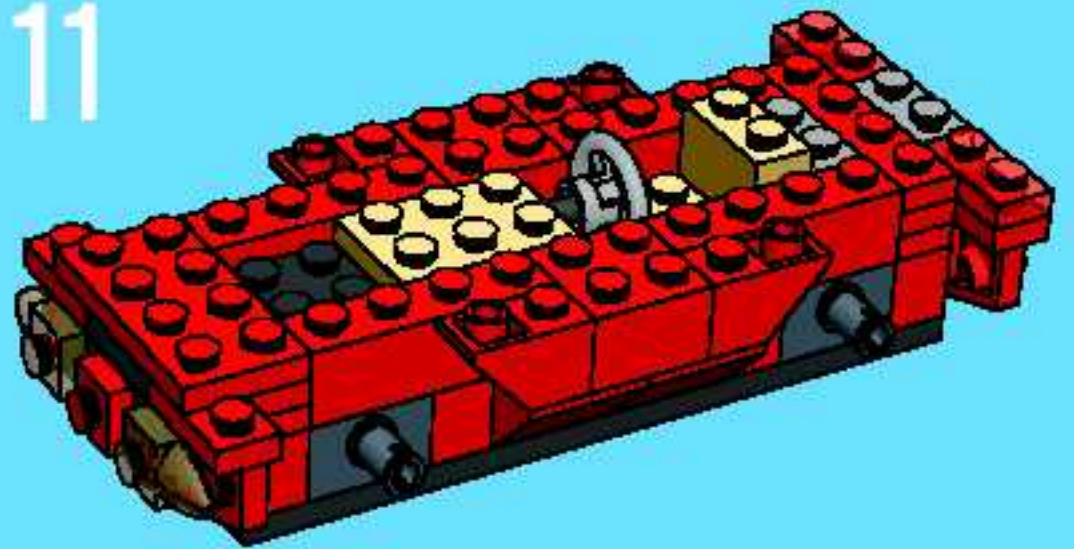

12

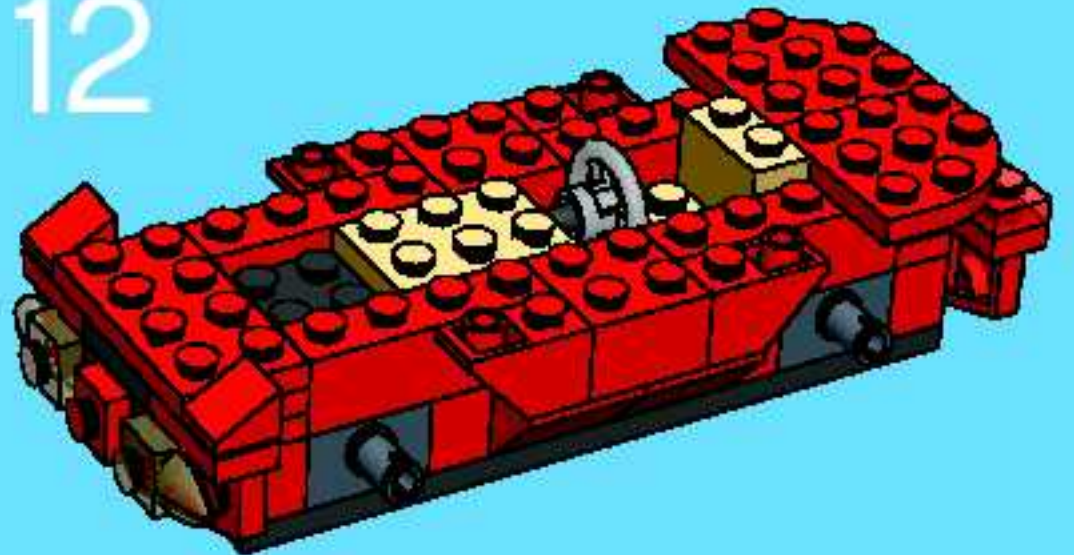



13

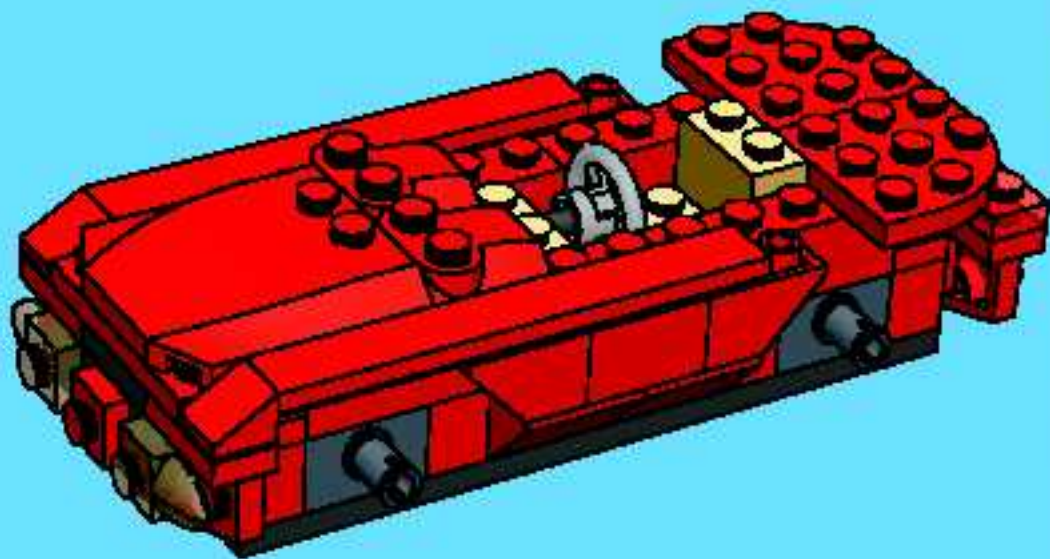

15

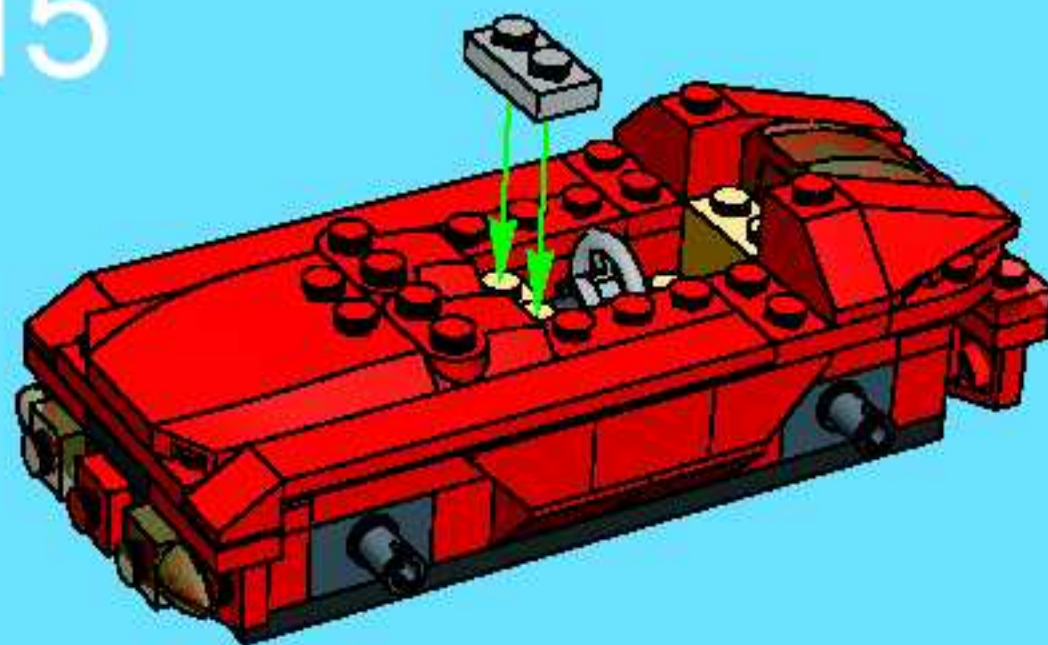

14

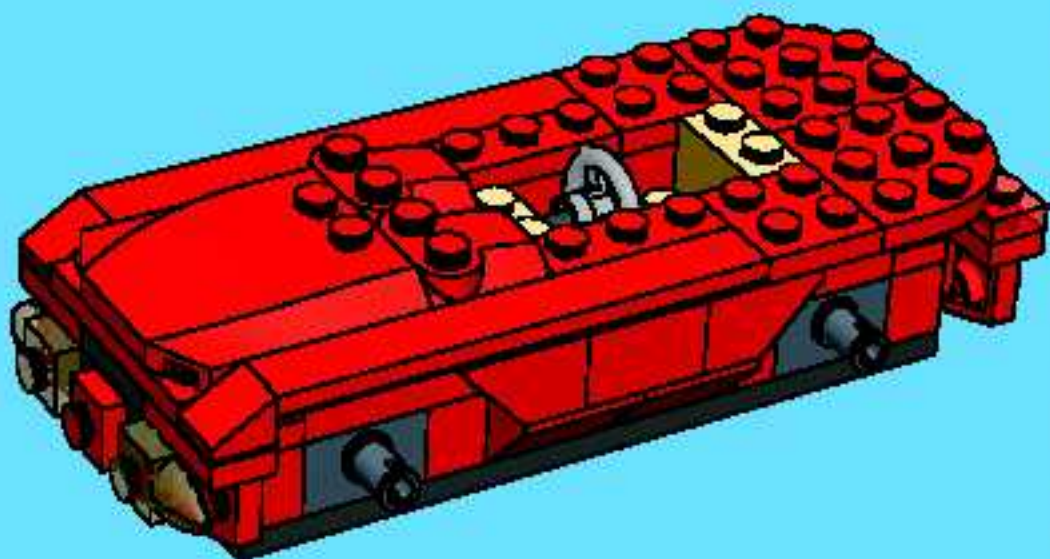

16

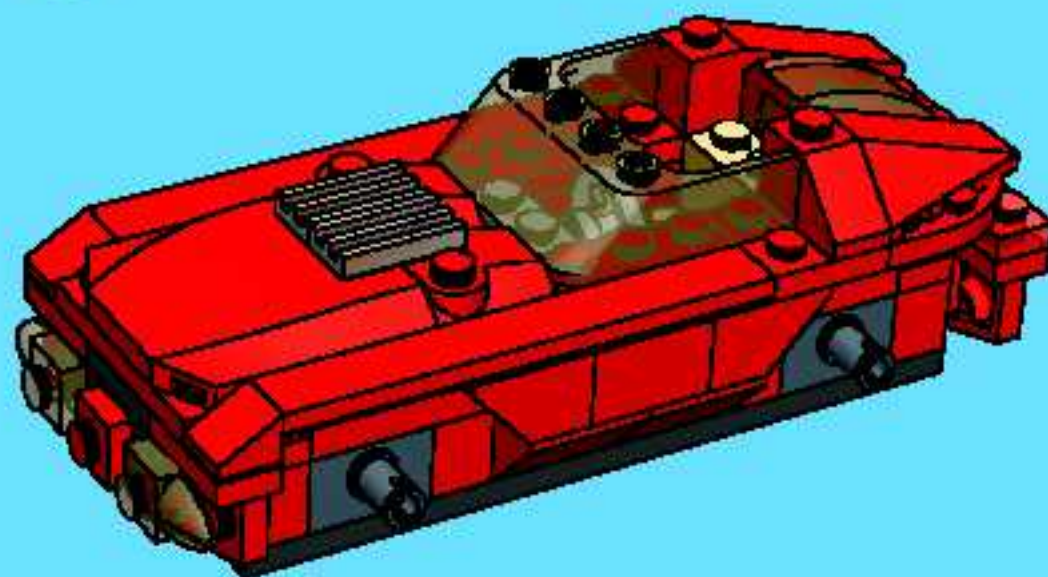

17

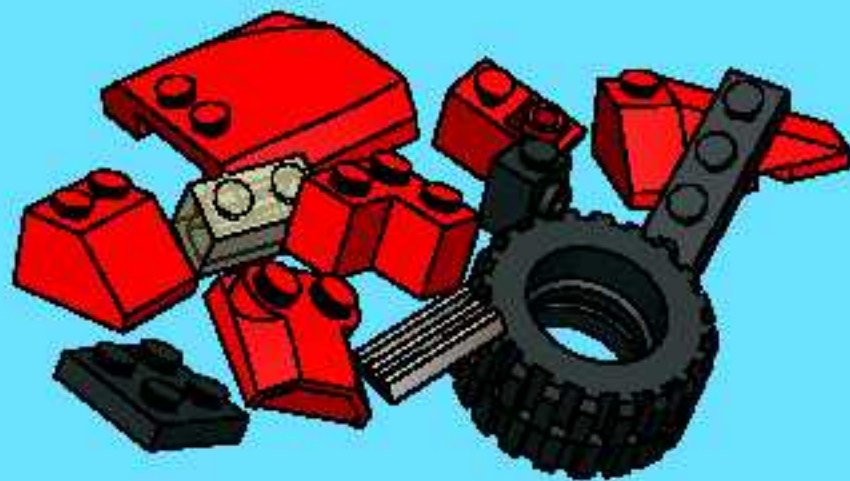
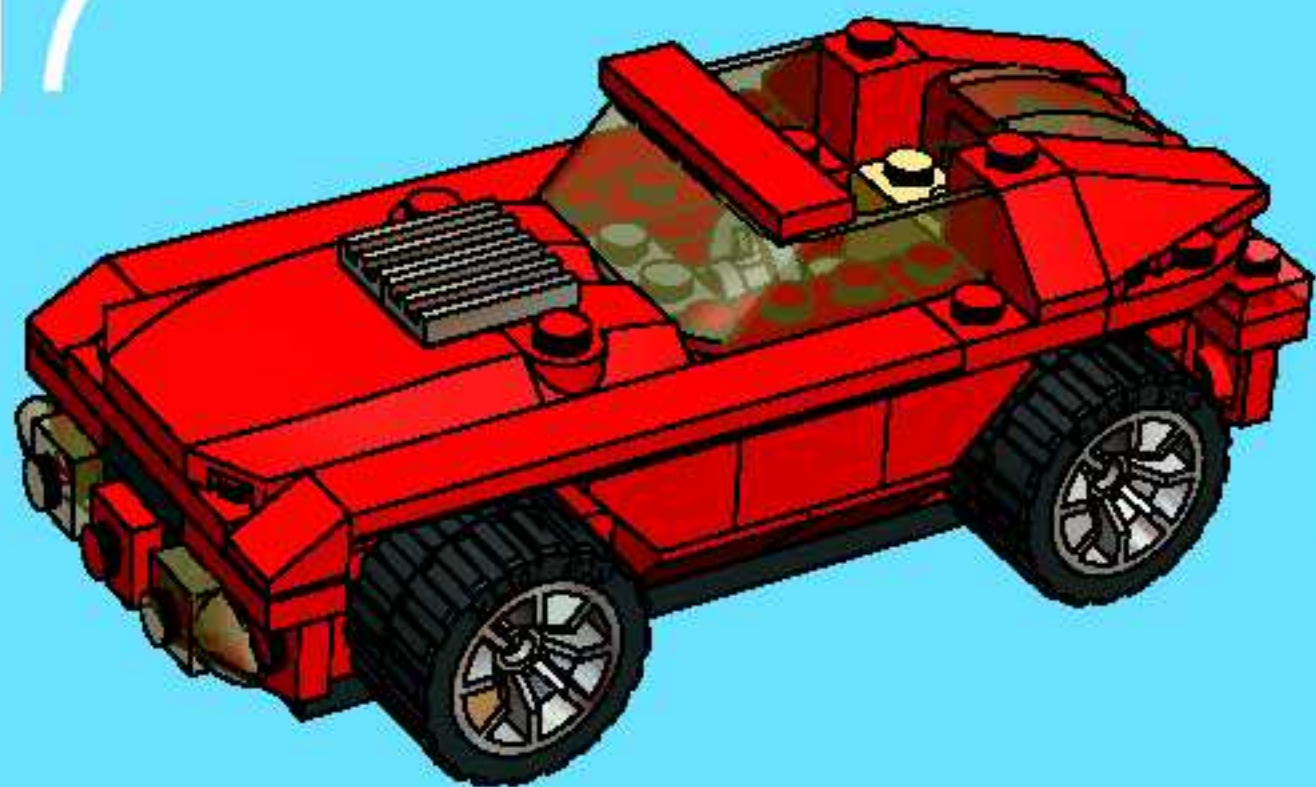

=



4



54



1

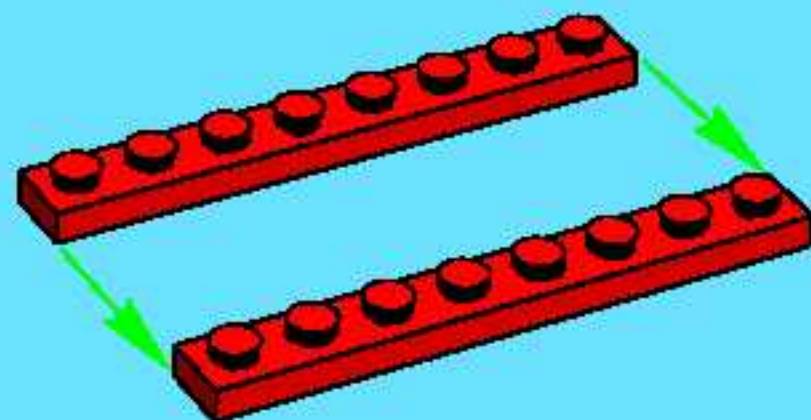

2

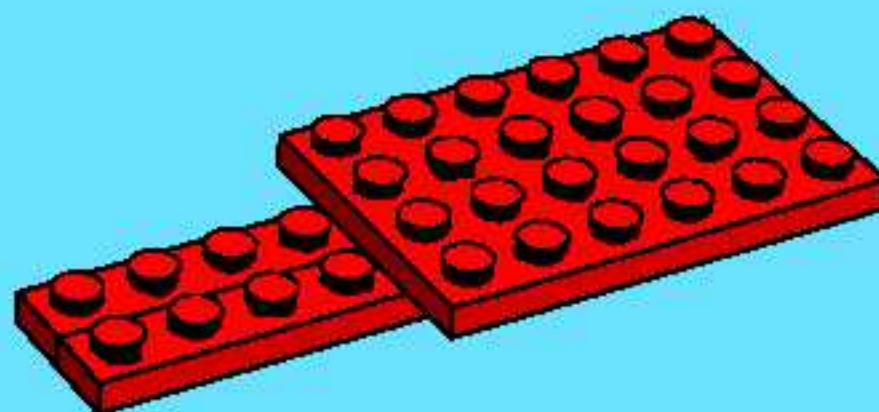

3

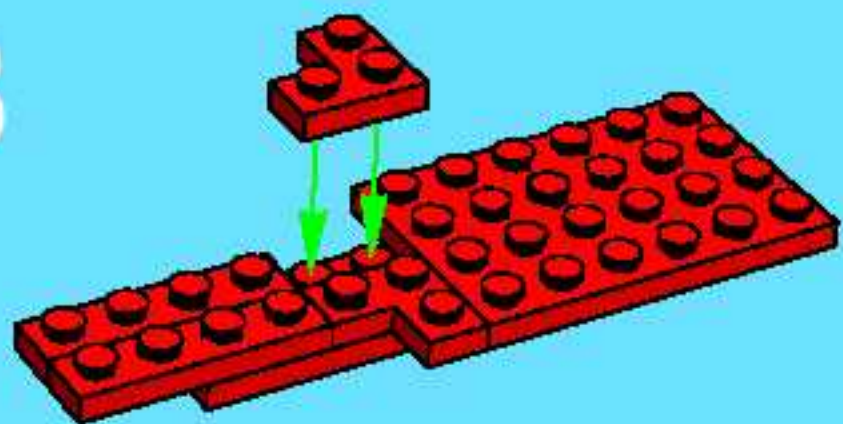

4

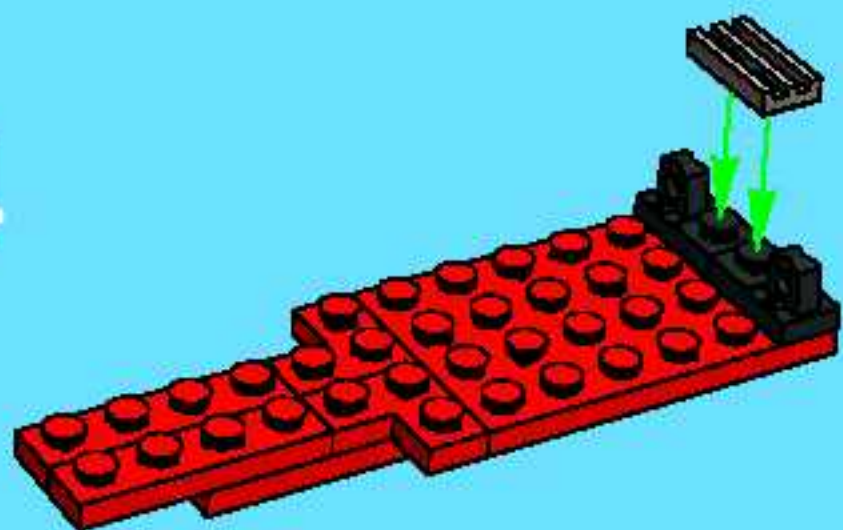

5

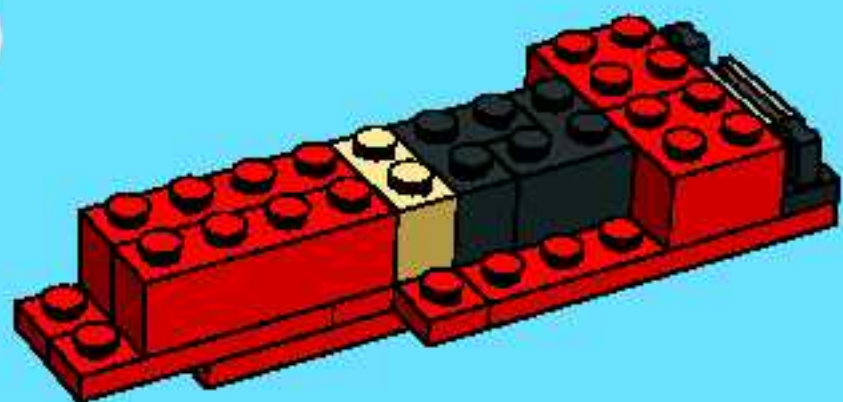

6

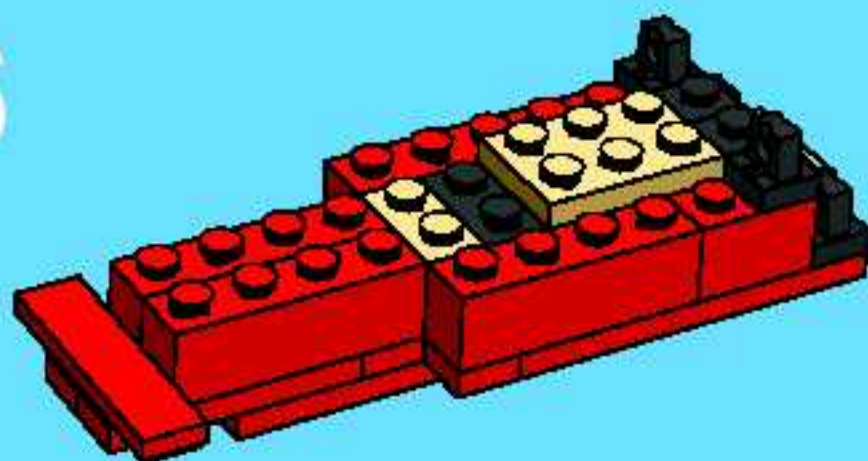

7

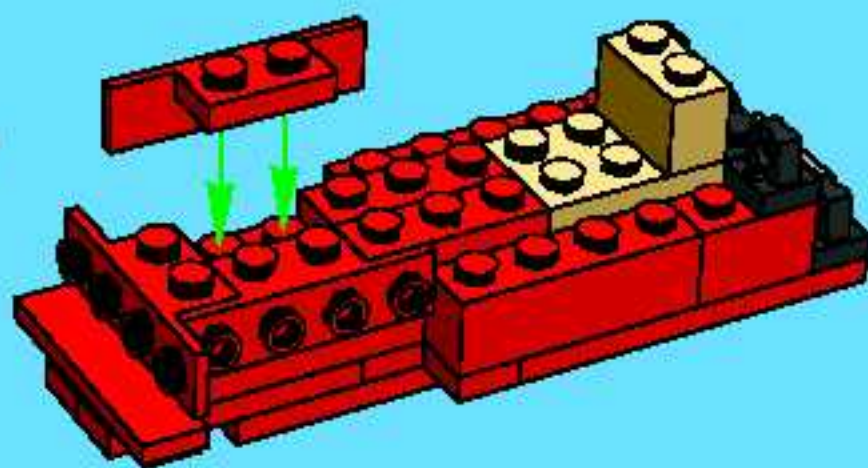

8

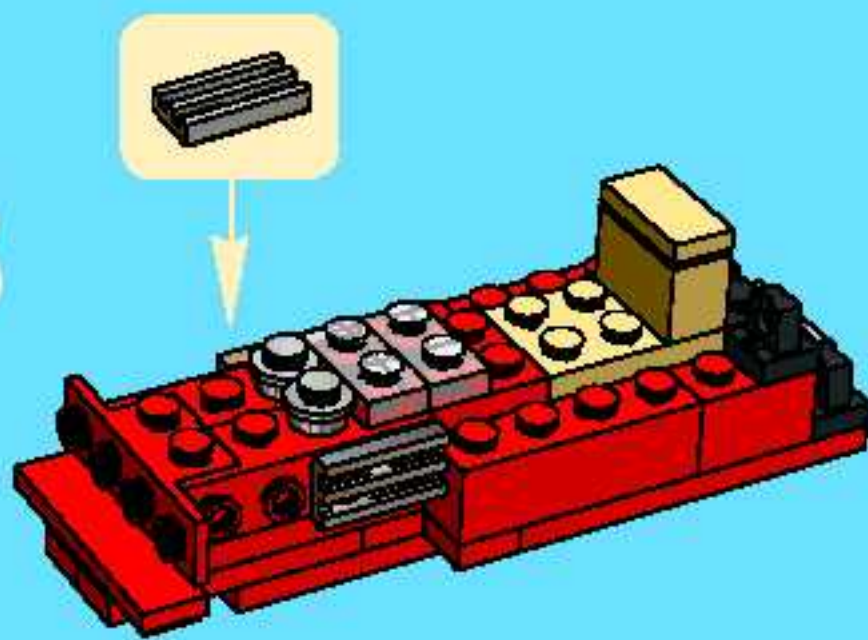

9

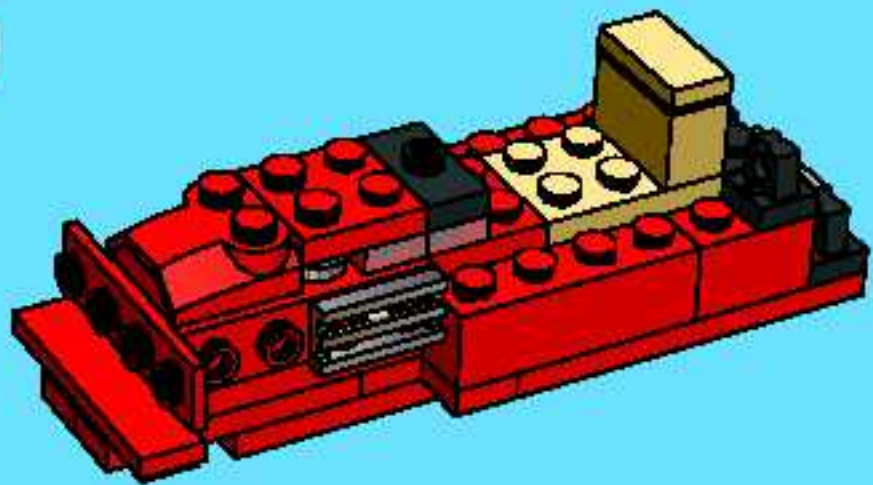

11

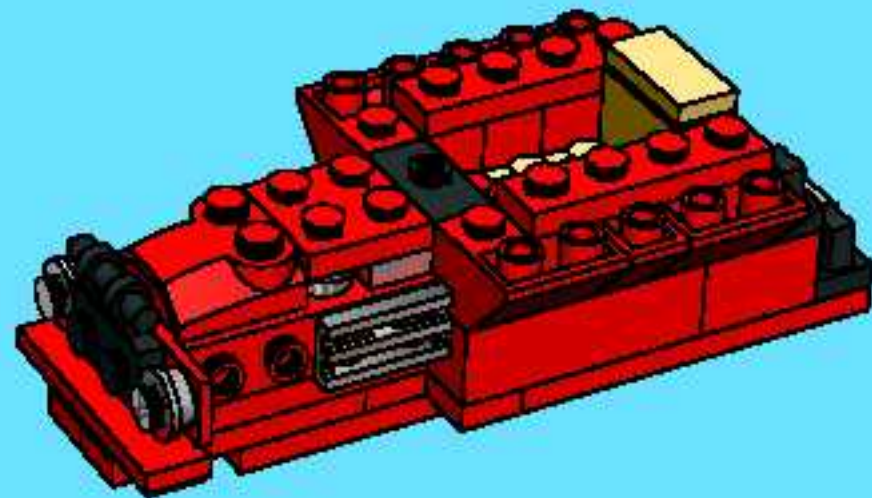

10

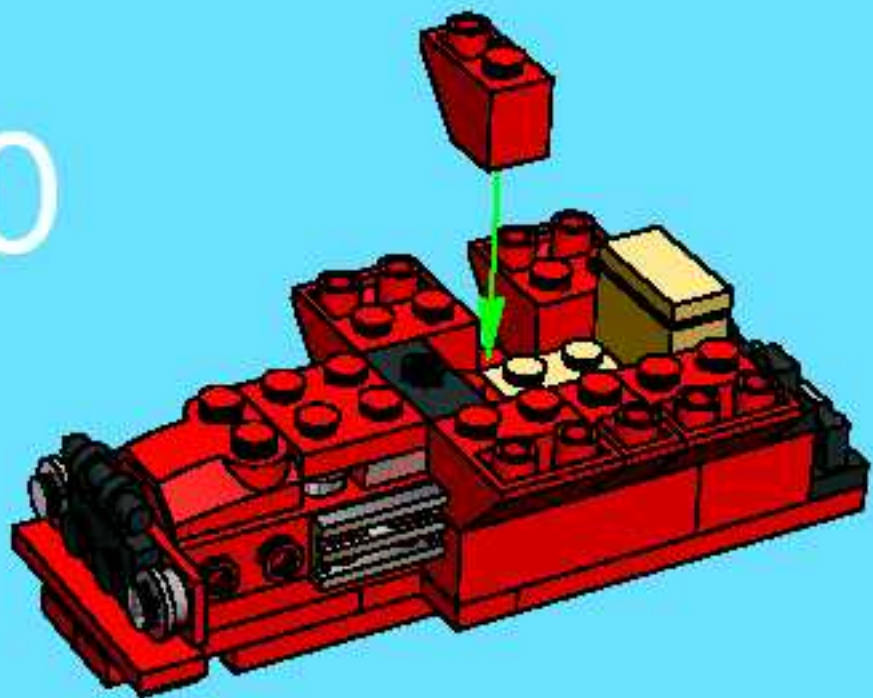

12

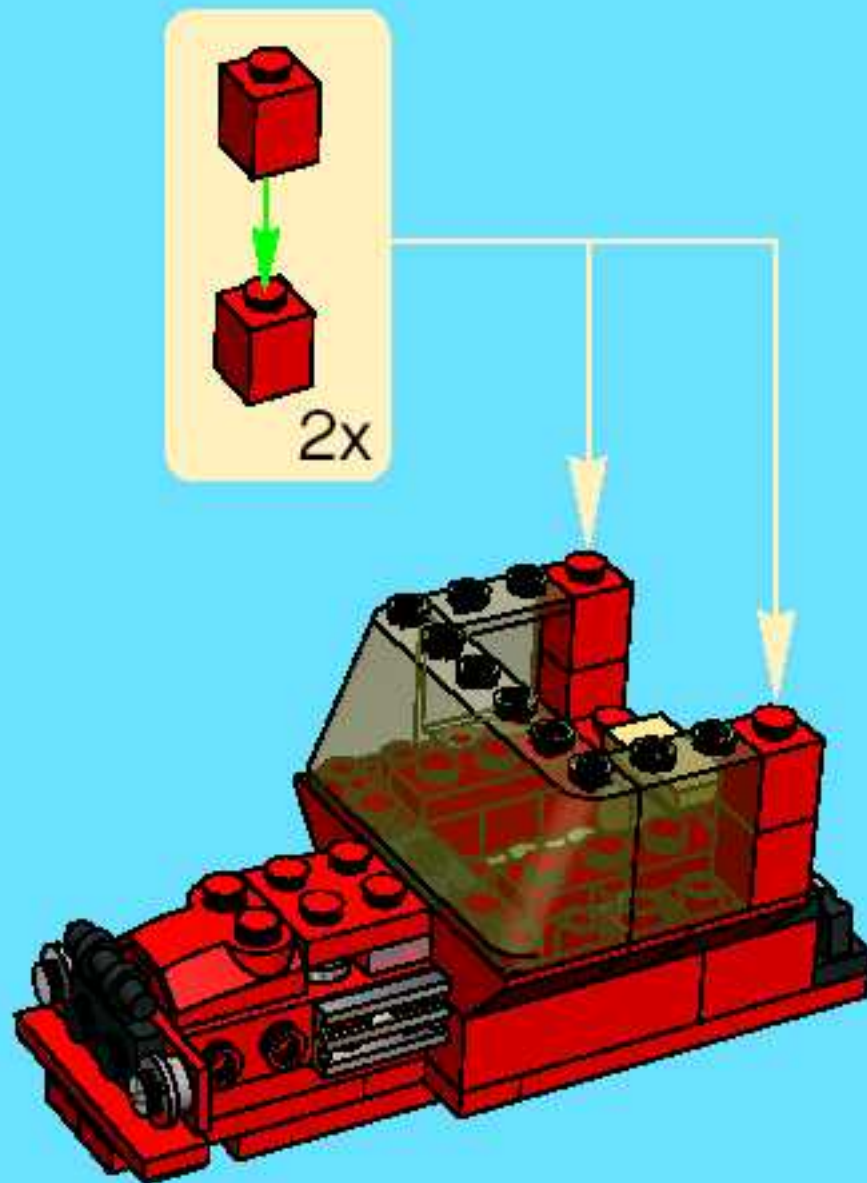

13

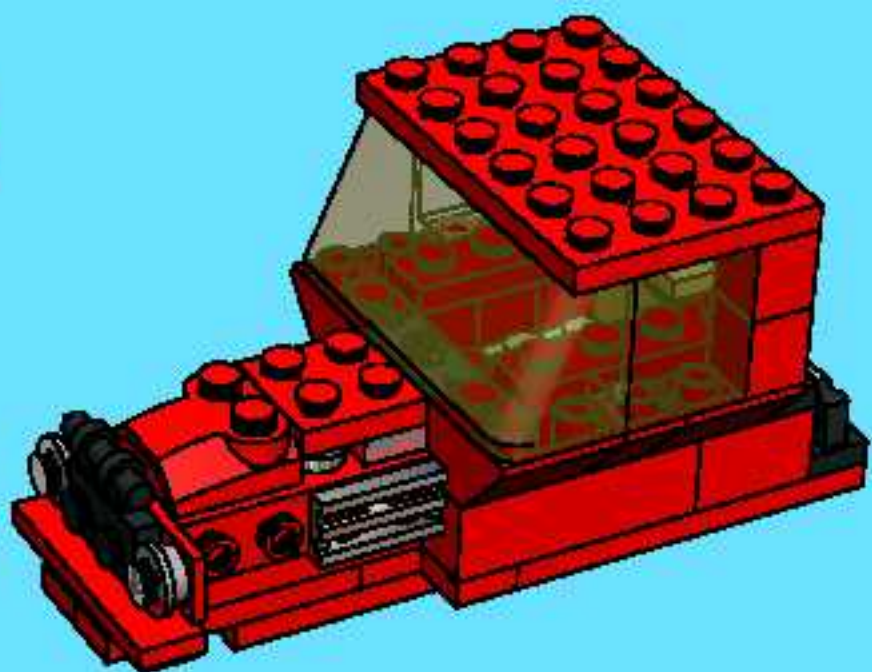

15

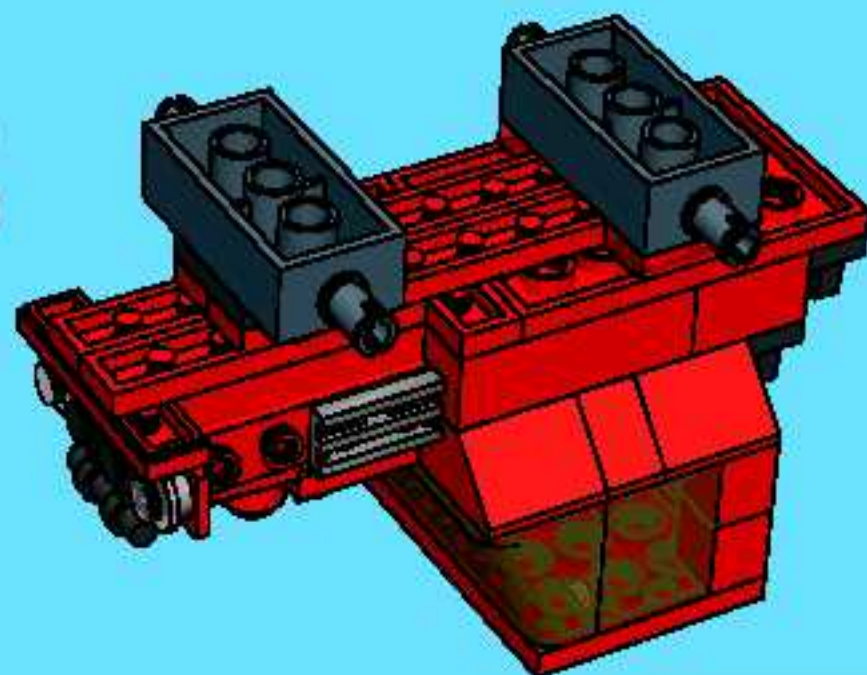

14

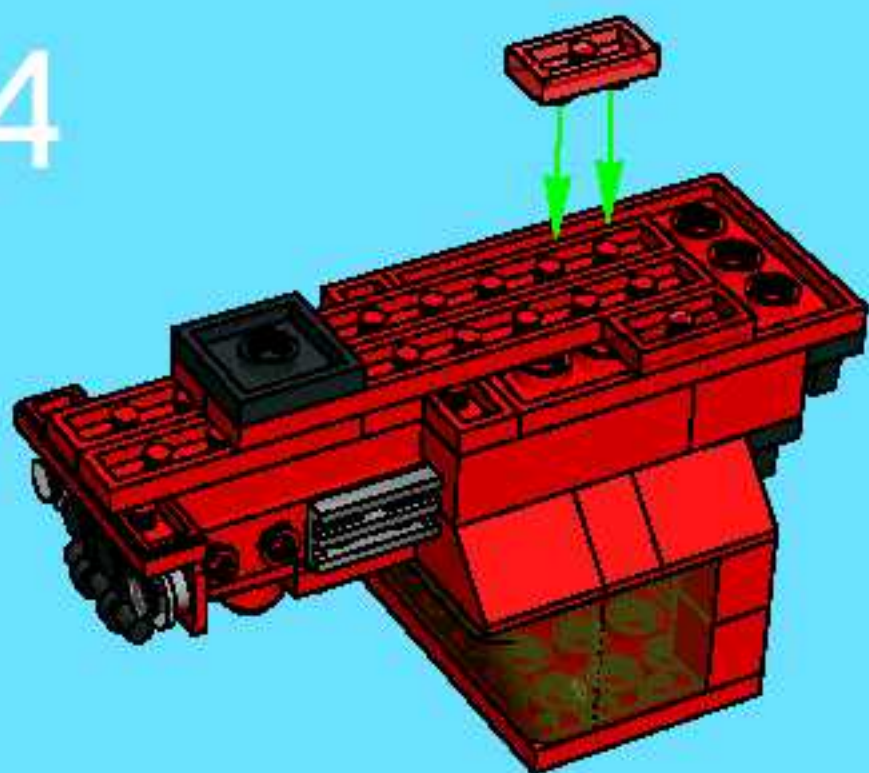

16

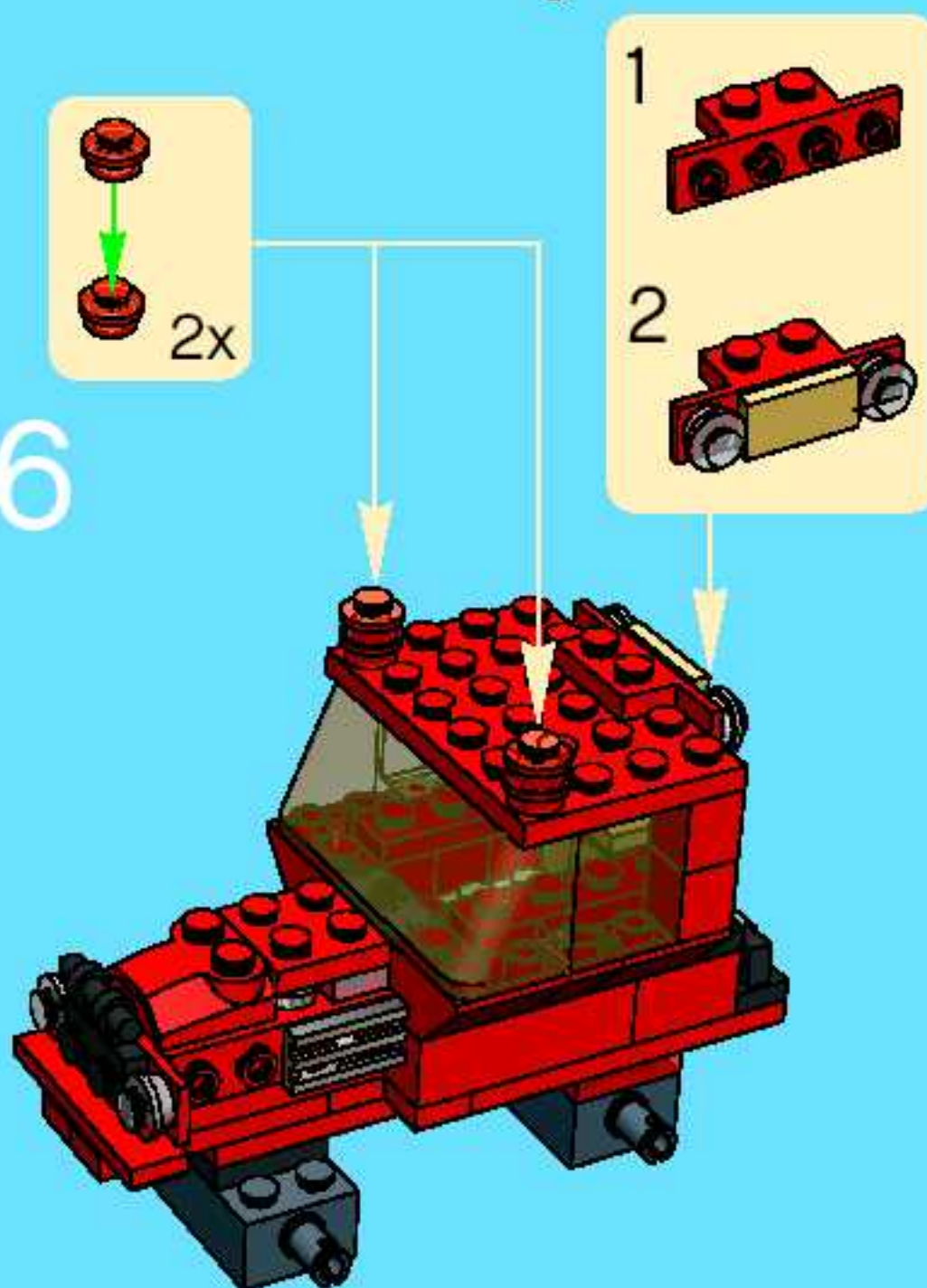

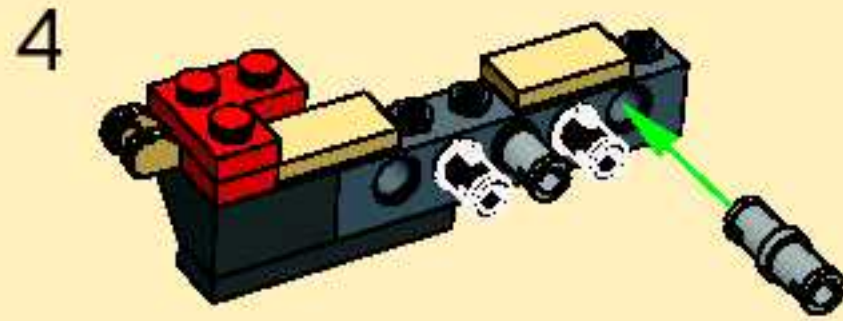
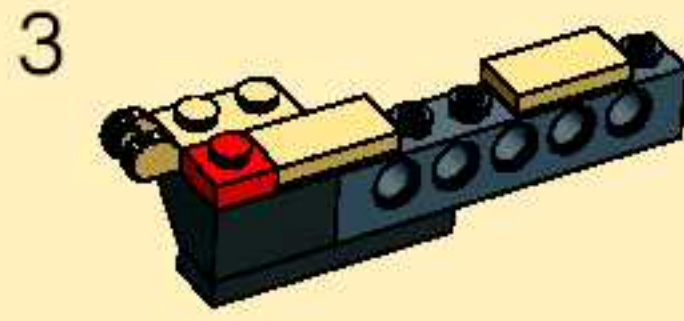
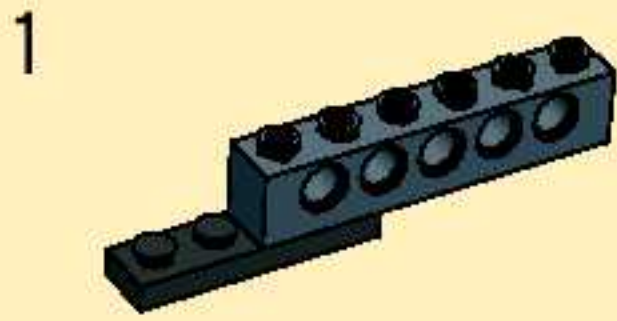

17

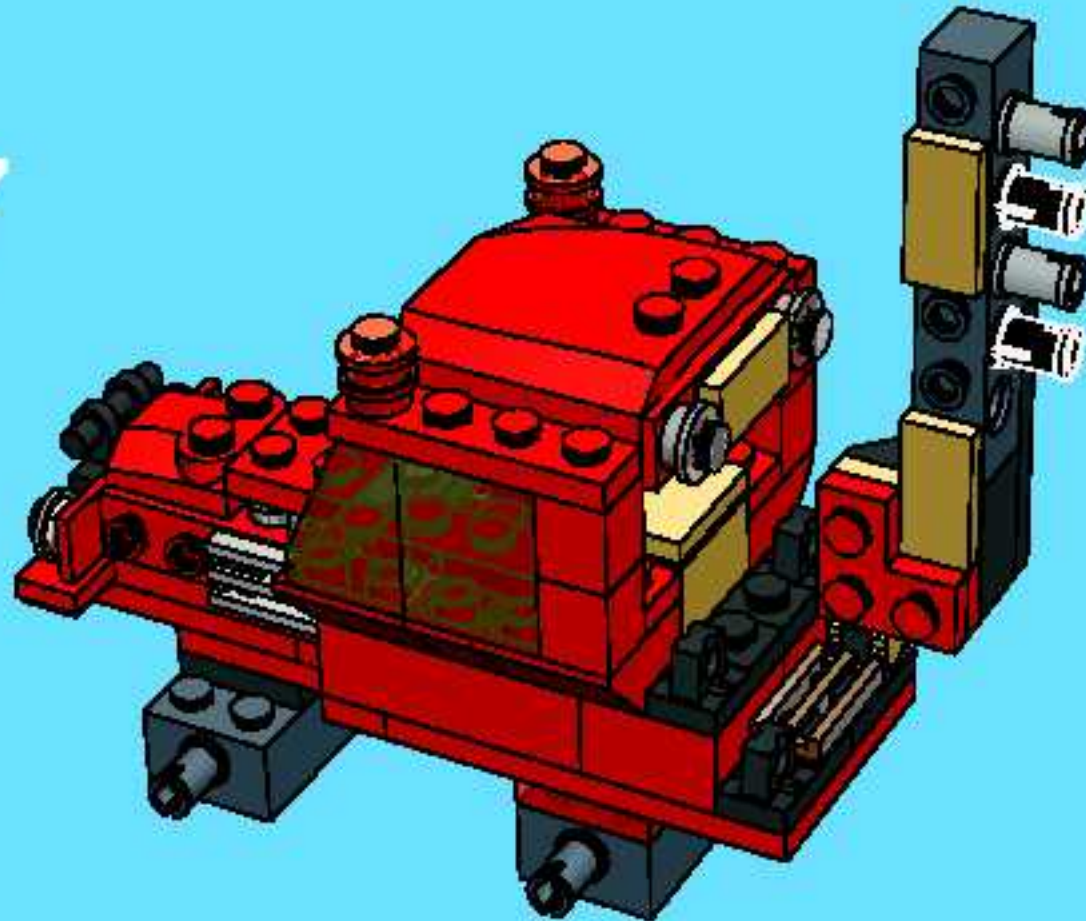

1



2

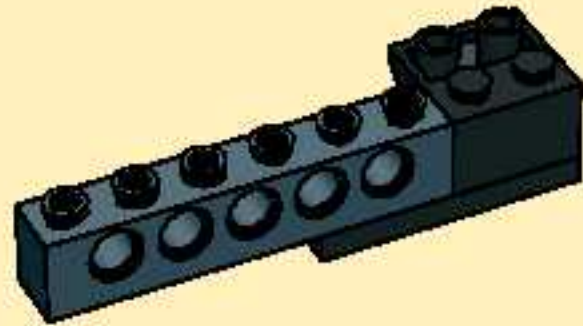

3

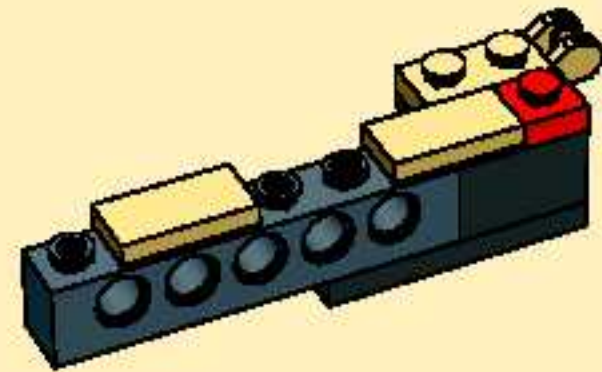

4

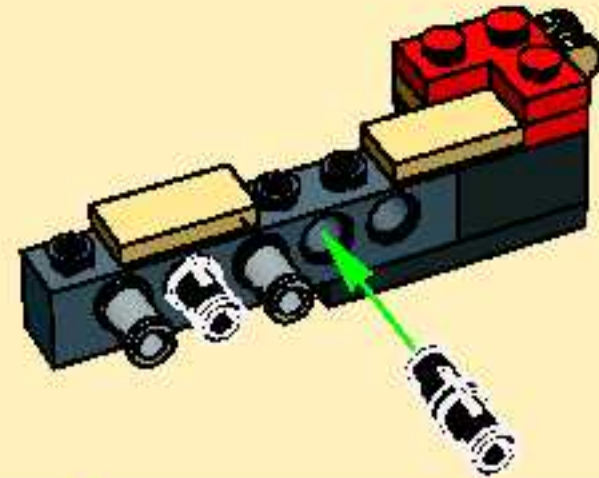

18

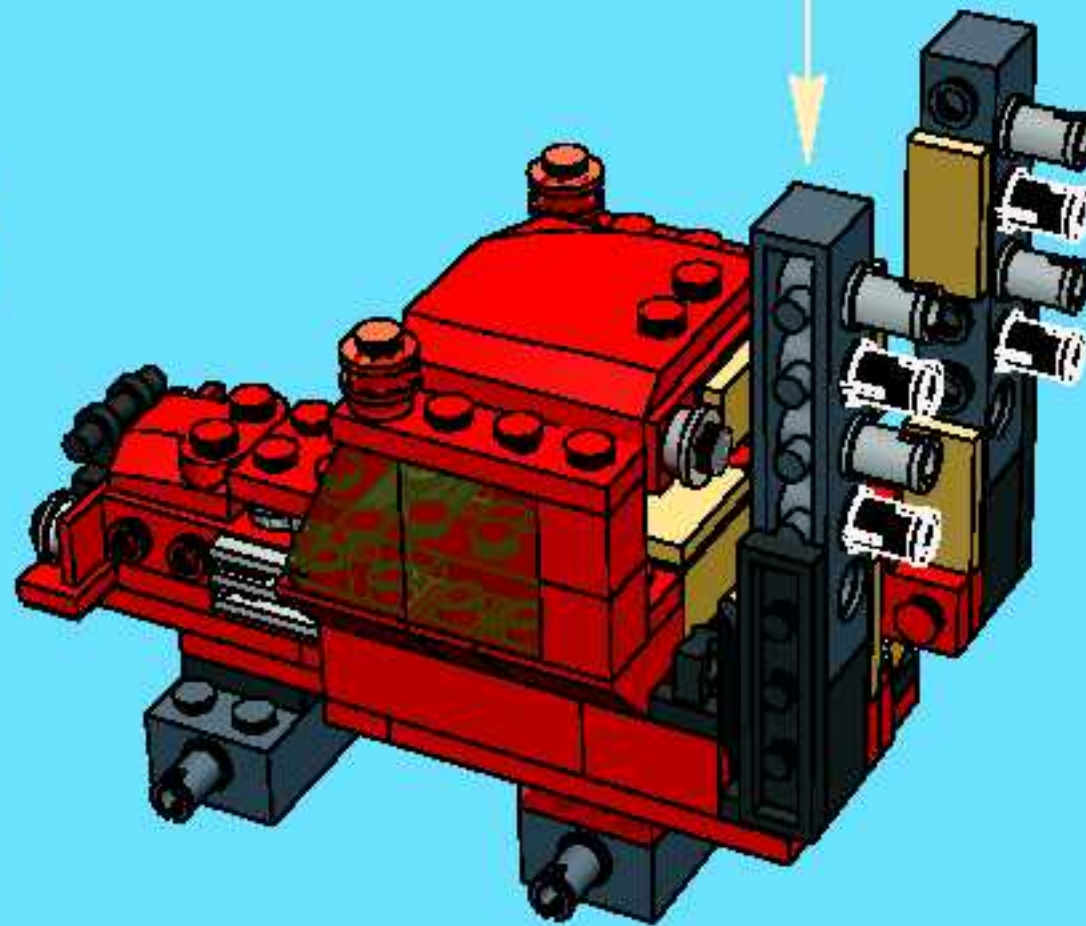

19

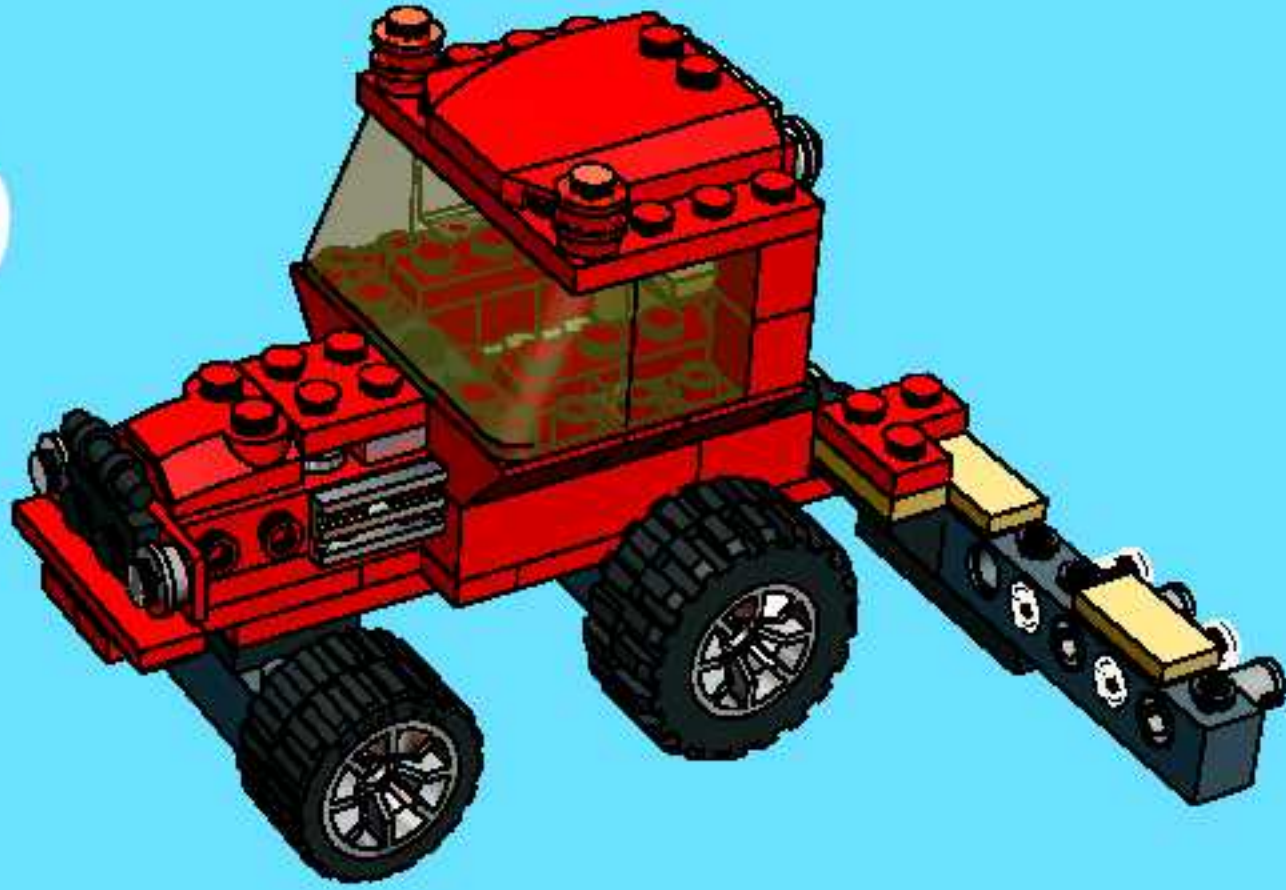

=



62



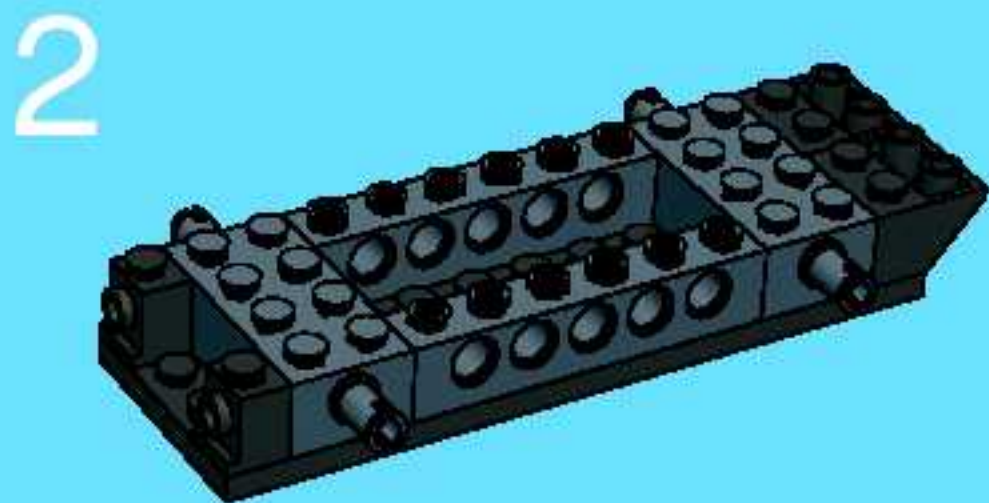
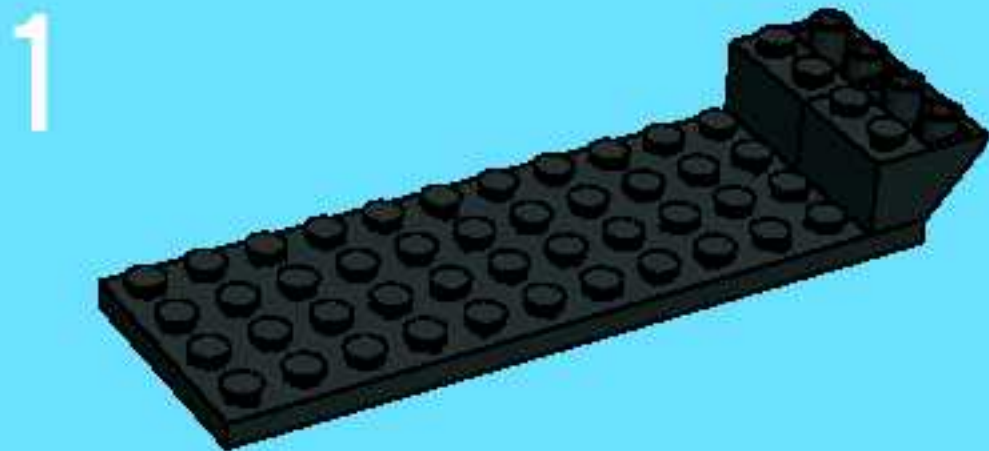
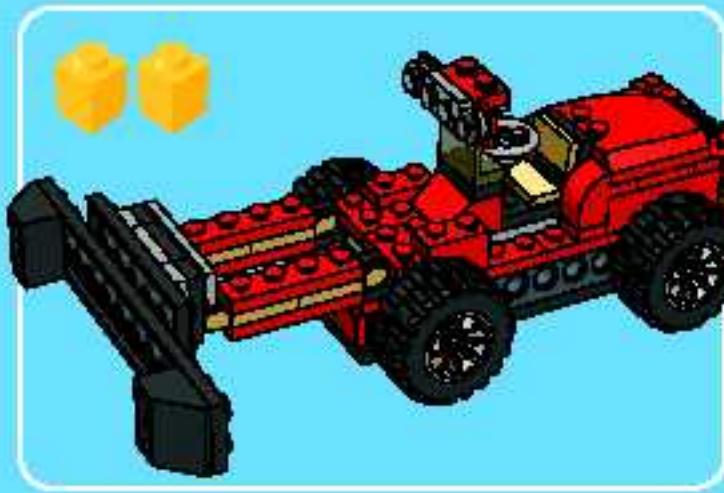

3

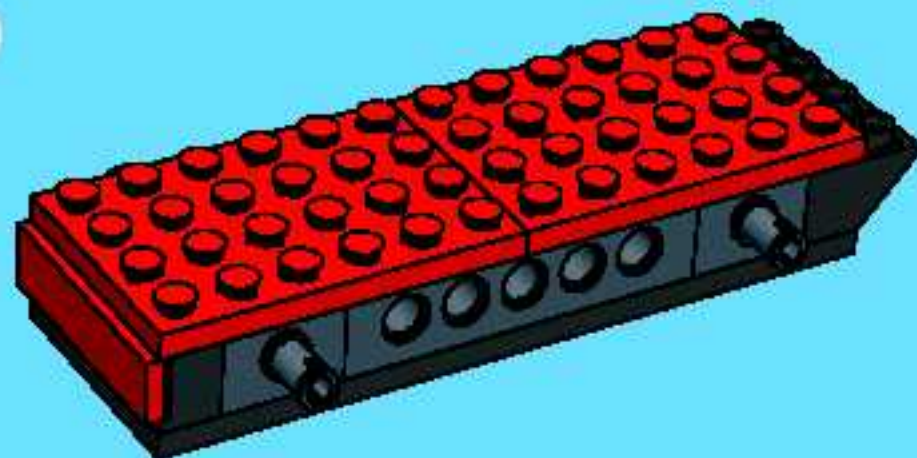

1

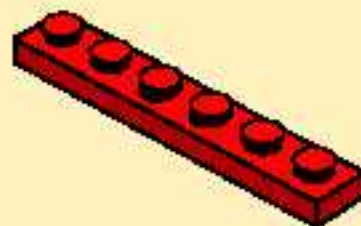

2

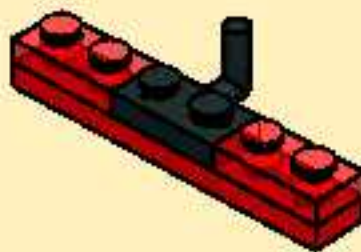

3

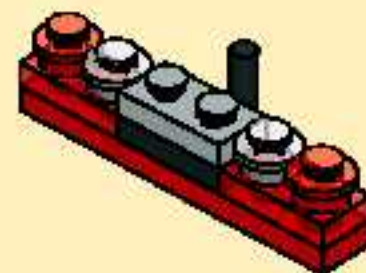

4



4

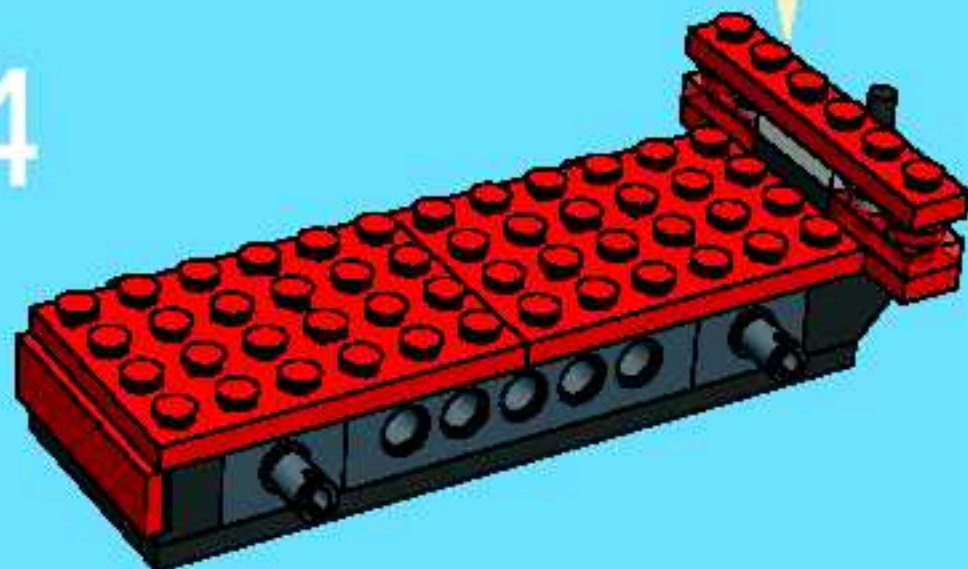

5

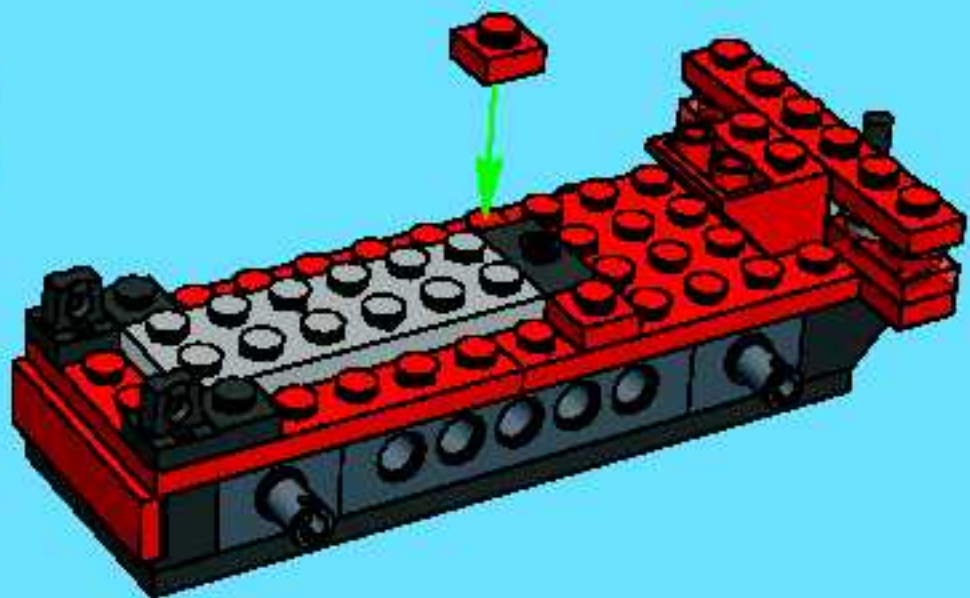

6

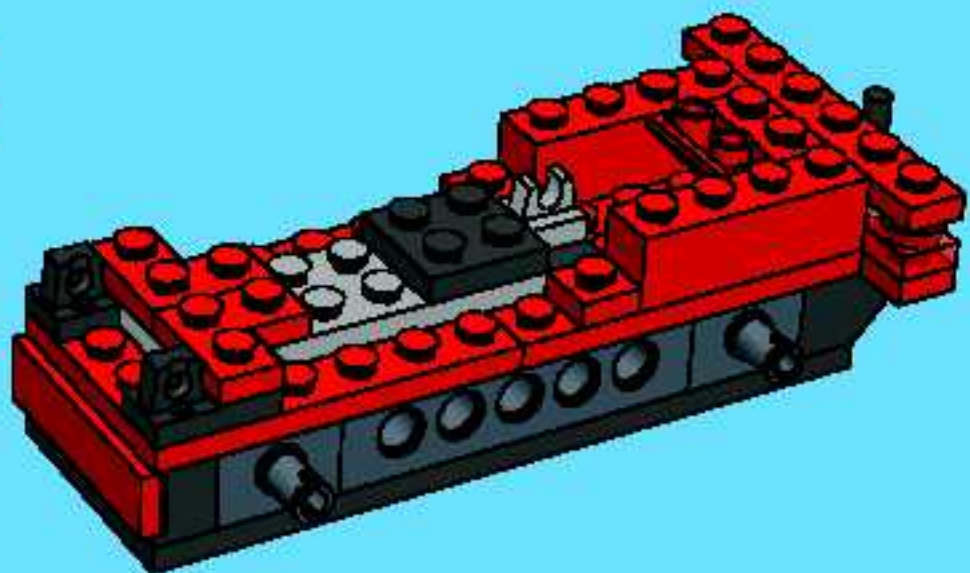

7

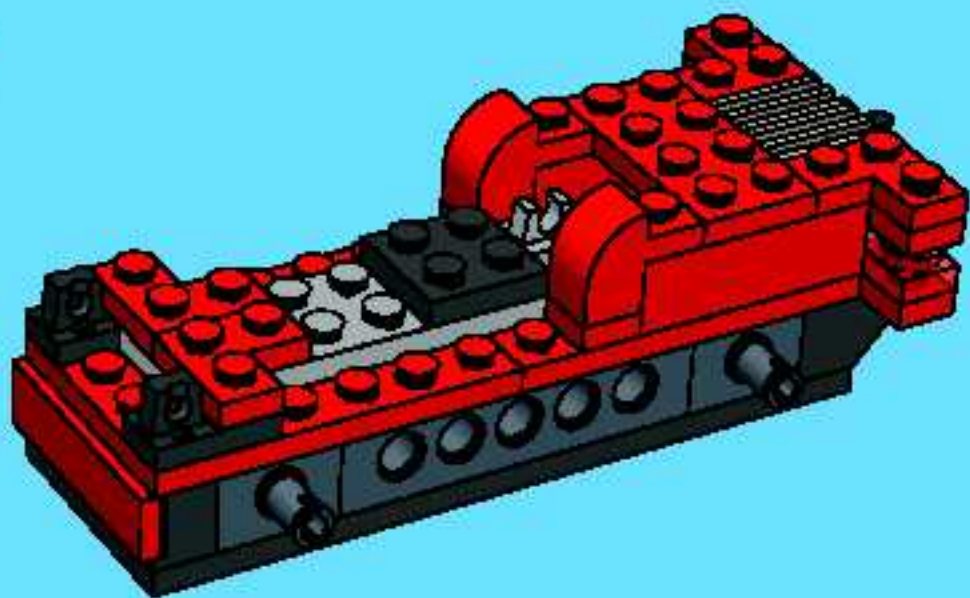

8

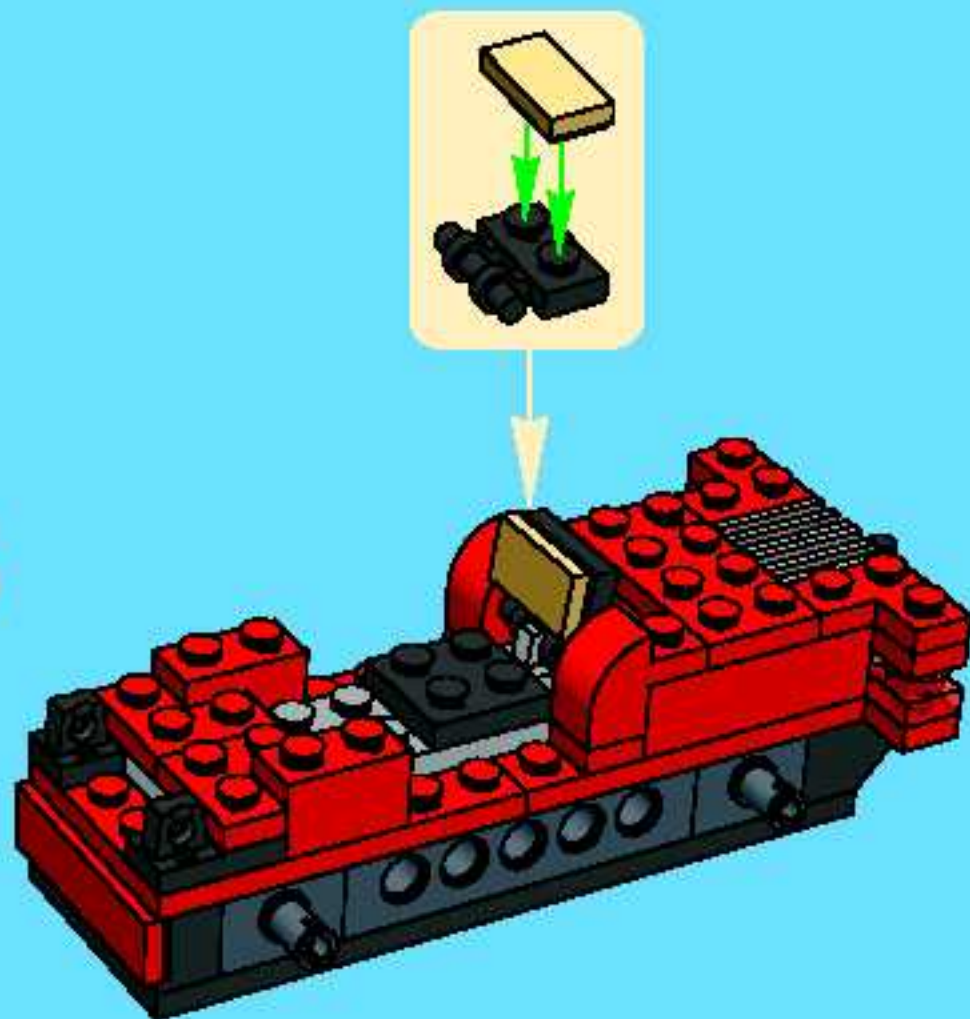

9

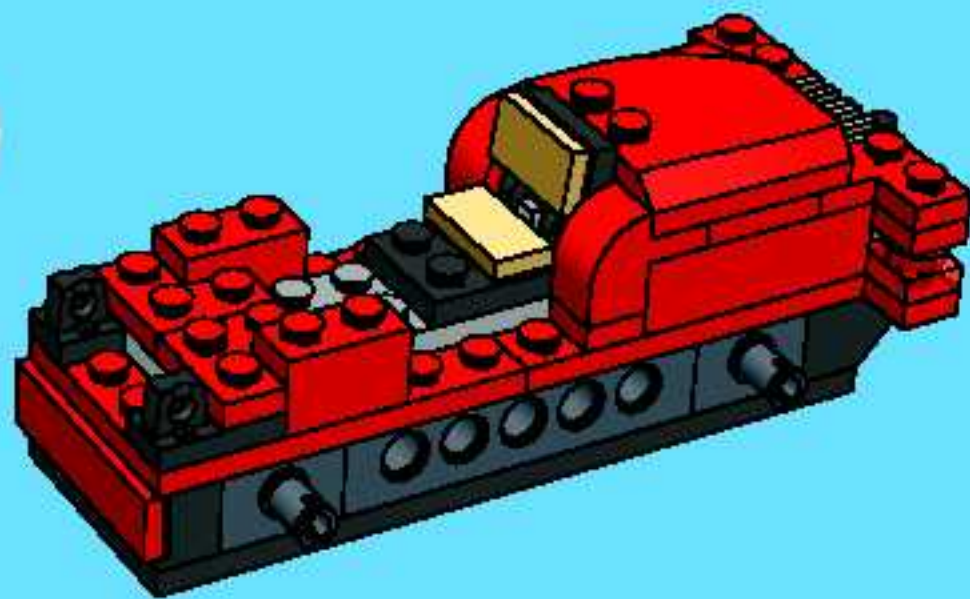

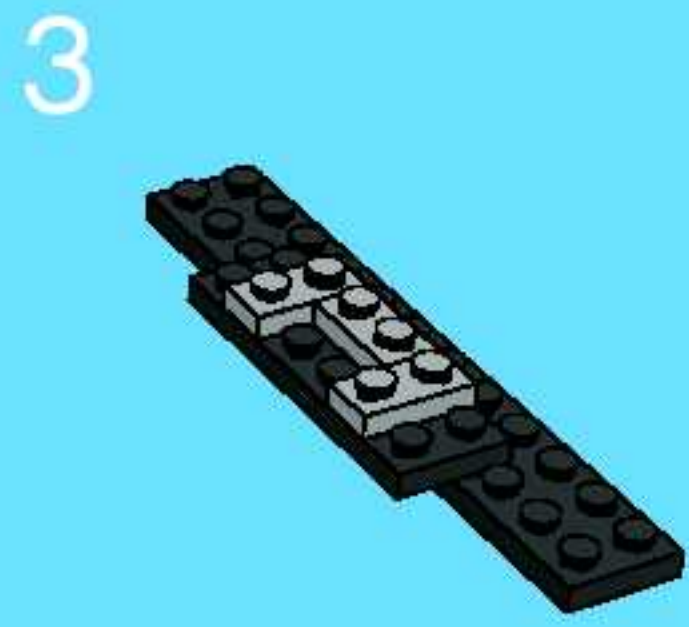
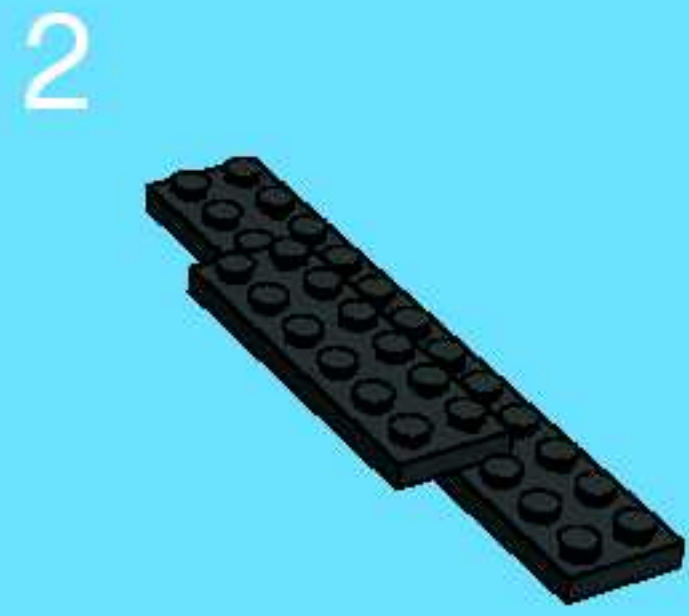
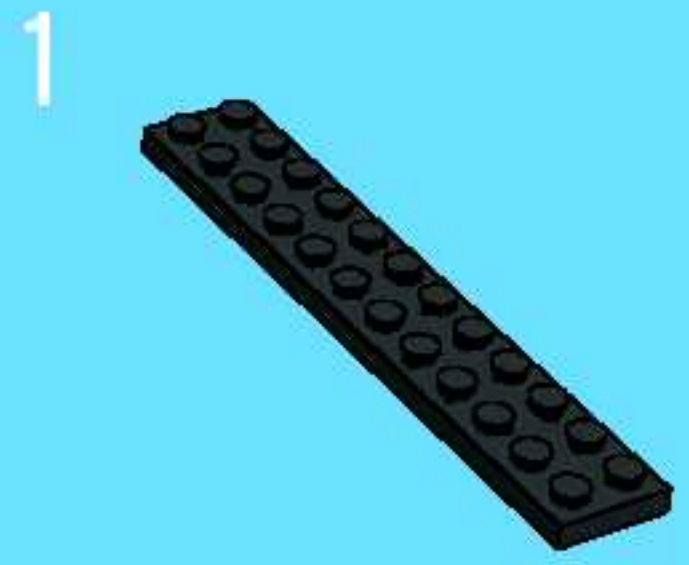
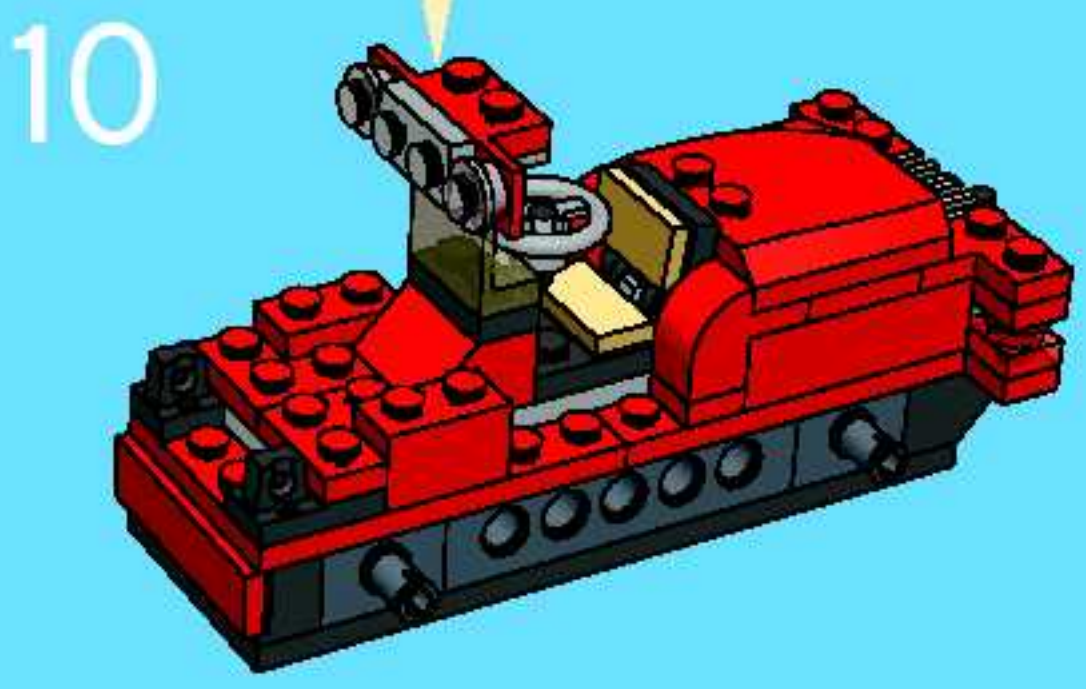
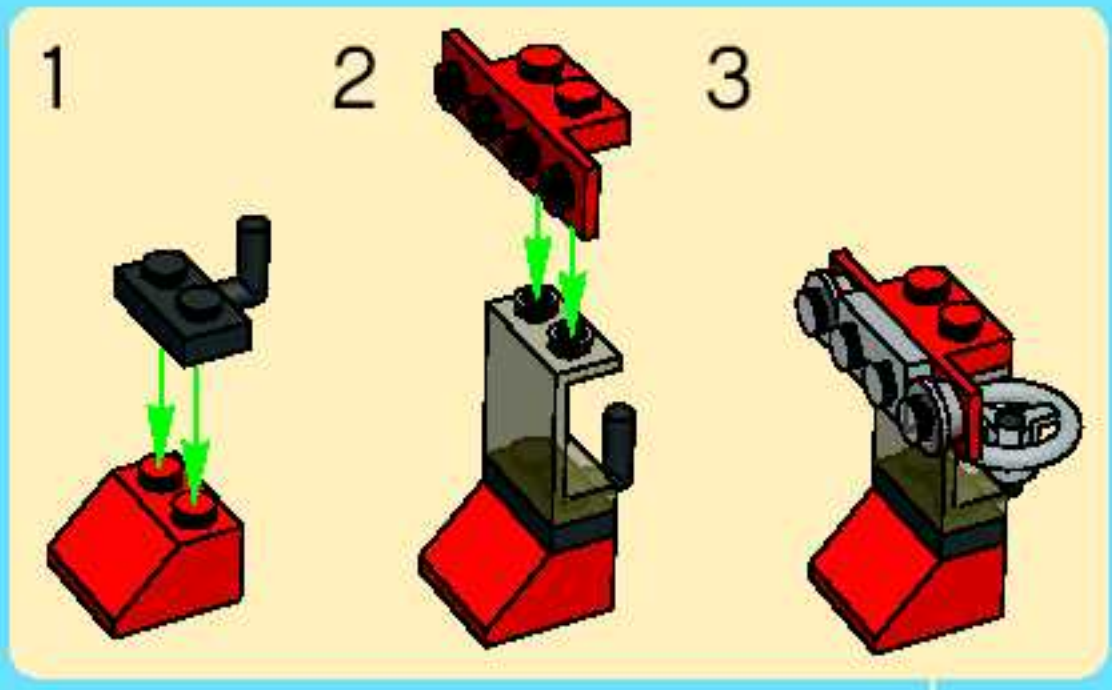

4

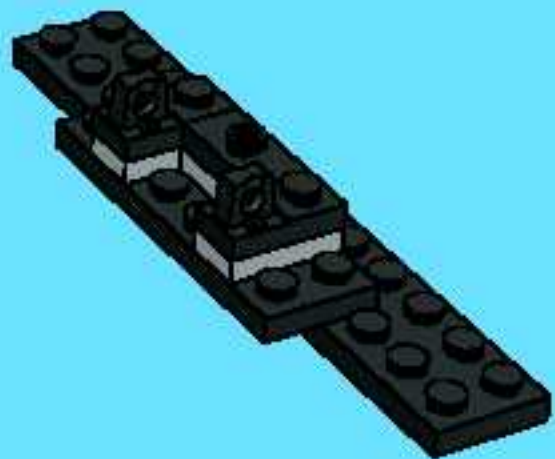

5

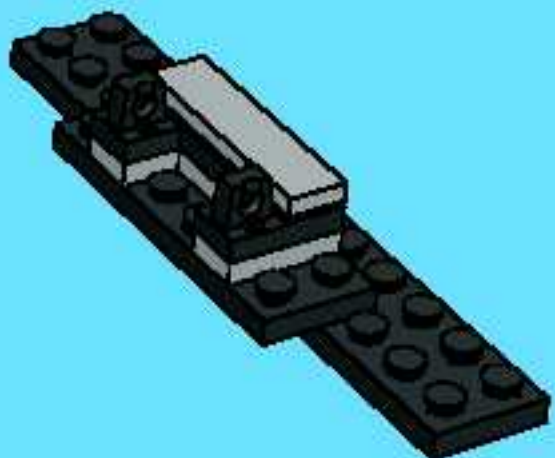

6

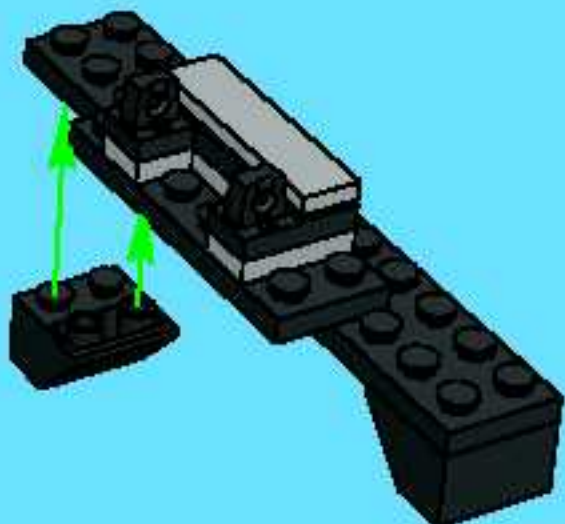

1

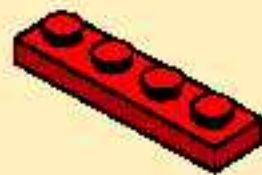

2

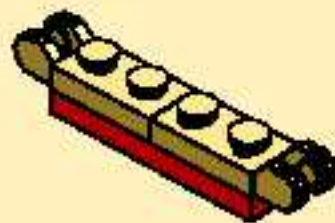

3



7

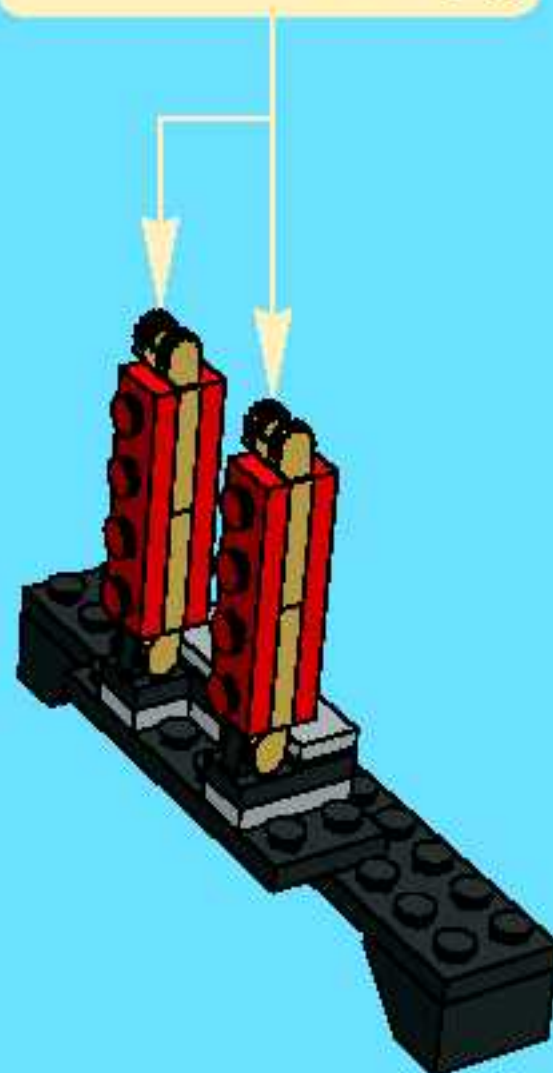

11

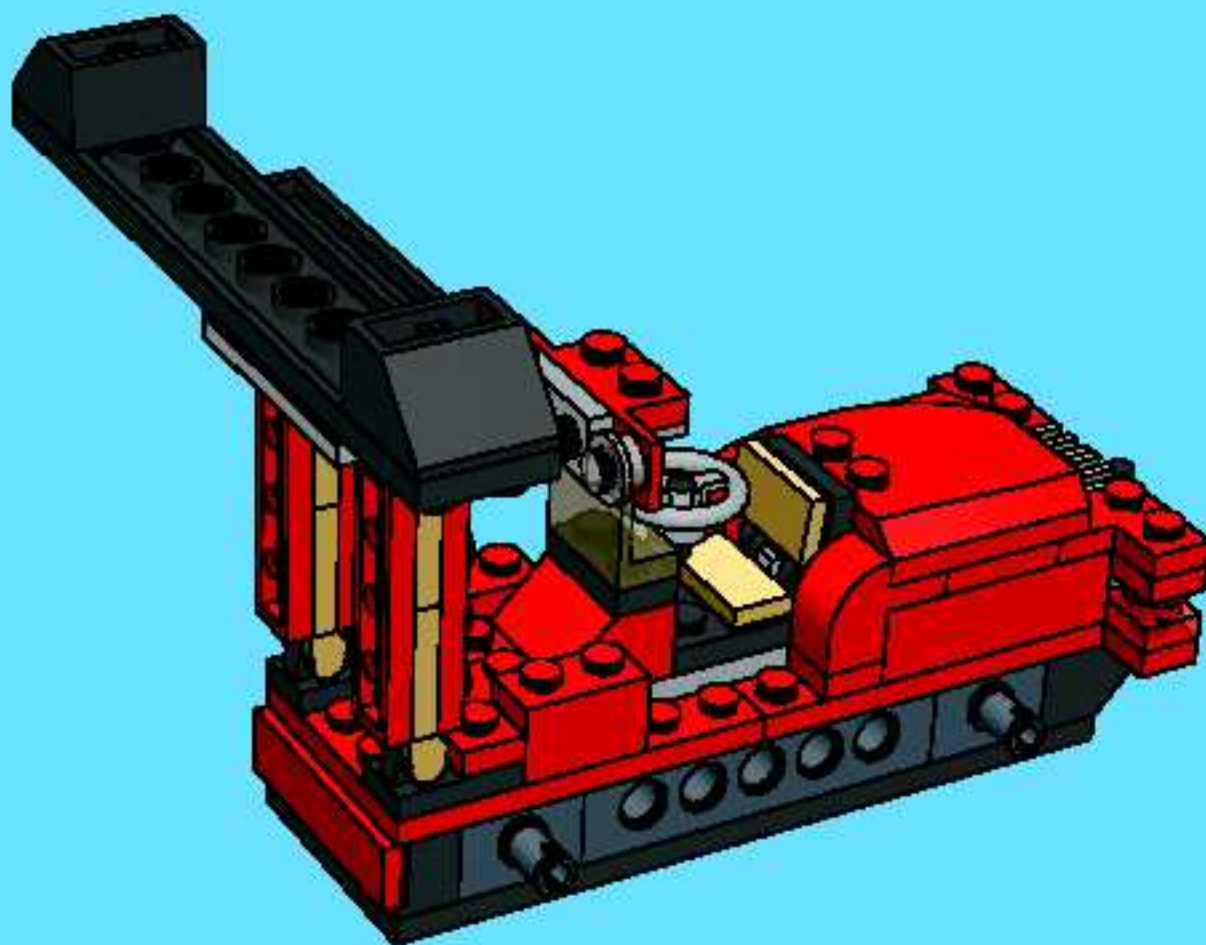

12

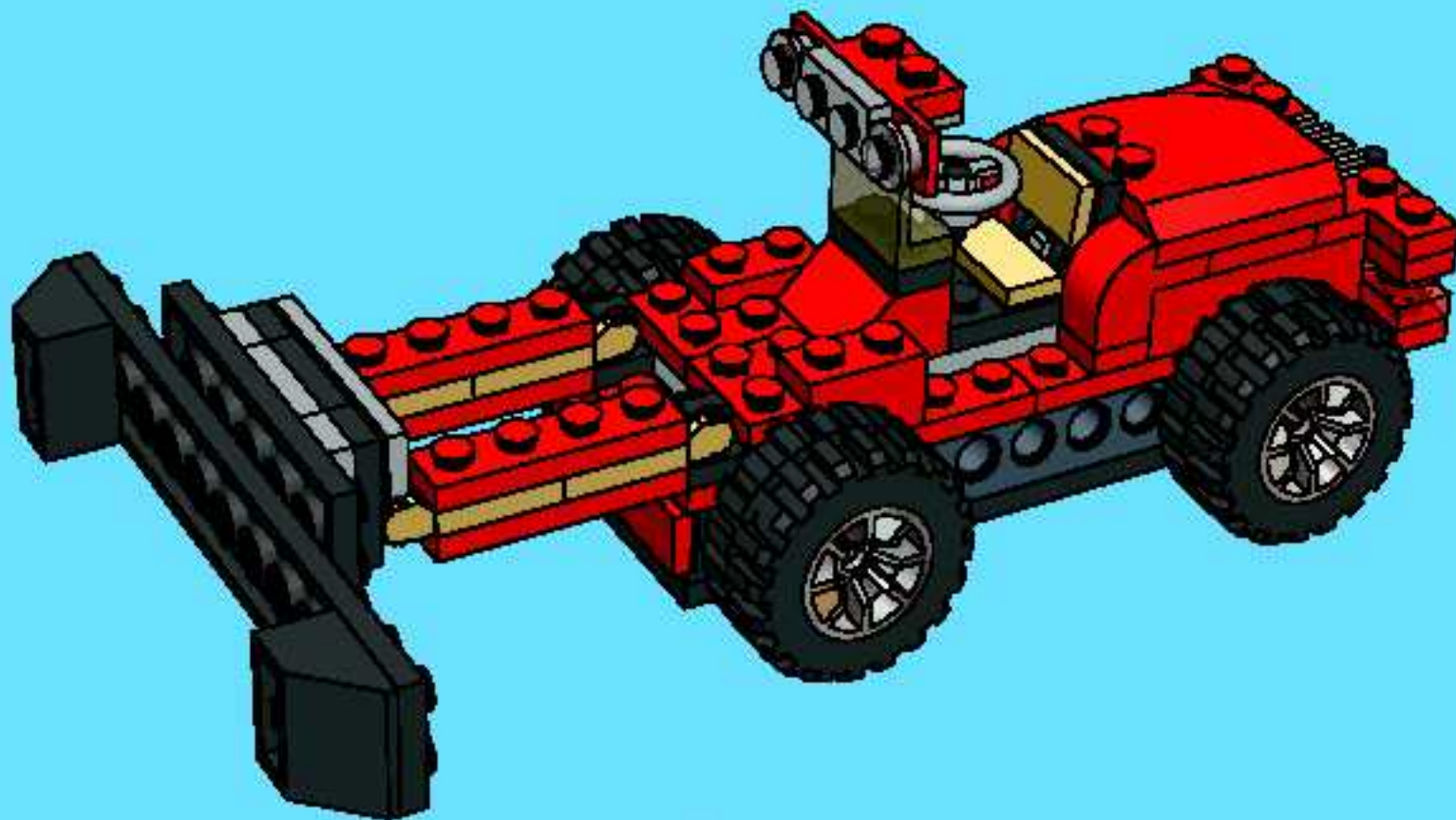

=





1

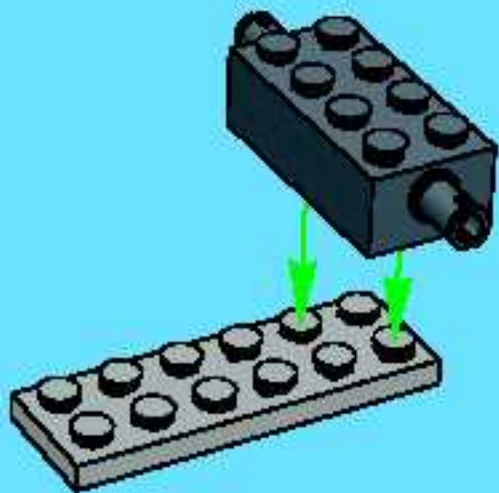

2

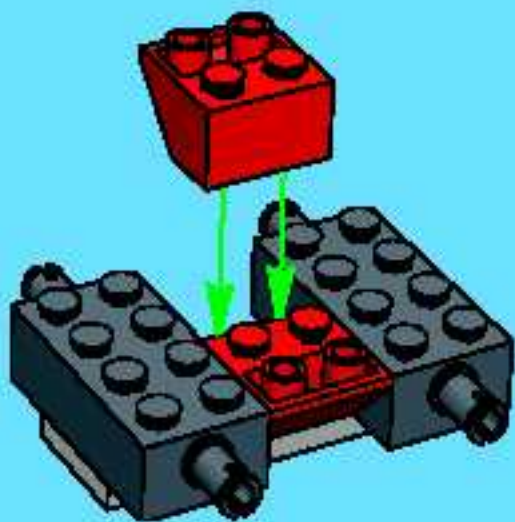

3

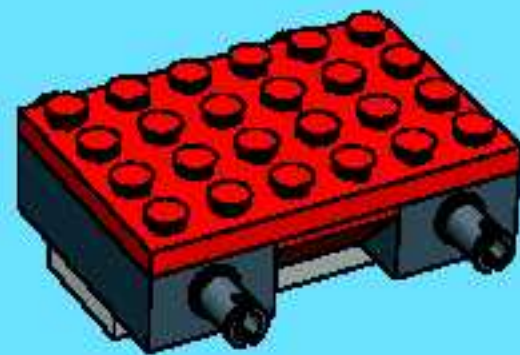

4

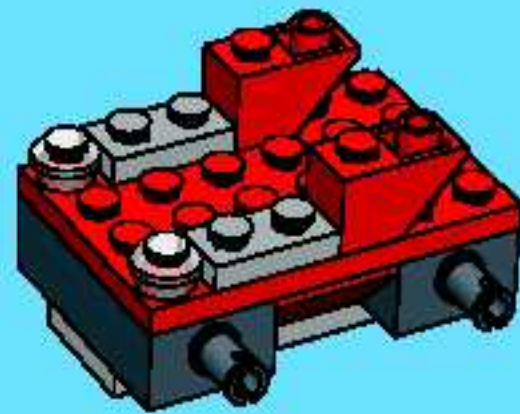

5

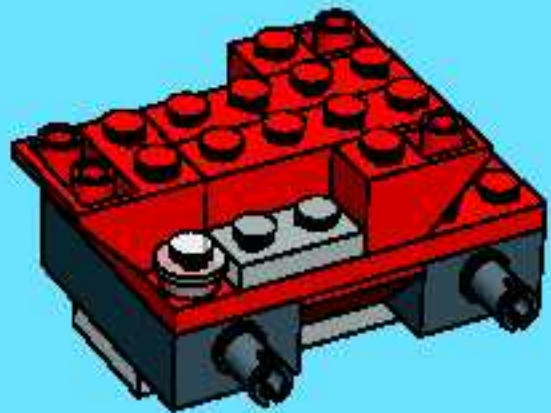

1

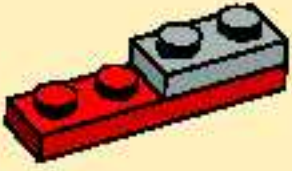

2

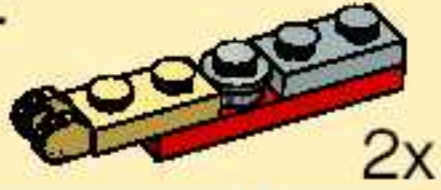

2x

6

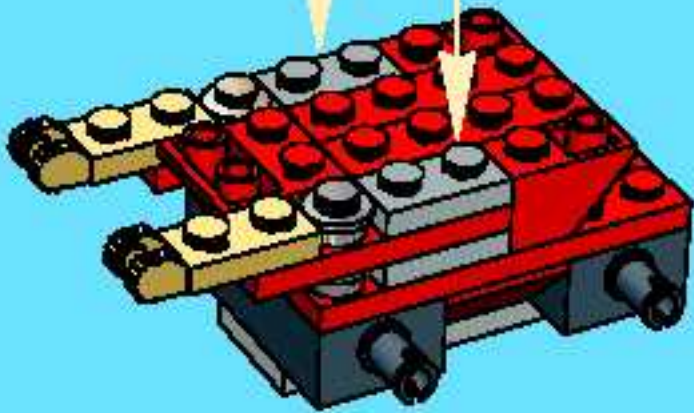

1



2



7

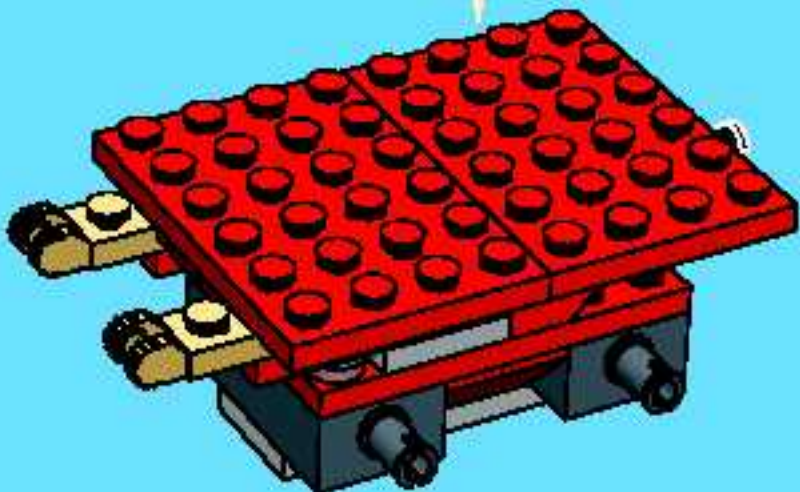

8

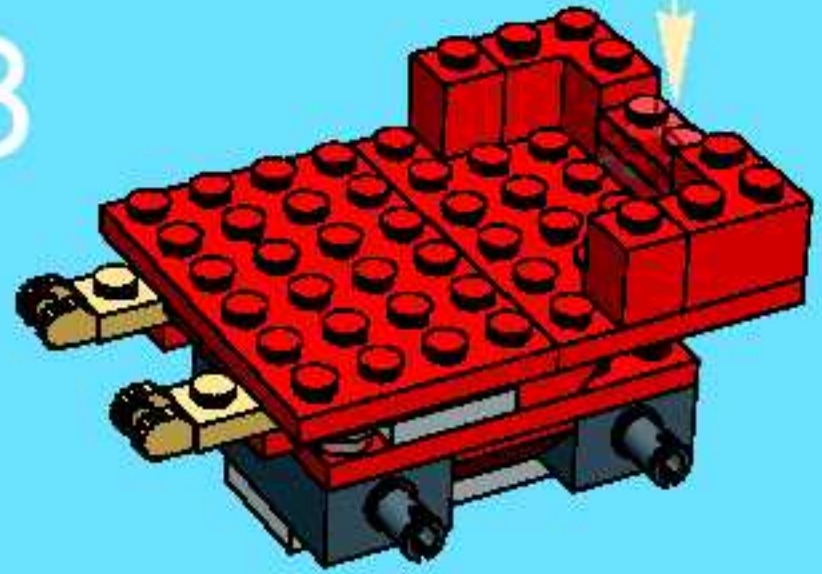

9

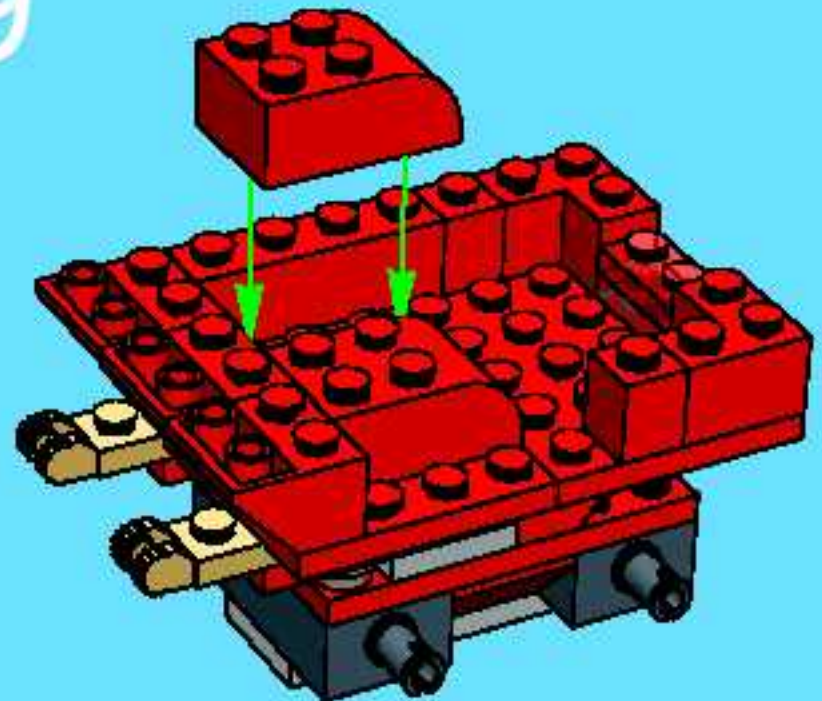



10

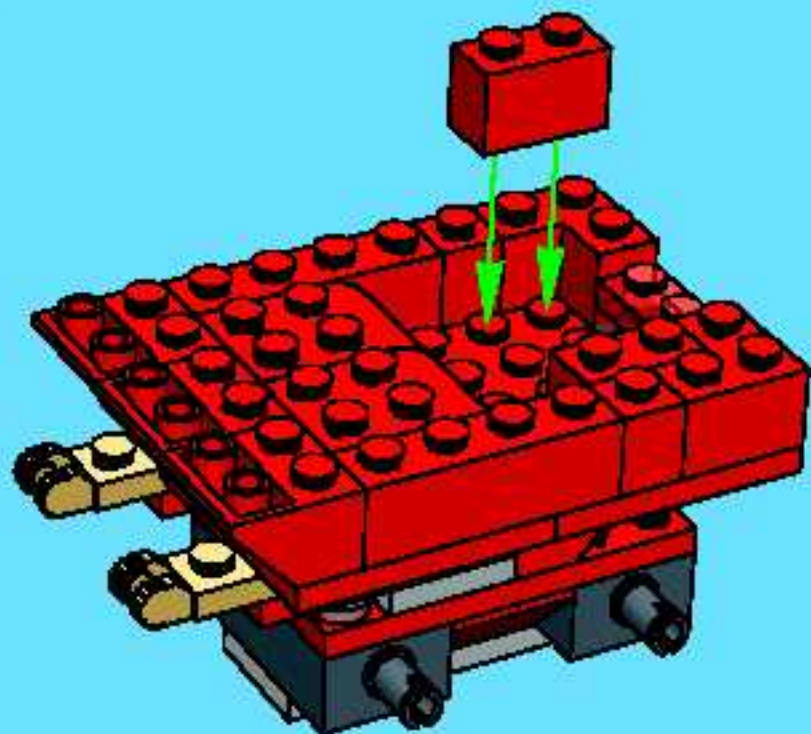

11

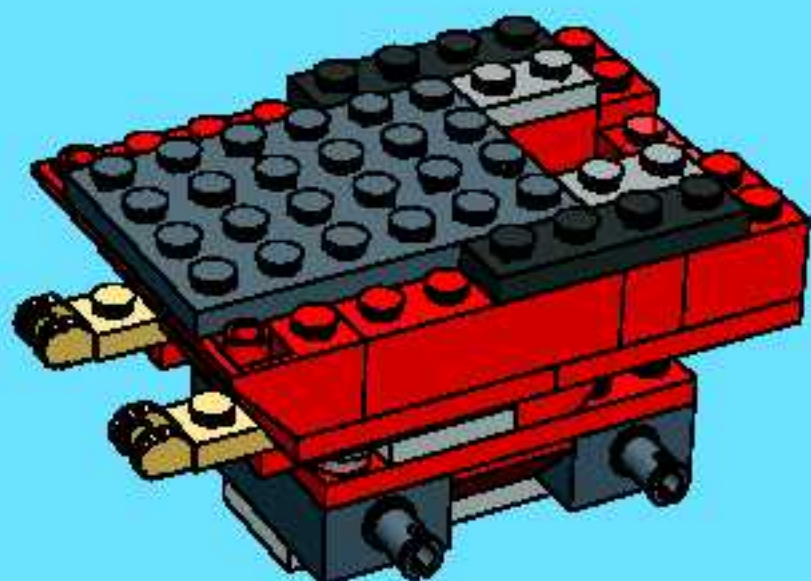

12

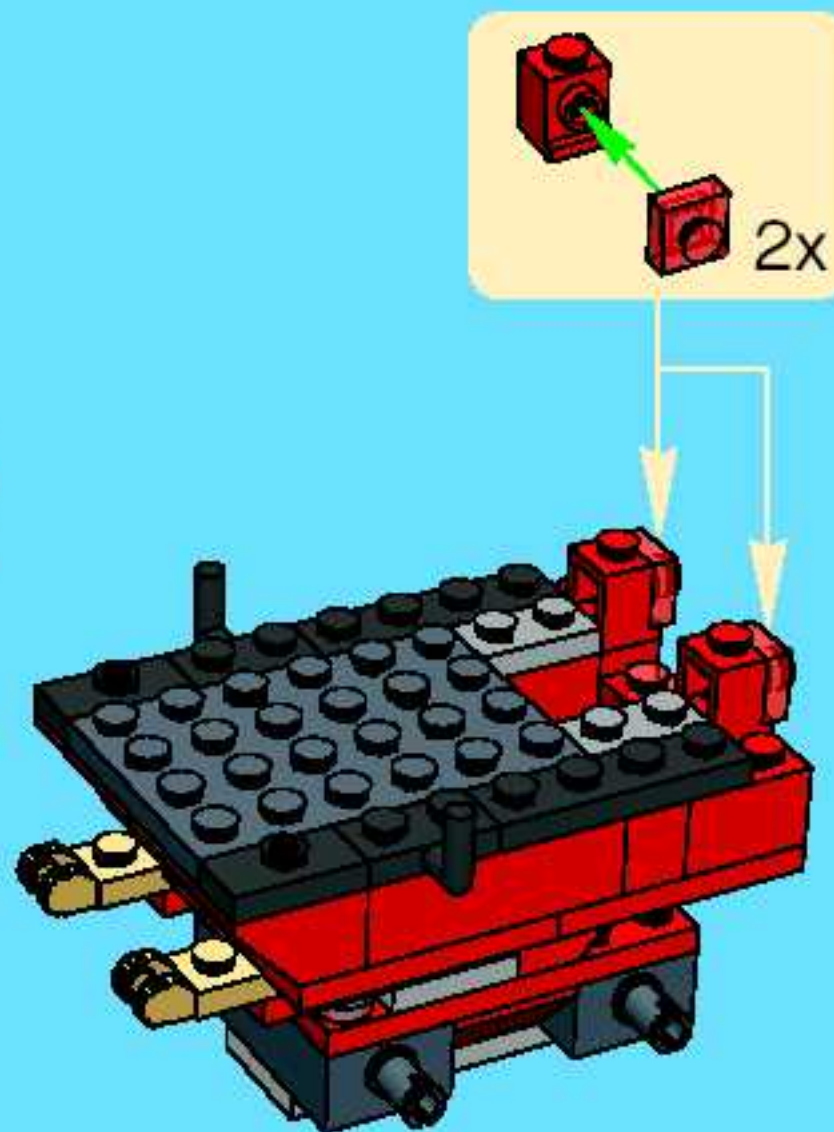

13

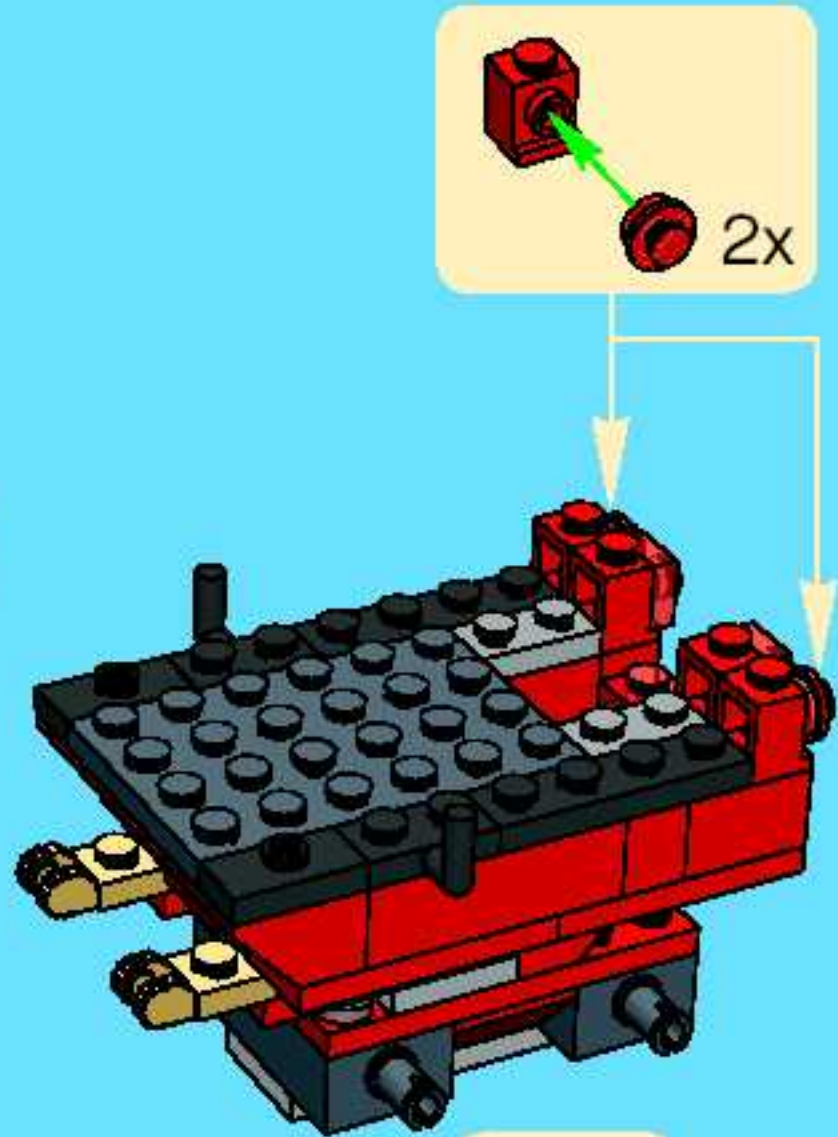

14

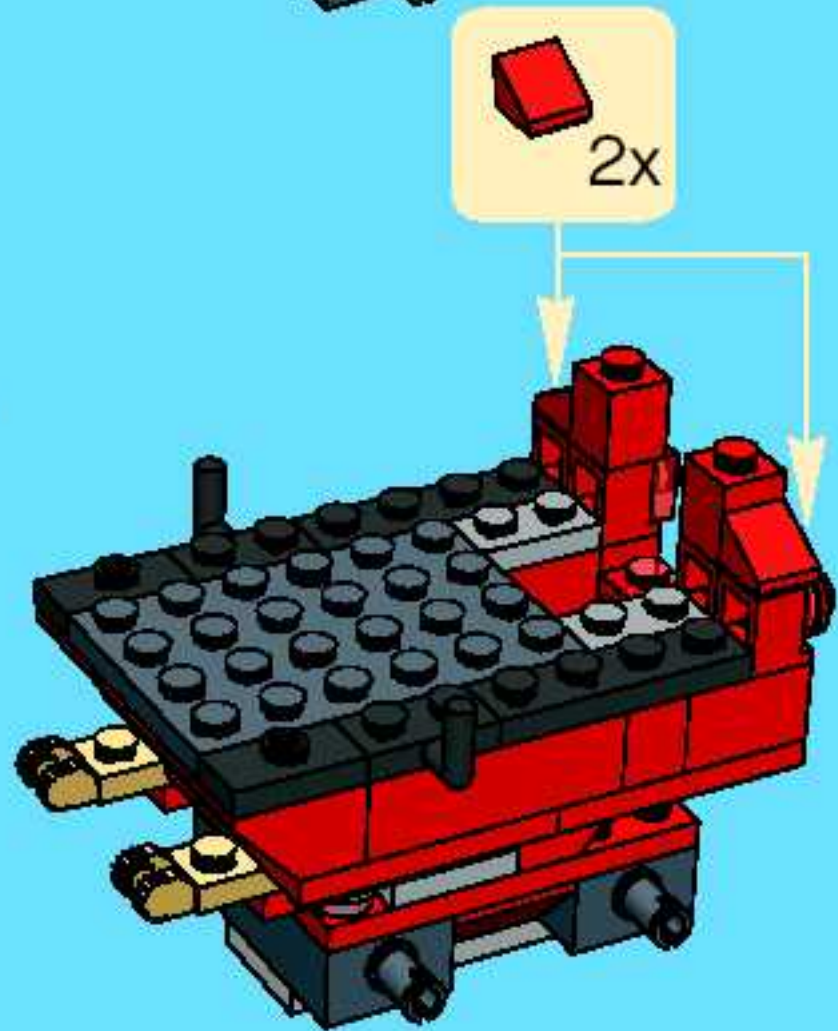

15

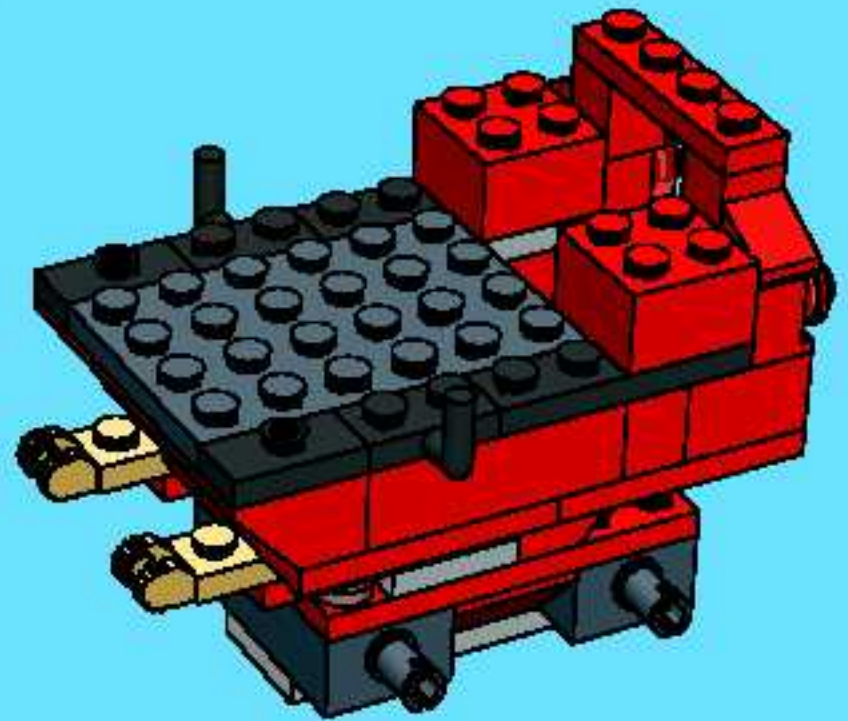

16

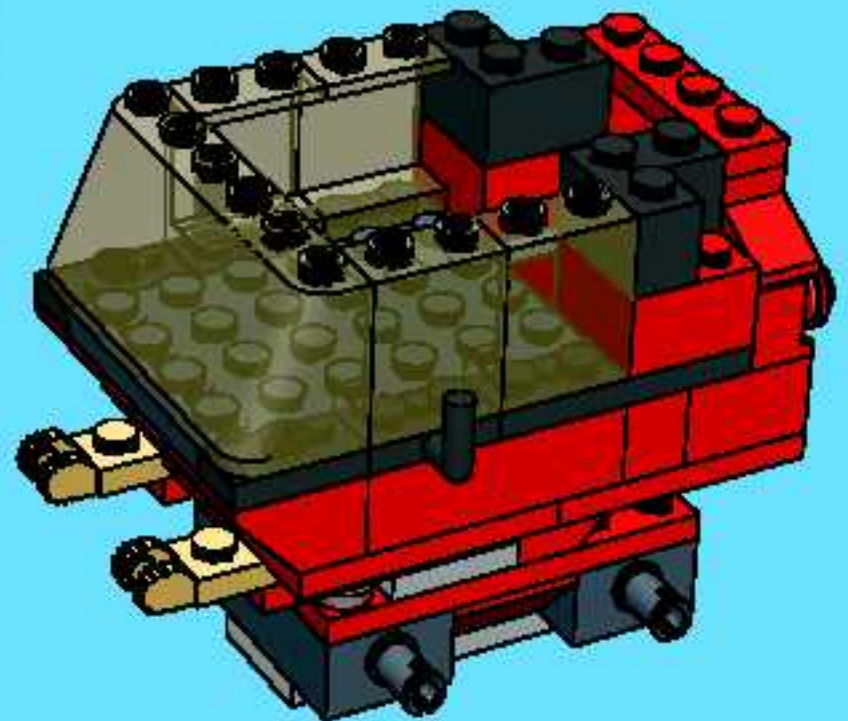

17



18

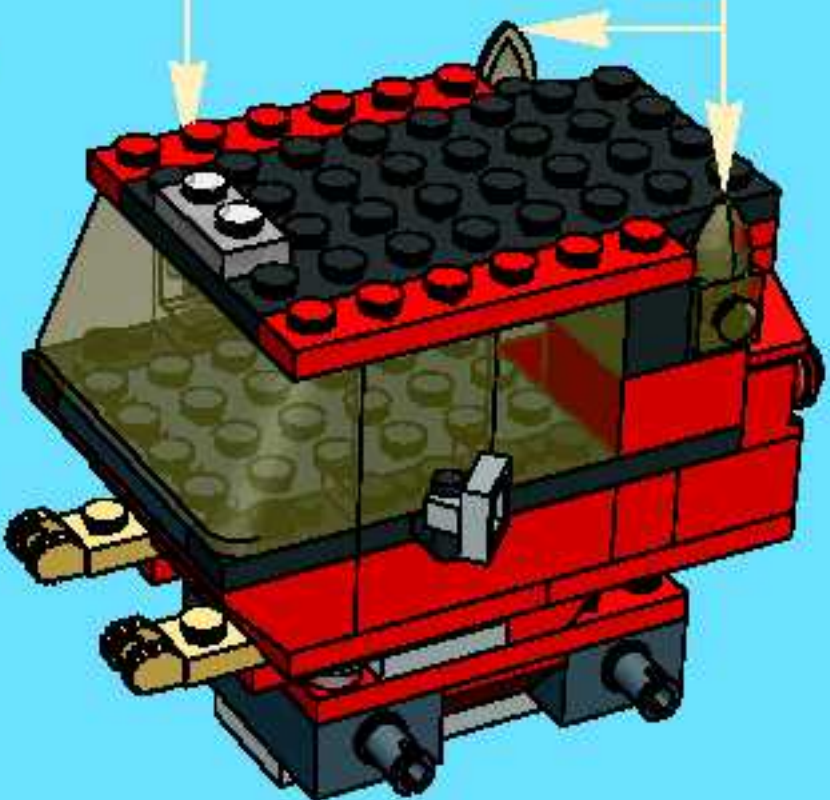

19

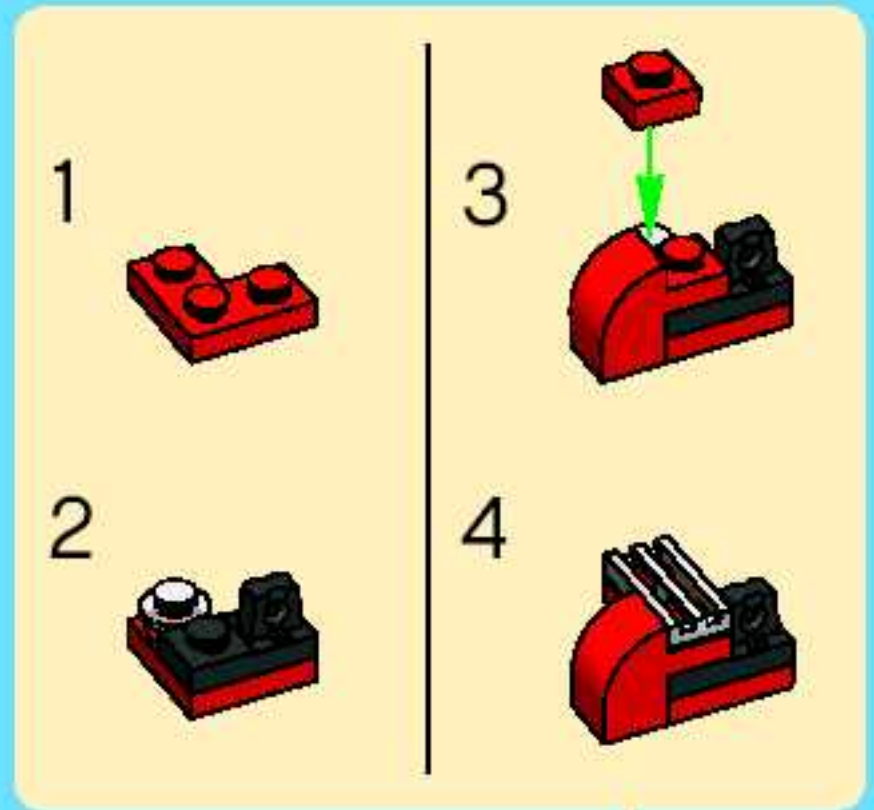
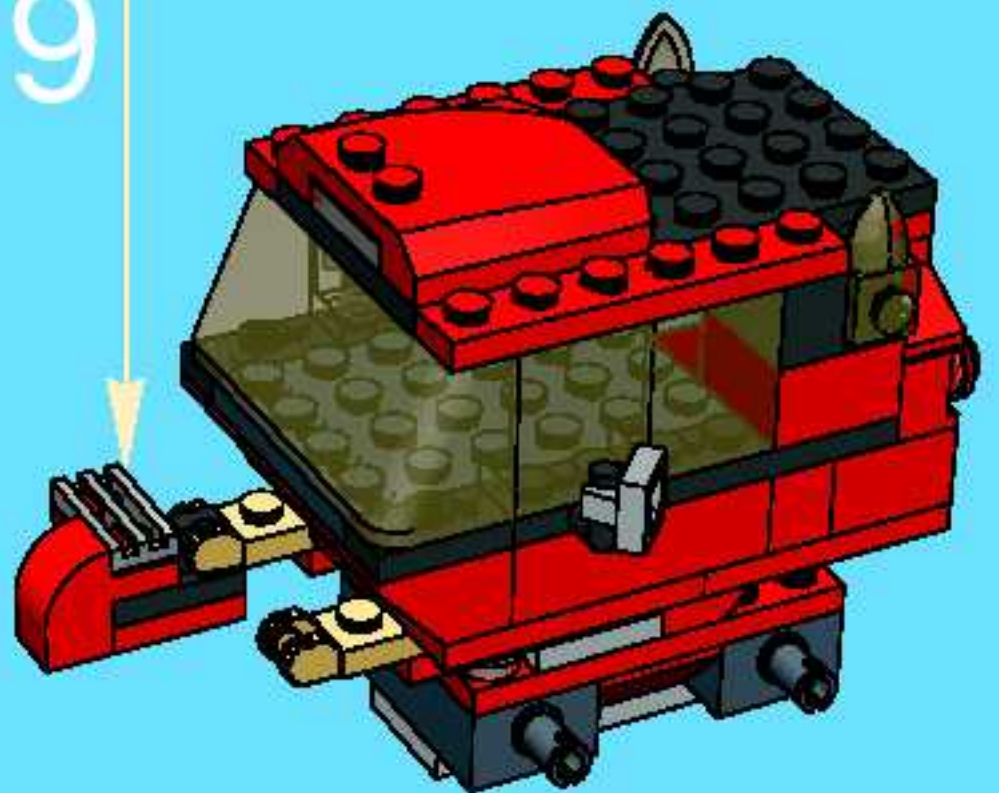

1



3



2



4



20

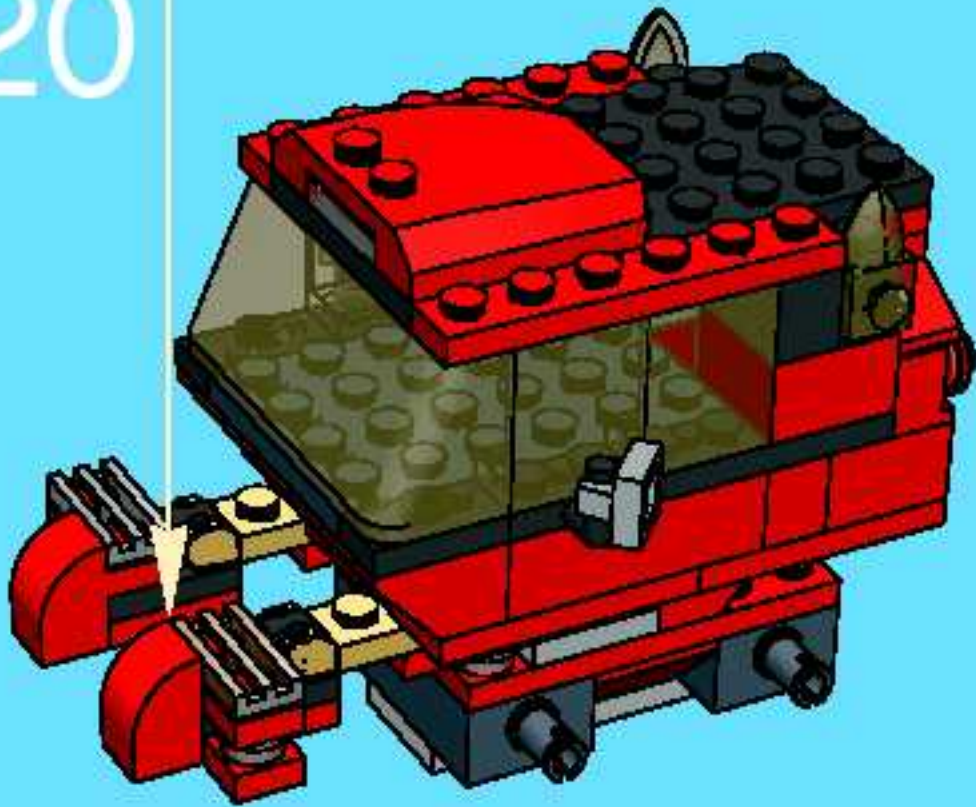

21





1

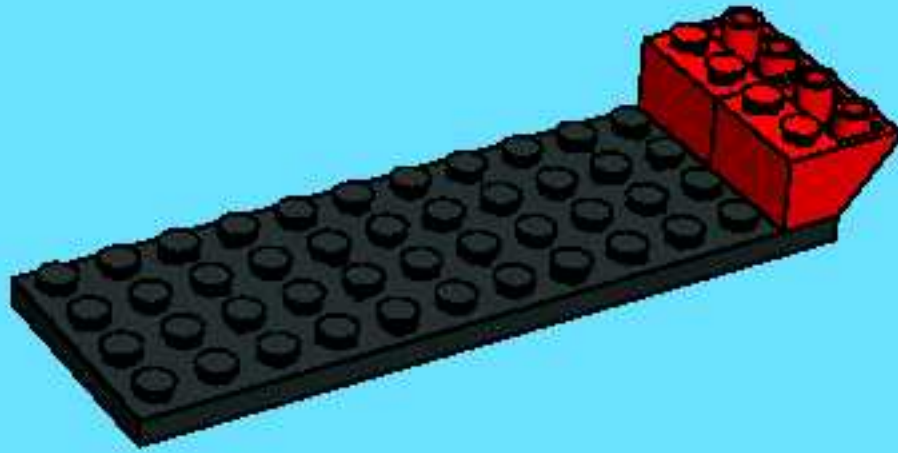

2

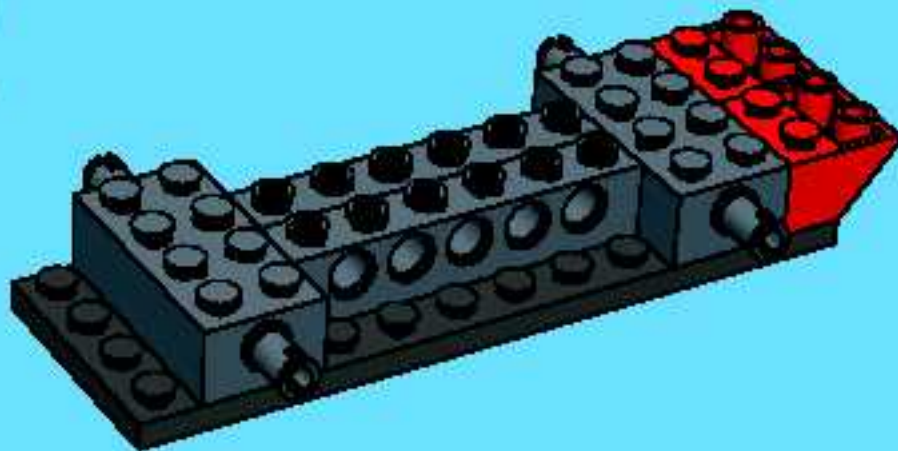

3

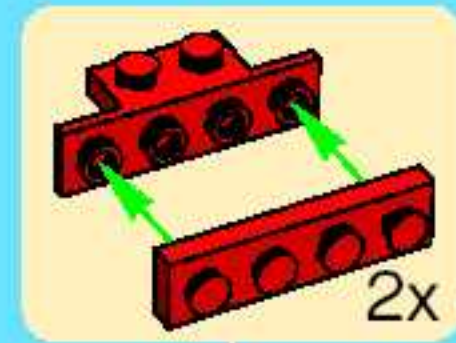
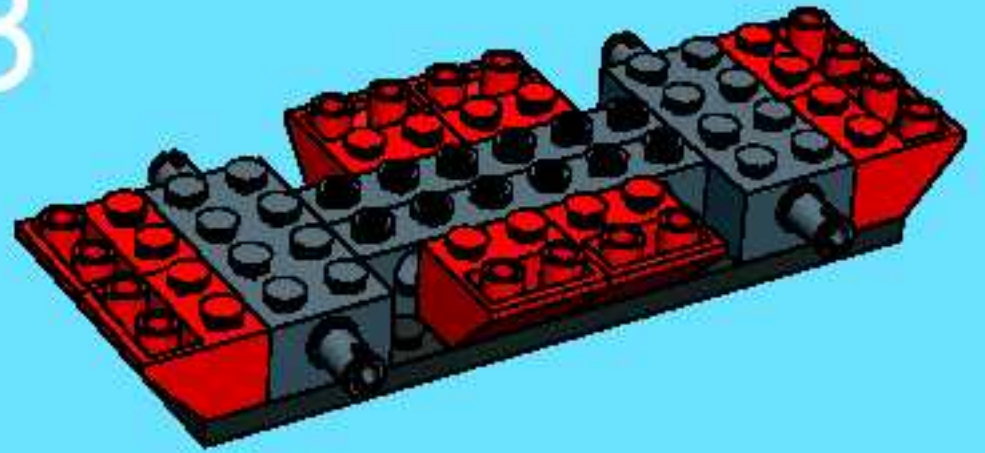

4

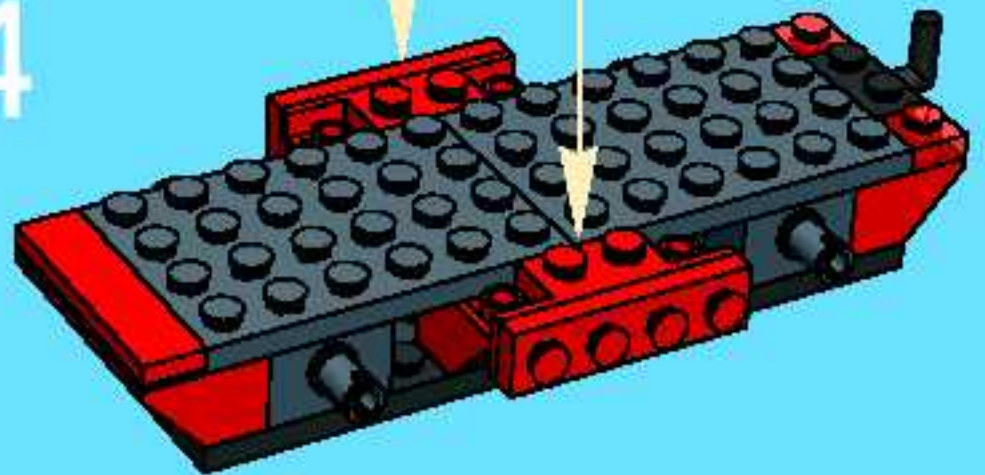

5

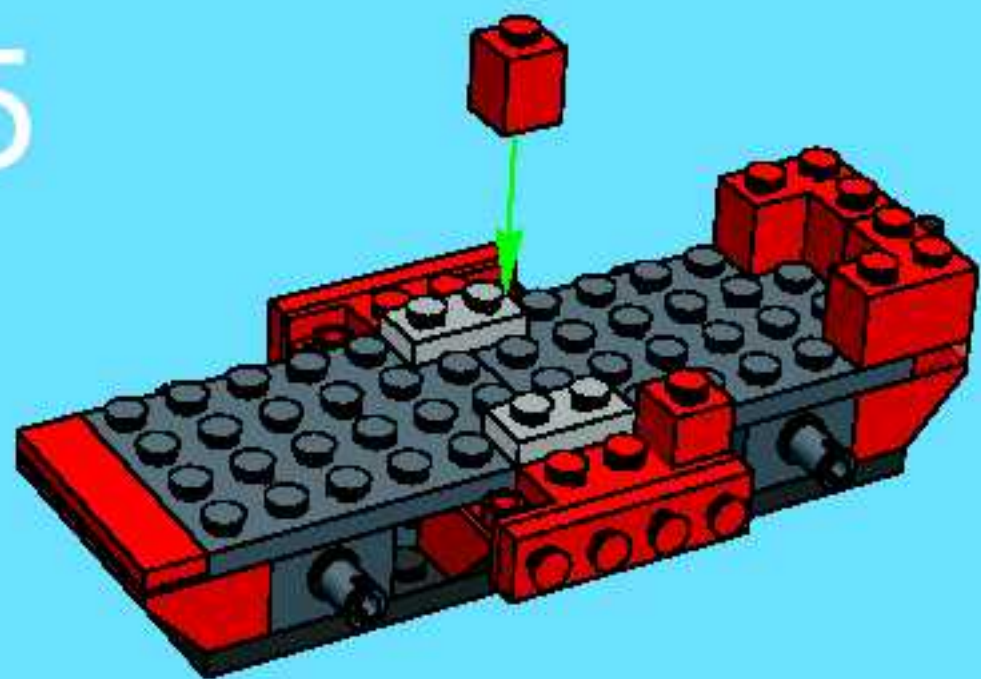

7

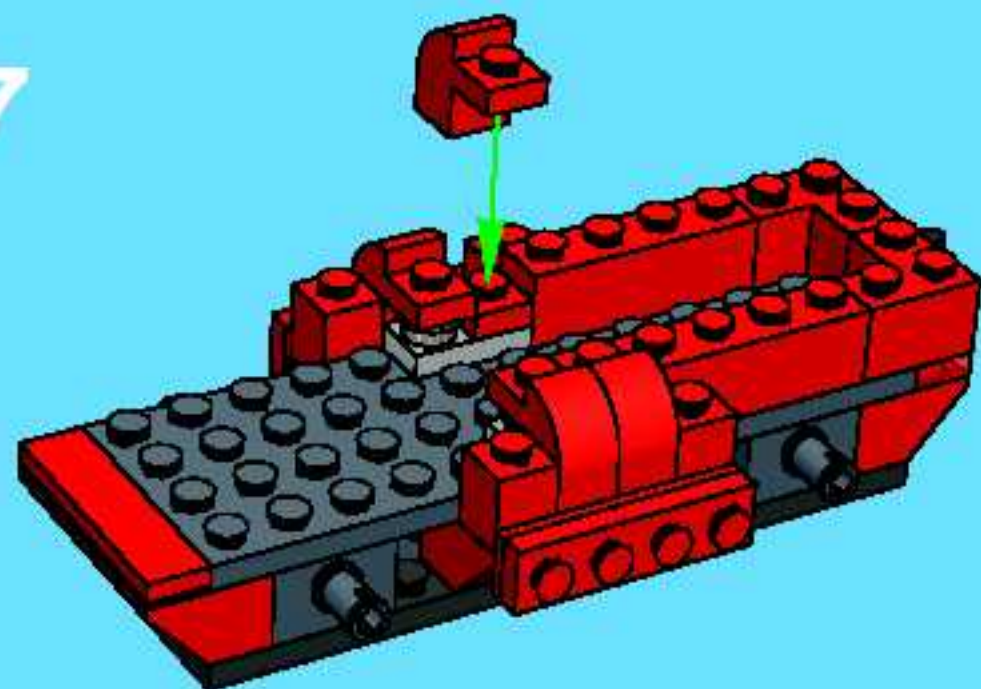

6

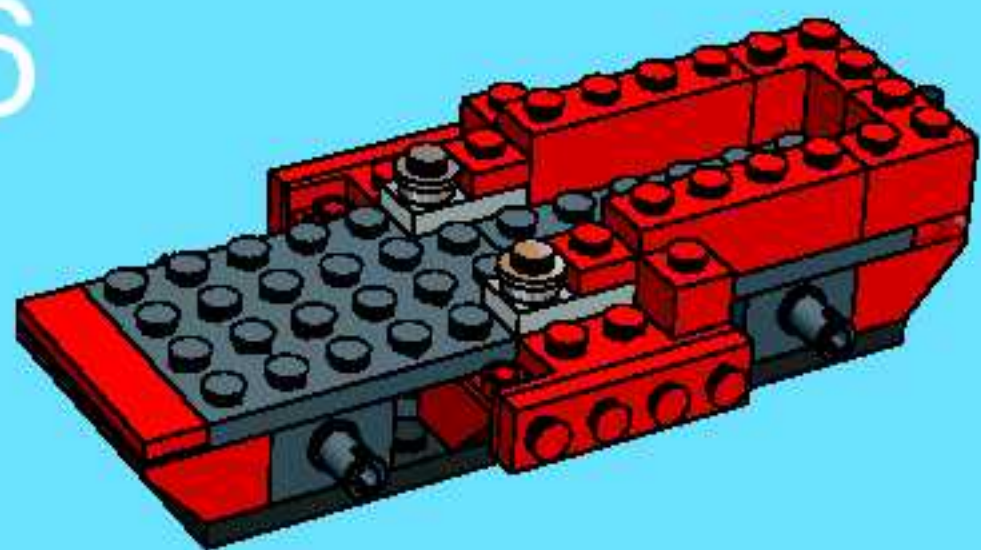

8

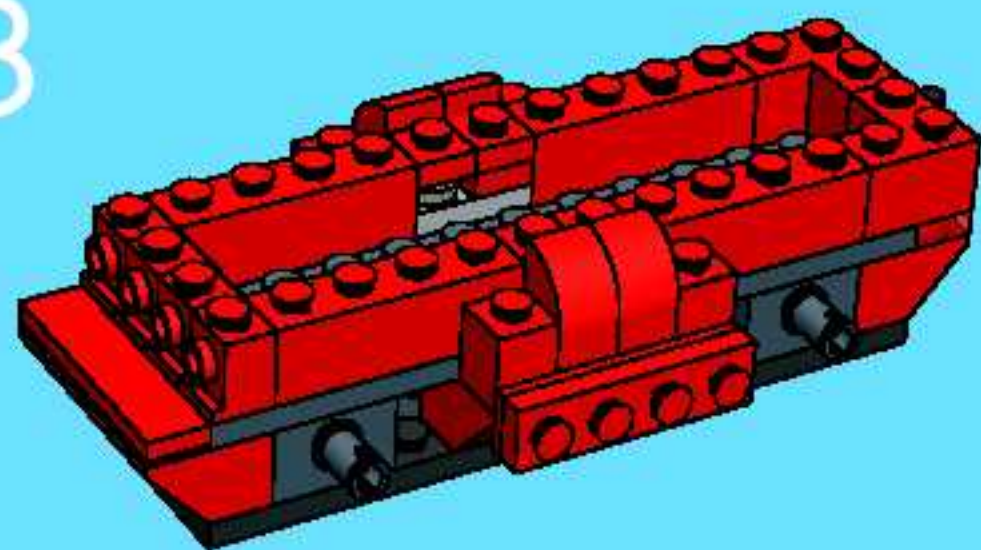

9

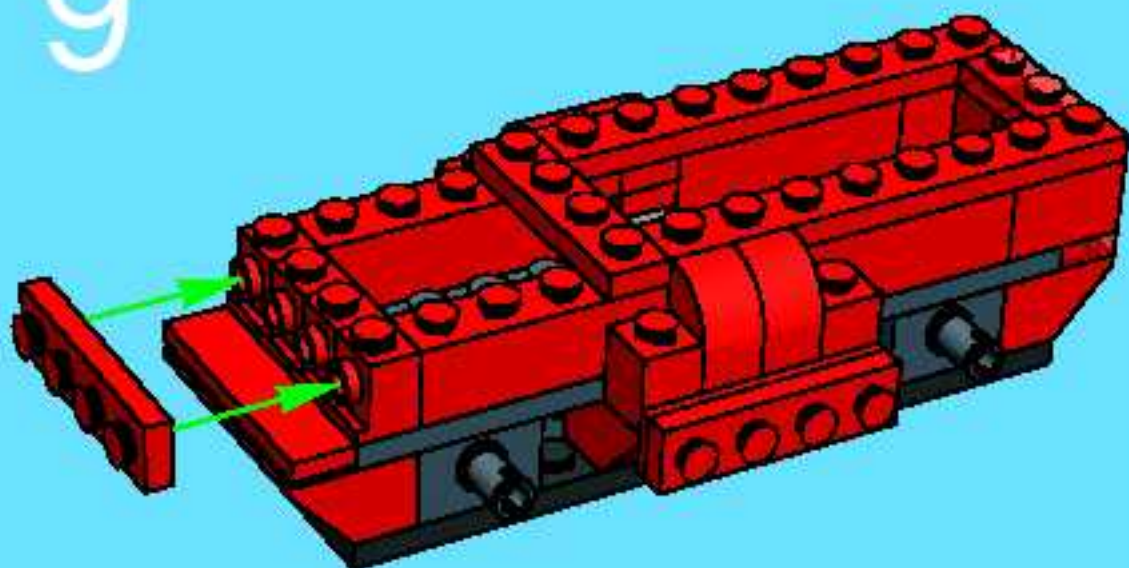

10

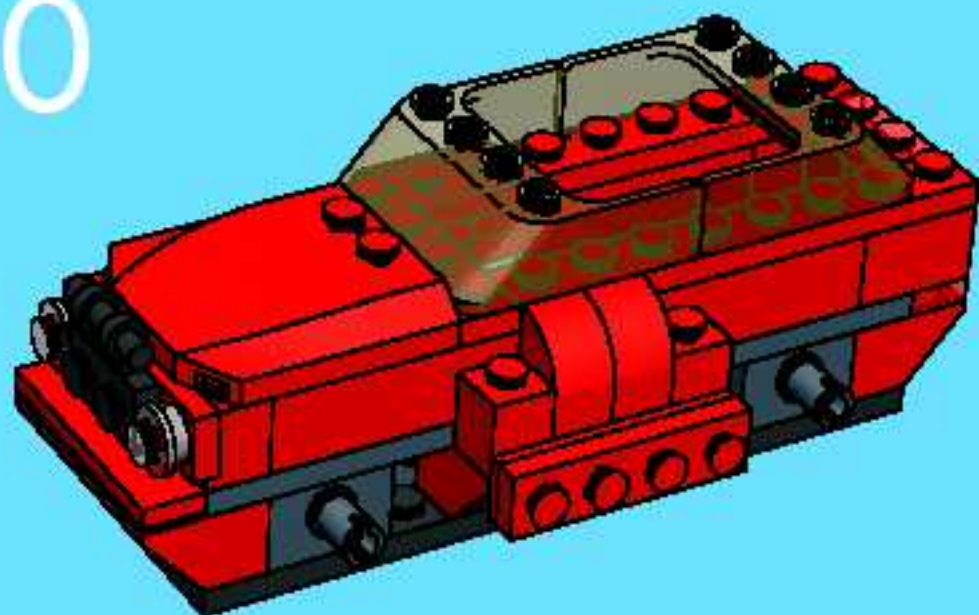

11

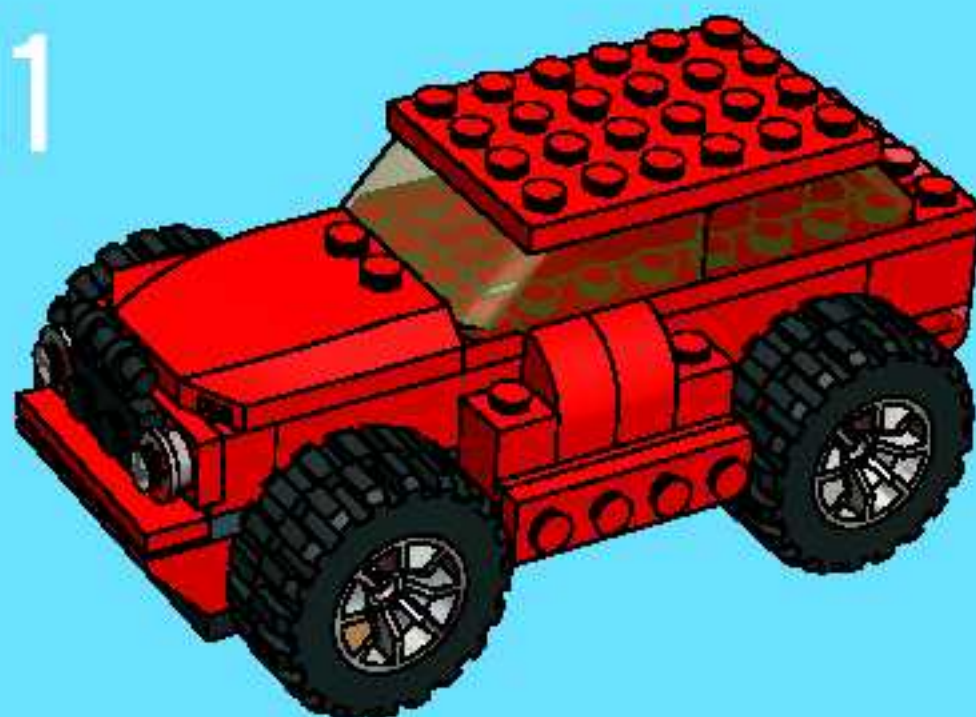



1



2

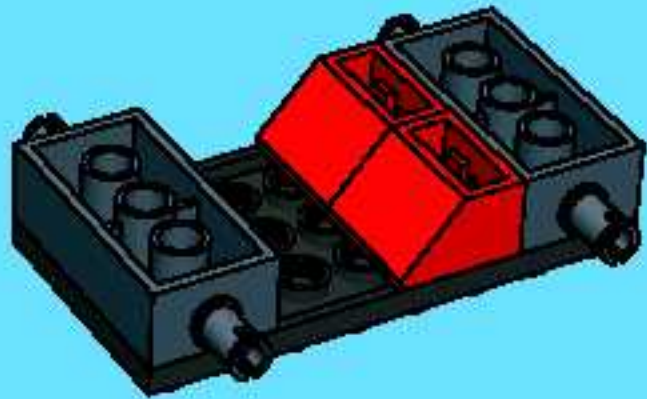

3

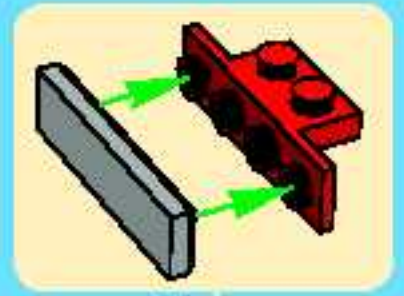

4

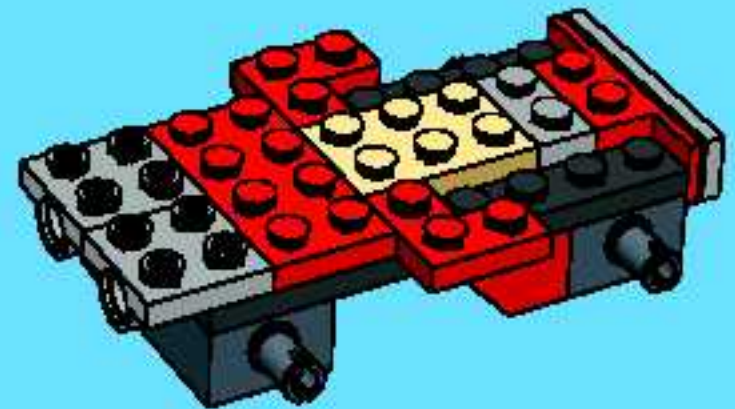



5

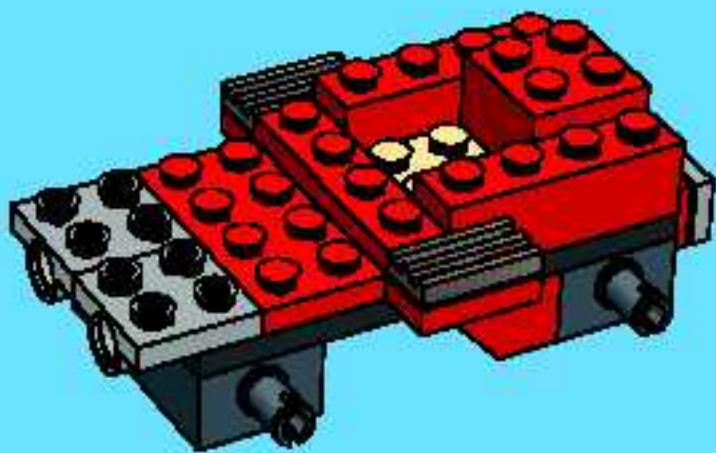

6

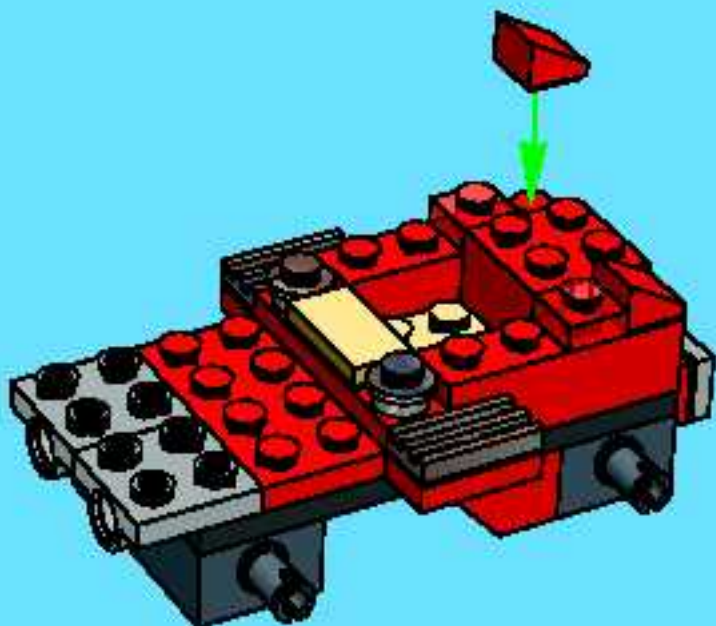

7



8

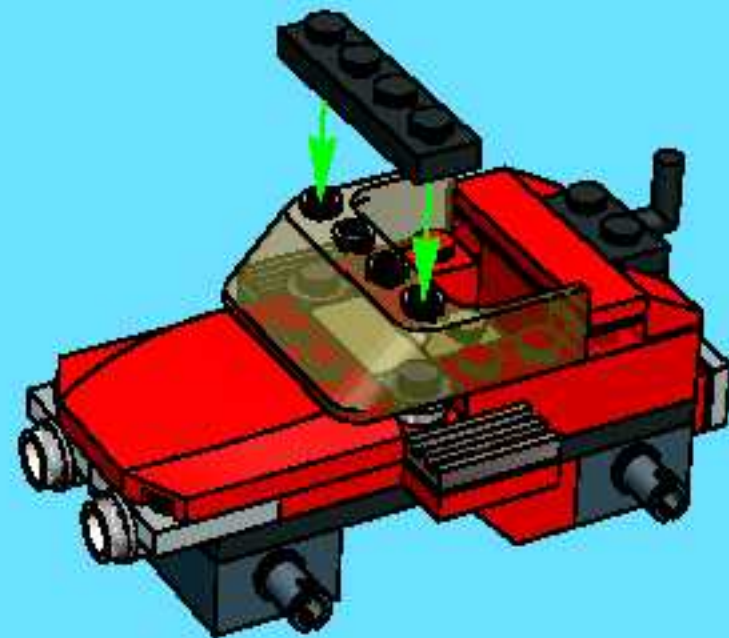

9





1

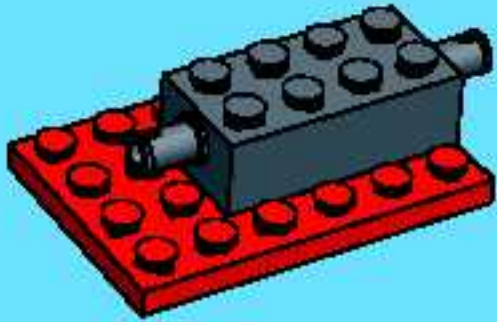

2



3

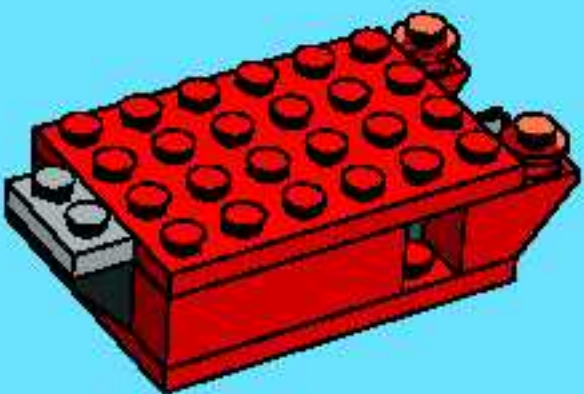

4

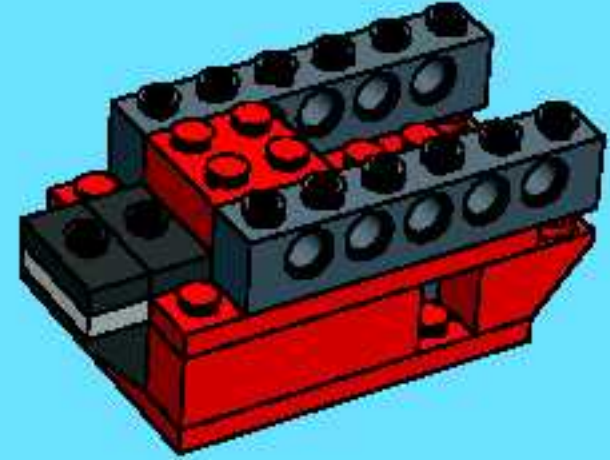

5

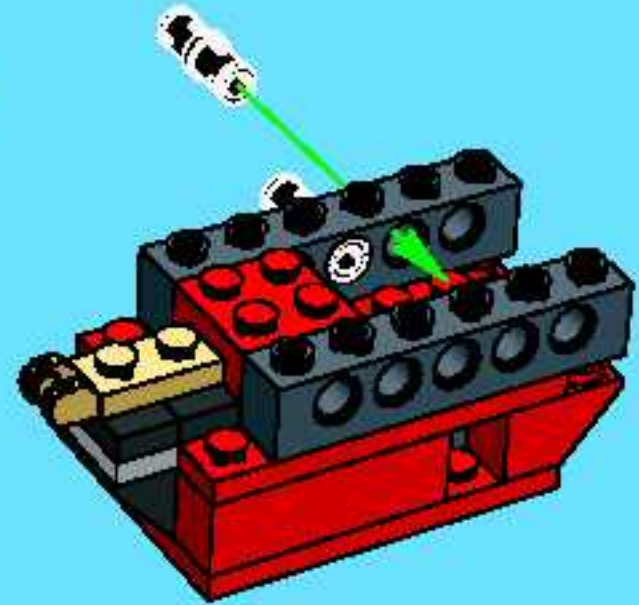

6

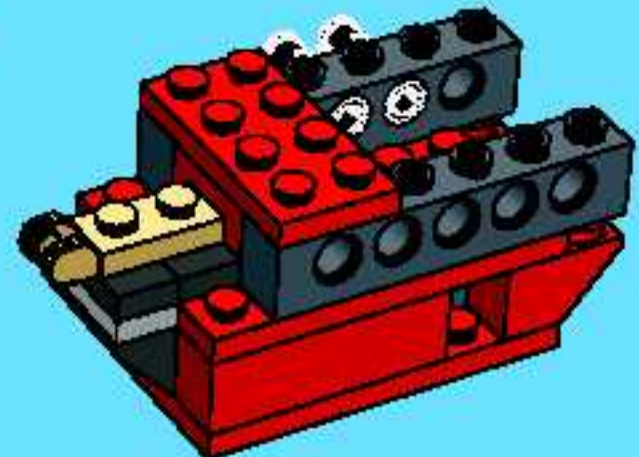

7



8

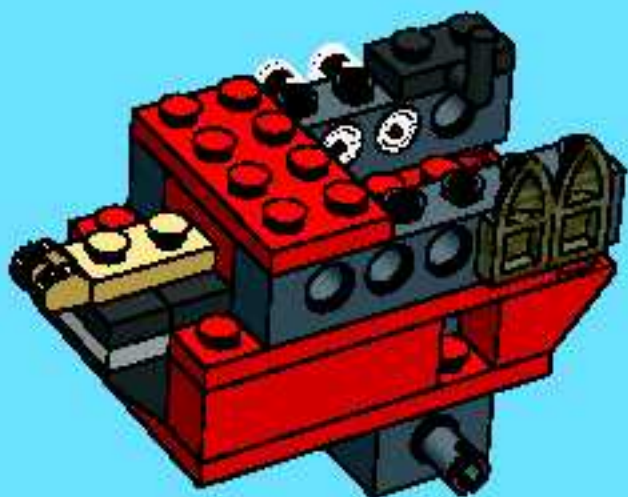

9

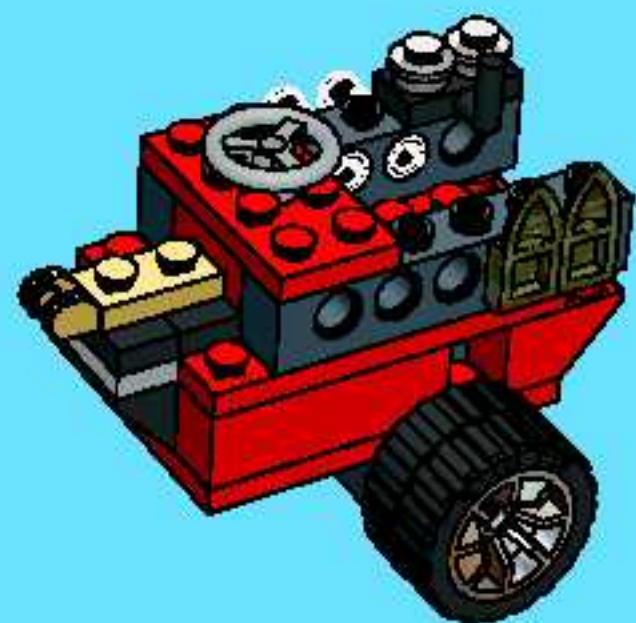

10









1

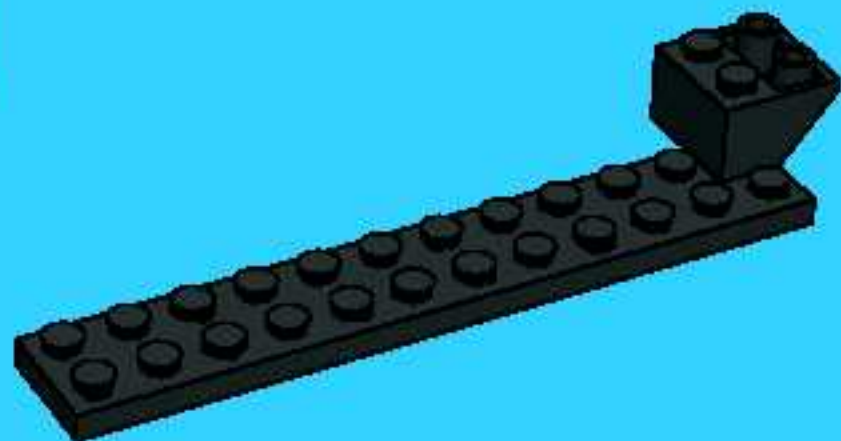

2

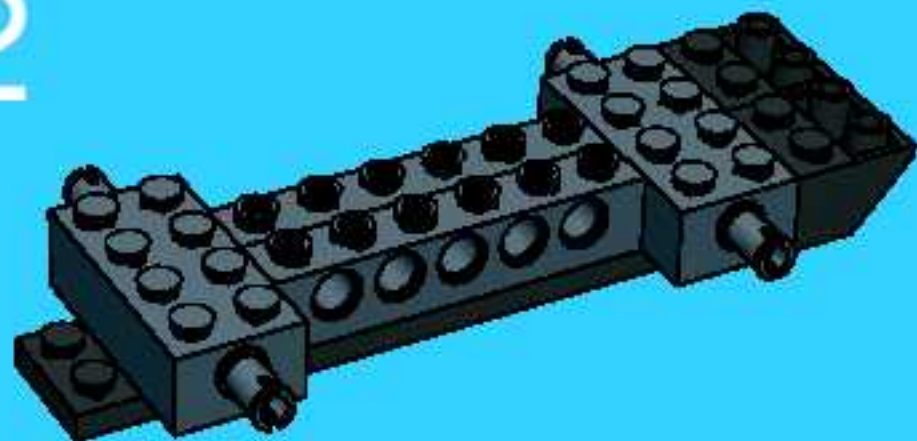

3

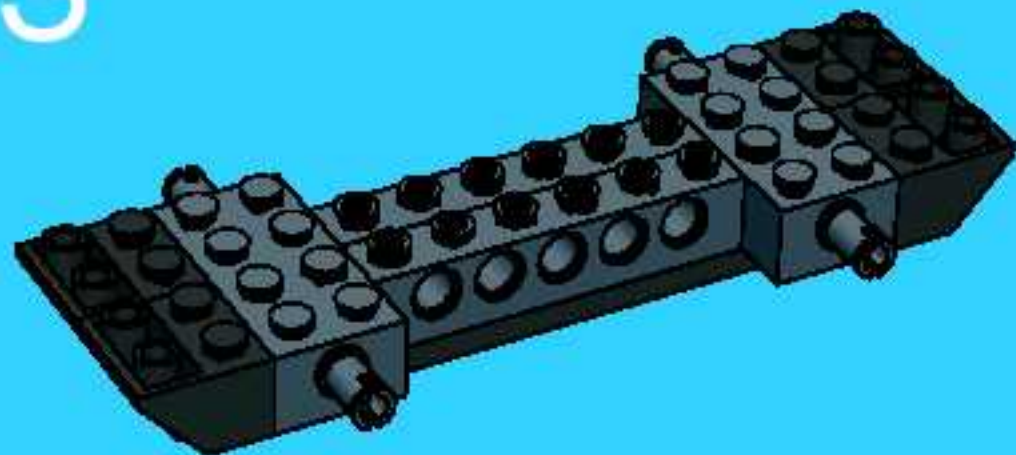

1



2



3

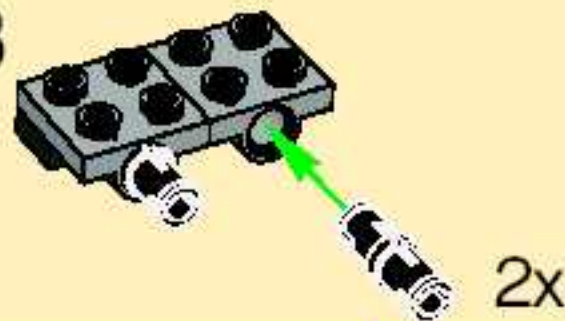

4

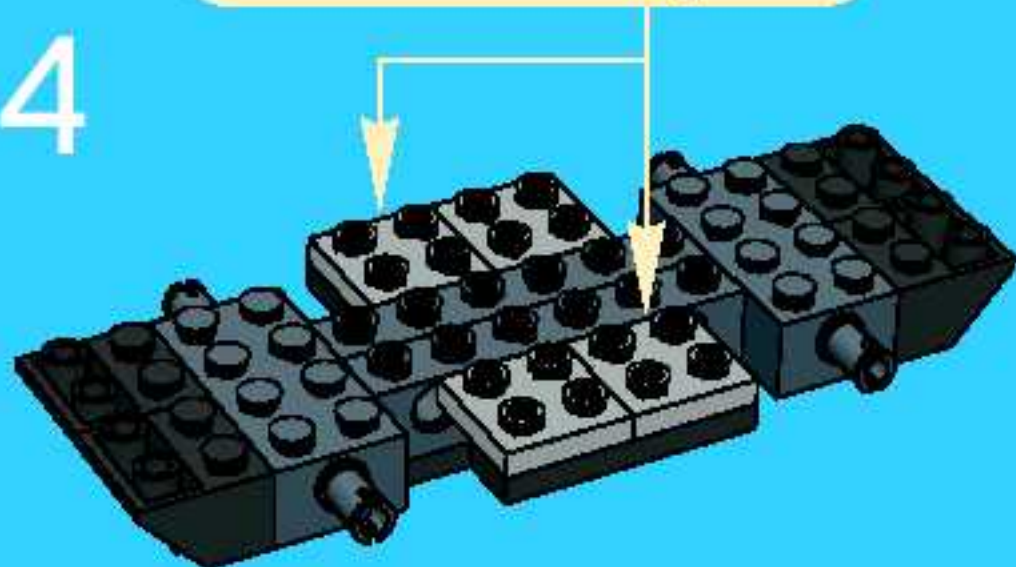

5

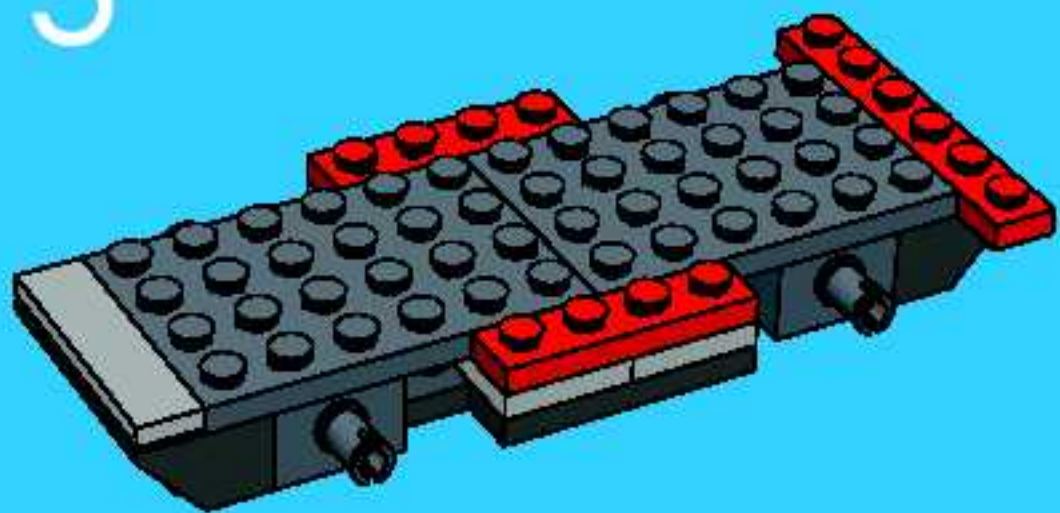

7

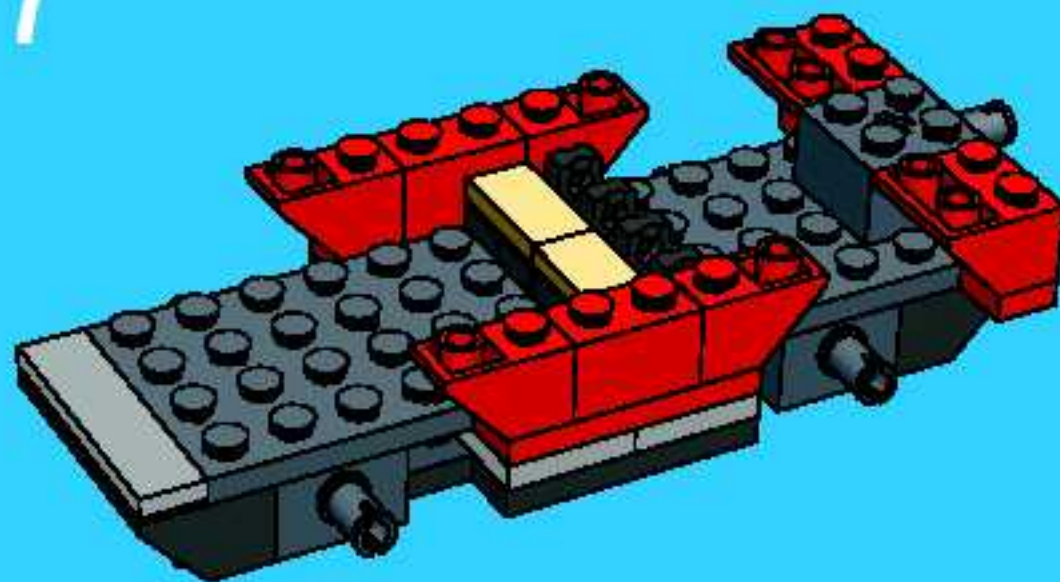

6

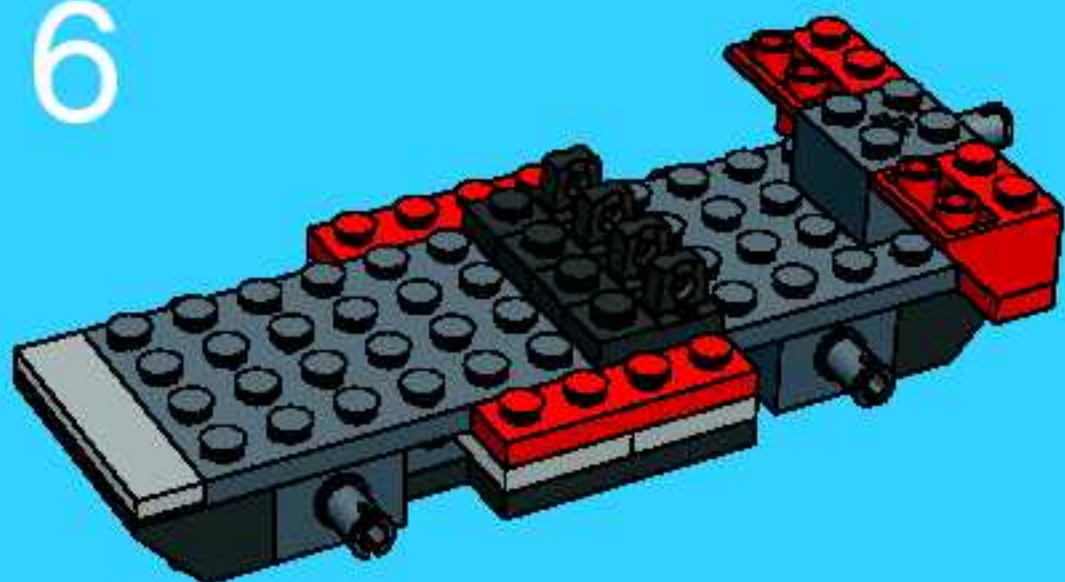

8

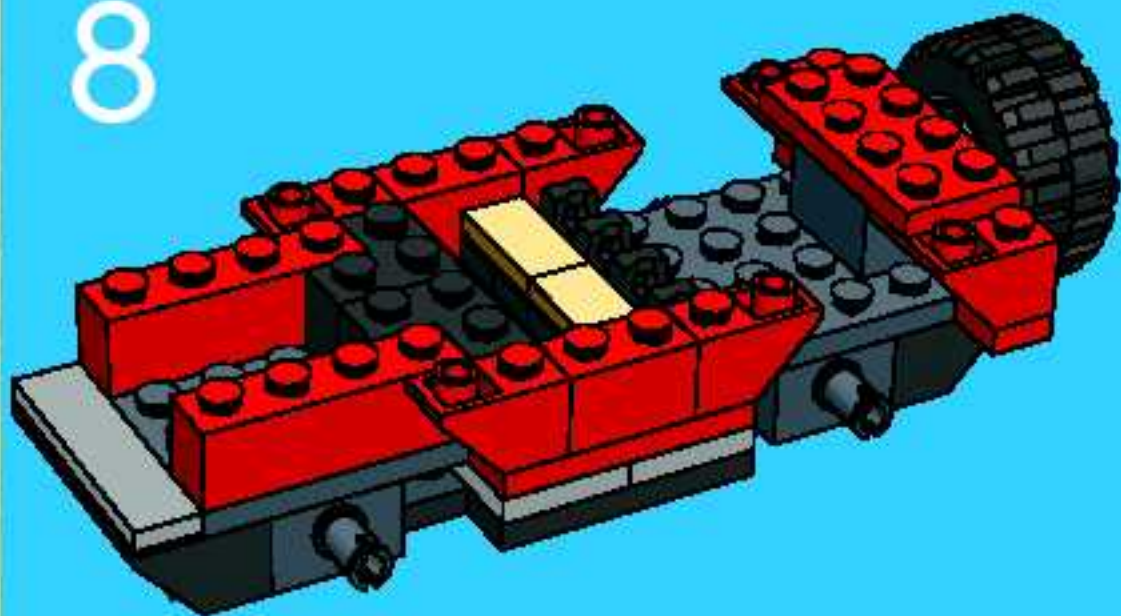

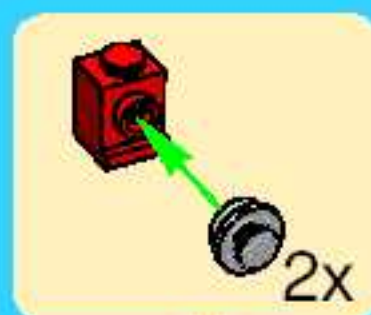
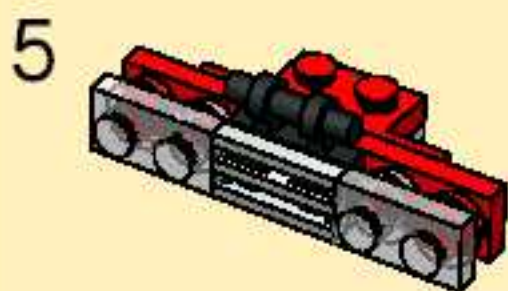
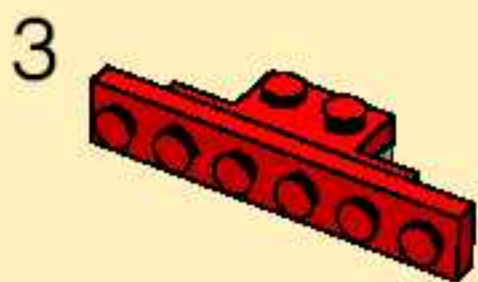
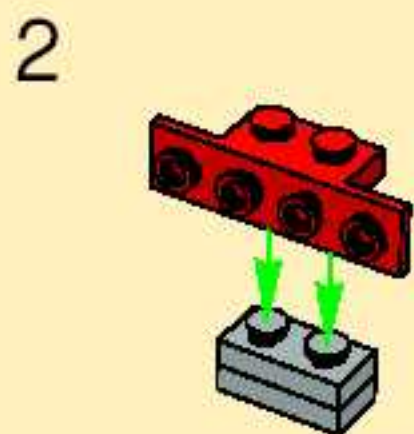
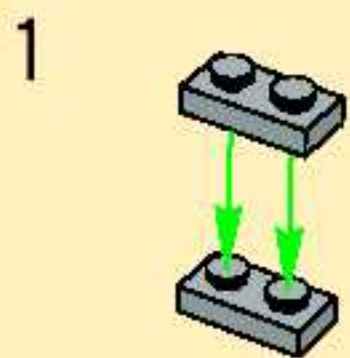

9

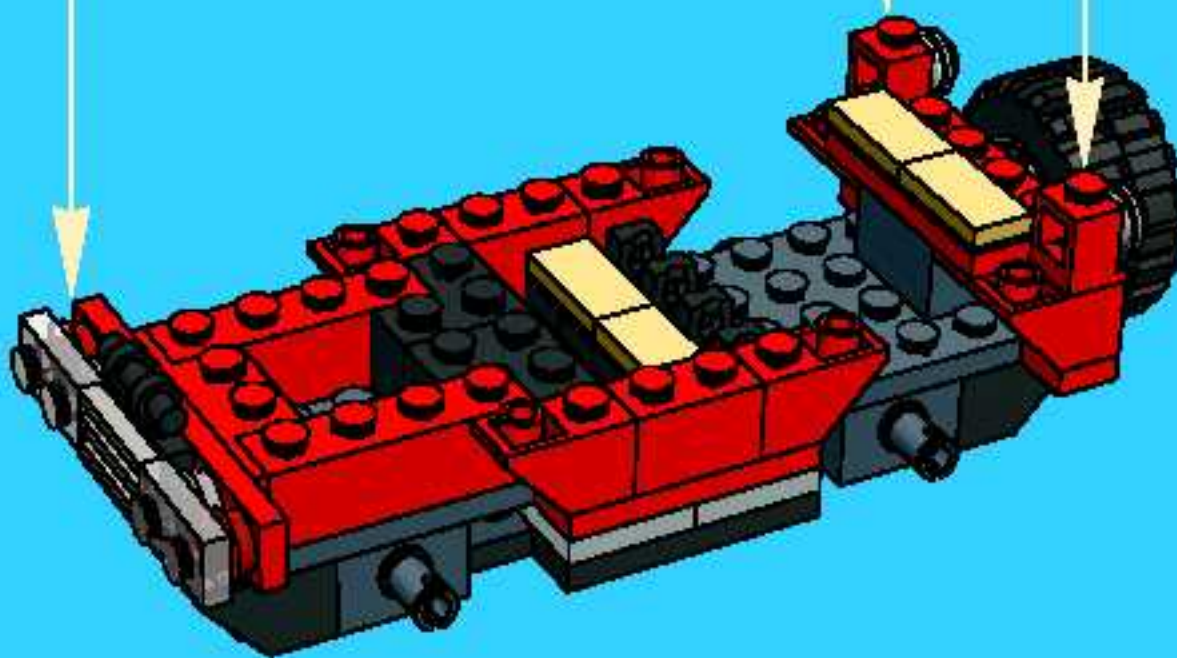



10

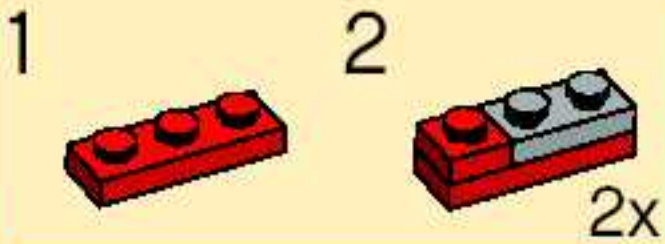
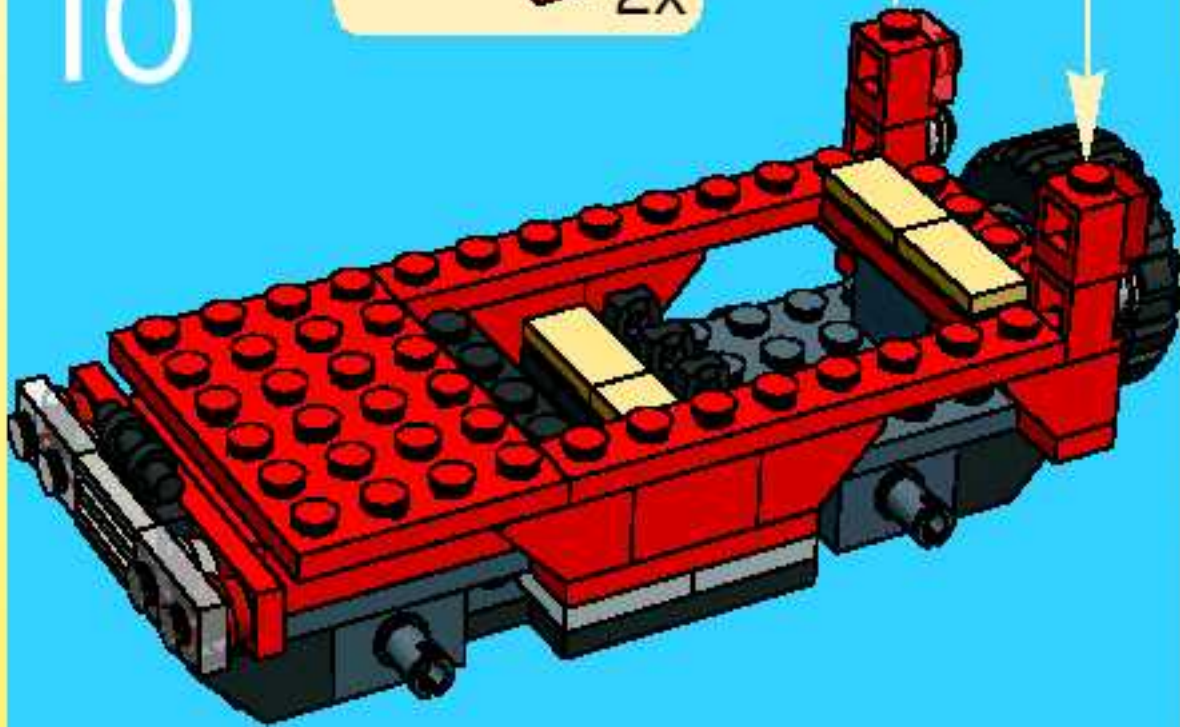
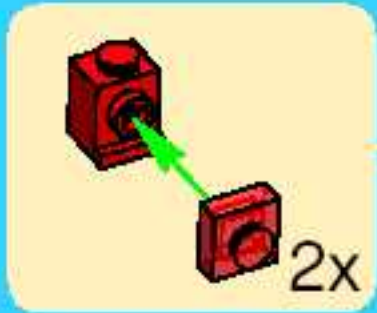

11

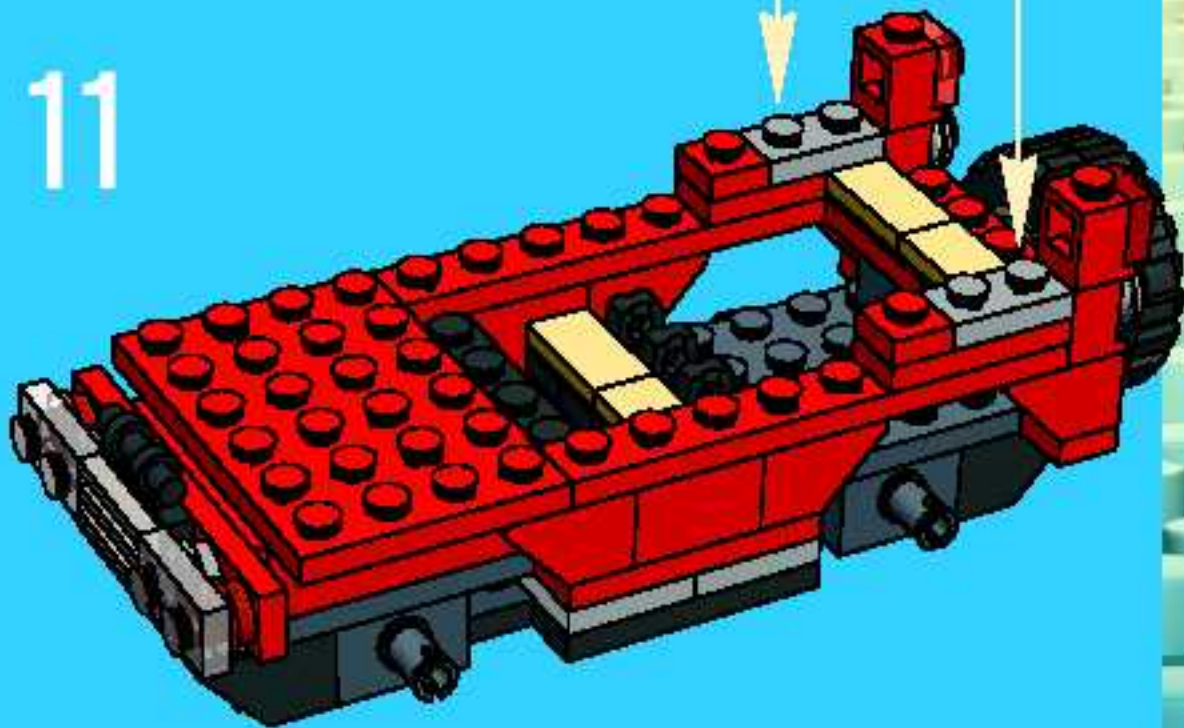

1

2

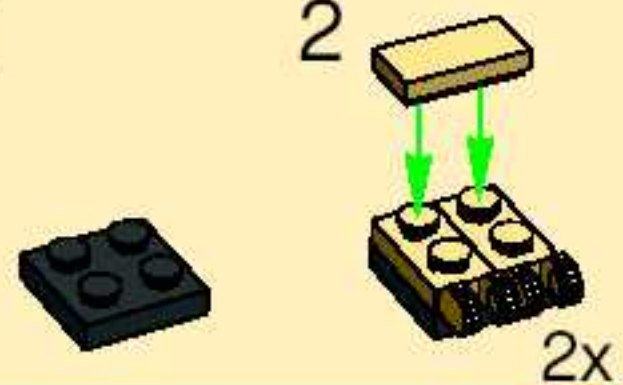

12

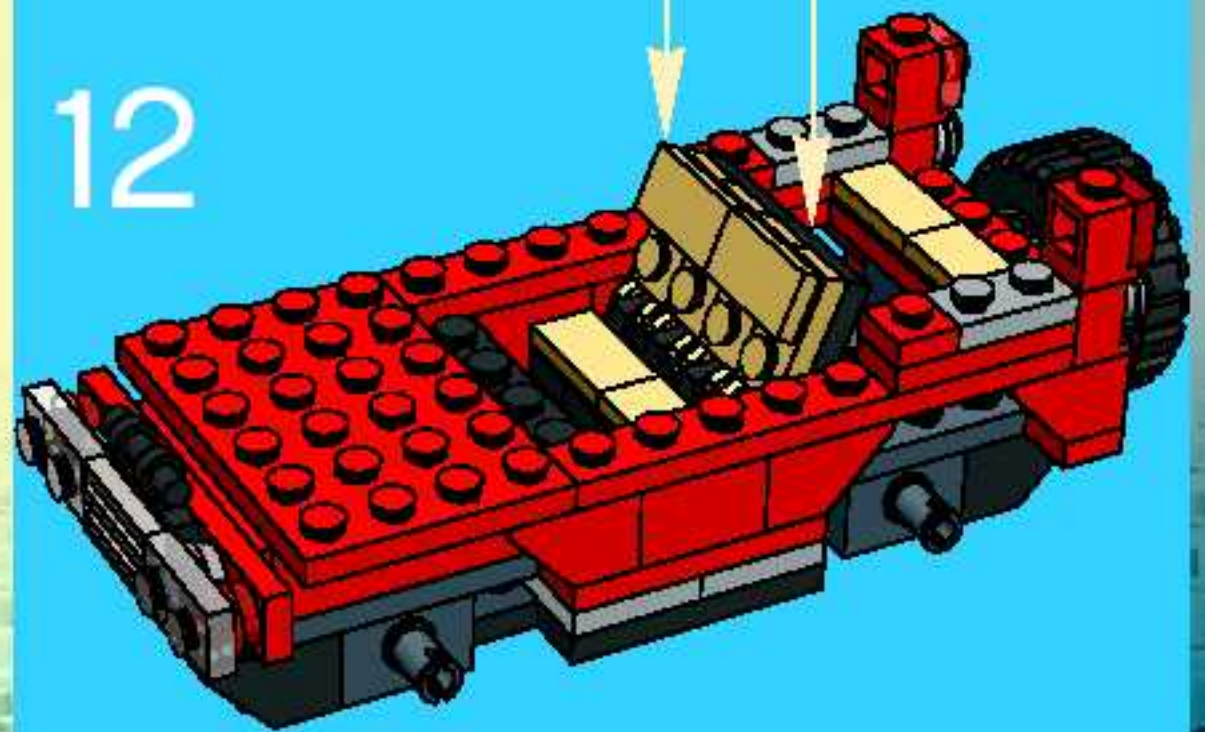

1



2

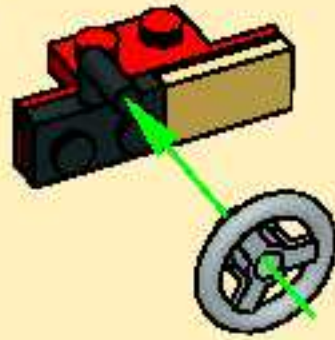

13

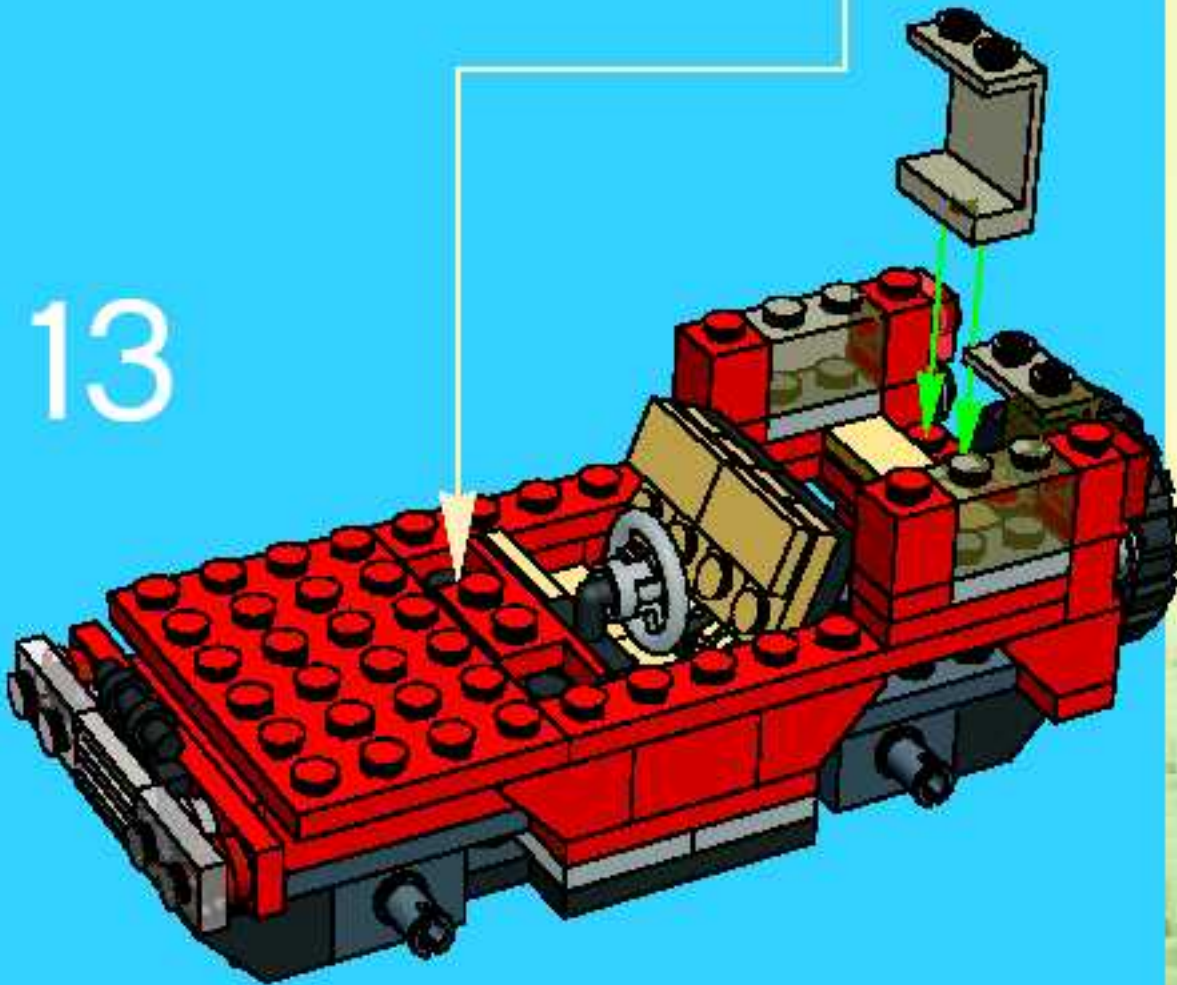

14

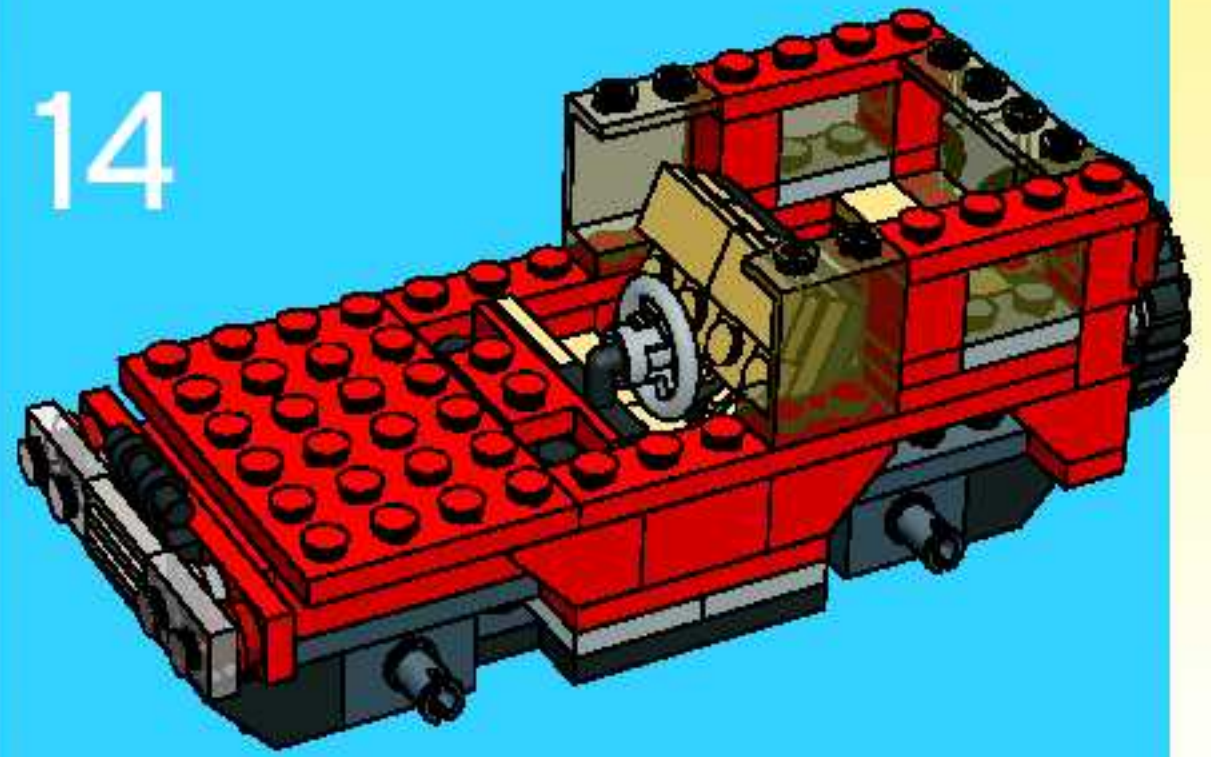

2x

15

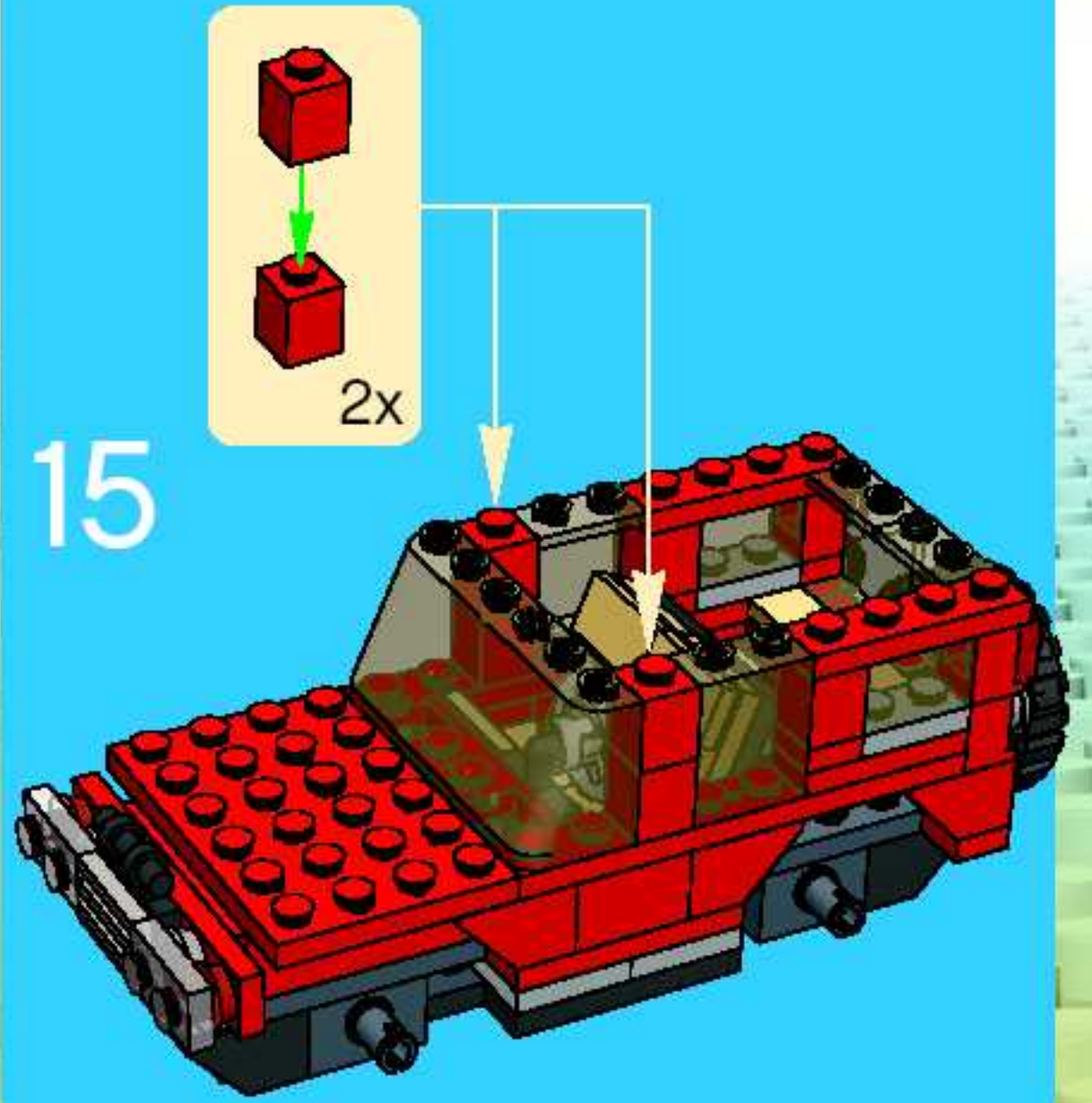

16

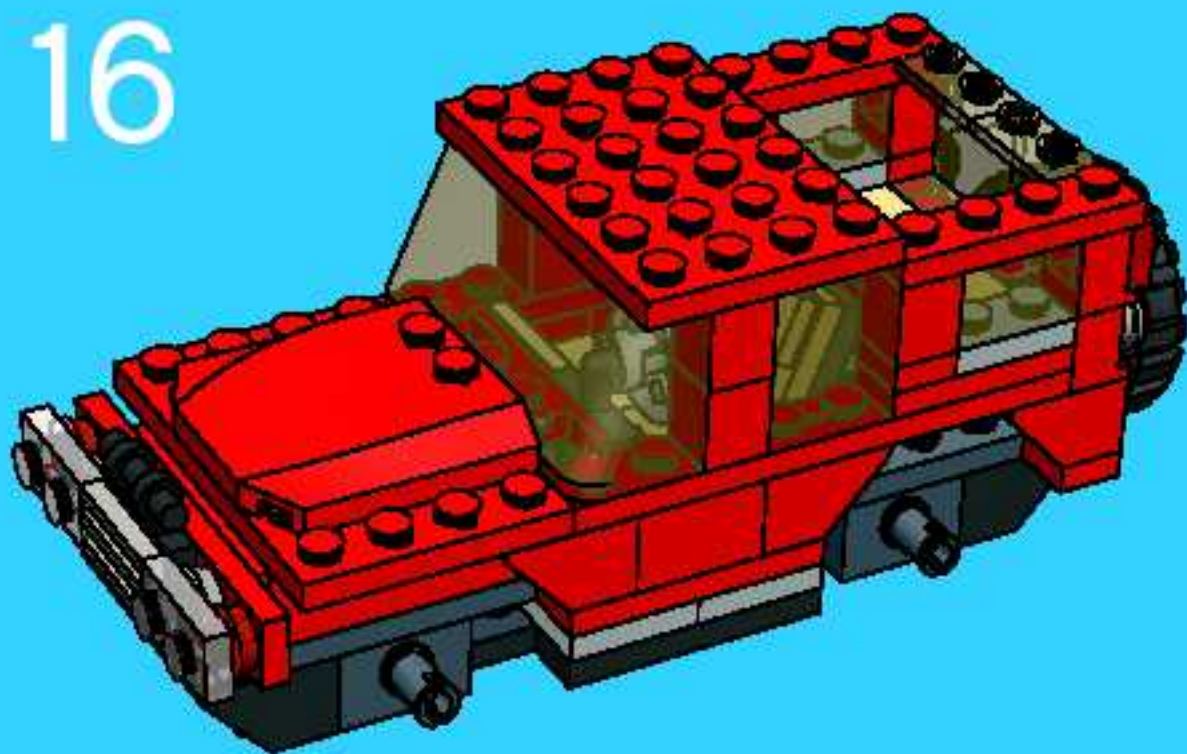

17



18



19

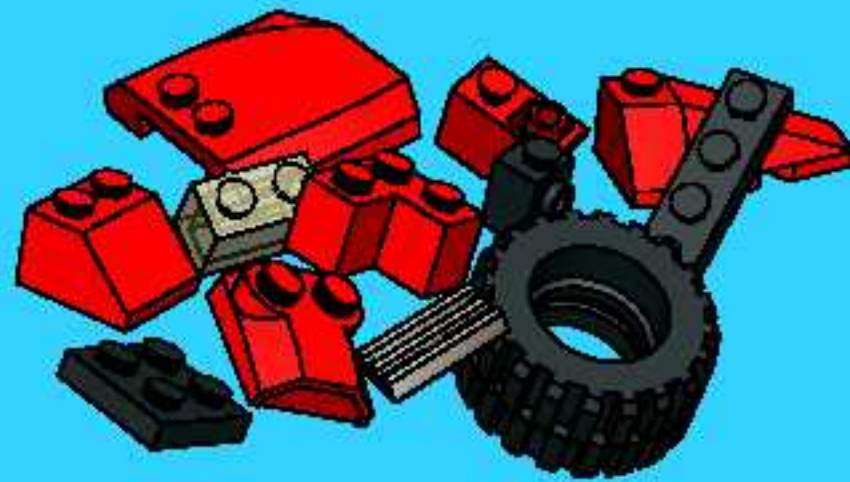

=



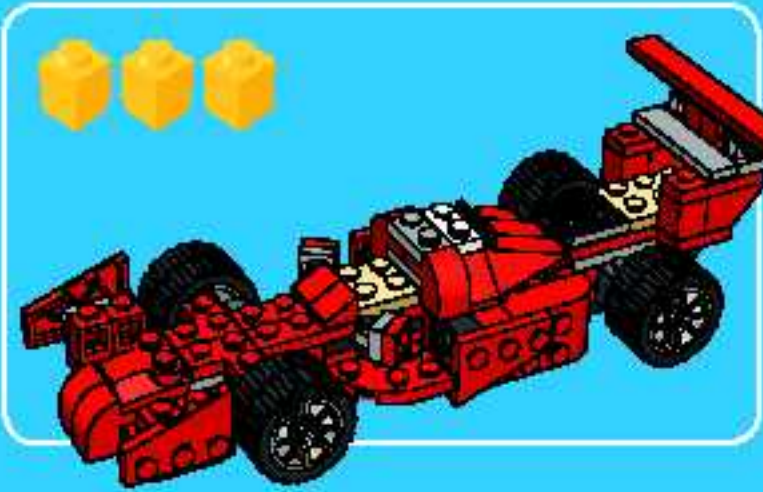

1

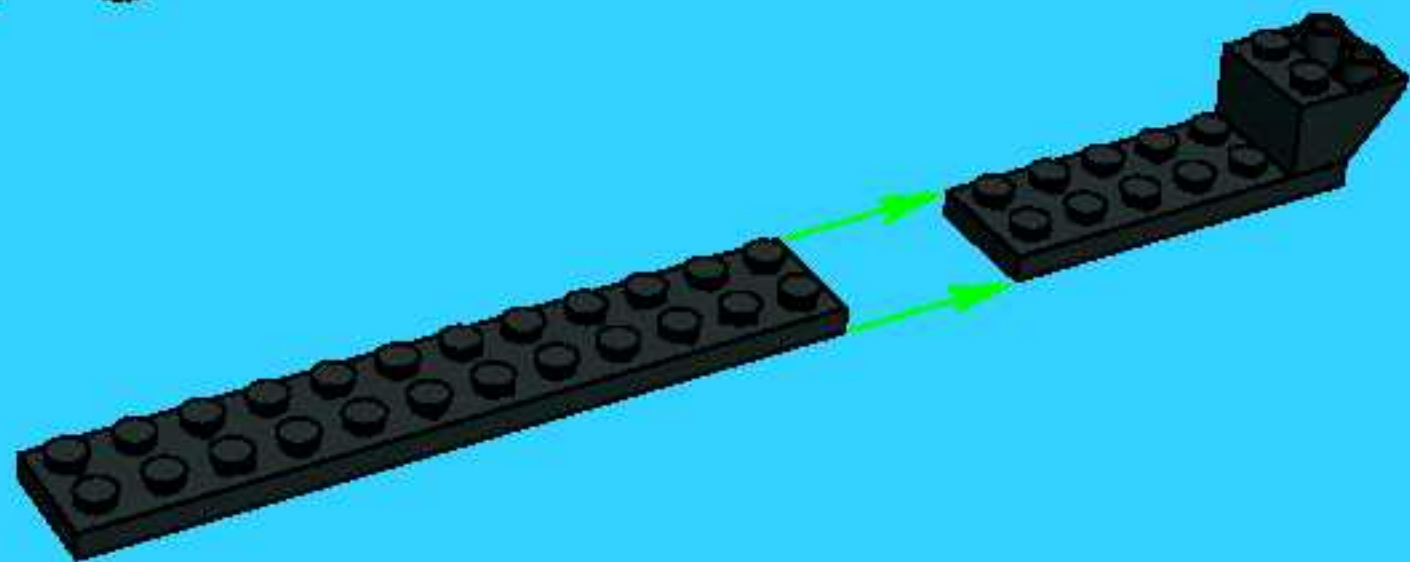

2

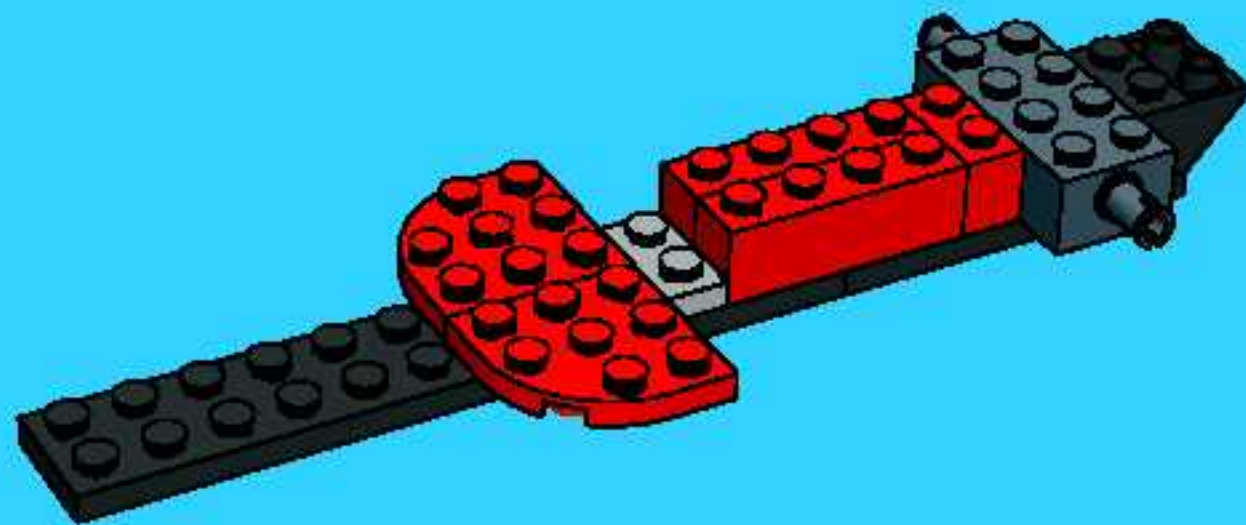

3

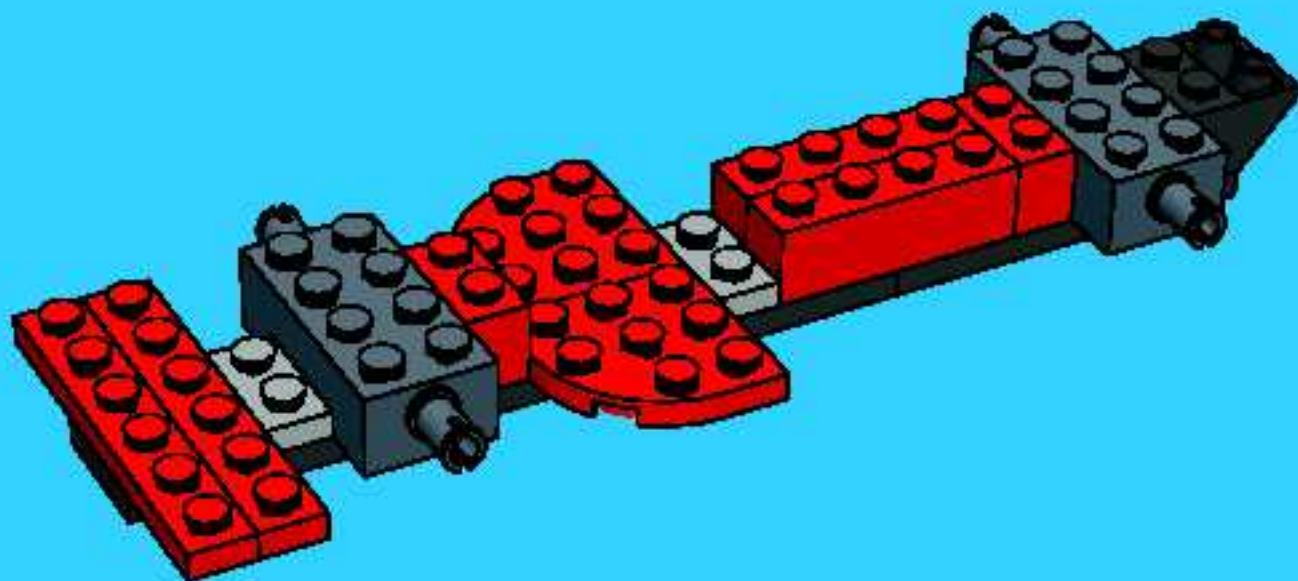

4

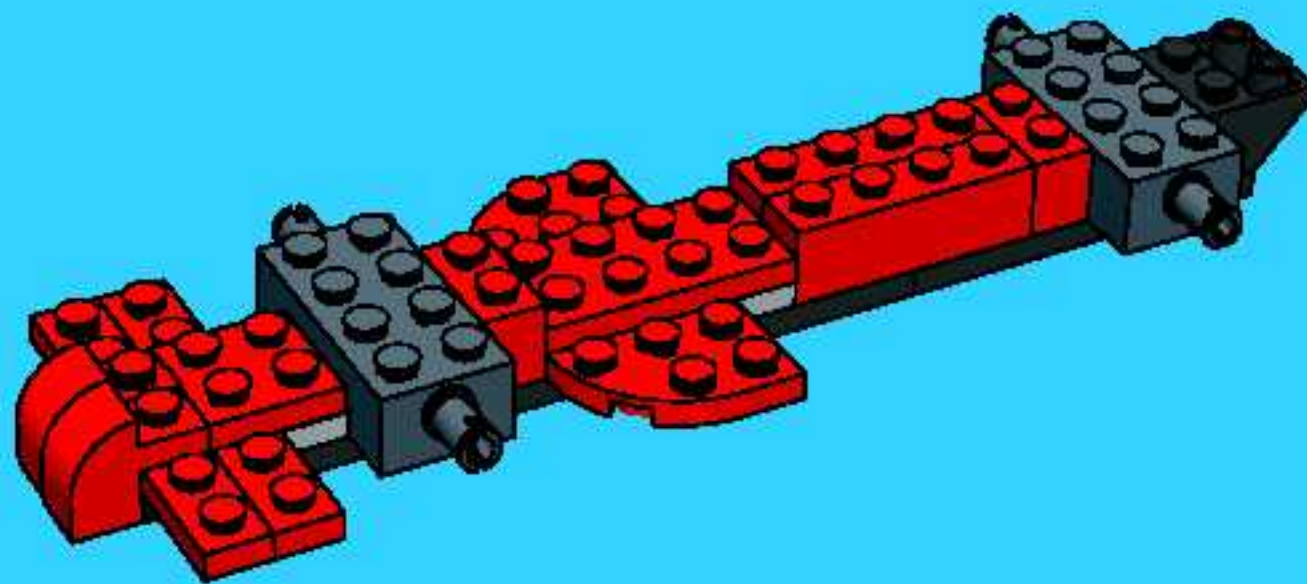

5

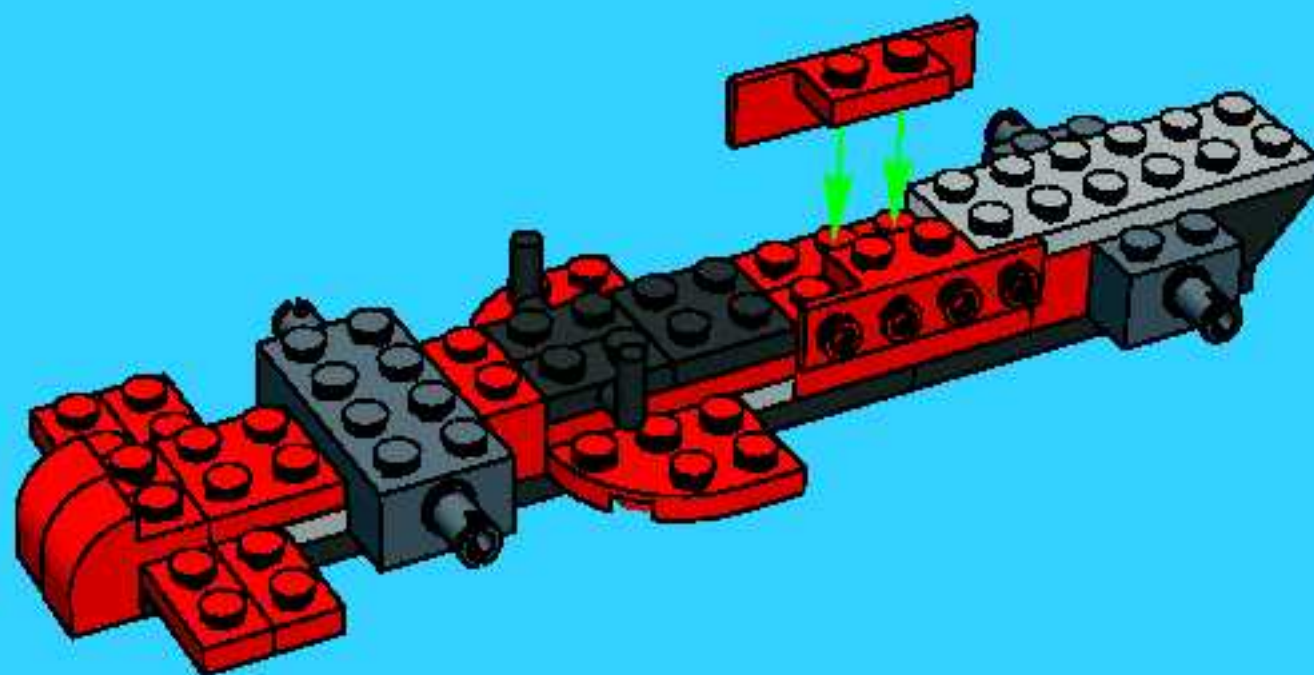

6

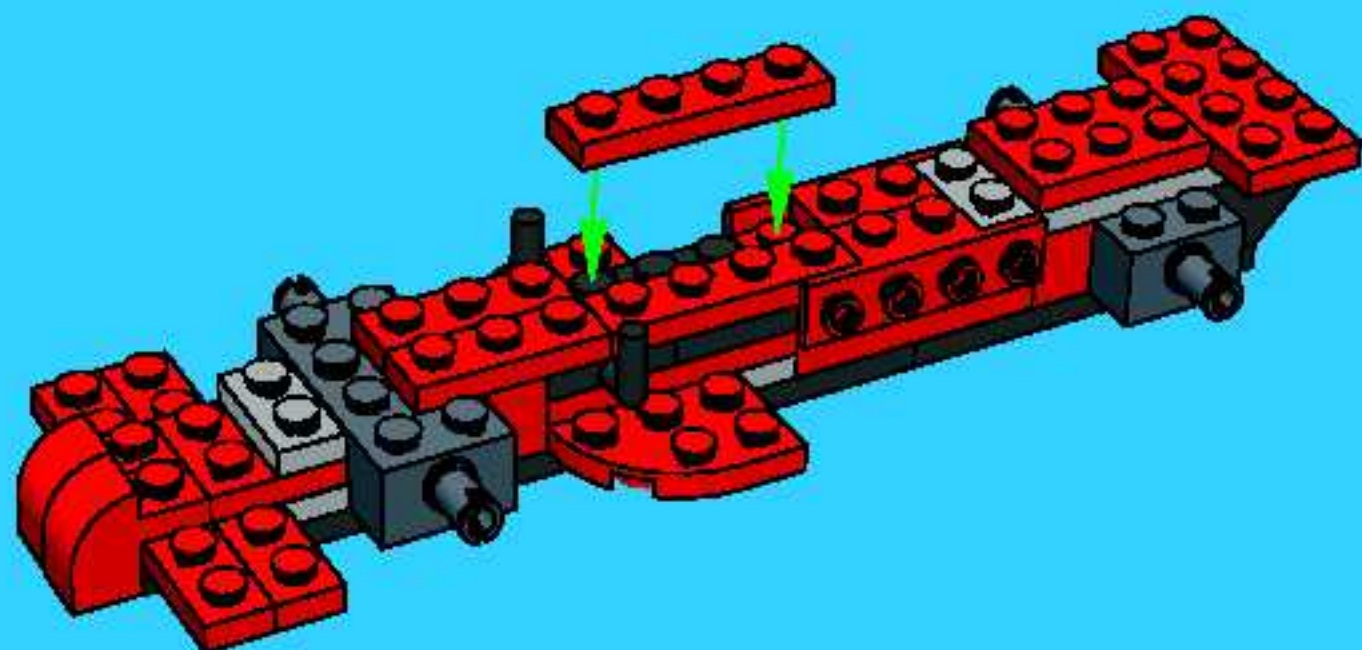

7

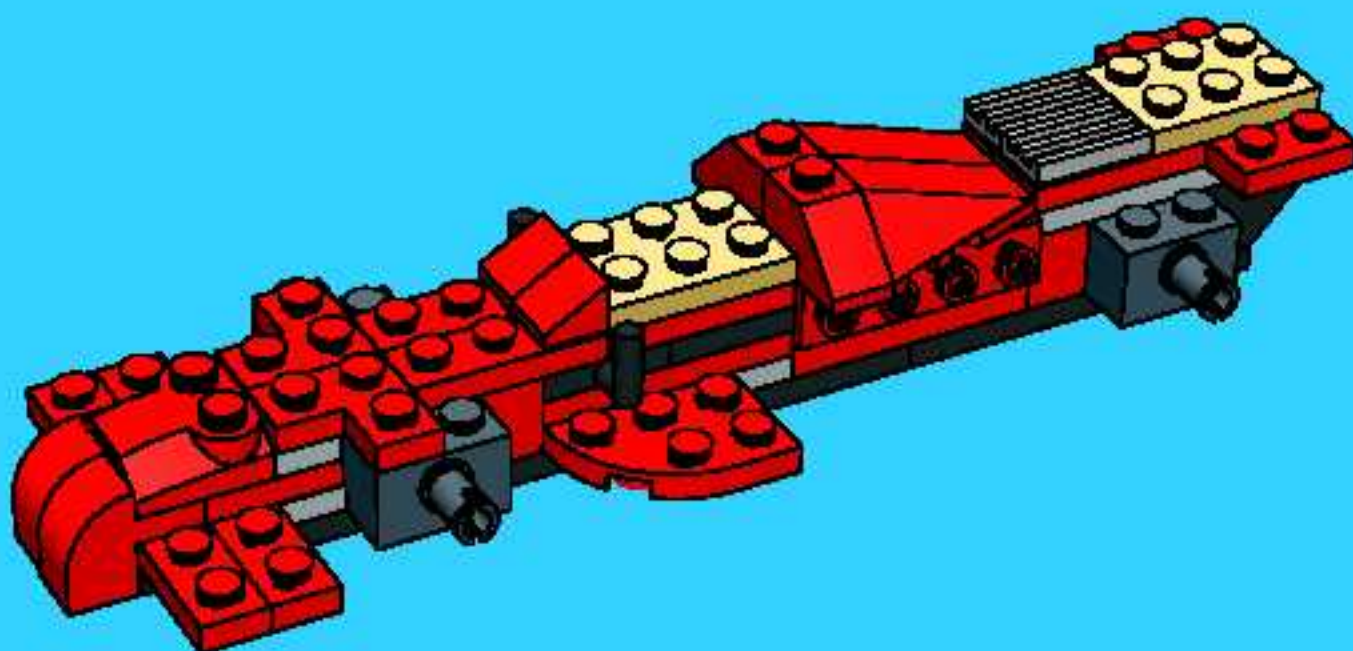

8

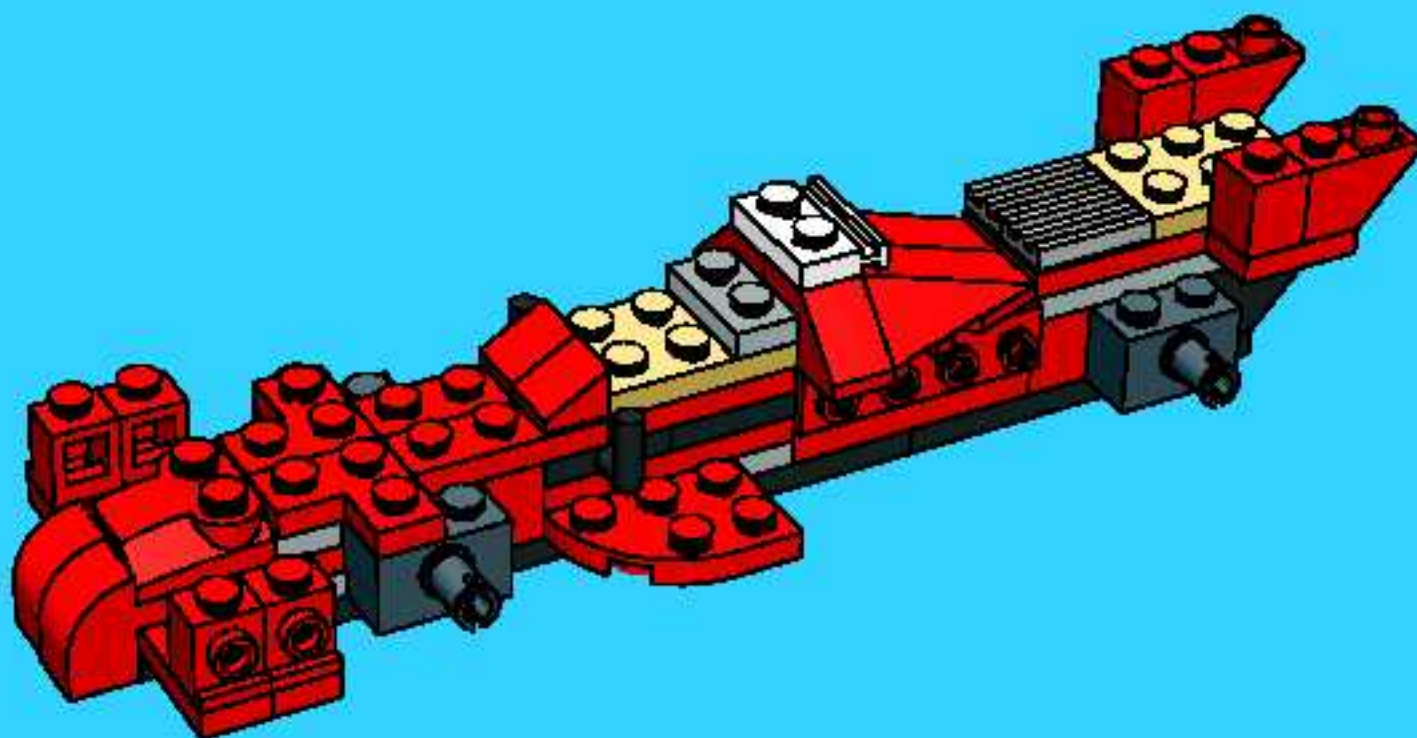



9

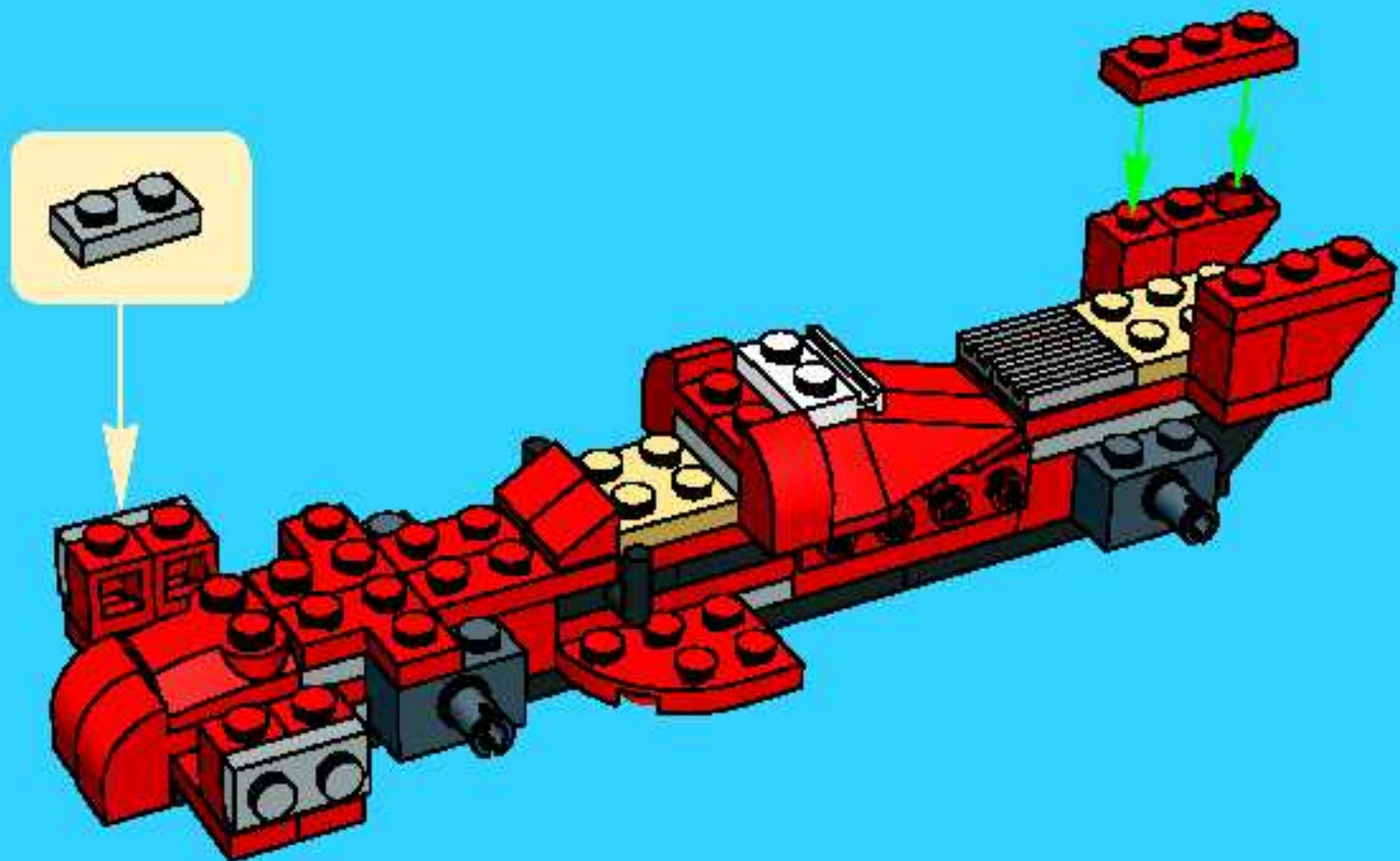

10

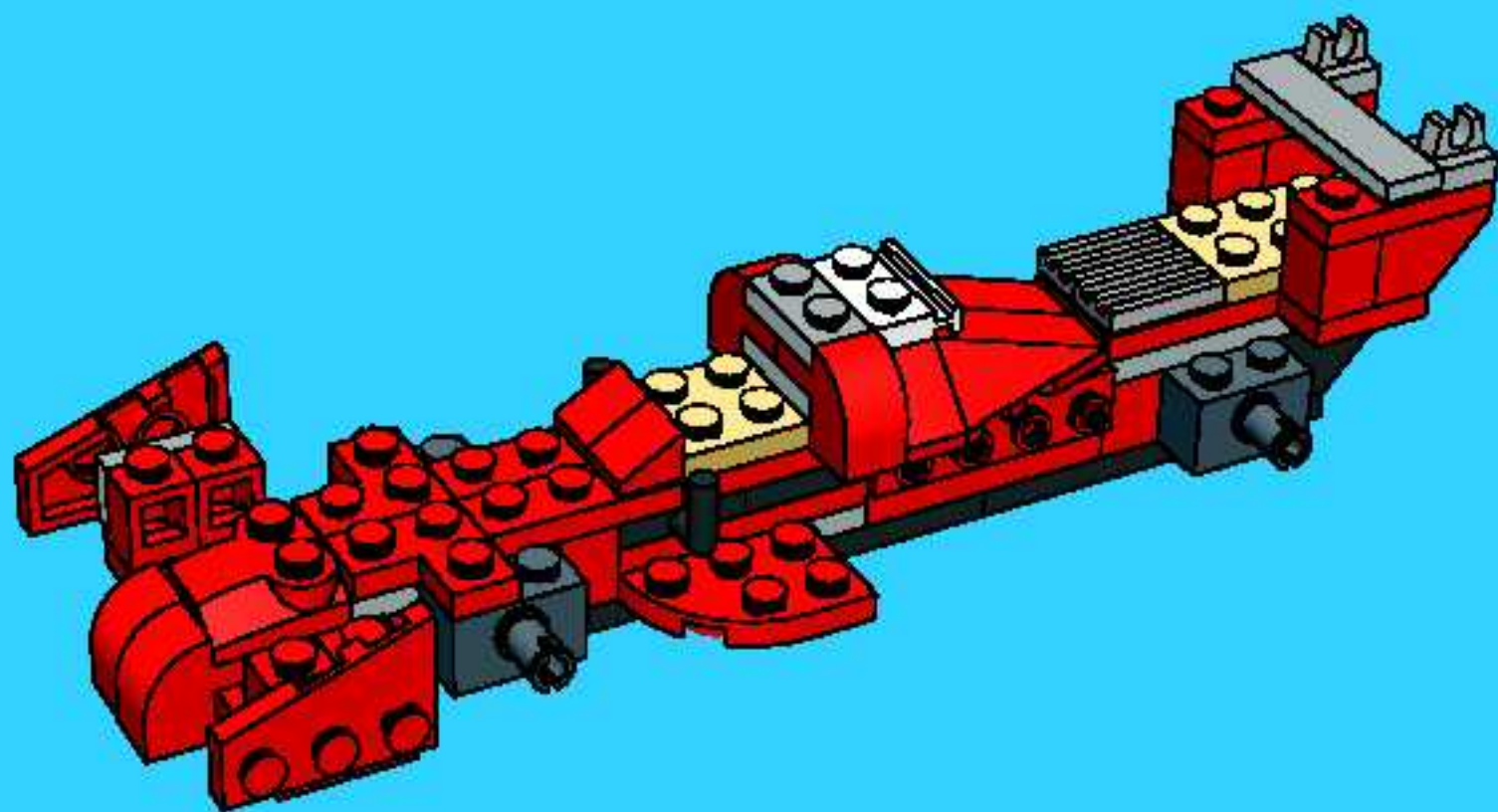

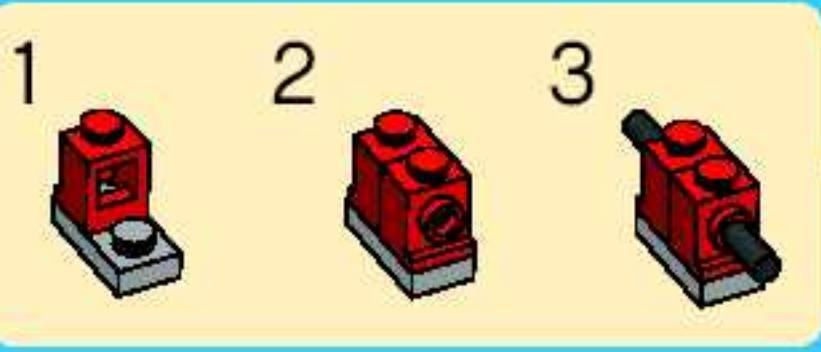

11

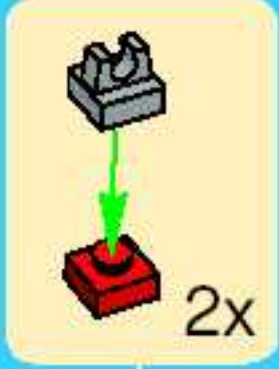
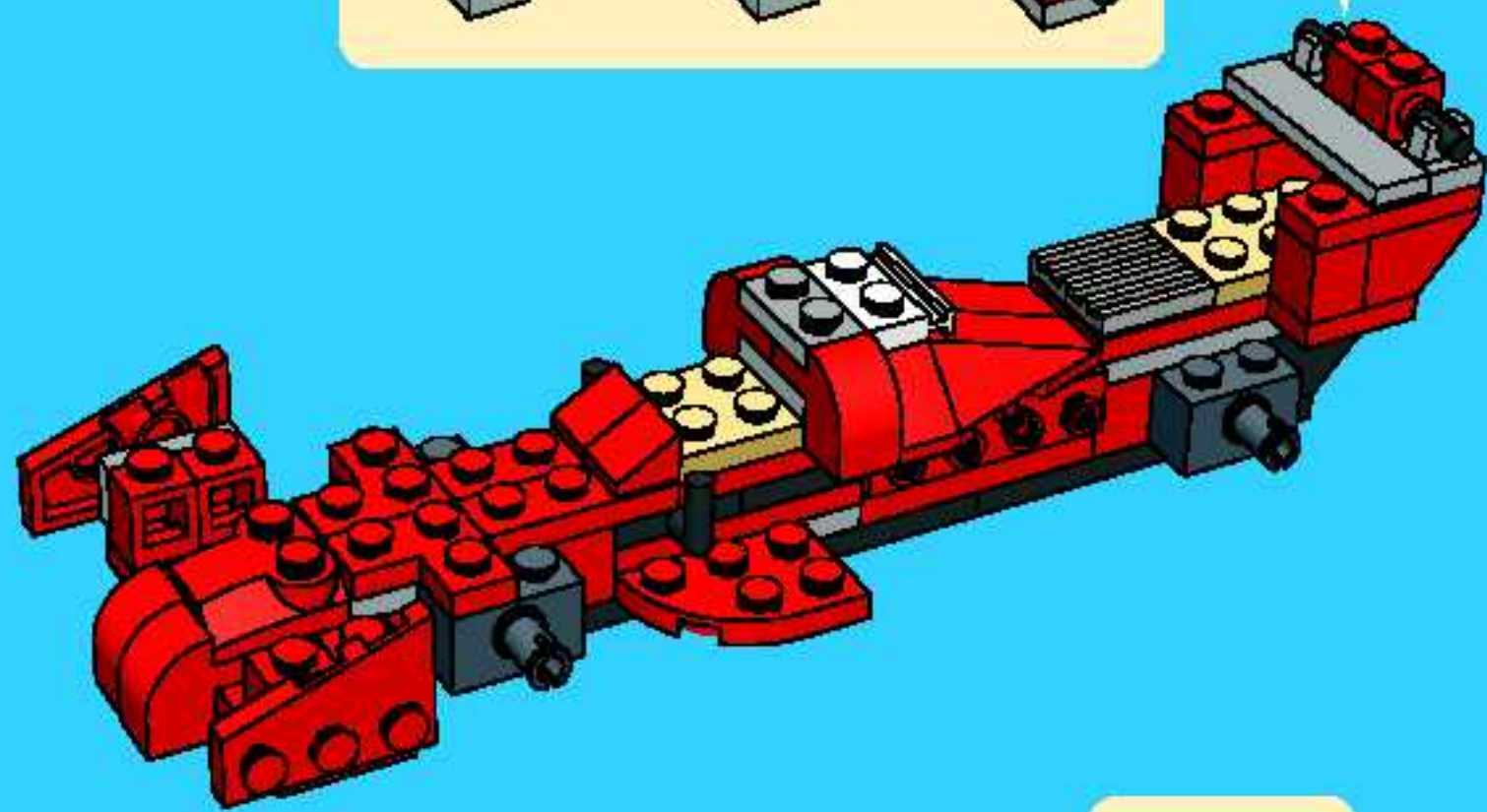

12

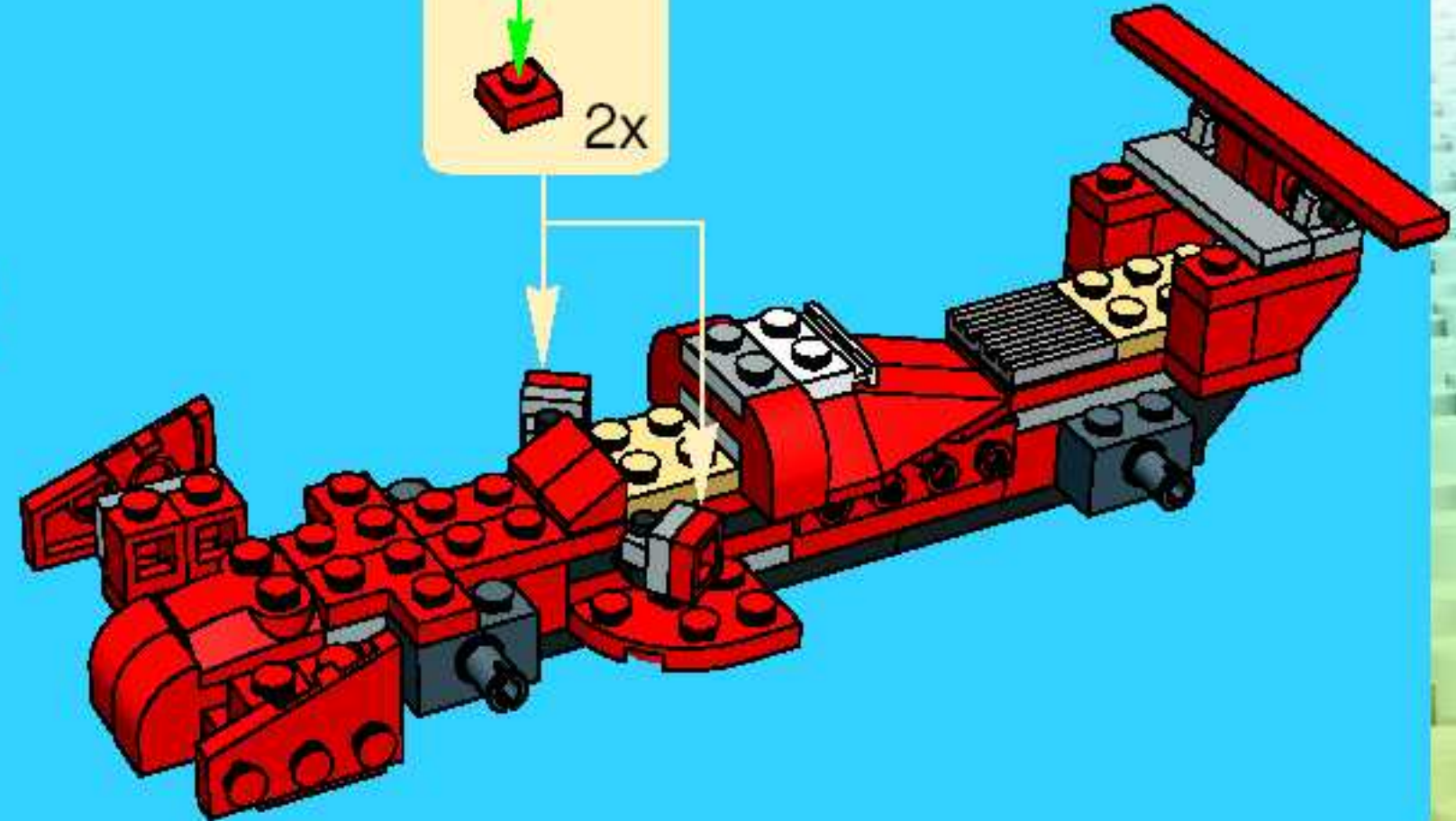

1

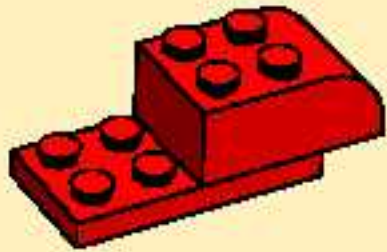

2



3

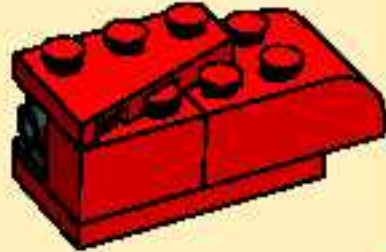

13

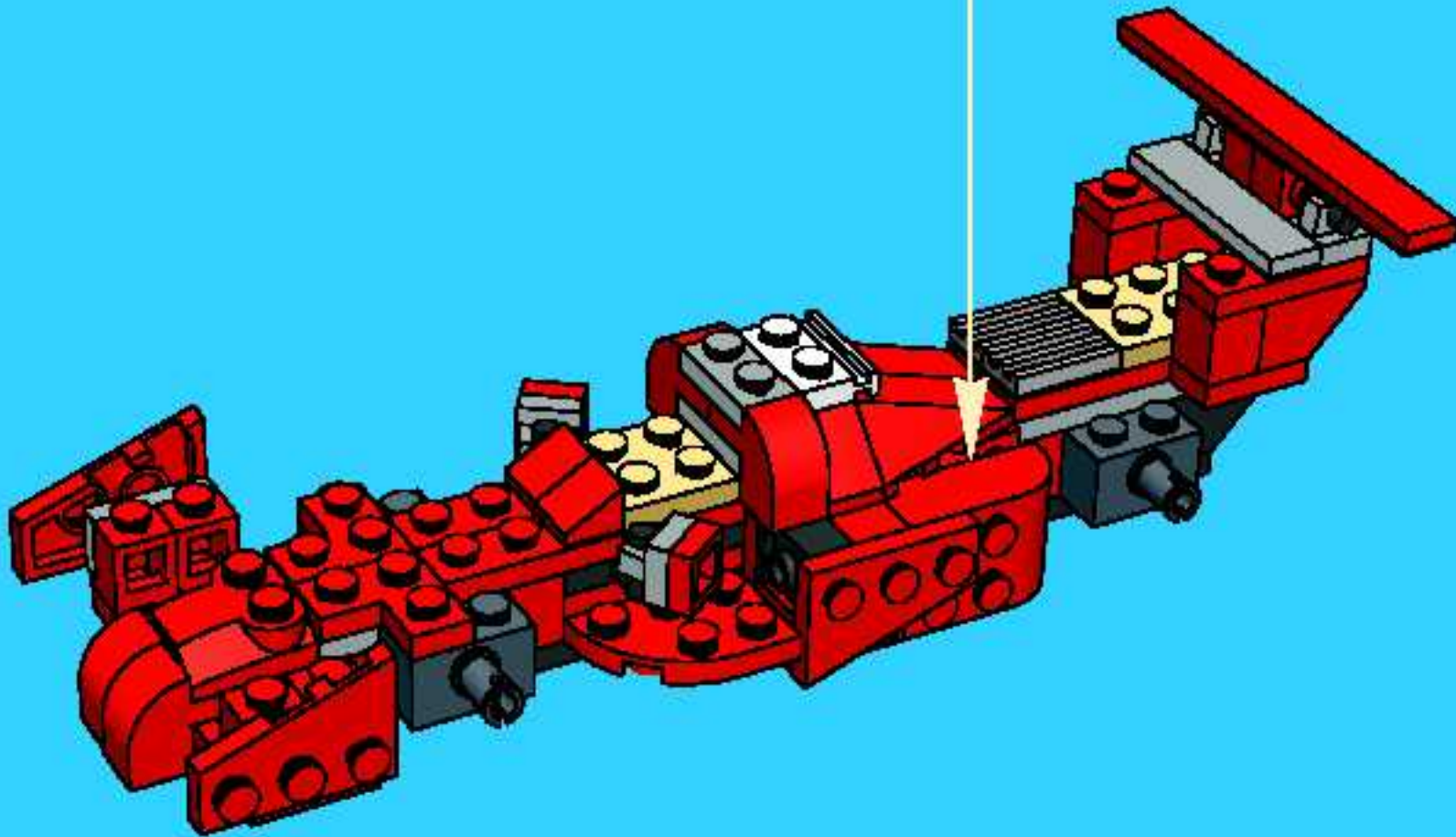

1

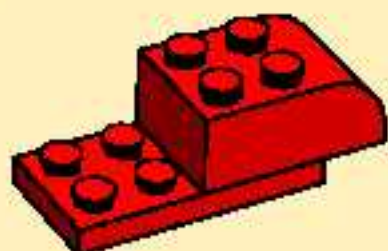

2



3



14

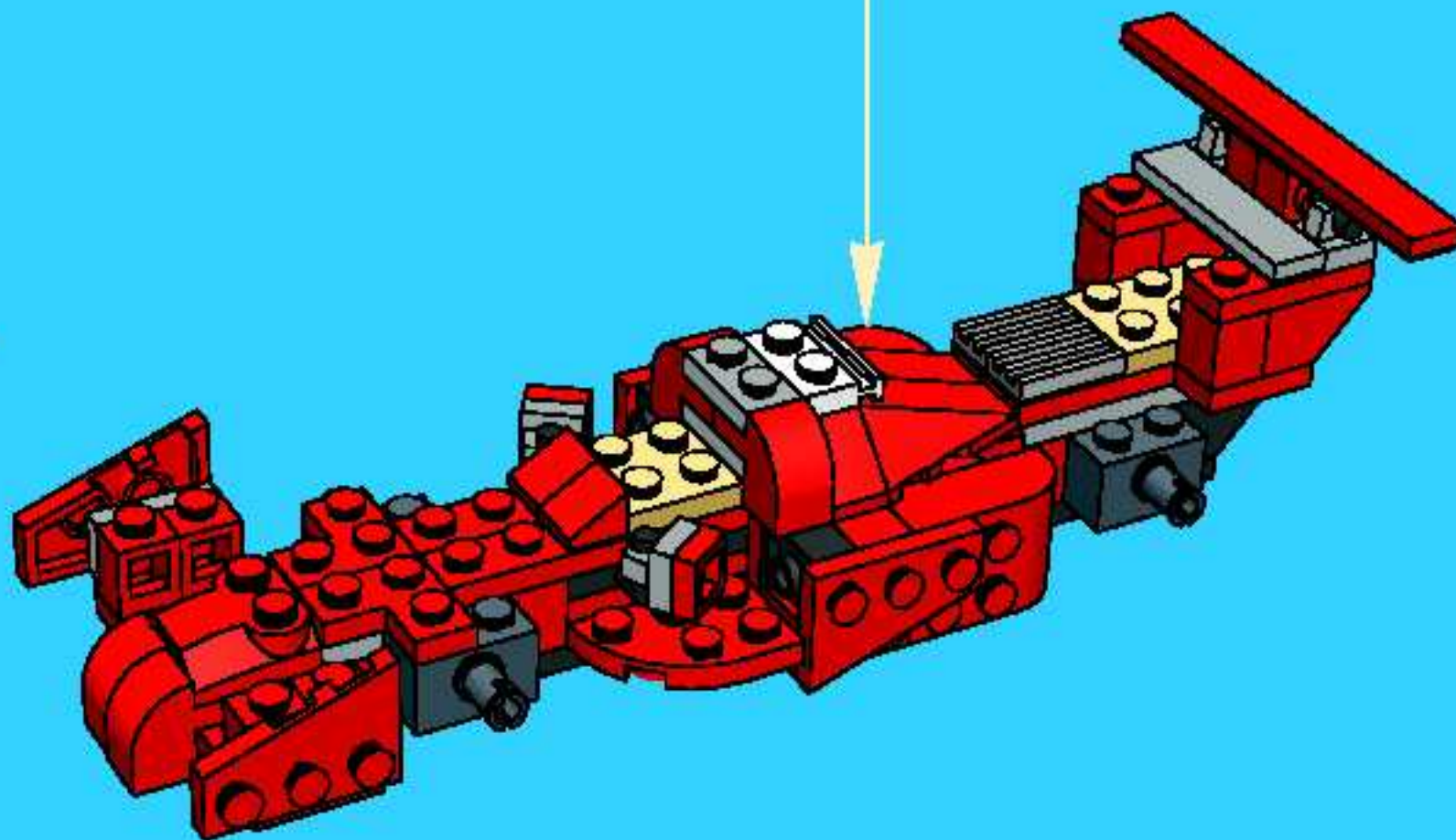

15

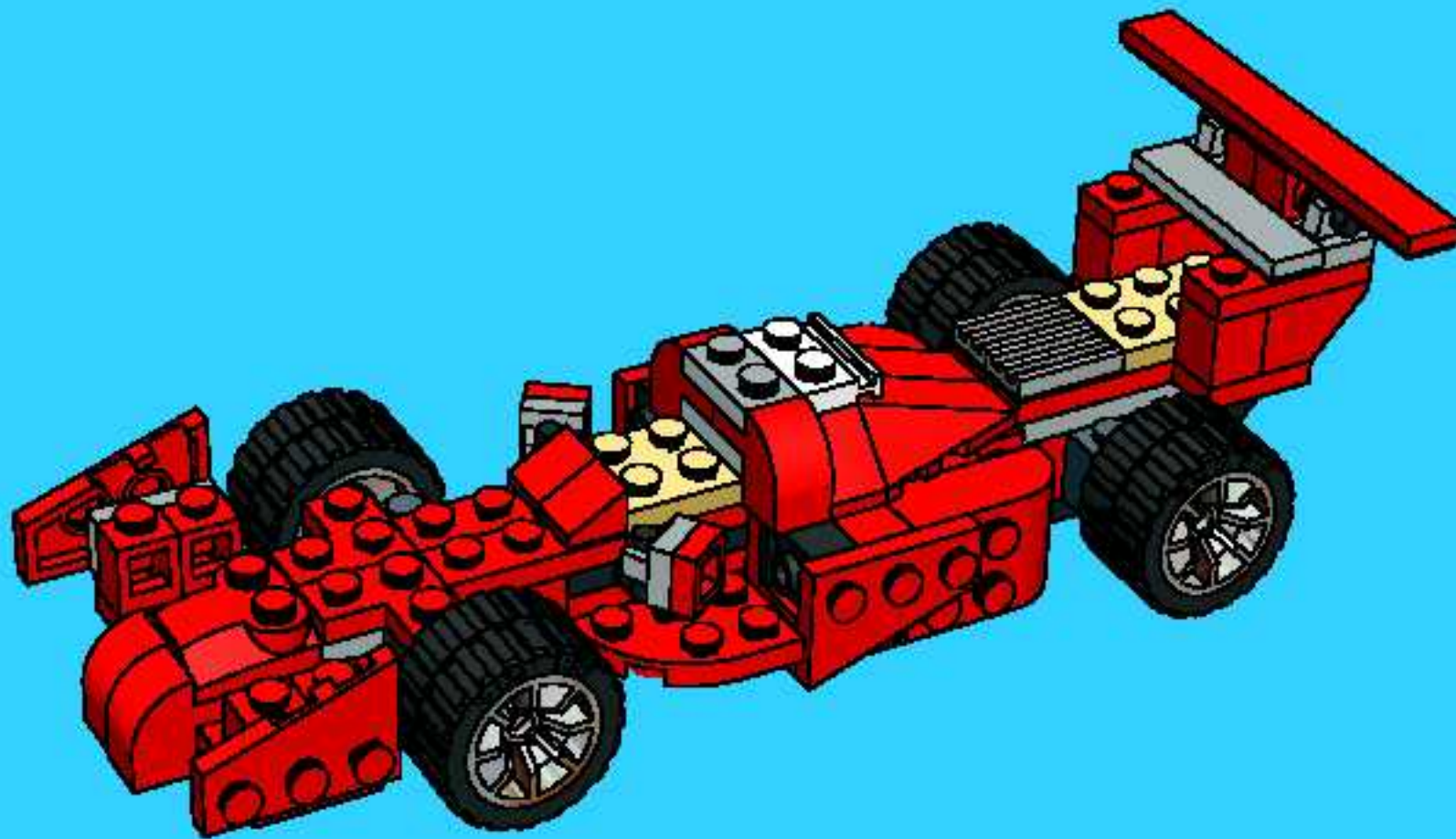

=



26

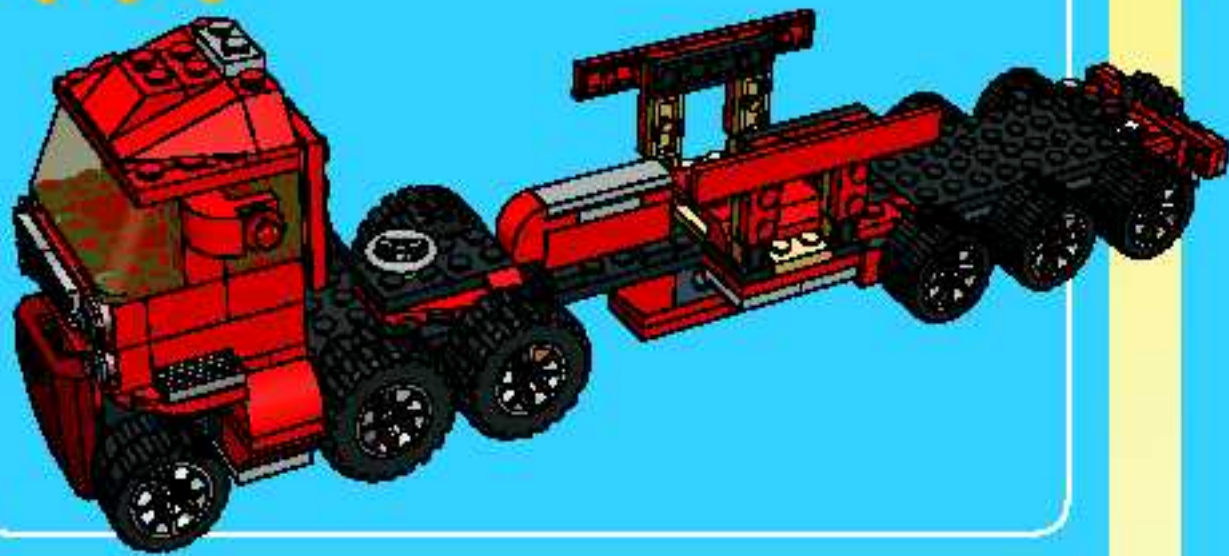

2

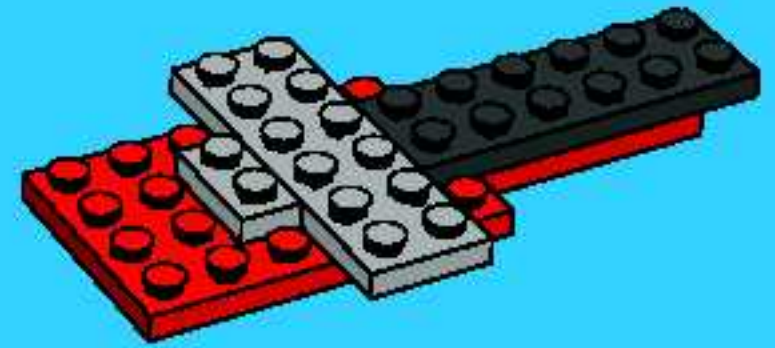

3

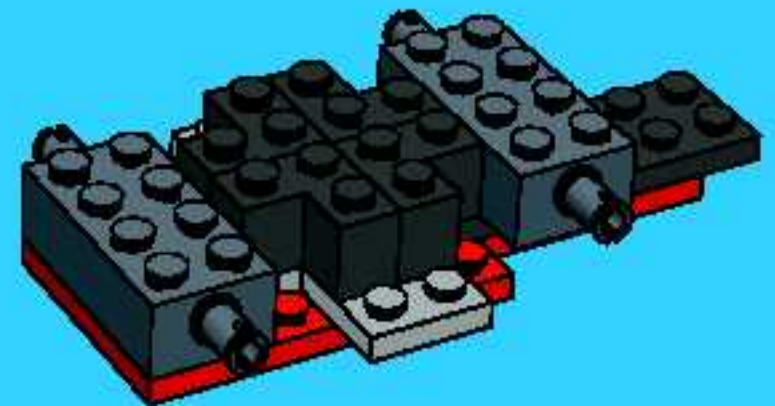

1

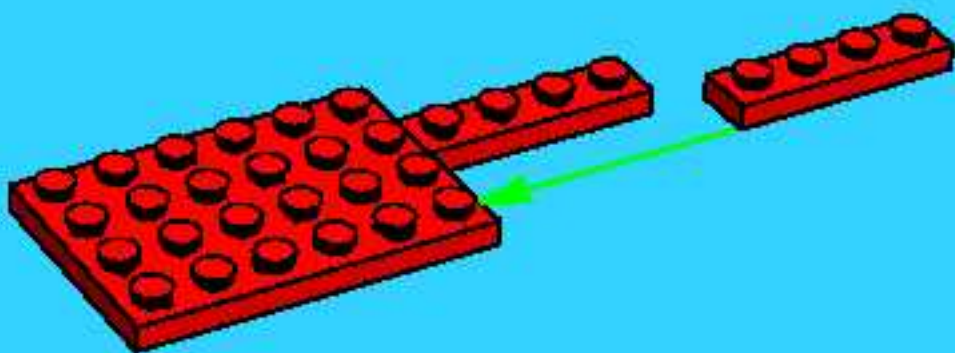

4

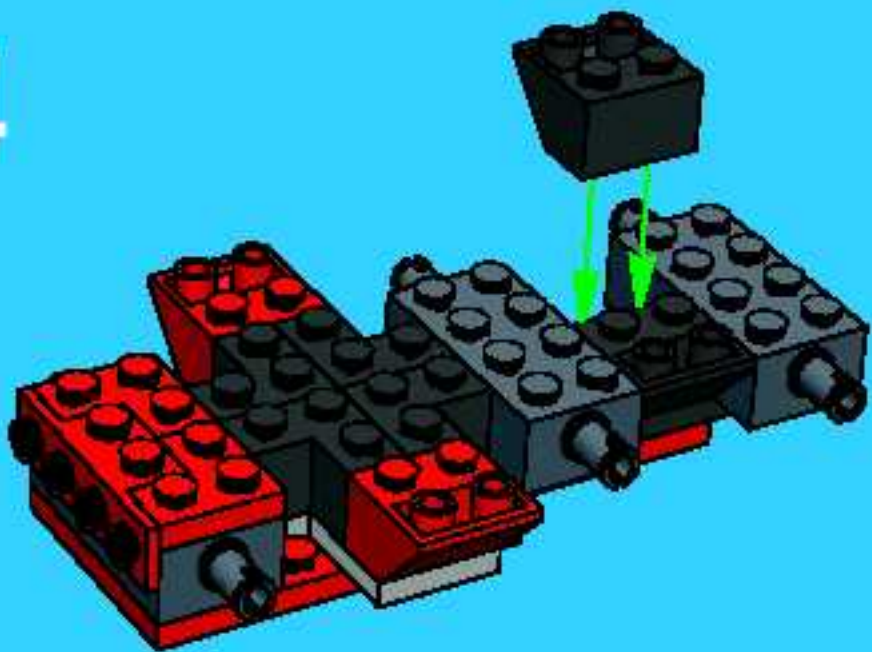

6

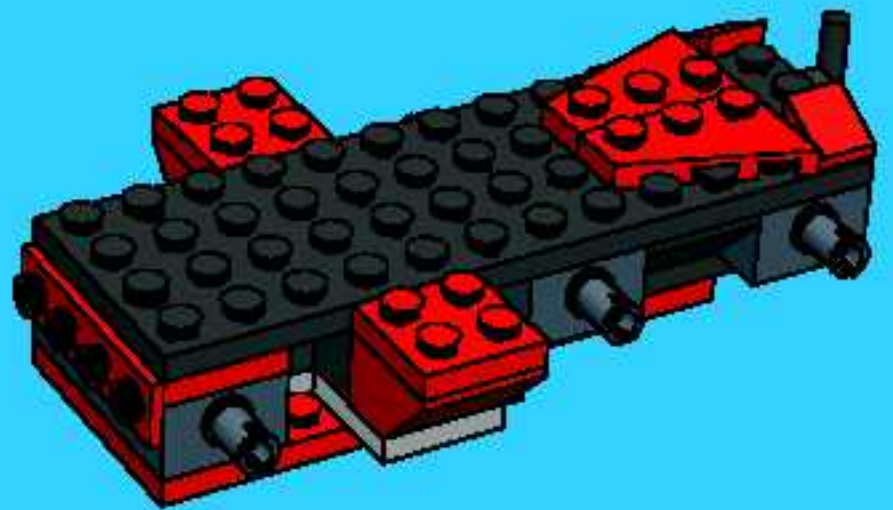

5

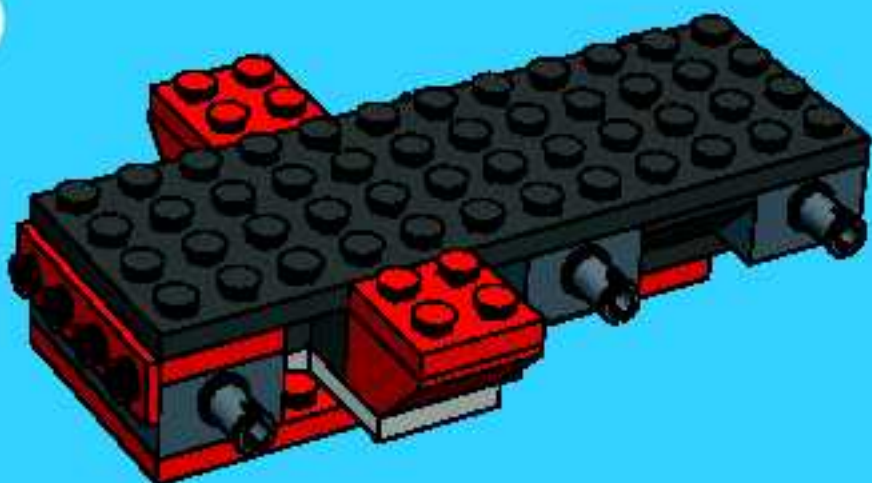

7

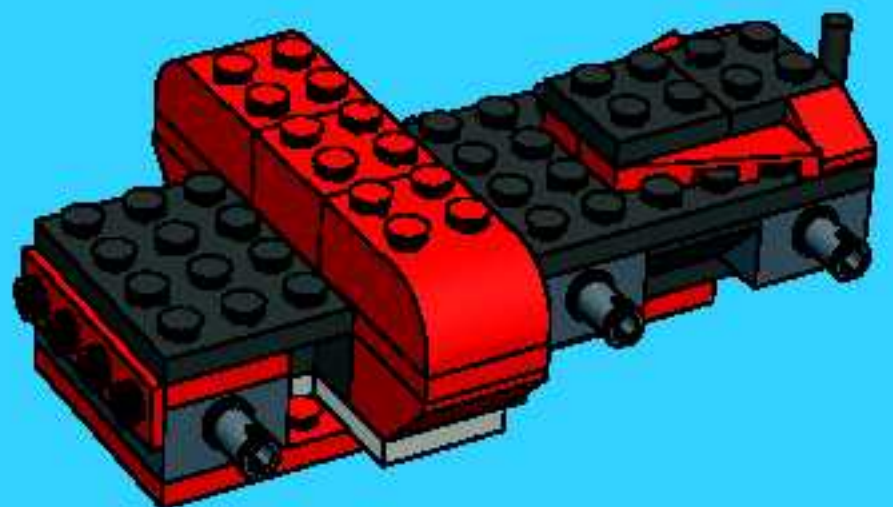

8

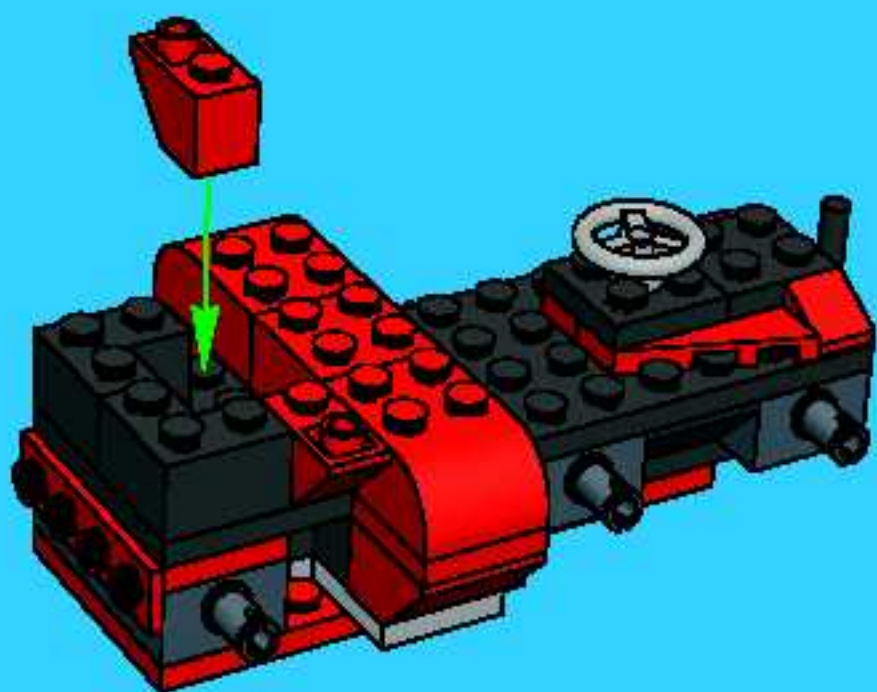

10

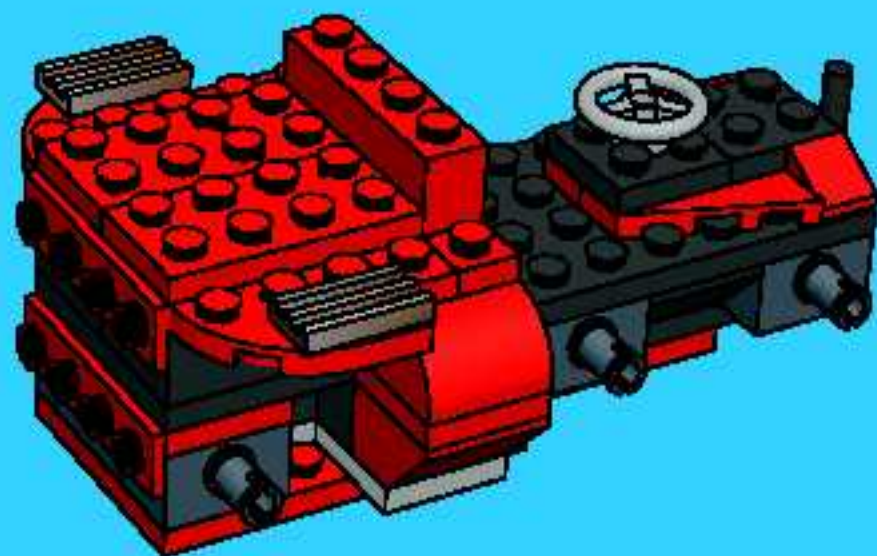

9

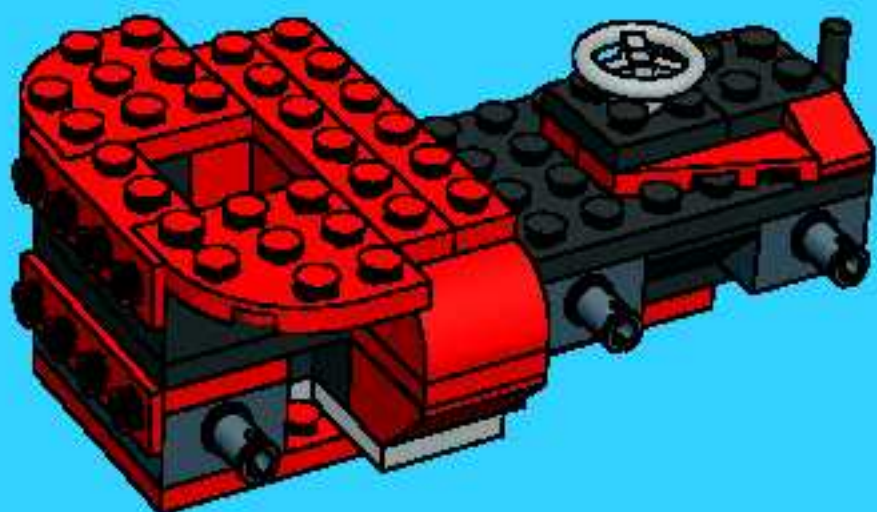

11

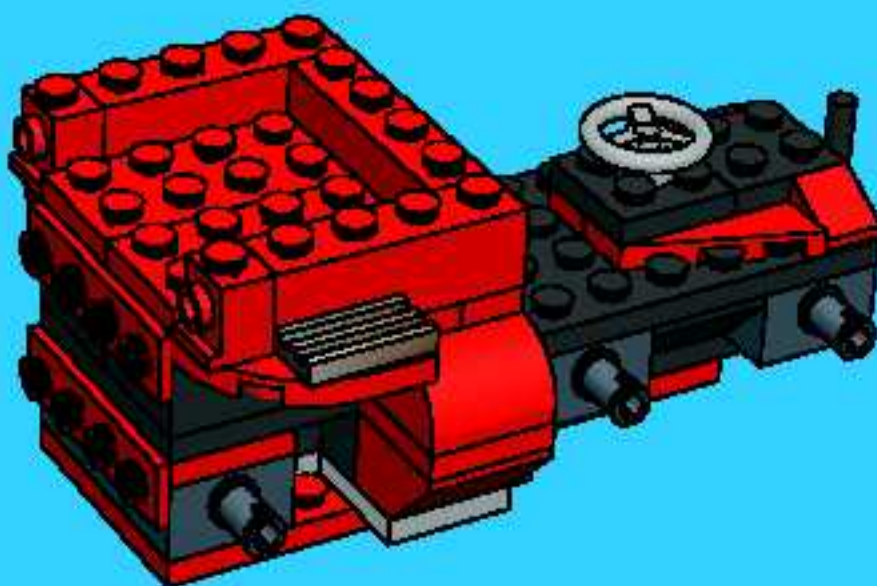



12

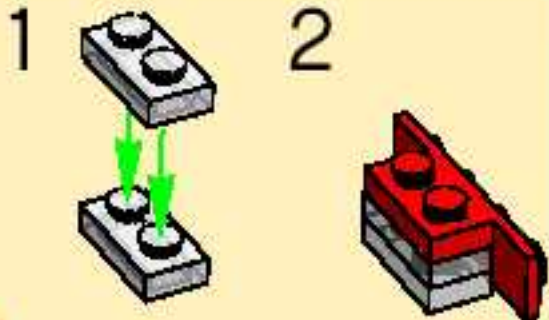
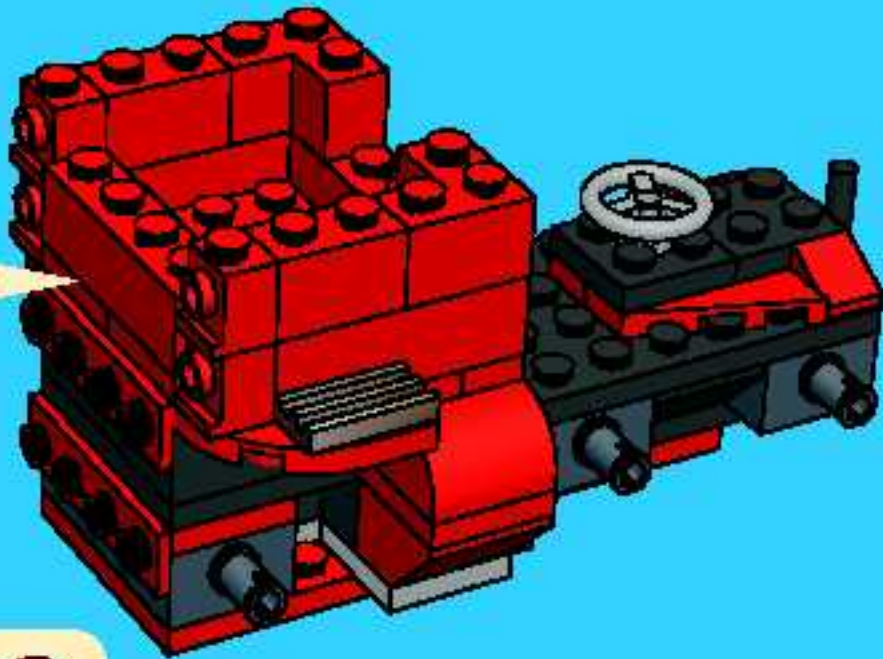

13

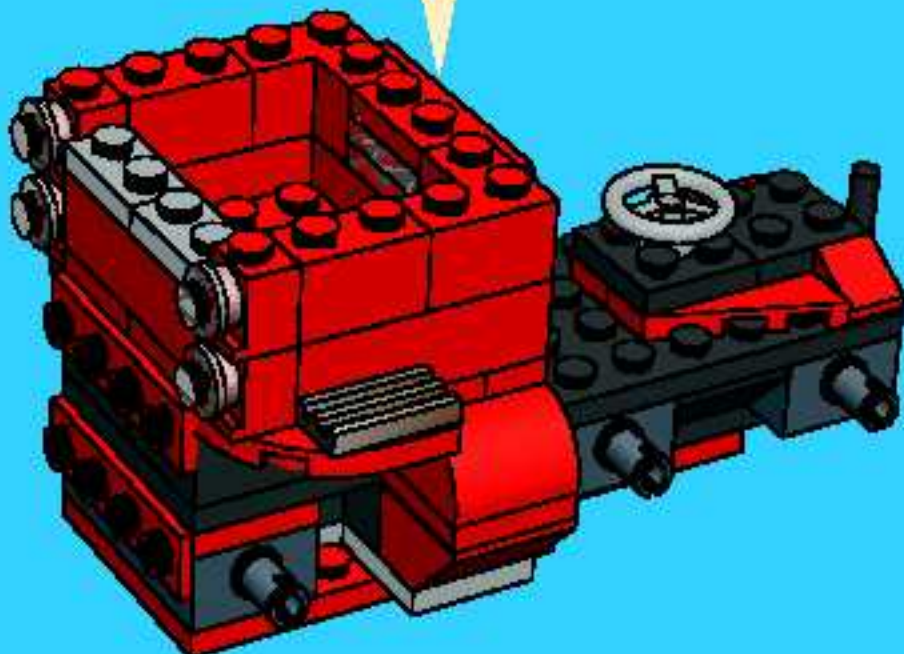

14

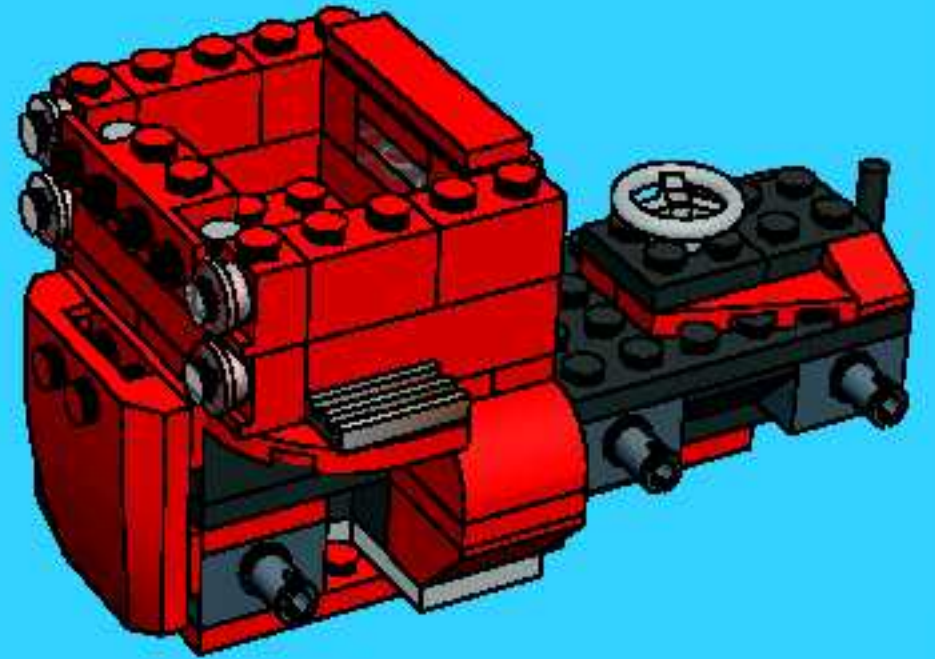

2x

15

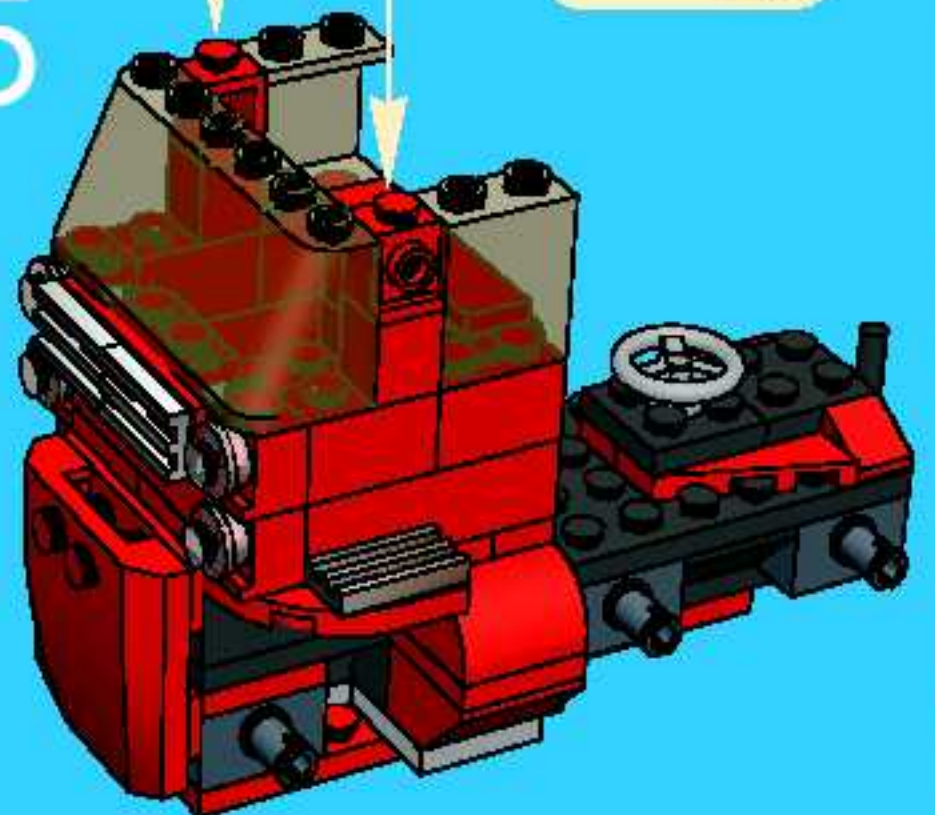

16

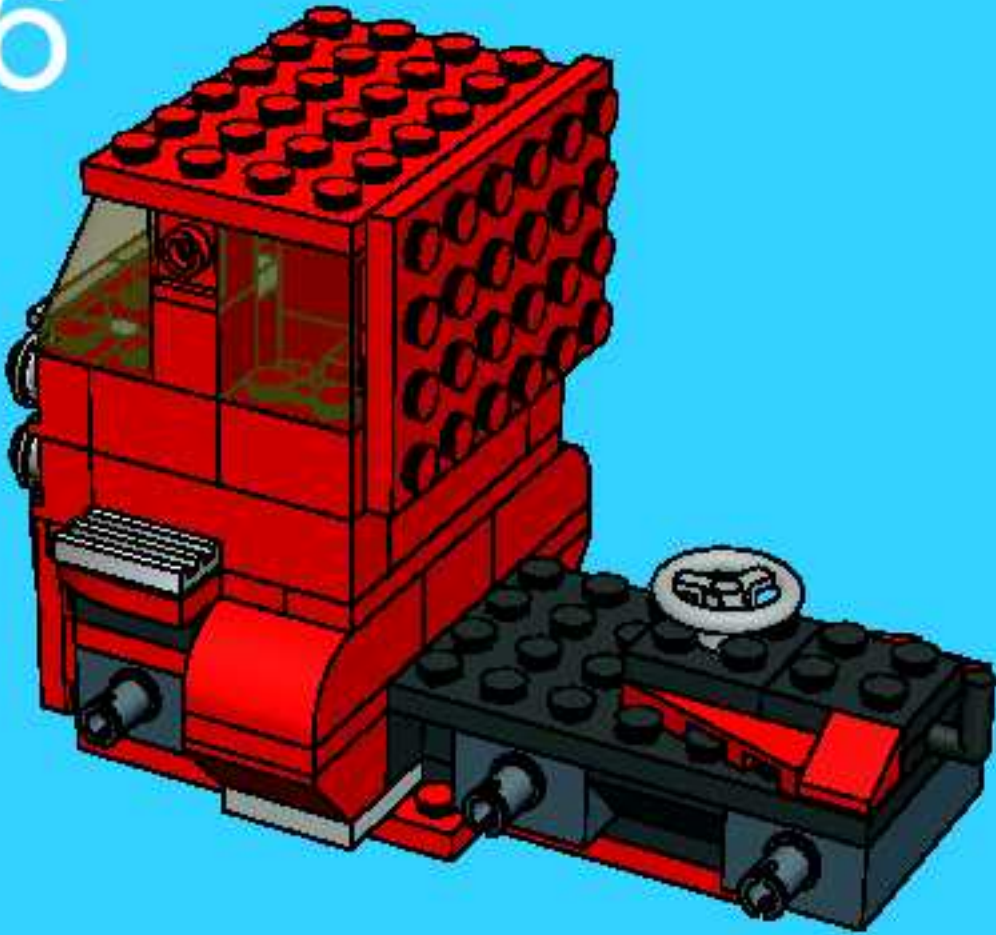

17

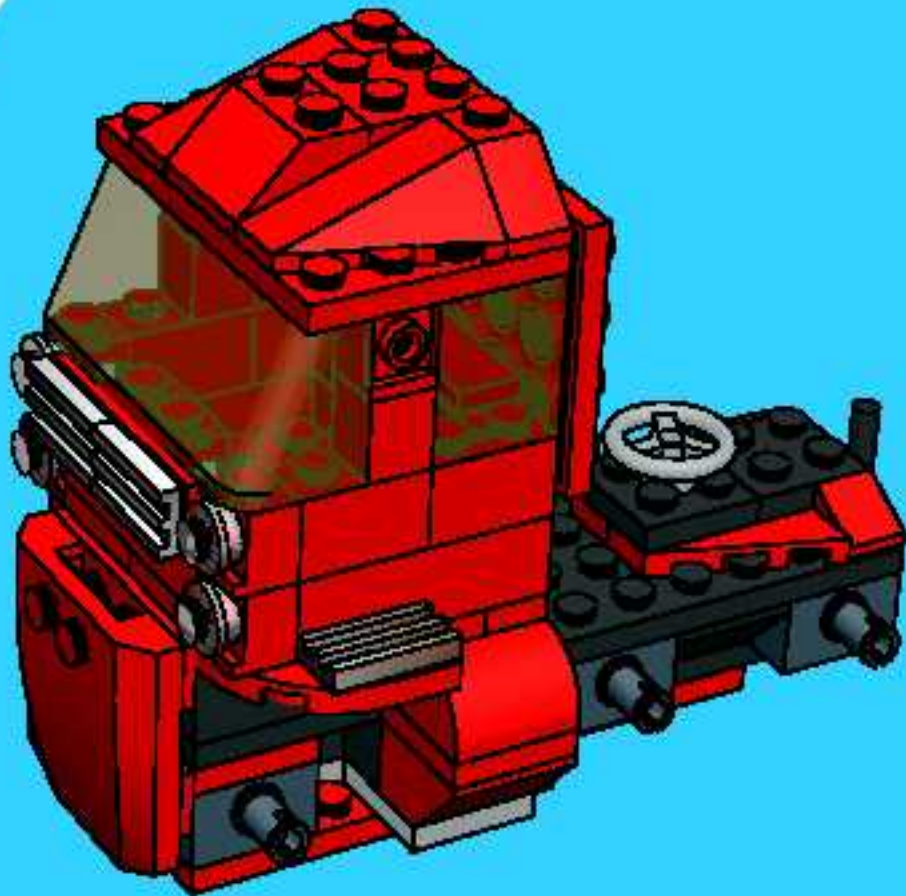

18

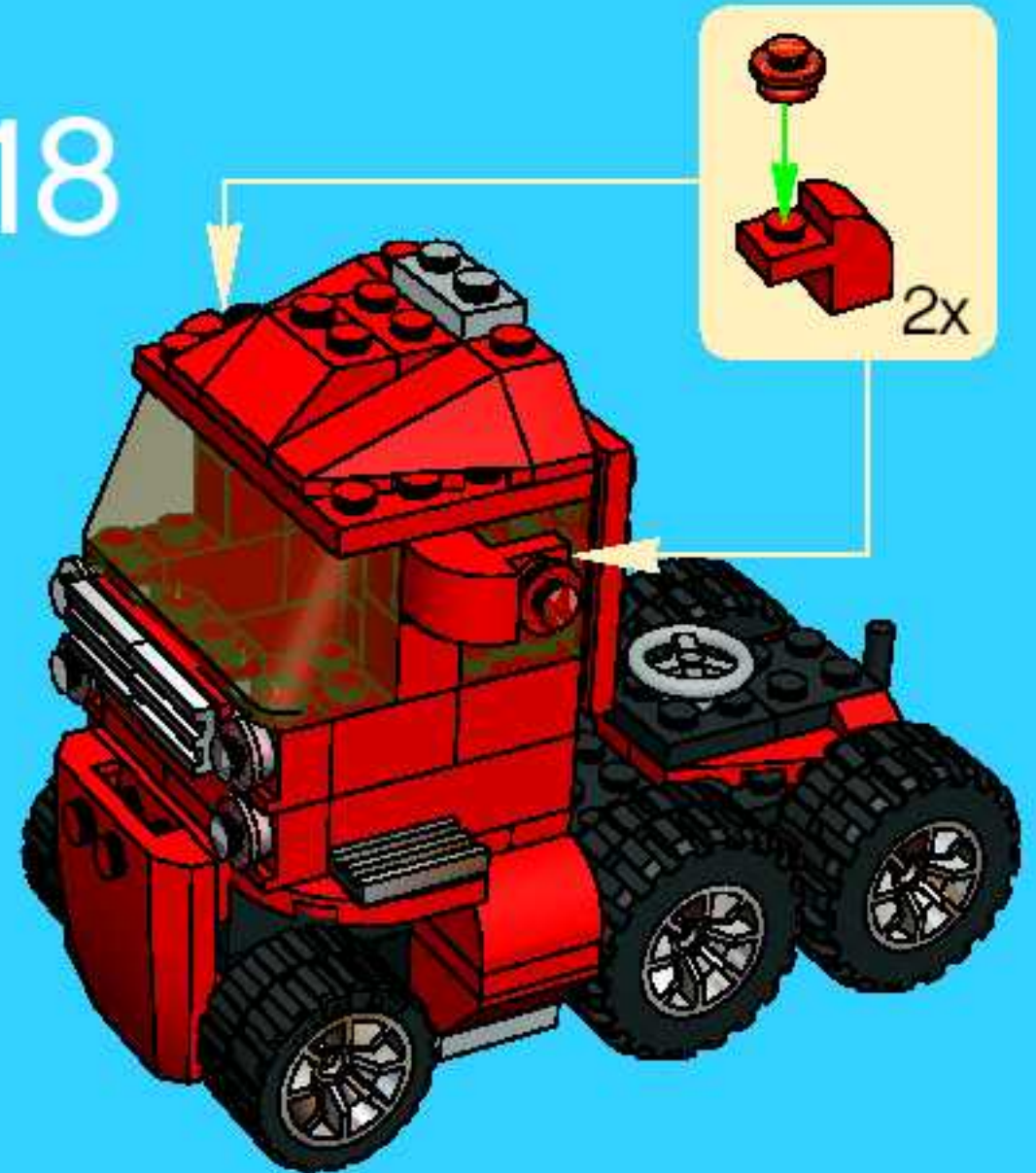



1

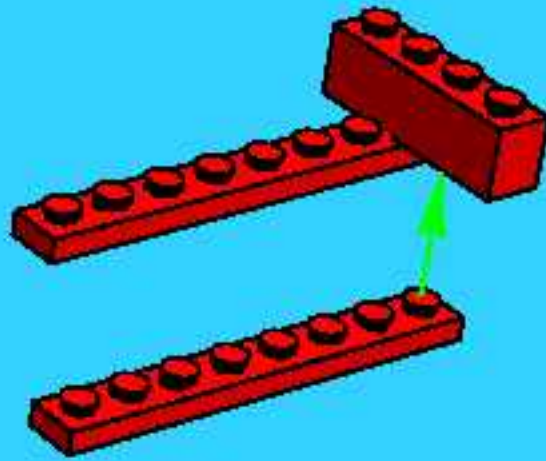

2



3

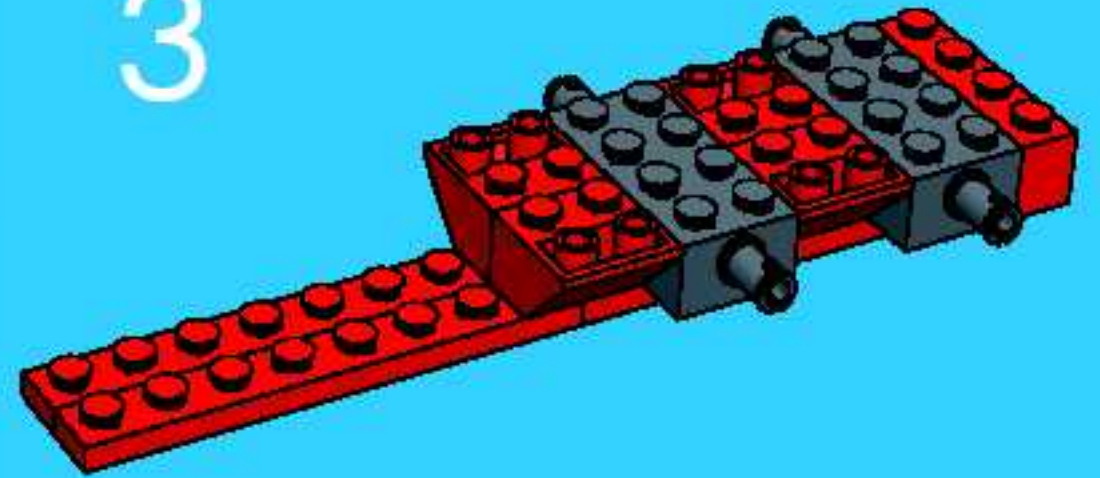

4

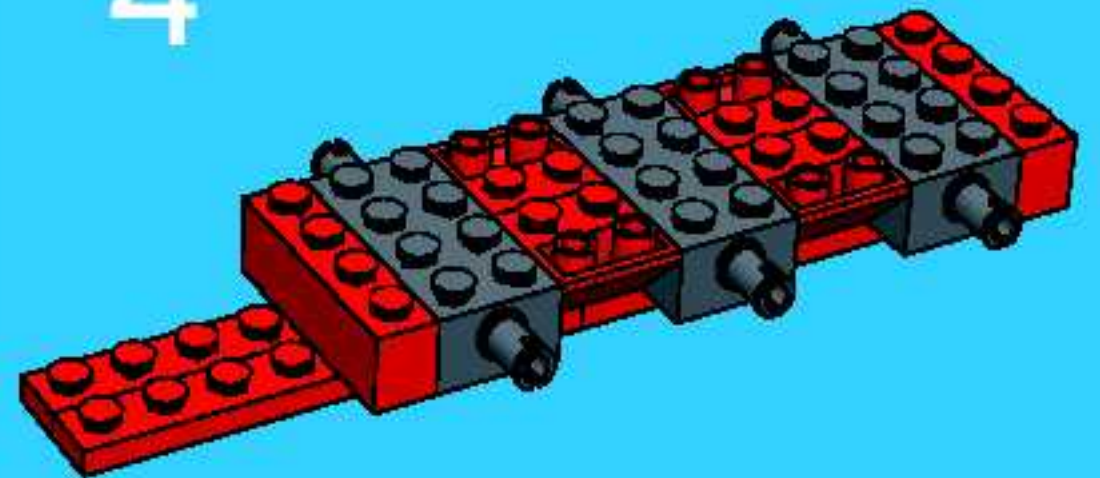

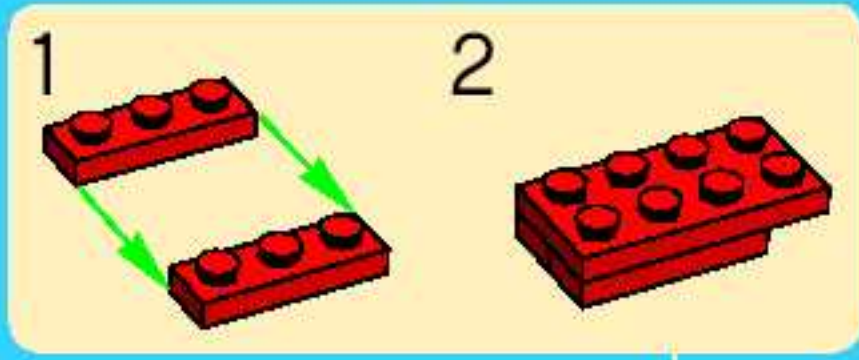

5

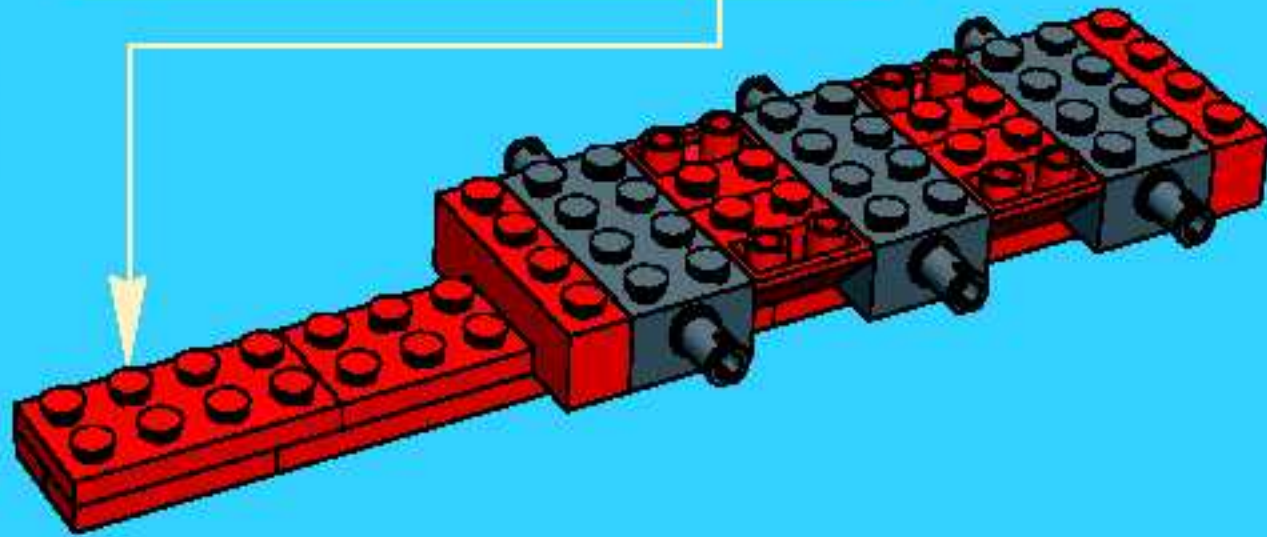

6

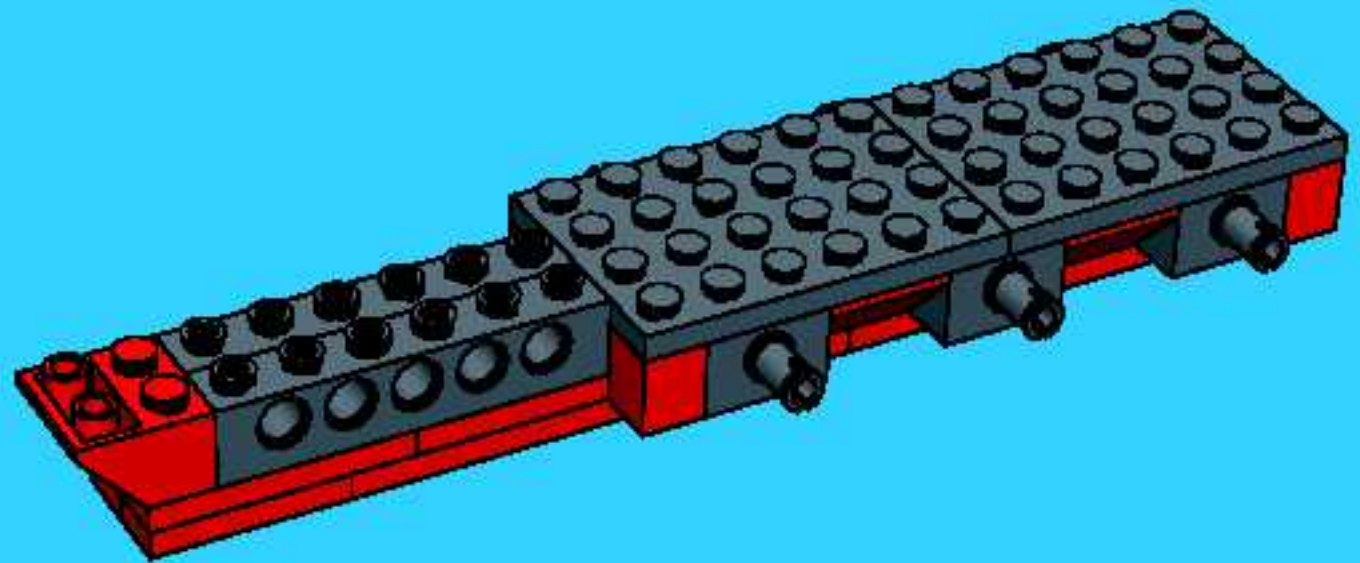

7

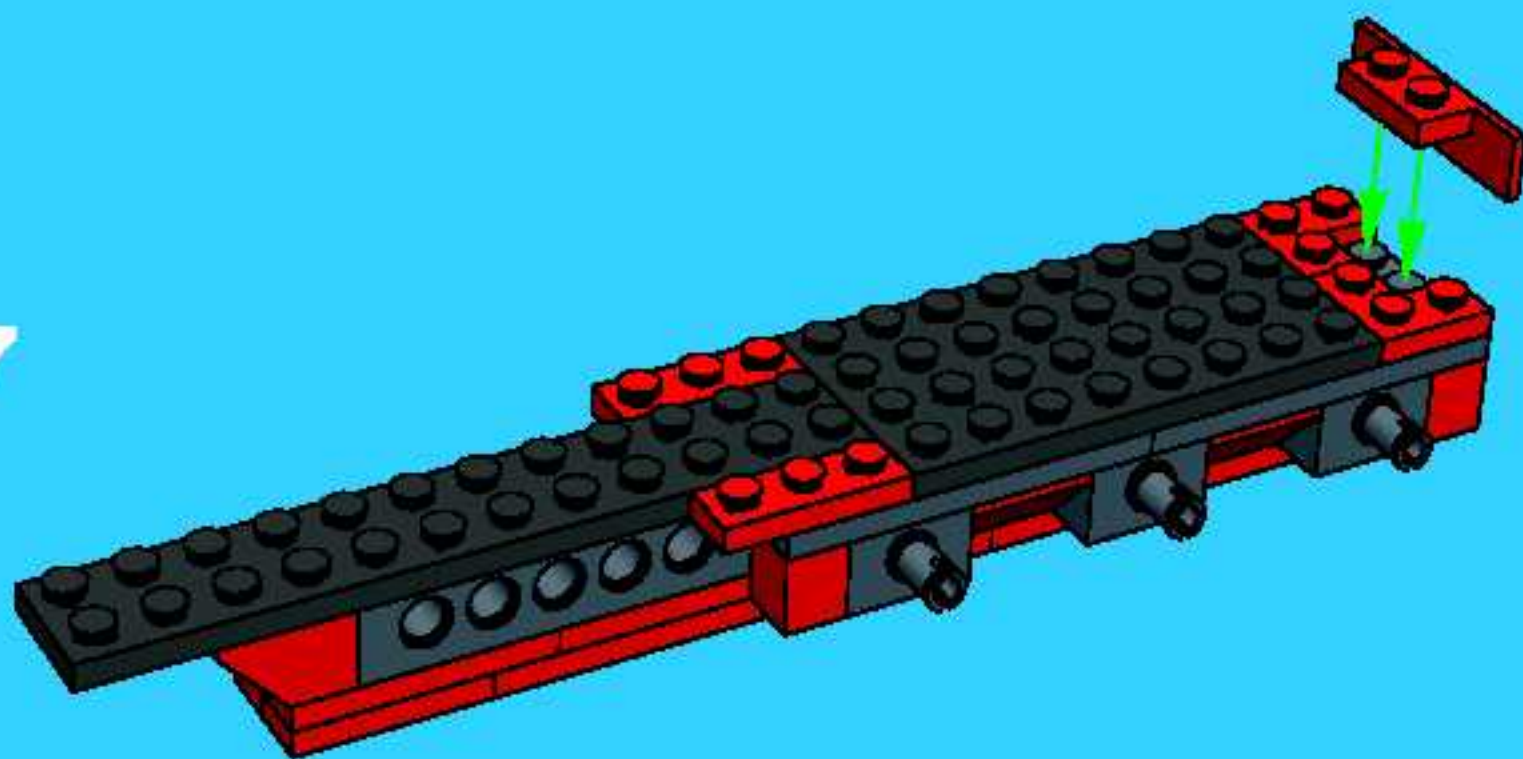

1

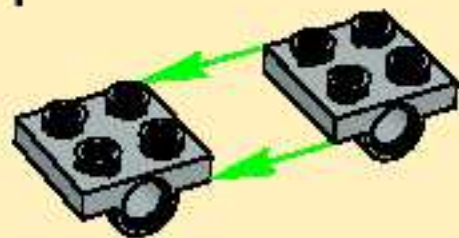

2



3

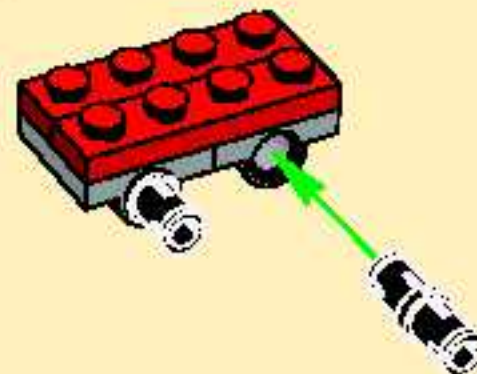

2x

8

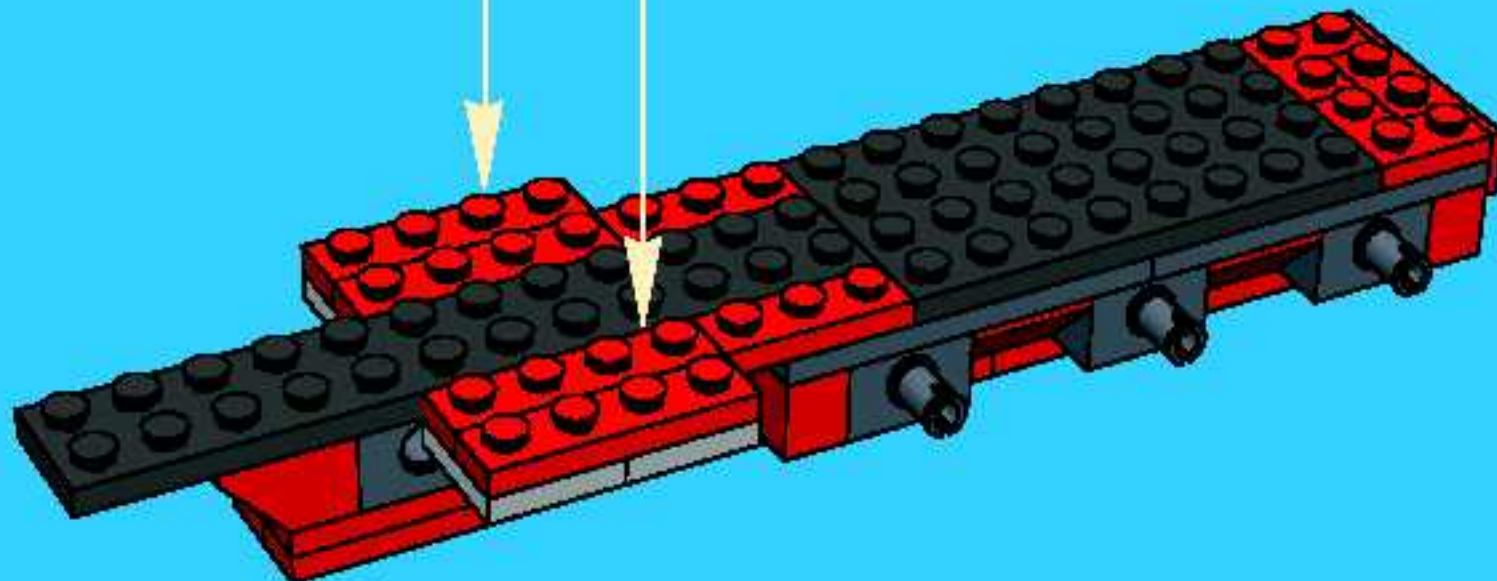

9

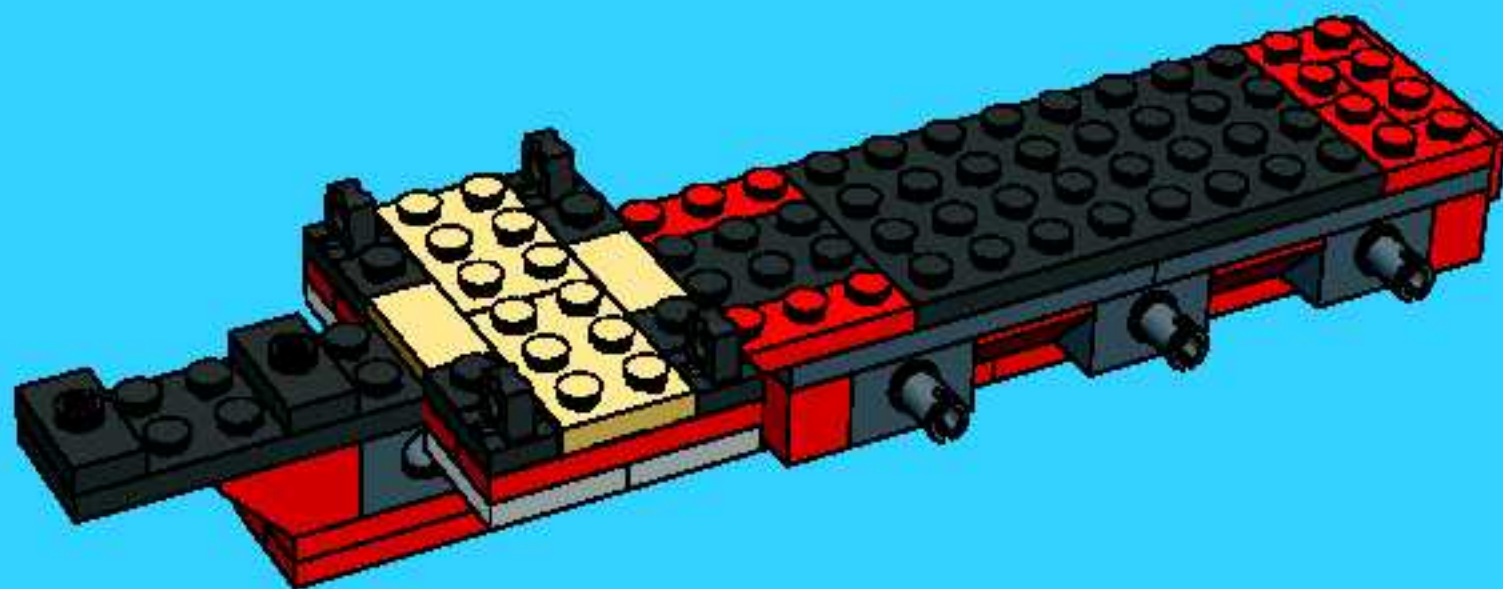

1



2



3



10

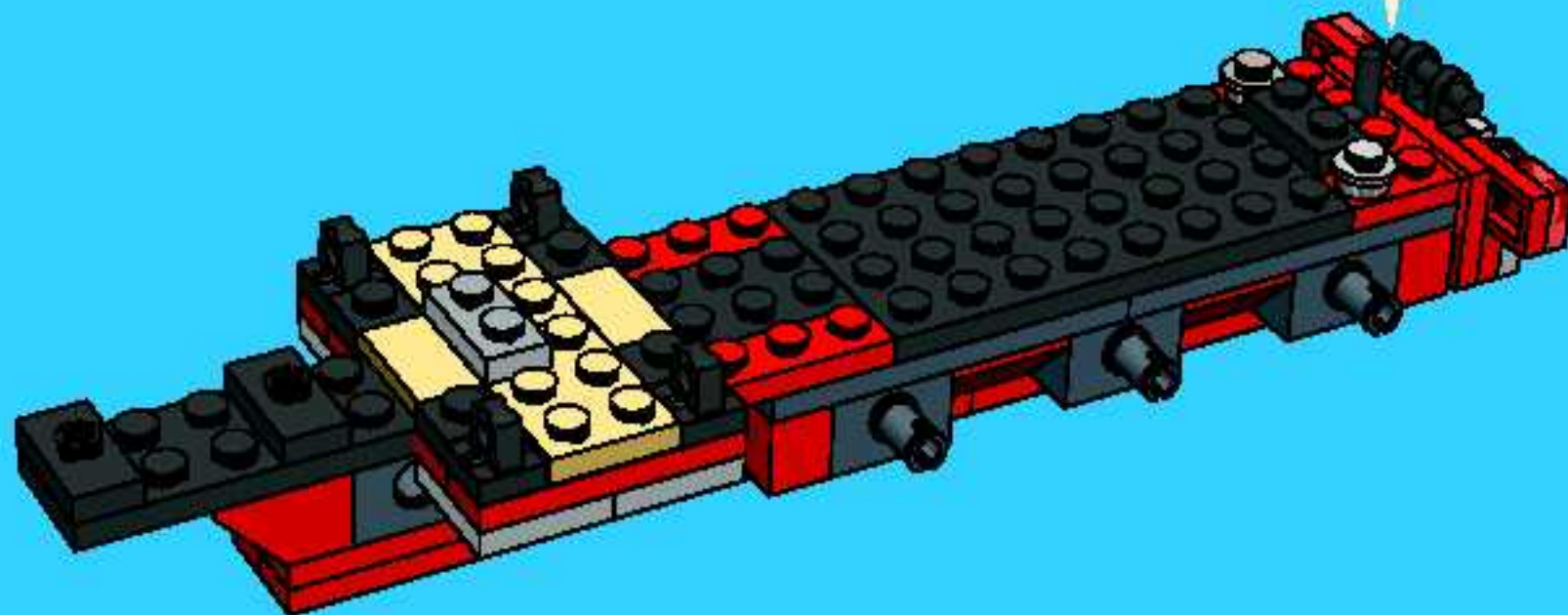

1



2

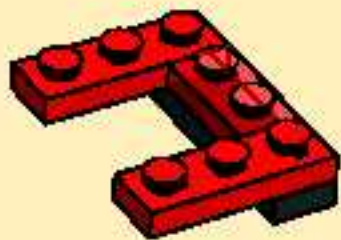

3

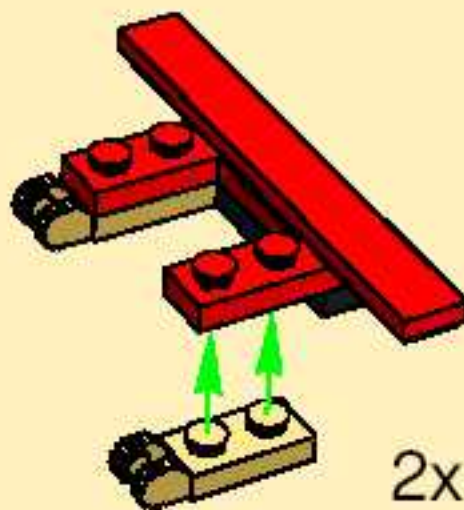

11

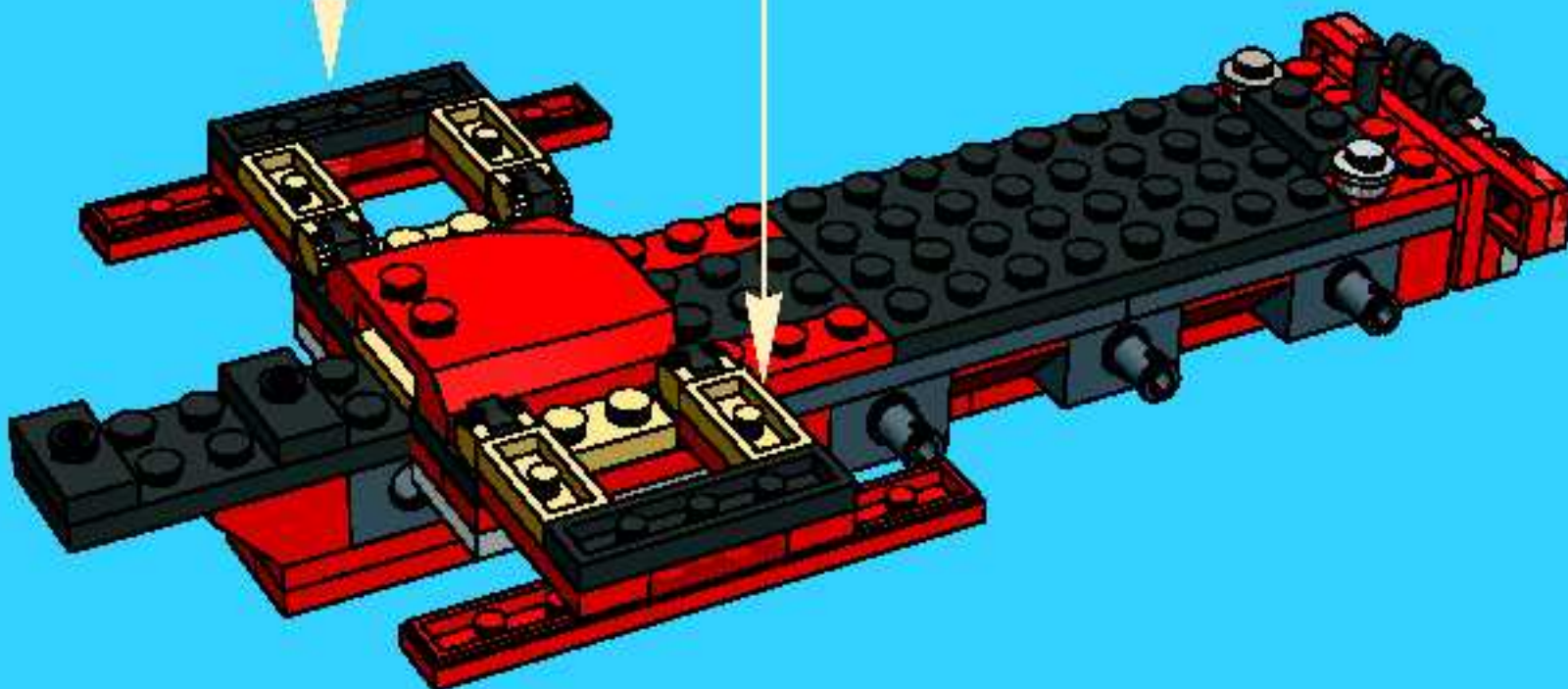

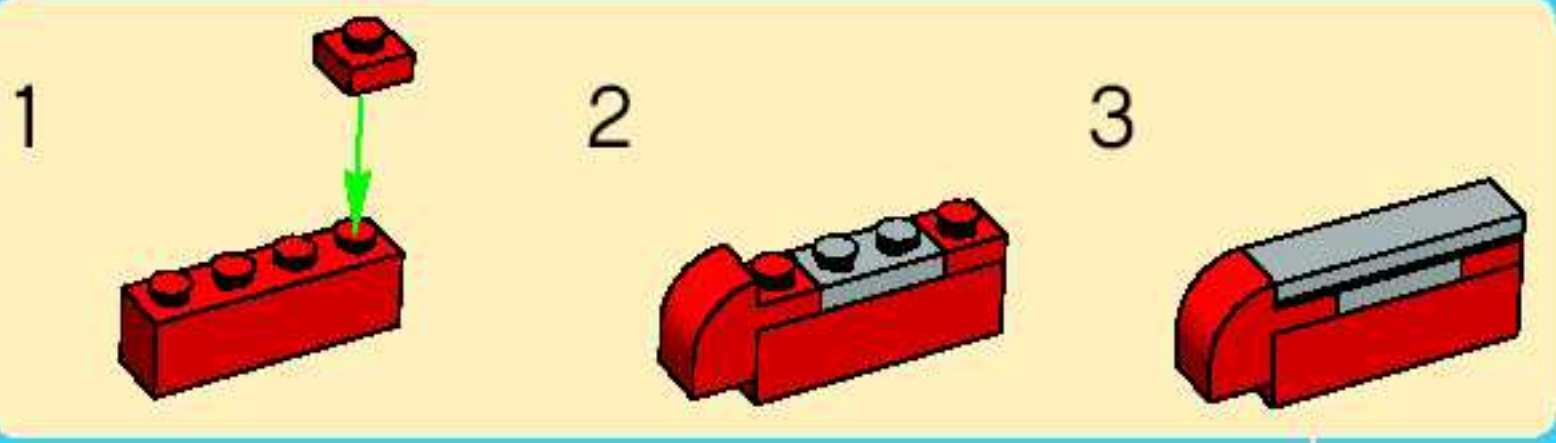

12

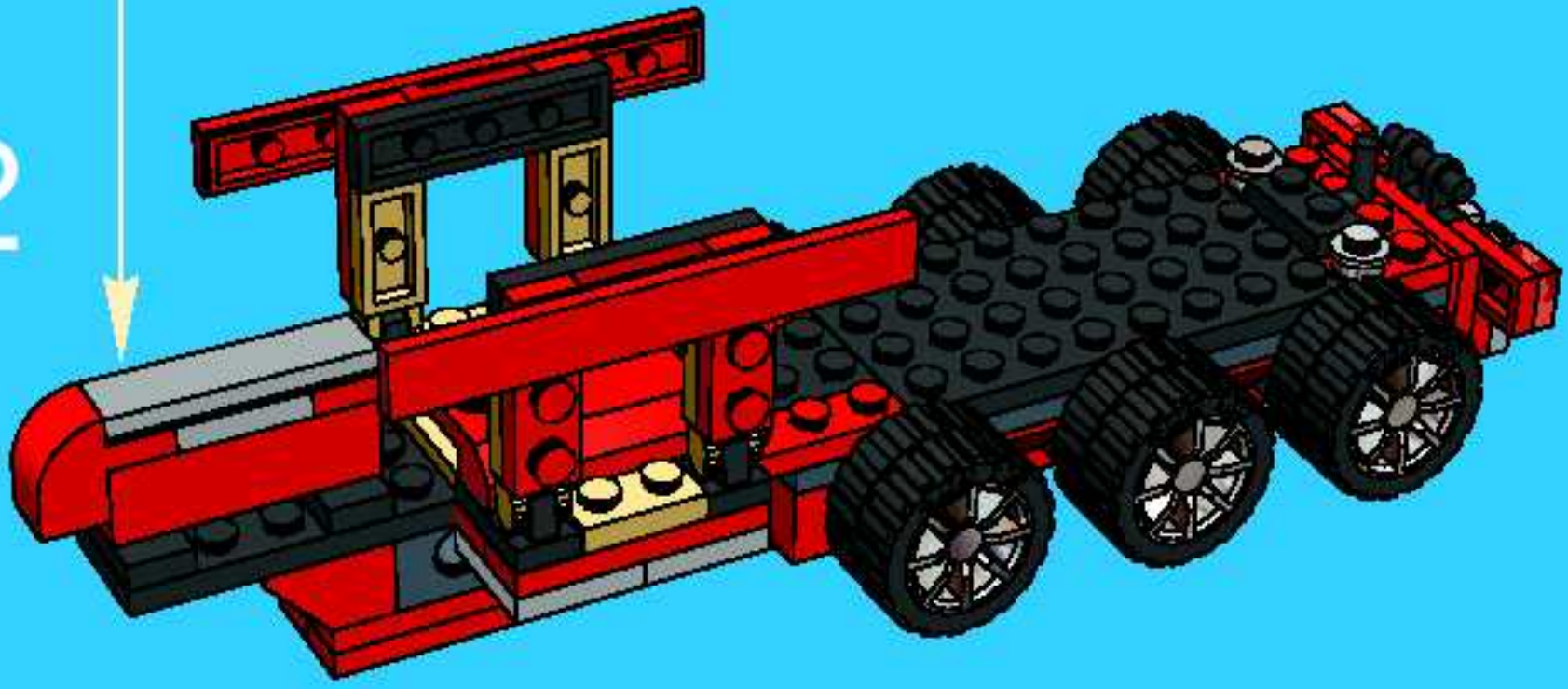



13



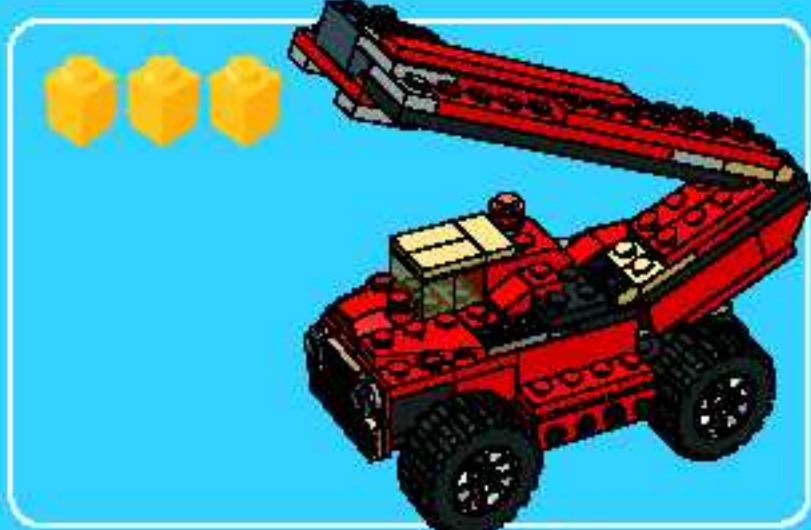

1



2

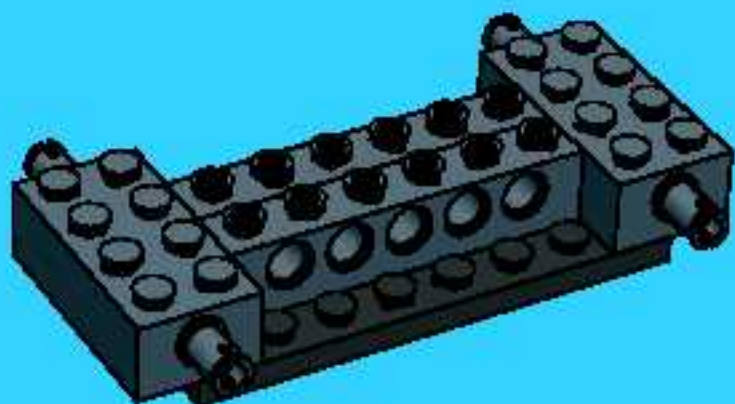

3

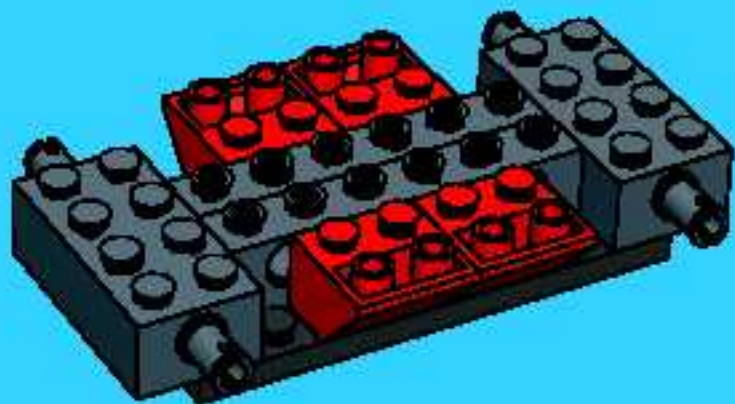

4

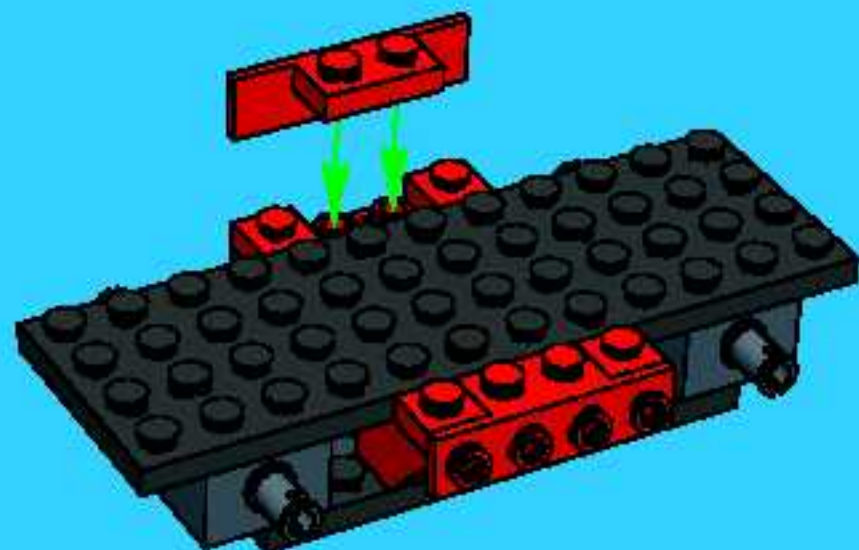

5

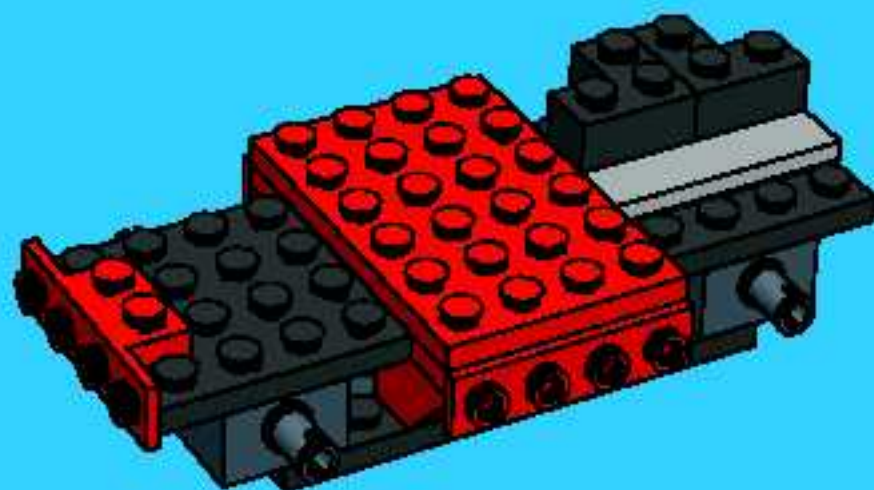

6

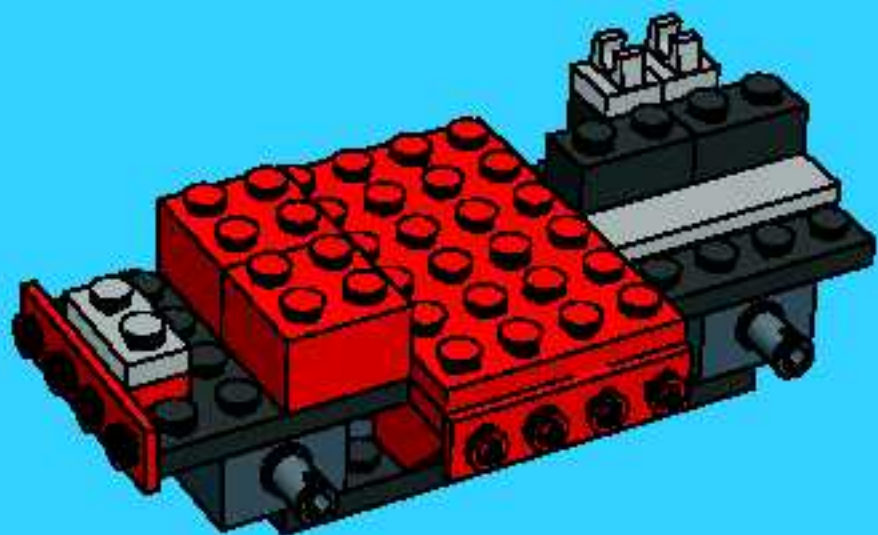

8

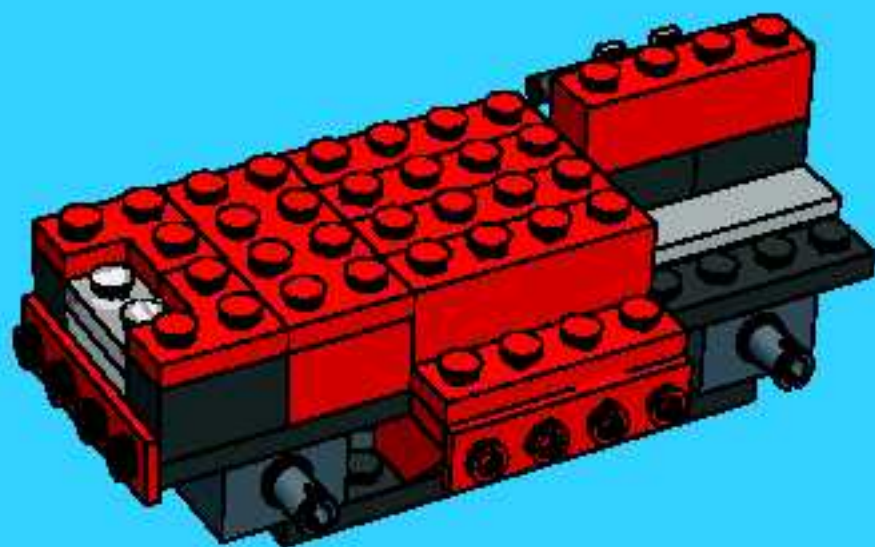

7

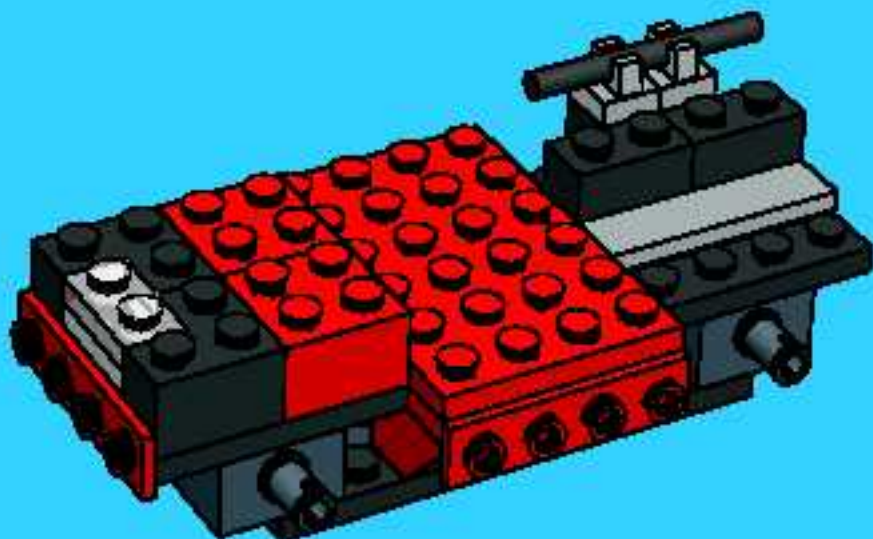

9

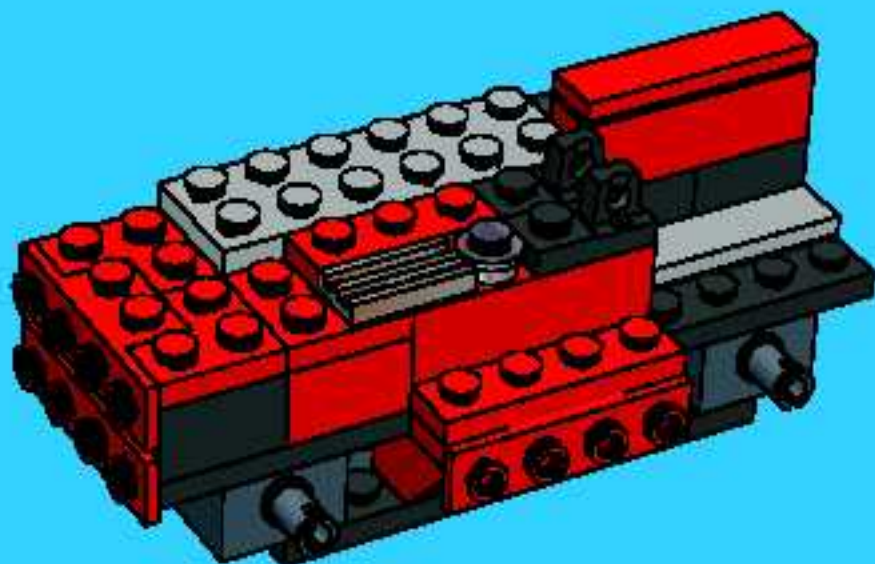

10

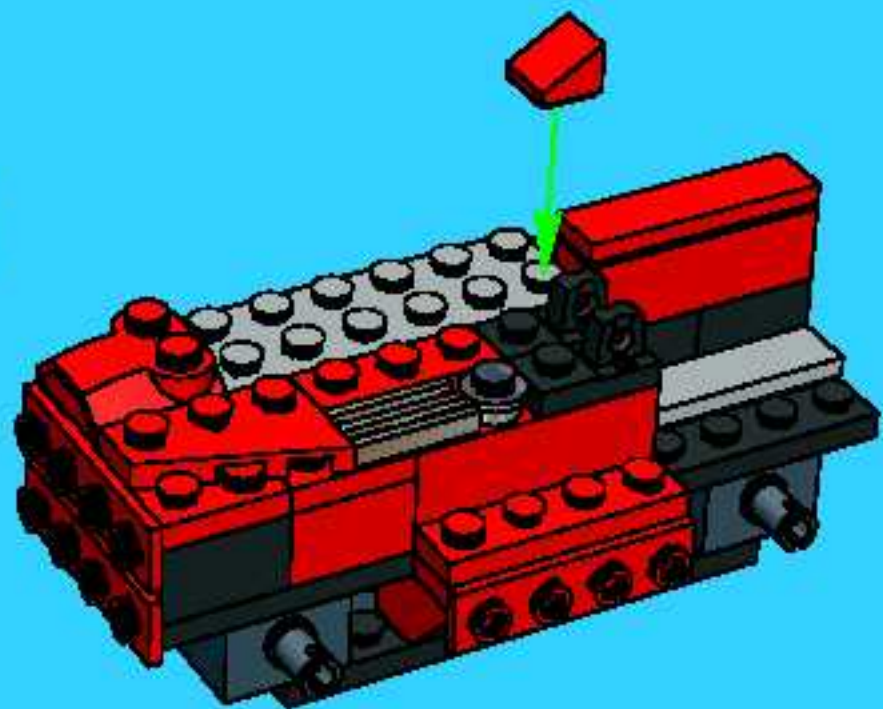

12

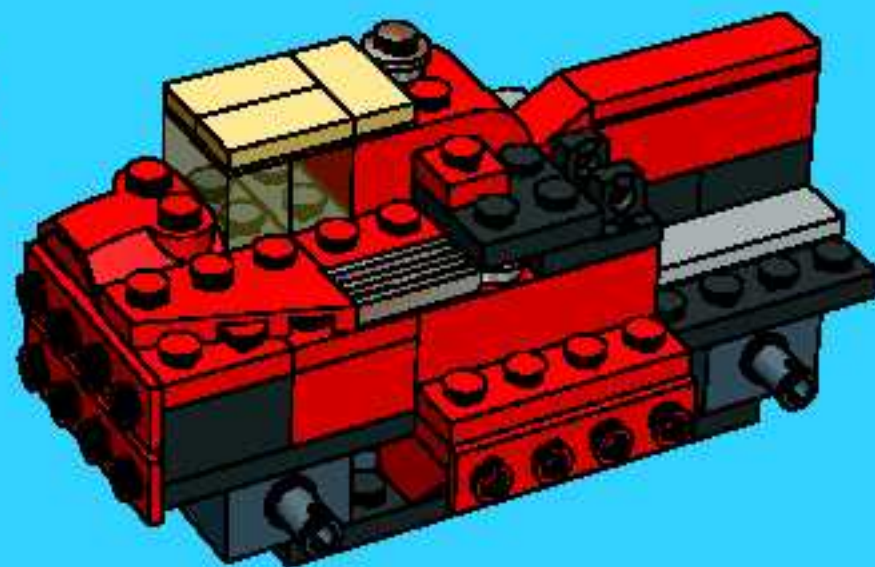

11

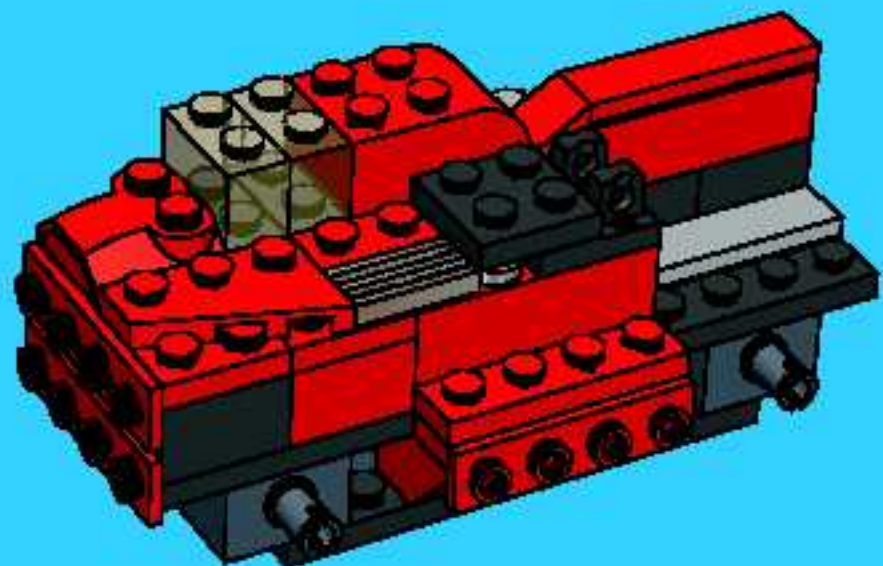

13

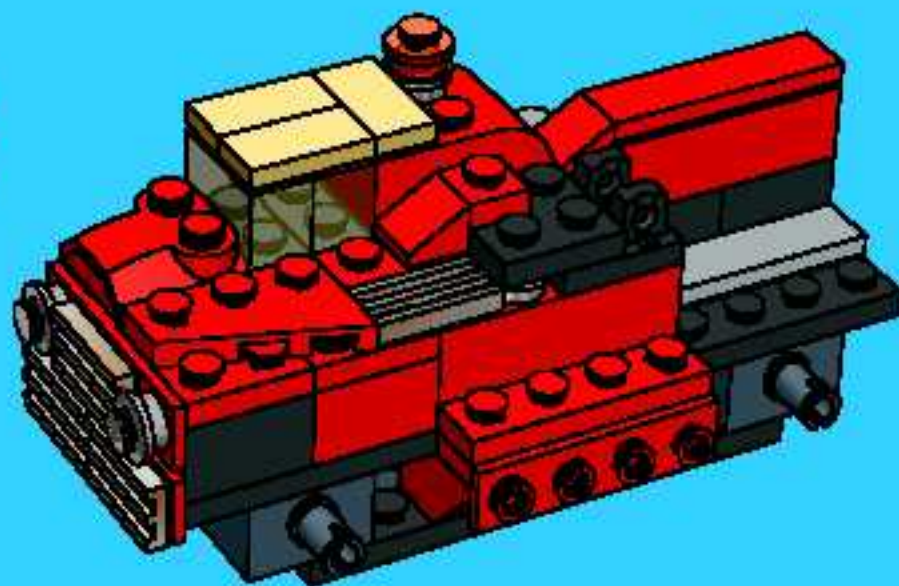

1

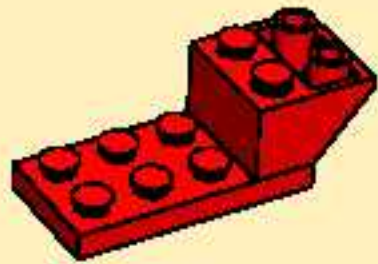

2

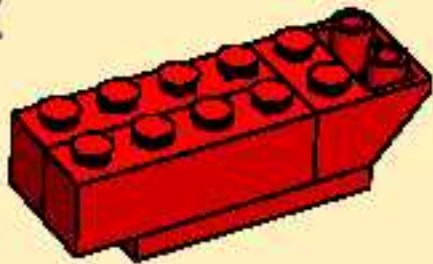

3



4

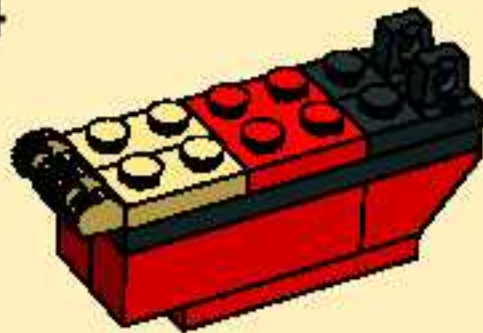

5



14

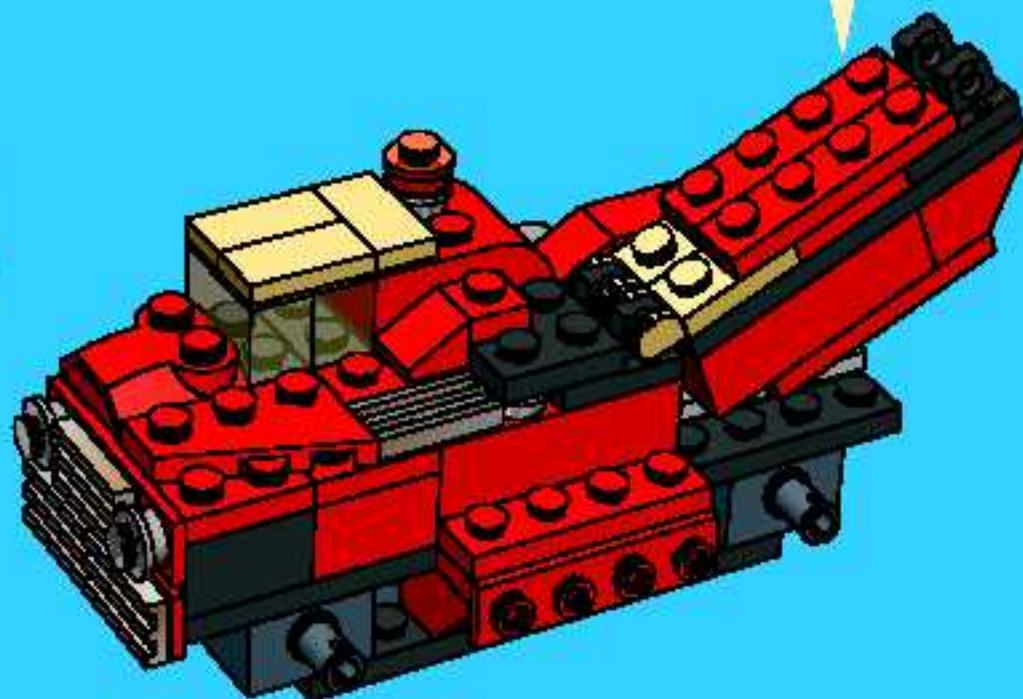

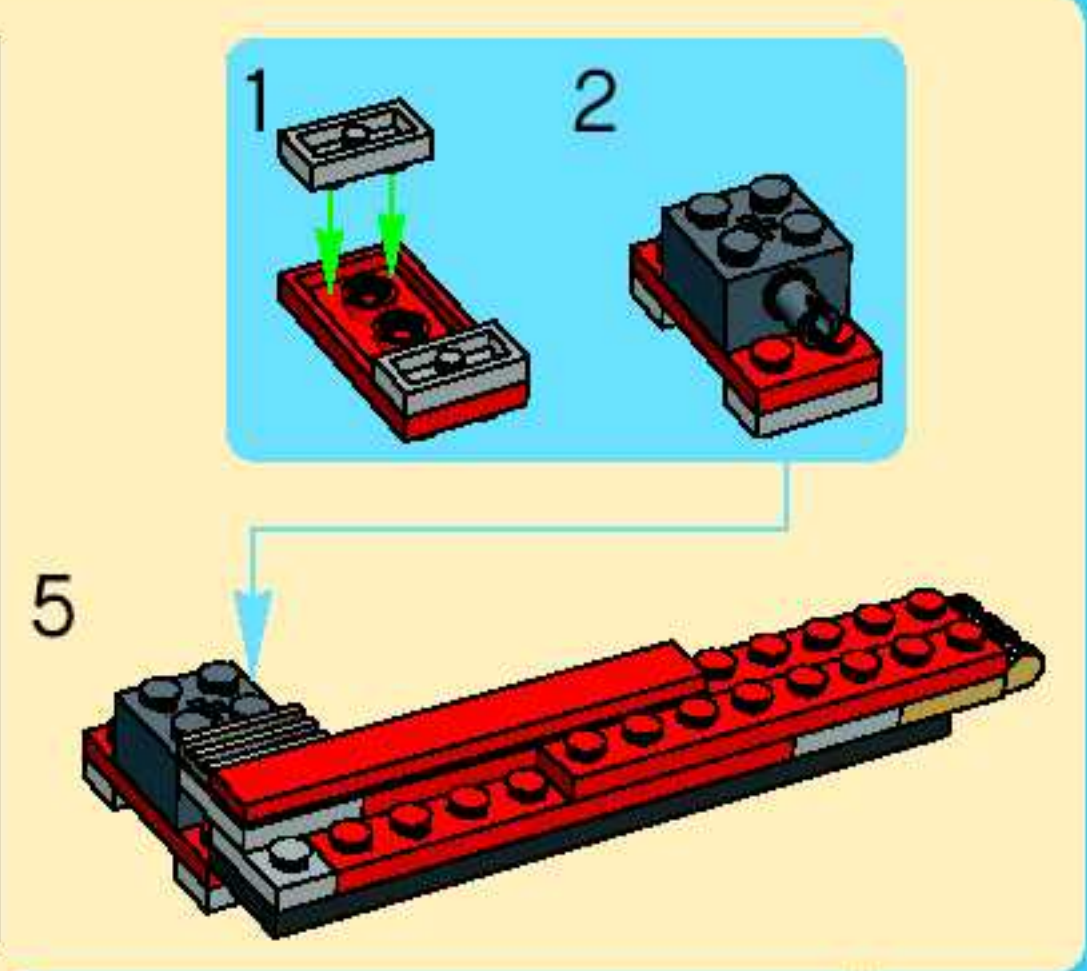
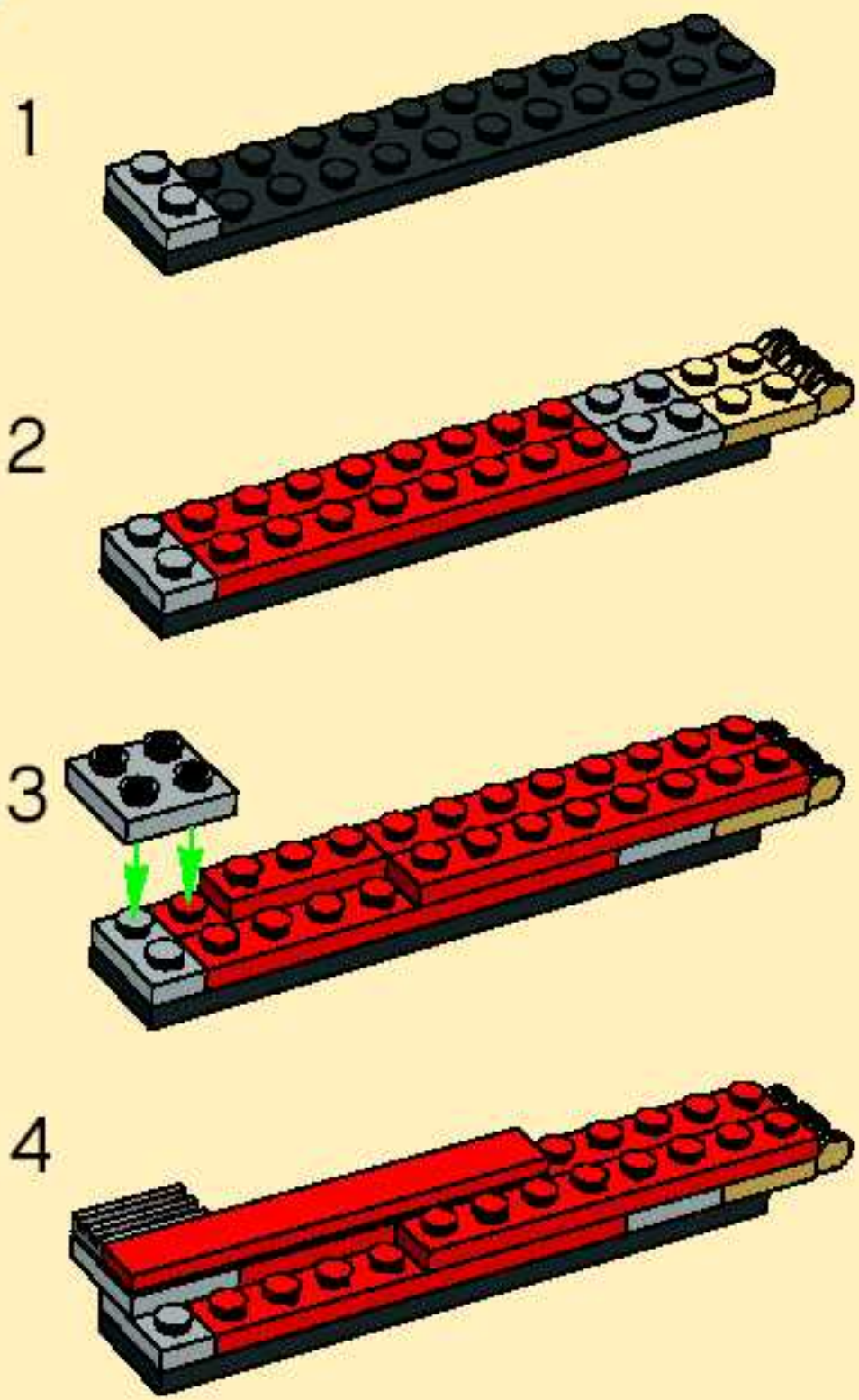



1

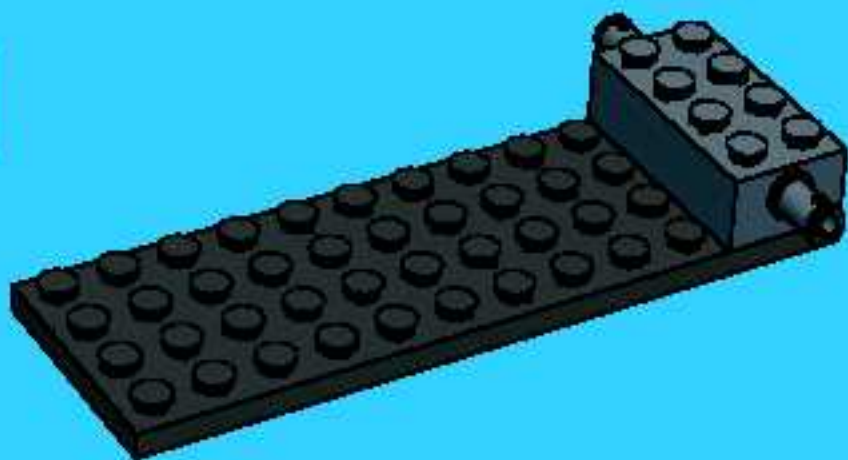

2

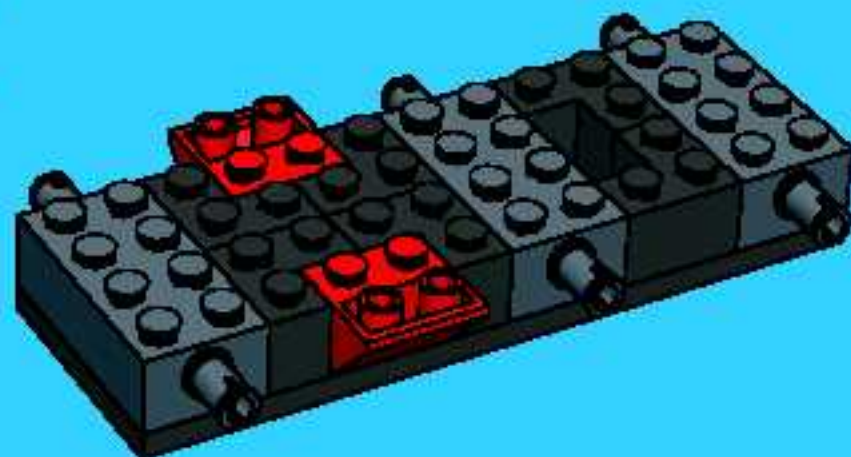

3

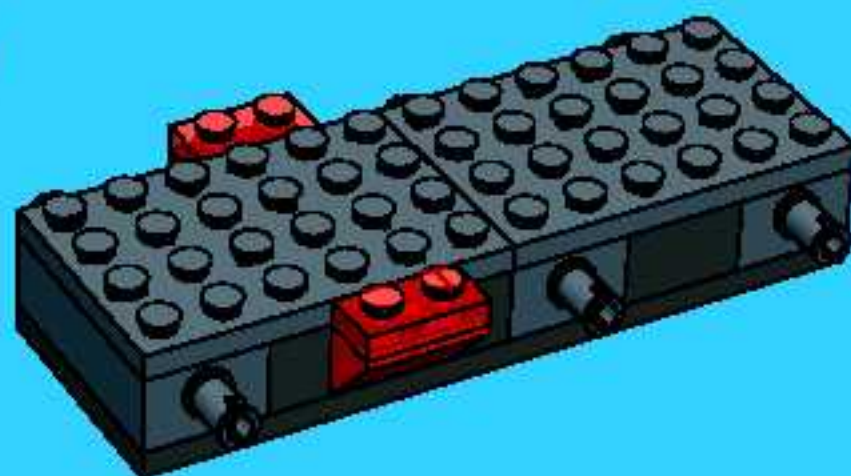

4

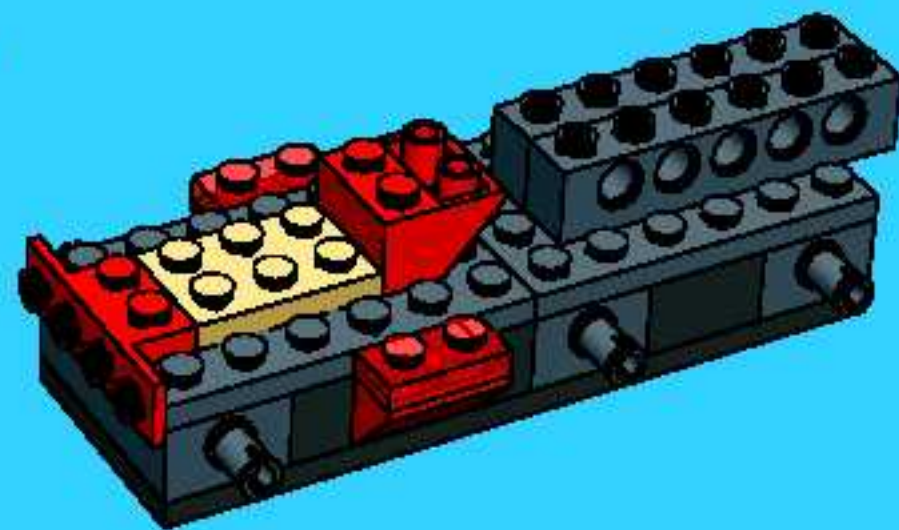

5

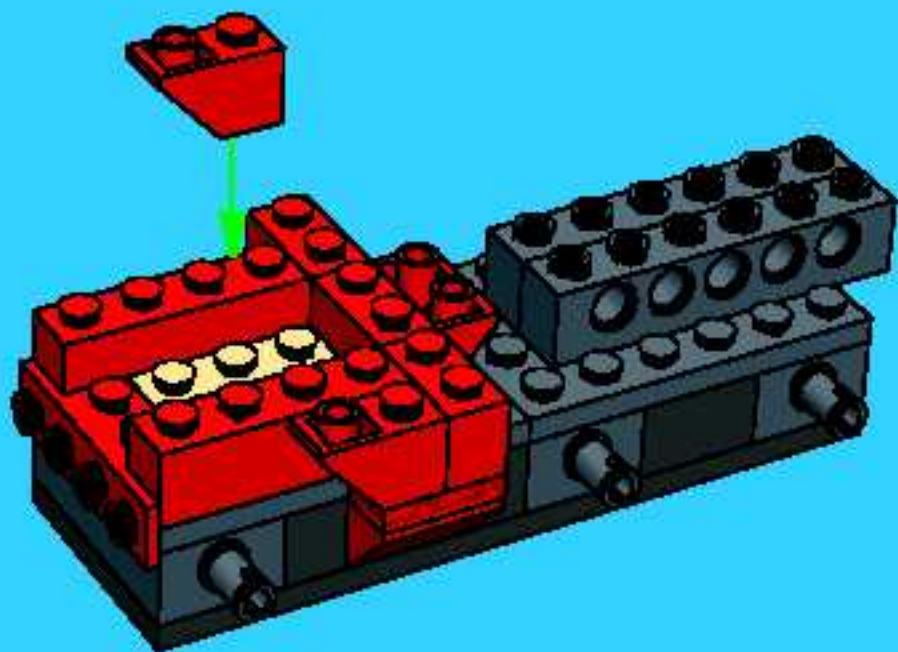

7

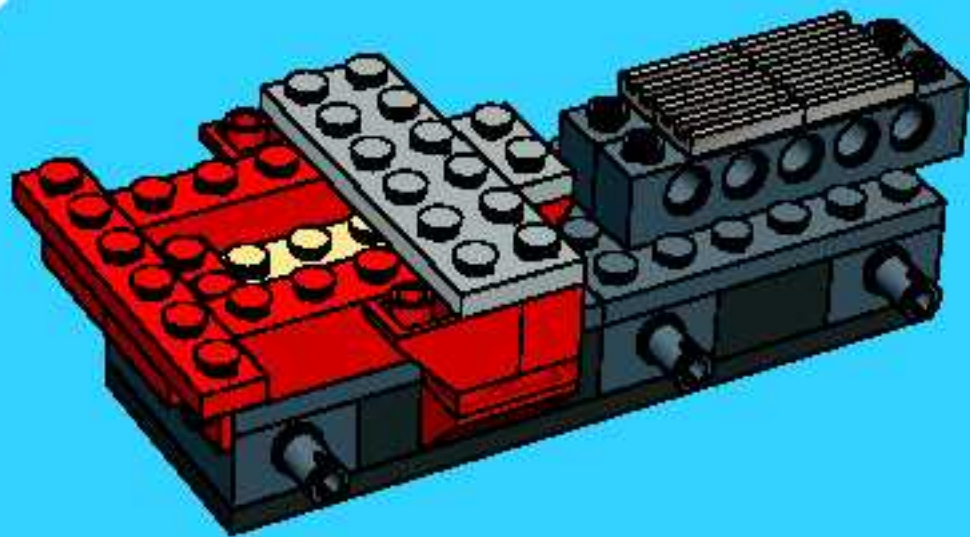

6

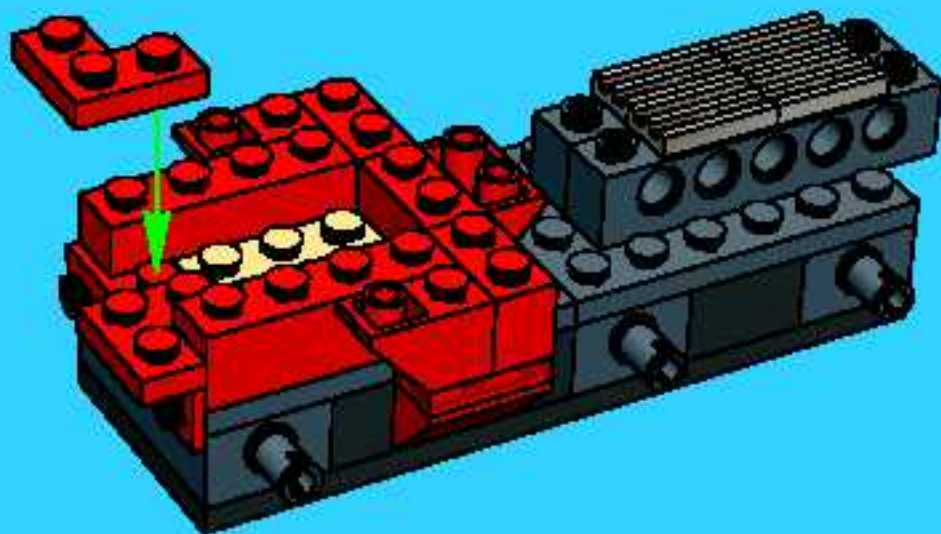

8

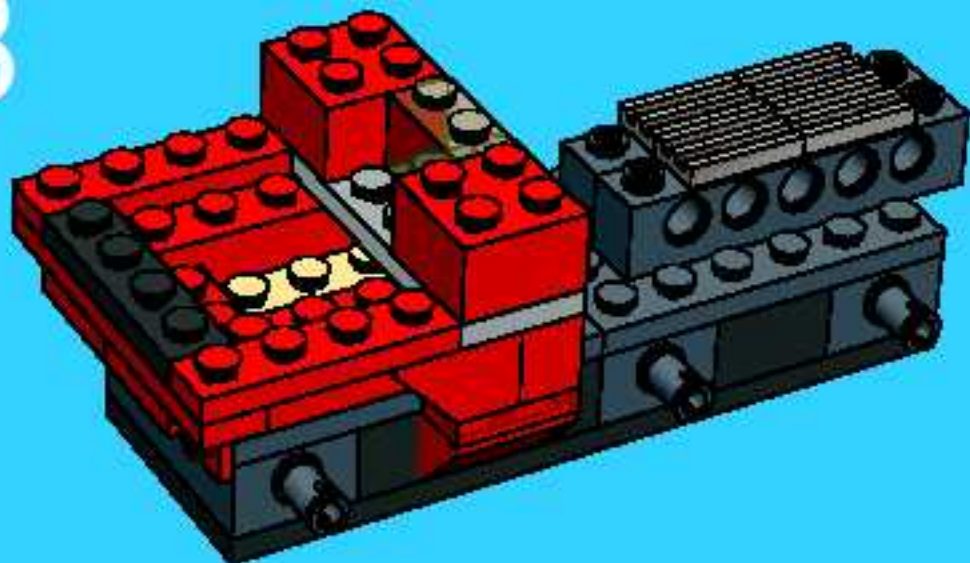



9

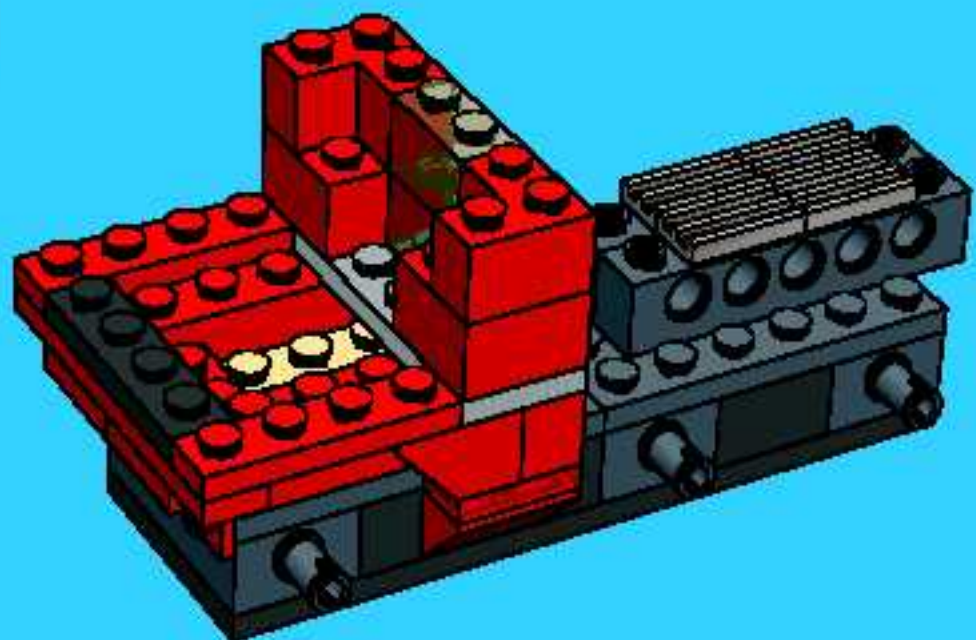

11

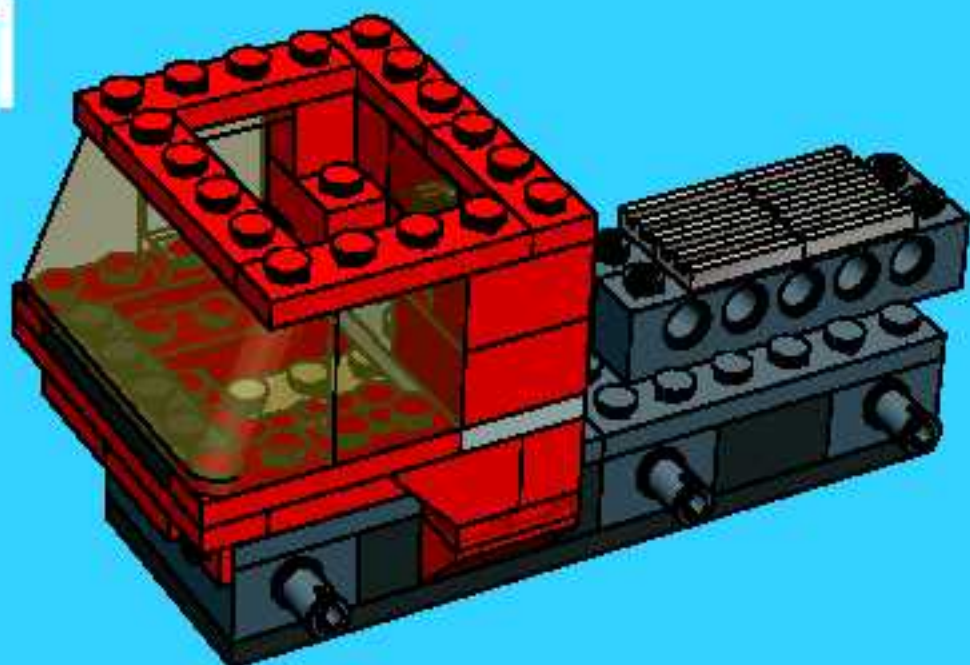

10

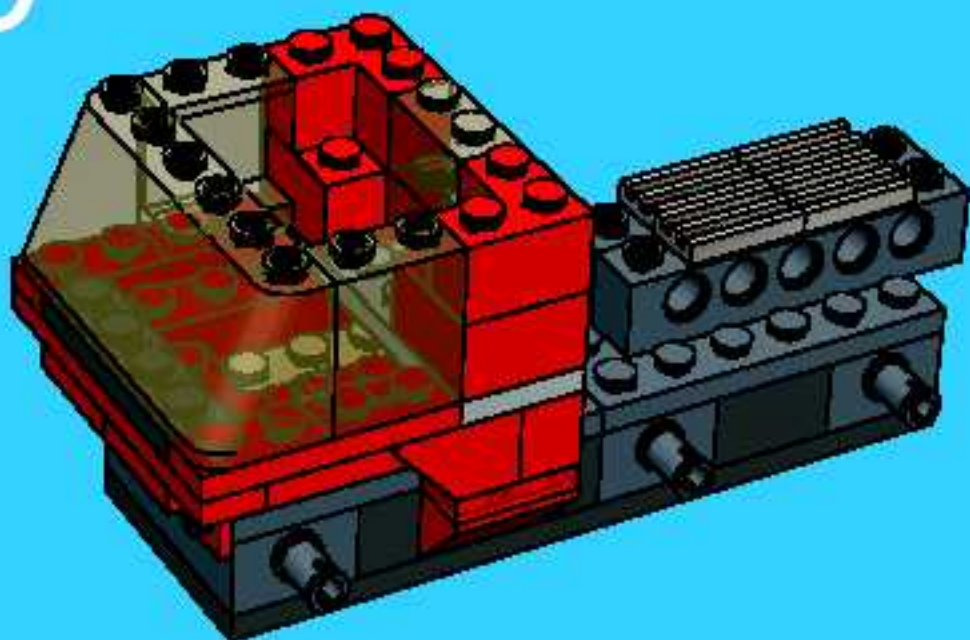

12

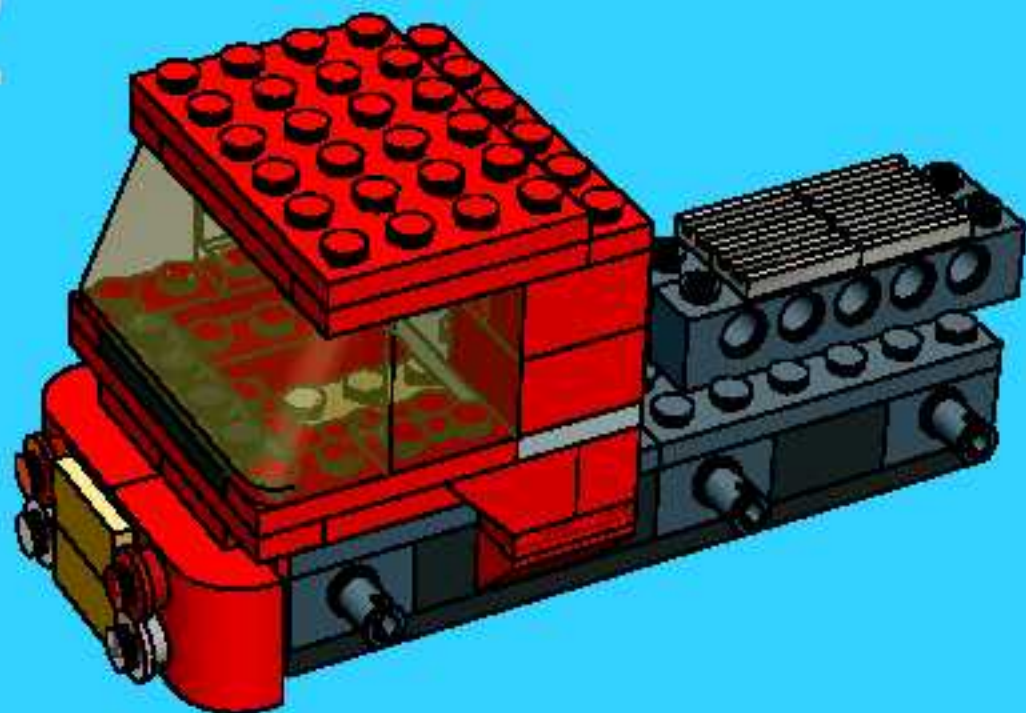

13

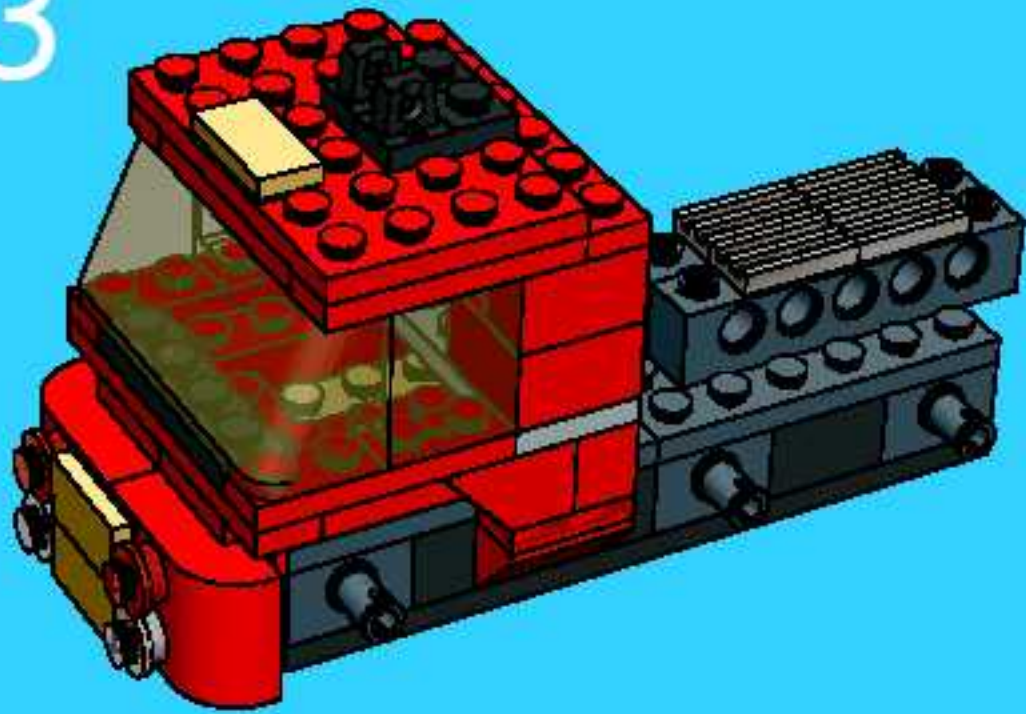

14

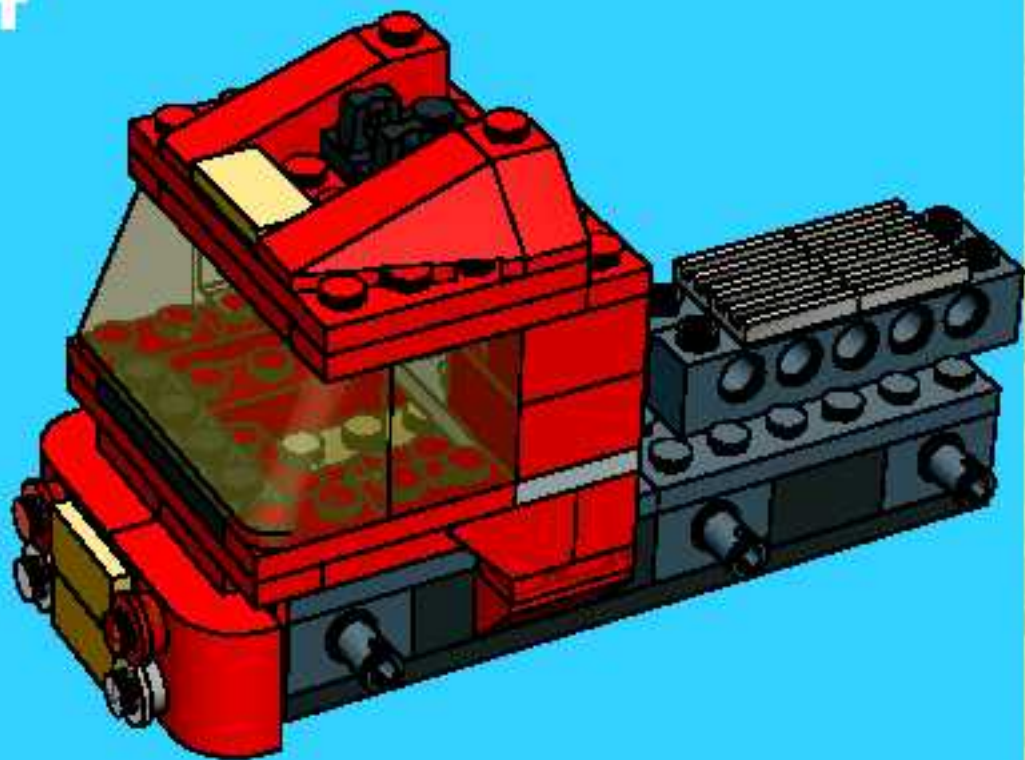

1

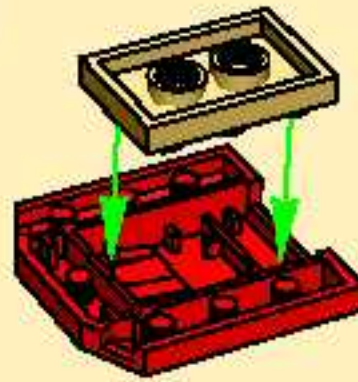

2



3



4



15

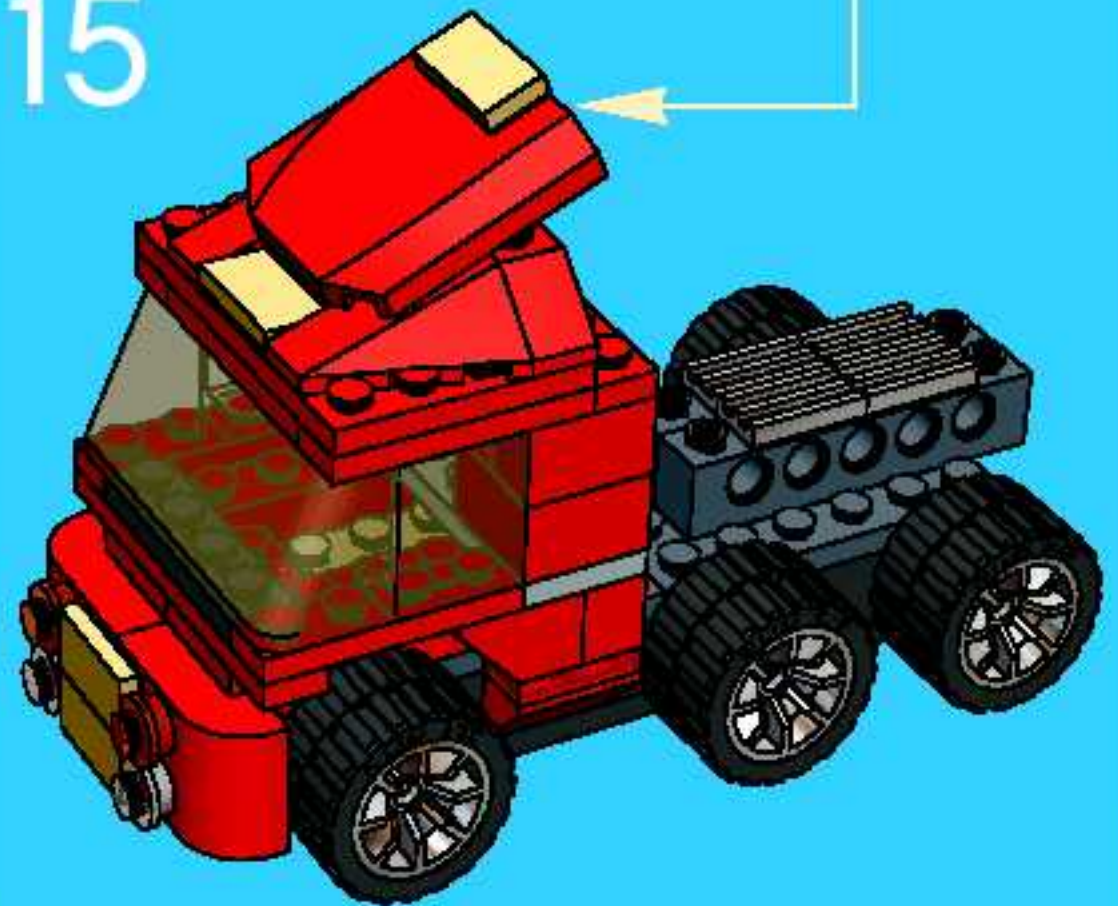



1



2

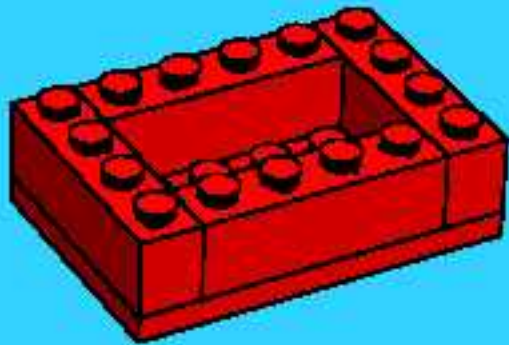

3

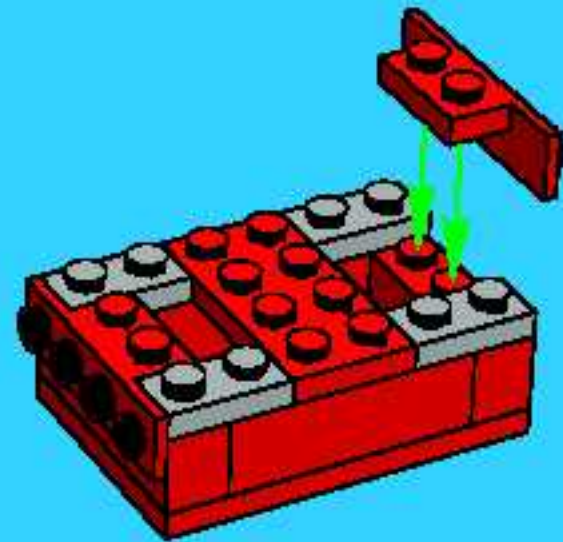

4

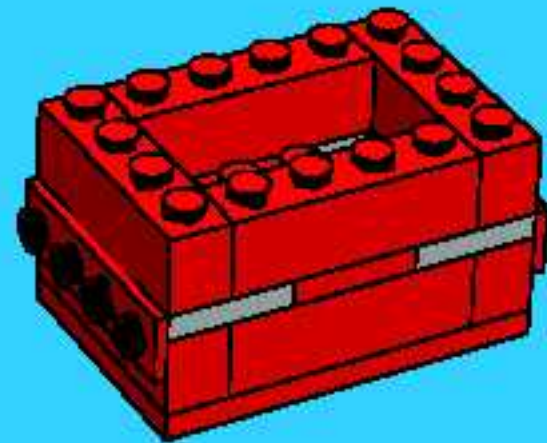

5

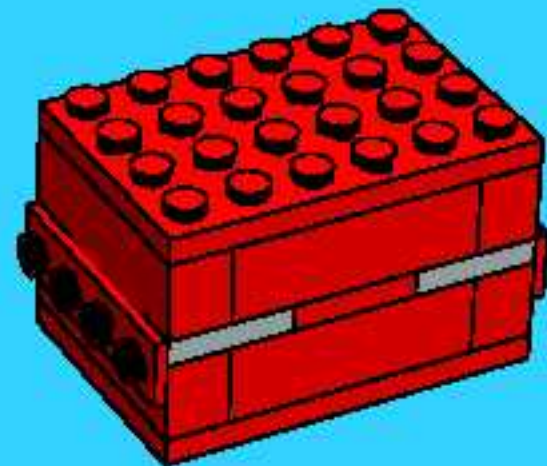

6

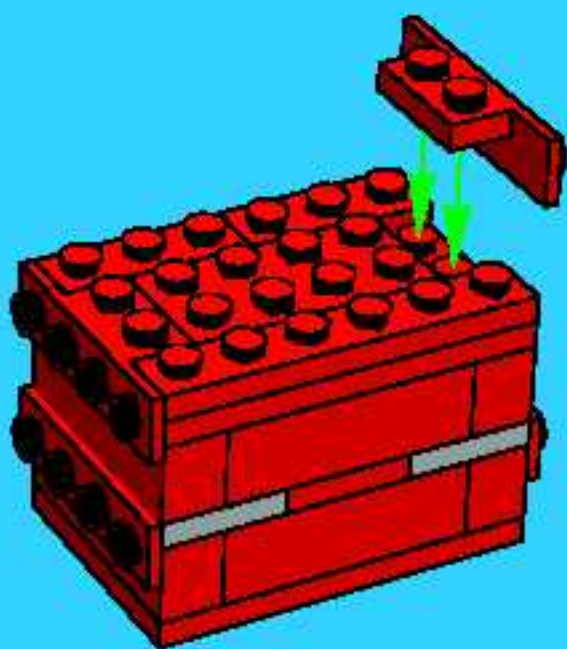

7

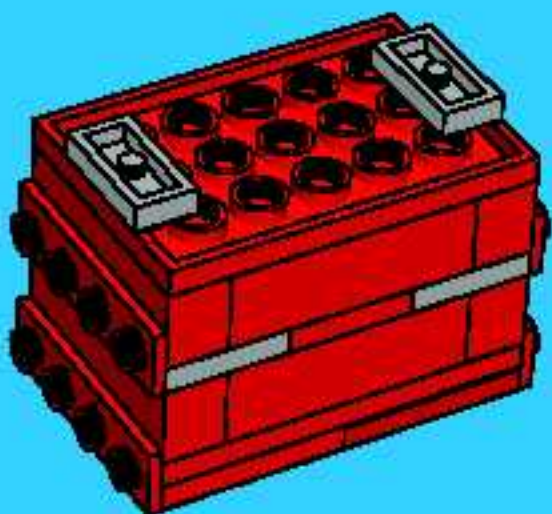

8

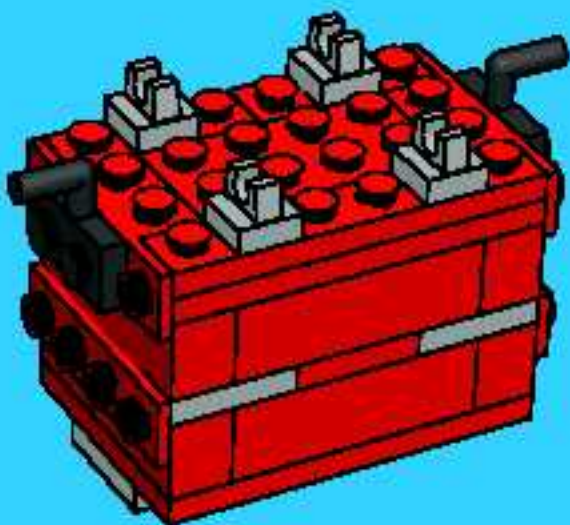

9

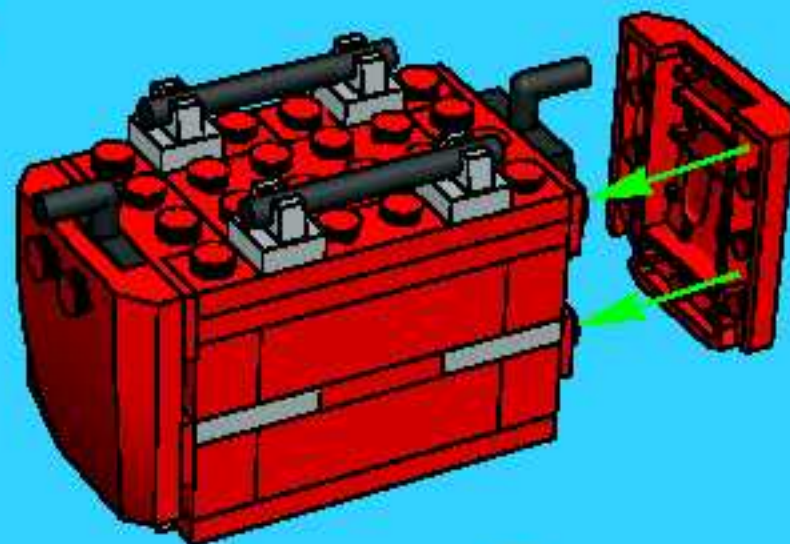

10











# Win! Gagne! Gewinne! 当たります



## WIN LEGO® PRODUCTS

We would like to know what you think about our new LEGO® product. If you could help us by answering a few questions you are in with a chance of winning an exciting LEGO prize. It will only take you about 3 minutes! Log on to the web address below for further instructions.

We would really like to hear what you think about your new LEGO product. If you'd like to help us, go to the web address below for further instructions.



## Estimado usuario LEGO®

Al contestar algunas preguntas en inglés, francés, alemán o japonés, en el sitio [www.acnielsen.aim.dk/lego](http://www.acnielsen.aim.dk/lego), podrás participar en el sorteo de algunos valiosos premios LEGO®.



## LEGO®製品が当たります

私達は、皆さんが買いたいLEGO®製品についてどんな感想をお持ちか、知りたく思っています。質問に答えて、楽しいLEGO®製品の抽選に参加しましょう。アンケートの回答には、ほんの3分ほどしかかかりません。詳しくは、以下のウェブアドレスまでアクセスしてください。



## GAGNE DES PRODUITS LEGO®

Nous aimerions savoir ce que tu penses de ton nouveau produit LEGO®. Si tu veux bien nous aider en répondant à quelques questions, tu recevras peut-être bientôt un fantastique prix LEGO. Et cela ne te prendra que 3 minutes environ ! Tu obtiendras davantage d'informations en visitant le site Internet indiqué ci-dessous.

Nous aimerions savoir ce que tu penses de ton nouveau produit LEGO. Si tu souhaites nous aider, rends-toi à l'adresse Internet ci-dessous où tu trouveras des instructions supplémentaires.



## Caro Consumidor de LEGO®

Ao responder a algumas perguntas em inglês, francês, alemão ou japonês no endereço [www.acnielsen.aim.dk/lego](http://www.acnielsen.aim.dk/lego) irá participar num concurso para ganhar valiosos prémios da LEGO®.



## GEWINNE LEGO® PRODUKTE

Wir sind sehr an deiner Meinung über dein neues LEGO® Produkt interessiert. Wenn du uns den Gefallen tust und ein paar Fragen beantwortest, kannst du einen tollen LEGO Preis gewinnen. Das Ganze dauert nur etwa 3 Minuten! Gehe einfach zu der unten angegebenen Webadresse - dort findest du weitere Informationen.

Wir möchten gerne wissen, was Sie von Ihrem neuen LEGO Produkt halten. Wenn Sie uns helfen möchten, besuchen Sie bitte die u.a. Website, auf der Sie alles Weitere erfahren.



## Kedves Új LEGO® Vásárló

Ha ellátogat az [www.acnielsen.aim.dk/lego](http://www.acnielsen.aim.dk/lego) honlapra és ott angol, francia, német vagy japán nyelven megválaszol az néhány kérdést, akkor részt vehet egy versenyben, amelyben értékes LEGO® díjakat nyerhet.

[www.acnielsen.aim.dk/LEGO](http://www.acnielsen.aim.dk/LEGO)





2x  
50748.21



7x  
3004.21



6x  
4070.21



6x  
3005.21



6x  
2420.21



2x  
3022.21



4x  
6091.21



8x  
3665.21



8x  
3660.21



2x  
3004.21



2x  
41855.21



2x  
2257.21



2x  
3003.21



1x  
3039.21



2x  
43723.21



2x  
43722.21



1x  
3021.21



2x  
6215.21



2x  
30952.21



6x  
2436.21



4x  
45677.21



1x  
4370.21



1x  
4371.21



10x  
3010.21



8x  
3823.21



6x  
3710.21



1x  
2431.21



4x  
3020.21



2x  
3666.21



4x  
3480.21



2x  
4182.21



3x  
3032.21



7x  
3089.5



4x  
44302.6



2x  
3004.5



3x  
3021.5



4x  
2655194



8x  
3023194



2x  
30663194



4x  
3673194



4x  
2444194



1x  
243194



1x  
3795194



1x  
6232.199



6x  
6249.199



2x  
3864.199



2x  
3052.199



2x  
30057.41



2x  
30008.41



2x  
6226.41



2x  
51800.301



5x  
51815.301



13x  
51569.301



6x  
30057.40



2x  
6225.40



4x  
30057.47



2x  
49673.111



2x  
3065.111



2x  
6227.111



1x  
47904.111



4x  
6298.111



2x  
6298.111



1x  
4798.111



2x  
4070.26



4x  
2760.26



2x  
4623.26



4x  
30985.26



2x  
3794.26



1x  
2540.26



2x  
3022.26



4x  
3660.26



6x  
2957.26



2x  
20374.26



5x  
30391.26



8x  
30648.26



2x  
3710.26



1x  
3795.26



1x  
3035.26



1x  
3029.26



1x  
2445.26



1x  
30028.1



1x  
45677.1

**LEGO**

Designer Set



4882



4886



4881



4266109

©2005 The LEGO Group.



[www.LEGO.com/create](http://www.LEGO.com/create)