

# BIONICLE®



8614

VAHKI NUURAKH





# METRU NUI



PO-METRU



ONU-METRU



KO-METRU

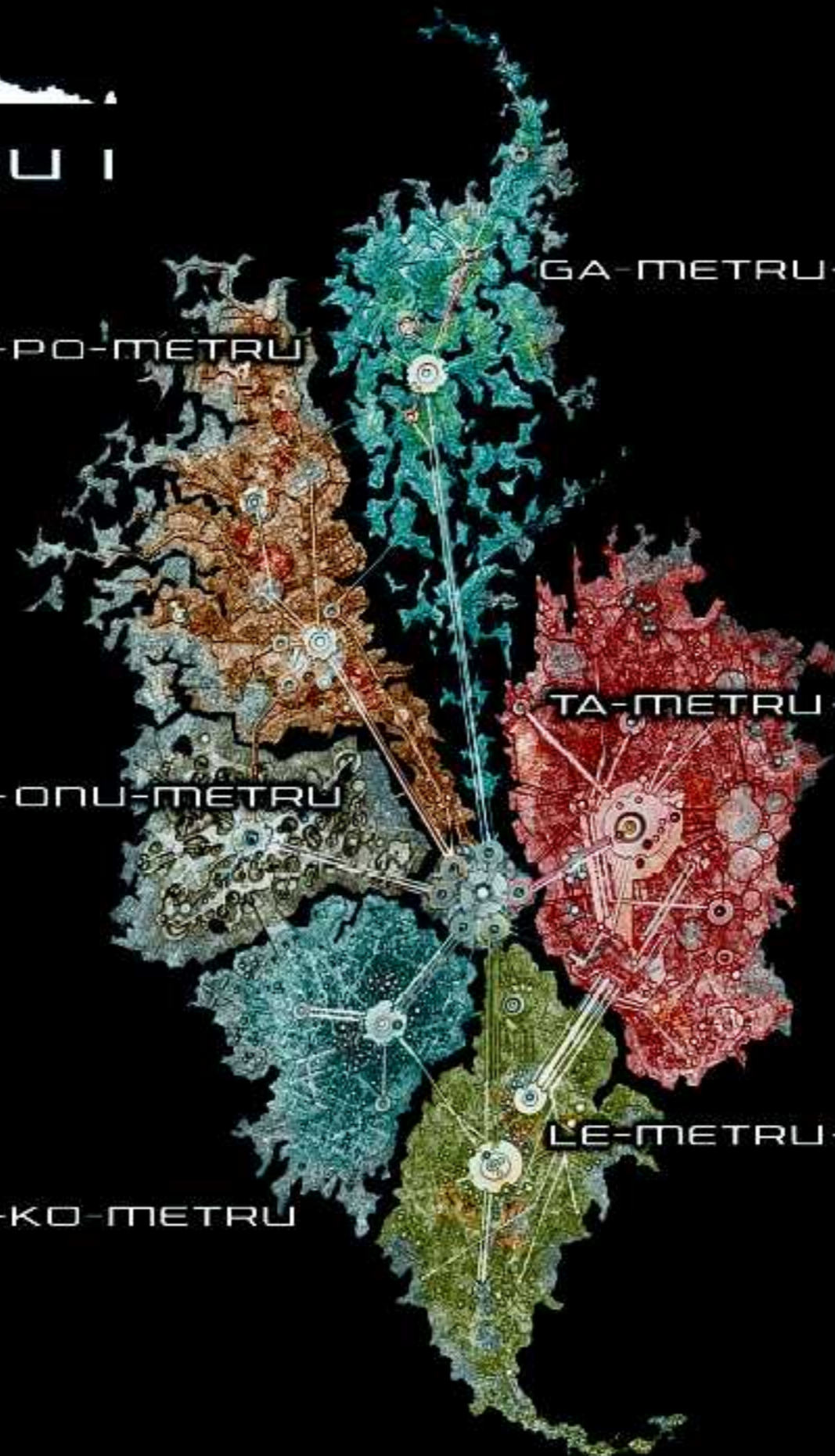

GA-METRU

TA-METRU

LE-METRU





1



2

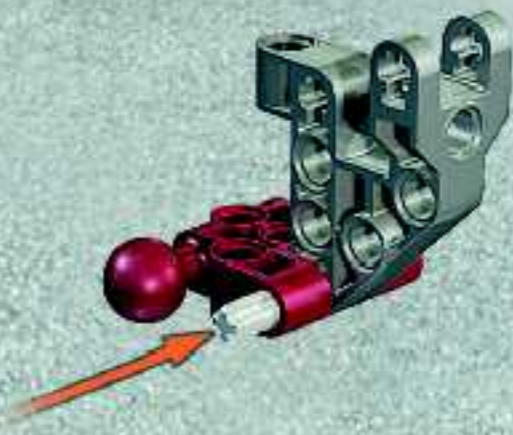



3

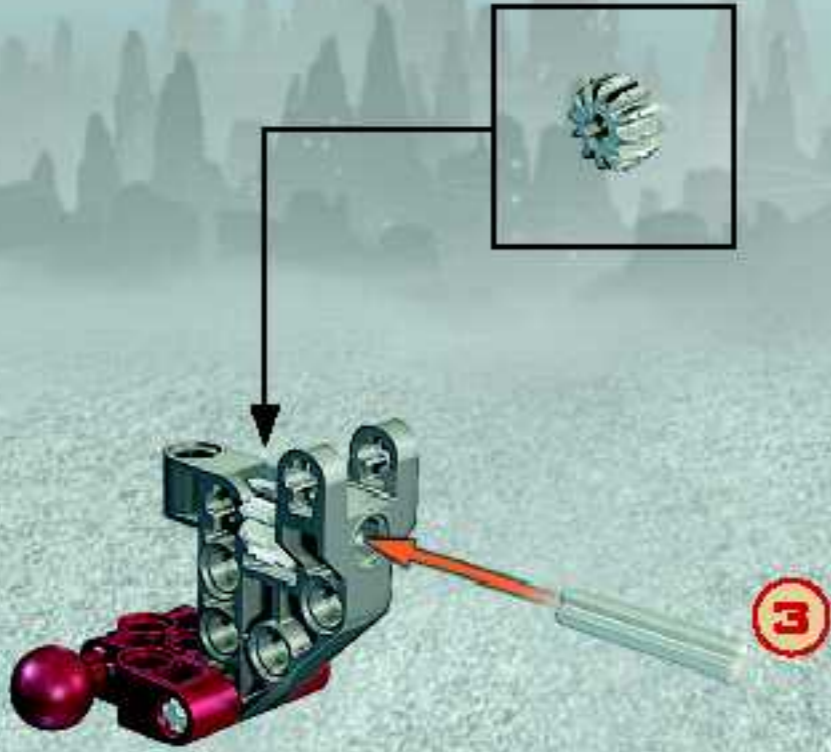

4





5





6

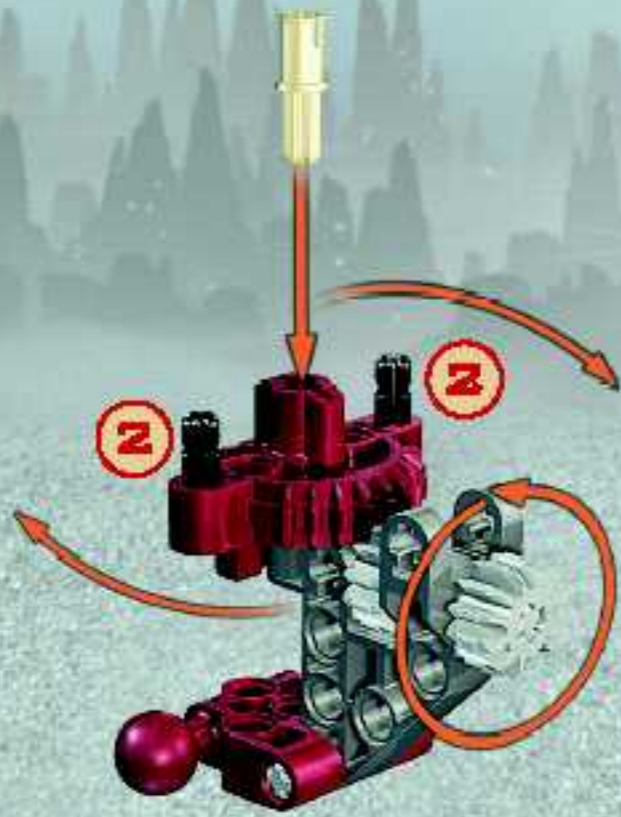

7

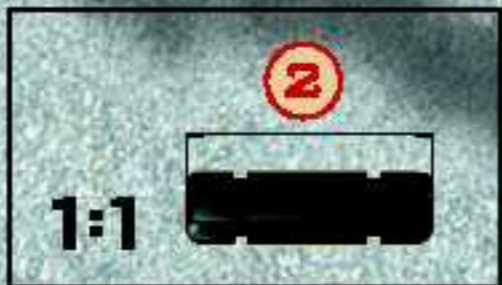
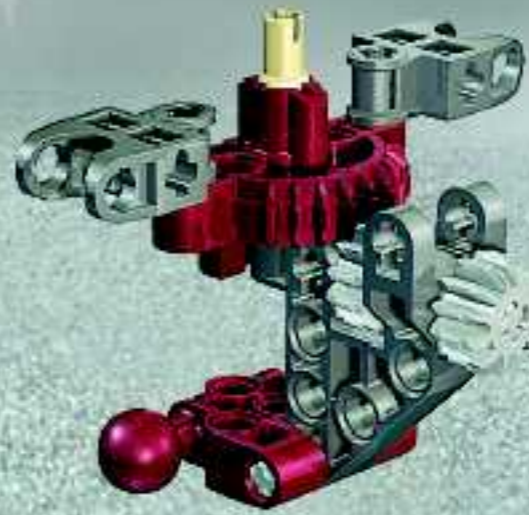



8



9



1:1





1



8

2



3



2x



11

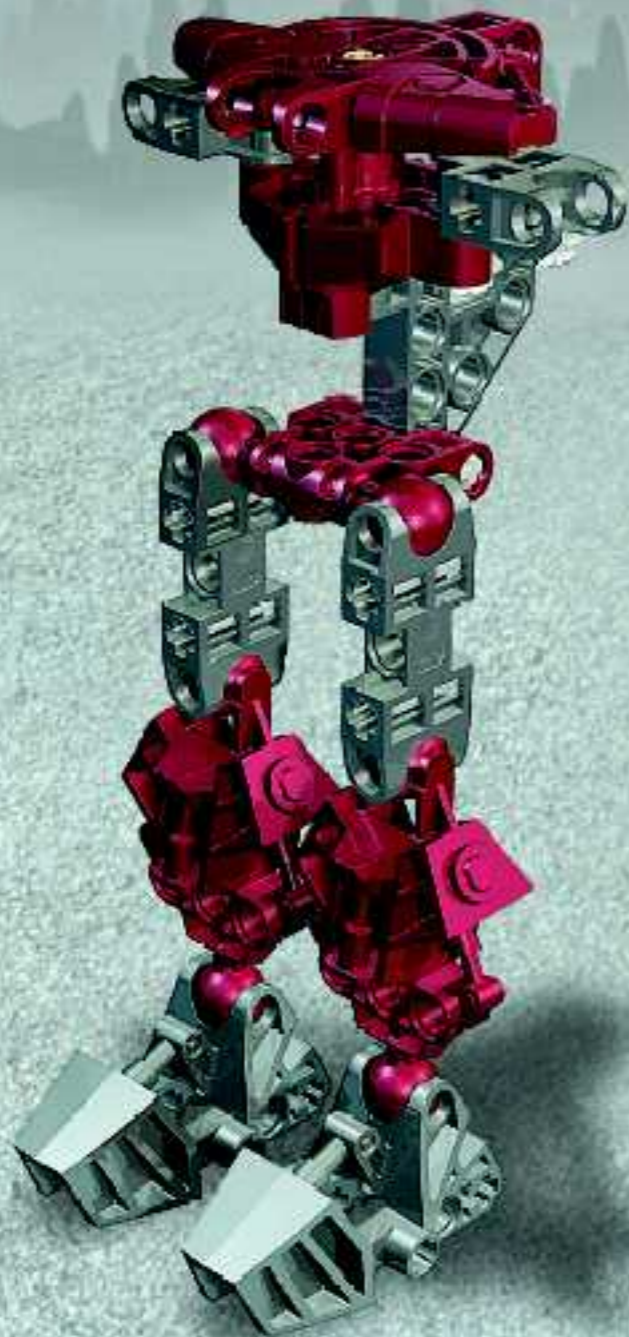

12

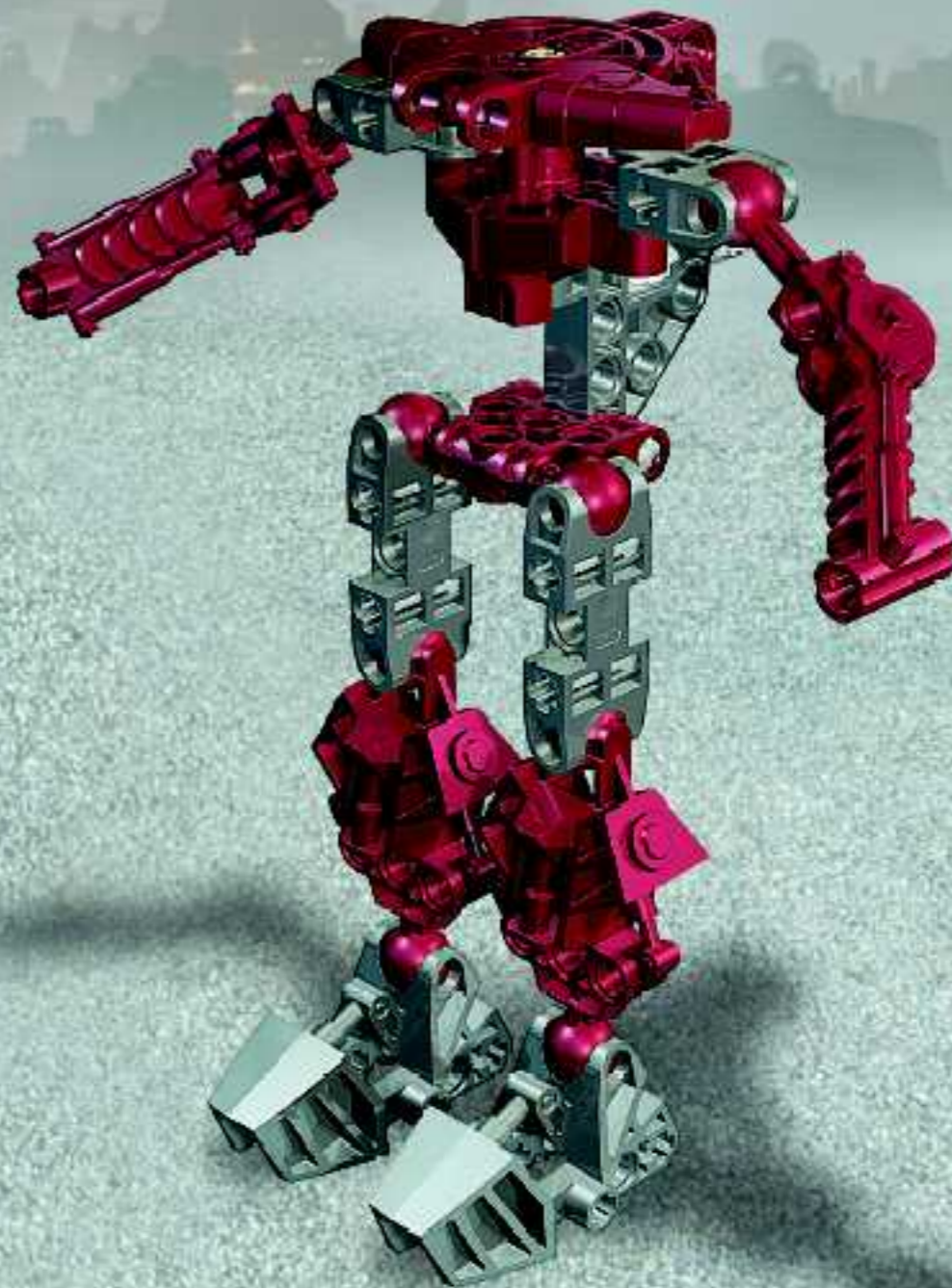



13

1

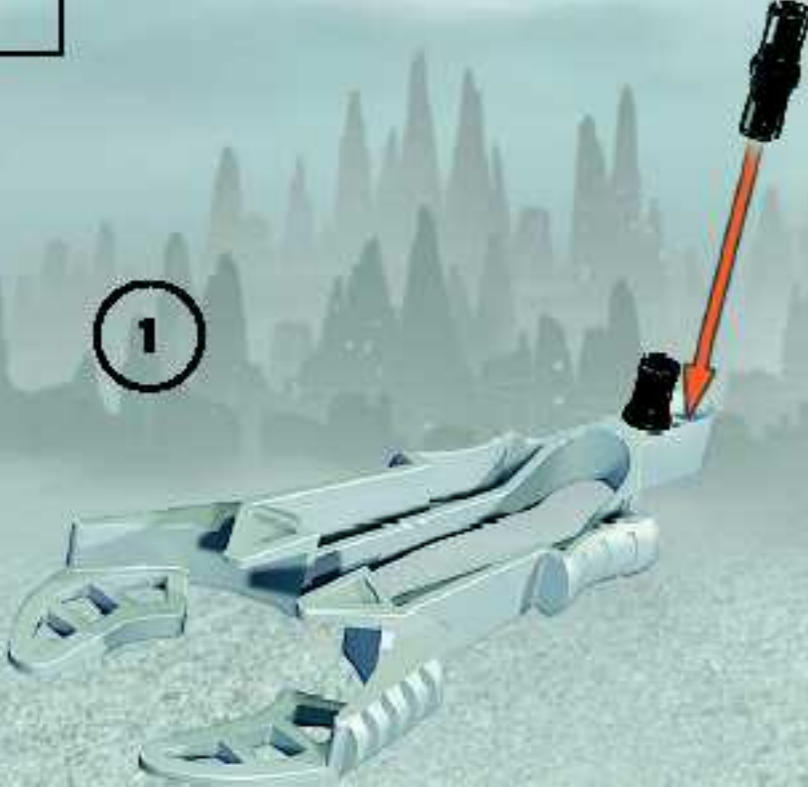

2





3

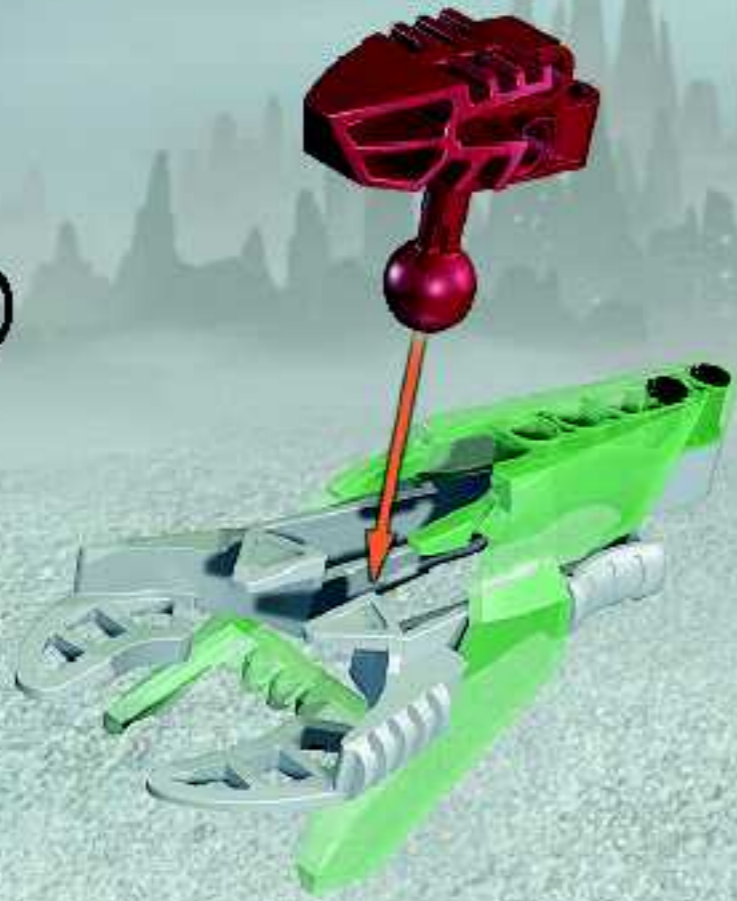

4

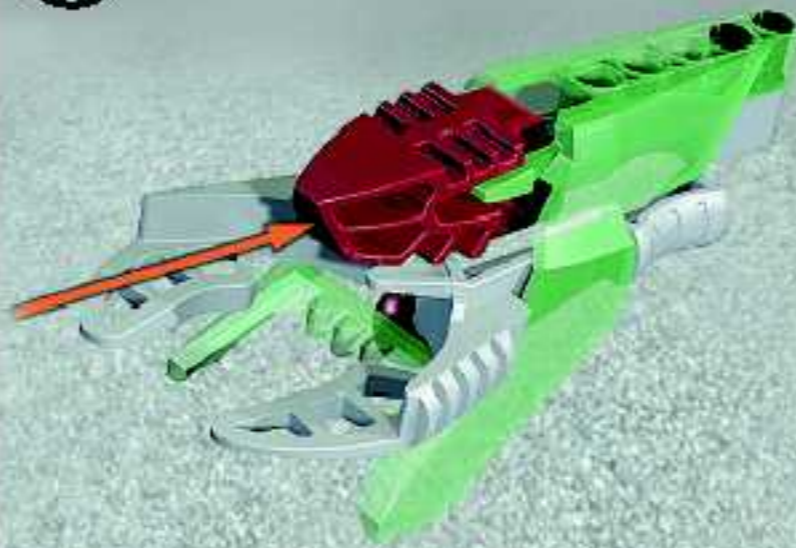

5





14





15





1





2





3





4





1



2





3

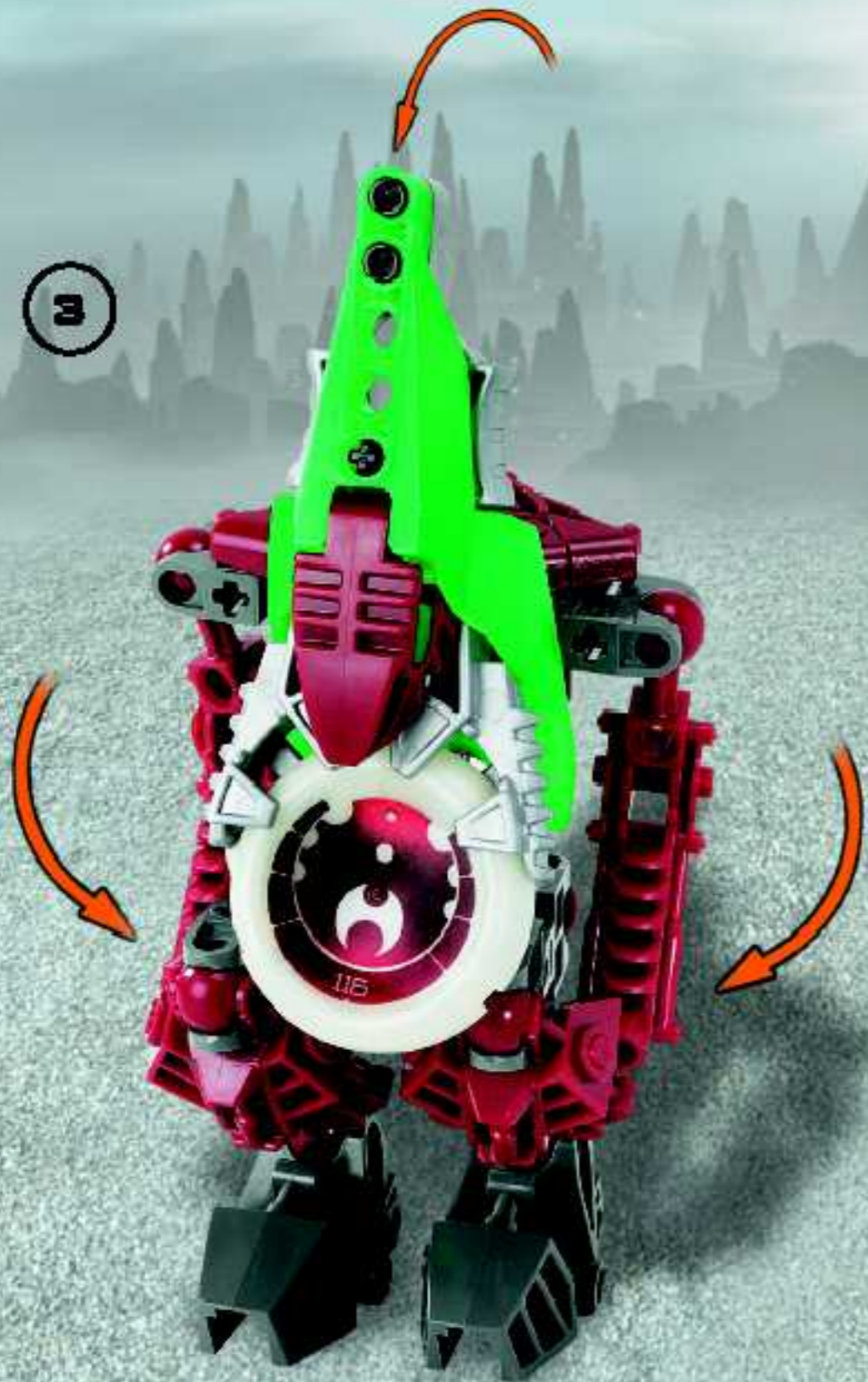

4





8614



+

8616



+

8618





**1**

**2**

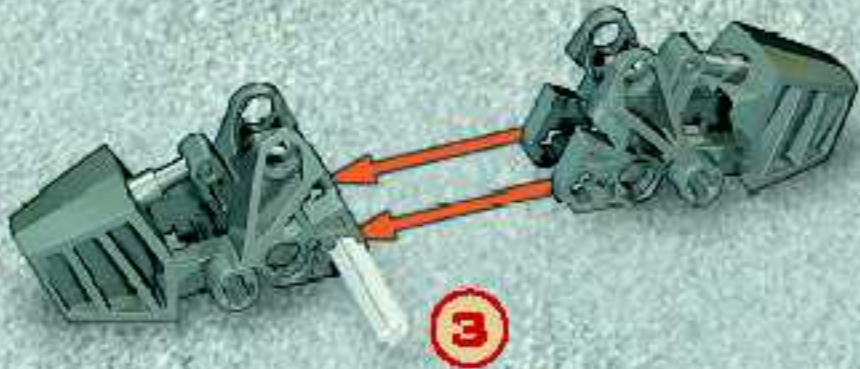



3





4

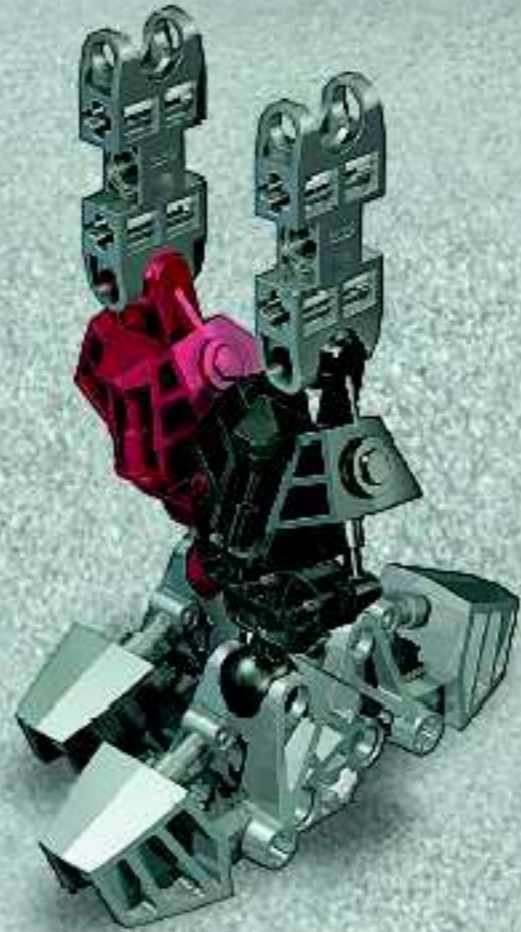



5

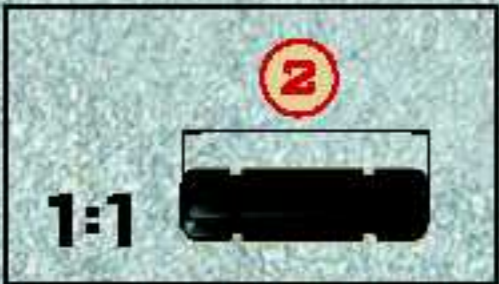
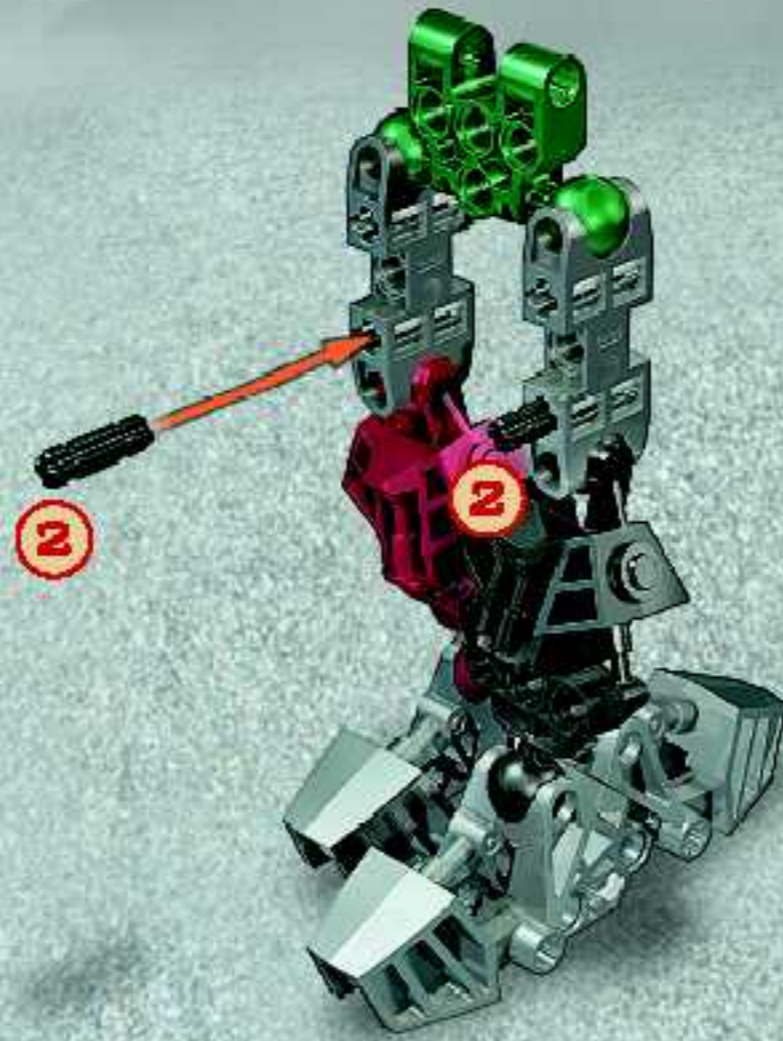



6

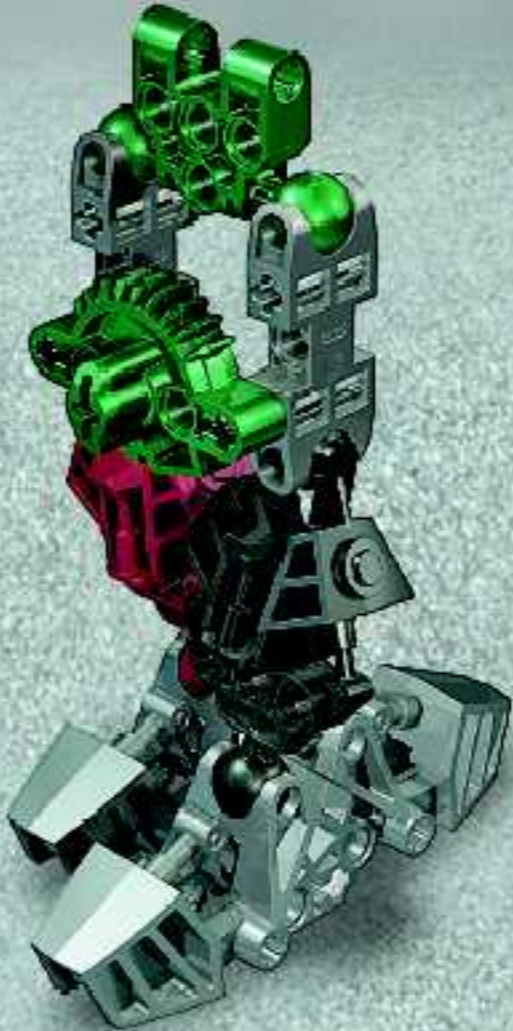



7

1



2

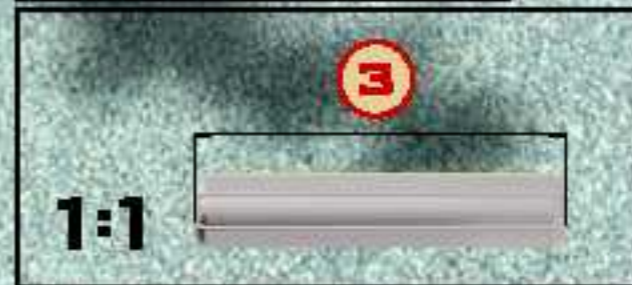
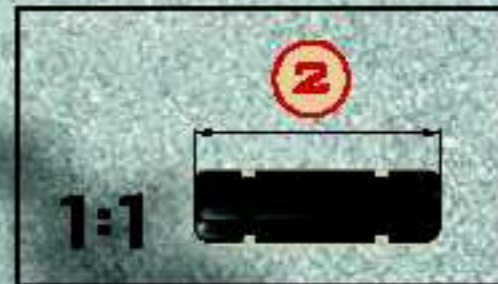
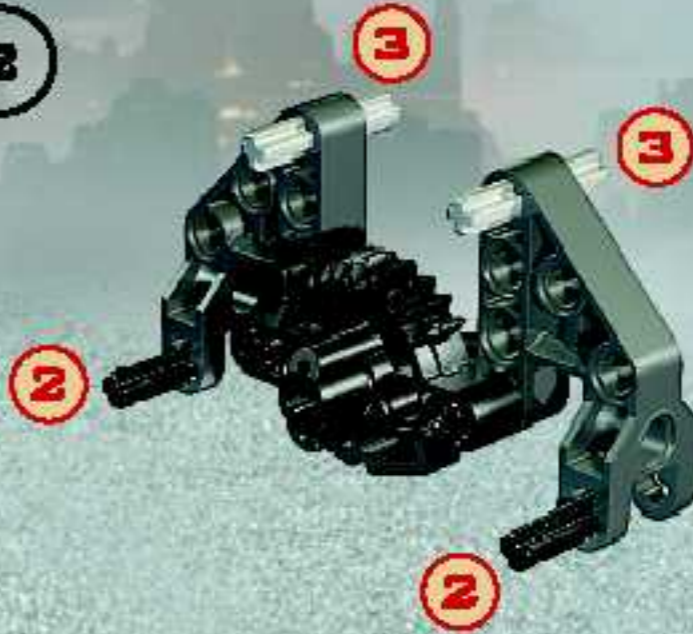



8

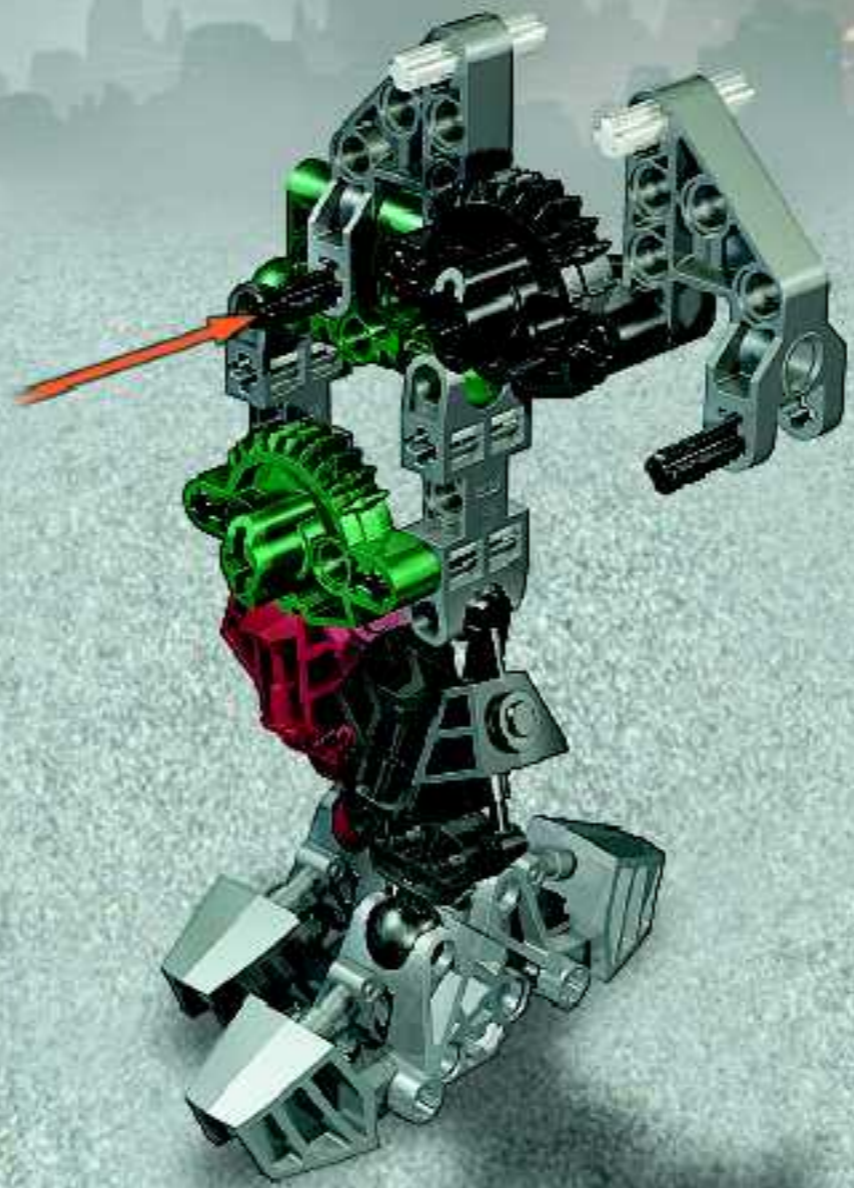



VAHKI  
KEERAKH  
8619



VAHKI  
VORZAKH  
8616



VAHKI  
PUURAKH  
8614







VAHKI  
RORZAKH  
8618

A Bionicle Vahki Rorzakh, a black and yellow mechanical warrior, is shown in a dynamic pose. It has a large, silver, claw-like hand on its right side and a smaller, similar hand on its left. The background is a bright, orange and red sky with a large, curved structure above it.



VAHKI  
BORDAKH  
8615

A Bionicle Vahki Bordakh, a blue and orange mechanical warrior, is shown in a dynamic pose. It has a large, silver, claw-like hand on its right side and a smaller, similar hand on its left. The background is a blue sky with a large, curved structure above it.



VAHKI  
ZADAKH  
8617

A Bionicle Vahki ZadaKh, a blue and red mechanical warrior, is shown in a dynamic pose. It has a large, silver, claw-like hand on its right side and a smaller, similar hand on its left. The background is a brown, rocky landscape with a large, curved structure above it.





8607 NUHRRI



8608 VHSOLA



8609 TEHUTTI



8610 AHKMOU

# МАТОРАН



8611 ORKAHM



8612 EHYRE





# Win! Gagne! Gewinne! 当たります



## WIN LEGO® PRODUCTS

We would like to know what you think about our new LEGO® product. If you could help us by answering a few questions you are in with a chance of winning an exciting LEGO prize. It will only take you about 3 minutes! Log on to the web address below for further instructions.



## Estimado usuario LEGO®

Al contestar algunas preguntas en inglés, francés, alemán o japonés, en el sitio [www.acnielsen.aim.dk/lego](http://www.acnielsen.aim.dk/lego), podrás participar en el sorteo de algunos valiosos premios LEGO®.



## 英語でレゴ®製品が当たります

私たちに、皆さんが新しいレゴ®製品についてどんな感想をお持ちか、知りたいと思っています。質問に答えて、新しいレゴ®製品の抽選に参加しましょう。アンケートの回答には、日本人の皆さんにも参加のチャンスがあります。詳しくは、以下のウェブアドレスまでアクセスしてください。



## GAGNE DES PRODUITS LEGO®

Nous aimerions savoir ce que tu penses de ton nouveau produit LEGO®. Si tu veux bien nous aider en répondant à quelques questions, tu recevras peut-être bientôt un fantastique prix LEGO. Et cela ne te prendra que 3 minutes environ ! Tu obtiendras davantage d'informations en visitant le site Internet indiqué ci-dessous.



## Caro Consumidor da LEGO®

Ao responder a algumas perguntas em inglês, francês, alemão ou japonês no endereço [www.acnielsen.aim.dk/lego](http://www.acnielsen.aim.dk/lego) irá participar num concurso para ganhar valiosos prémios da LEGO®.



## GEWINNE LEGO® PRODUKTE

Wir sind sehr an deiner Meinung über dein neues LEGO® Produkt interessiert. Wenn du uns den Gefallen tust und ein paar Fragen beantwortest, kannst du einen tollen LEGO Preis gewinnen. Das Ganze dauert nur etwa 3 Minuten! Gehe einfach zu der unten angegebenen Webadresse - dort findest du weitere Informationen.



## Kedves Új LEGO® Vásárló

Ha eldögtet az [www.acnielsen.aim.dk/lego](http://www.acnielsen.aim.dk/lego) honlapon és ott angol, francia, német vagy japán nyelven megválaszolsz néhány kérdést, akkor részt vehetsz egy versenyben, amelyben értékes LEGO® díjakat nyerhetsz.

# [www.acnielsen.aim.dk/LEGO](http://www.acnielsen.aim.dk/LEGO)





4270006



BIONICLE<sup>®</sup>

# 2

LEGENDS OF  
**METRU NUI**



[www.bioniclemovies.com](http://www.bioniclemovies.com)



©2004 The LEGO Group.