



STAR WARS

9496



1

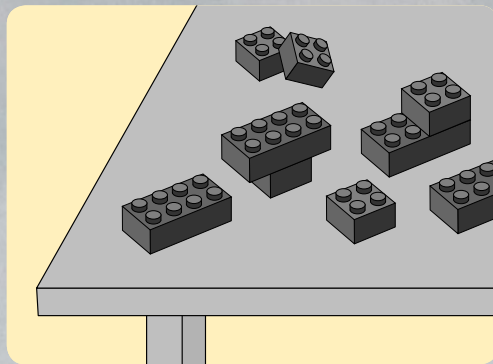
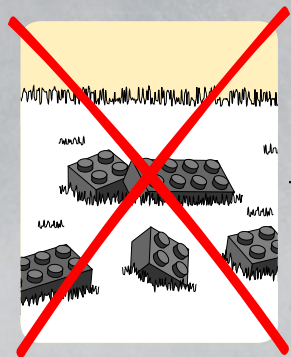

2

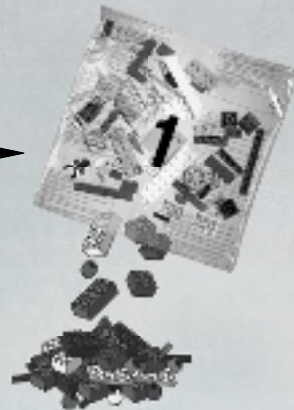

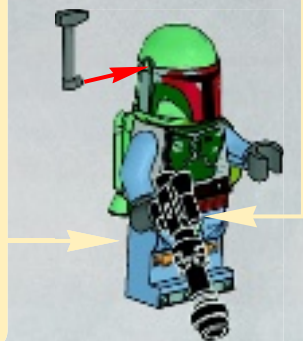
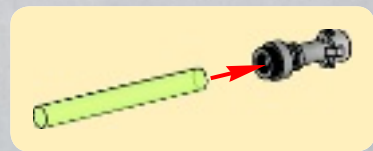
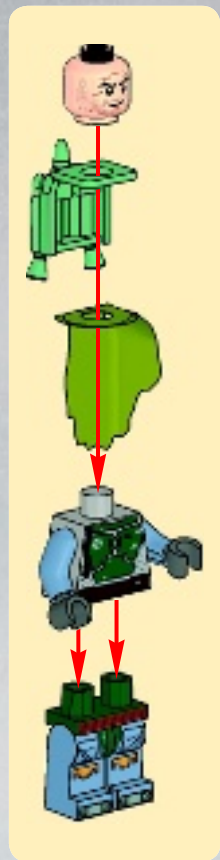



1

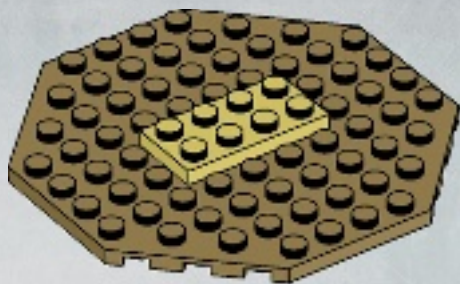



2x



4x

2

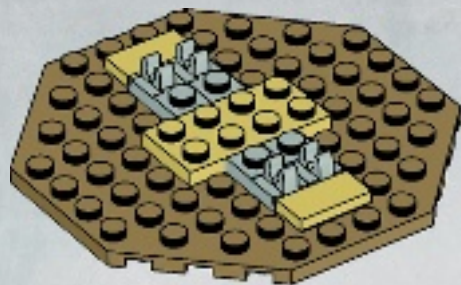

2x



1x

3

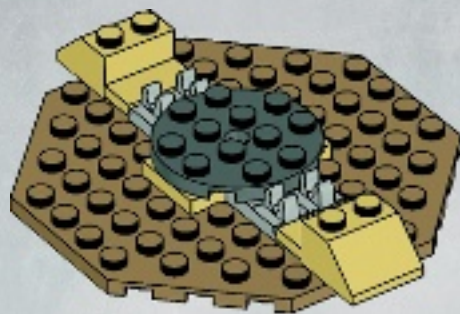



4x

4

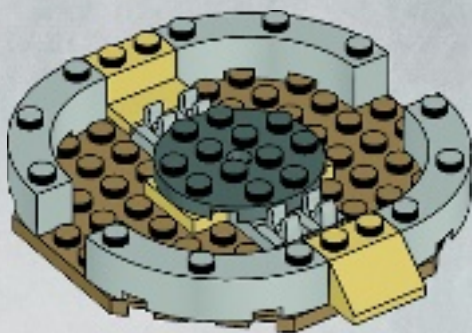

6



2x



4x



2x

5

1



2

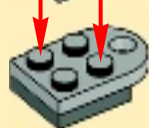

3

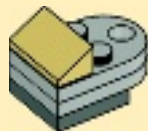

2x





4x

6

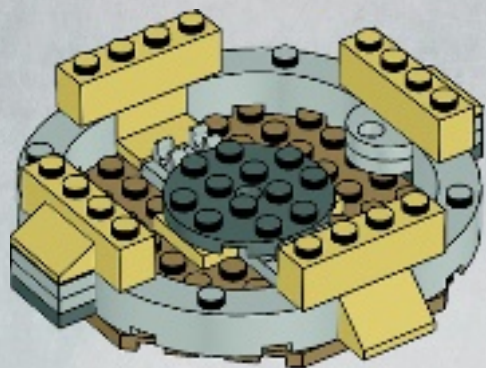

8



4x

7

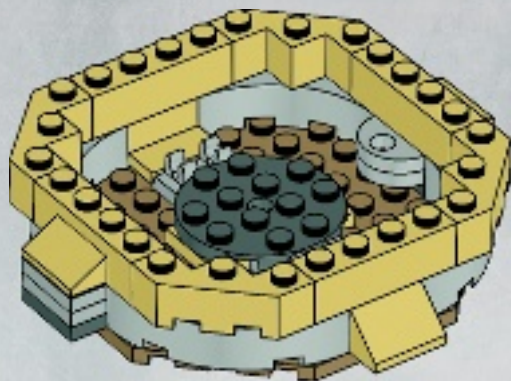



8x

8

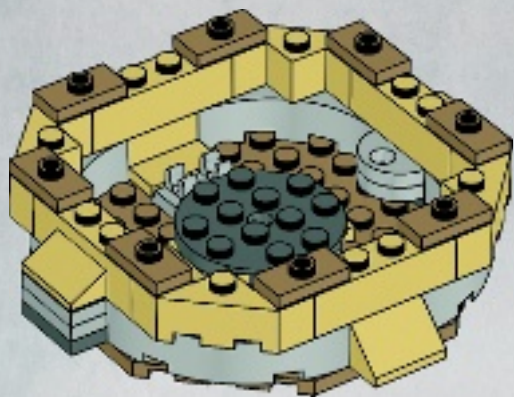

8x

9

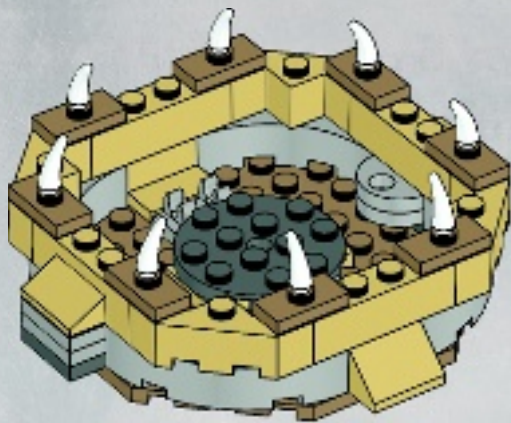

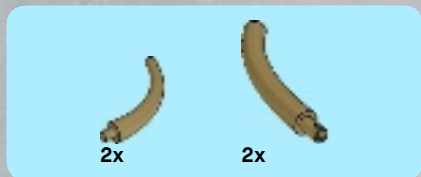

10

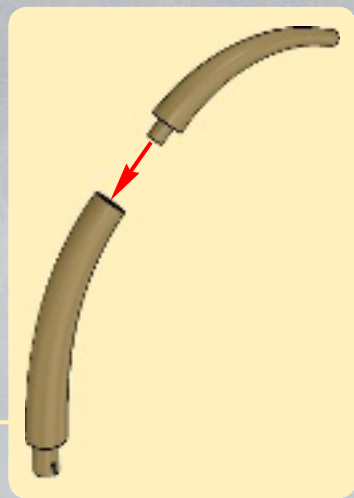
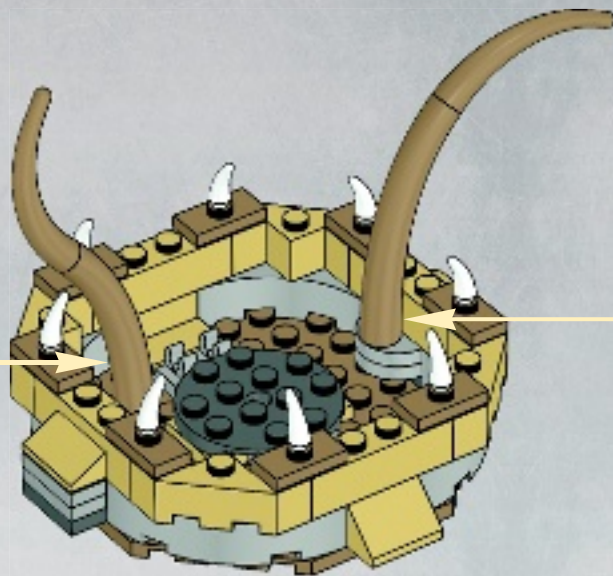
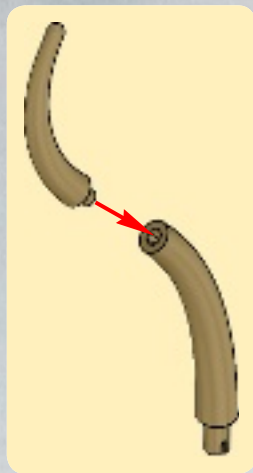



2x

11

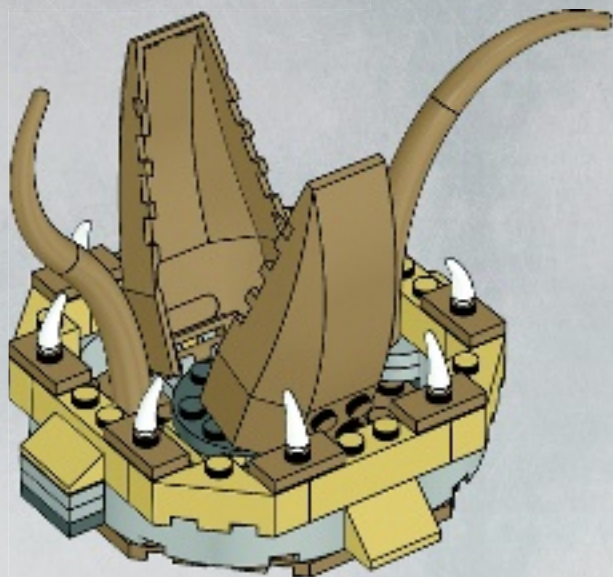

12

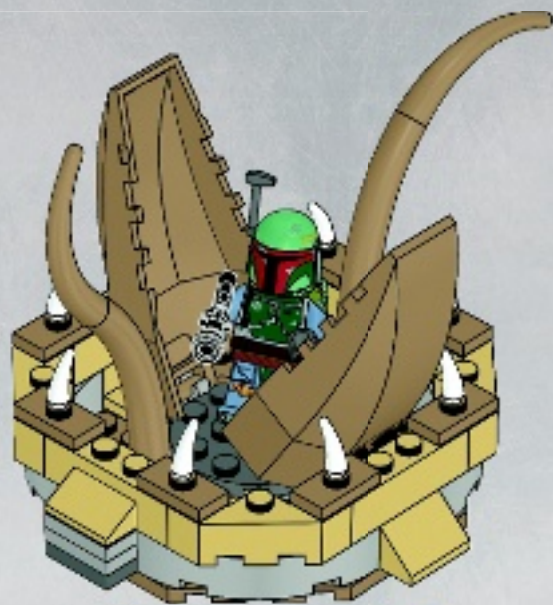

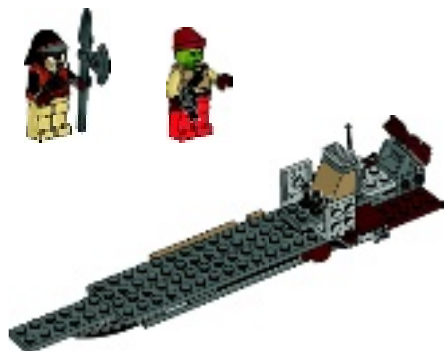

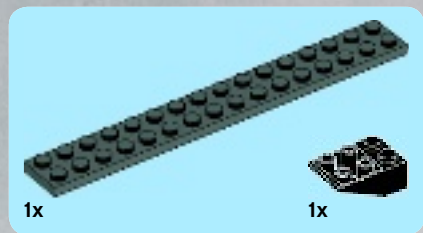

1

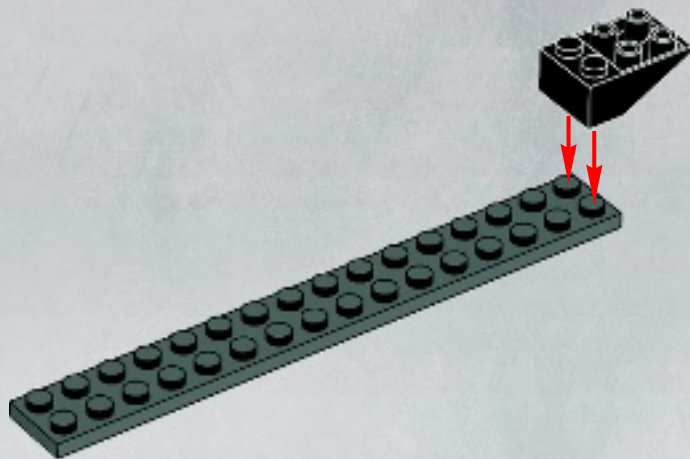



2x



2x

2

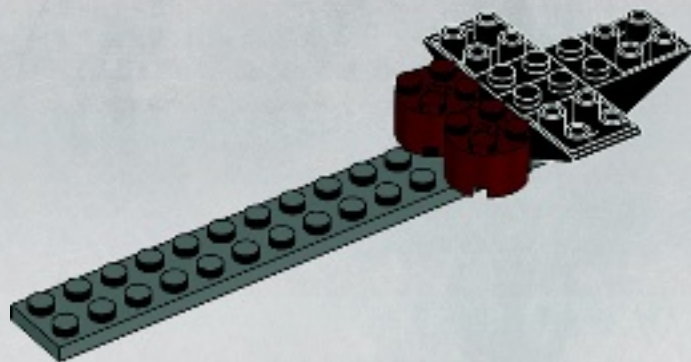



1x



1x



2x

3

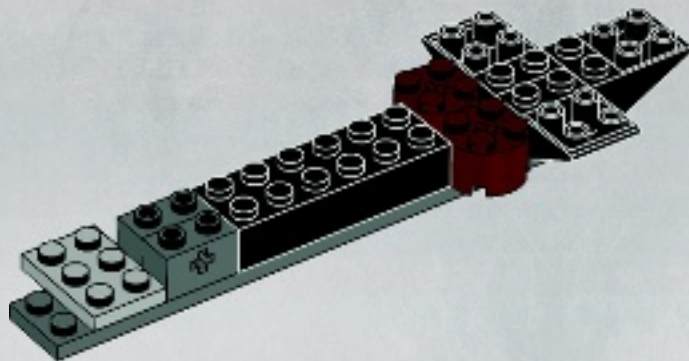



2x

4

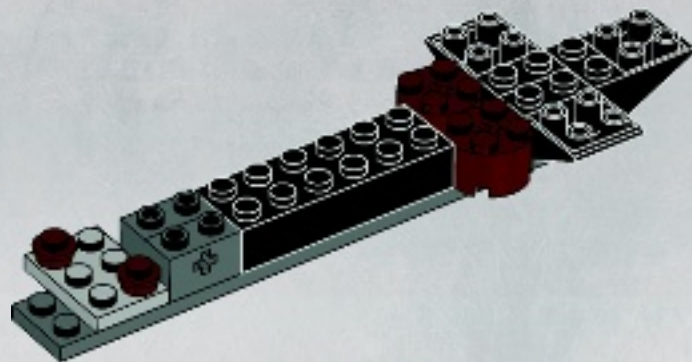

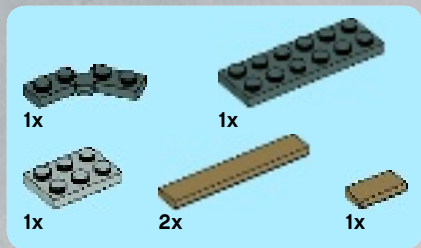

5

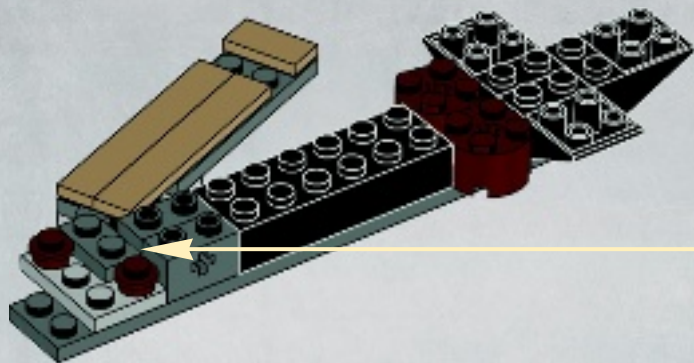

1



2

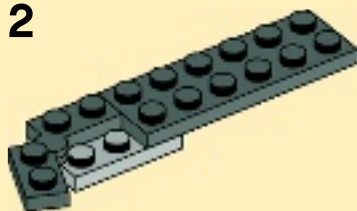

3

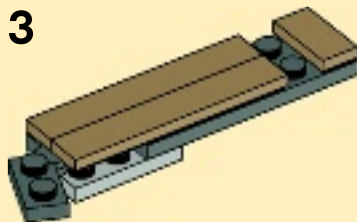



6

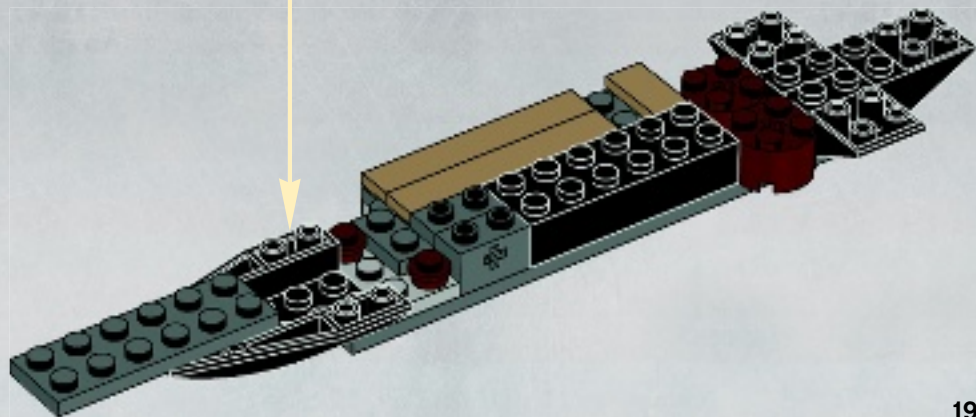
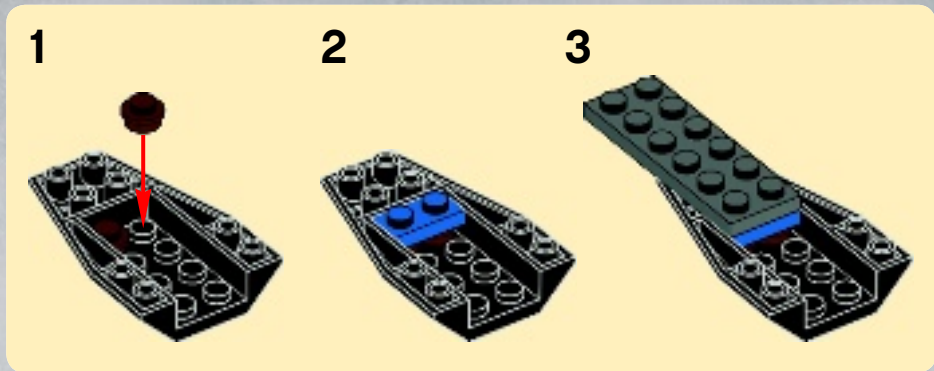



1x

7

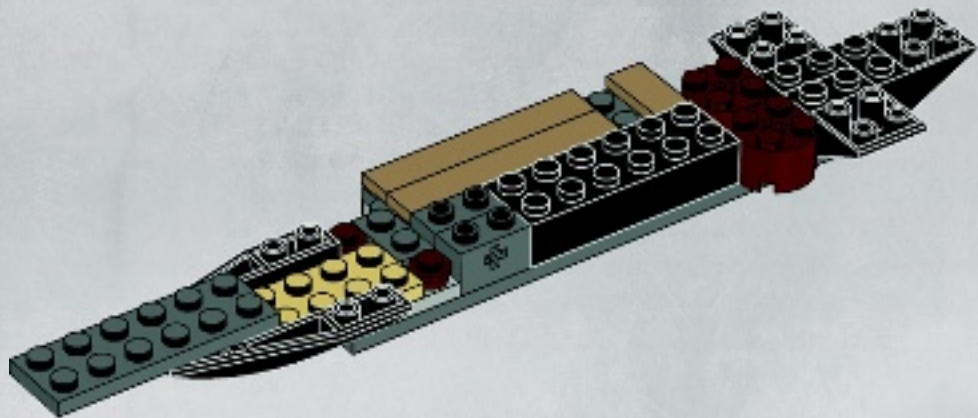

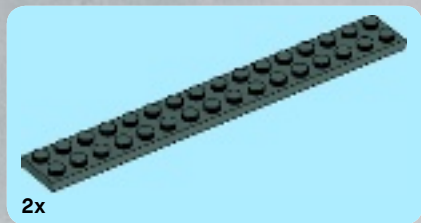

9

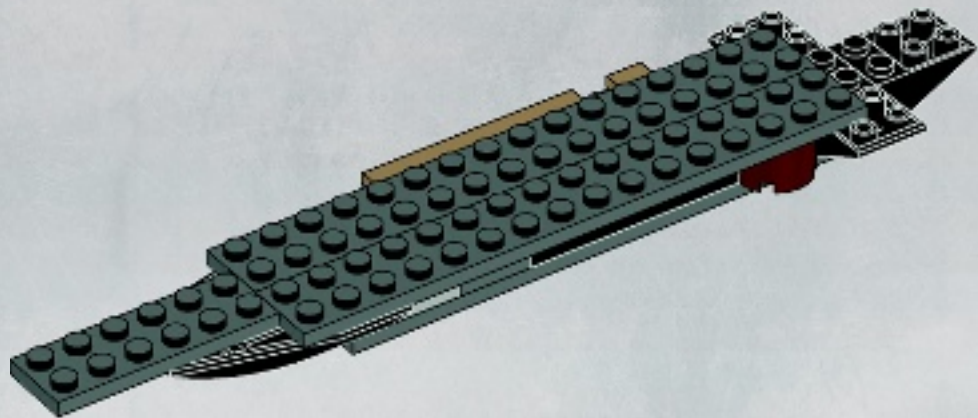



10

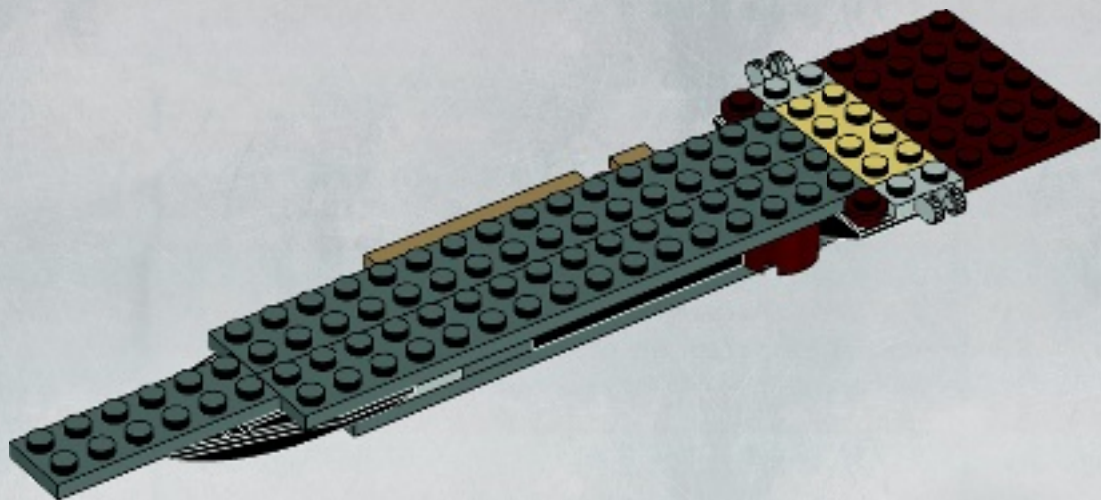



1x



2x

11

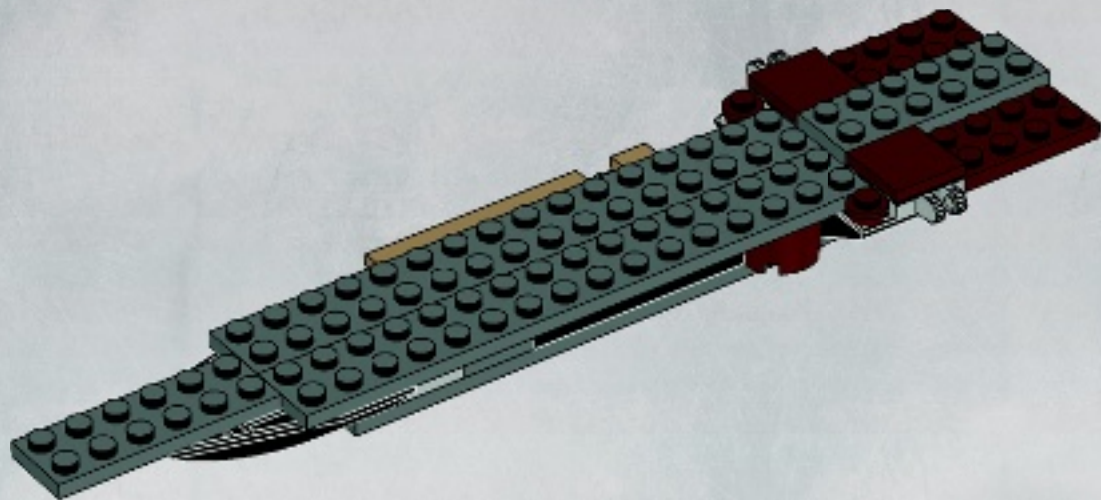



1x



2x

12

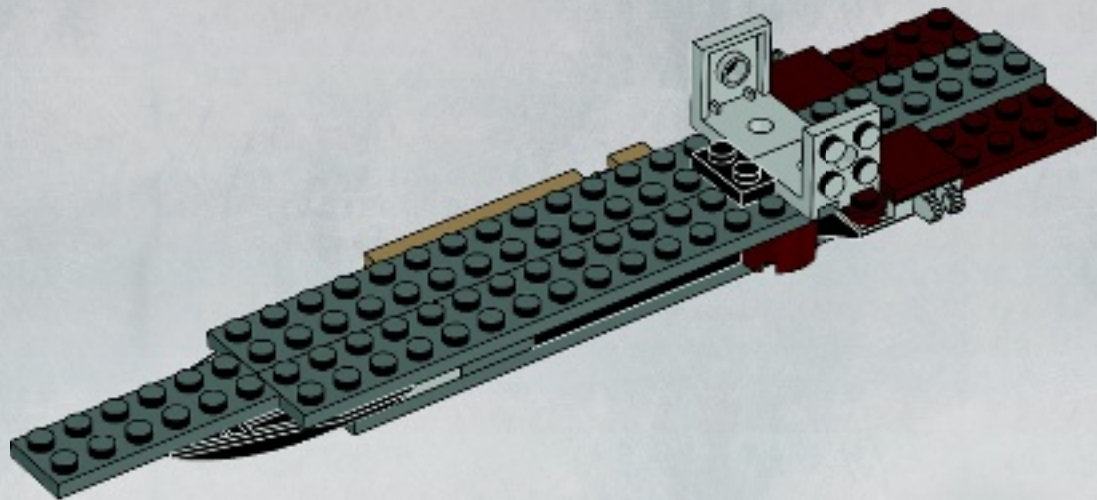



1x



1x



2x

13

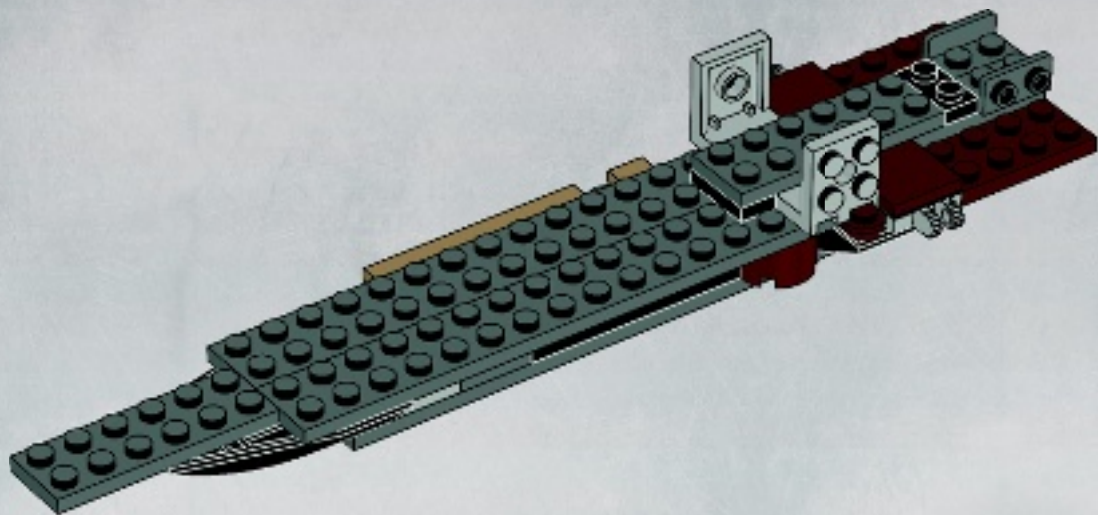



1x



1x



1x

14

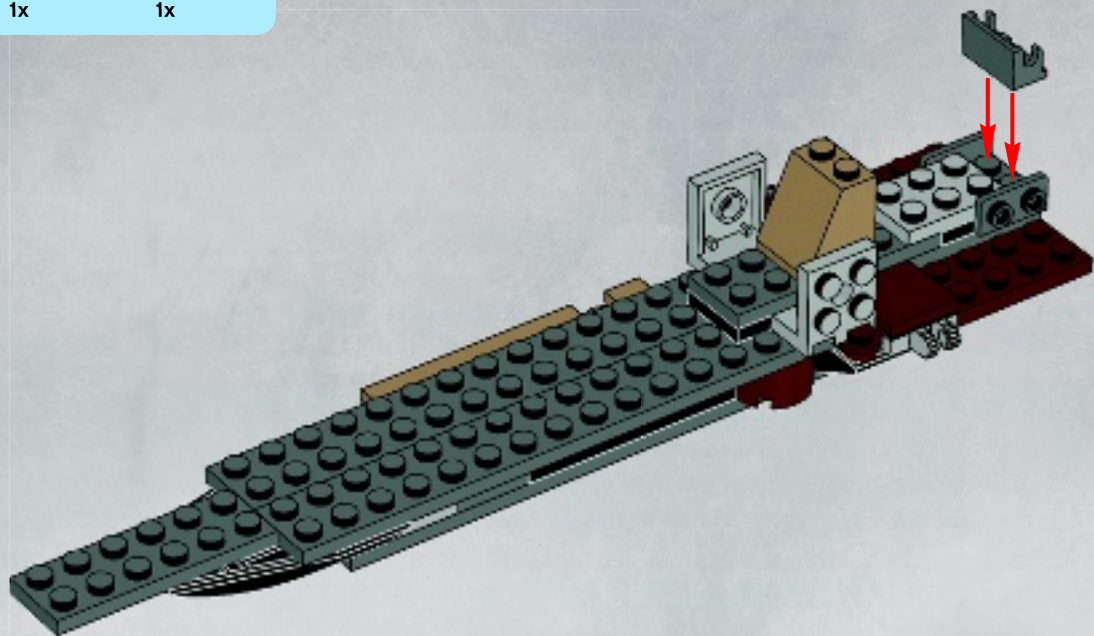



1x



1x

15

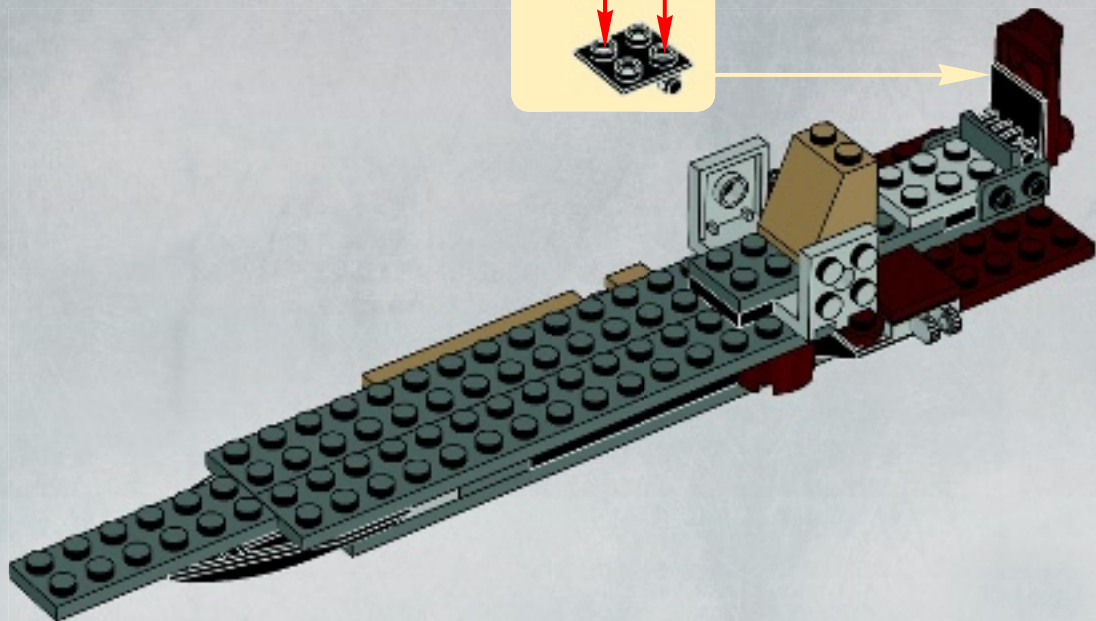



2x



2x



1x

17

1



2



3

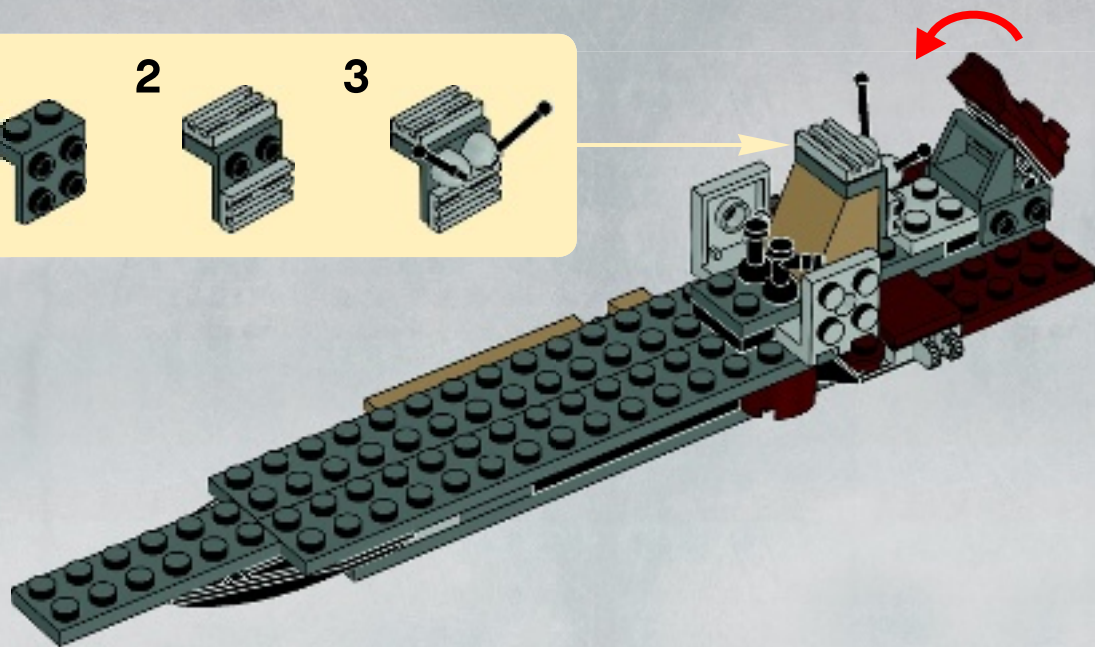
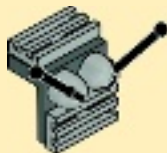

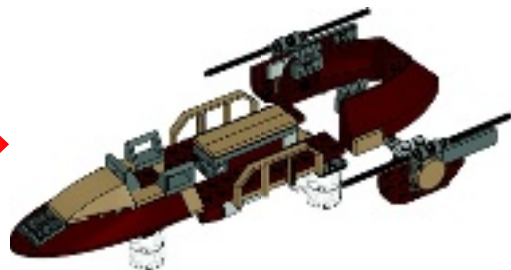

1x



1x



2x



2x

18

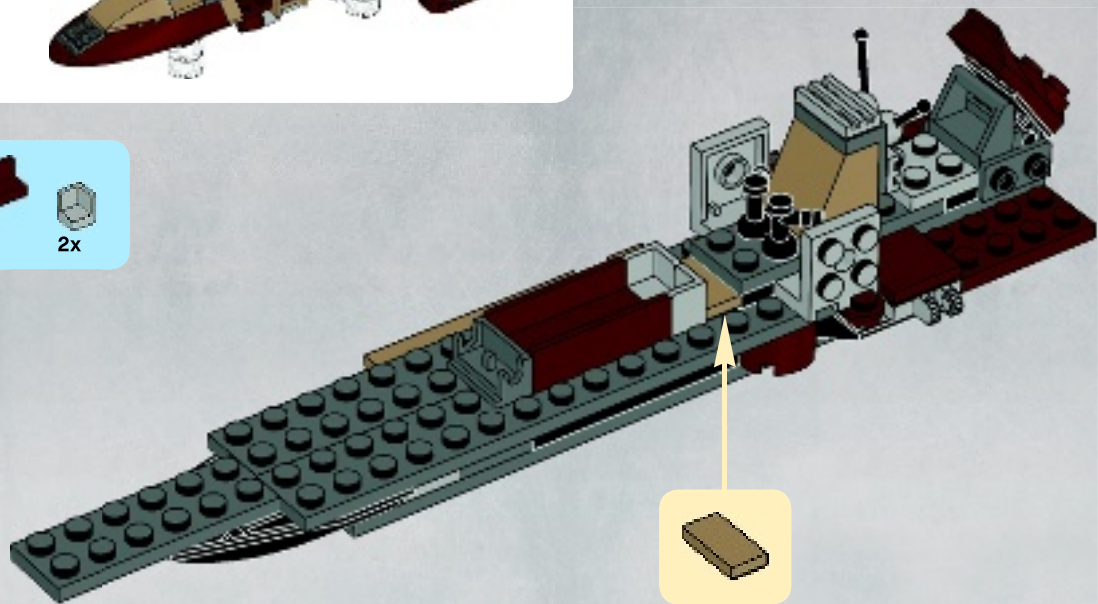

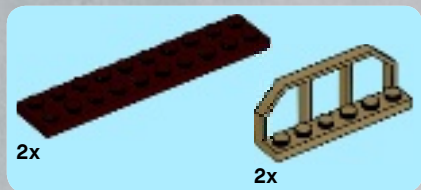

19

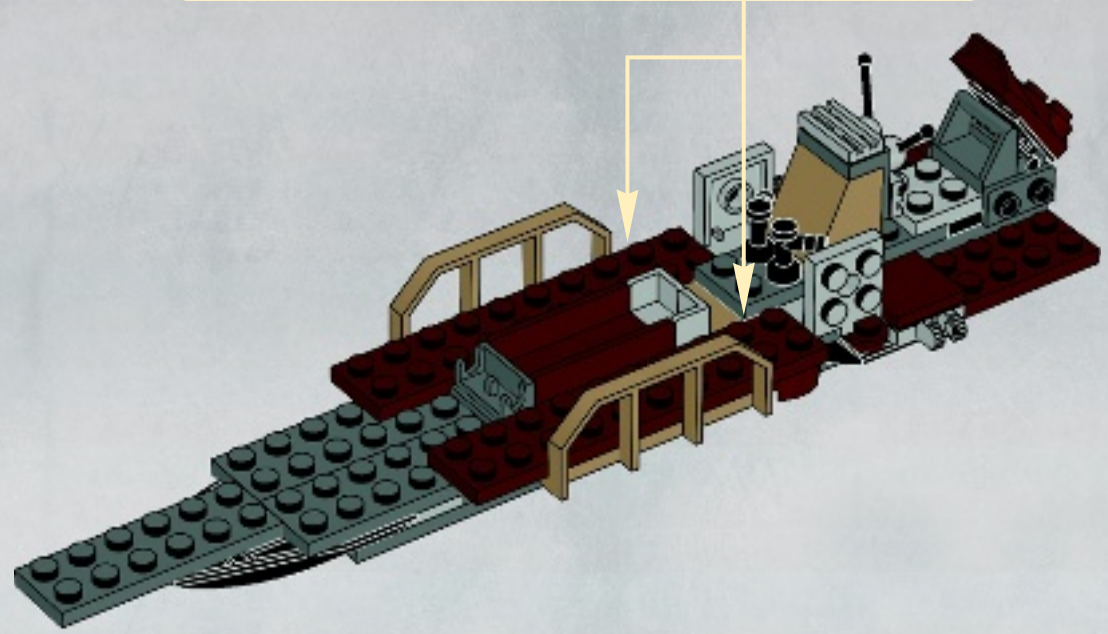



1x



2x

20

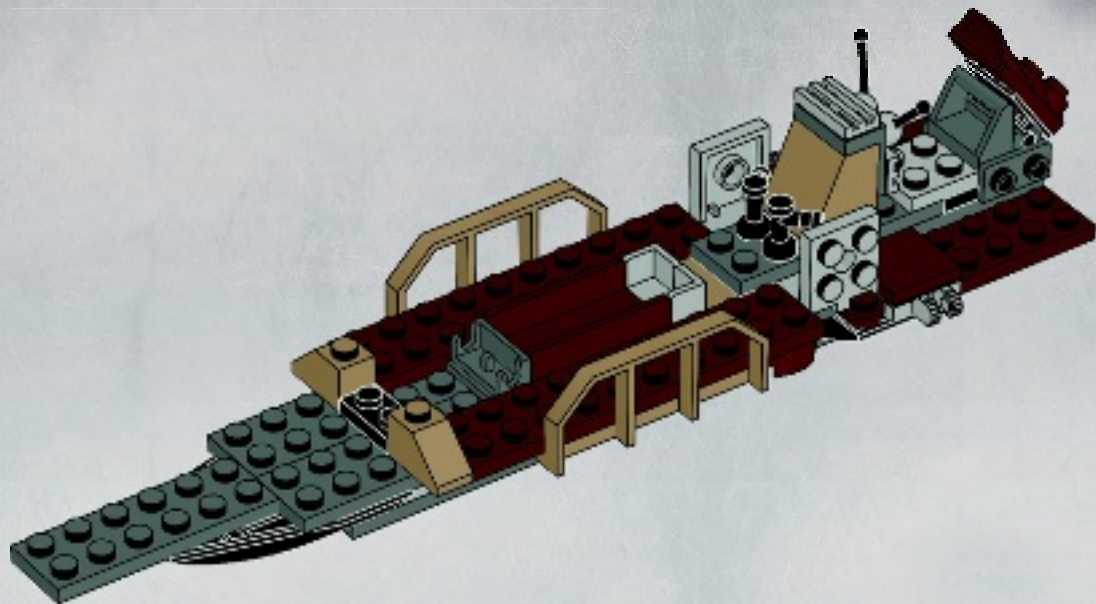



2x



1x



2x

21

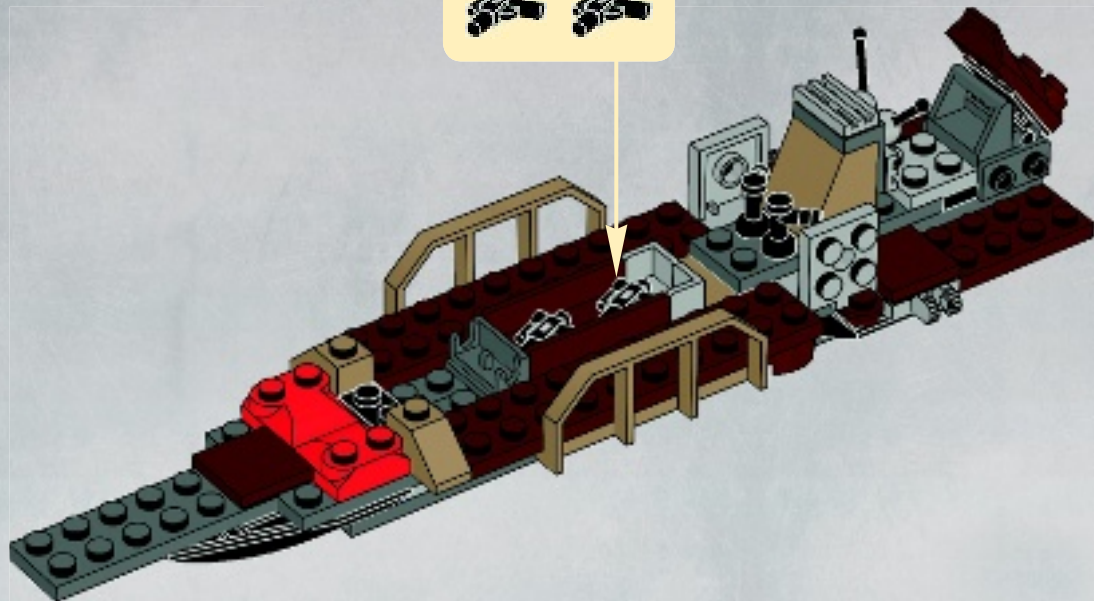

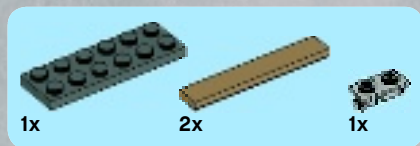

22

1



2



3

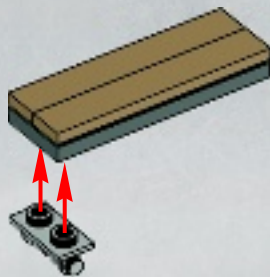

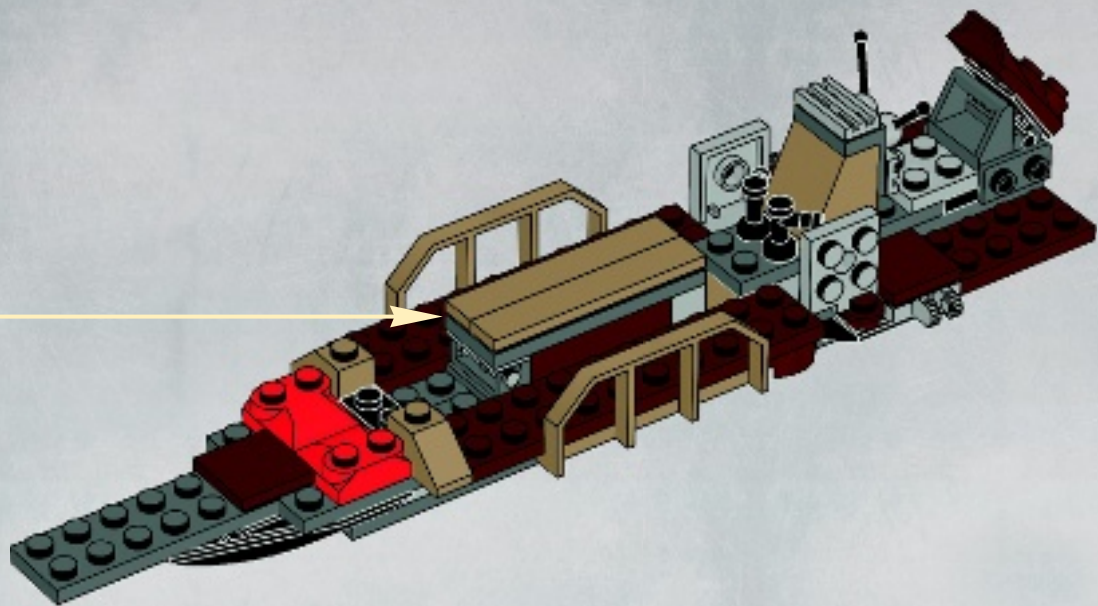



1x

23

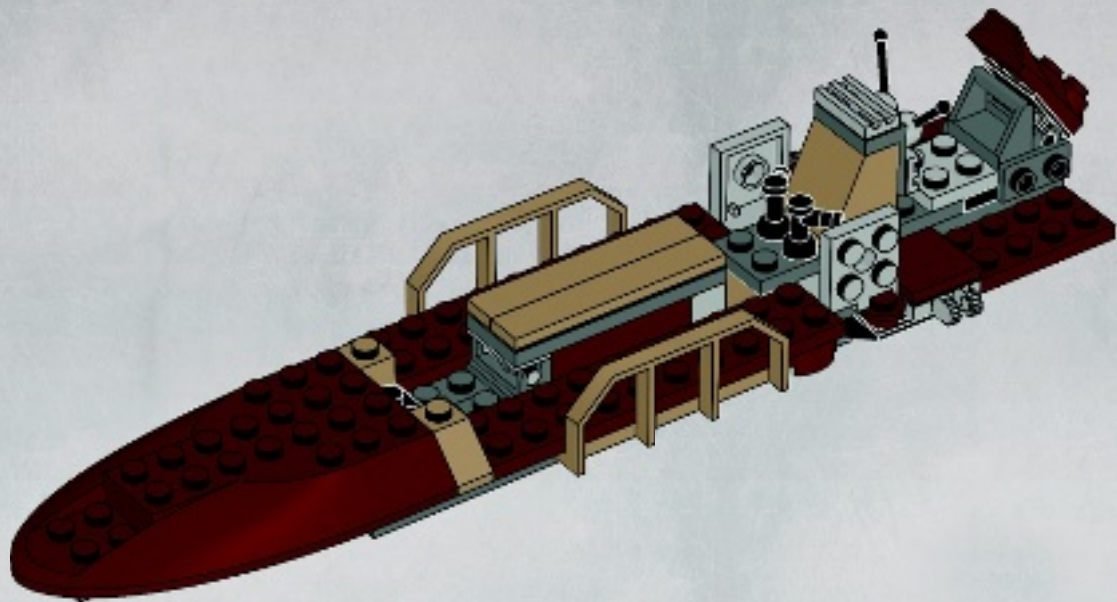



1x



2x



2x

24

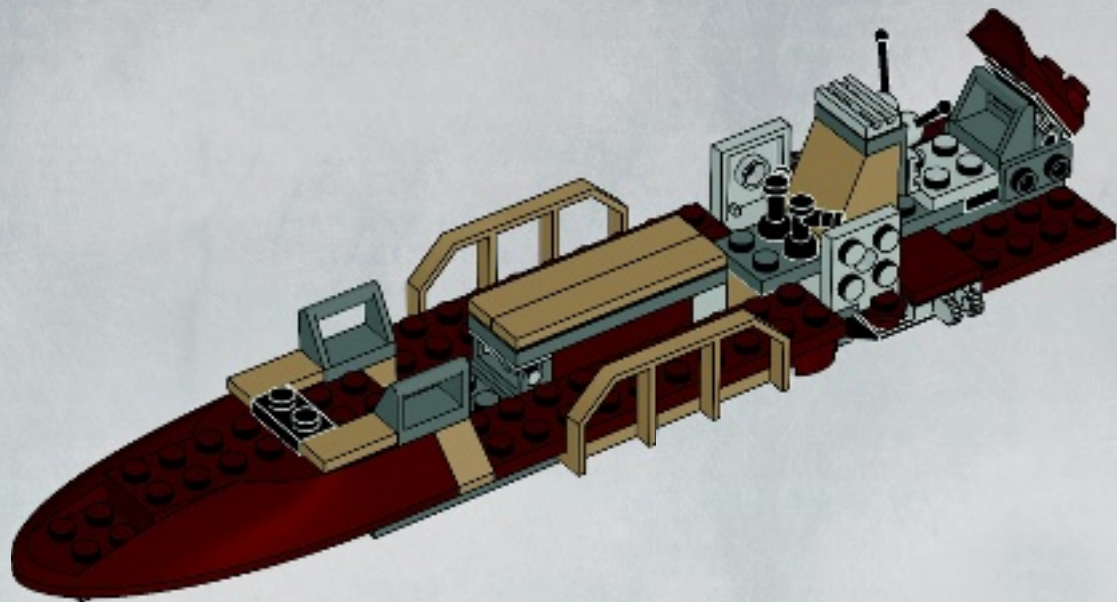

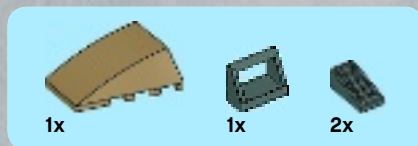

25

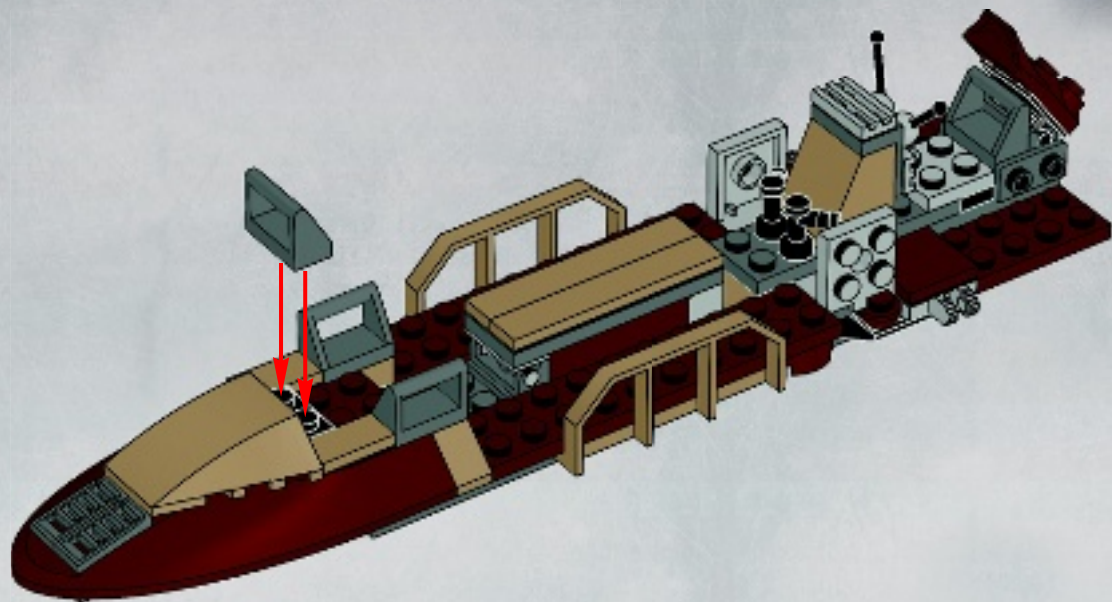



26

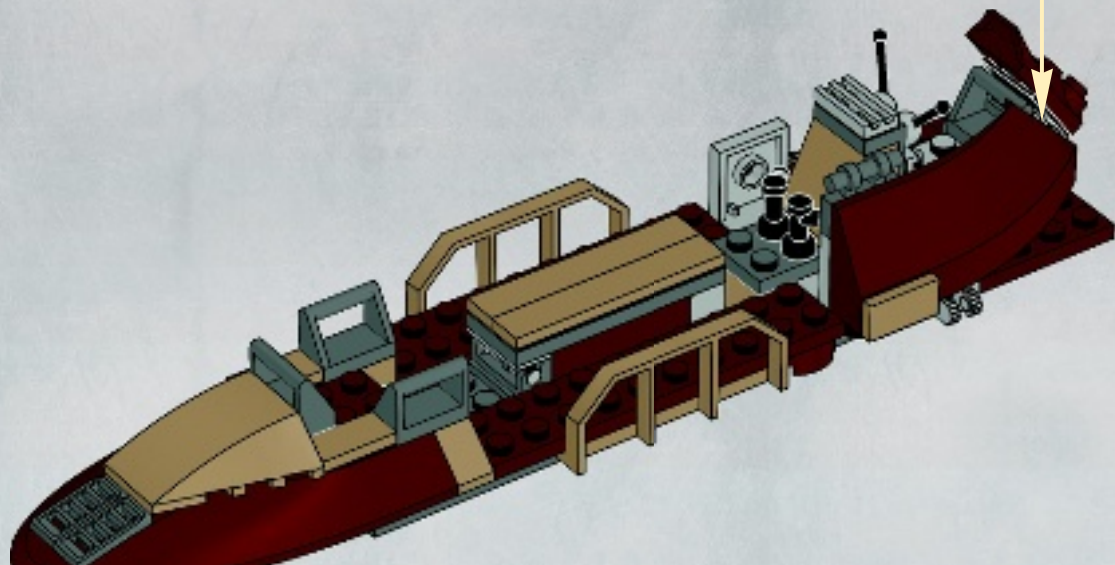



27

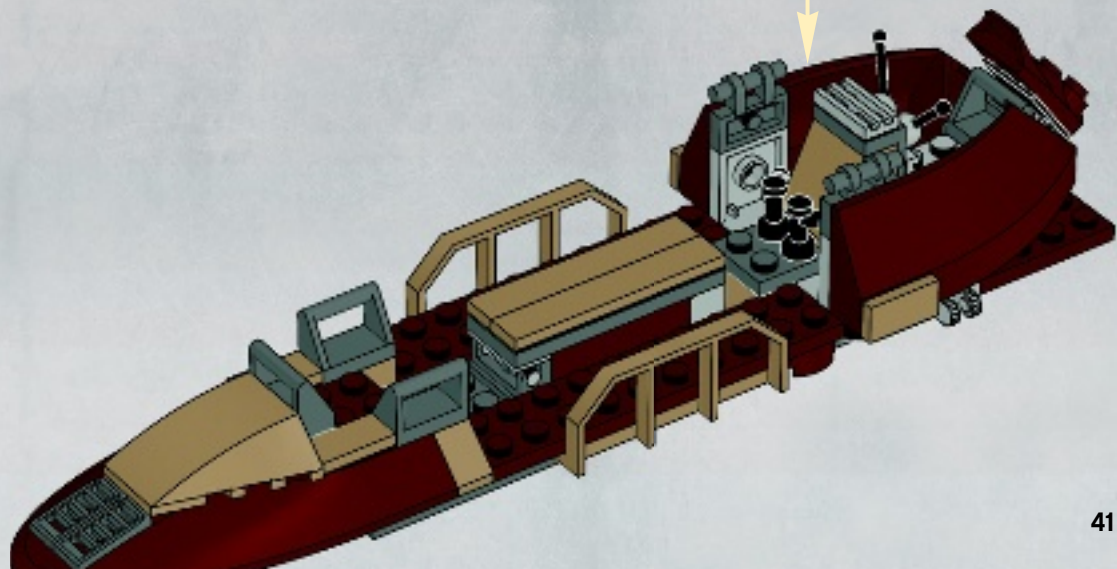



28

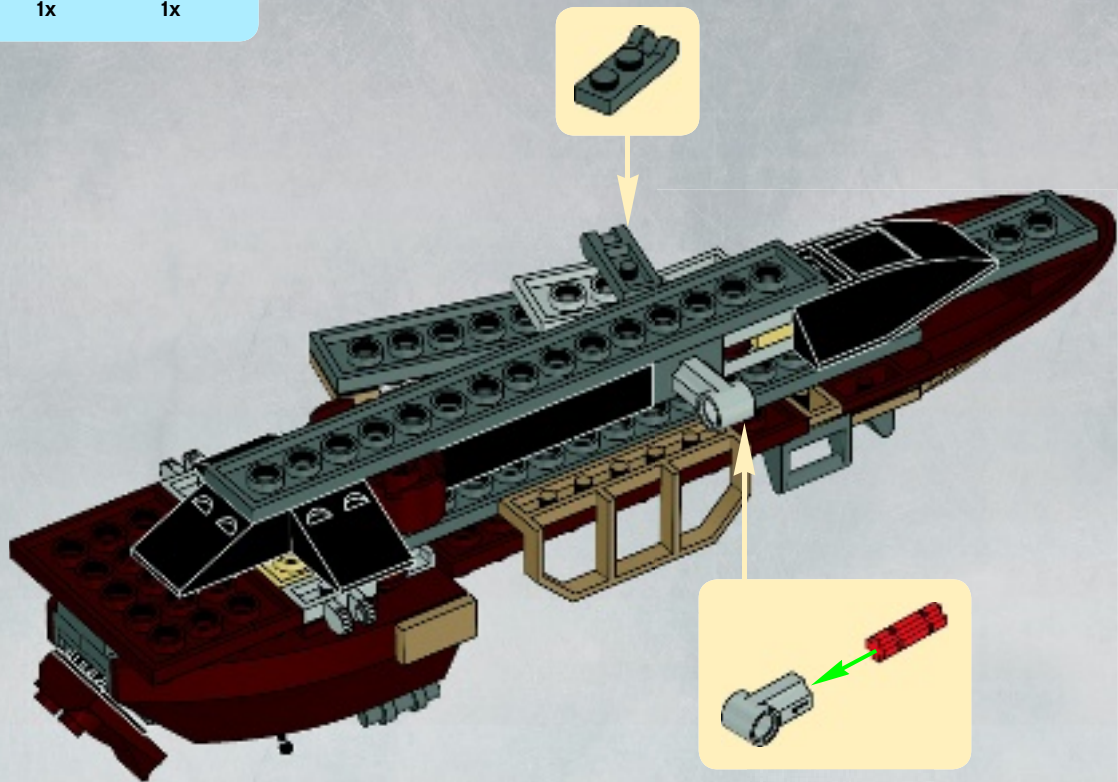



3x



6x

29

1



2



3x

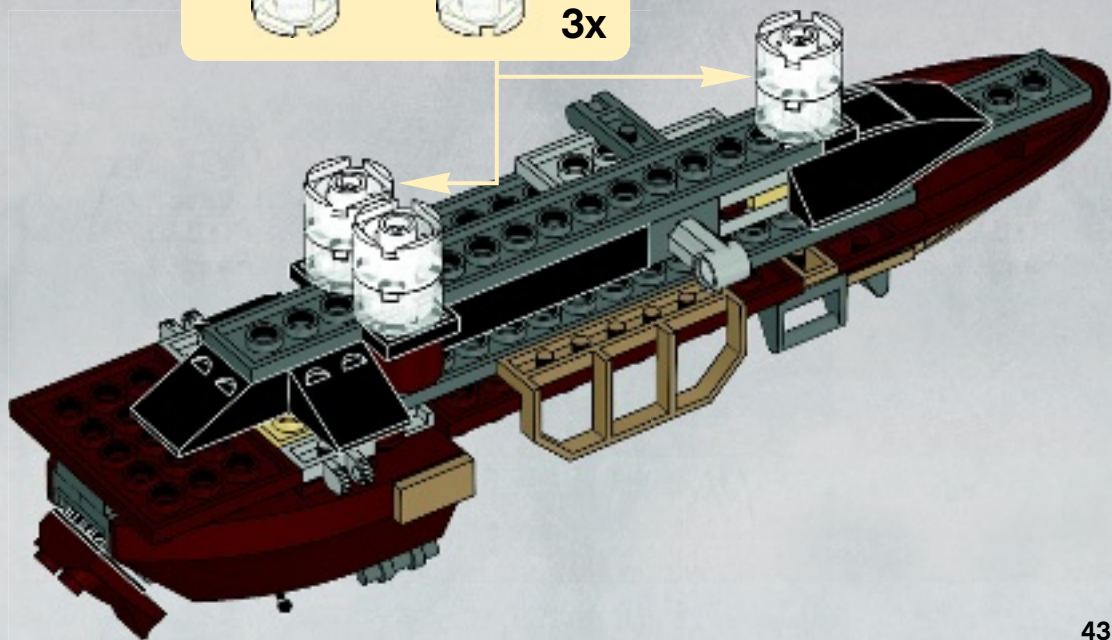



1x



1x

1

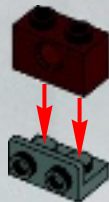

1x

2

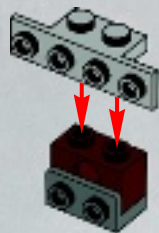



2x

3

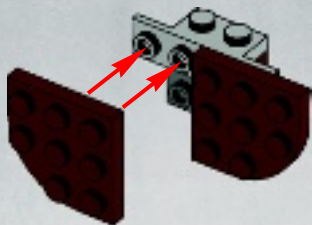

1x



2x

4





1x



1x

5



1x



2x

6

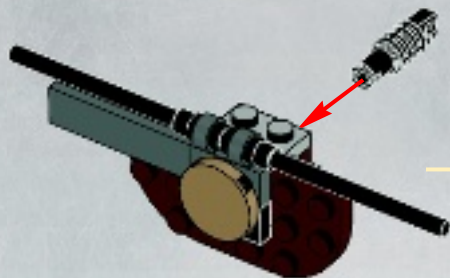

30

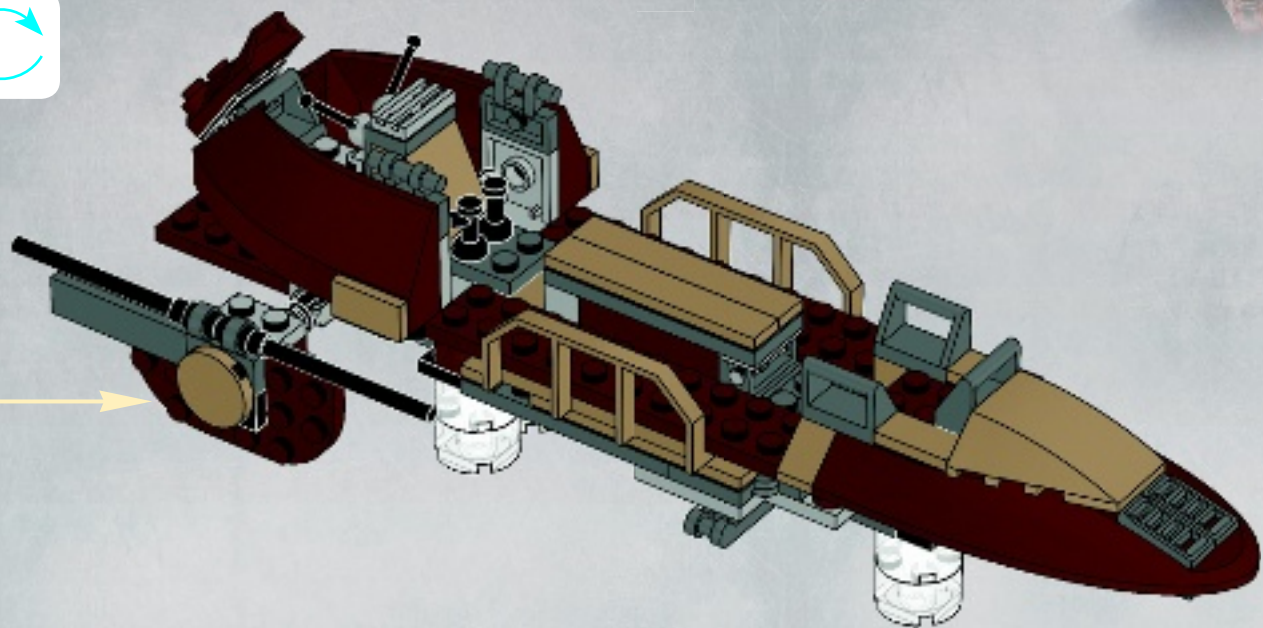



1x



1x

1

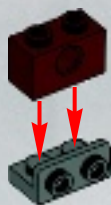

1x

2

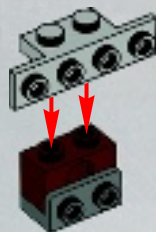



2x

3

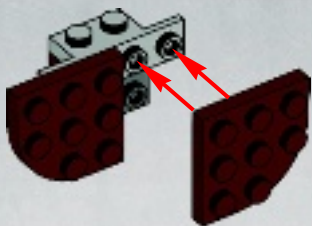

1x



2x

4

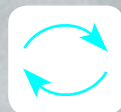



1x



1x

5



1x



2x

6

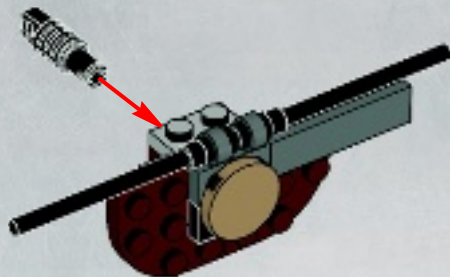

31

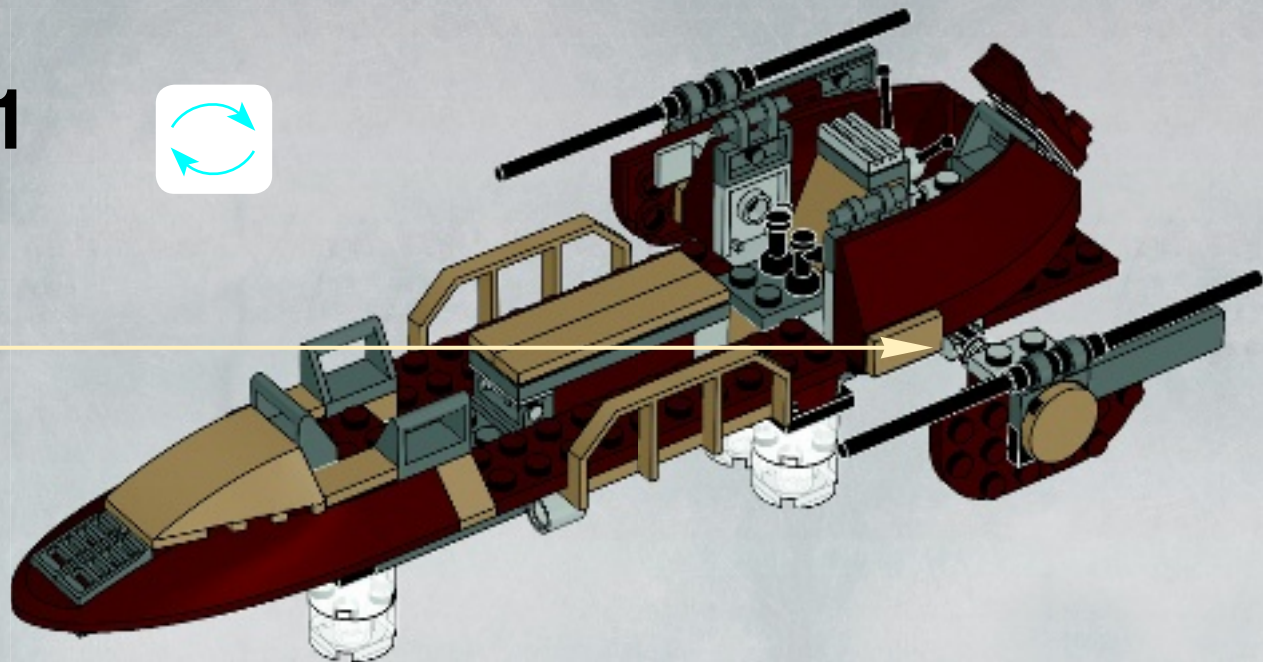



1x



1x

32

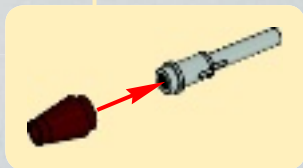
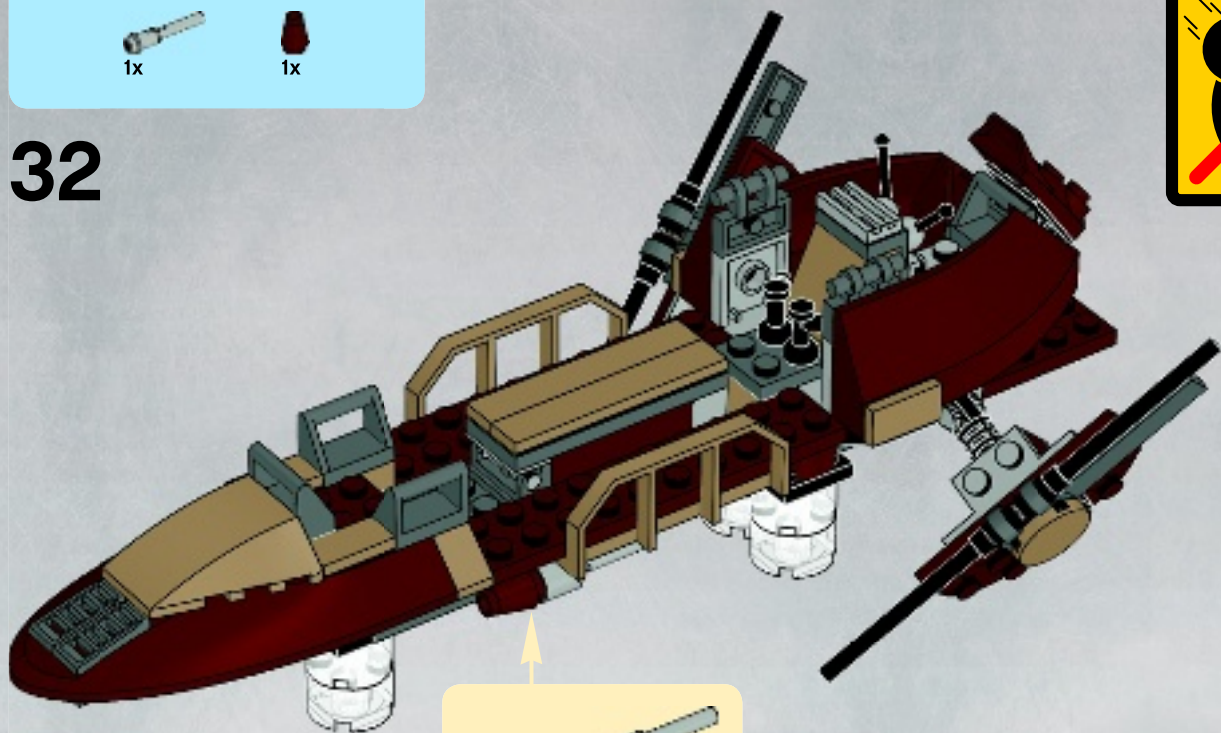

33

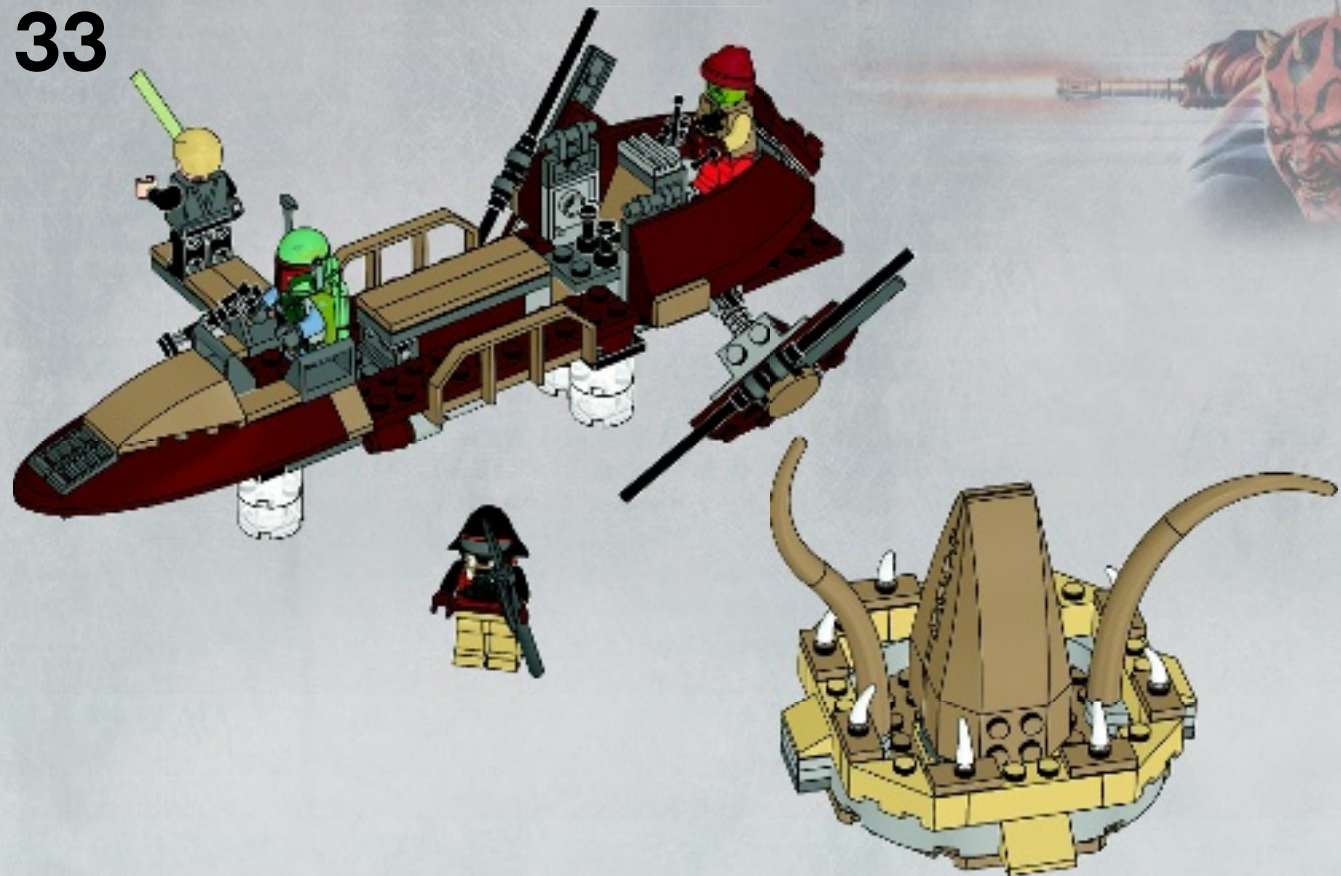

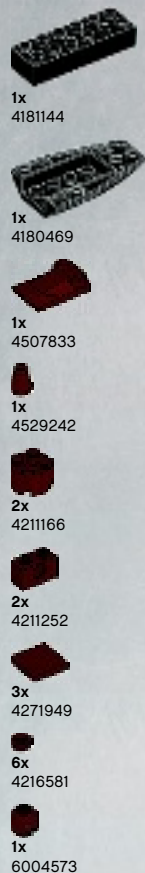
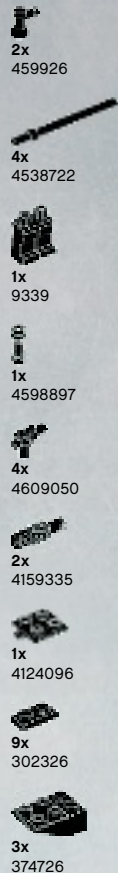
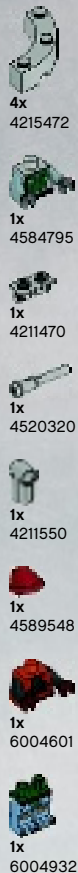

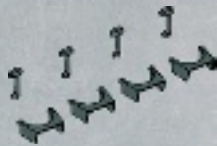

1x
6004908



2x
4210660



1x
4521187



2x
4211053



2x
4210935



2x
4211094



5x
4211002



3x
4210796



4x
4632574



1x
6004905



2x
4540386



2x
4211066



1x
4271344



1x
4528323



4x
4211039



1x
4277928



4x
6000606



1x
6004956



1x
6004725



1x
4569715



1x
4584444



1x
4548731



1x
6004560



8x
4568387



1x
4584441



1x
4584809



1x
4626400



1x
4613958



1x
4614336



2x
4530678



2x
4625275



6x
4496699



1x
9342



2x
4220515



1x
4142865



1x
302323



8x
4266902



4x
4507047



1x
6004868



1x
4616593



2x
4611758



2x
4611760



1x
4293756



2x
6003566



2x
6003492



1x
4584485



Customer Service

Kundenservice

Service Consommateurs

Servicio Al Consumidor

www.lego.com/service or dial



: 00800 5346 5555

: 1-800-422-5346





9496



9498



9497



9499



9500



9515



9516



ATELIER DE BD



**STAR
WARS**

starwars.LEGO.com



2



3

www.LEGOclub.com/Max

LEGO club™

FREE*! GRATIS! GRATUIT!

*Paid subscription in Australia and New Zealand.
*Abonnement payant en Australie et Nouvelle-Zélande.

©2012 The LEGO Group.





WIN!

Go to www.LEGOsurvey.com/product to fill out a survey for a chance to win a cool LEGO® Product.

No purchase necessary.

Open to all residents where not prohibited.



www.LEGOsurvey.com/product

GEWINNE!

Nimm an der Umfrage auf www.LEGOsurvey.com/product teil und hab die Chance ein cooles LEGO® Produkt zu gewinnen!

Die Teilnahme am Gewinnspiel führt zu keinerlei Kaufverpflichtungen. Teilnahme in allen nicht ausgeschlossenen Ländern möglich.

WIN!

Ga naar www.LEGOsurvey.com/product, vul een enquêteformulier in en maak kans op een cool LEGO® product.

Geen aankoopverplichting. Iedereen mag deelnemen, uitgezonderd ingezetenden van landen waar een enquêteverbod geldt.

GAGNE!

Visite www.LEGOsurvey.com/product pour répondre à un questionnaire et avoir une chance de gagner un produit LEGO® très cool!

Aucune obligation d'achat. Ouvert à tous les résidents des pays autorisés.

当てよう!

www.LEGOsurvey.com/product にアクセスして、アンケートにご記入ください。当選者にはレゴ®製品を差し上げます。

お買い上げの必要はありません。禁止されていない限り、すべての皆様にご利用いただけます。



www.LEGO.com

6015463 / 6015461

LEGO and the LEGO logo are trademarks of the/sont des marques de commerce de/son marcas registradas de LEGO Group. ©2012 The LEGO Group.

© 2012 Lucasfilm Ltd. & TM. All rights reserved/Tous droits réservés/Todos los derechos reservados.