

LEGO CLASSIC

30510

6414974



WIN

Terms & Conditions apply

Go to WWW.LEGO.COM/RB2022 to fill out a short survey on this product for a chance to win a cool LEGO® set.



LEGO.com/RB2022

GAGNE

Rendez-vous au www.LEGO.com/RB2022 pour remplir un court questionnaire sur ce produit et courir la chance de gagner un fantastique set LEGO®.

Voir Conditions Générales

GANA

Visita www.LEGO.com/RB2022 y responde una breve encuesta sobre este producto. ¡Puedes ganar un fantástico set LEGO®!

Términos y Condiciones aplicables

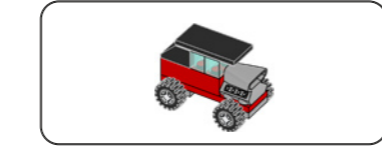

1



2

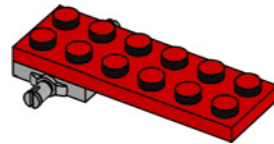

3

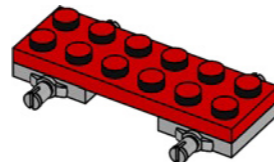

4

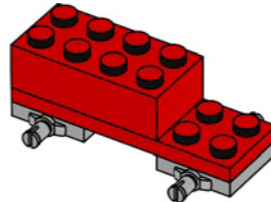

5

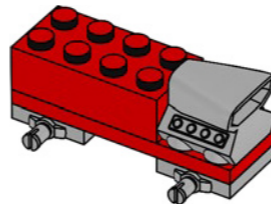

6

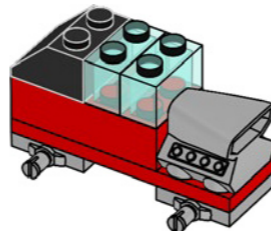

7

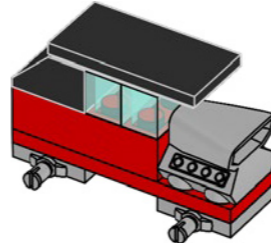

8

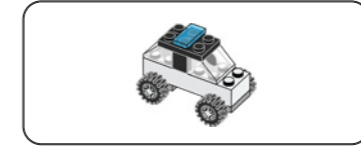
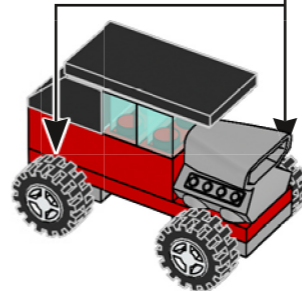

1



2

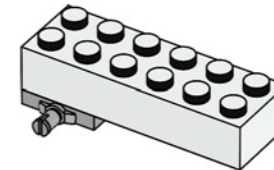

3

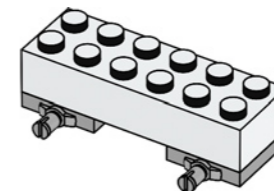

4

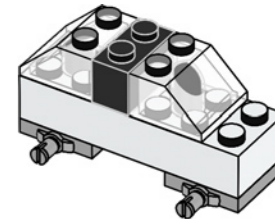

5

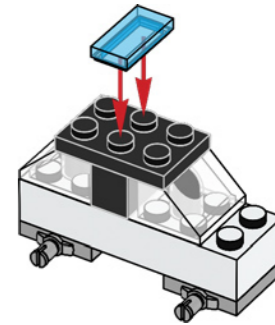

6

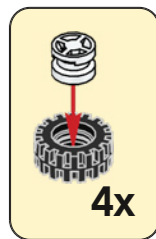
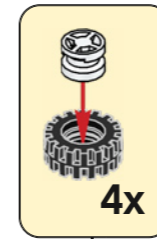
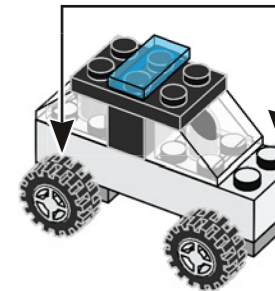

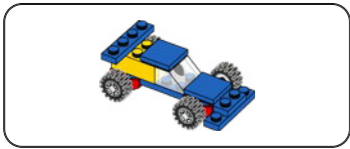

1

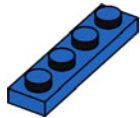

2

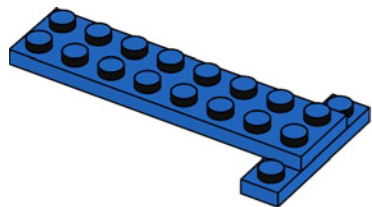

3

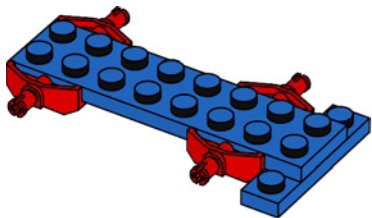

4

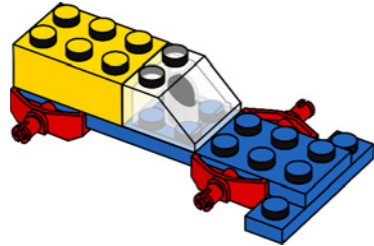

5

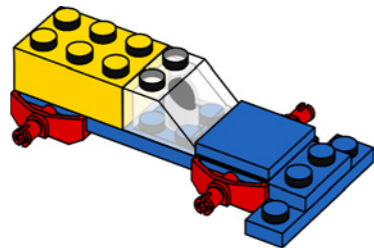

6

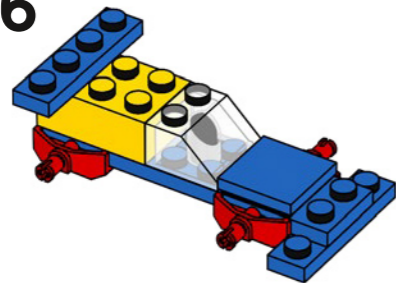

7

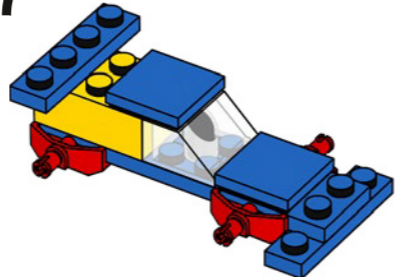

8

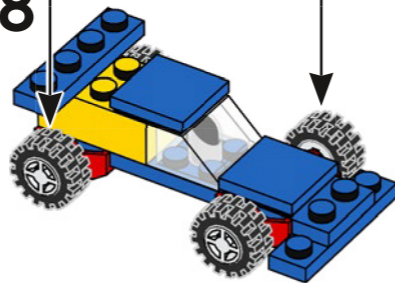

1

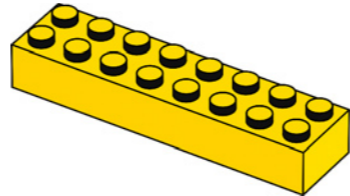

2

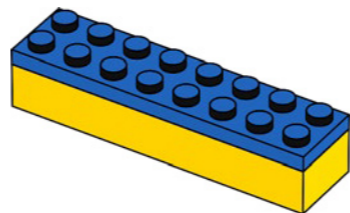

3

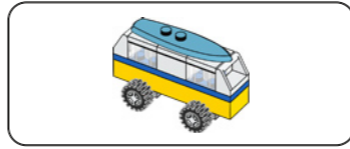
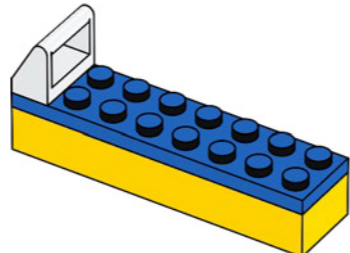

4

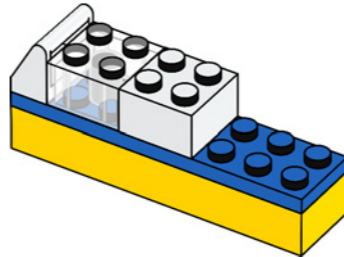

5

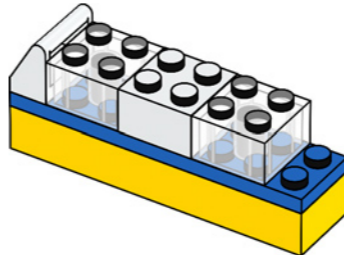

6

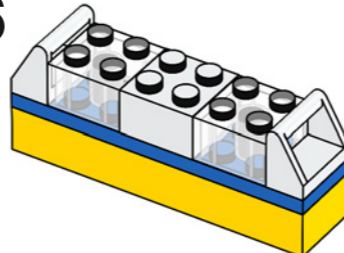

7

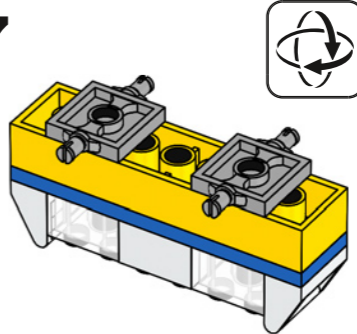

8

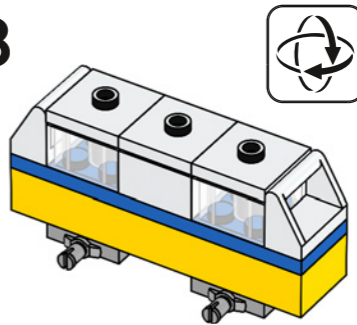

9

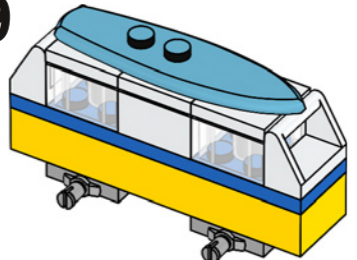

10

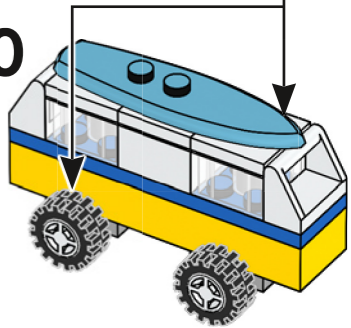

LEGO.com/classic

LEGO.com/service

LEGO and the LEGO logo are trademarks of the/sonnt des marques de commerce du/son marcas registradas de LEGO Group. ©2022 The LEGO Group. 6414974