



ALIEN CONQUEST

7049



1

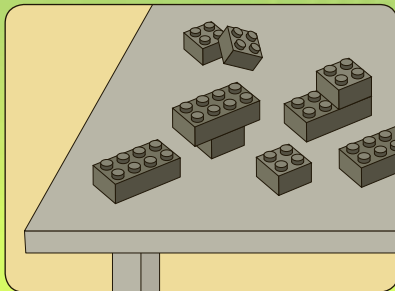

2

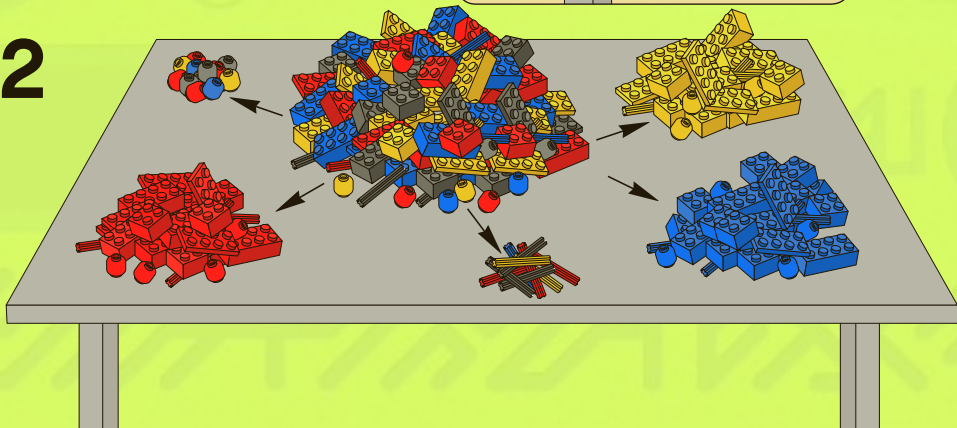

2

3

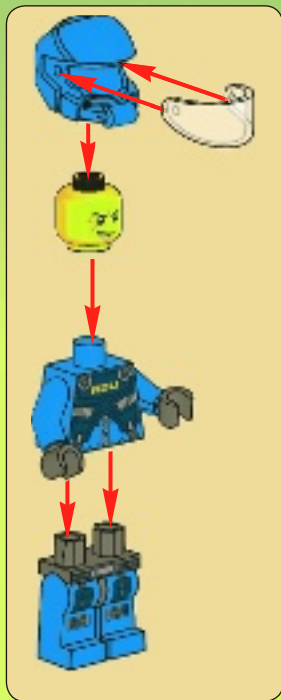



1x

1



4



2x

2

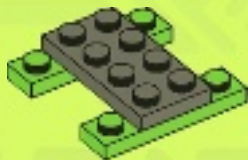



4x

3

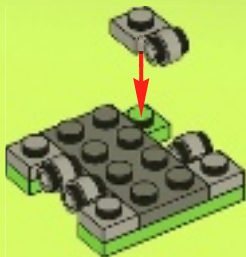

2x

4

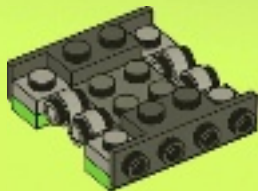



2x



2x

5

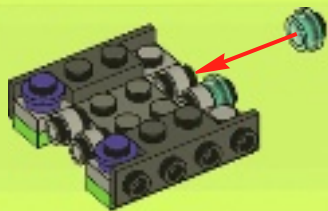

6



2x

6





2x

7



2x

8





2x

9

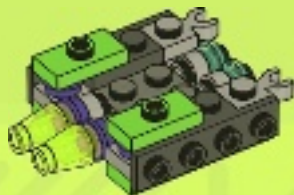

8



2x

10

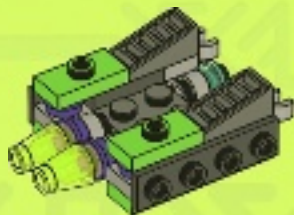



11

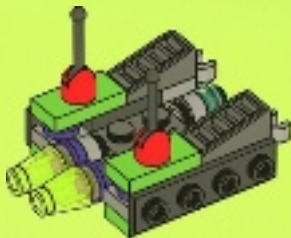

12

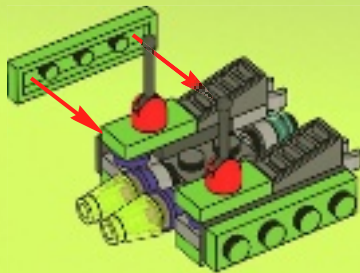



2x

13

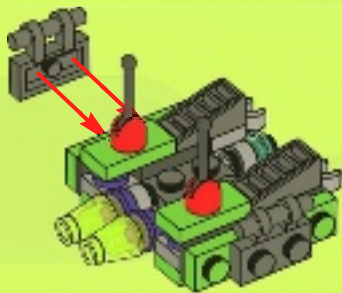



4x

14

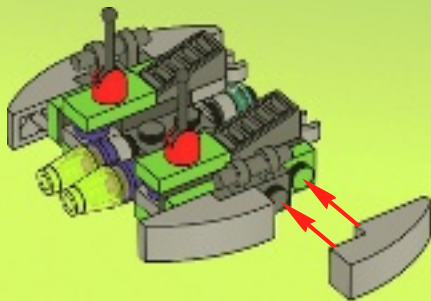



2x
74335

1x
4640010

1x
4624753



1x
4624619

1x
4626452

4x
4566522

2x
4540386

1x
4624618

1x
4623600

2x
4282746

2x
4567334

4x
4187743

2x
4500069

1x
4625828

4x
4251163

2x
4594238

4x
4632575

1x
4211065

2x
4210660

1x
4623236

1x
4626724

2x
4163917



Customer Service

Kundenservice

Service Consommateurs

Servicio Al Consumidor

www.lego.com/service or dial



: 00800 5346 5555

: 1-800-422-5346



ALIEN CONQUEST



ALIENCONQUEST.LEGO.COM



www.LEGOclub.com



LEGO[®] Club Email

LEGO clubTM

FREE! GRATIS! GRATUIT!



LEGO[®] Club Magazine

SIGN UP ONLINE!

www.LEGOclub.com

00800 5346 5555*



1-866-534-6258 • 1-877-518-5346

©1-8 Canada (toll)

Canada (toll-free)

B1110

- * Freephone. Mobile charges may apply.
- * Numéro sans frais. Des frais peuvent s'appliquer avec les téléphones cellulaires.
- * Gebührenfrei. Kosten für Anrufe aus Mobilfunknetzen können abweichen.
- * Gratis telefoonnummer vanaf vaste lijn.
- * Det er et gratis nummer, når du ringer fra fasttelefon.
- * Det är gratis, när du ringer från en fast telefon.
- * Numéro sans frais. Des frais peuvent s'appliquer avec les téléphones portables.



WIN!

 www.LEGO.com

Go to www.LEGOsurvey.com/product to fill out a survey for a chance to win a cool LEGO® Product.

No purchase necessary.

Open to all residents where not prohibited.



www.LEGOsurvey.com/product

GEWINNE!

Nimm an der Umfrage auf www.LEGOsurvey.com/product teil und hab die Chance ein cooles LEGO® Produkt zu gewinnen!

Die Teilnahme am Gewinnspiel führt zu keinerlei Kaufverpflichtungen. Teilnahme in allen nicht ausgeschlossenen Ländern möglich.

WIN!

Ga naar www.LEGOsurvey.com/product, vul een enquêteformulier in en maak kans op een

cool LEGO® product. Geen aankoopverplichting. Iedereen mag deelnemen, uitgezonderd ingezetenden van landen waar een enquêteverbod geldt.

GAGNE !

www.LEGOsurvey.com/product pour répondre à un questionnaire et avoir une chance de gagner un produit LEGO® très cool !

Aucune obligation d'achat. Ouvert à tous les résidents des pays autorisés.

当てよう!

www.LEGOsurvey.com/product にアクセスして、アンケートにご記入ください。当選者にはレゴ®製品を差し上げます。

お買い上げの必要はありません。禁止されていない限り、すべての皆様にご利用いただけます。

4645658 / 4645660

LEGO and the LEGO logo are trademarks of the/sont des marques de commerce de/son marcas registradas de LEGO Group. ©2011 The LEGO Group.