



70906



[LEGO.com/BATMANMOVIE](https://www.LEGO.com/BATMANMOVIE)



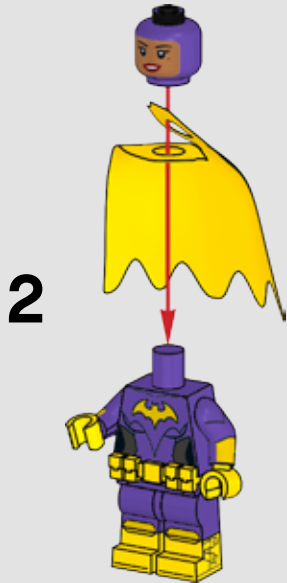
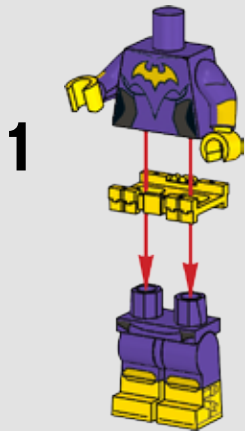
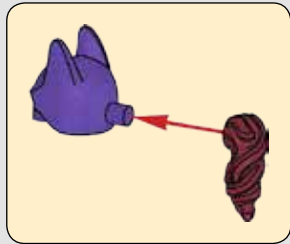
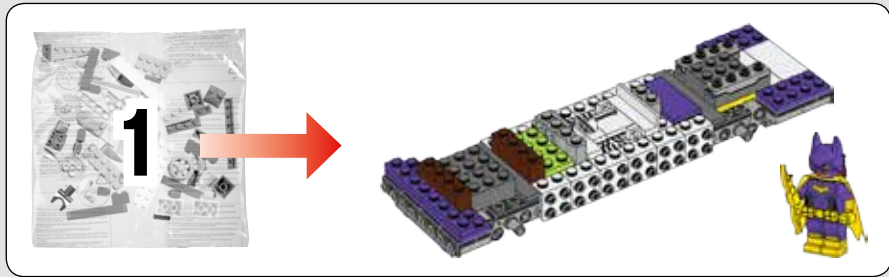

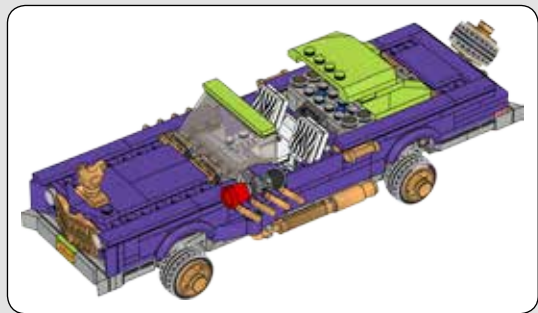

1x

1



4



2x

2

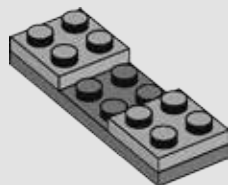

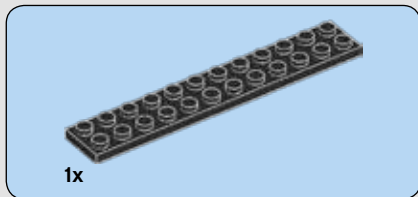

3

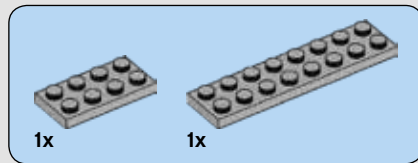
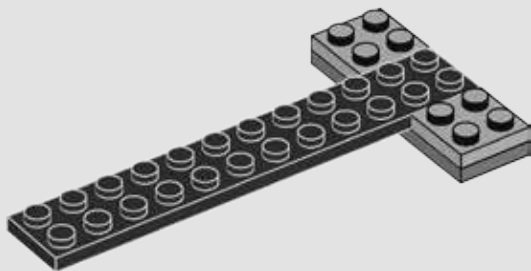

4

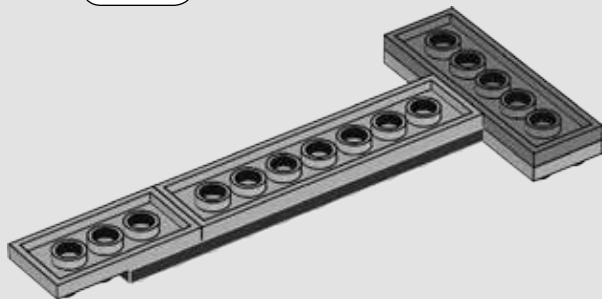
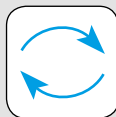

5

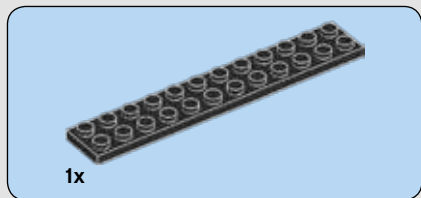

5

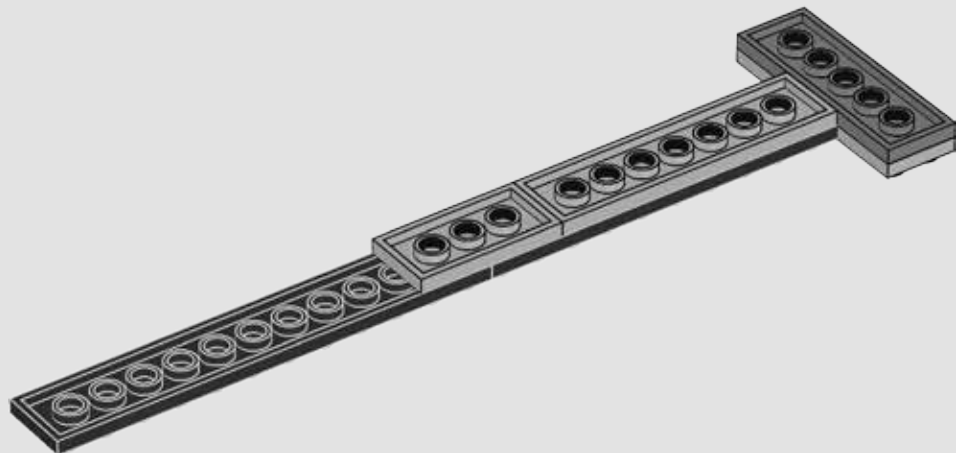

6

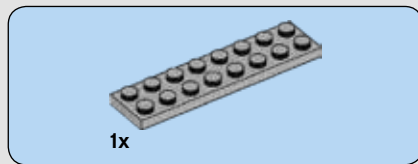

6

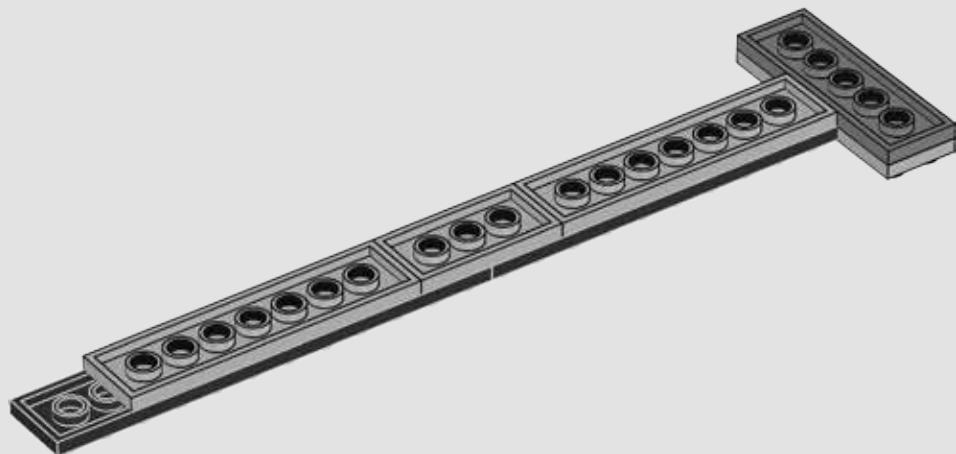



7

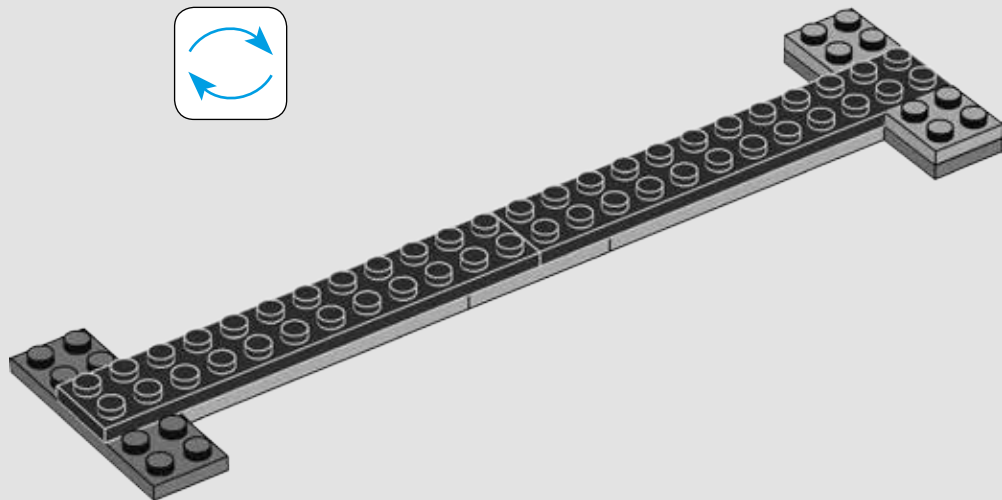
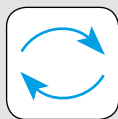

8

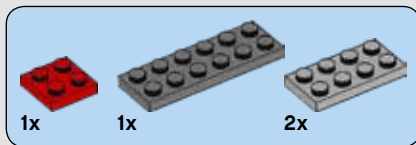

8

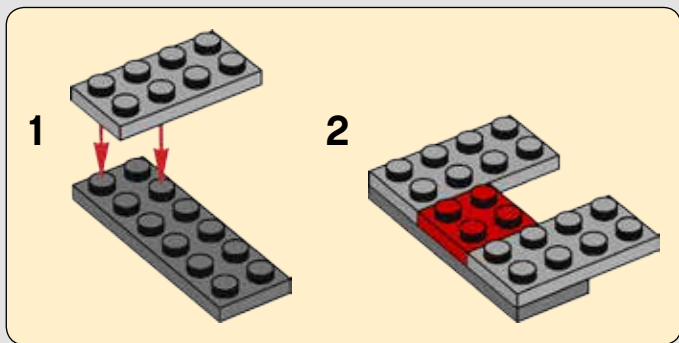

2

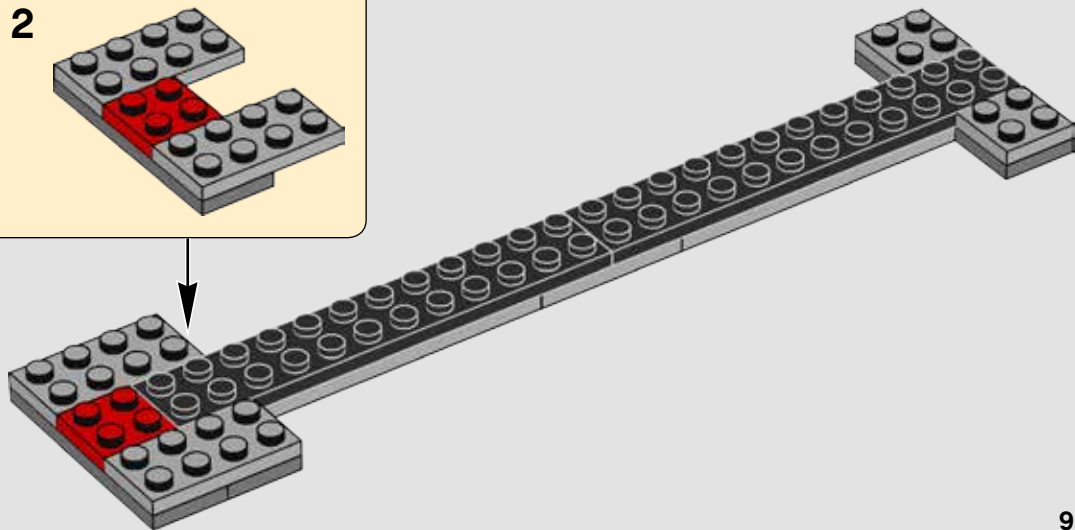
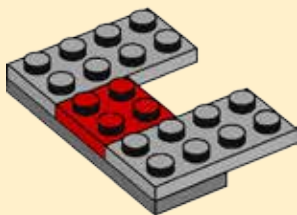

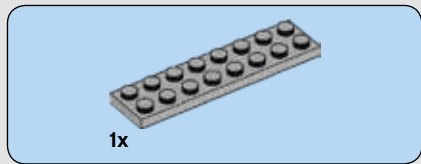

9

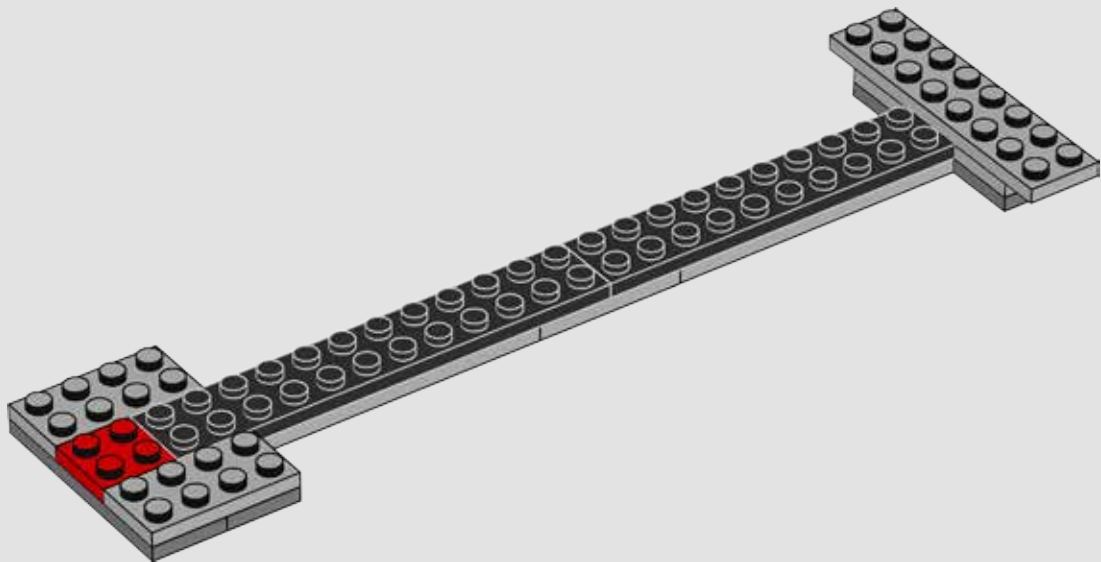

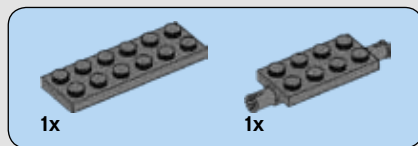

10

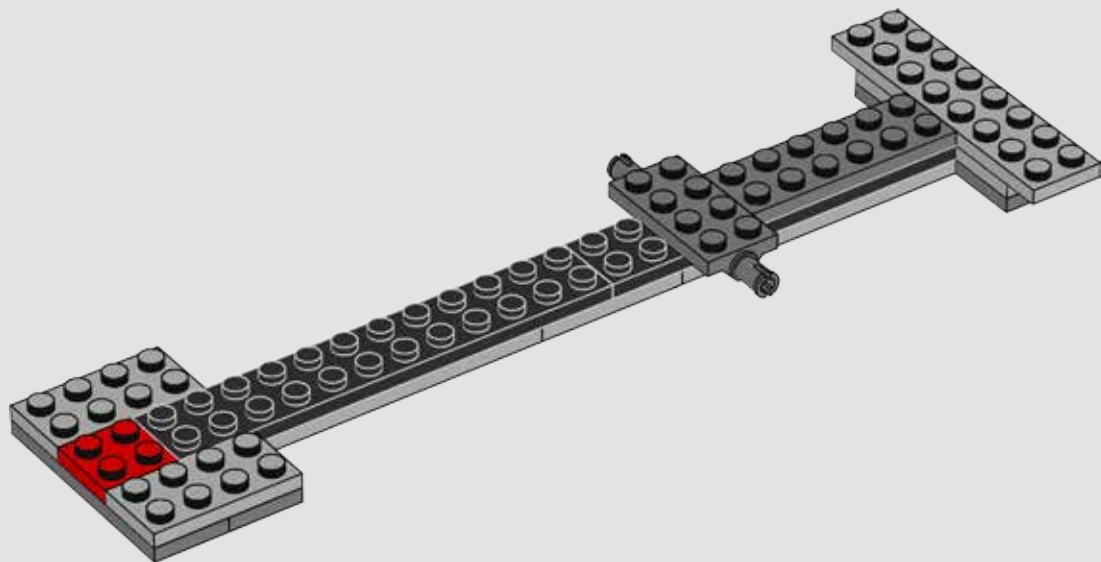

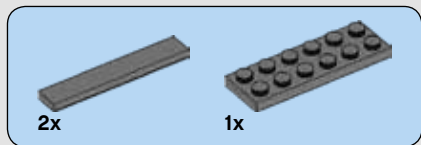

11

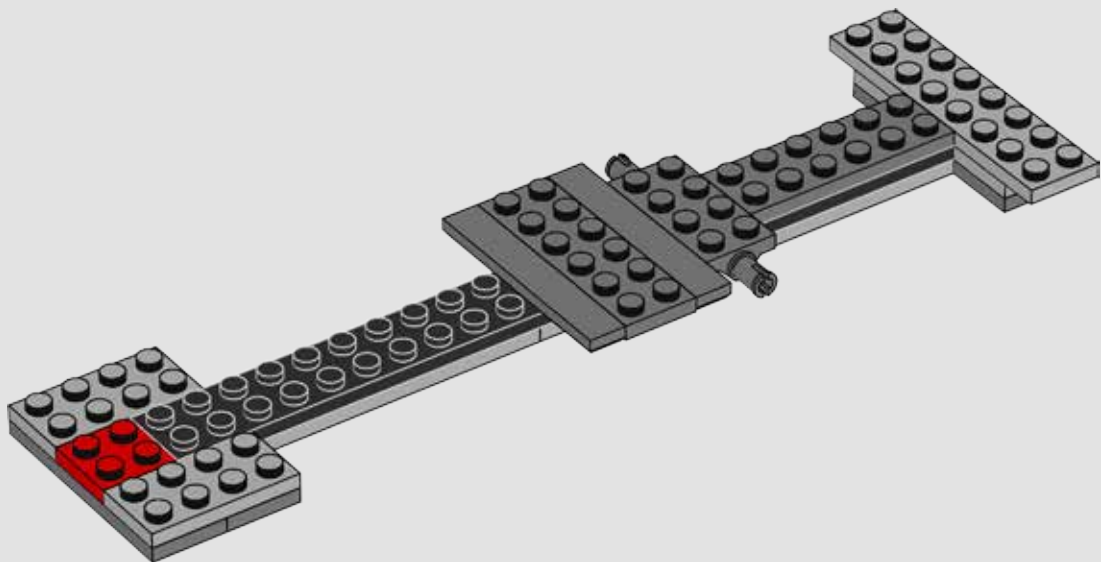

12

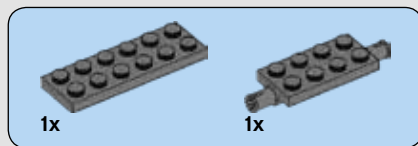

12

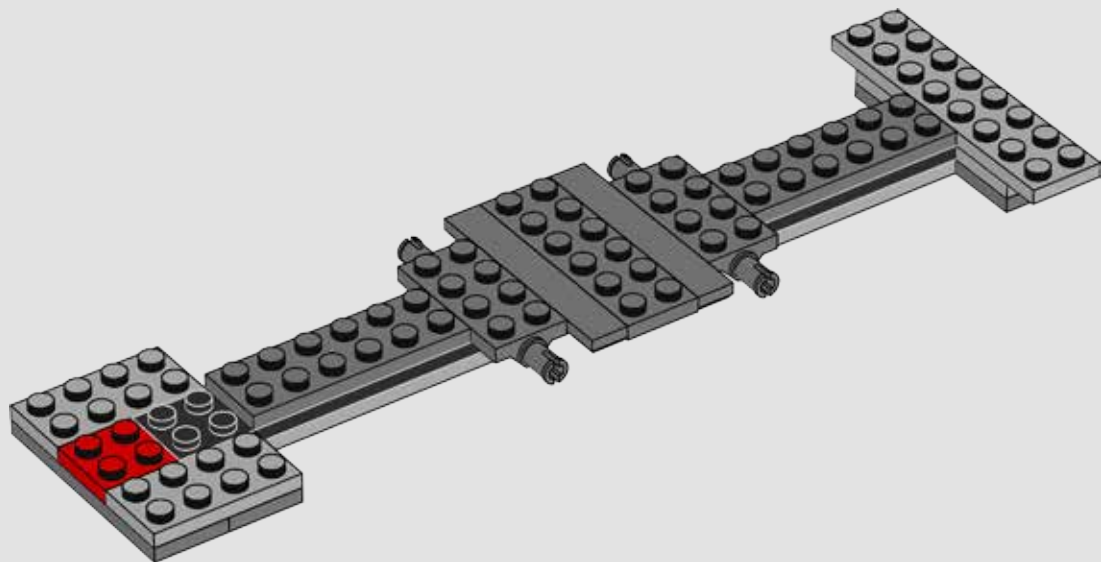

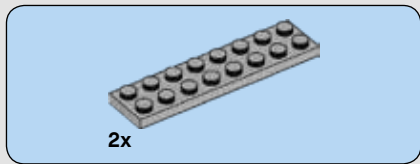

13

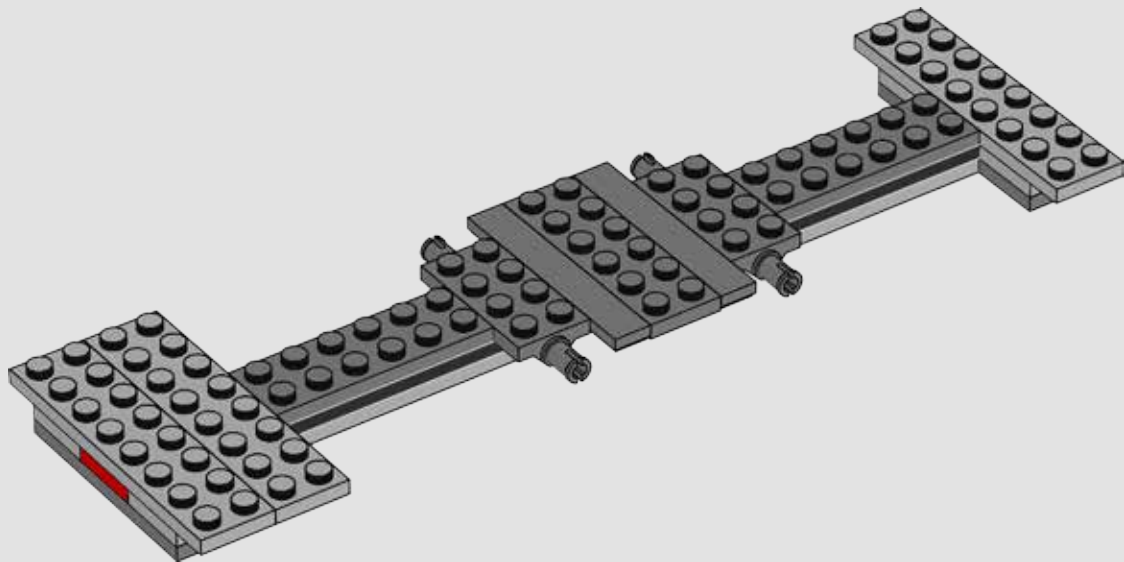

14



4x

14

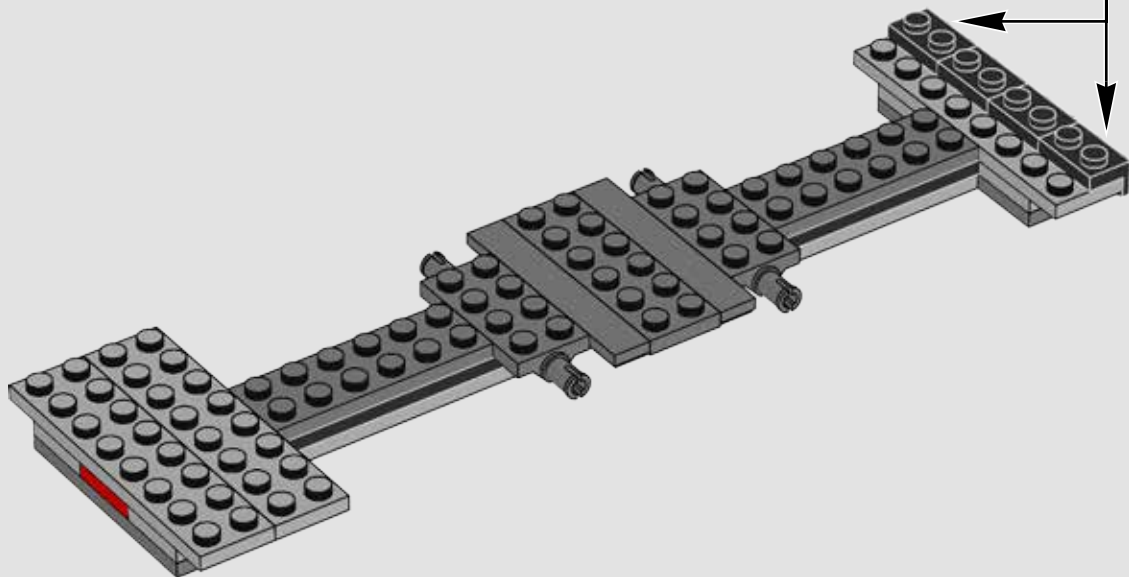

4x



2x

15

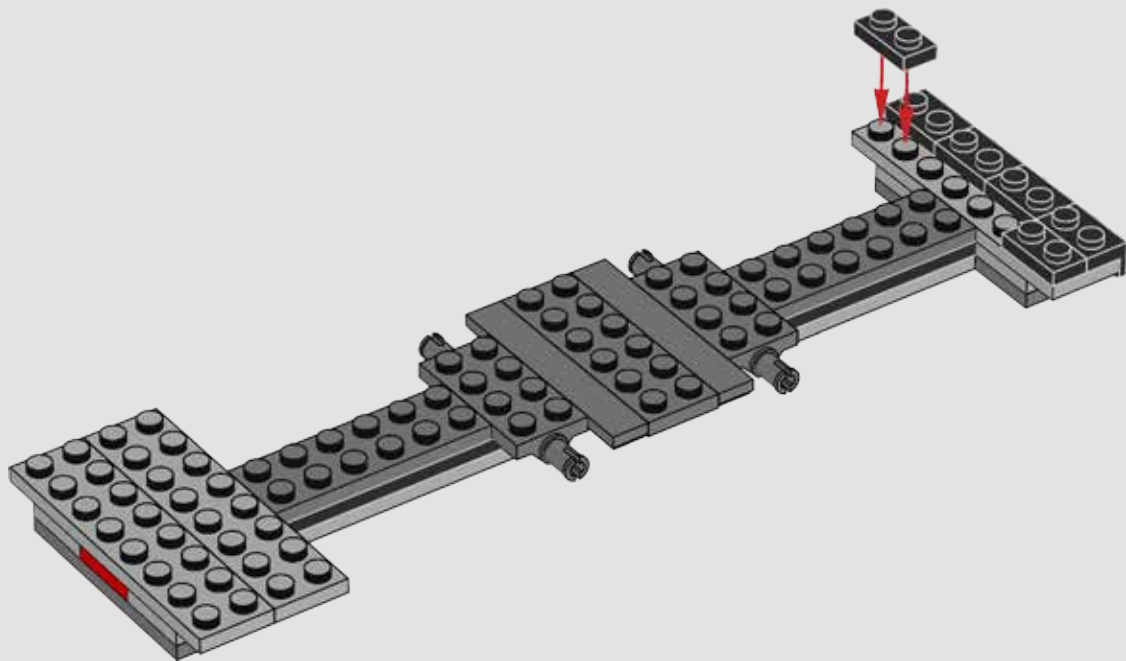

16



2x



2x

16

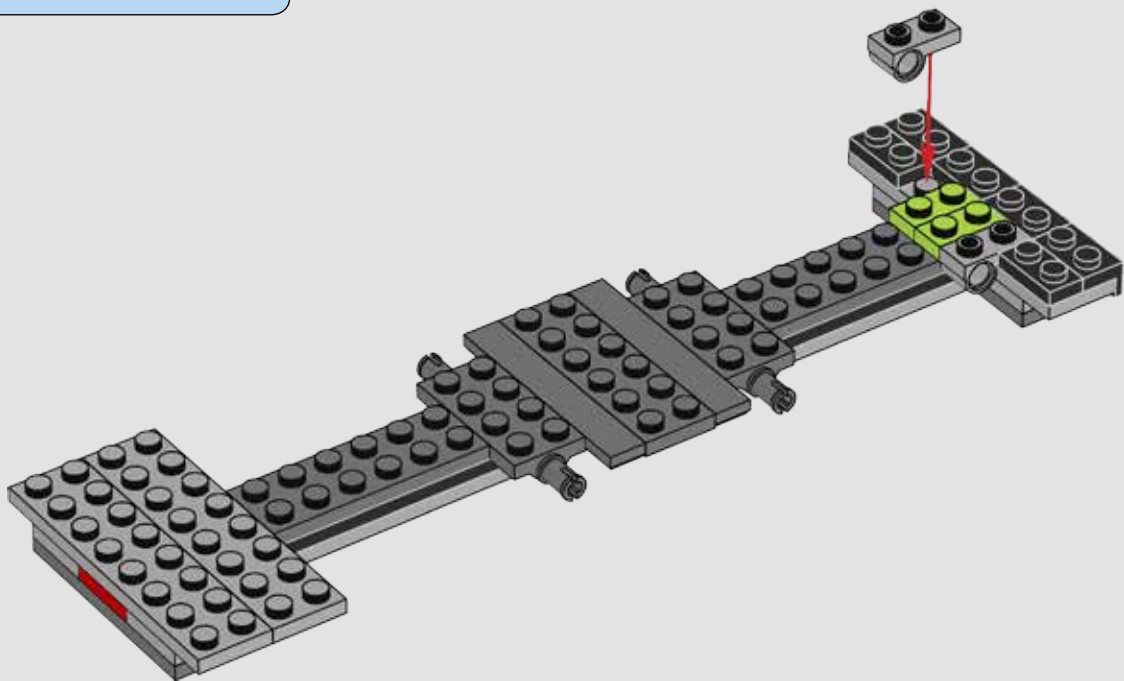

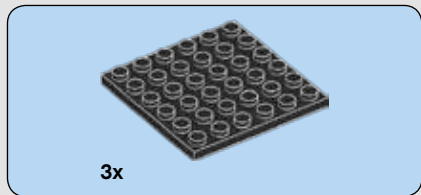

17

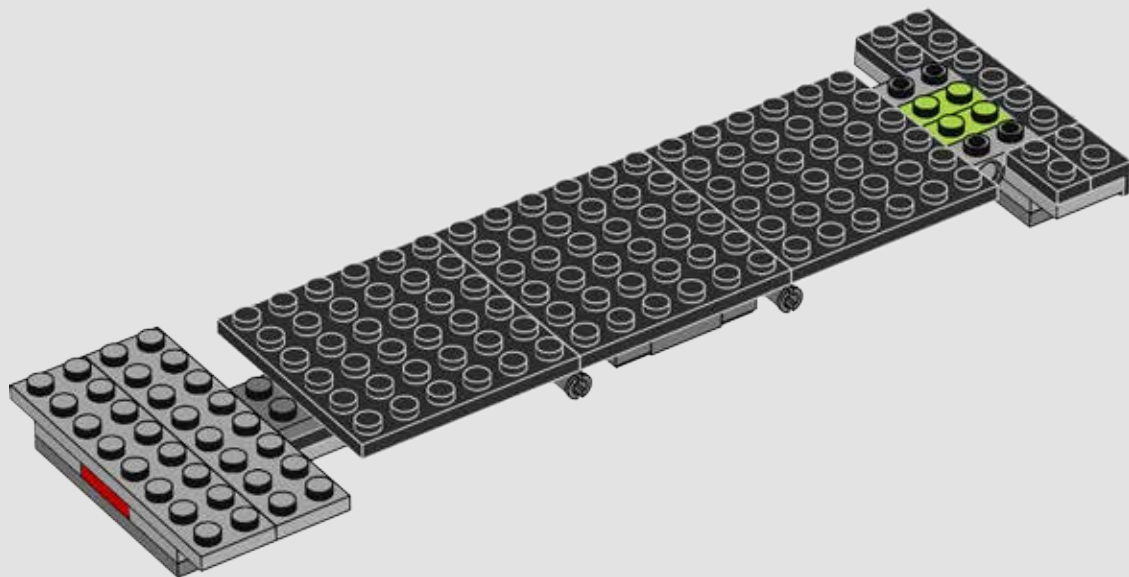

18



1x



2x

18

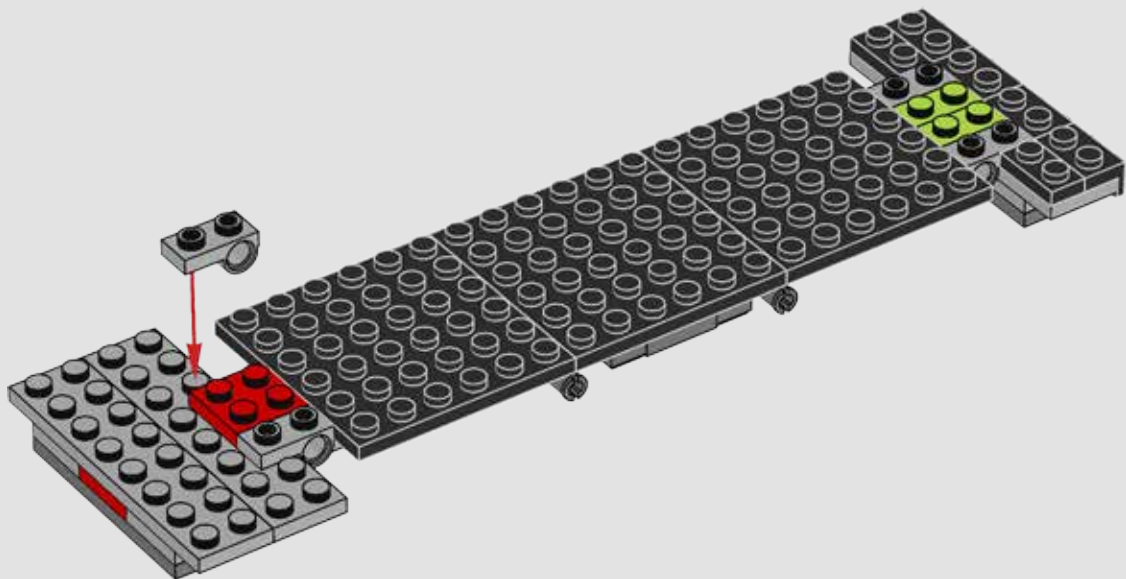

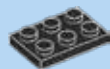

2x



1x

19

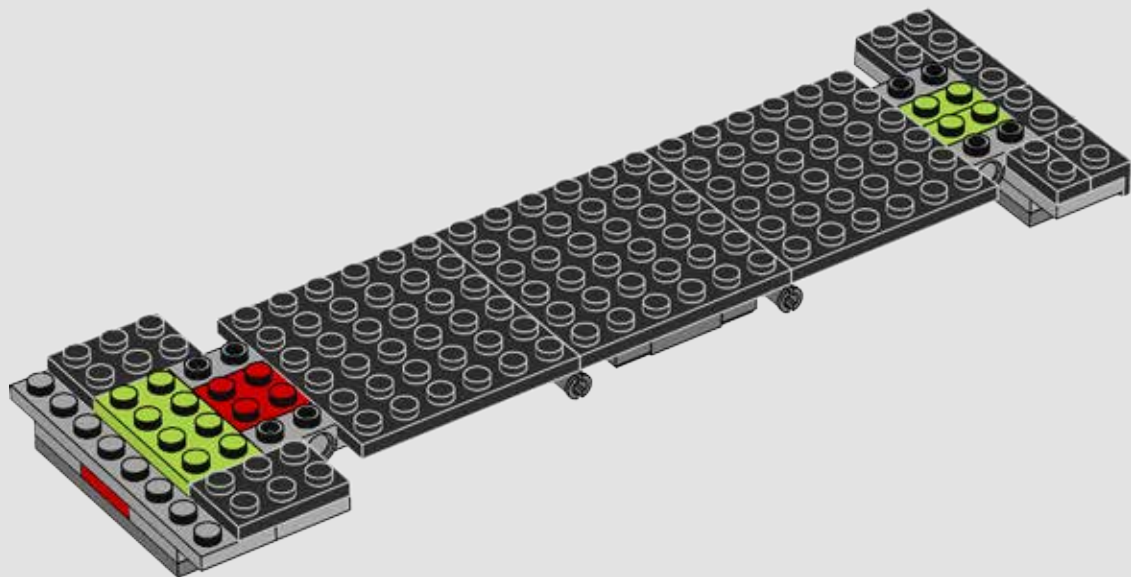

20



4x

20

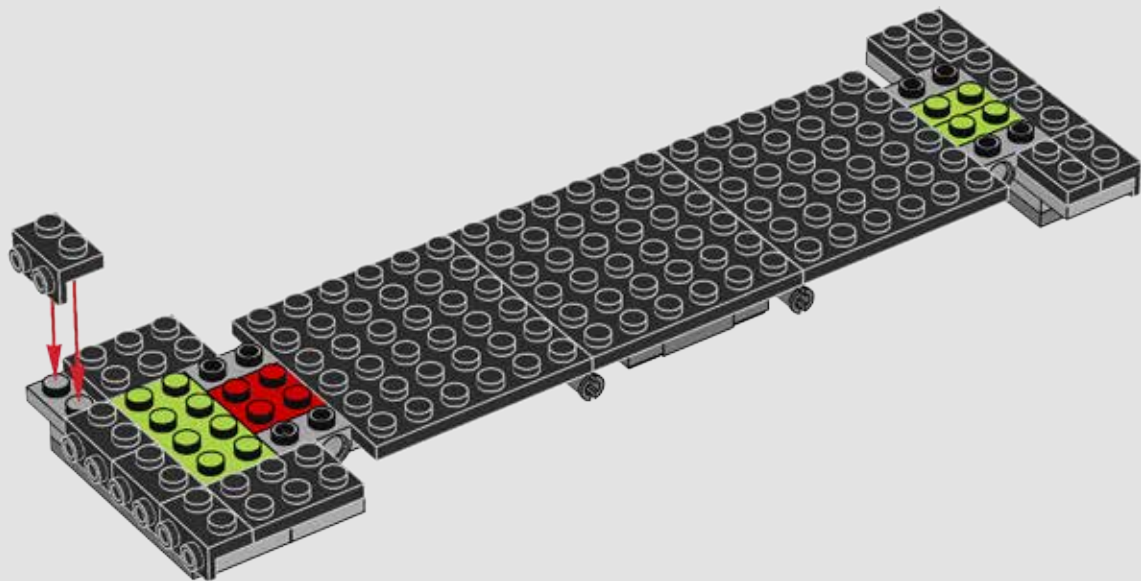

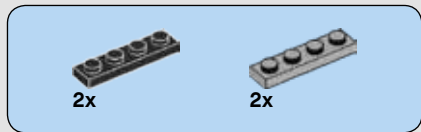

21

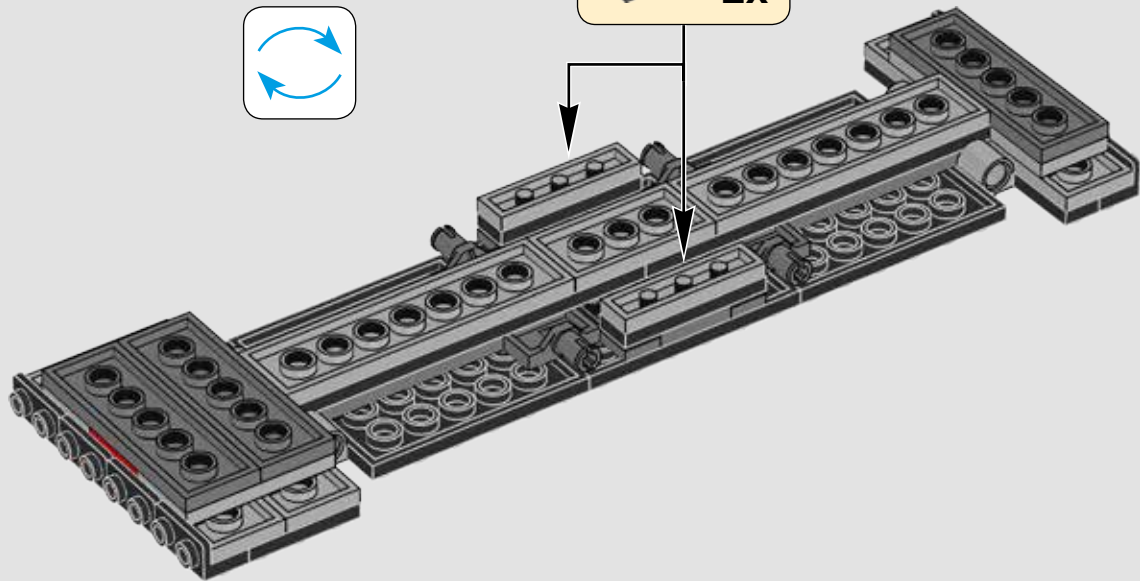
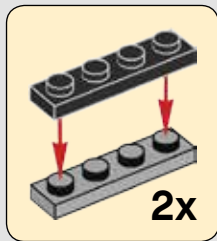
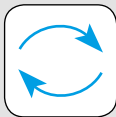

22



8x

22

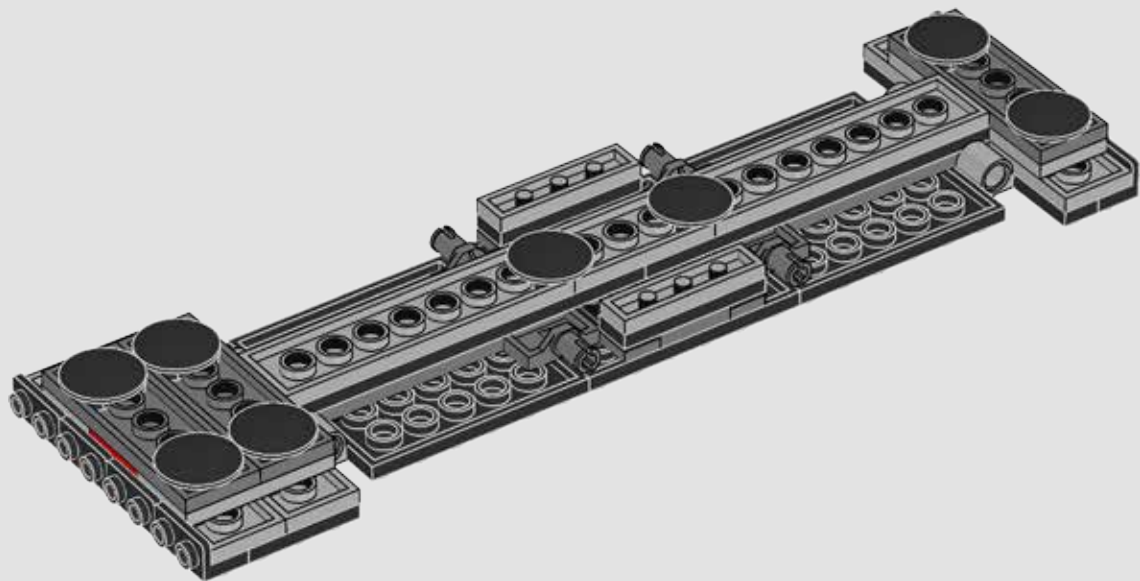



2x



2x



1x

23

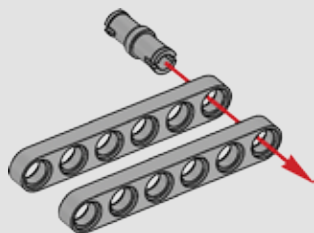

24



2x



1x

24

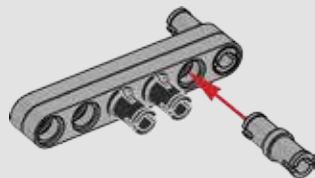

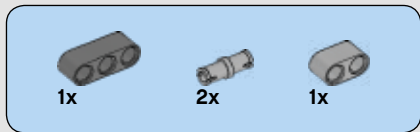

25

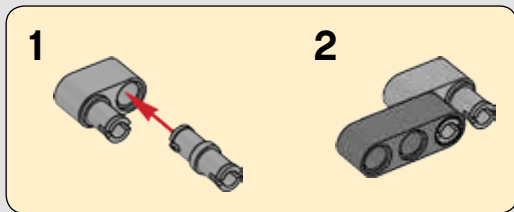

2

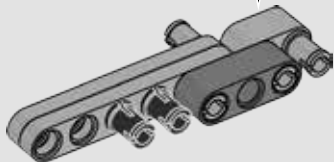
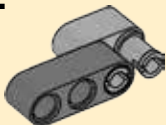

26



1x

26

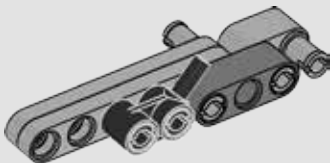

2x

27

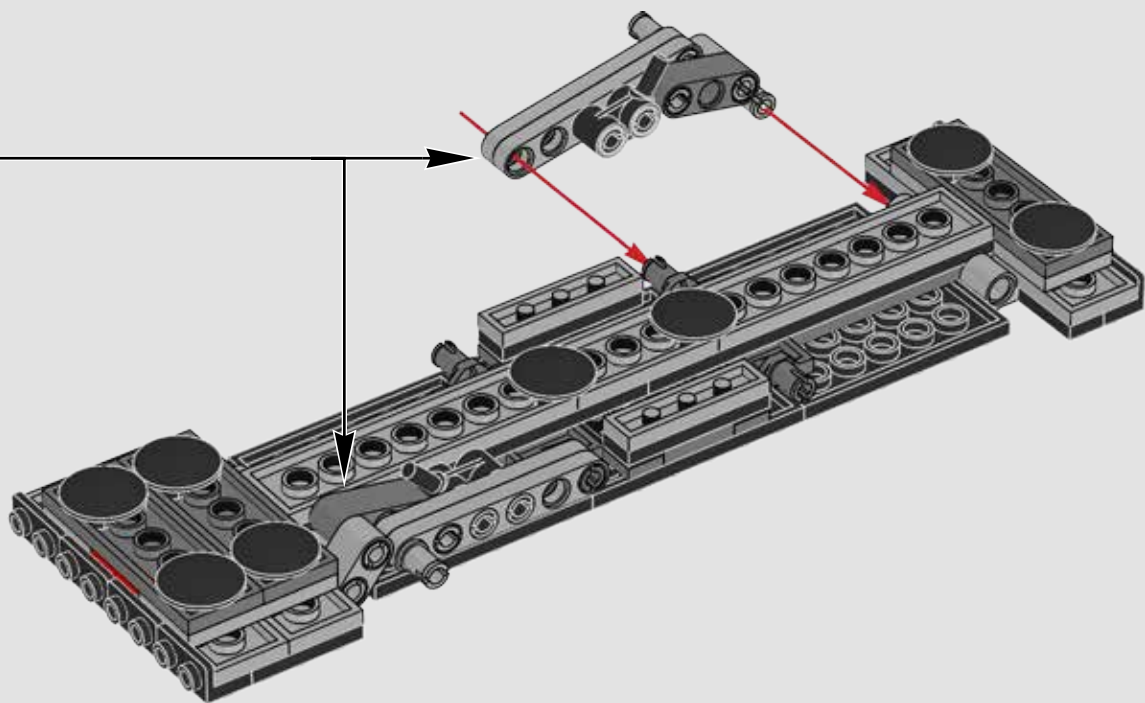

28



2x



2x



1x

28

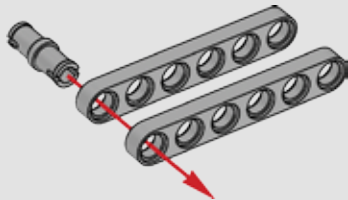



2x



1x

29

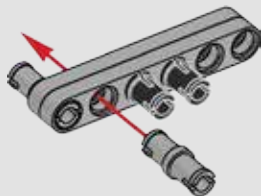

30

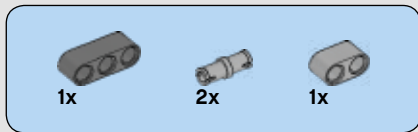

30

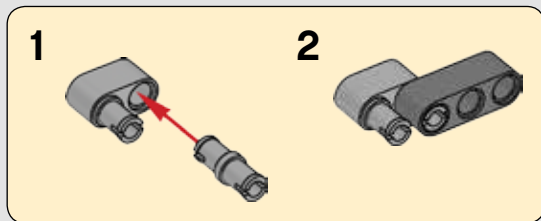

2

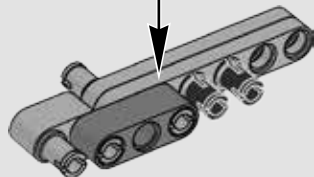
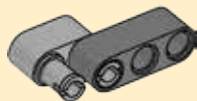



1x

31

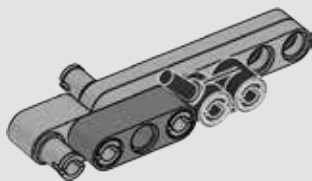

2x

32

32

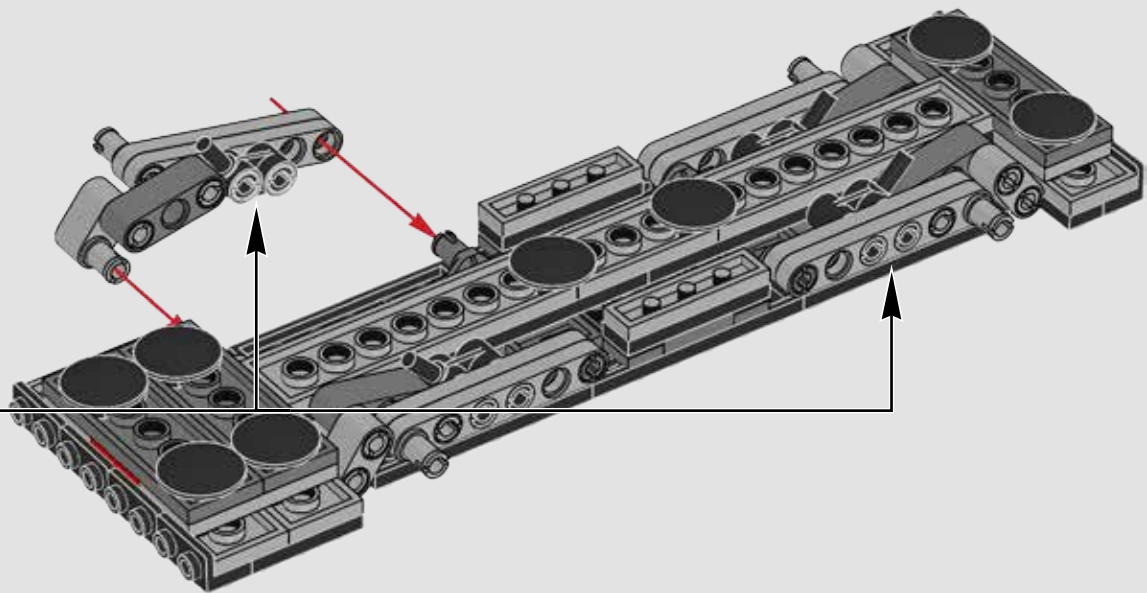

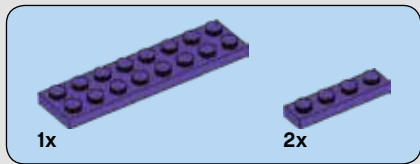

33

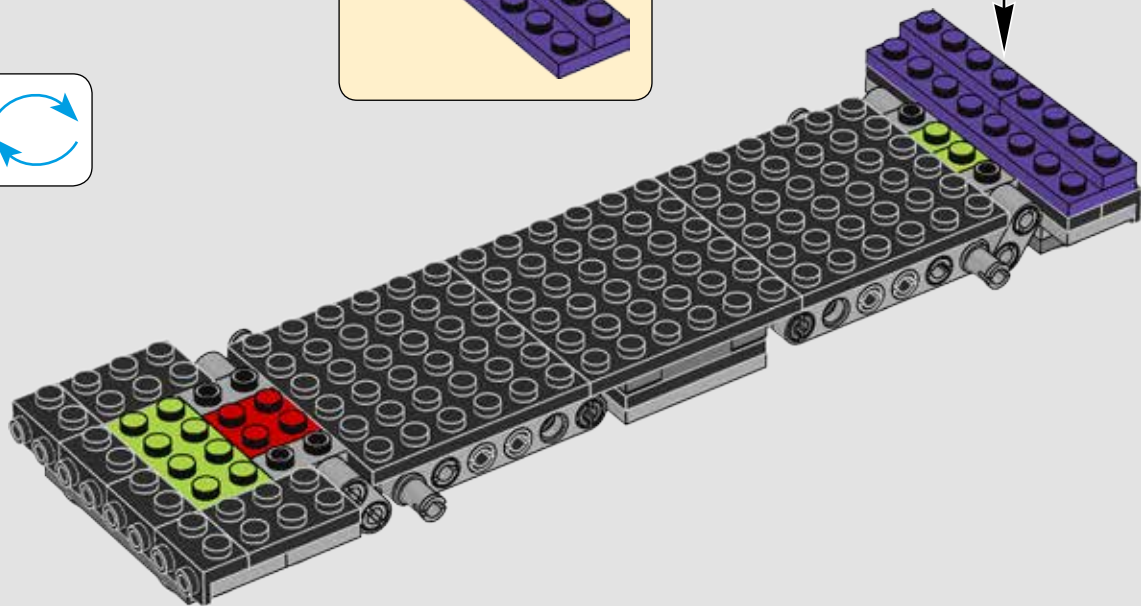
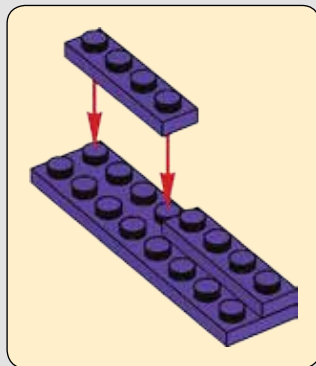

34



34

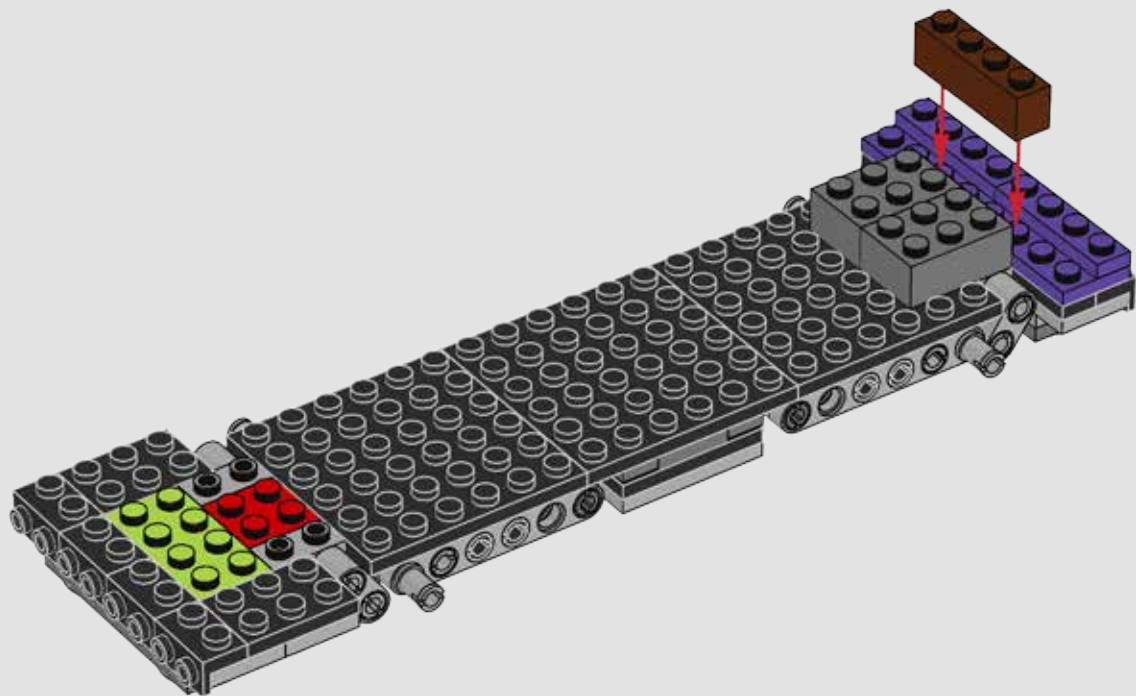

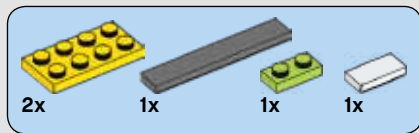

35

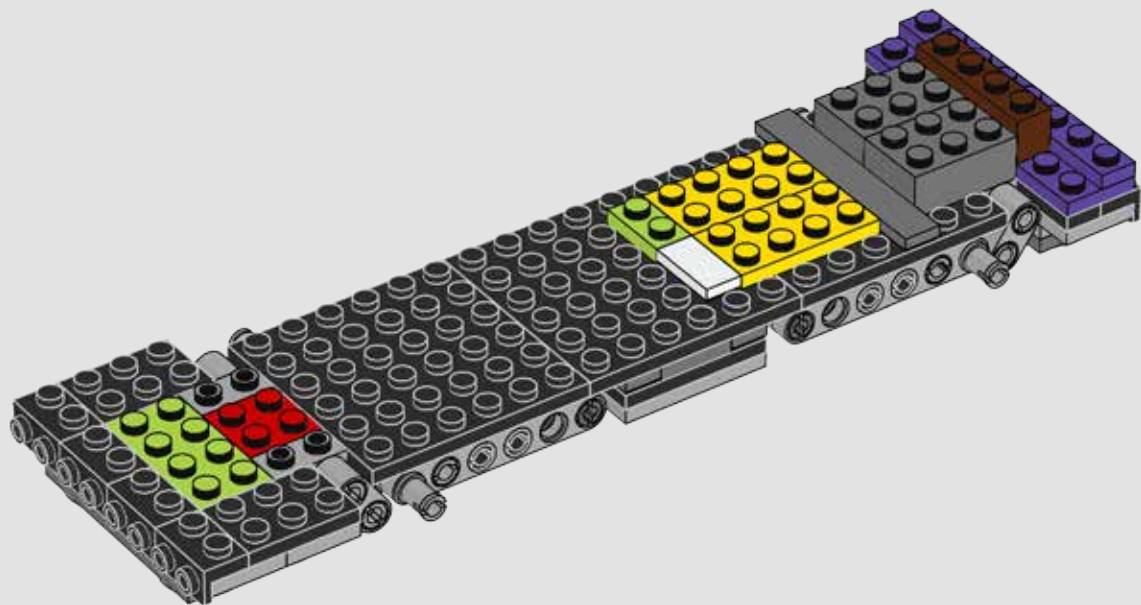

36



1x



2x

36

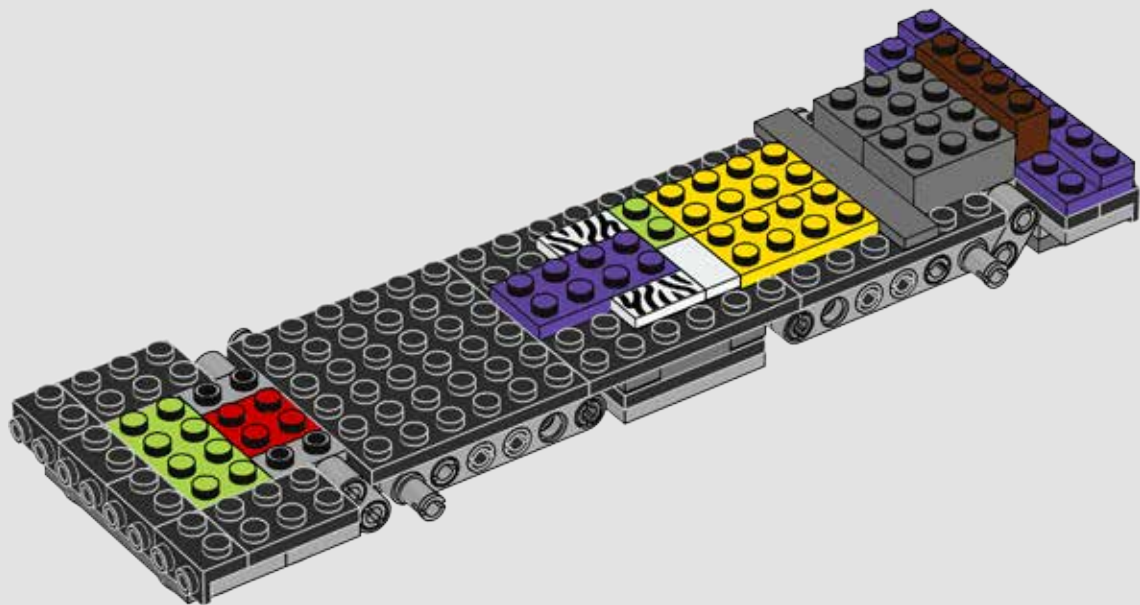



2x



2x

37

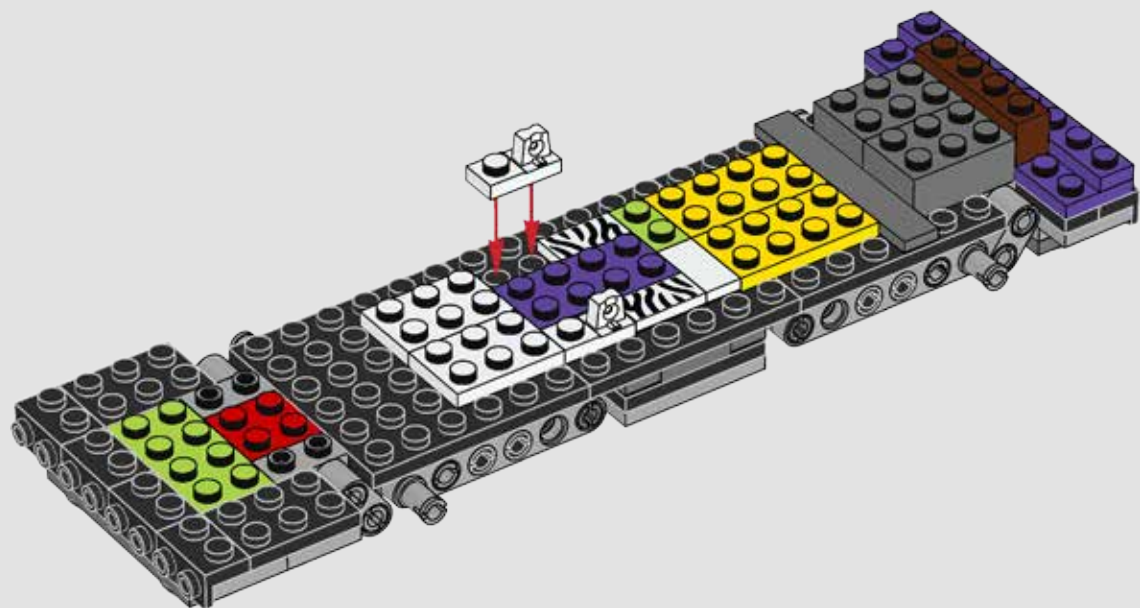

38



38



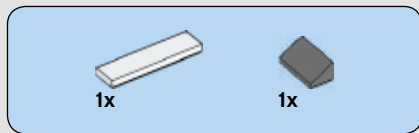

39

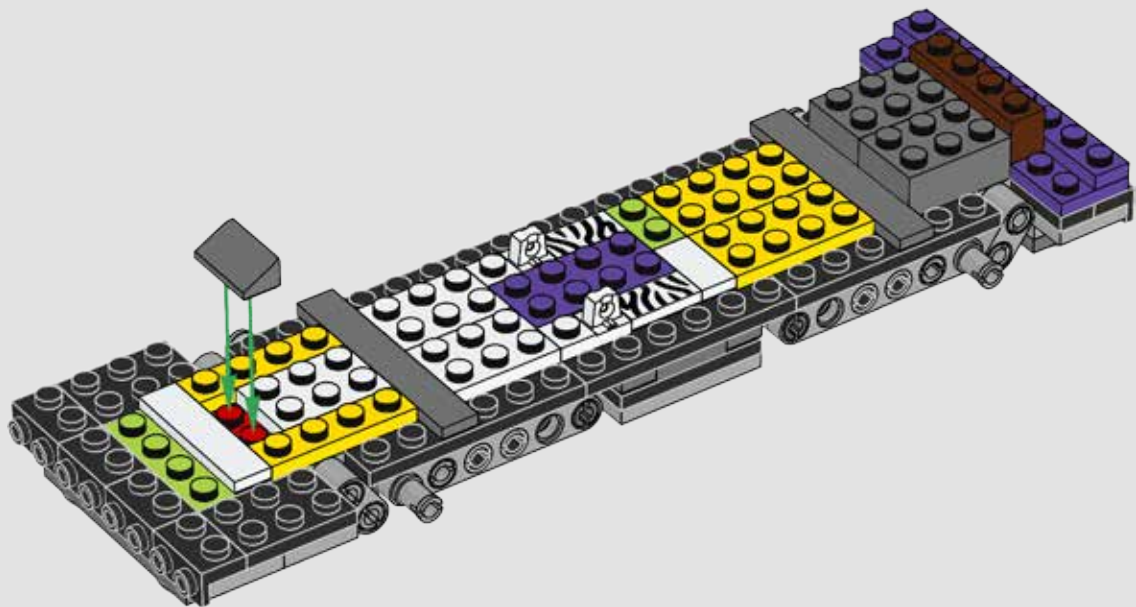

40

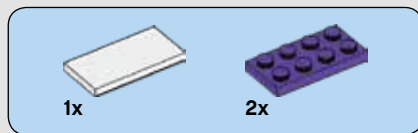

40





12x

41

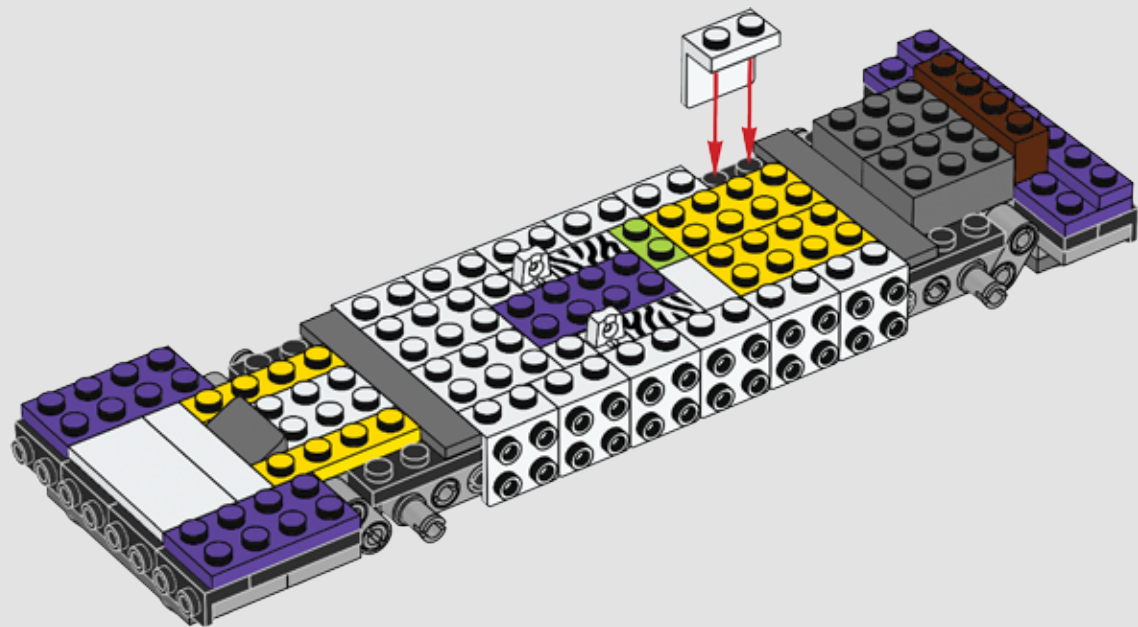

42



42





2x



1x



1x

1

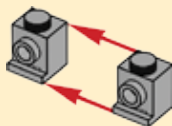

2

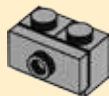

43

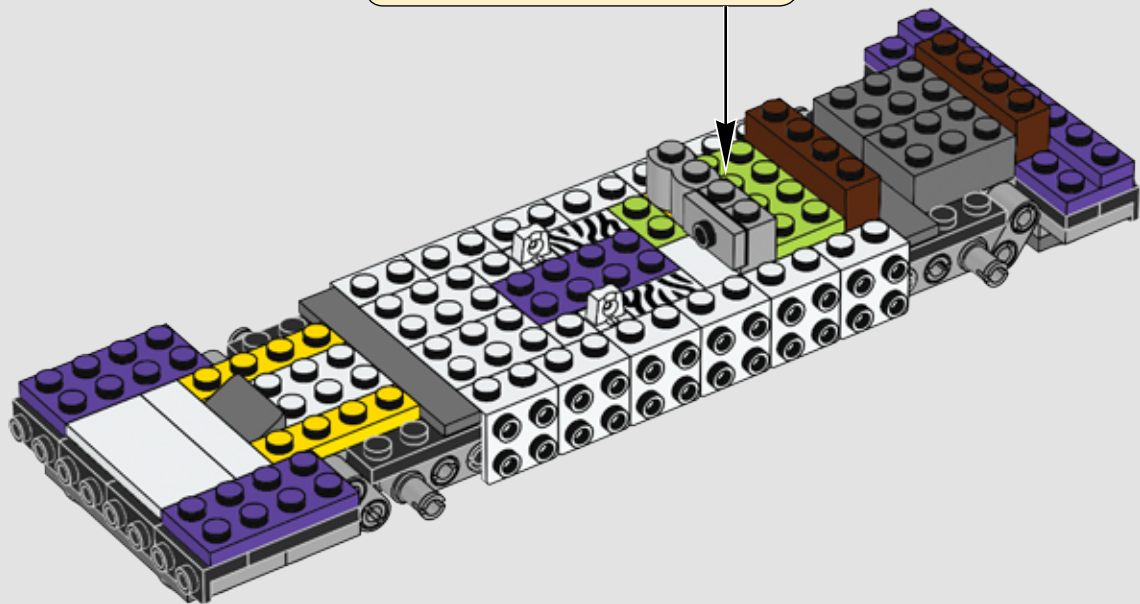

44

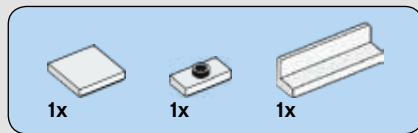

44

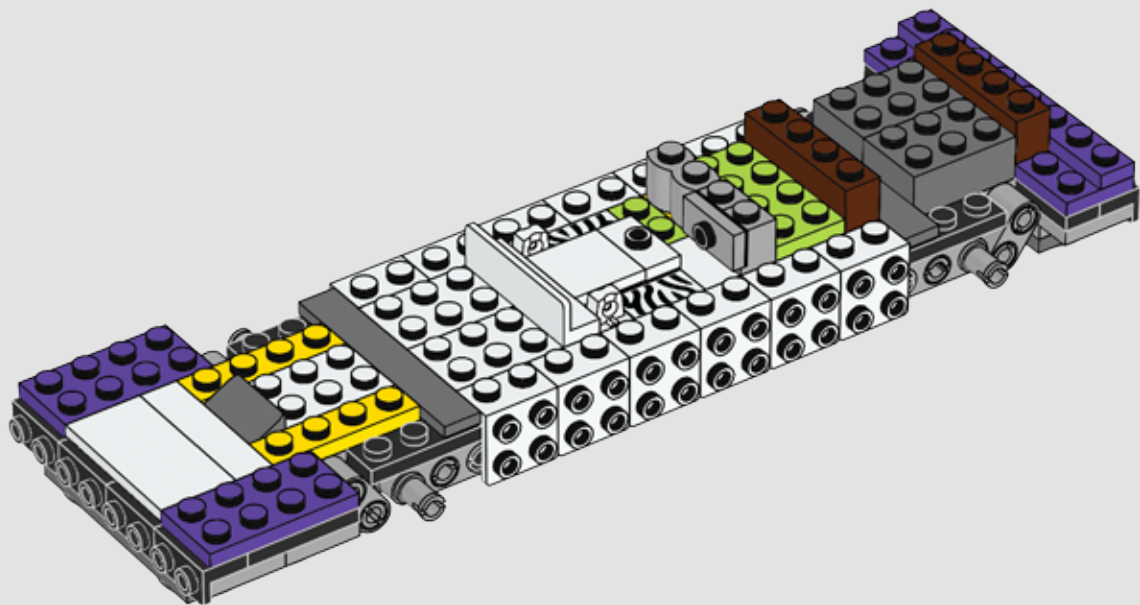



1x



1x

45

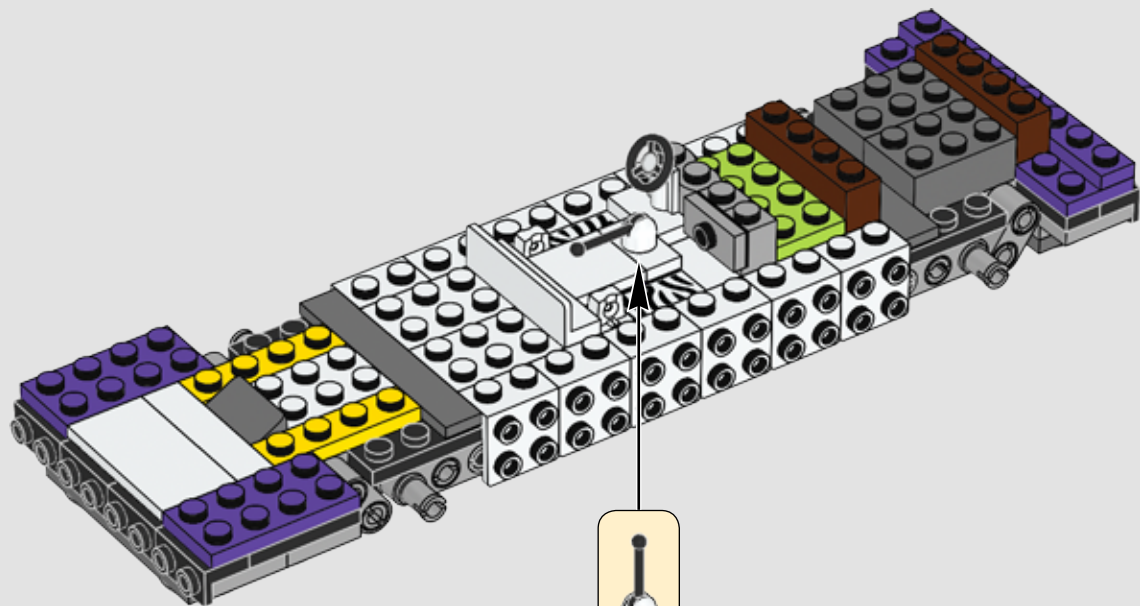

46



1x



1x

46

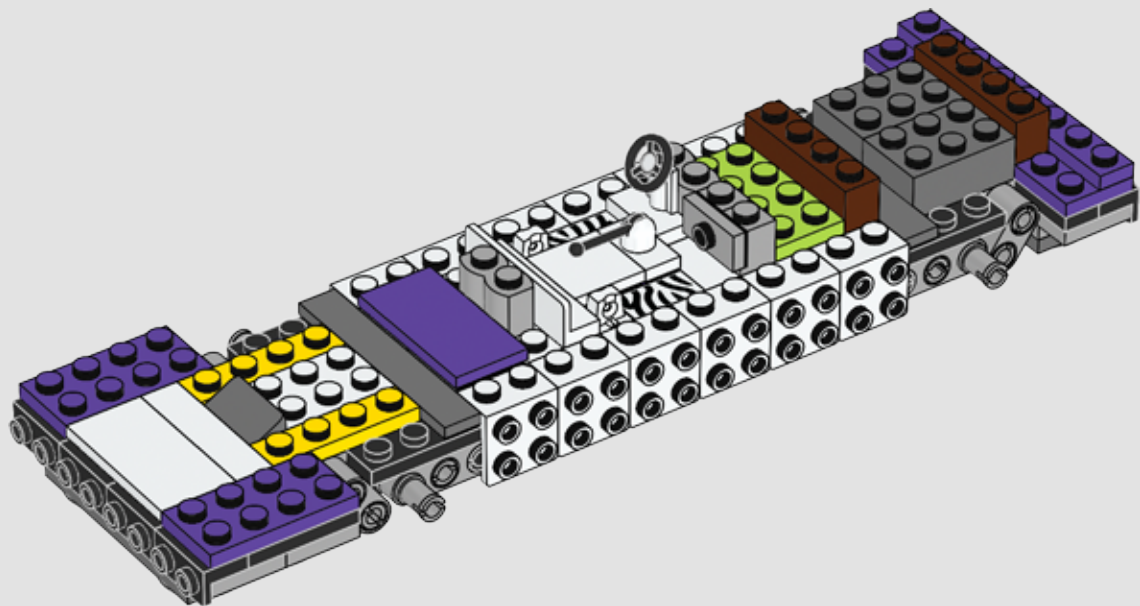

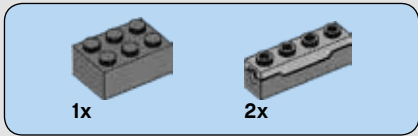

47

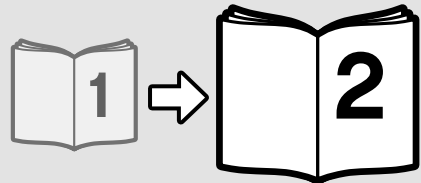
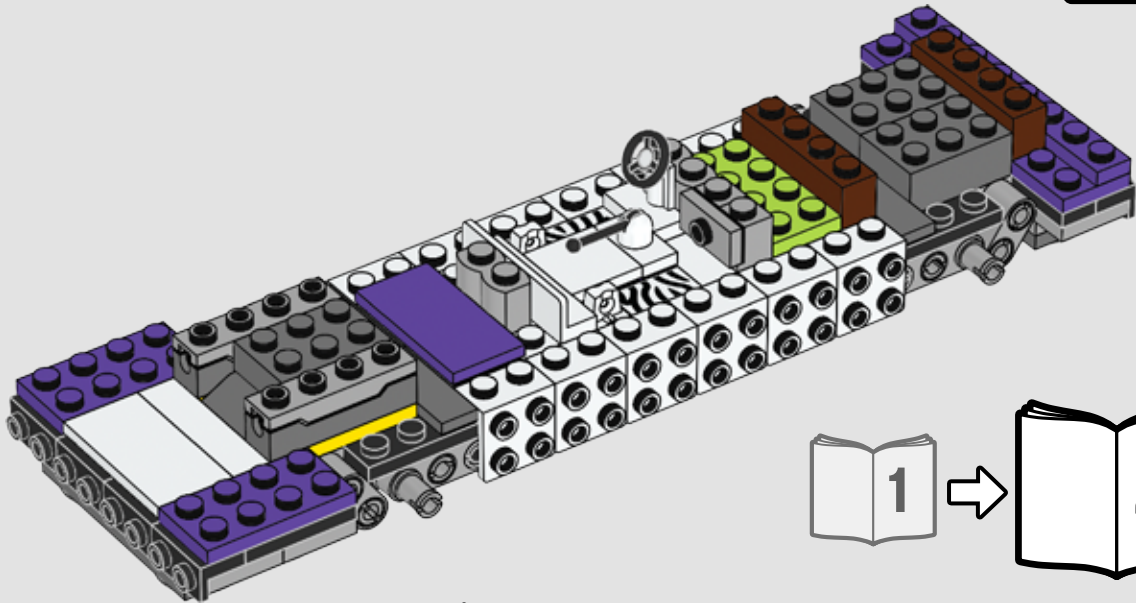

48