



**STAR  
WARS**™

**8-12**



4176941

**7143**

**JEDI STARFIGHTER™**

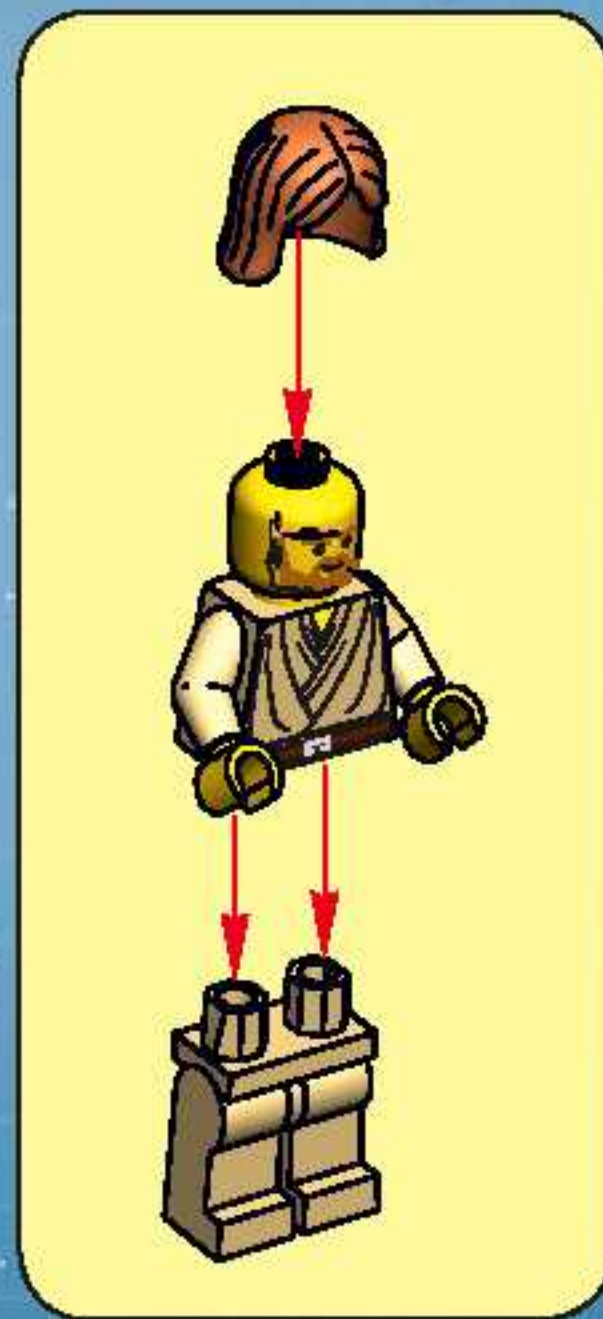
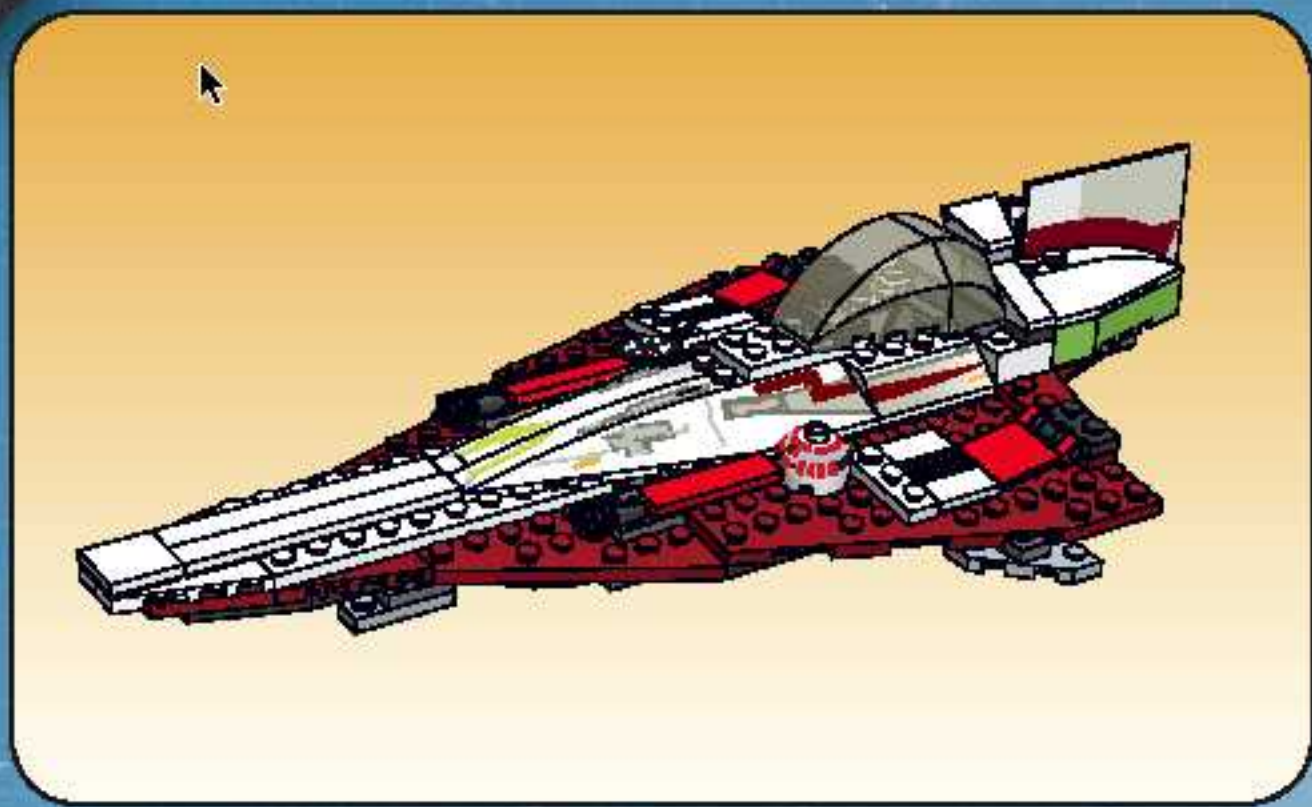

1

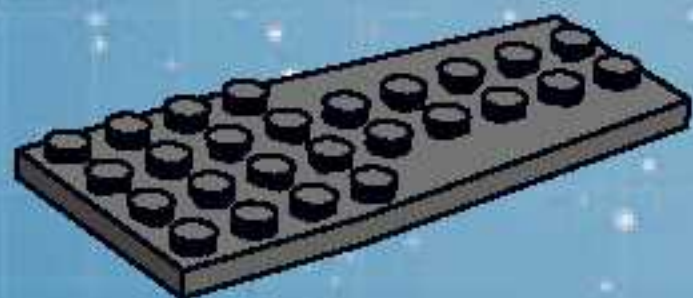

2

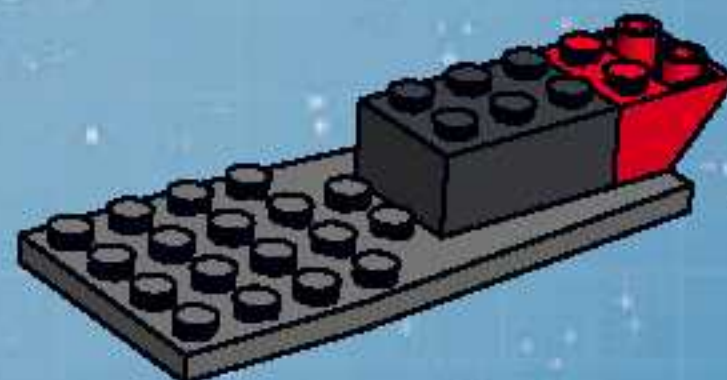

1

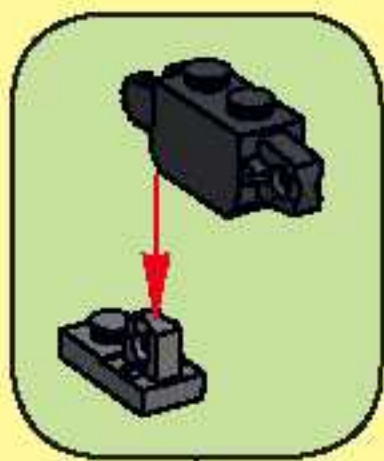

2



3

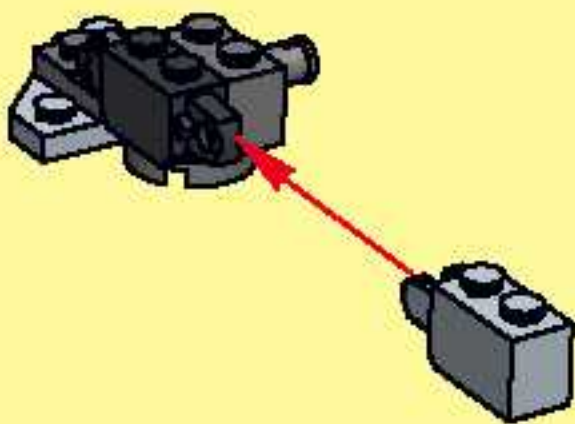

4

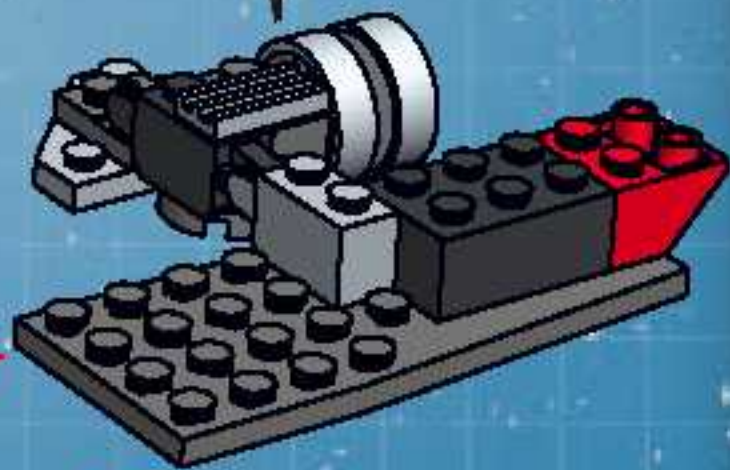
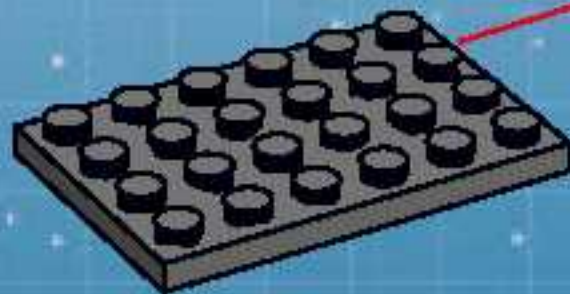
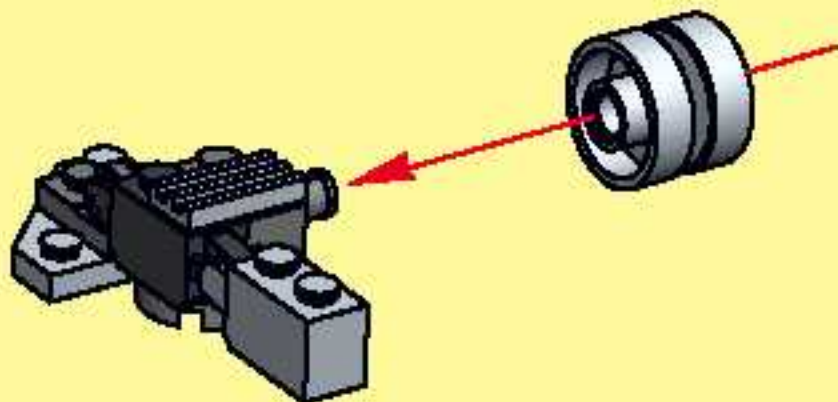

1

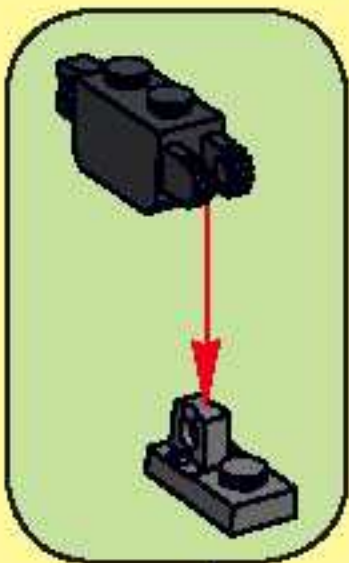
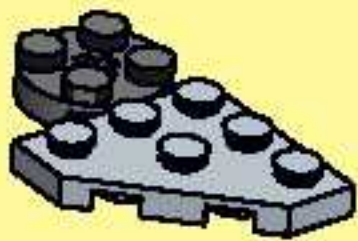

2

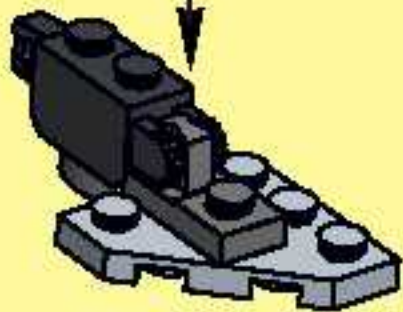

3

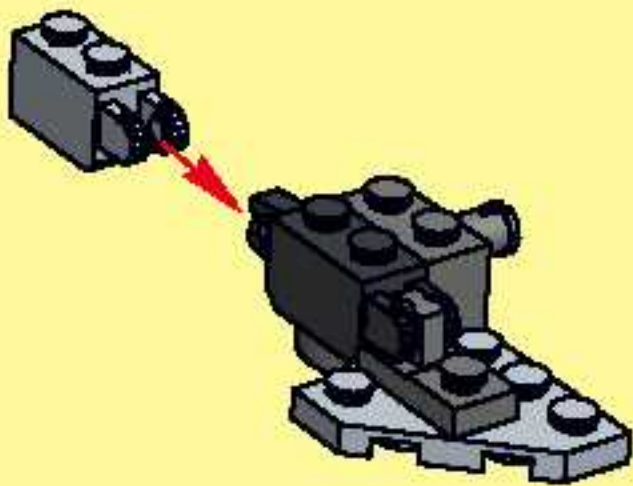

4

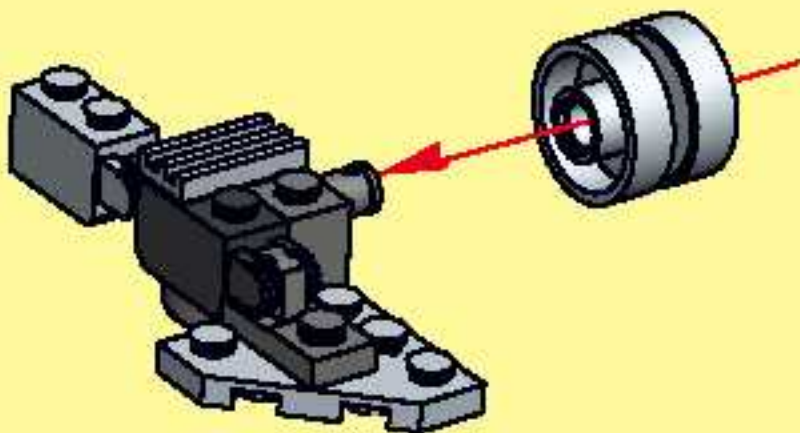

4

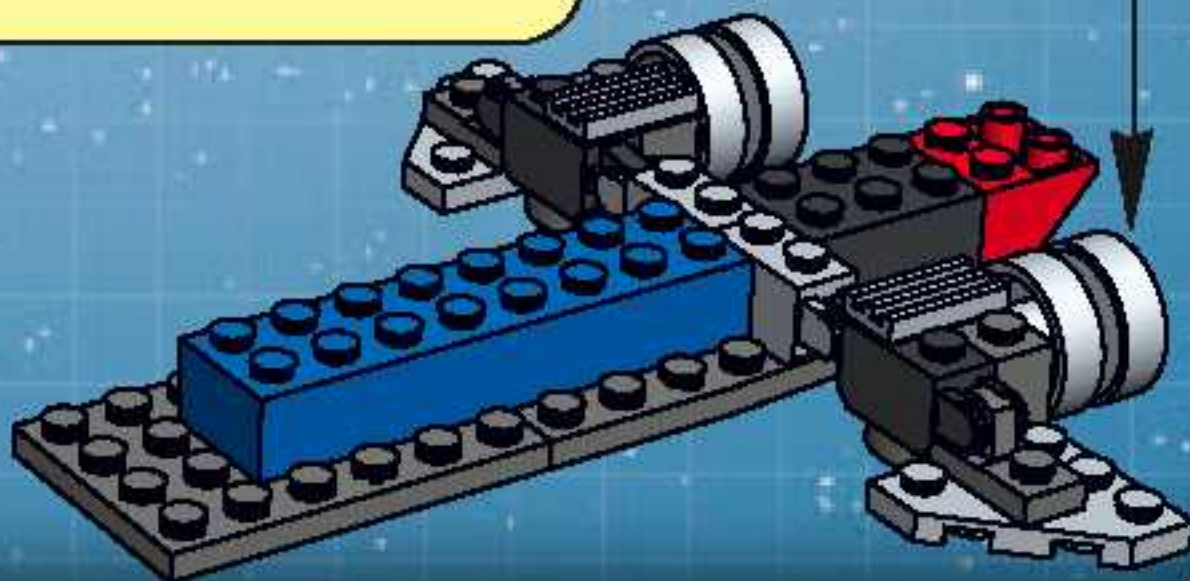

5

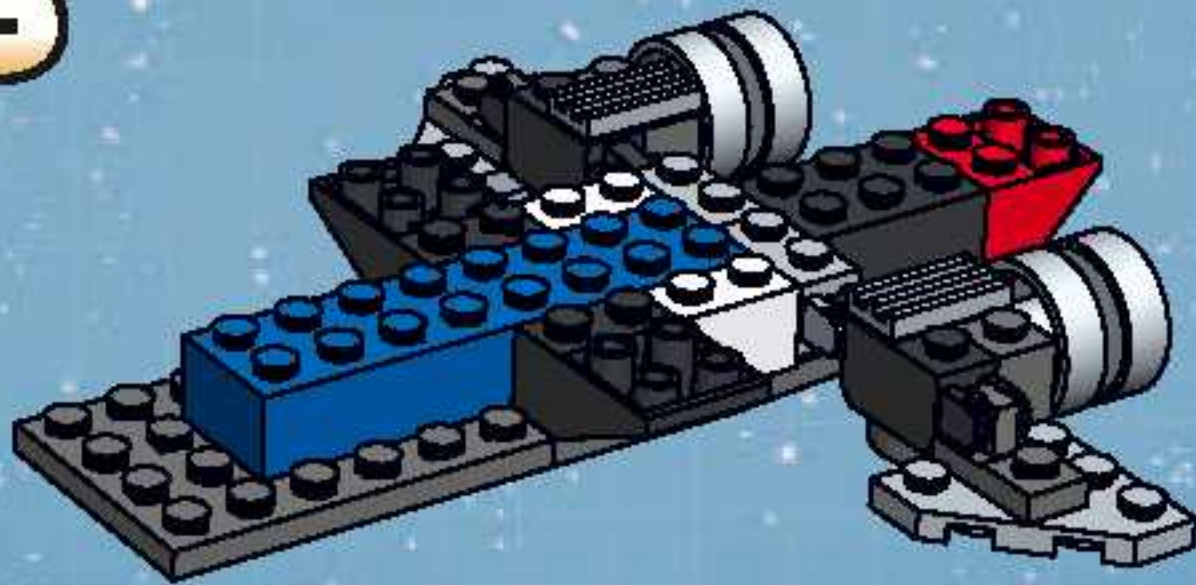

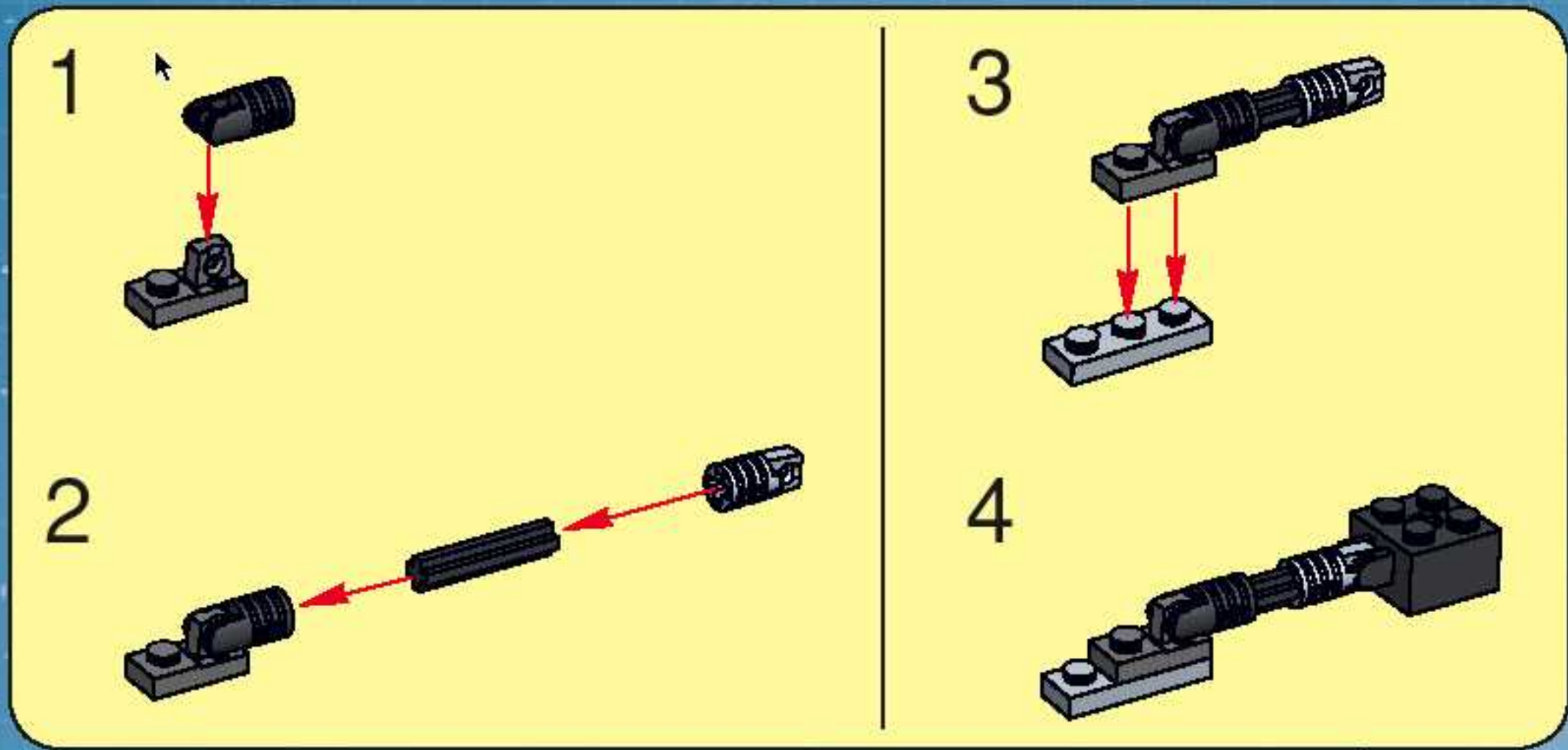

6

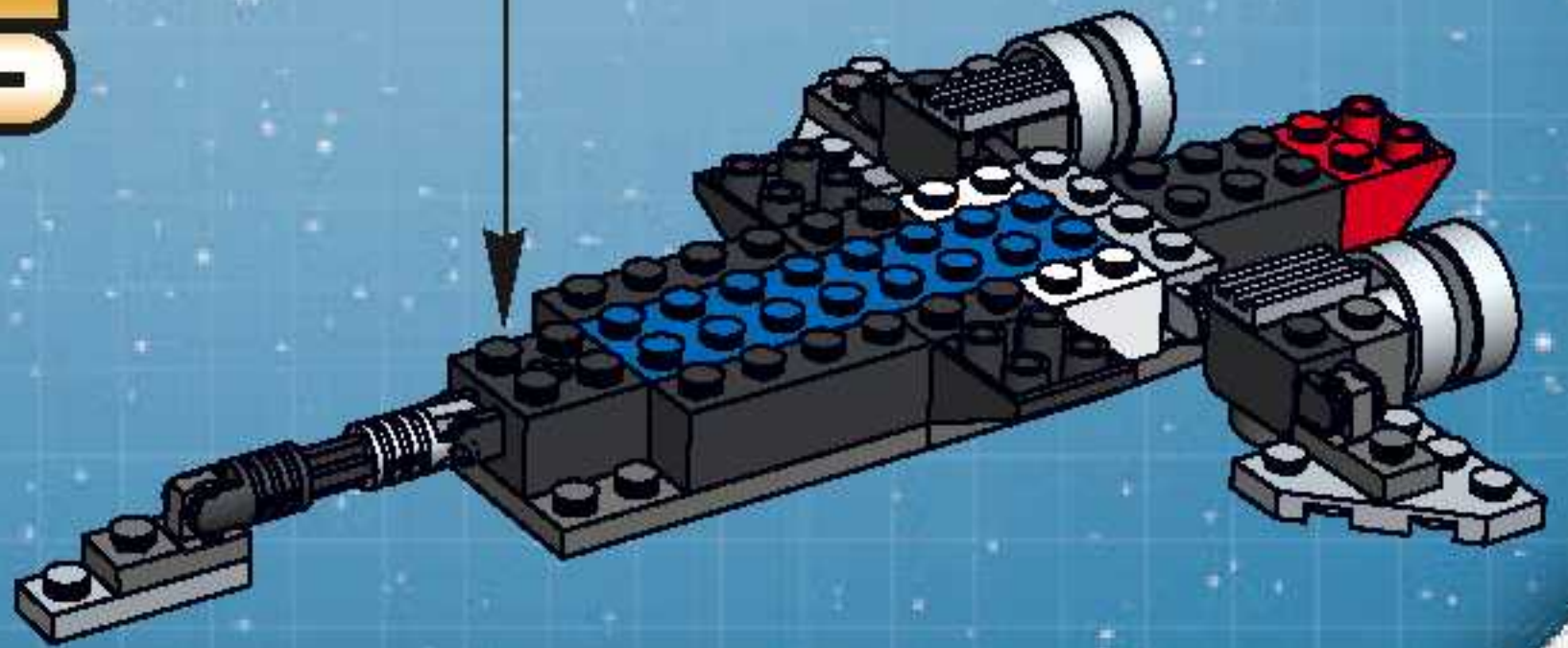

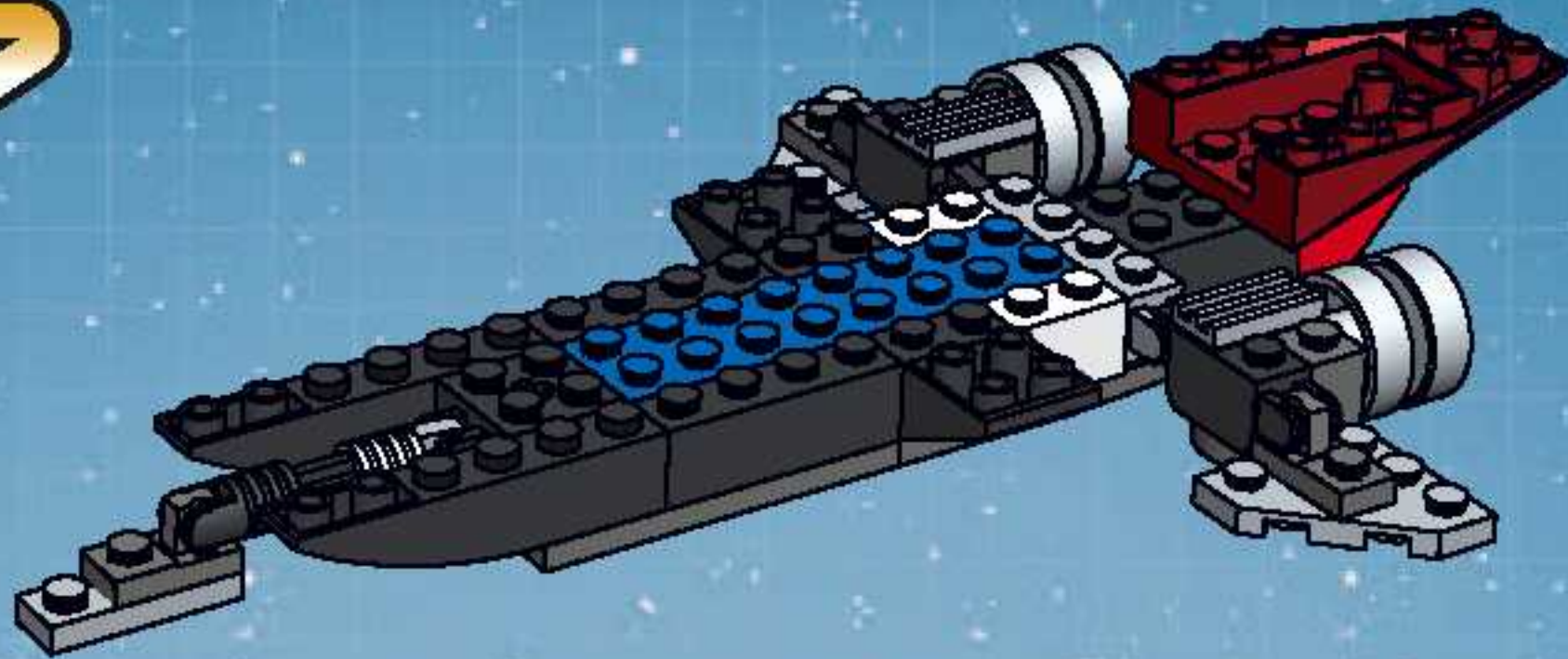



9

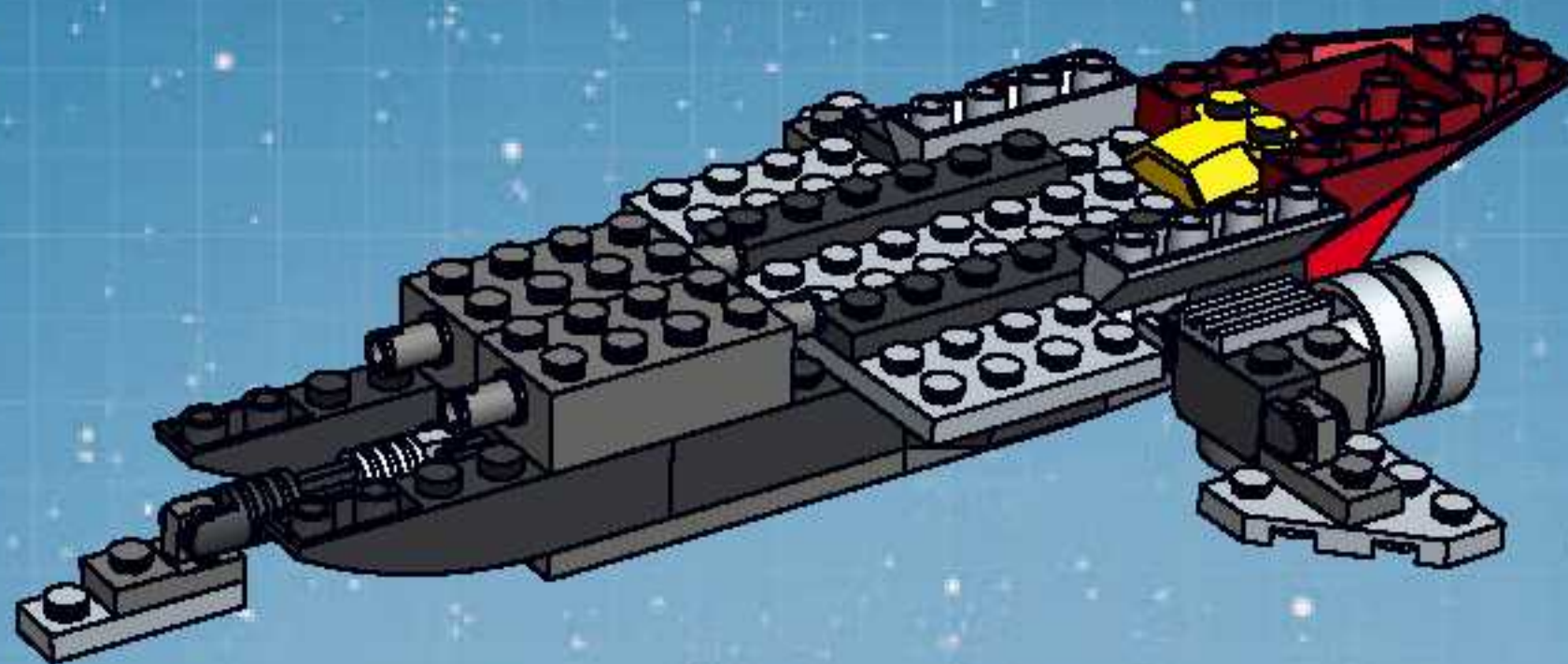

10

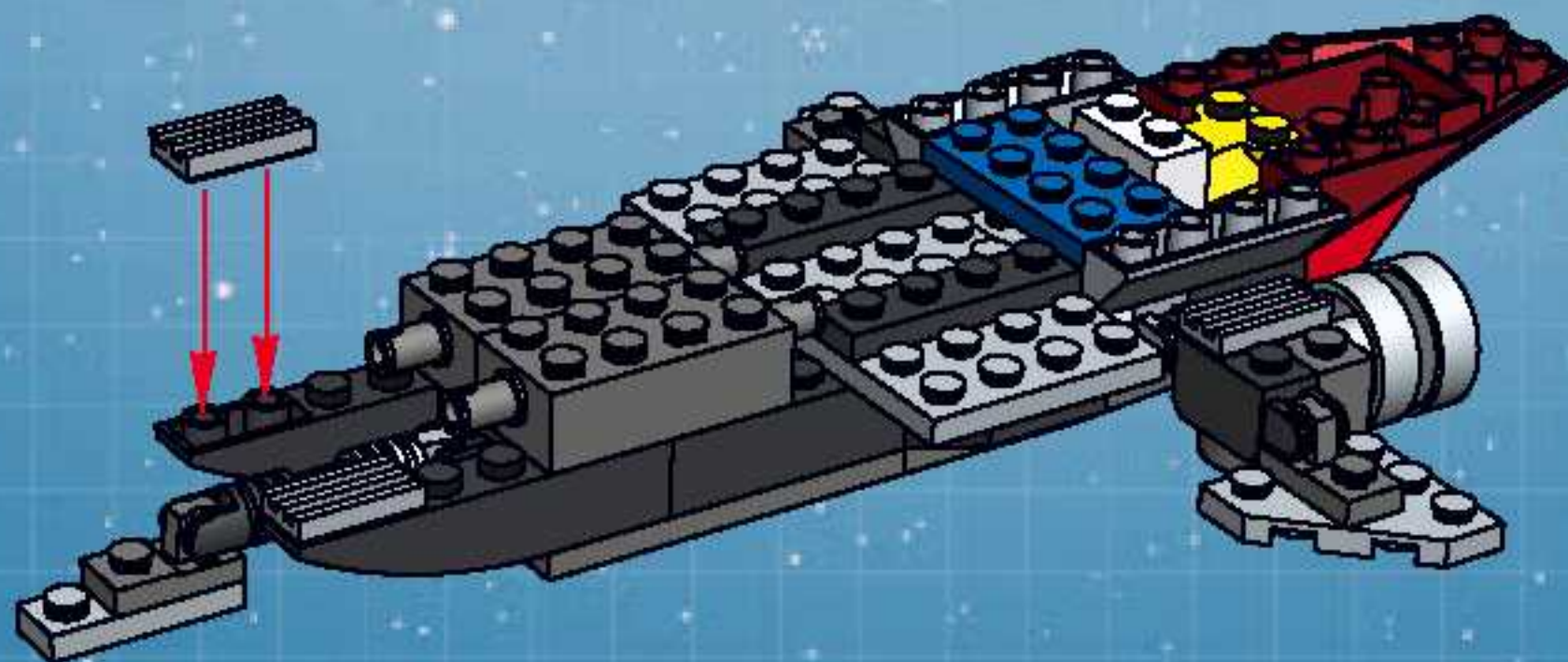



12

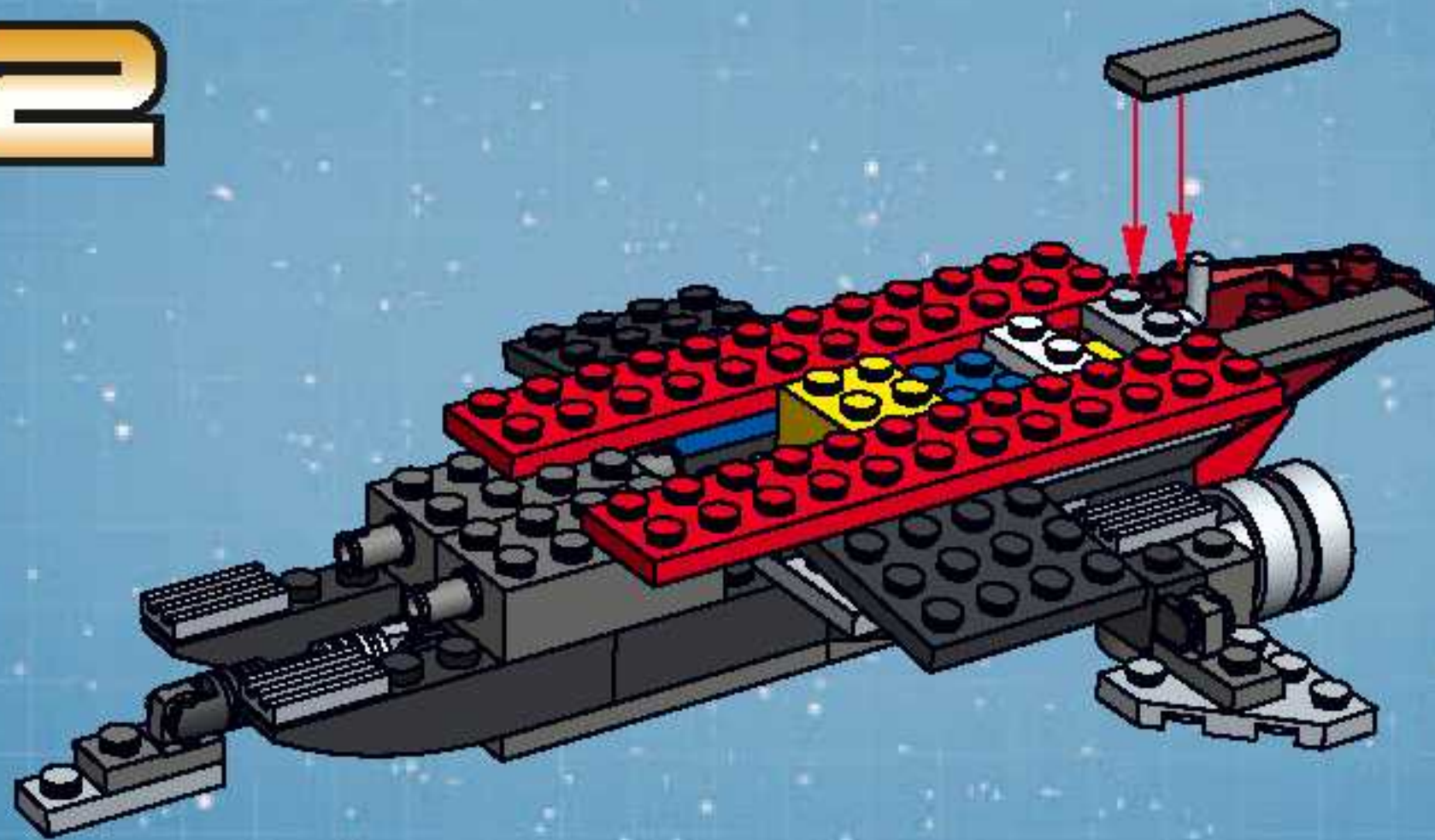

1

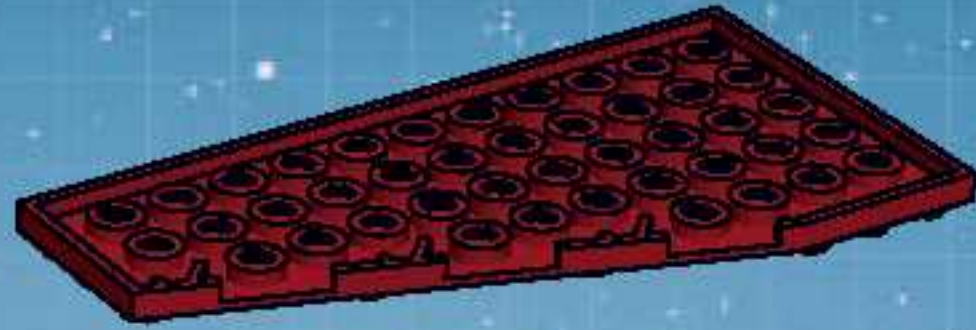

2

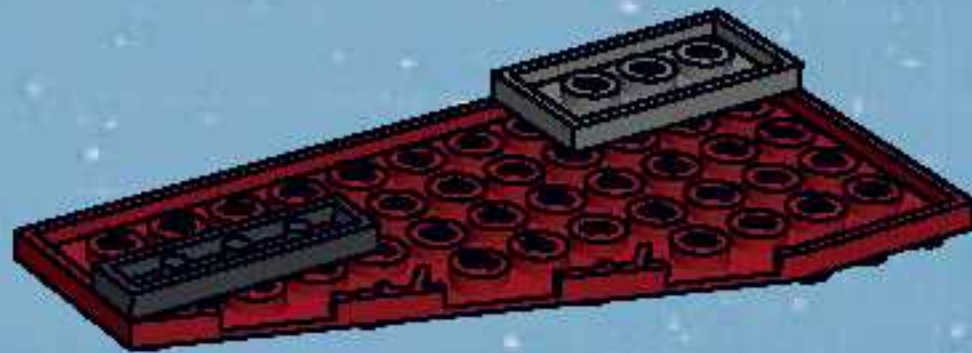

3

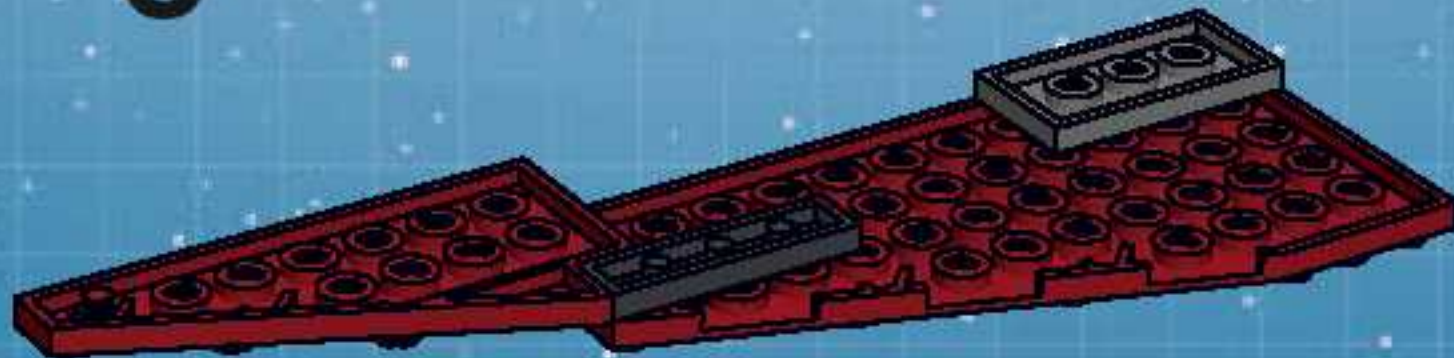

4

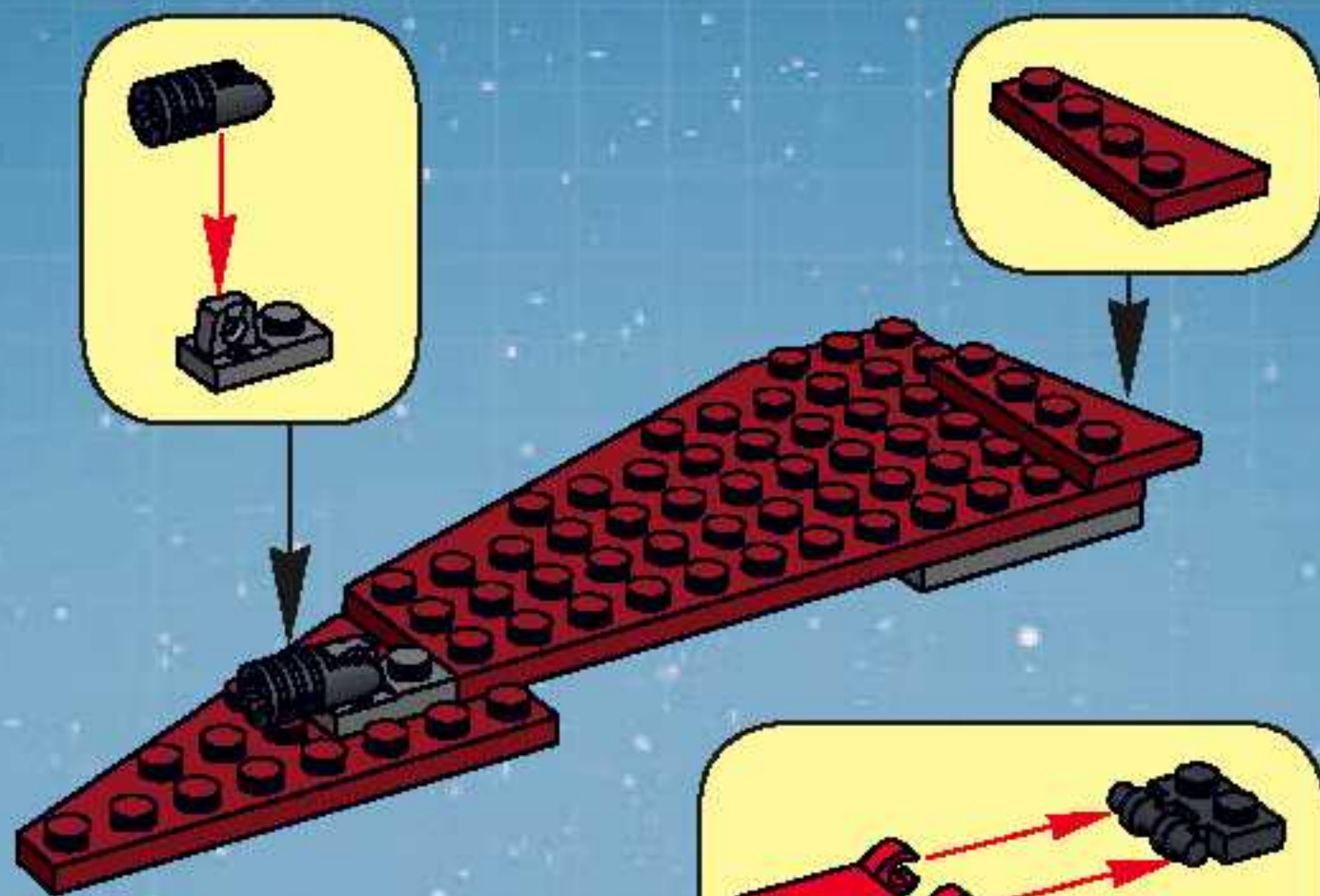

5

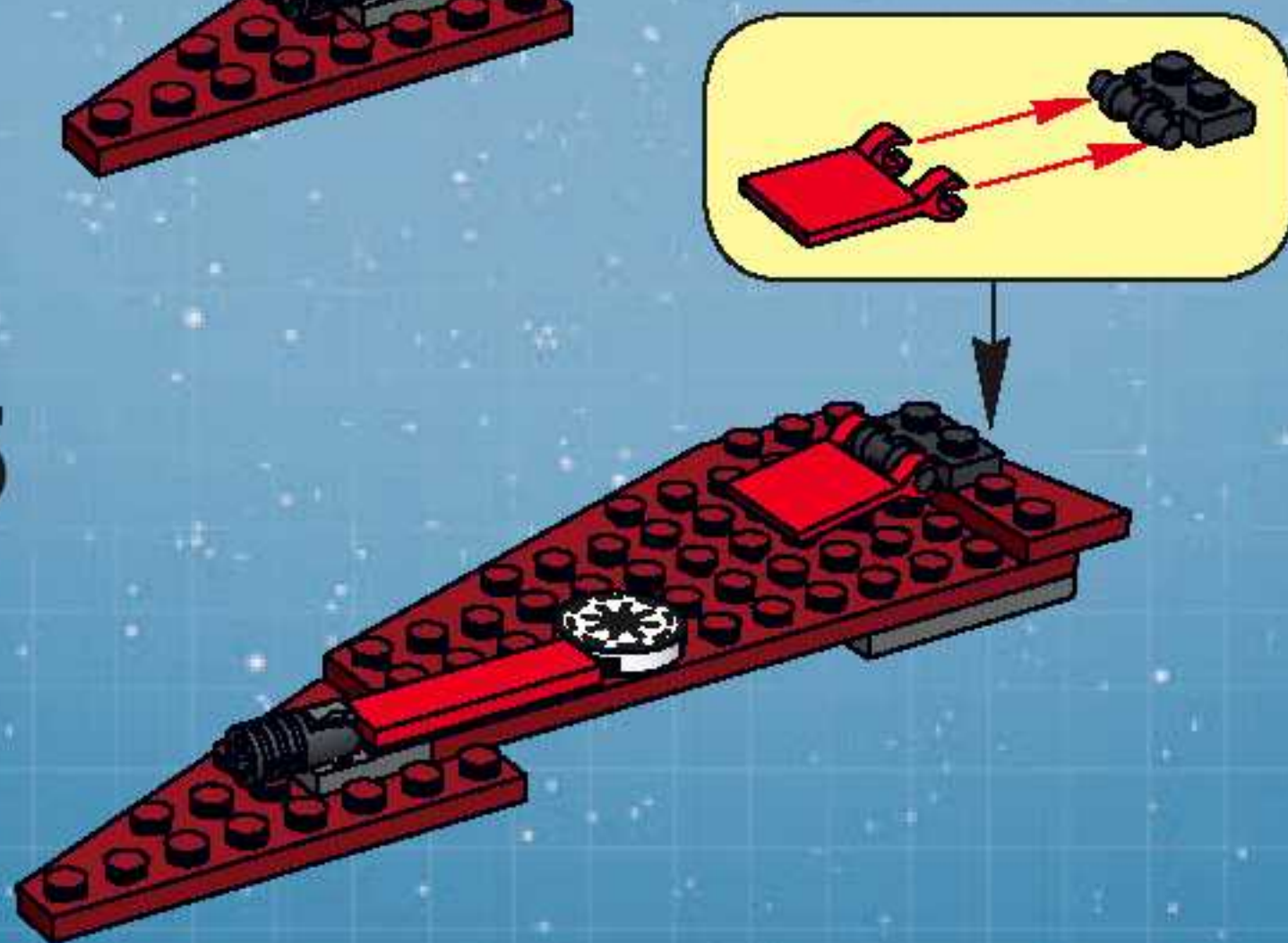

6

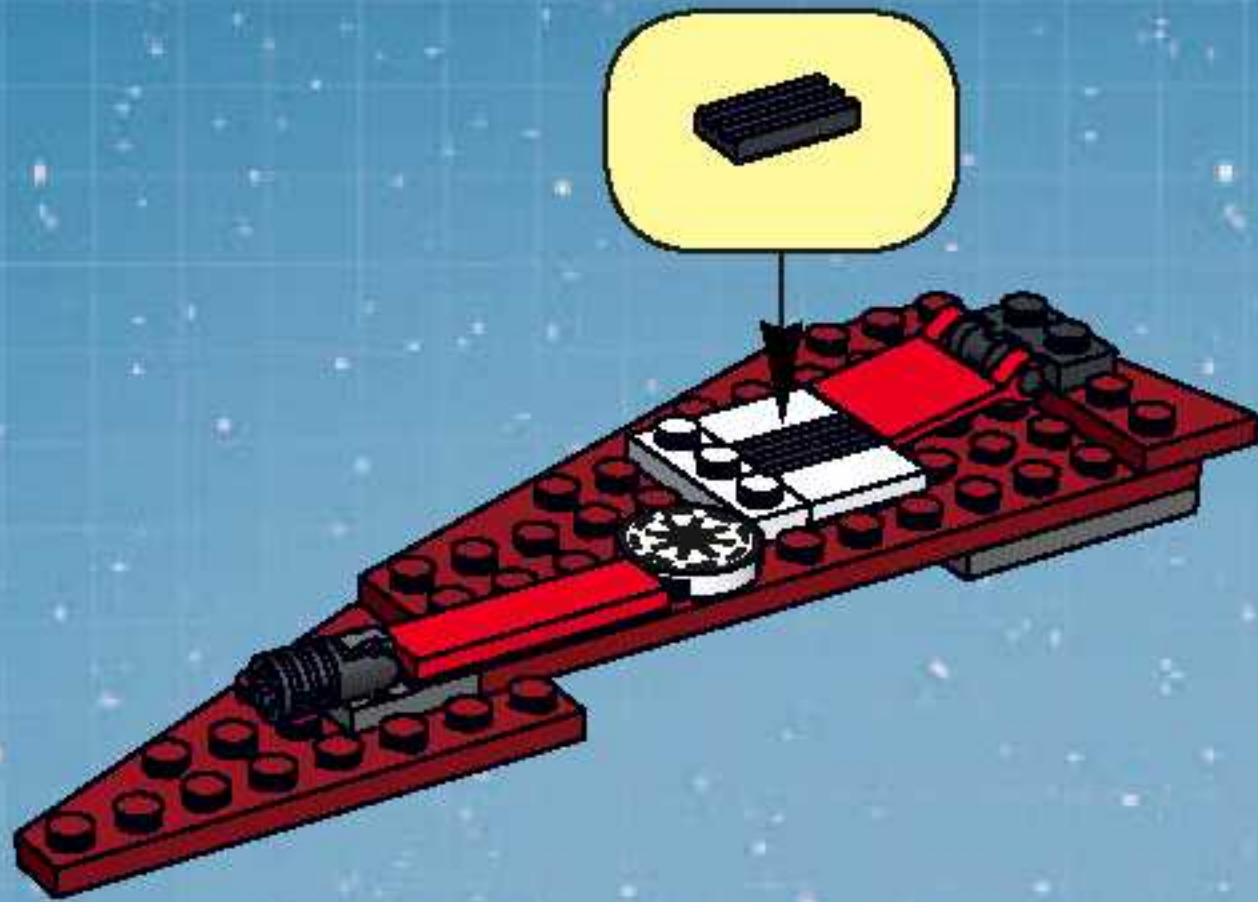

13



1

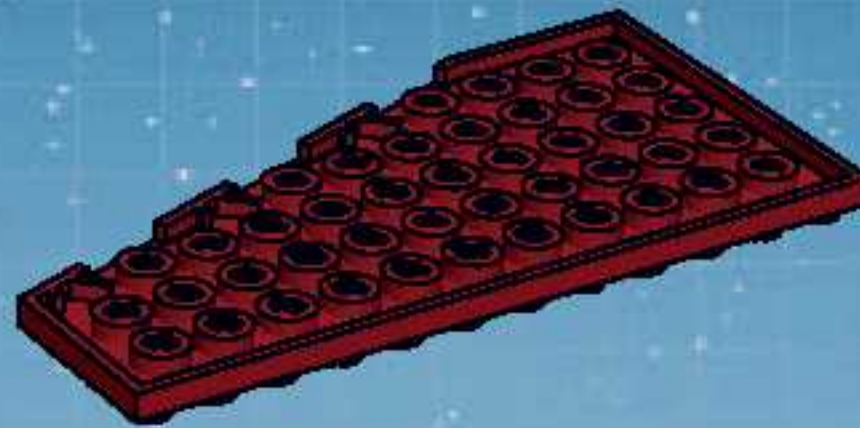

2

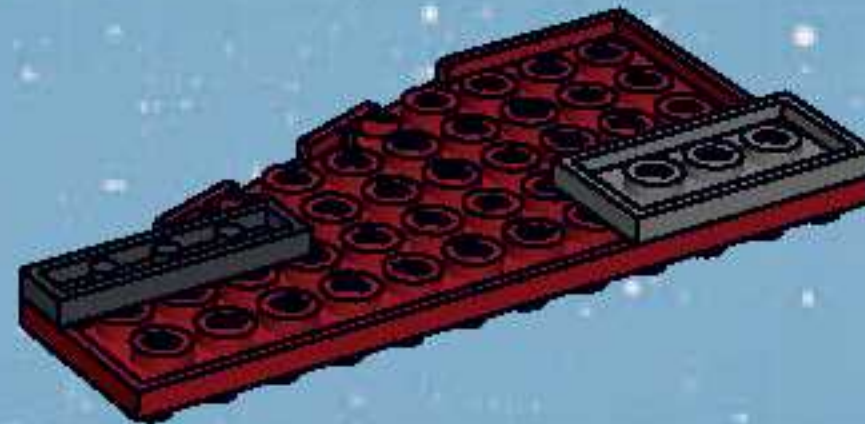

3

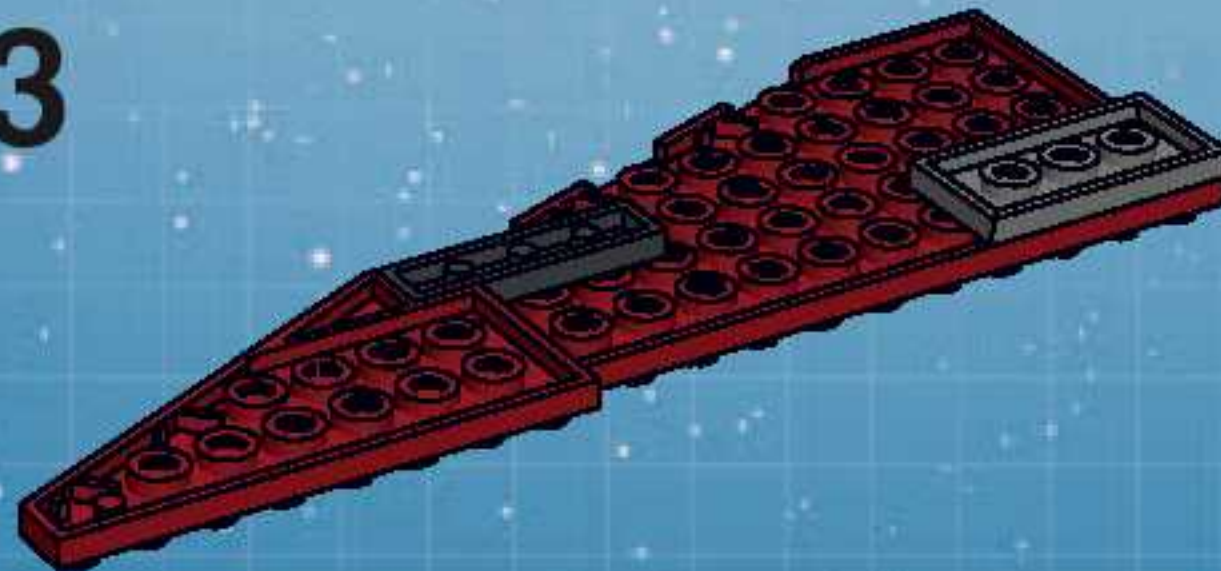

4

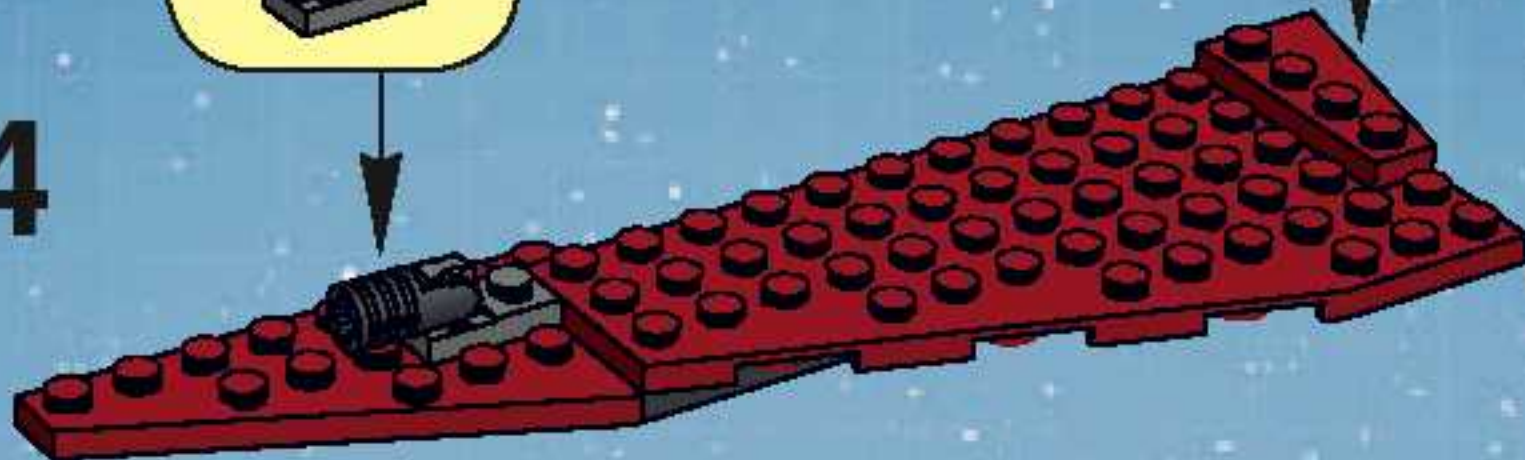
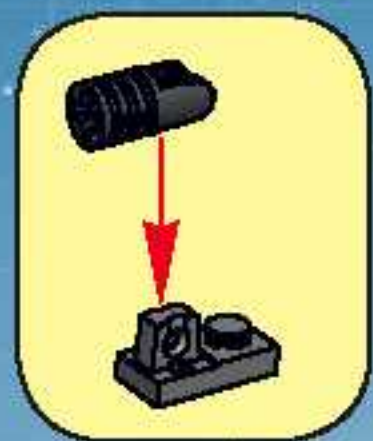

5

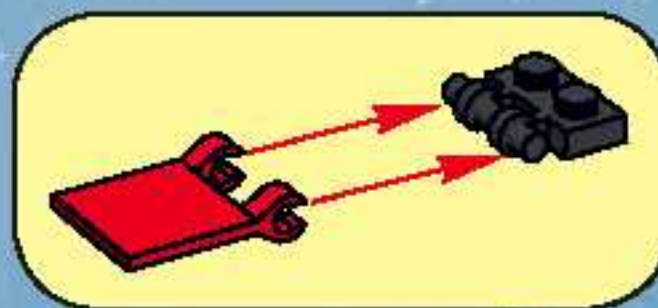



6

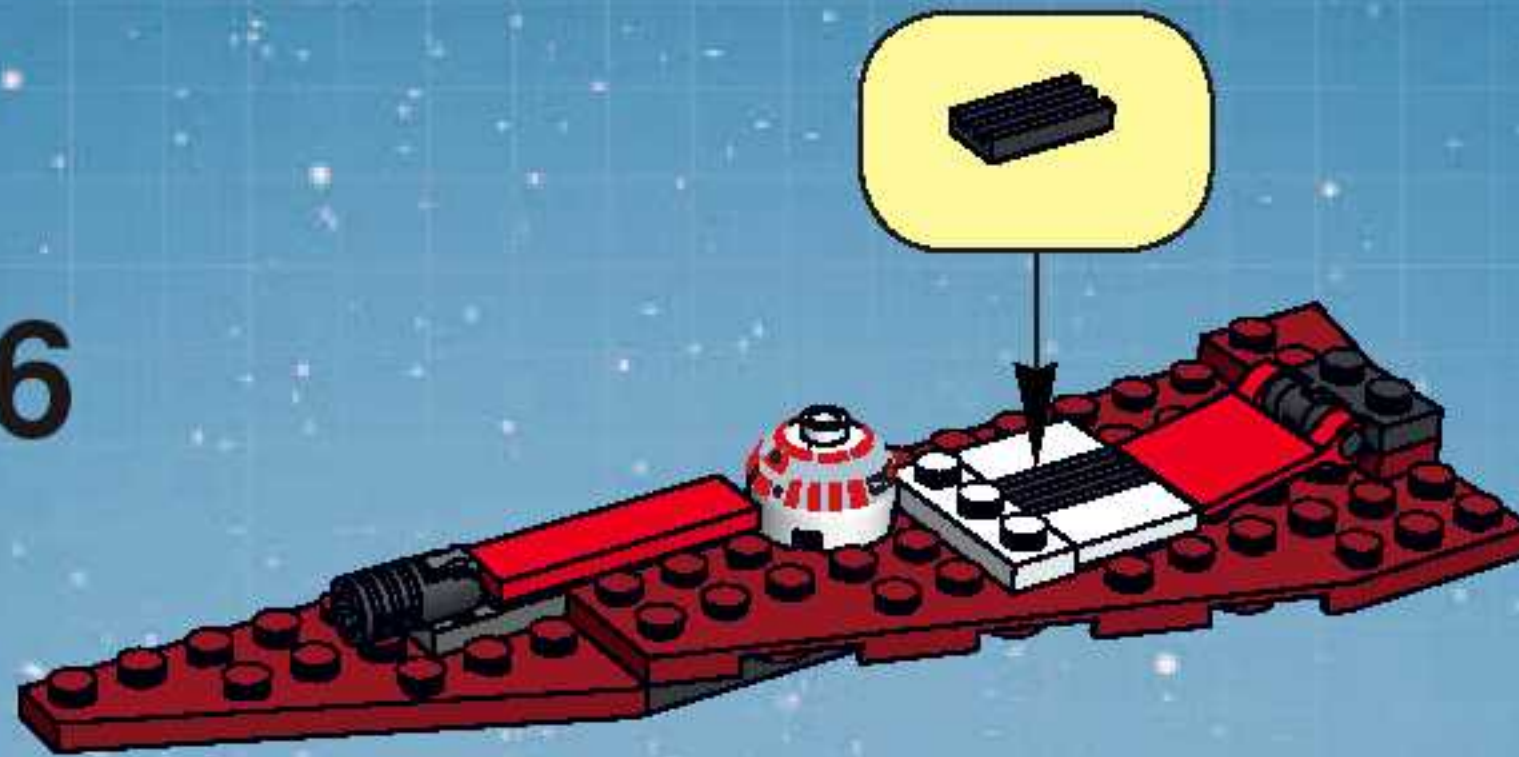

14



1

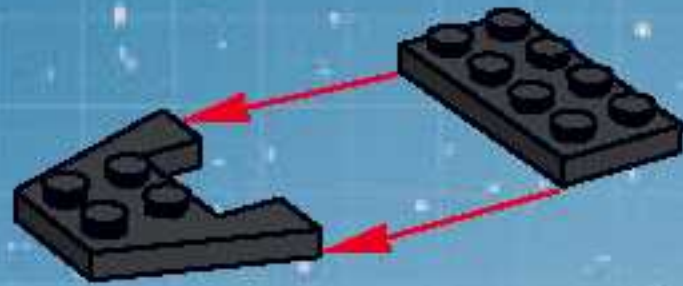

2

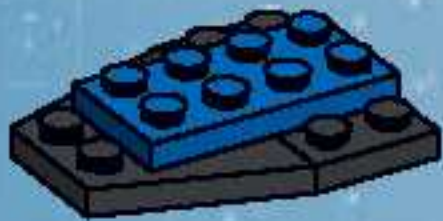

3

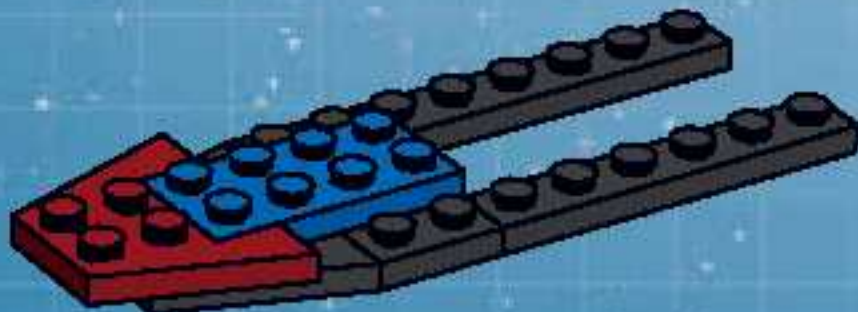

4

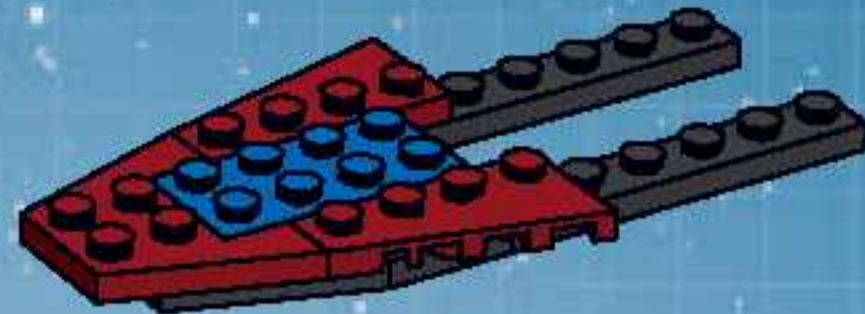

5

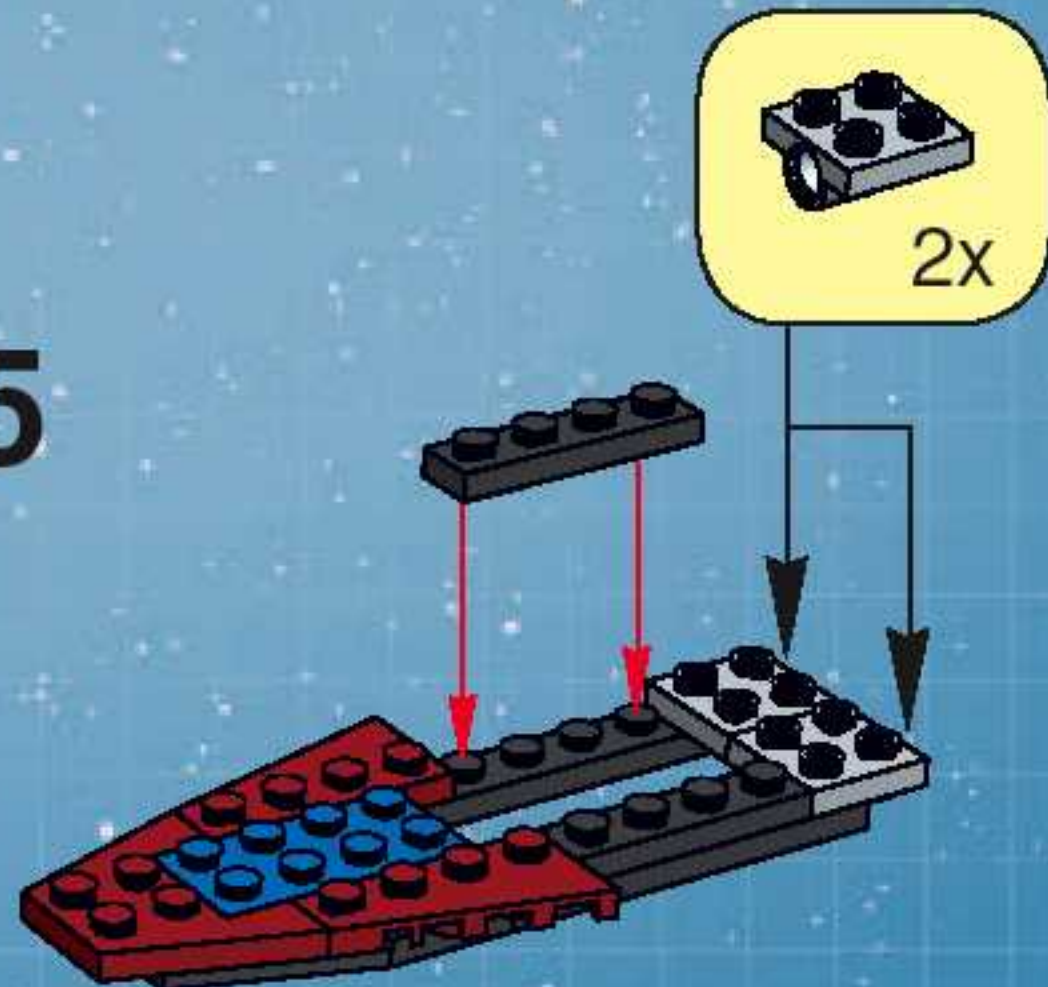

6

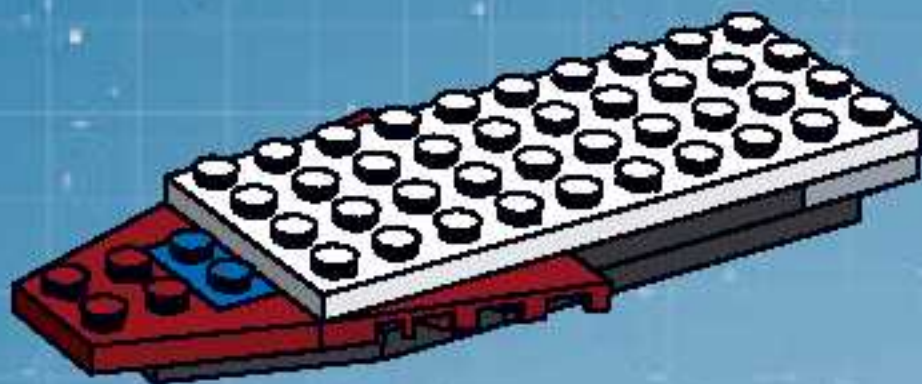

8

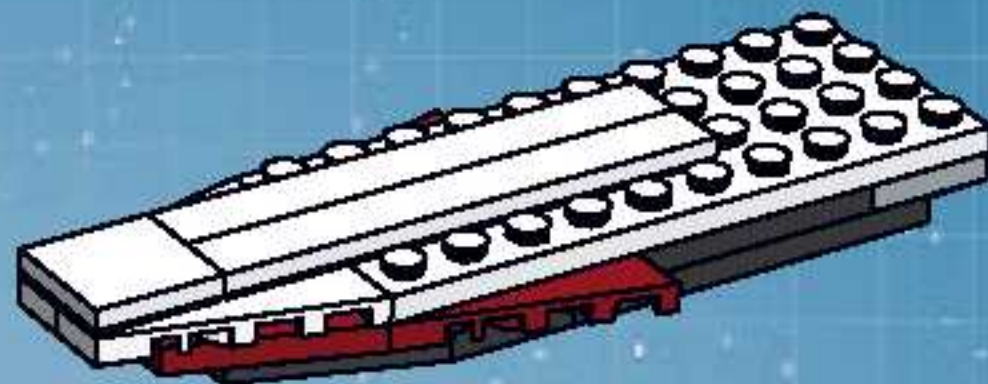

7

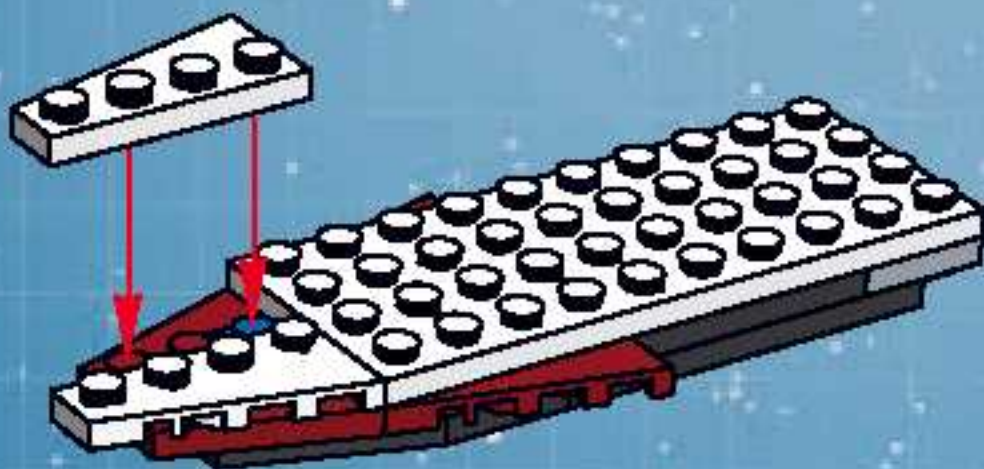



16



1

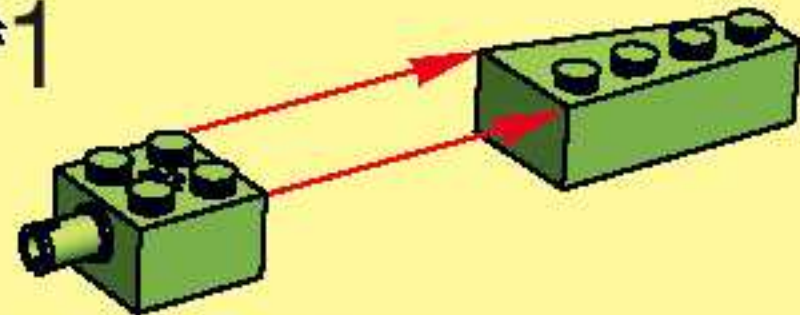

2

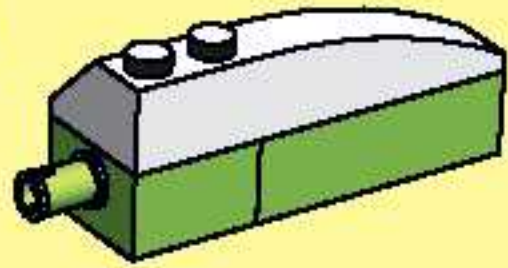

17



1

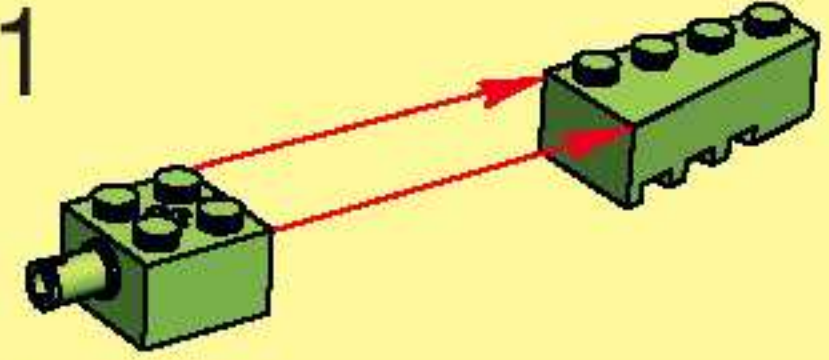

2

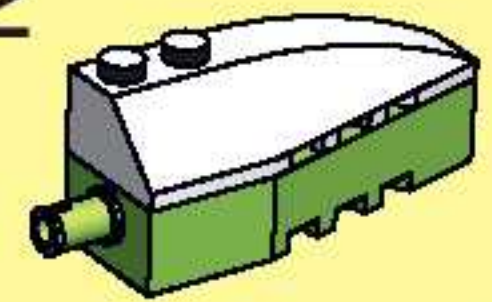

18

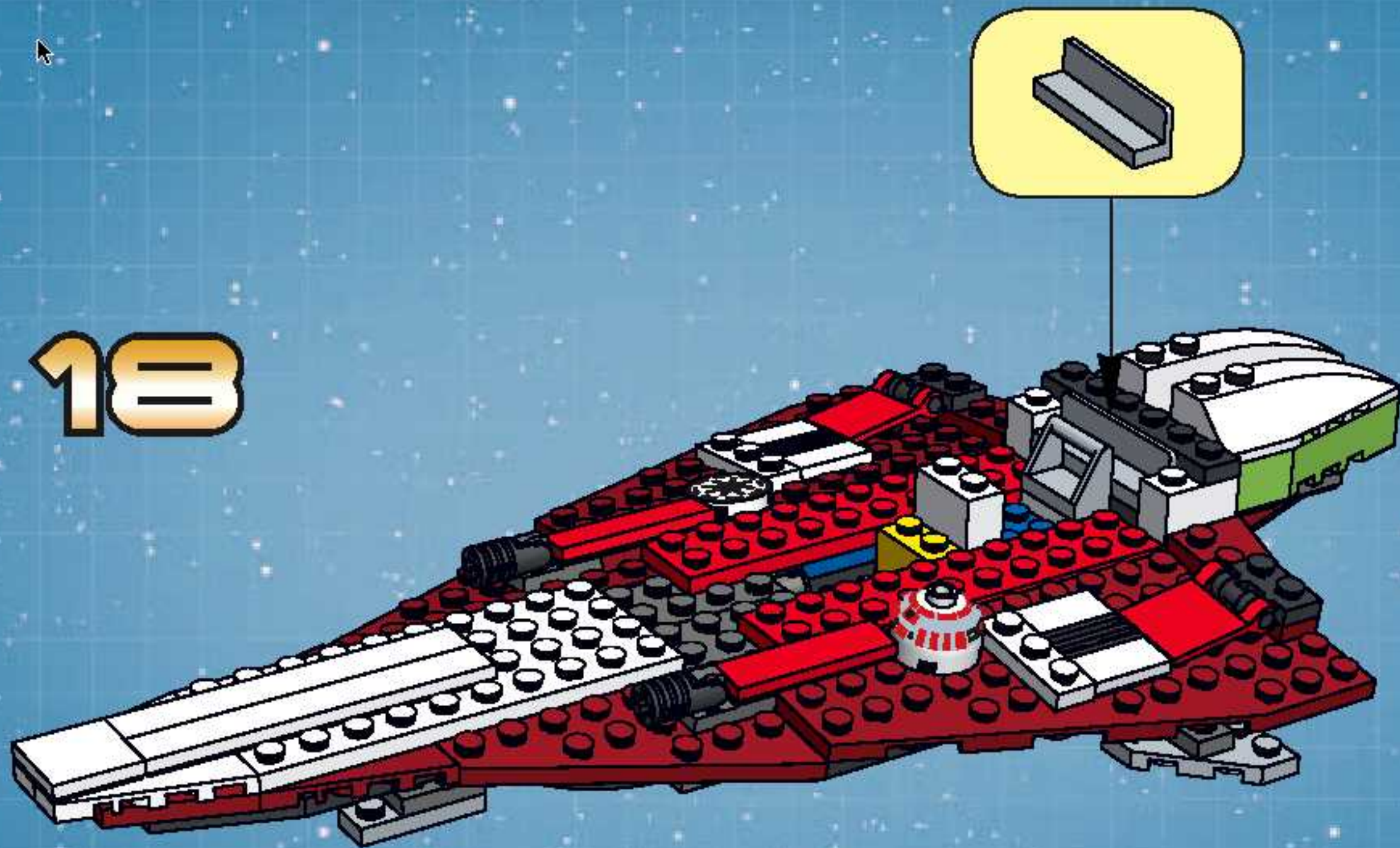

19





20



21



22





# STAR WARS

## ATTACK OF THE CLONES™





7119

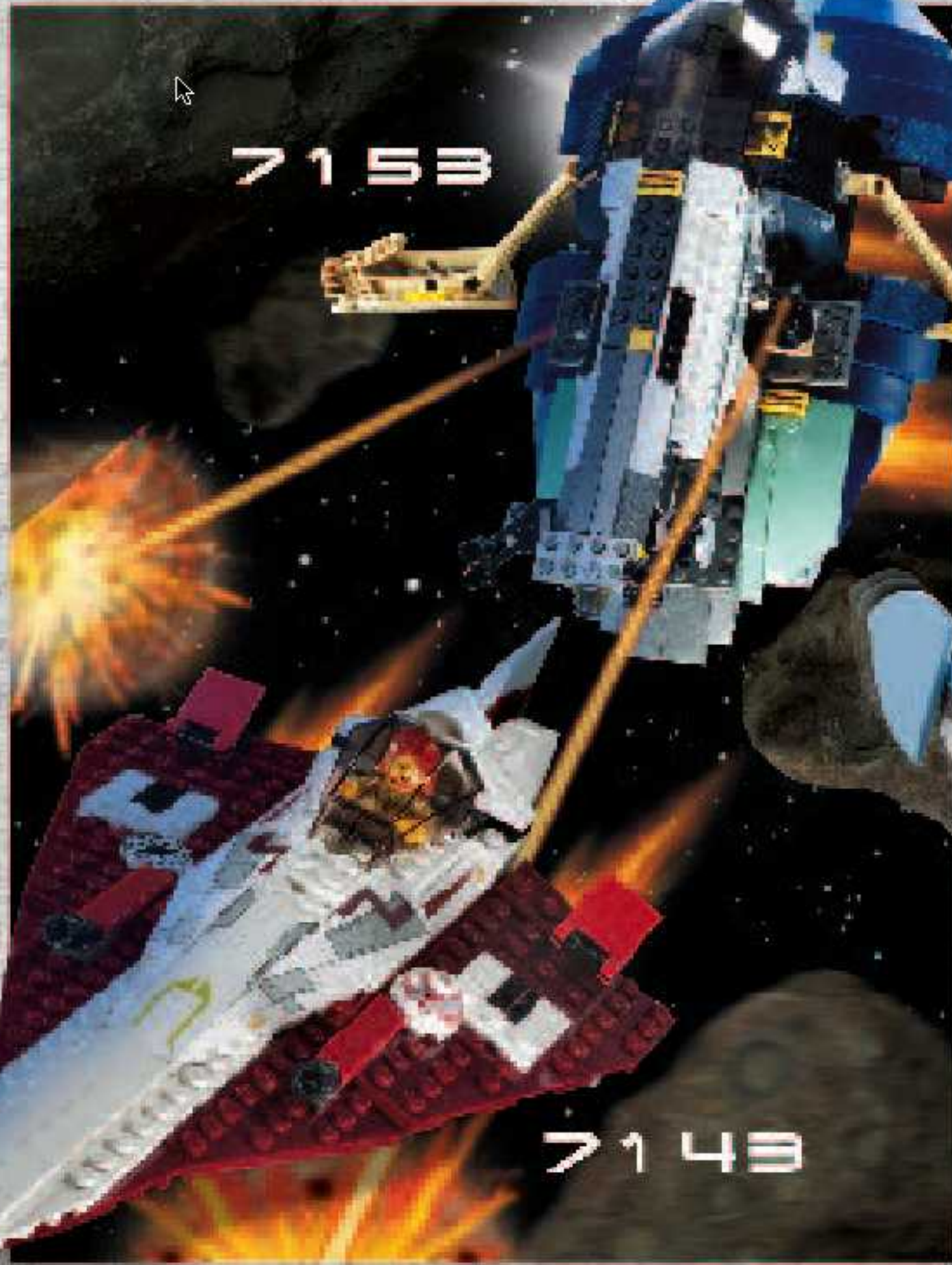



**STAR  
WARS**



7200

7201



**STAR WARS**  
WWW.STARWARS.COM

**WWW.LEGO.com/starwars**

LEGO, the LEGO logo, the JUST IMAGINE logo and the Minifigure are trademarks of/ sont des marques de commerce de/ son marcas registradas de LEGO Group.  
©2002 The LEGO Group.

©2002 Lucasfilm Ltd. & TM/AC. All rights reserved. Used under authorization./Tous droits réservés. Utilisé sous autorisation./ Todos los derechos reservados. Usado bajo autorización.