



# STAR WARS

# BOOST

BUILD CODE PLAY



 [LEGO.com/starwars](https://www.lego.com/starwars)

#### ENUS/ENGB

This document contains building instructions for the LEGO® *Star Wars*™ BOOST Droid Commander. You can build:

- R2-D2 with the Move Hub
- Mouse Droid without the Move Hub
- Gonk Droid with the iconic saw and shooting arm without the Move Hub

These building instructions are recommended only for builders who would like to display the droids and they do not lead to the full build, code, play experience. To enjoy the complete galactic adventure, download the LEGO BOOST *Star Wars* app to control the droids, go on missions to build the extra accessories and learn new coding features.

Building instructions in the LEGO BOOST *Star Wars* app allow you to zoom in and out on cool details, flip and rotate the 3D models, and check your building progress. They can be found as a part of the full app experience or in the settings separately.

#### DE

Dieses Dokument enthält Bauanleitungen für das Set „LEGO® *Star Wars*™ BOOST Droide“. Folgendes lässt sich damit bauen:

- R2-D2 mit Move Hub
- Mausdroide ohne Move Hub
- Gonk-Droide inklusive kultverdächtiger Arme mit u. a. integrierter Säge, aber ohne Move Hub

Diese Bauanleitungen werden nur Baumeistern empfohlen, die ihre Droiden als Schaustücke präsentieren möchten. Das volle Bau-, Programmier- und Spielerlebnis ist darin nicht beschrieben. Zunächst muss die LEGO BOOST *Star Wars* App heruntergeladen werden, um in den Genuss des gesamten galaktischen Abenteuers zu kommen und die Droiden zu steuern, bei Missionen weiteres Zubehör zu bauen und neue Programmierfunktionen zu erlernen.

Mit den Bauanleitungen in der LEGO BOOST *Star Wars* App lassen sich coole Details vergrößern und verkleinern, 3D-Ansichten der Modelle drehen und wenden und der Baufortschritt kontrollieren. Die Funktionen sind im Rahmen des App-Erlebnisses oder separat in den Einstellungen verfügbar.

#### FR/FRCA

Ce document contient des instructions de montage pour les droïdes LEGO® *Star Wars*™ BOOST, afin de construire :

- R2-D2 avec le Move Hub
- Un droïde souris sans le Move Hub
- Un droïde Gonk avec la scie et le bras fusil emblématiques, sans le Move Hub

Ces instructions de montage sont recommandées uniquement pour les constructeurs qui souhaitent exposer les droïdes, elles ne mènent pas à l'expérience complète de construction, de programmation et de jeu. Pour profiter de l'aventure galactique complète, il suffit de télécharger l'application LEGO BOOST *Star Wars* afin de contrôler les droïdes, partir en mission pour construire les accessoires supplémentaires et apprendre de nouvelles fonctionnalités de programmation.

Les instructions de montage dans l'application LEGO BOOST *Star Wars* permettent de faire un zoom avant et arrière sur les détails fantastiques, de retourner et faire pivoter les modèles 3D, et de vérifier la progression de la construction. Elles font partie de l'expérience globale de l'application et sont aussi disponibles séparément, dans les paramètres.

## IT

Questo documento contiene le istruzioni per la costruzione del Comandante Droide LEGO® *Star Wars*™ BOOST.

Potrai costruire:

- R2-D2 con il Move Hub
- Droide Topo senza il Move Hub
- Droide Gonk senza il Move Hub

Queste istruzioni per la costruzione sono consigliate solo se si desidera esporre i droidi, senza completare il modello e la programmazione. Per un'avventura galattica completa, scarica l'app LEGO BOOST *Star Wars*: controlla i droidi, costruisci gli accessori in divertenti missioni e apprendi nuove funzioni di programmazione. Le istruzioni per la costruzione nell'app LEGO BOOST *Star Wars* consentono di ingrandire e rimpicciolire i dettagli, capovolgere e ruotare i modelli 3D e controllare i progressi della costruzione. Sono disponibili nell'ambito dell'esperienza completa dell'app o separatamente, nelle impostazioni.

## ES/ESMX

Este documento contiene instrucciones de construcción para el set LEGO® *Star Wars*™ BOOST Comandante Droide/Droide Comandante. Puedes construir:

- R2-D2 (con el Move Hub)
- Droide ratón (sin el Move Hub)
- Droide Gonk con su sierra característica y un brazo que dispara (sin el Move Hub)

El uso de estas instrucciones de construcción se recomienda solo a constructores que quieran exponer los droides y no proporciona la experiencia completa de construcción, programación y juego. Para disfrutar de la aventura galáctica completa, descarga la app LEGO BOOST *Star Wars*. Con ella podrás controlar los droides, embarcarte en misiones para construir los diferentes accesorios y aprender a usar nuevas funciones de programación.

Las instrucciones de construcción que contiene la app LEGO BOOST *Star Wars* te permiten acercar y alejar para ver los detalles más interesantes, voltear y girar los modelos en 3D, y consultar el avance de la construcción. Puedes acceder a ellas como parte de la experiencia completa que ofrece la app o, por separado, en la sección de ajustes.

## PT

Este documento contém instruções de construção para o Comandante Droid LEGO® *Star Wars*™ BOOST. Podes construir:

- O R2-D2 com o Move Hub
- O droid rato sem o Move Hub
- O droid Gonk com a icónica serra e braço de disparo sem o Move Hub

Estas instruções de construção são recomendadas apenas para os construtores que gostariam de expor os droids e não trazem o modelo total, código e experiência de jogo. Para desfrutar da aventura galáctica completa, descarrega a app LEGO BOOST *Star Wars* para controlar os droids, participar em missões para construir os acessórios extra e aprender novas funcionalidades de codificação.

As instruções de construção na app LEGO BOOST *Star Wars* permitem ampliar e reduzir os pormenores incríveis, virar e rodar os modelos 3D, e verificar o progresso de construção. Podem ser encontradas como parte da experiência total da app ou em separado nas definições.



## HU

Ez a dokumentum tartalmazza a LEGO® Star Wars™ BOOST droidparancsnok összeszerelési útmutatóját.

Megépíthetsz egy:

- R2-D2-t Move Hub-bal
- Keresődroidot Move Hub nélkül
- Gonk droidot a jellegzetes fűrészszel és lőfegyverszerű karral, de Move Hub nélkül

Ez az összeszerelési útmutató csak azoknak az építőknak ajánlott, akik szeretnék kiállítani a droidokat, és nem törekednek teljes építési, kódolási és játék élményre. Ahhoz, hogy a teljes galaktikus kalandot átélhesd, töltsd le a LEGO BOOST Star Wars alkalmazást, hogy irányíthasd a droidokat, küldetésekre indulhass, extra kiegészítőket építhess és új kódolási funkciókat ismerhess meg.

A LEGO BOOST Star Wars alkalmazásban az összeszerelési útmutató lehetővé teszi, hogy ráközelíts a klassz részletekre, átforgasd és elforgasd a 3D modelleket, és ellenőrizd az építési folyamatodat. Ezt megtalálod a teljes alkalmazásban, vagy külön a beállításokban.

## LV

Šajā dokumentā ir sniegta LEGO® Star Wars™ BOOST komplekta Droīdu komandieris būvēšanas instrukcijas. Var uzbūvēt šādu modelus:

- R2-D2 ar kustības bloku
- Mouse droīds bez kustības bloka
- Gonk droīds ar leģendāro zāģi un šaušanas roku, bez kustības bloka

Šīs būvēšanas instrukcijas ieteicams izmantot tikai būvētājiem, kuri vēlas droīdus izlikt apskatei; tās nenodrošina pilnās būvēšanas, programmēšanas un rotaļu iespējas. Lai pilnībā izbaudītu galaktiskos piedzīvojumus, lejupielādējiet lietotni LEGO BOOST Star Wars, ar kuru var vadīt droīdus, doties misijās, lai uzbūvētu papildu piederumus, un apgūt jaunus programmēšanas iespējas.

Lietotnē LEGO BOOST Star Wars pieejamajās būvēšanas instrukcijās var tuvināt un tālīnāt detaļas, apvērst un pagriez 3D modeļus, kā arī pārbaudīt būvēšanas gaitu. Tās var atrast pilnajā lietotnes iespēju klāstā vai atsevišķi iestatījumos.

## ZHSI

本文档内含乐高® 星球大战 BOOST 机器人指挥官的拼搭说明。您可以拼搭：

- 带移动集线器的 R2-D2
- 未带移动集线器的老鼠机器人
- 配备标志性锯片和射击手臂的 GNK 动力机器人，未带移动集线器

此拼搭说明仅供那些希望展示机器人的拼搭者参考，并未包含完整的拼搭、编程和玩乐说明。如想体验完整的银河冒险，请下载乐高 BOOST 星球大战应用程序来控制机器人，进行系列任务以拼搭额外配件，并了解新的编程功能。

乐高 BOOST 星球大战应用程序内含的拼搭说明允许您缩放炫酷的细节，翻转和旋转 3D 模型，以及查看拼搭进度。可通过应用程序体验或设置部分找到这些拼搭说明。



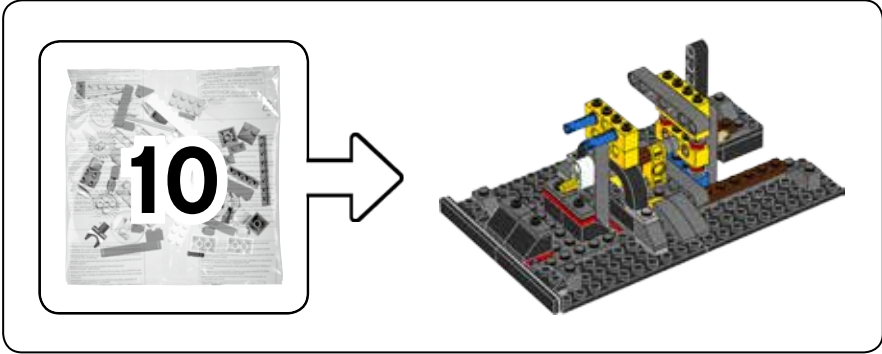

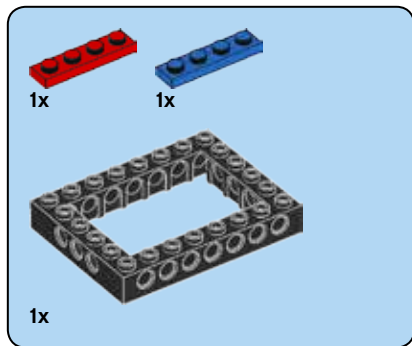

1

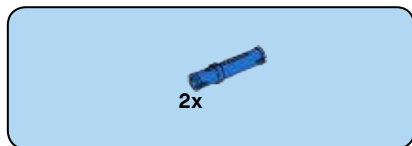
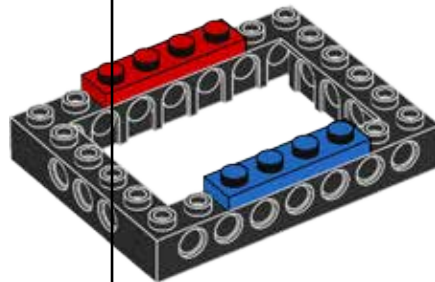

2

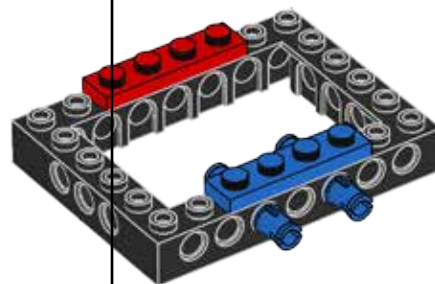

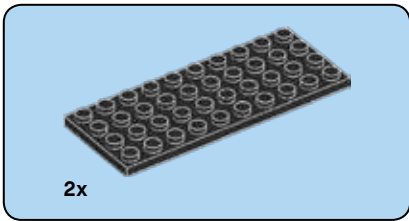

**3**

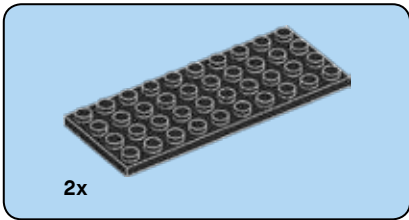
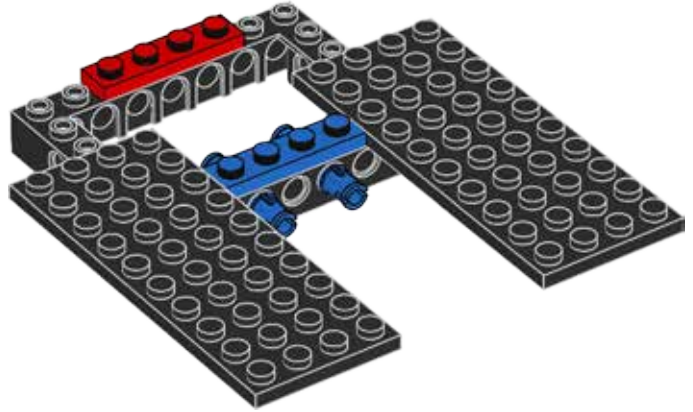

**4**

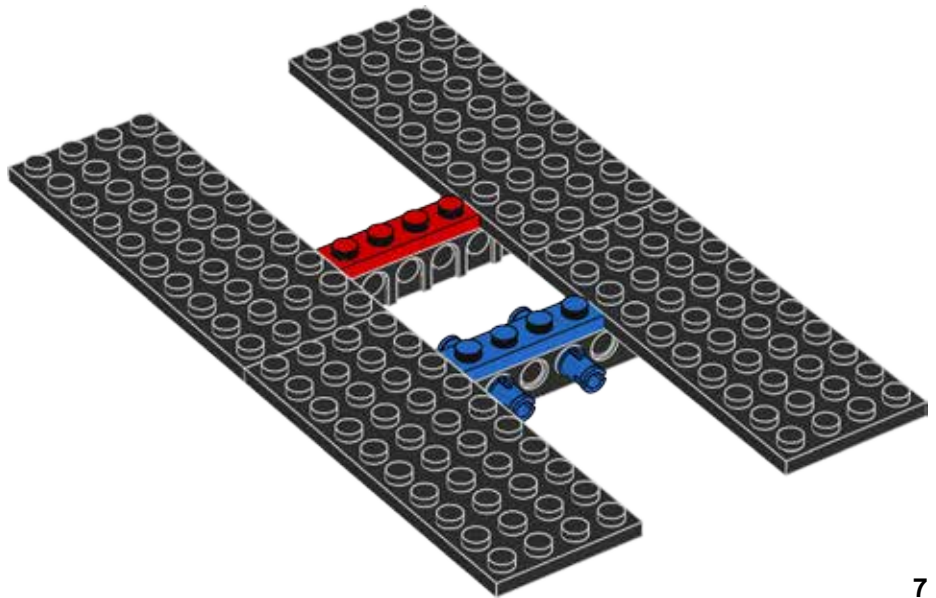

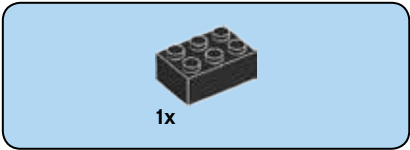

5

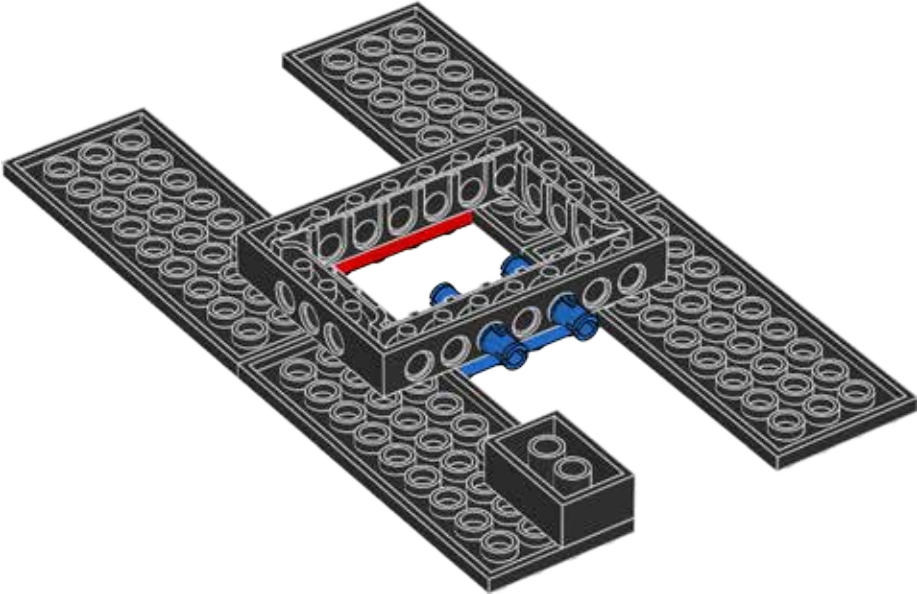

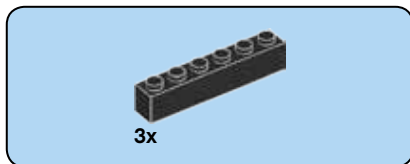

6

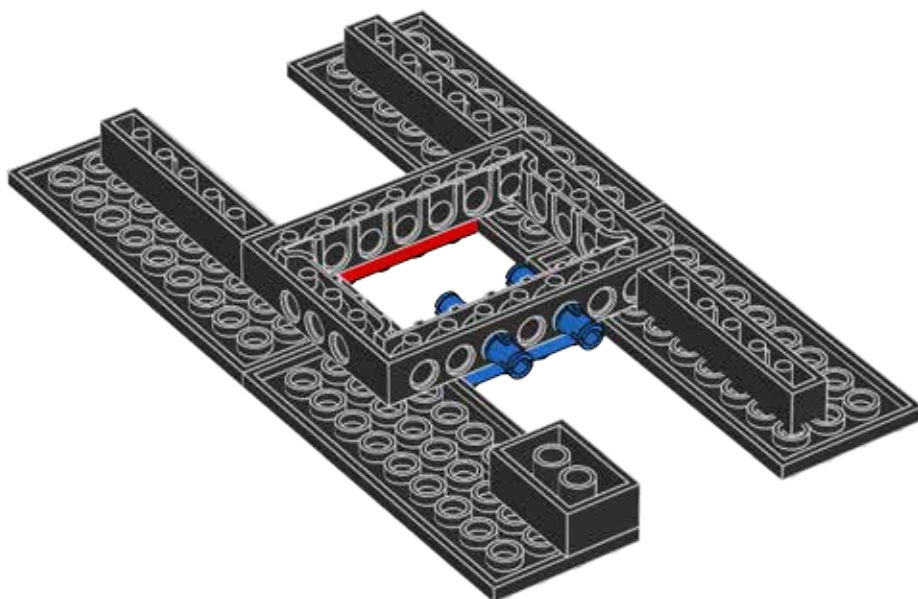



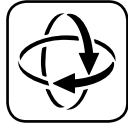
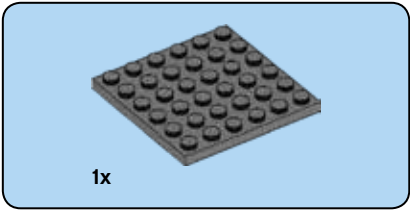

7

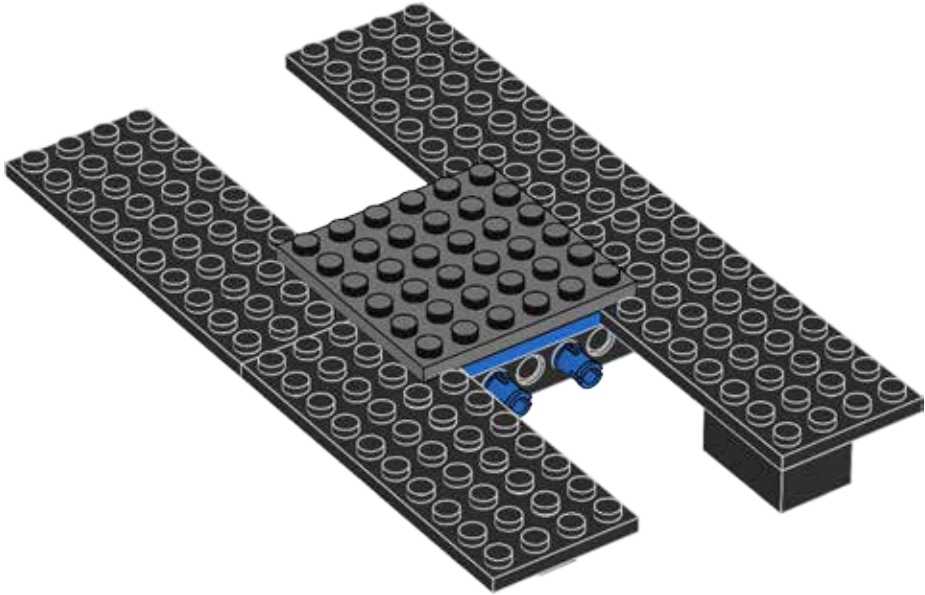

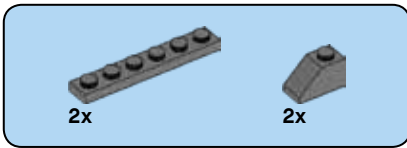

8

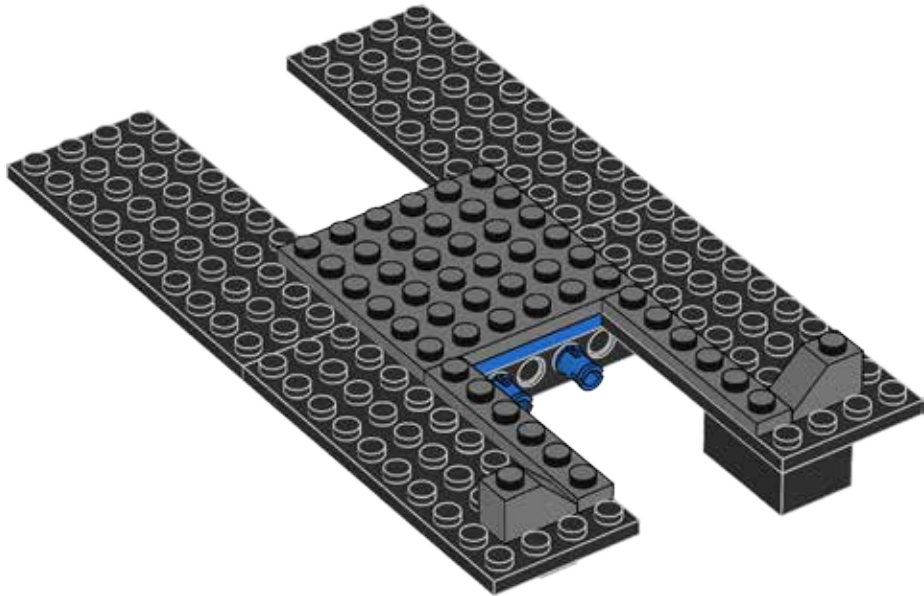

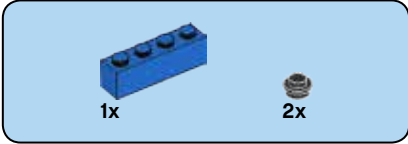

9

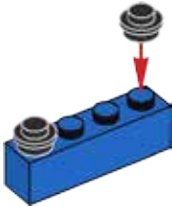

10

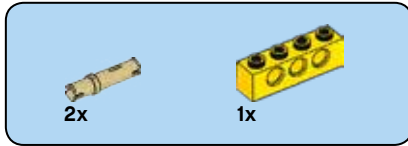
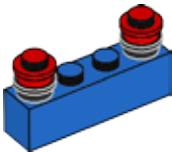

11

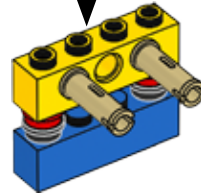
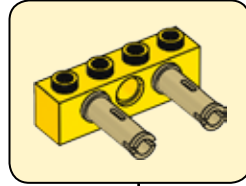

12

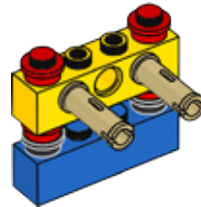

2x

13

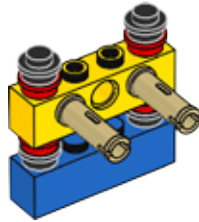

3x

1x

14

1

2

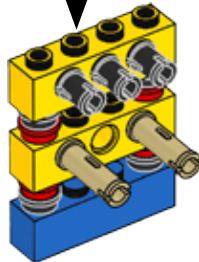
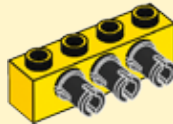
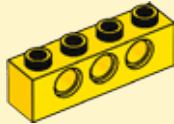

15

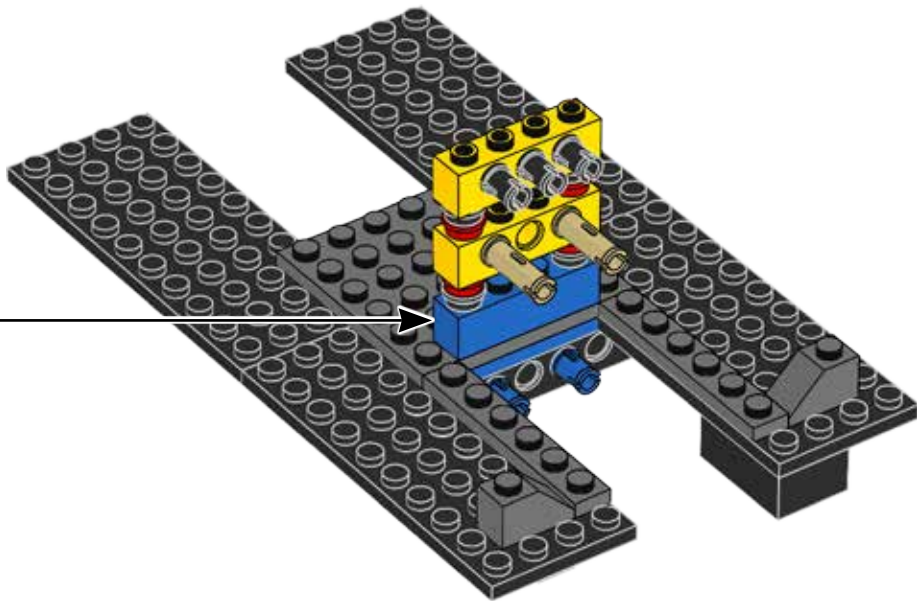



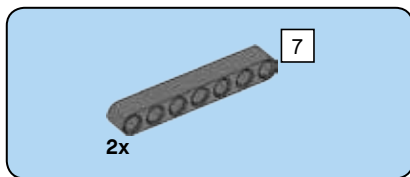

16

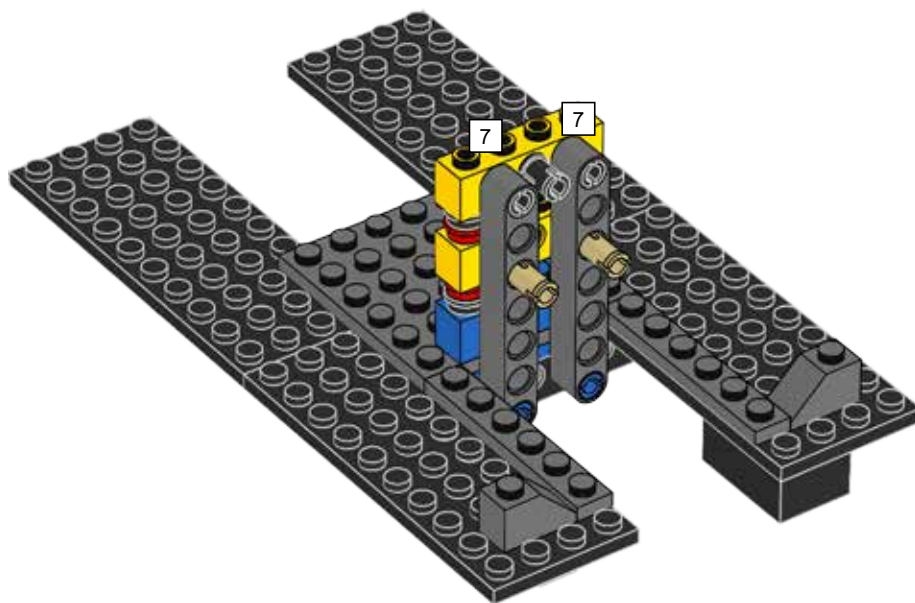

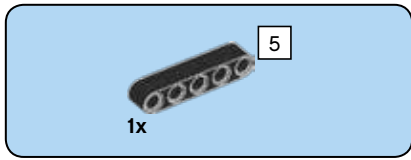

17

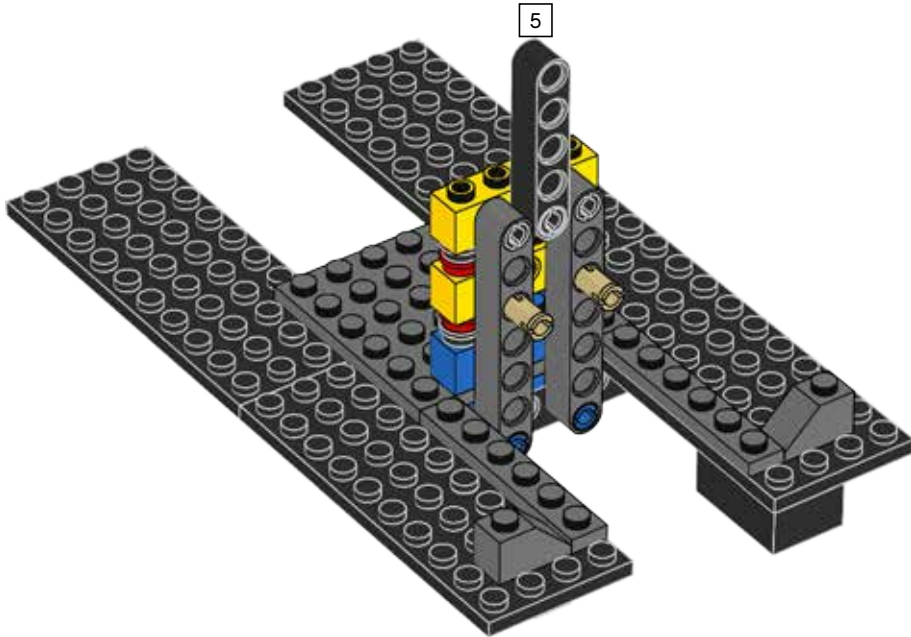

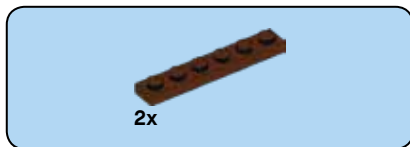

18

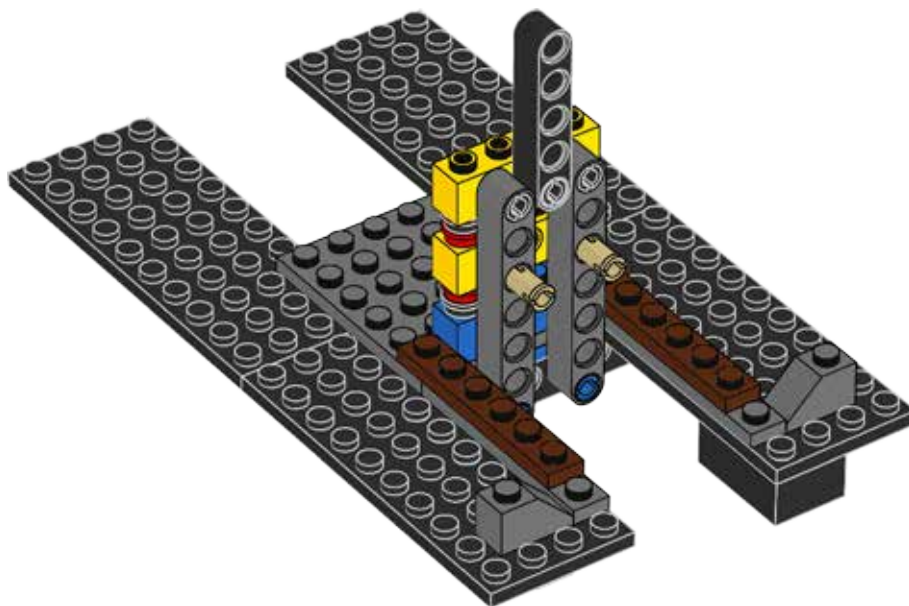

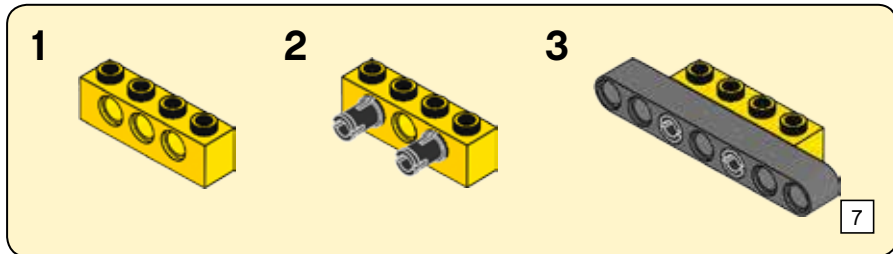
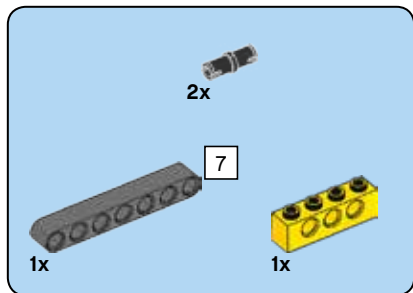

19

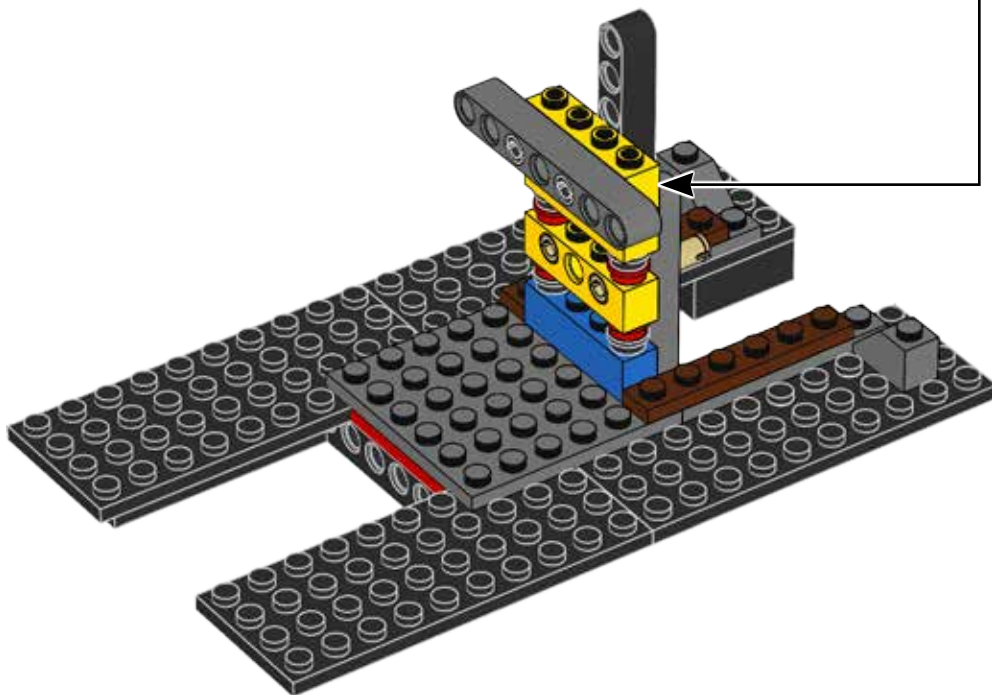

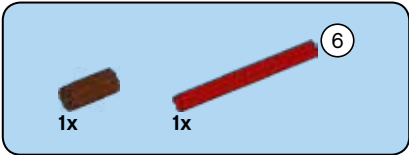
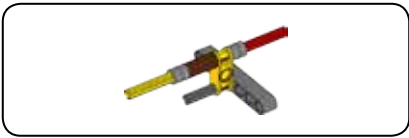

20

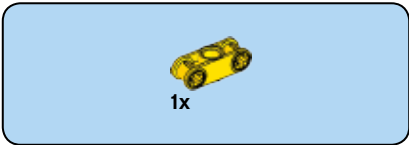
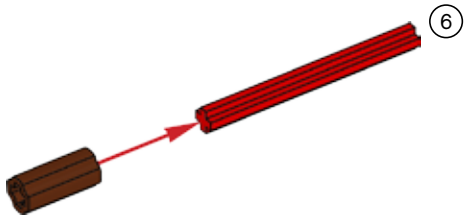

21

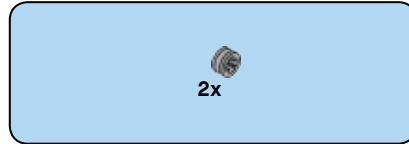
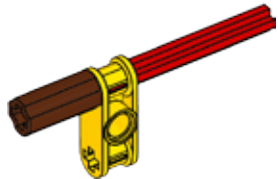

22

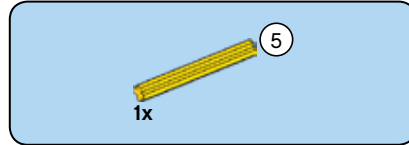
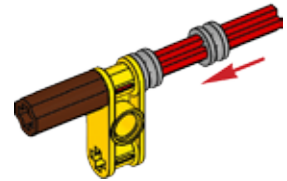

23

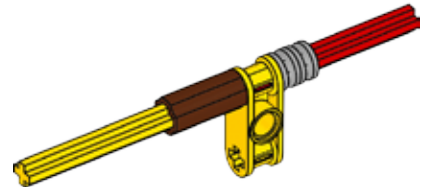



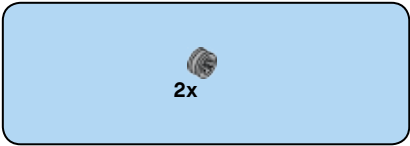

24

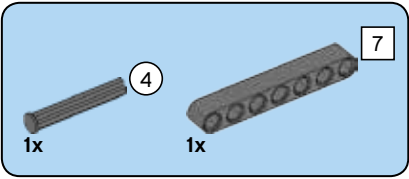
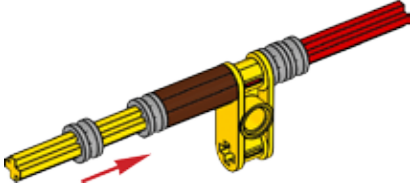

25

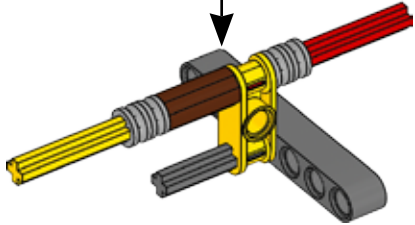
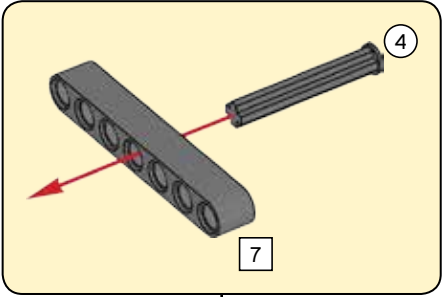

26

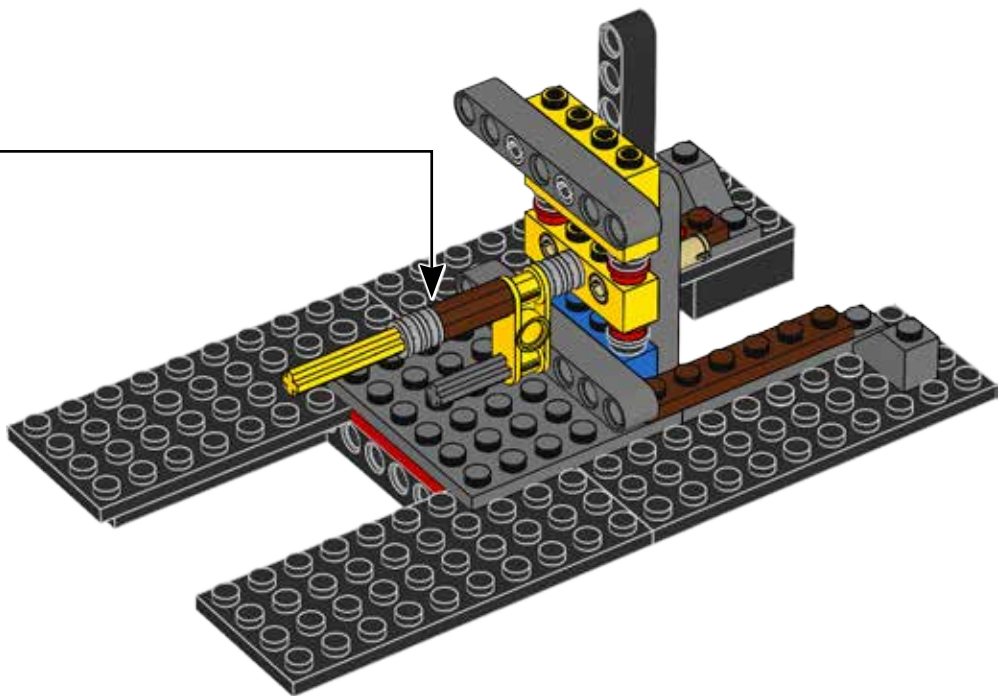





2x

28

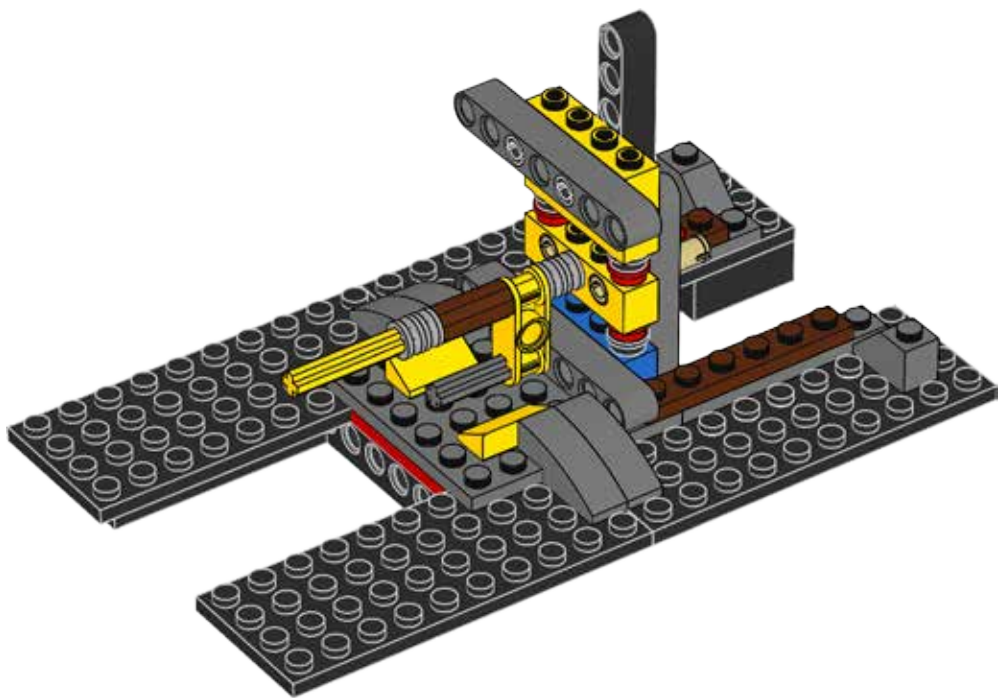



2x

29

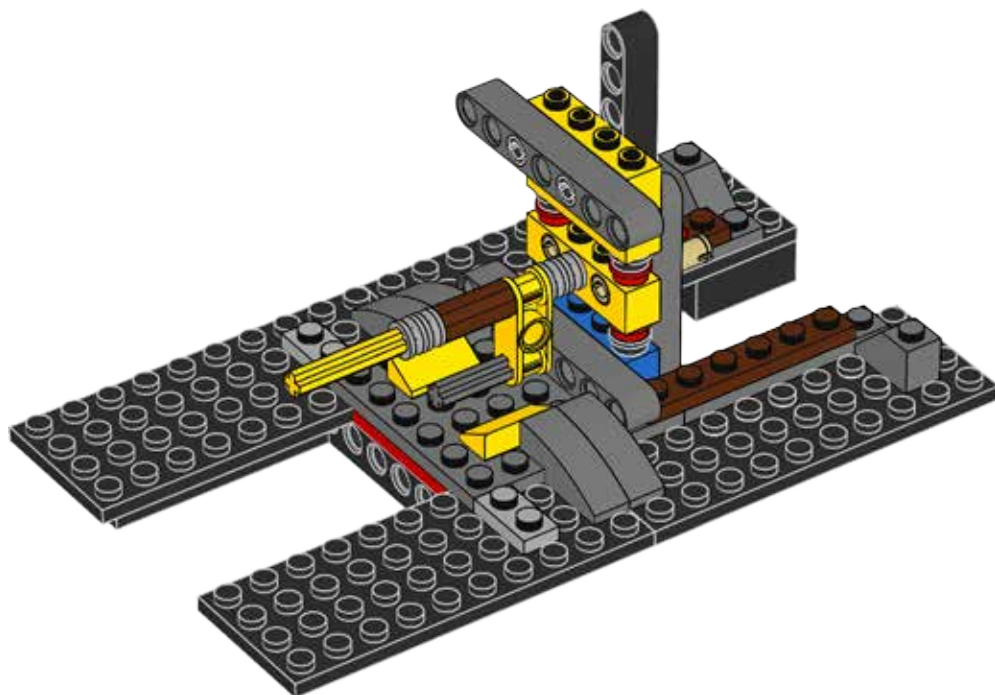



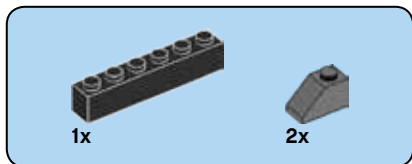

**30**

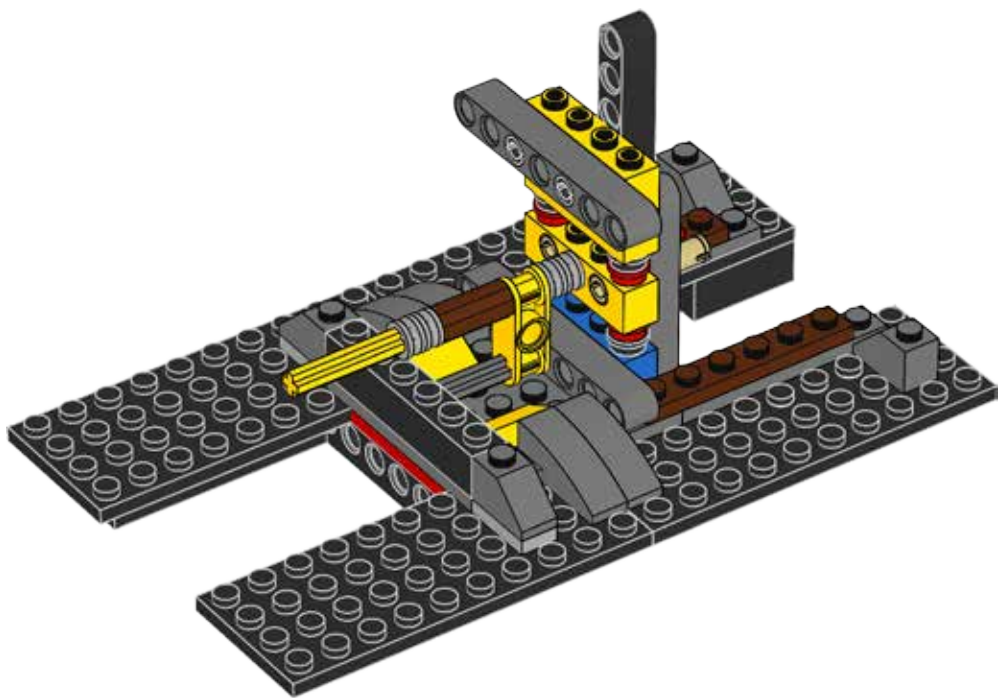



2x

31



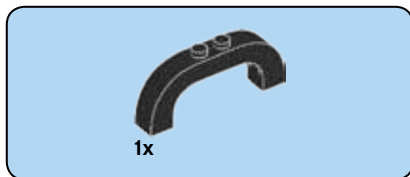

32

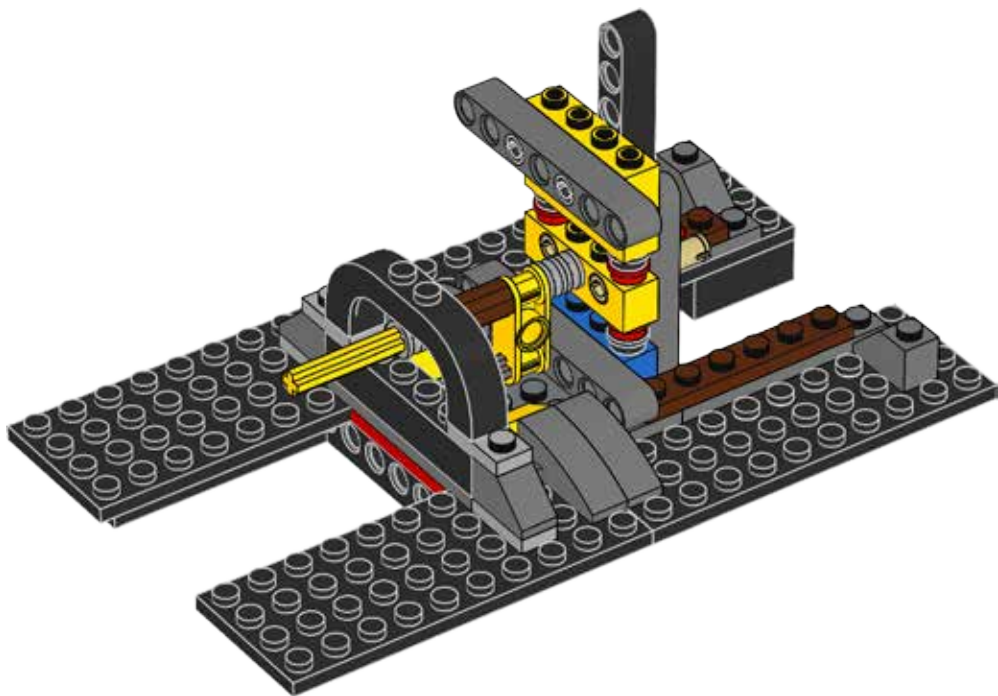

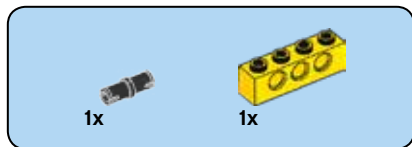

33

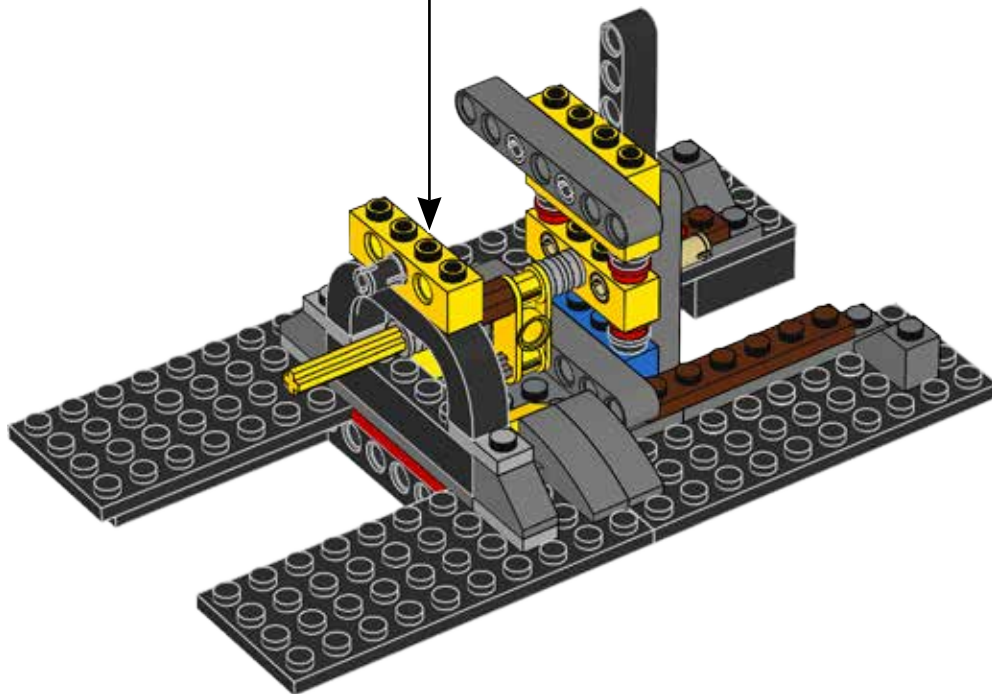
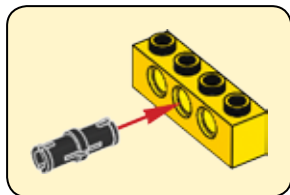

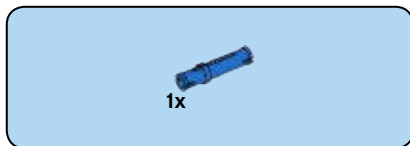

34

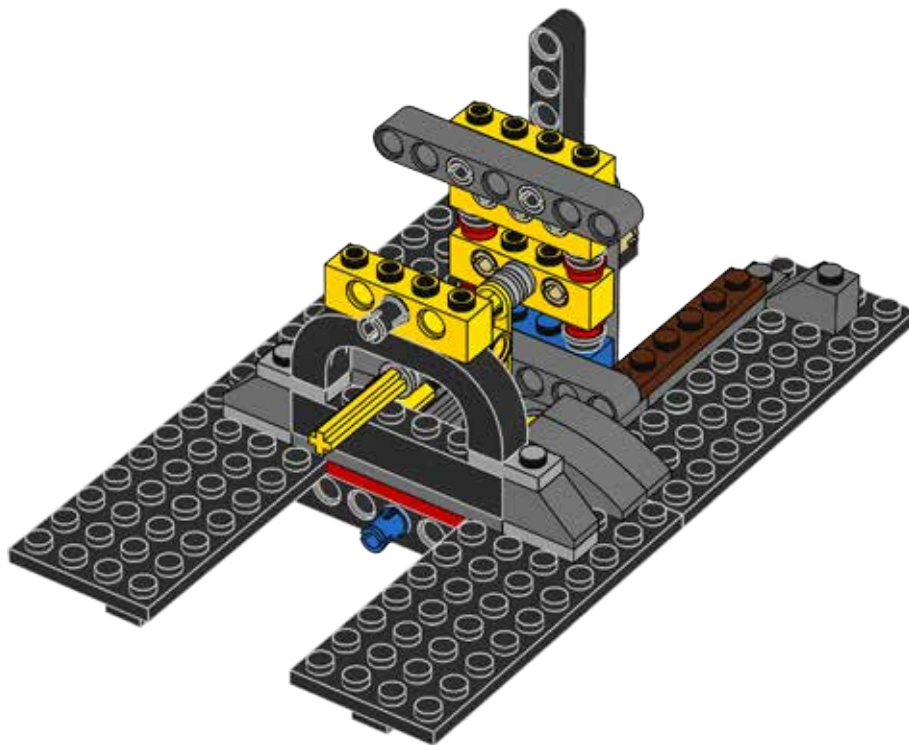

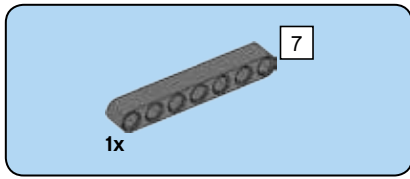

35

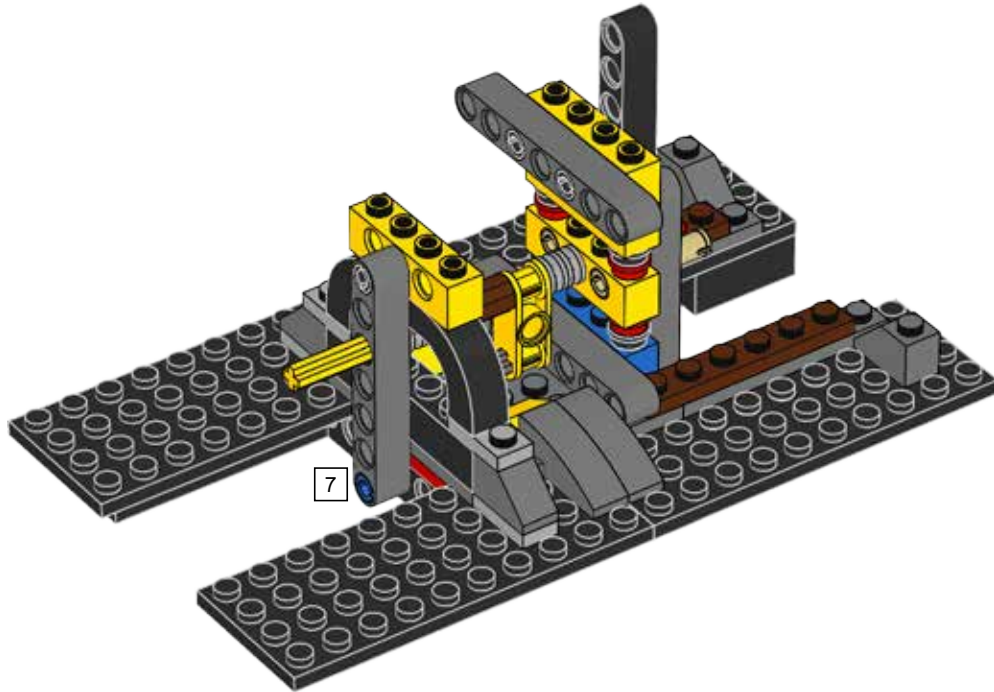

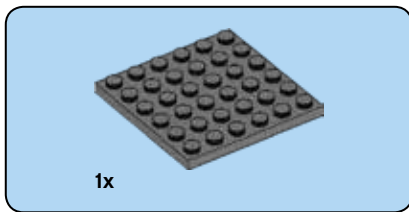

**36**

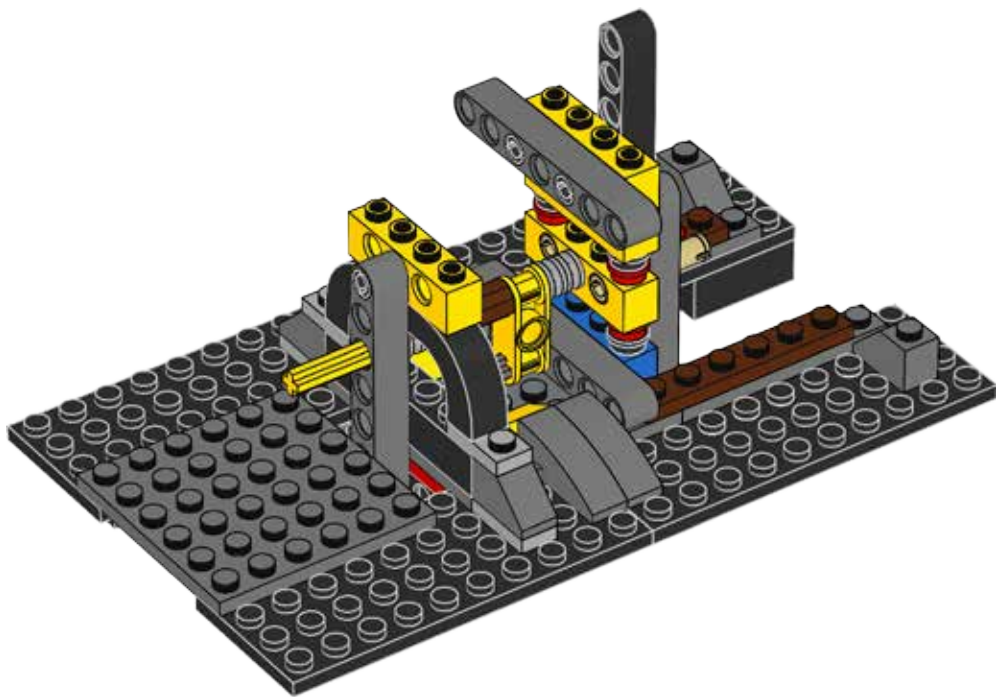



2x

37

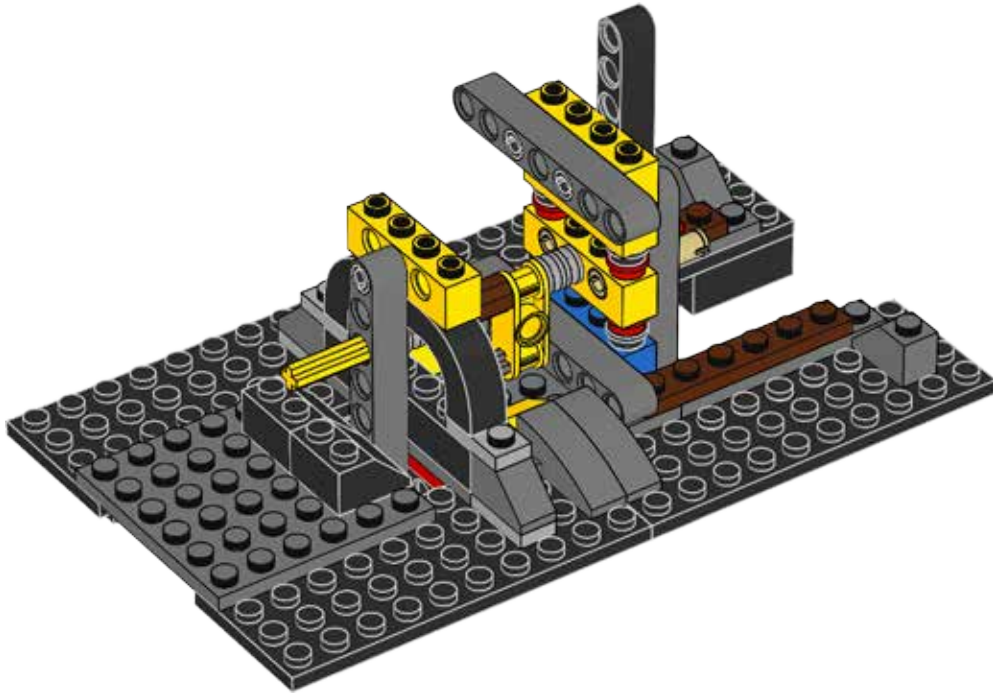





38

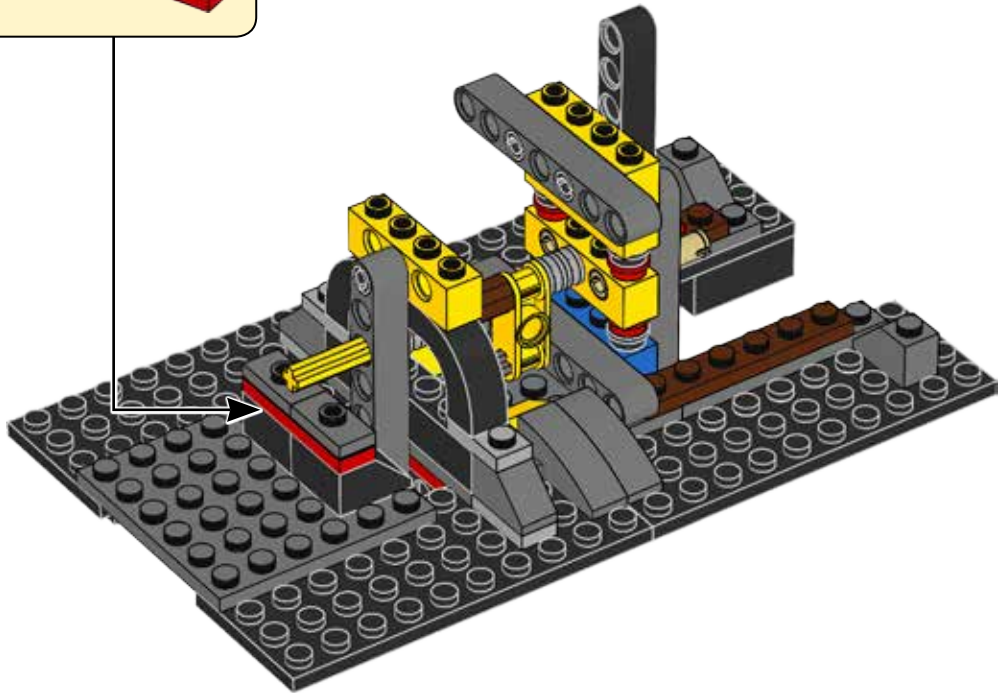
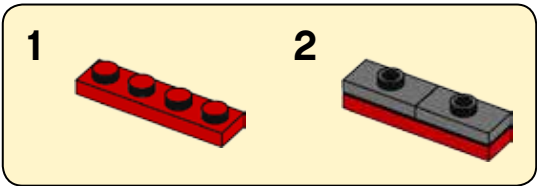













2x

44

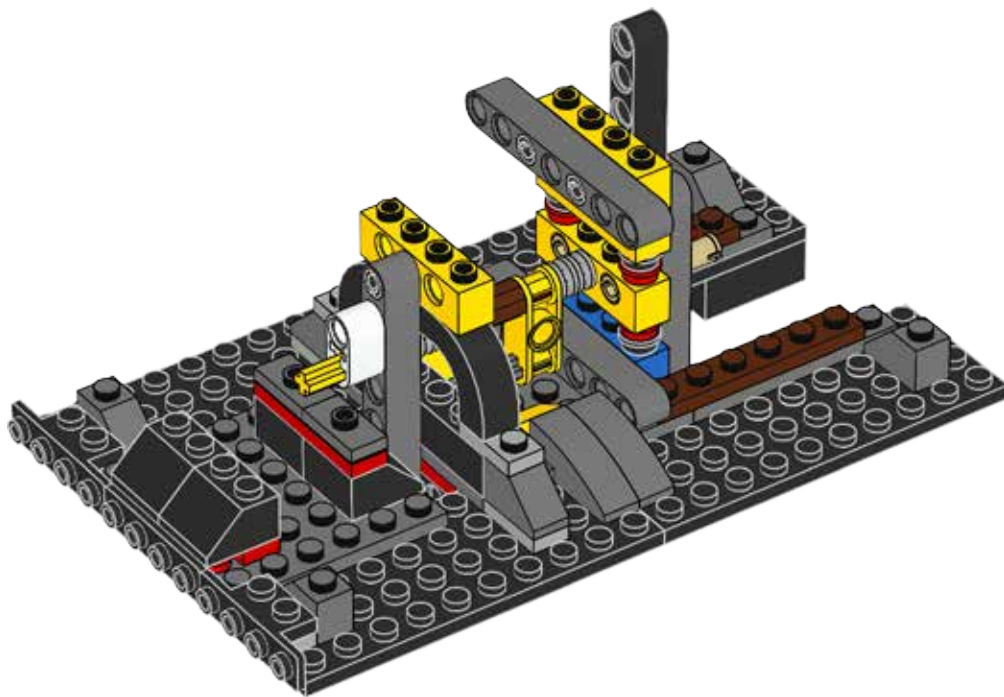





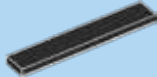

2x

**46**

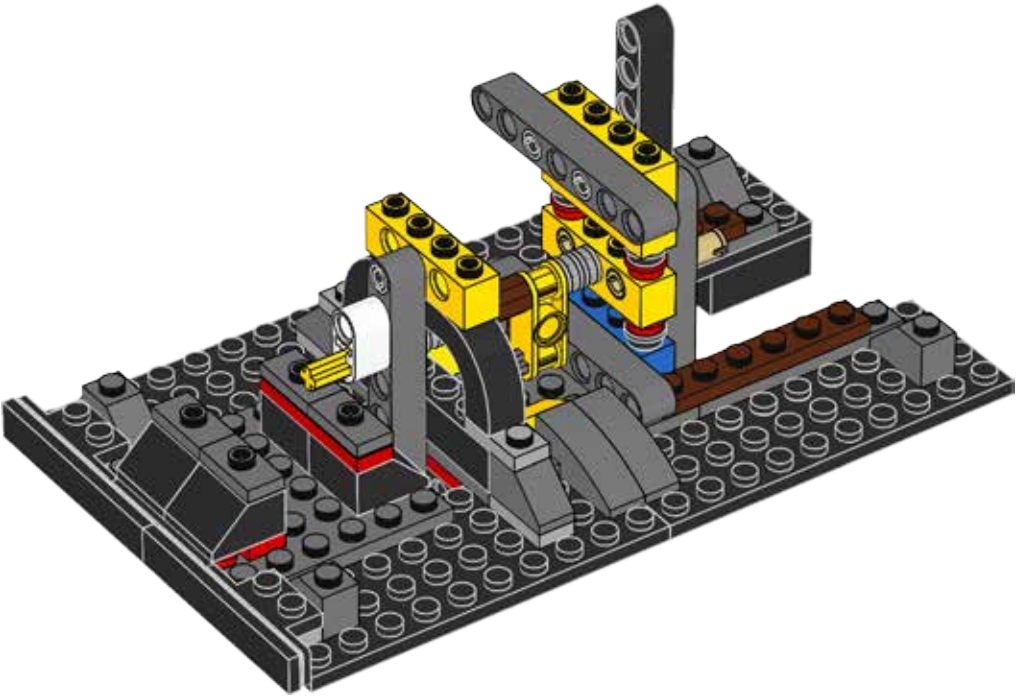

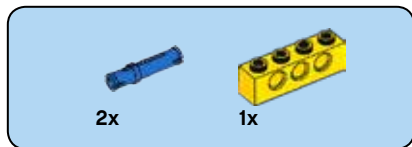

47

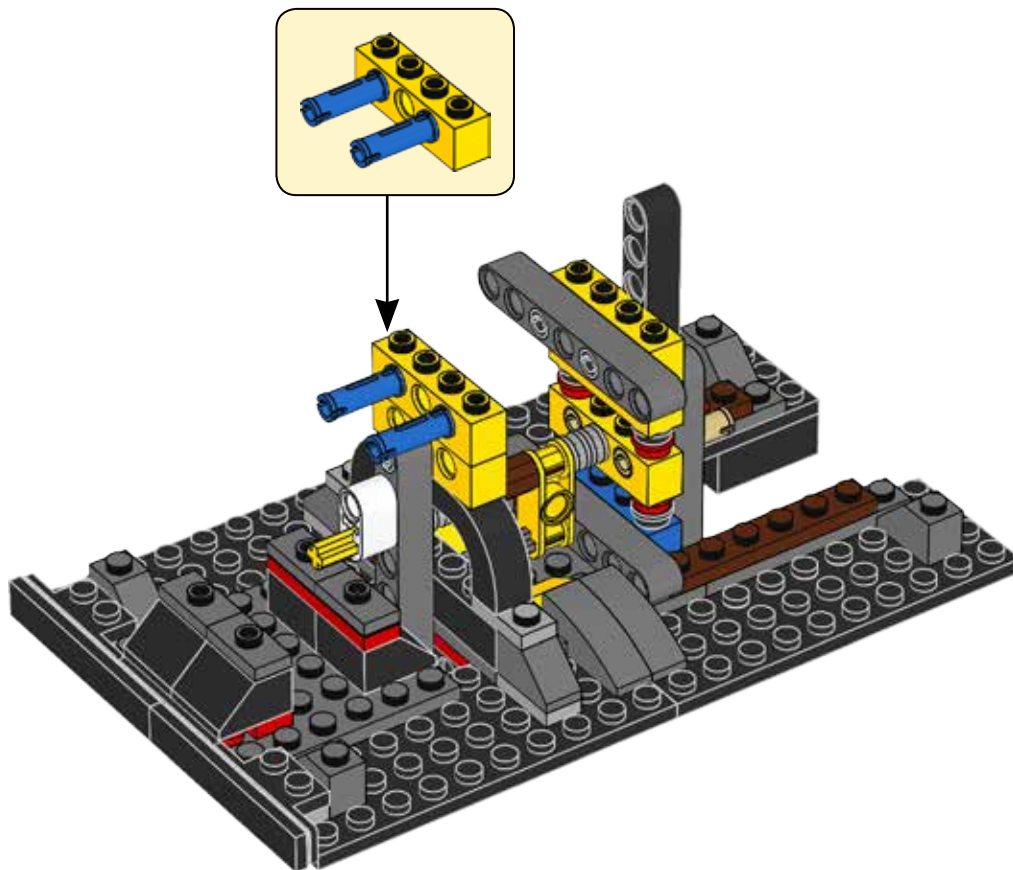

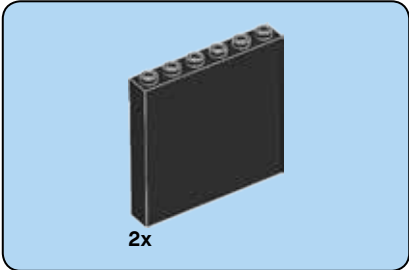
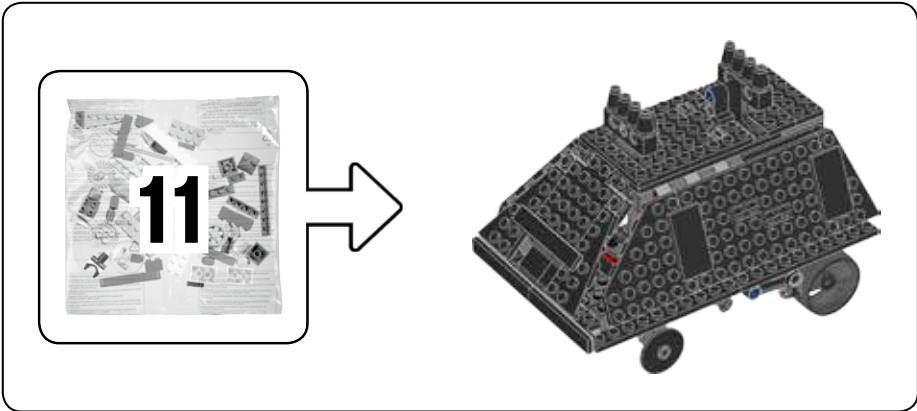

48

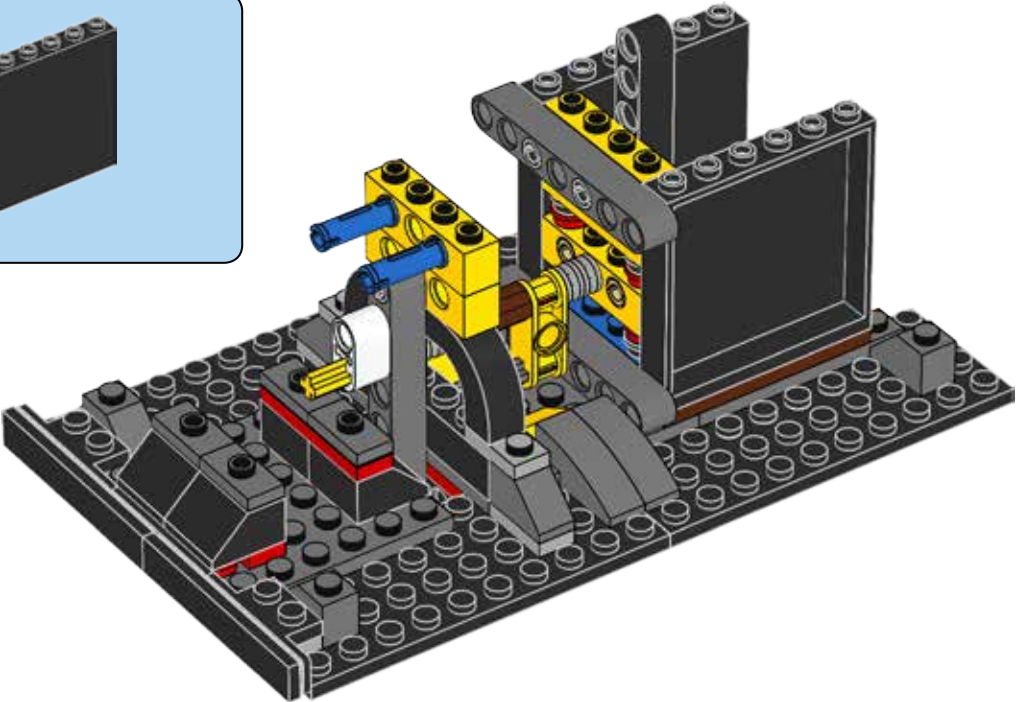

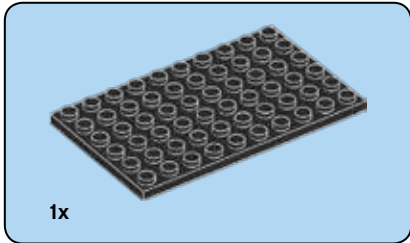
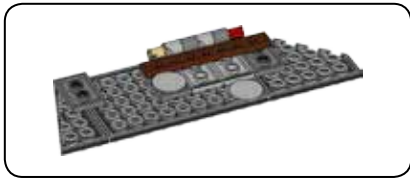

49

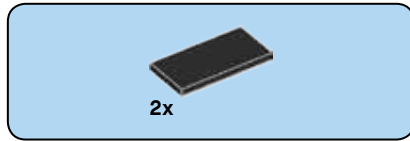
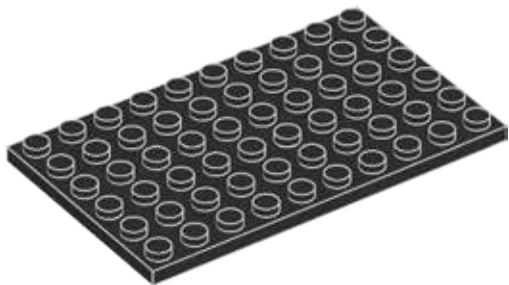

50

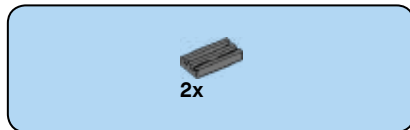
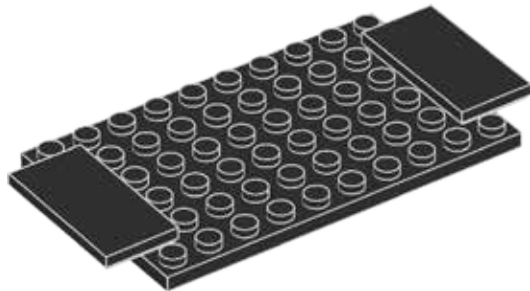

51

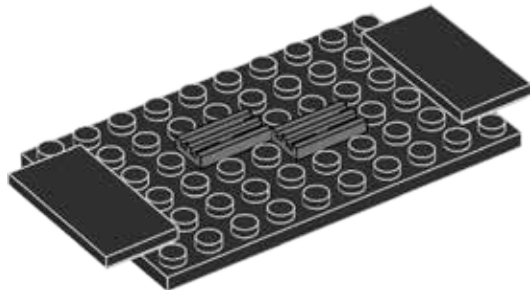

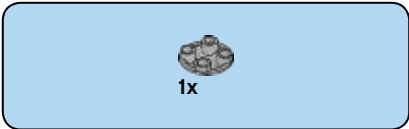

52

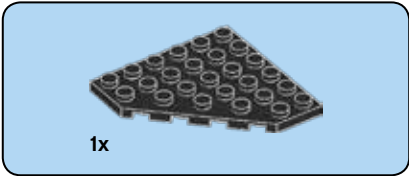
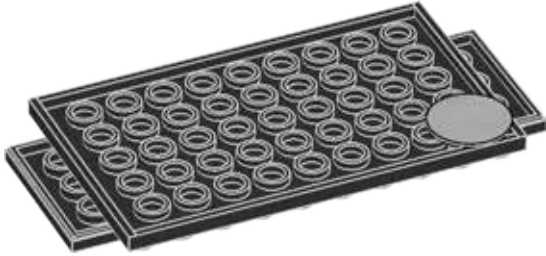

53

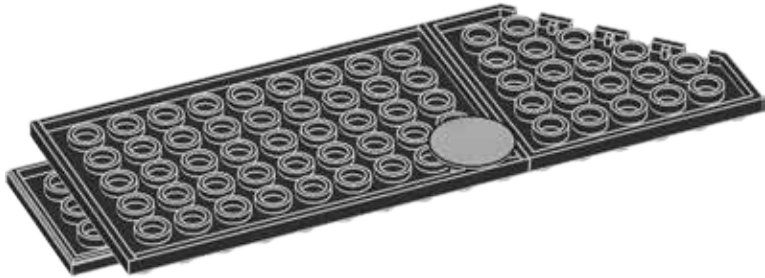

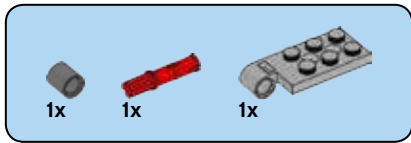

54

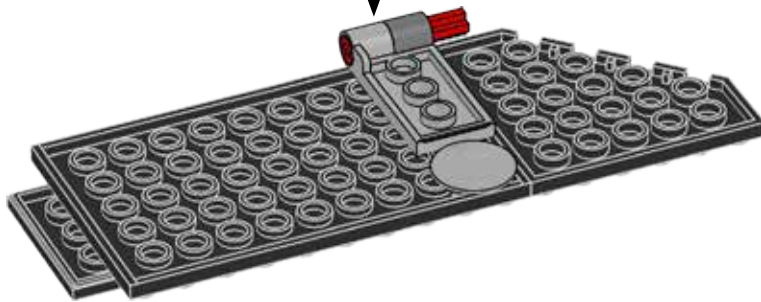
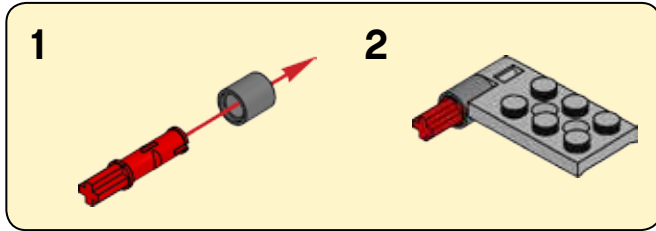

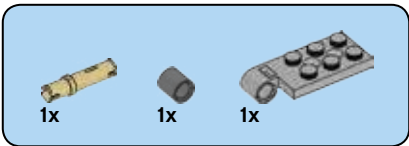

55

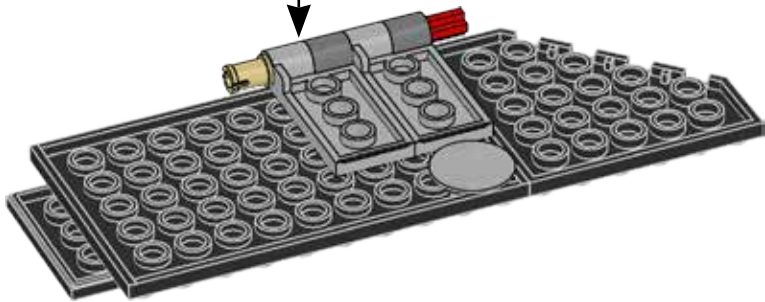
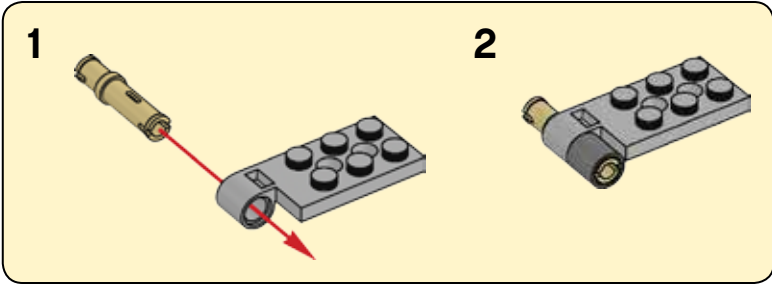

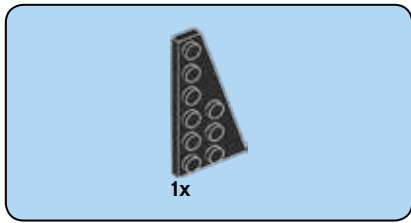

56

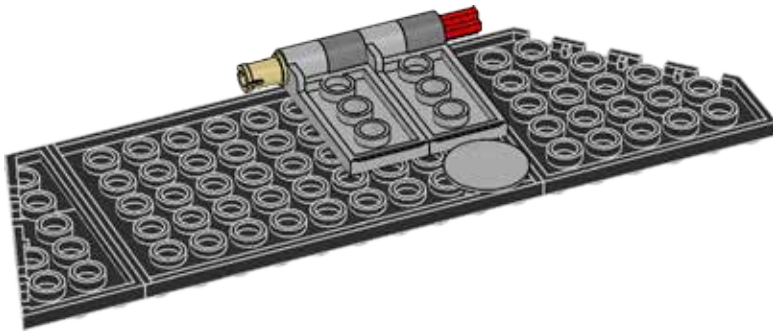







59

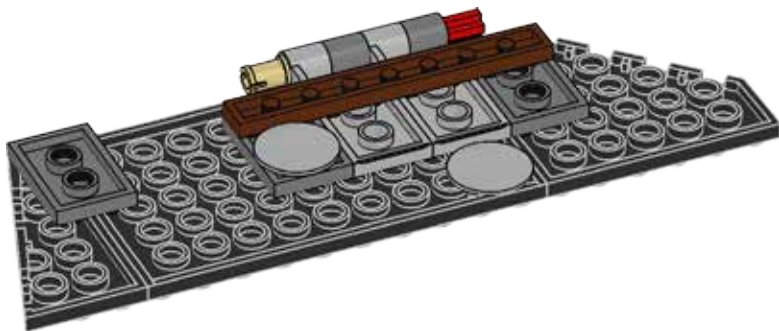

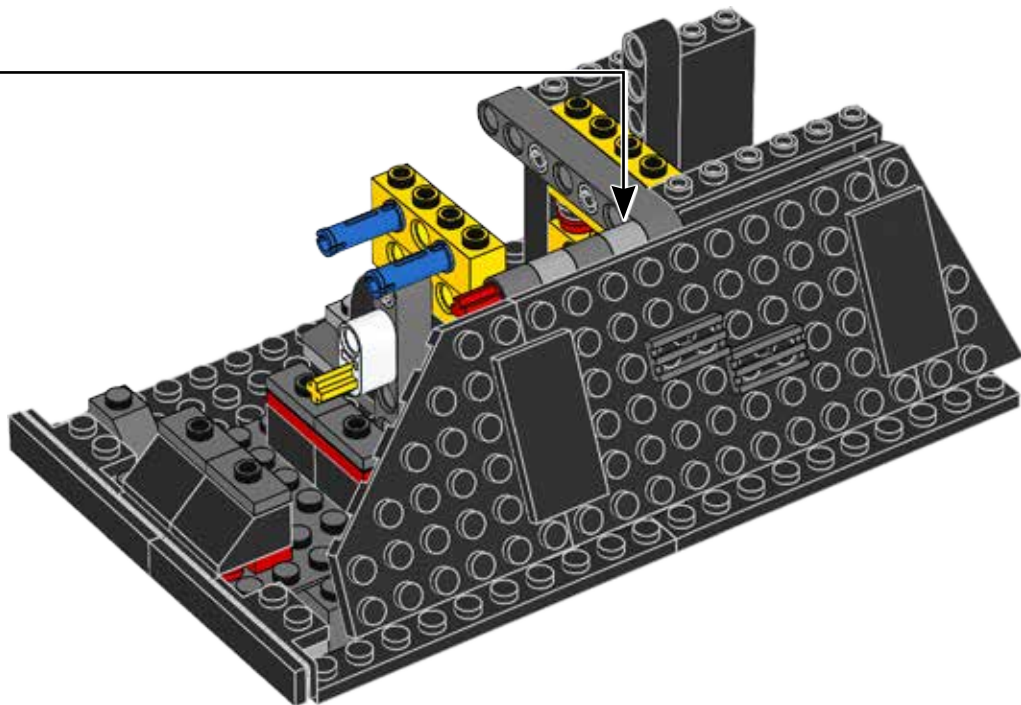

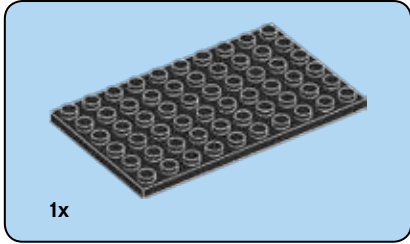
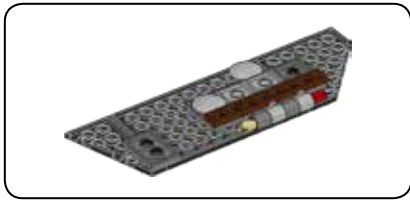

1x

**61**

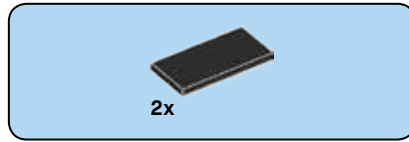
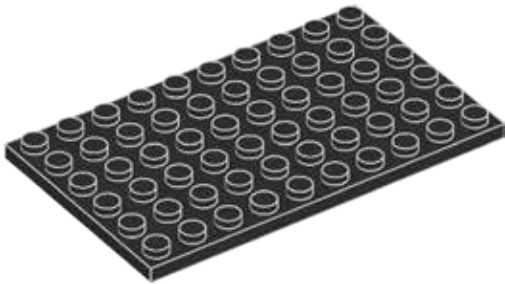

2x

**62**

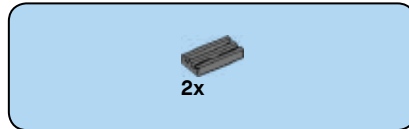
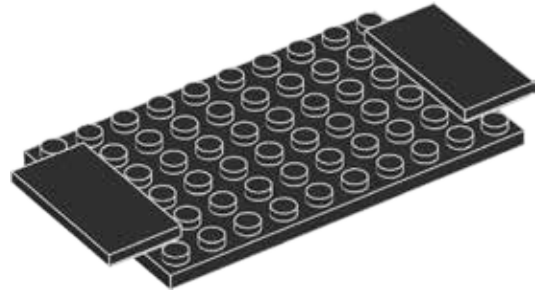

2x

**63**

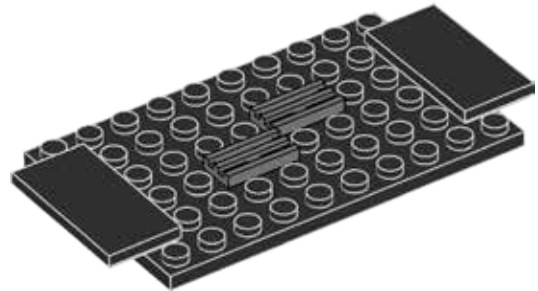

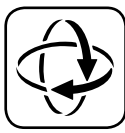
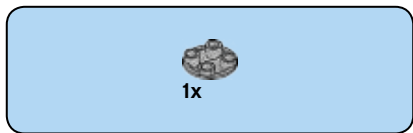

64

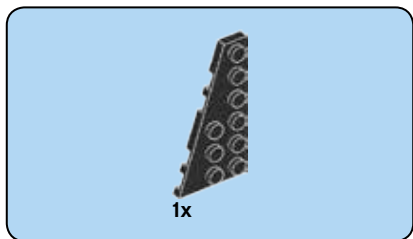
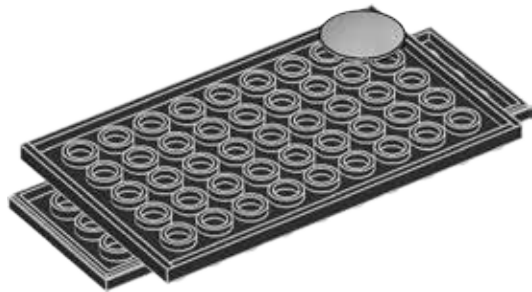

65

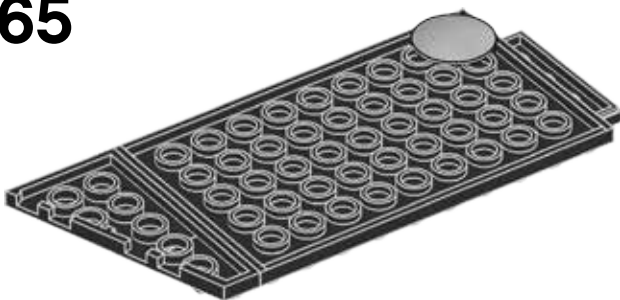

66

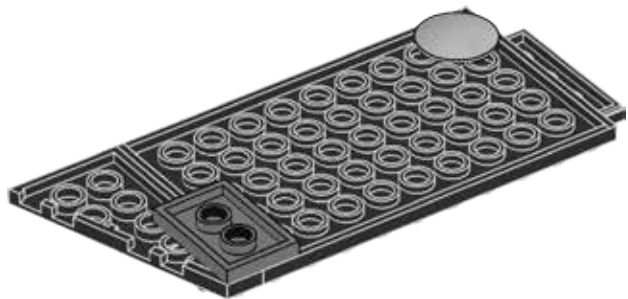

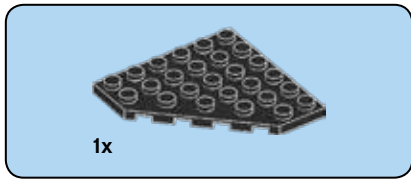

67

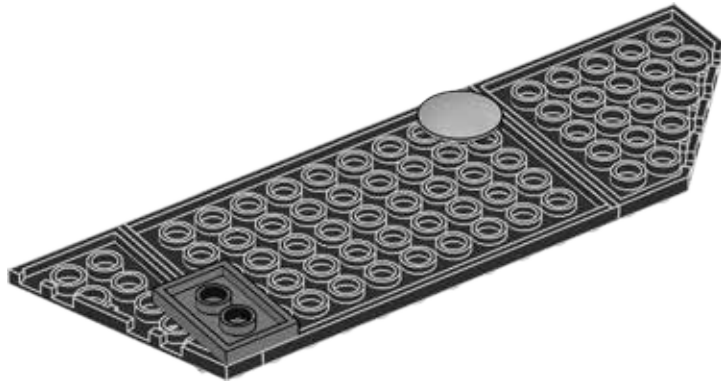

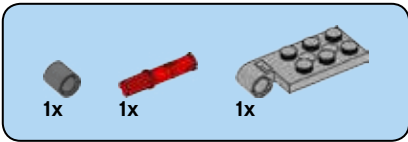

68

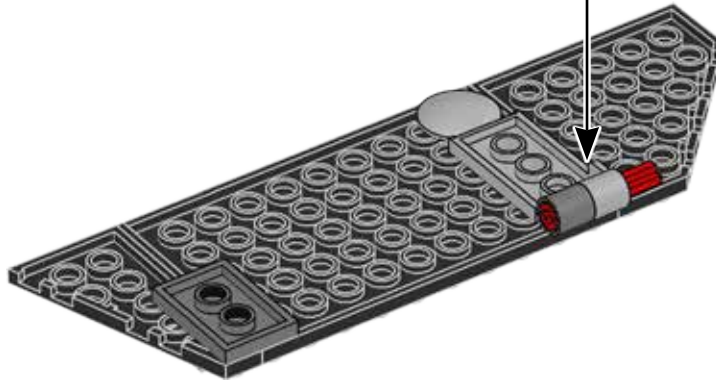
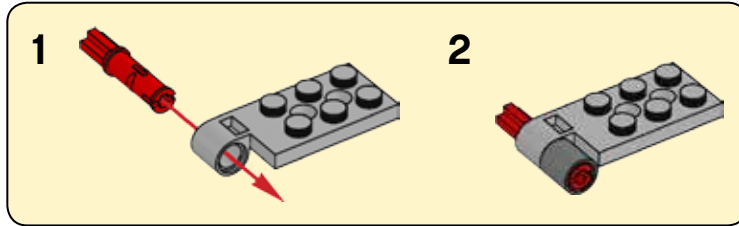

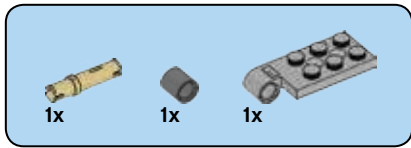

69

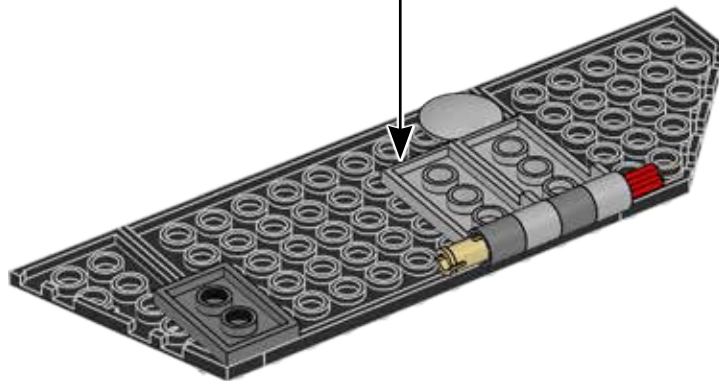
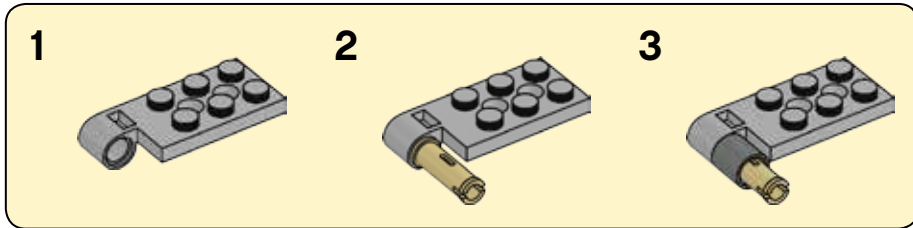





2x

70

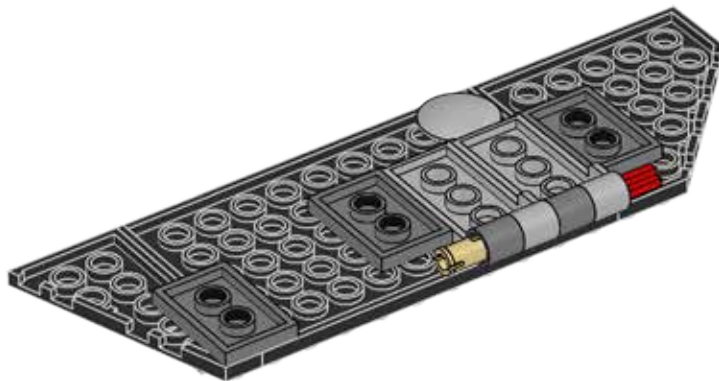



71

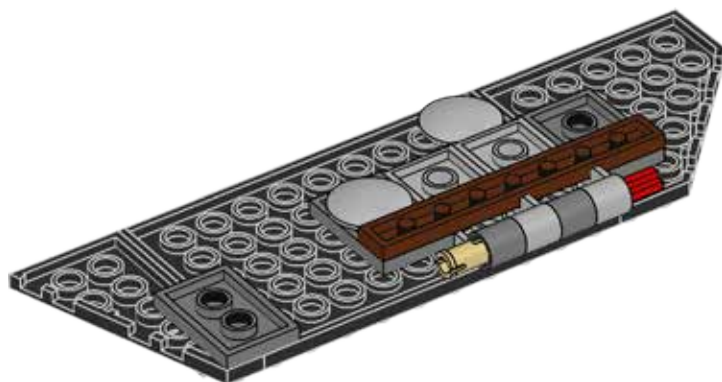

72

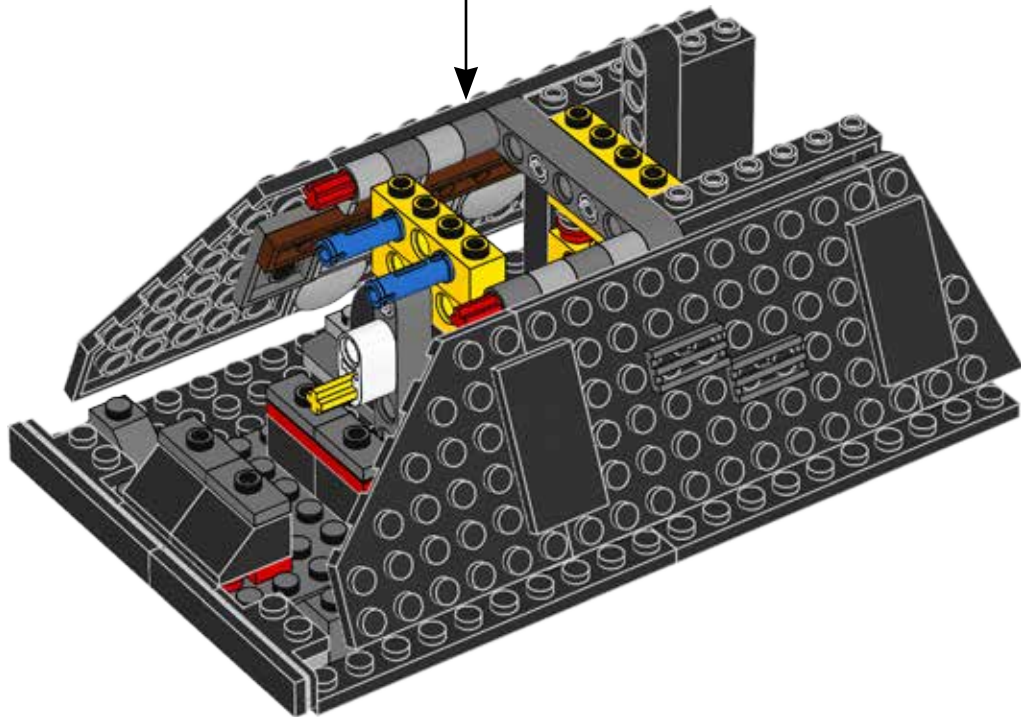

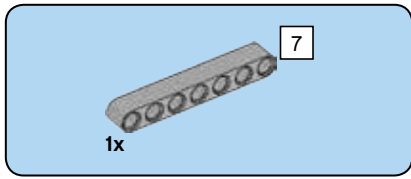

73

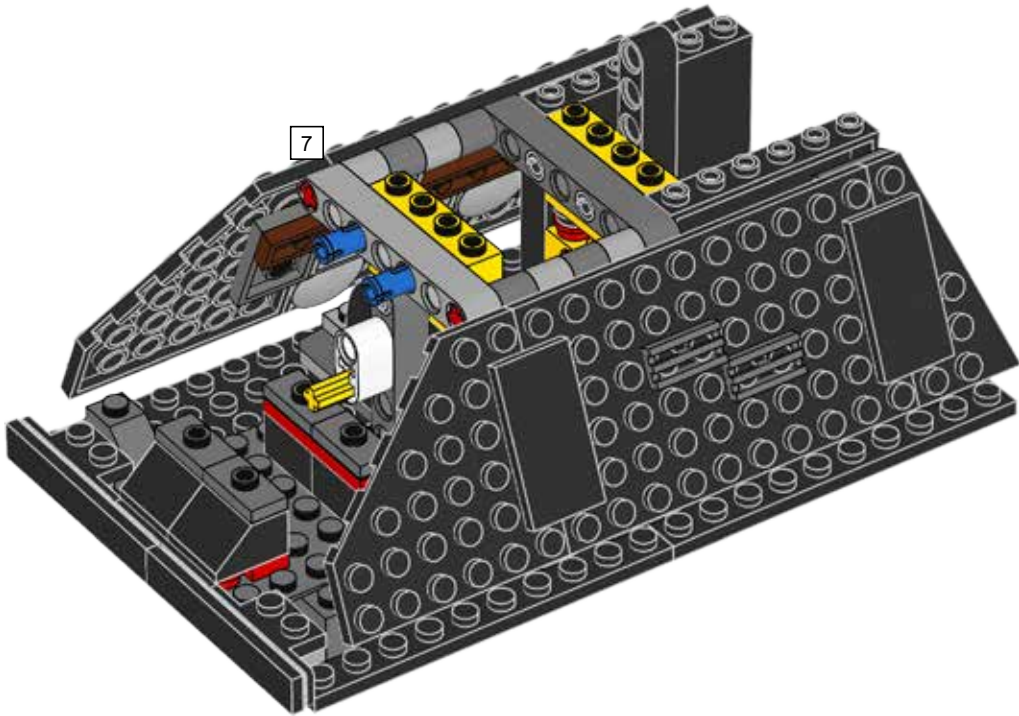

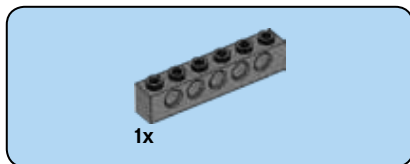

74

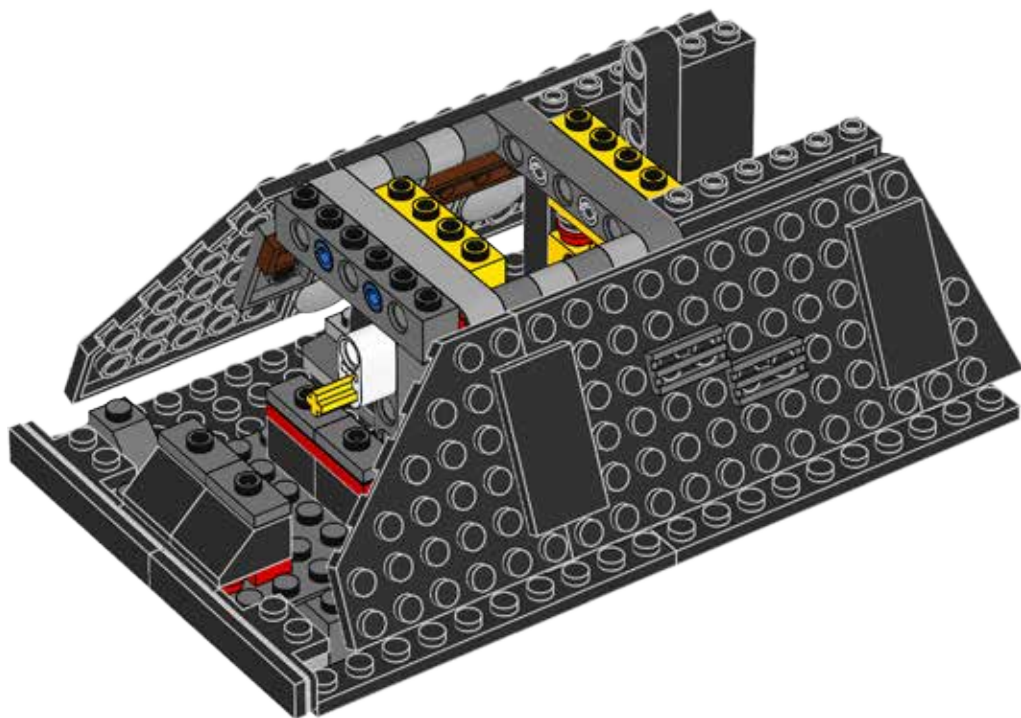

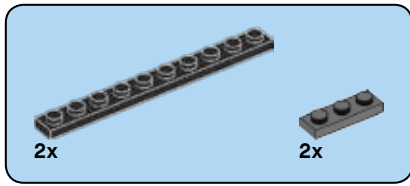

75

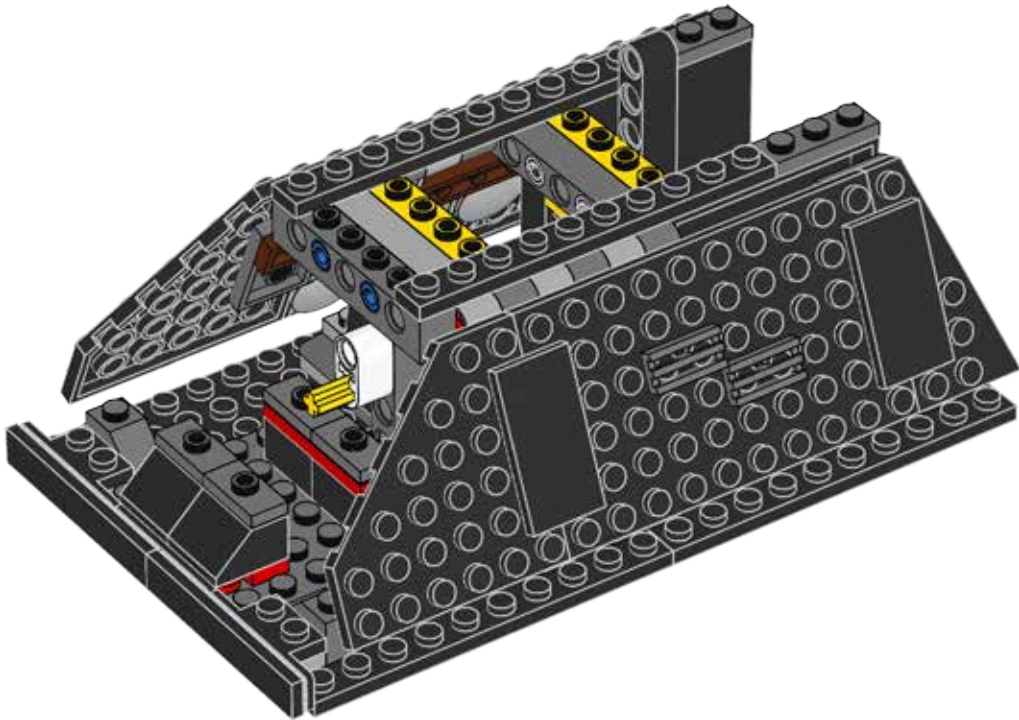

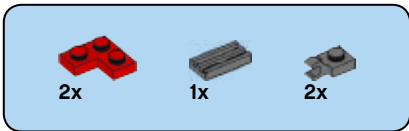

76

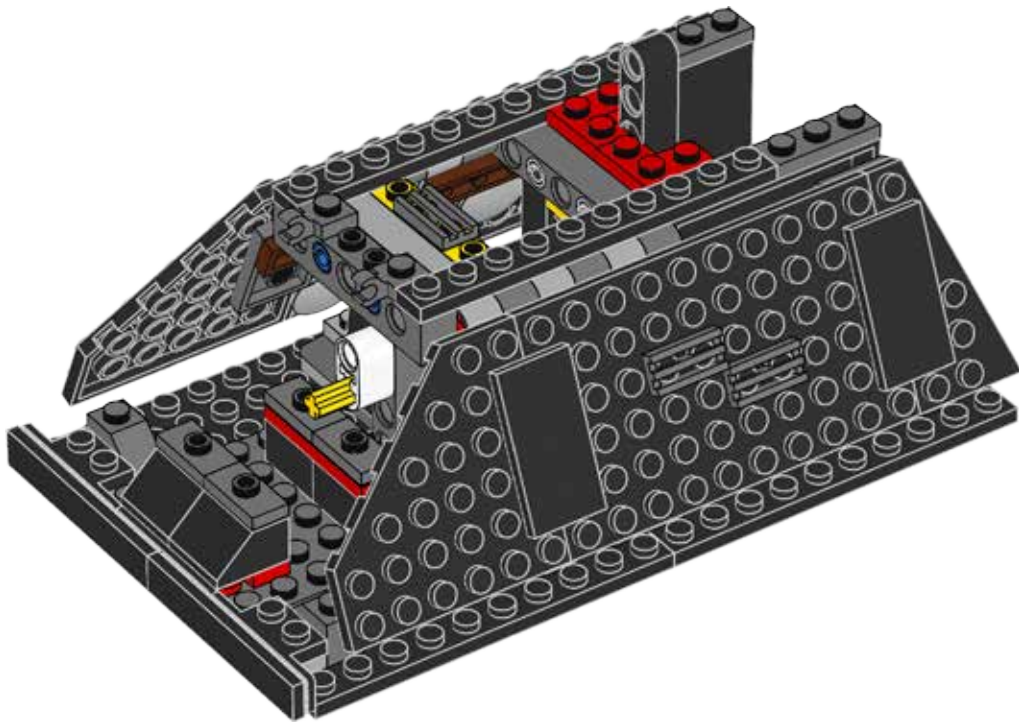



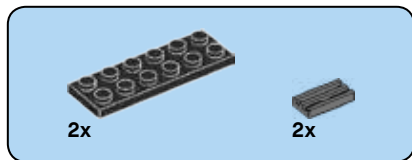

77

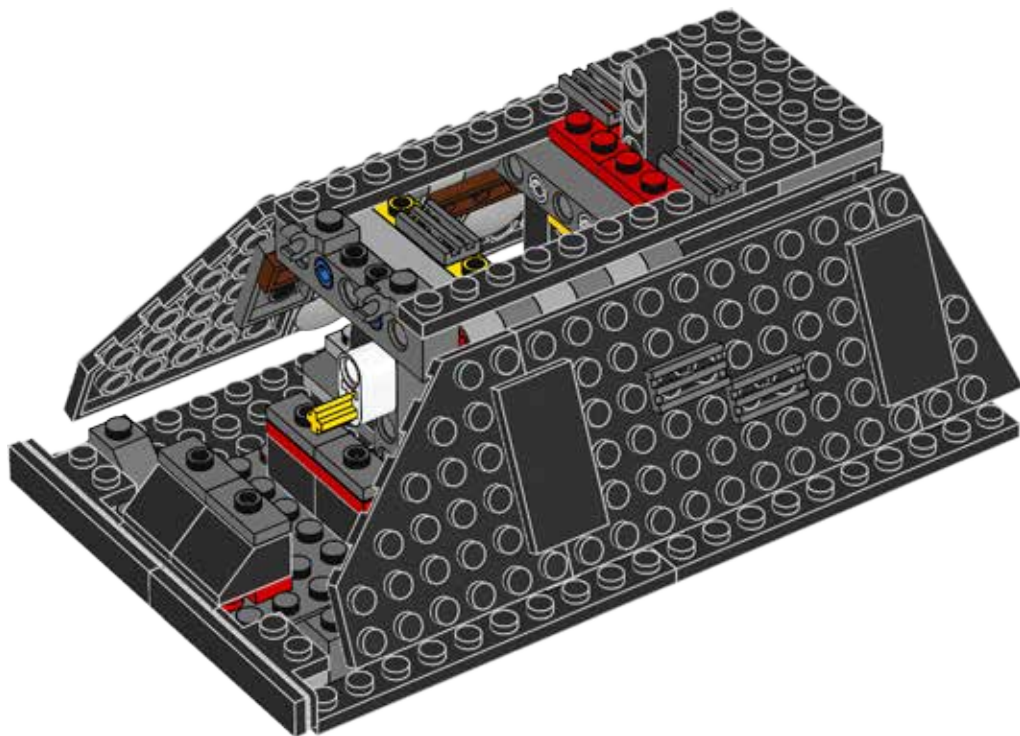



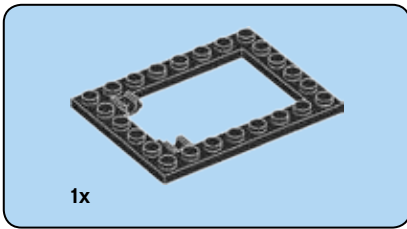

78

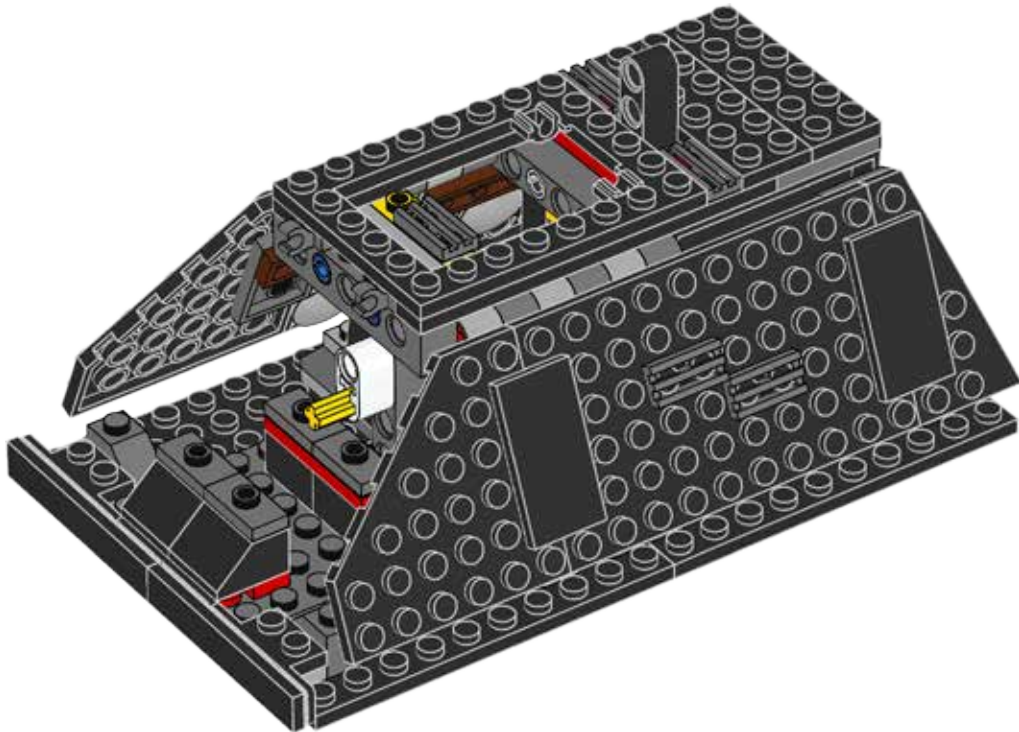

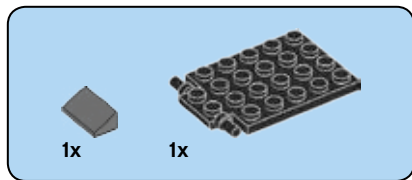

79

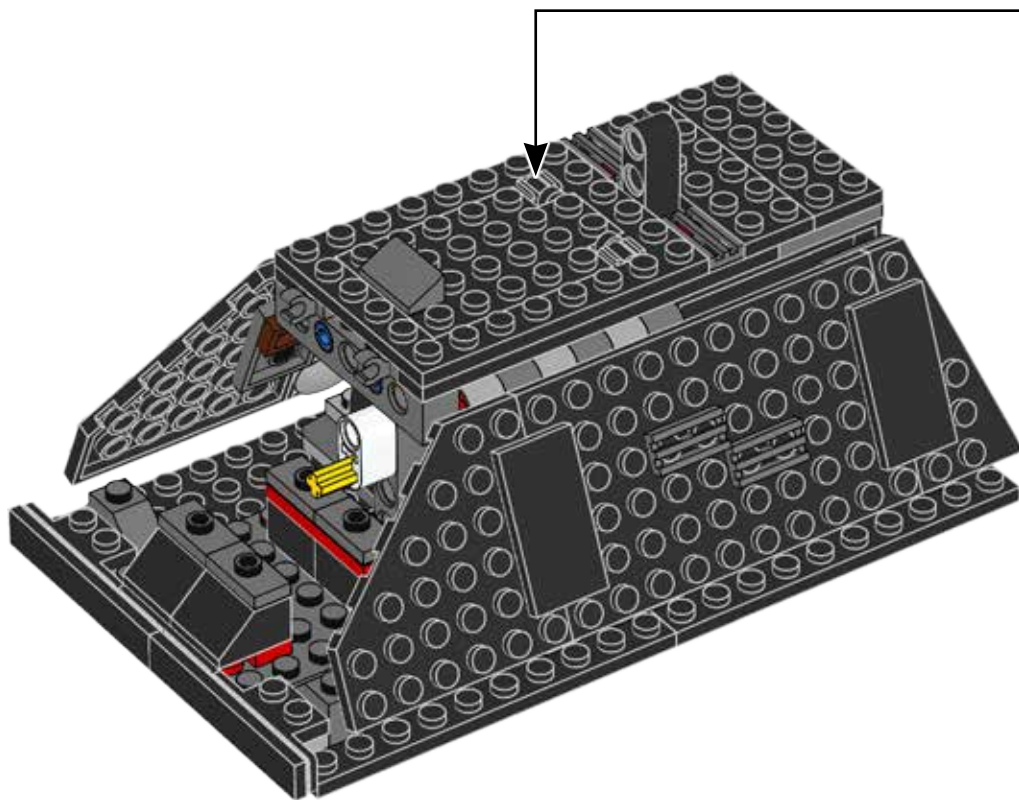
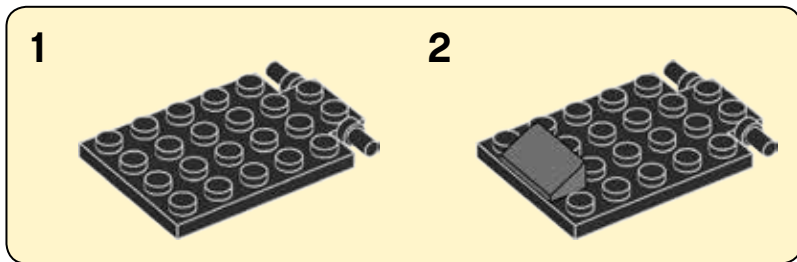



1x



1x

# 80

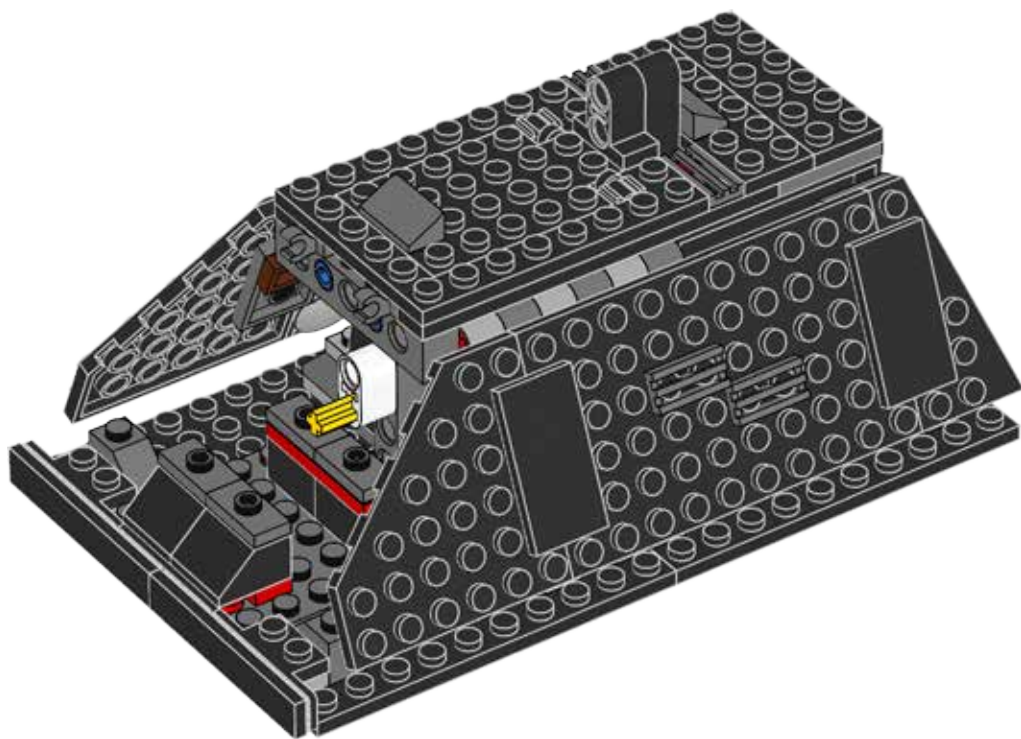



1x

81

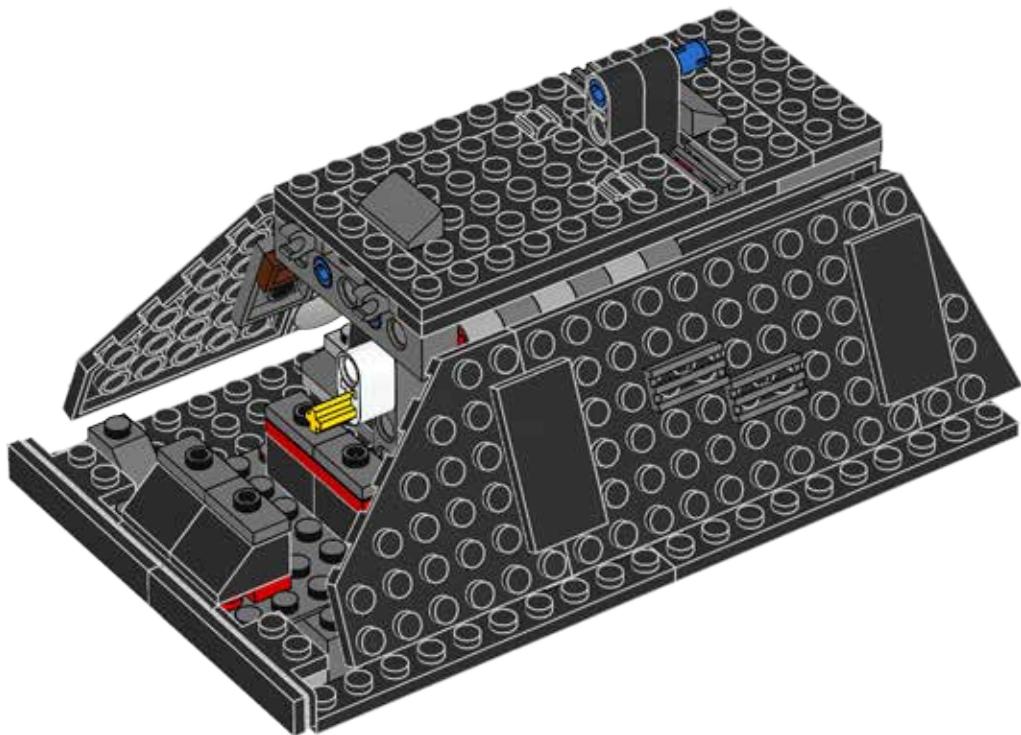

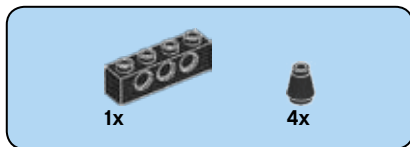

82

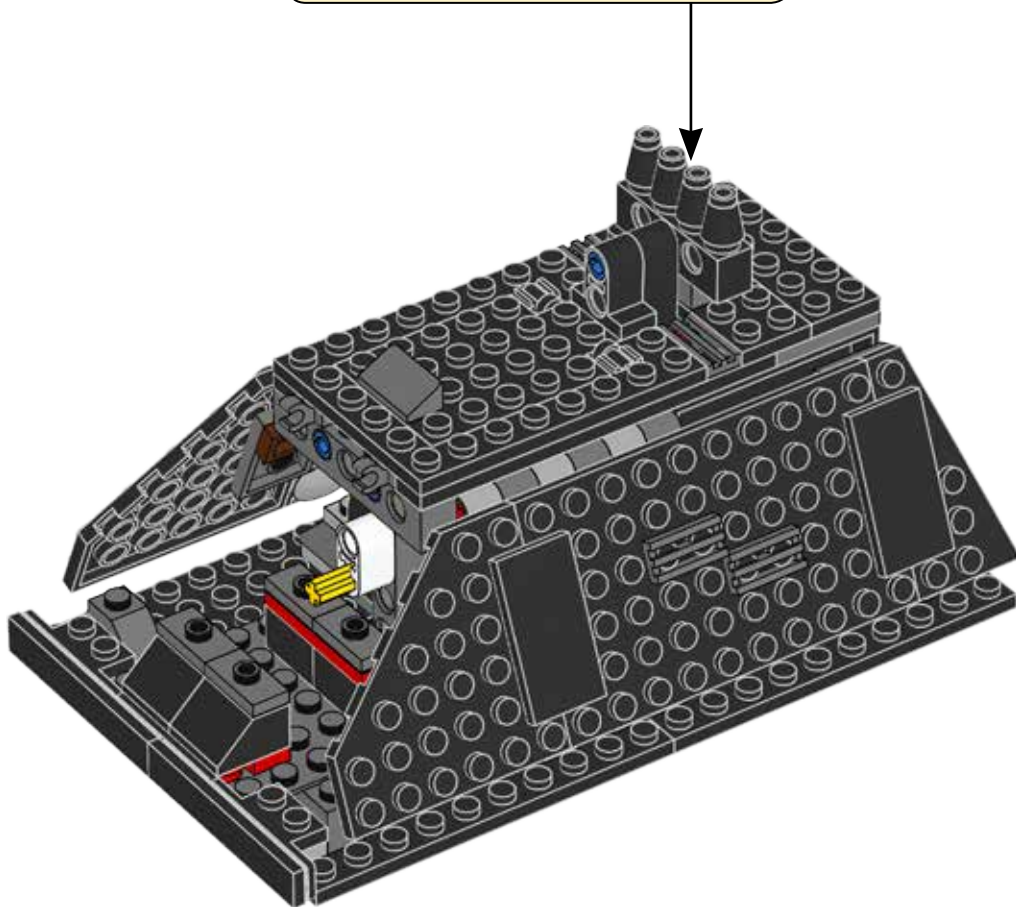
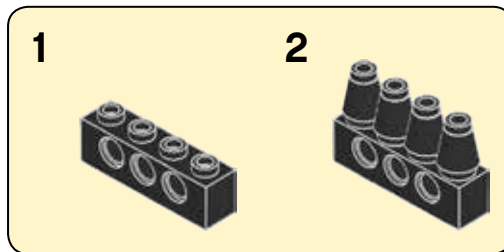



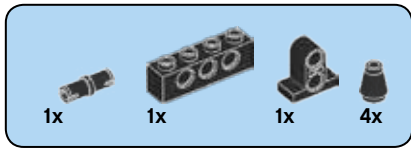

83

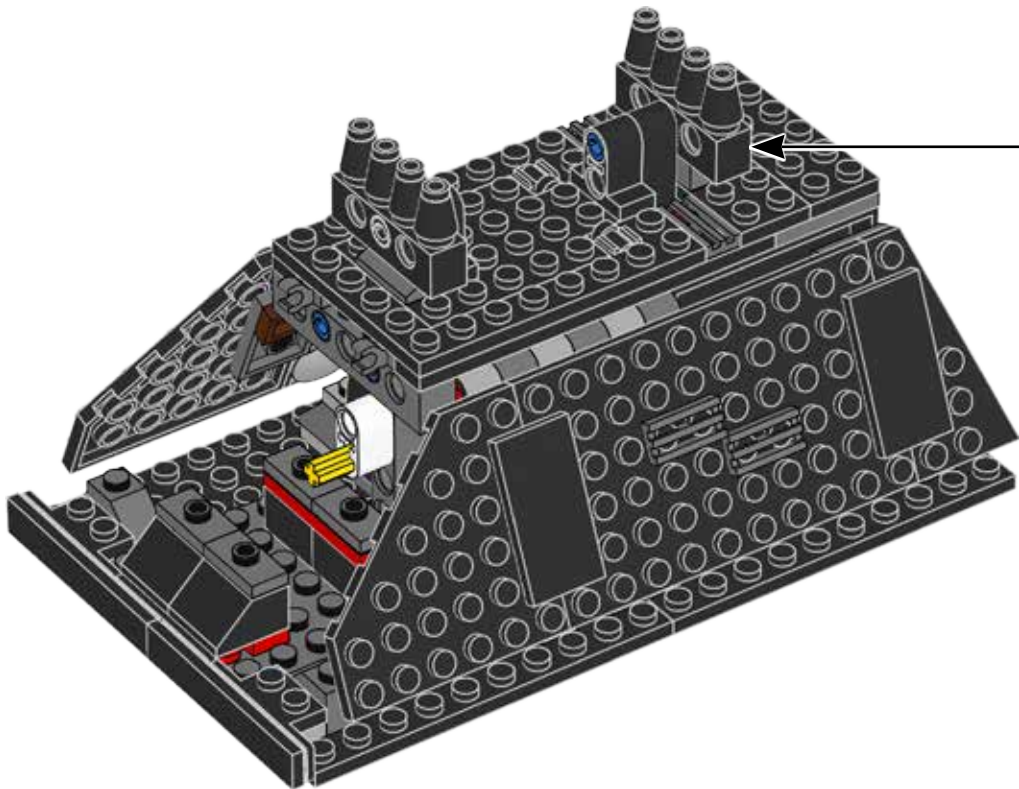
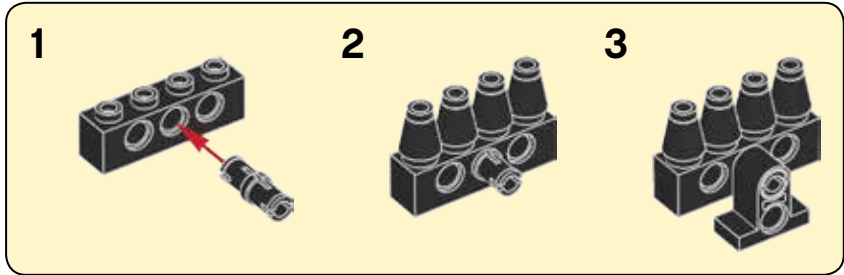

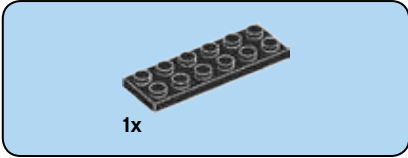
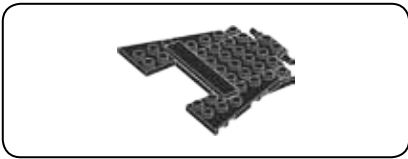

1x

**84**

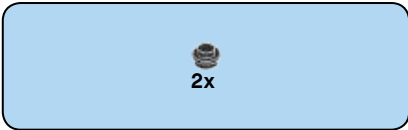
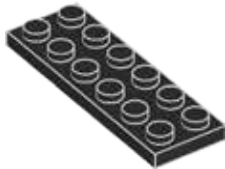

2x

**85**

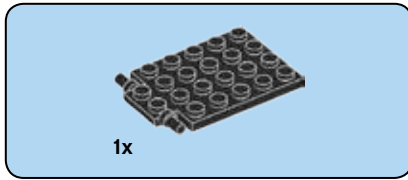
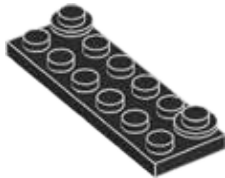

1x

**86**

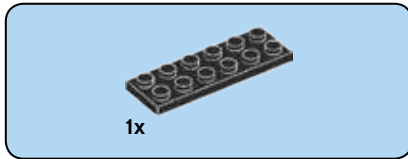
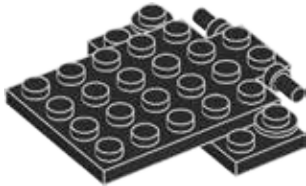

1x

**87**

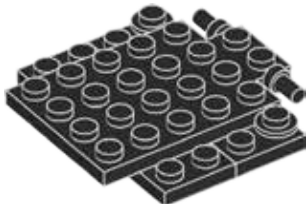

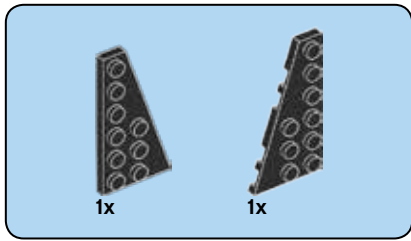

88

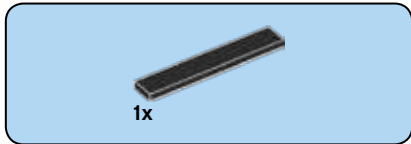

89

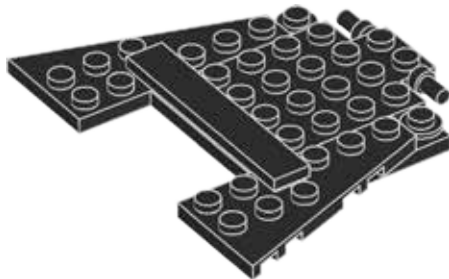



90

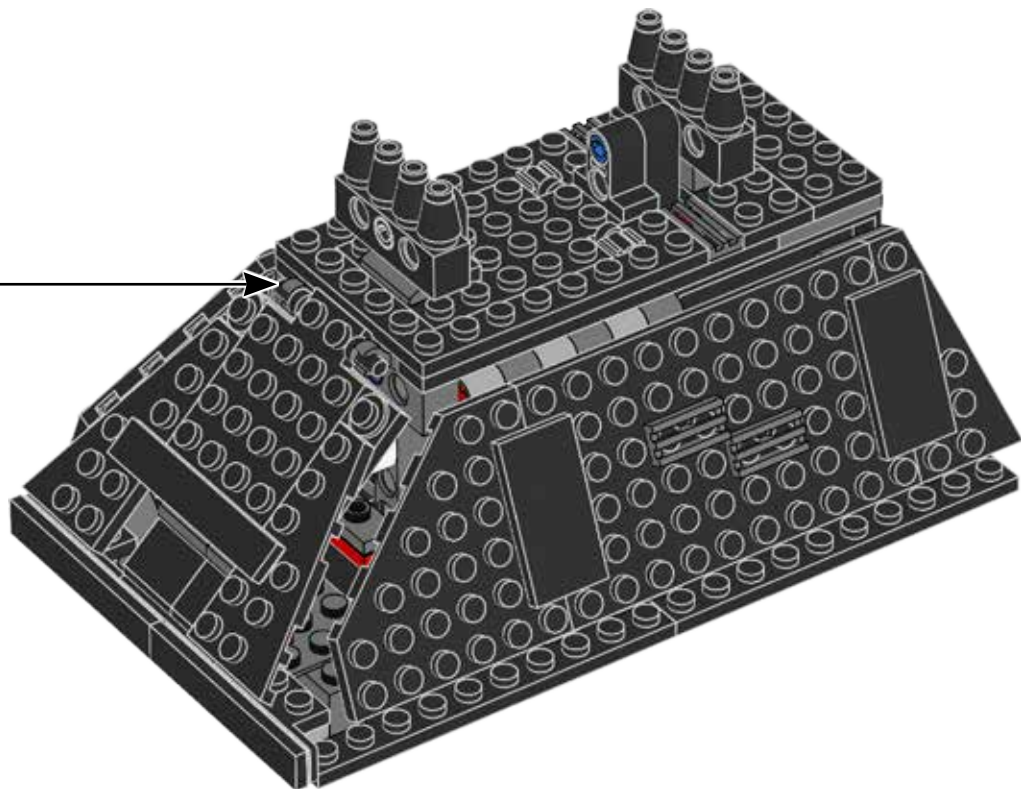

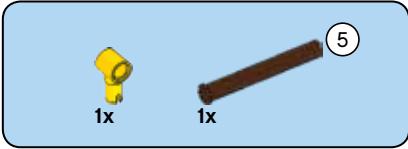
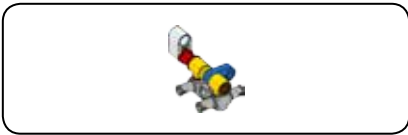

91

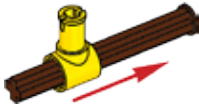

92

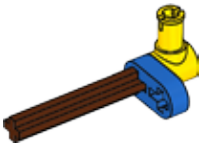

93



94

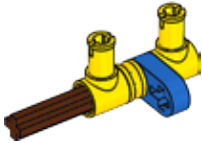

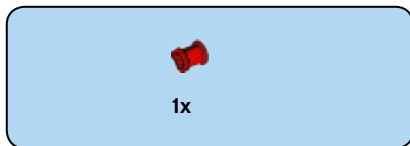

95

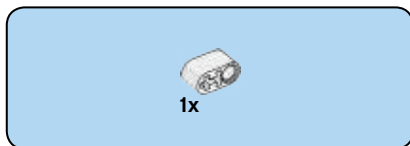
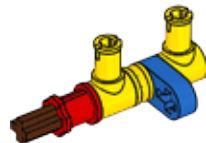

96

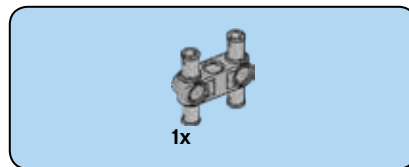
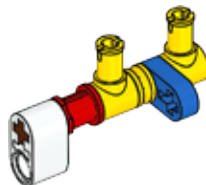

97

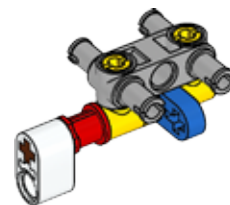

98

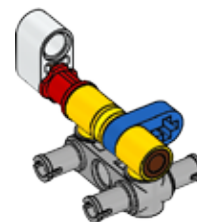

99

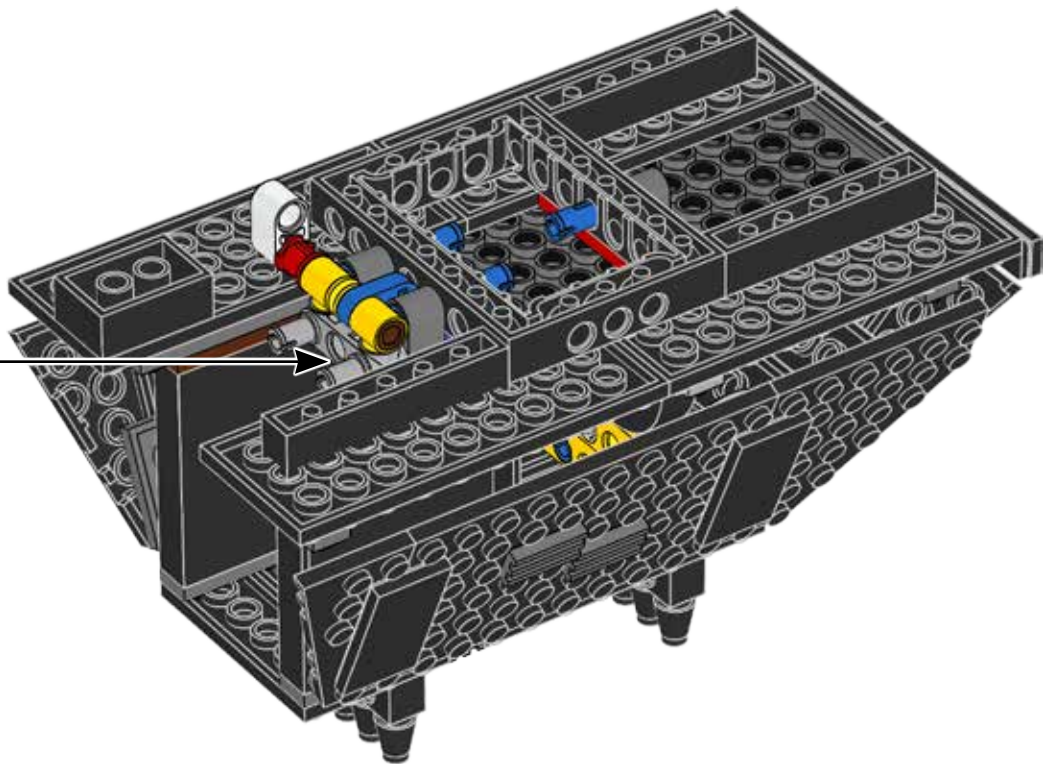



1x

100

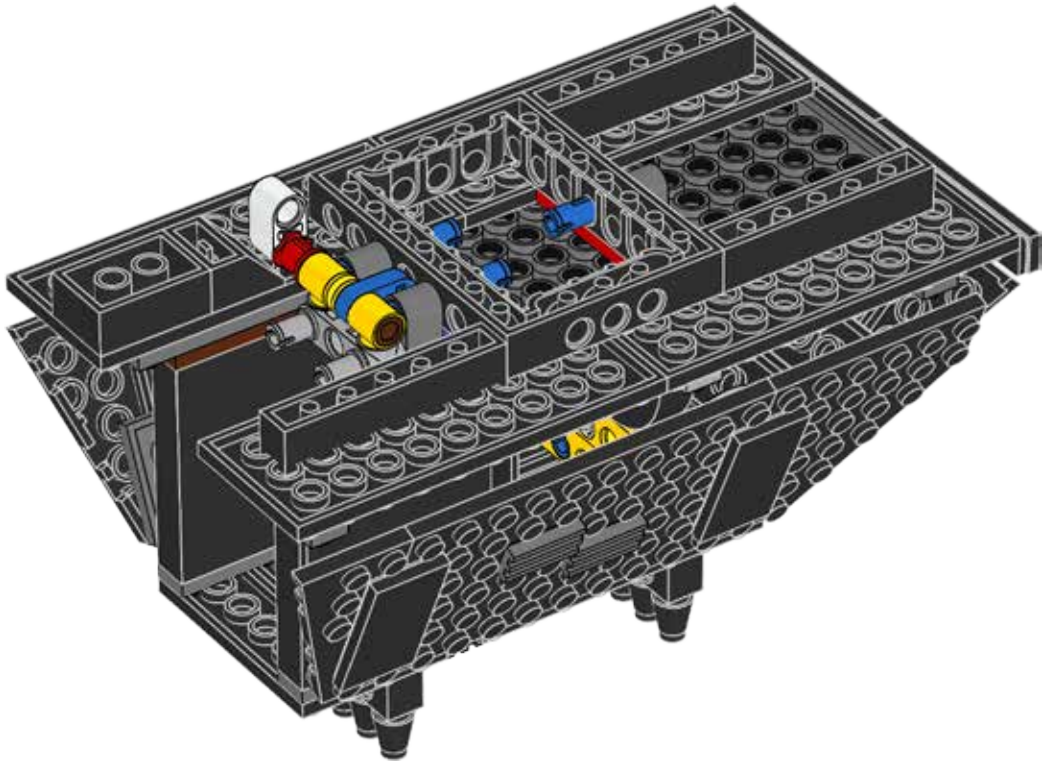

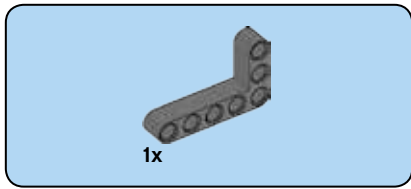

101

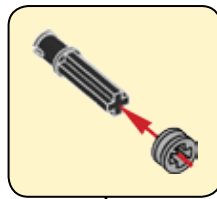
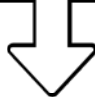

1

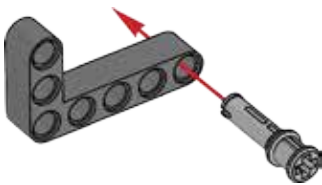

2

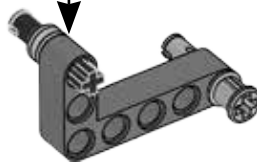

3



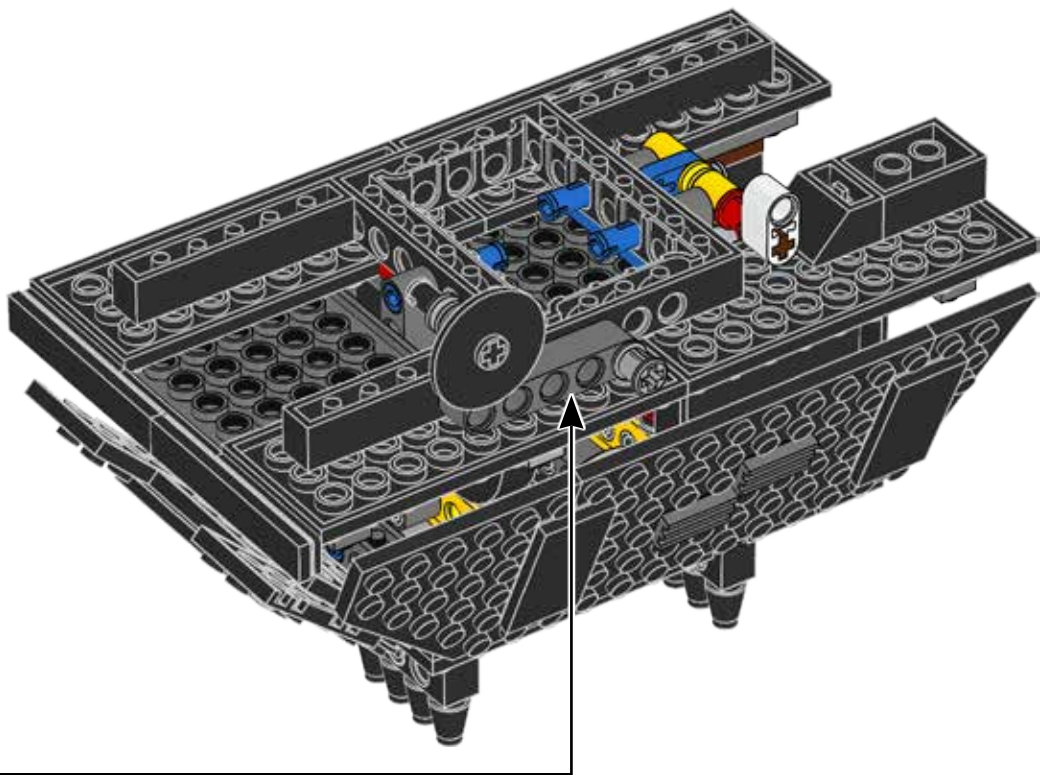

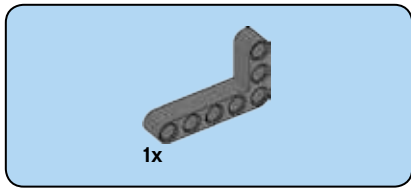

102

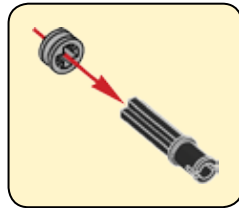
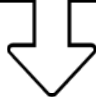

1

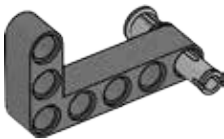

2

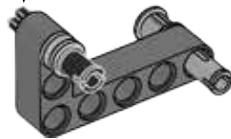

3

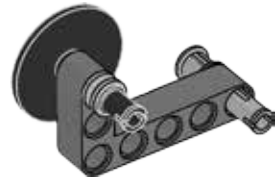



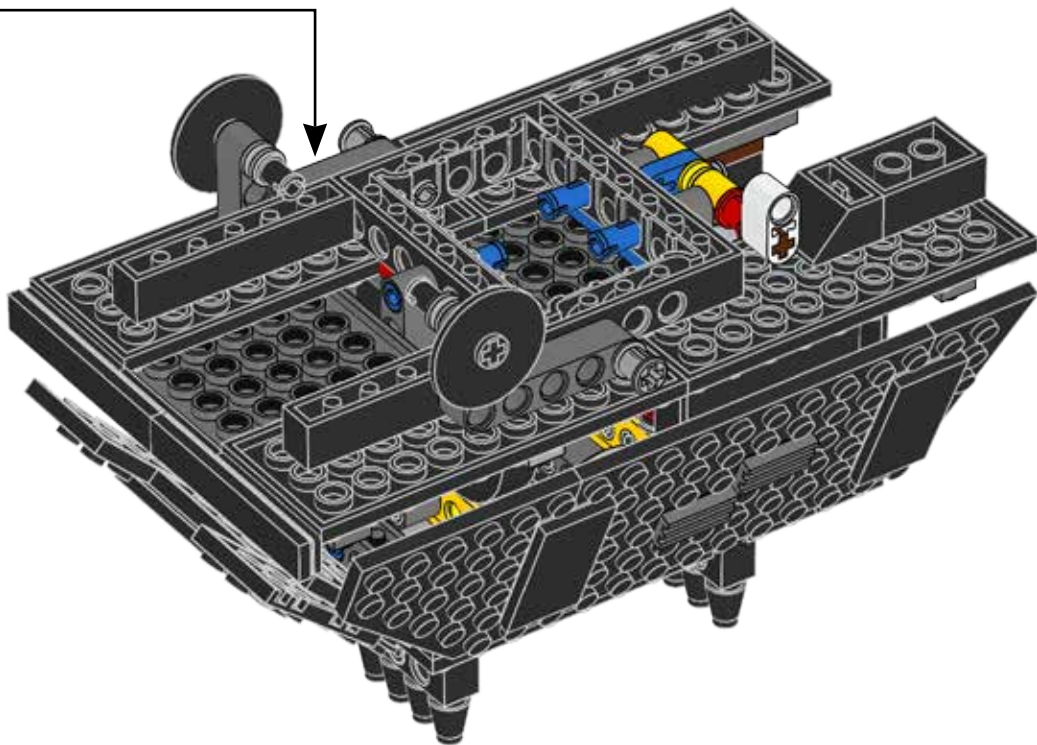

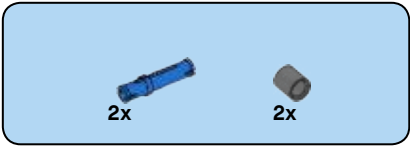

103

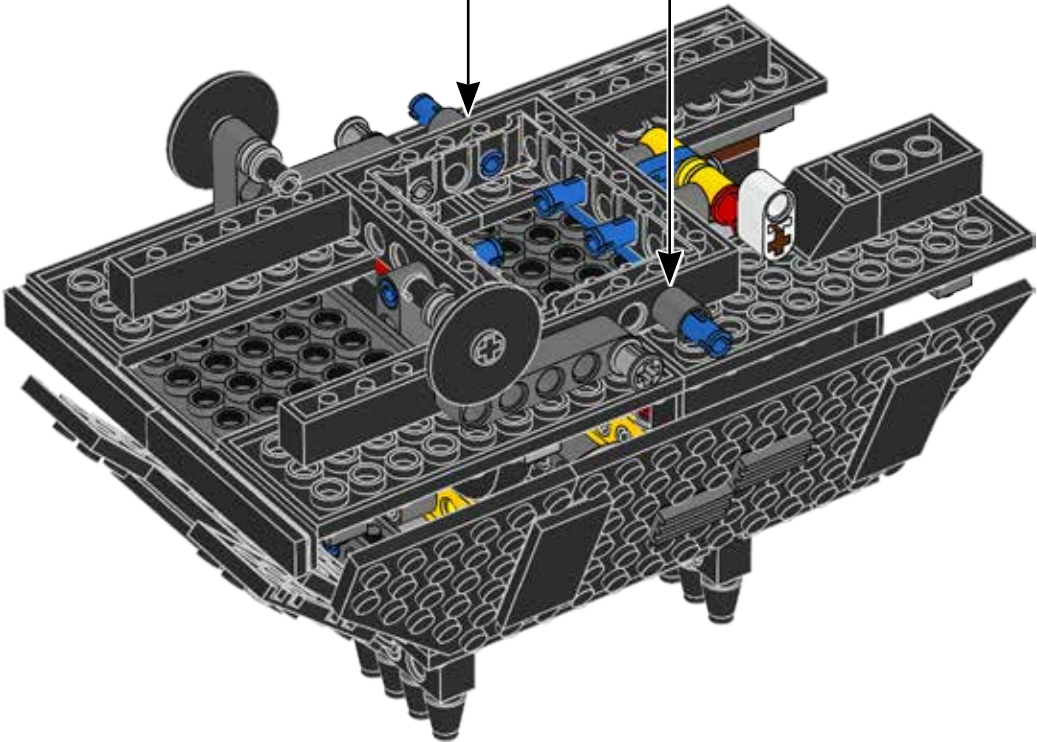
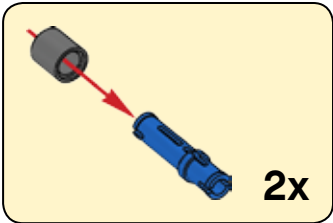



104

