



STAR WARS

75332



2





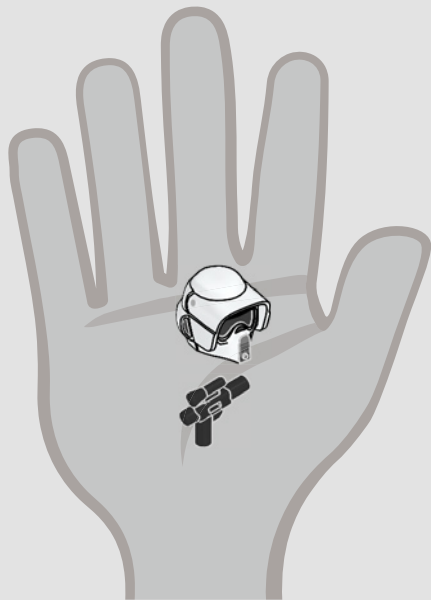
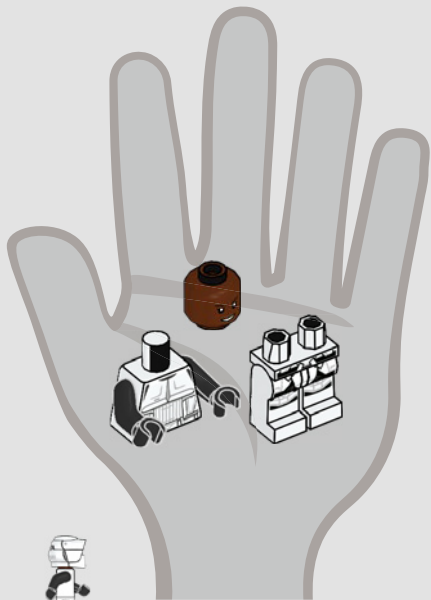

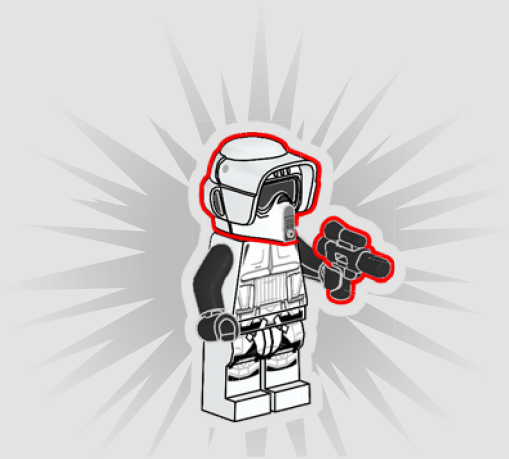
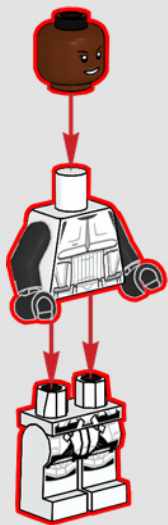

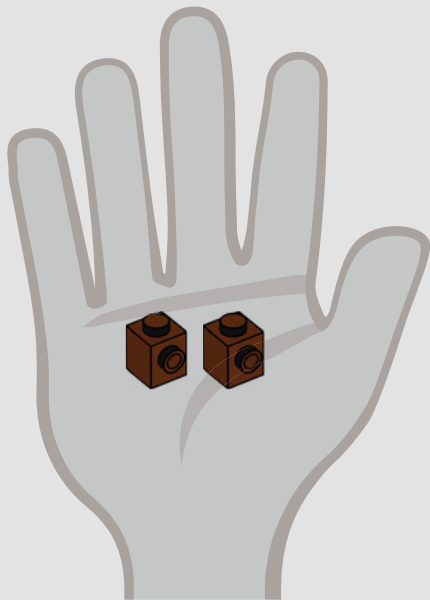
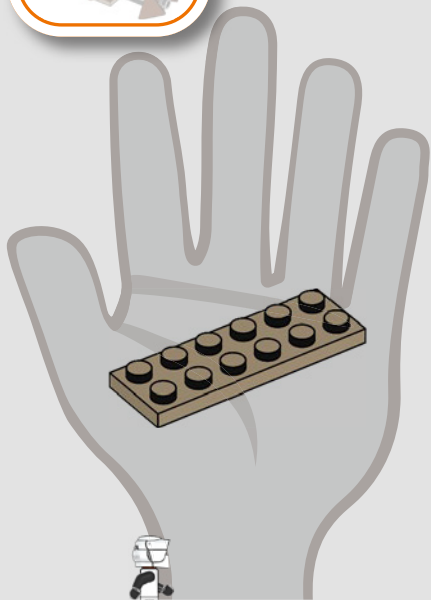

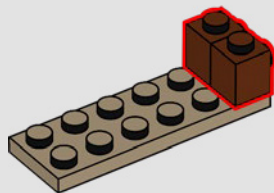
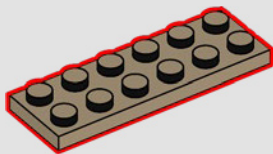

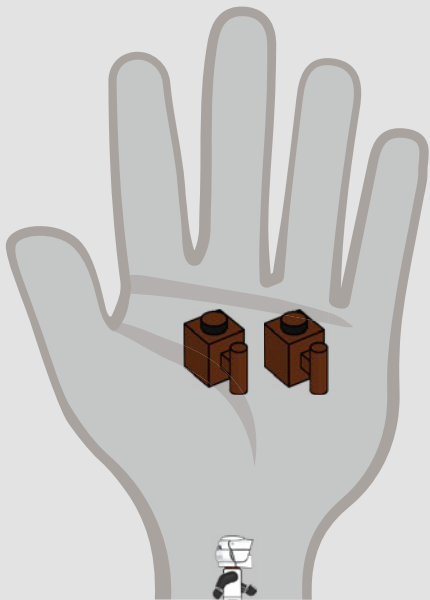

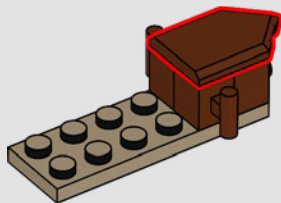
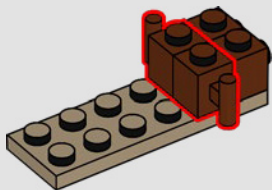

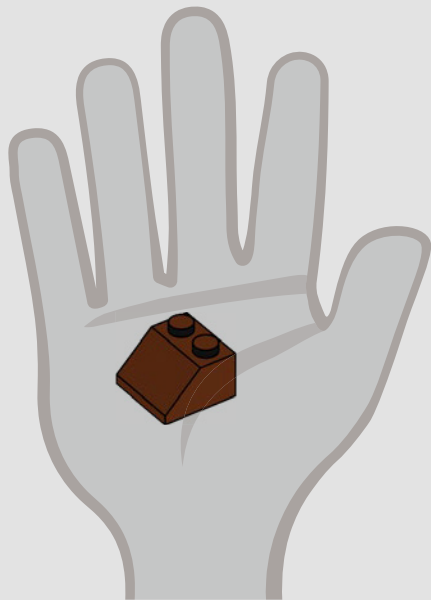
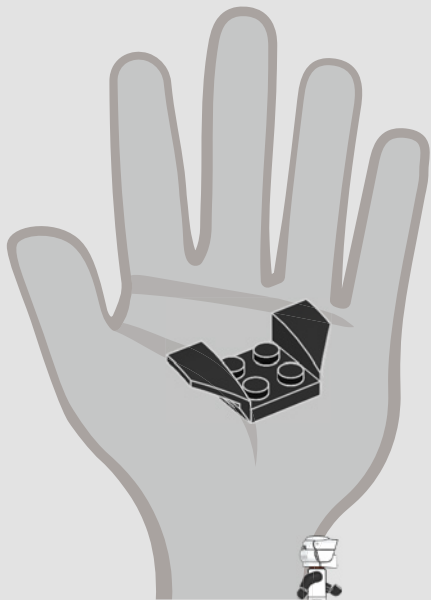

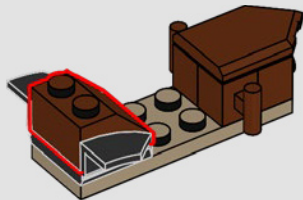
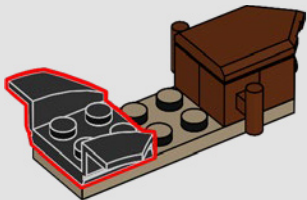

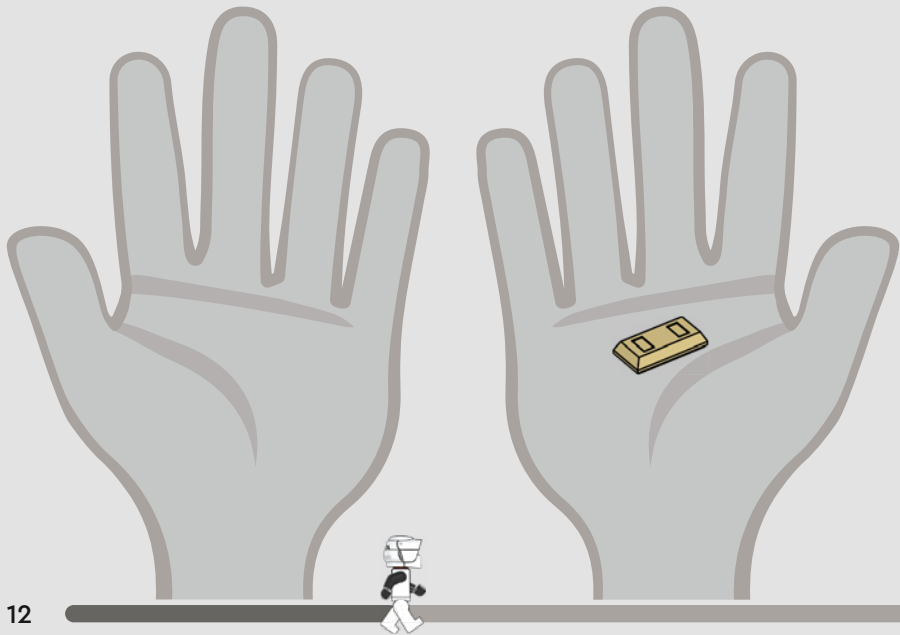

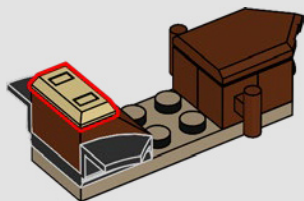

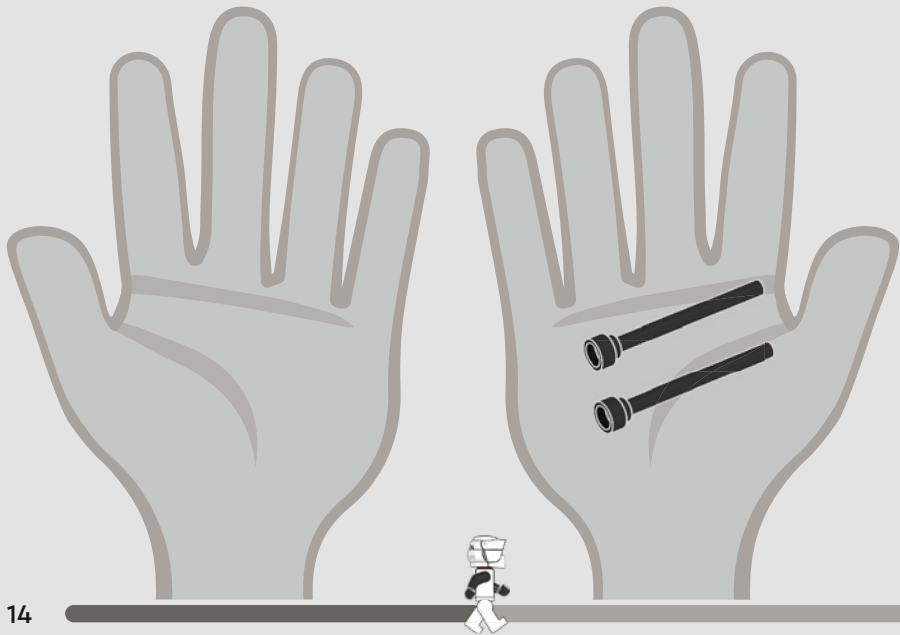

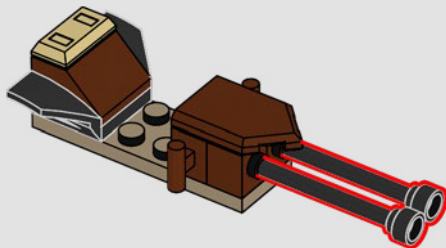

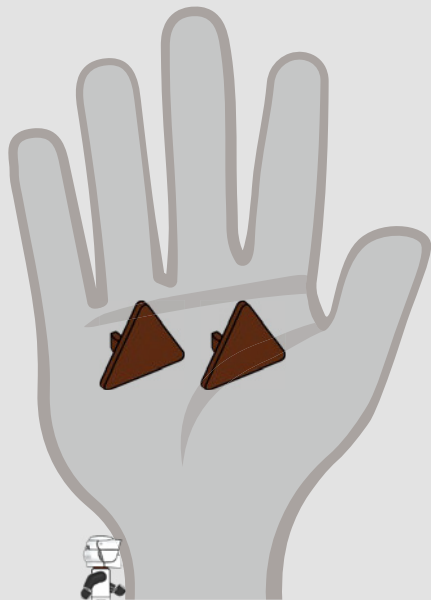

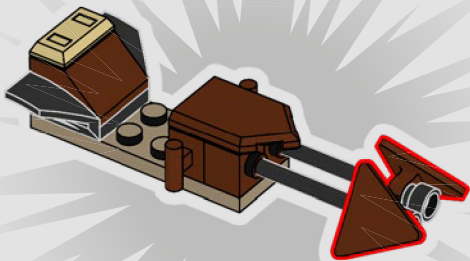



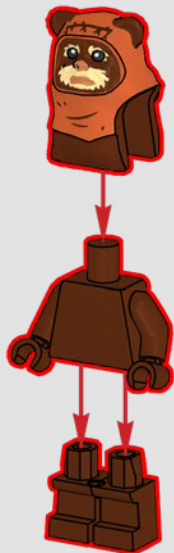

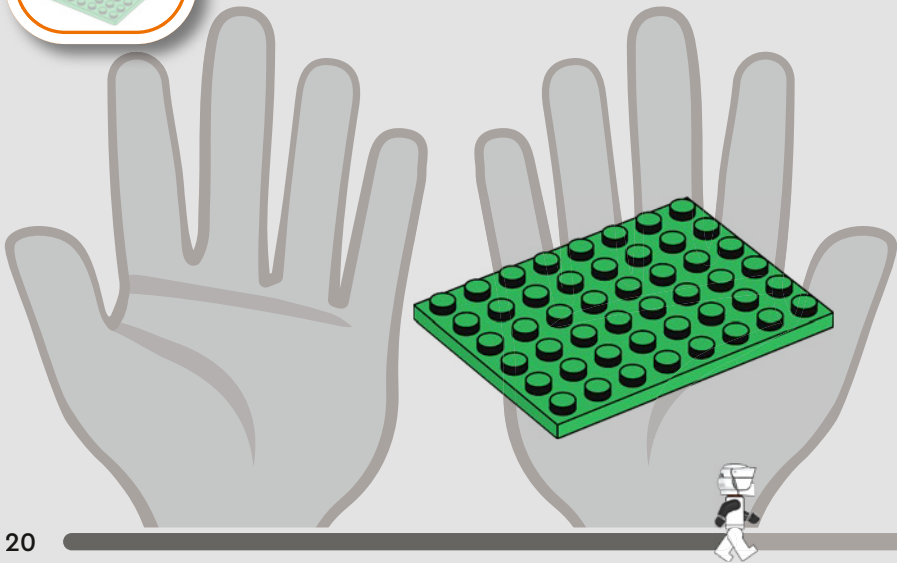

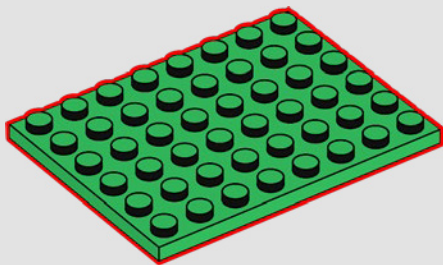

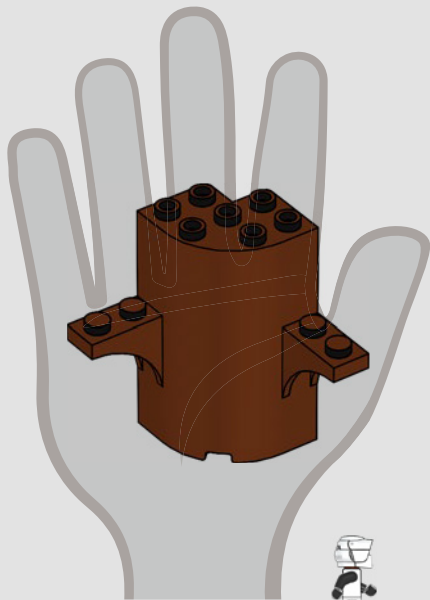

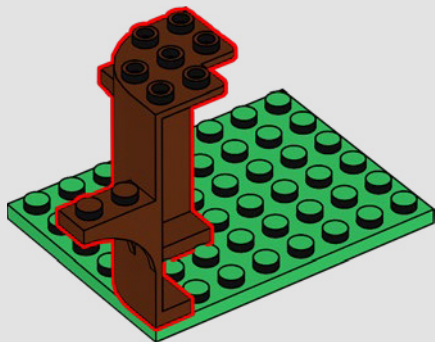

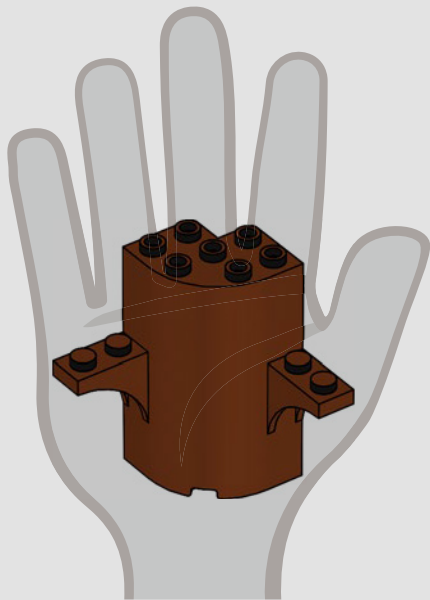

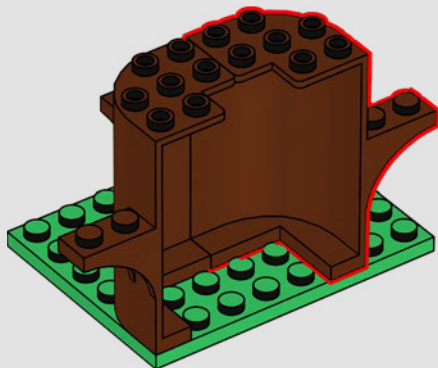

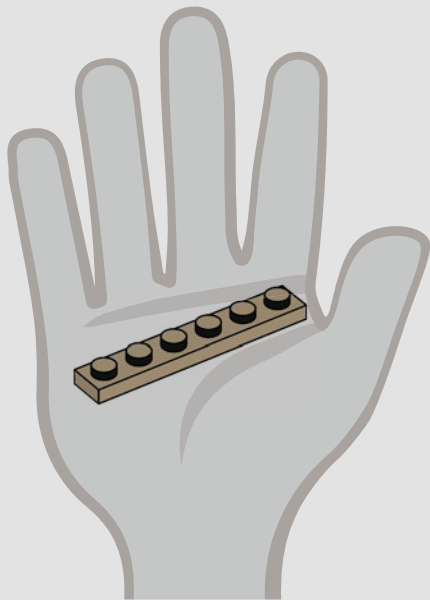

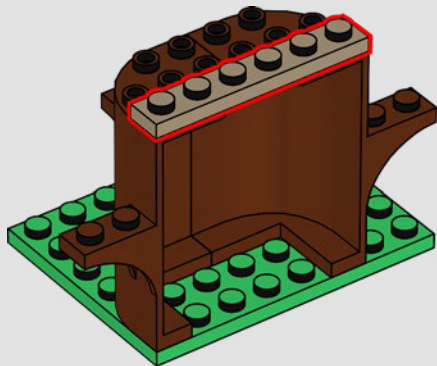

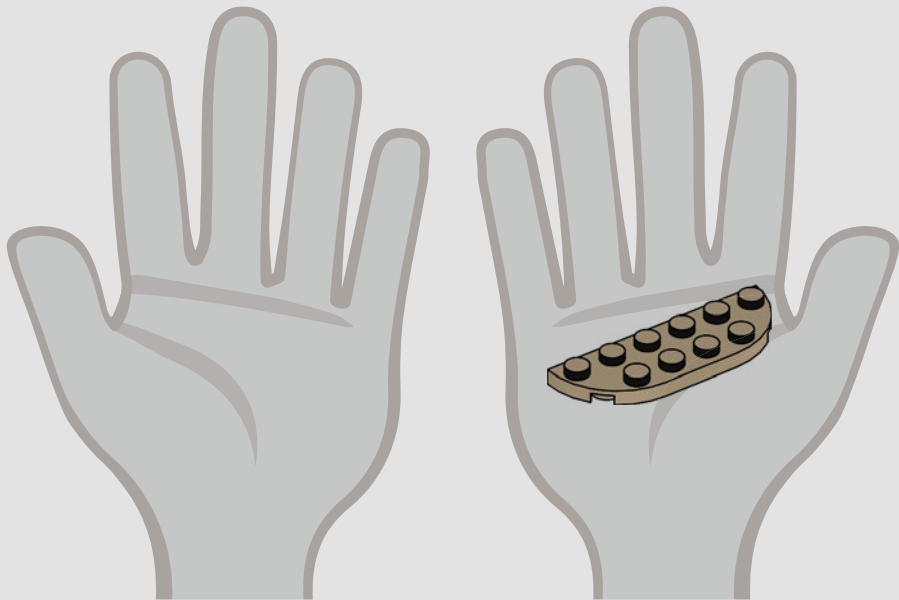

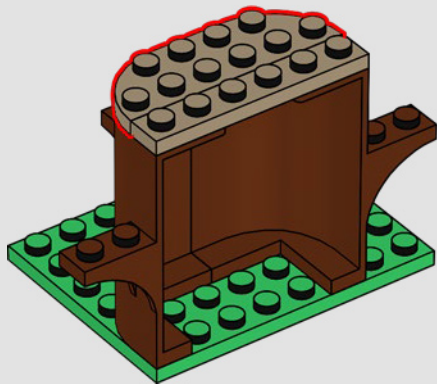

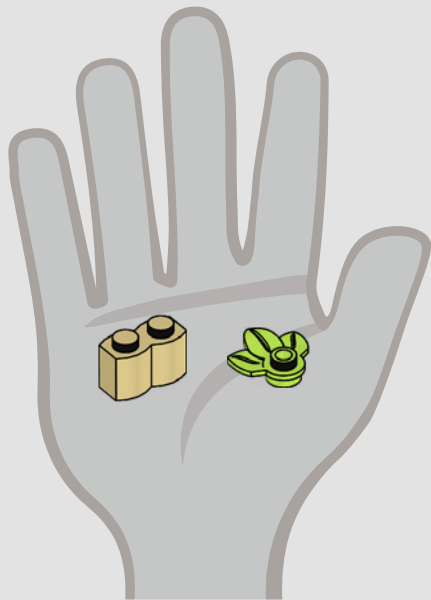

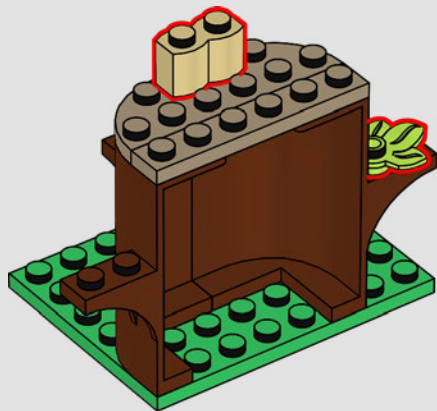

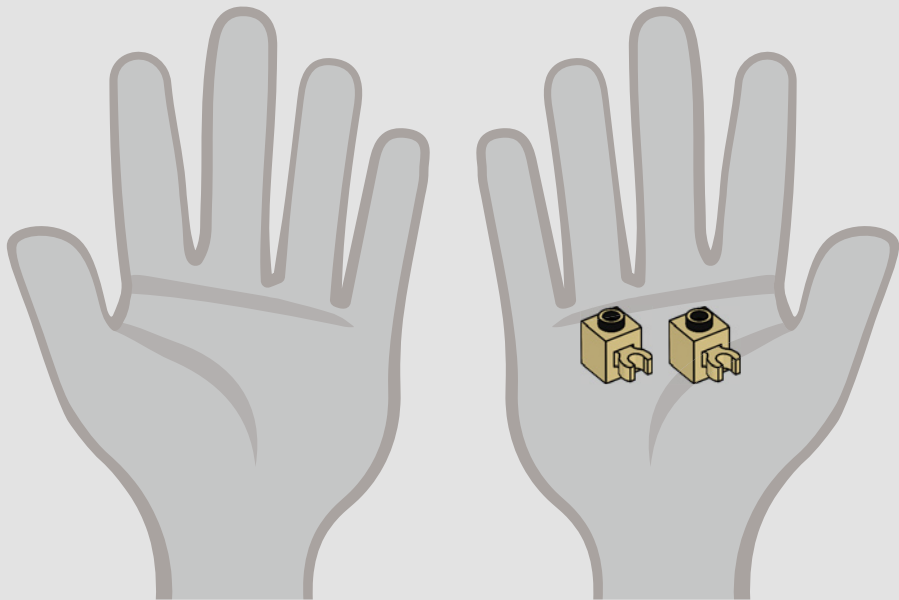

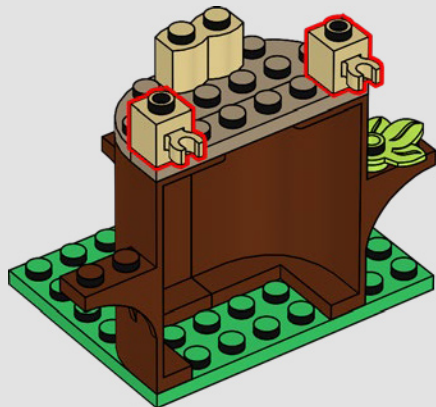

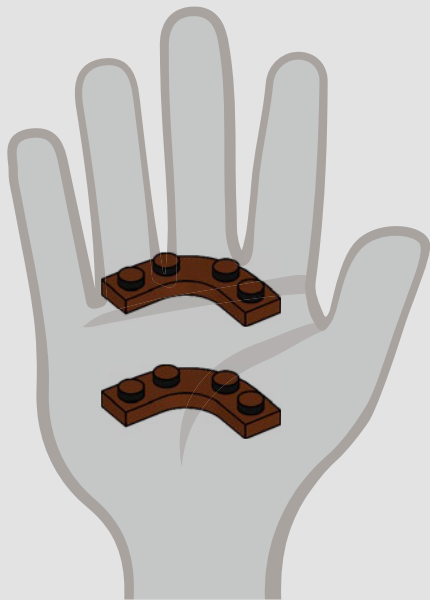

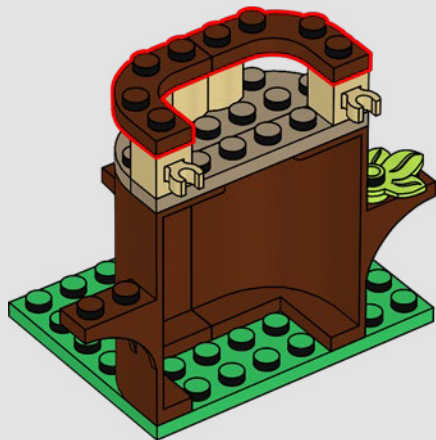

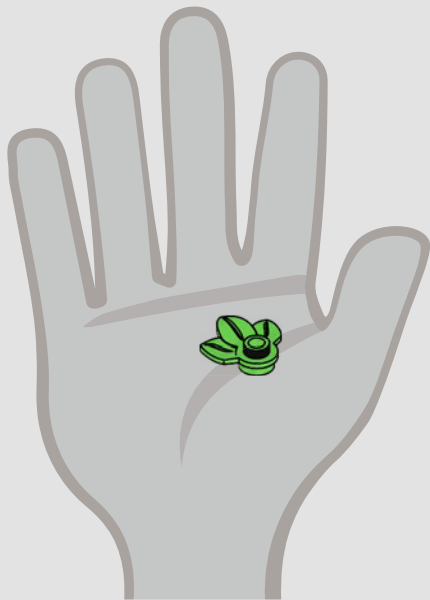

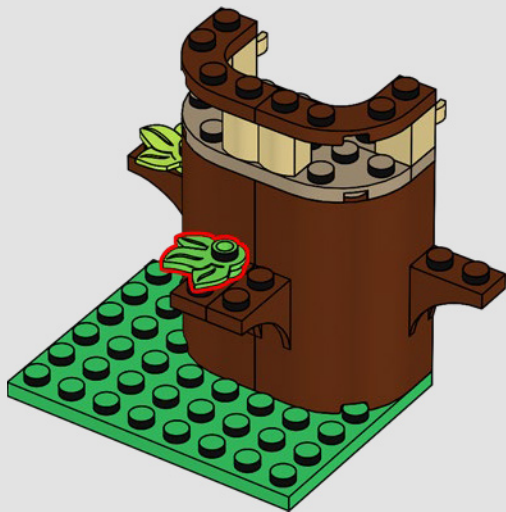



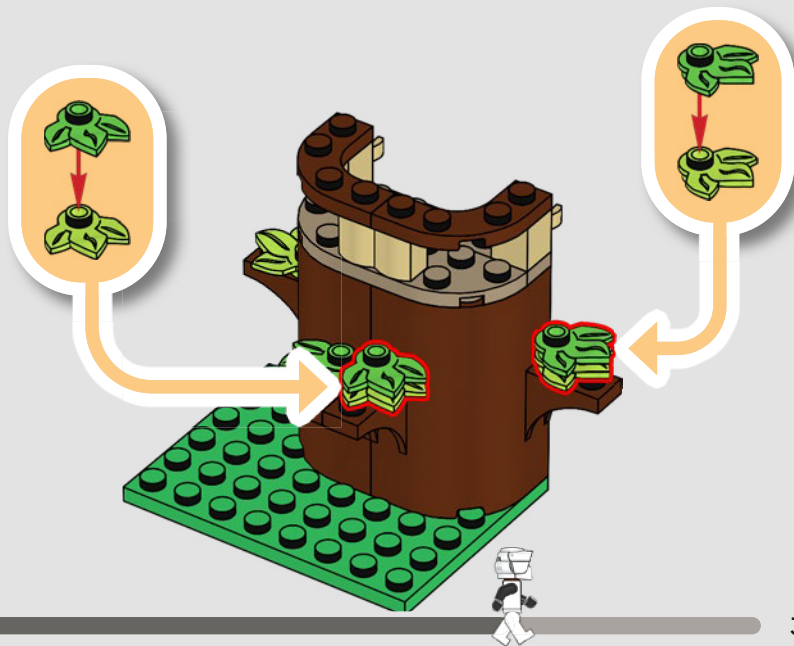

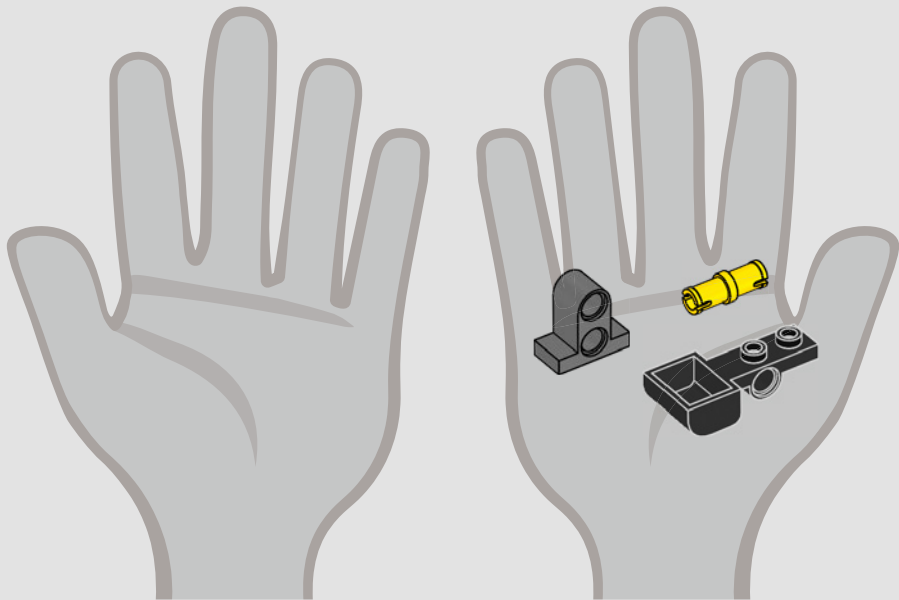

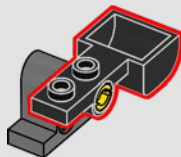
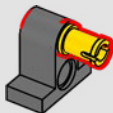

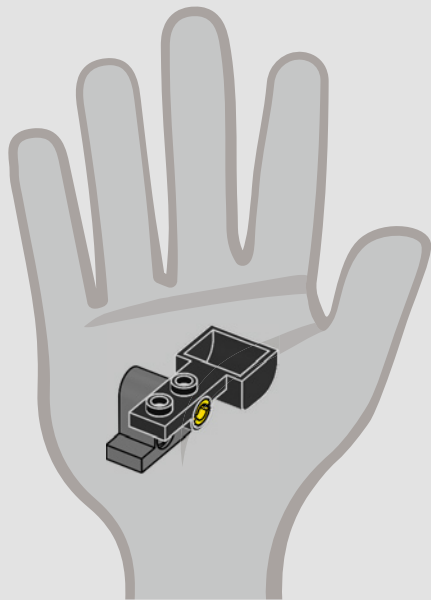

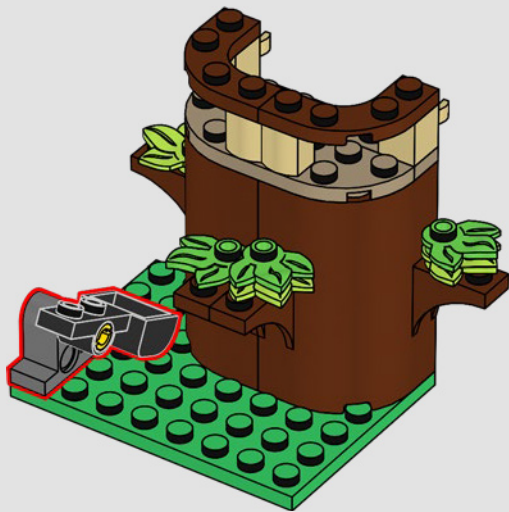

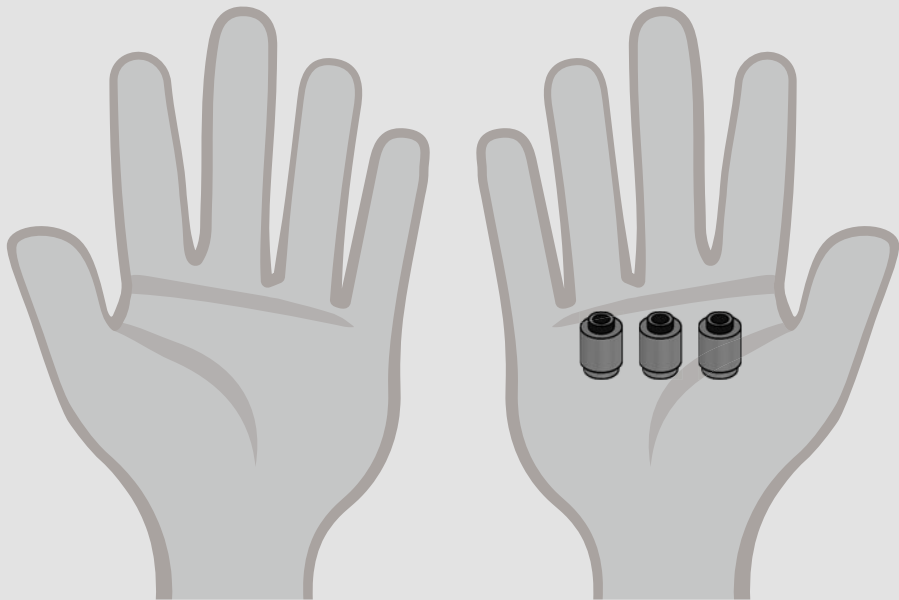



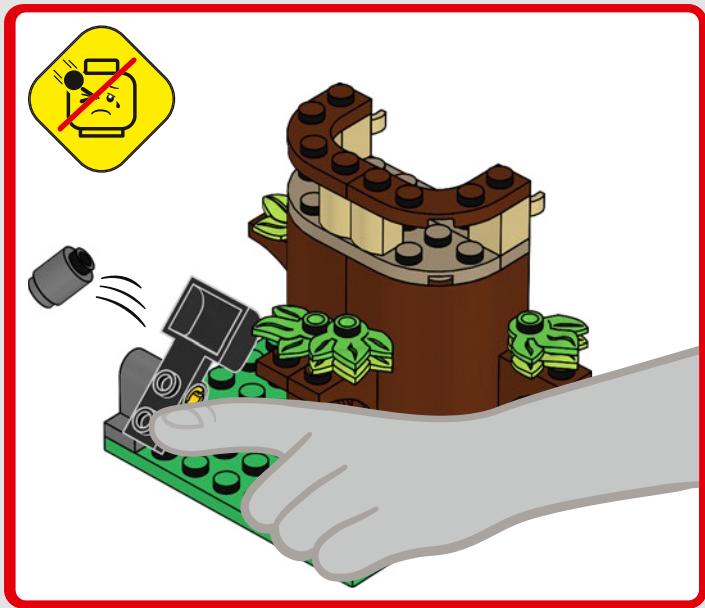

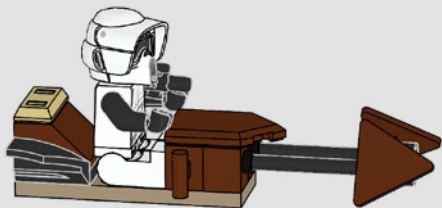





STAR WARS



75335



75333



75332



75336



75323



75337



75338



75334



STAR WARS



75337

© & ™ Lucasfilm Ltd.



75323



75343



STAR WARS



75333



75336



75334



LEGO and the LEGO logo are trademarks of the LEGO Group.
©2022 The LEGO Group. 6431116
© & ™ Lucasfilm Ltd.

Rebuild
the
world™

