



STAR
WARS™

75341



Disney

Booklet available in English on
Livret disponible en français sur
Folleto disponible en español en

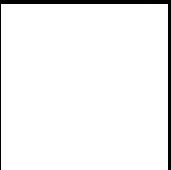

INTRODUCED BY POPULAR DEMAND

We are beyond excited to present the first ever LEGO® Star Wars™ Ultimate Collector Series version of Luke Skywalker's X-34 Landspeeder.

Speeders are a familiar sight throughout the *Star Wars* galaxy, and Luke's X-34 model is the first we encounter in *A New Hope*. Our team has seen so many great fan-built LEGO landspeeders over the years. This model has been in high demand for a long time and our designers developed new elements, building techniques and colors to create the most authentic-looking replica possible, right down to the turbine wiring and cockpit details. And, at this scale, it almost feels as if you could just jump right in and speed off on your own galactic adventures!



Enjoy building!

A stylized, handwritten signature in black ink.

Jens Kronvold Frederiksen

Design Director & Creative Lead,
LEGO® Star Wars™

LANCÉ À LA DEMANDE GÉNÉRALE

Nous sommes emballés à l'idée de présenter la toute première version du Landspeeder X-34 de Luke Skywalker de la série de collection suprême LEGO® *Star Wars*™.

Les speeders sont monnaie courante dans la galaxie *Star Wars*, et le modèle X-34 de Luke est le premier que nous découvrons dans *Un nouvel espoir*. Notre équipe a vu tant de superbes landspeeders LEGO construits par des passionnés de la saga au fil des ans. Ce modèle est attendu depuis longtemps, et nos concepteurs ont développé de nouveaux éléments ainsi que de nouvelles techniques de construction et couleurs pour créer la réplique la plus authentique possible, jusqu'au câblage de la turbine et aux détails de l'habitacle. Et, à cette échelle, on a presque l'impression de pouvoir sauter à bord et filer à toute vitesse vers ses propres aventures galactiques !

Bonne construction !



Jens Kronvold Frederiksen
Directeur de la création,
LEGO® *Star Wars*™

PORQUE EL PÚBLICO LO PIDIÓ...

Estamos más que emocionados de presentar la primera versión LEGO® *Star Wars*™ Ultimate Collector Series del landspeeder X-34 de Luke Skywalker.

Es muy común encontrar speeders por toda la galaxia de *Star Wars*, y el modelo X-34 de Luke es el primero que aparece en *Una Nueva Esperanza*. Nuestro equipo ha visto una gran cantidad de fantásticos landspeeders LEGO construidos por fans a lo largo de muchos años. Por un largo tiempo, el público ha solicitado con insistencia este modelo. Nuestros diseñadores desarrollaron nuevos elementos, técnicas de construcción y colores para crear la réplica más auténtica posible, llegando a recrear incluso el cableado de las turbinas y detalles de la cabina. Y, con semejante escala, ¡casi podríamos pensar en subir al vehículo y lanzarnos a toda velocidad a vivir nuestras propias aventuras galácticas!

¡Que disfrutes la construcción!



Jens Kronvold Frederiksen
Director creativo,
LEGO® *Star Wars*™

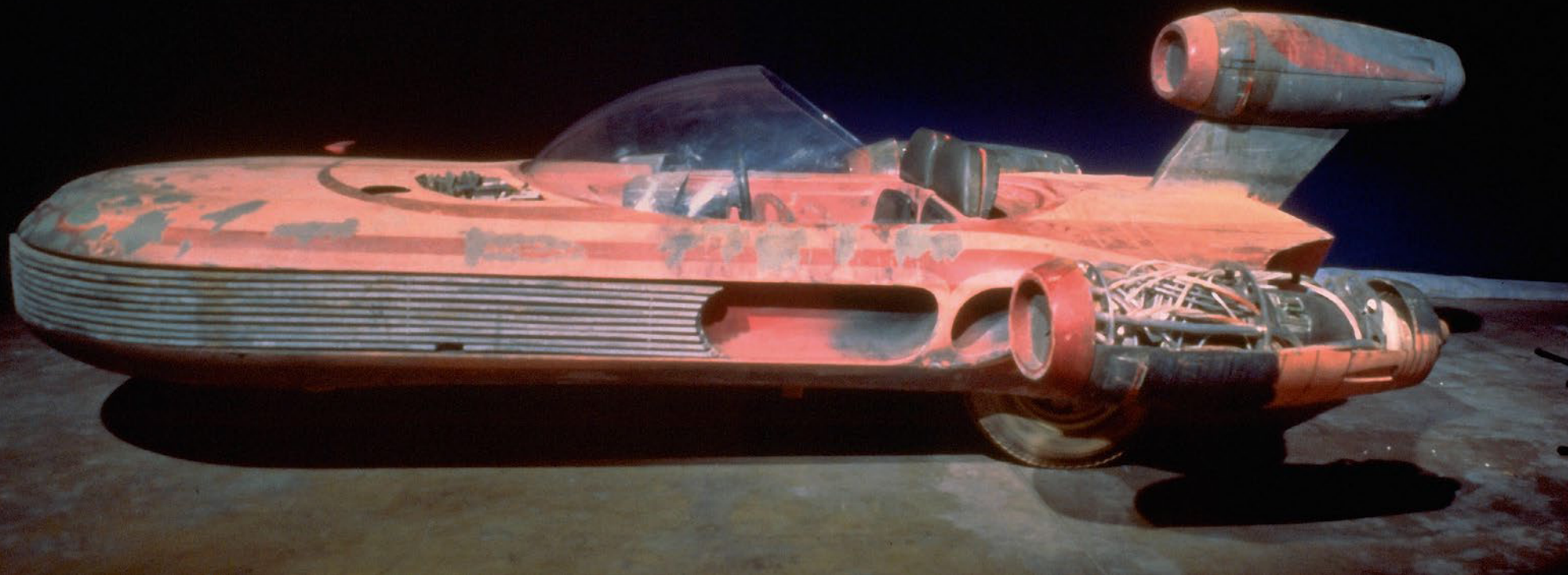

*Movie prop model
Modèle accessoire
Modelo de utilería de la película*

**“LOOK AT THIS.
EVER SINCE THE
XP-38 CAME OUT,
THEY JUST AREN’T
IN DEMAND.”**

While Luke’s speeder is in high demand in this galaxy, we can see why his old sand- and sun-beaten version might be a tough sell on Tatooine, with newer models available on the market. It clearly has more than a few kilometers on its repulsor lift engine, and the missing port turbine cowling might leave the air-cooled thrust turbines vulnerable to Tatooine sandstorms. Fortunately, the sketchy traders in Mos Eisley seem willing to buy anything that moves, and even things that don’t. And, as Luke’s main source of transportation between his home and the Tosche

Station and Anchorhead outposts, his speeder is at least in decent working condition. With the Lars homestead burned to the ground, Luke has no qualms about selling it if it can get him enough cash to hitch a ride to Alderaan with Obi-Wan Kenobi.

Different X-34 Landspeeder models were created for the production of *A New Hope*. A life-size prop version was based on a car the actors could drive. A smaller scale model was used for special effects.

« C'EST LAMENTABLE. DEPUIS QUE LE XP-38 EST SORTI, MON SPEEDER NE VAUT PLUS RIEN. »

Alors que le speeder de Luke est très convoité dans cette galaxie, on peut comprendre pourquoi sa vieille version, rongée par le sable et le soleil, pourrait être difficile à vendre sur Tatooine, où des modèles plus récents sont disponibles sur le marché. Il a manifestement parcouru bien des kilomètres avec son moteur à répulsion, et l'absence du capot de la turbine bâbord pourrait rendre les turbines de poussée refroidies par air vulnérables aux tempêtes de sable de Tatooine. Heureusement, les commerçants de Mos Eisley semblent prêts à acheter tout ce qui bouge, et même ce qui ne bouge pas. Et, en tant que principal moyen de transport de Luke entre sa

“MIRA ESTO. DESDE QUE SALIÓ EL XP-38, NADIE LOS QUIERE”

Si bien hay una alta demanda de speeders como el de Luke en esta galaxia, podemos ver que su unidad, bastante desgastada por el sol y la arena, podría ser difícil de vender en Tatooine, especialmente cuando hay modelos nuevos en el mercado. Es evidente que su motor de repulsión ha recorrido muchísimos kilómetros, y las turbinas de impulso enfriadas por aire podrían sufrir daños en las tormentas de arena de Tatooine sin la protección de la cubierta de babor. Por fortuna, los desinformados comerciantes de Mos Eisley parecen dispuestos a comprar cualquier cosa que se mueva, incluso las que no lo hacen. Considerando que es el principal medio que utiliza Luke para trasladarse

maison et les avant-postes de la station Tosche et d'Anchorhead, le speeder est au moins en bon état de marche. La ferme des Lars ayant été réduite en cendres, Luke n'a aucun remord à vendre son speeder si cela lui permet d'avoir assez d'argent pour atteindre Alderaan en compagnie d'Obi-Wan Kenobi.

Différents modèles de Landspeeder X-34 ont été créés pour la production de *Un nouvel espoir*. Une version grandeur nature servant d'accessoire était basée sur une voiture que les acteurs pouvaient conduire. Un modèle à plus petite échelle a été utilisé pour les effets spéciaux.

entre su hogar, la Estación Tosche y la ciudad de Anchorhead, su speeder se encuentra en condiciones lo suficientemente buenas como para funcionar. Y con la vivienda de Lars calcinada hasta los cimientos, Luke no tiene inconveniente en venderlo si puede obtener el dinero suficiente para ir a Alderaan en compañía de Obi-Wan Kenobi.

Se fabricaron diferentes modelos del landspeeder X-34 para la grabación de *Una Nueva Esperanza*. Había una versión de utilería a escala real que los actores podían conducir construida a partir de un auto. Se utilizó un modelo a una escala menor para los efectos especiales.



© & ™ Lucasfilm Ltd.

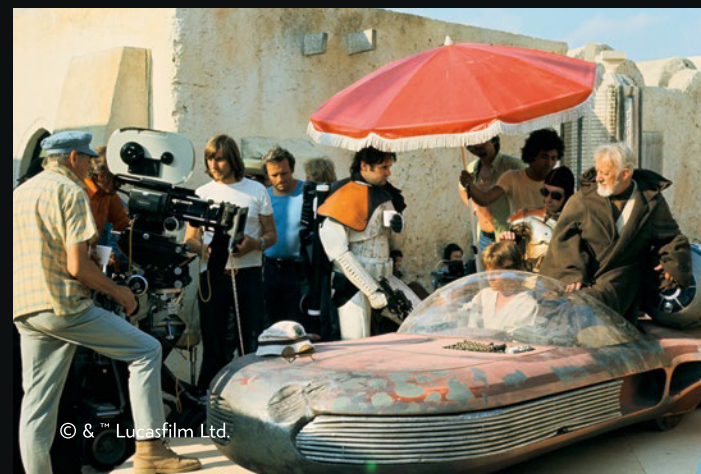

© & ™ Lucasfilm Ltd.



© & ™ Lucasfilm Ltd.

MEET THE MODEL DESIGNER

César Carvalhosa Soares
LEGO® Star Wars™ Designer



Luke's X-34 Landspeeder is one of the most recognizable vehicles in the *Star Wars*™ universe. It is with the landspeeder that Luke, Obi-Wan Kenobi, C-3PO and R2-D2 travel to Mos Eisley, where they meet Han Solo and Chewbacca for the first time and the adventure really begins!

As a *Star Wars* superfan, I was thrilled to bring the speeder to life, and this scale allowed us to add a bunch of super cool details, new elements and fun new building techniques. The big windshield, vital for protecting the speeder's driver and passenger from the intense Tatooine winds, is a new element designed specifically for this model. The first iteration of the speeder had a sand color scheme, but the nougat color gave it a much more realistically weather-beaten look. In the movie, the speeder has a powerful thruster that lets it travel at great speed, hovering up to 1 meter (just over 3 feet) above ground. I hope this model will look great "hovering" above your shelf or desk!

César Carvalhosa Soares
LEGO® *Star Wars*™ Designer

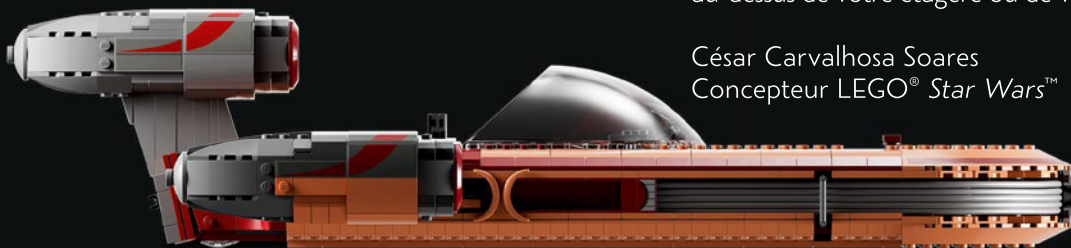

RENCONTRE AVEC LE CONCEPTEUR DU MODÈLE

Le Landspeeder X-34 de Luke est l'un des véhicules les plus reconnaissables de l'univers *Star Wars*™. C'est à bord du landspeeder que Luke, Obi-Wan Kenobi, C-3PO et R2-D2 se rendent à Mos Eisley, où ils rencontrent Han Solo et Chewbacca pour la première fois et où l'aventure prend son envol !

En tant que grand amateur de *Star Wars*, j'ai été ravi de donner vie au speeder, et cette échelle nous a permis d'ajouter une pléthore de détails, de nouveaux éléments et de nouvelles techniques de construction amusantes. Le grand pare-brise, indispensable pour protéger le pilote et le passager du speeder des vents intenses de Tatooine, est un nouvel élément conçu spécifiquement pour ce modèle. La première version du speeder avait une couleur sable, mais la couleur nougat lui donne un aspect beaucoup plus réaliste et usé par le temps. Dans le film, le speeder est équipé d'un puissant propulseur qui lui permet de se déplacer à grande vitesse, lévitant jusqu'à 1 mètre au-dessus du sol. J'espère que ce modèle aura fière allure « en lévitation » au-dessus de votre étagère ou de votre bureau !

César Carvalhosa Soares
Concepteur LEGO® *Star Wars*™

CONOCE AL DISEÑADOR DEL MODELO

El landspeeder X-34 de Luke es uno de los vehículos más icónicos del universo *Star Wars*™. Este es el landspeeder en el que Luke, Obi-Wan Kenobi, C-3PO y R2-D2 viajan a Mos Eisley, donde conocen a Han Solo y Chewbacca por primera vez, ¡y donde la aventura comienza de verdad!

Como superfanático de *Star Wars*, me emocionó muchísimo dar vida al speeder. Su escala nos permitió añadir un montón de detalles supergeniales, nuevos elementos y divertidas técnicas de construcción nunca antes utilizadas. El enorme parabrisas, vital para proteger al conductor y el pasajero del speeder de los intensos vientos de Tatooine, es un nuevo elemento diseñado específicamente para este modelo. La primera iteración del speeder tenía un esquema de colores basado en tonalidades de arena, pero el color caramelo le dio mucho más realismo a su apariencia desgastada por el paso del tiempo y los fenómenos meteorológicos. En la película, el speeder cuenta con un poderoso propulsor que le permite viajar a gran velocidad flotando solo 1 m por encima del suelo. ¡Espero que este modelo se vea genial "flotando" sobre tu estante o escritorio!

César Carvalhosa Soares
Diseñador de LEGO® *Star Wars*™

A SOROSUUB CORPORATION CLASSIC

With large-scale models like this comes the freedom to incorporate more intricate and authentic details.

- The cockpit is fitted with the design features of its movie counterpart, like right-hand driving, stick shift and detailed dashboard and display.
- Each thrust turbine has its own characteristics. The center turbine's distinct color pattern shows signs of multiple repairs with random scrap parts.
- How the port turbine lost its cowling we may never know. Luke is a skilled pilot, but with a maximum speed of 250 km/h (155.3 mph), the speeder has likely seen a mid-air collision or two in its time.
- The display plaque includes technical specifications, a Luke Skywalker minifigure and an all-new C-3PO minifigure unique to this set.

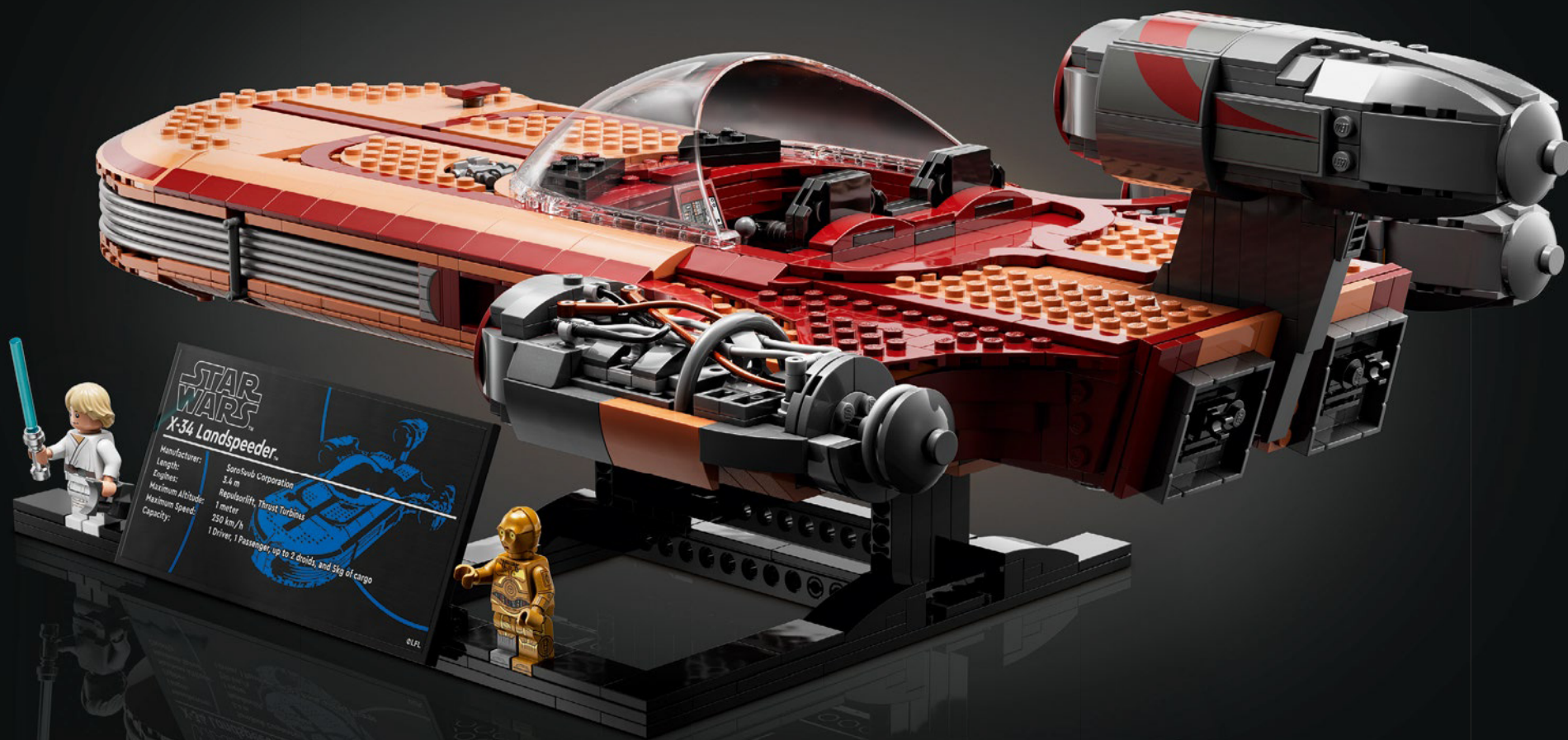

UN CLASSIQUE DE LA CORPORATION SOROSUUB

Avec des modèles à grande échelle comme celui-ci, il est possible d'incorporer des détails plus complexes et plus authentiques.

- L'habitacle reprend les caractéristiques de son homologue cinématographique, comme la conduite à droite, le levier de vitesse, ainsi que le tableau de bord et le système détaillés.
- Chaque turbine de poussée possède ses propres caractéristiques. Les coloris distincts de la turbine centrale montrent des signes de réparations multiples avec des pièces de ferraille aléatoires. Nous ne saurons probablement jamais comment la turbine de bâbord a perdu son capot. Luke est un pilote expérimenté, mais avec une vitesse maximale de 250 km/h, le speeder a probablement une ou deux collisions à son actif.
- Le socle comporte une plaque avec des spécifications techniques, une figurine de Luke Skywalker et une toute nouvelle figurine de C-3PO unique à cet ensemble.



UN CLÁSICO DE SOROSUUB CORPORATION

Los modelos de mayor escala como este nos dan la libertad de incorporar detalles más elaborados y auténticos.

- El diseño de la cabina incorpora las mismas características que tiene su contraparte de la película, como el asiento del conductor a la derecha, la palanca de cambios, un detallado tablero y una pantalla.
- Cada turbina de impulso tiene características propias. El singular patrón de colores de la turbina central muestra signos de múltiples reparaciones con todo tipo de piezas de desecho. Quizá jamás sepamos cómo se perdió la cubierta de la turbina de babor. No obstante que Luke es un piloto muy hábil, el hecho de que tenga una velocidad máxima de 250 km/h hace que sea muy probable que el speeder participara en una o dos colisiones en el aire desde su fabricación.
- La placa de información incluye especificaciones técnicas. También hay una minifigura de Luke Skywalker y una de C-3PO totalmente nueva que no encontrarás en ningún otro set.

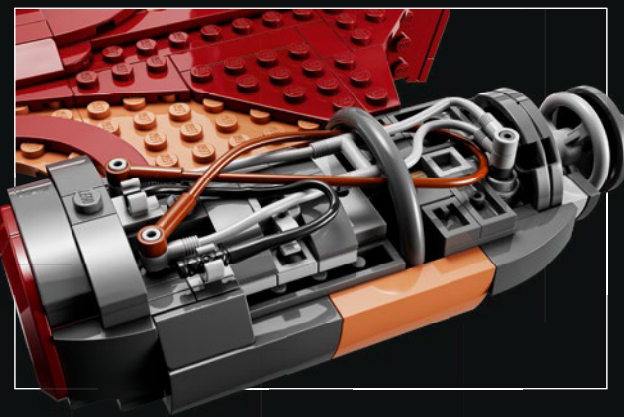

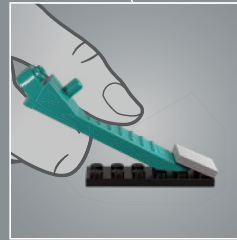
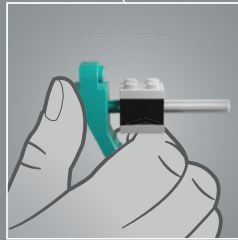
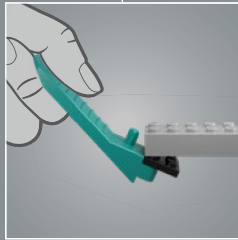
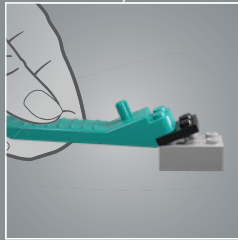
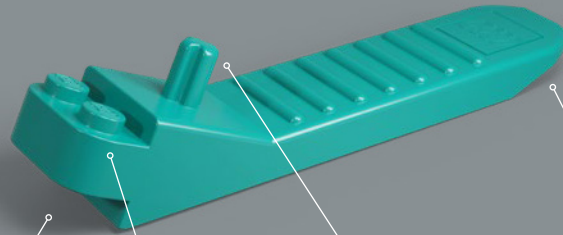

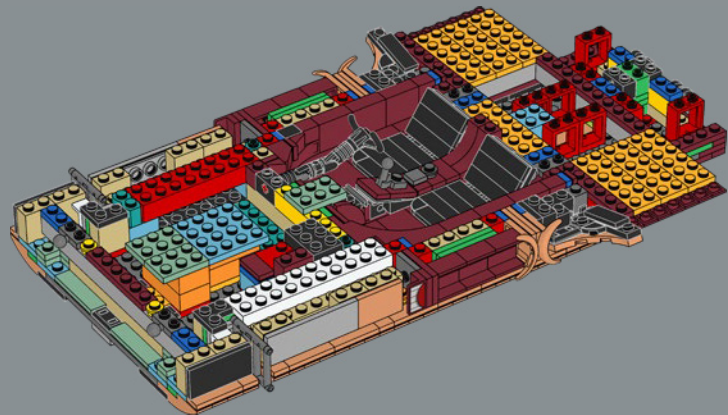
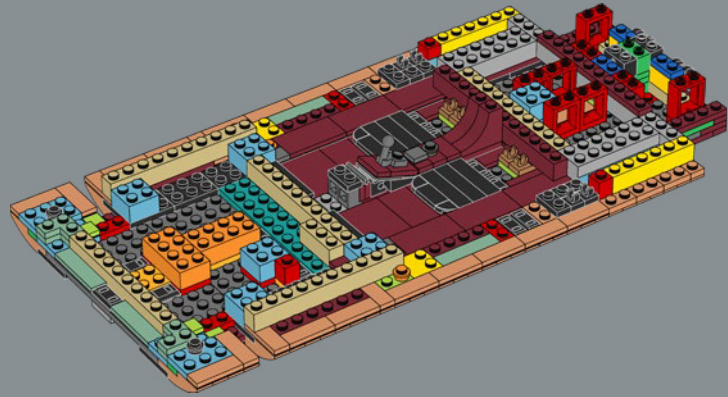
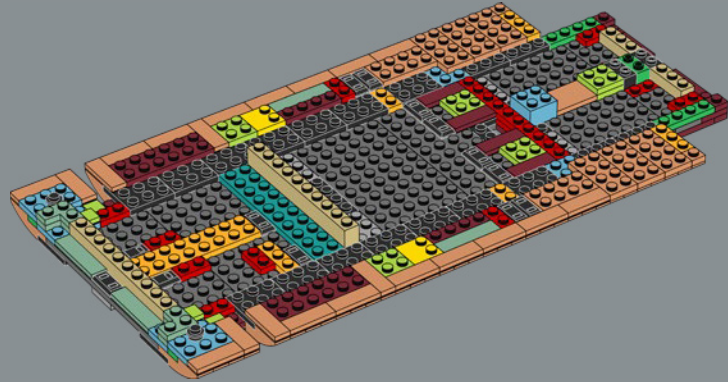

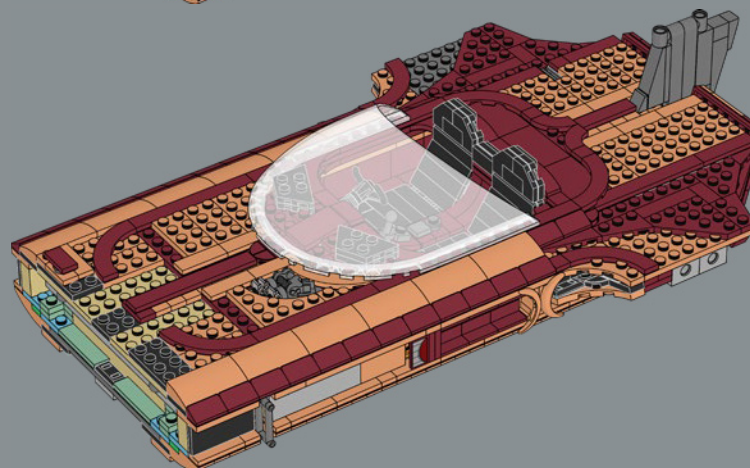
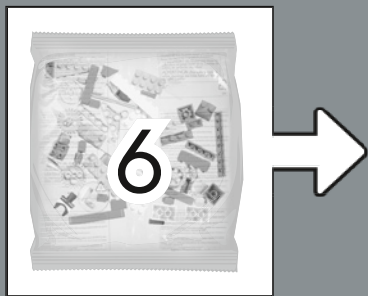
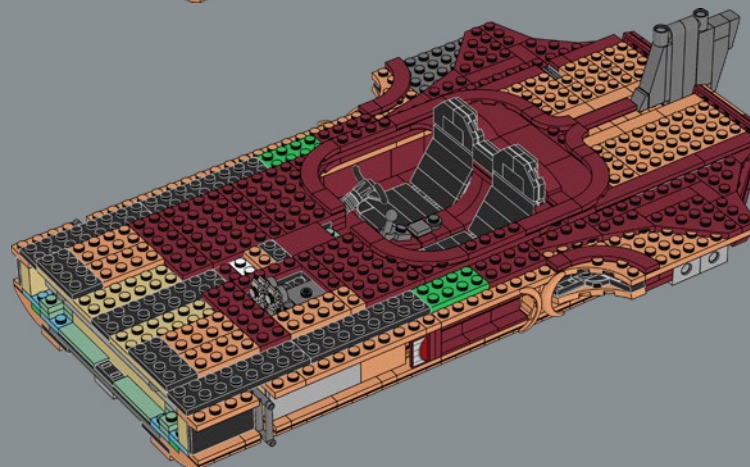
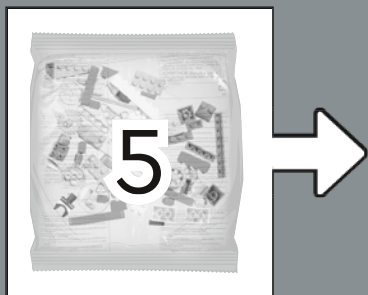
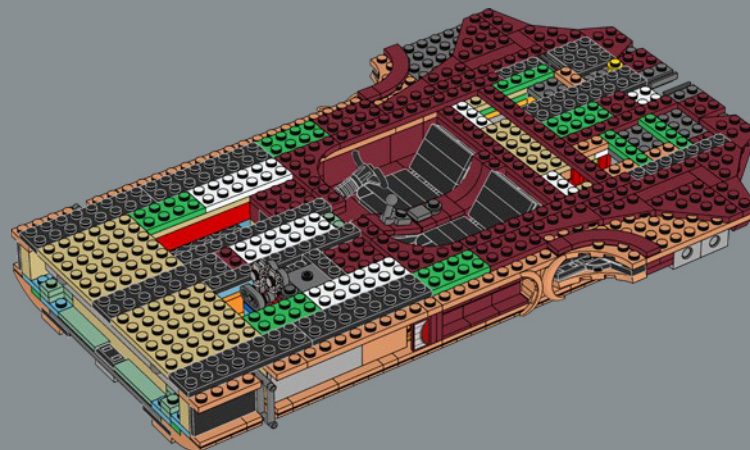
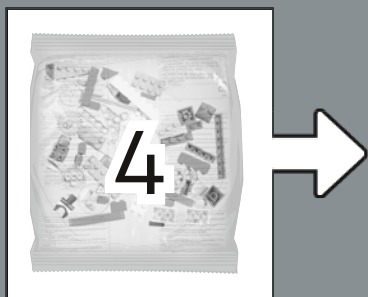

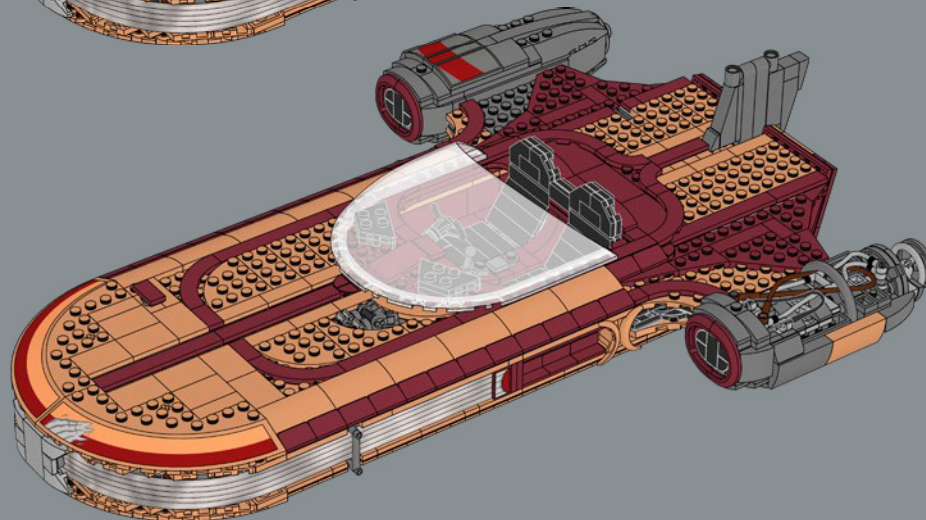
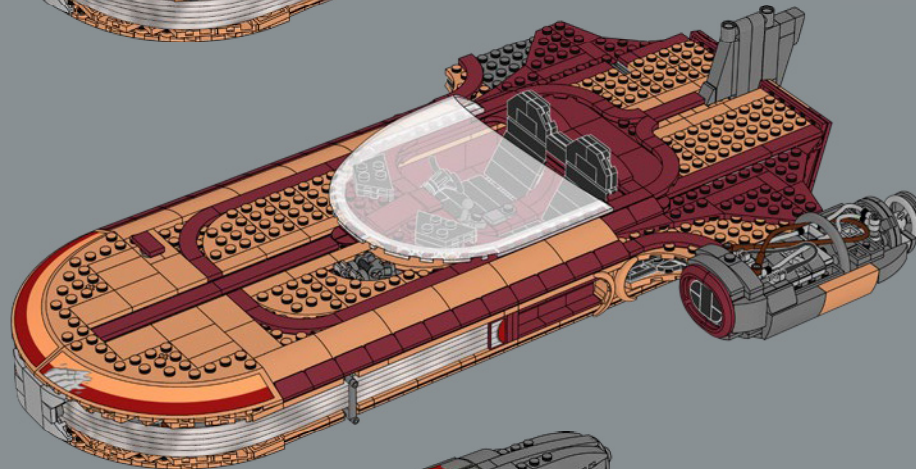
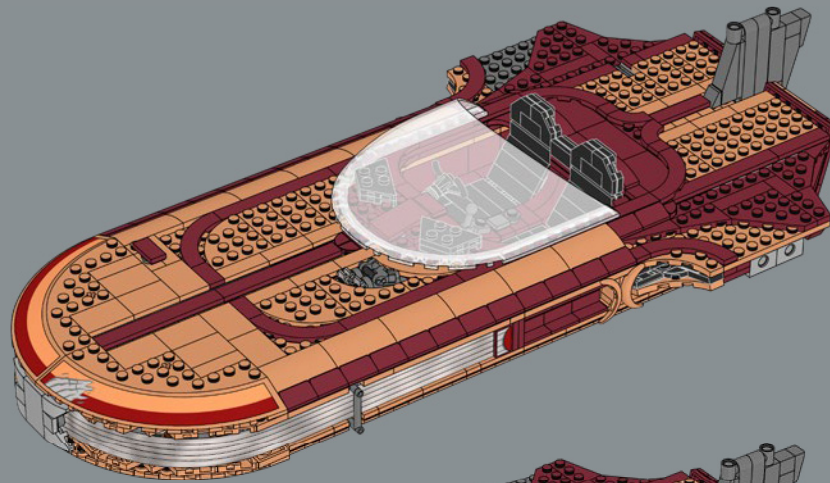

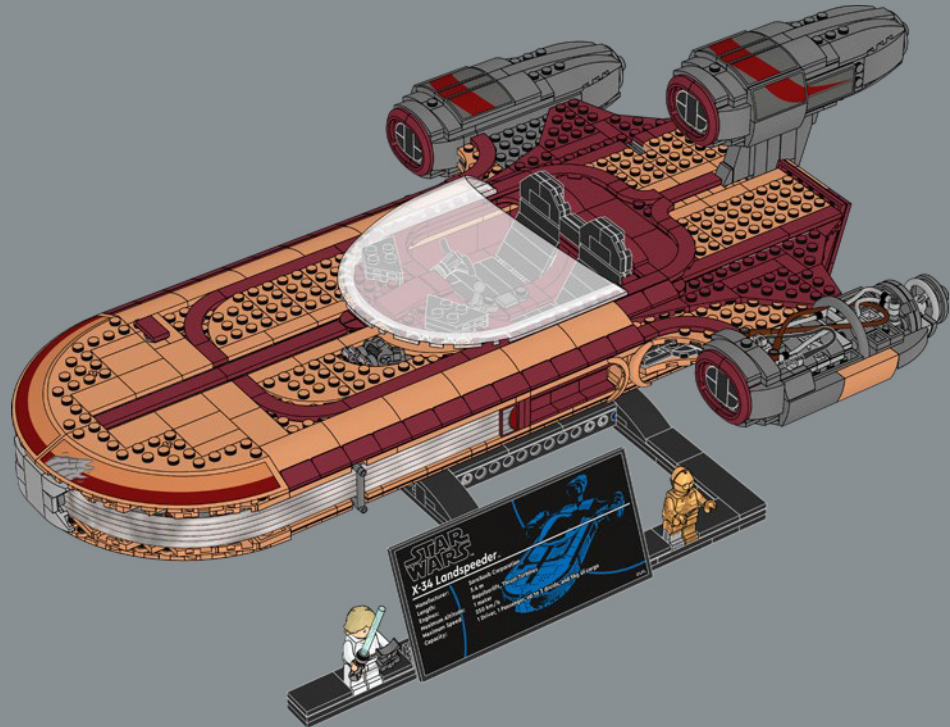
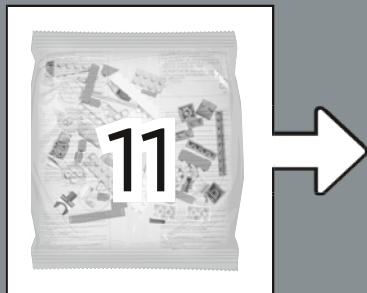
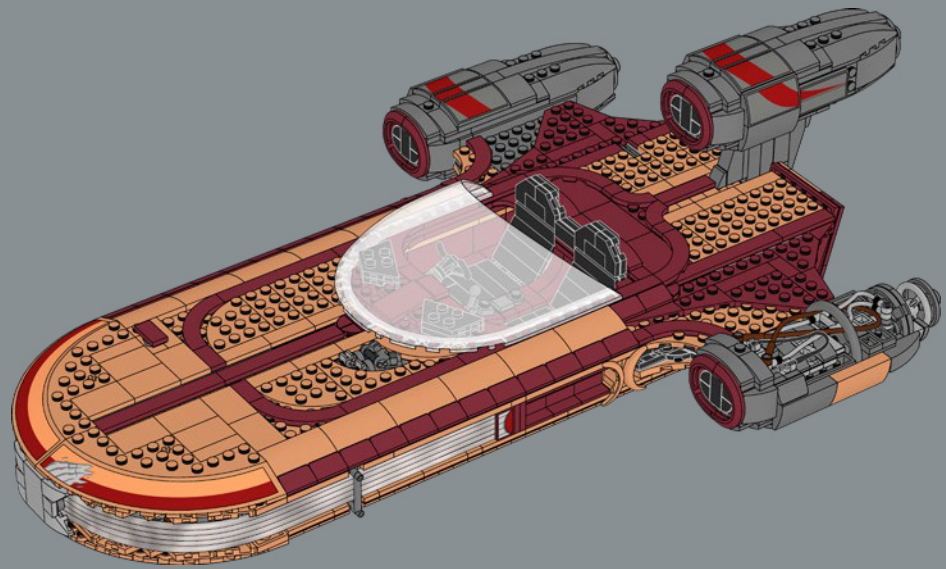
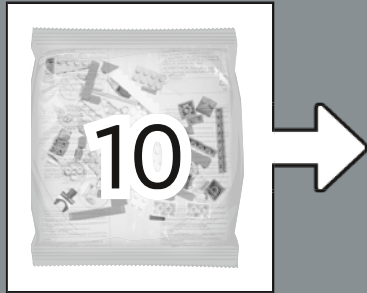

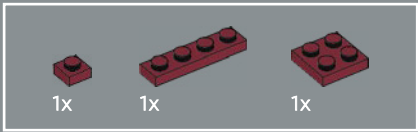

3

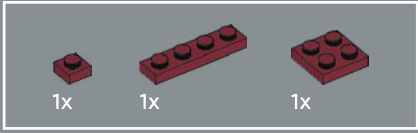
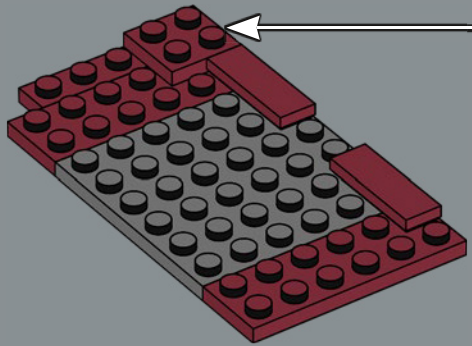
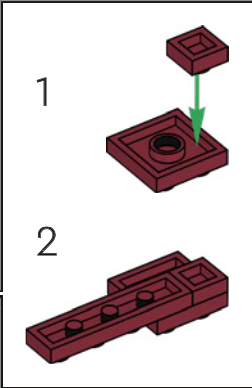

4

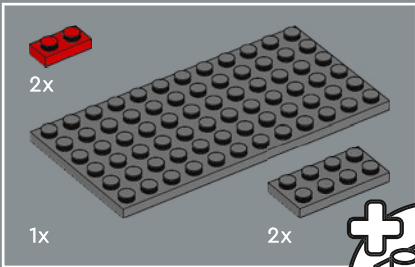
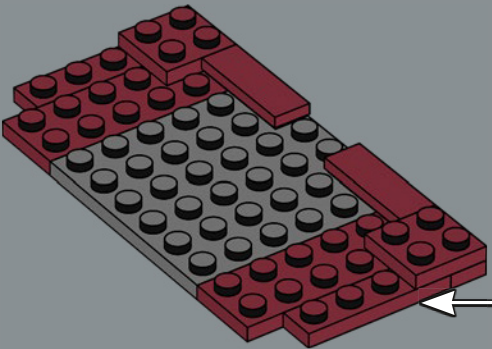
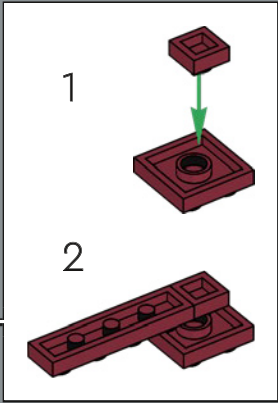

5

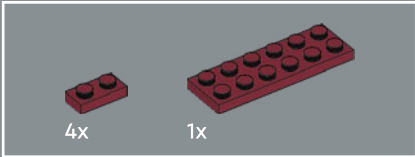
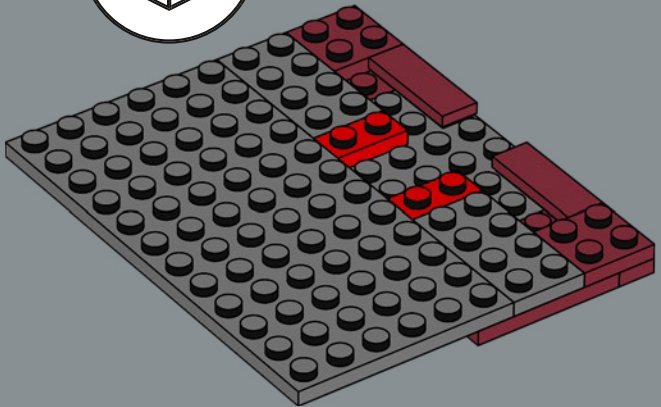
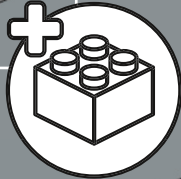

6

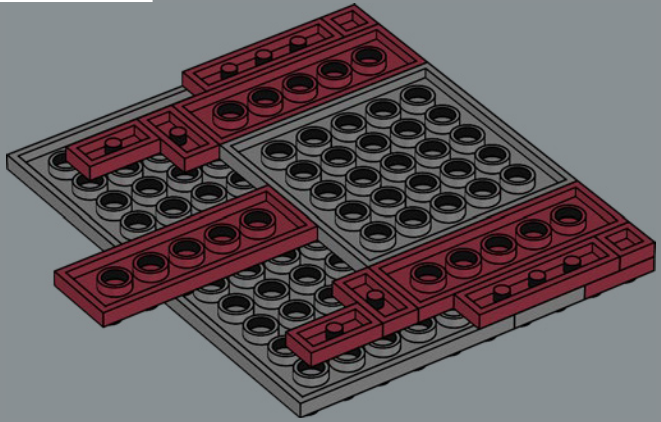

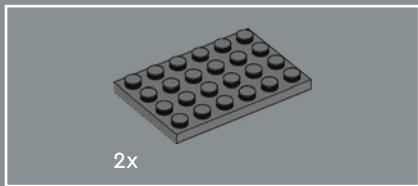

7

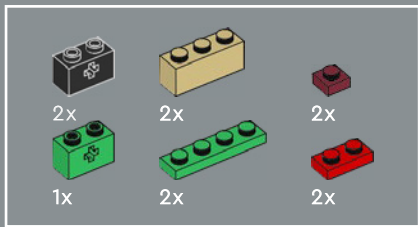
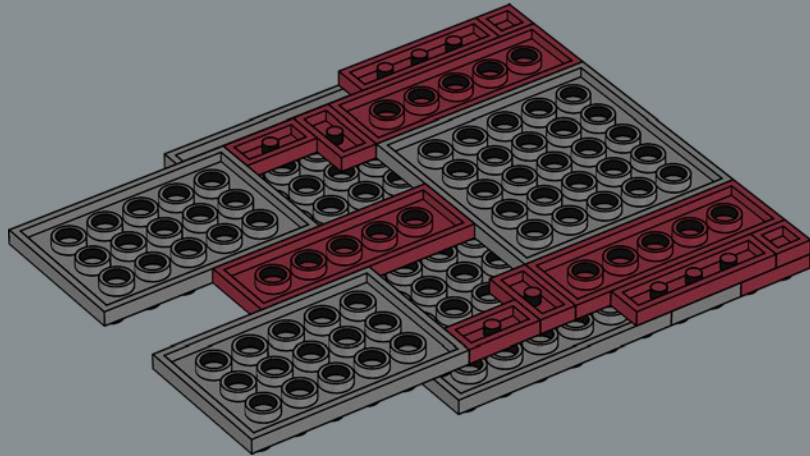

8

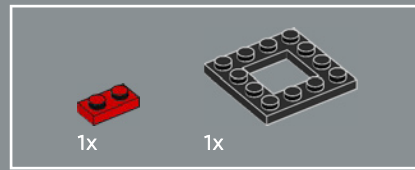
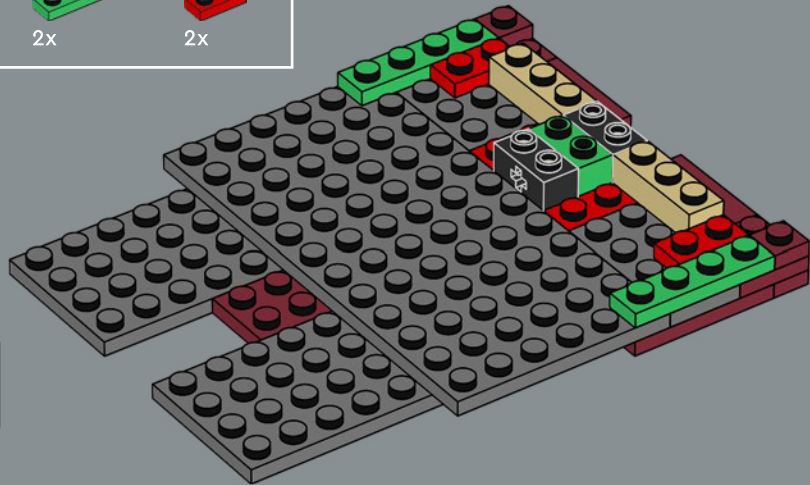

9

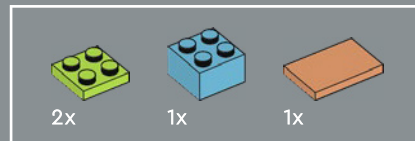
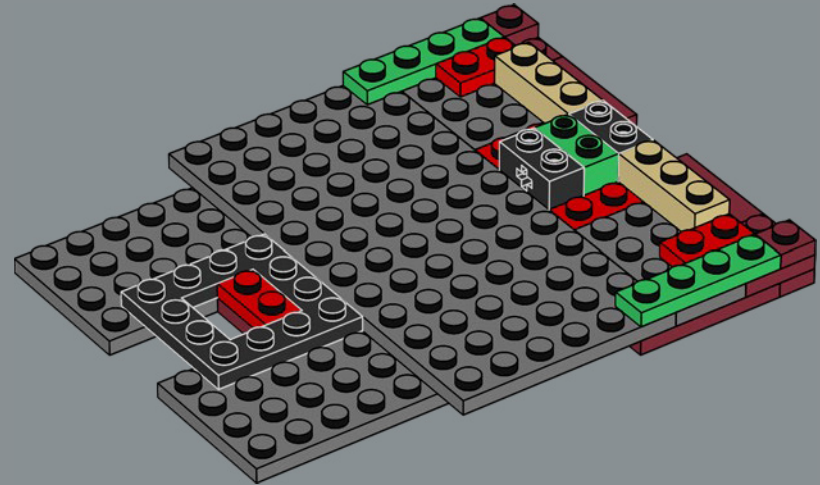

10

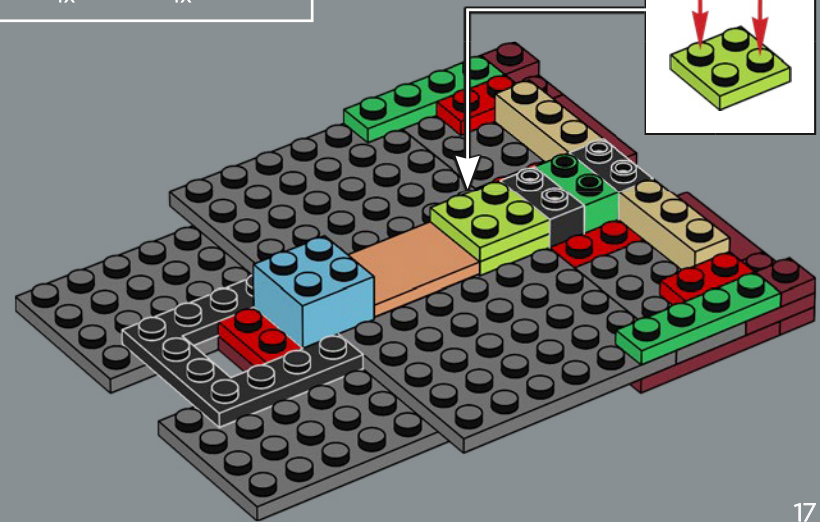

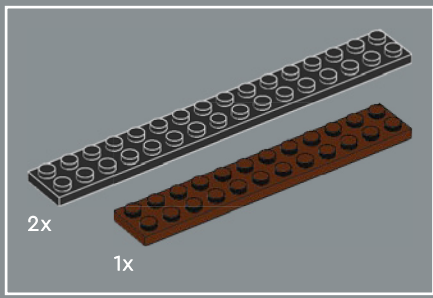

11

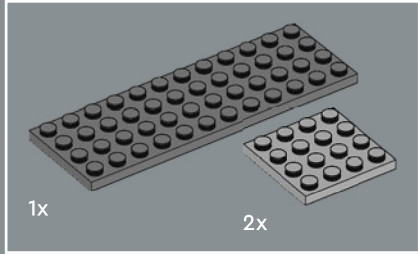
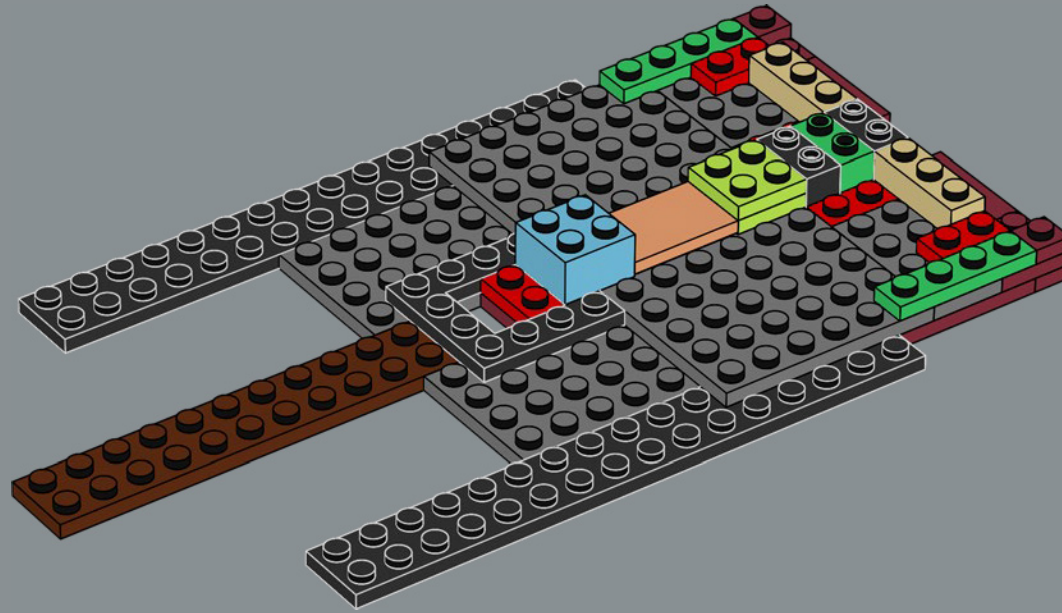

12

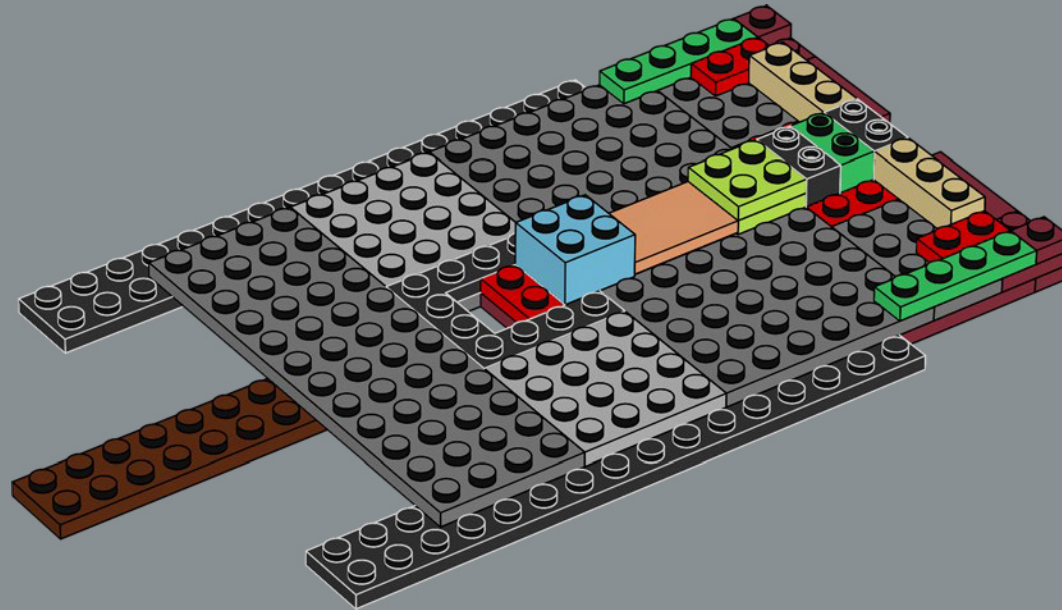

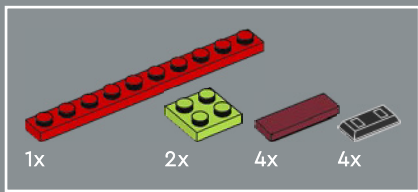

13

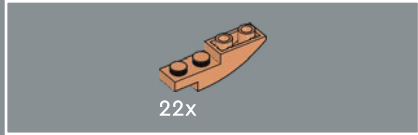
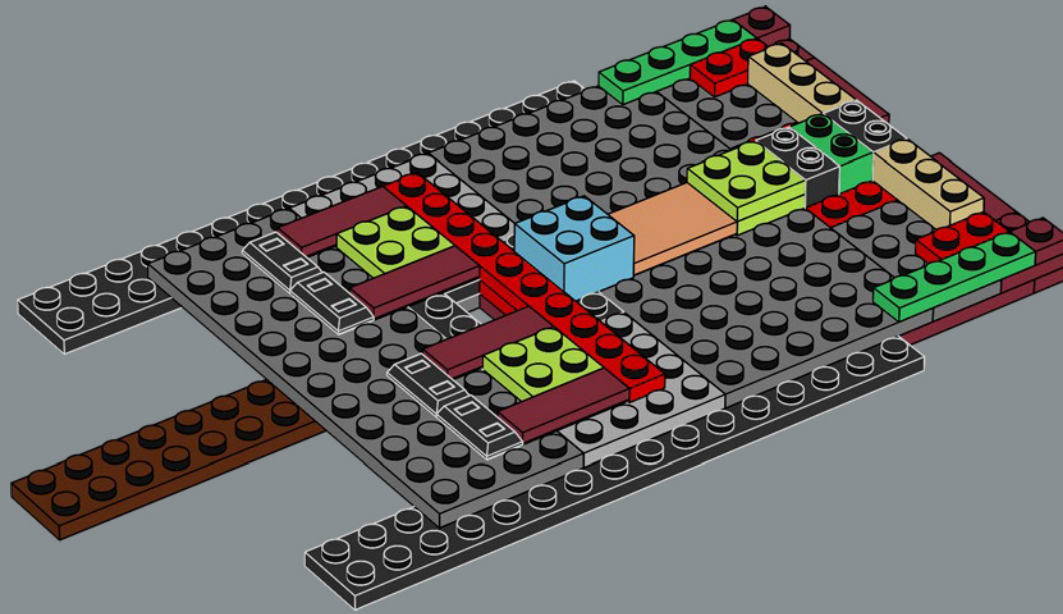

14

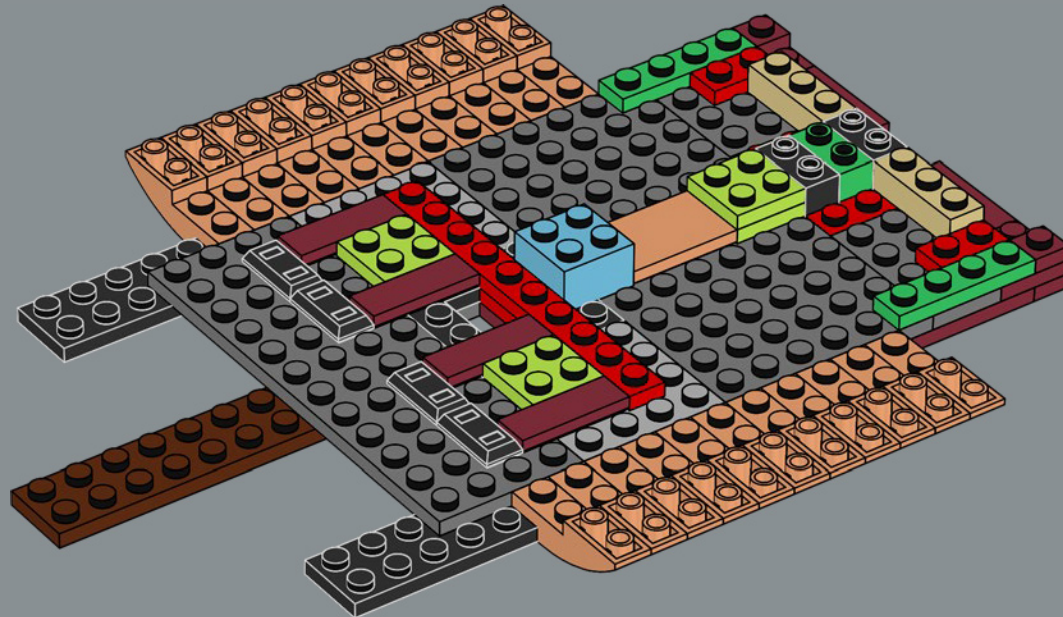

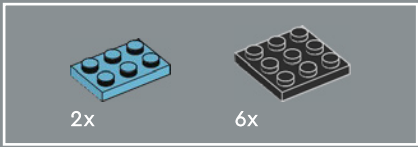

15

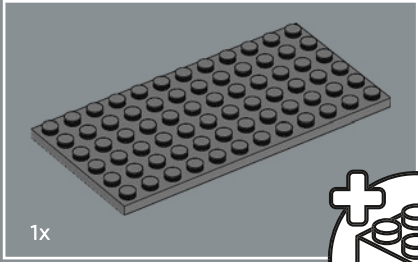
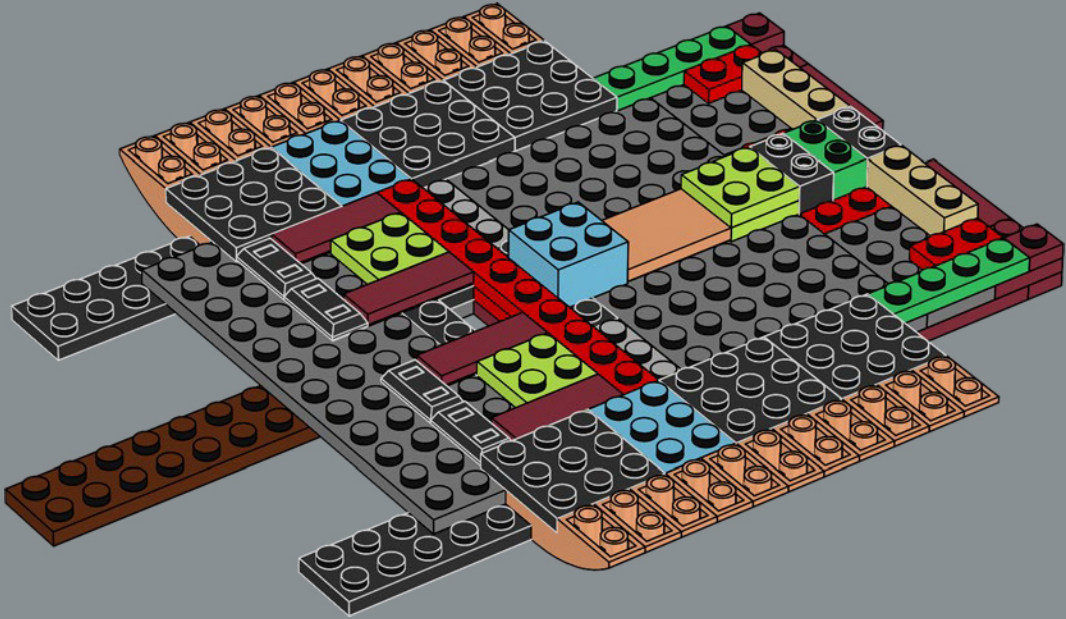

16

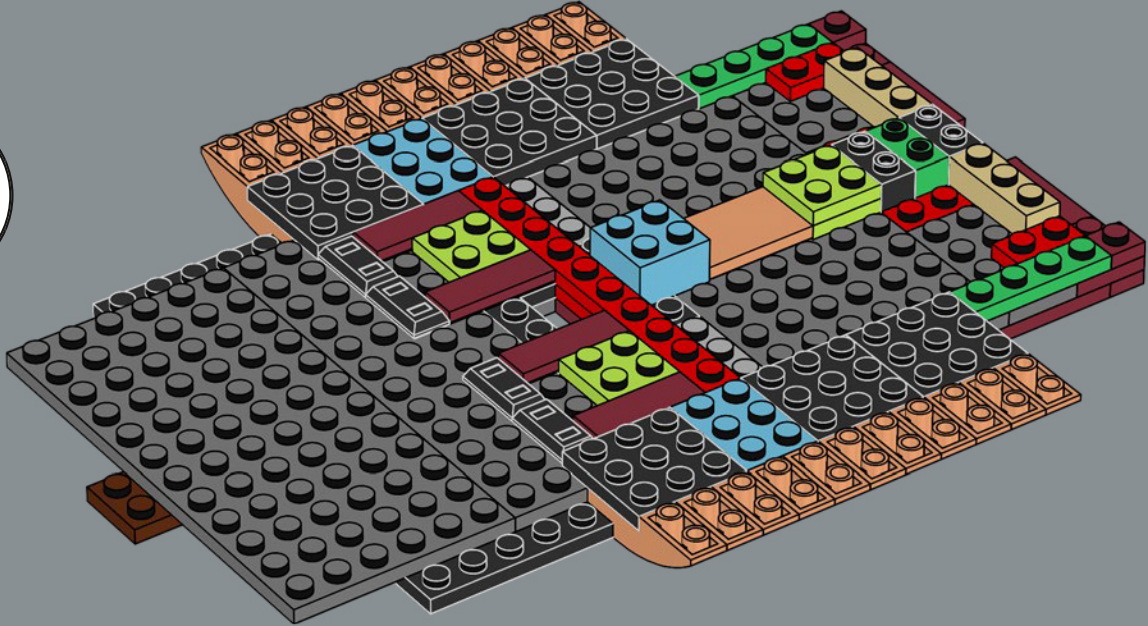
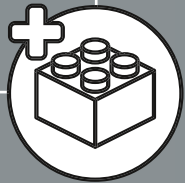

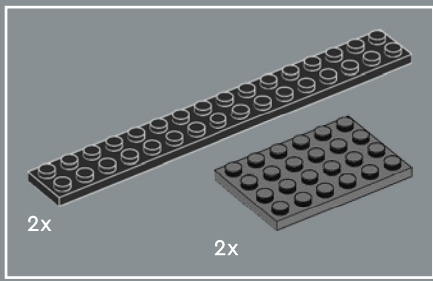

17

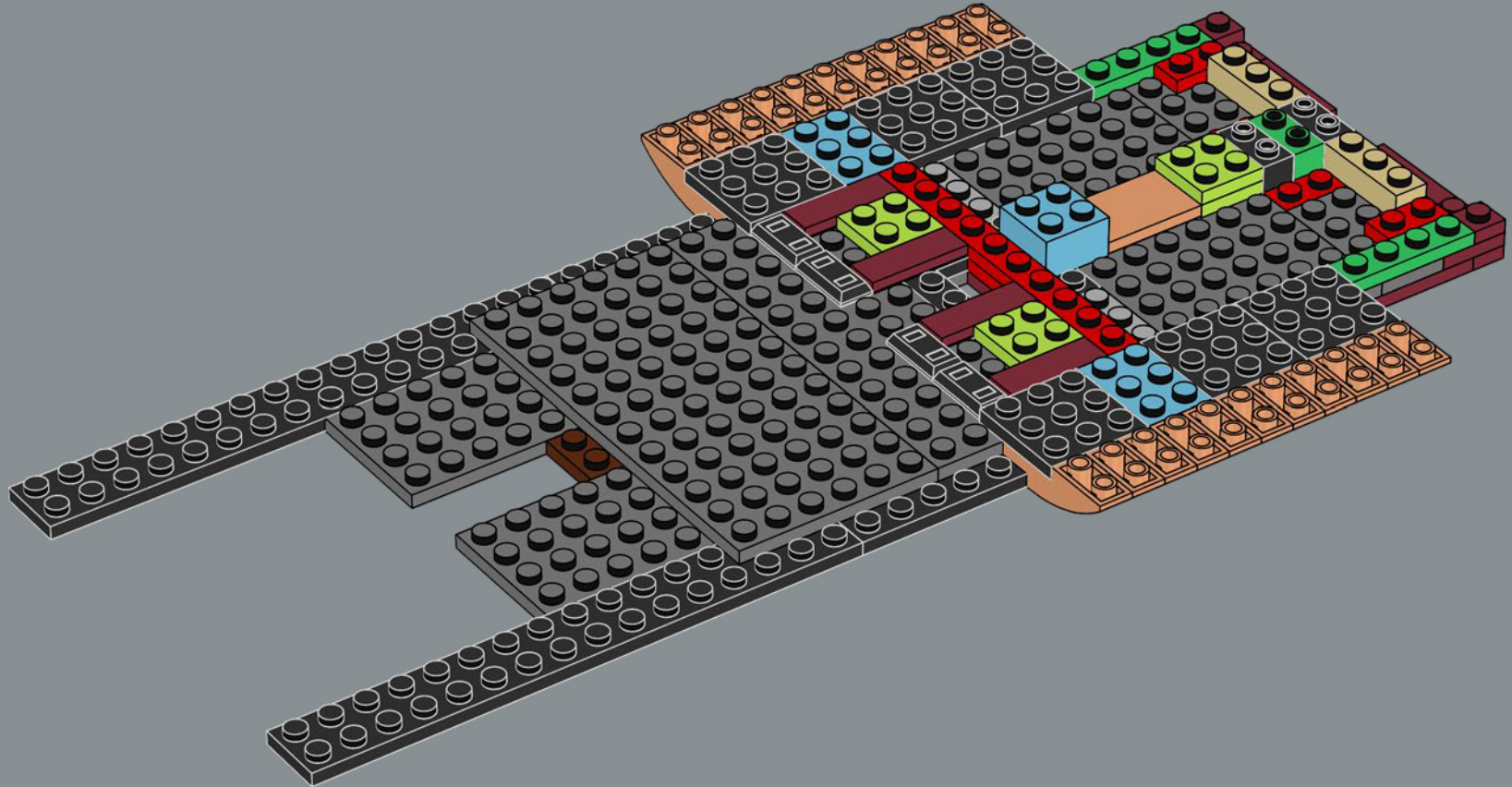

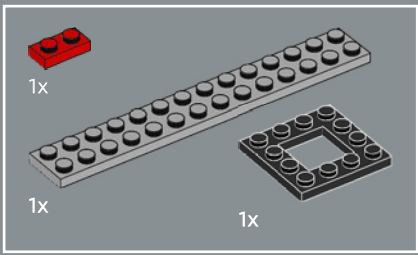

18

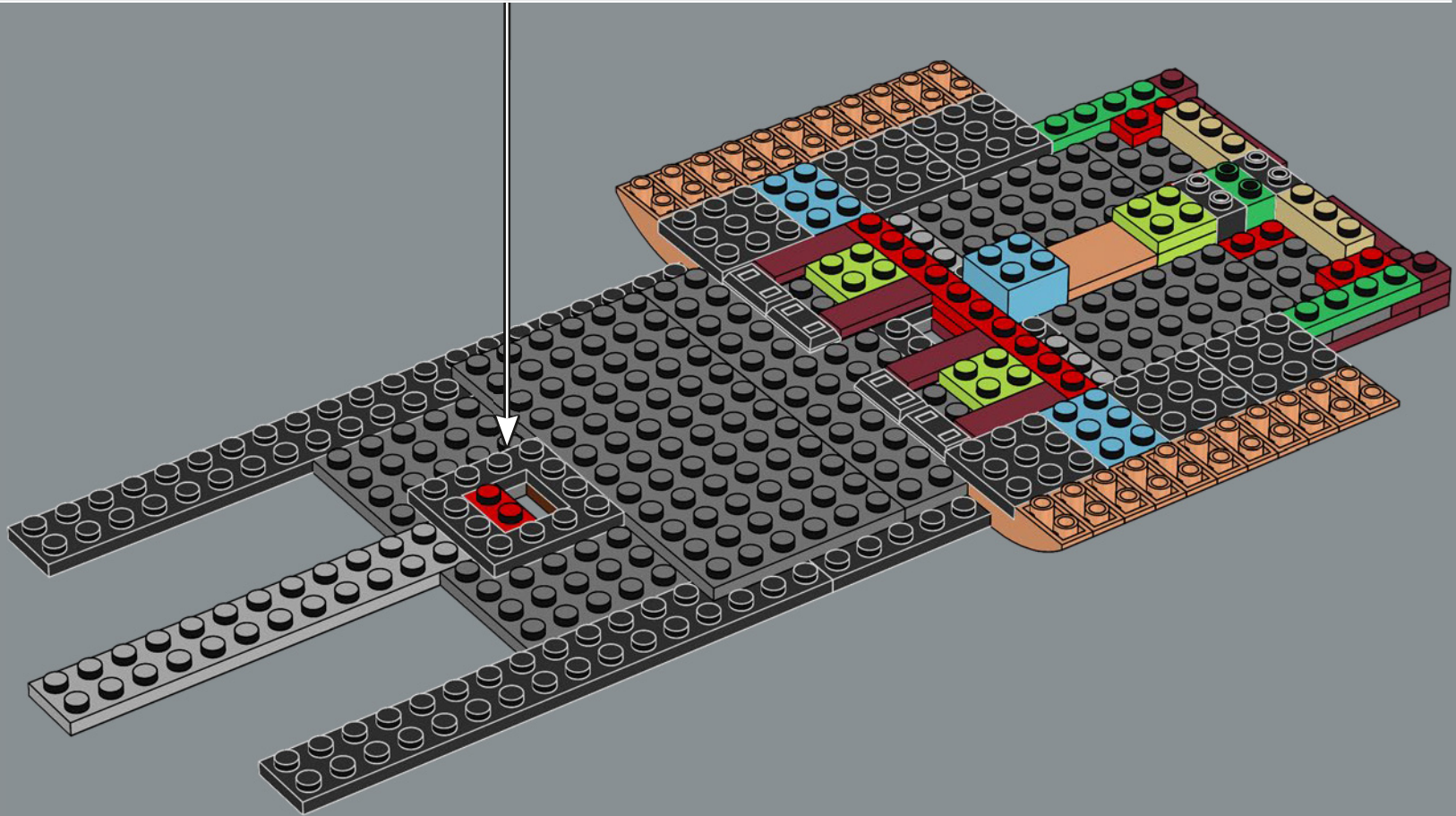
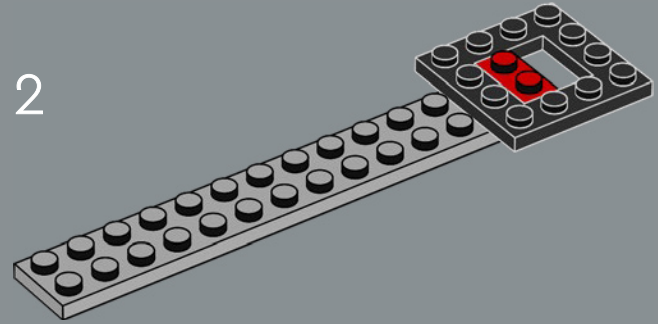
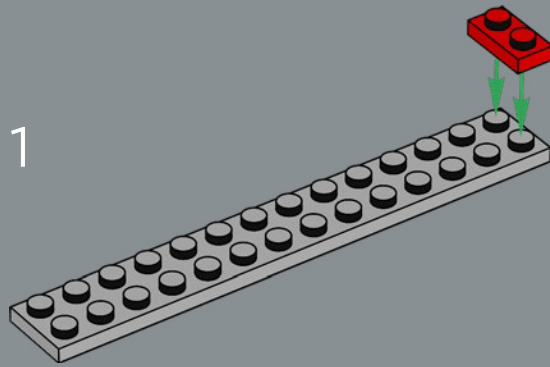

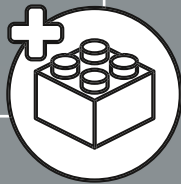
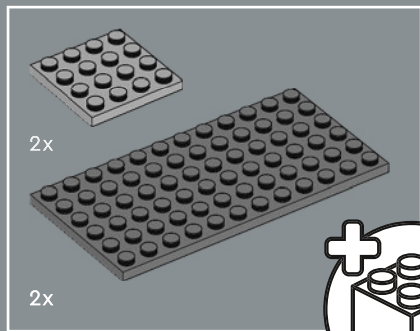

19

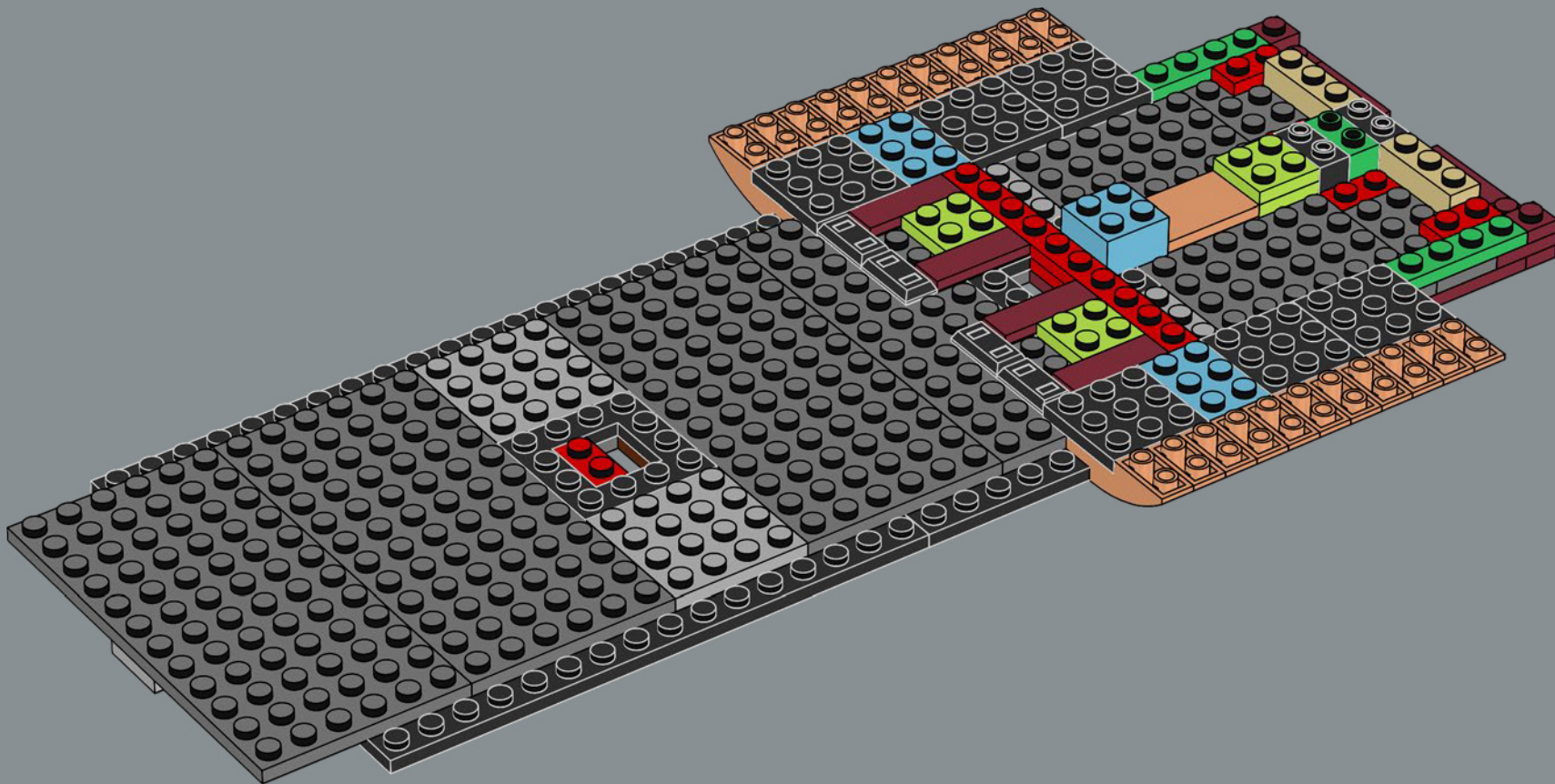

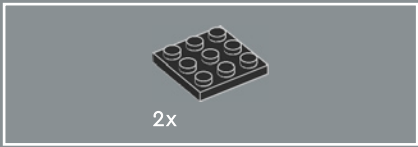

20

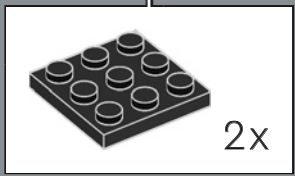
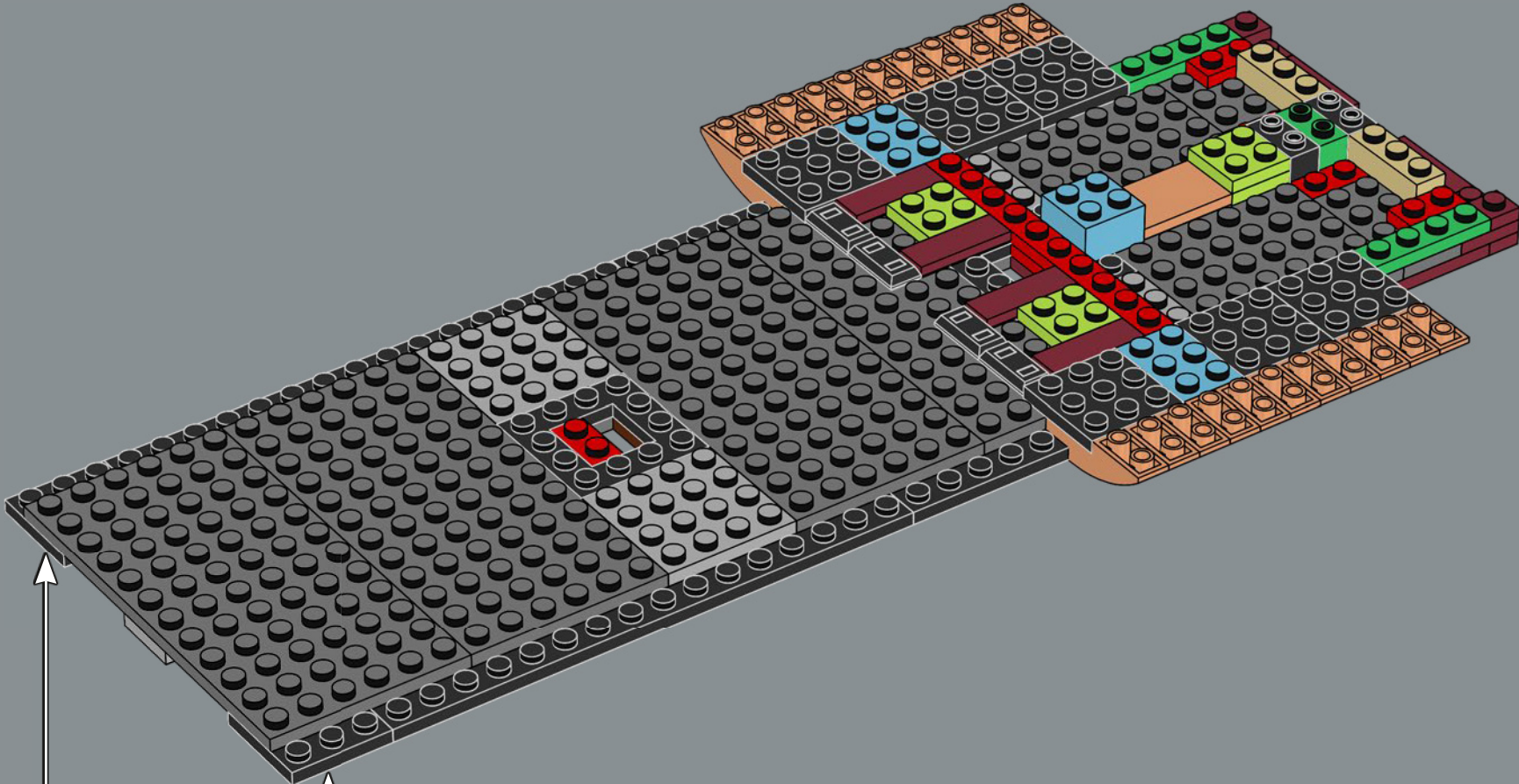

24

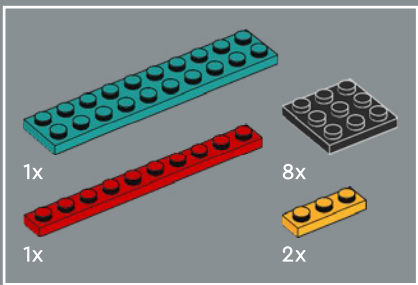

22

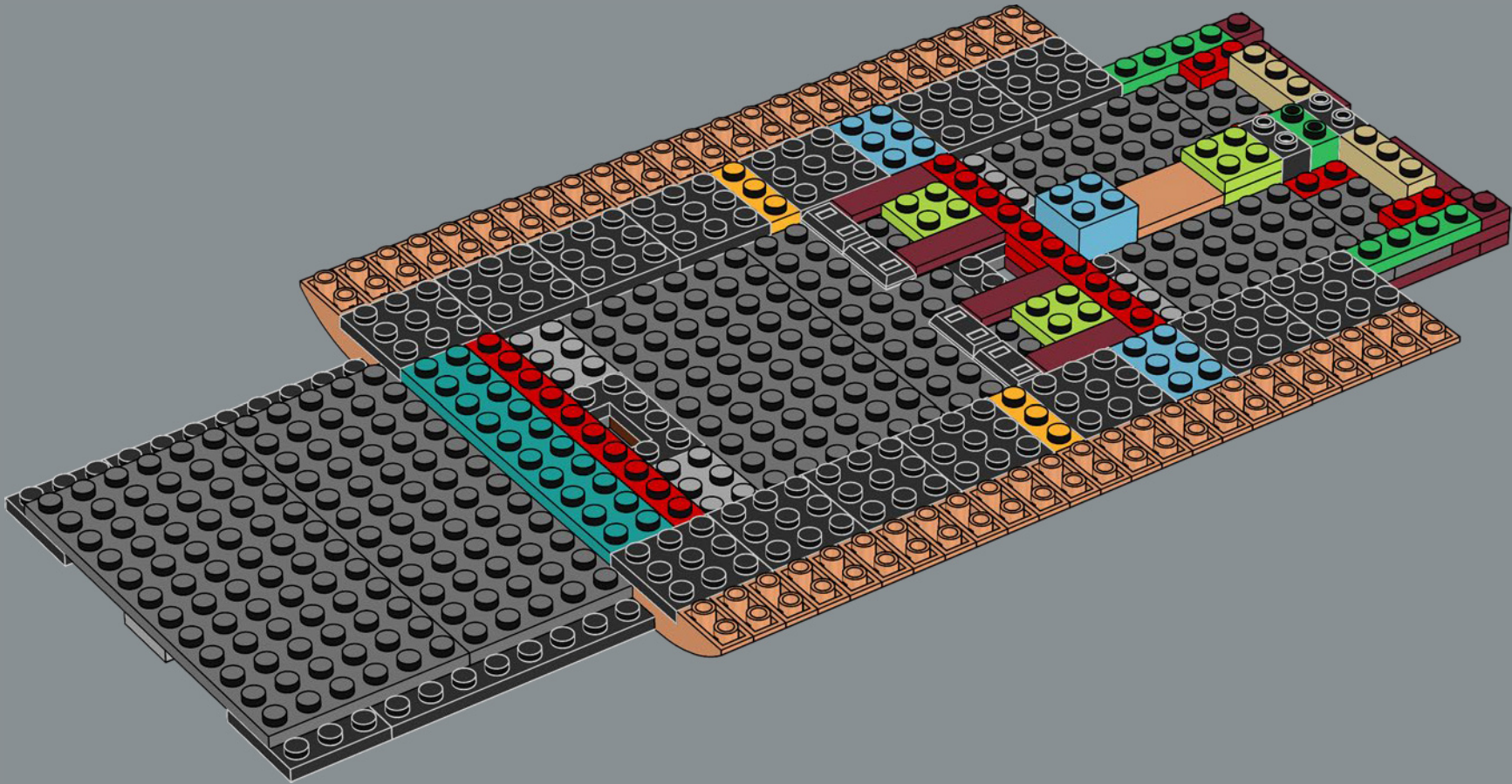

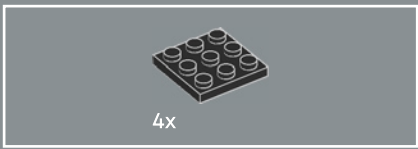

24

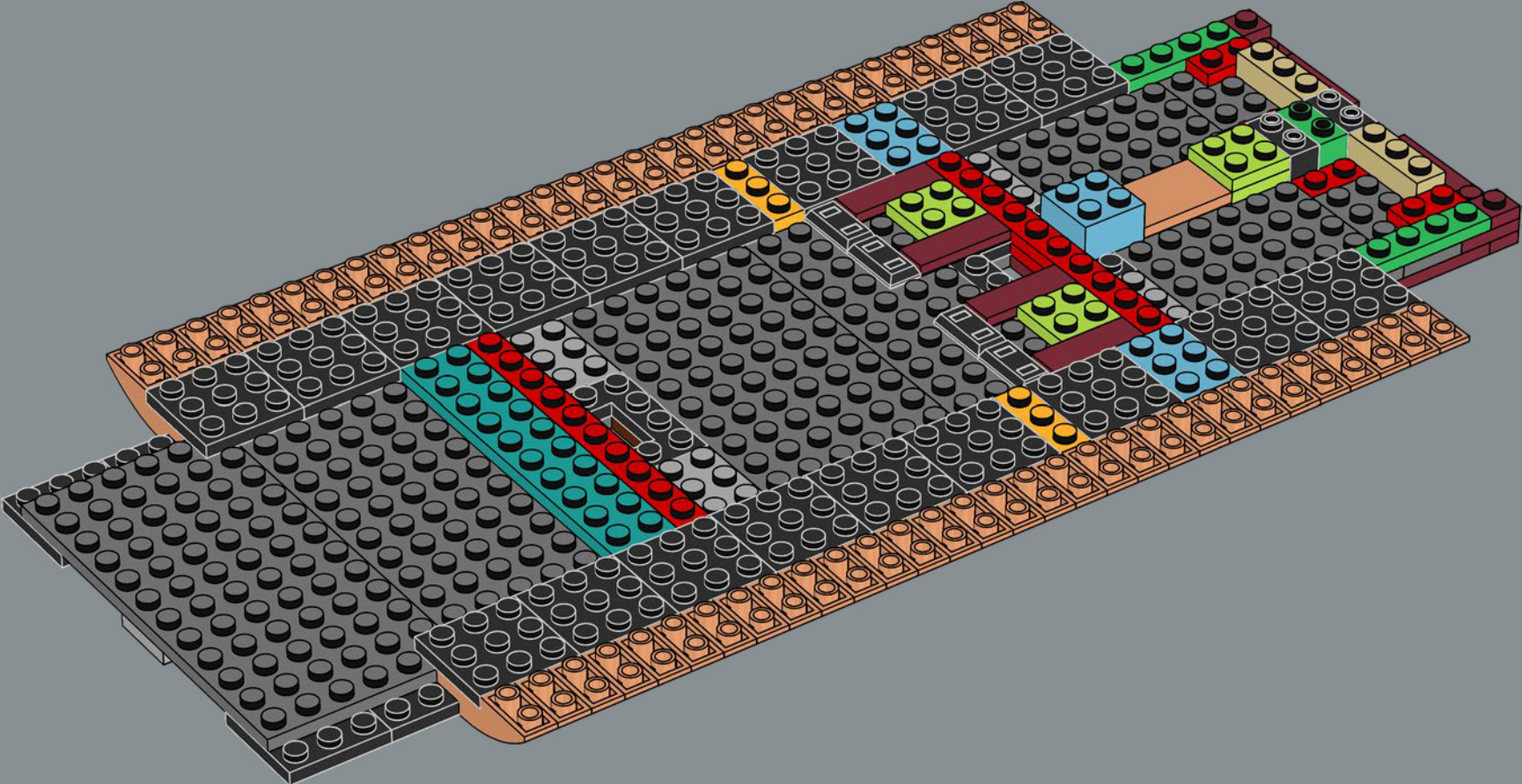

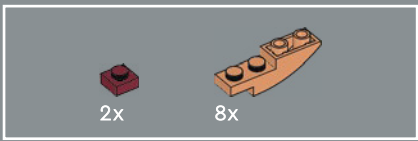

25

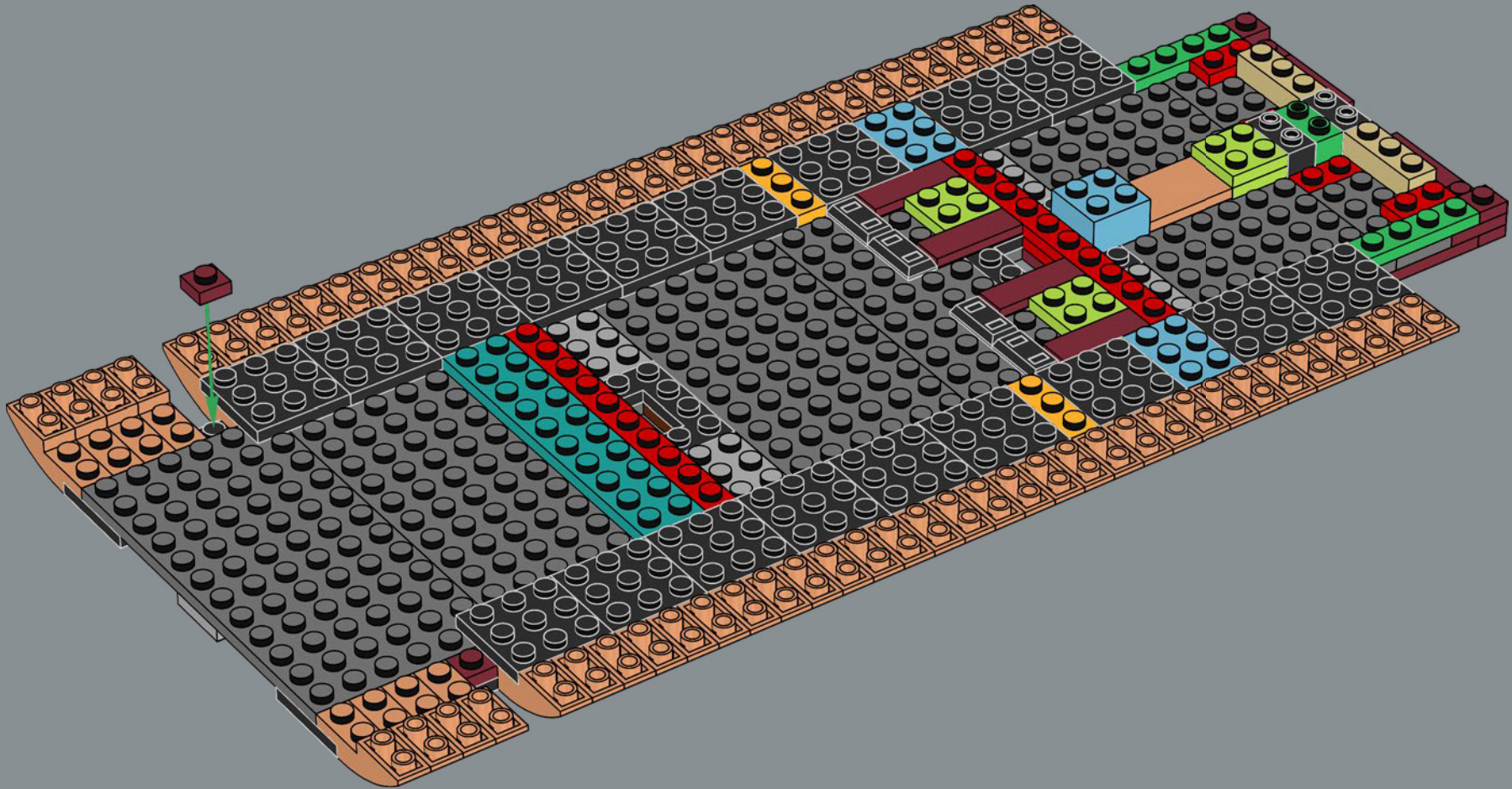

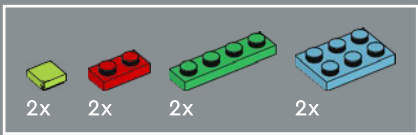

26

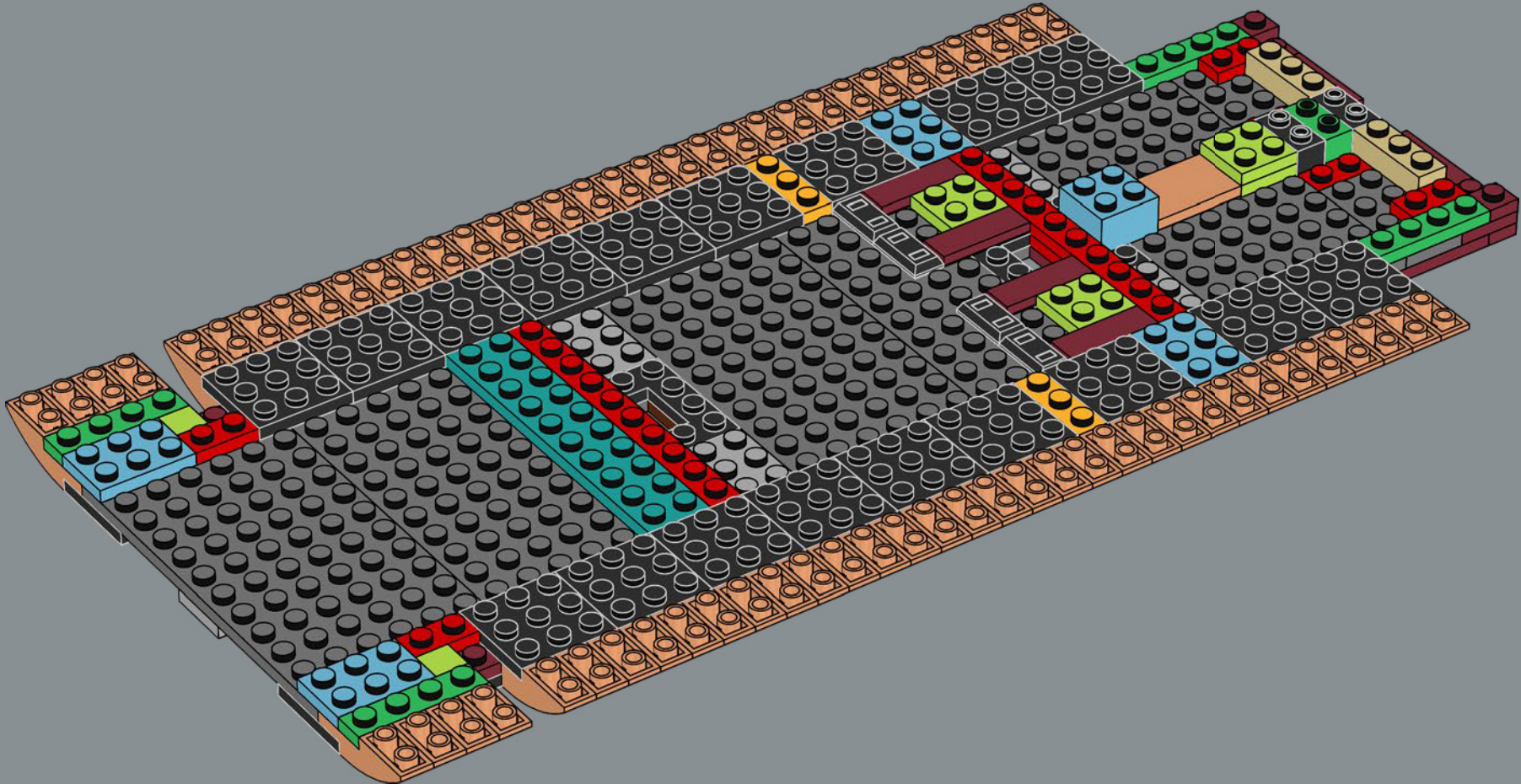

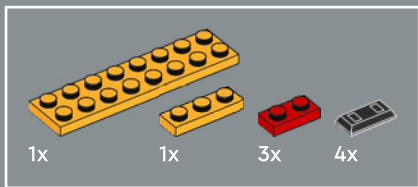

27

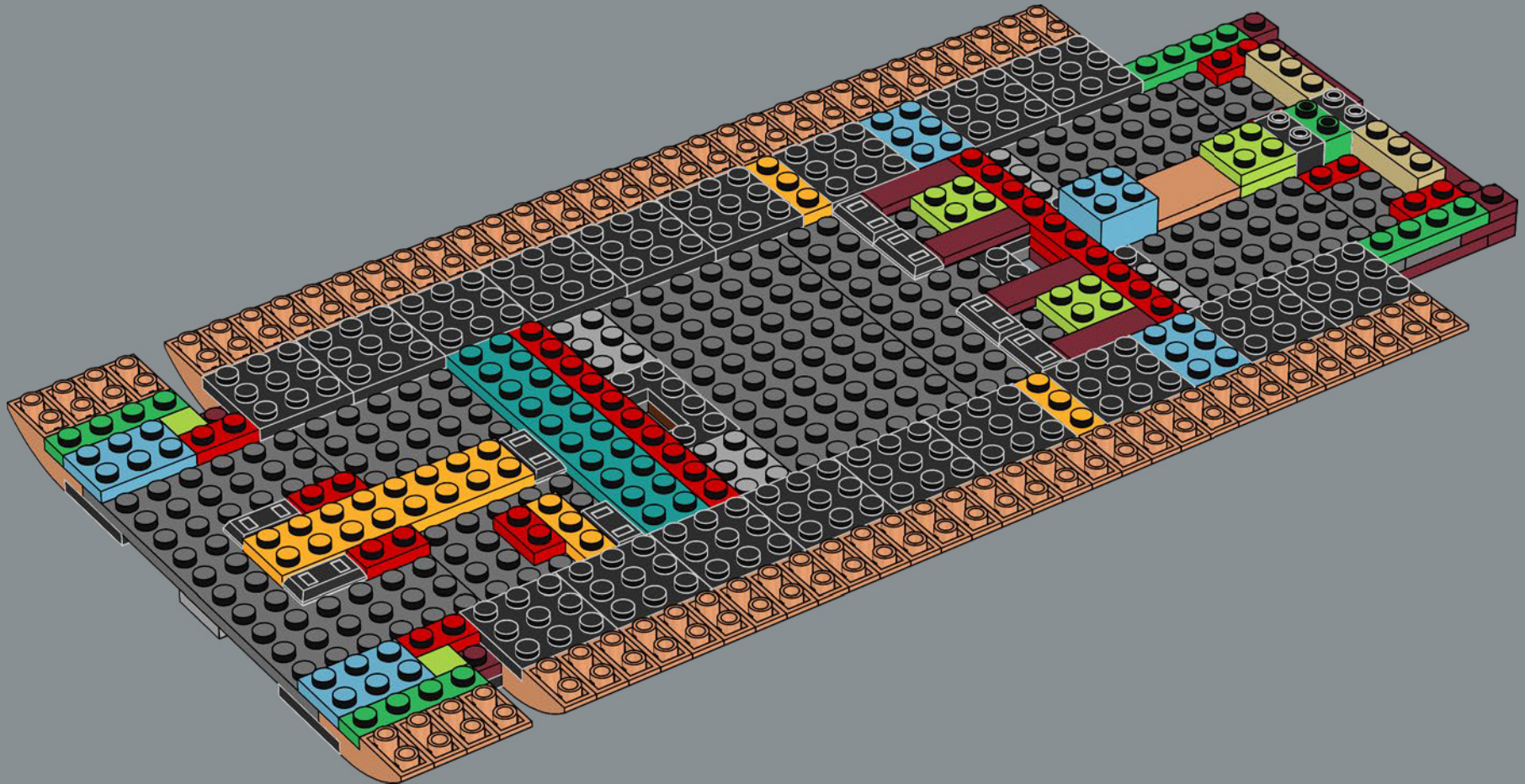

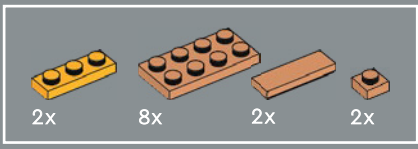

28

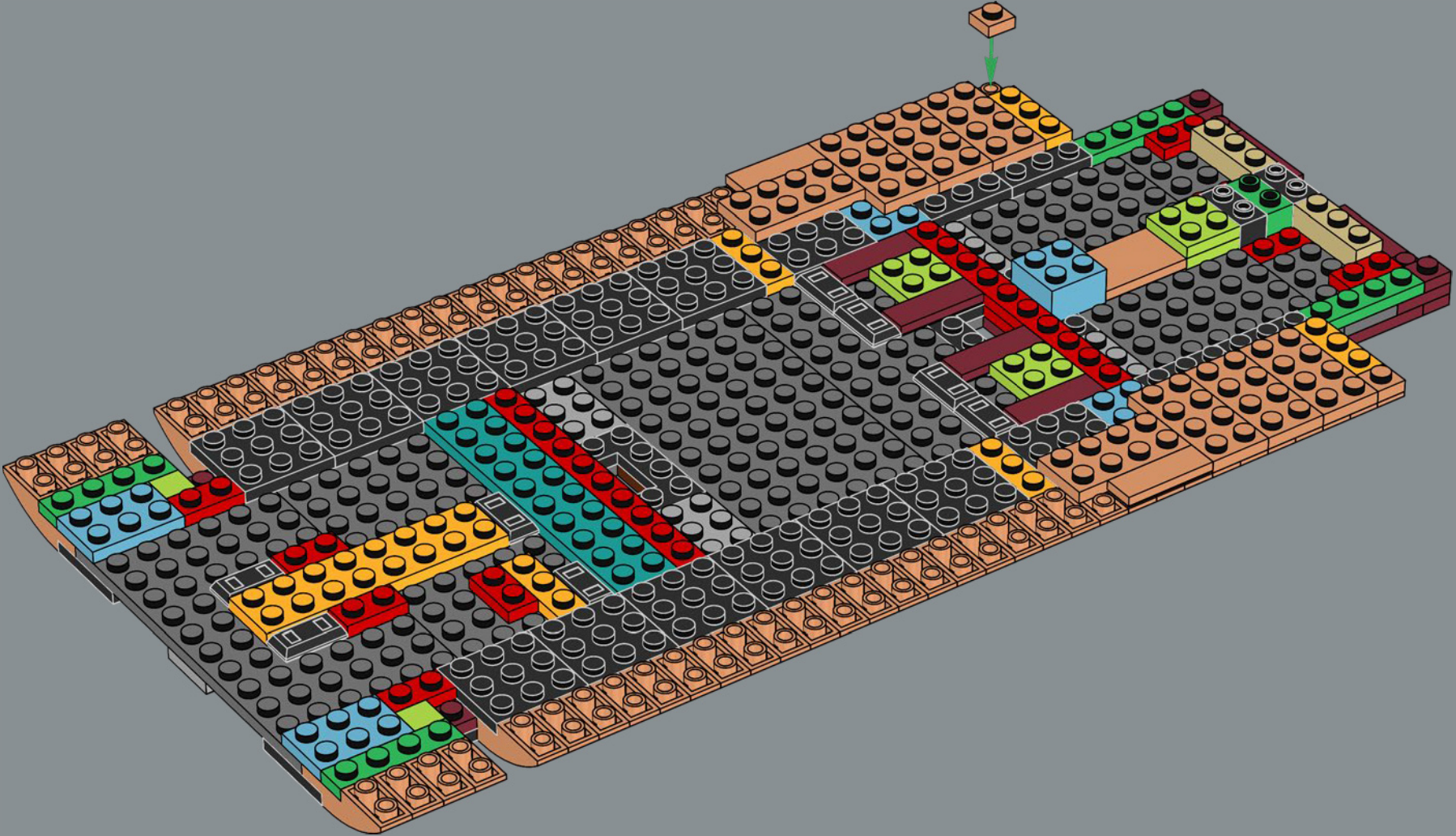

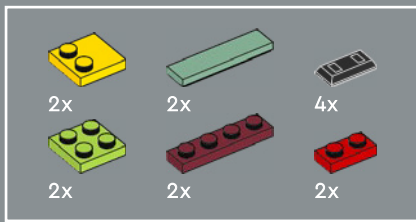

29

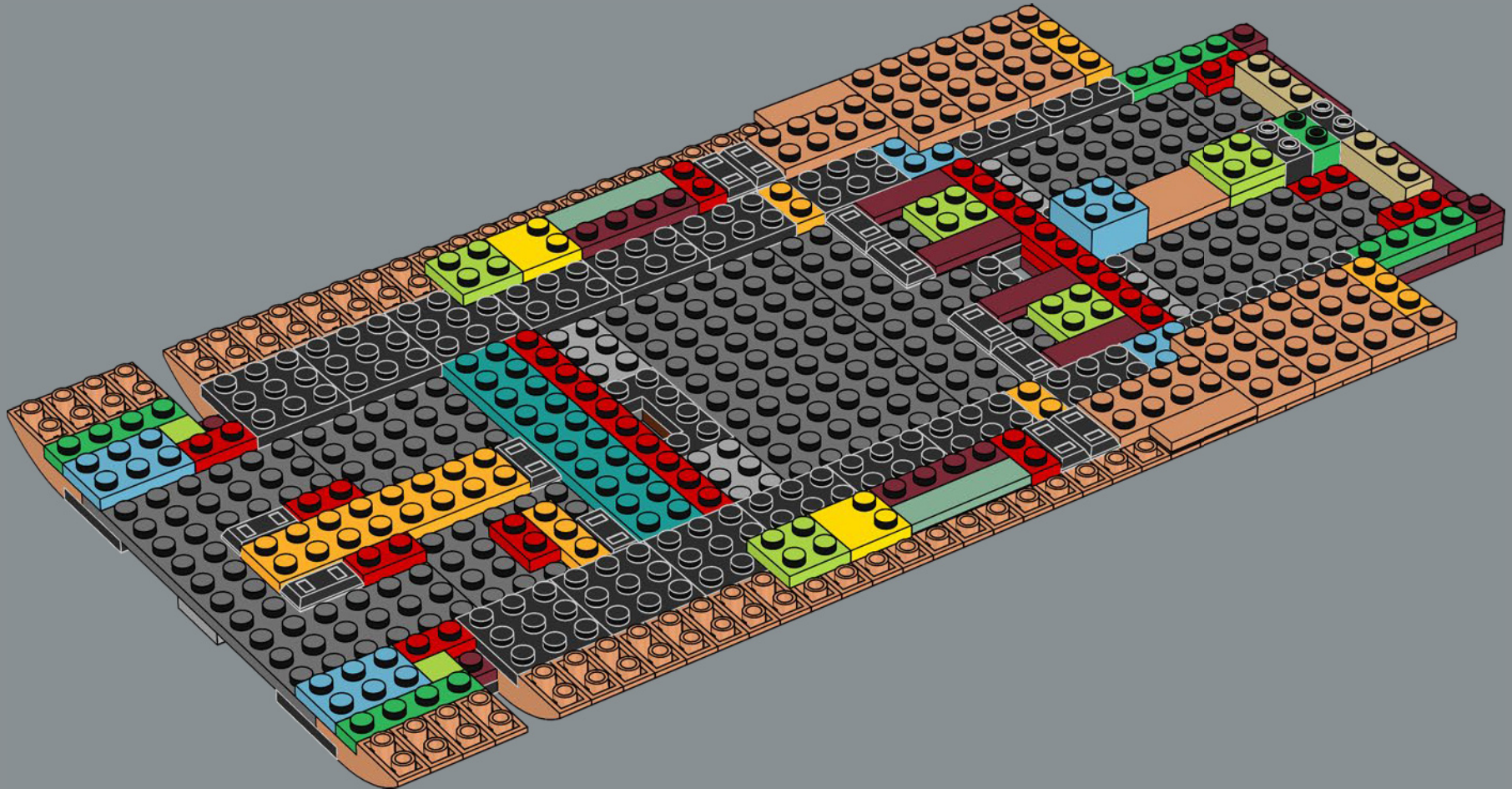

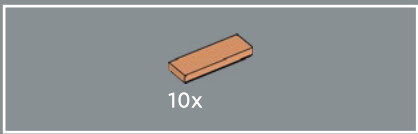

30

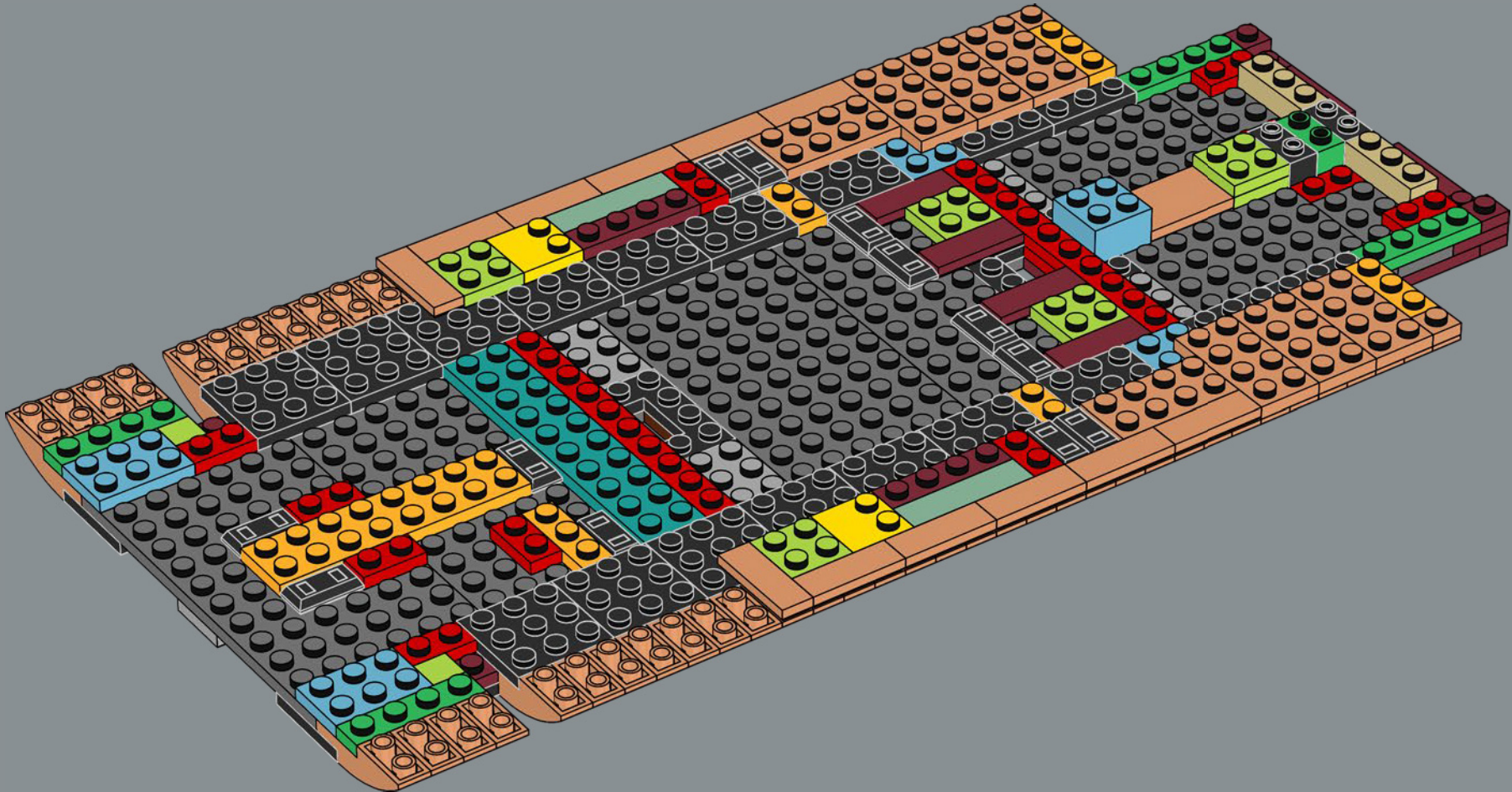

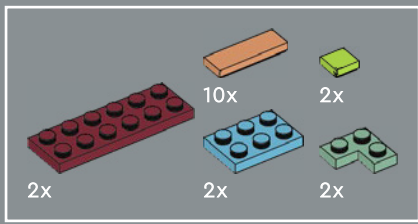

31

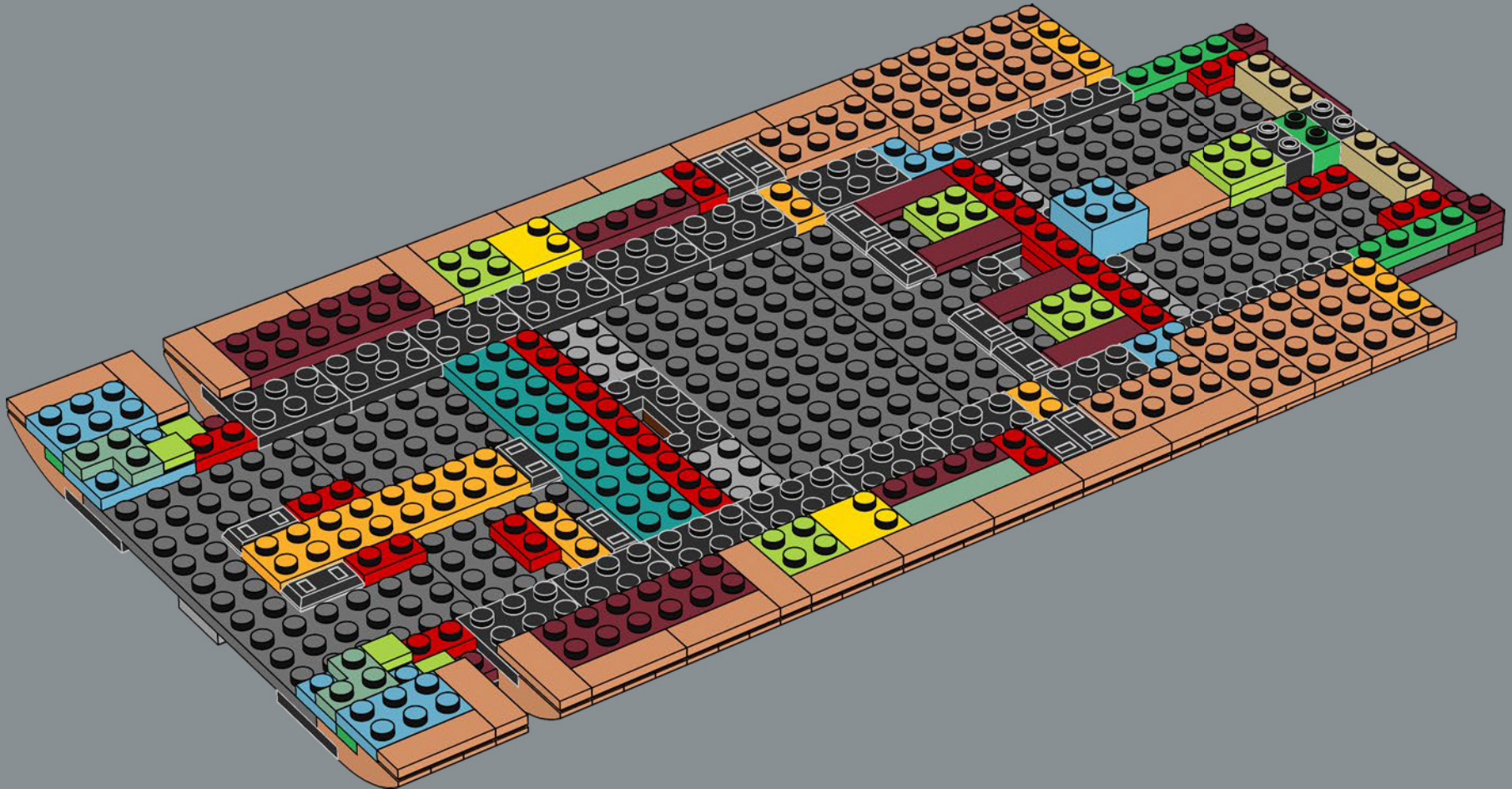

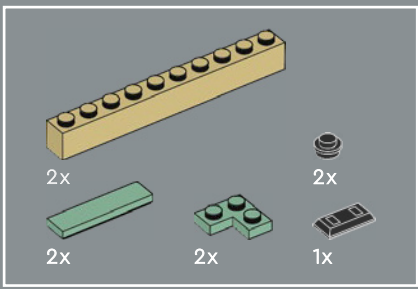

32

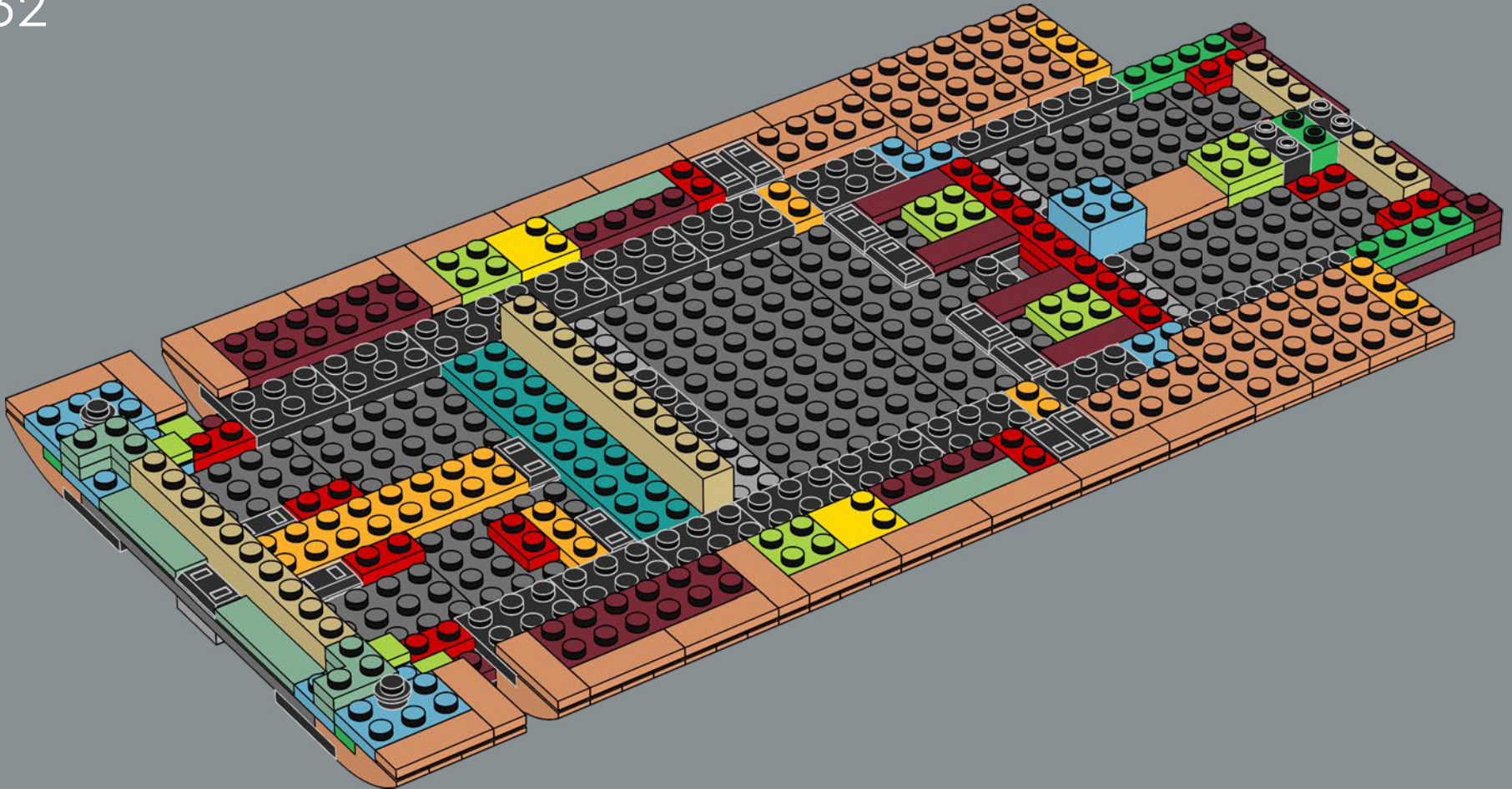

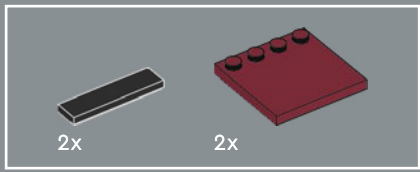

34

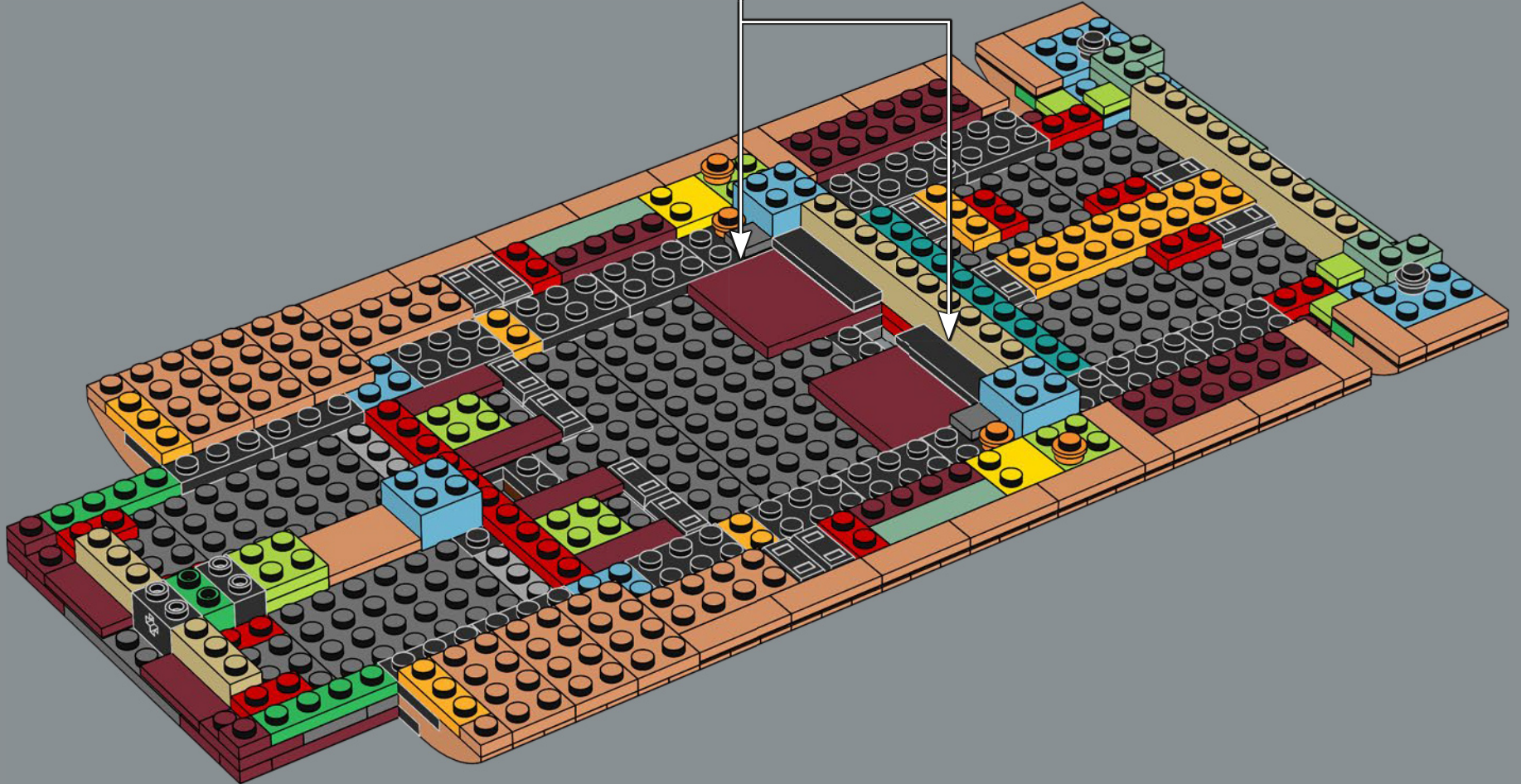
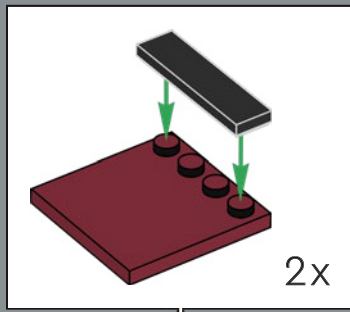

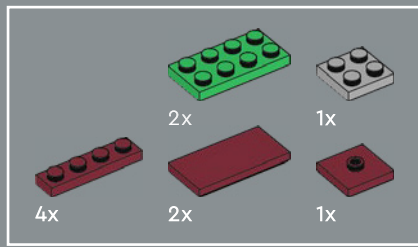

35

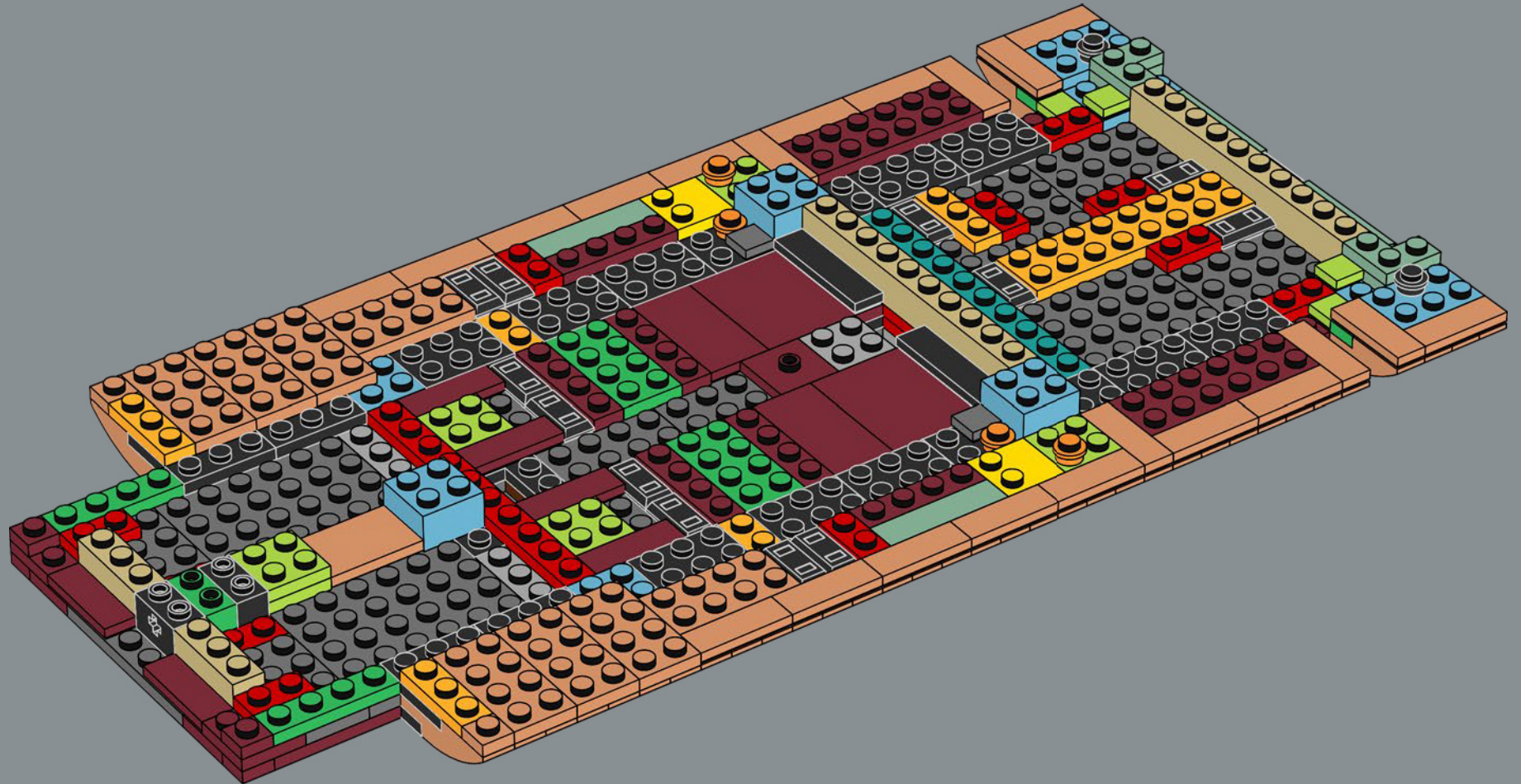

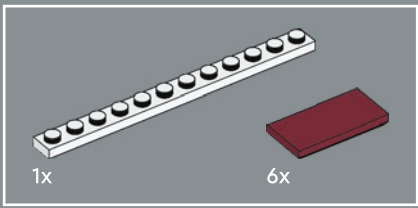

36

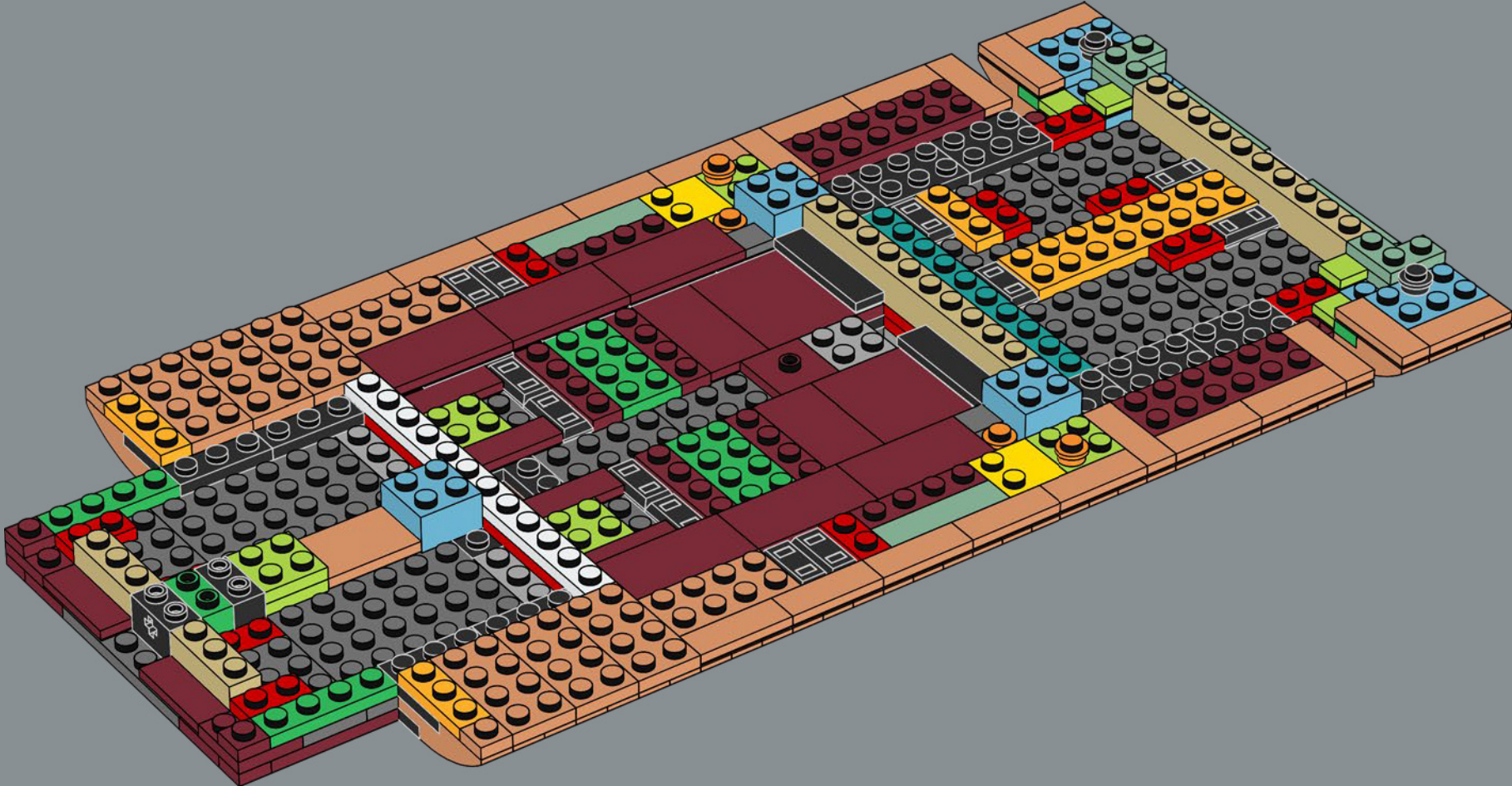

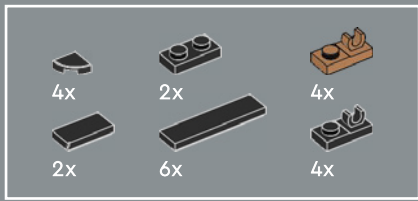

37

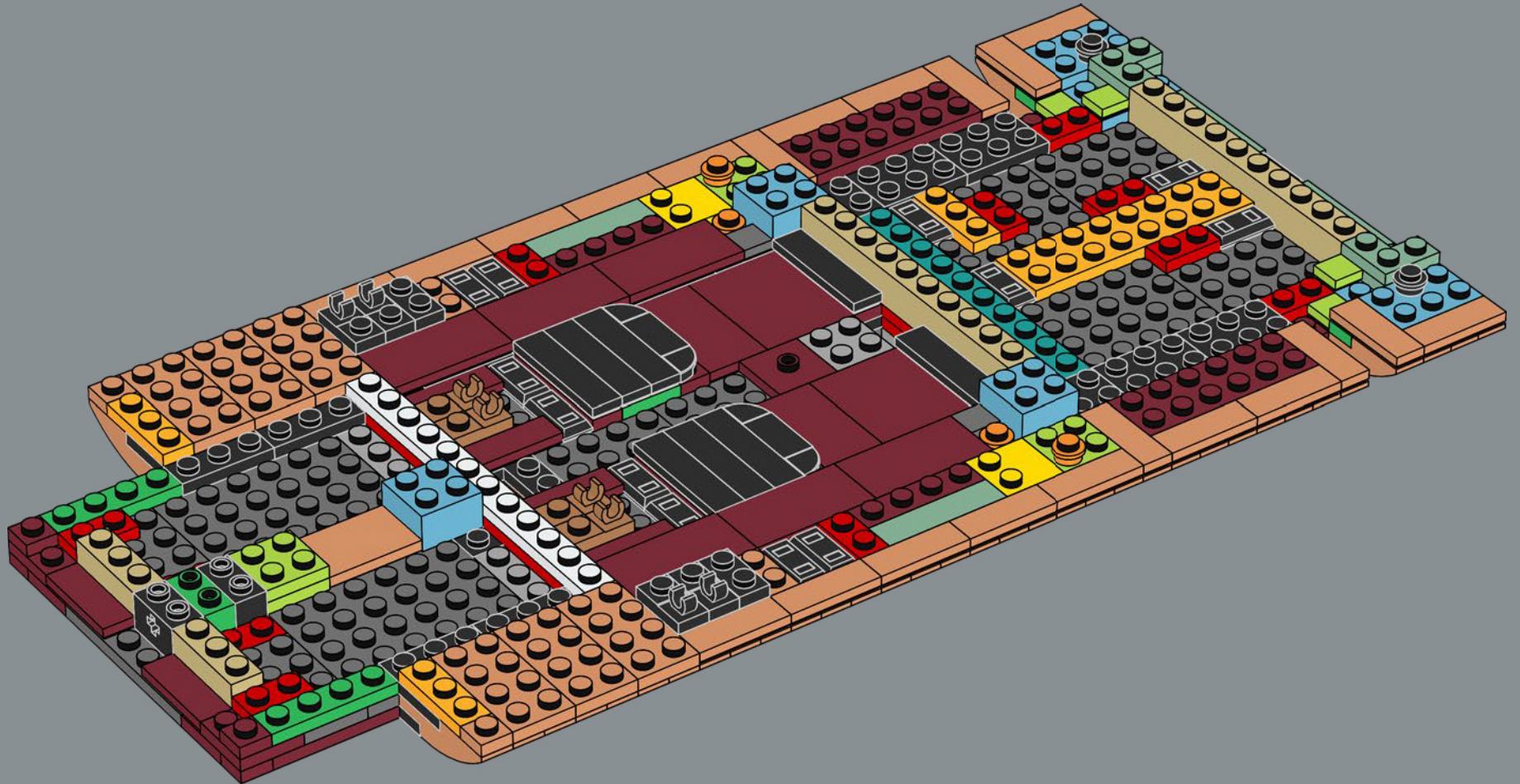

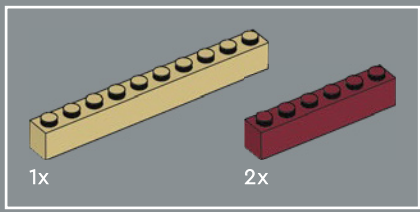

38

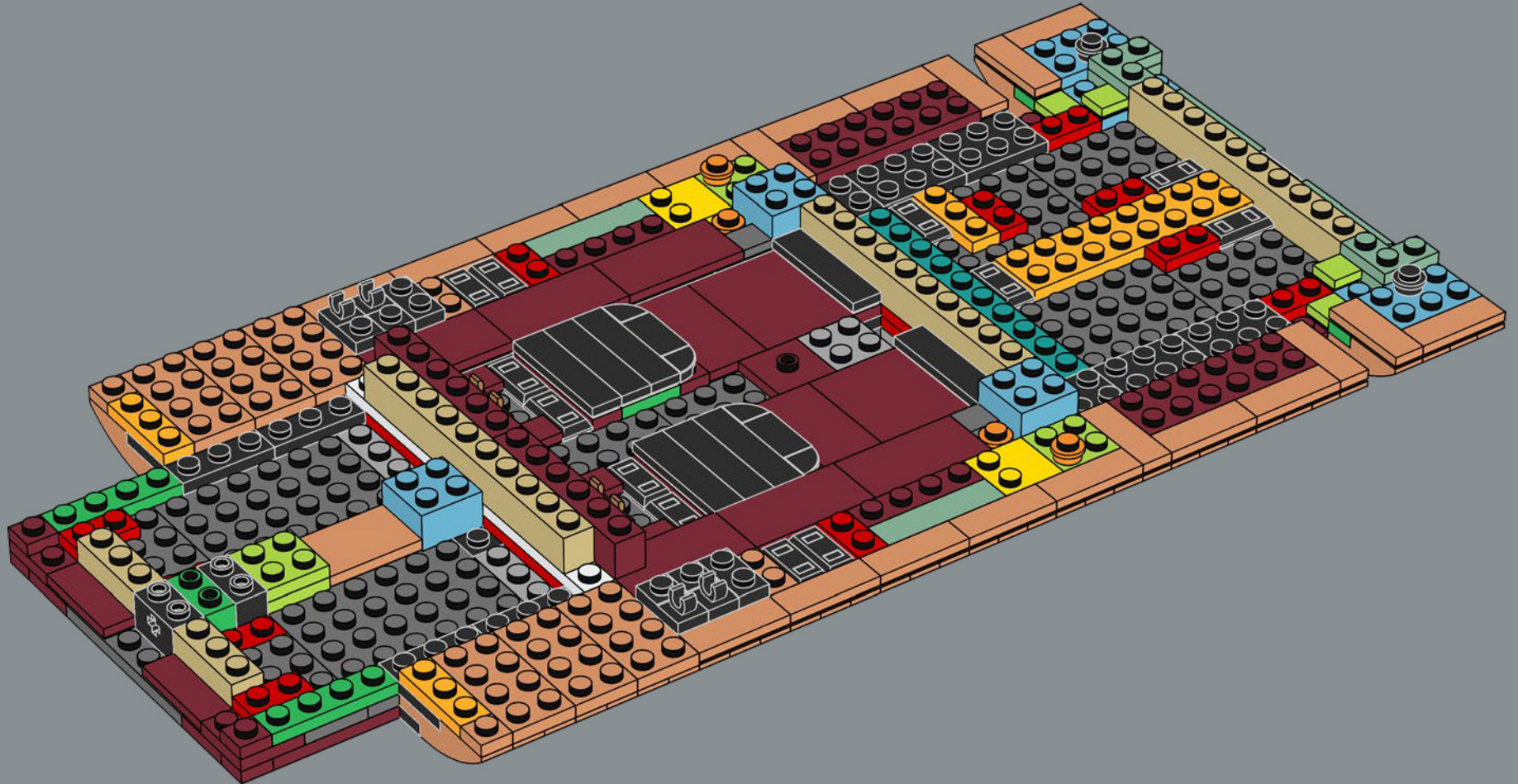

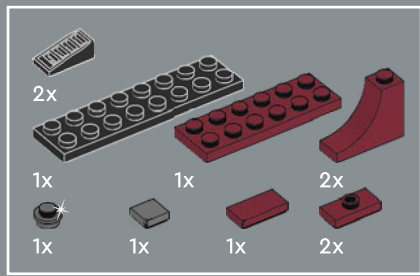

39

1

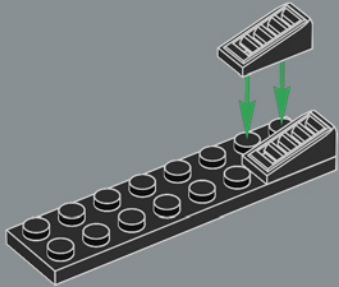

2

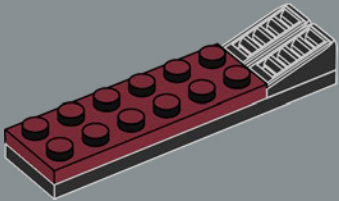

3

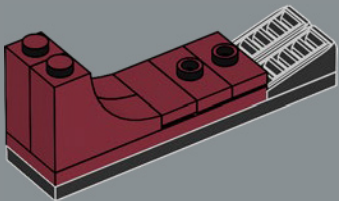

4

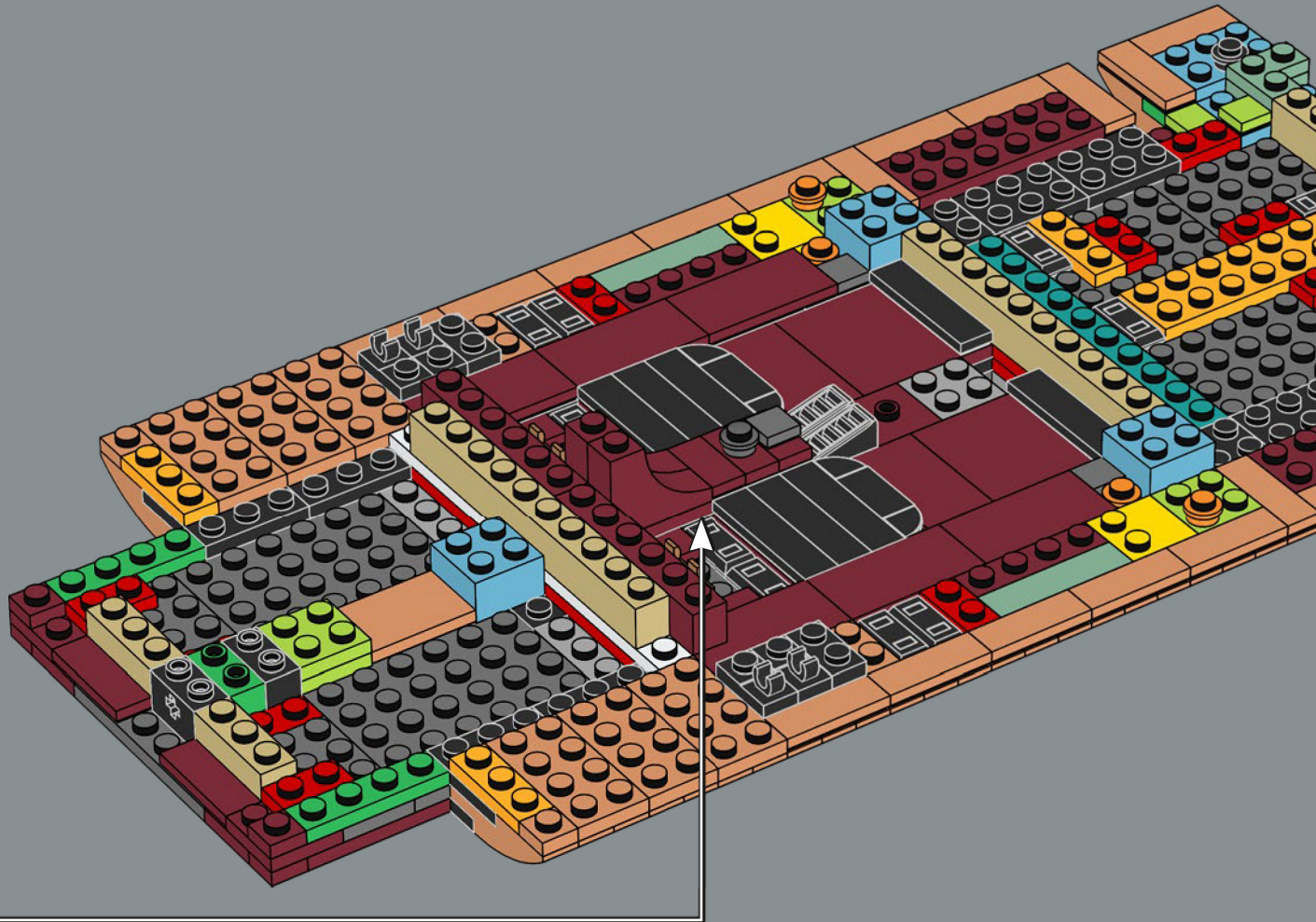
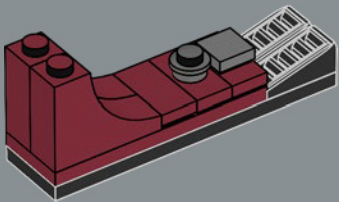

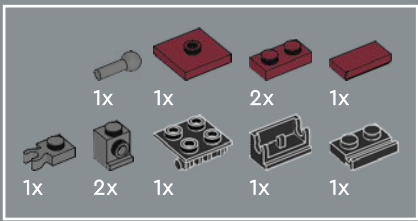

40

1

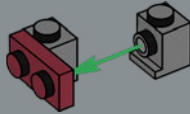

2

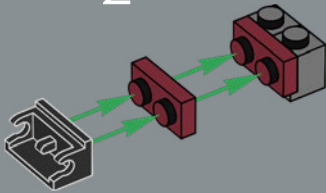

3

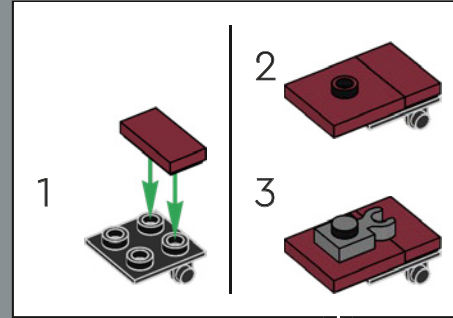
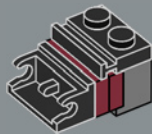

4

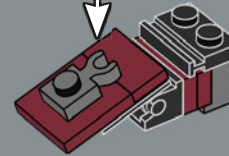

5

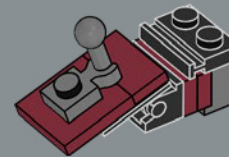

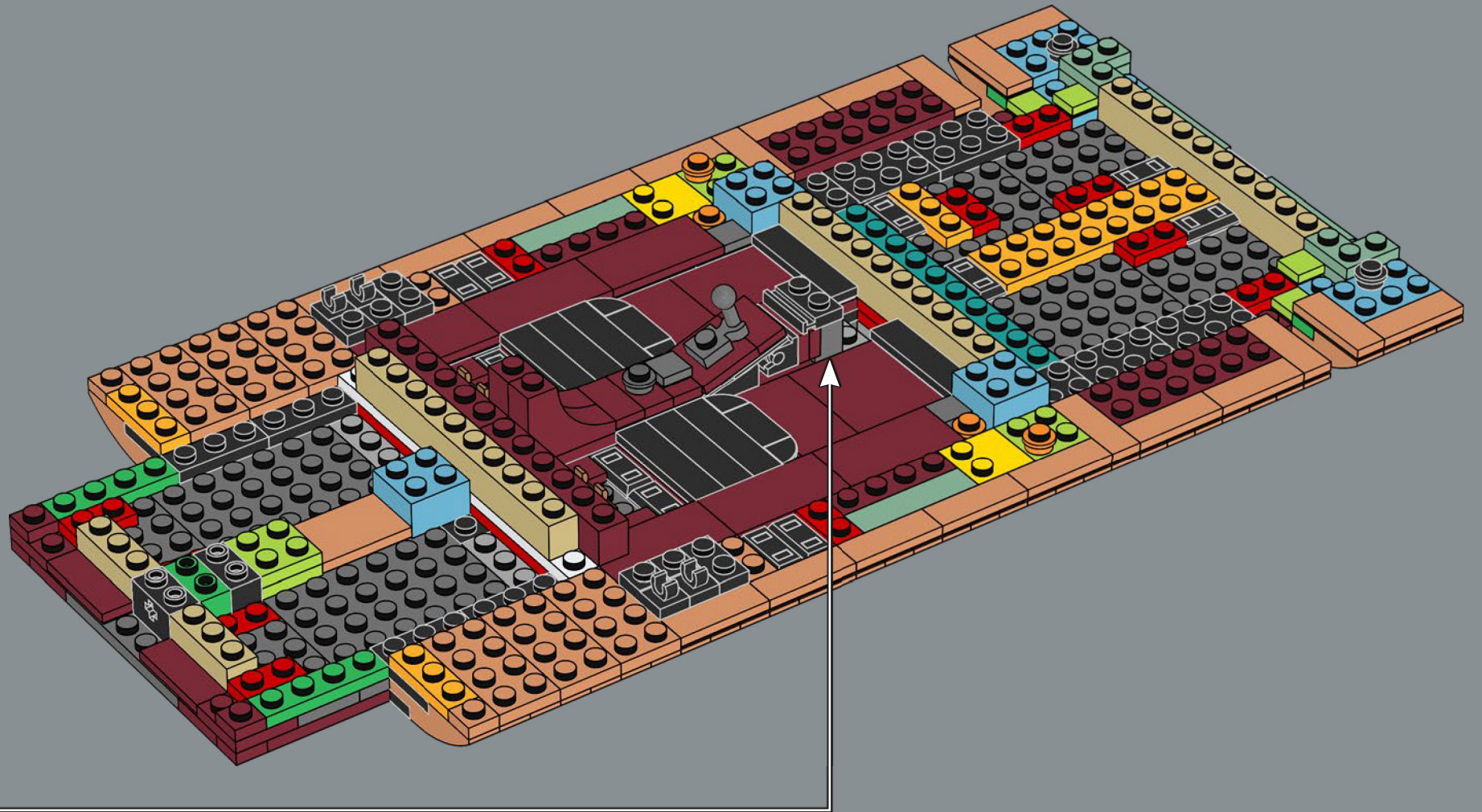

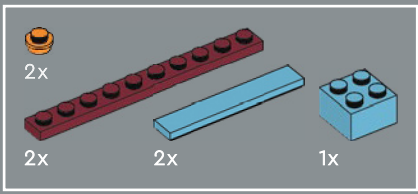

41

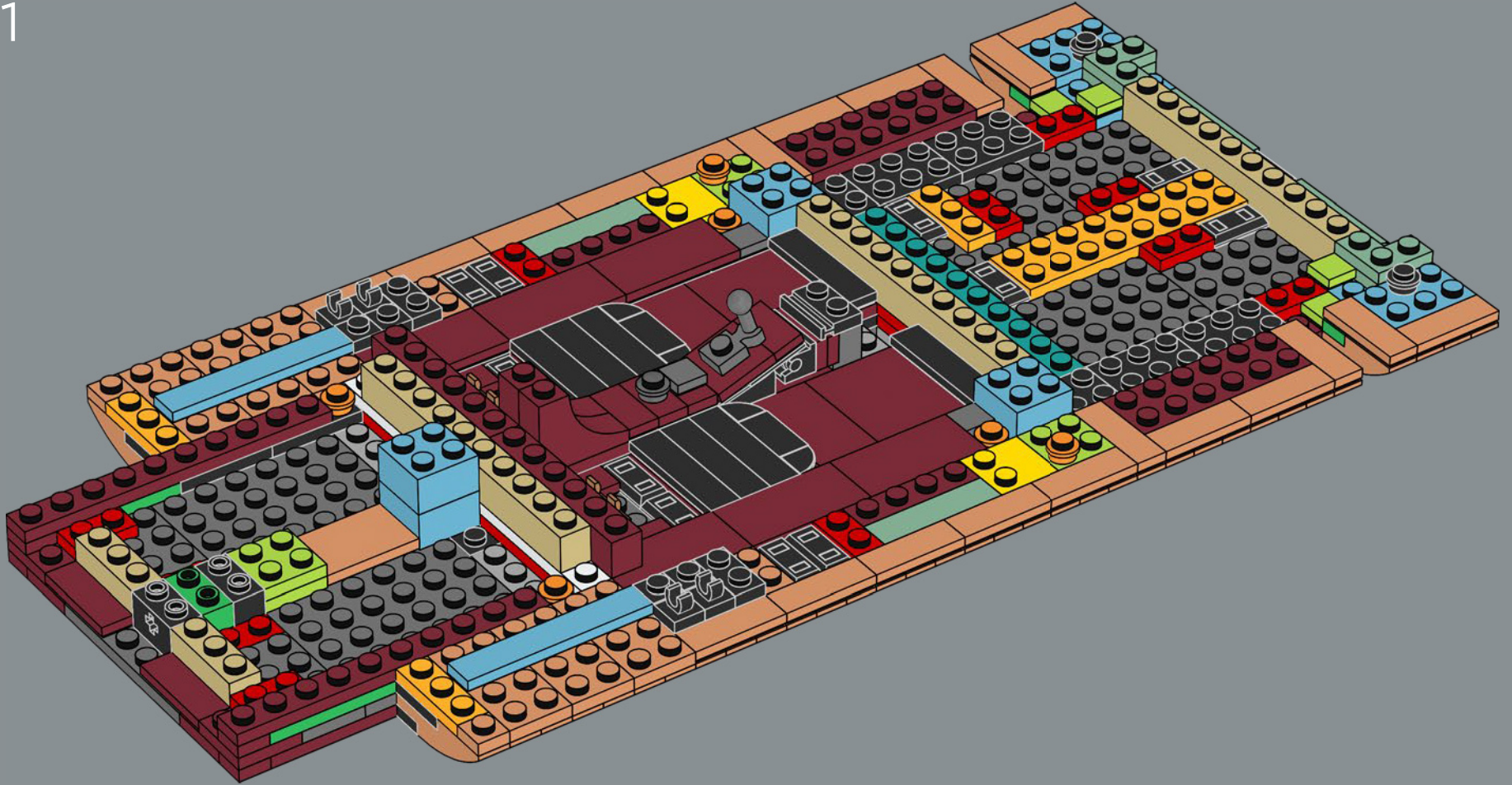

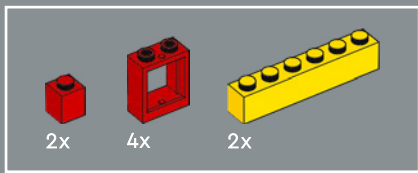

42

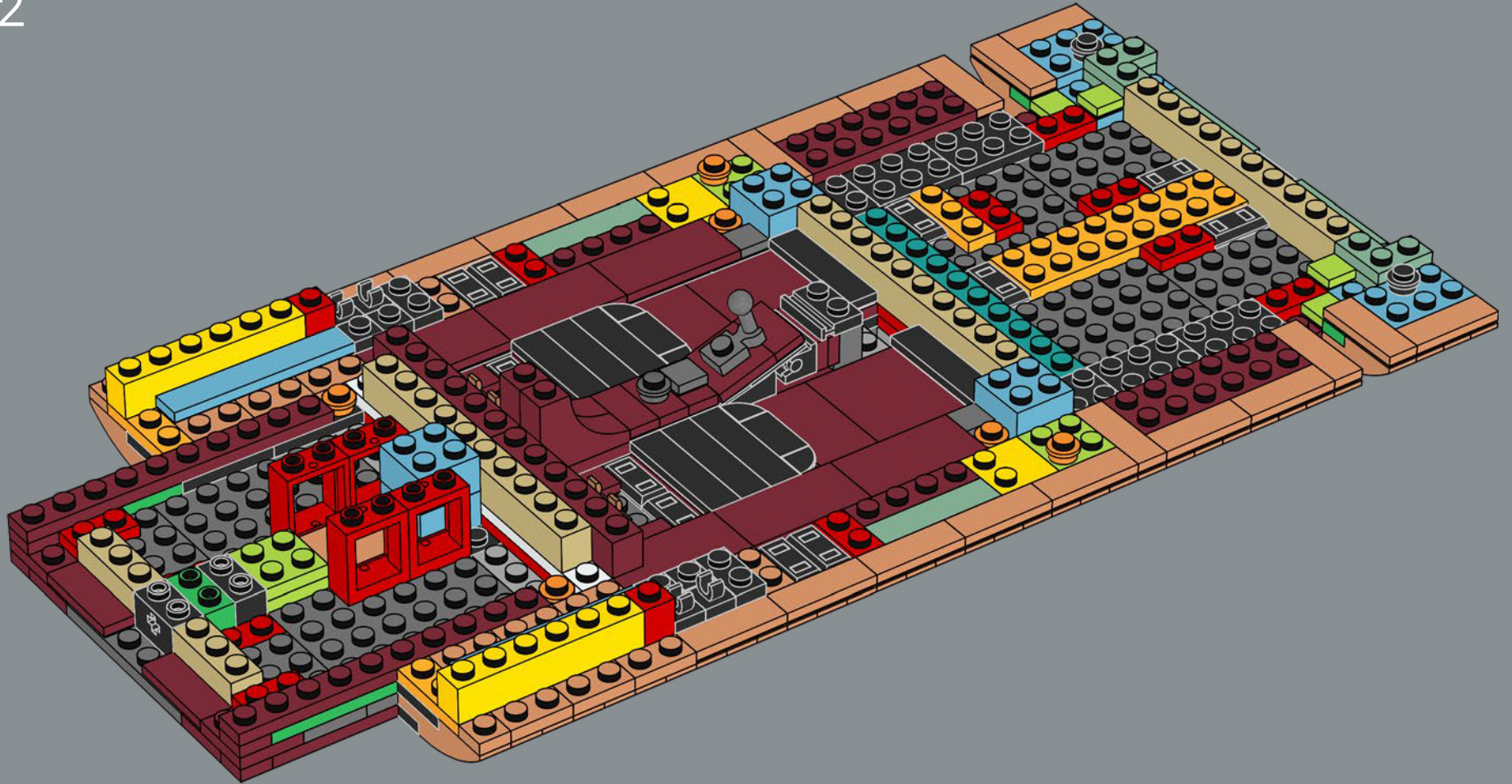

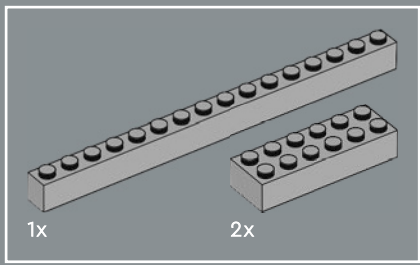

43

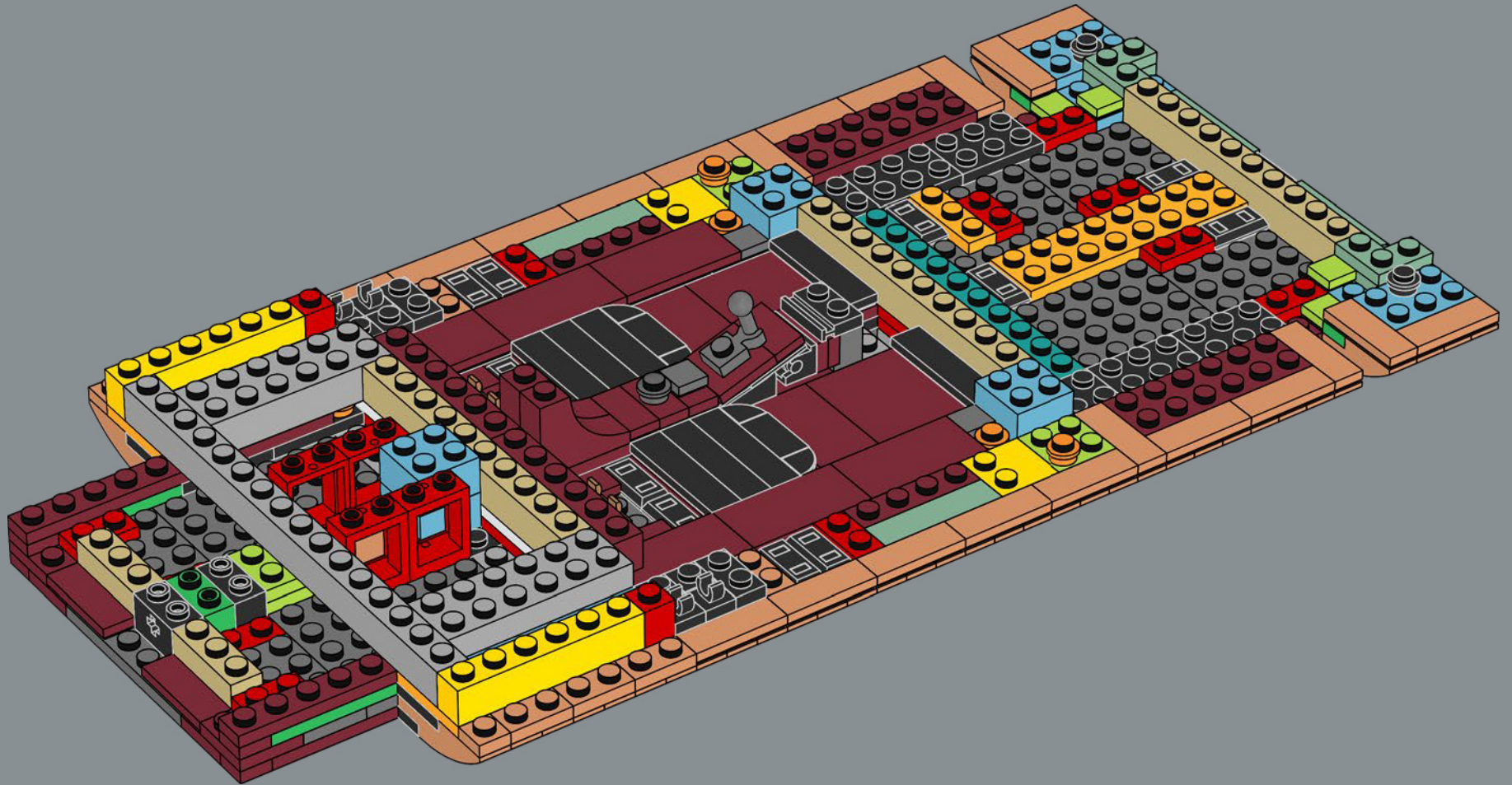

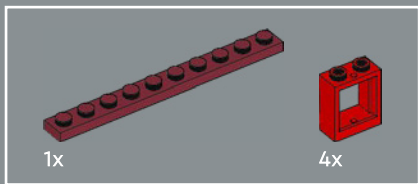

44

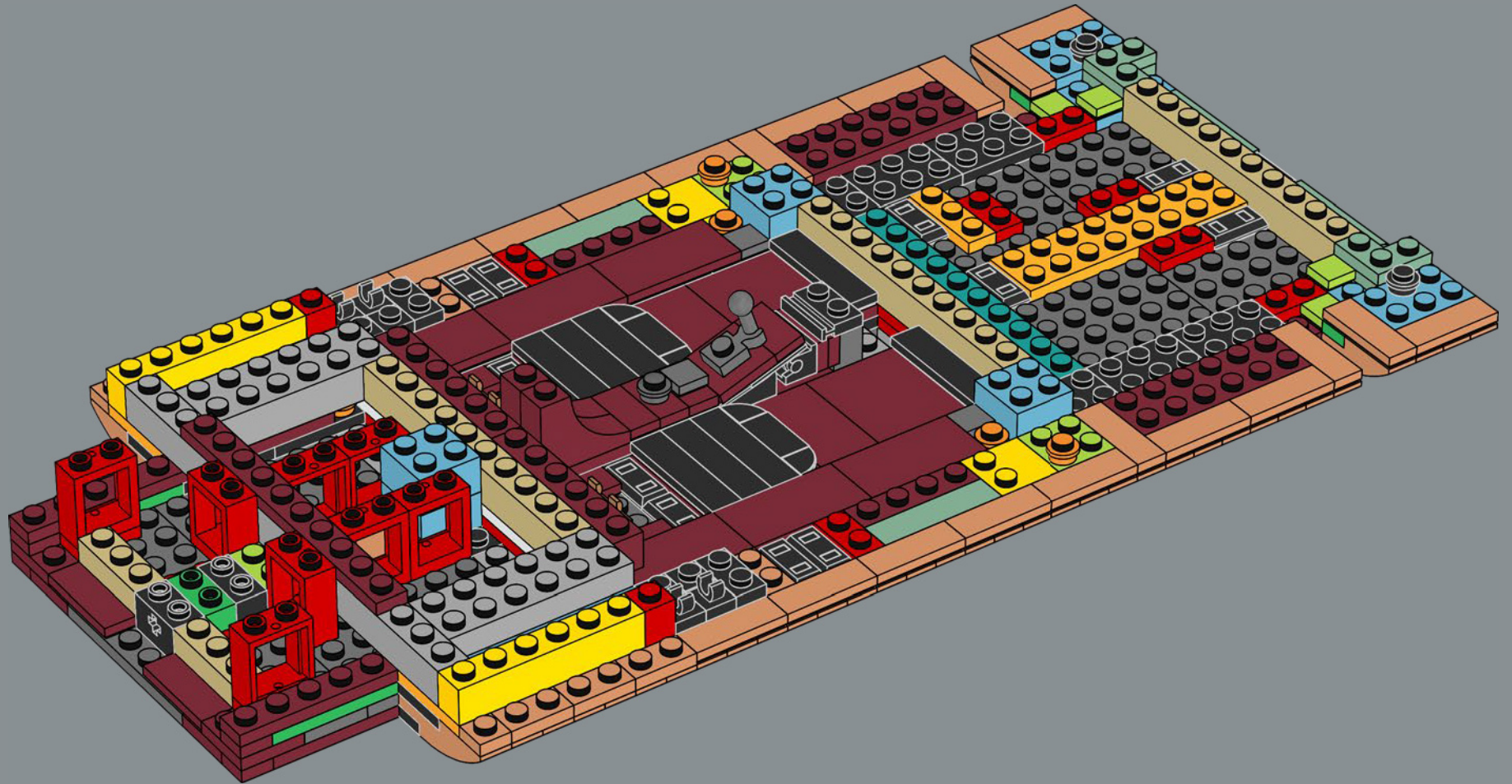

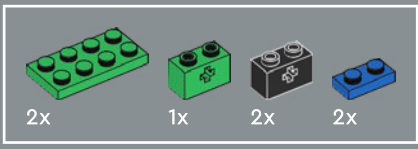

45

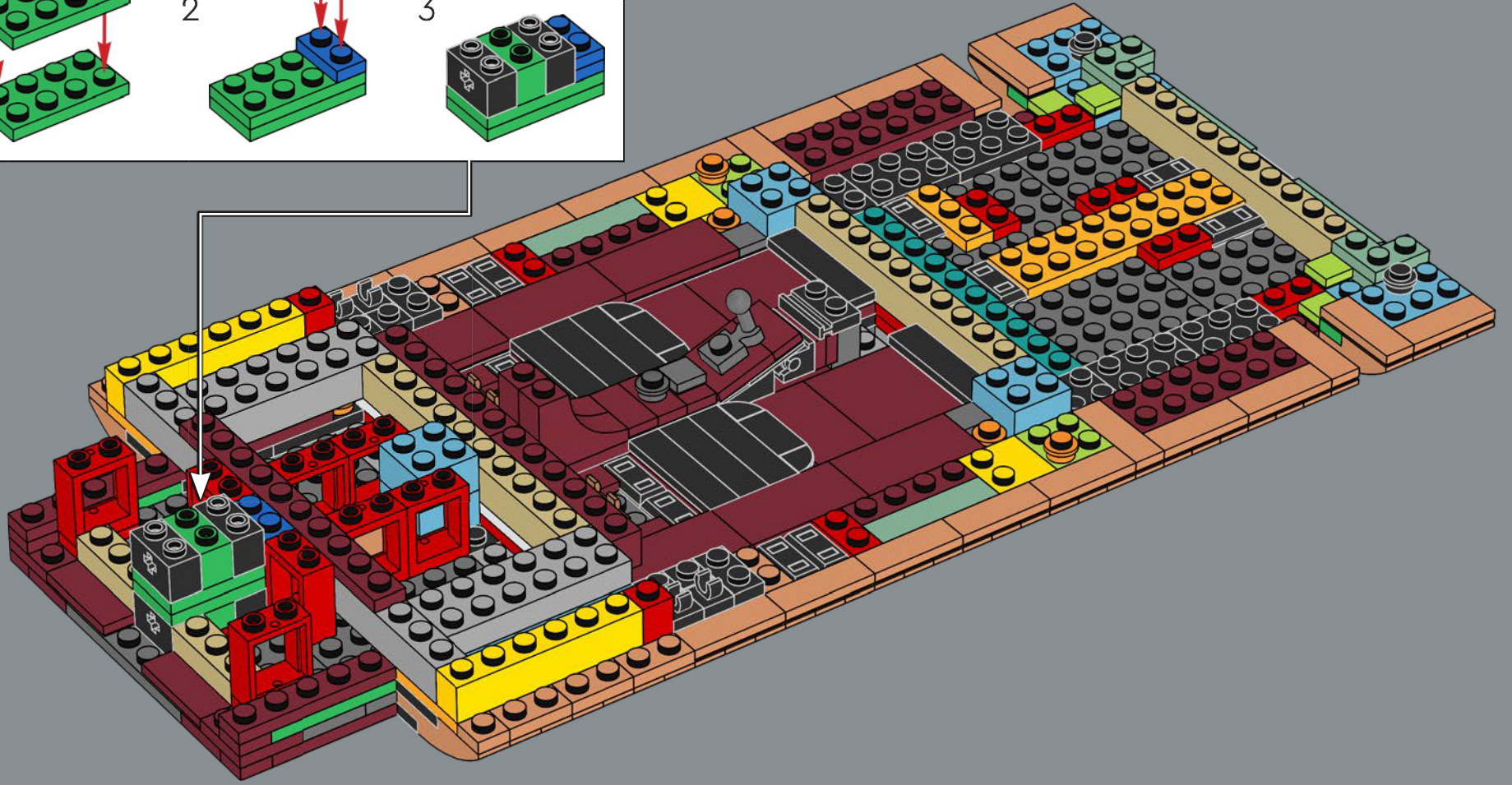
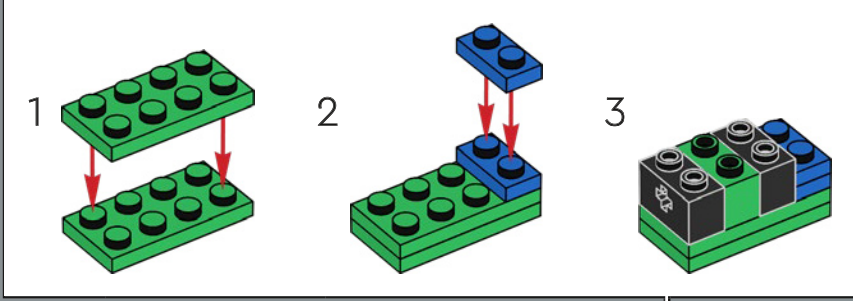



46

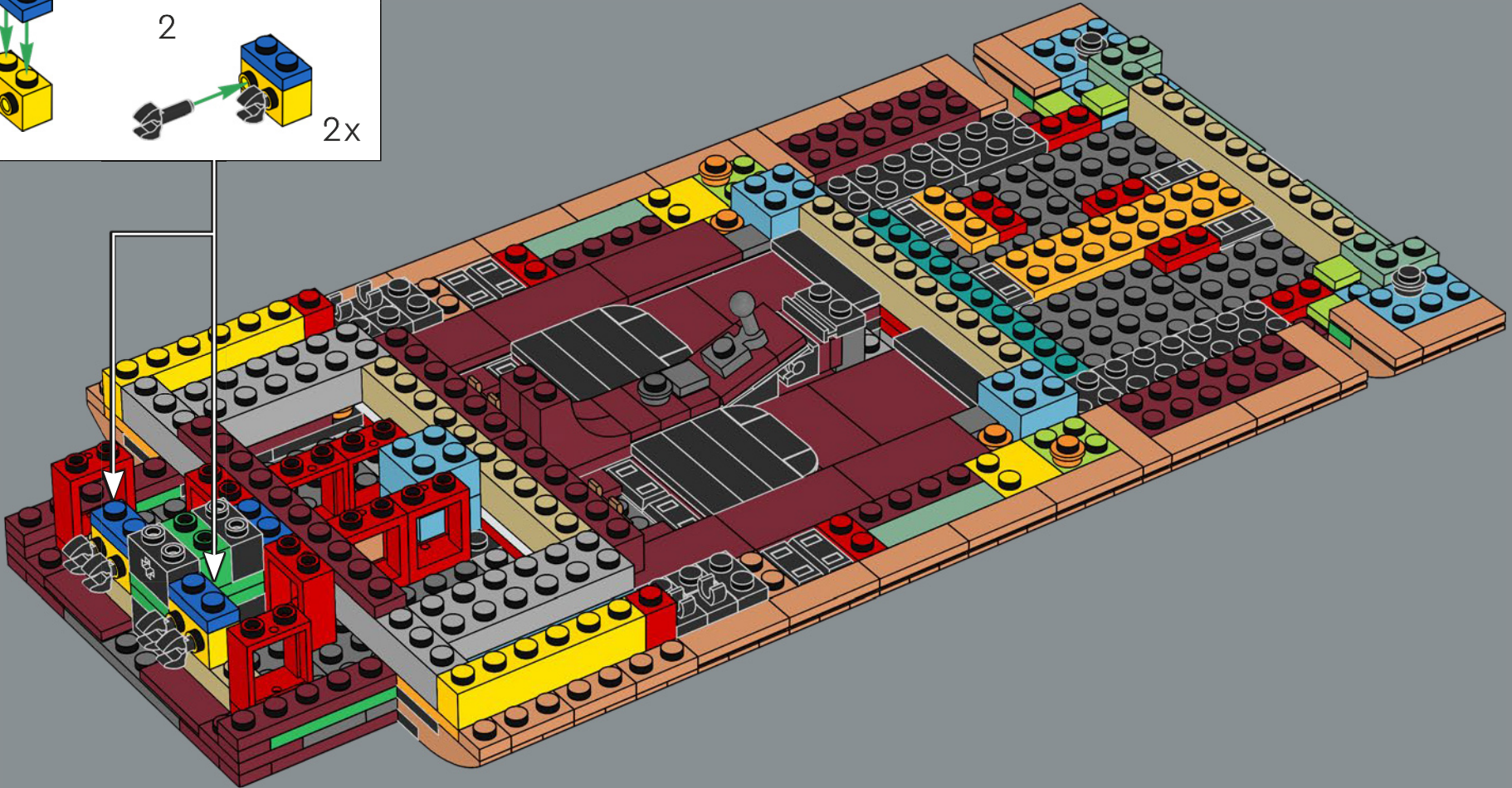
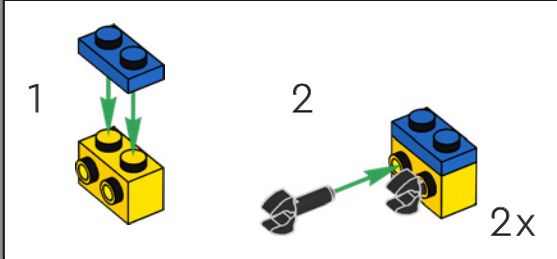

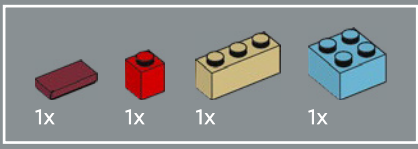

47

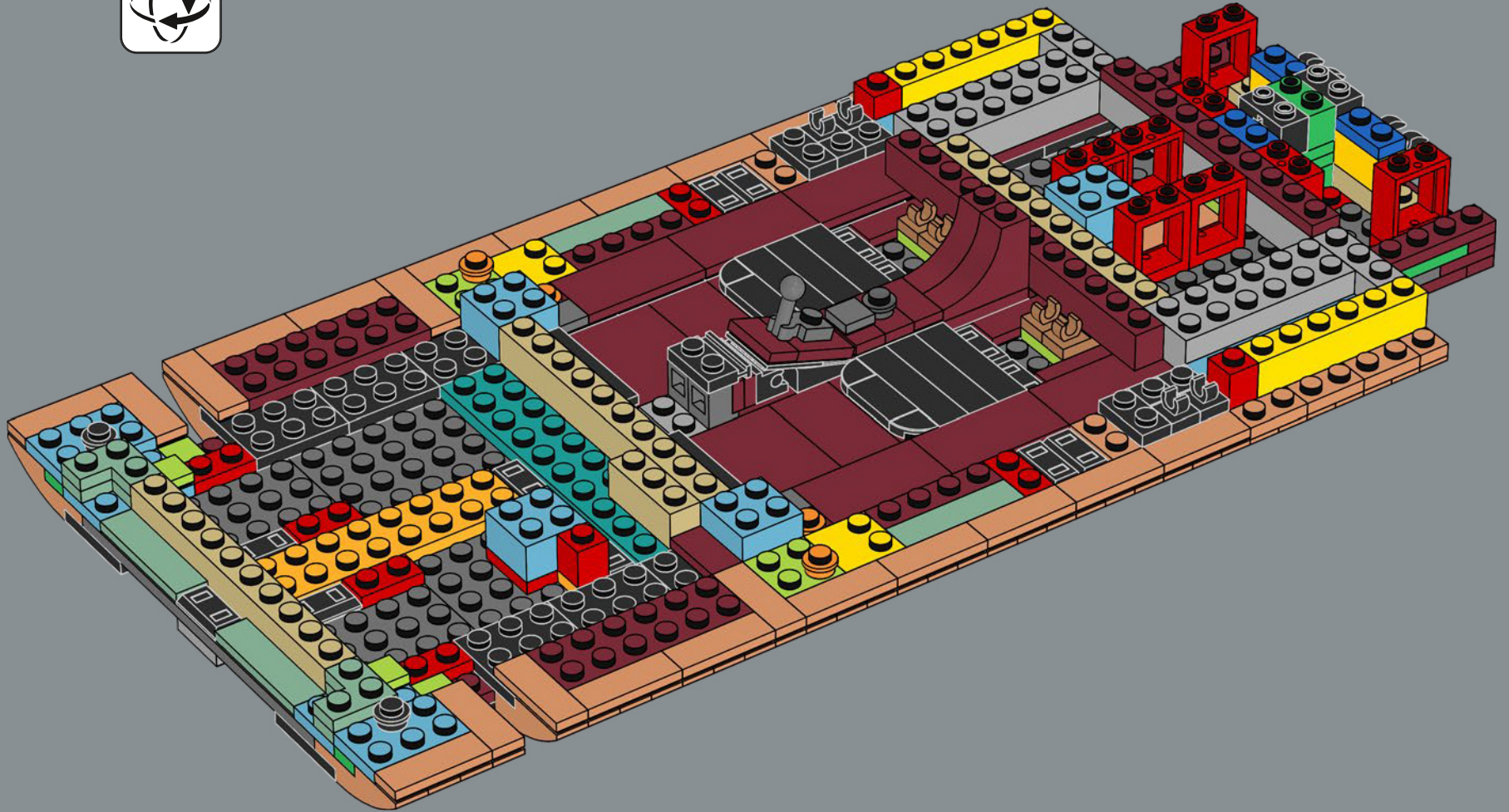

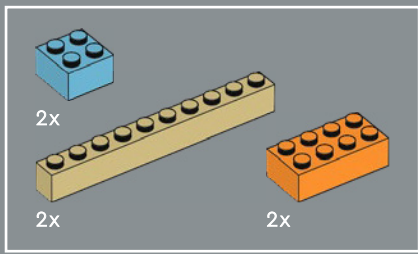

48

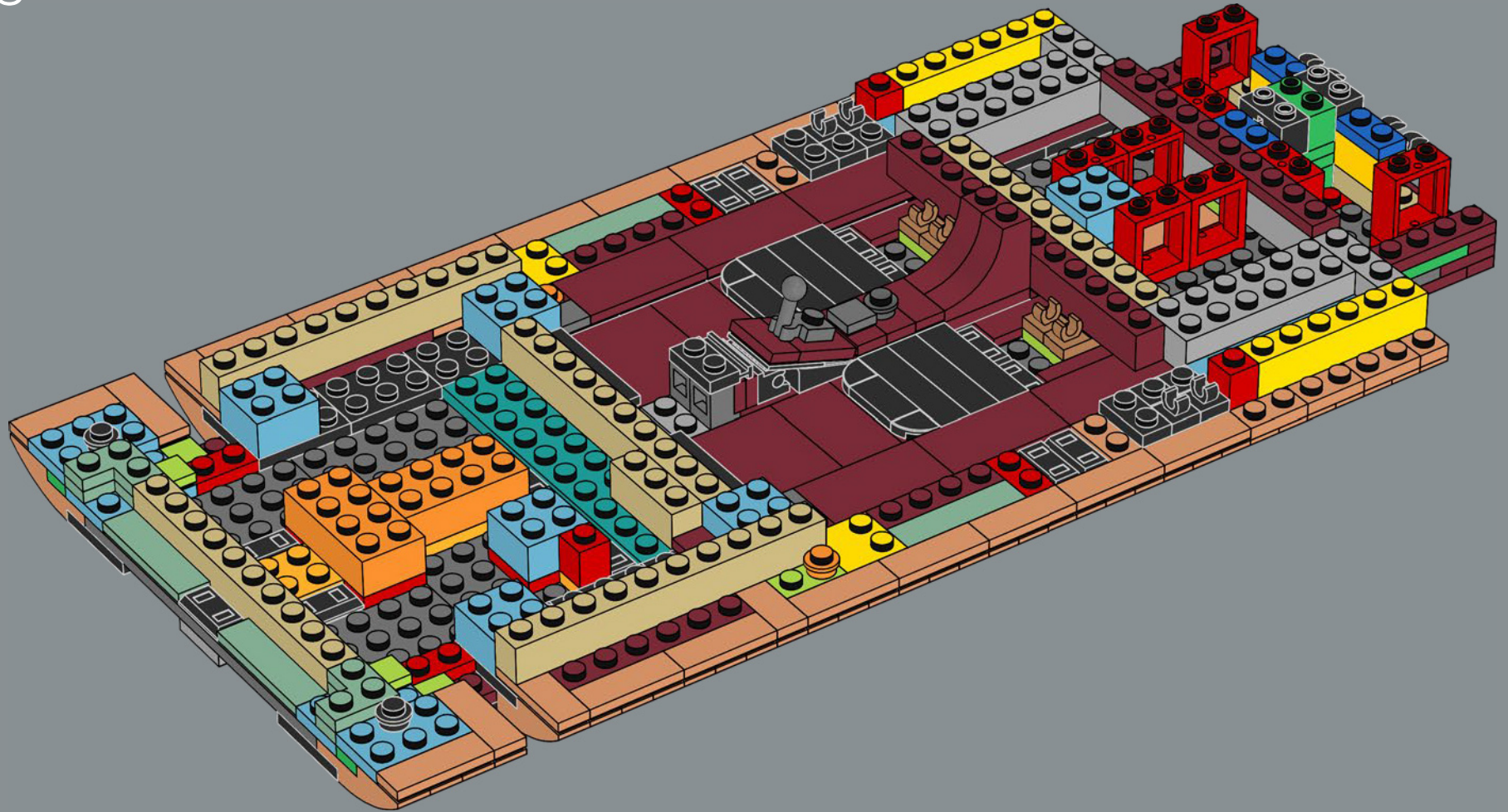

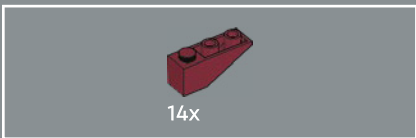

49

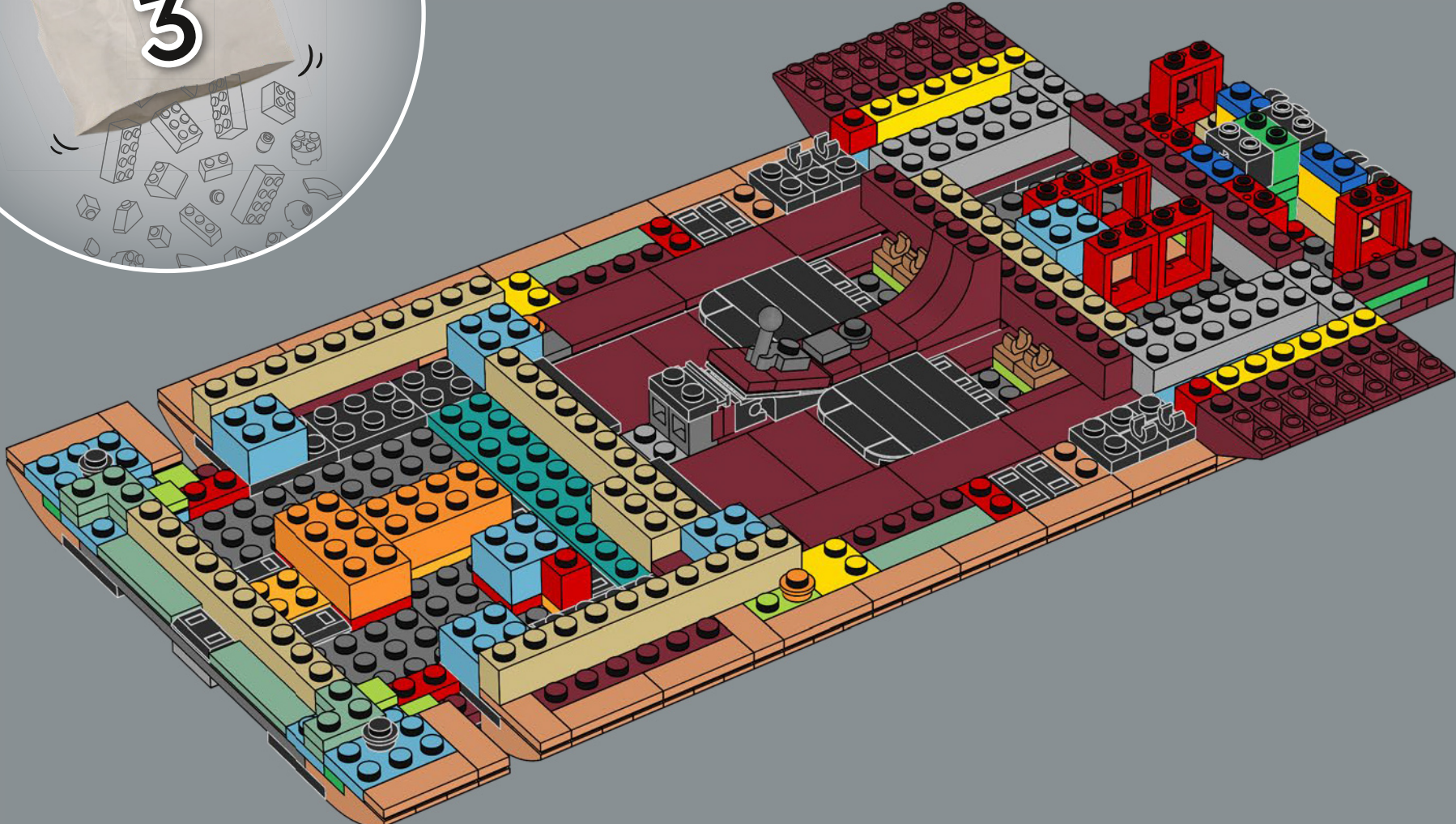

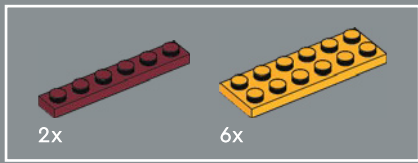

50

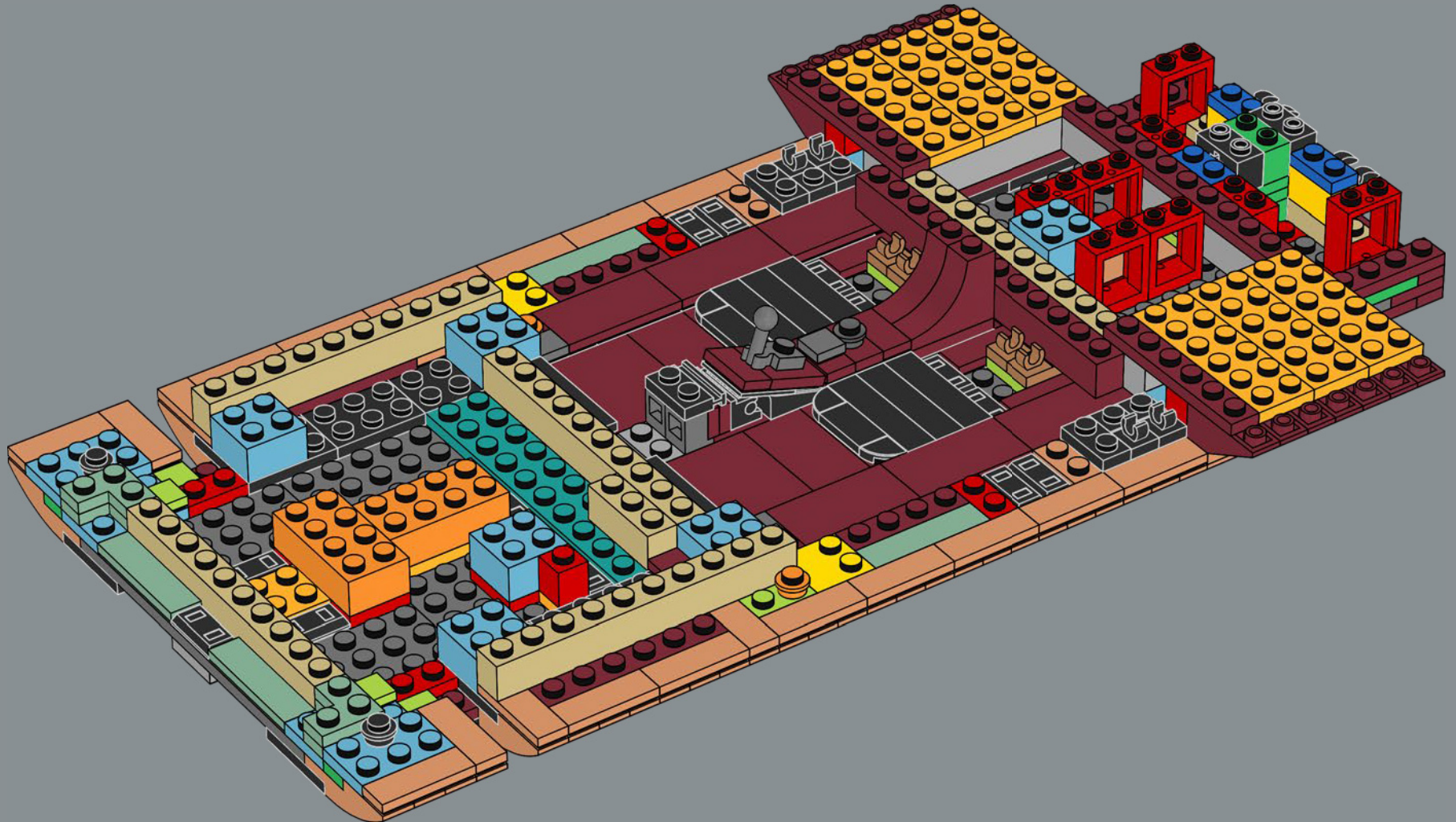

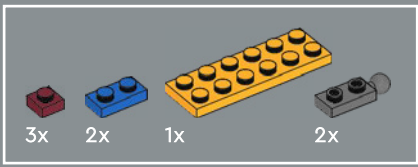

51

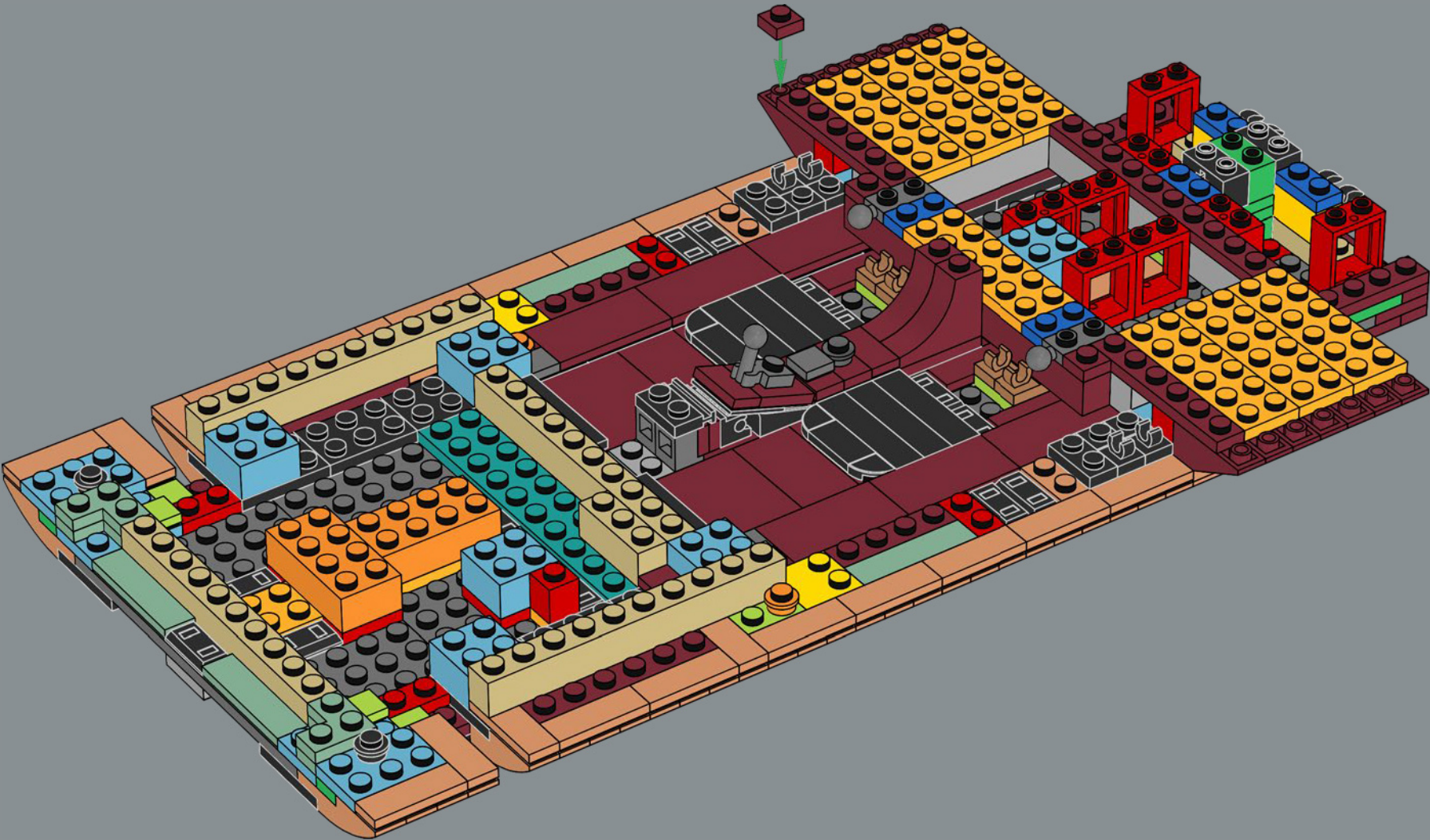

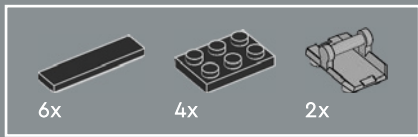

52

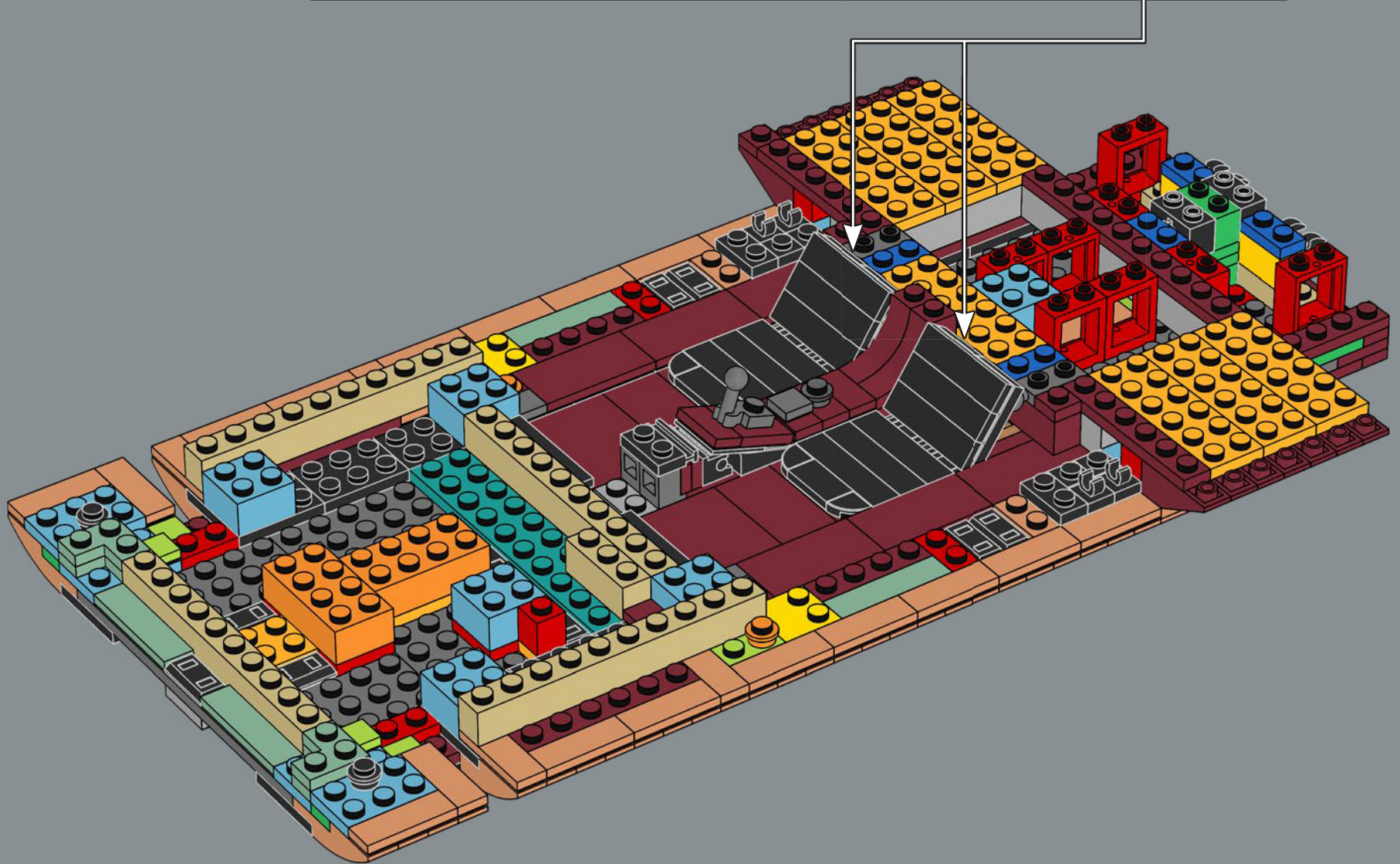
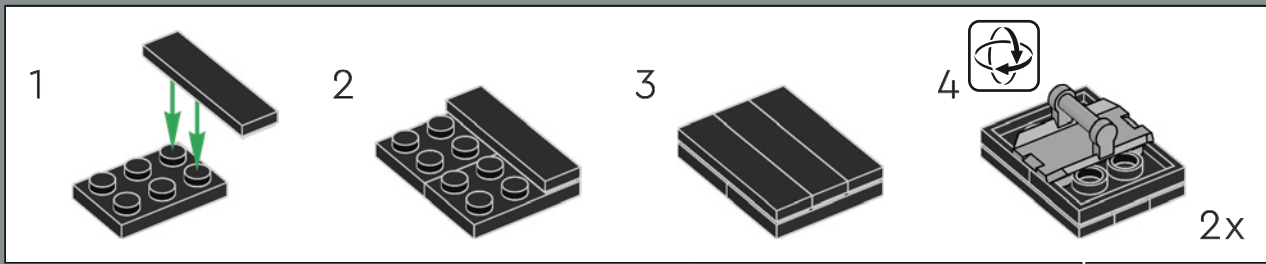

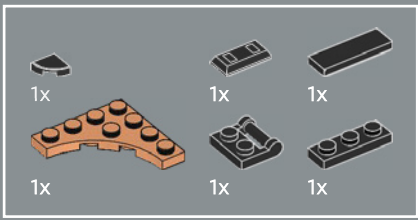

53

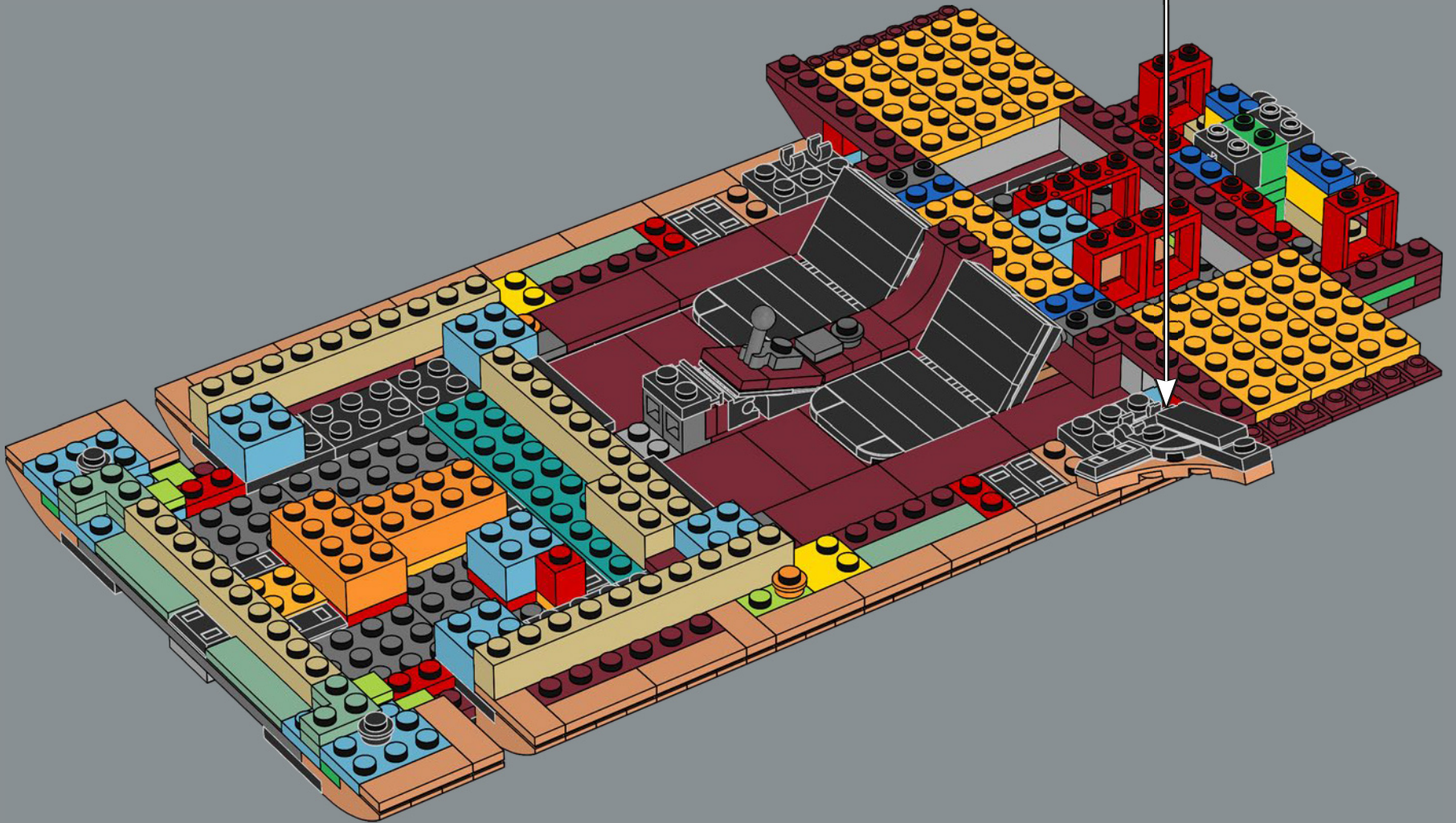
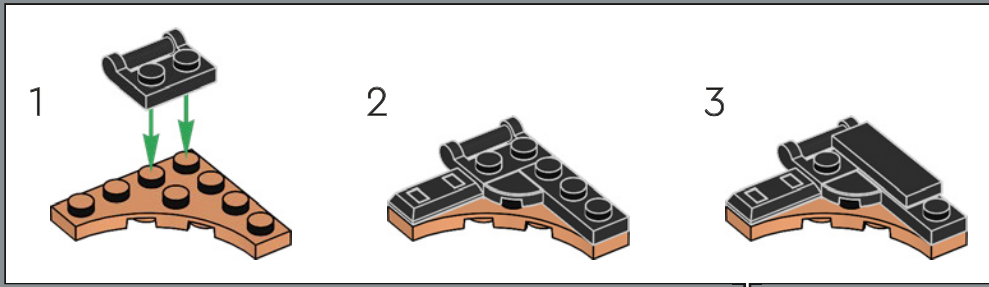

58

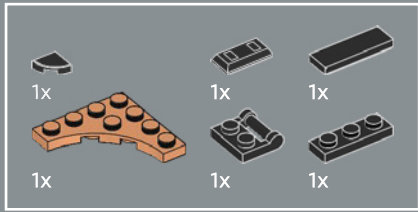

54

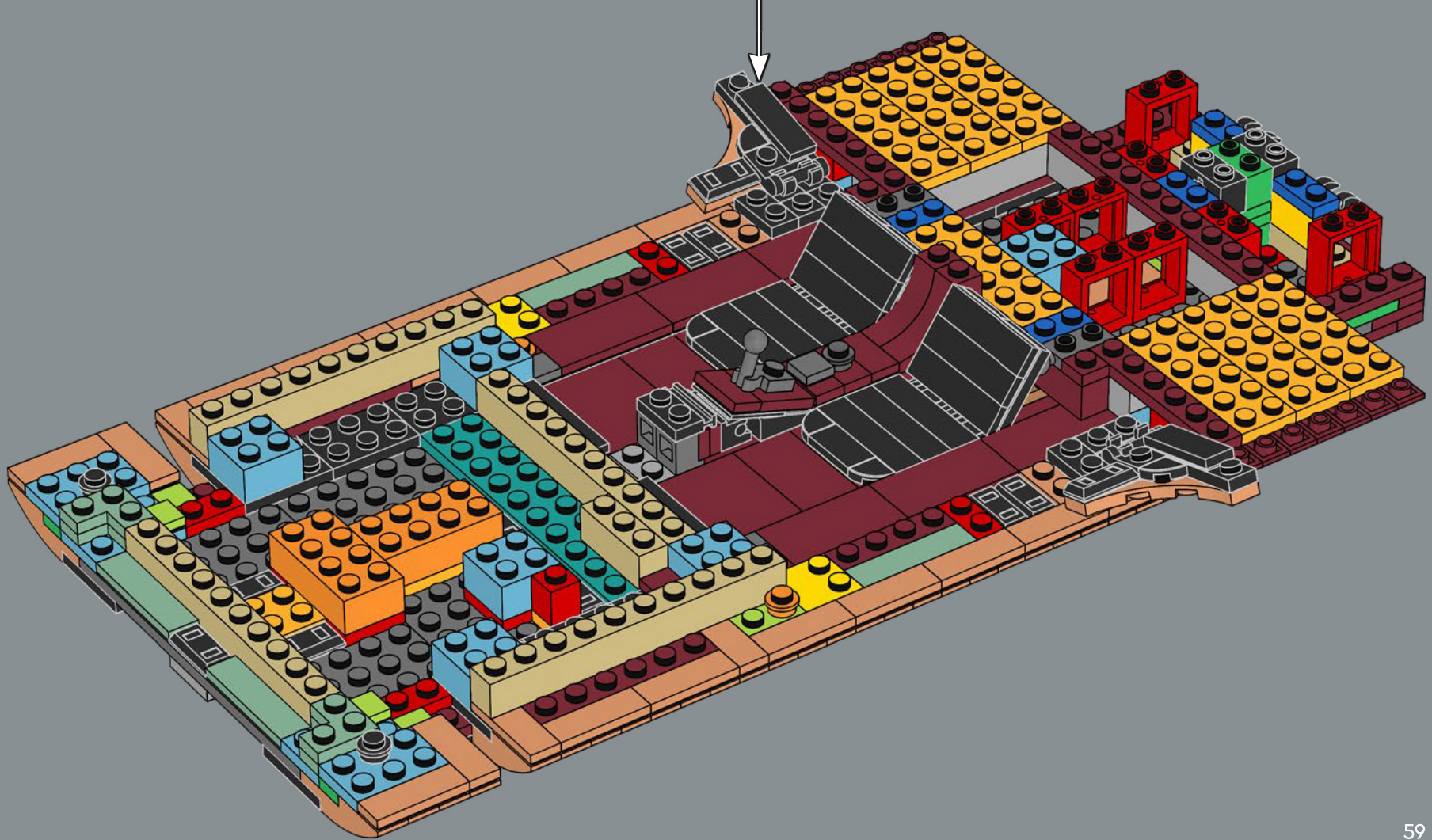
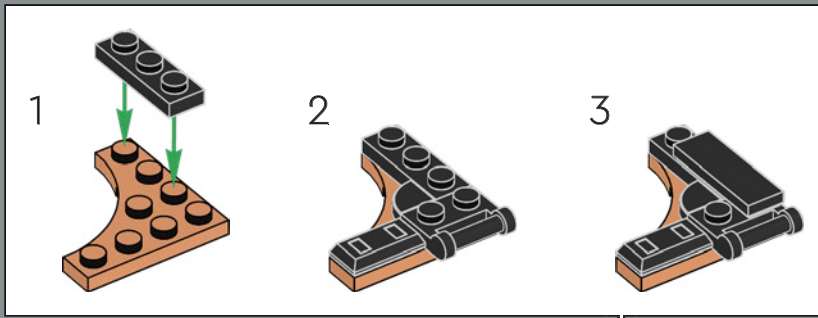

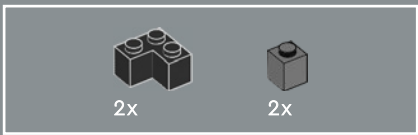

55

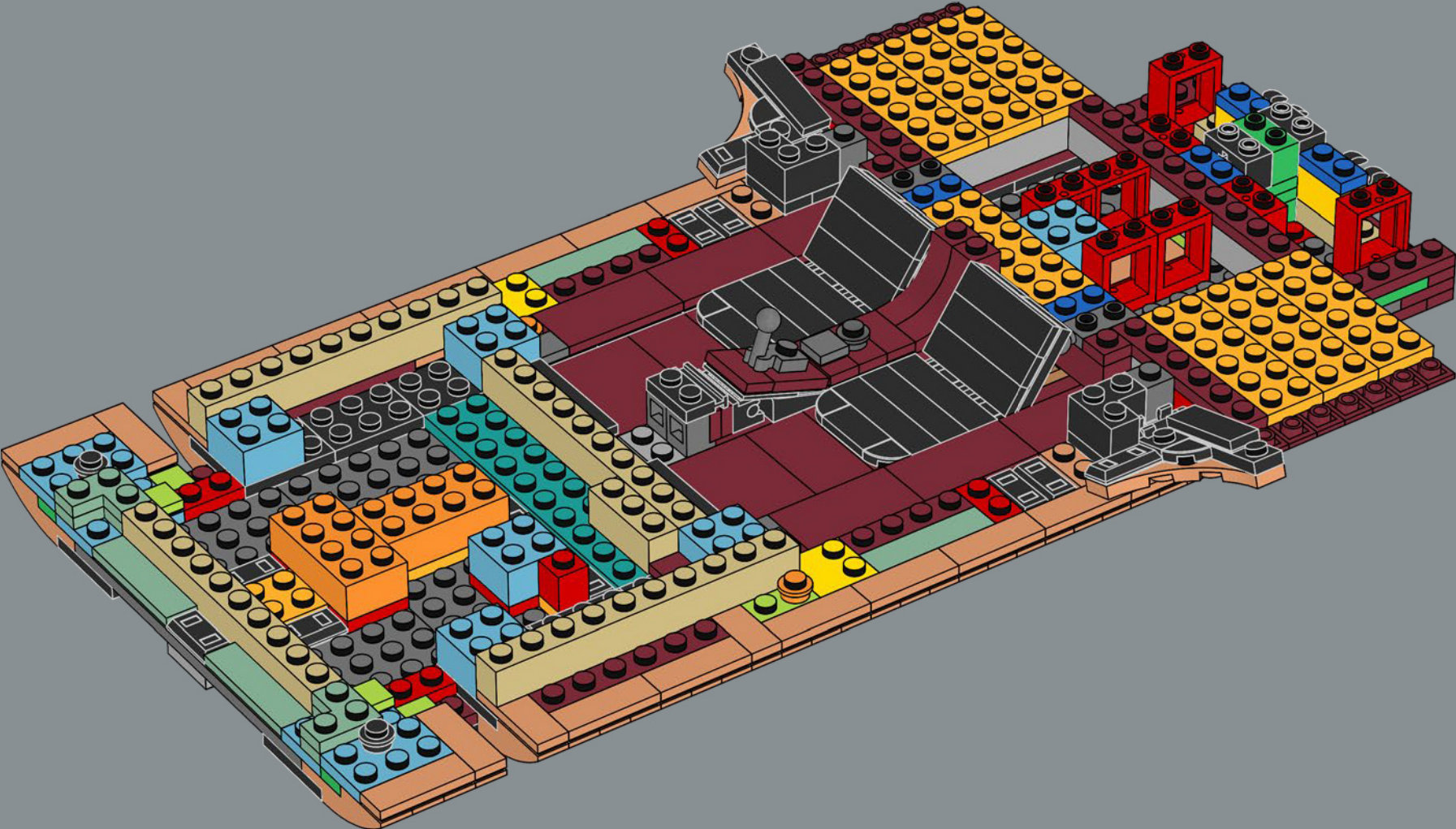

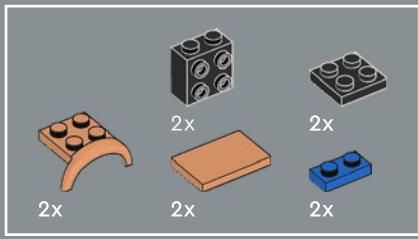

56

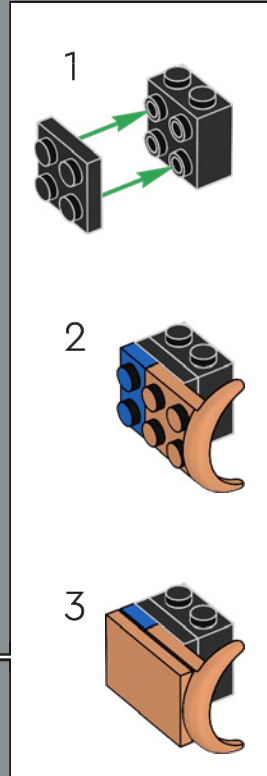
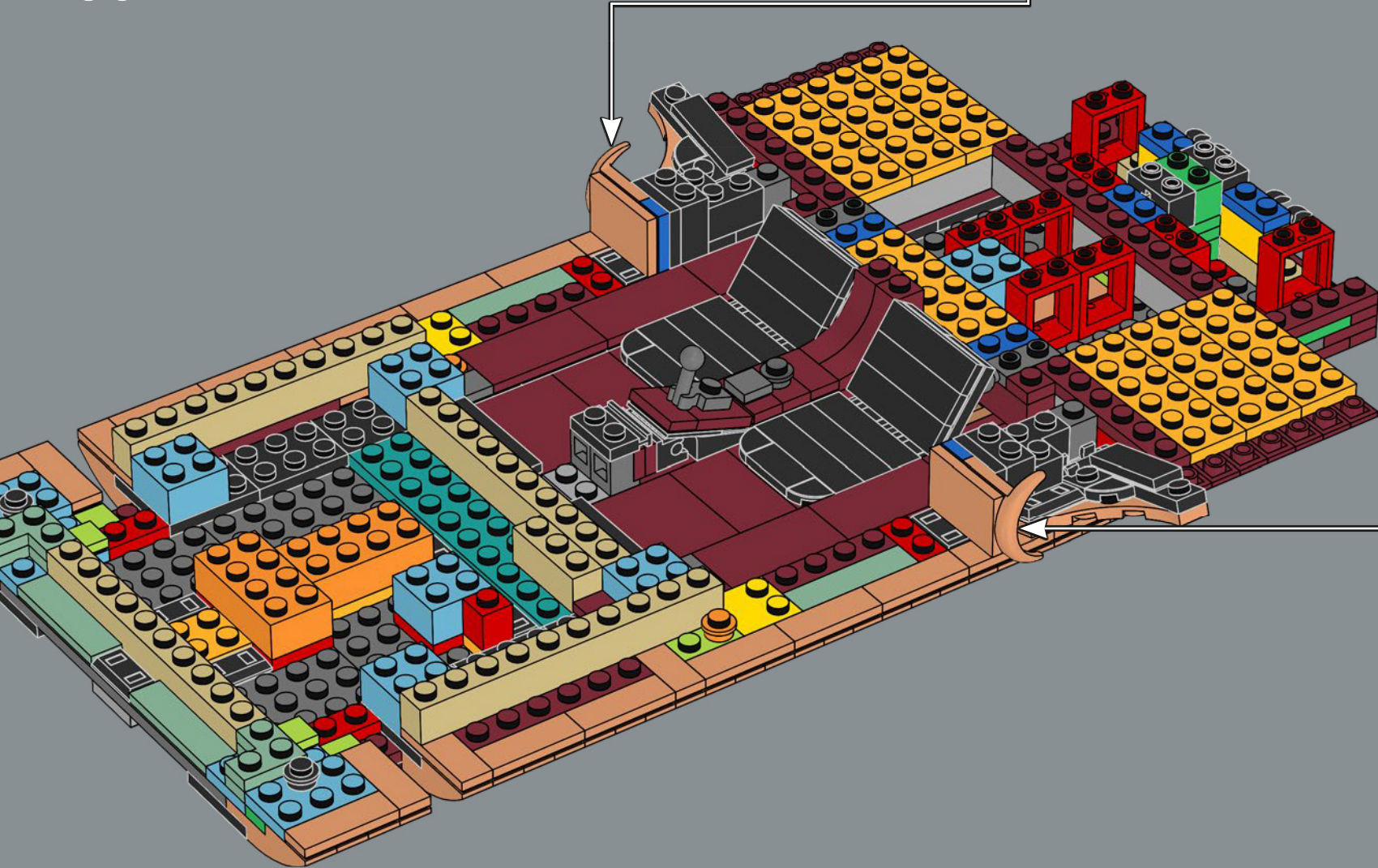
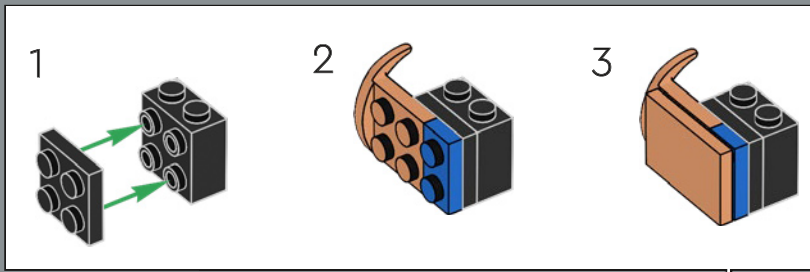

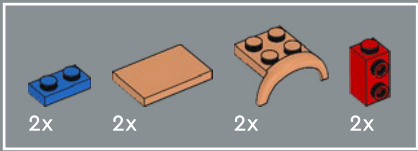

57

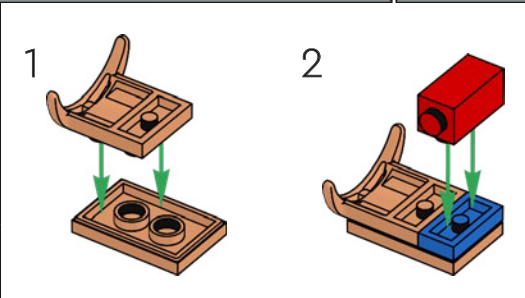
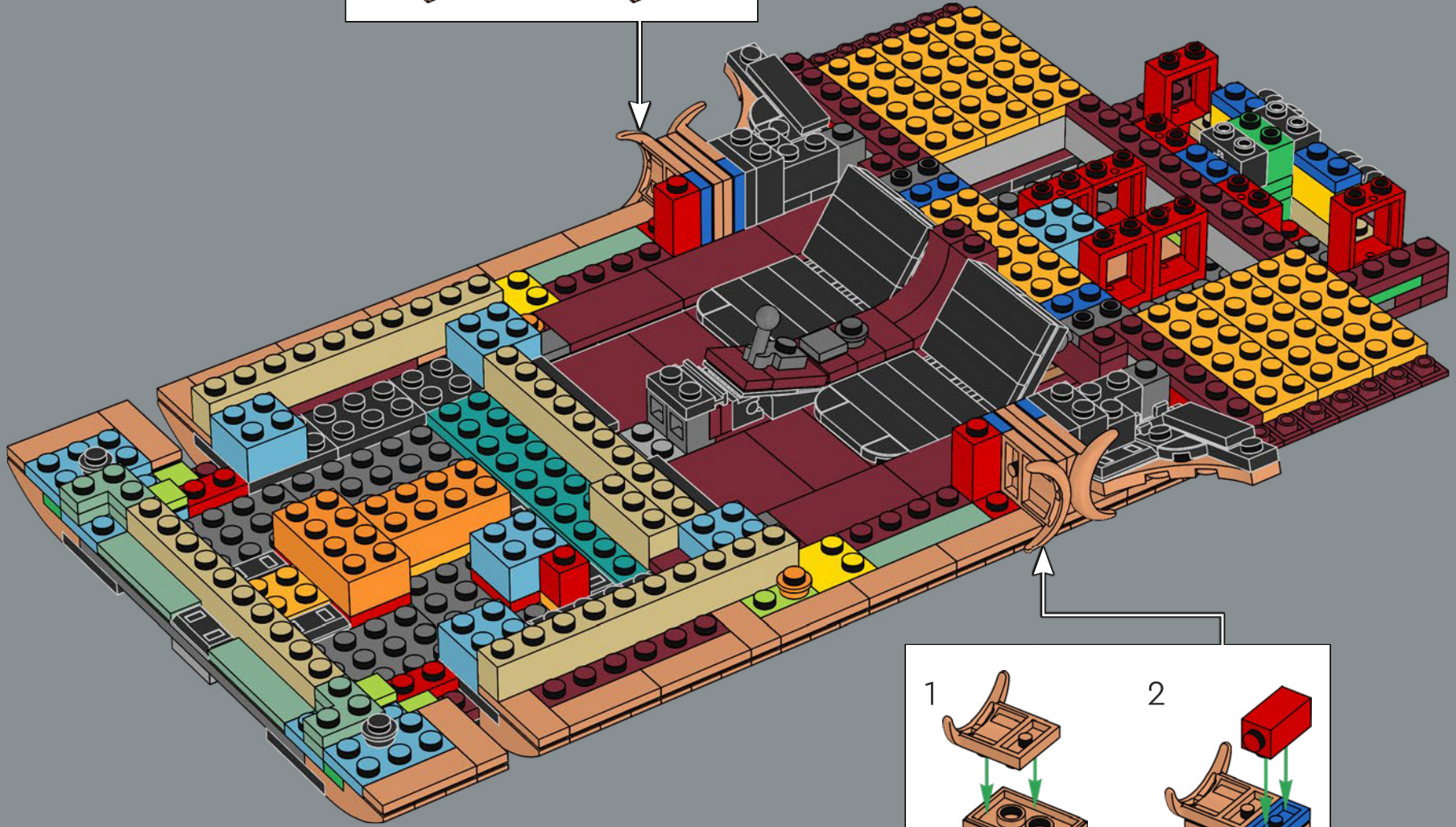
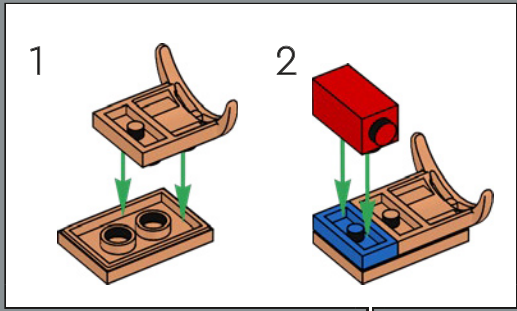

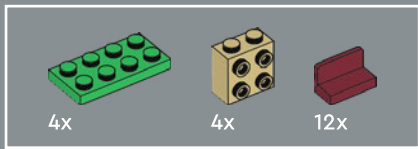

58

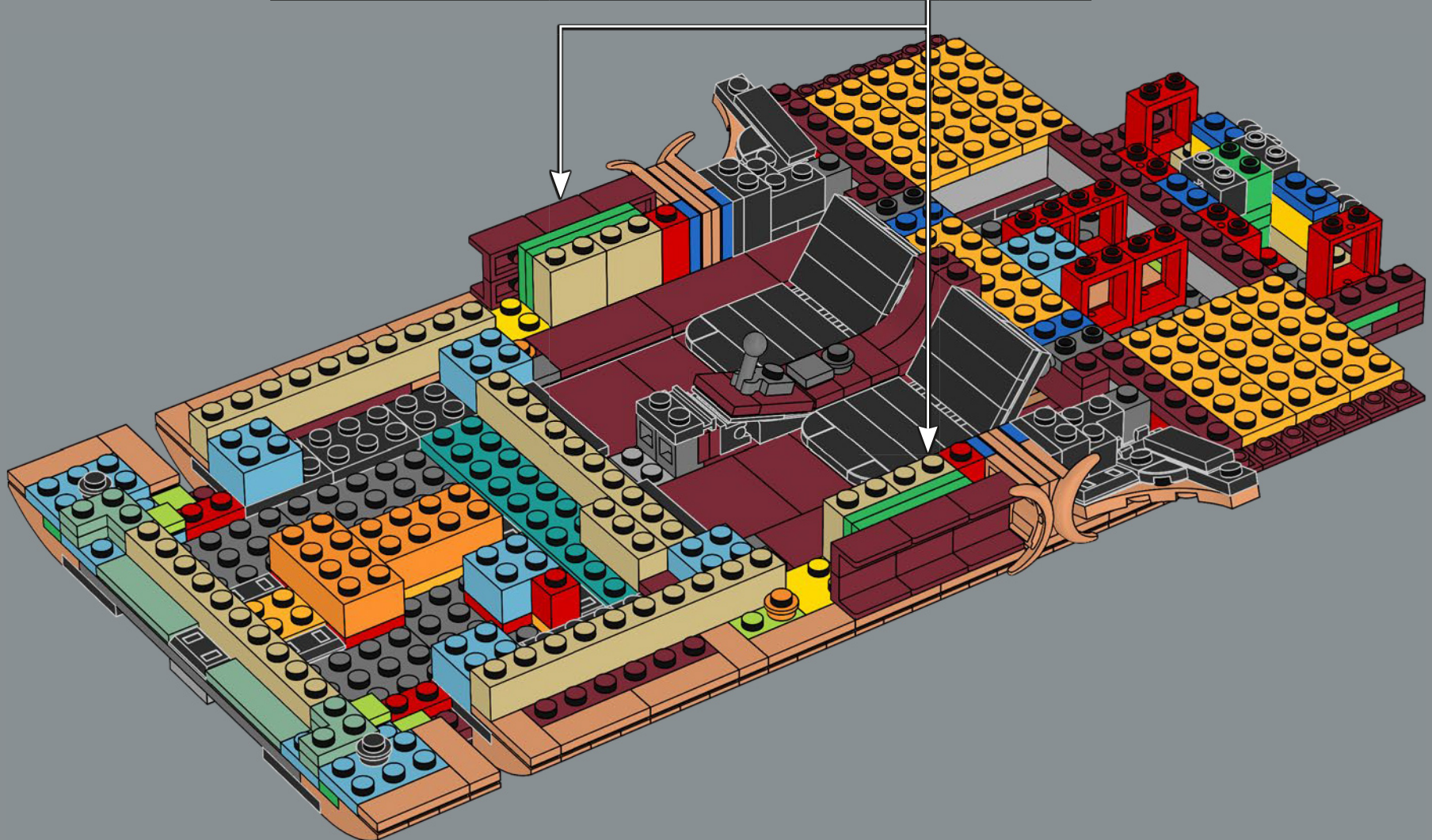
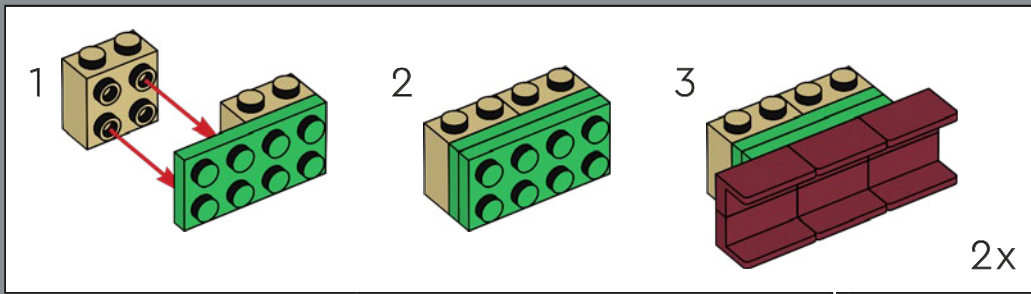

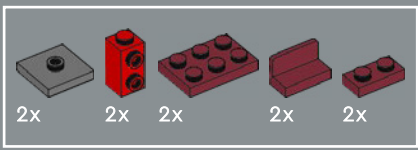

59

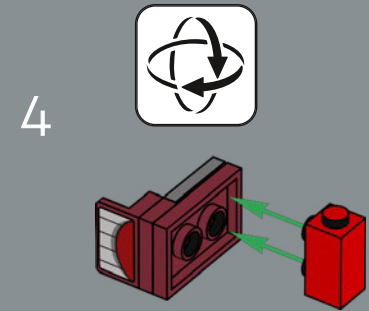
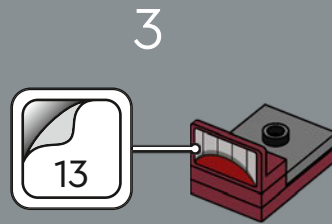
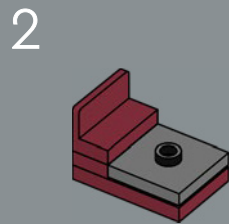
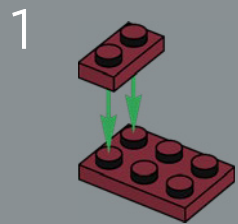
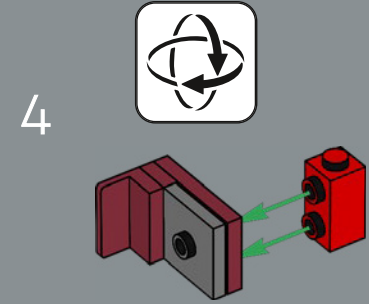
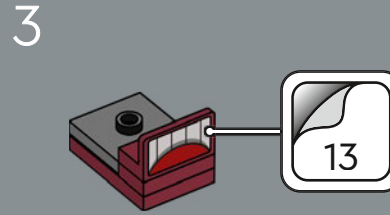
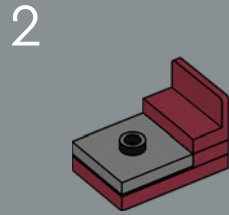
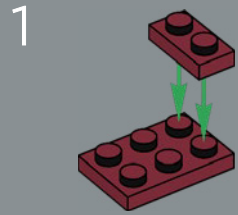

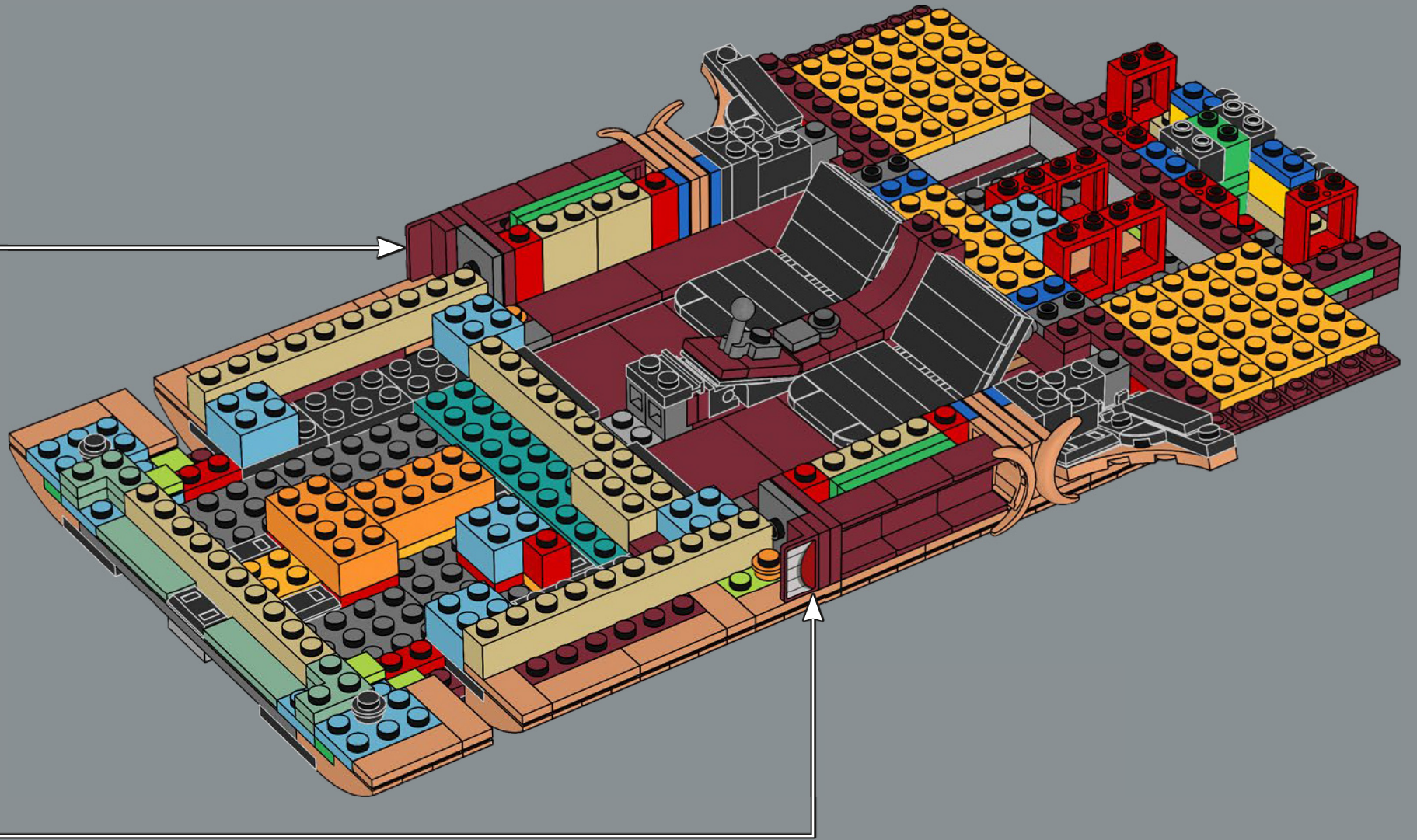

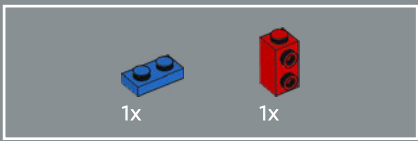

60

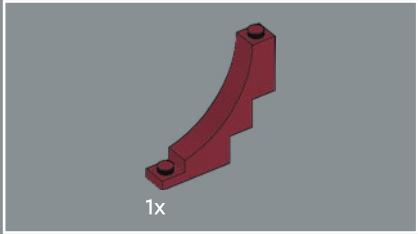
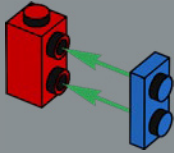

61

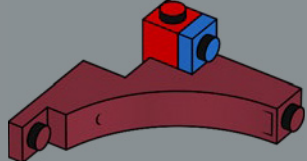

62

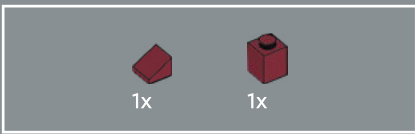
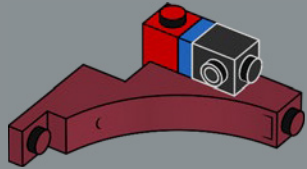

63

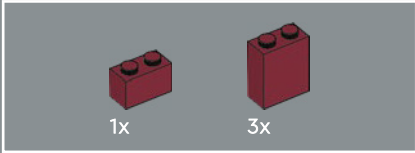
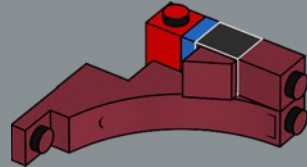

64

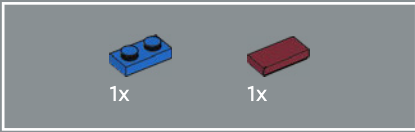
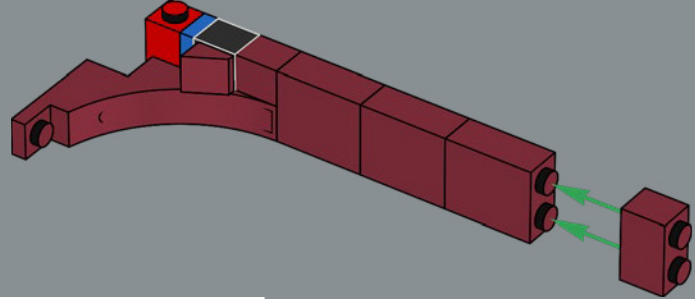

65

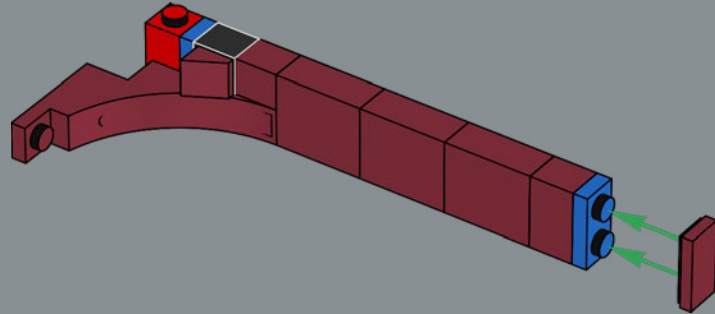

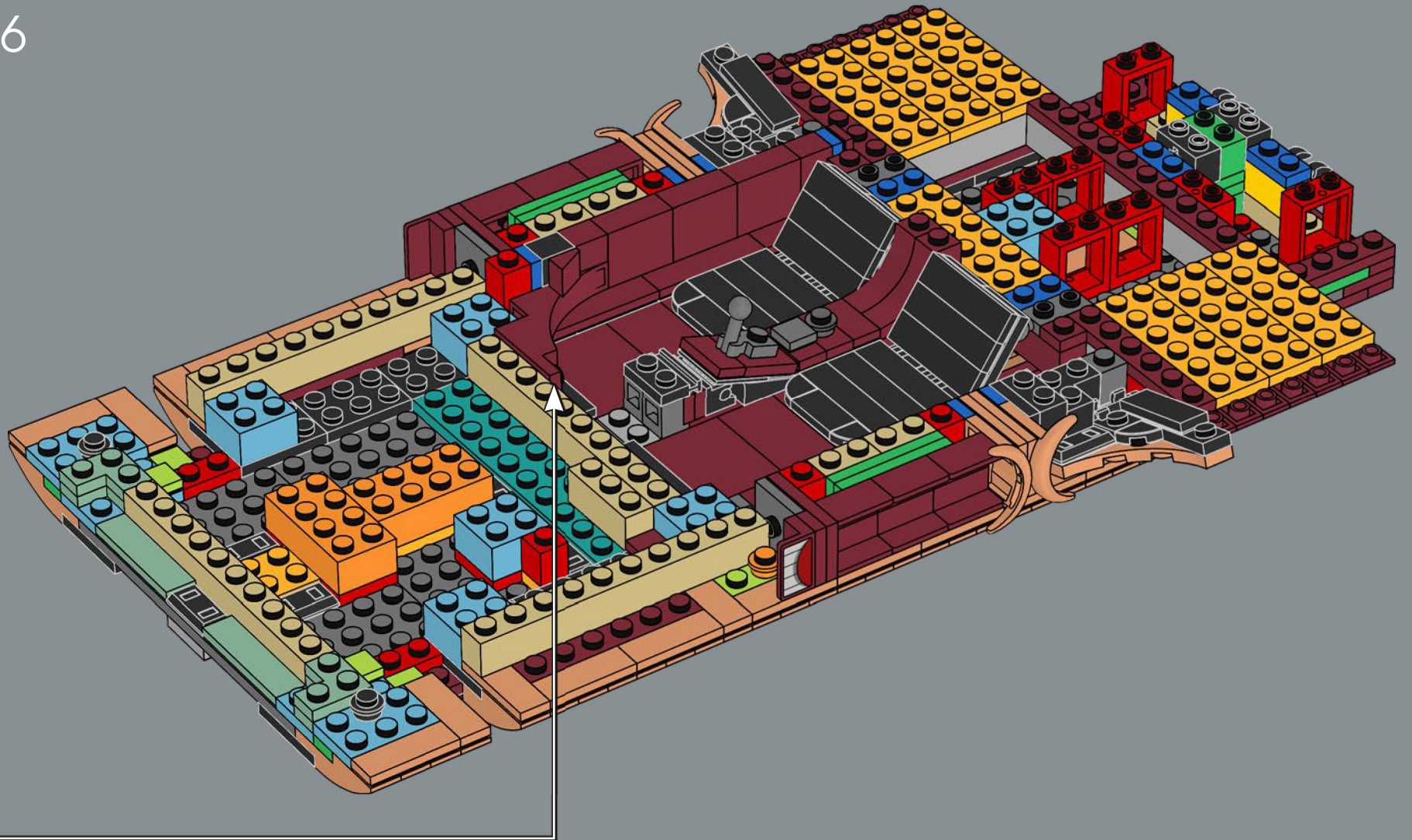

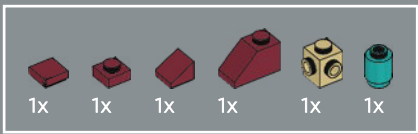

67

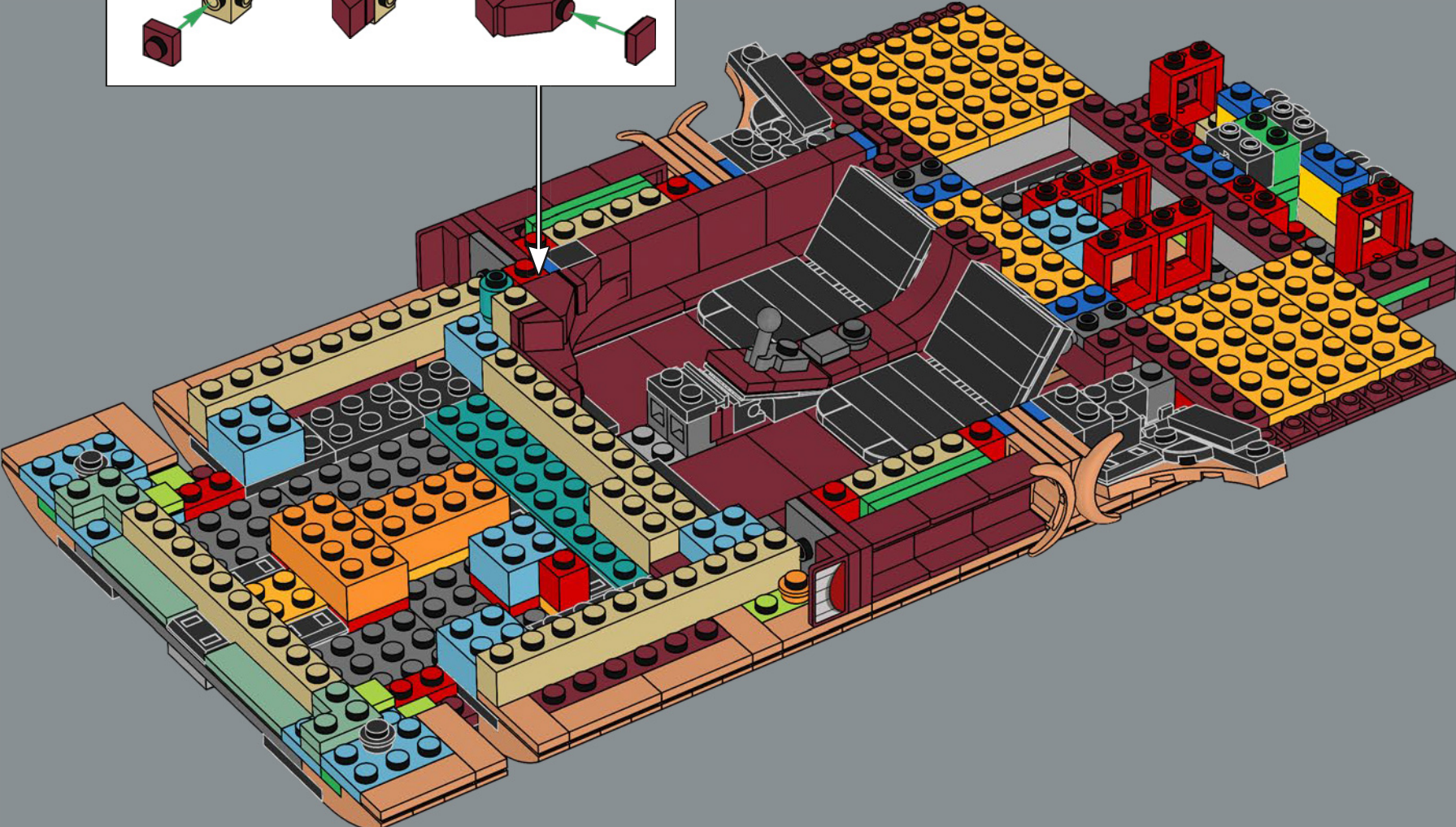
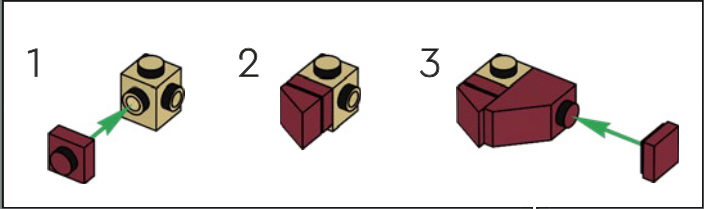

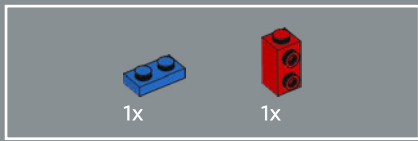

68

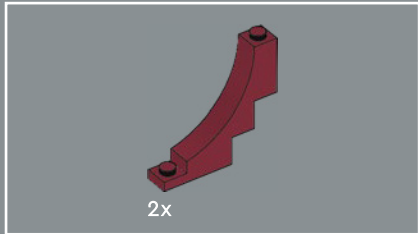
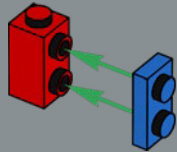

69

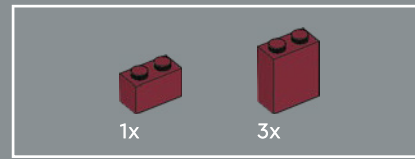
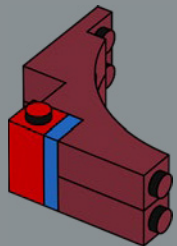

70

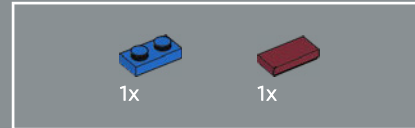
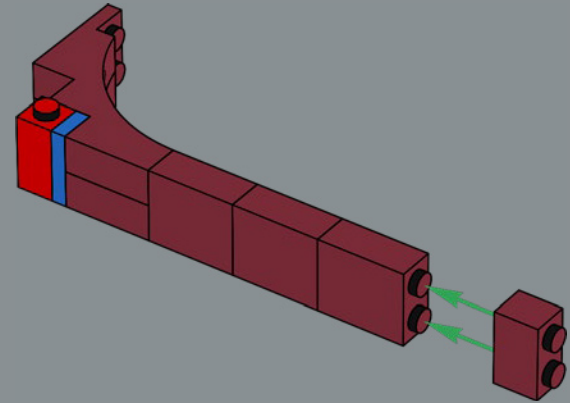

71

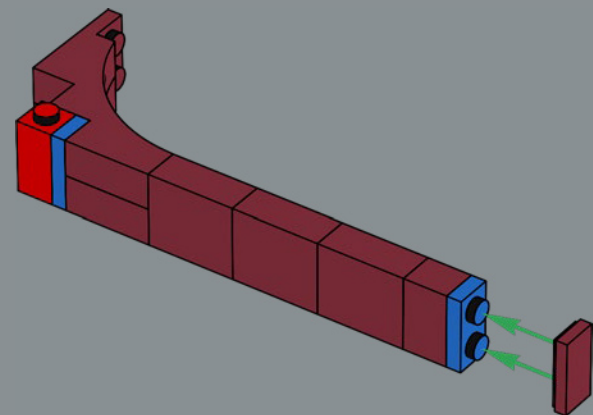

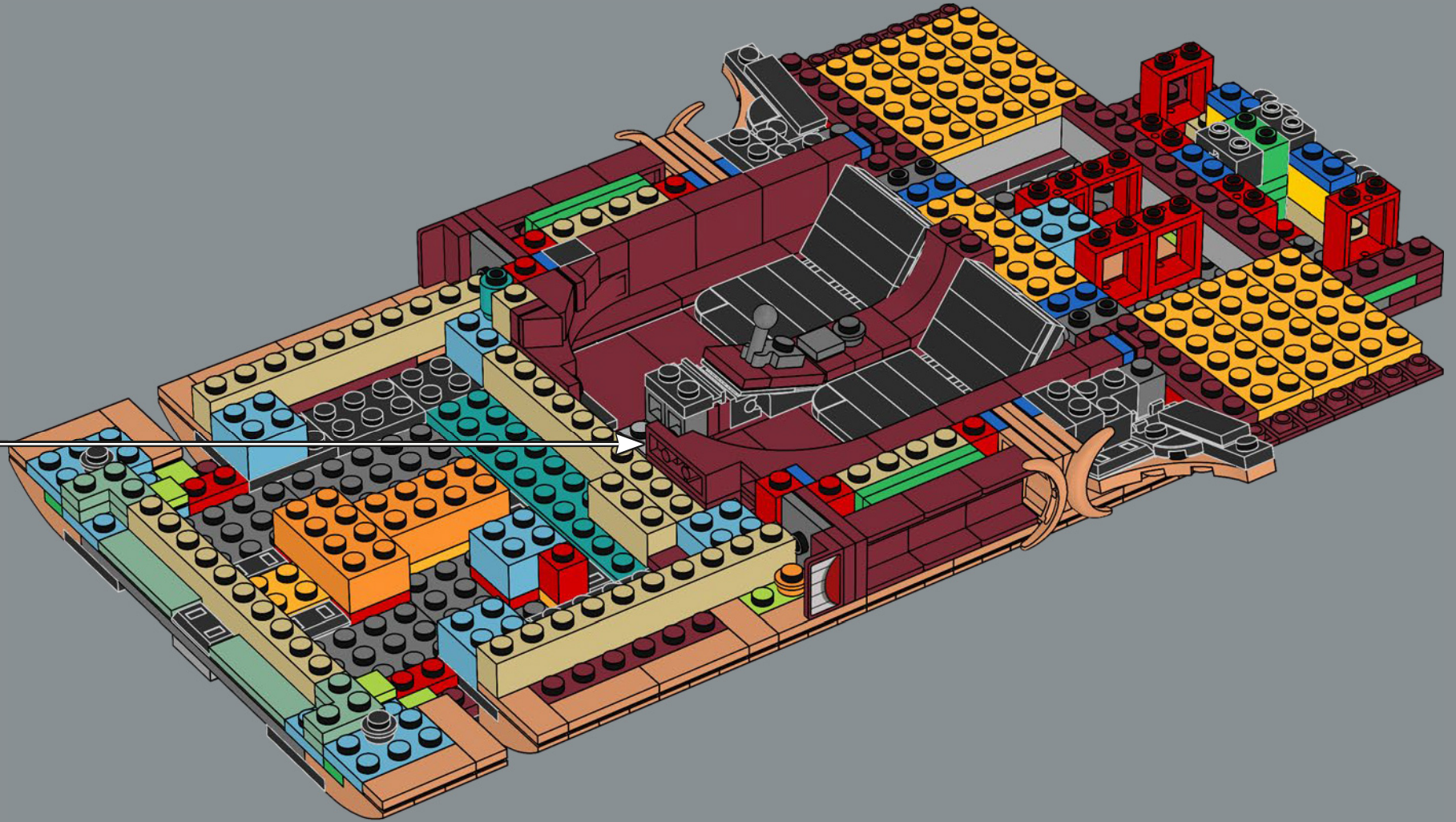

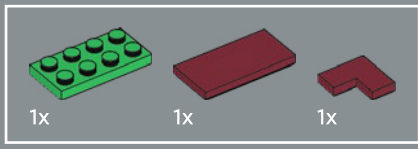

73

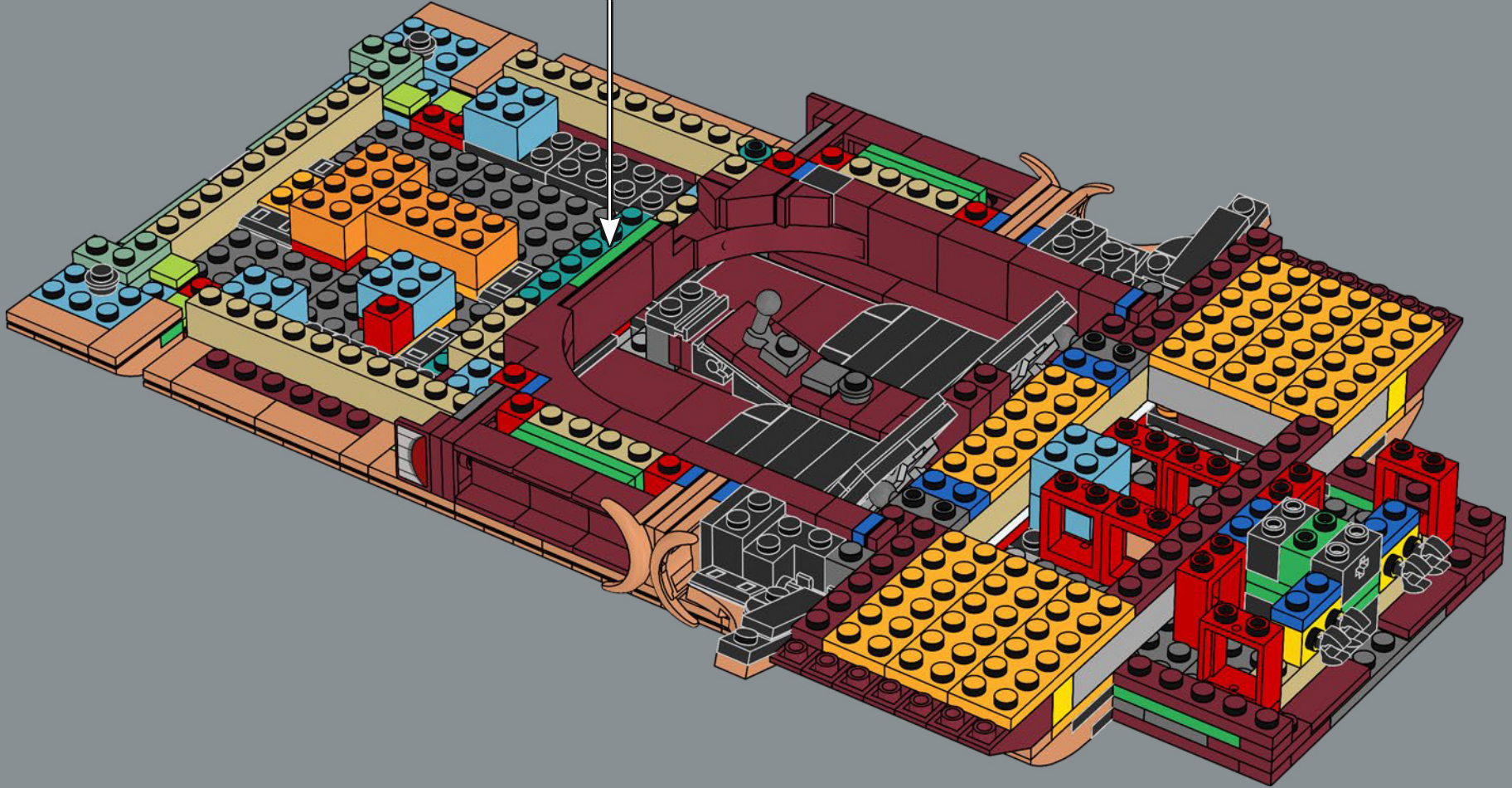
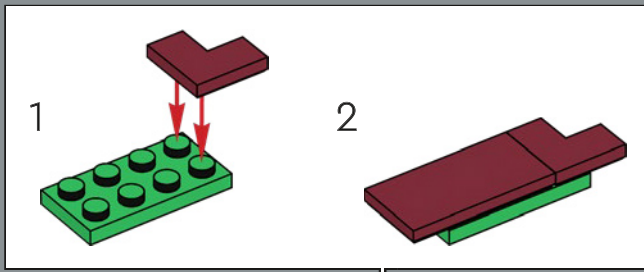

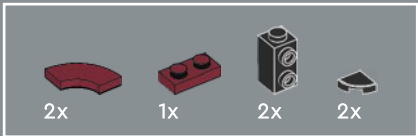

74

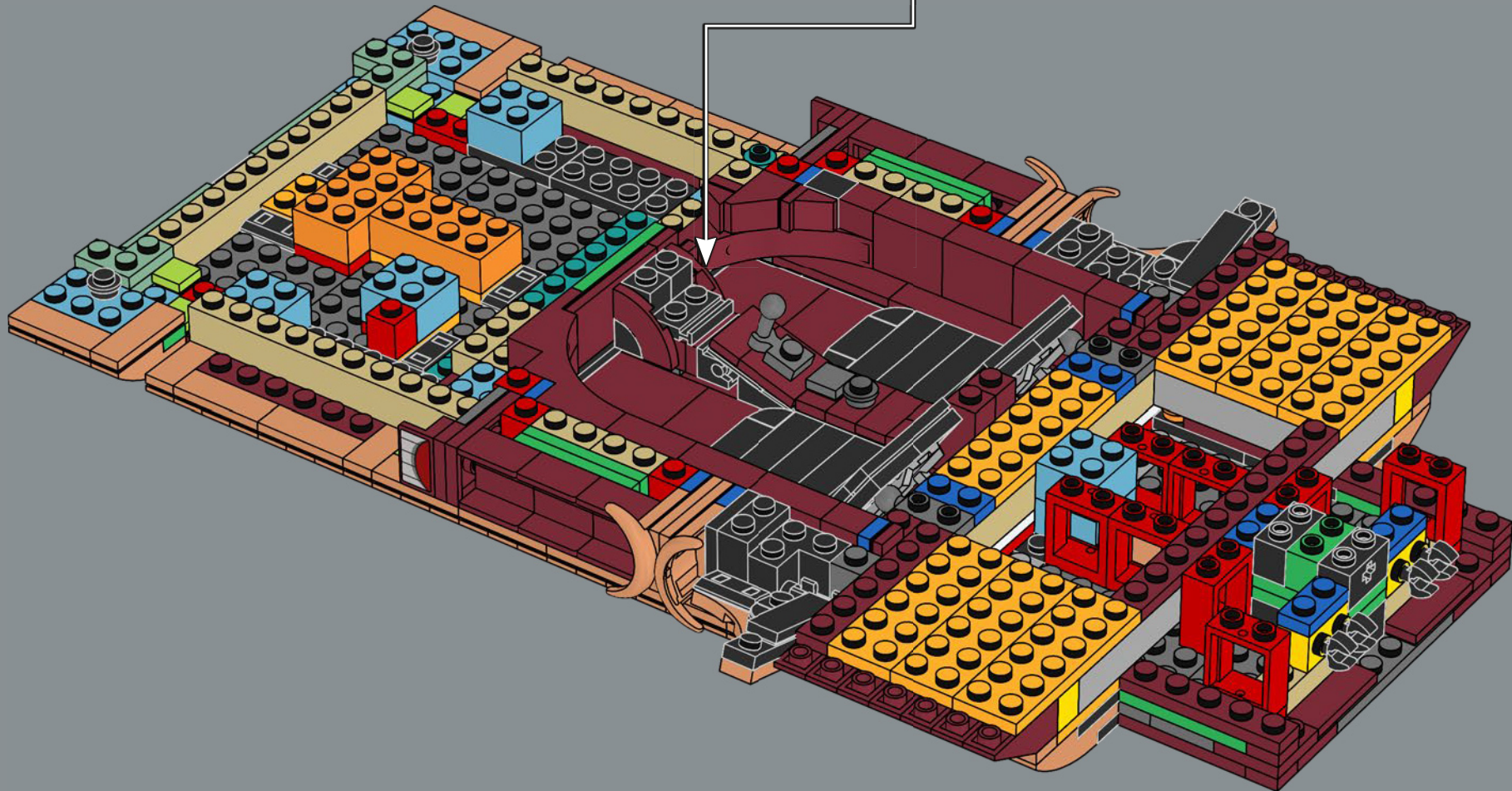
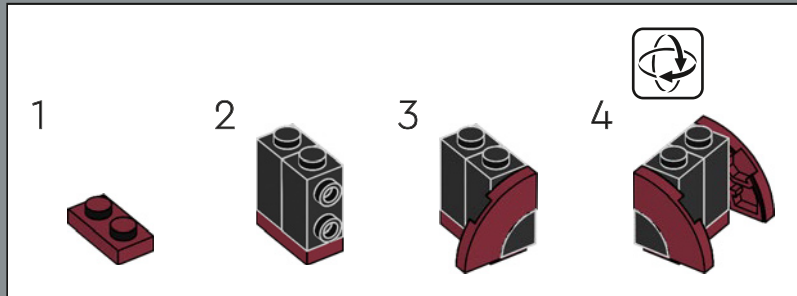

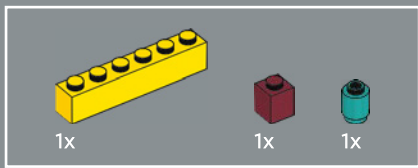

75

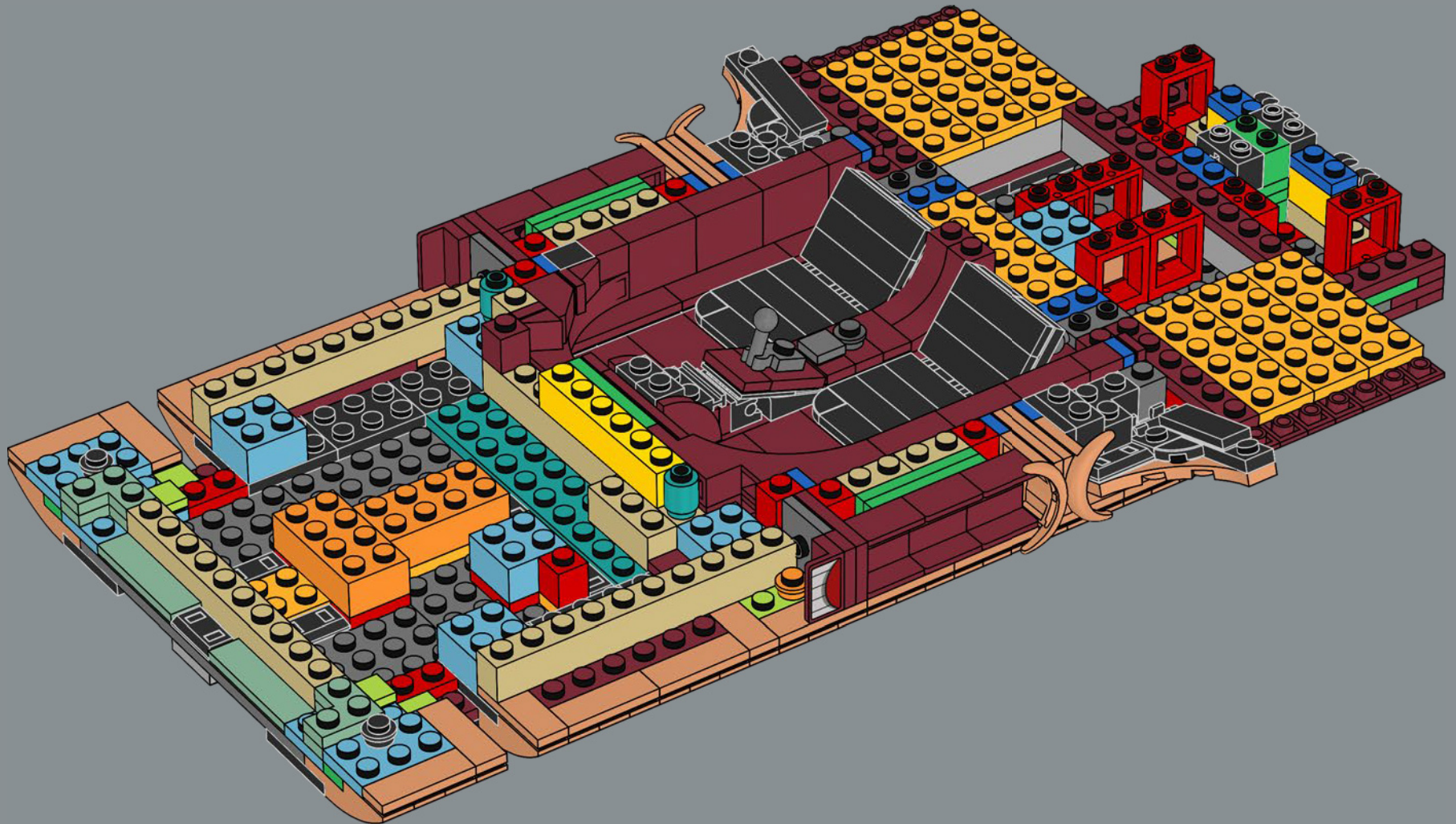

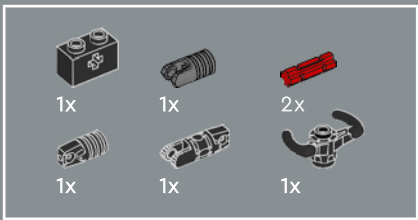

76

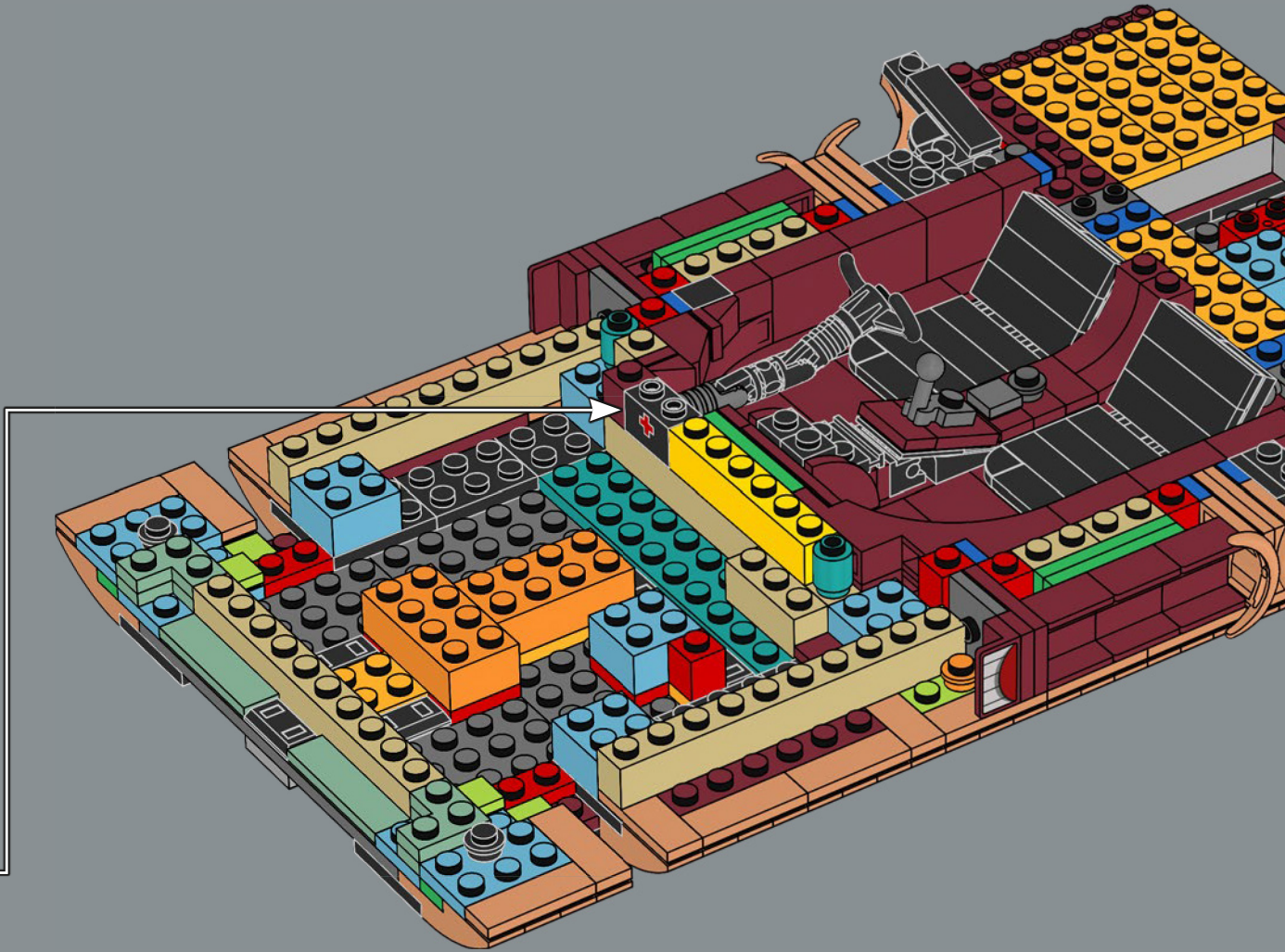
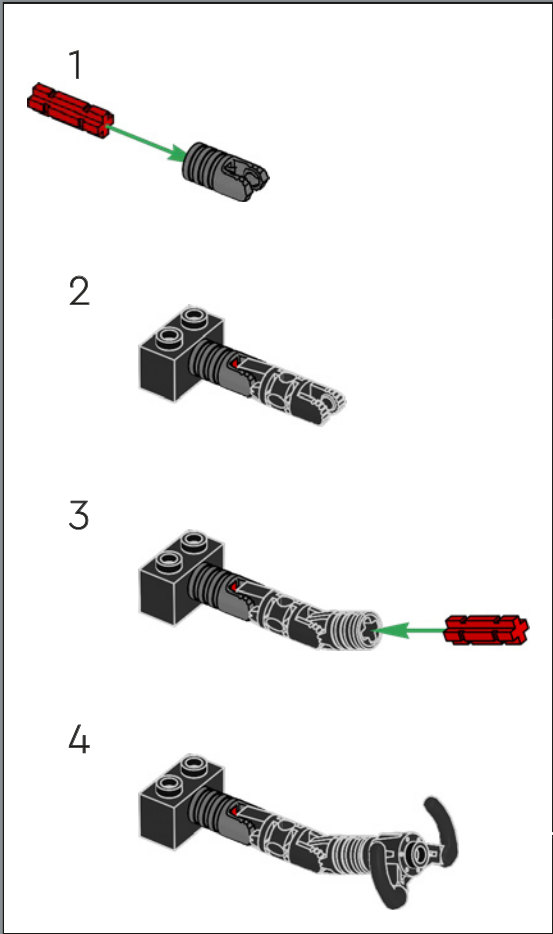

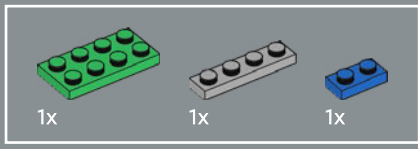

77

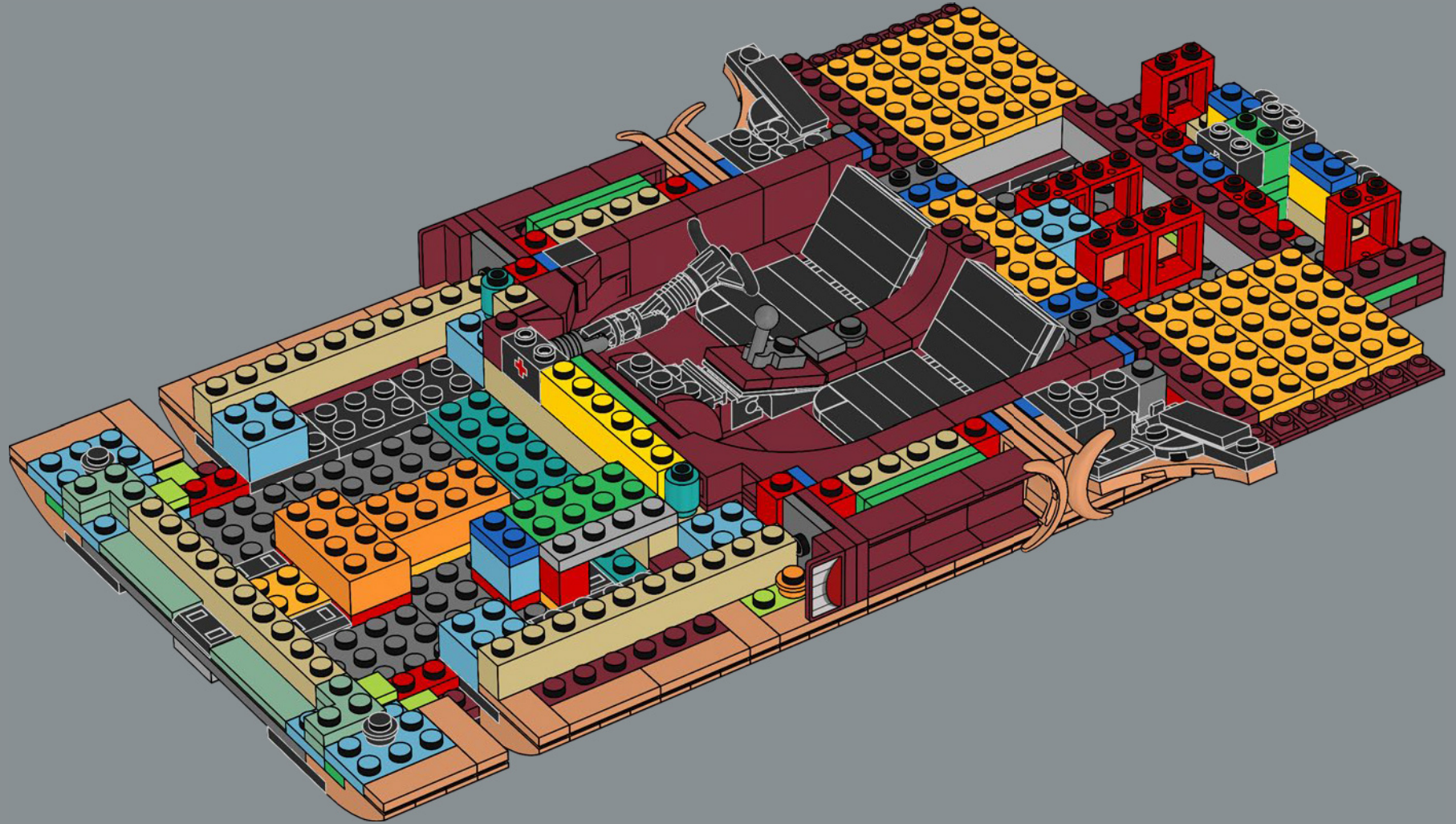

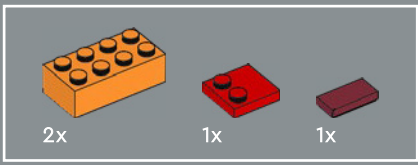

78

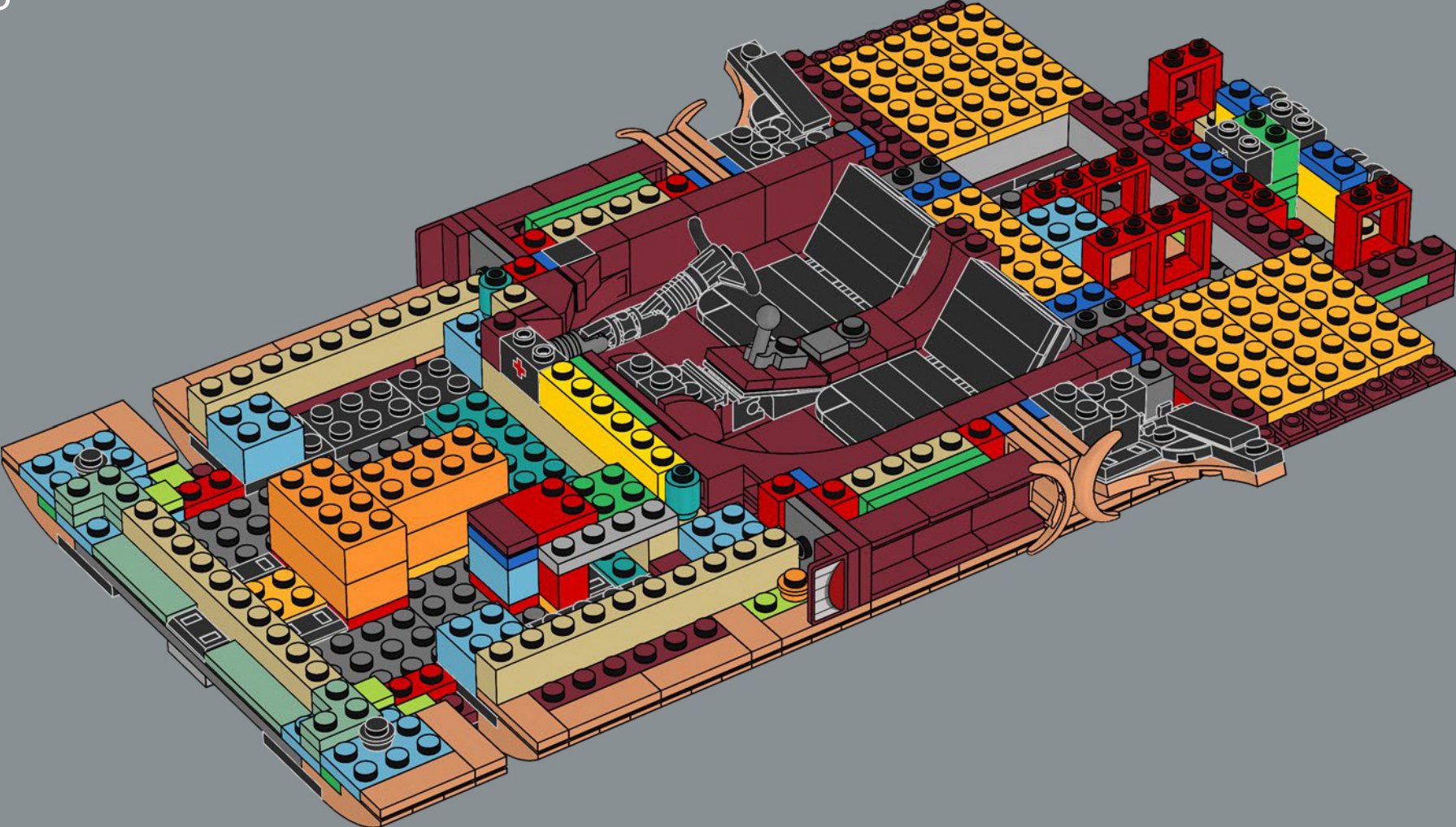

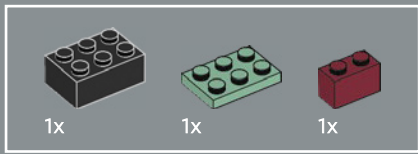

79

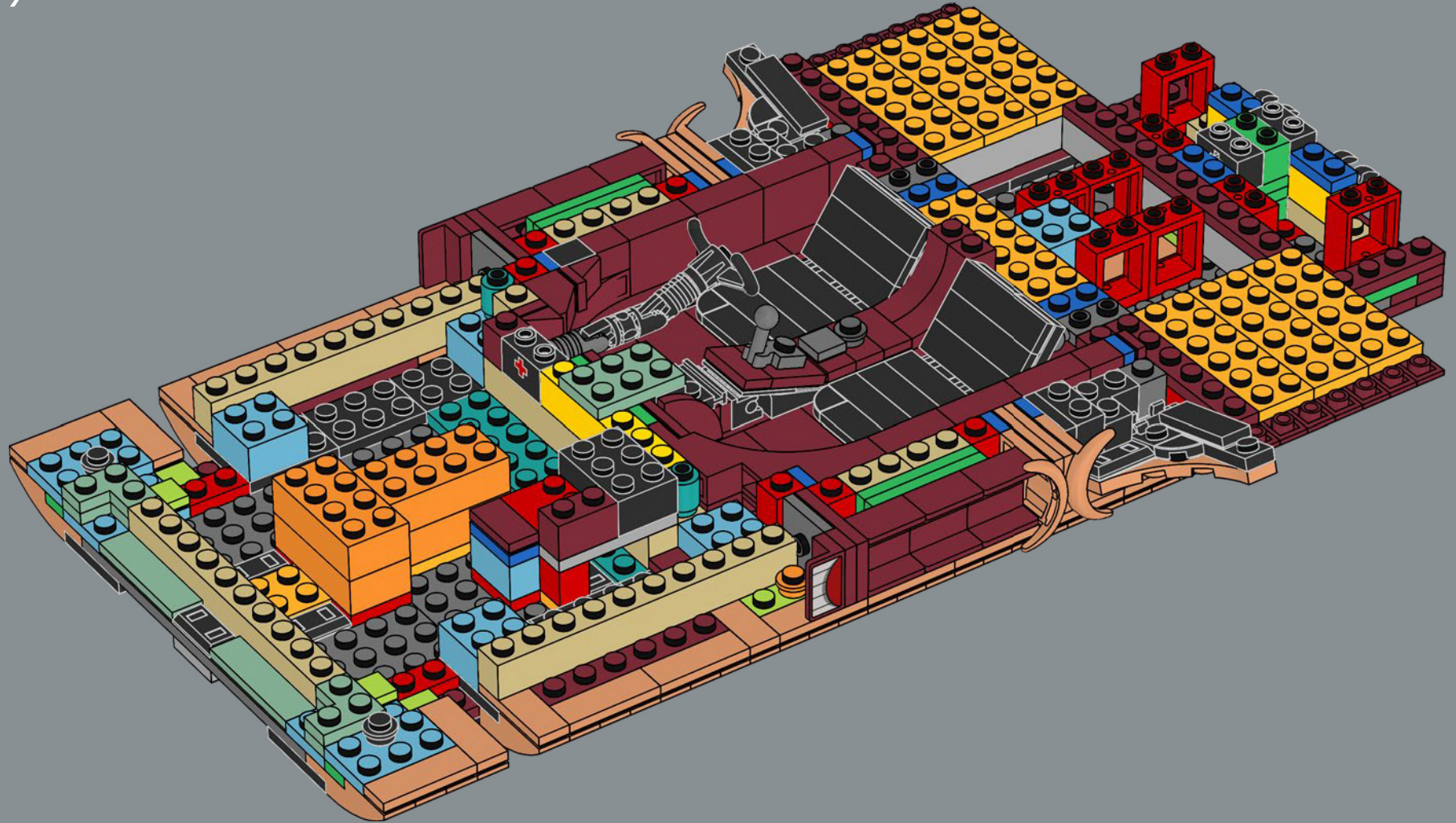

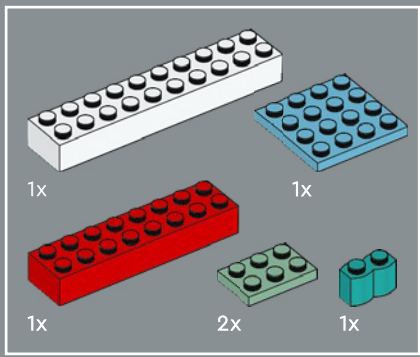

80

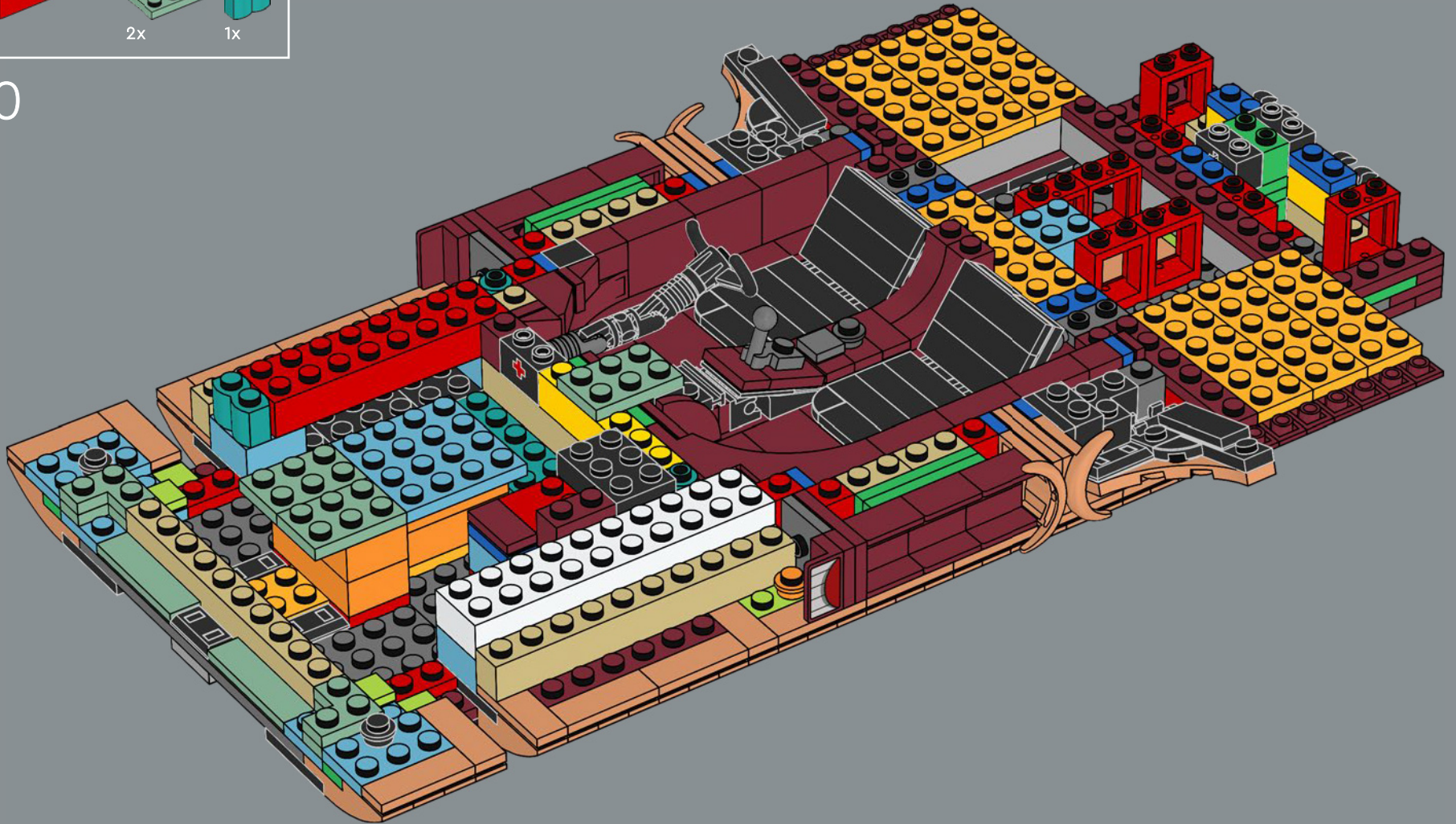

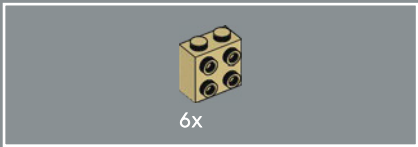

81

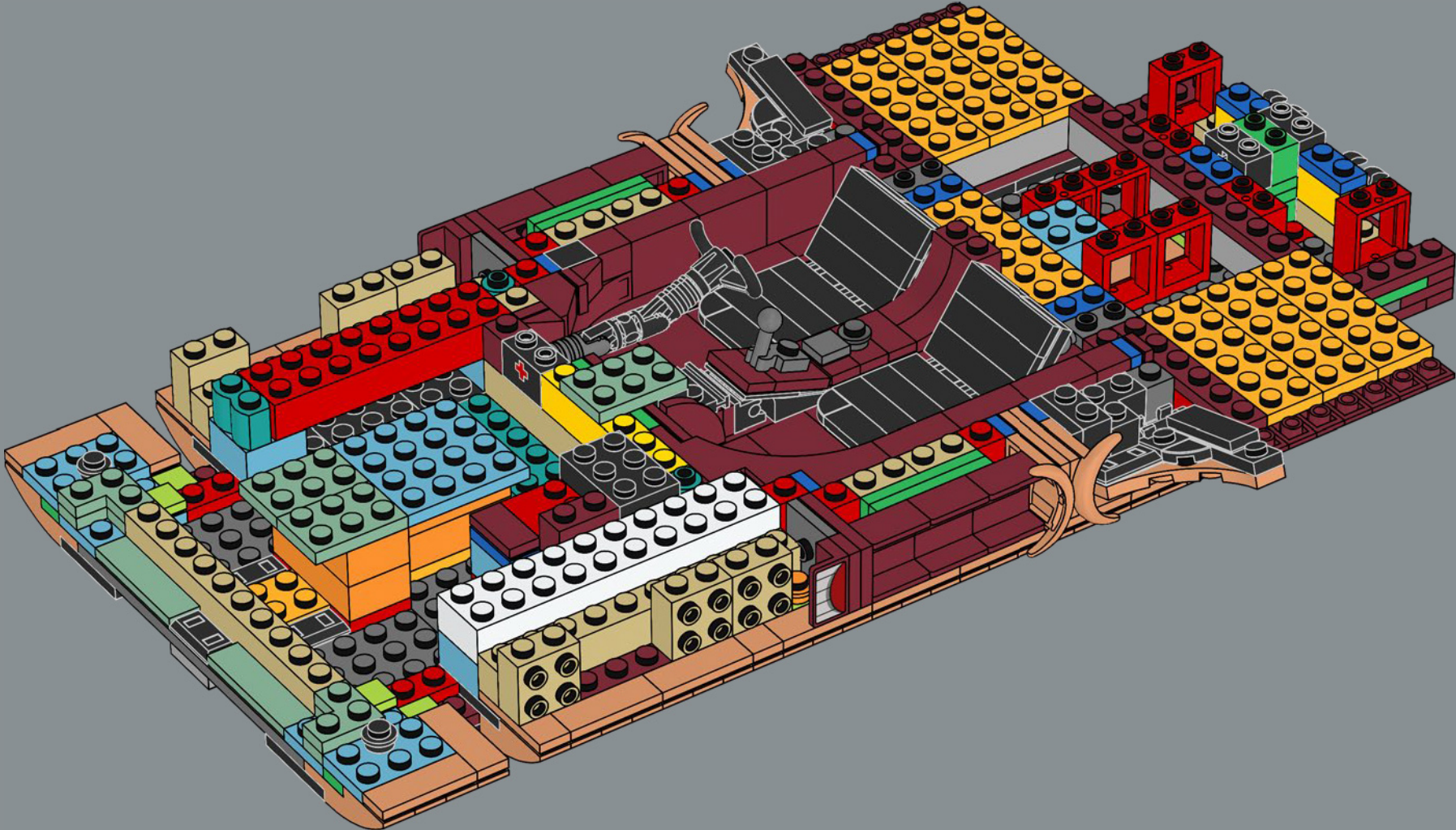

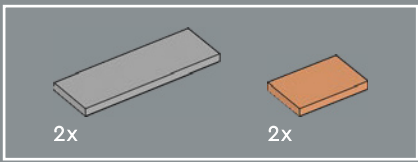

82

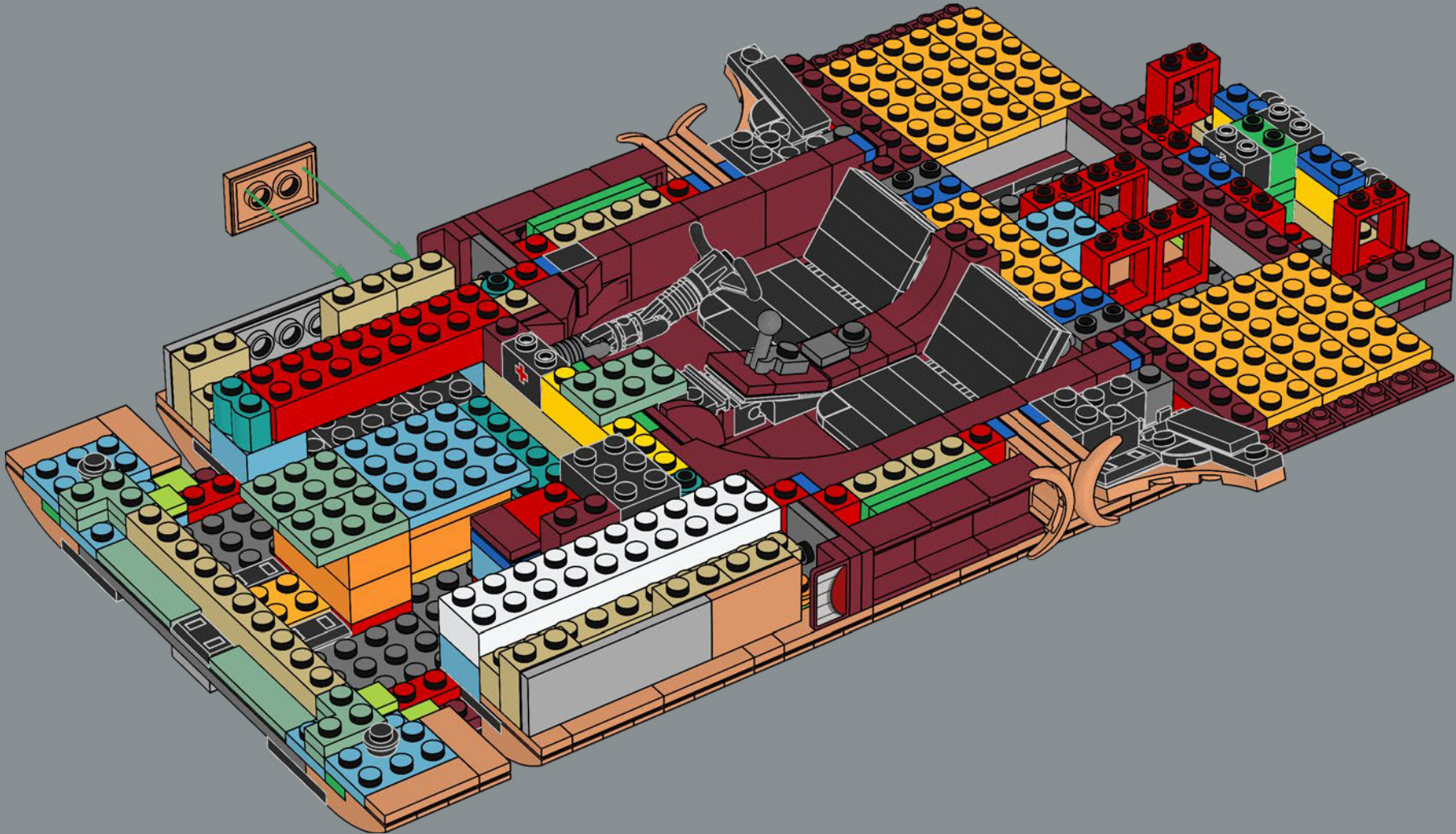

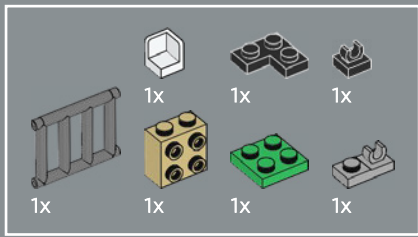

83

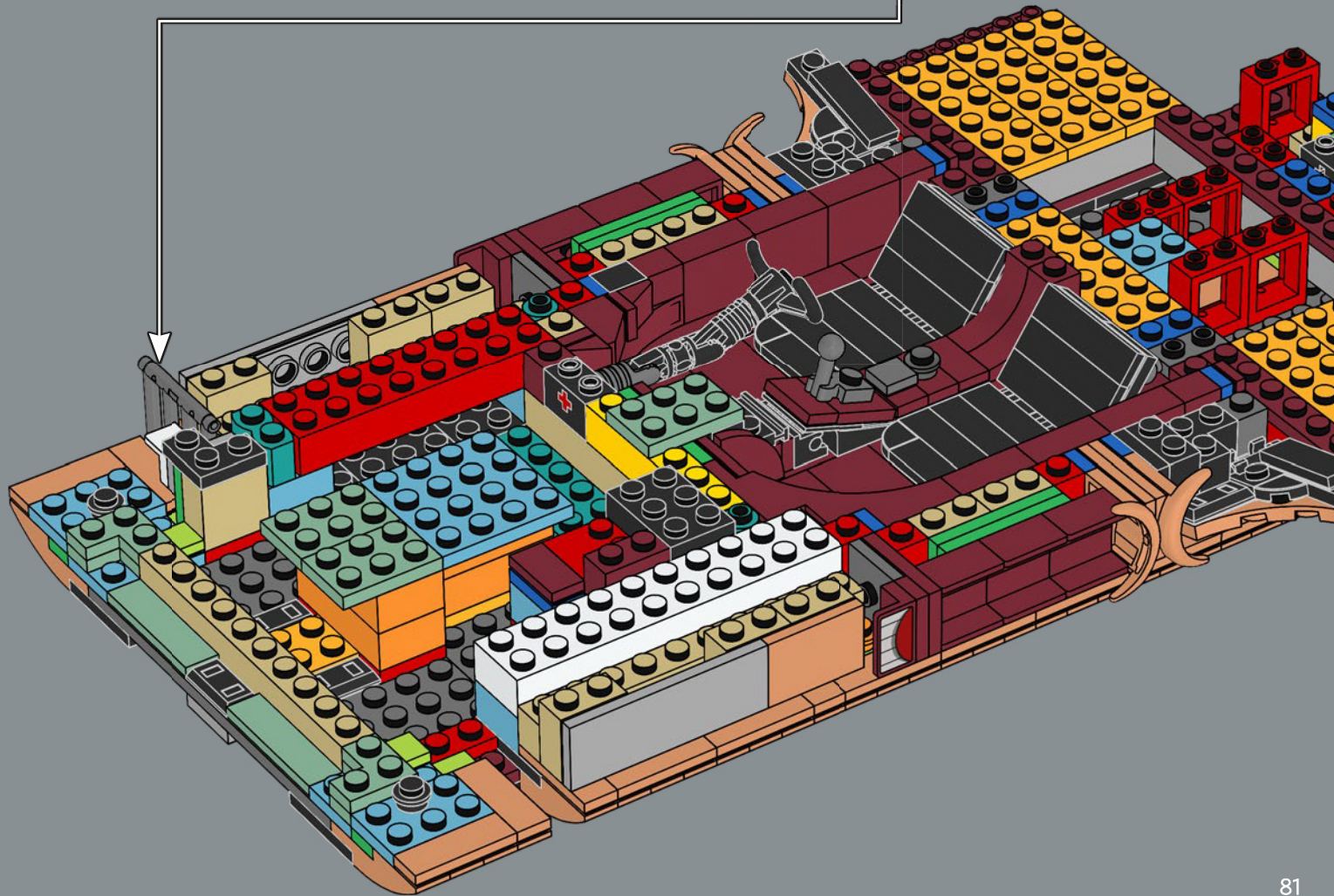
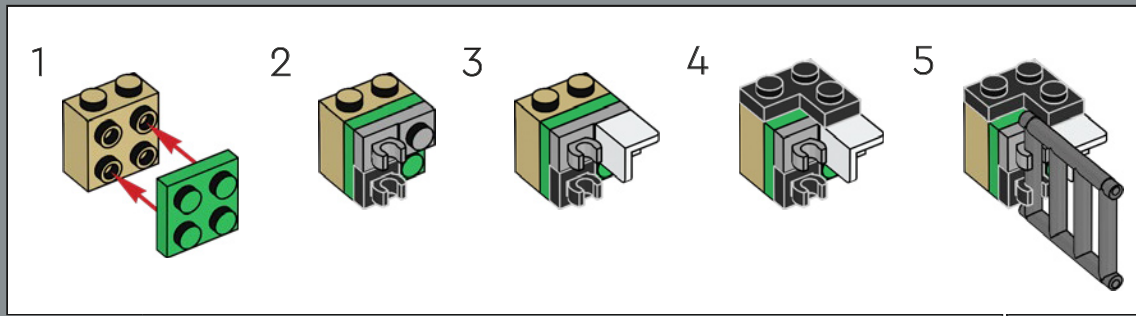

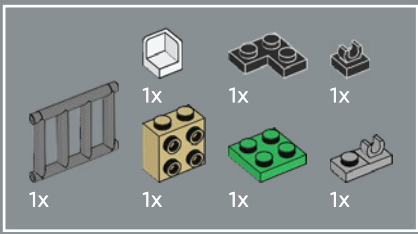

84

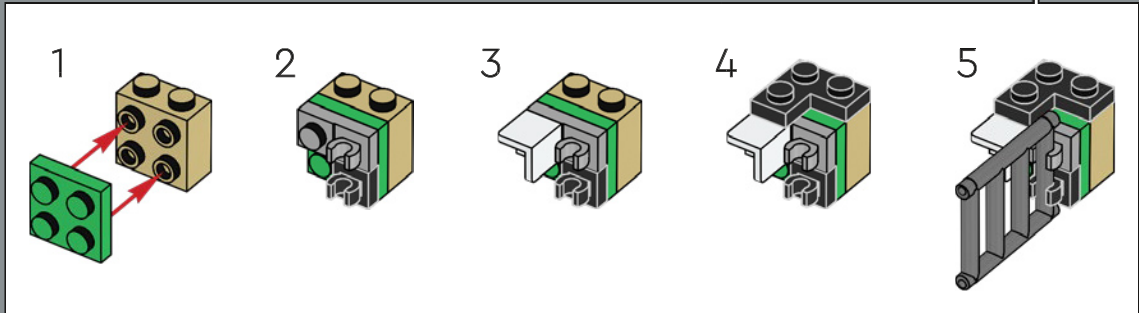
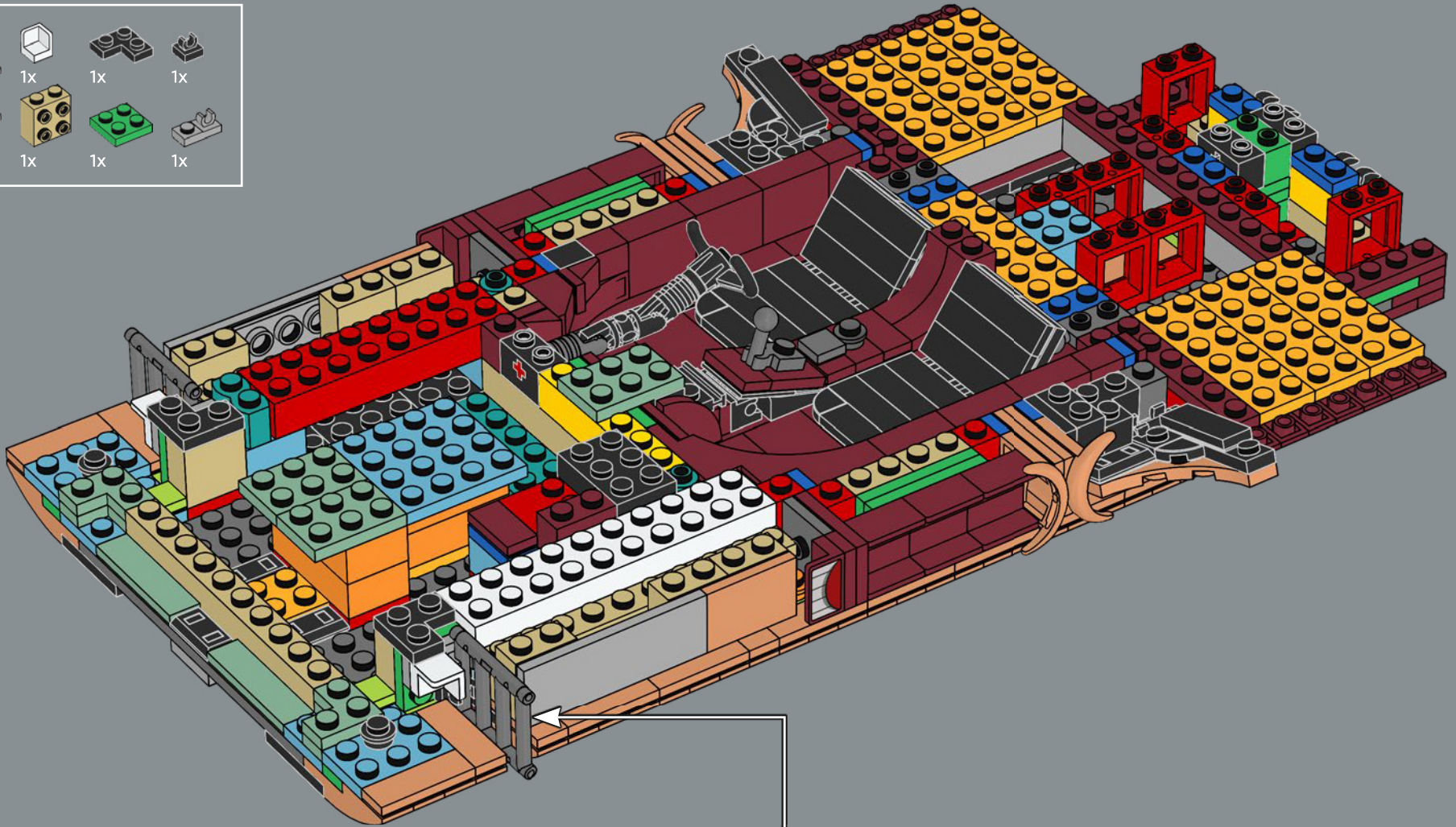

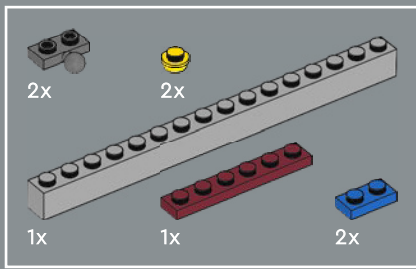

85

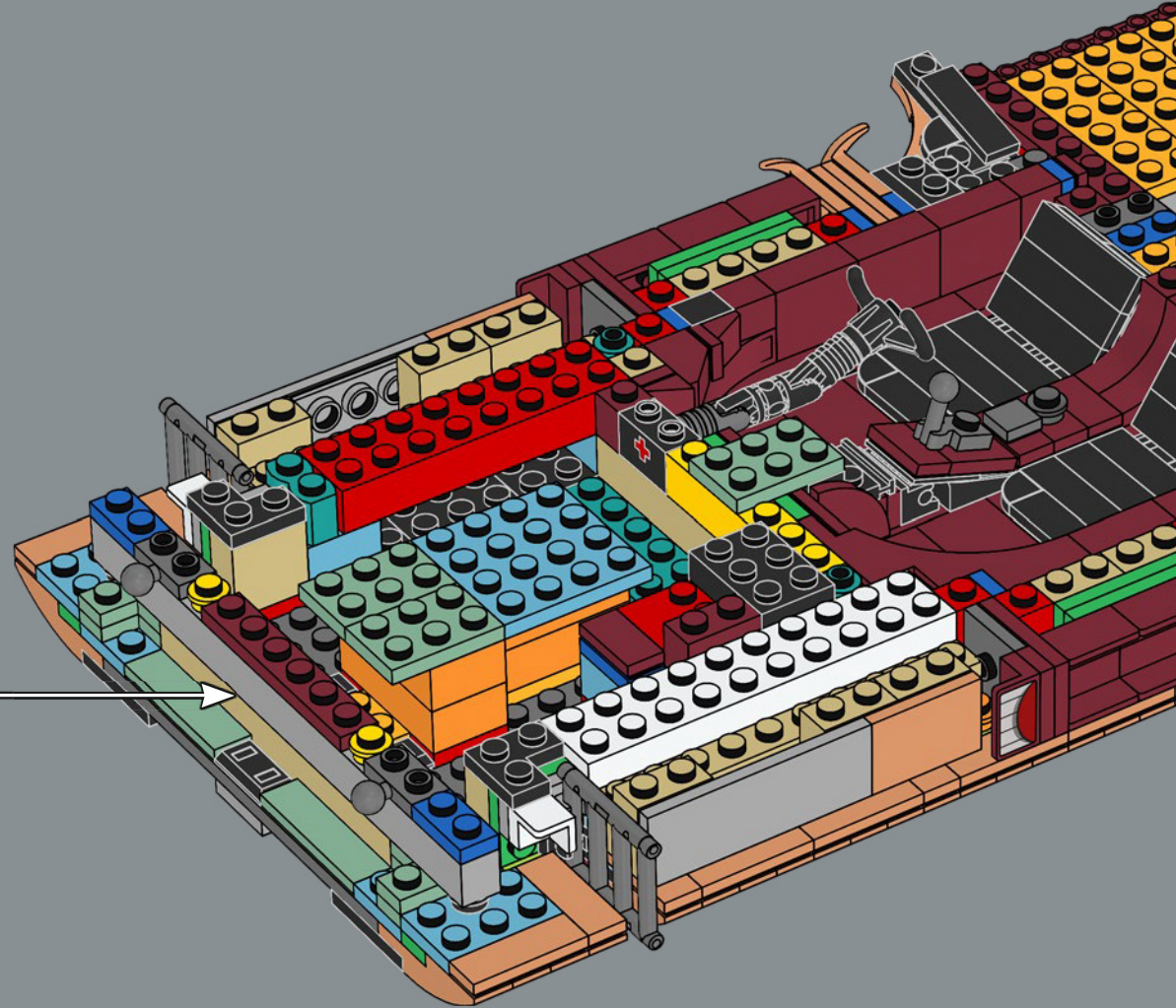
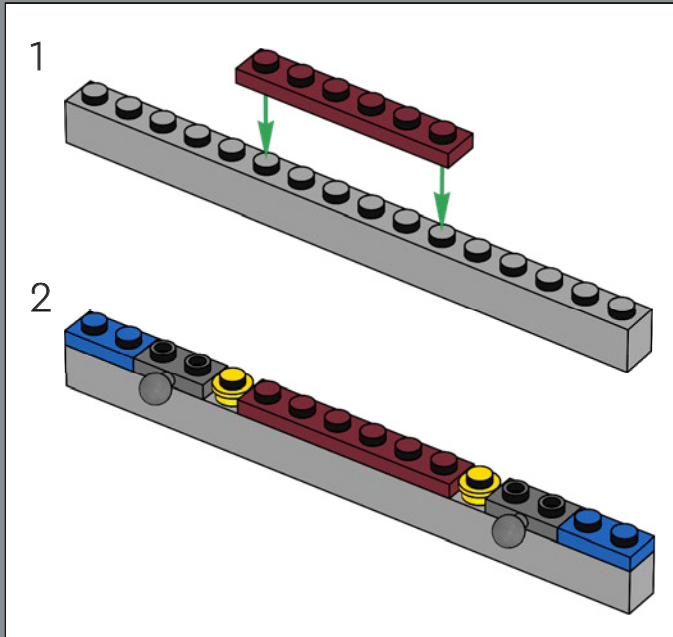



86

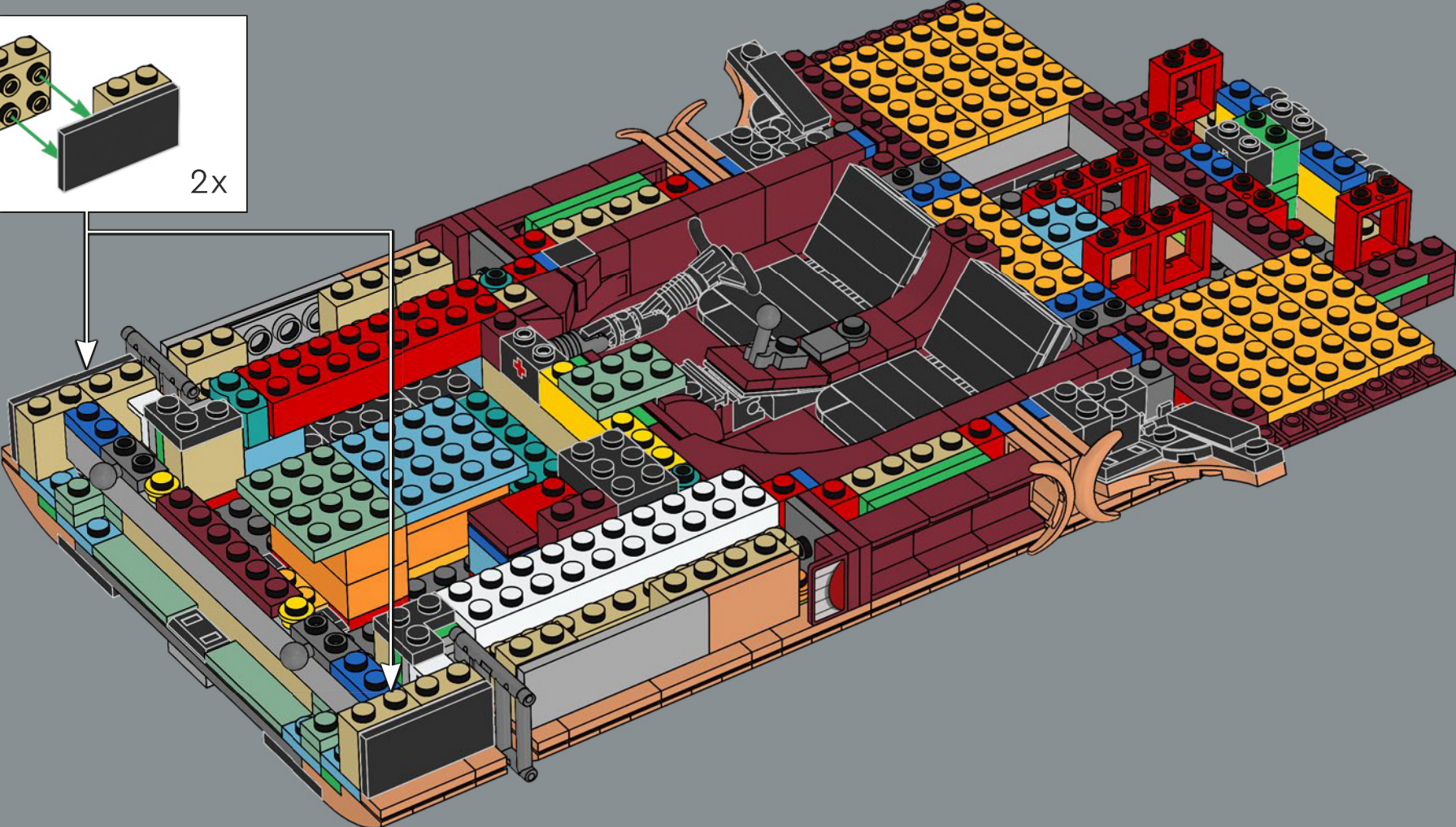
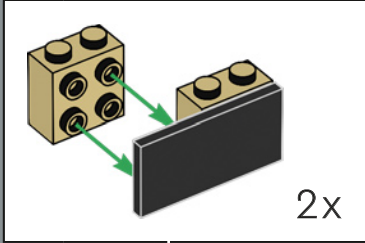

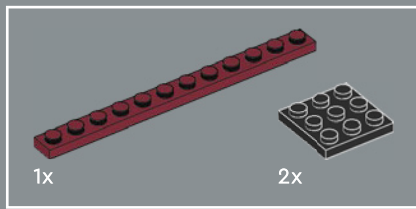

87

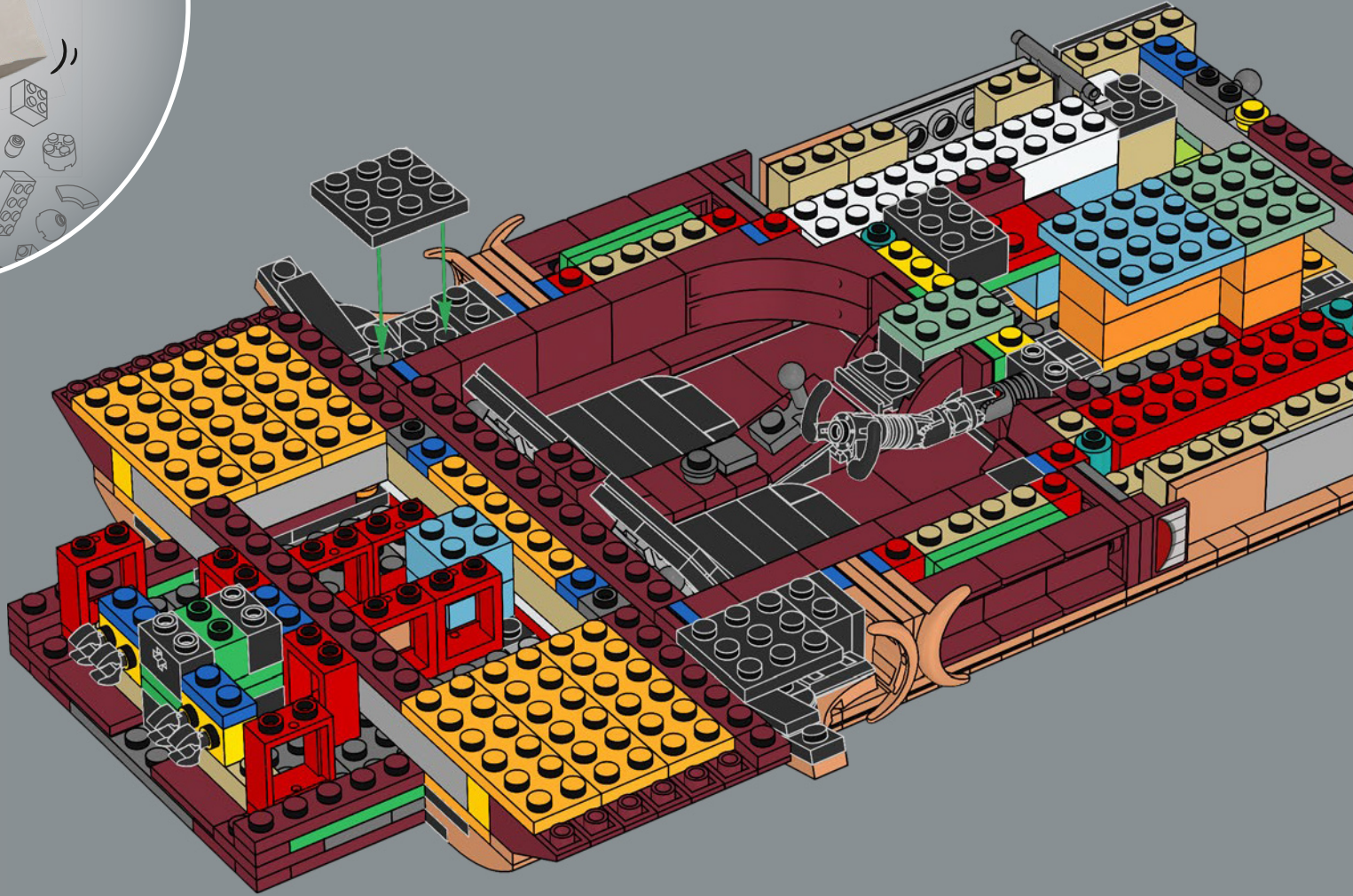

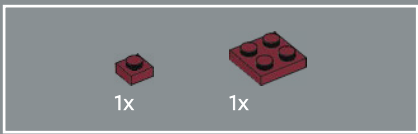

88

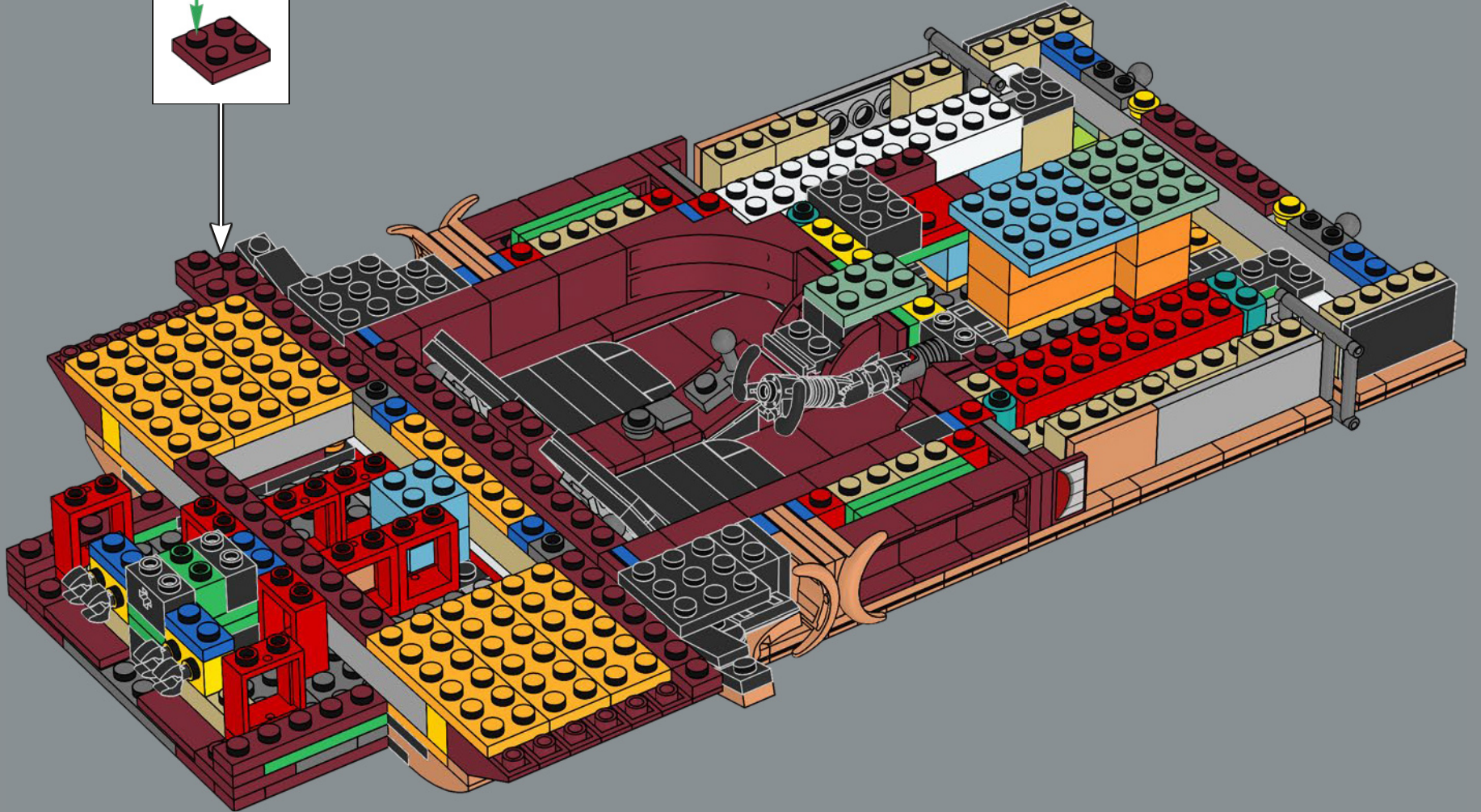
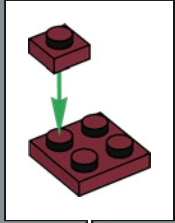

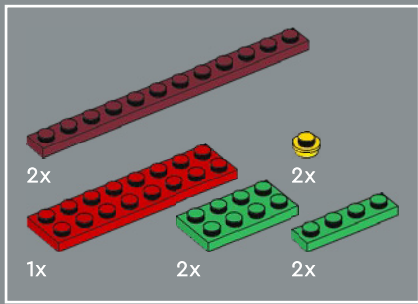

89

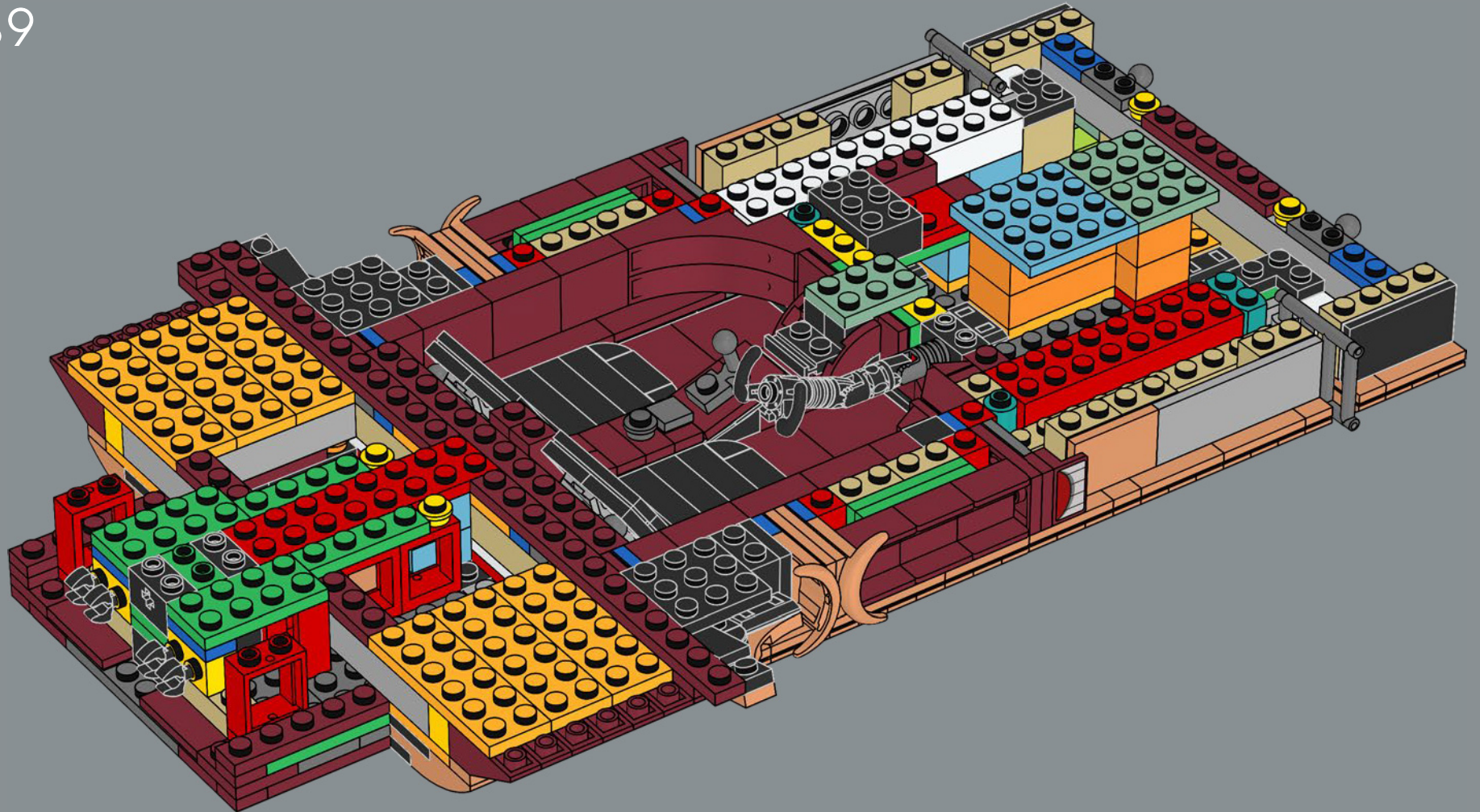

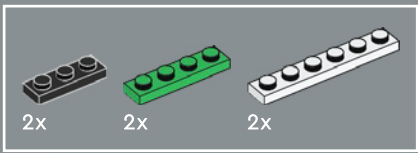

90

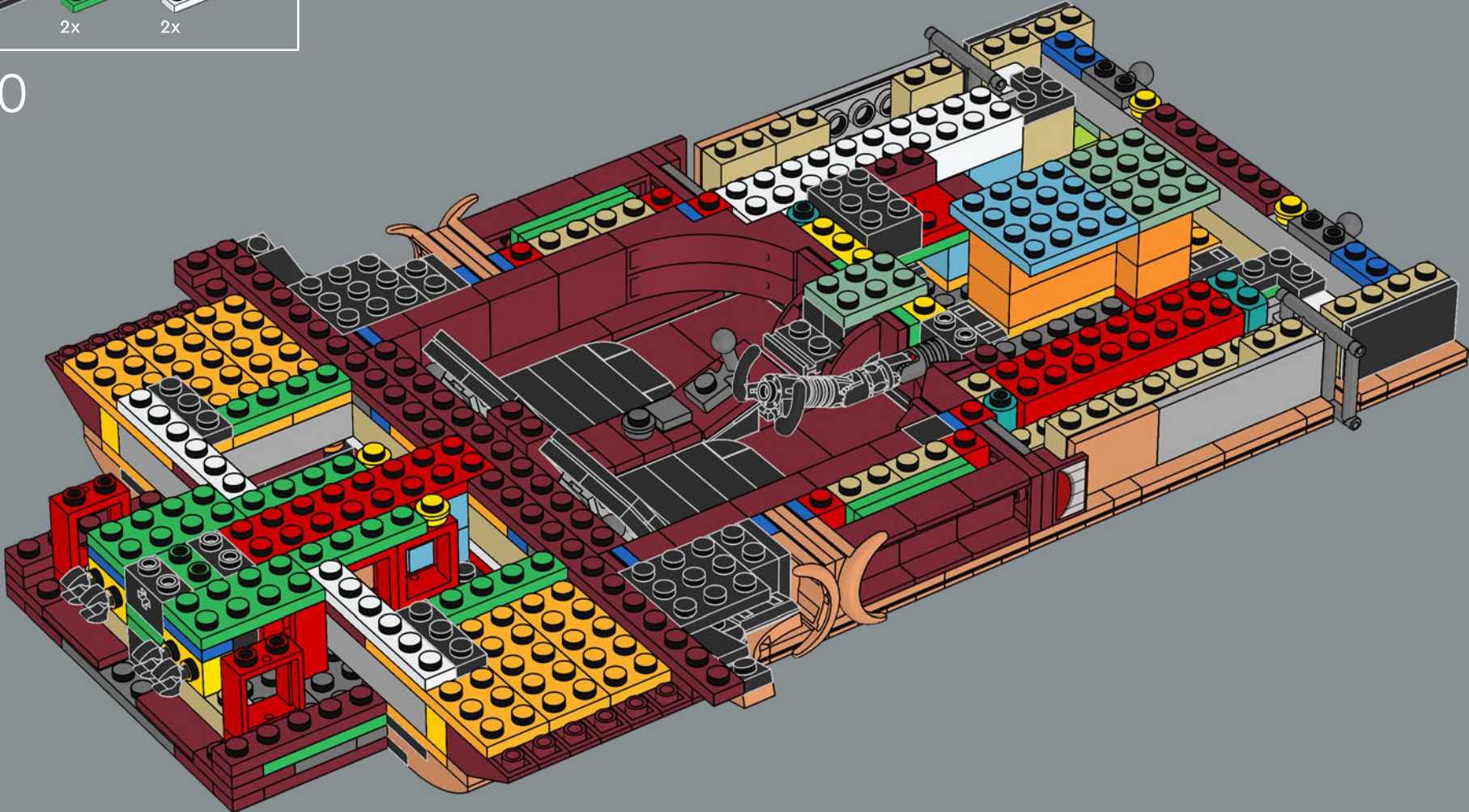

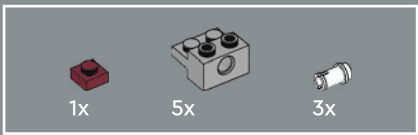

91

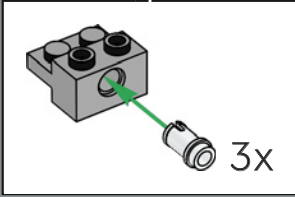
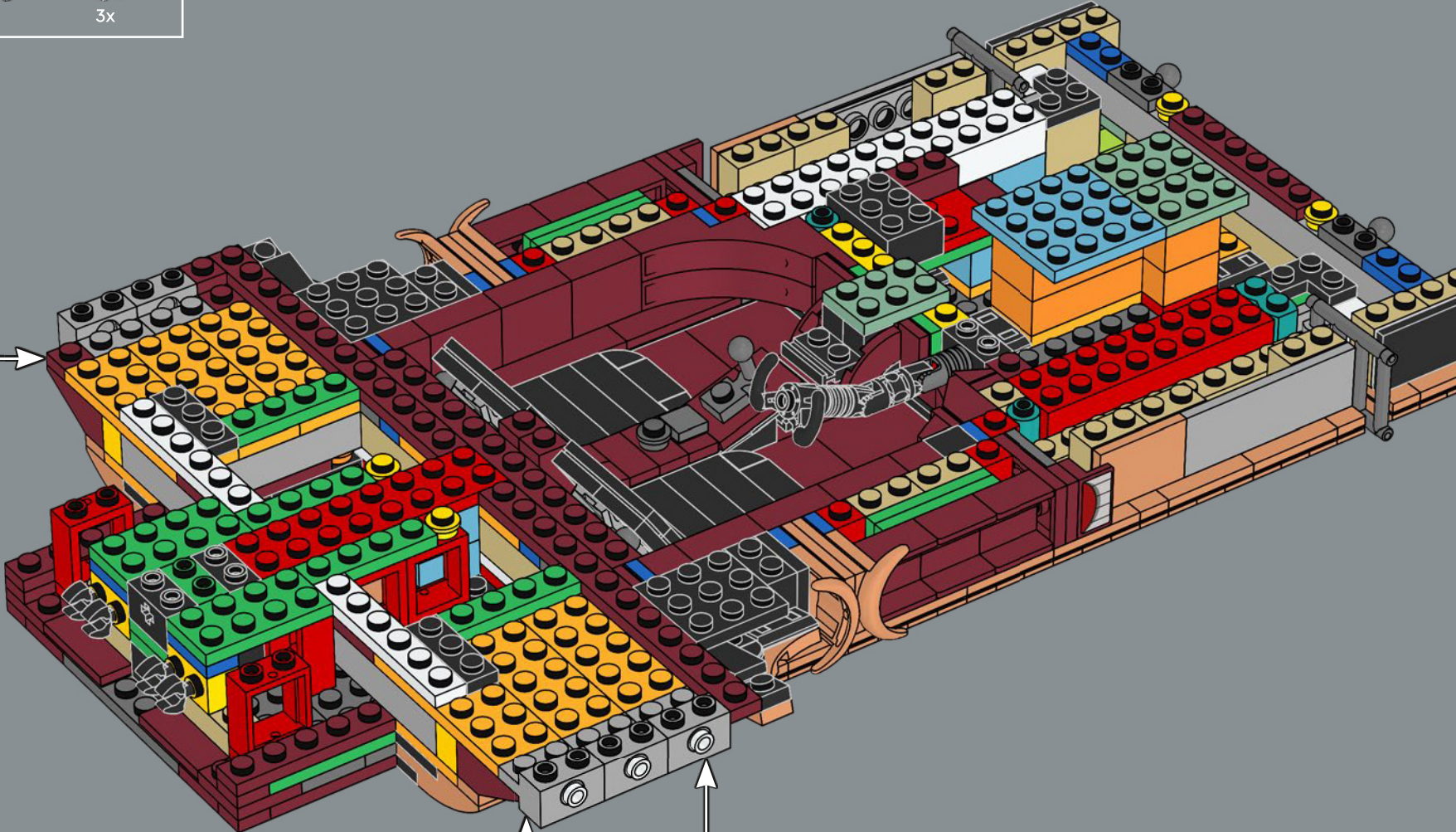

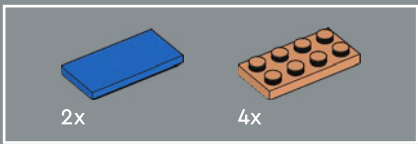

92

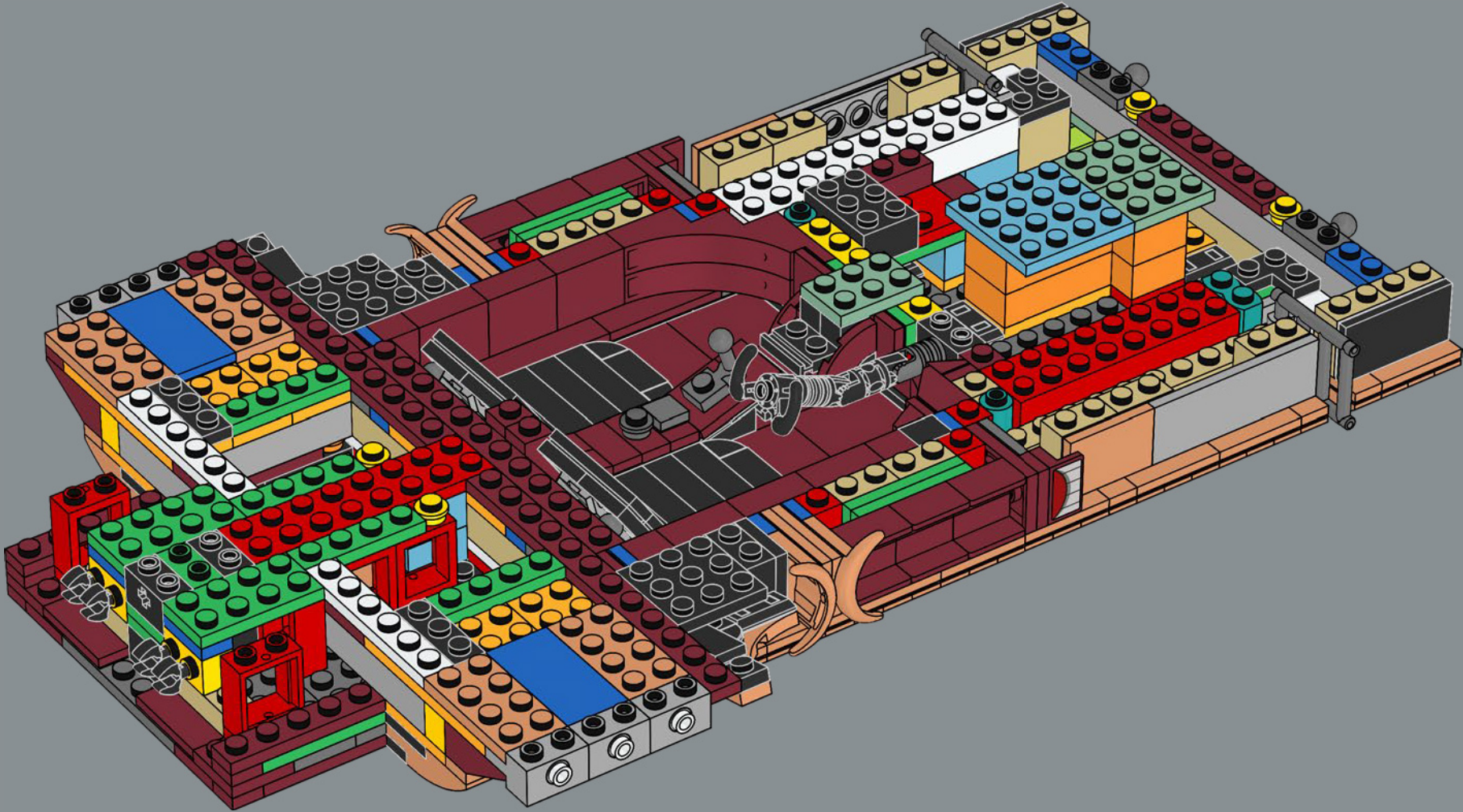

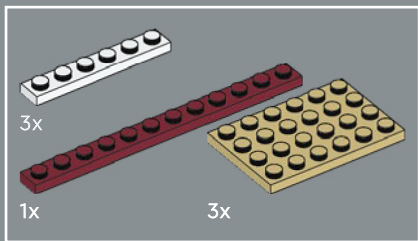

93

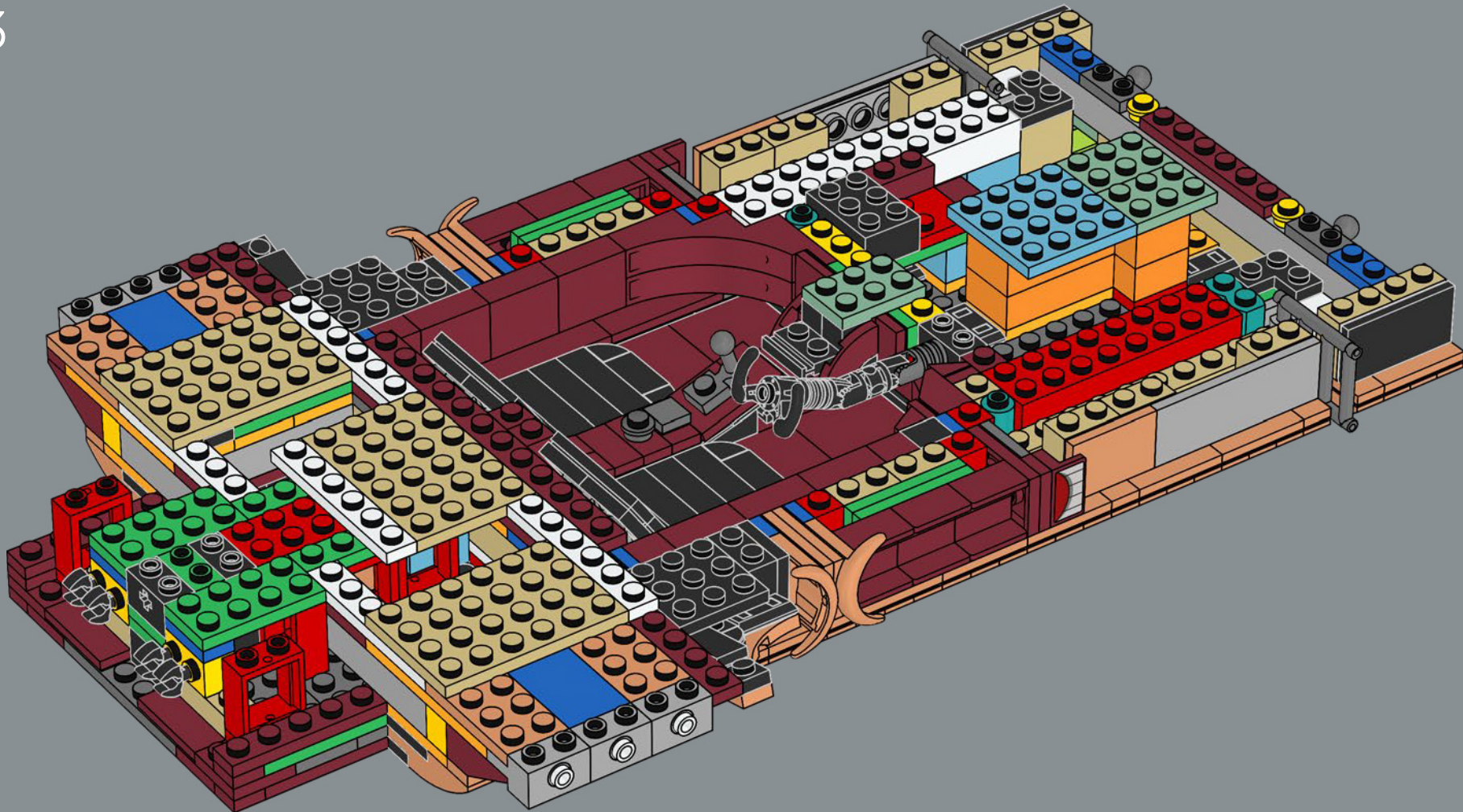

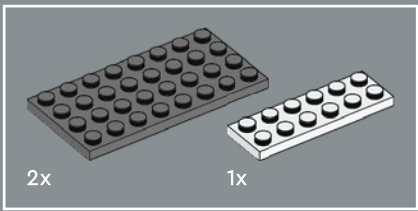

94

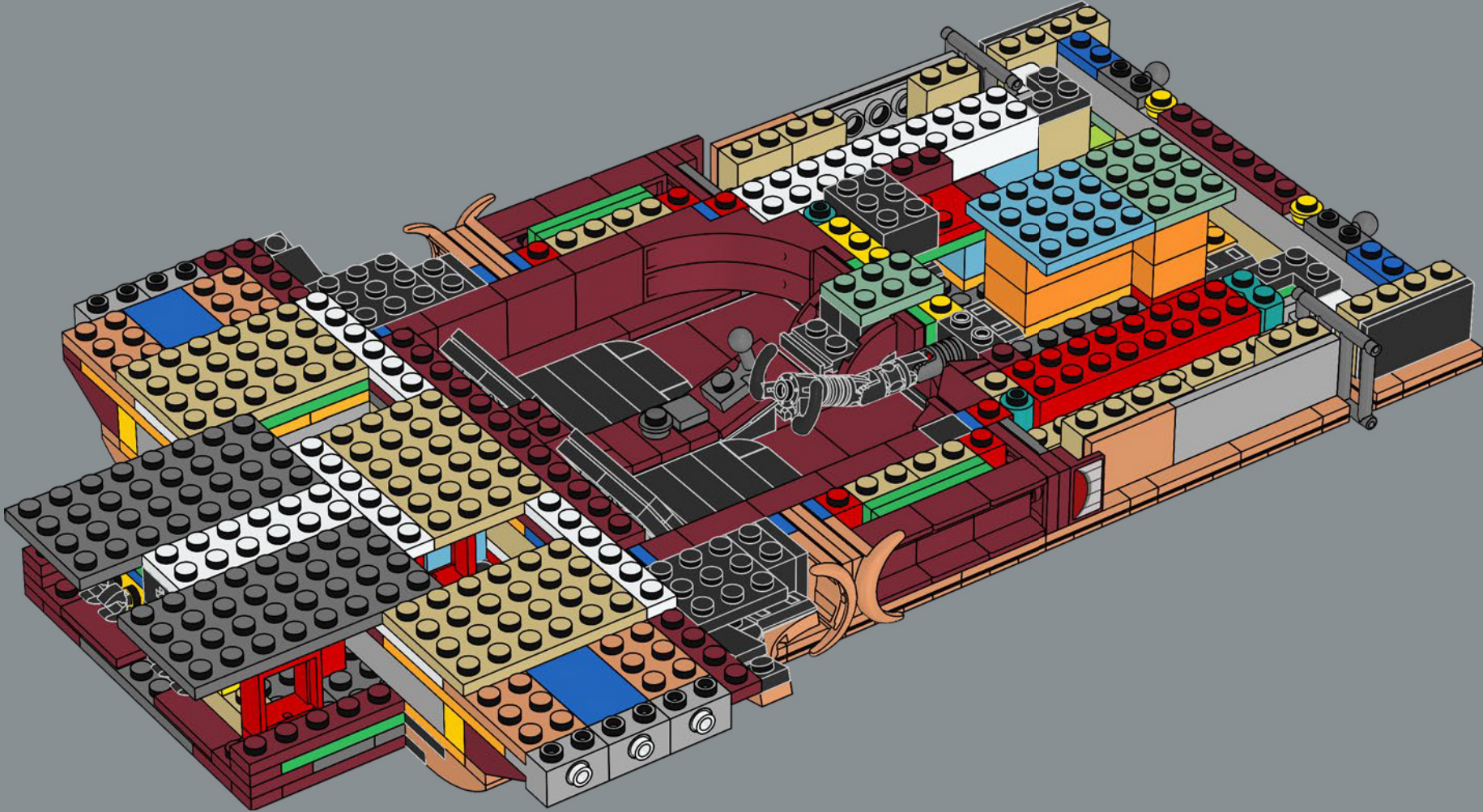

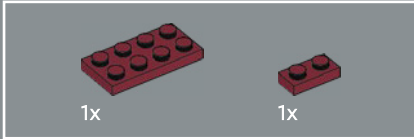
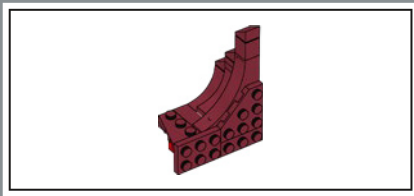

95

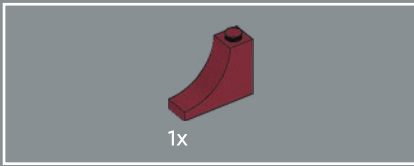
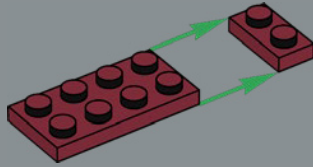

96

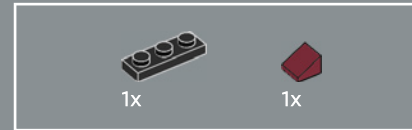
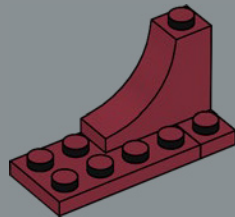

97

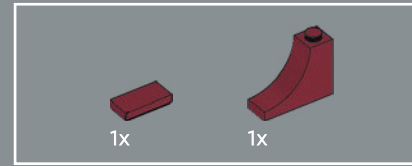
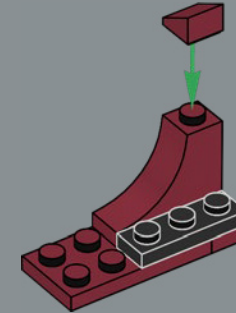

98

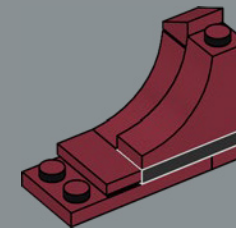

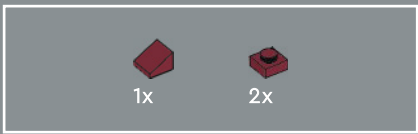

99

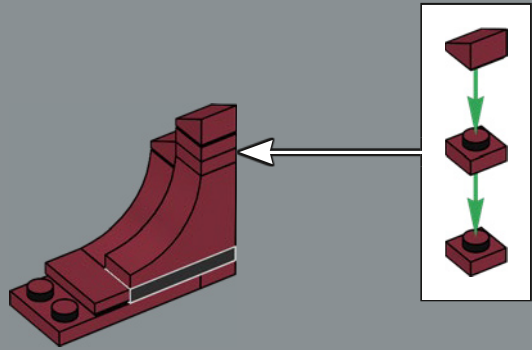

101

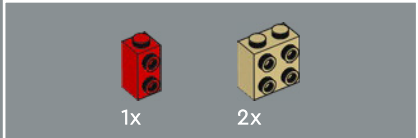
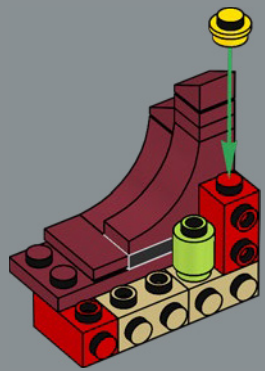

100

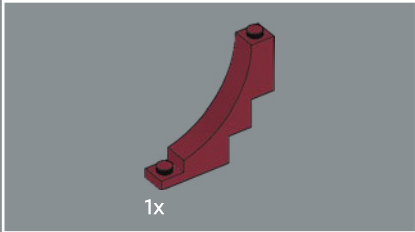
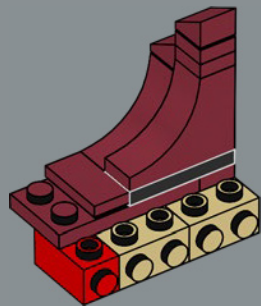

102

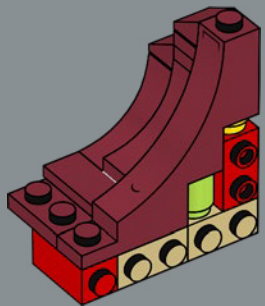

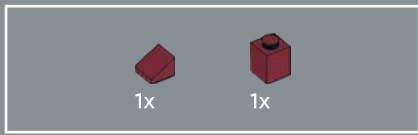

103

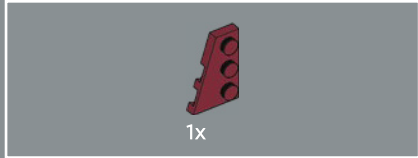
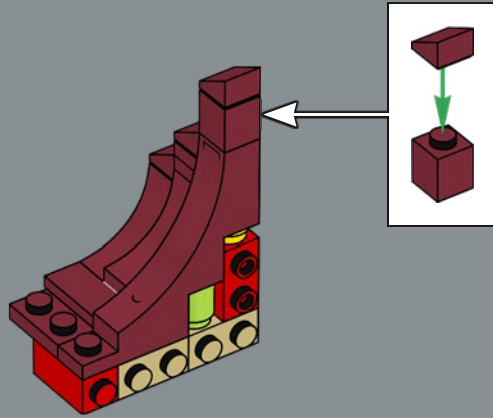

104

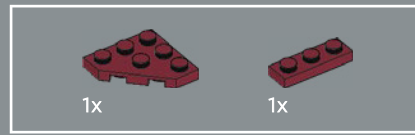
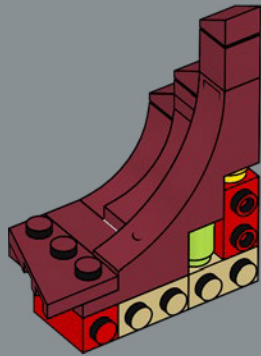

105

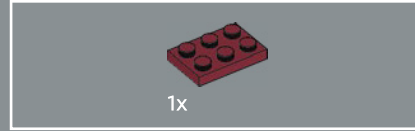
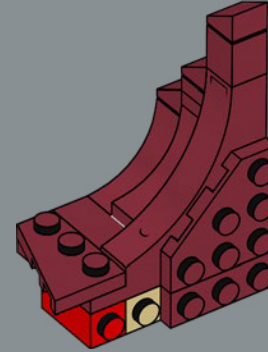

106

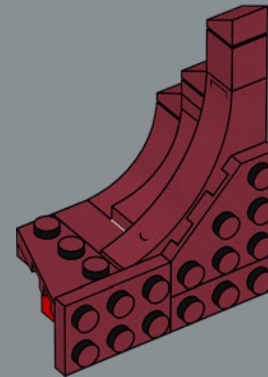

107

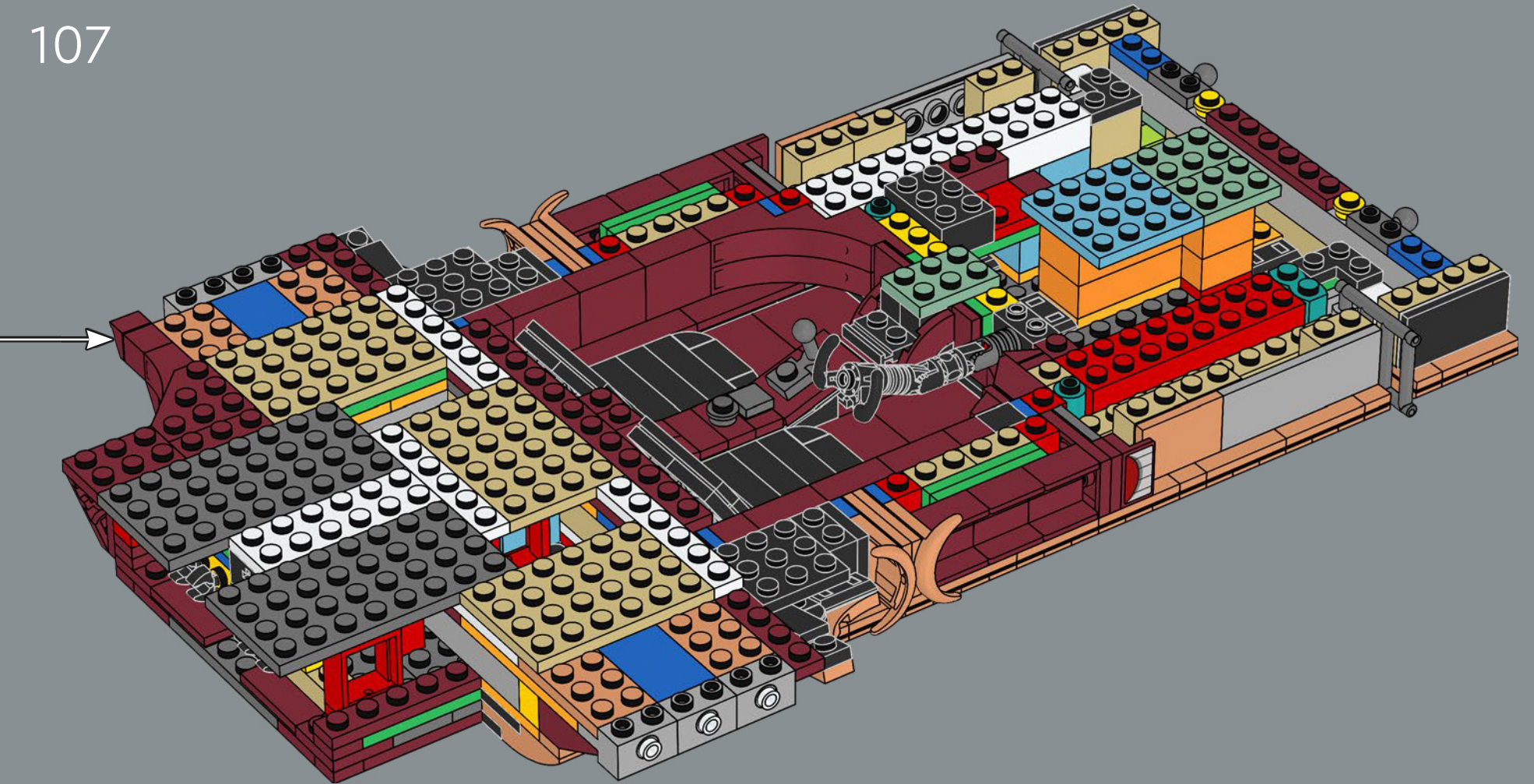

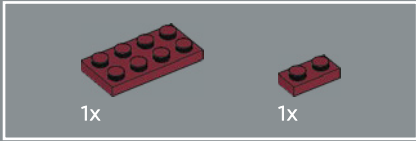
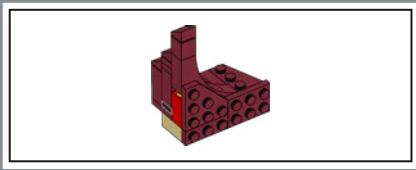

108

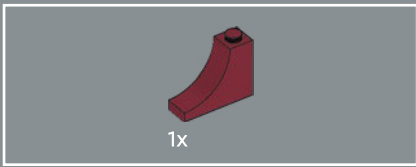
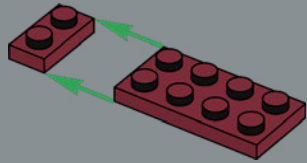

109

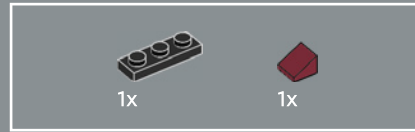
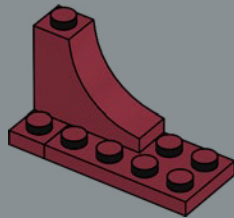

110

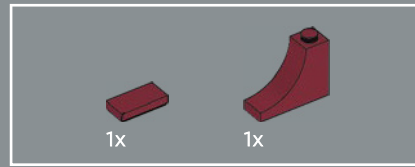
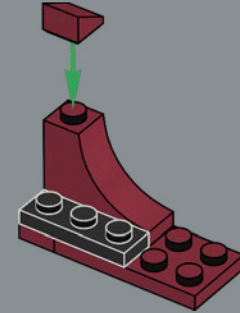

111

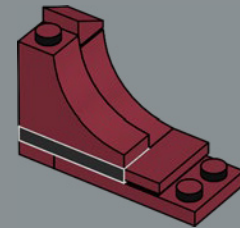

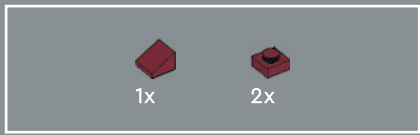

112

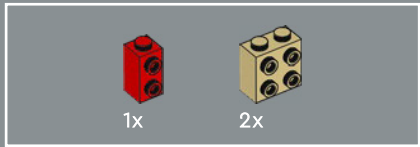
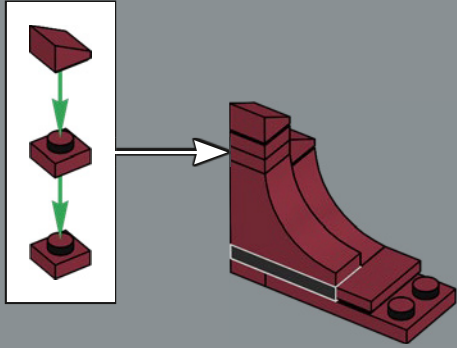

113

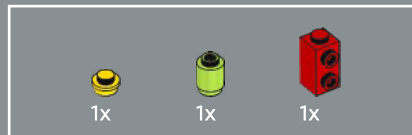
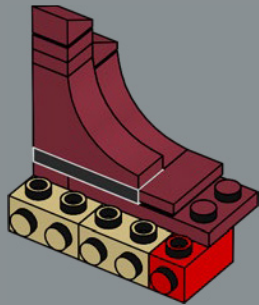

114

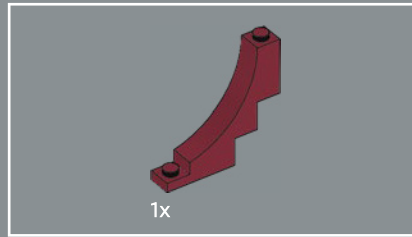
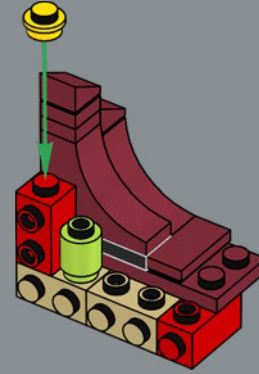

115

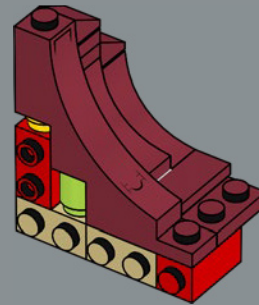

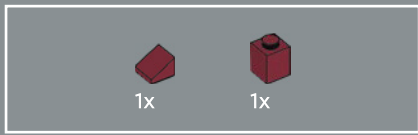

116

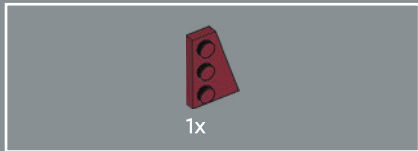
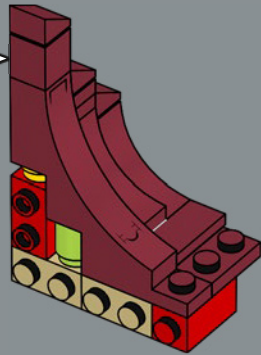
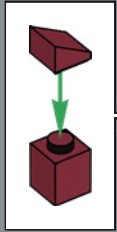

117

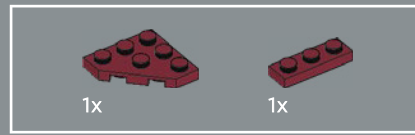
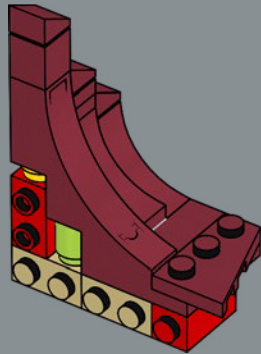

118

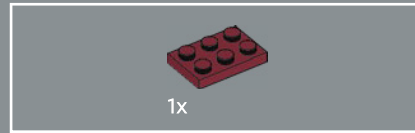
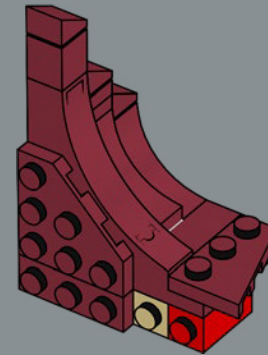

119

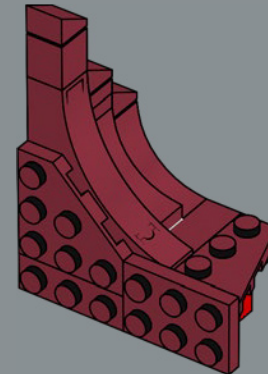

120

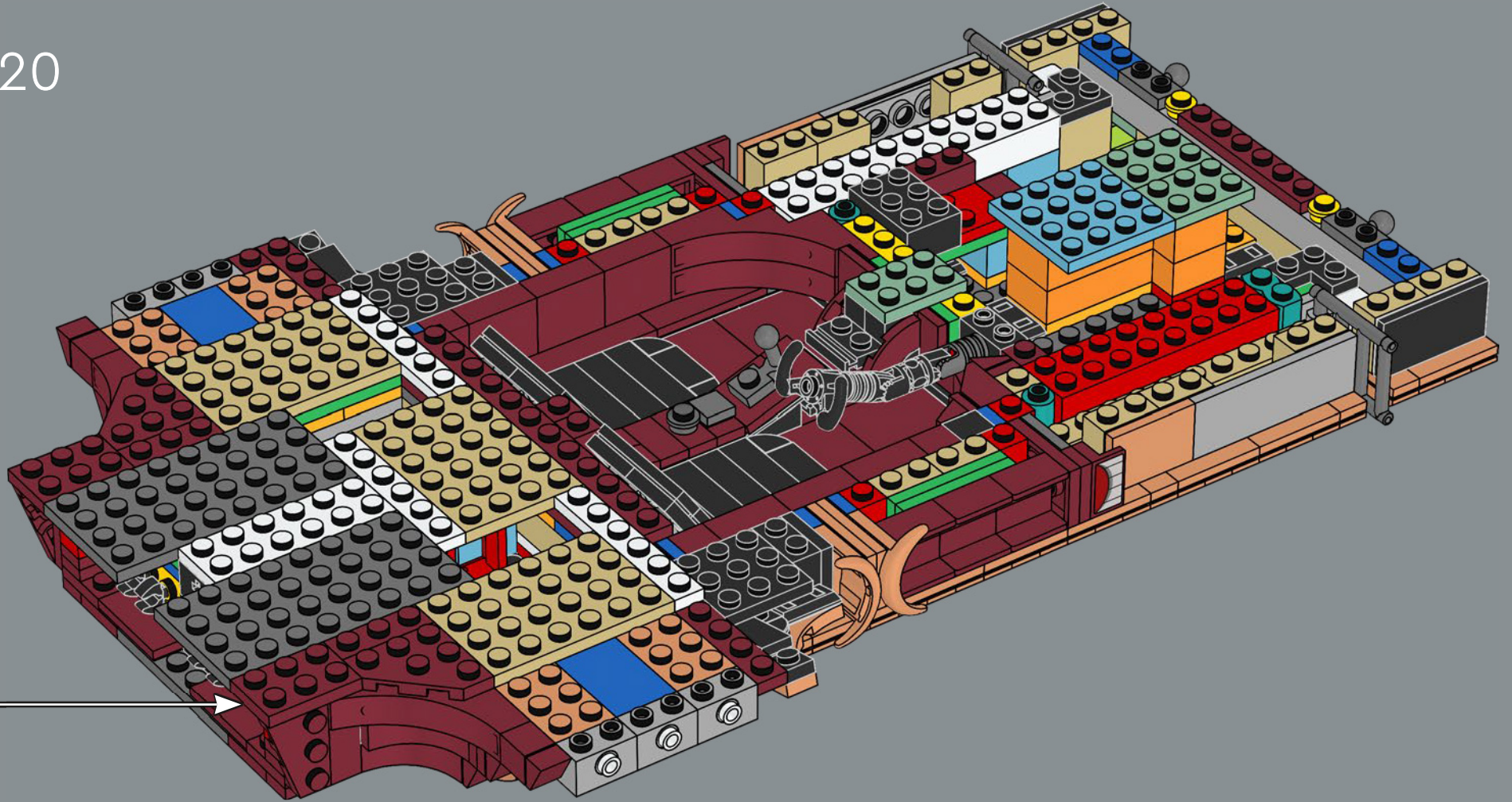

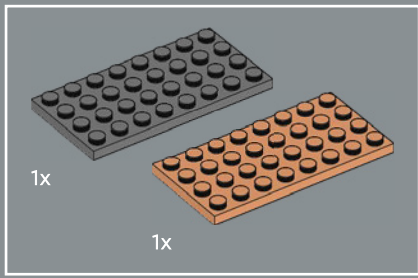

121

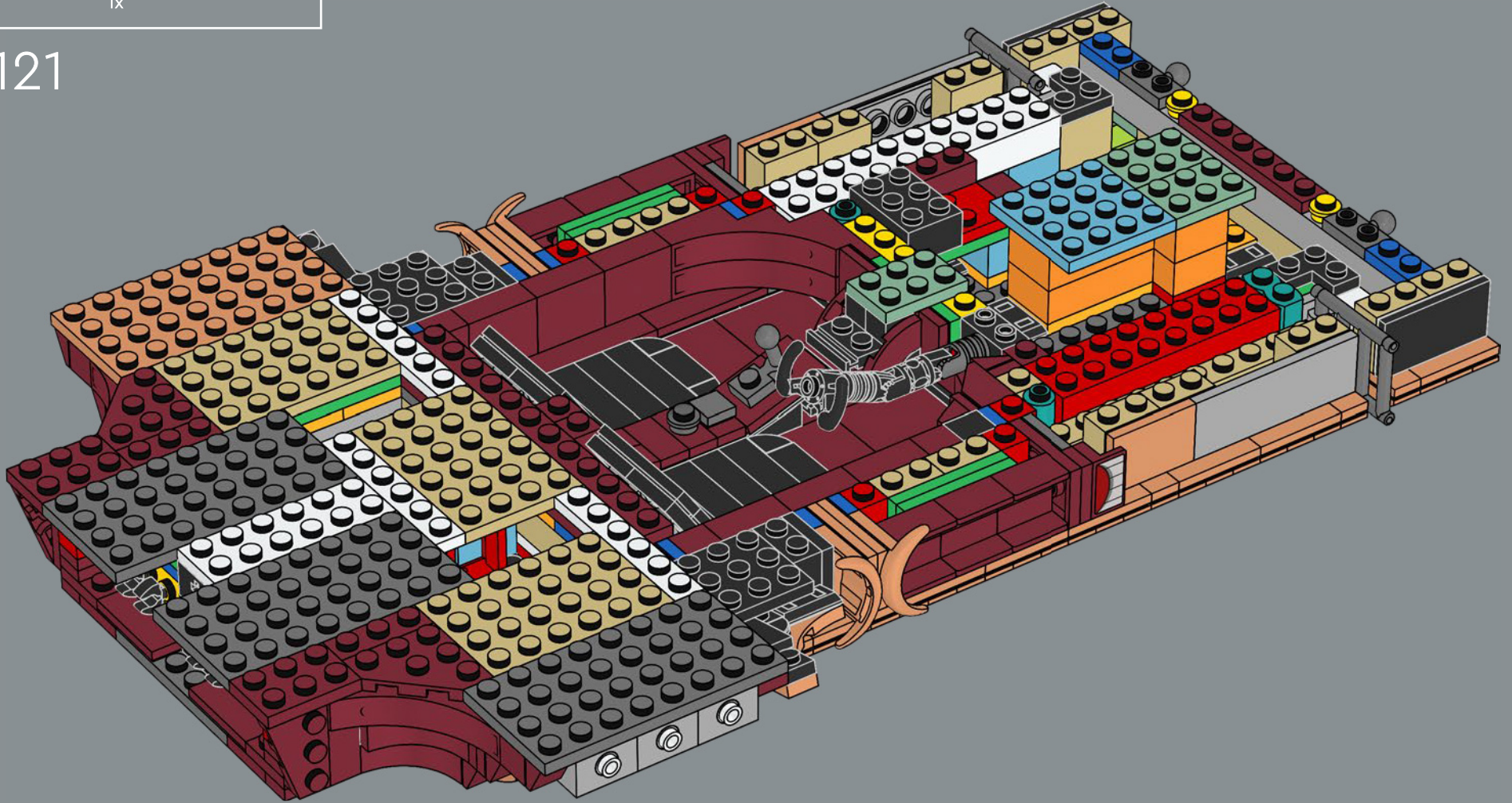

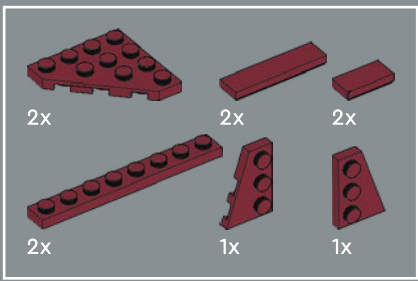

122

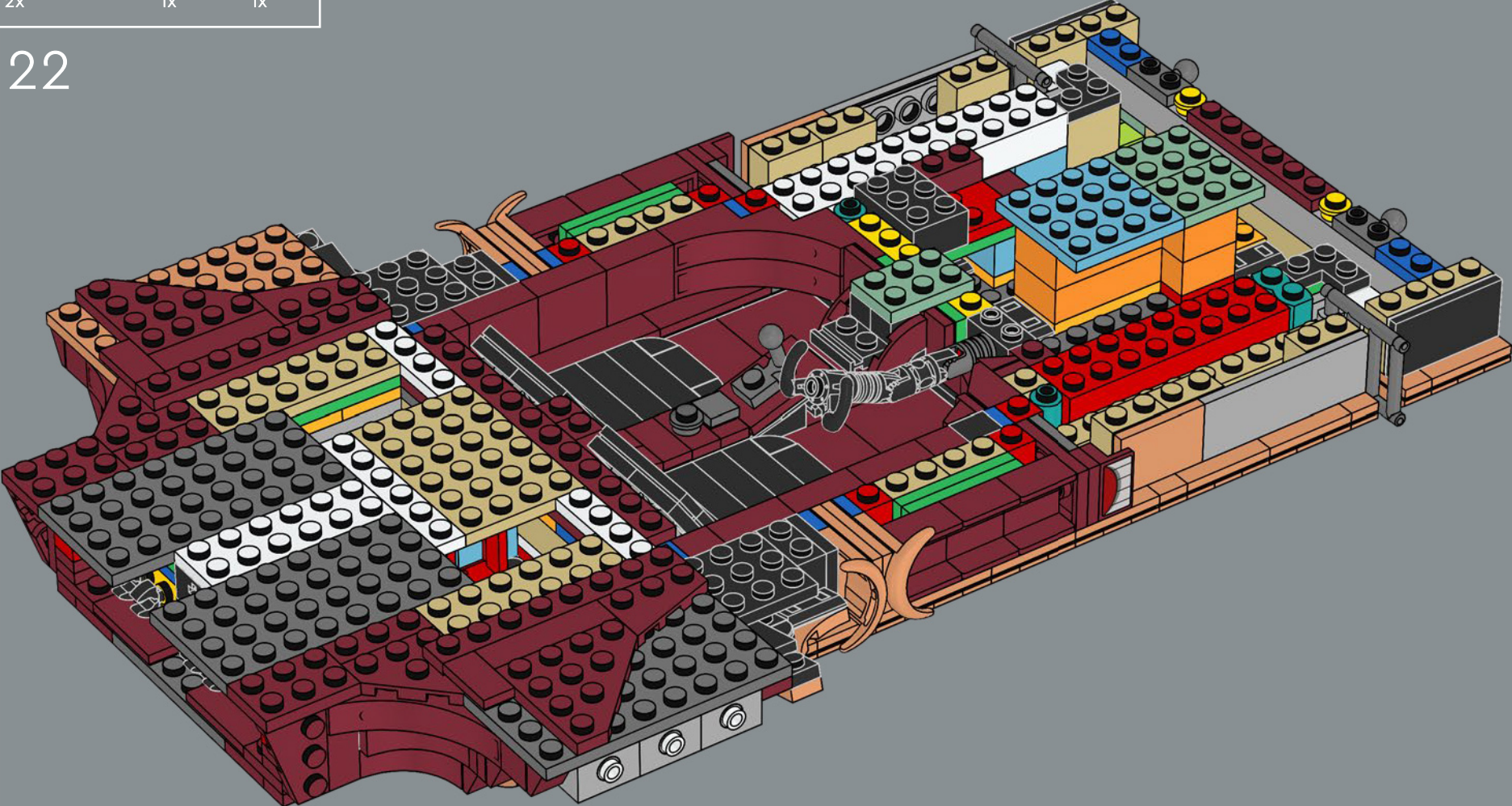

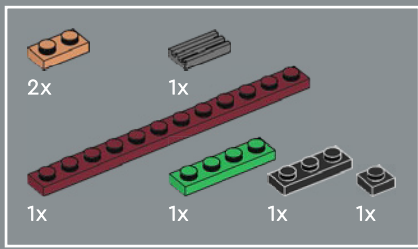

123

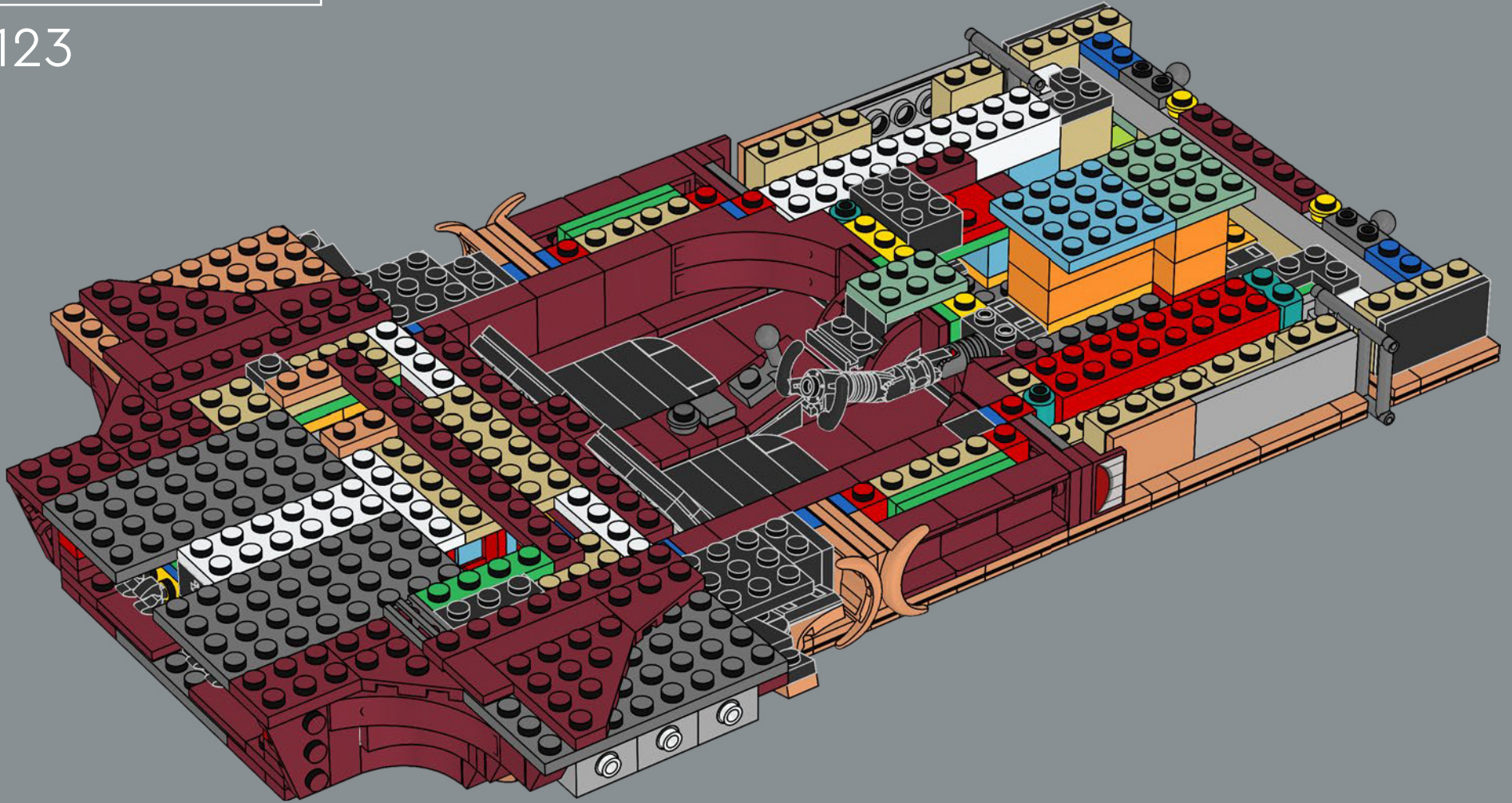

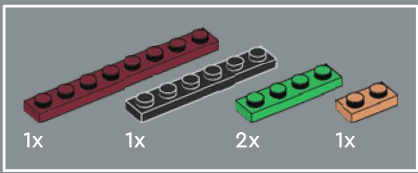

124

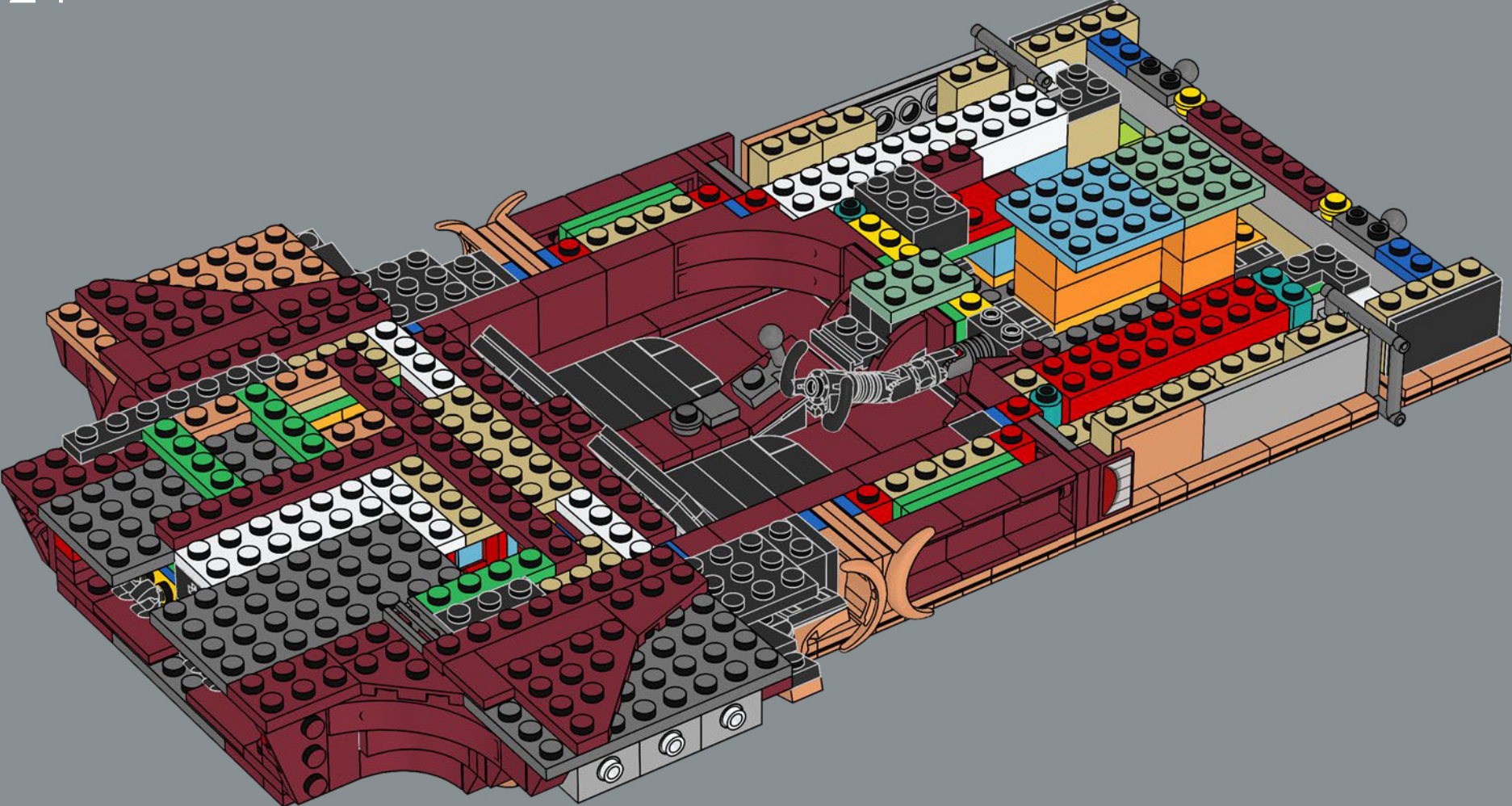

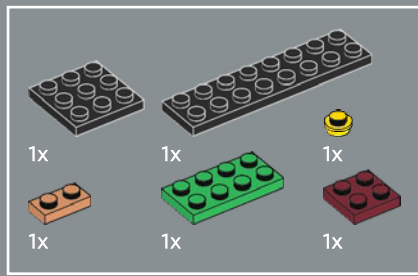

125

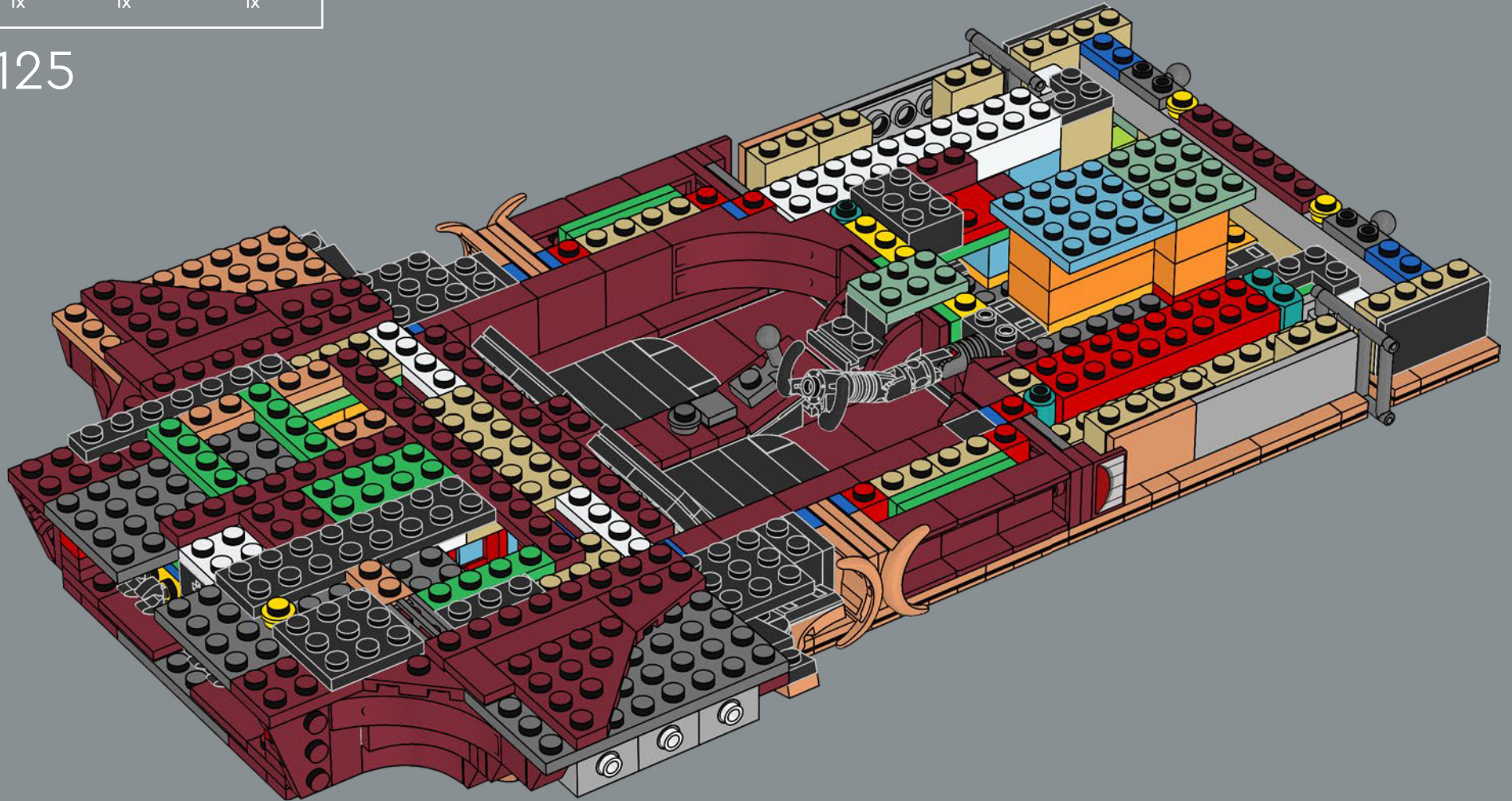

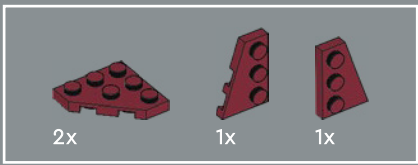

126

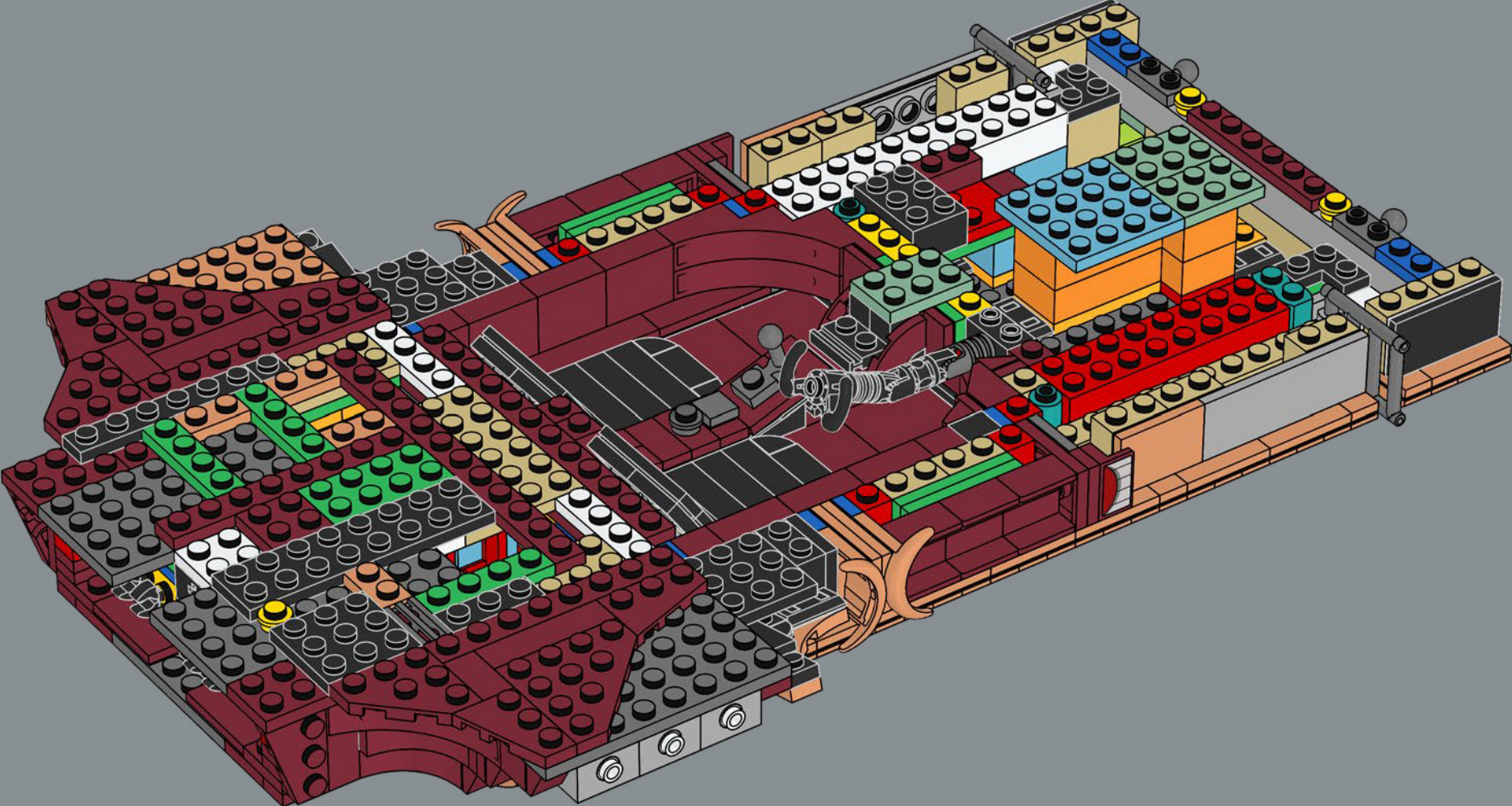

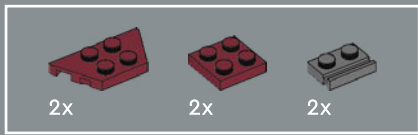

127

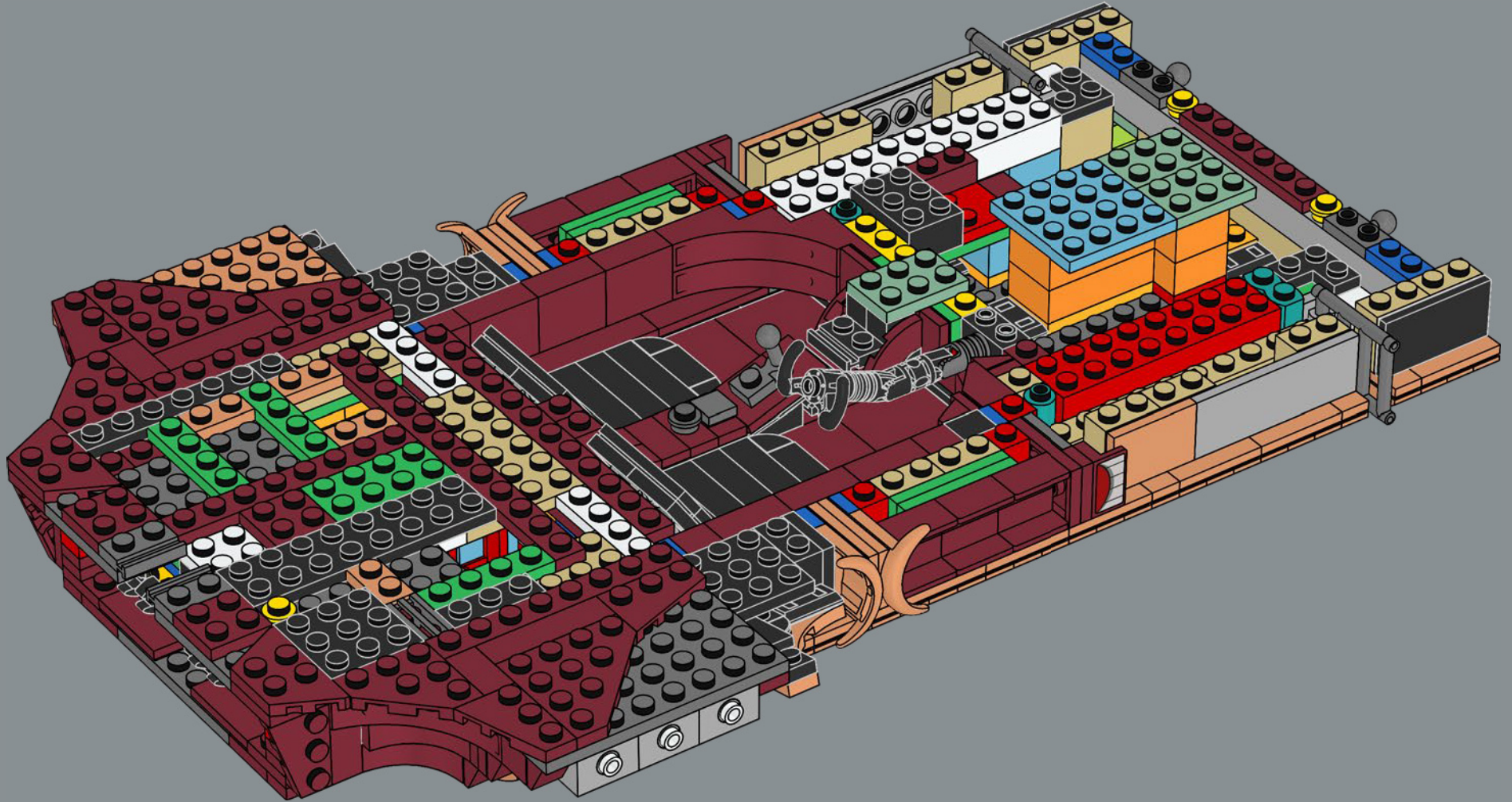

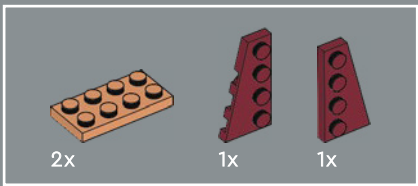

128

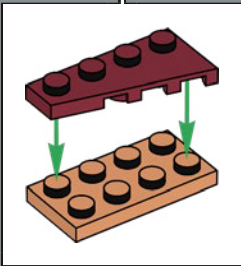
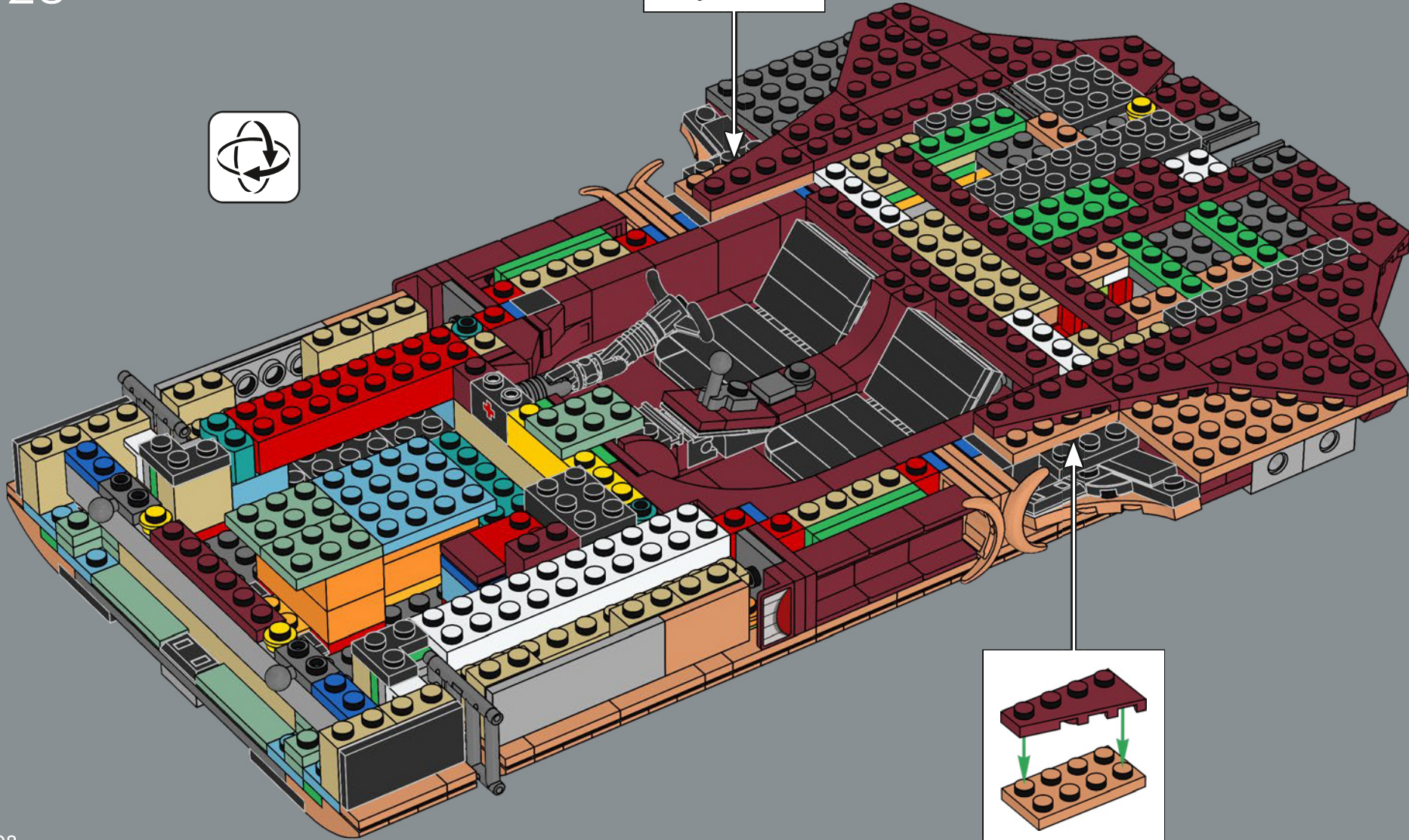
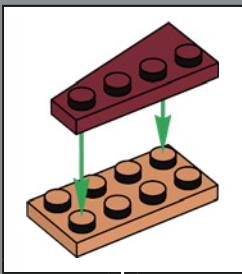

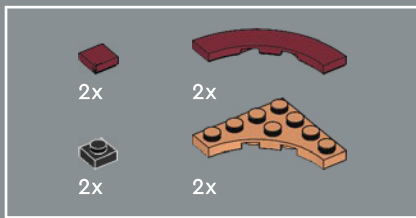

129

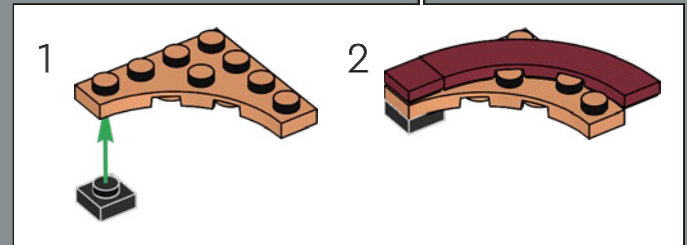
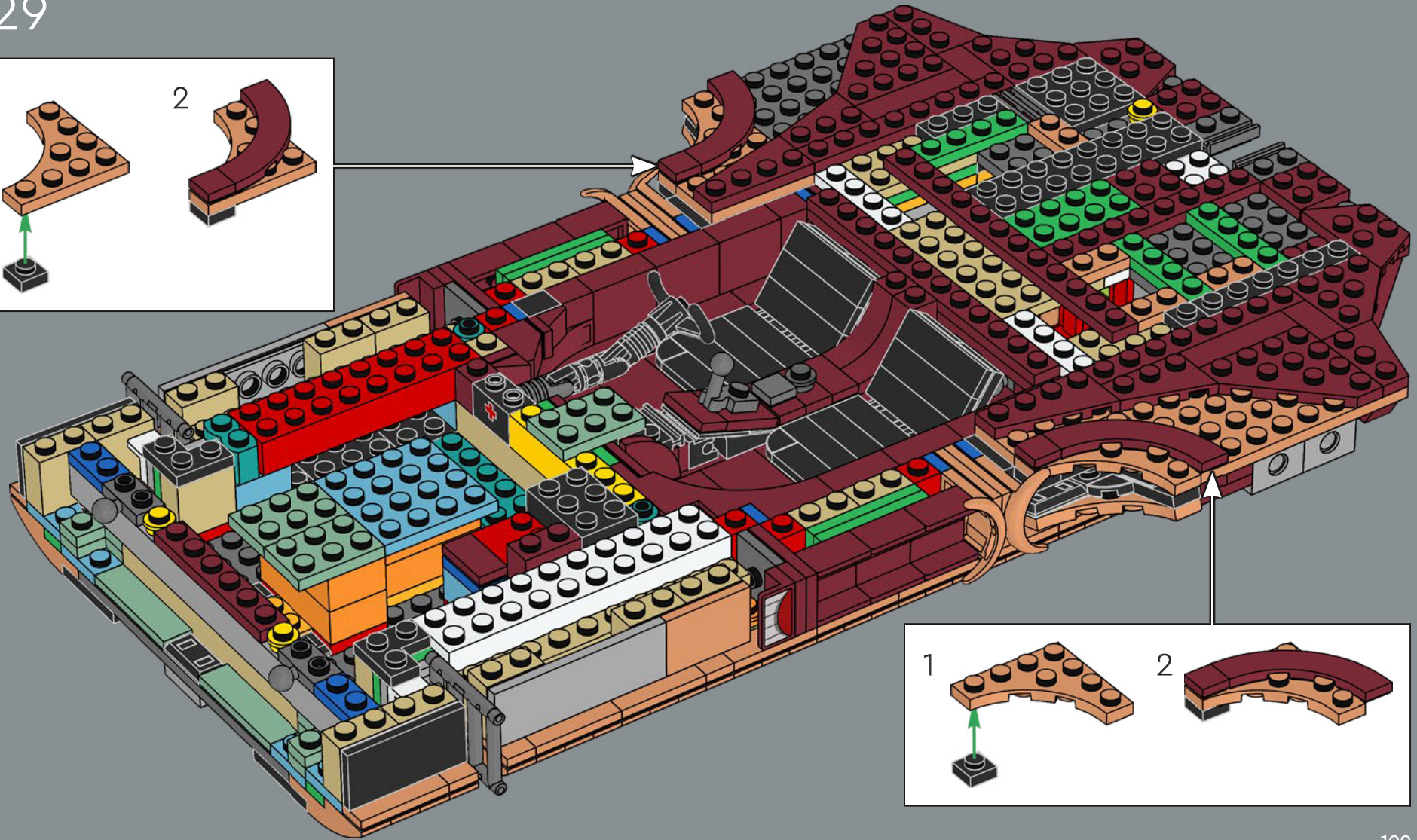
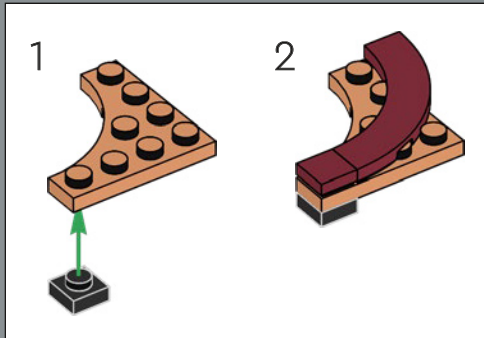

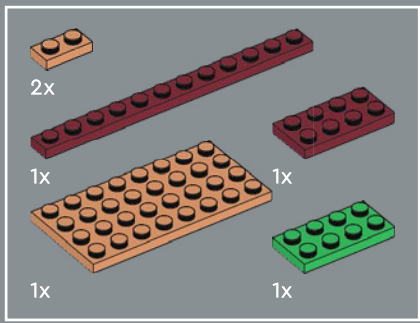

130

1

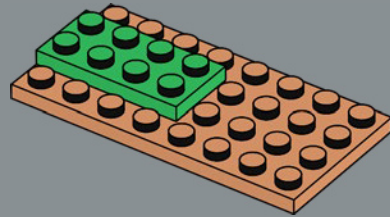

2

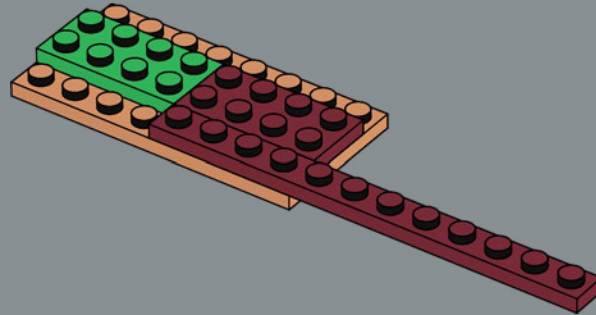

3

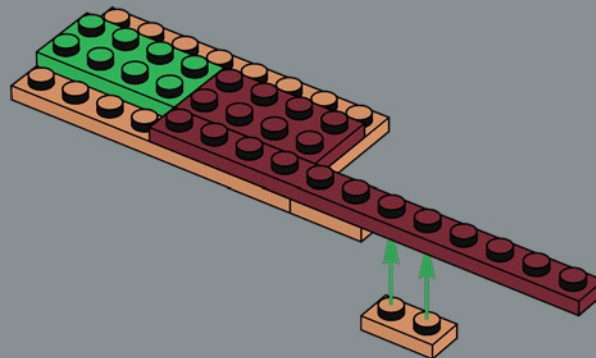

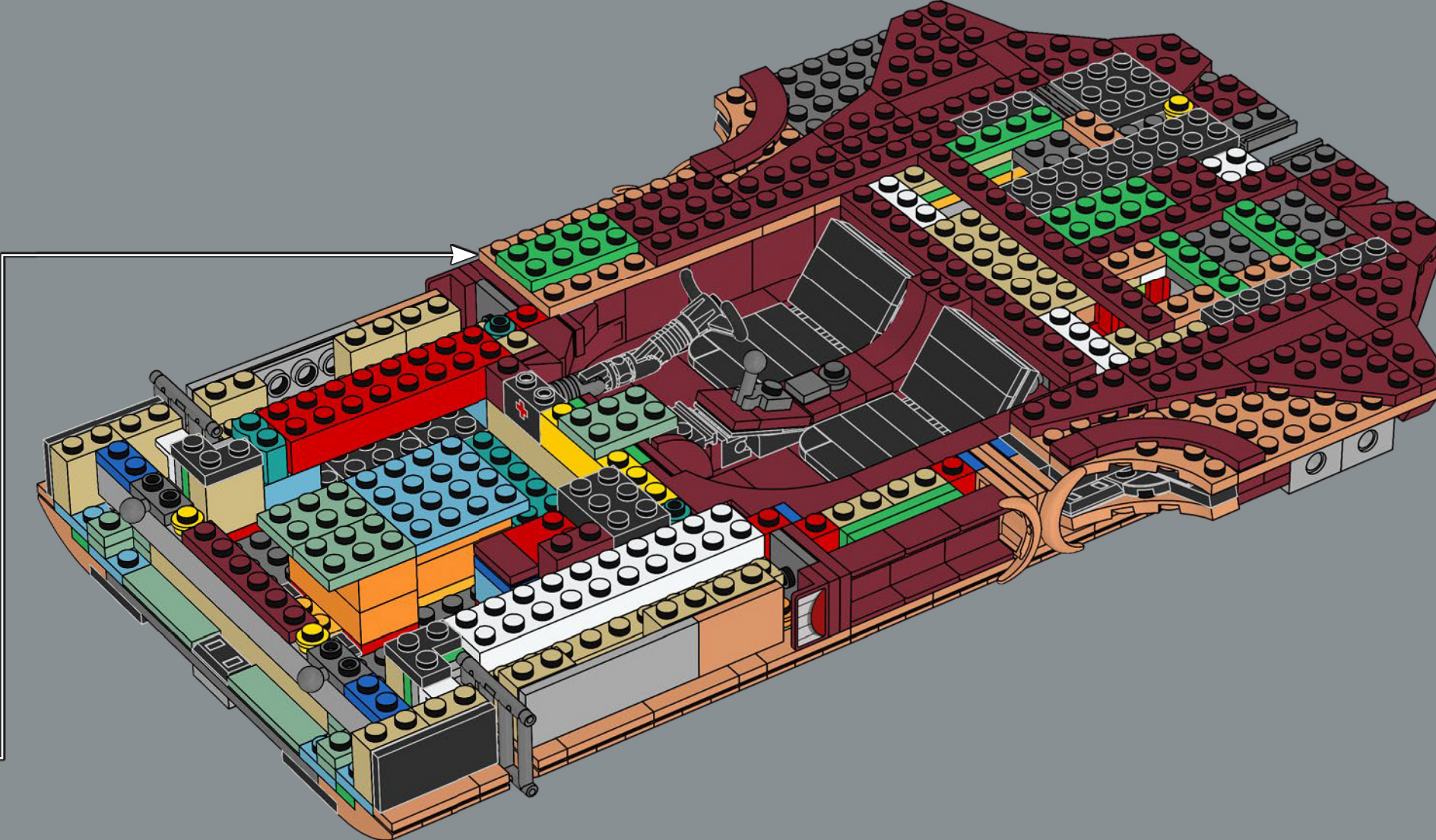

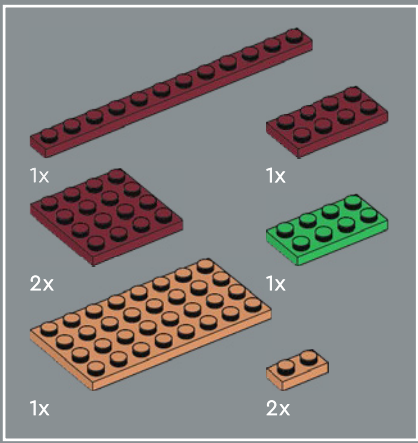

131

1

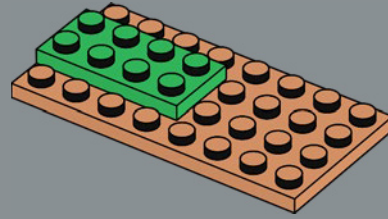

2

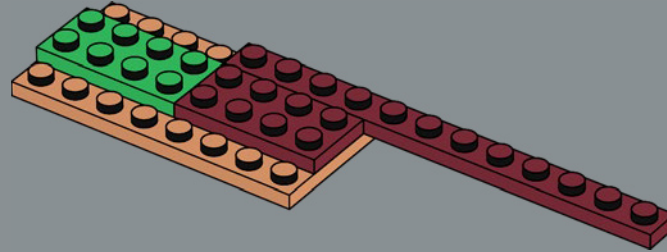

3

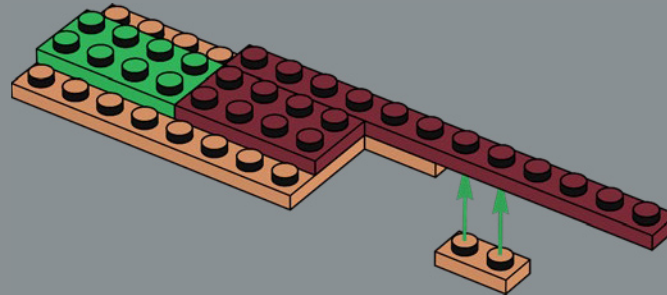

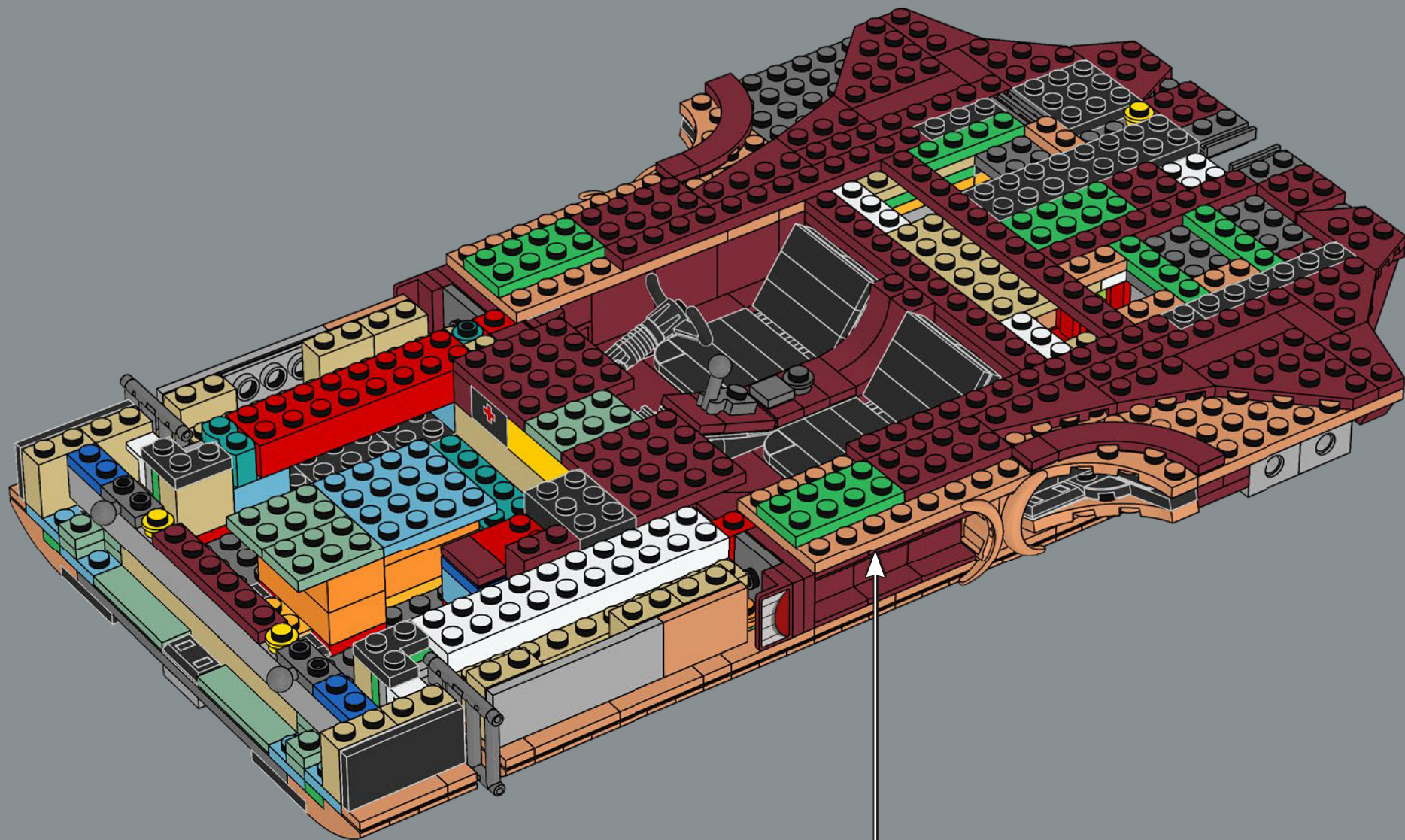

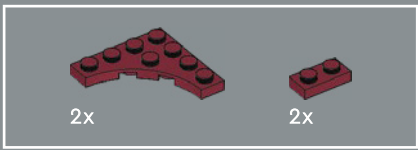

132

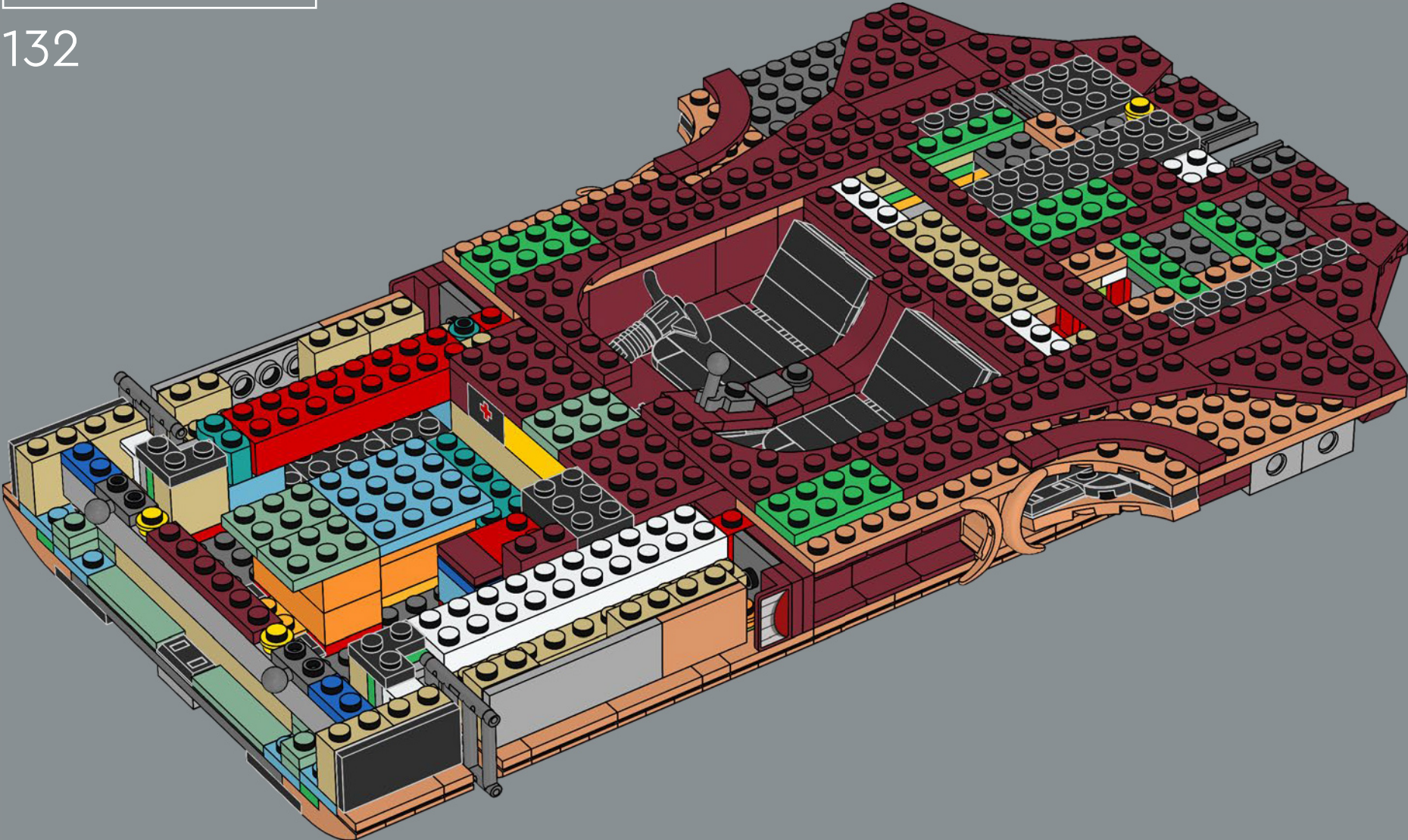

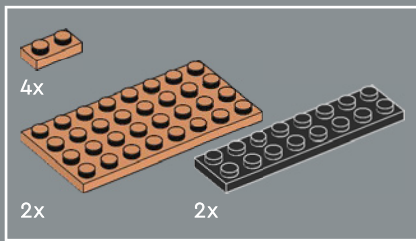

133

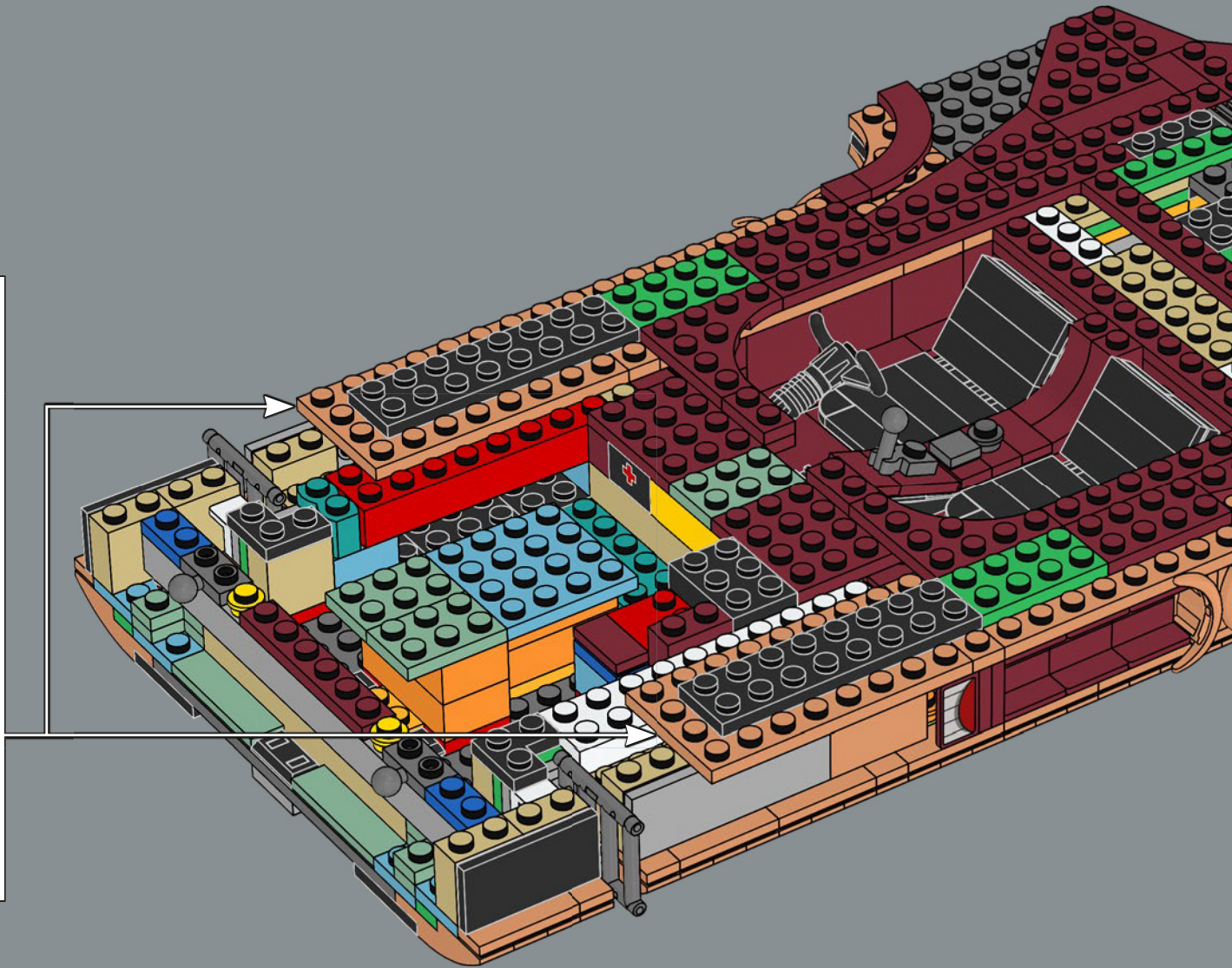
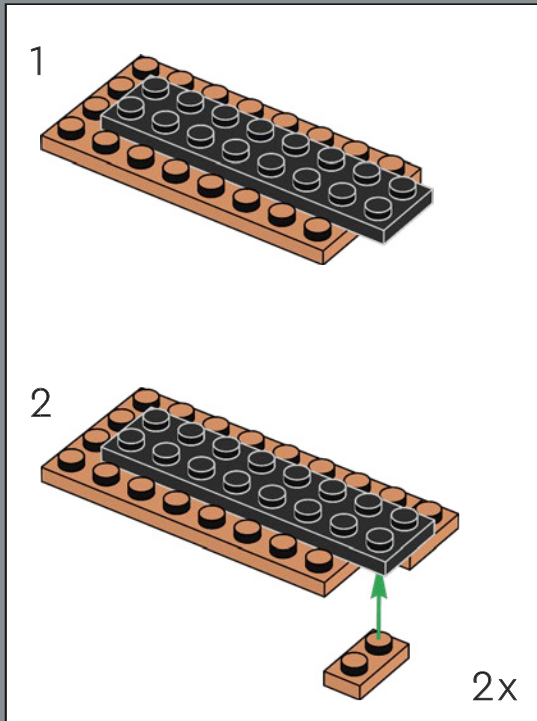

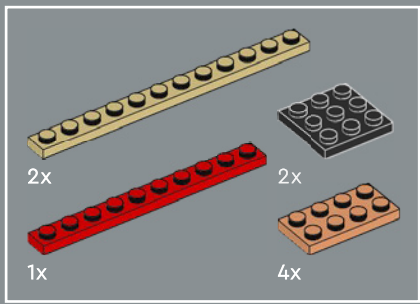

134

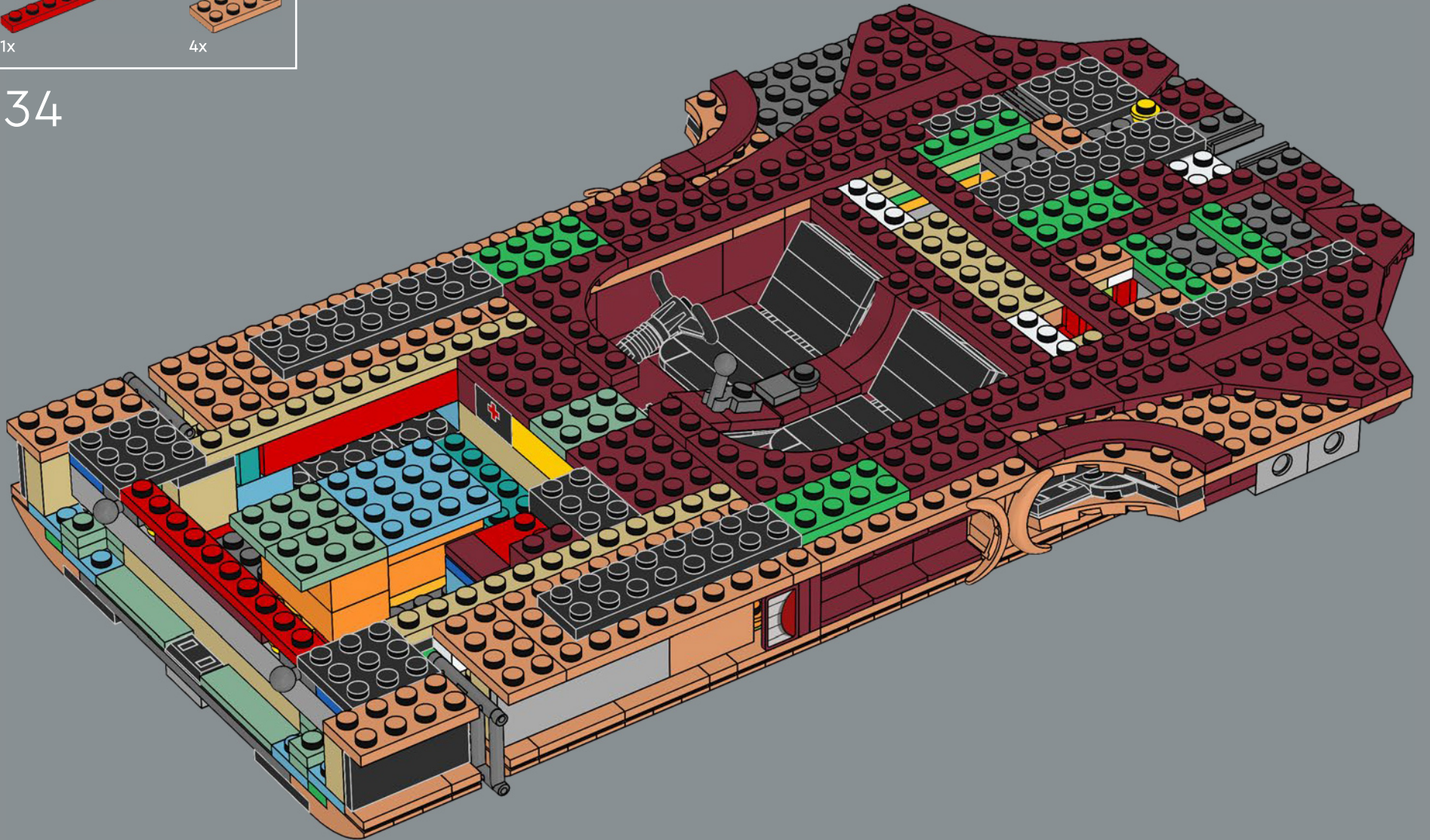

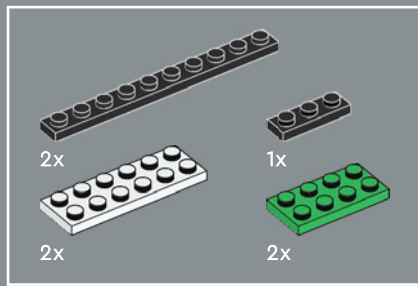

135

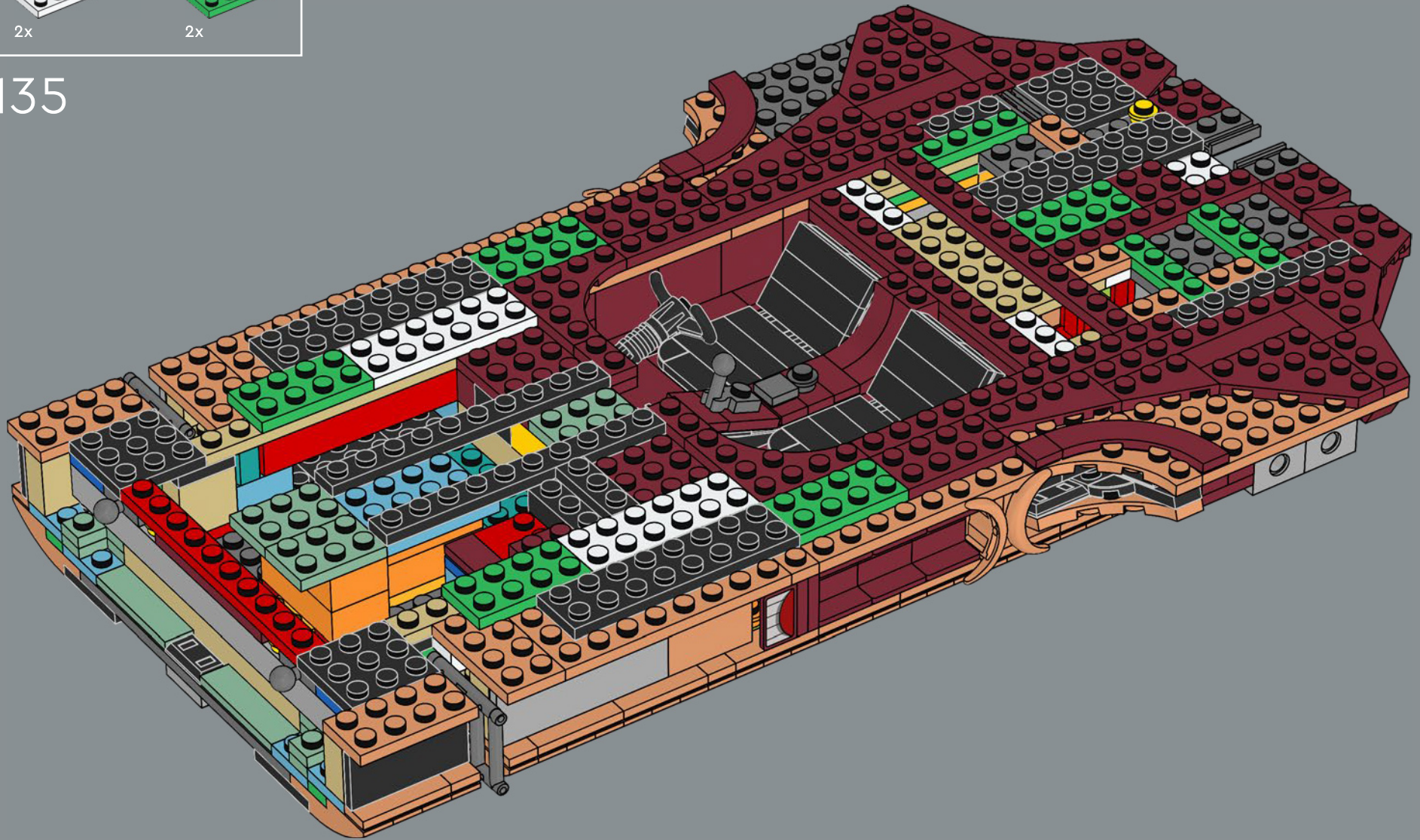

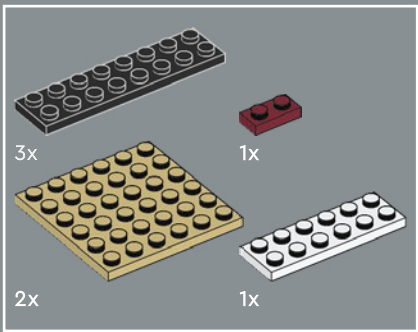

136

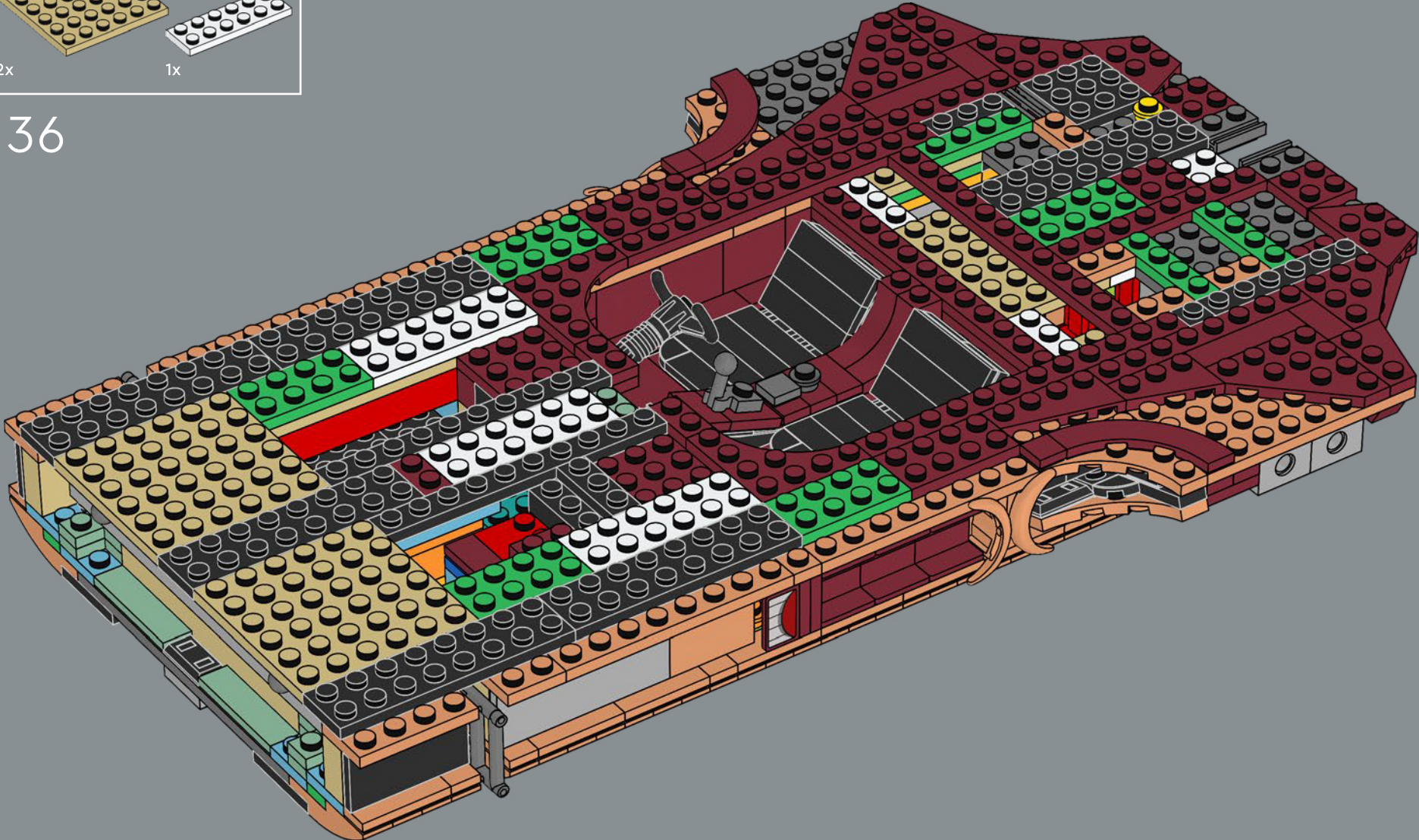

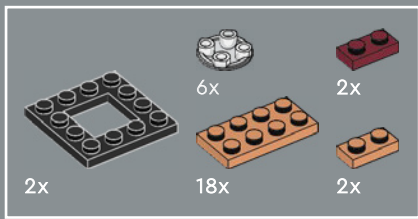

137

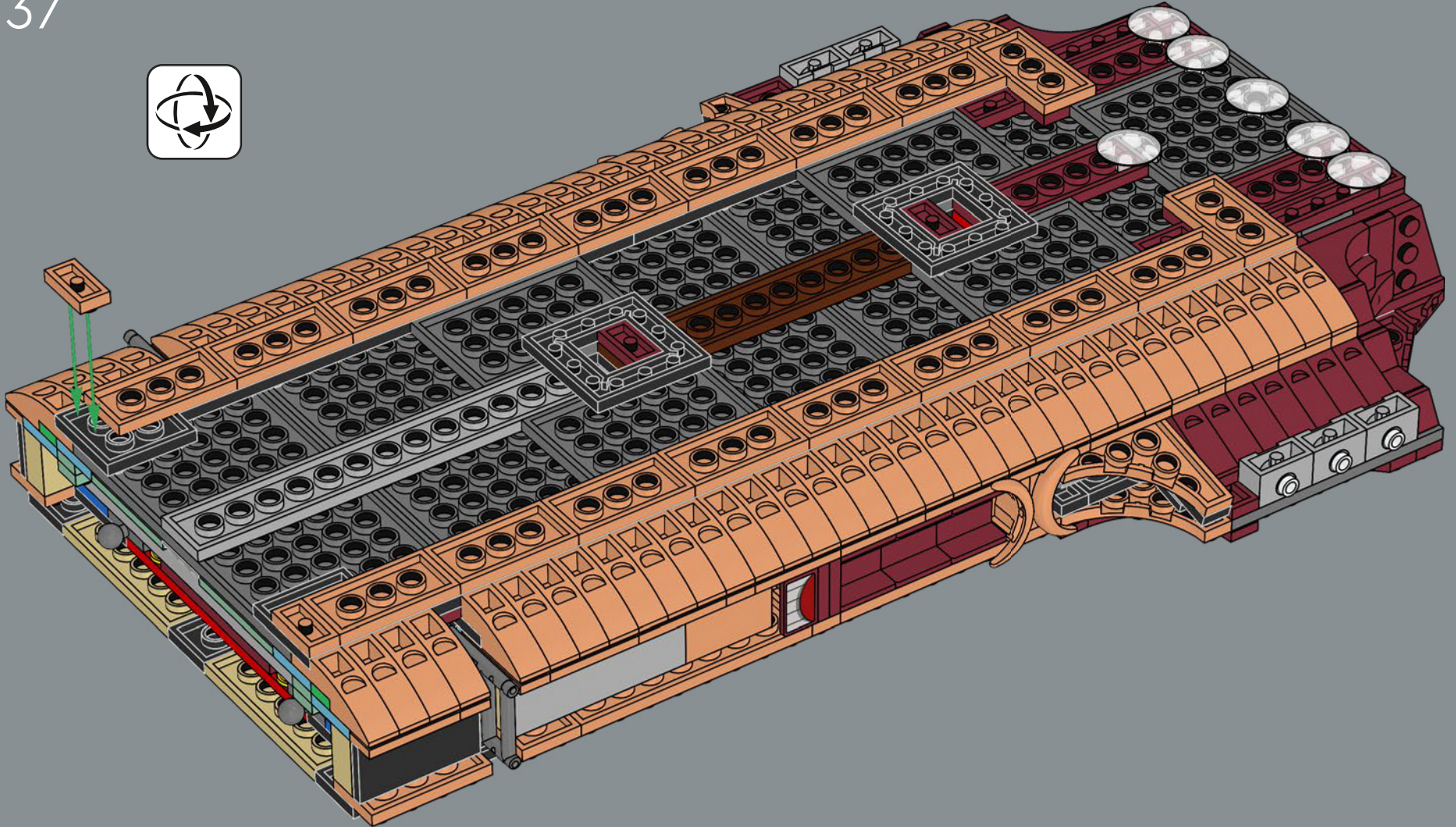



1x



4x



2x



3x

138



1

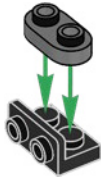

2



3

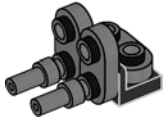

4

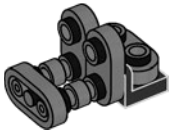

5

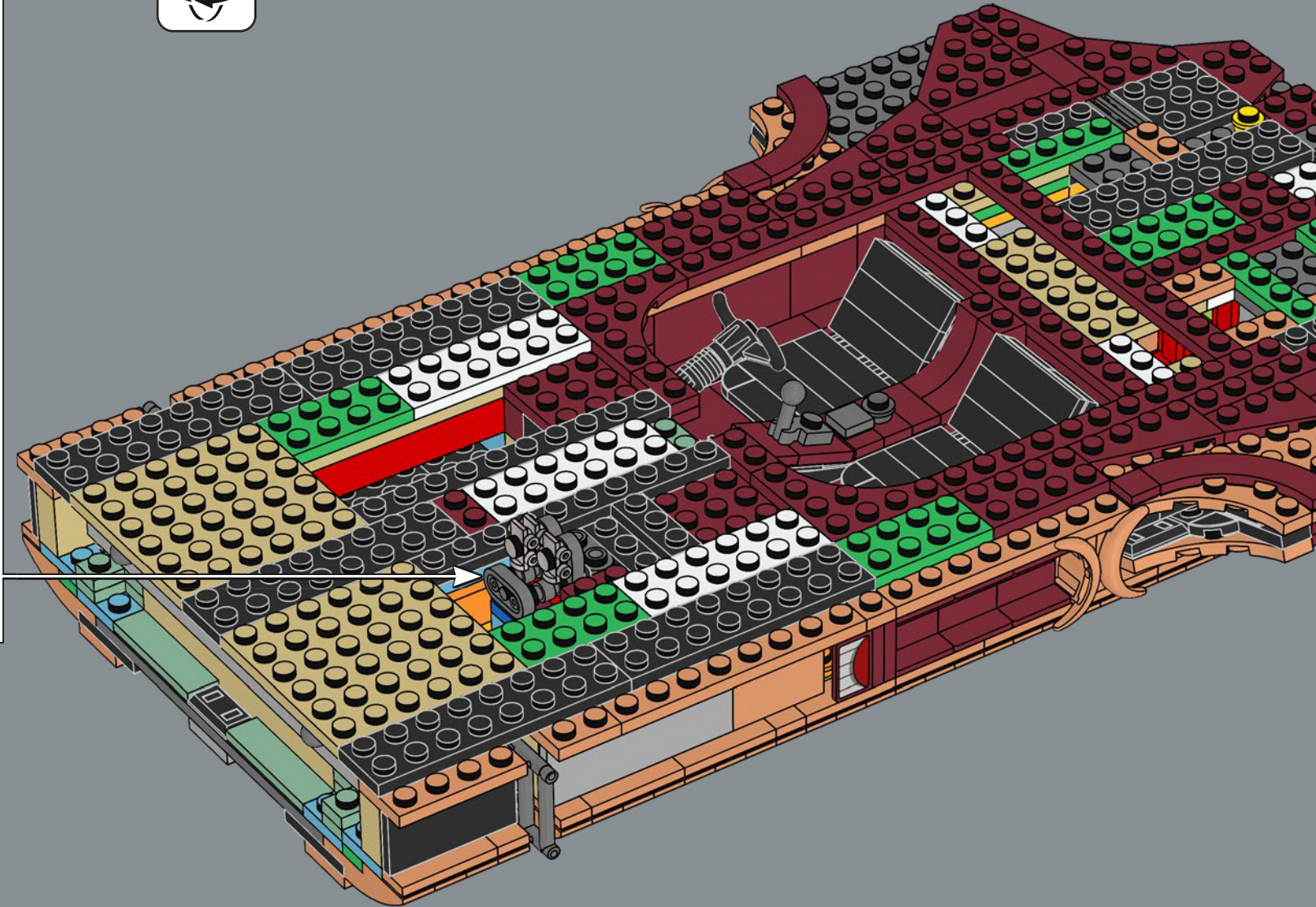
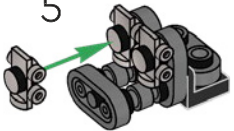

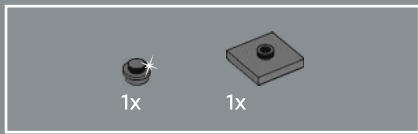

139

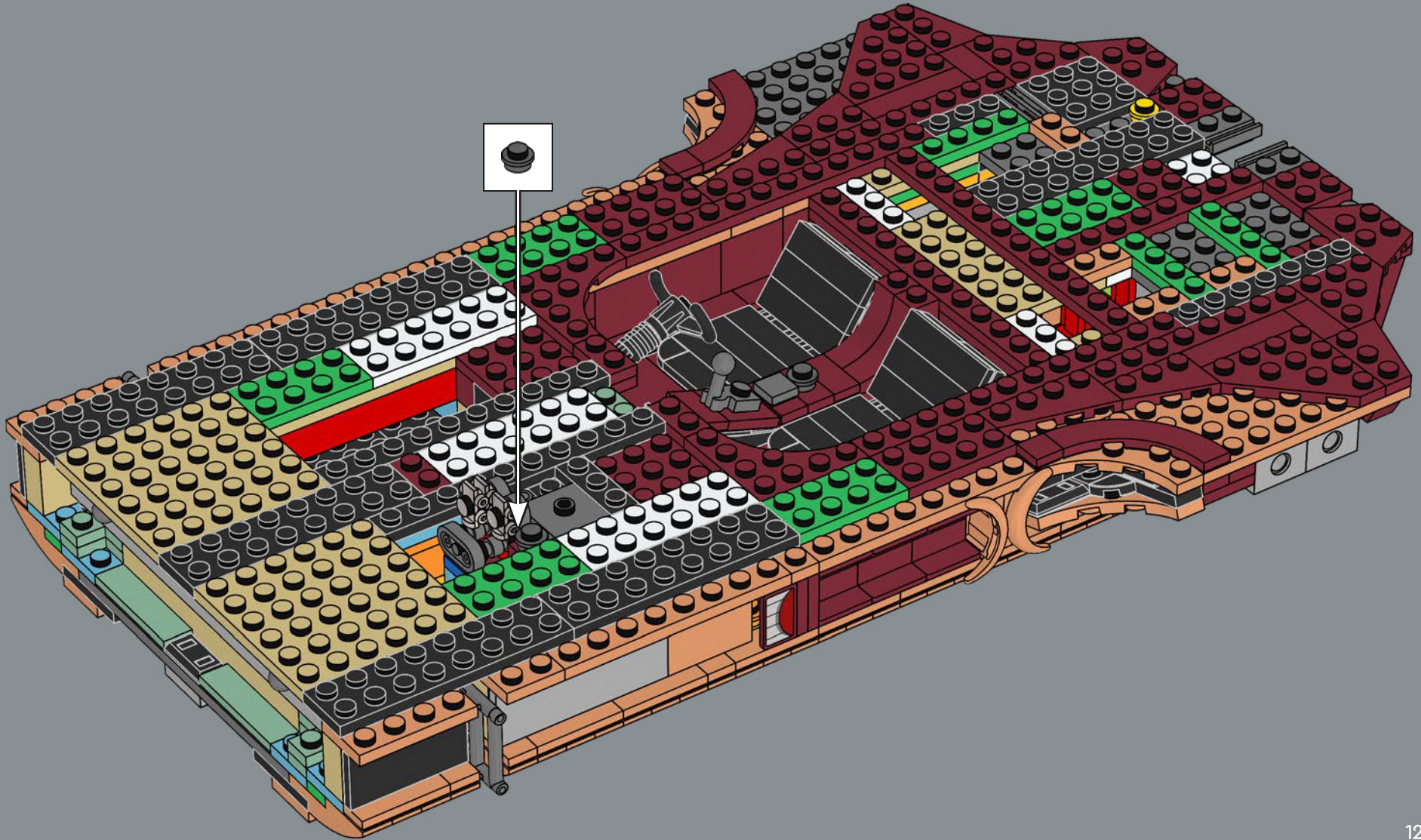

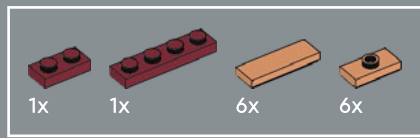

140

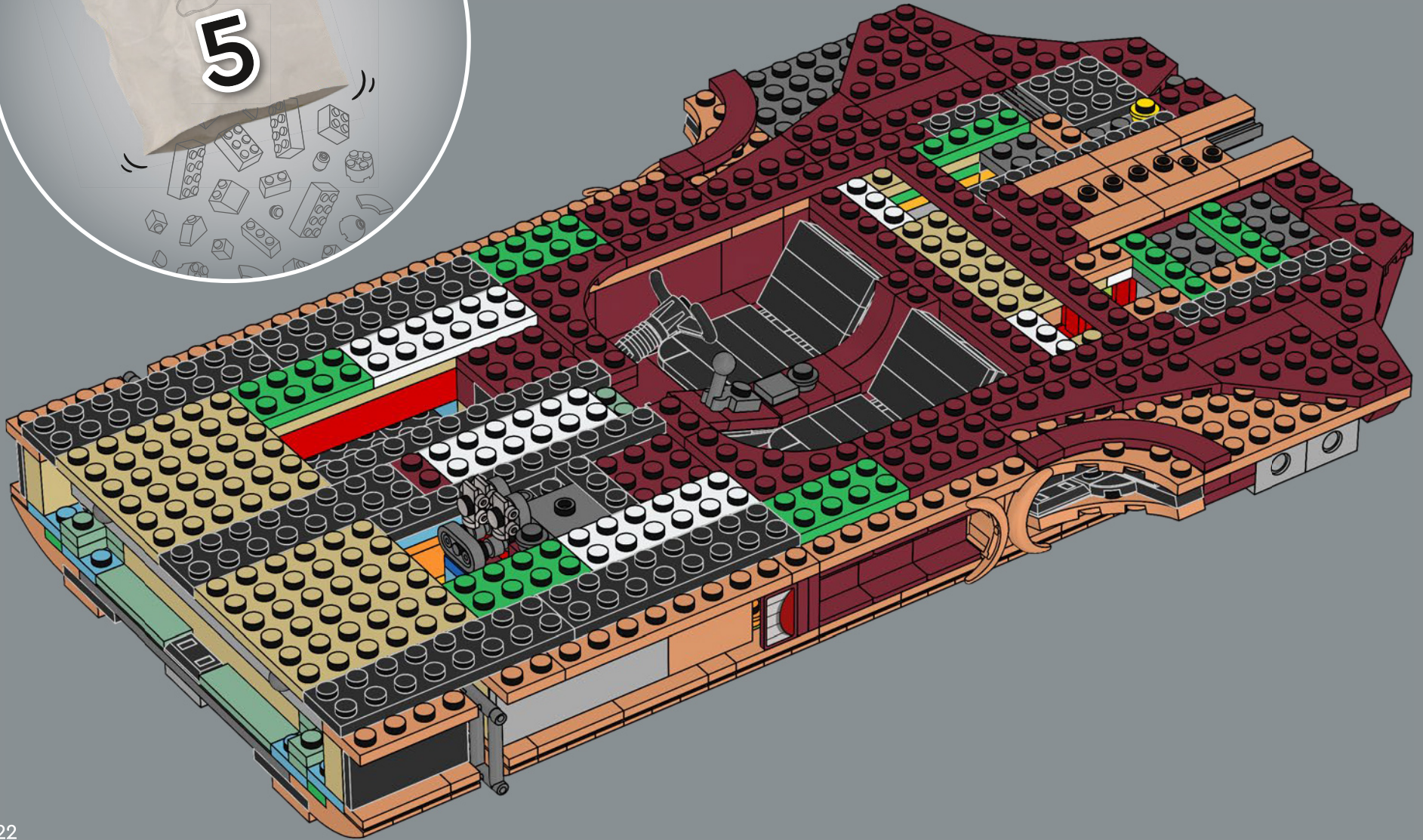

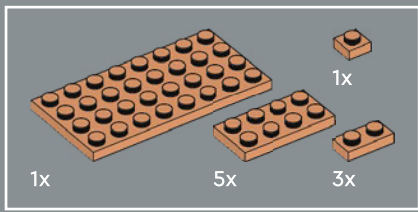

141

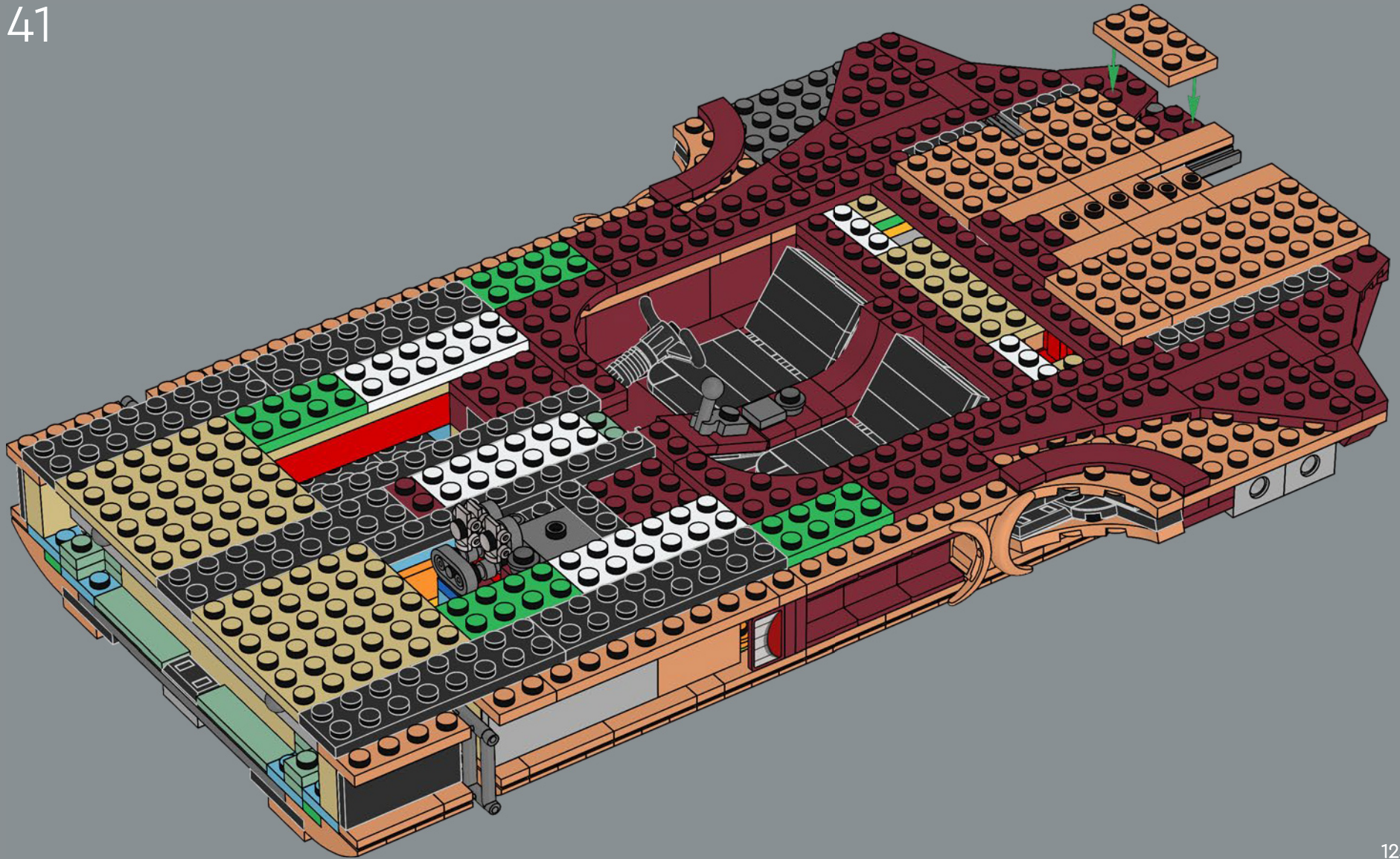

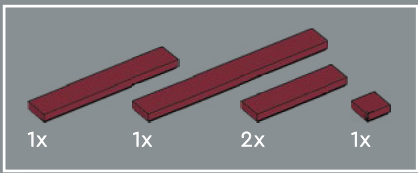

142

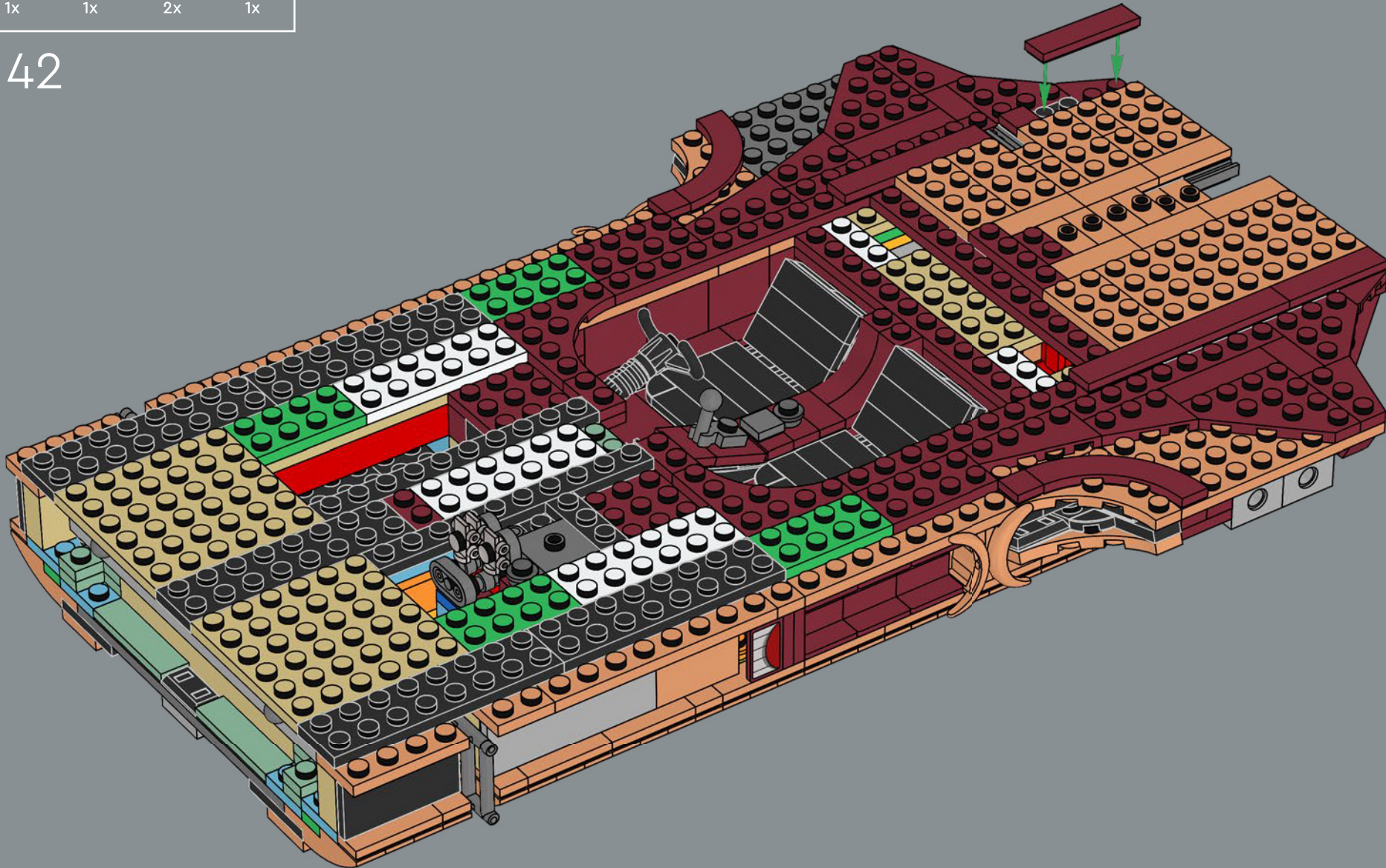



4x

143

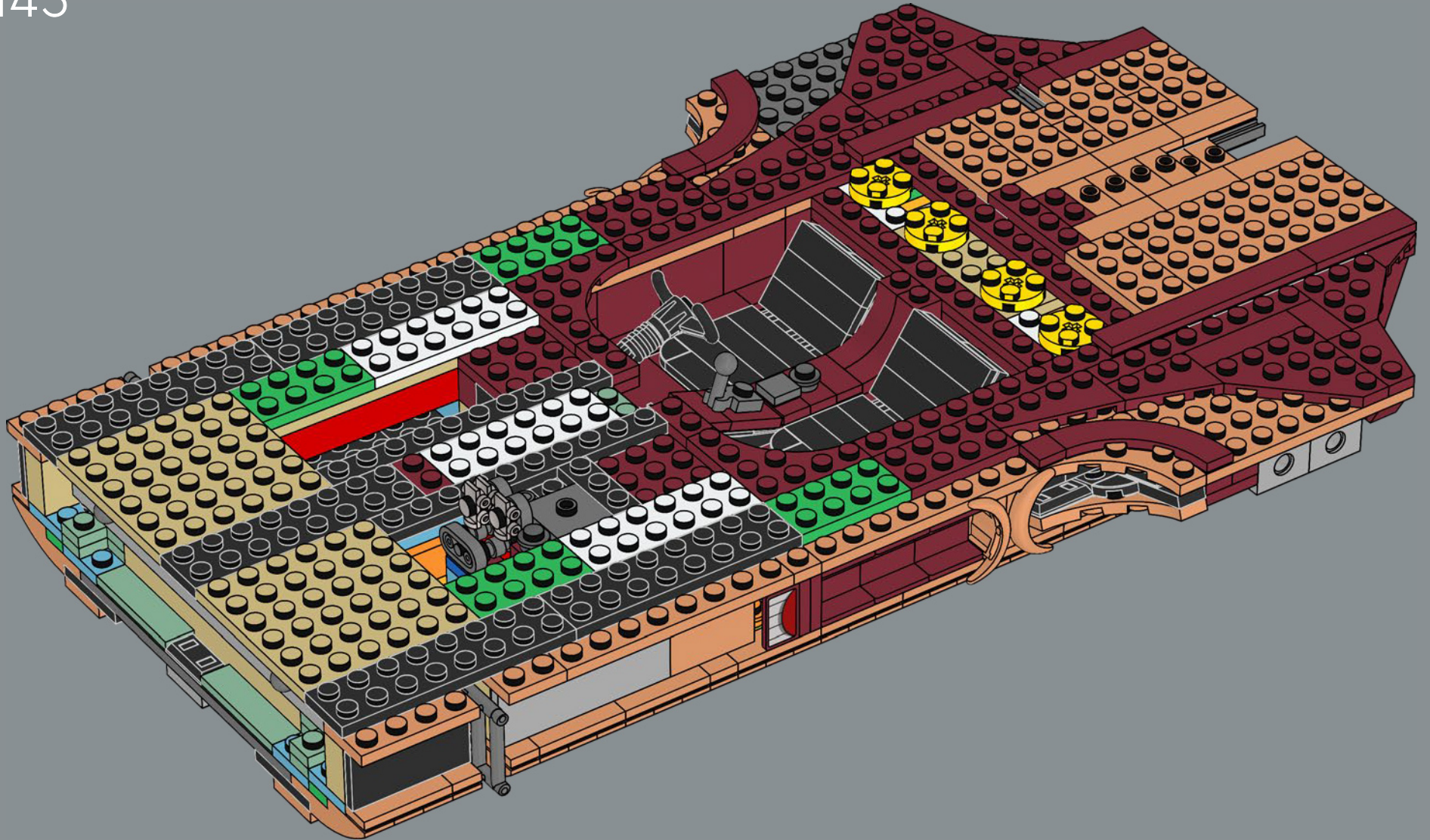



144

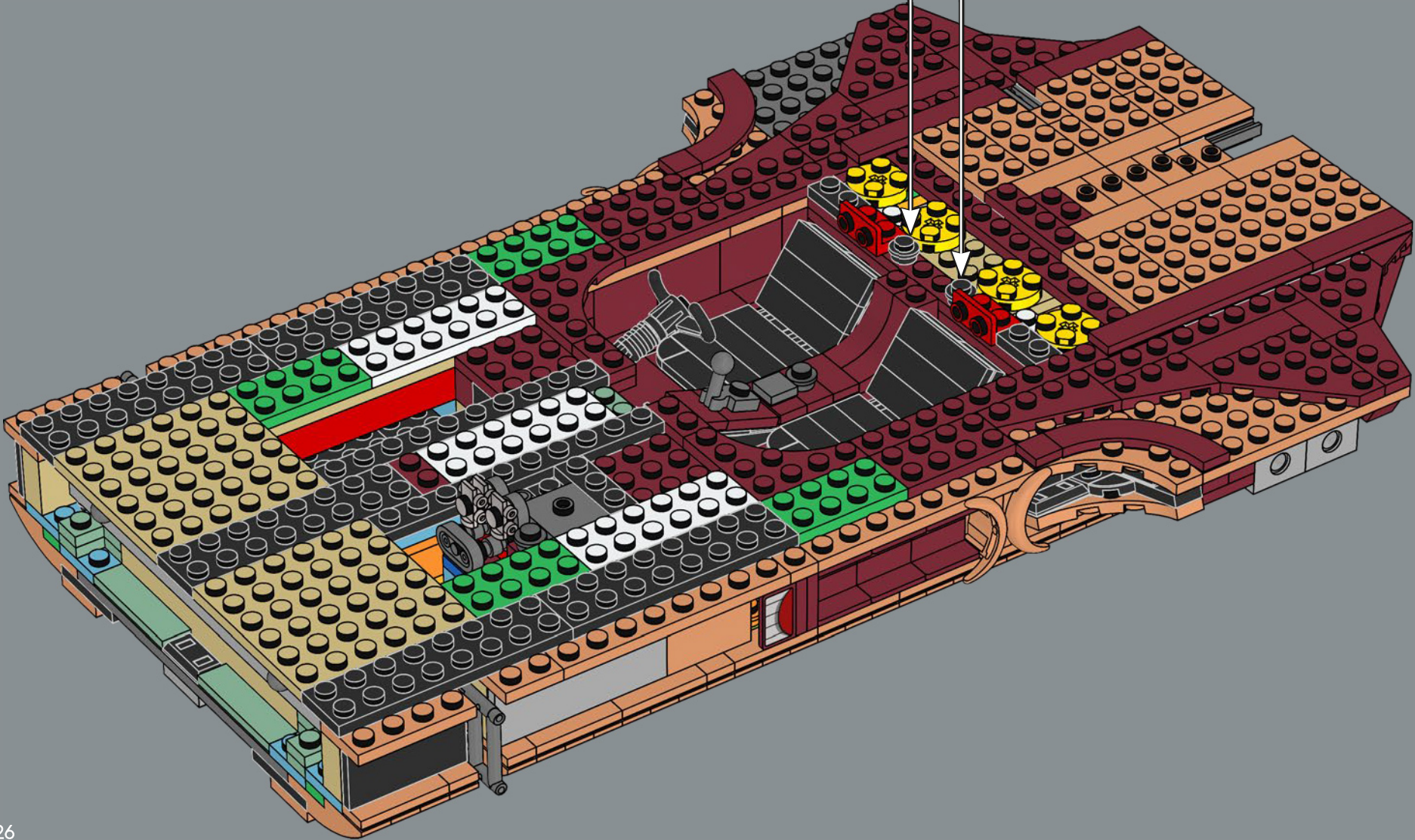
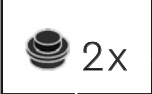

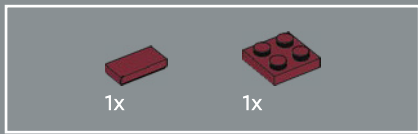

145

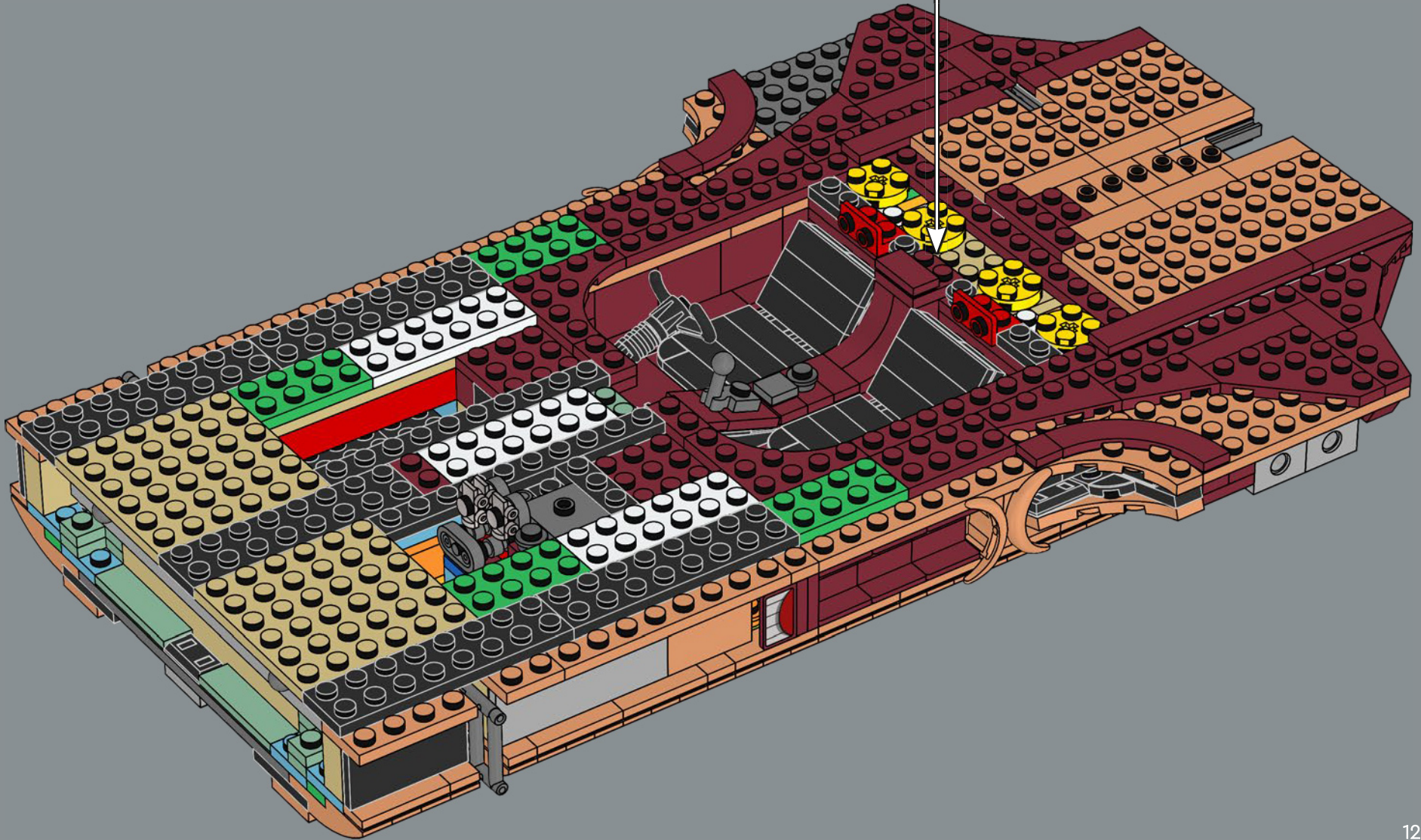
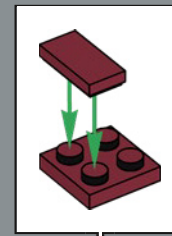

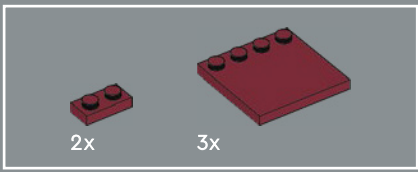

146

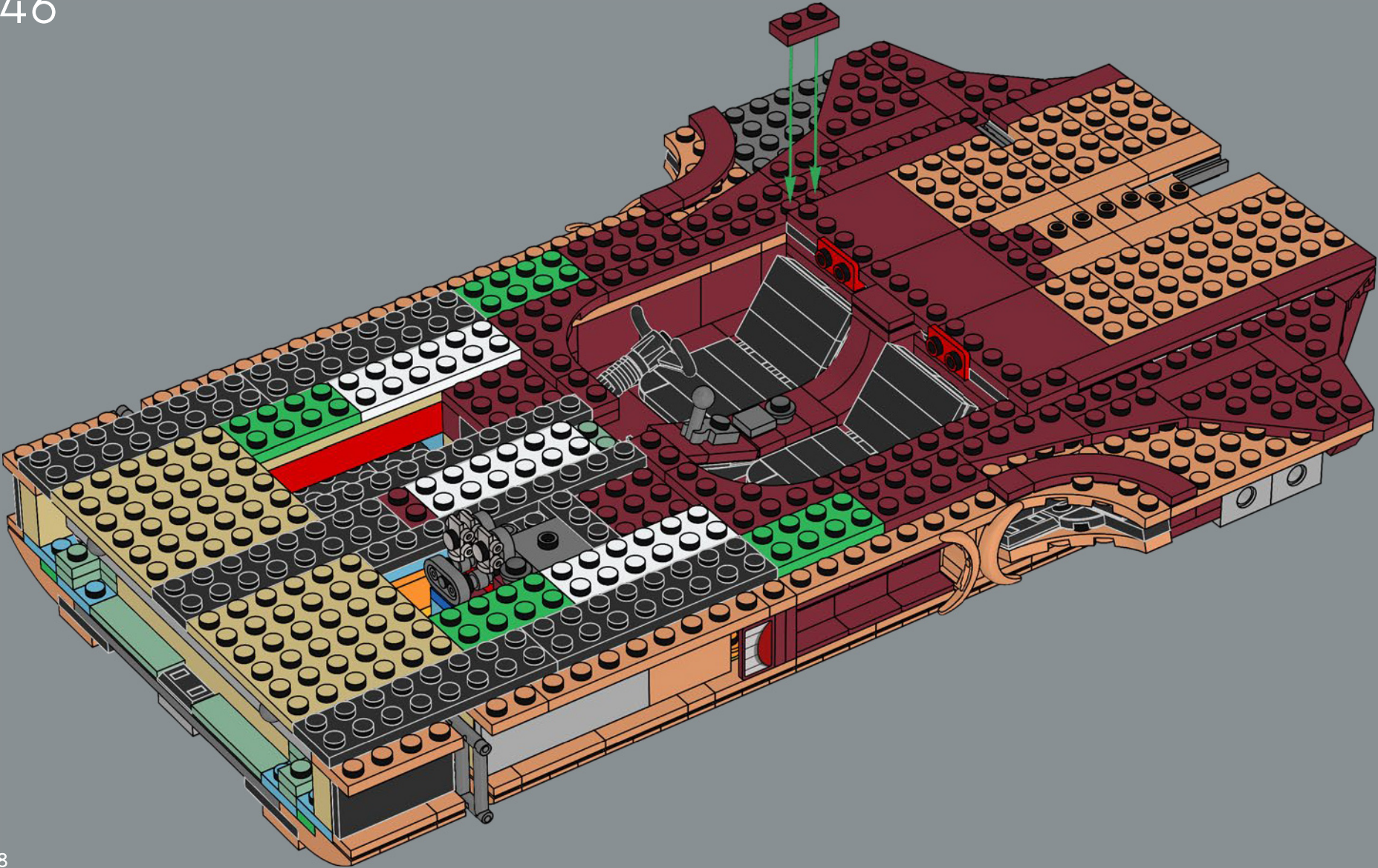

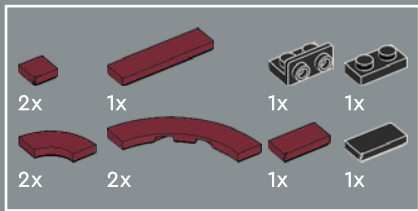

147

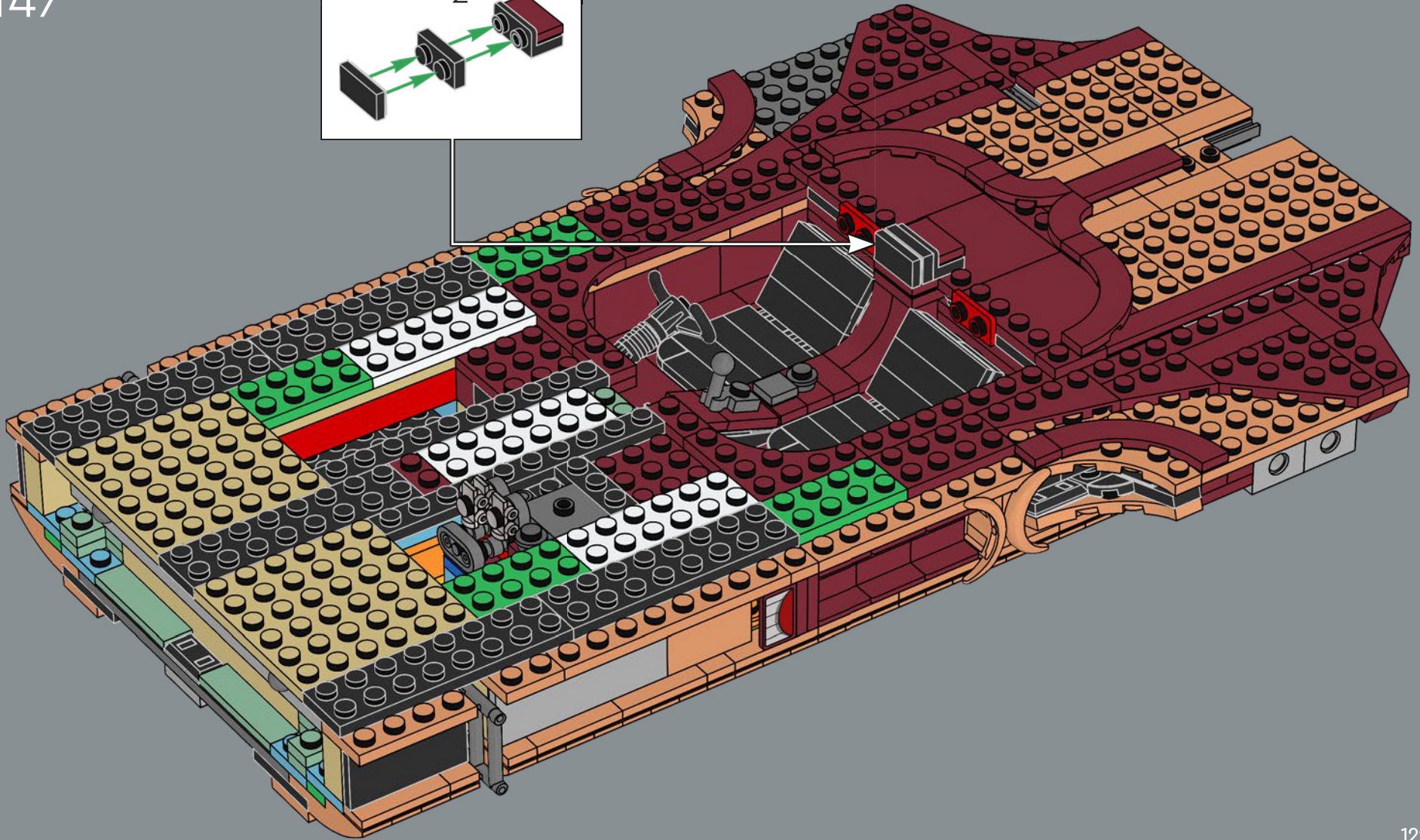
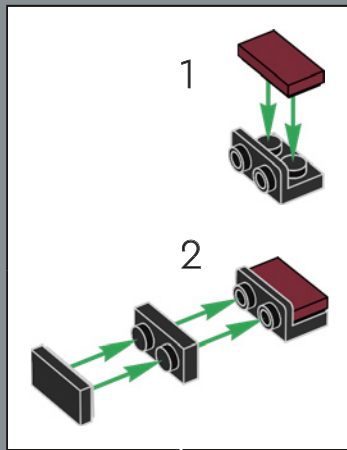

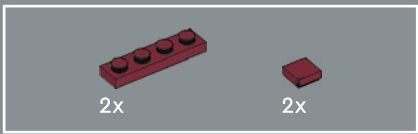

148

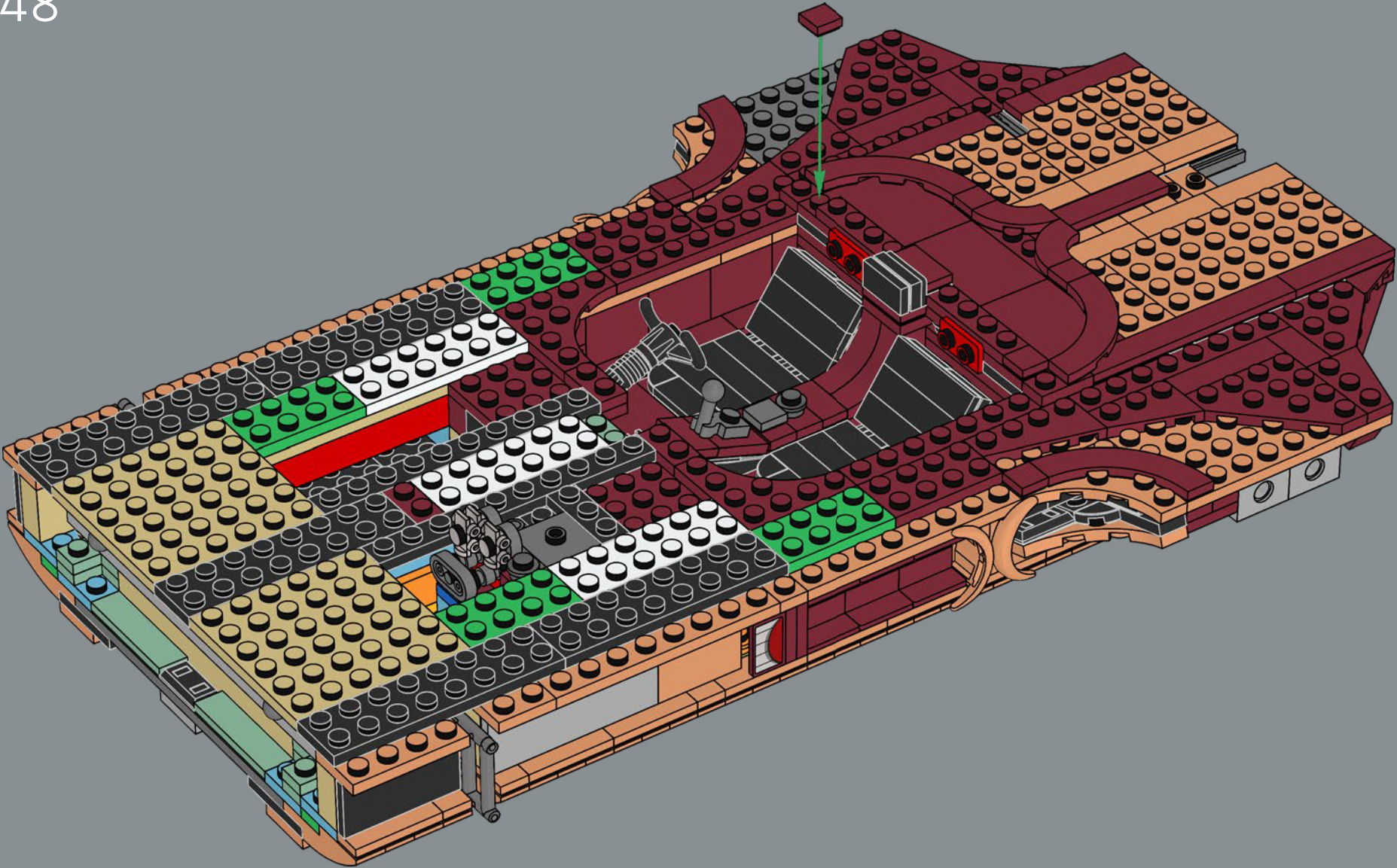

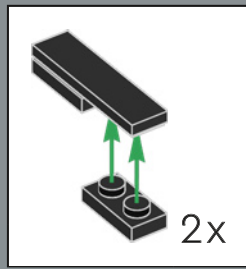

149

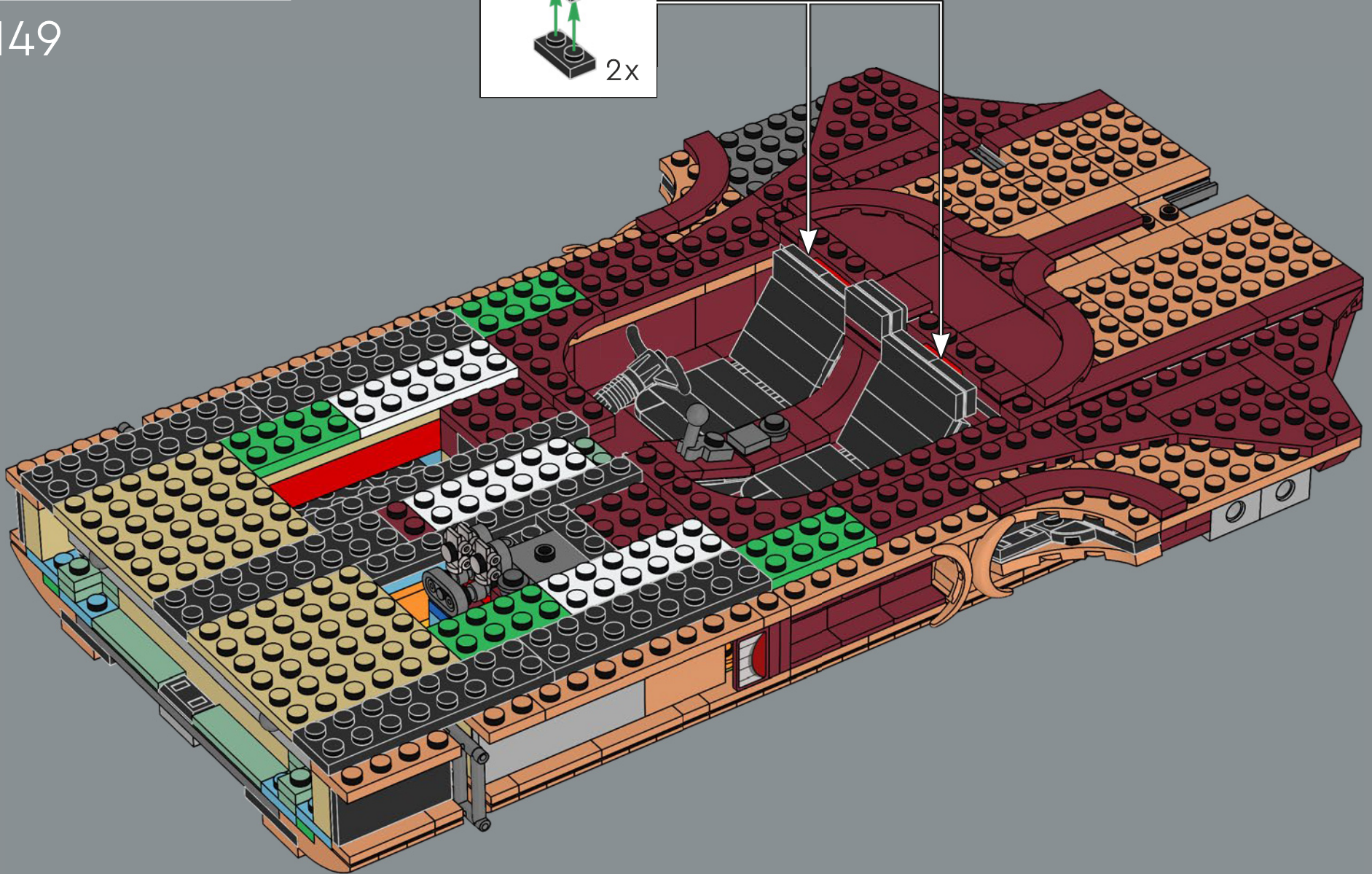

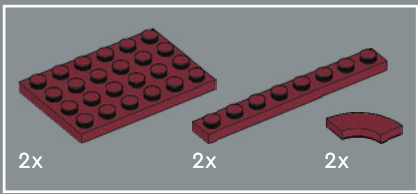

150

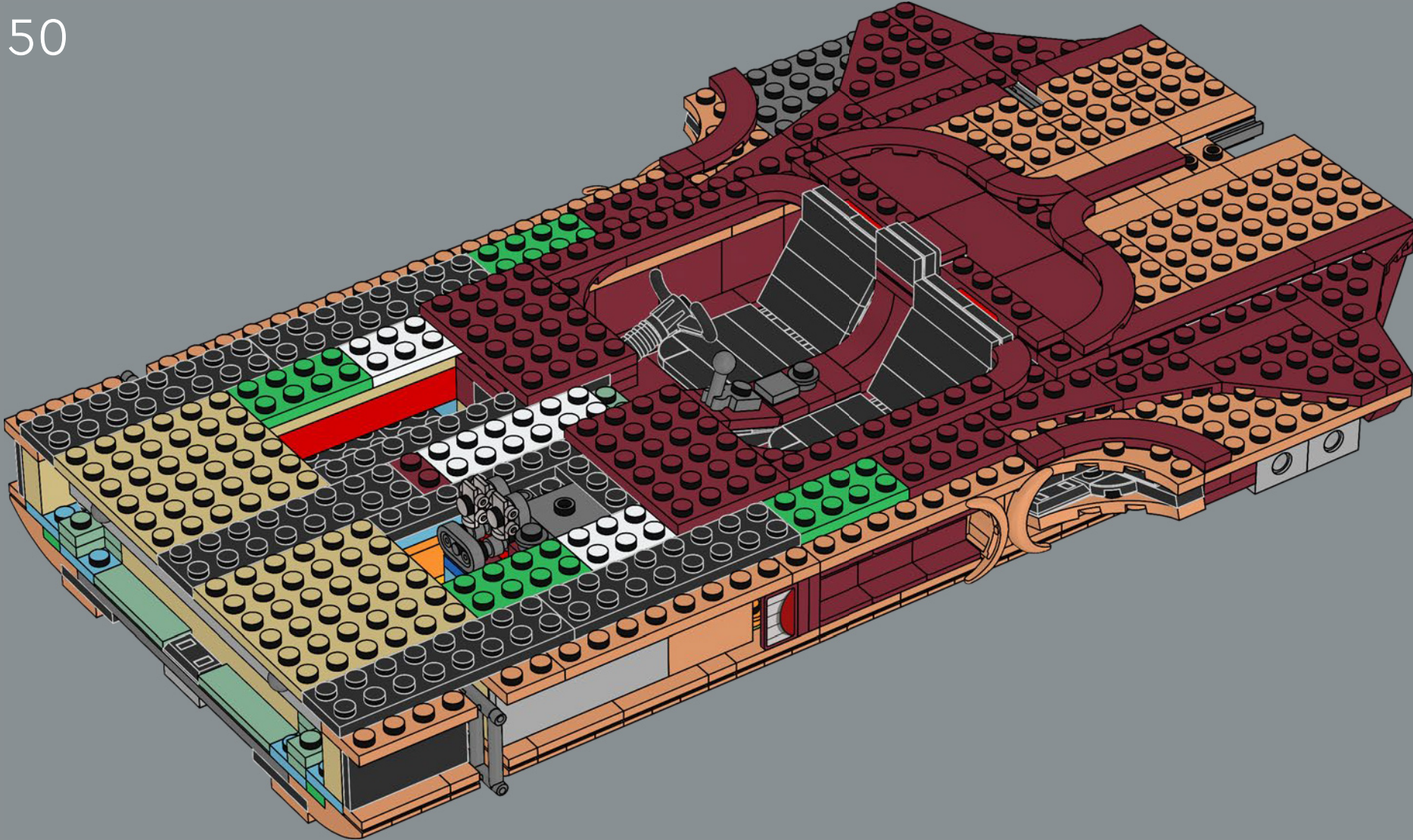

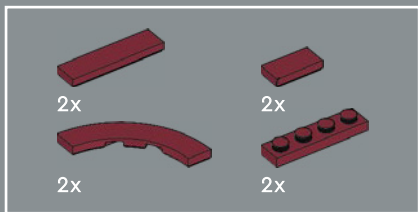

151

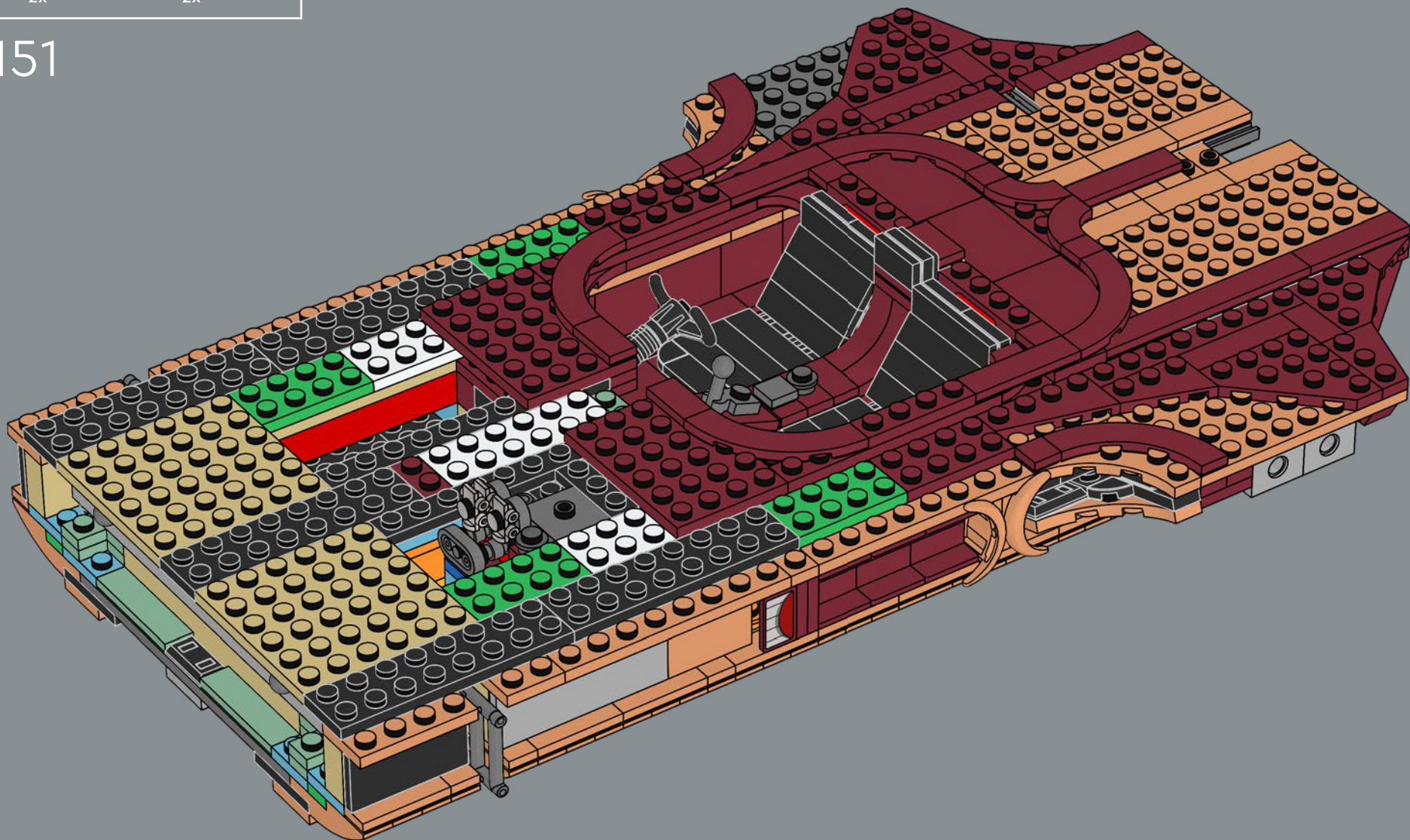

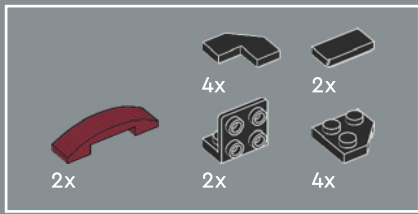

152

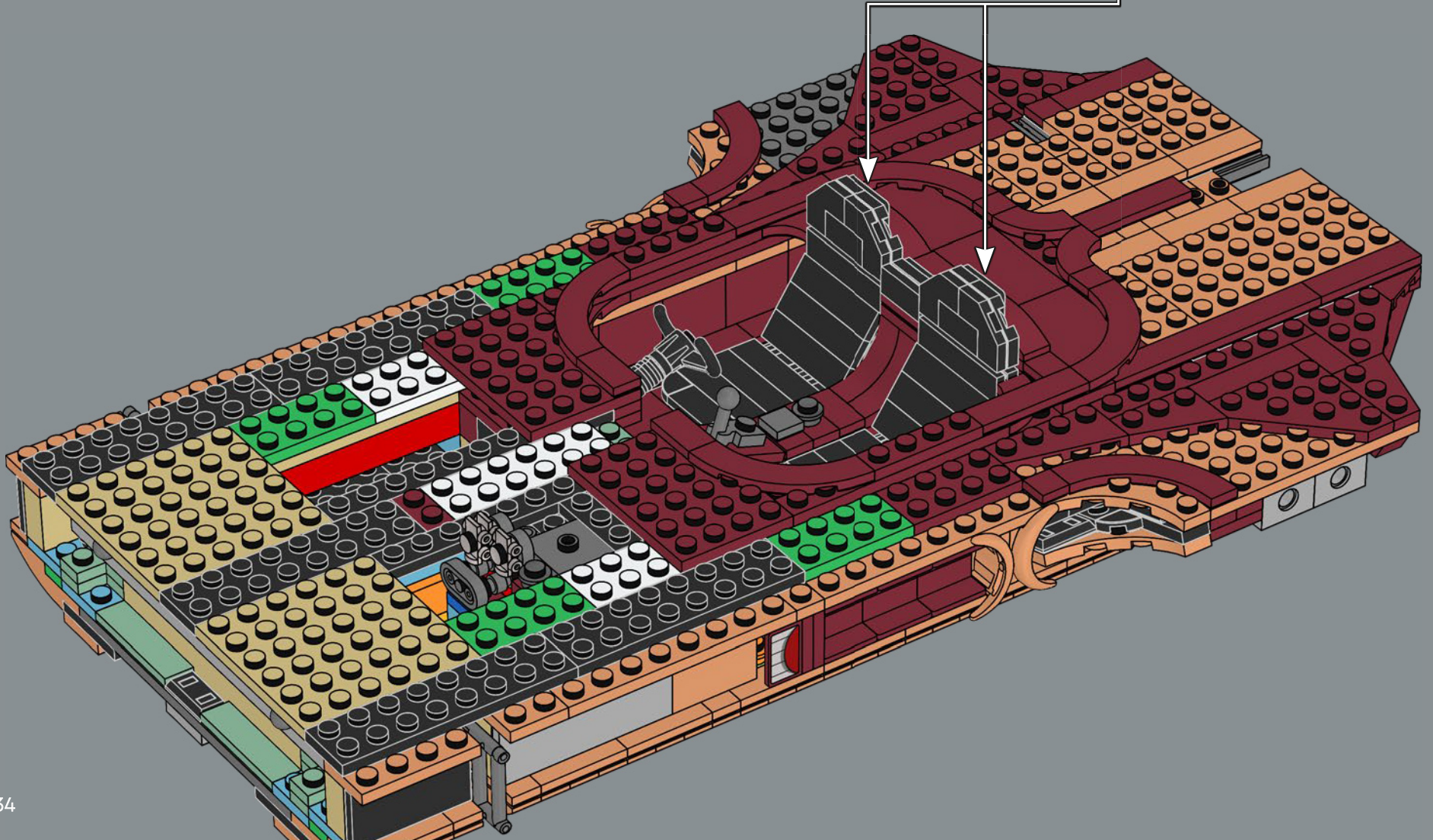
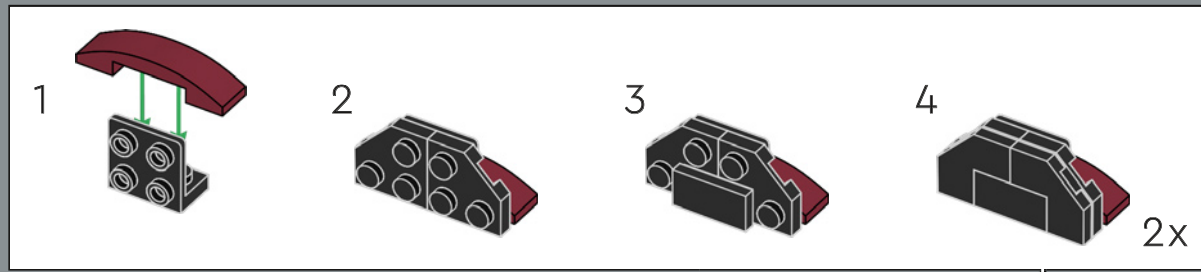

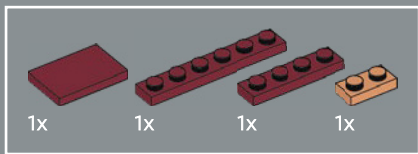

153

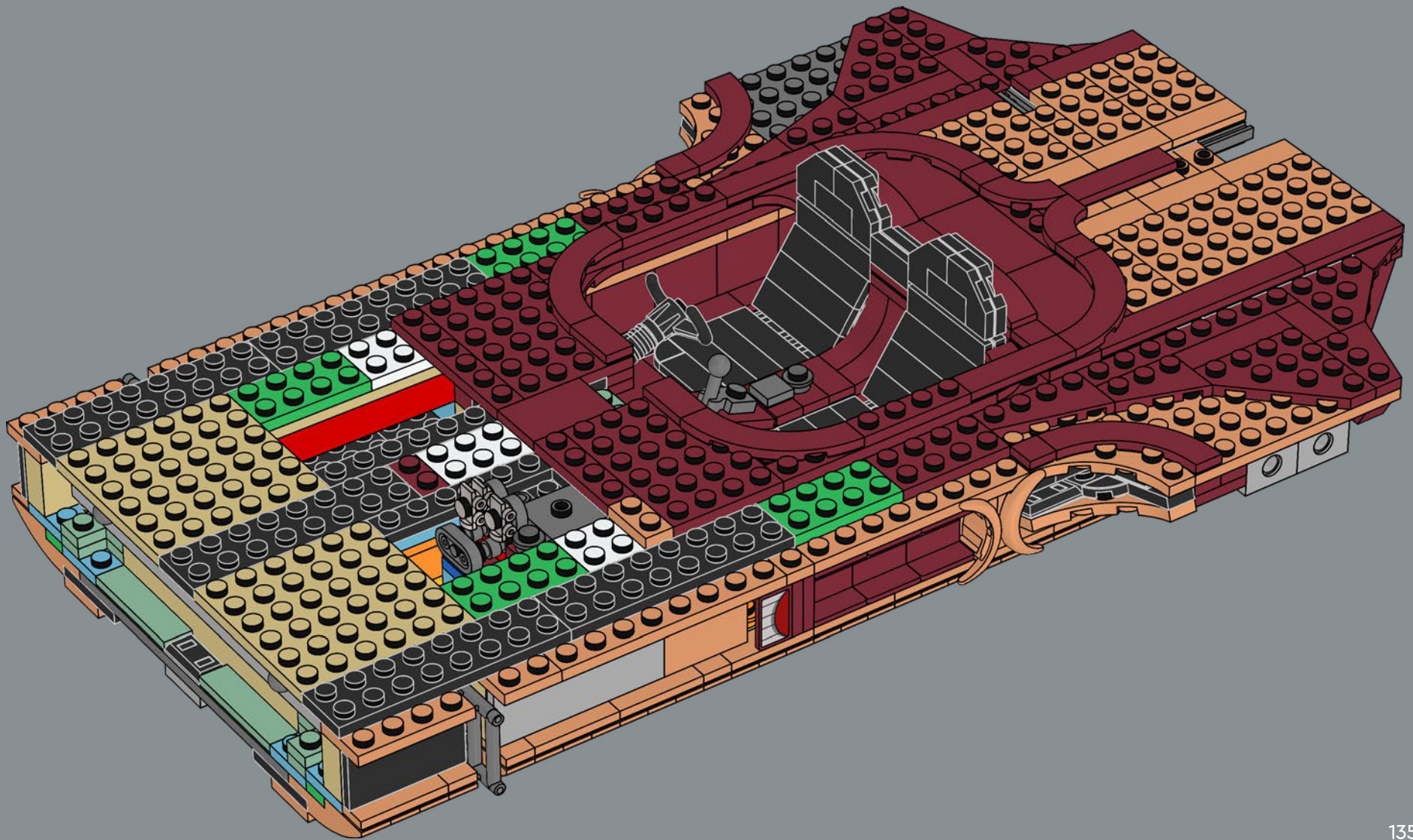

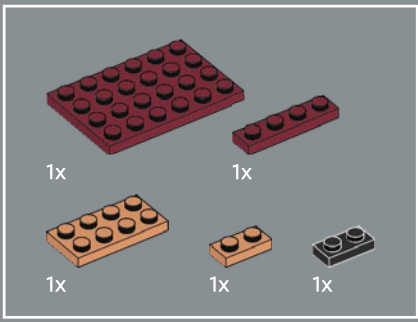

154

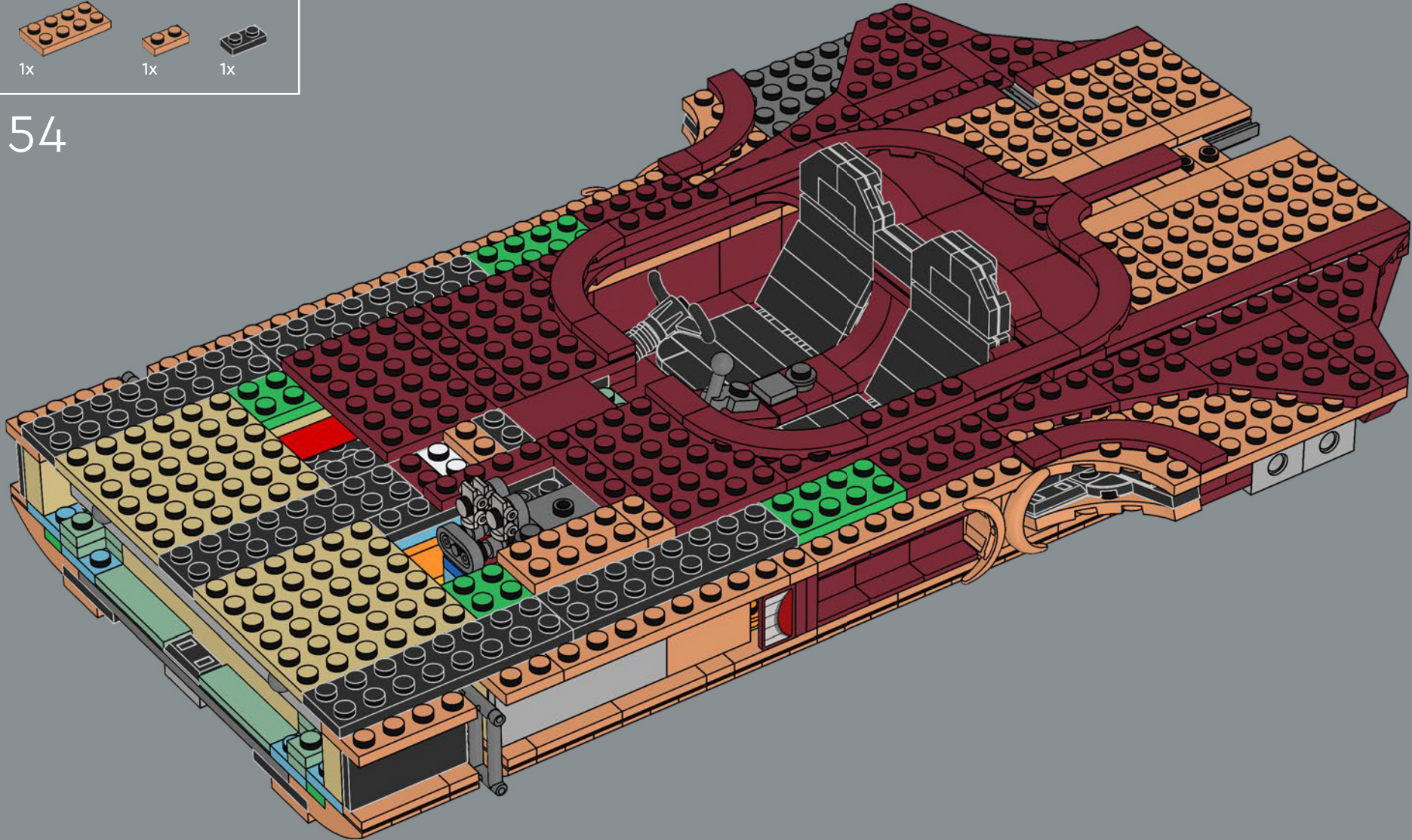

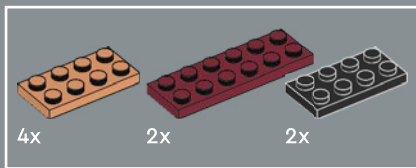

155

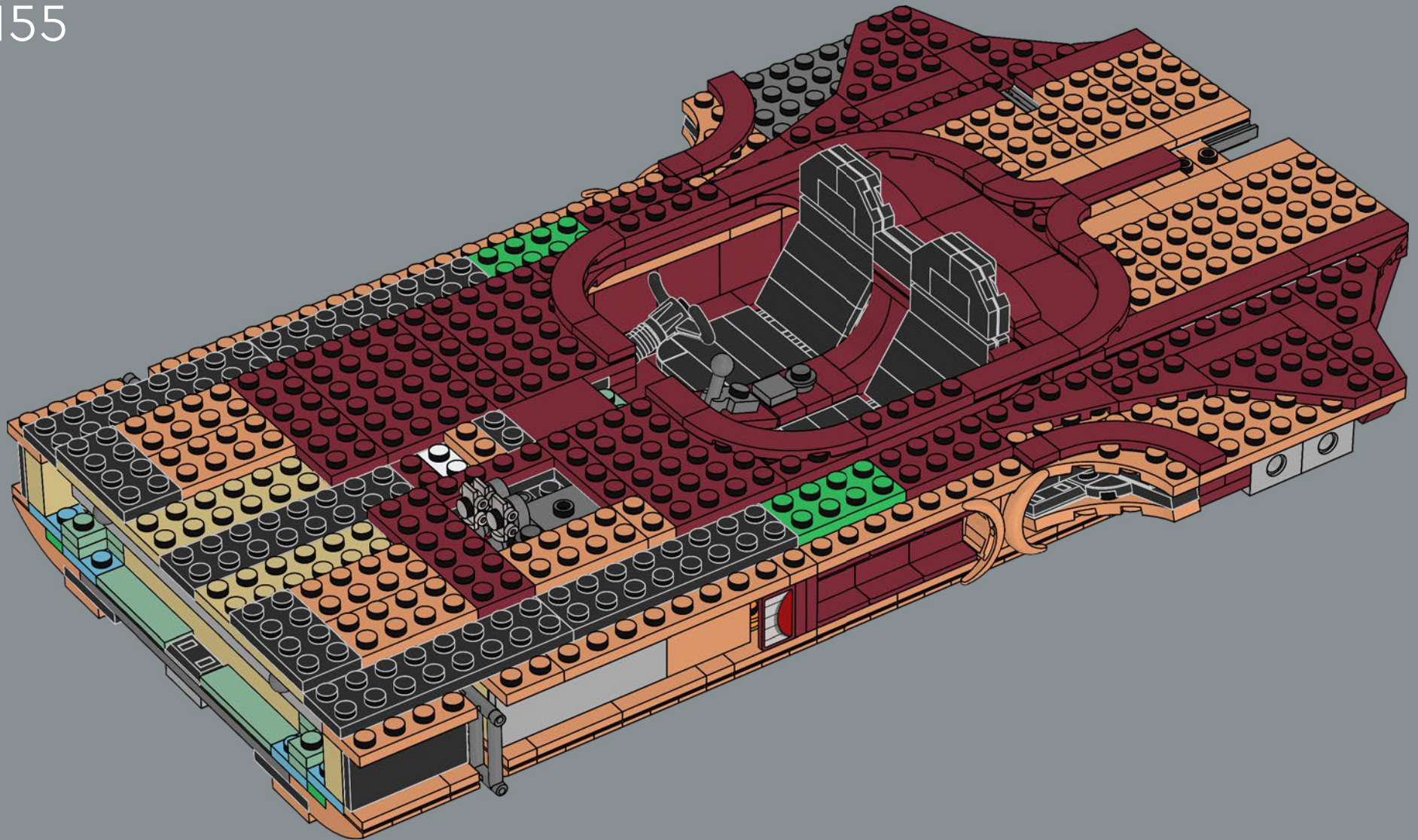

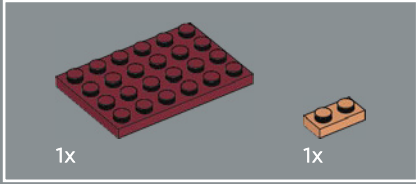
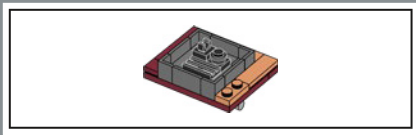

156

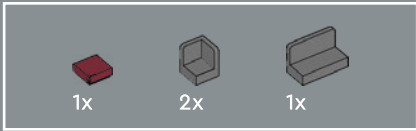
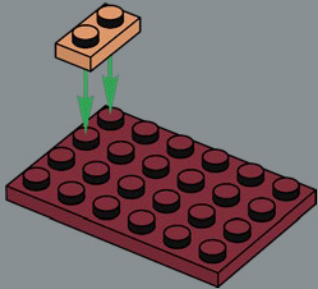

157

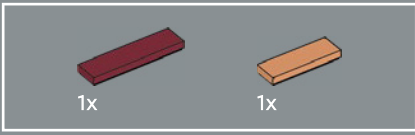
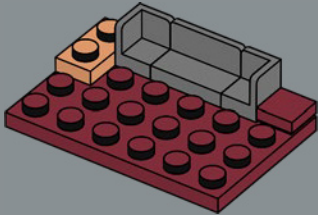

158

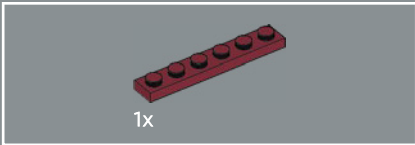
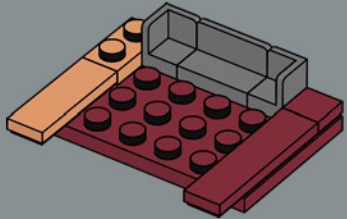

159

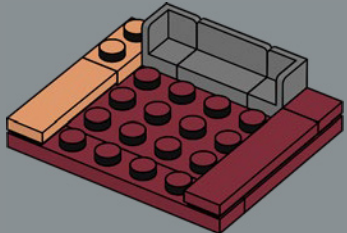

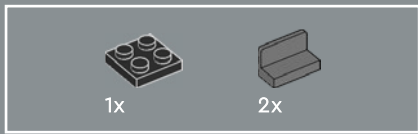

160

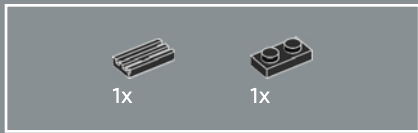
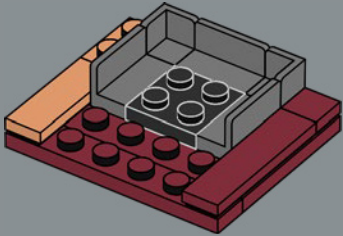

161

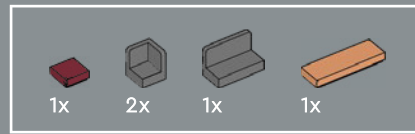
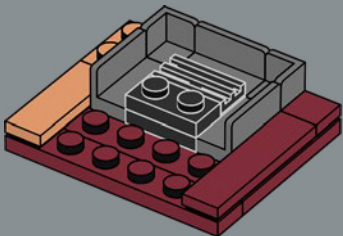

162

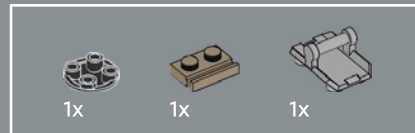
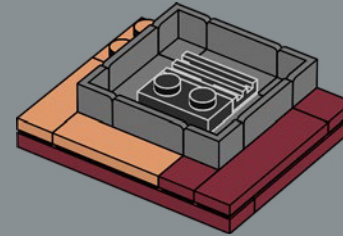

163

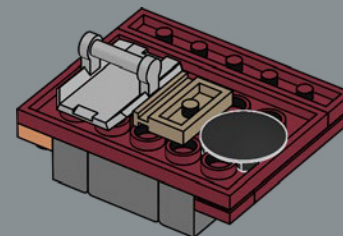

1x

1x

164

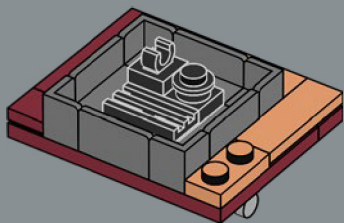

165

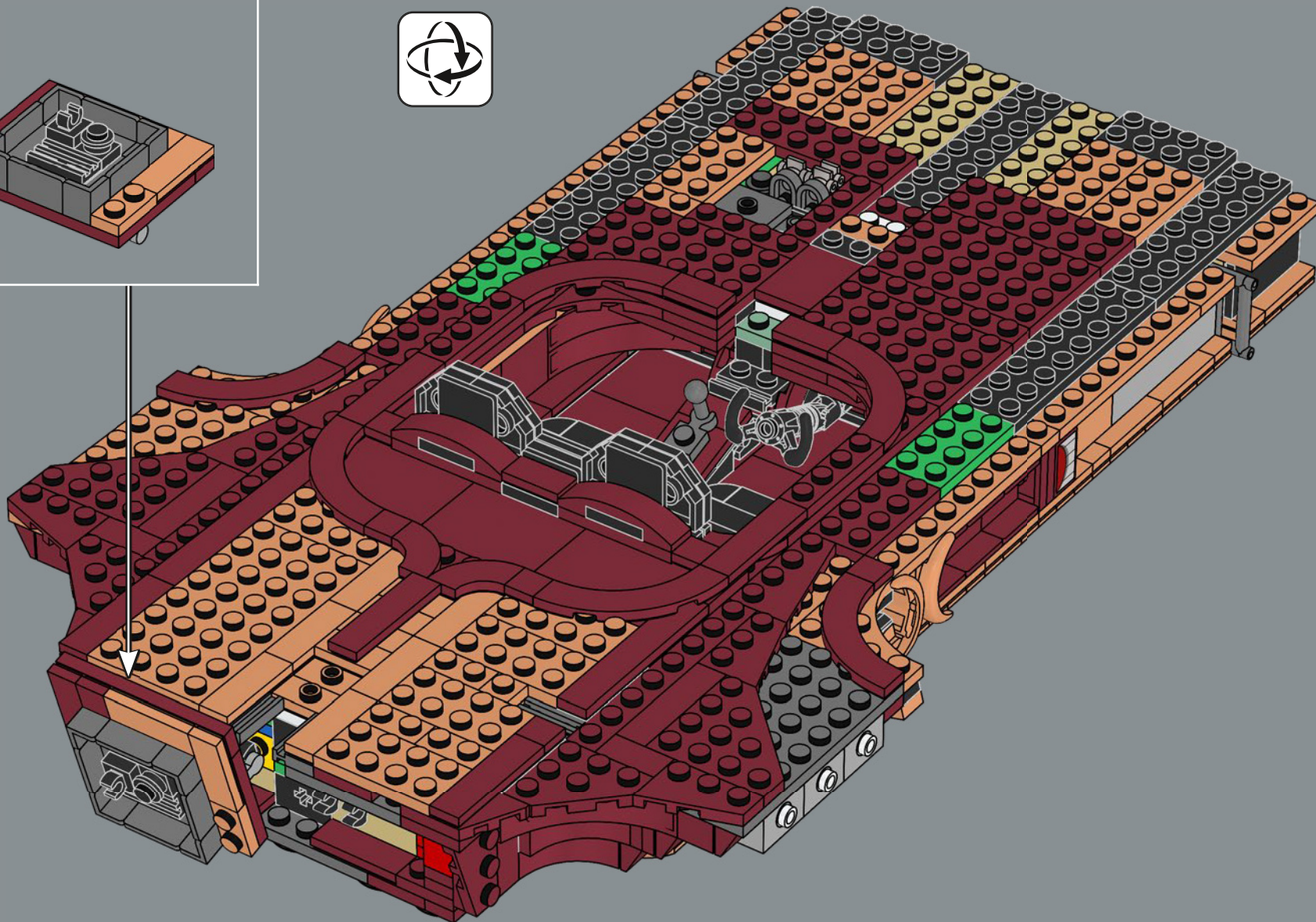

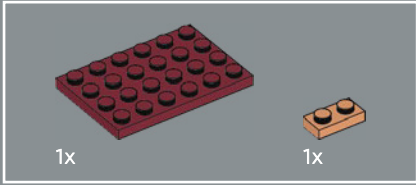
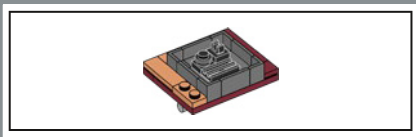

166

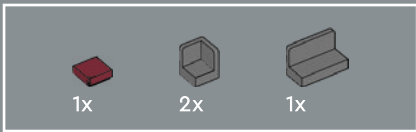
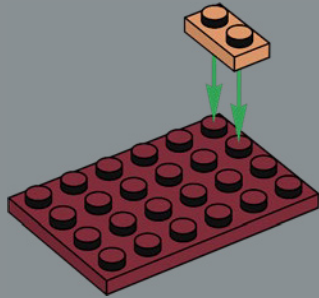

167

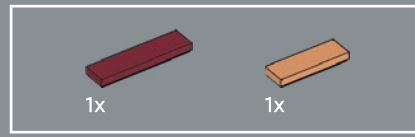
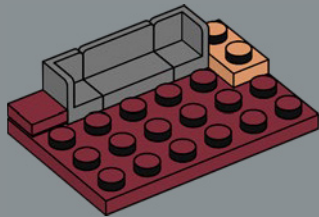

168

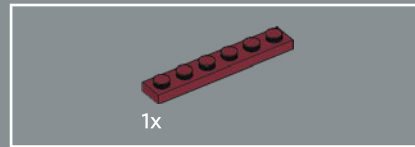
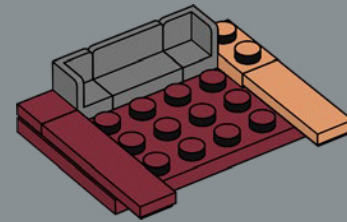

169

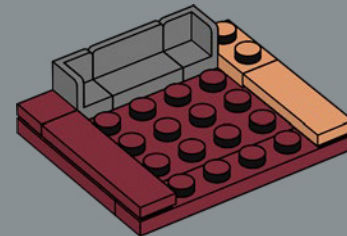

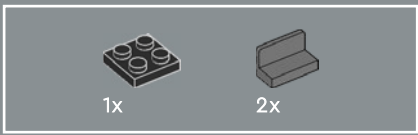

170

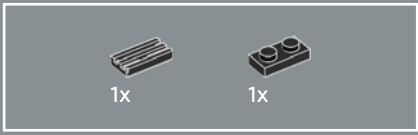
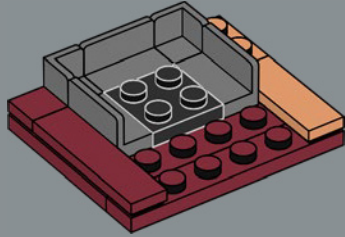

171

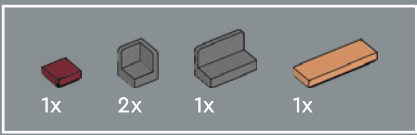
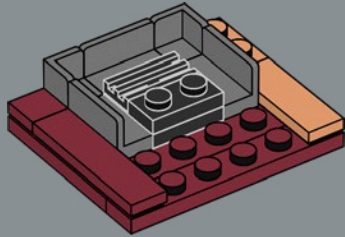

172

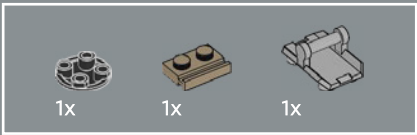
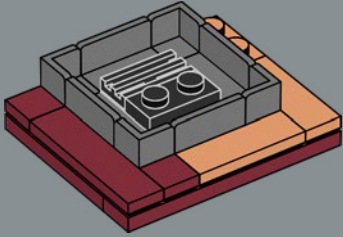

173

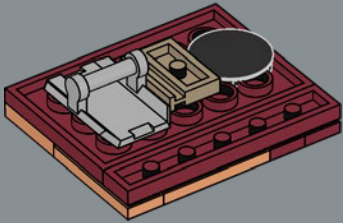

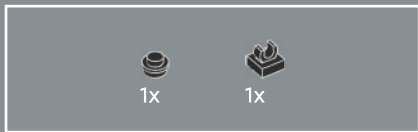

174

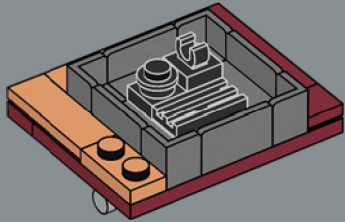

175

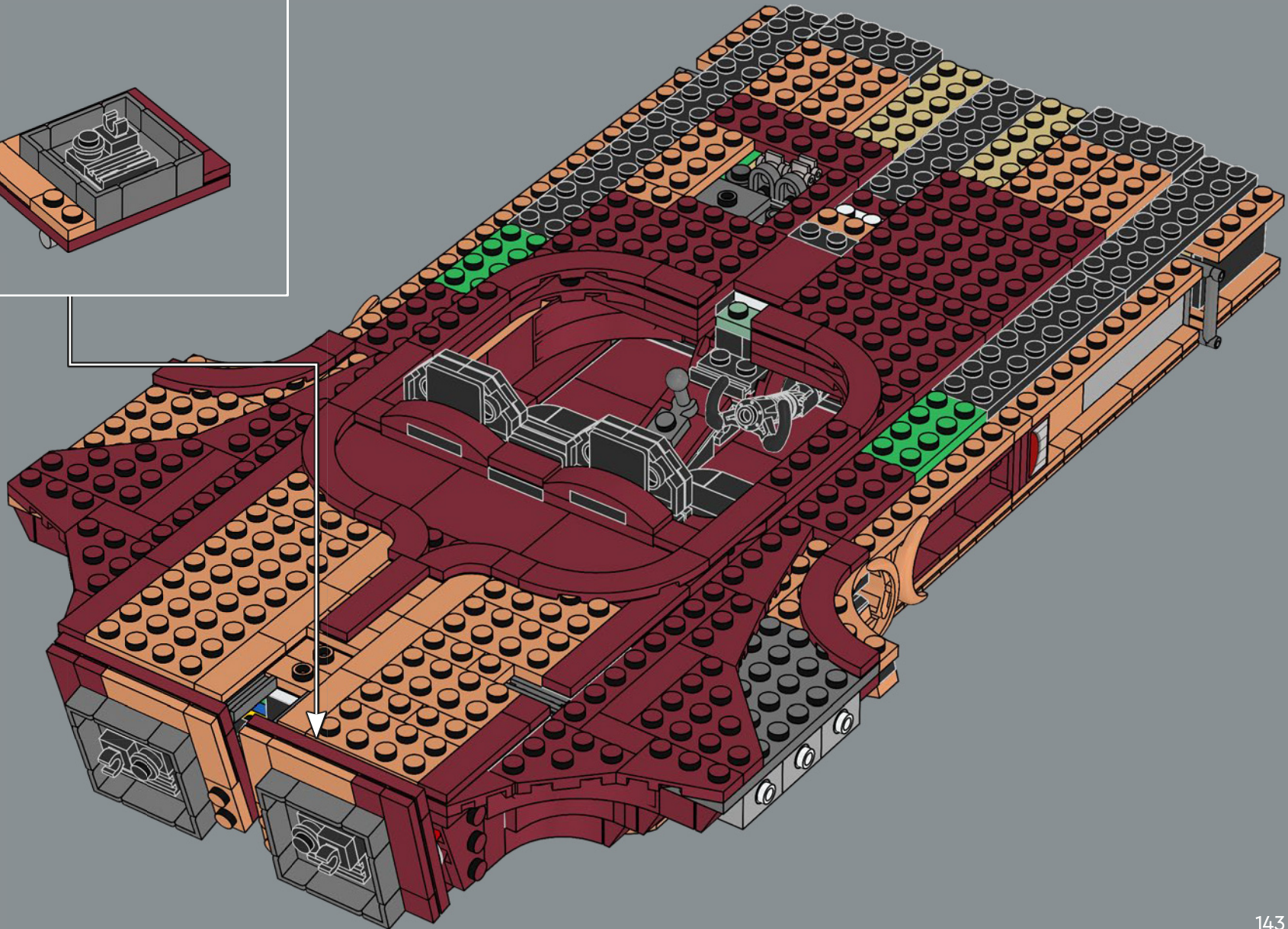

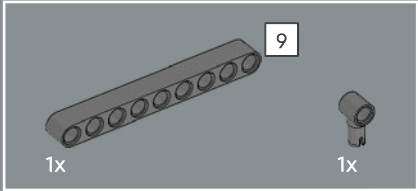
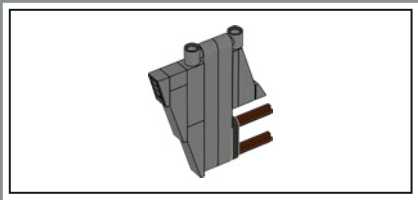

176

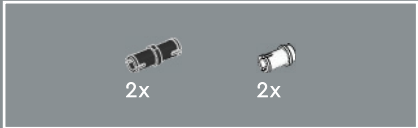
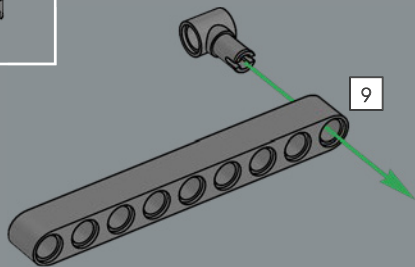

177

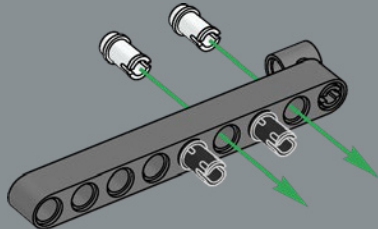

144

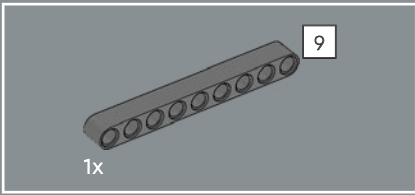

178

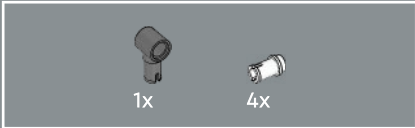
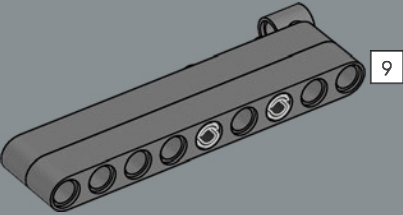

179

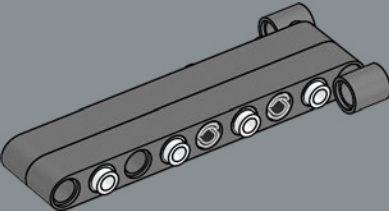

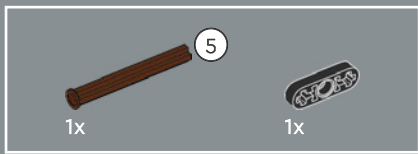

180

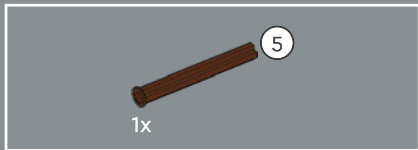
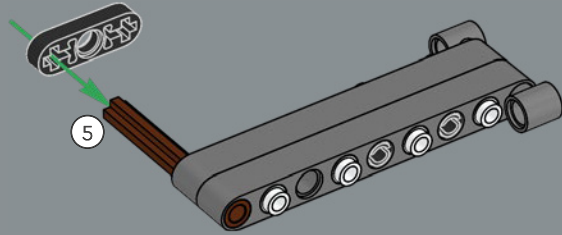

181

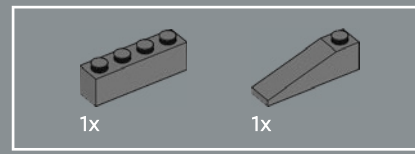
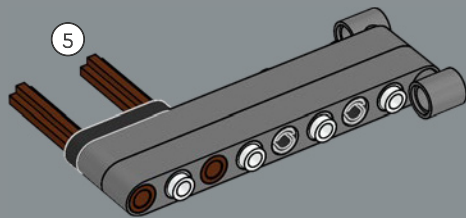

182

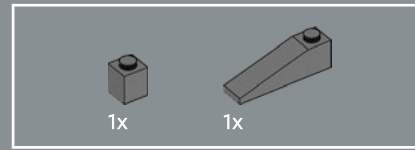
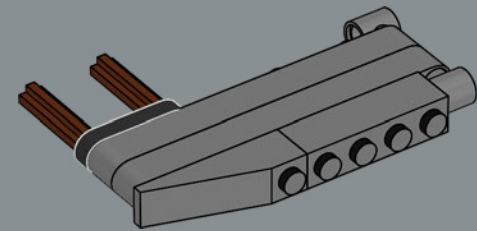

183

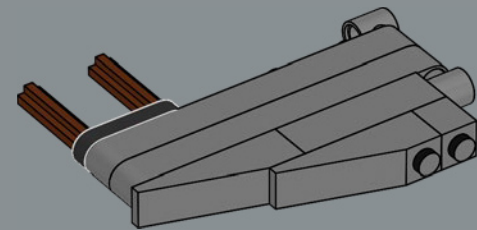



1x

184

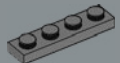
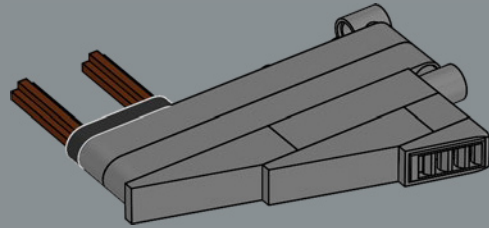

1x

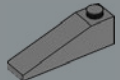

1x



1x

185

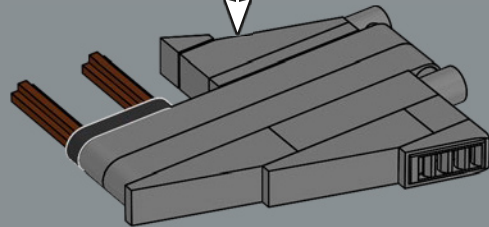
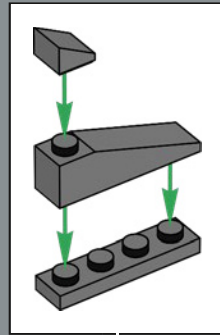

186

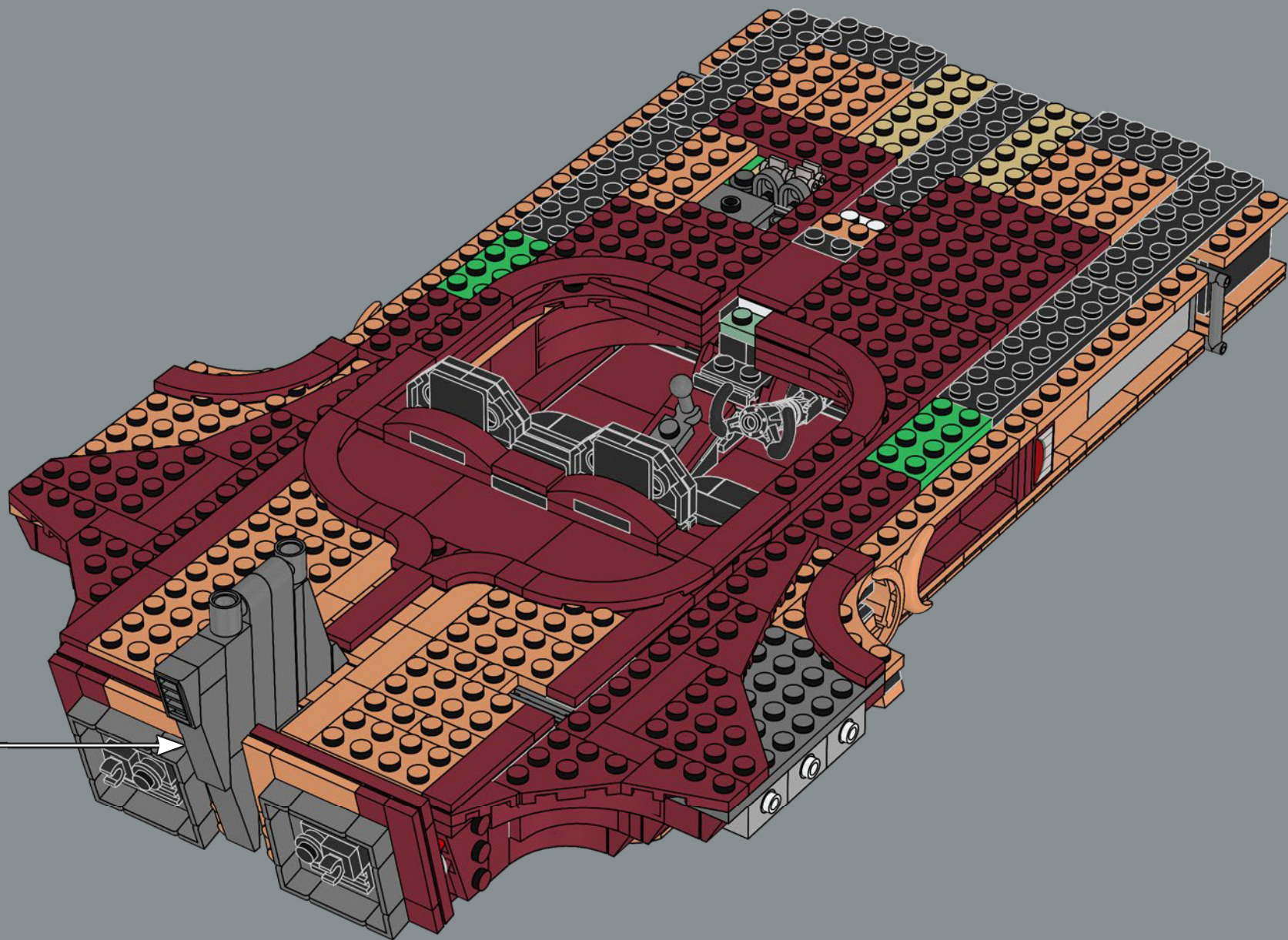

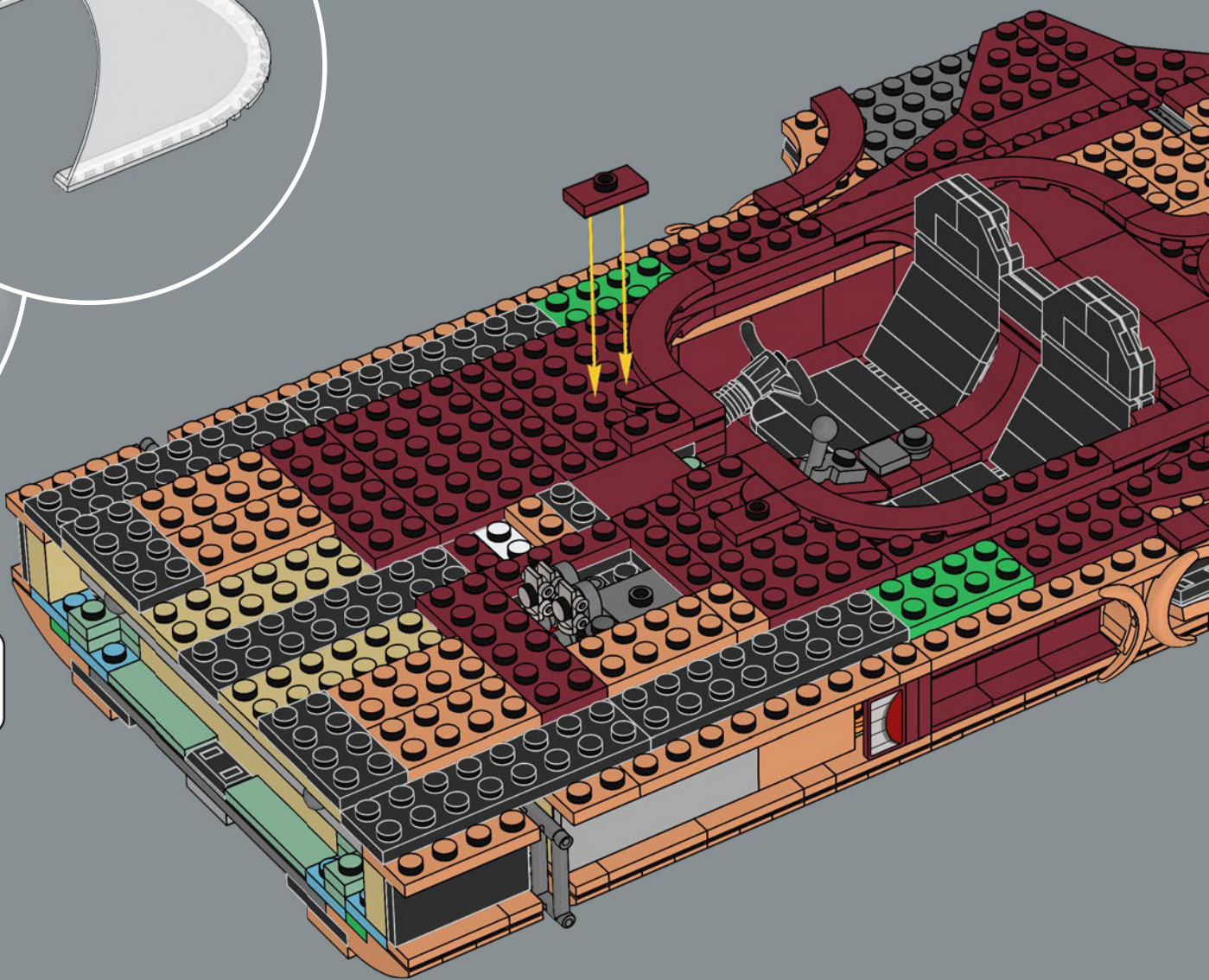
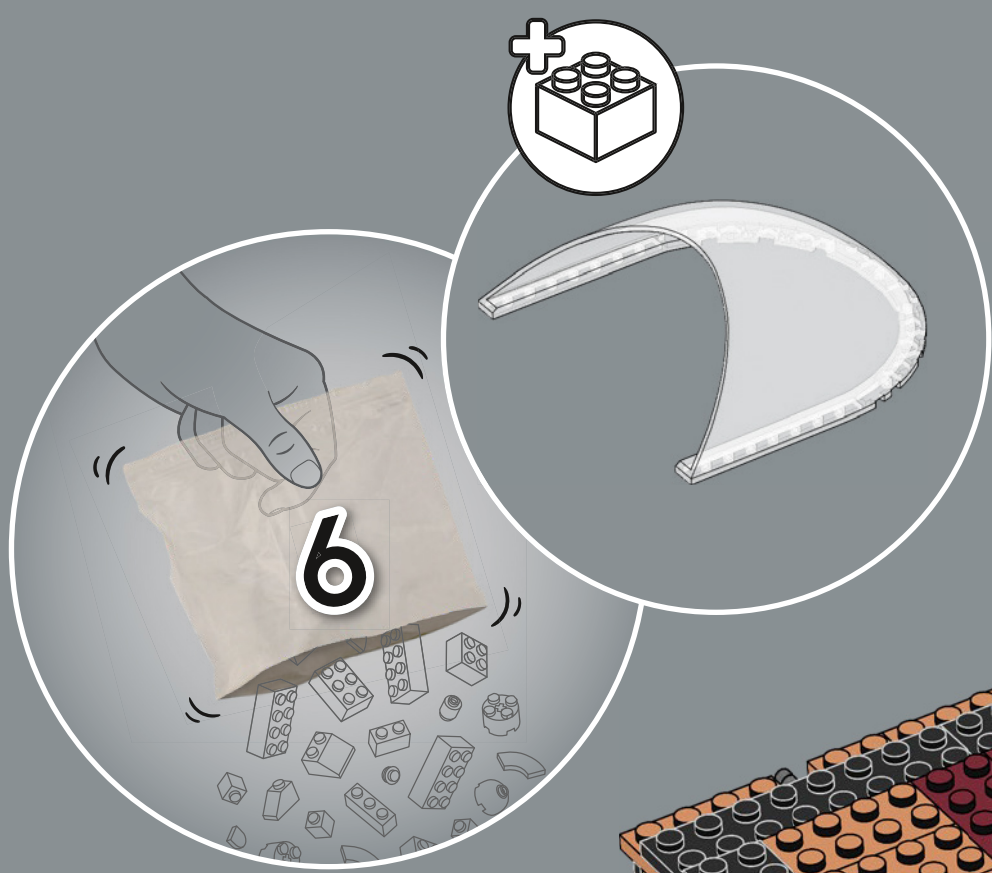



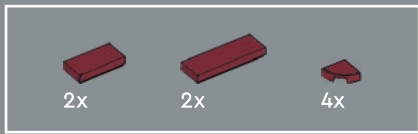

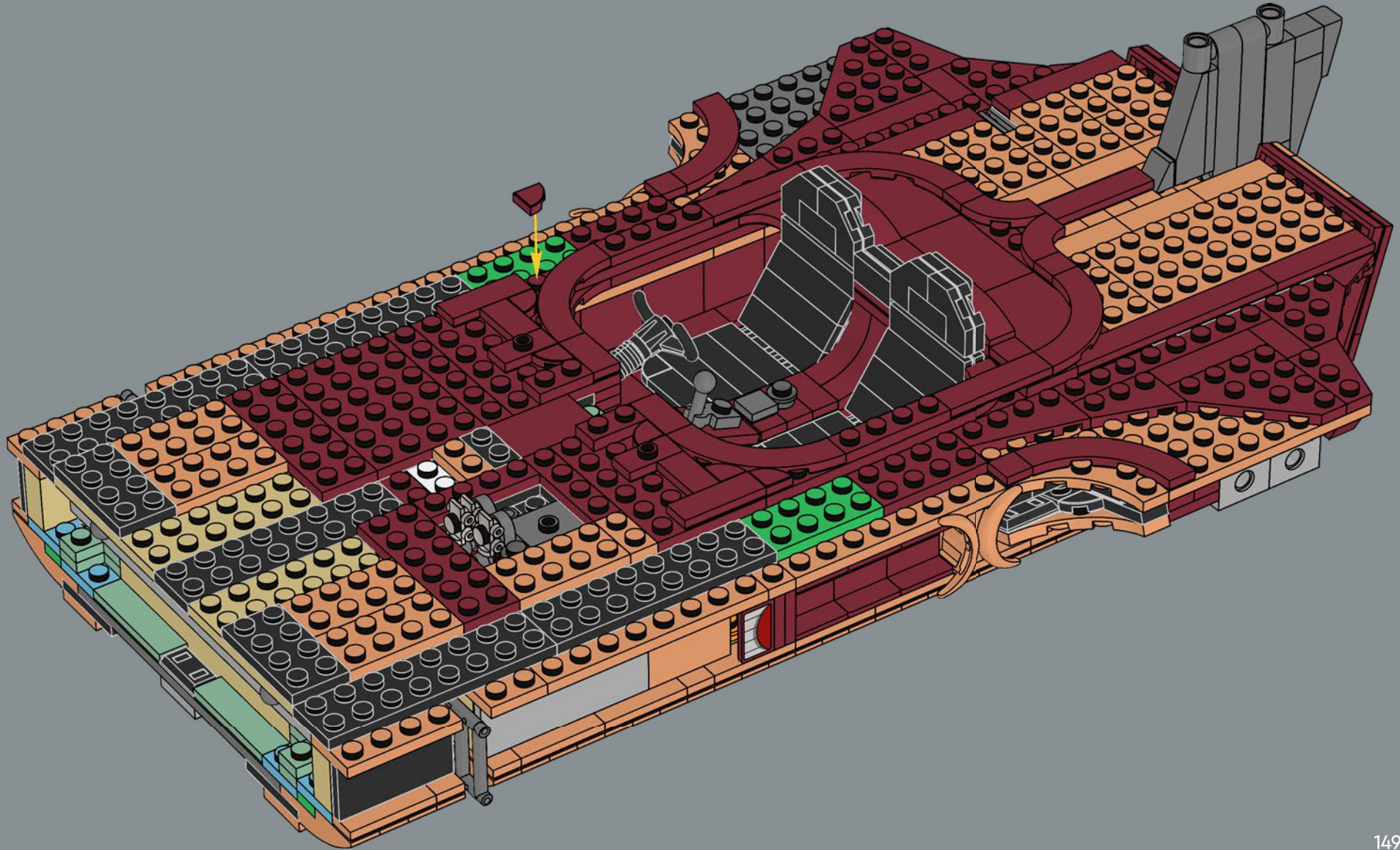

187



188



- | | | |
|--|---|---|
|  |  |  |
| 7x | 1x | 1x |
|  |  |  |
| 1x | 1x | 2x |

189

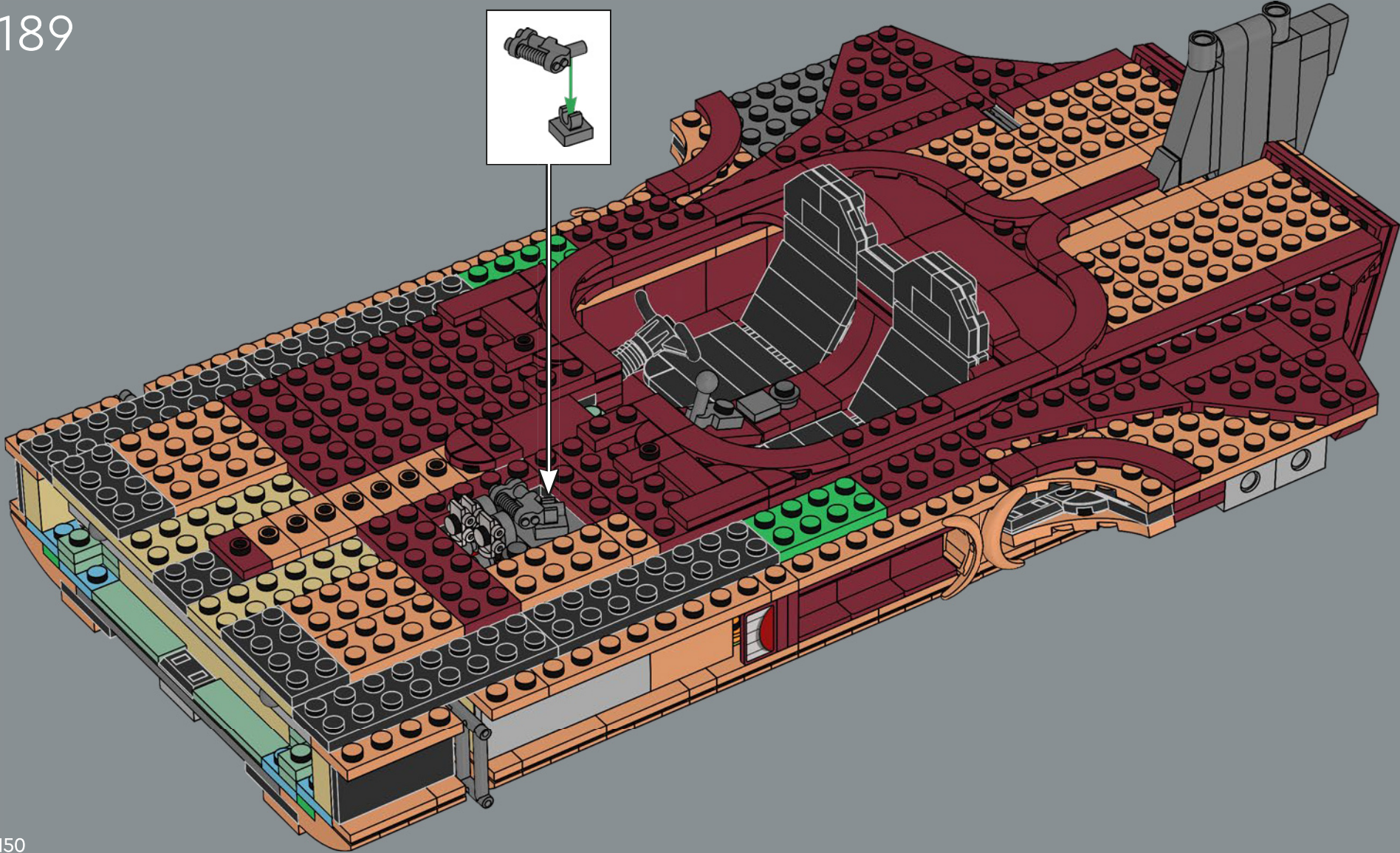
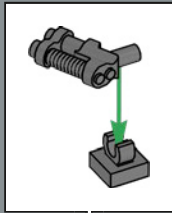

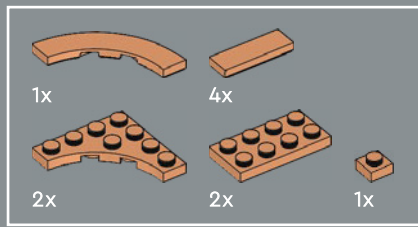

190

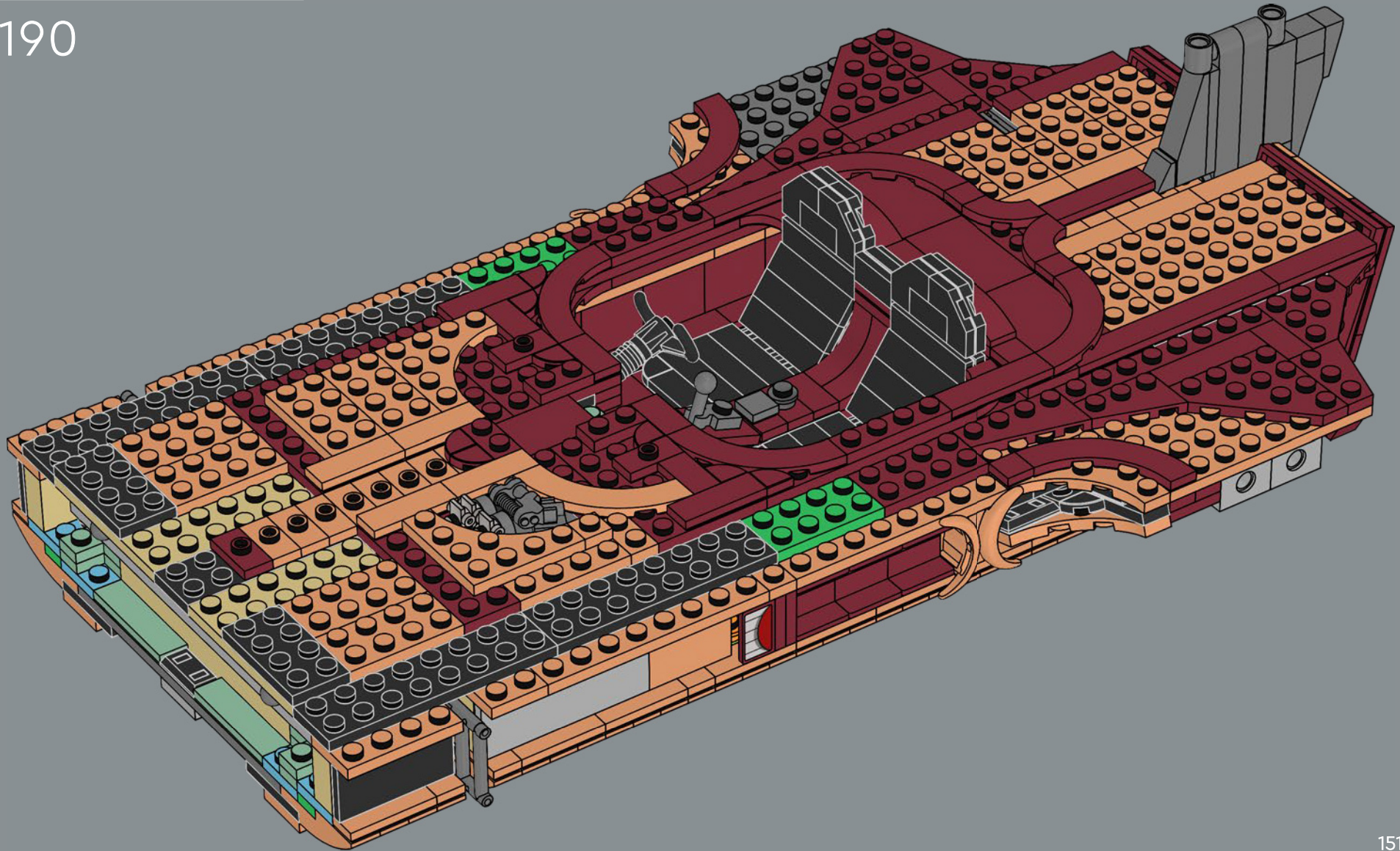

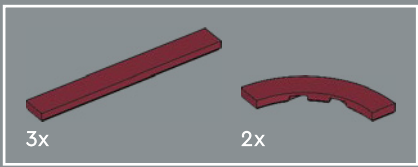

191

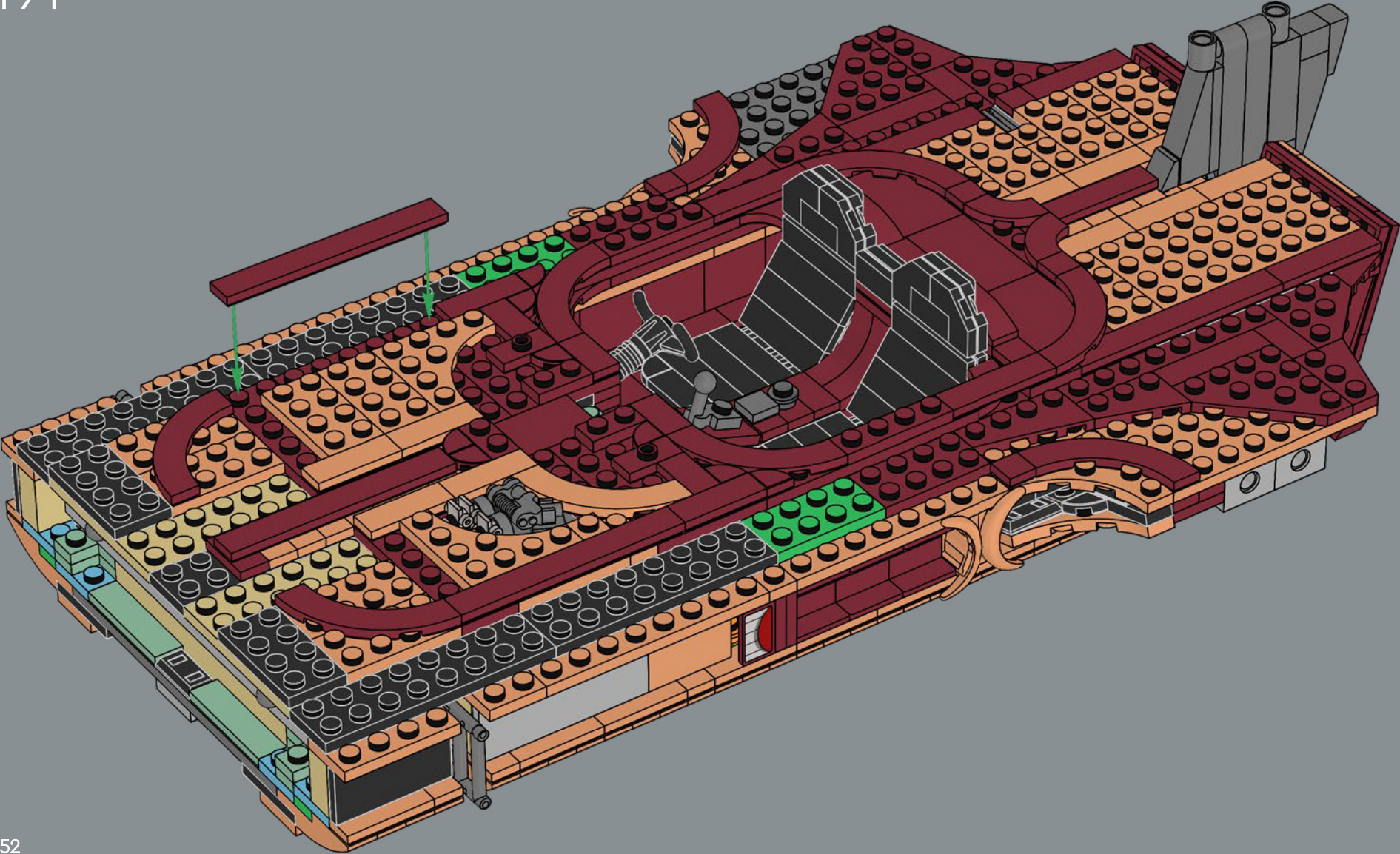

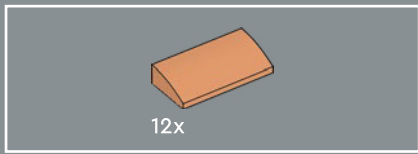

192

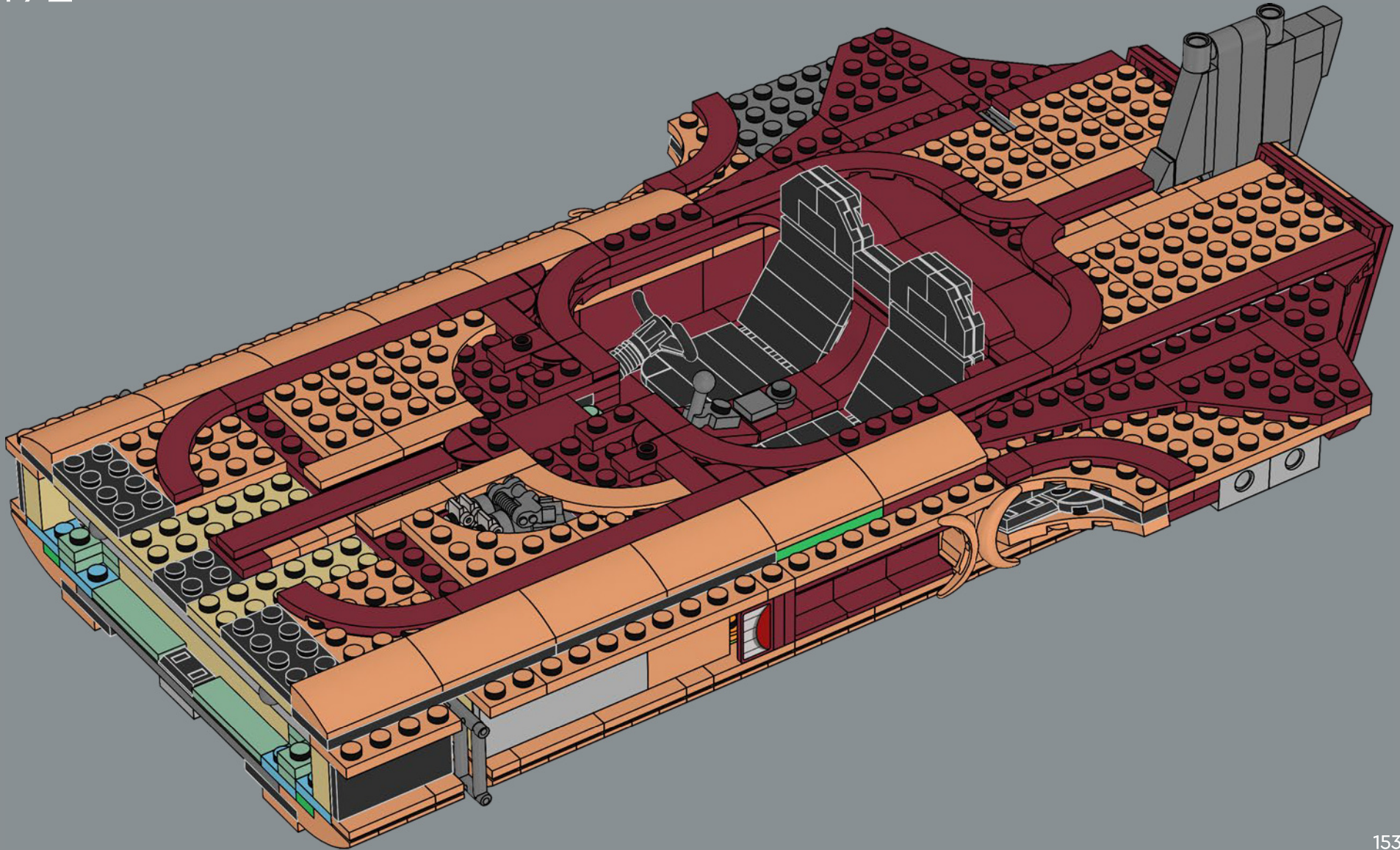



193

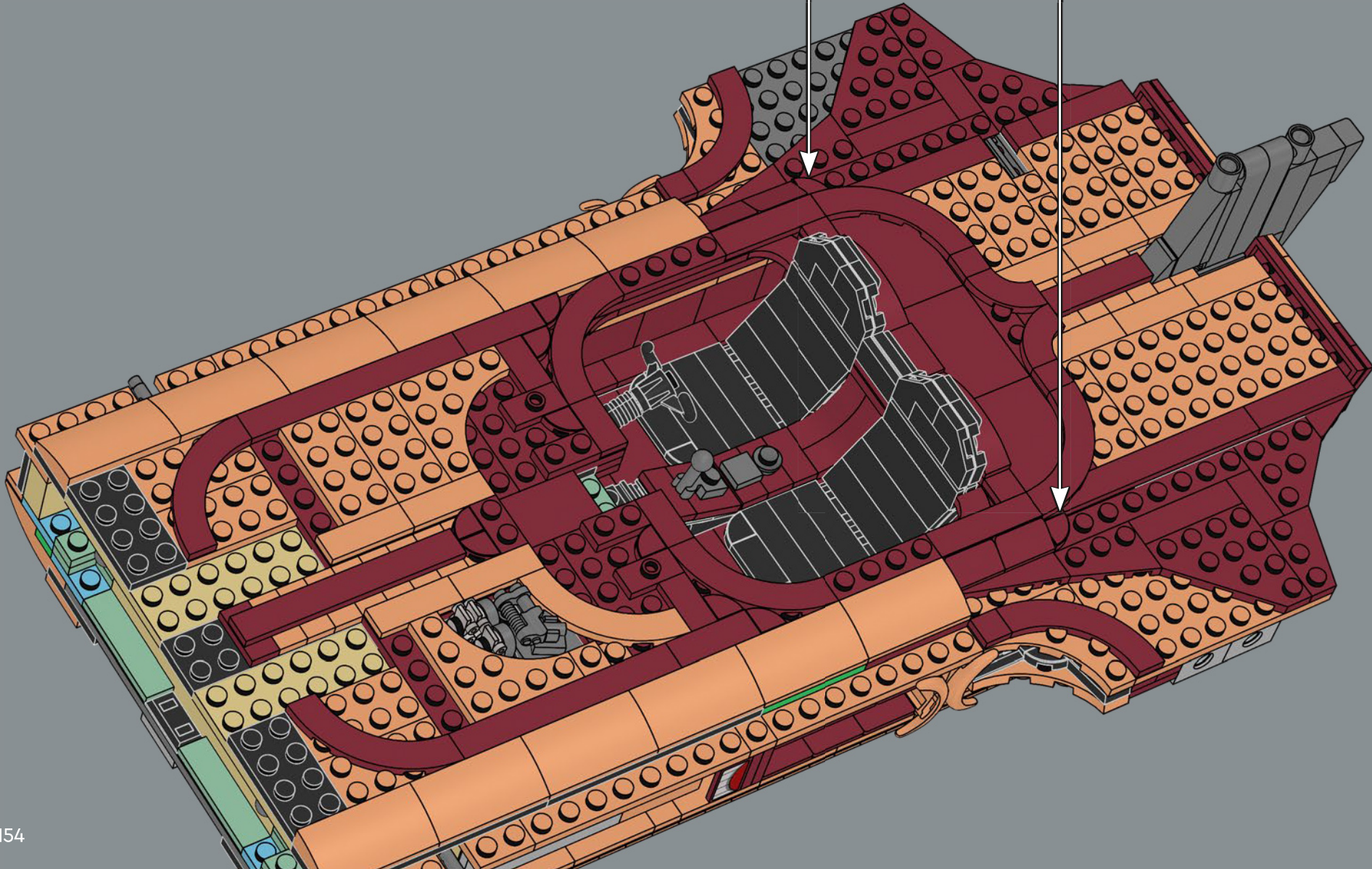



194

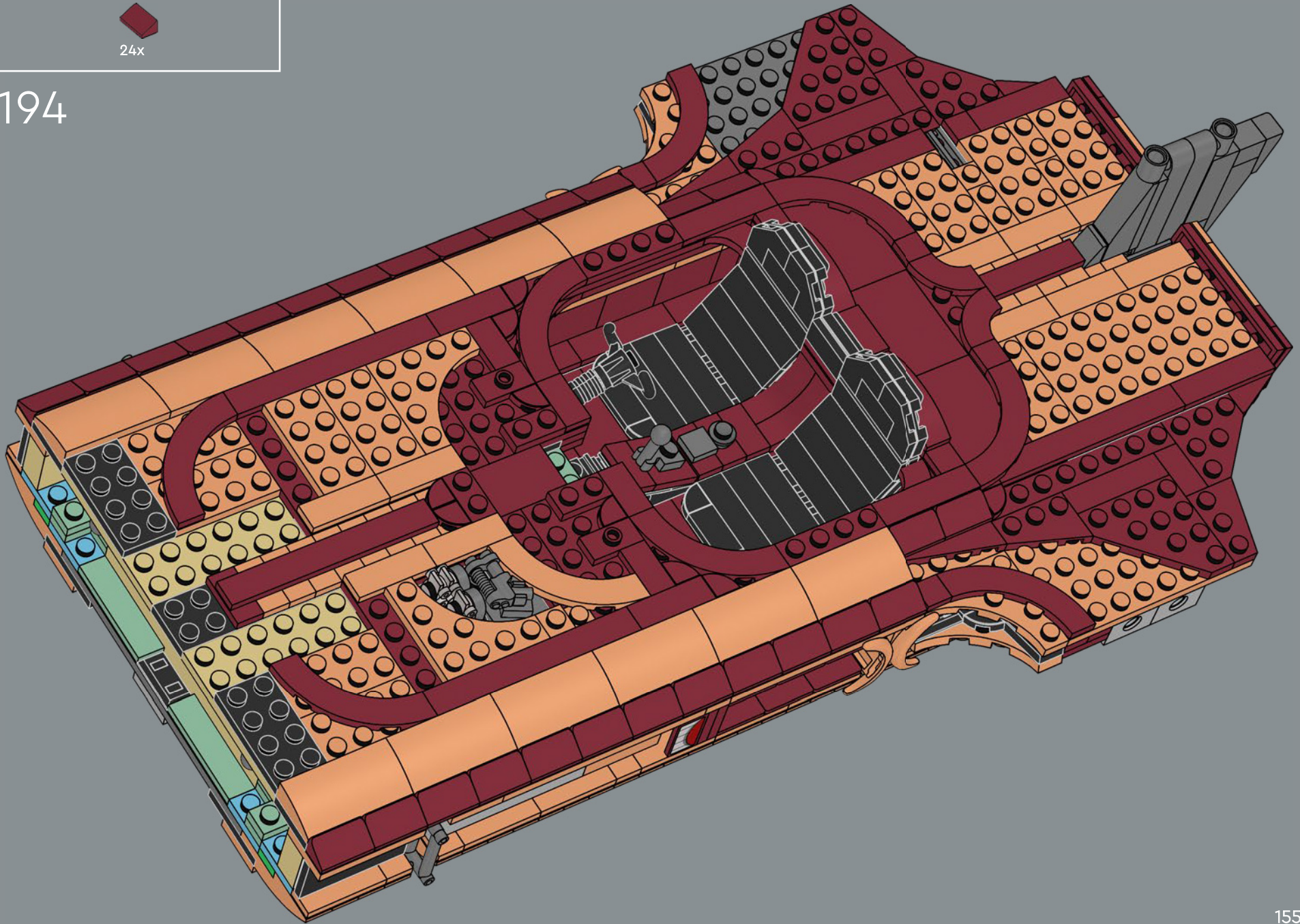

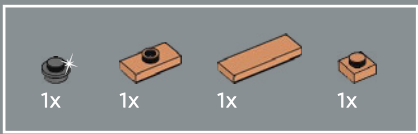

195

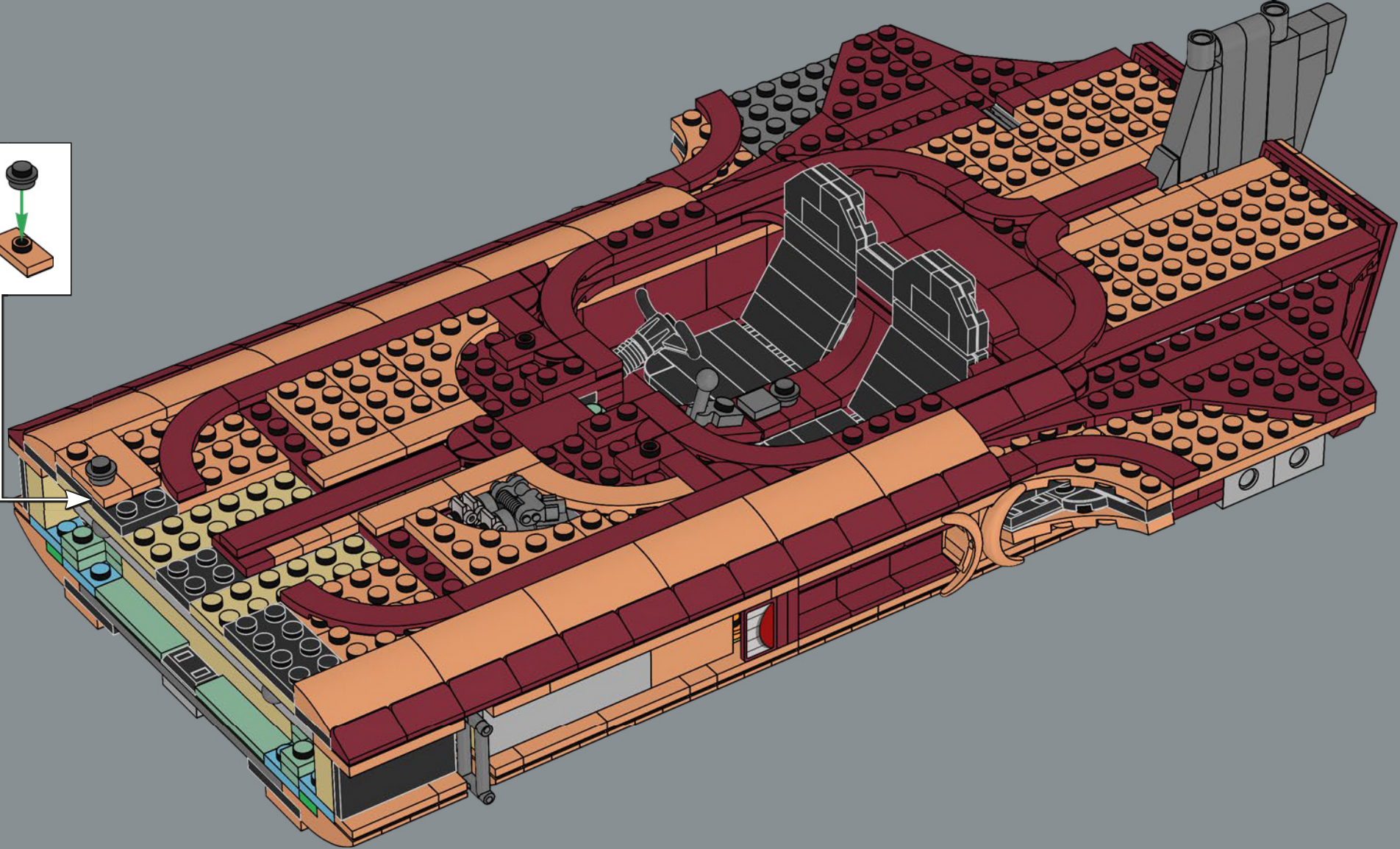
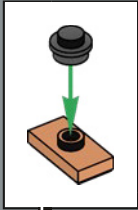

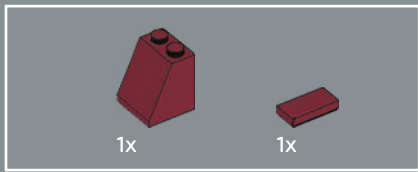

196

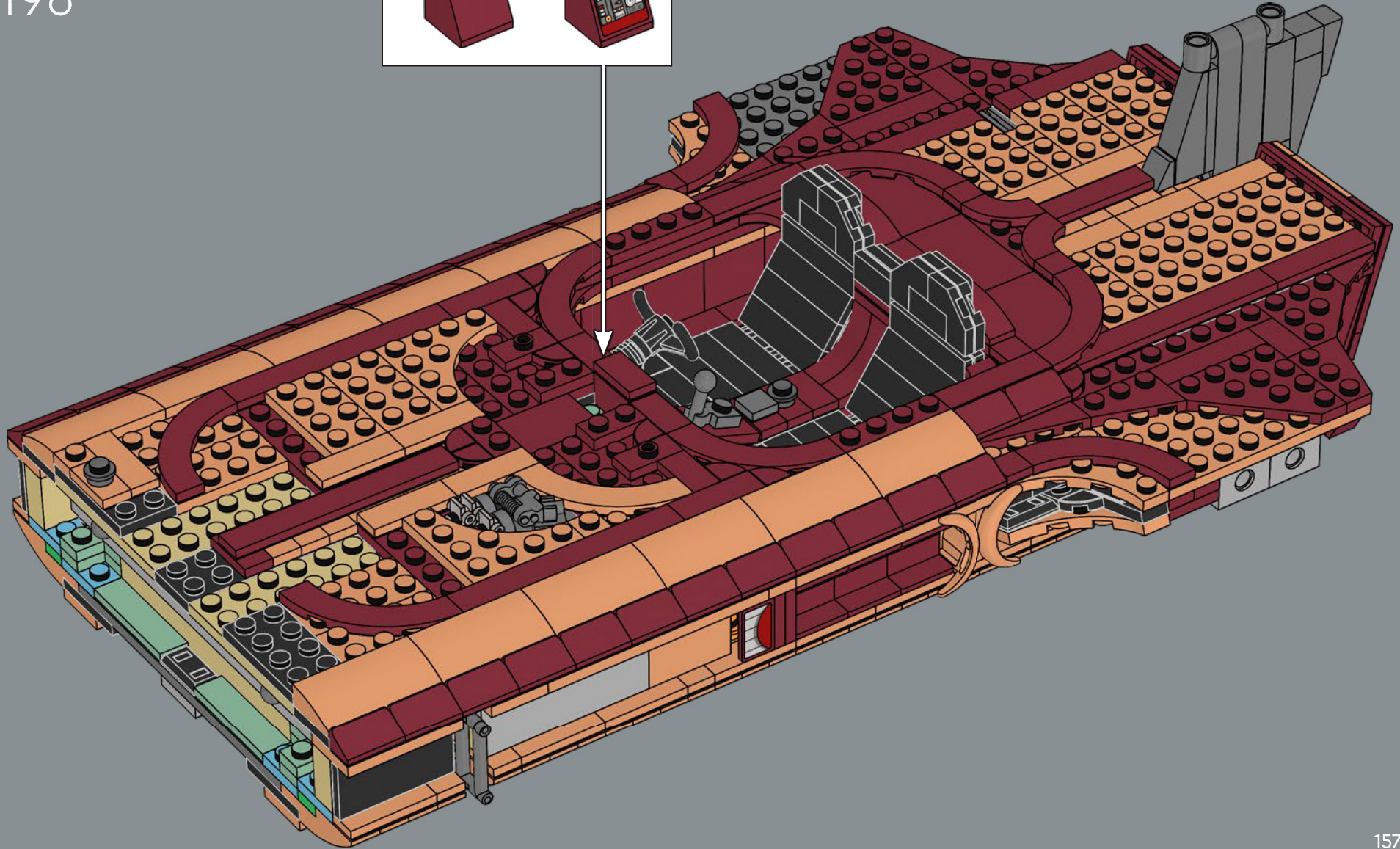
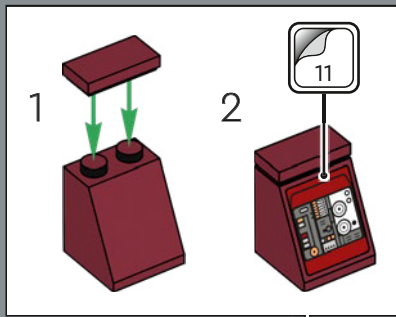

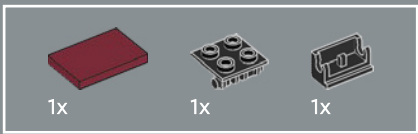

197

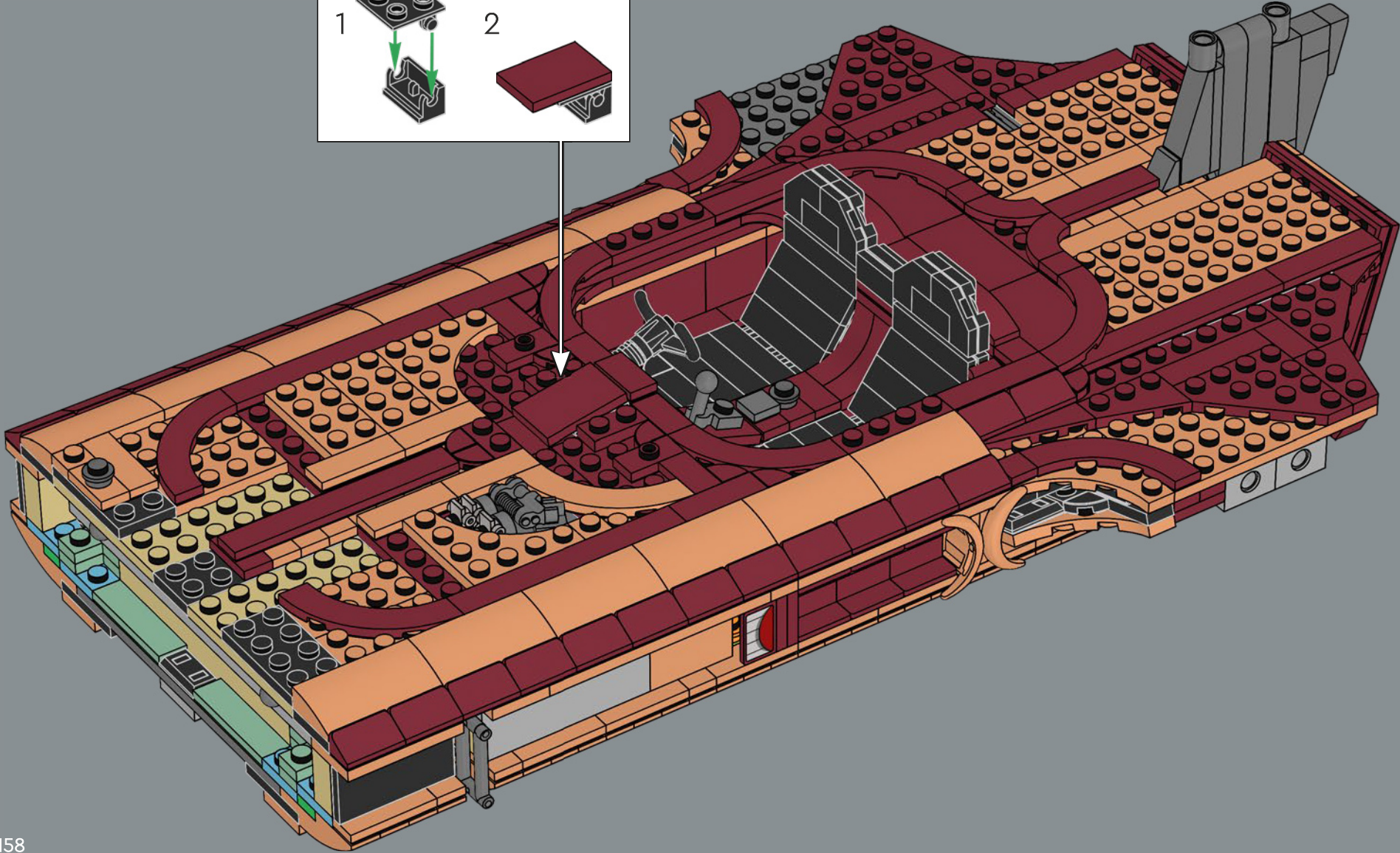
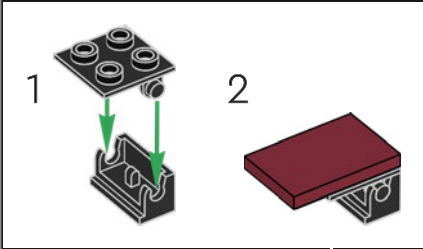

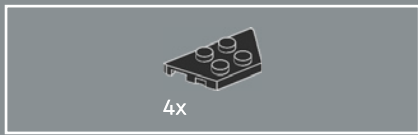

198

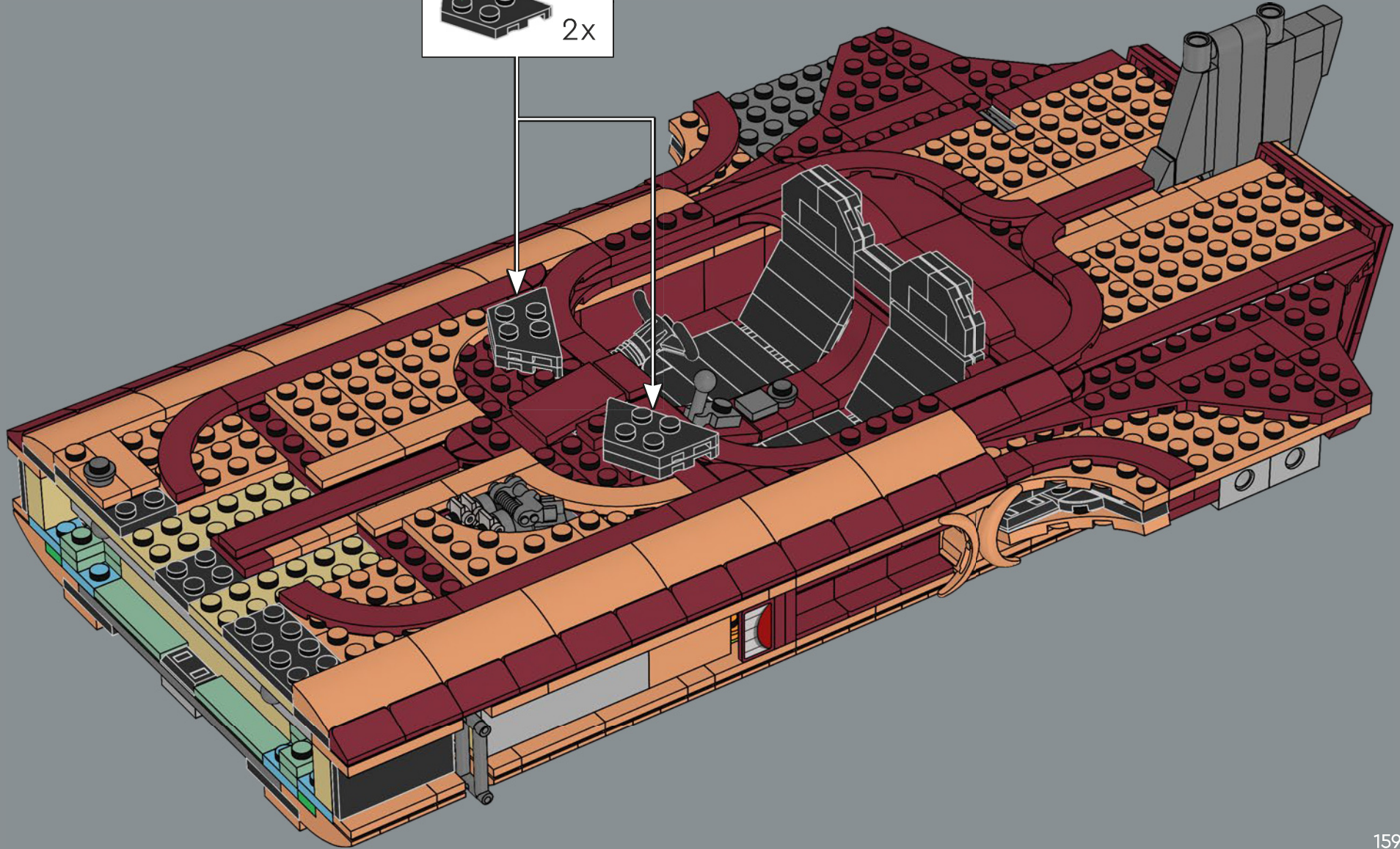
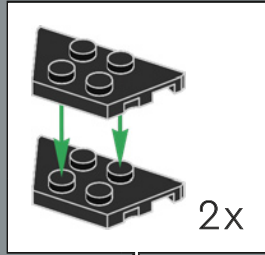

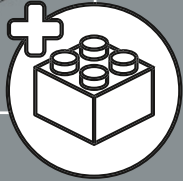
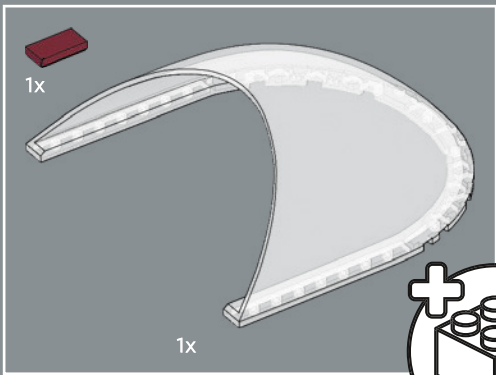

199

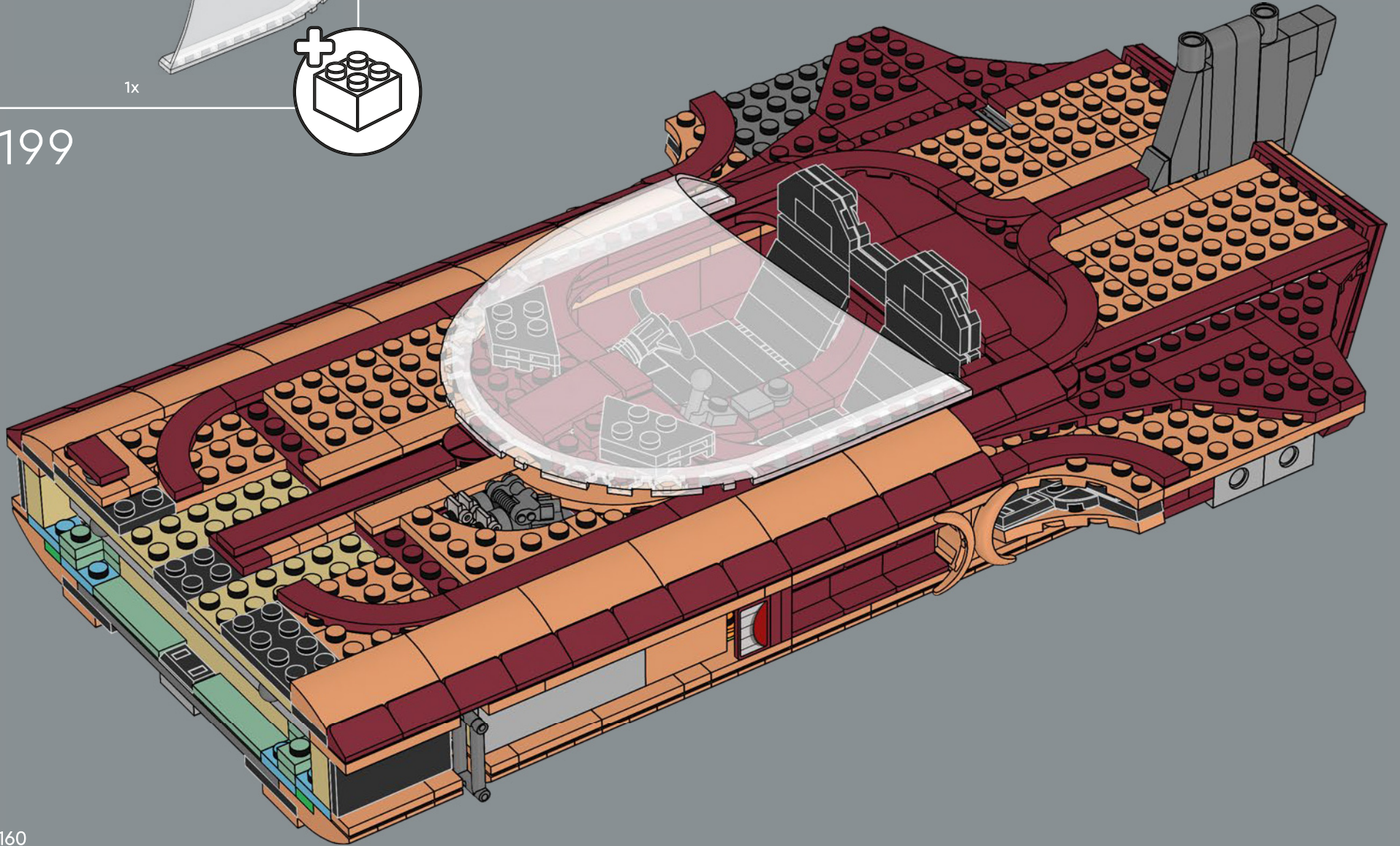

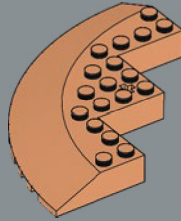
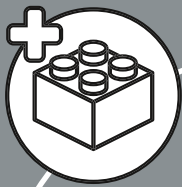

4x

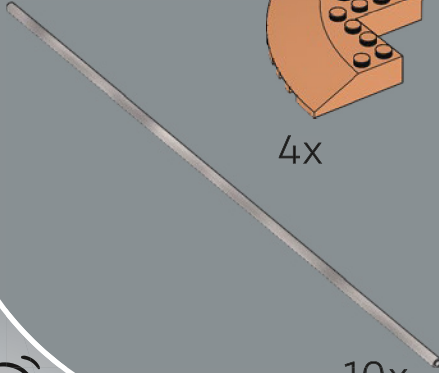

10x

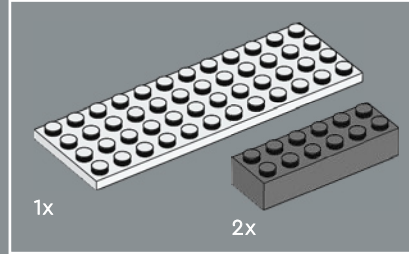
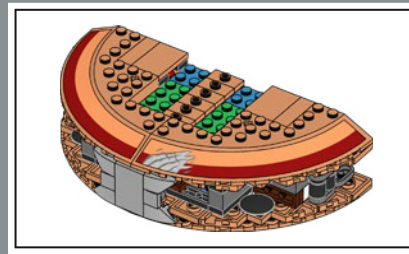

1x

2x

200

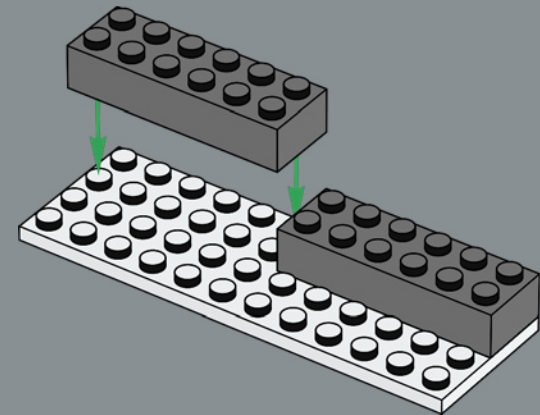

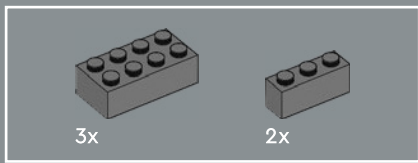

201

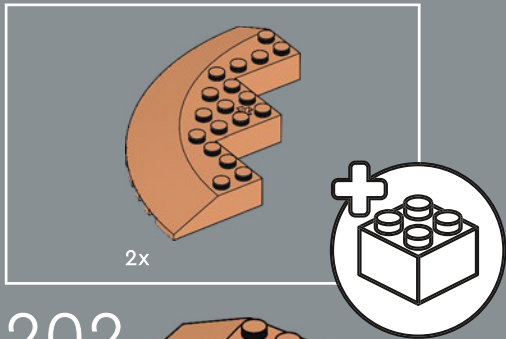
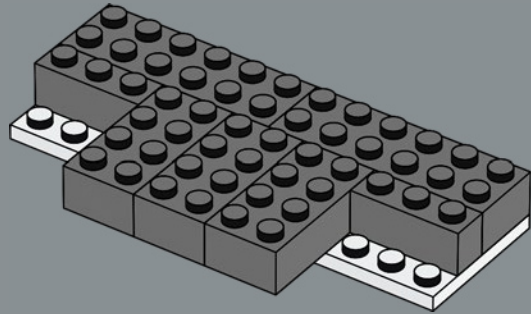

202

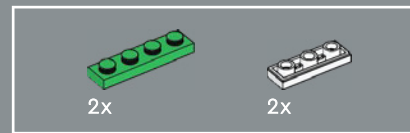
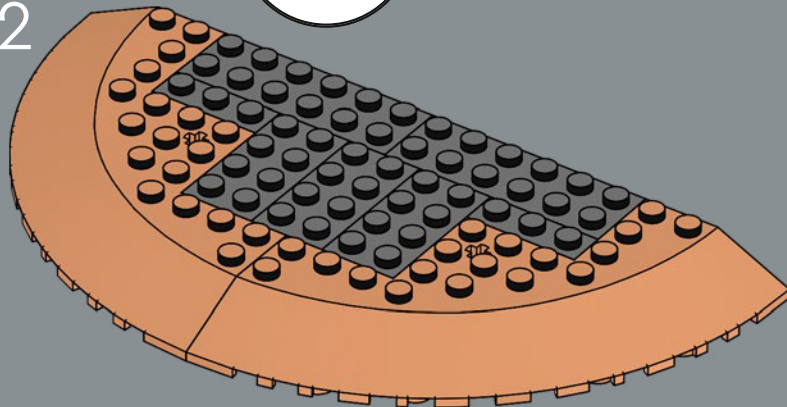

203

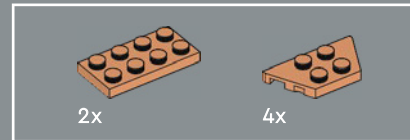
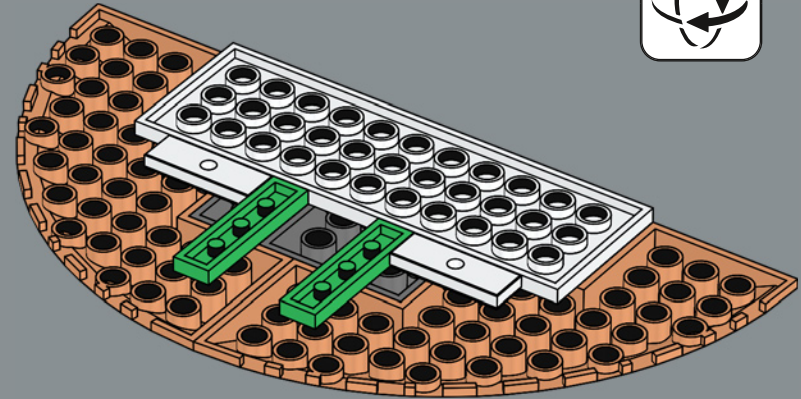

204

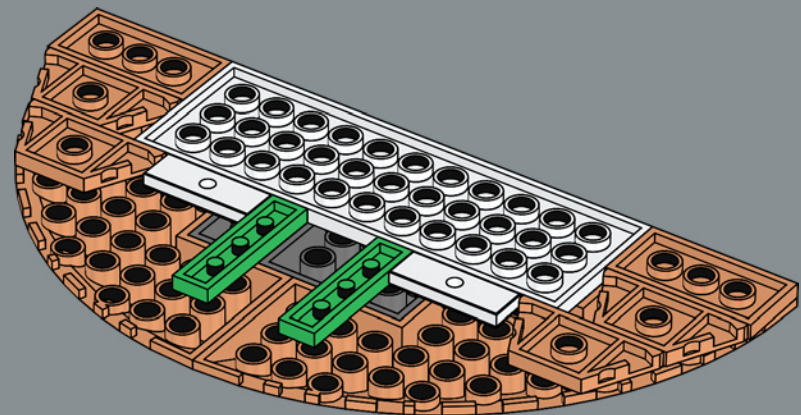

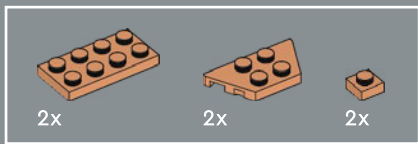

205

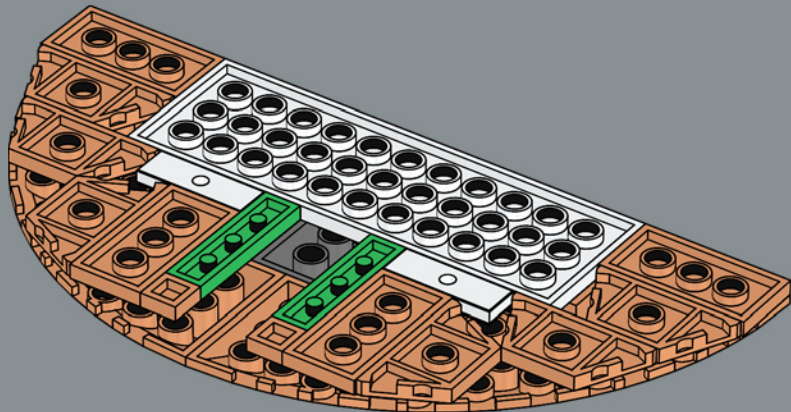

206

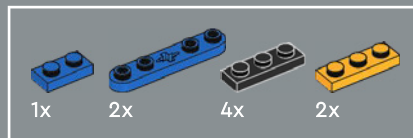
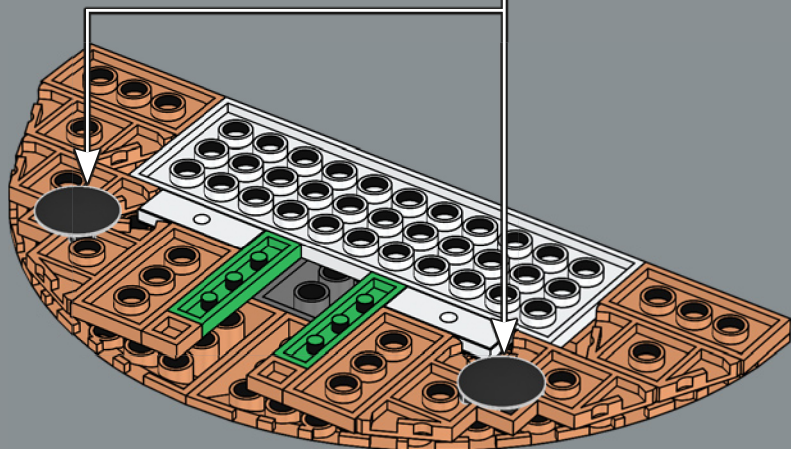
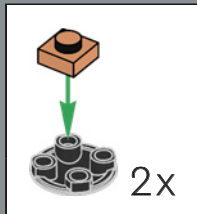

207

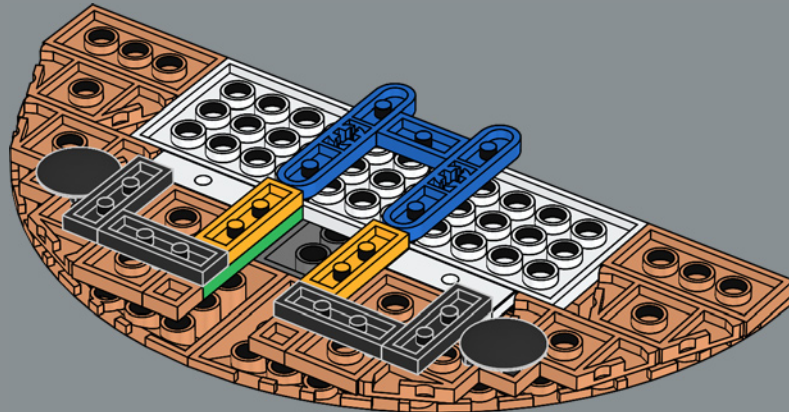

208

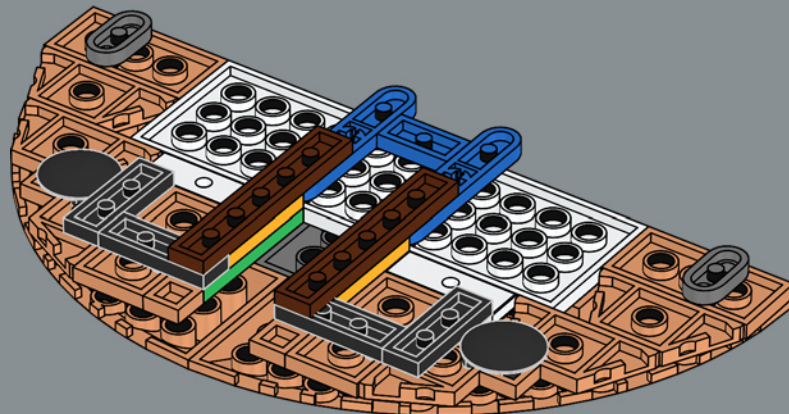

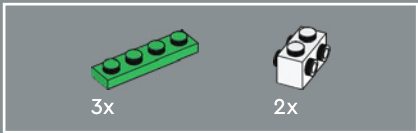

209

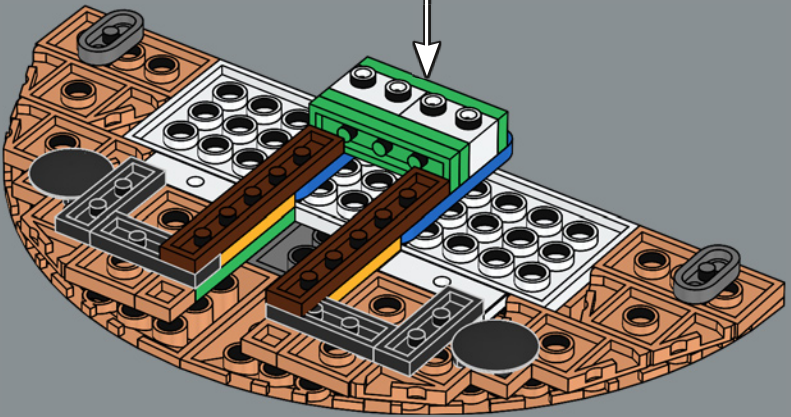
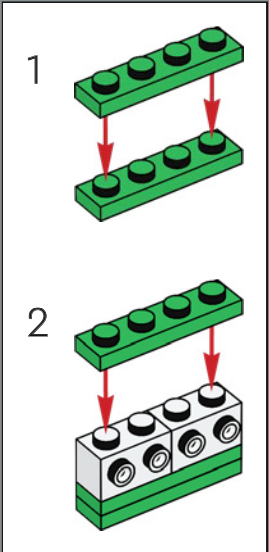

210

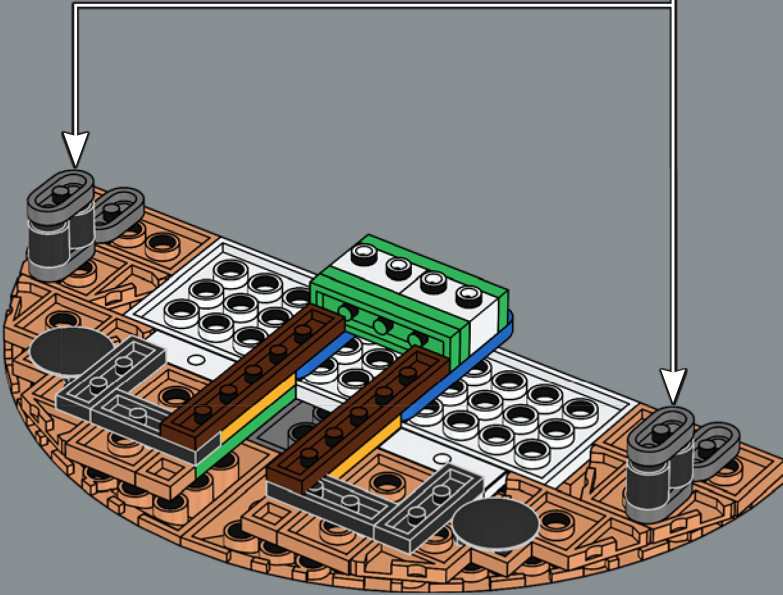
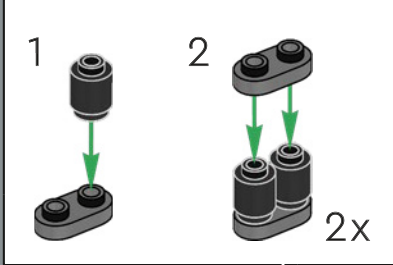

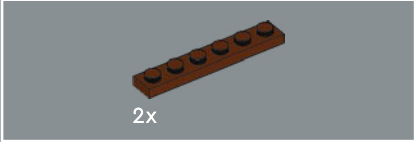
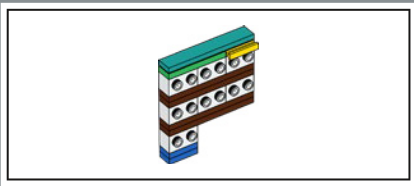

2x

211

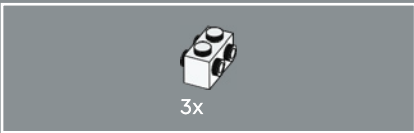
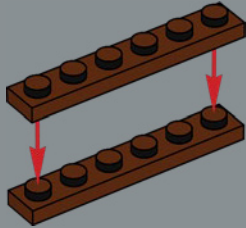

3x

212

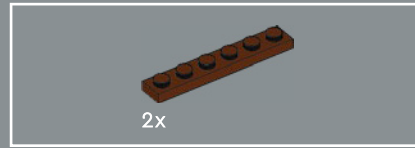
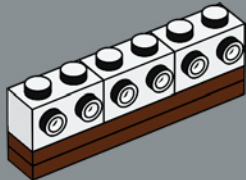

2x

213

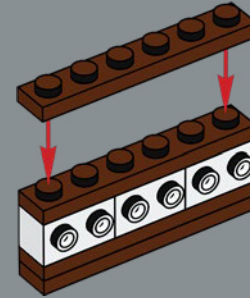

3x

214

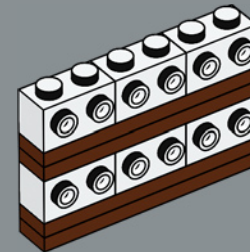

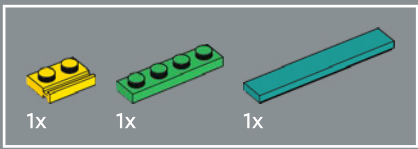

215

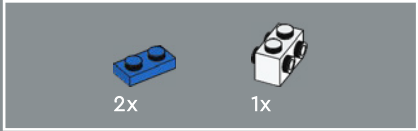
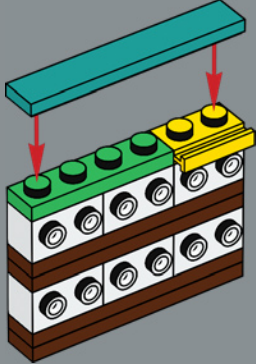

216

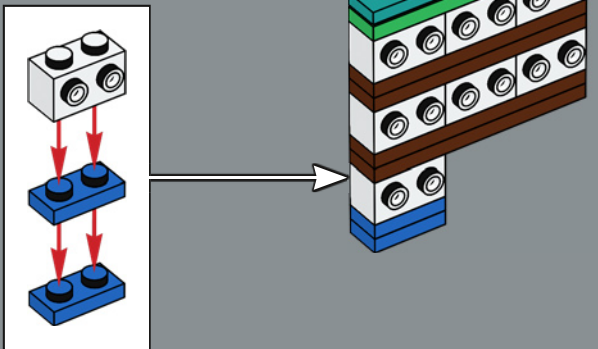

217

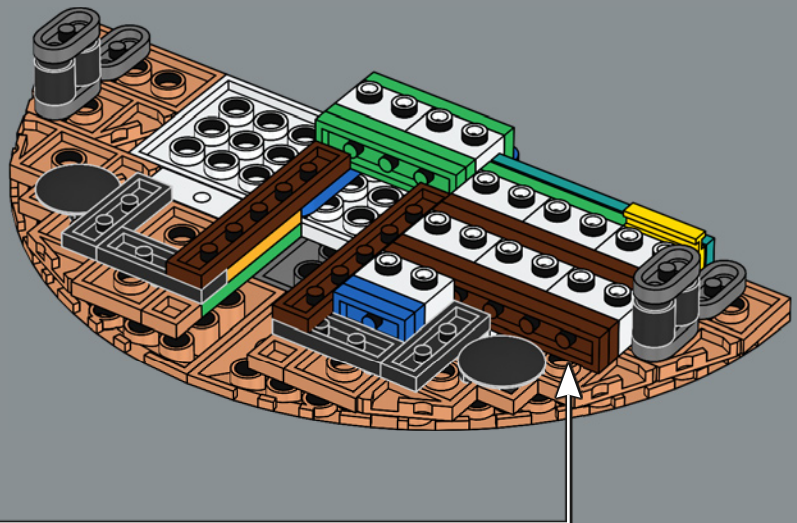

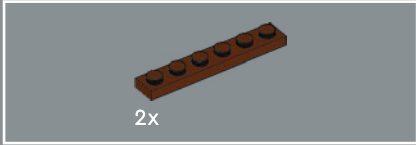
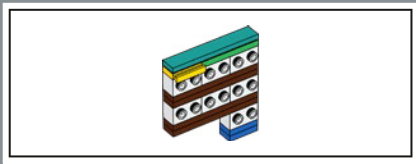

218

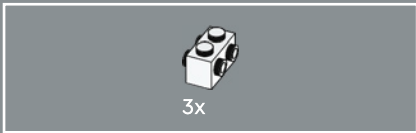
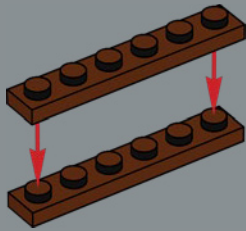

219

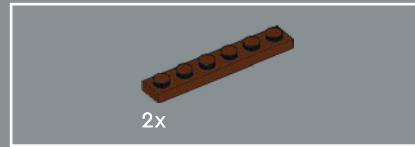
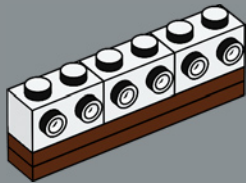

220

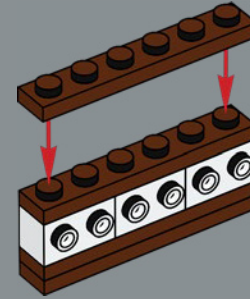

221

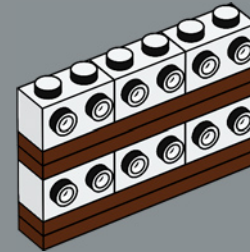

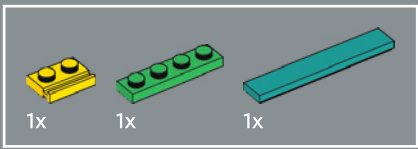

222

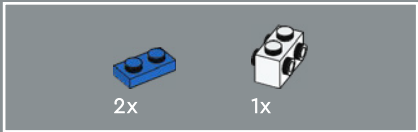
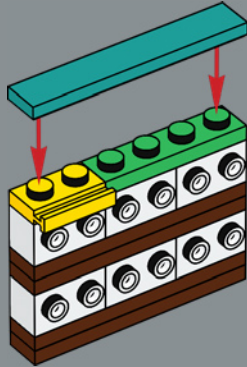

223

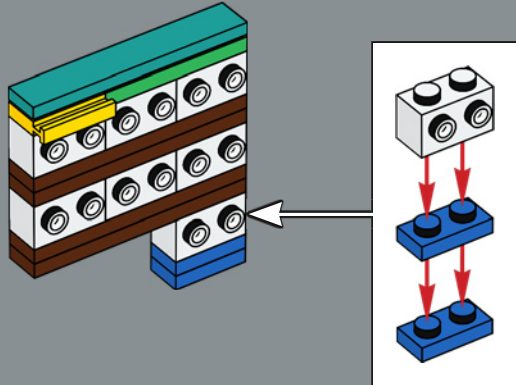

224

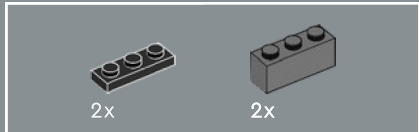
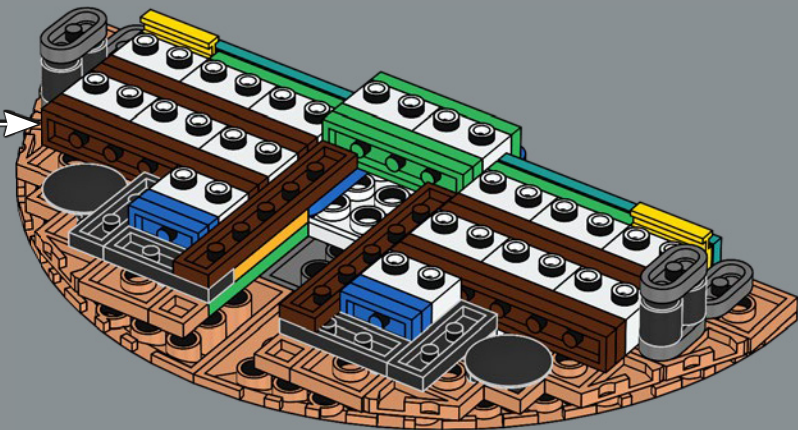

225

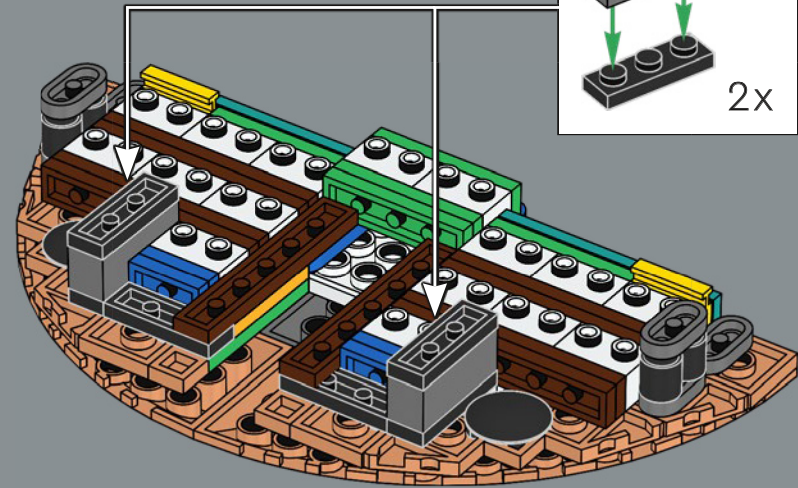

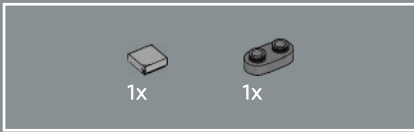
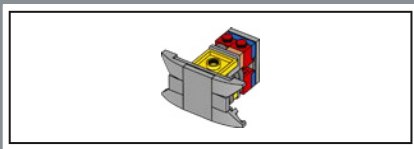

226

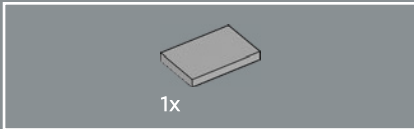
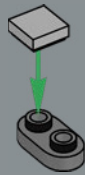

227

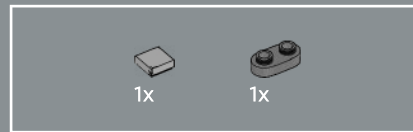
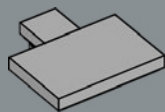

228

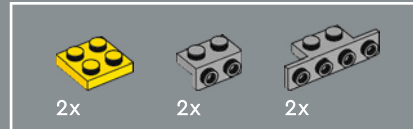
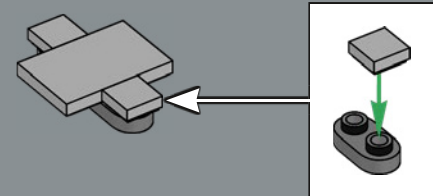

229

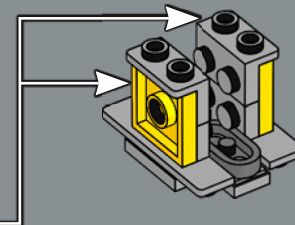
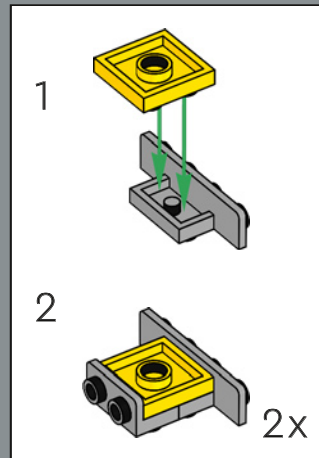

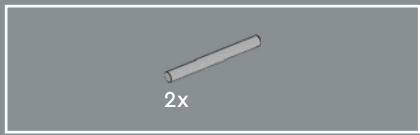

230

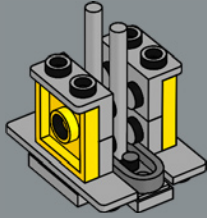

231

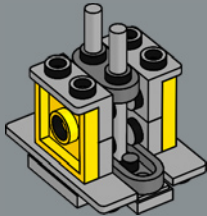

232

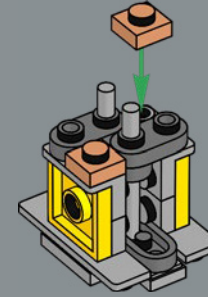

233

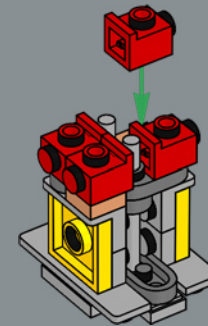

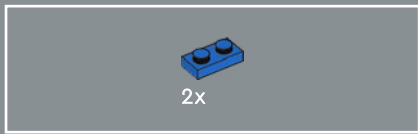

234

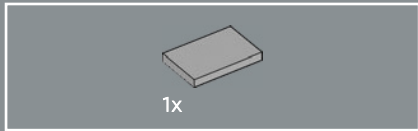
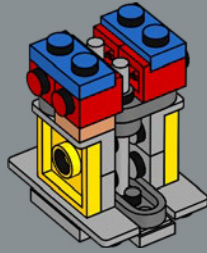

235

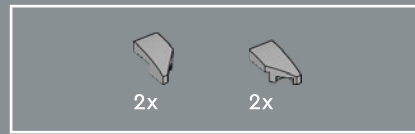
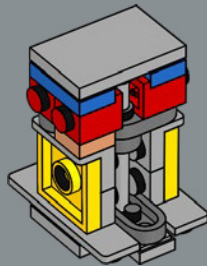

236

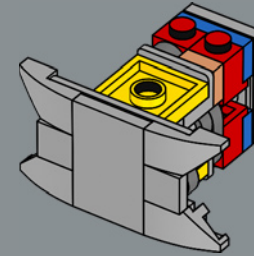

237

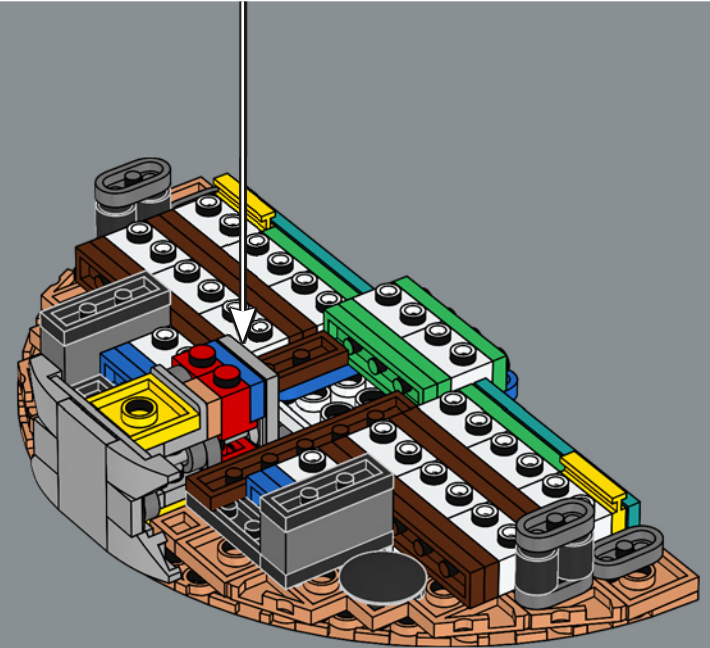

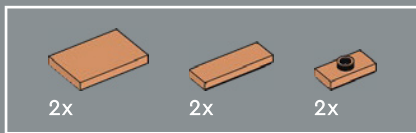

241

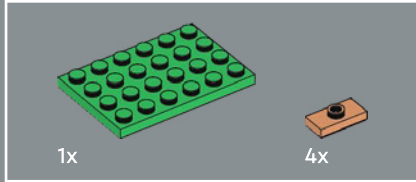
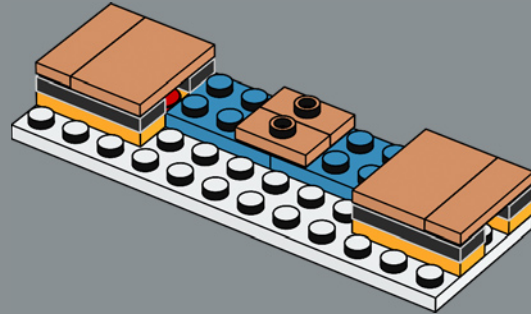

242

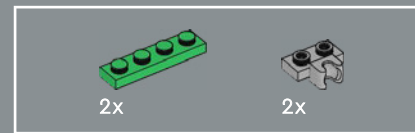
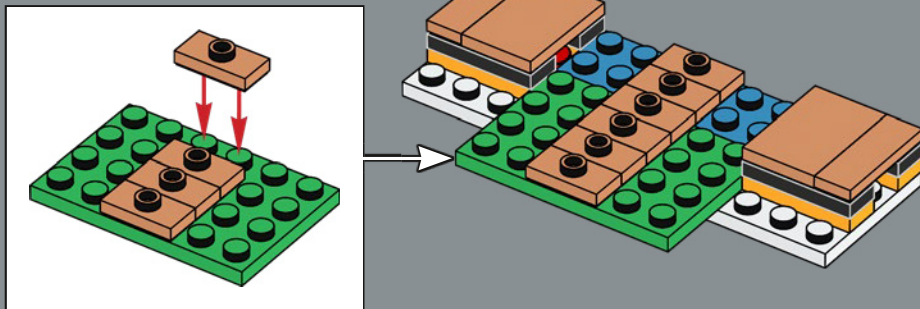

243

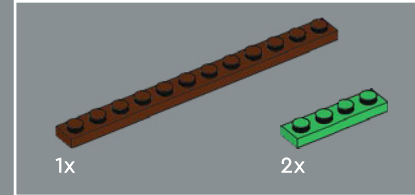
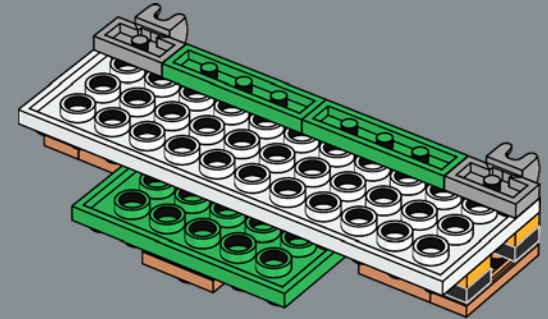

244

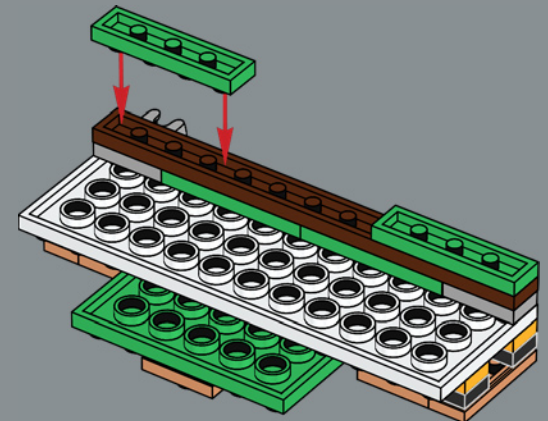

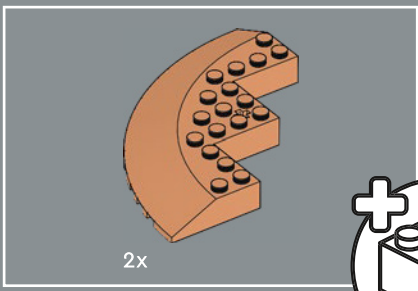

2x

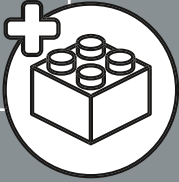

245

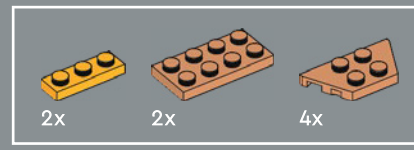
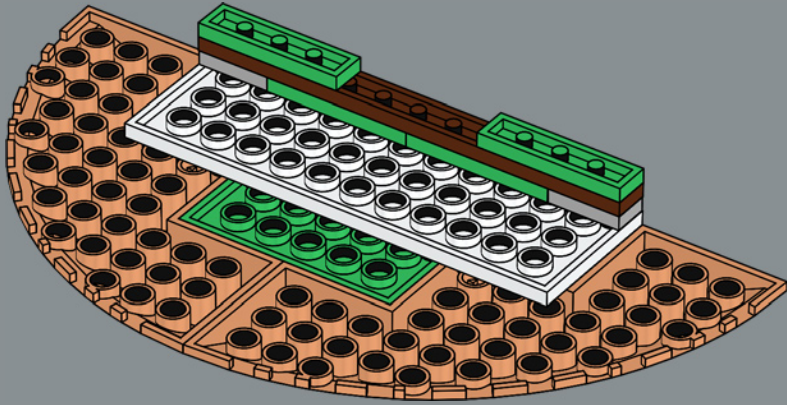

2x

2x

4x

246

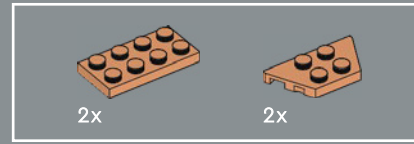
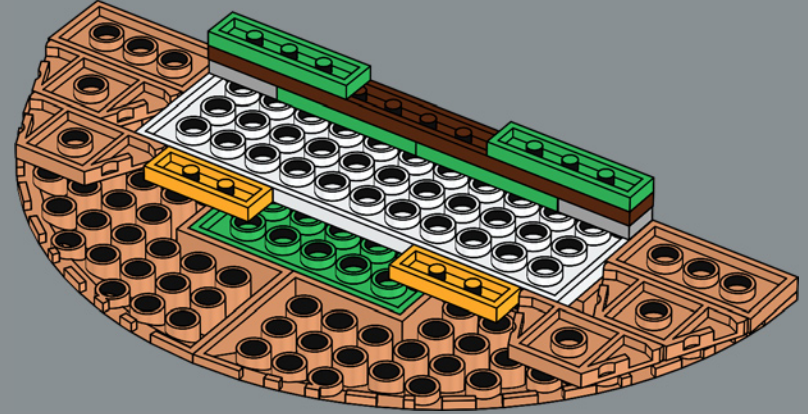

2x

2x

247

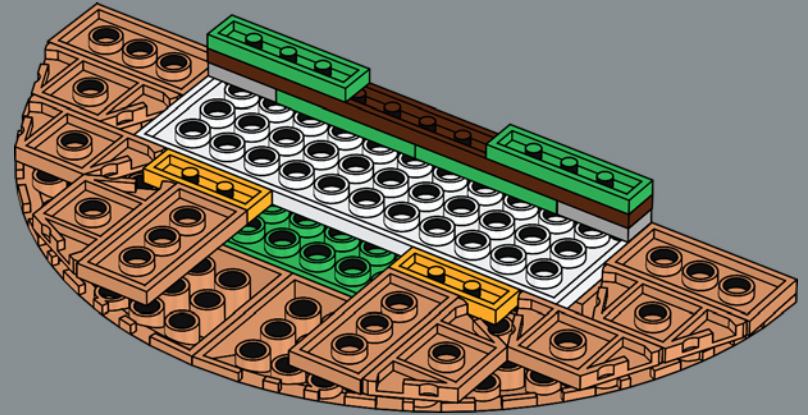

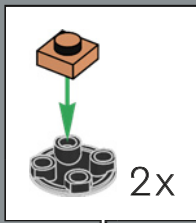

248

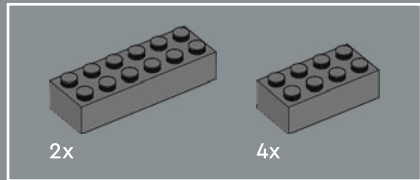
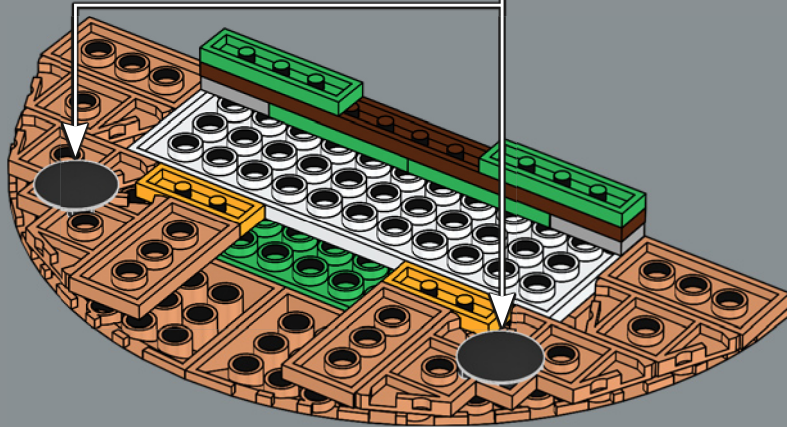

249

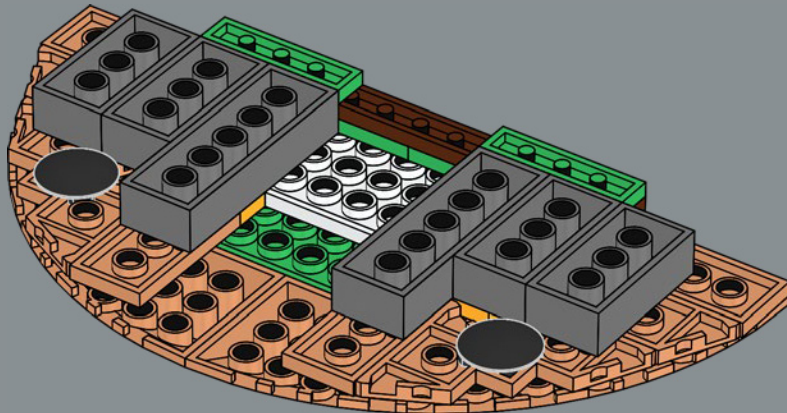

250

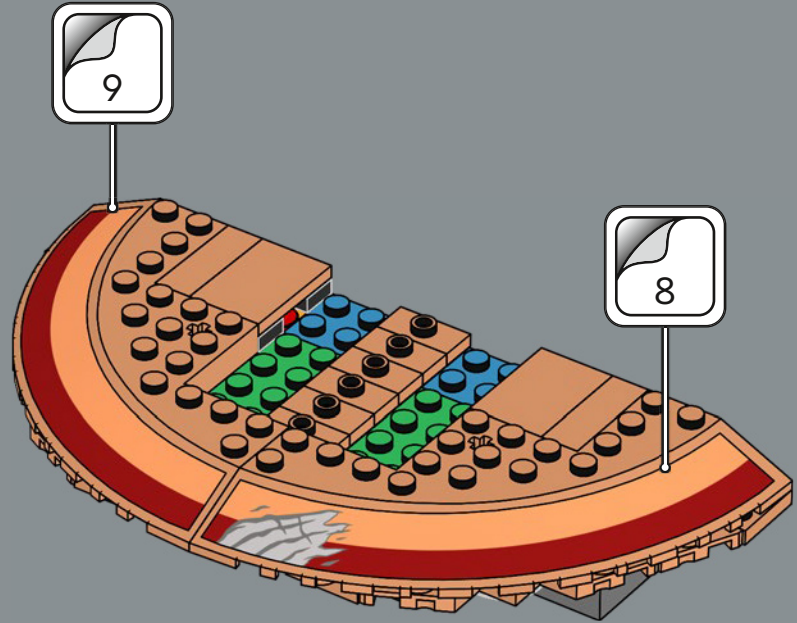

251

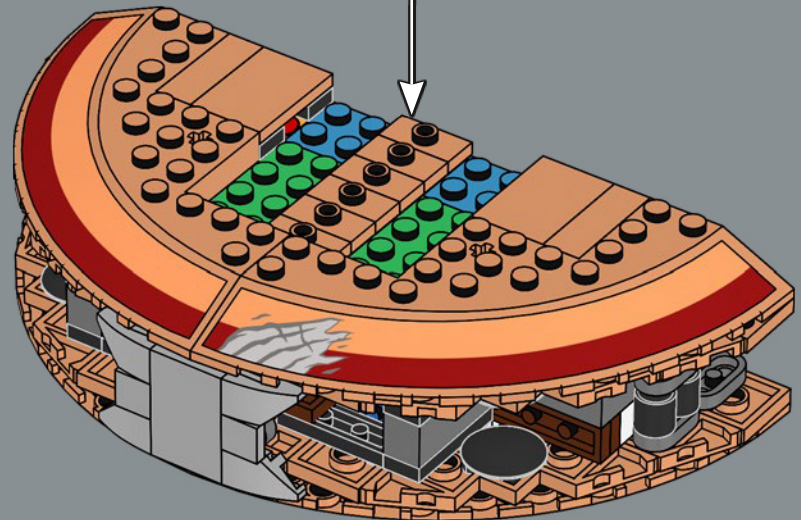

252

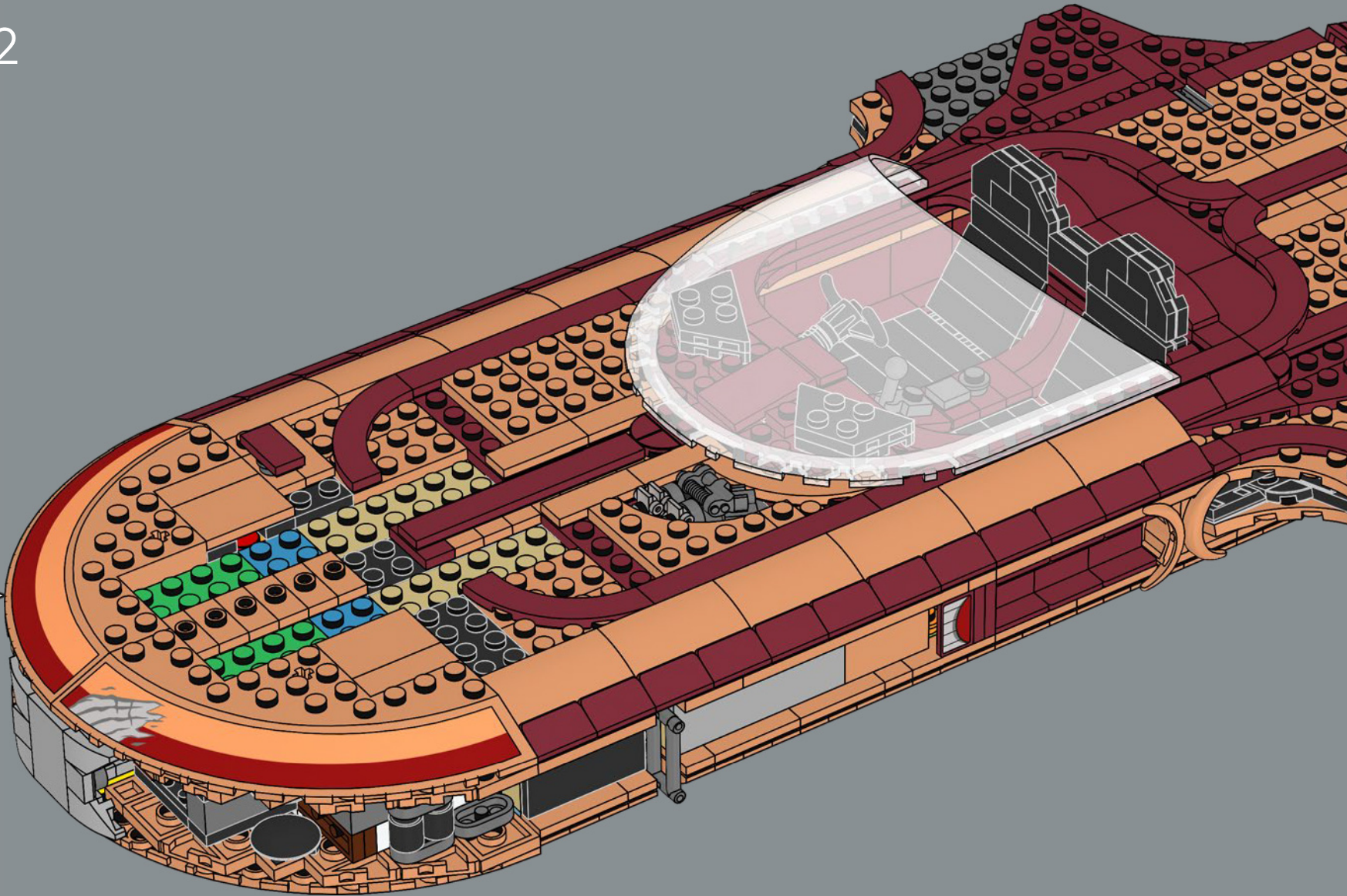

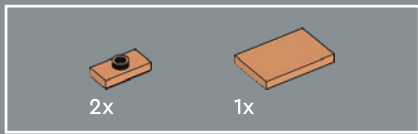

253

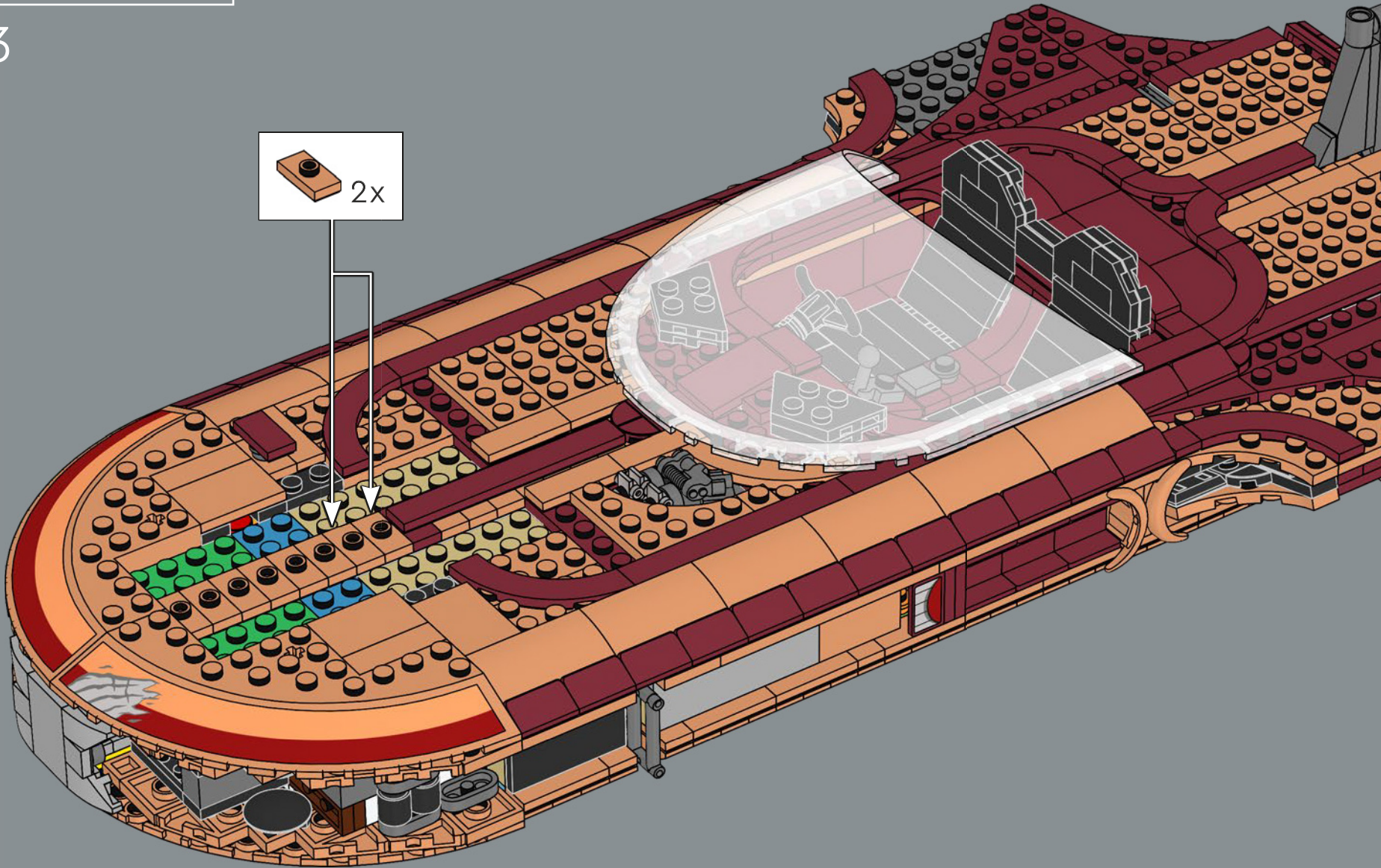

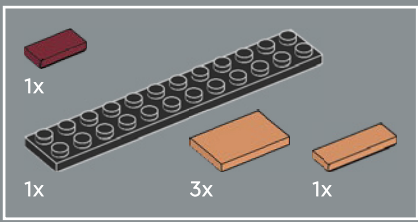

254

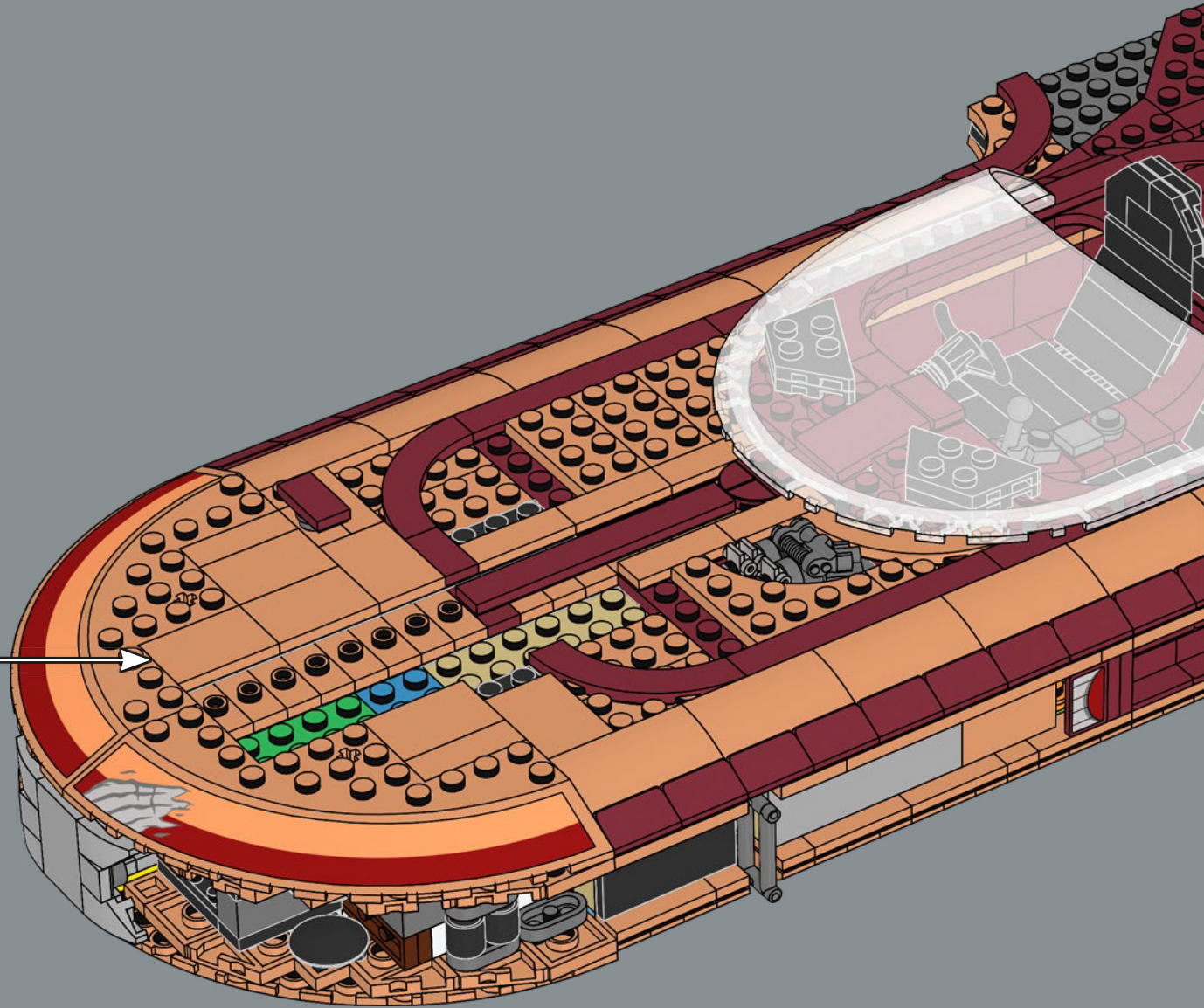
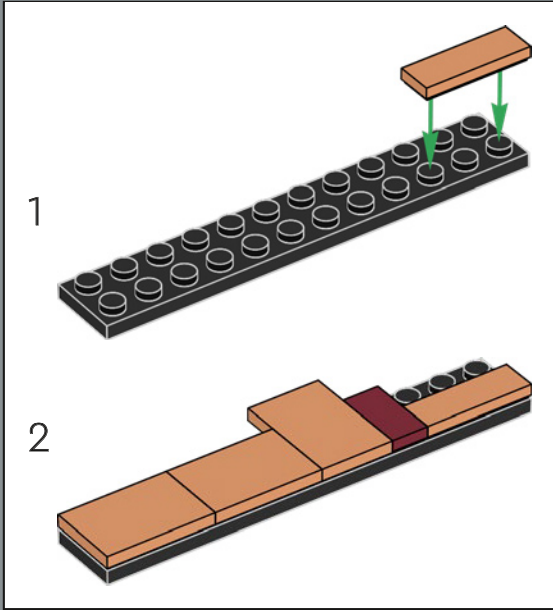

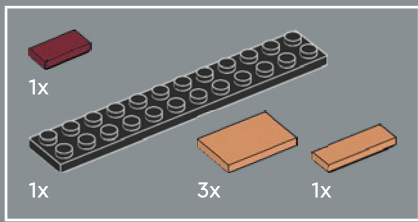

255

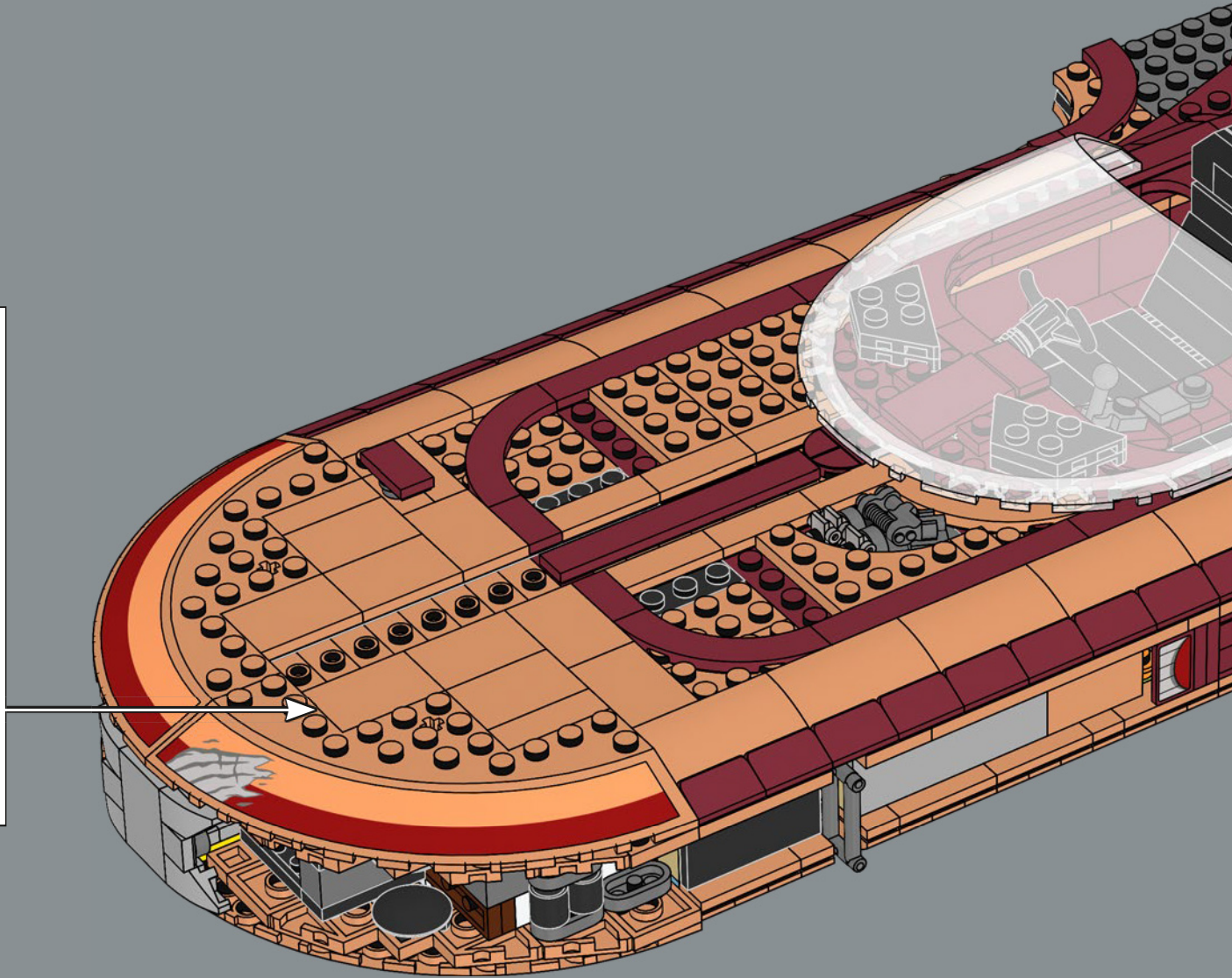
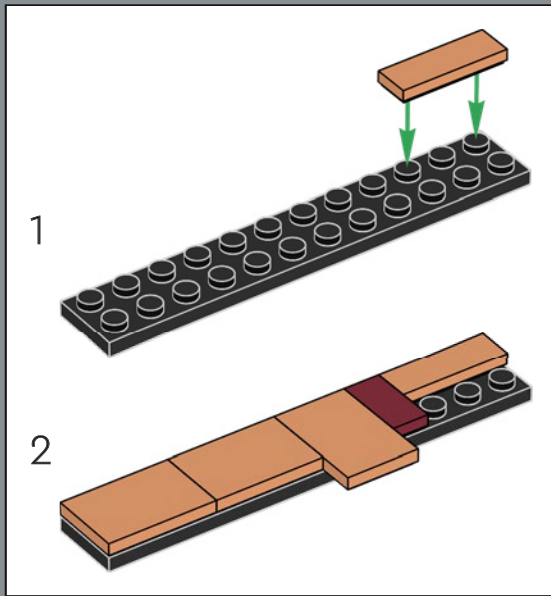

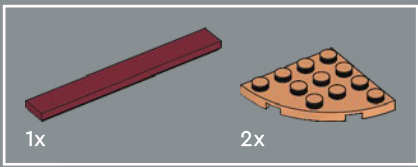

256

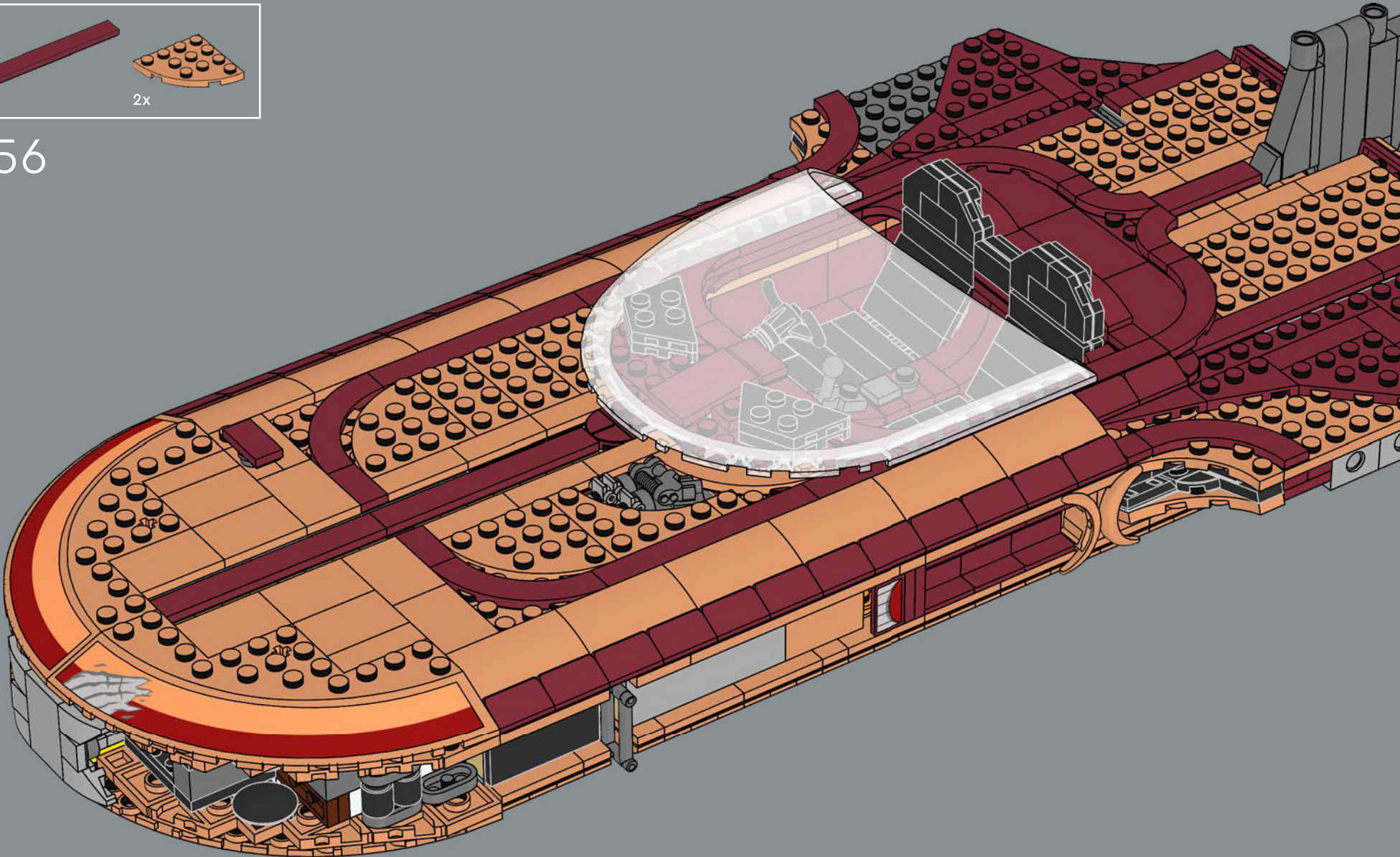

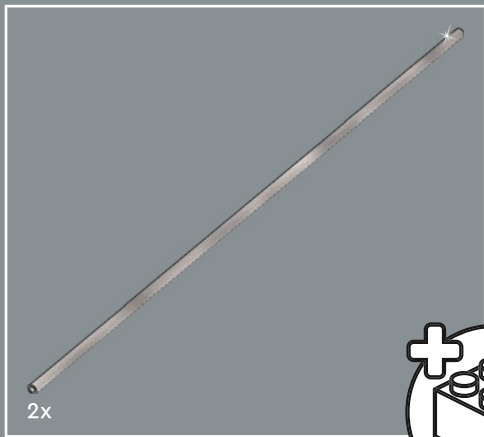

2x

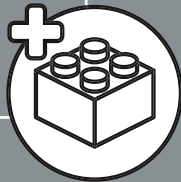

257

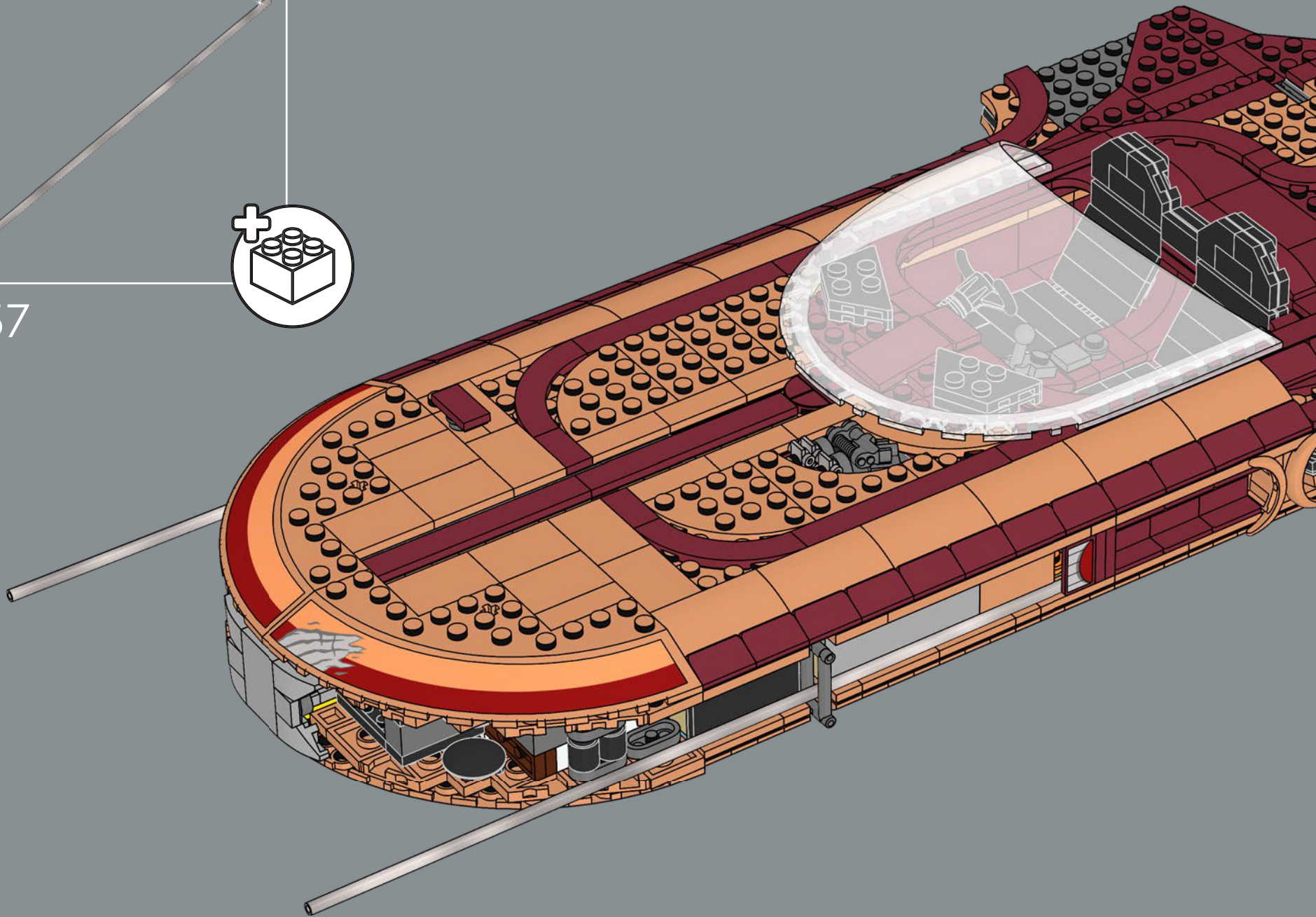

258

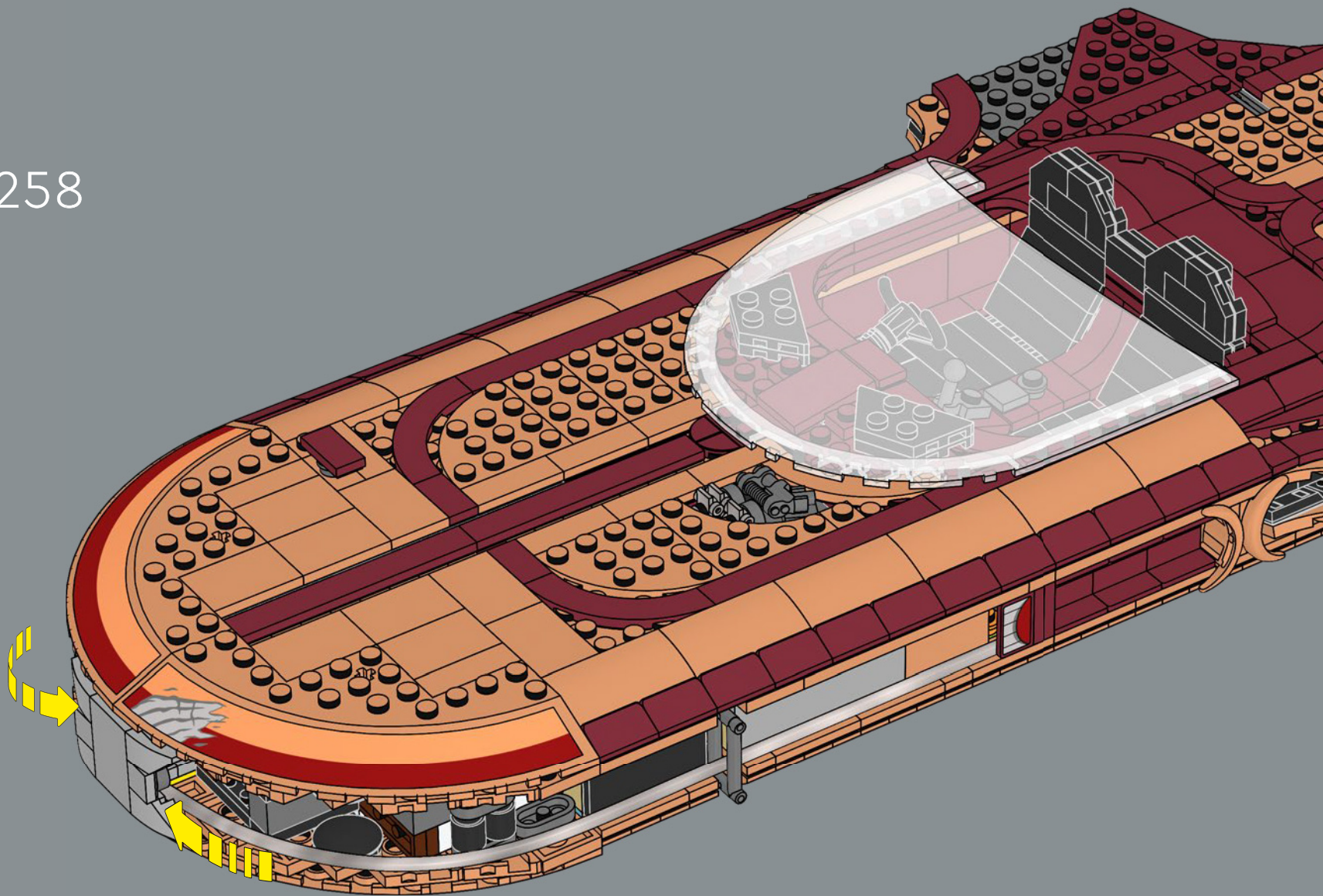

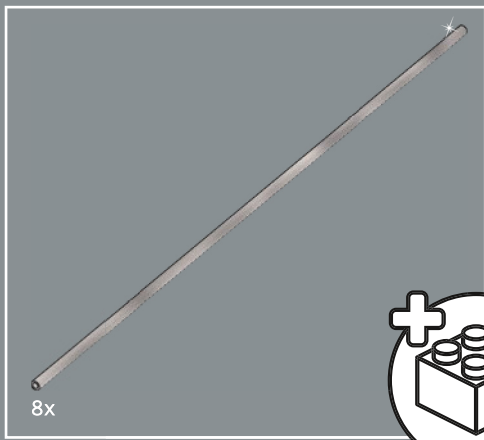

8x

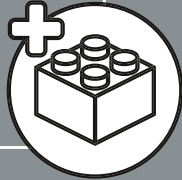

259

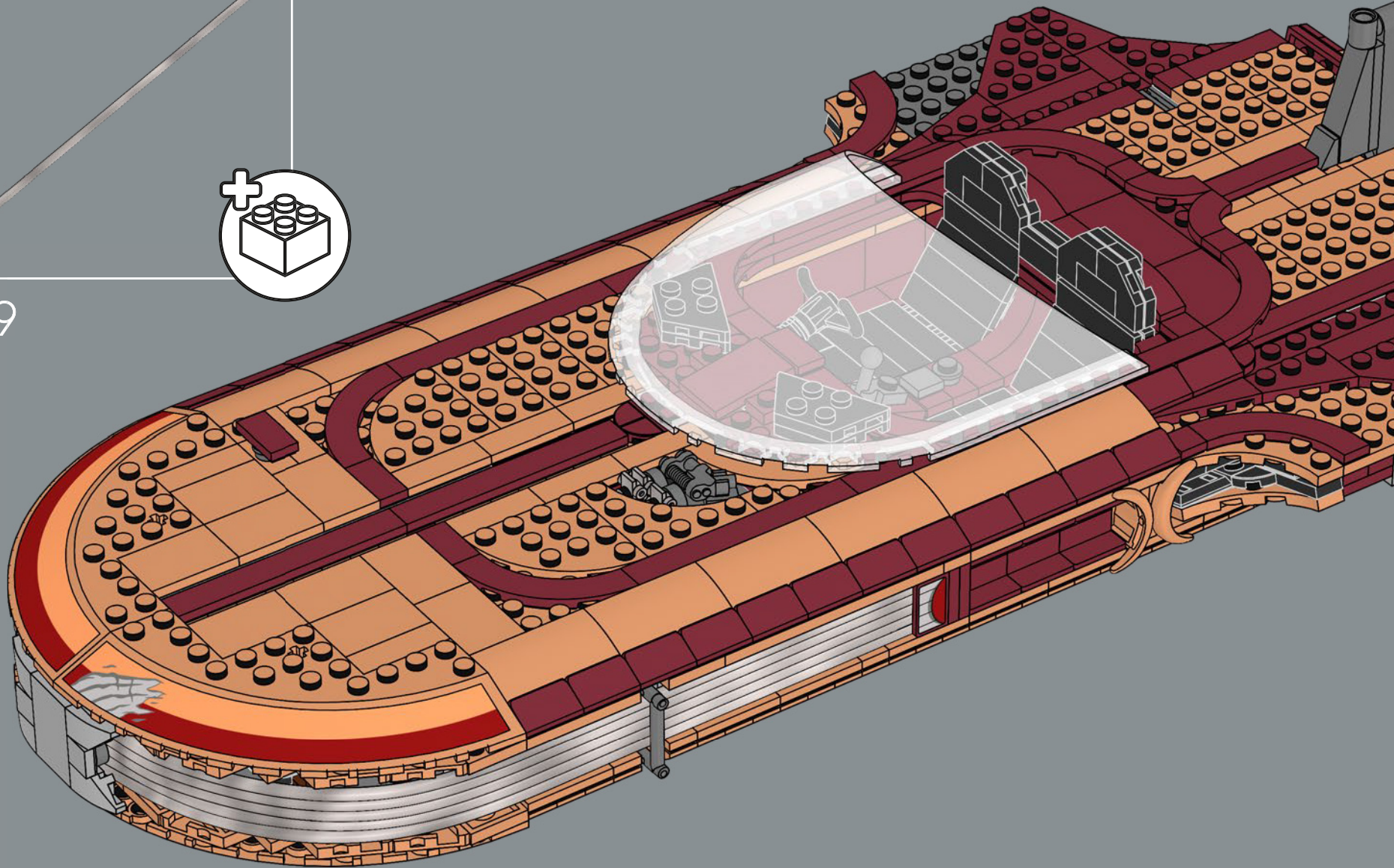

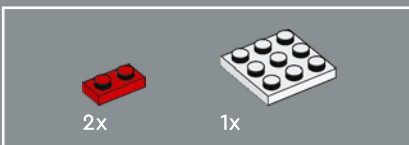
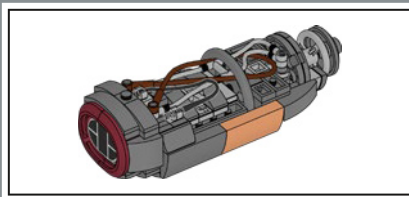
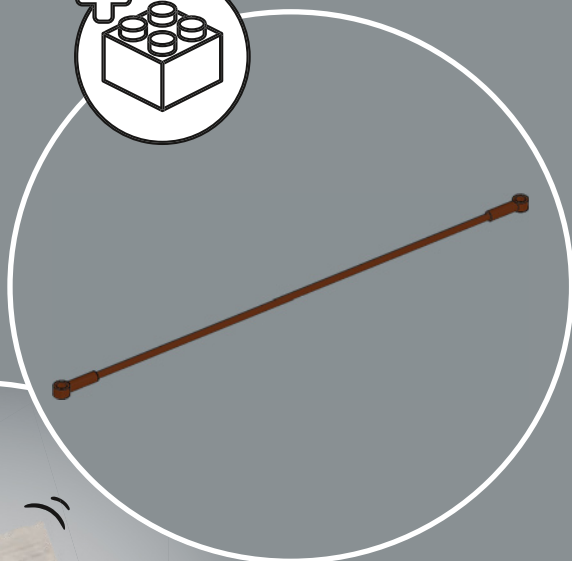
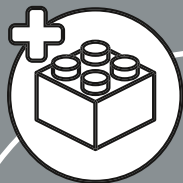

260

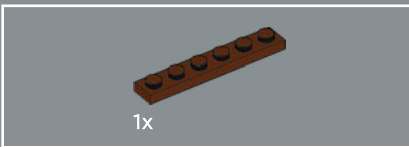
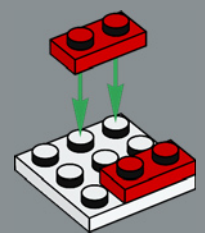

261

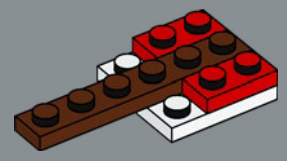

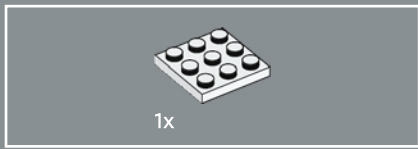

262

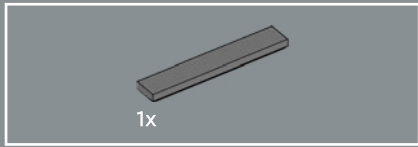
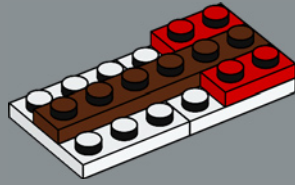

263

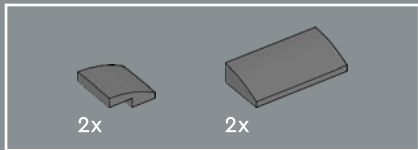
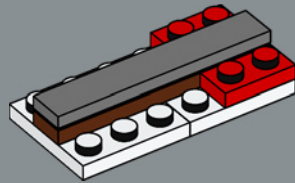

264

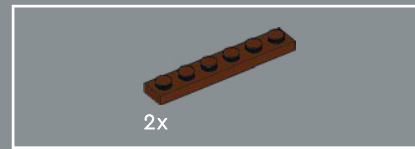
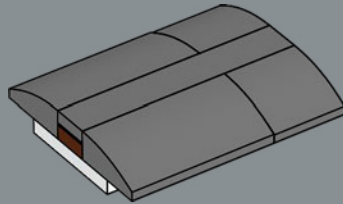

265

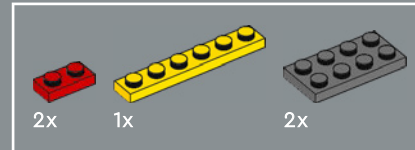

266

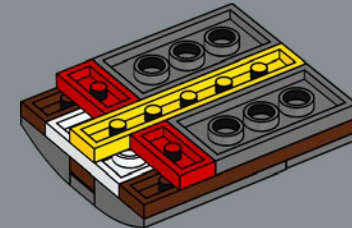

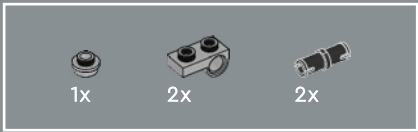

267

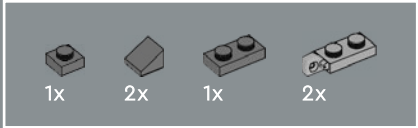
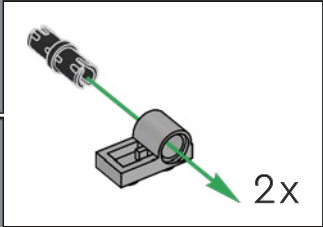
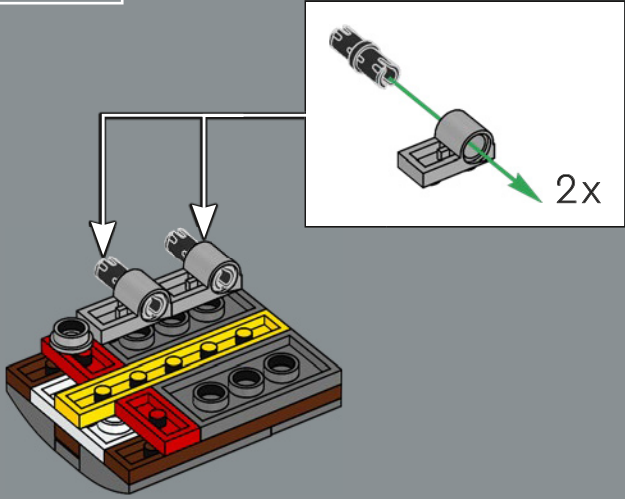

268

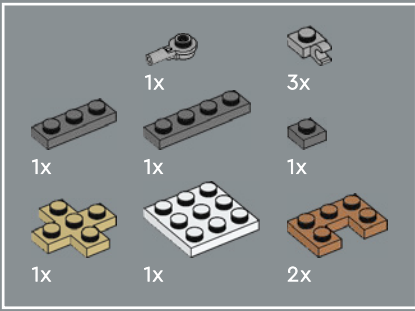
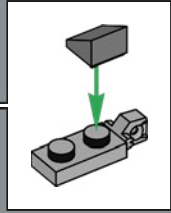
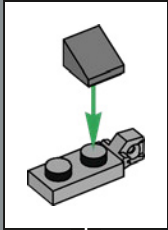
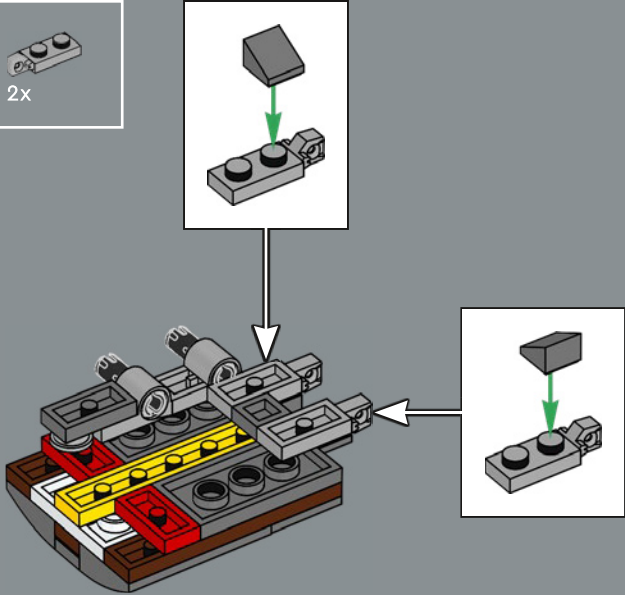

269

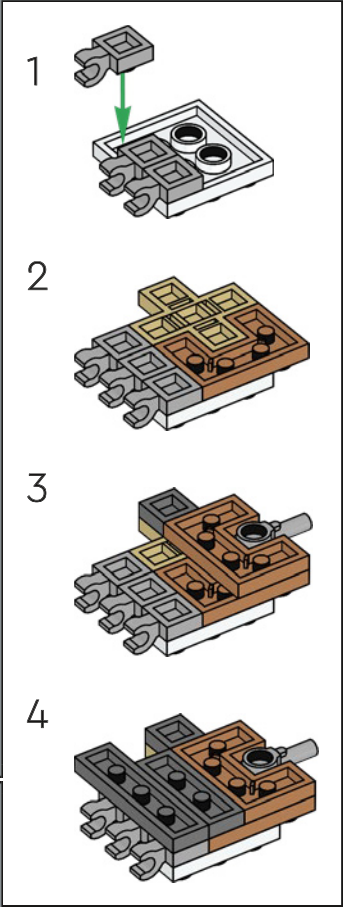
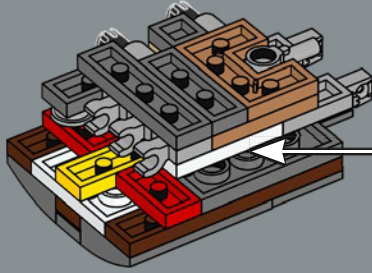

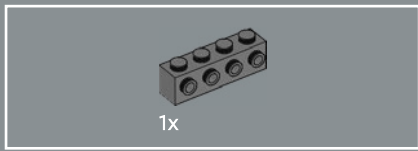

270

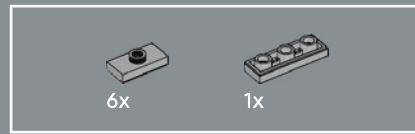
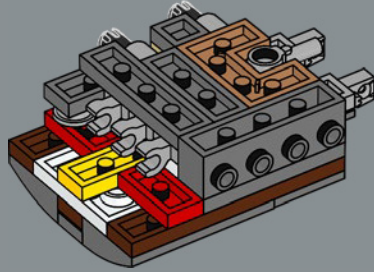

271

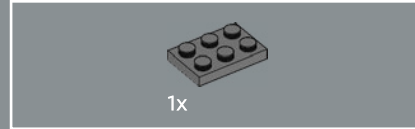
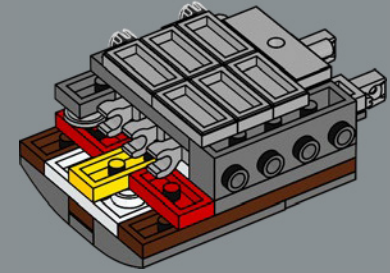

272

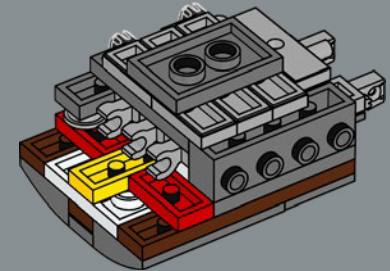

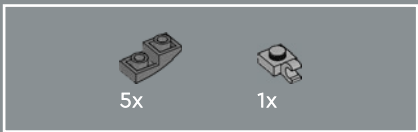

273

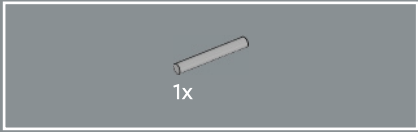
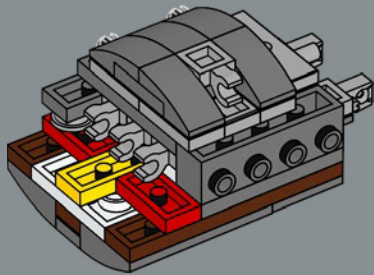

274

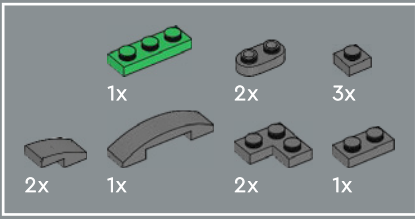
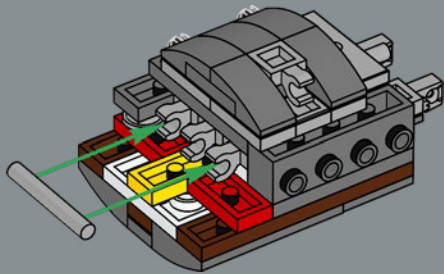

275

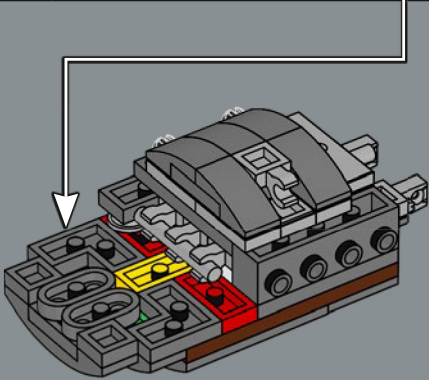
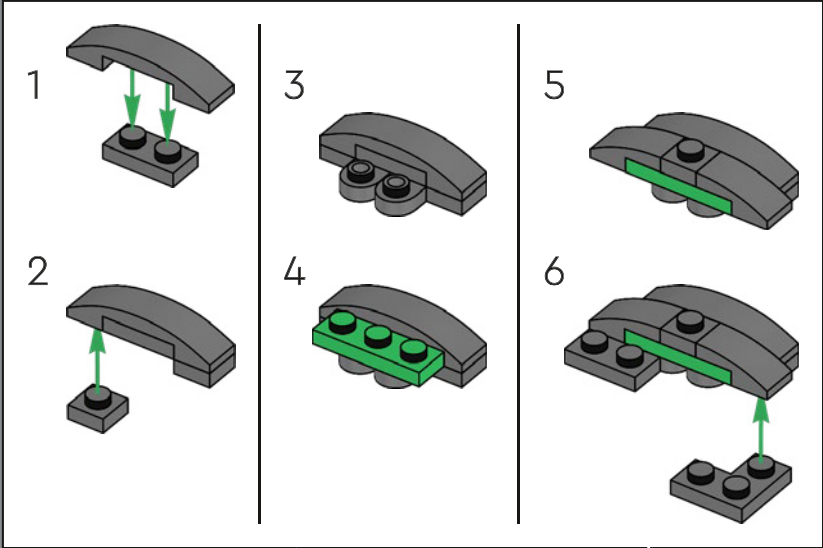

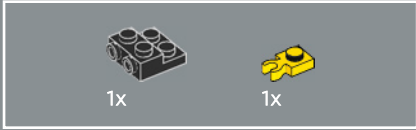
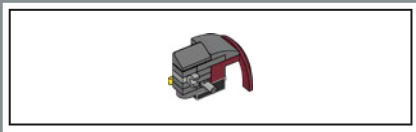

276

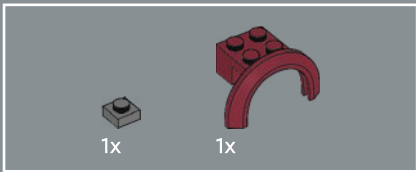
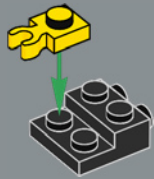

277

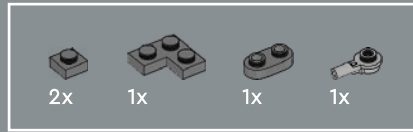
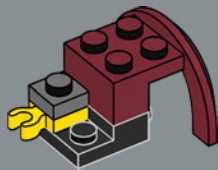

278

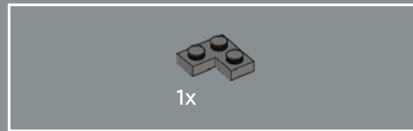
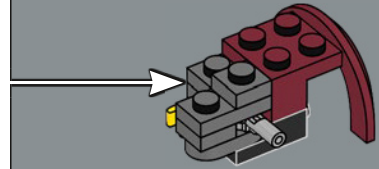
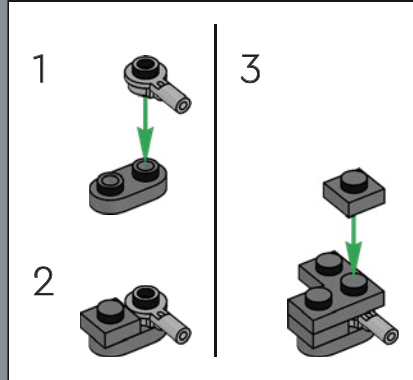

279

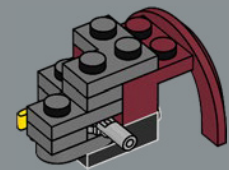

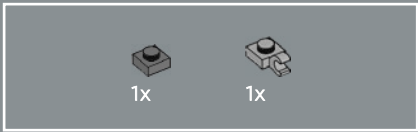

280

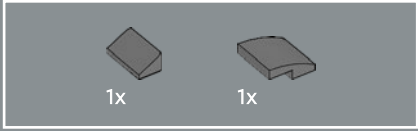
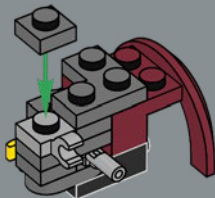

281

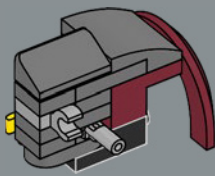

282

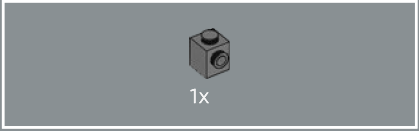
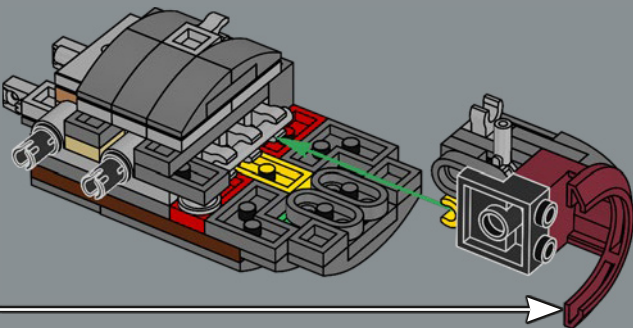

283

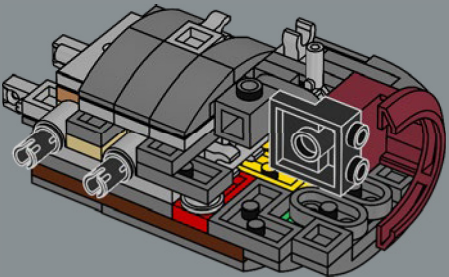

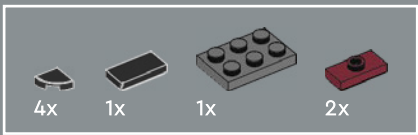

285

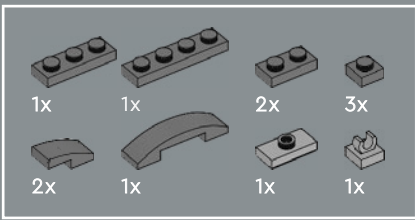
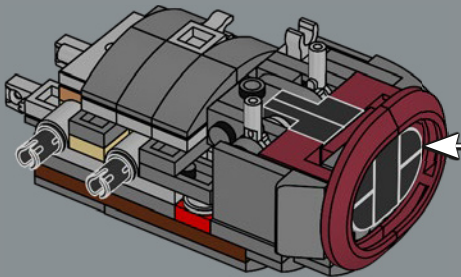
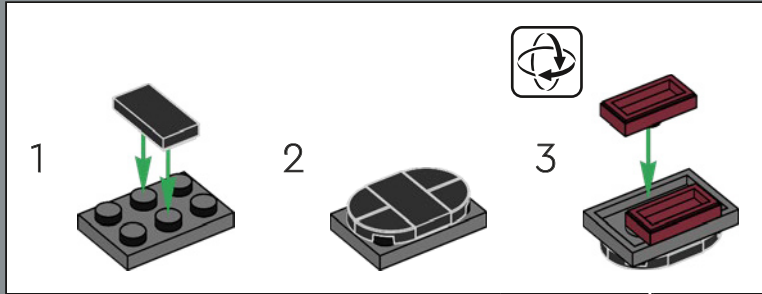

286

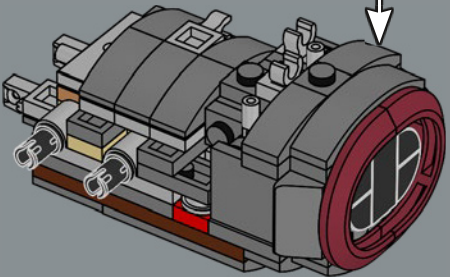
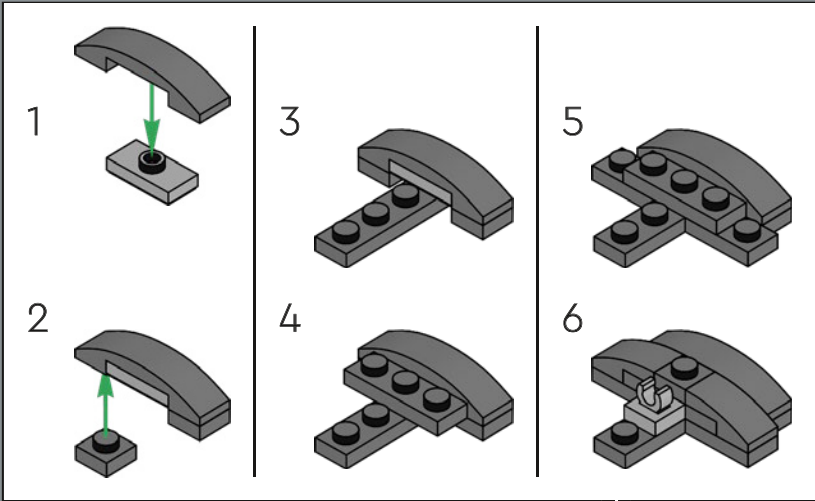

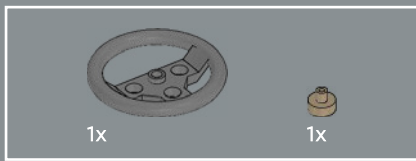

287

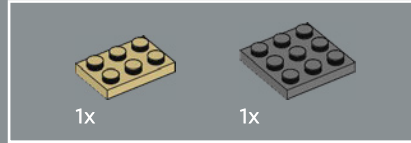
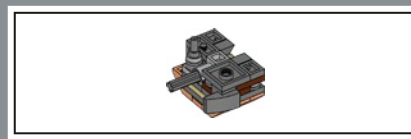
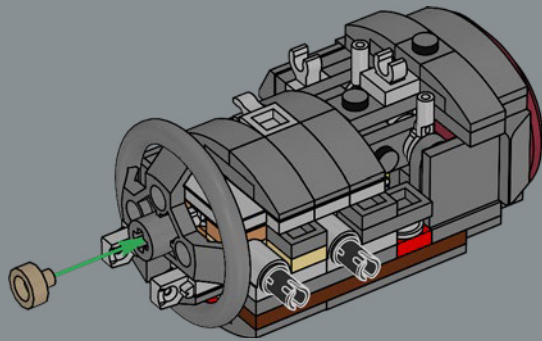

288

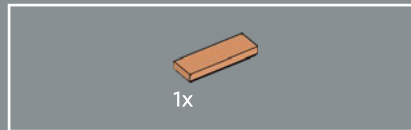
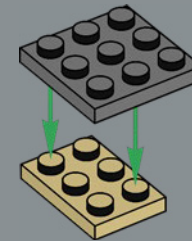

289

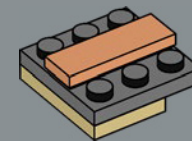



6x

290

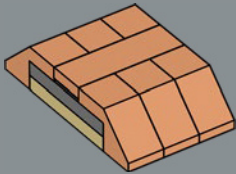

1x

291

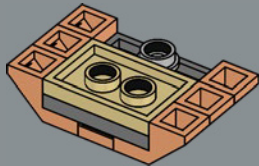

1x



1x



2x

292

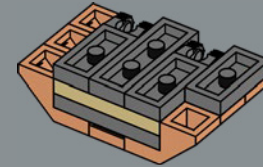

1x



1x



1x

293

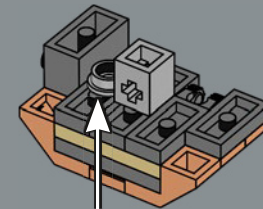



294

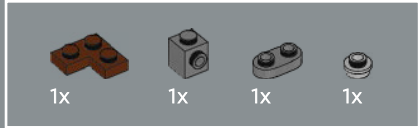
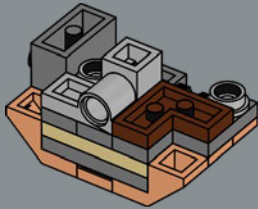

295

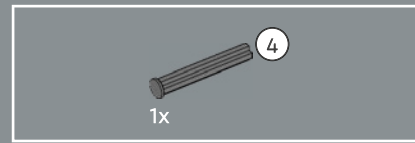
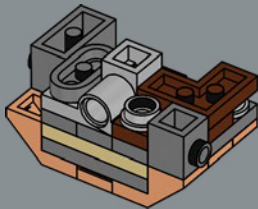

296

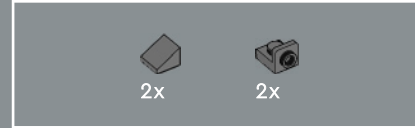
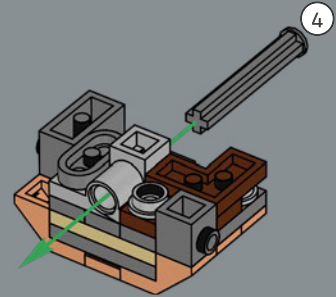

297

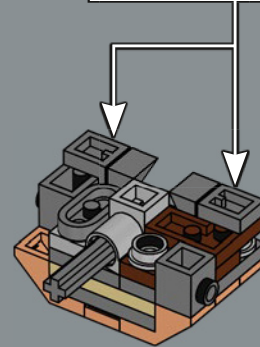
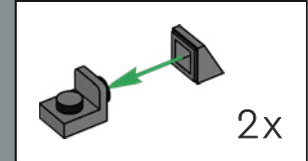

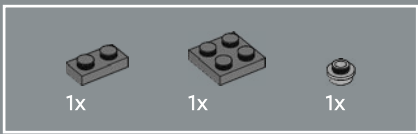

298

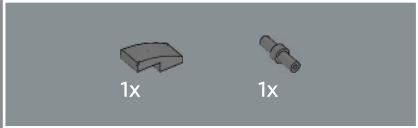
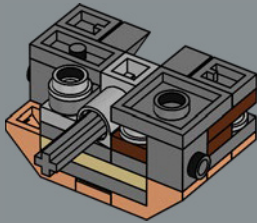

299

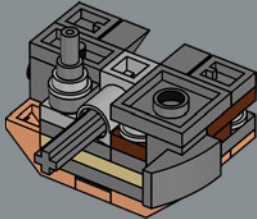

300

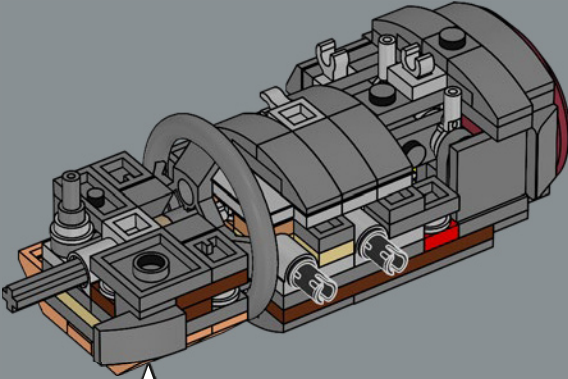

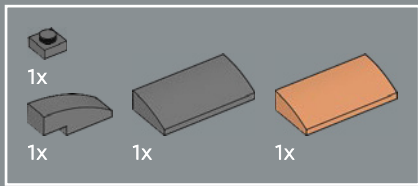

301

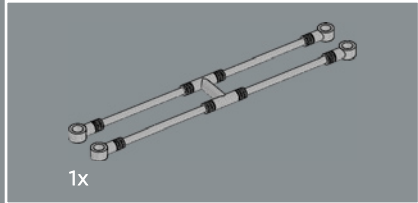
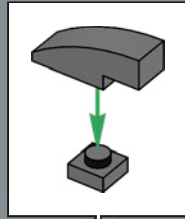
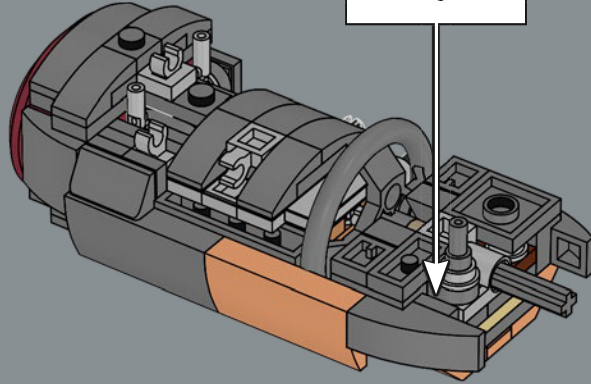

302

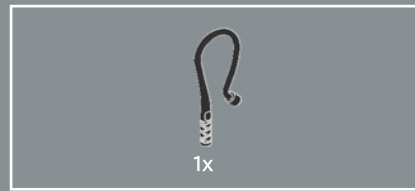
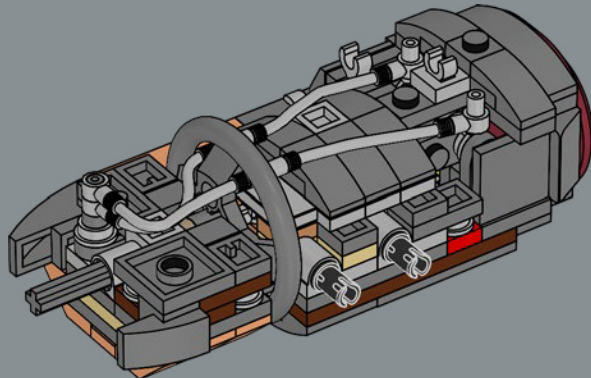

303

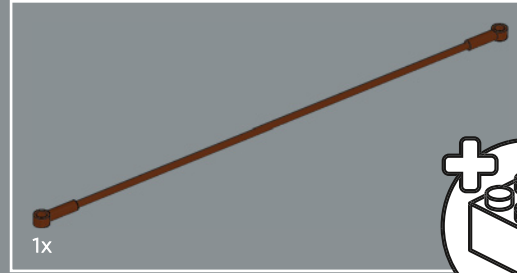
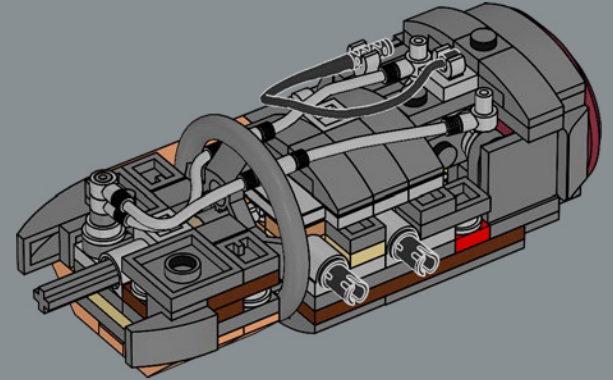

304

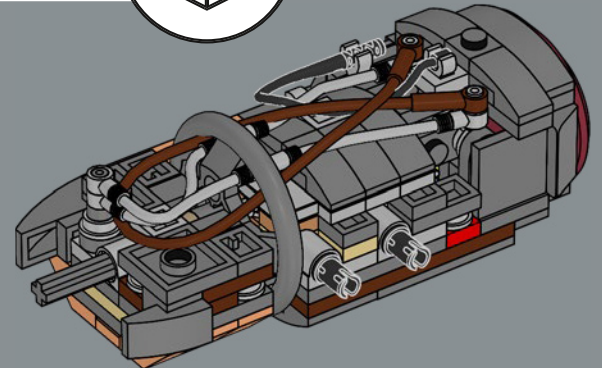
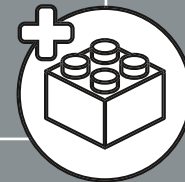

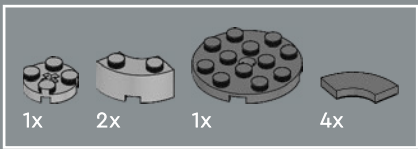

305

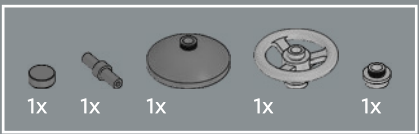
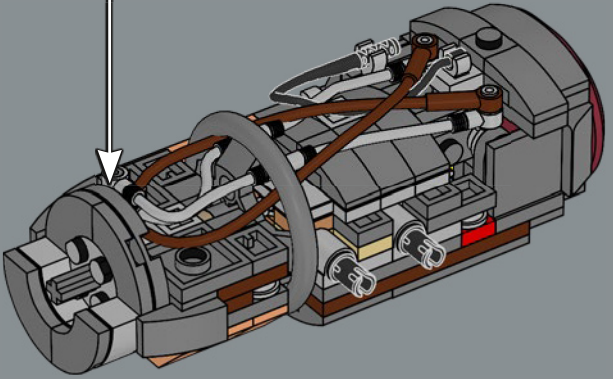
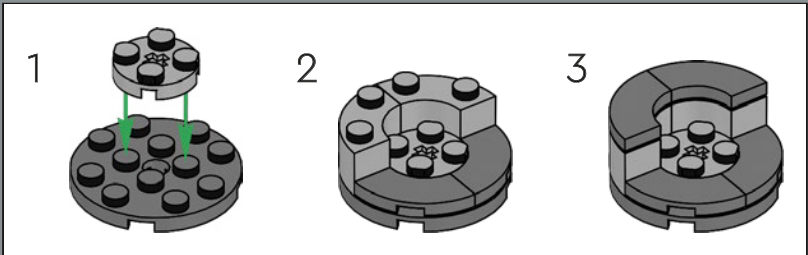

306

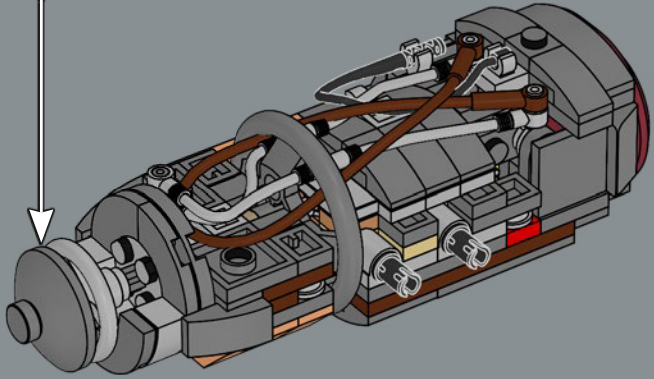
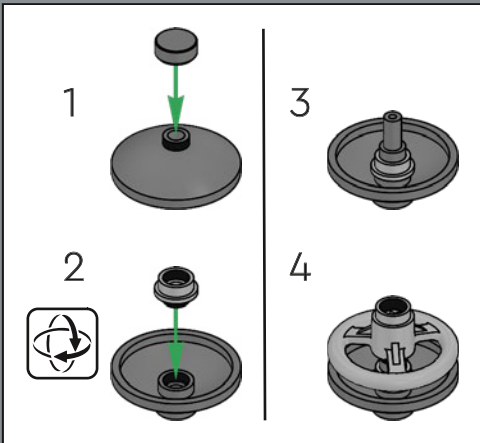

307

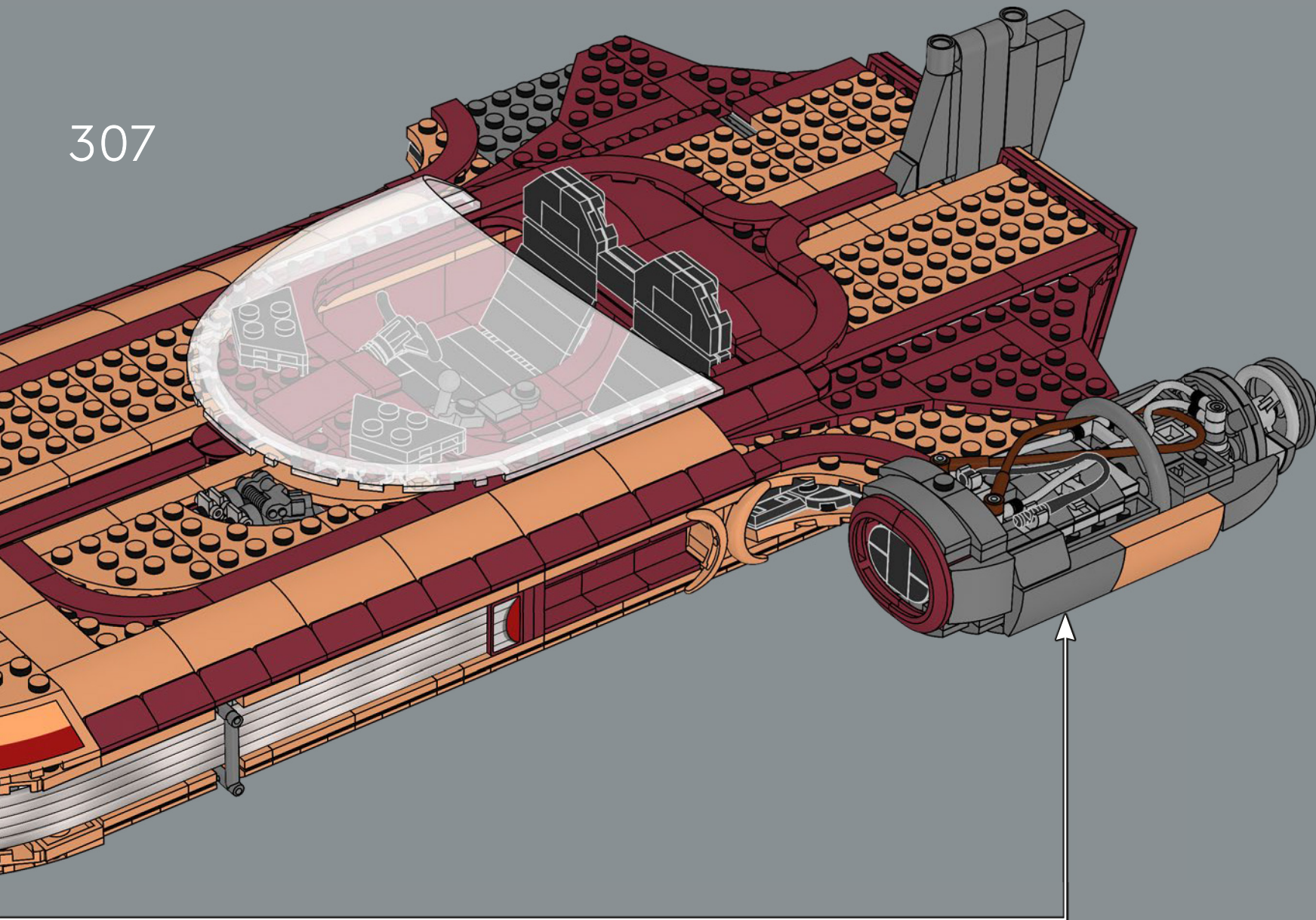

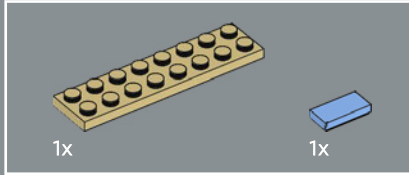
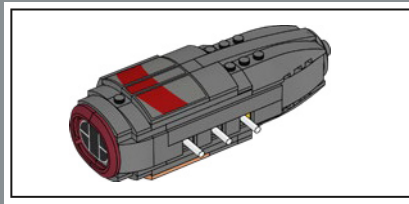

308

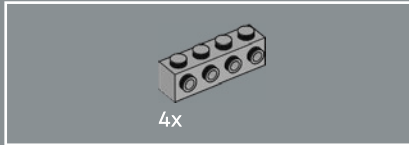
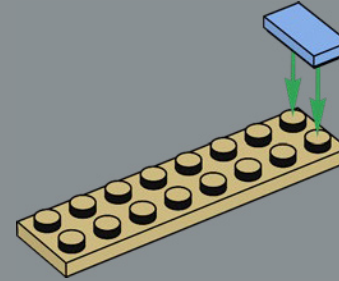

309

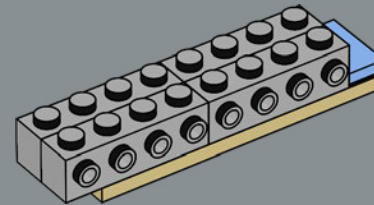



310

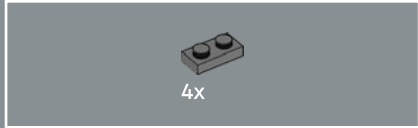
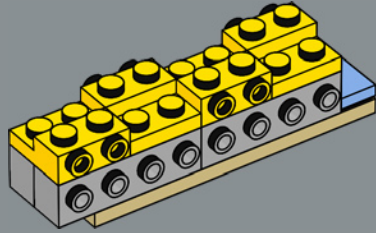

311

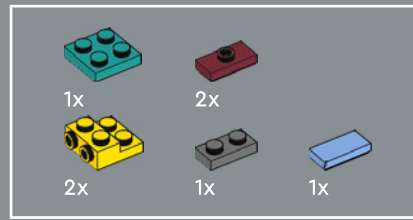
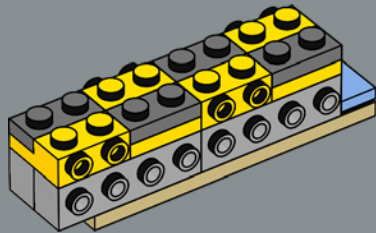

312

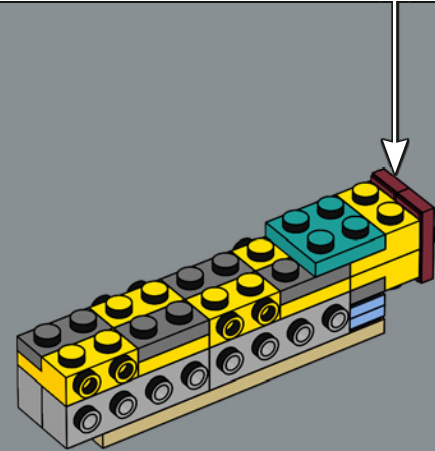
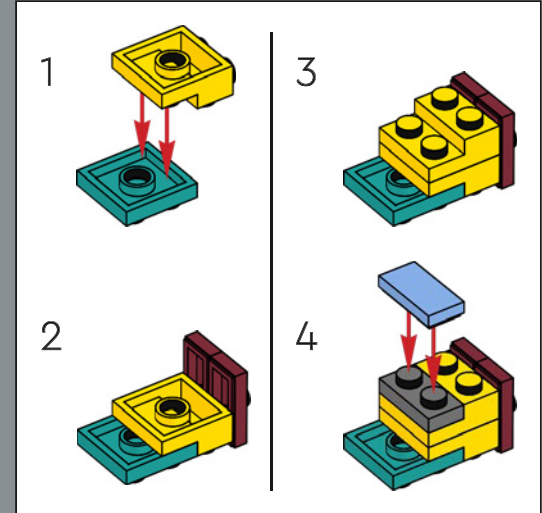

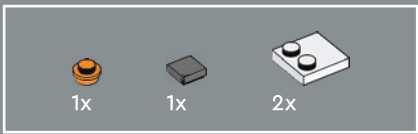

313

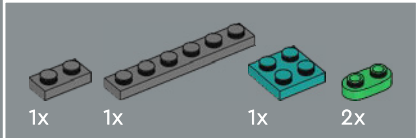
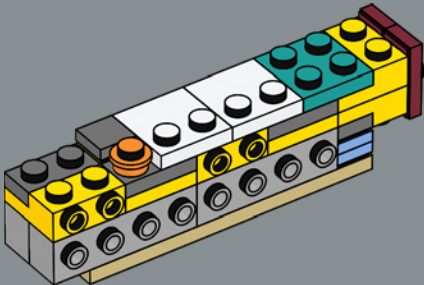

314

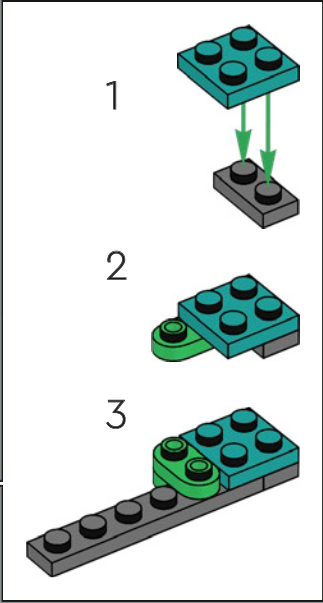
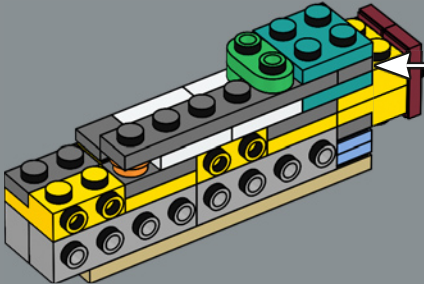

315

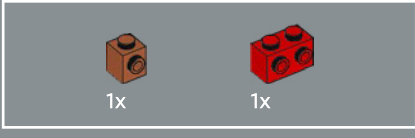
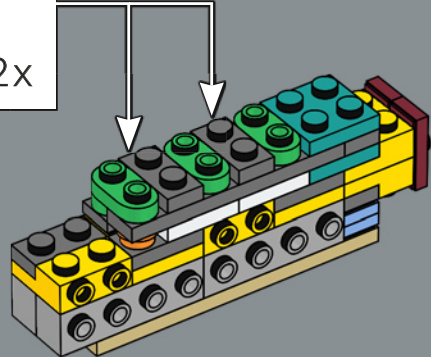
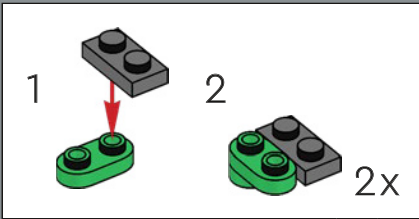

316

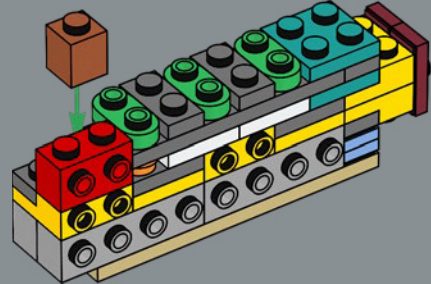

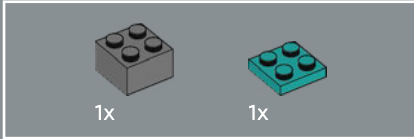
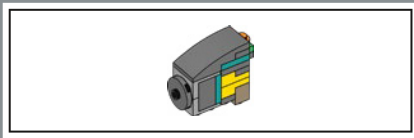

317

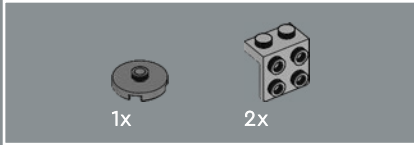
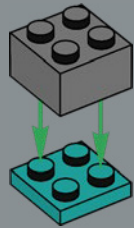

318

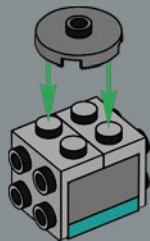

319

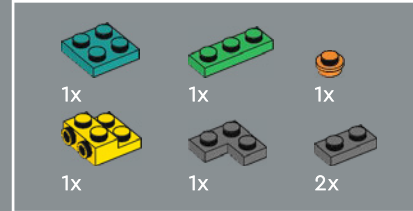
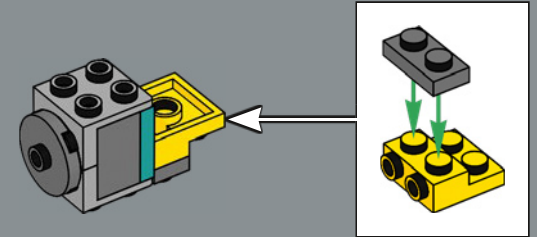

320

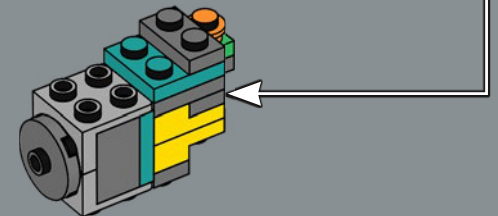
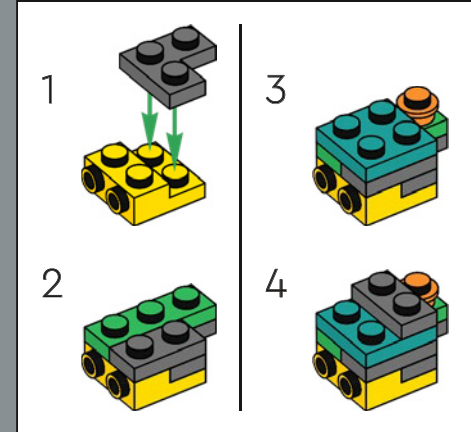

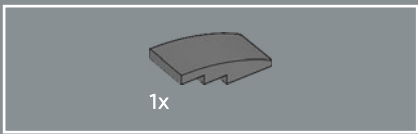

321

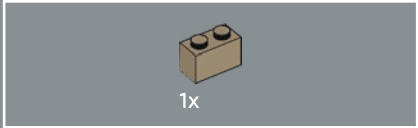
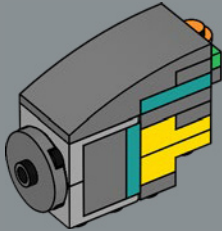

322

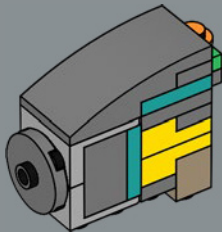

323

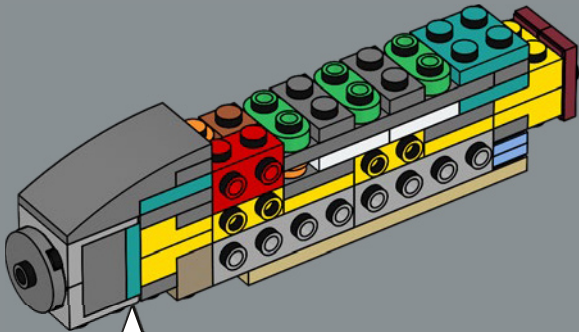

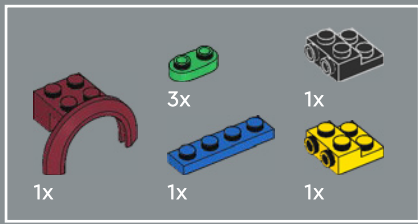

324

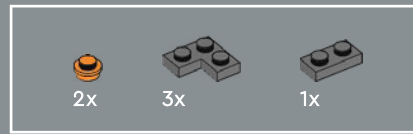
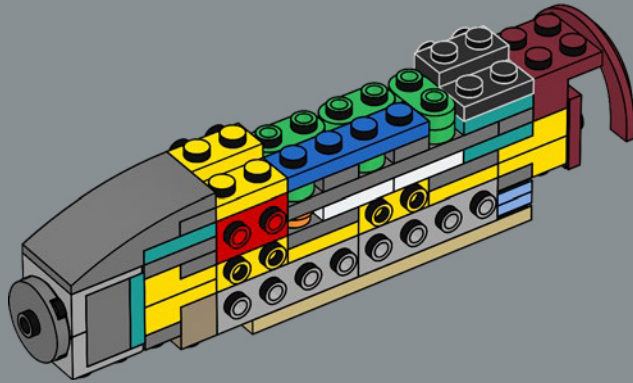

325

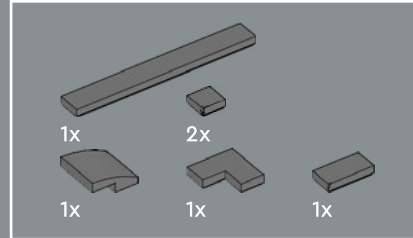
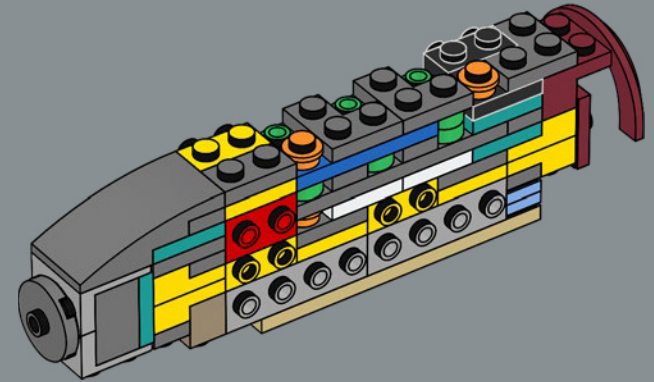

326

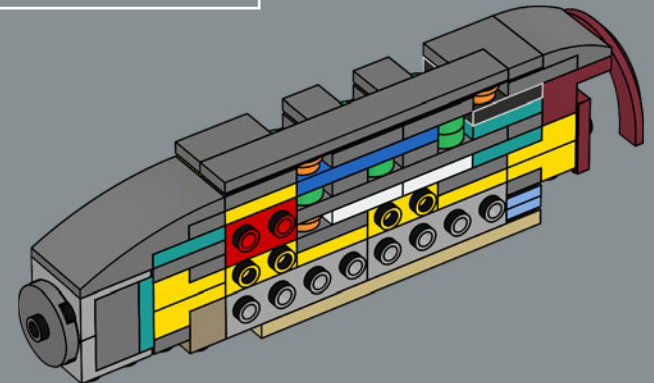

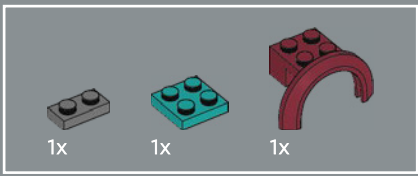

327

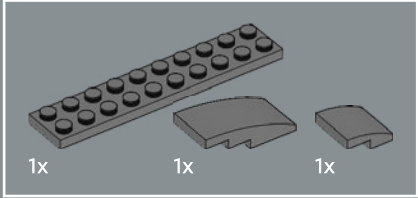
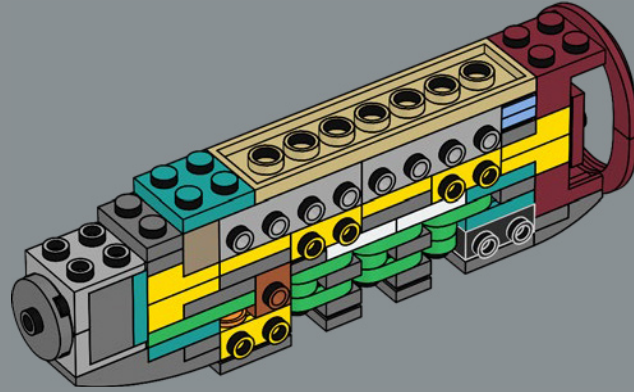

328

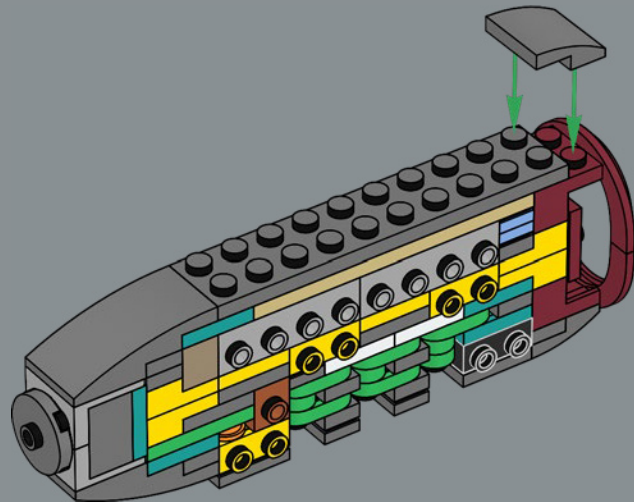

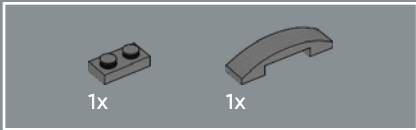
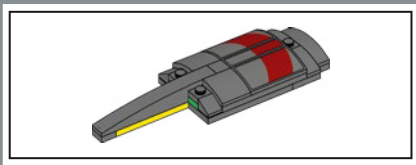

1x

1x

329

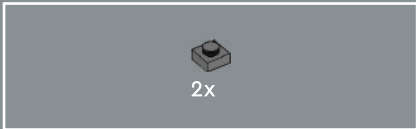
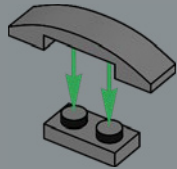

2x

330

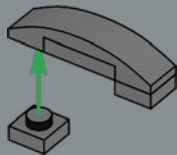

2x

331

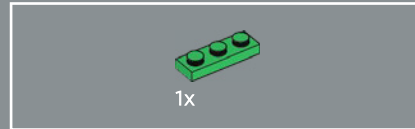
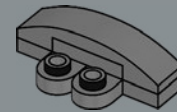

1x

332

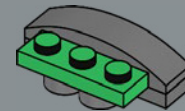



2x

333

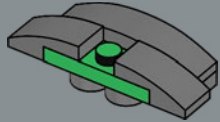

2x

334

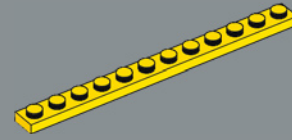
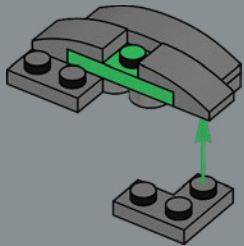

1x

335

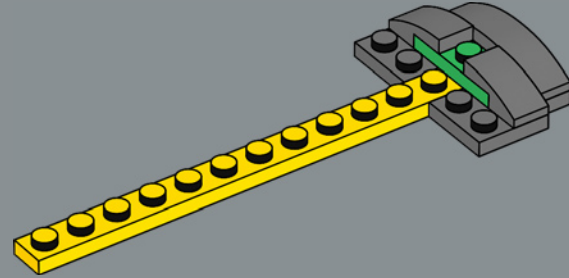

1x

336

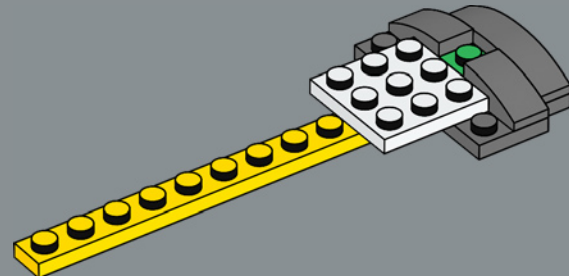

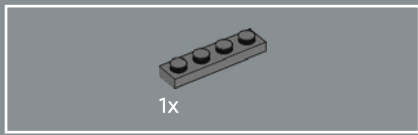

337

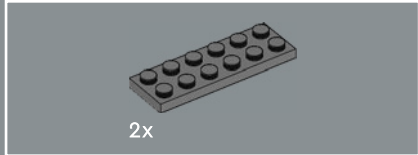
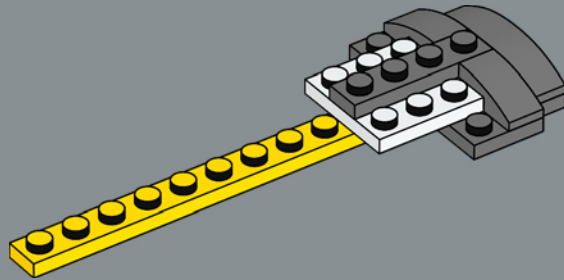

338

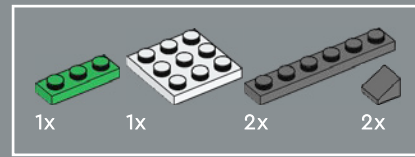
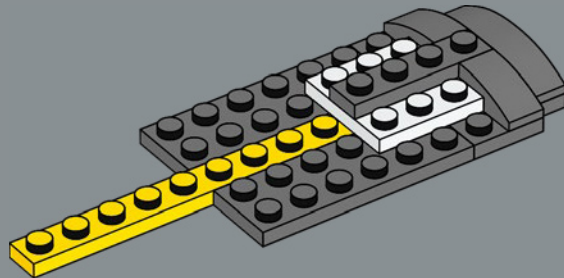

339

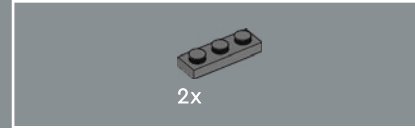
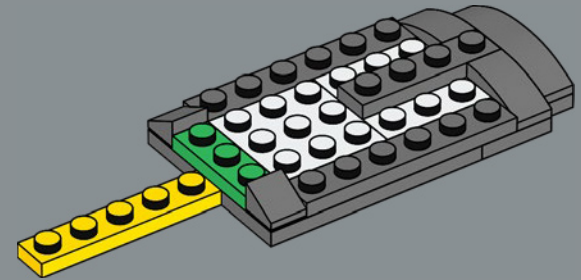

340

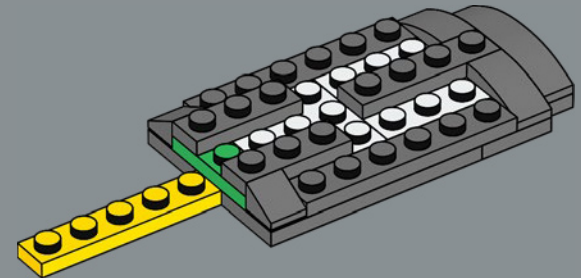

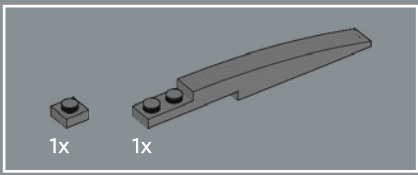

341

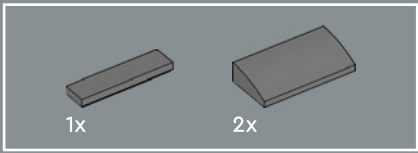
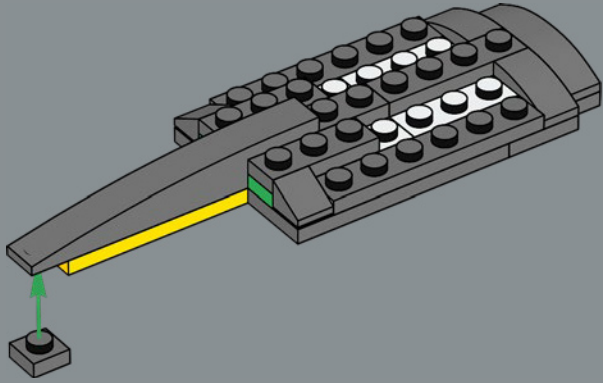

342

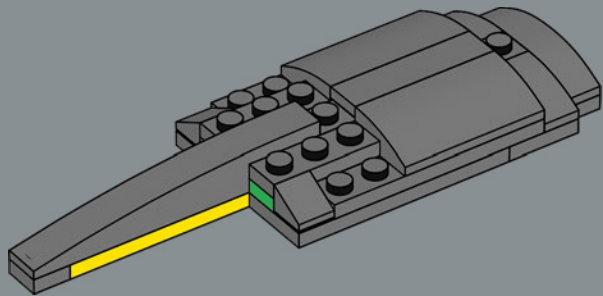

343

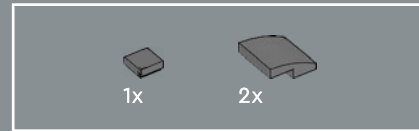
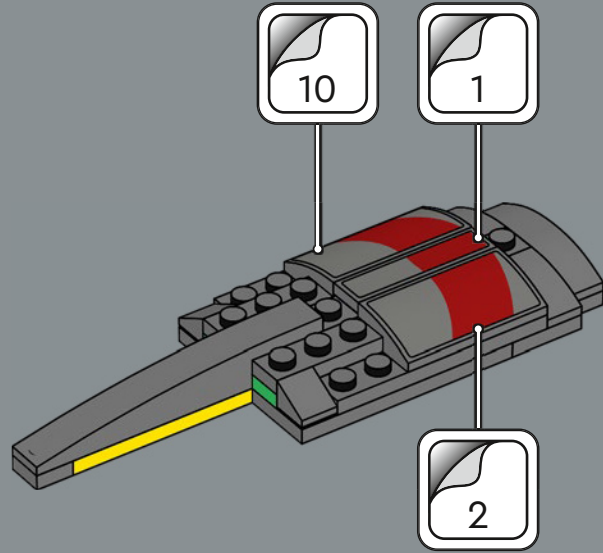

344

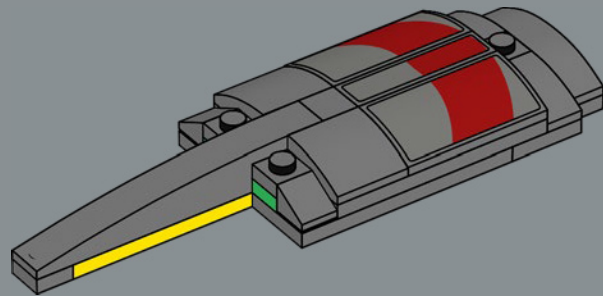

345

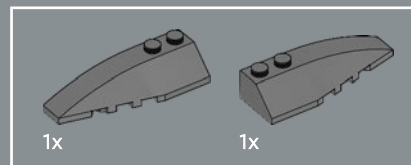
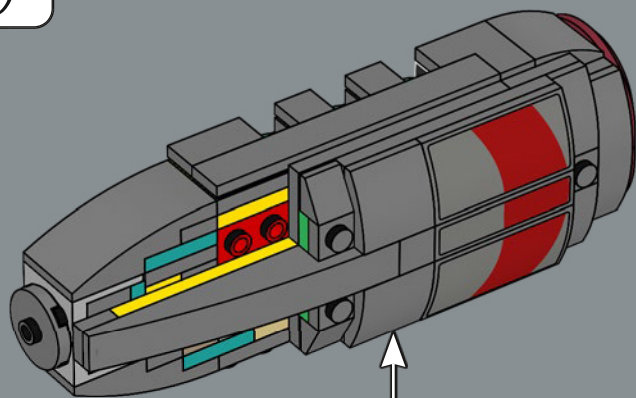

346

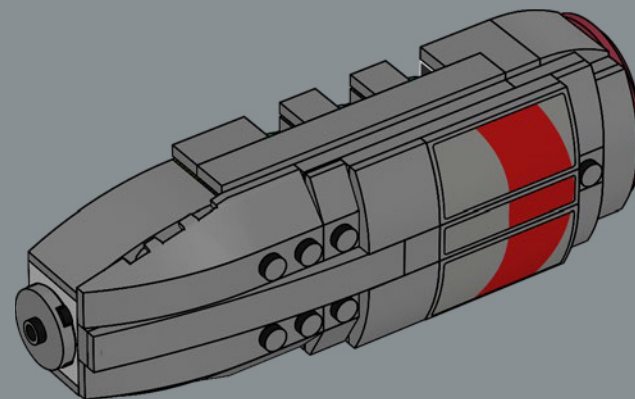

347

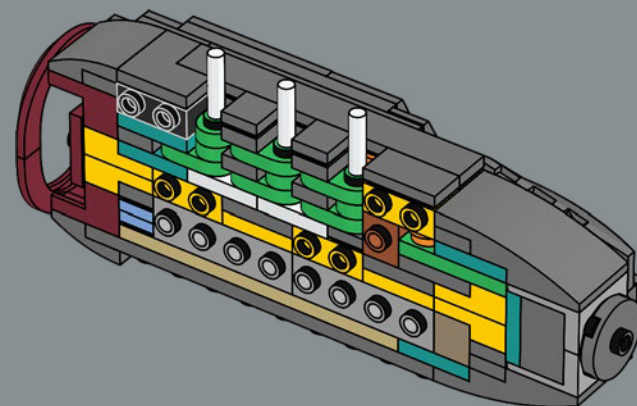

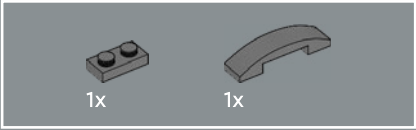
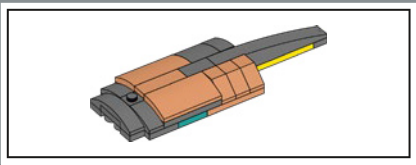

348

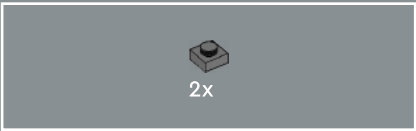
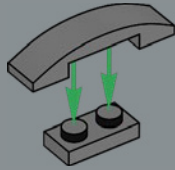

349

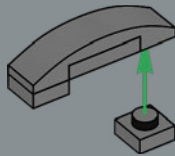

350

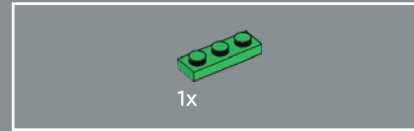
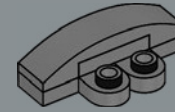

351

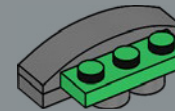

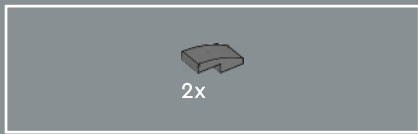

352

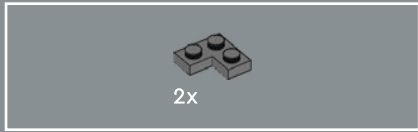
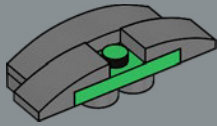

353

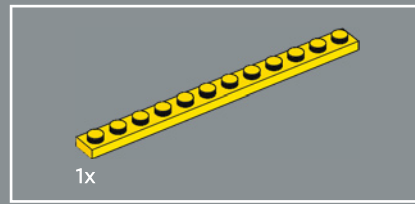
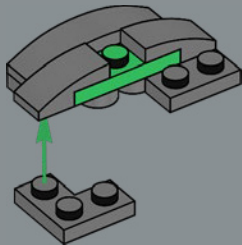

354

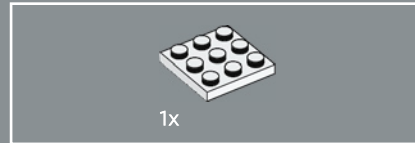
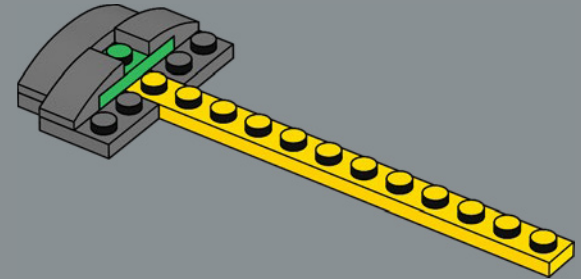

355

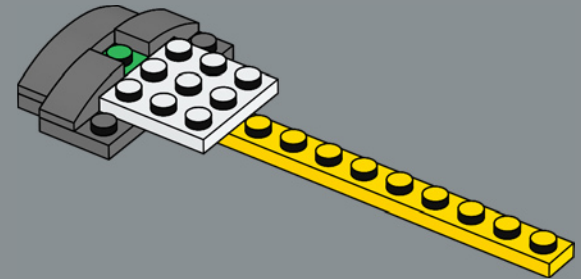

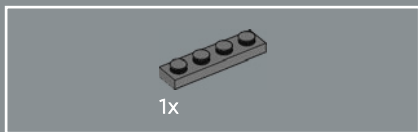

356

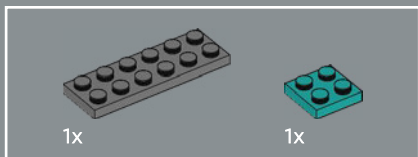
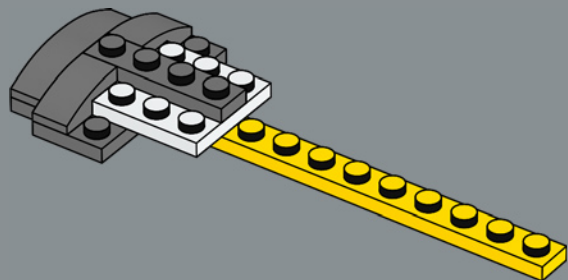

357

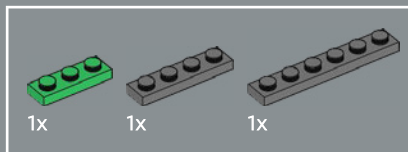
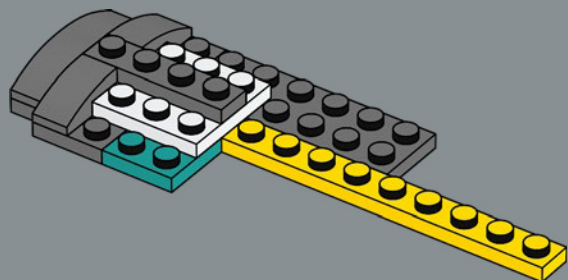

358

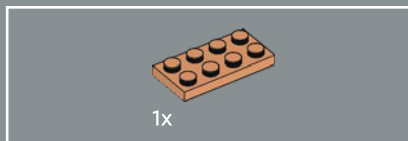
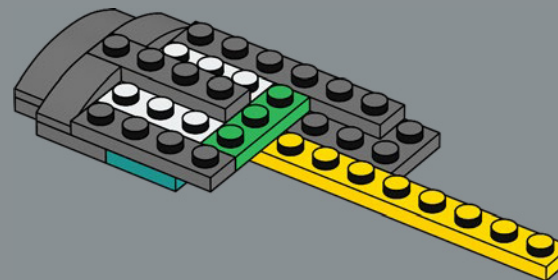

359

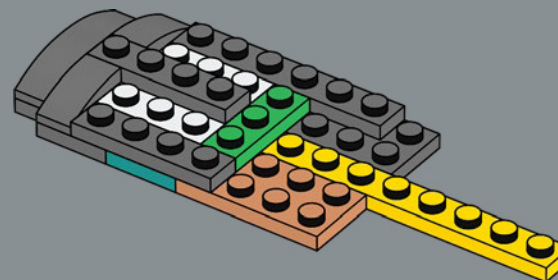

364

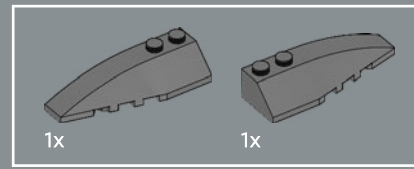
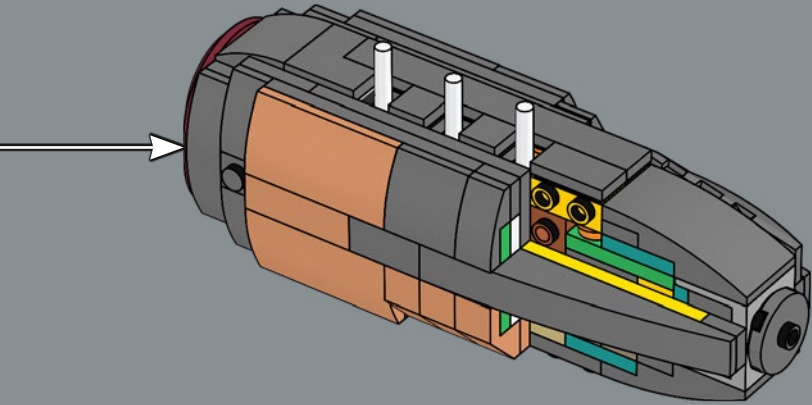

365

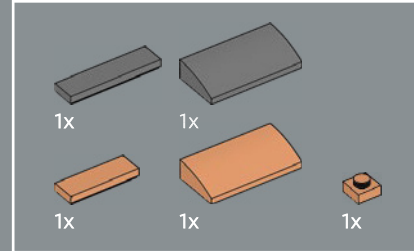
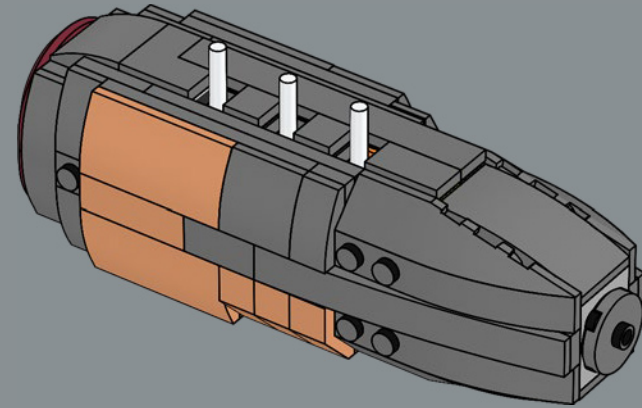

366

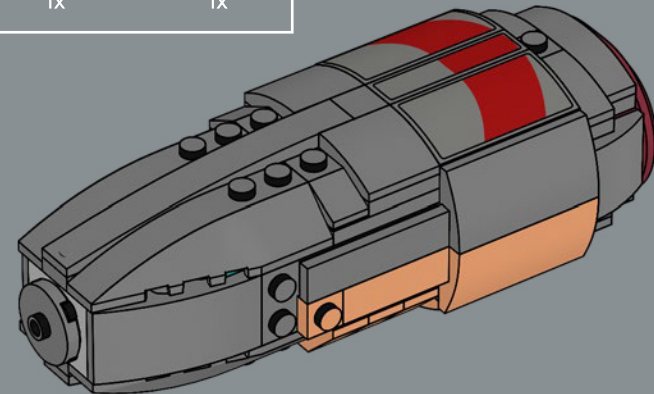

367

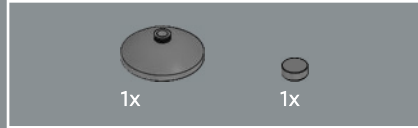
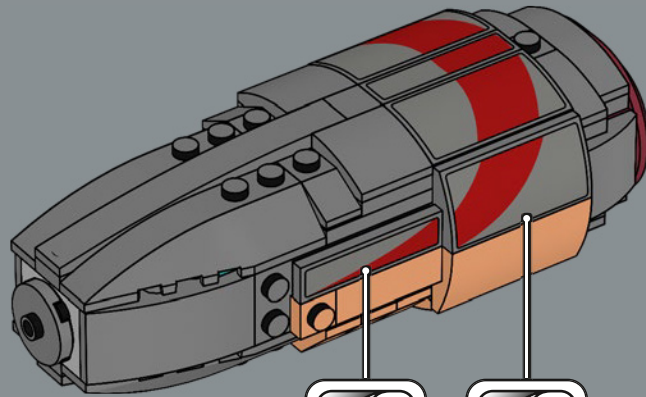

368

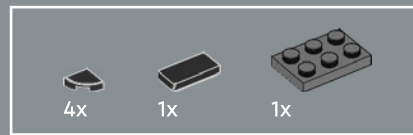
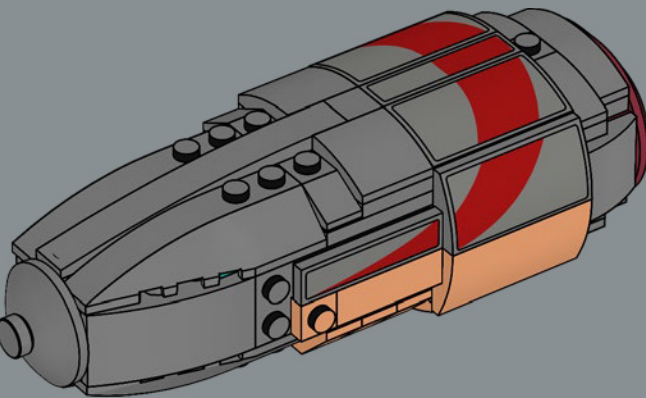
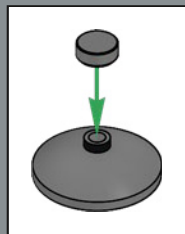

369

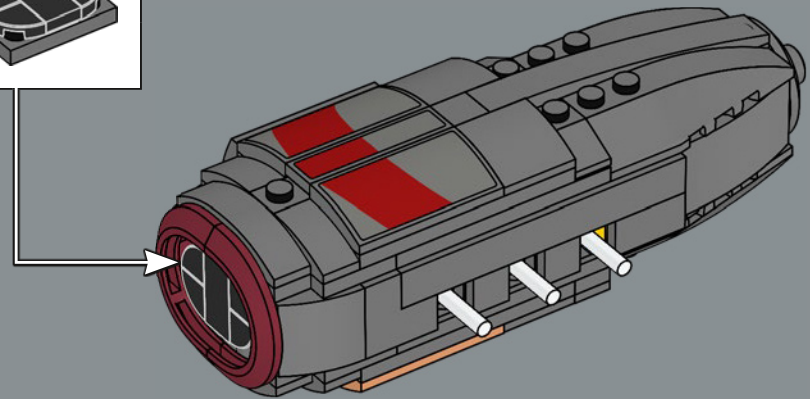
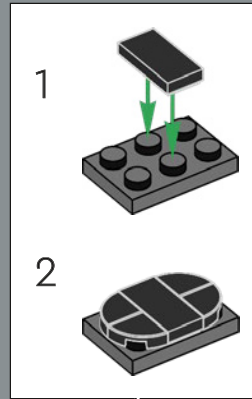

370

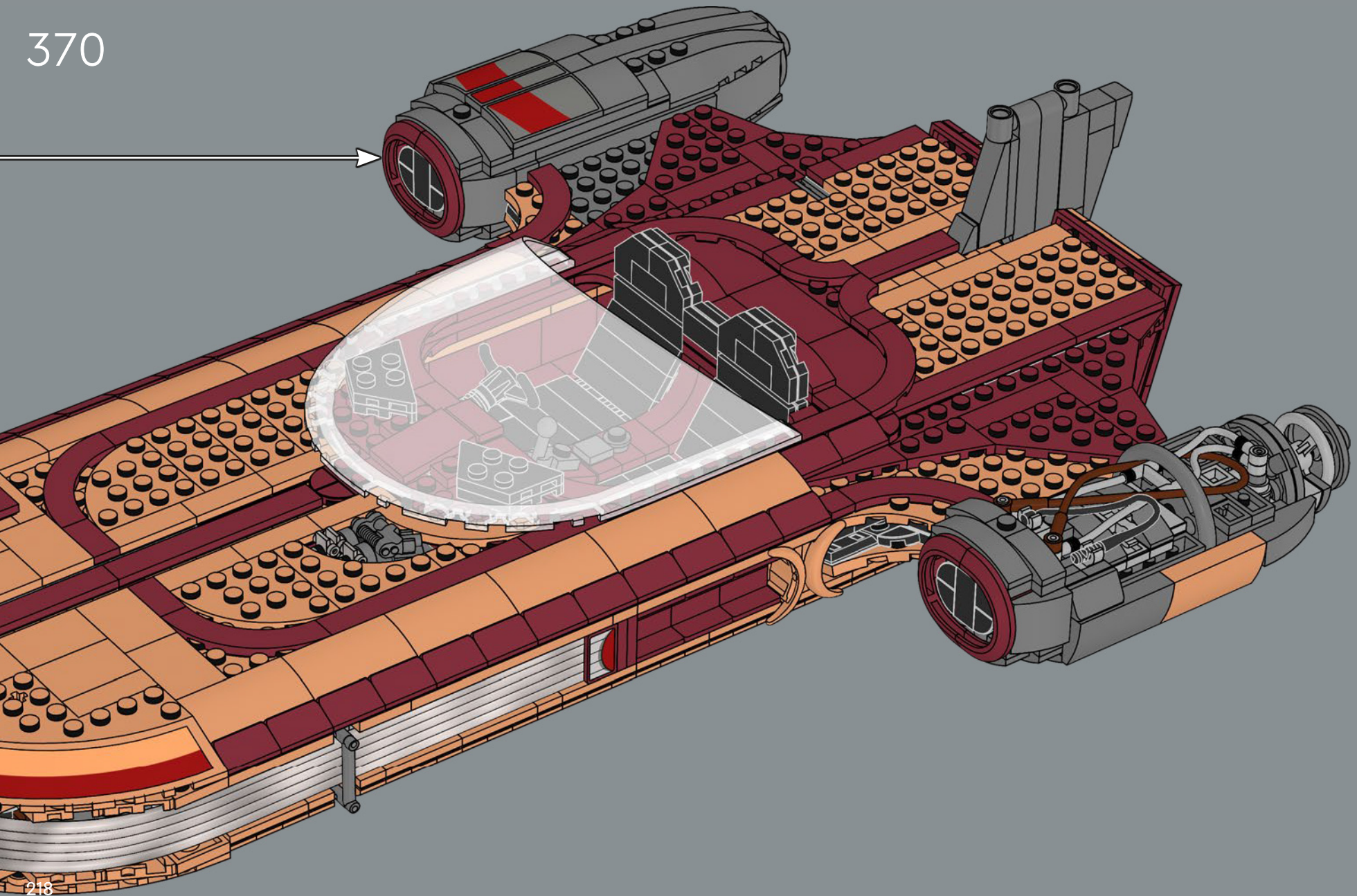

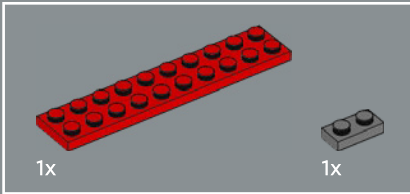
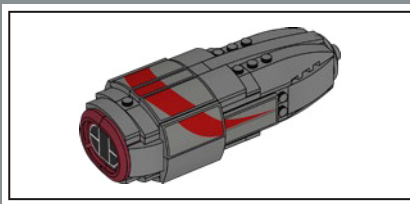

371

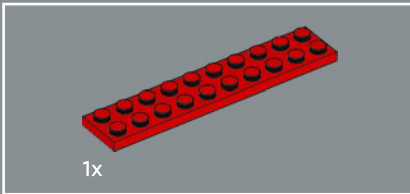
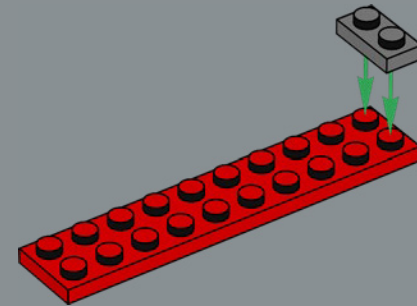

372

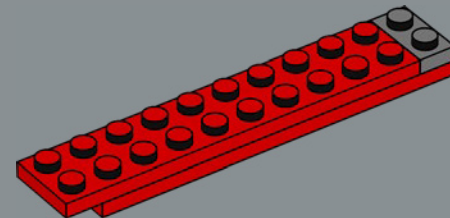

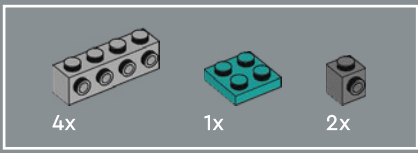

373

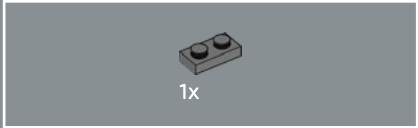
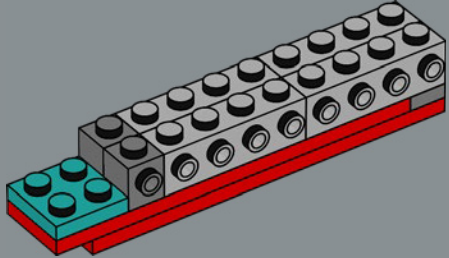

374

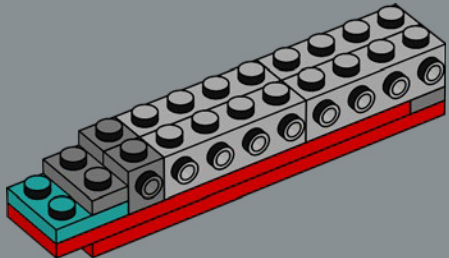

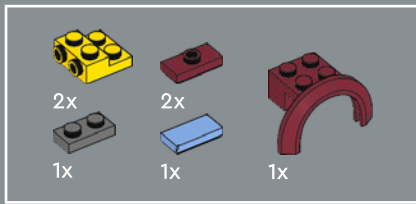

375

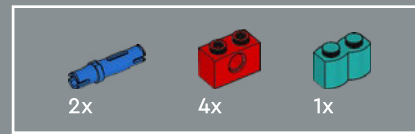
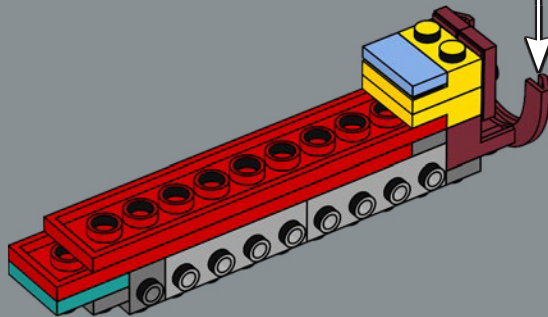
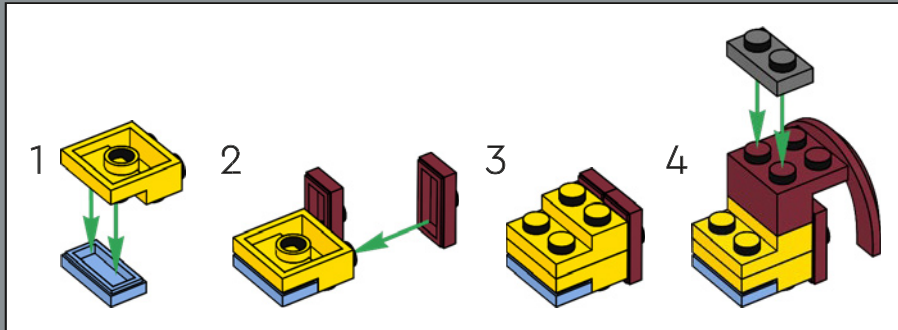

376

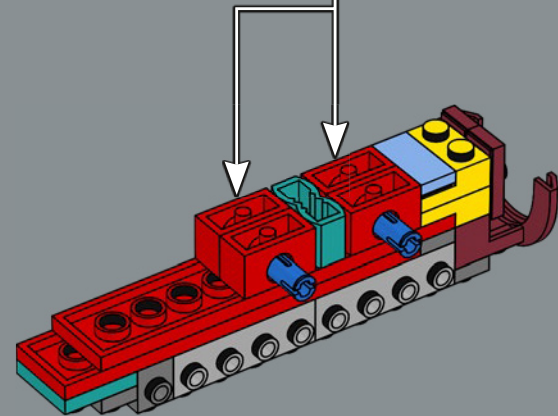
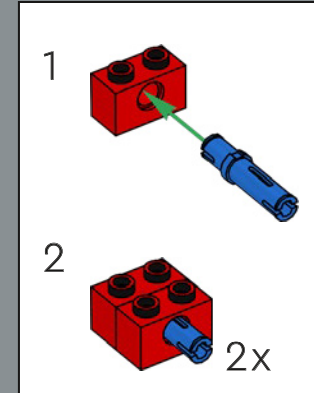

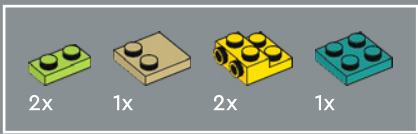

377

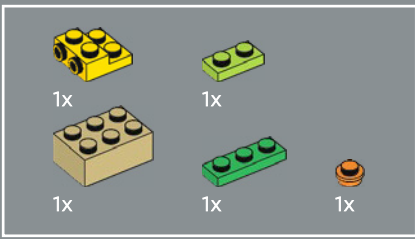
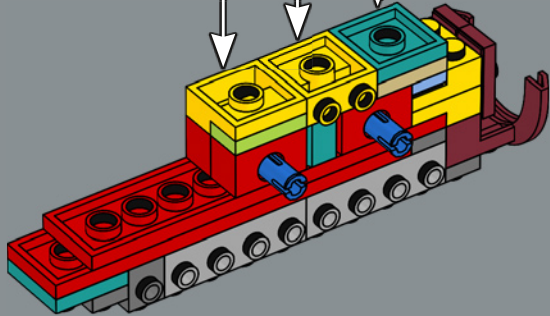
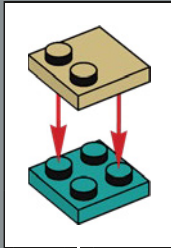
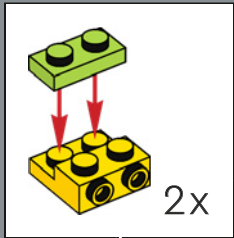

378

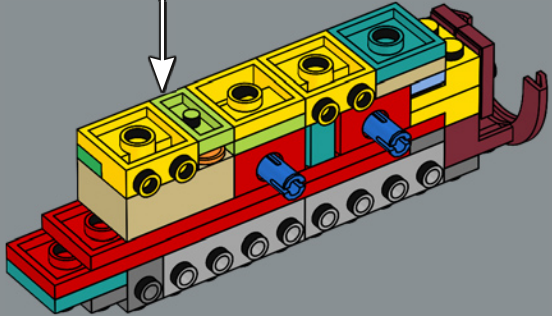
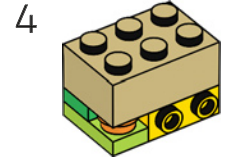
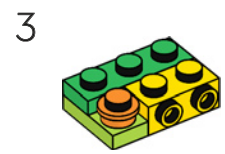
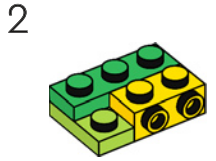
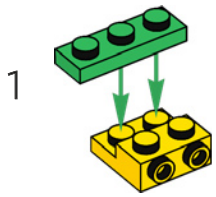



379

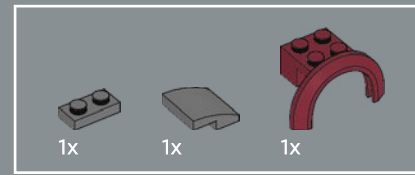
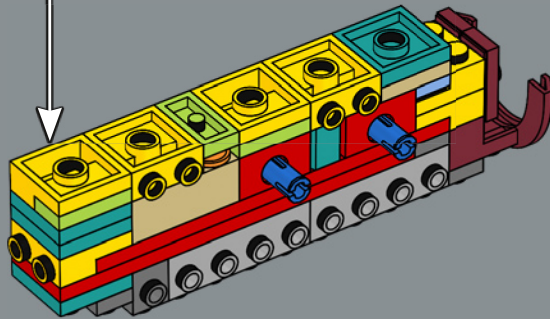
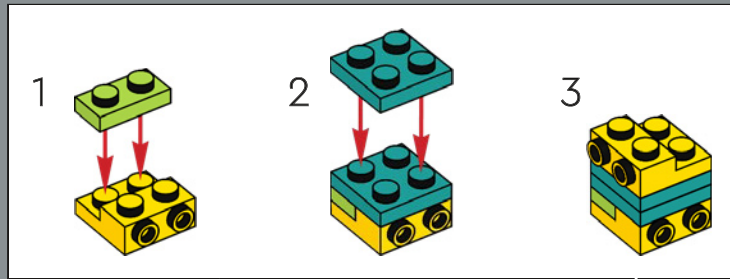

380

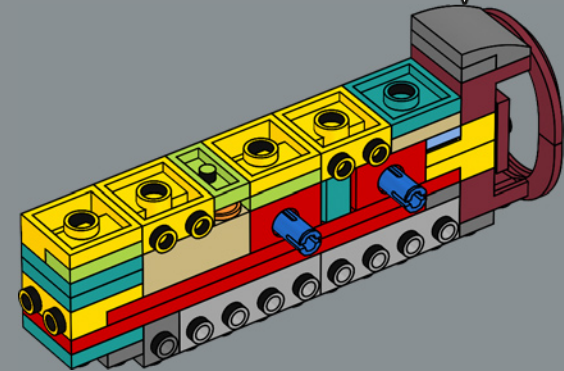
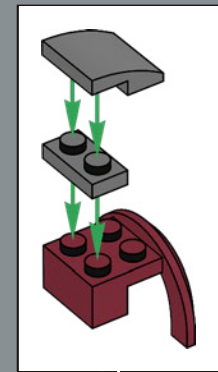

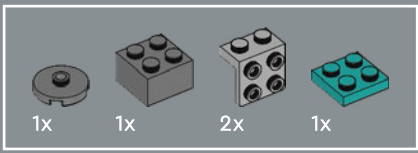

381

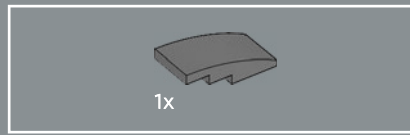
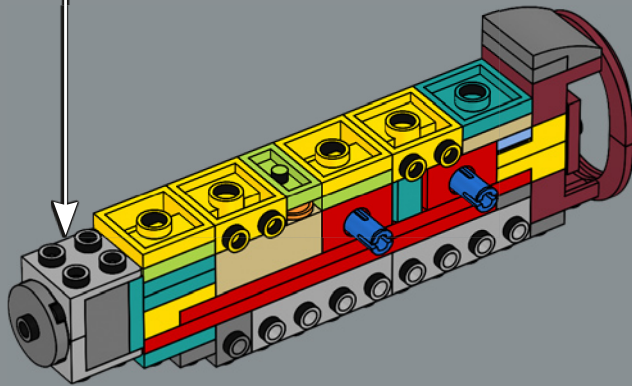
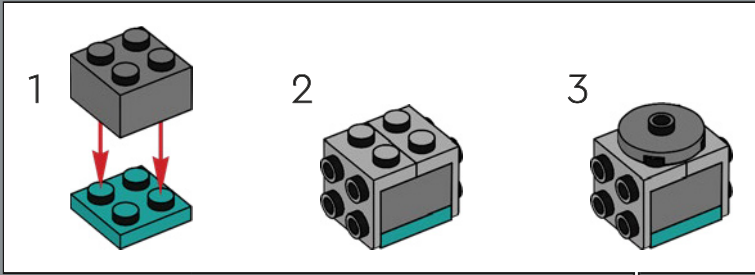

382

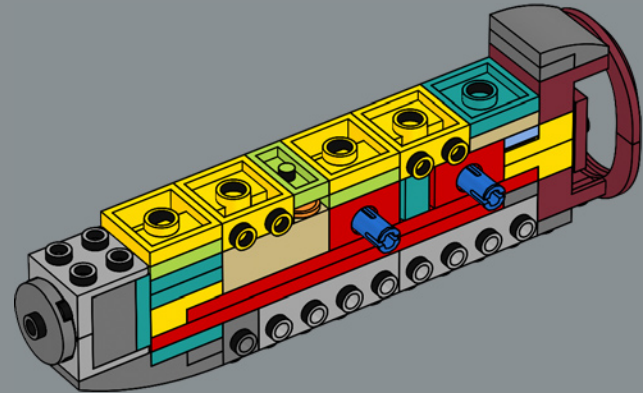

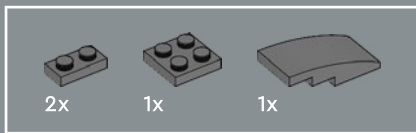

383

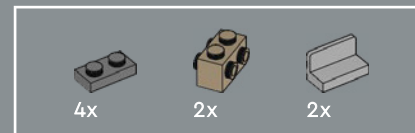
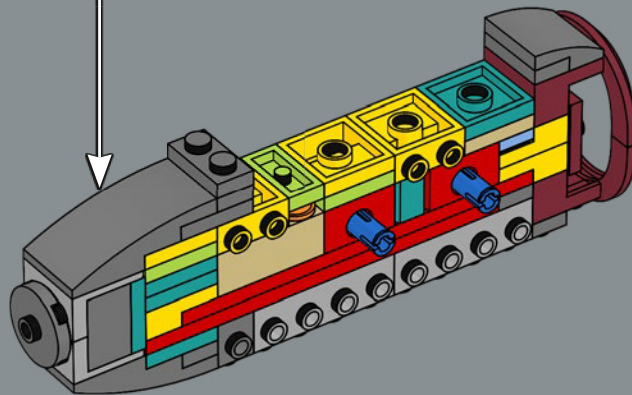
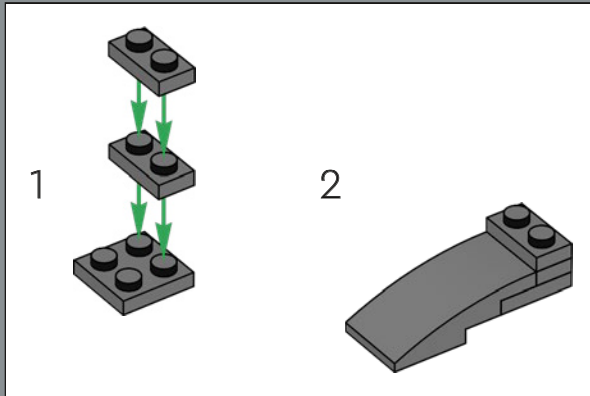

384

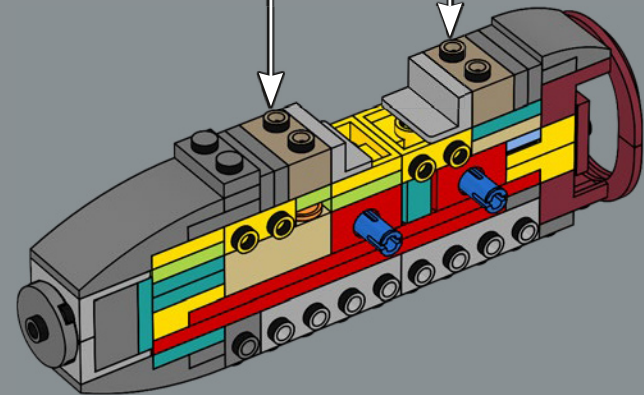
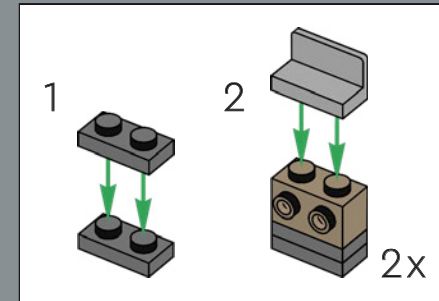

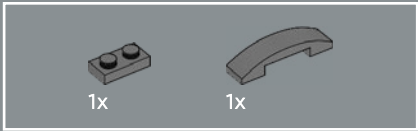
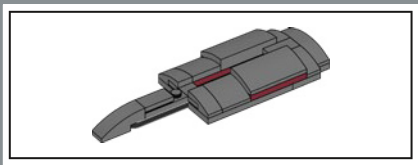

385

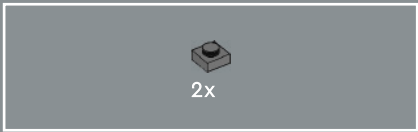
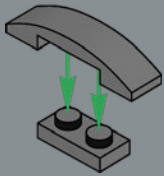

386

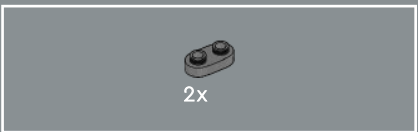
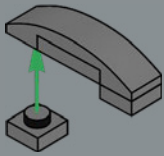

387

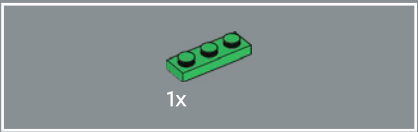
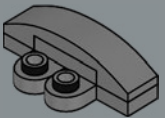

388

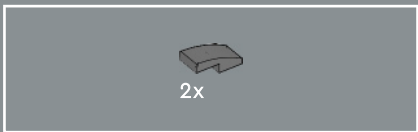
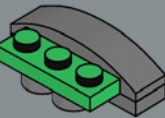

389

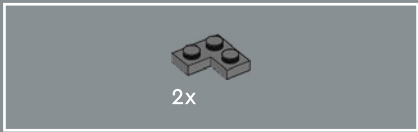
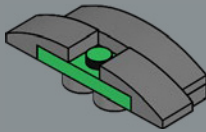

390

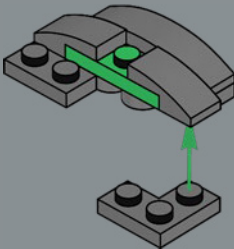

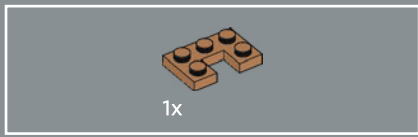

391

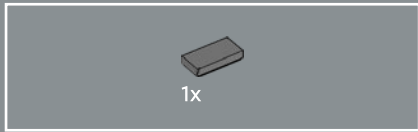
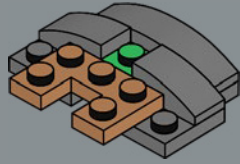

392

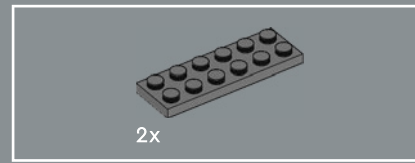
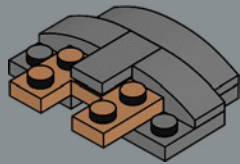

393

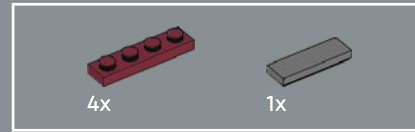
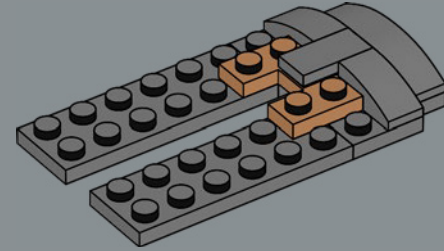

394

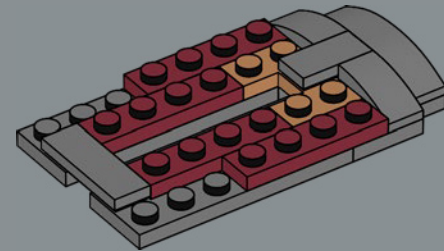

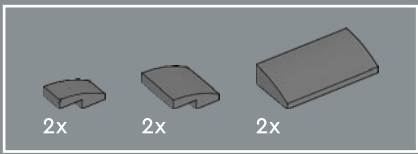

395

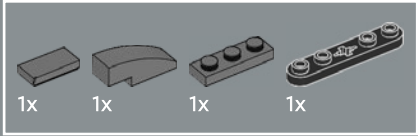
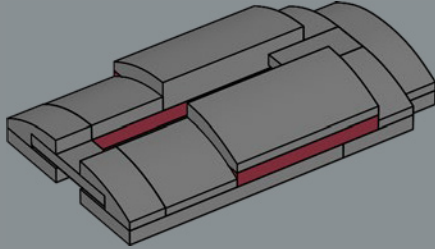

396

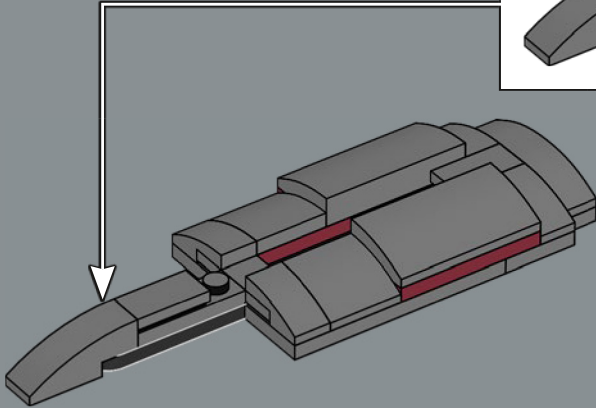
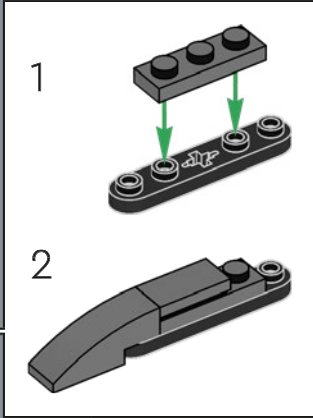

397

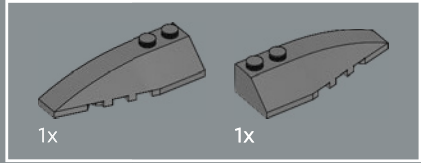
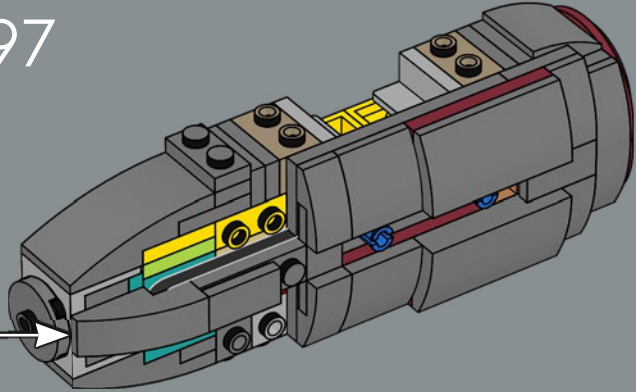

398

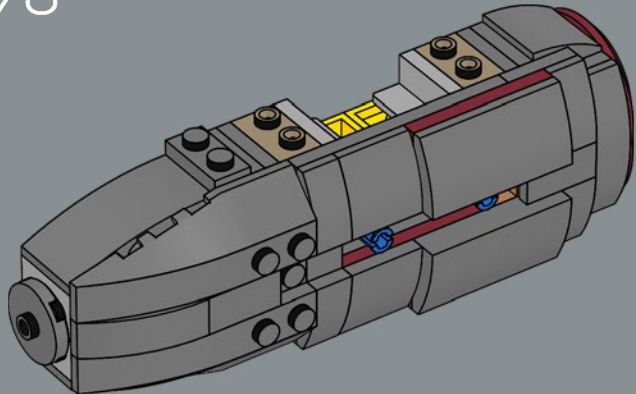

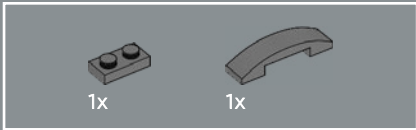
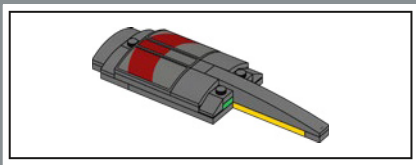

399

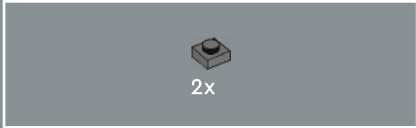
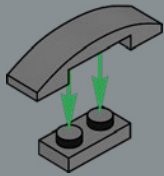

400

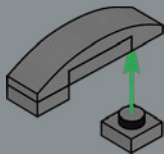

401

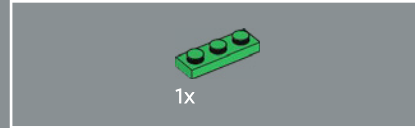
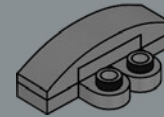

402

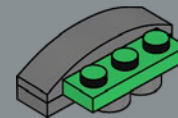



2x

403

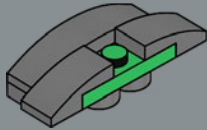

2x

404

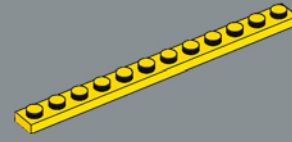
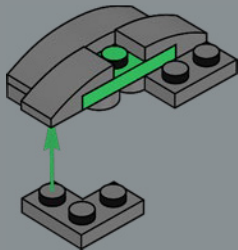

1x

405

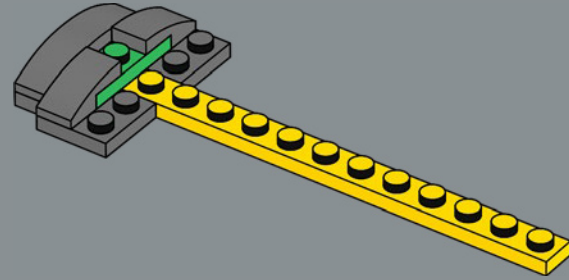

1x

406

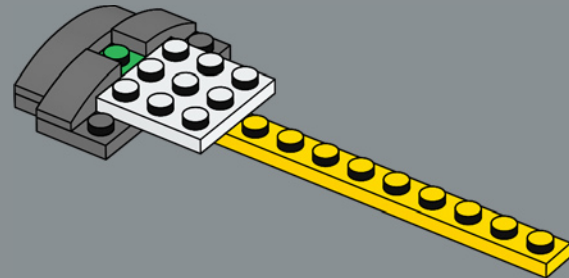

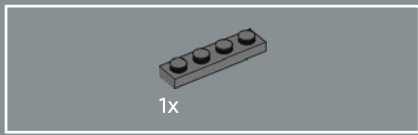

407

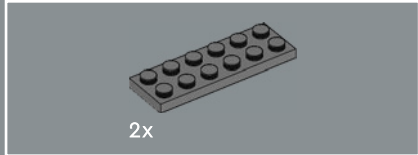
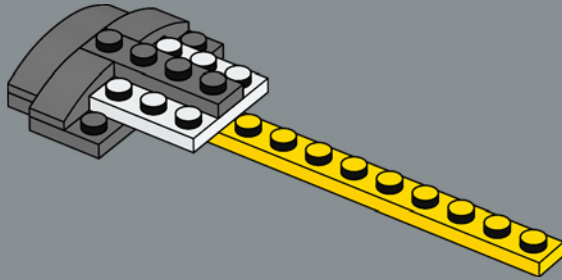

408

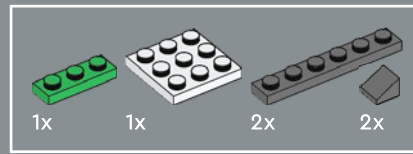
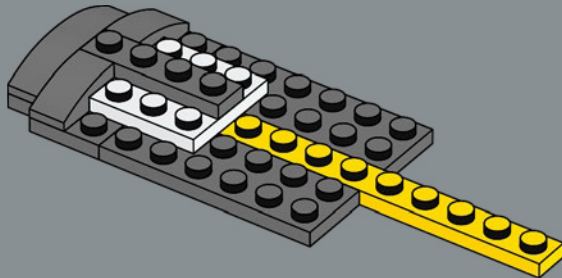

409

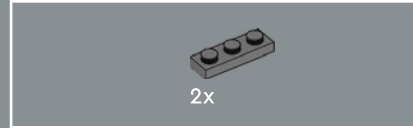
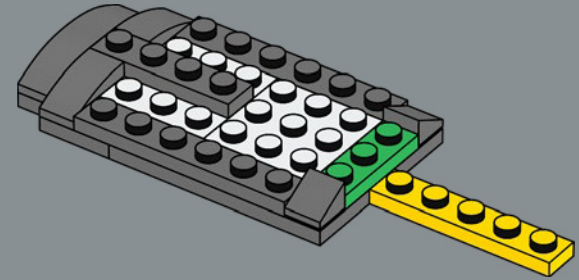

410

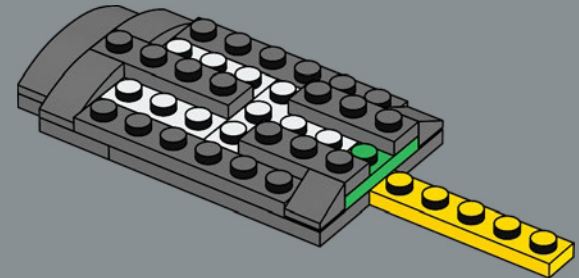

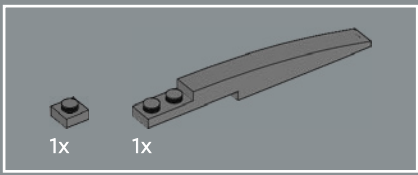

411

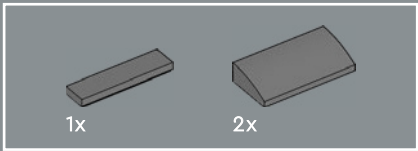
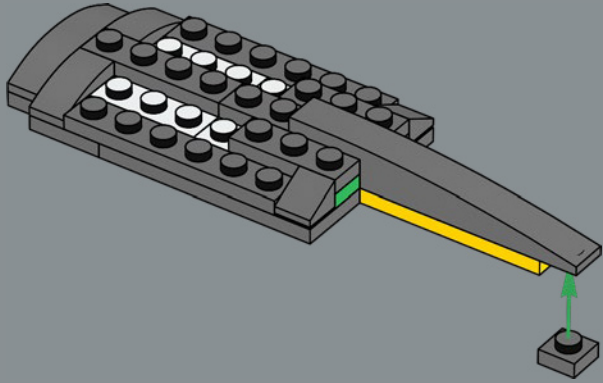

412

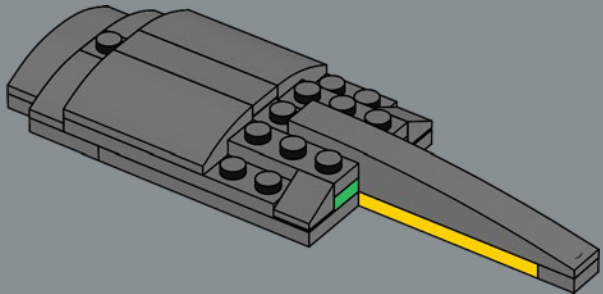

413

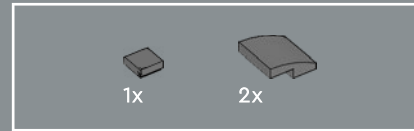
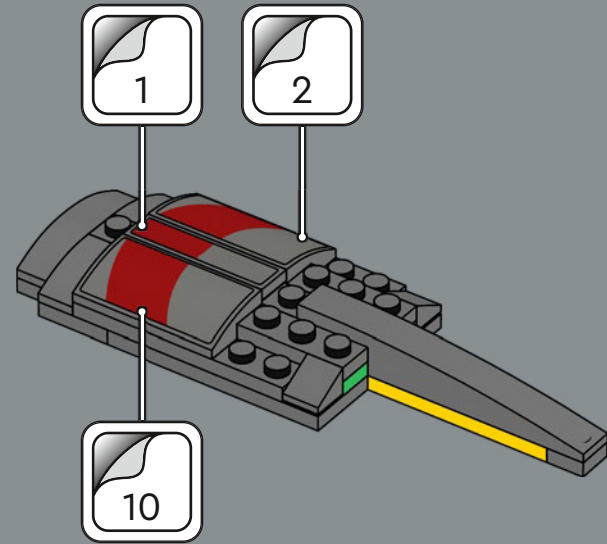

414

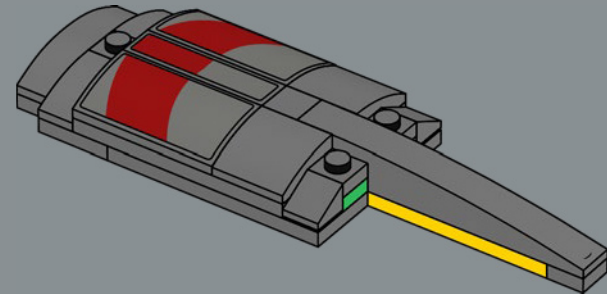



415

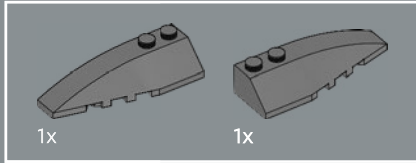
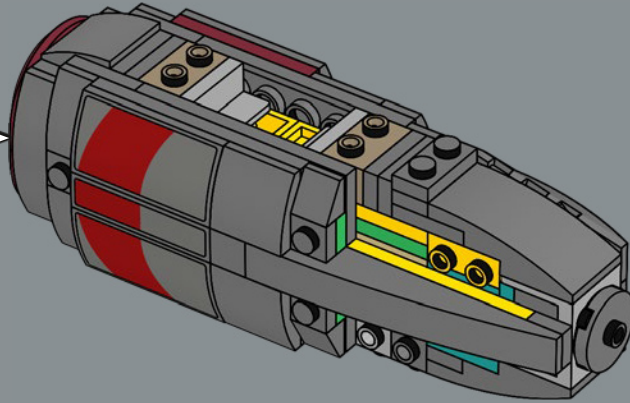

416

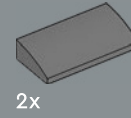
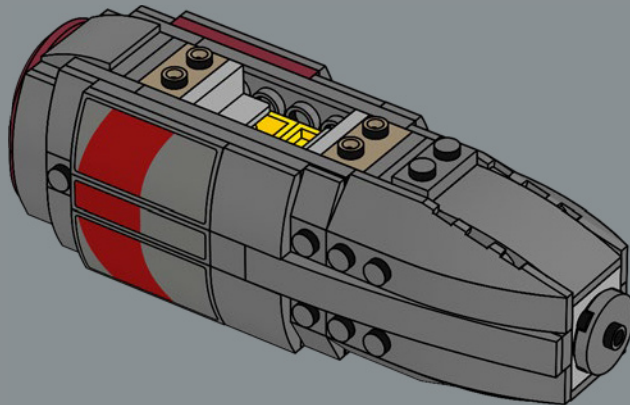

417

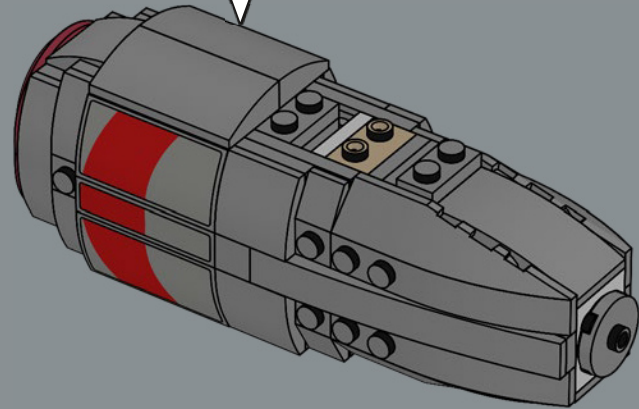
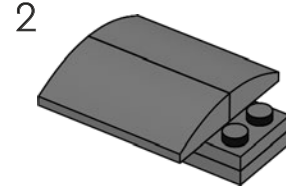
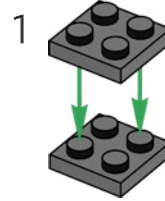

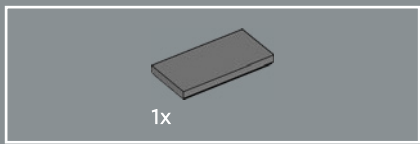

418

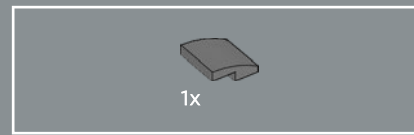
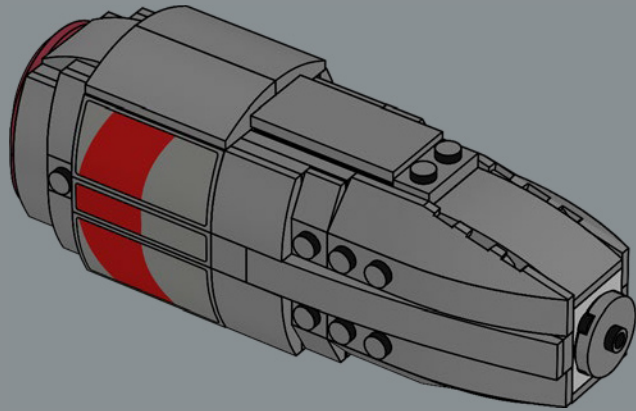

420

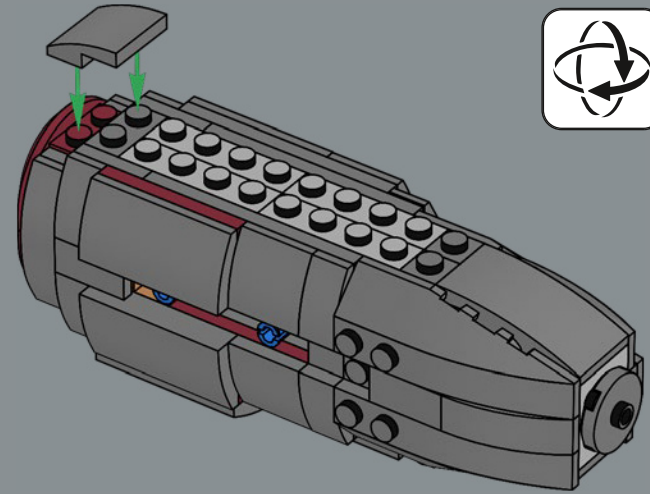

419

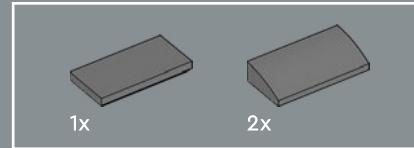
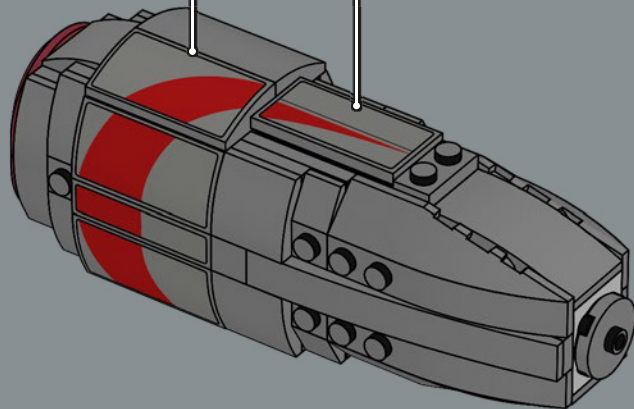
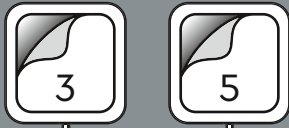

421

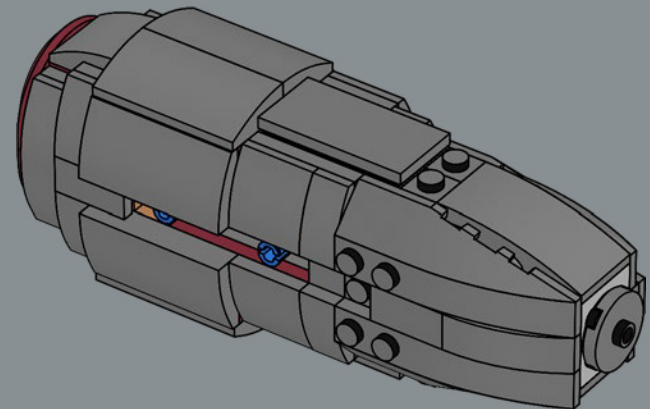

422

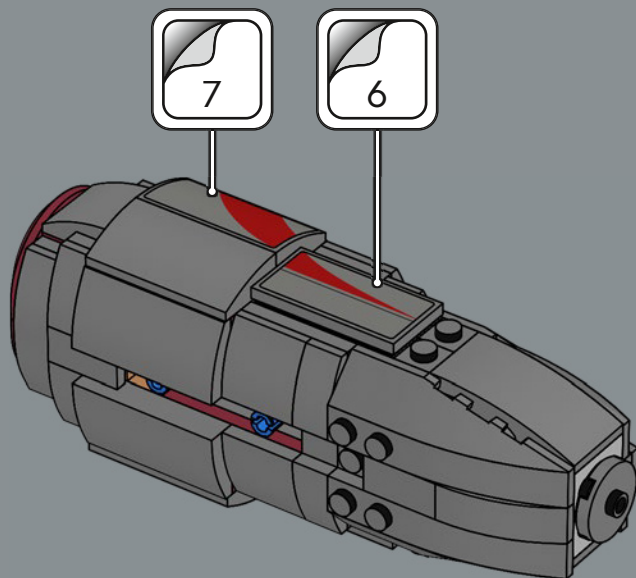

423

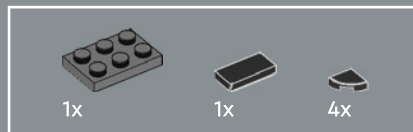
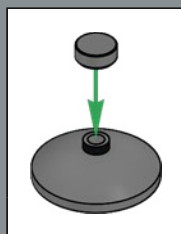
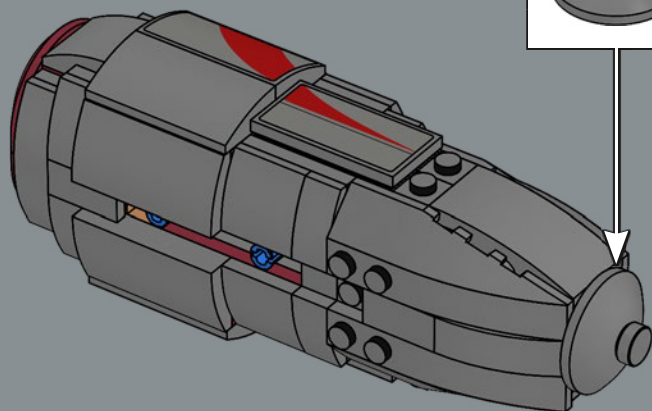

424

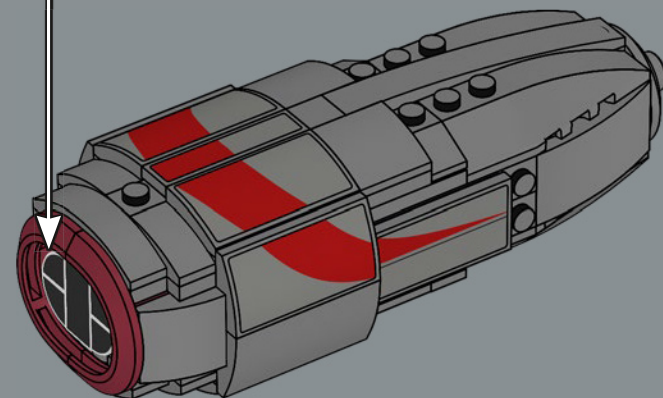
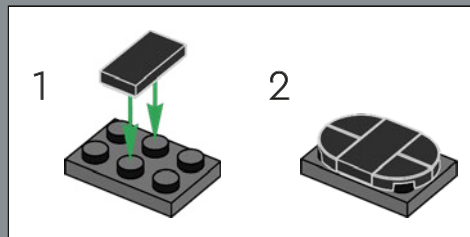

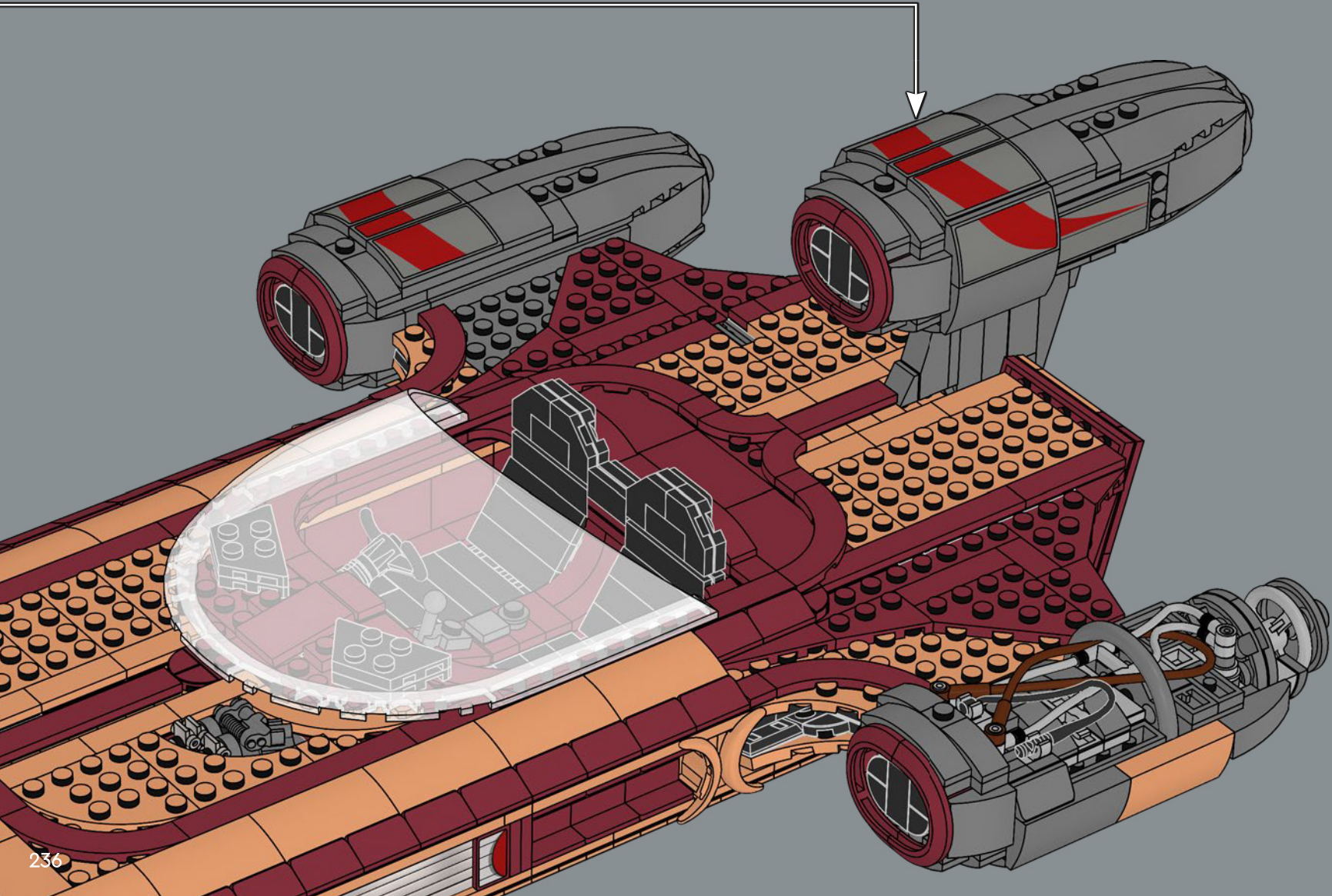

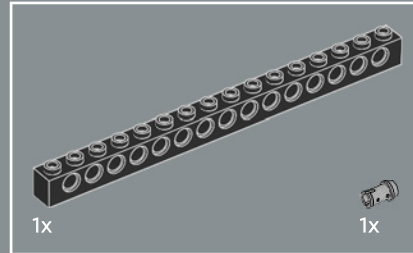
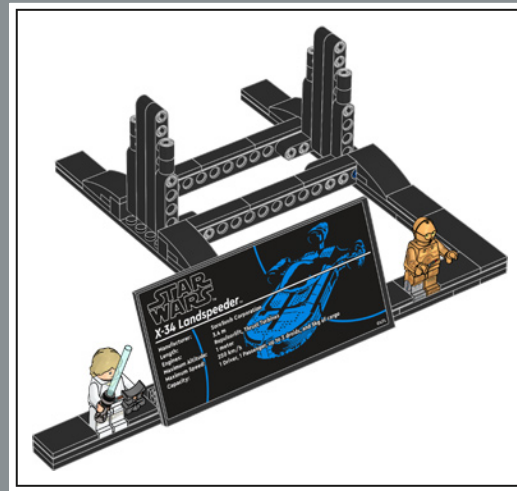
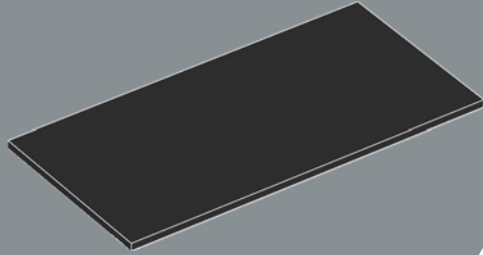
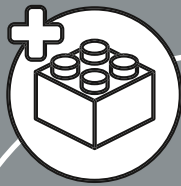

426

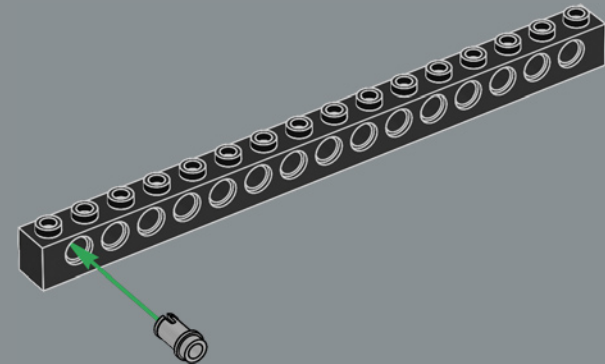



427

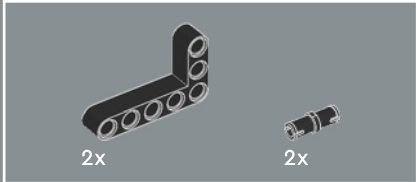
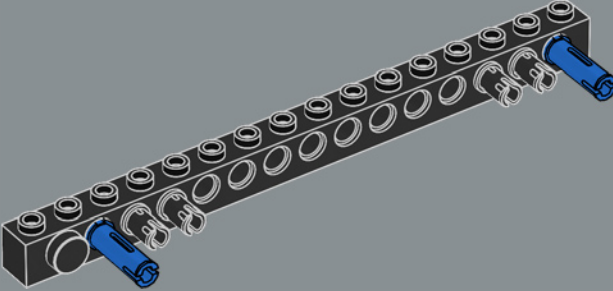

428

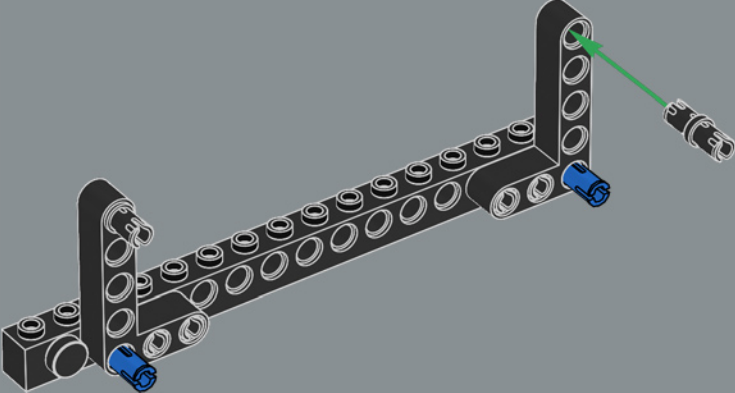

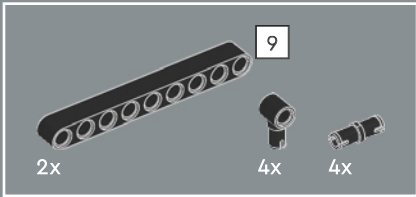
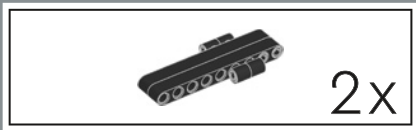

429

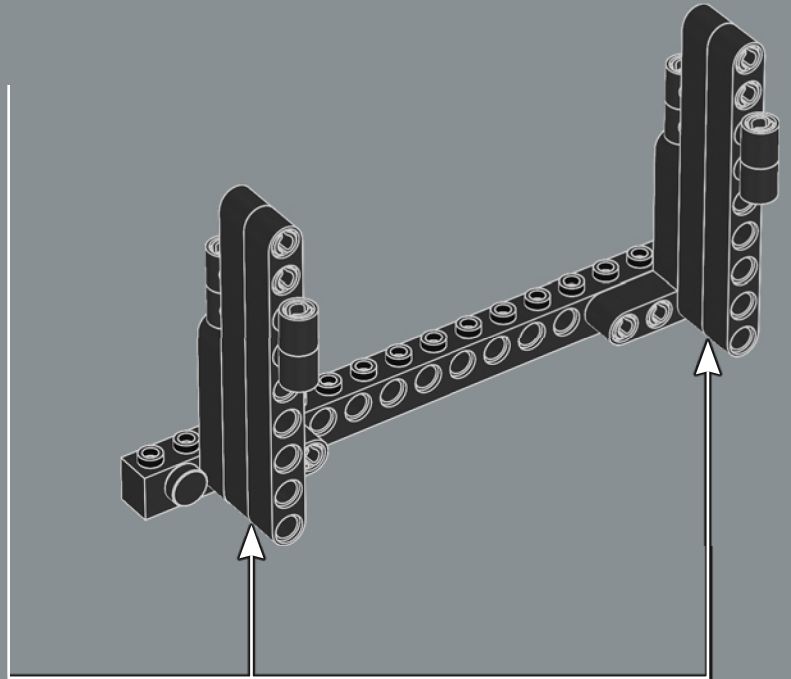
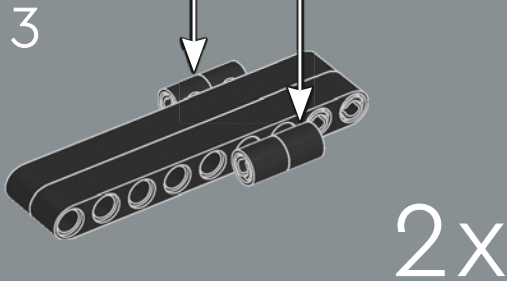
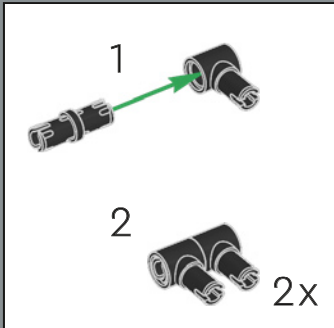
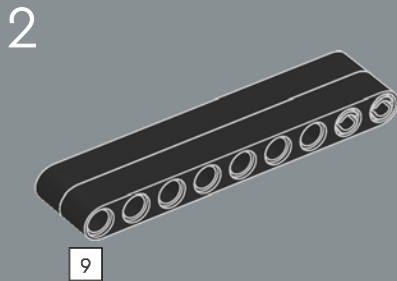
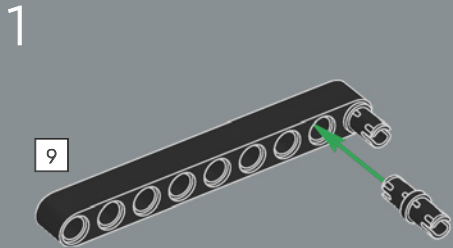

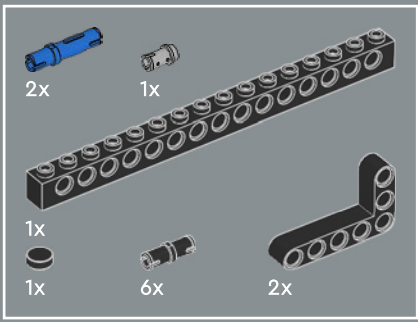

430

1

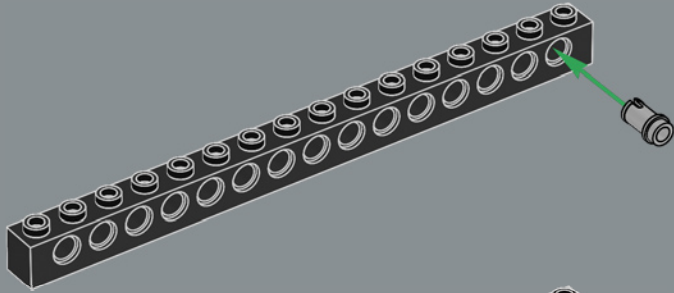

2

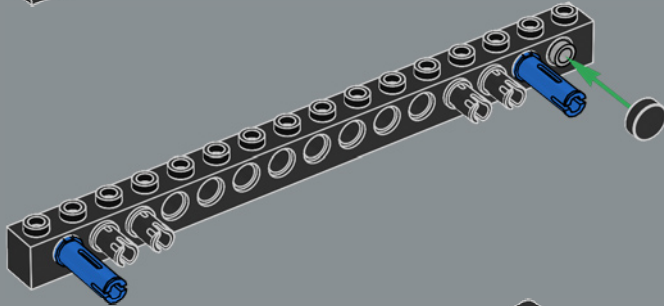

3

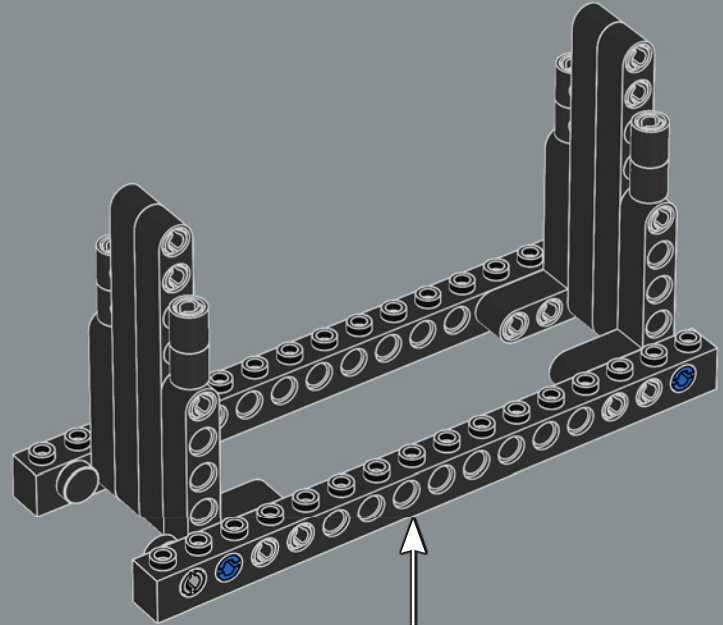
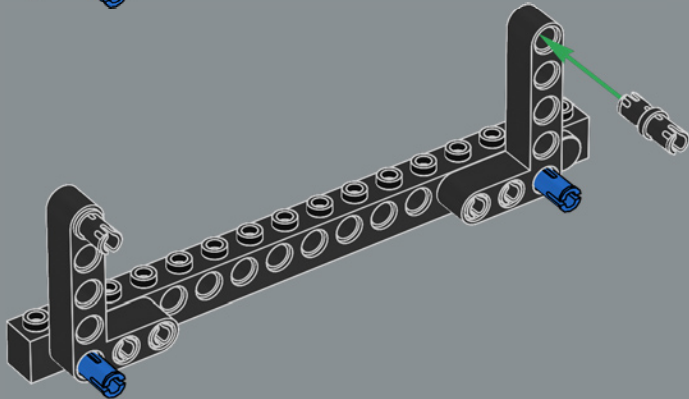

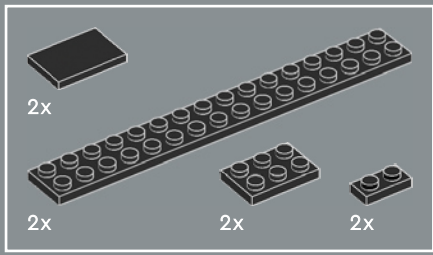

431

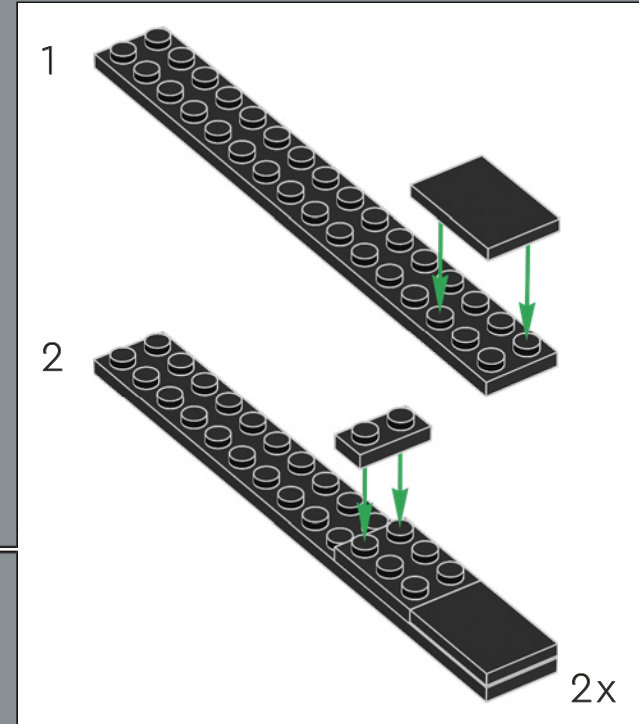
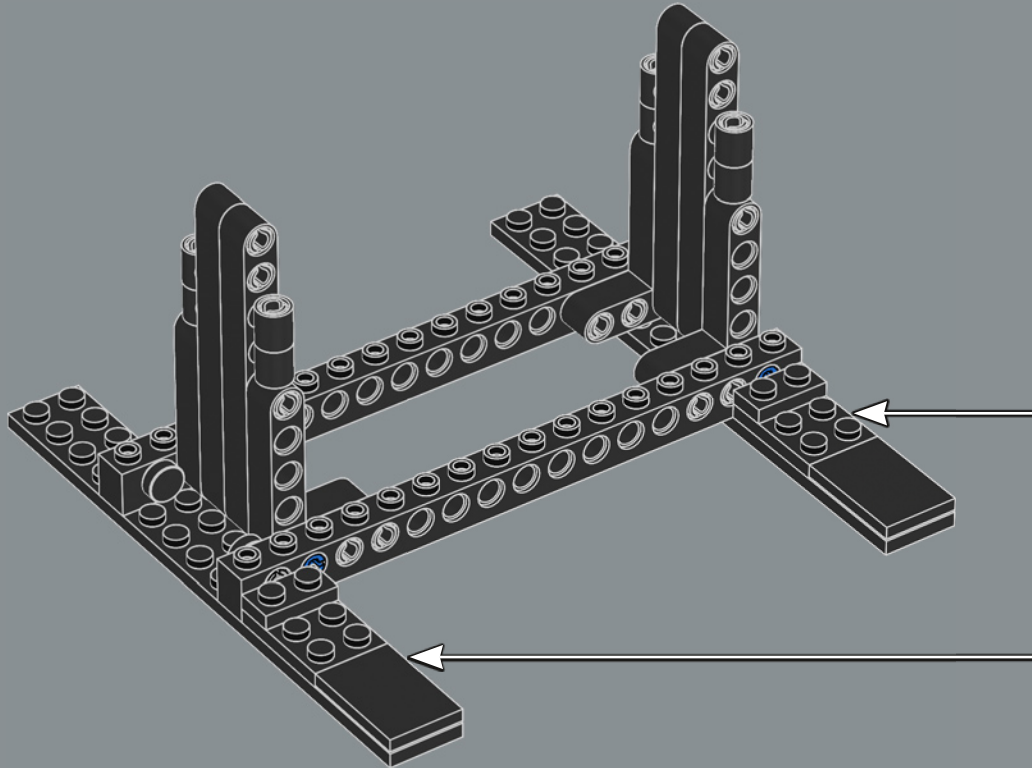

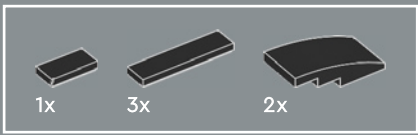

432

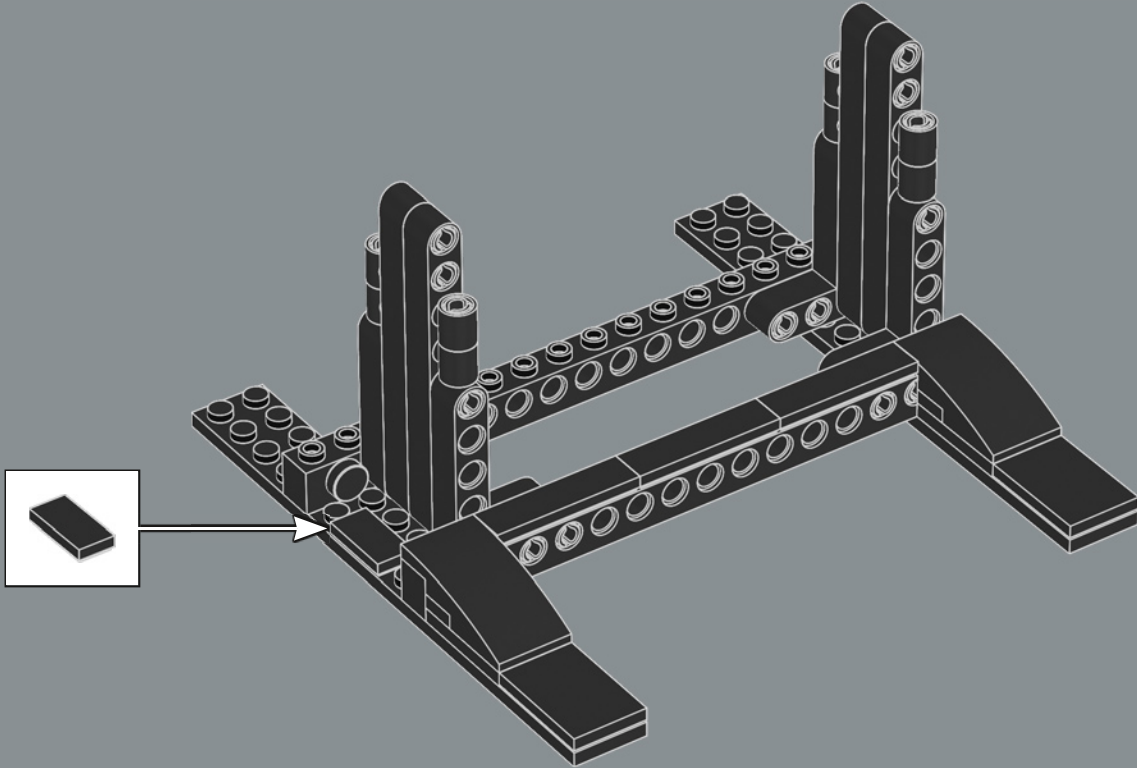

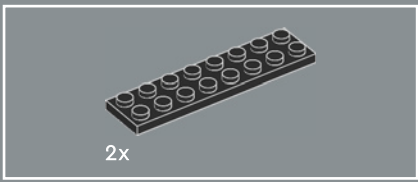

433

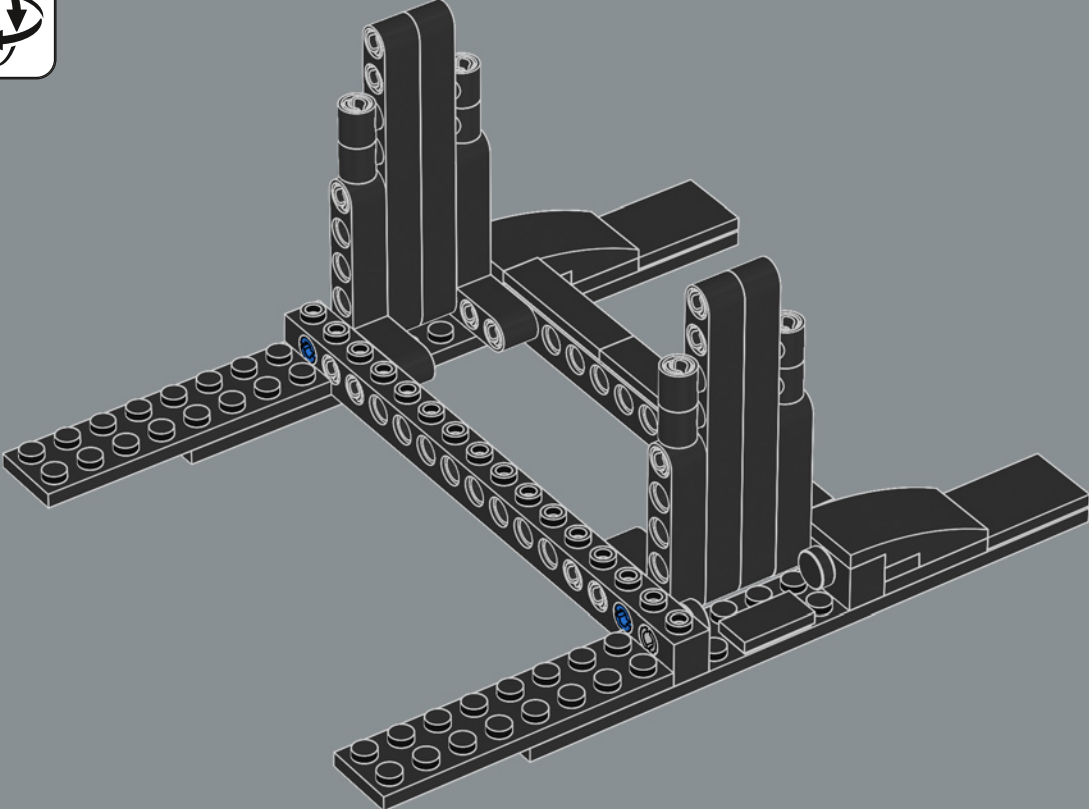

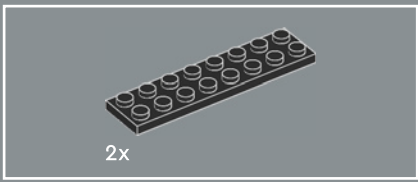

434

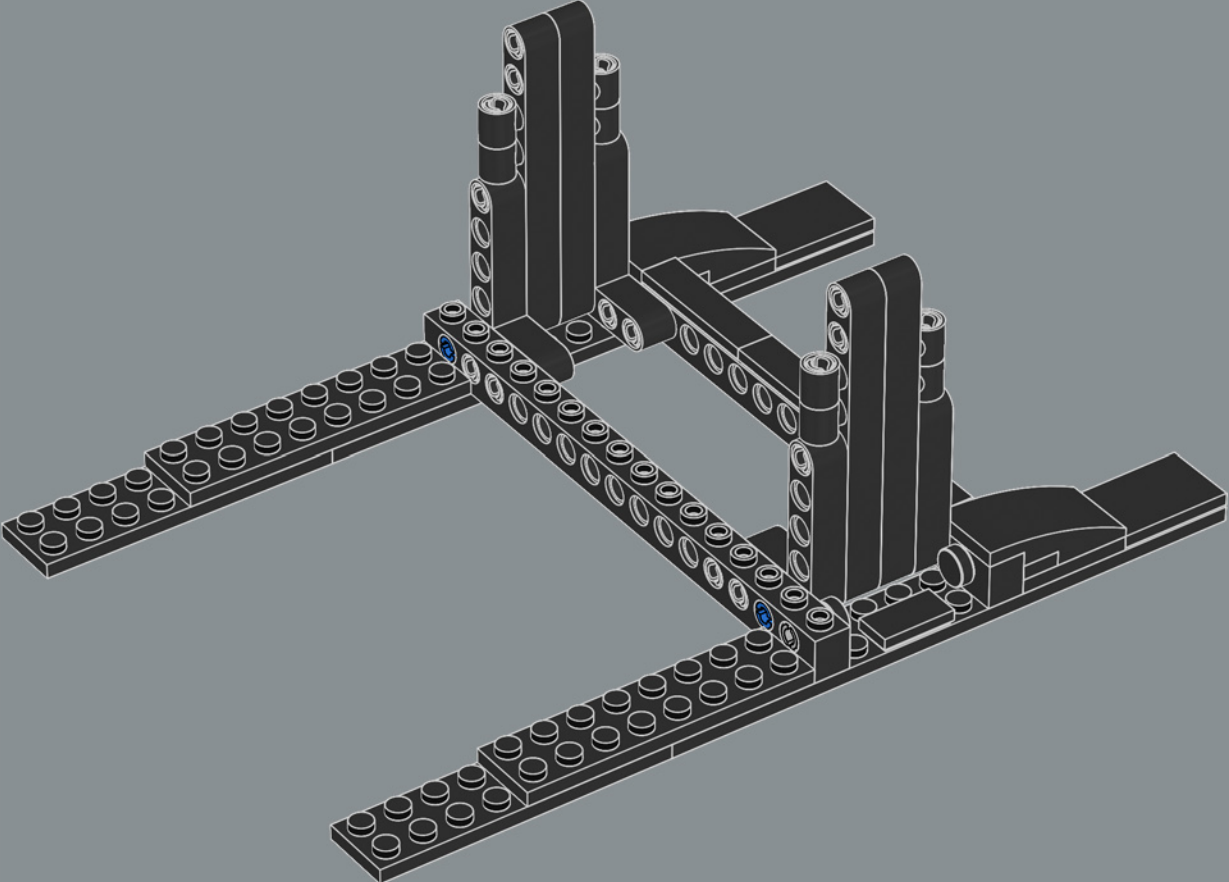

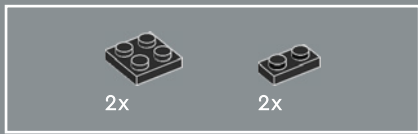

435

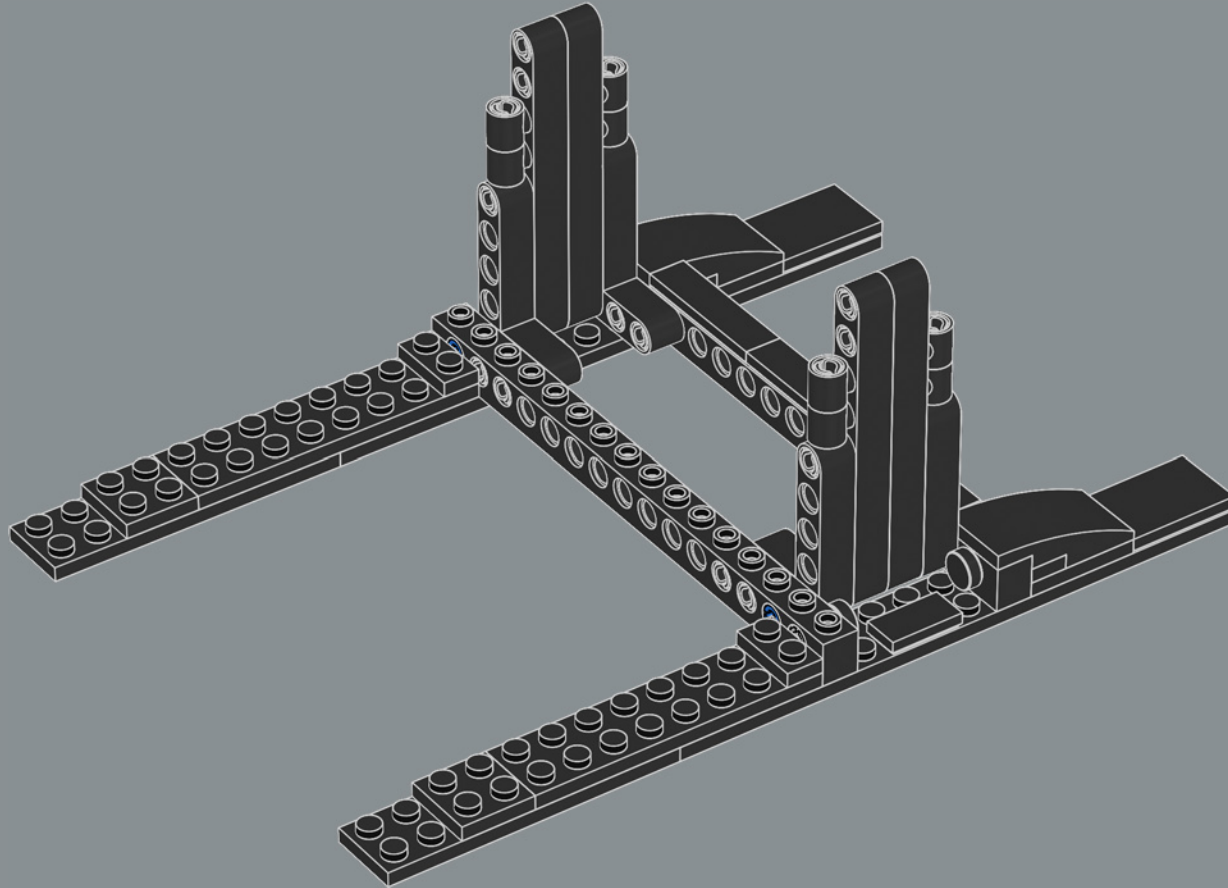

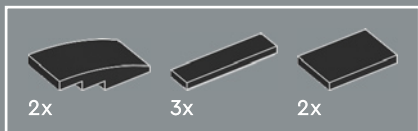

436

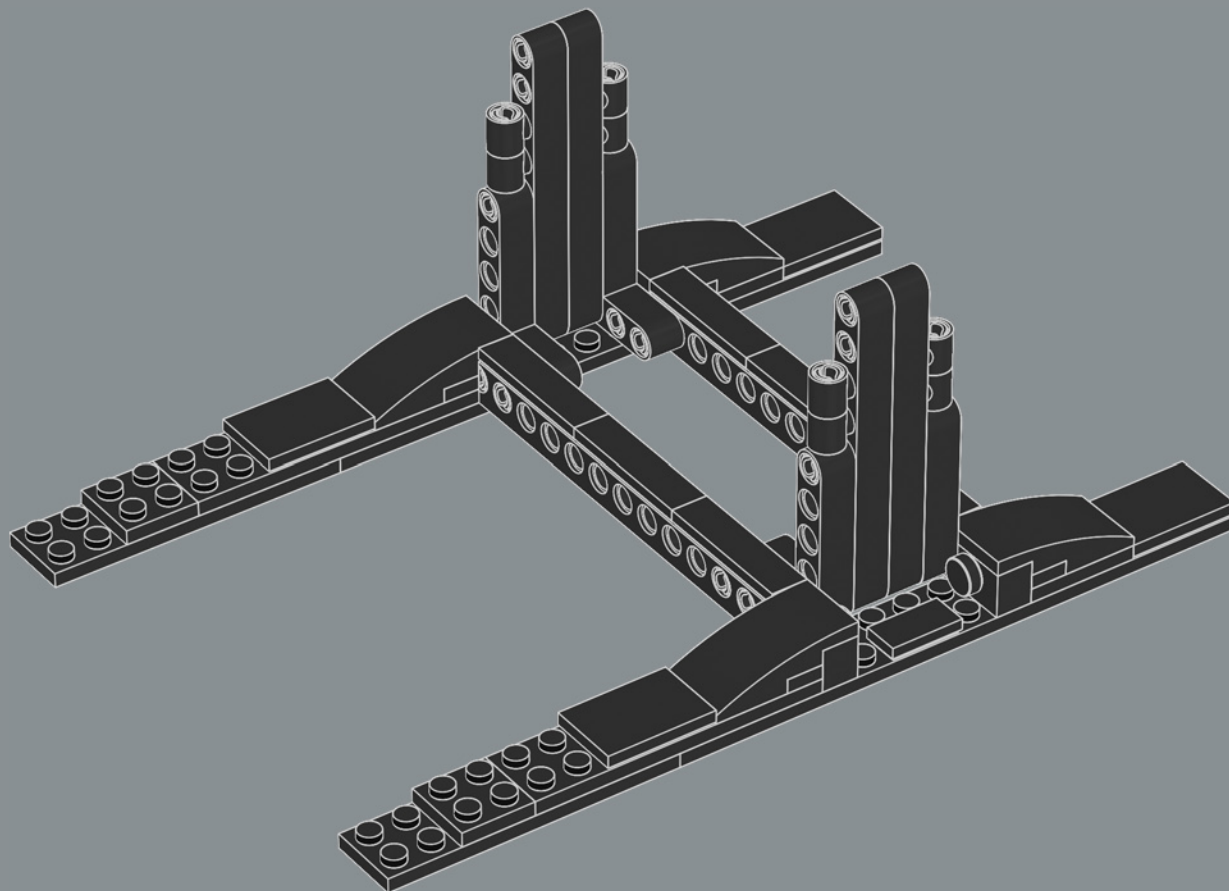

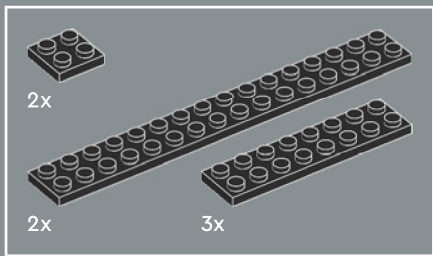

437

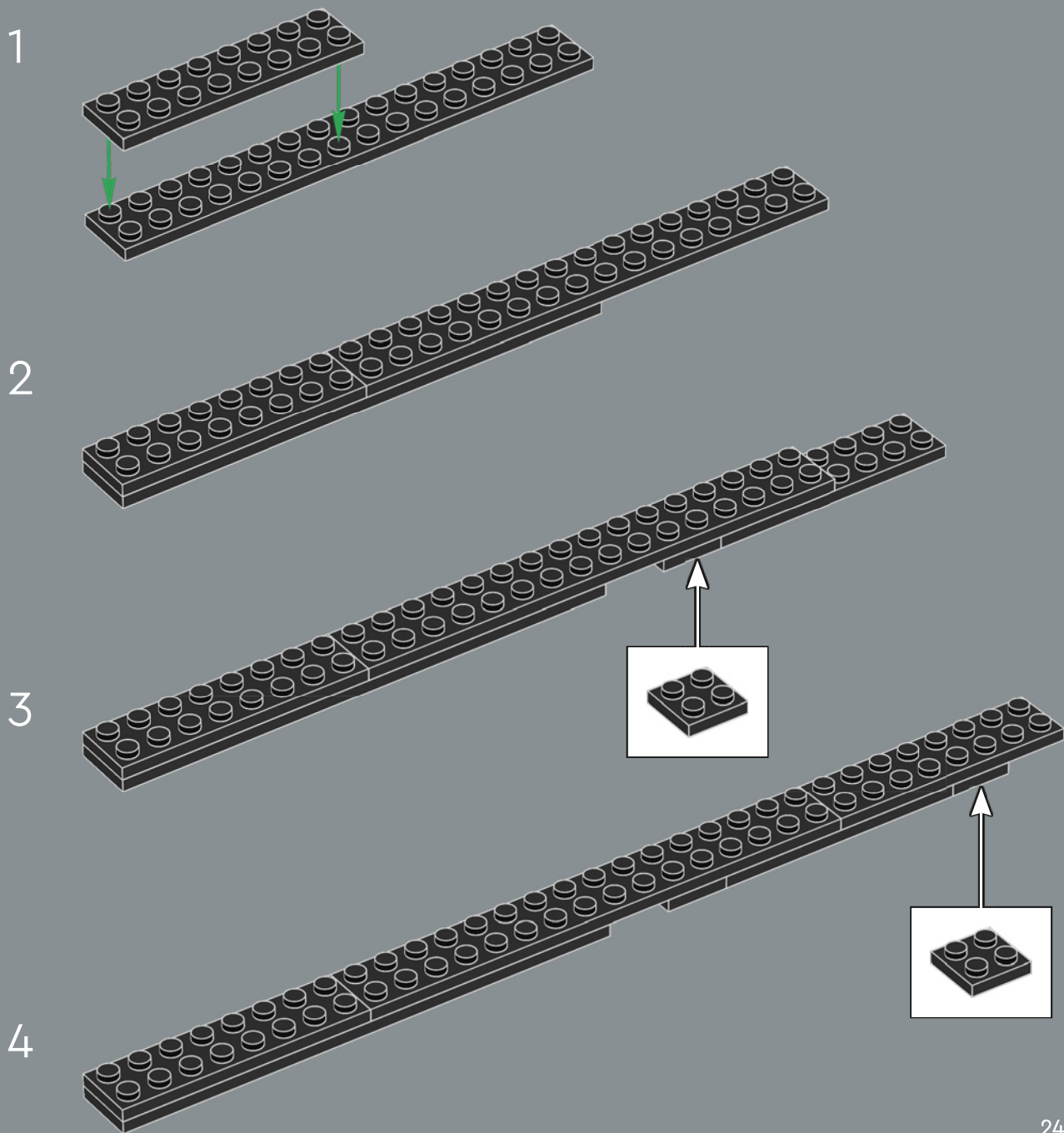

438

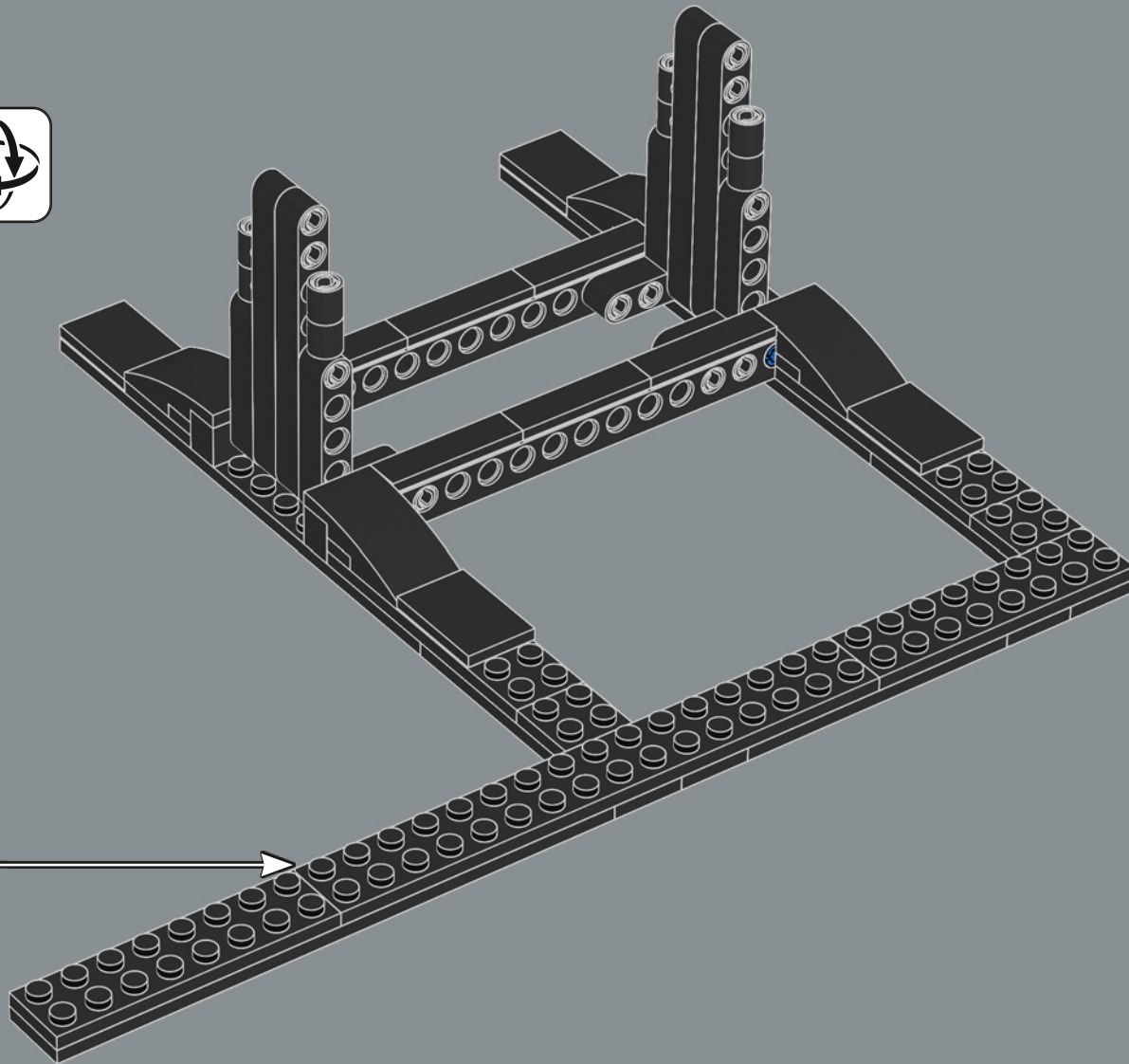

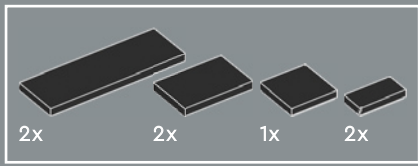

439

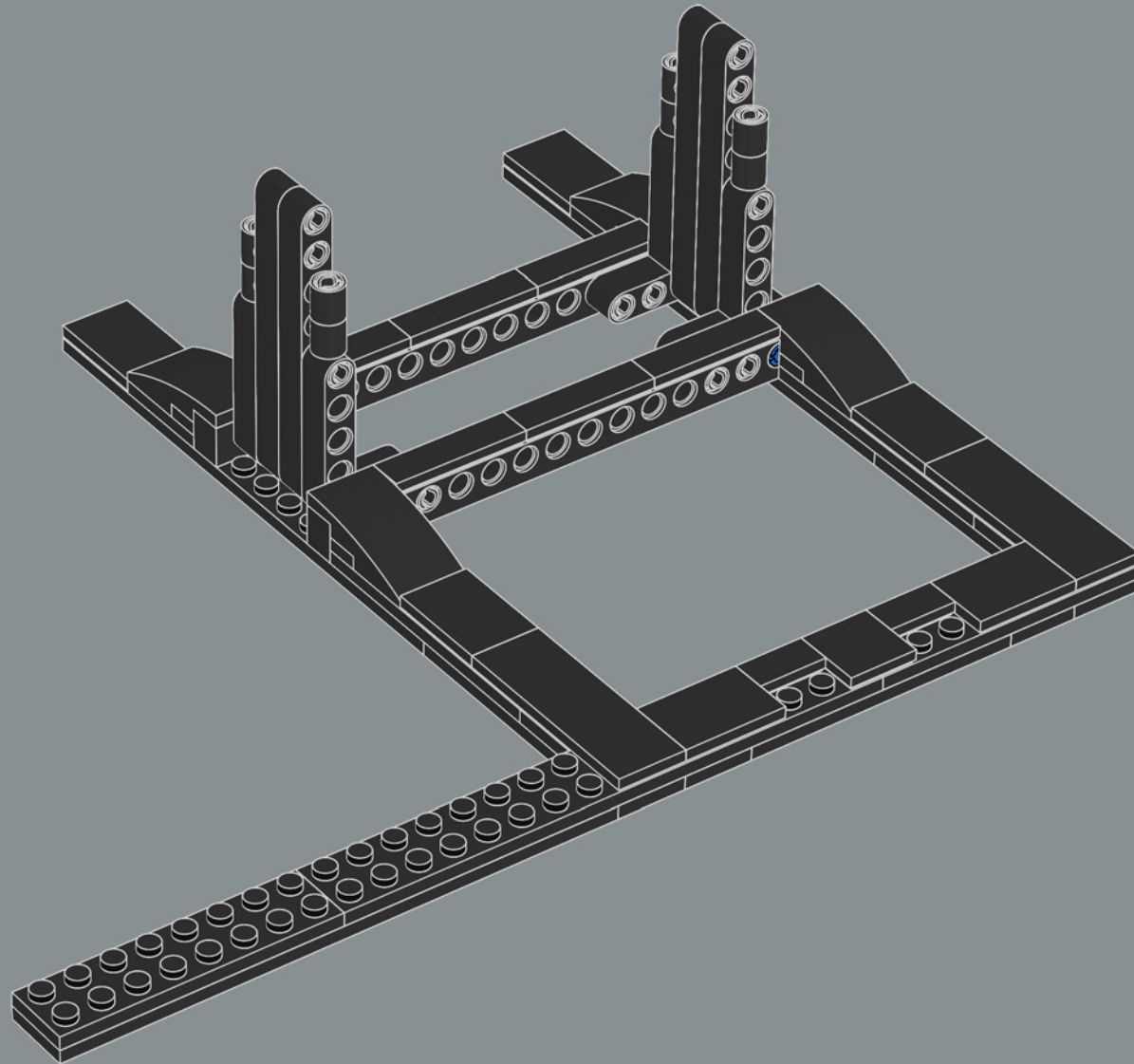

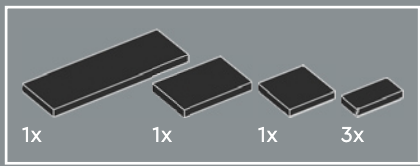

440

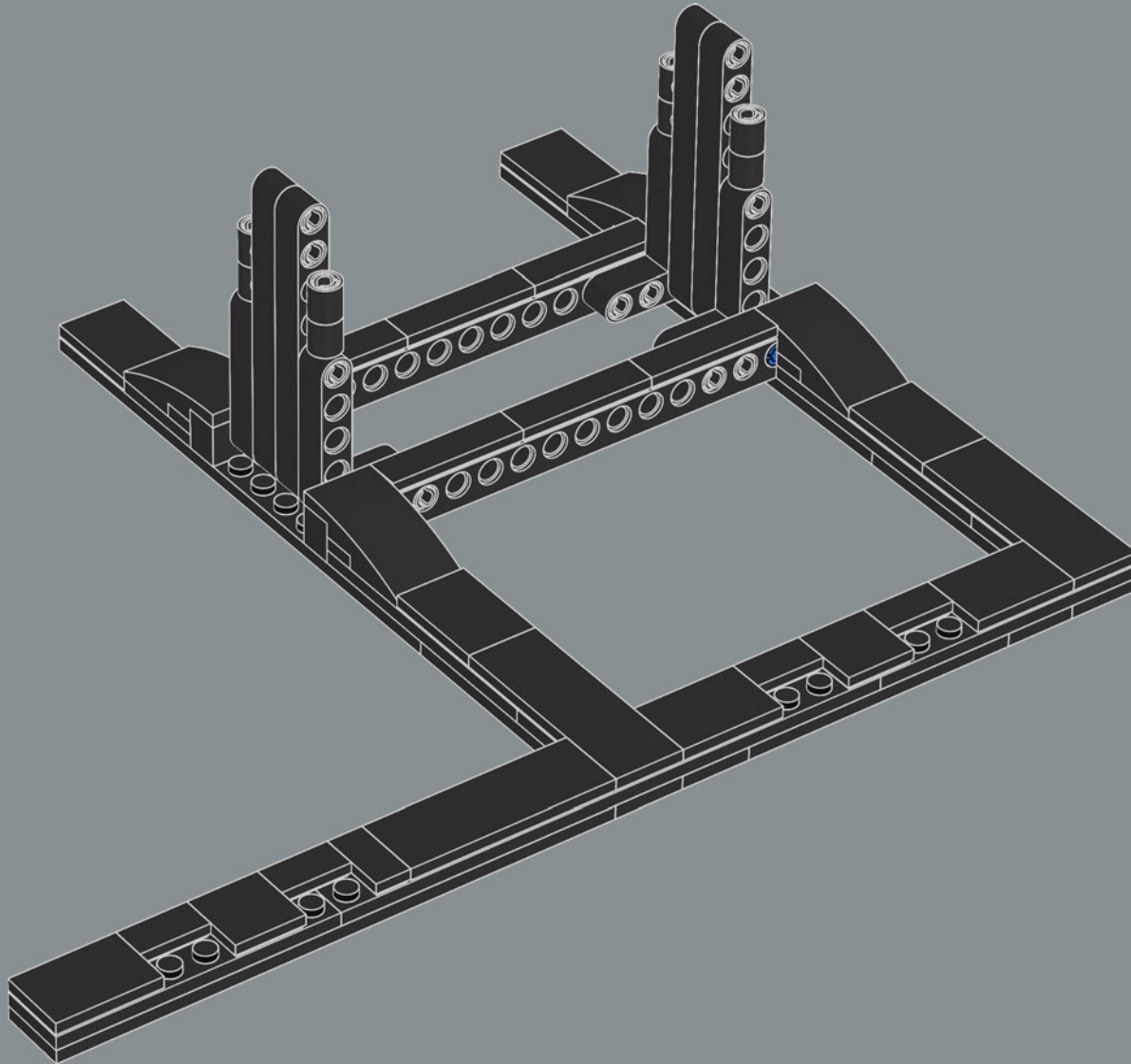

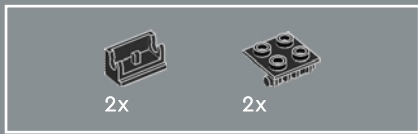

441

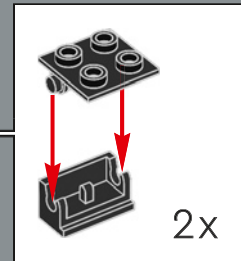
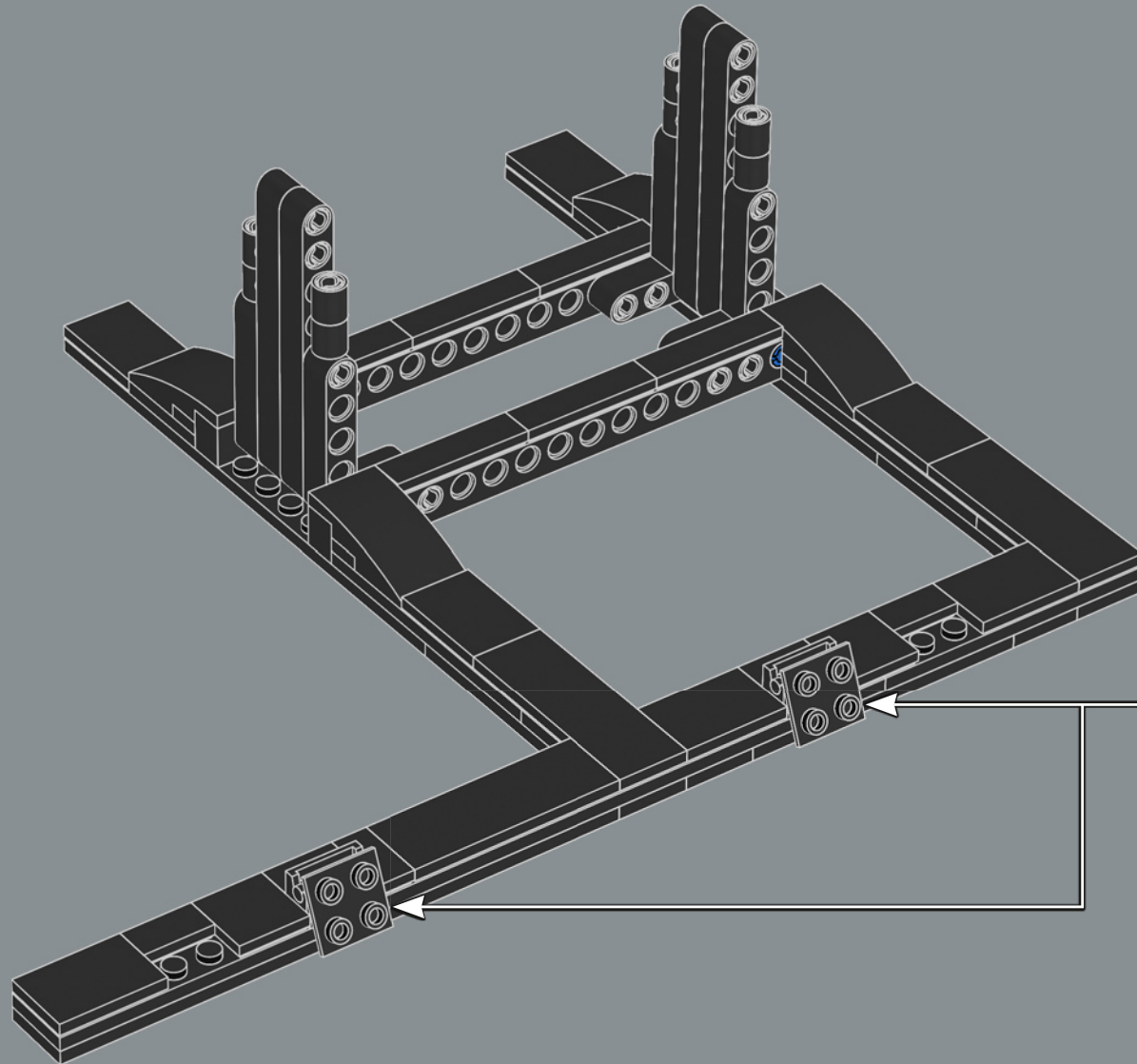

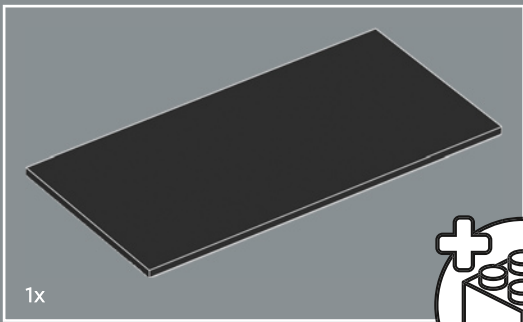

1x

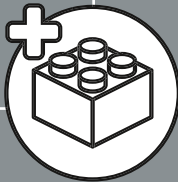

442

1

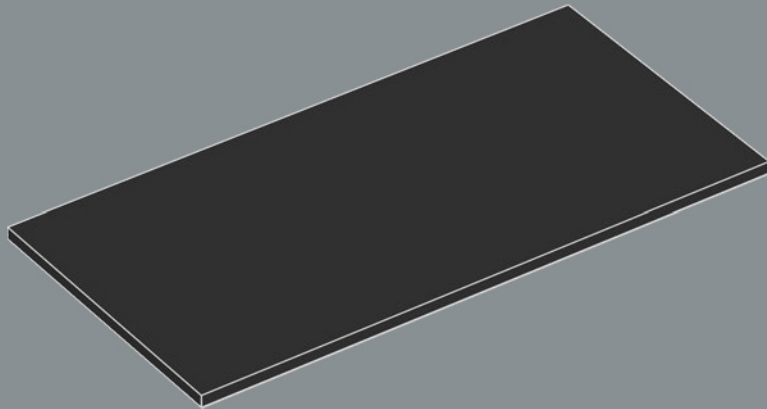

2



12

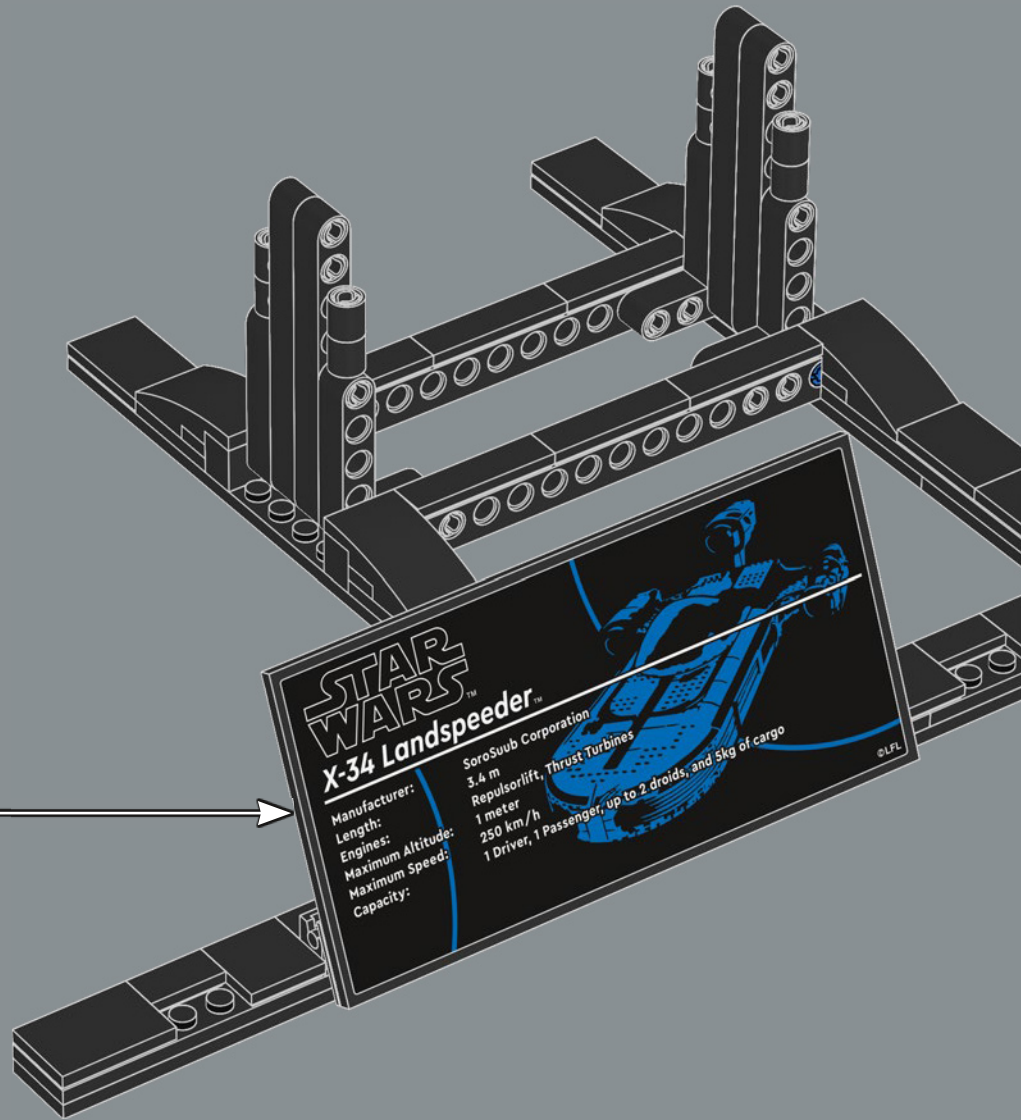

443

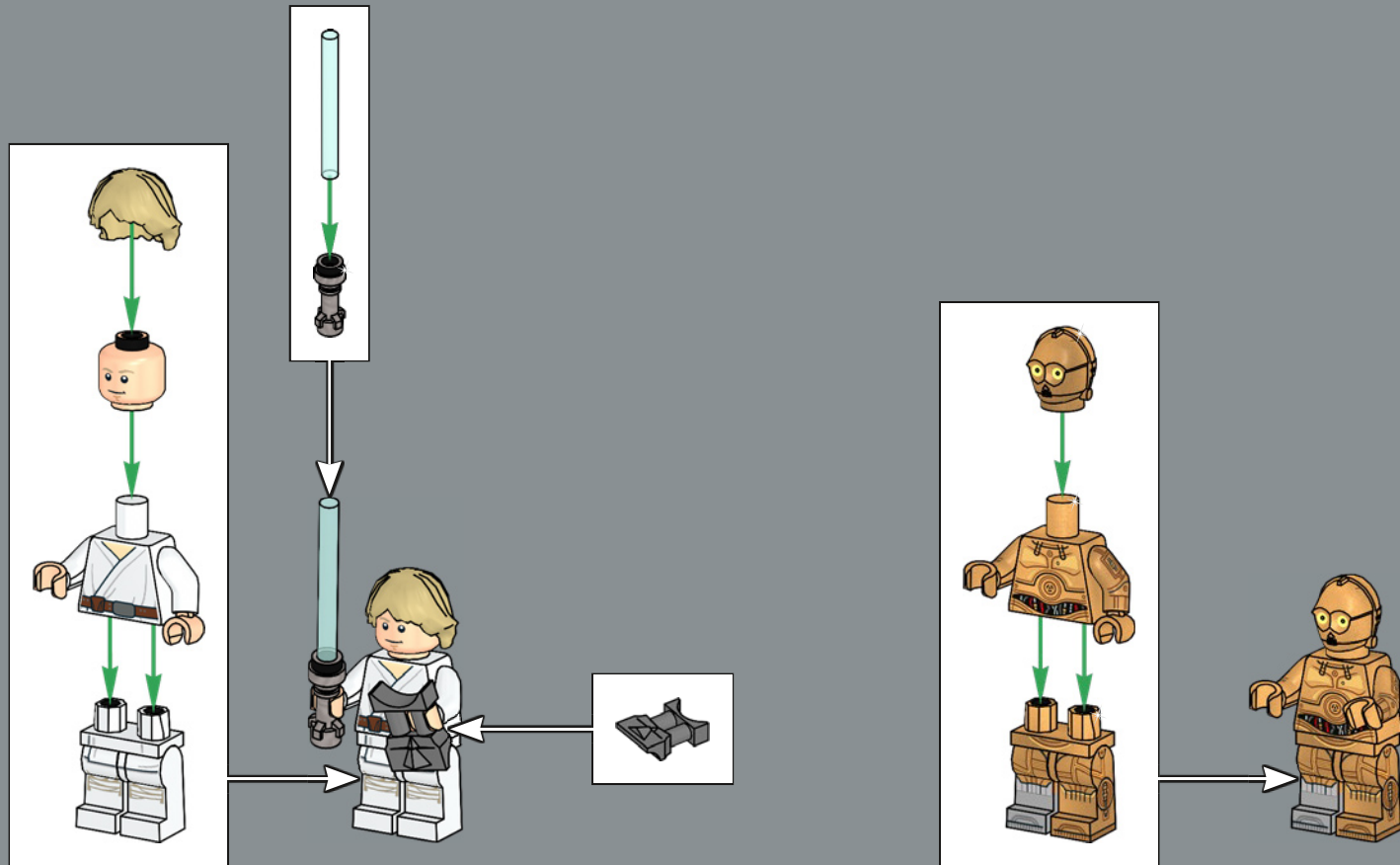

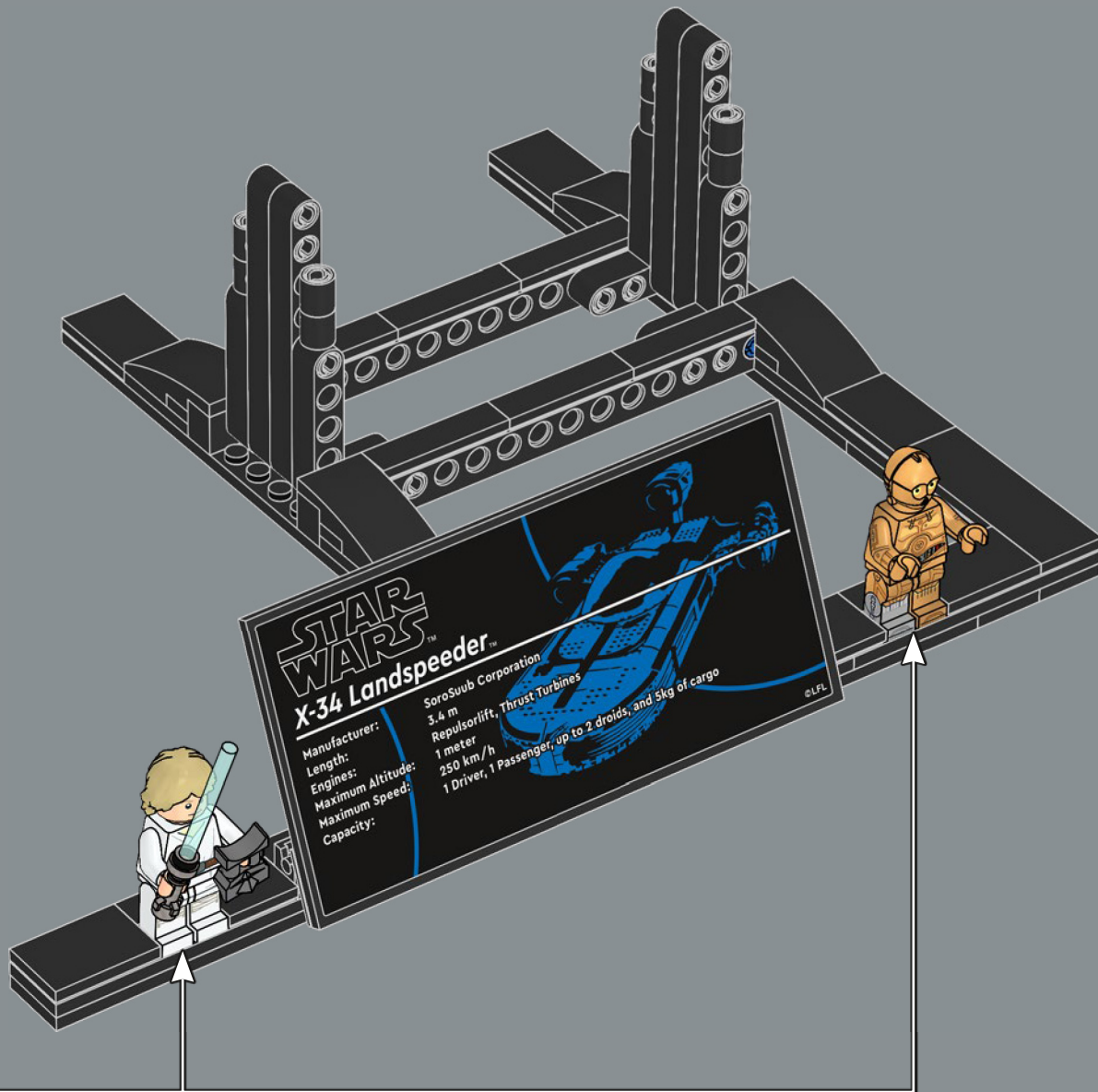

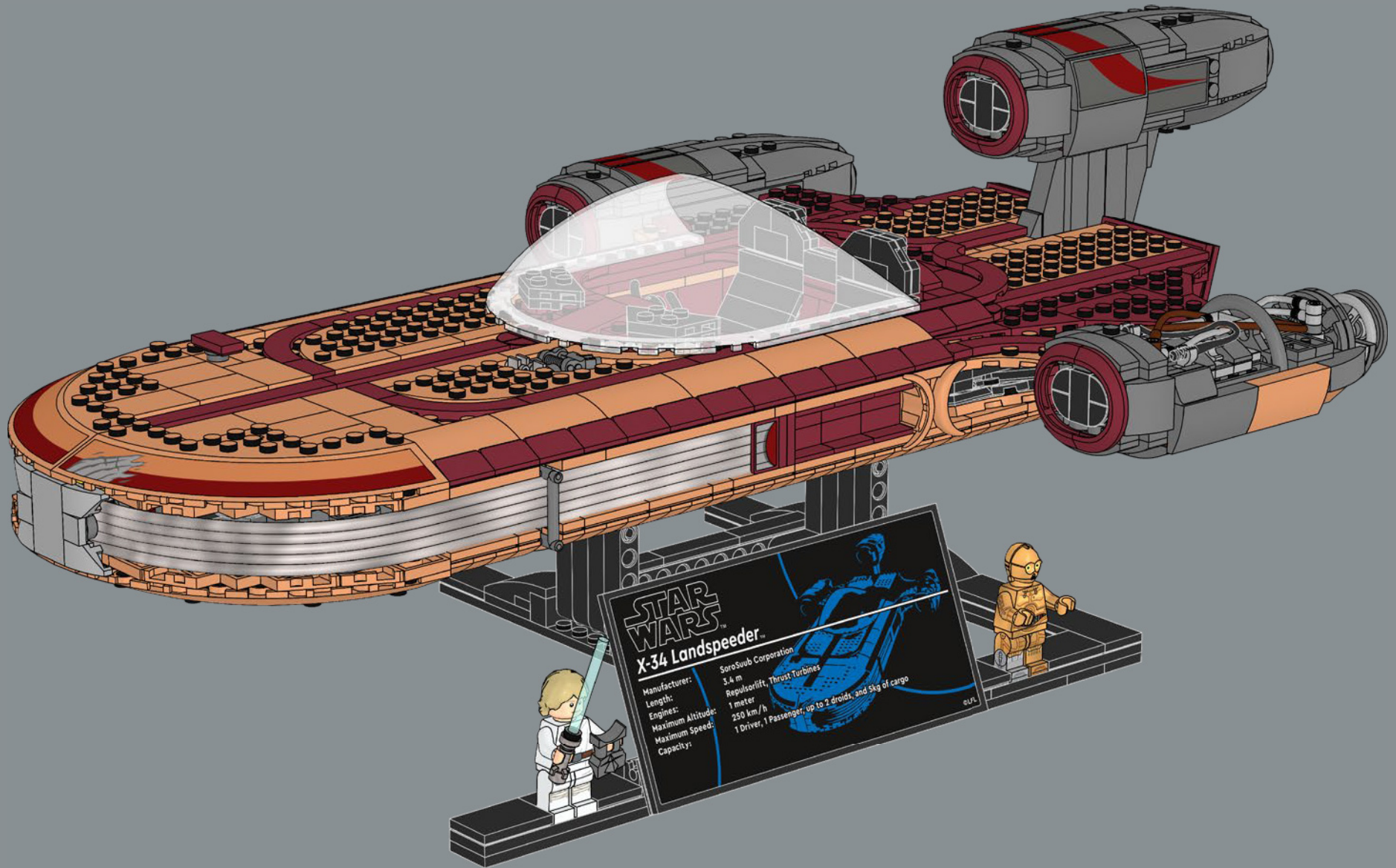

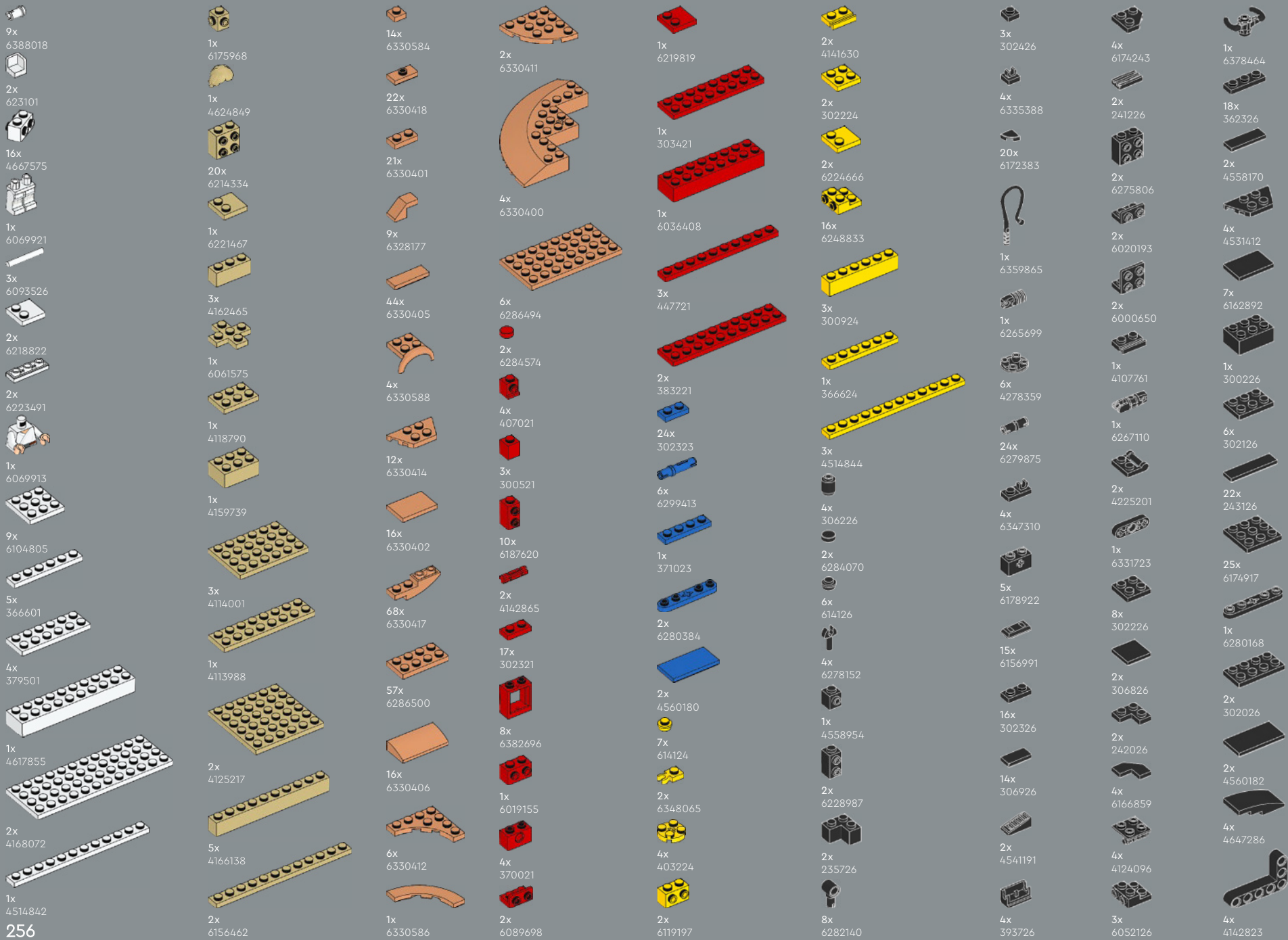

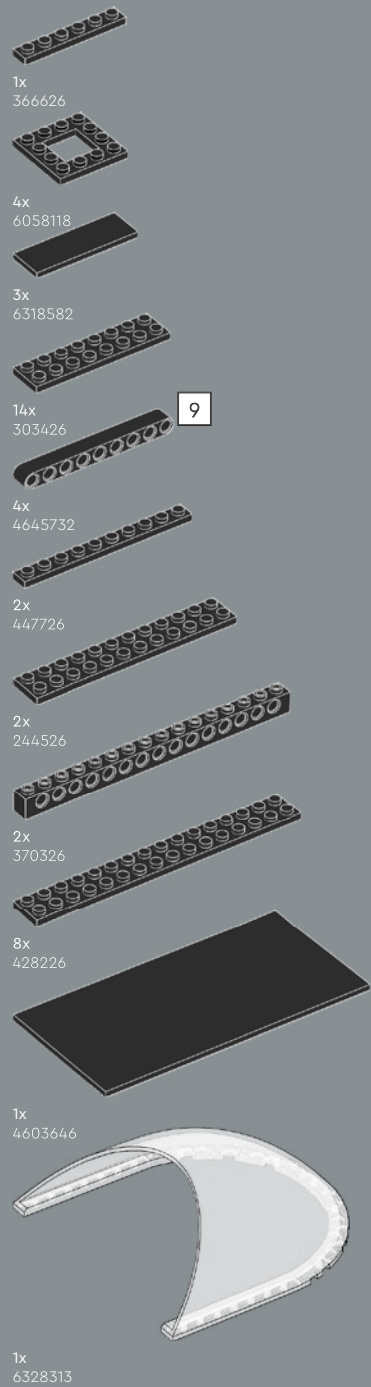

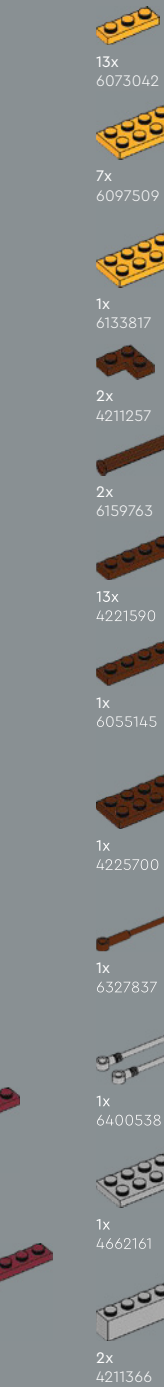

9



5

2x 4211483	2x 6146223	1x 4580510	1x 6359935	1x 6296892	3x 6126083	4x 4211043			4x 4211115	1x 6254100
2x 4211415	2x 4654582	2x 6168615	2x 6282144	1x 4623236	14x 6071261	1x 6083620	4		4x 6005668	1x 6388280
2x 6225139	8x 6168647	2x 6116608	26x 4210719	2x 4567887	1x 4211055	7x 4211001			10x 6335213	1x 6396913
1x 6308012	4x 6117967	2x 6171894	8x 4210848	1x 6271538	4x 4211094	3x 4211053			1x 4211008	1x 4653753
1x 6336539	2x 6266231	1x 4211445	3x 4211098	2x 6115080	17x 4210635	6x 4648256		9	2x 4560184	1x 6347304
5x 6335378	1x 6093527	8x 4211636	2x 4211044	2x 6039479	2x 4211060	1x 4210725			7x 4211085	4x 6336665
2x 6225142	1x 4211397	1x 4211636	9x 4504378	33x 4211063	4x 4211052	1x 6247784			1x 6306723	3x 6215447
3x 6227897	5x 6326478	4x 4243797	1x 6344022	4x 4211052	16x 6029948	4x 6265306			3x 6037666	3x 6038201
1x 4211475	2x 4567448	2x 6318584	2x 6146225	8x 4211052	8x 6146225	2x 6267047			6x 4211056	2x 6144149
2x 6043656	2x 4567448	2x 6318584	4x 4558955	8x 4211052	1x 4540386	3x 4535930			3x 4211061	7x 4653970
2x 6326078	4x 6195471	2x 4211795	8x 6025235	3x 4210865	1x 4210865	1x 4528323			1x 4210678	6x 4619513
3x 6168633	1x 6251044	3x 6284596	4x 6350724	4x 4211104	4x 4211104	1x 6039176			4x 6063685	2x 6185309
7x 6066097			2x 6225494	8x 4211133	2x 4246896	4x 4211065			1x 4210706	4x 4210875
			1x 6364352	2x 6230233	1x 4568734	14x 6121296			1x 6051389	1x 6141594
			28x 6221607	5x 6215212	2x 4543086					
				1x 6230233	2x 6123814					
				2x 4246896	2x 4521886					
				1x 4568734						
				4x 4211065						
				14x 6121296						
				7x 4211002						
				4x 4256149						



Customer Service
Kundenservice
Service Consommateurs
Servicio Al Consumidor

LEGO.com/service or dial

00800 5346 5555 : 

1-800-422-5346 : 



FEEDBACK AND WIN



FEEDBACK AND WIN

Your feedback will help shape the future development of this product series.

Please visit:

FEEDBACK UND GEWINNEN

Dein Feedback trägt zur Weiterentwicklung dieser Produktreihe bei.

Geh auf:

COMMENTEZ ET GAGNEZ

Vos commentaires nous aideront à concevoir les futurs produits de cette gamme.

Rendez-vous sur :

COMENTA Y GANA

Tu opinión nos ayudará a dar forma al desarrollo de esta serie de productos en el futuro.

Visita:

反馈有奖

您的反馈将有助于我们在今后改进本系列产品。

请访问：

[LEGO.com/productfeedback](https://www.lego.com/productfeedback)

By completing, you will automatically enter a drawing to win a LEGO® set.

Terms & Conditions apply.

Durch Ausfüllen nimmst du automatisch an der Verlosung eines LEGO® Preises teil.

Es gelten die Teilnahmebedingungen.

En envoyant vos commentaires, vous serez automatiquement inscrit(e) à un tirage au sort qui vous permettra de remporter un prix LEGO®.

Offre soumise à conditions.

Al contestar, participarás automáticamente en el sorteo y podrás ganar un set LEGO®.

Sujeto a Términos y Condiciones.

完成我们的反馈调查，即可自动进入抽奖环节，赢取乐高®套装。

适用《条款和条件》。

STAR
WARS™

LEGO and the LEGO logo are trademarks of the/sont des marques de commerce du/
son marcas registradas de LEGO Group. ©2022 The LEGO Group. 6417353
© & ™ Lucasfilm Ltd.

Disney