



75377

**STAR
WARS**™



Disney

Booklet available in English on
Livret disponible en français sur
Folleto disponible en español en



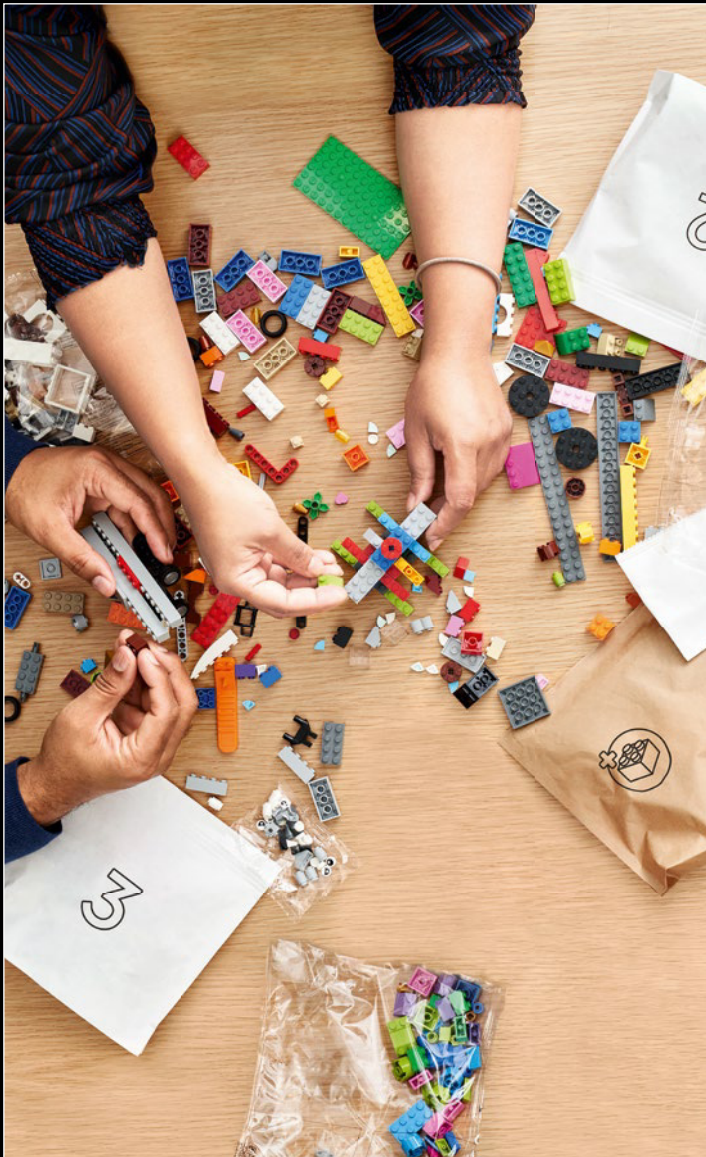

WE'RE MAKING OUR PACKAGING MORE SUSTAINABLE

We're transitioning from single-use plastic to paper-based packaging. As we progress, you may find a mix of paper and plastic in our boxes.

NOUS RENDONS NOS EMBALLAGES PLUS DURABLES

Nous passons des emballages en plastique à usage unique aux emballages à base de papier. Durant la transition, vous pourriez trouver un mélange de papier et de plastique dans nos boîtes.

QUEREMOS HACER MÁS SUSTENTABLES NUESTROS MATERIALES DE EMBALAJE

Estamos cambiando las bolsas de plástico desechables por bolsas con base de papel. Conforme avanzamos en este propósito, puedes encontrar una mezcla de papel y de plástico en nuestras cajas.

LEGO.com/sustainable-packaging



BUILDER



Apple and the Apple logo are trademarks of Apple Inc., registered in the U.S. and other countries and regions. App Store is a service mark of Apple Inc. Google Play and the Google Play logo are trademarks of Google LLC. Tencent and the Tencent logo are trademarks of Tencent Inc.

Q [LEGO.com/devicecheck](https://www.lego.com/devicecheck)



Q LEGO® Builder



INVISIBLE HAND™

STAR WARS

WE'RE STILL FLYING AN ENTIRE SHIP

We're so excited to land this model safely in our Starship Collection, as part of our LEGO® Star Wars™ 25th anniversary. Of all the spectacular *Star Wars* starship scenes in the saga, few compare with the destruction of General Grievous' behemoth, the *Invisible Hand*, in *Revenge of the Sith*. As his kidnapping of Supreme Chancellor Palpatine is thwarted by the Jedi, and his starship is under enemy attack, Grievous launches the escape pods to save his own droid skin, leaving Anakin Skywalker and Obi-Wan Kenobi to pilot the remaining half of the wreck, plummeting to a monumental crash-landing back on Coruscant. It's a breathtaking demonstration of Anakin's pilot skills – and use of the Force.

Enjoy building!

Jens Kronvold Frederiksen
Creative Director, LEGO® Star Wars™



© & TM Lucasfilm Ltd.



© & TM Lucasfilm Ltd.



LA MAIN INVISIBLE™

STAR WARS

NOUS PRENONS LES COMMANDES D'UN VAISSEAU ENTIER

Nous sommes vraiment ravis de faire atterrir ce modèle dans notre Collection de vaisseaux, dans le cadre du 25^e anniversaire de LEGO® Star Wars™. De toutes les scènes spectaculaires de vaisseaux de *Star Wars*, peu sont comparables à la destruction du mastodonte du général Grievous, la *Main Invisible*, dans *La Revanche des Sith*. Alors que son enlèvement du Chancelier suprême Palpatine est contrecarré par les Jedi et que son vaisseau est attaqué par l'ennemi, Grievous lance les capsules de sauvetage pour sauver sa peau, laissant Anakin Skywalker et Obi-Wan Kenobi piloter la moitié restante de l'épave, qui plonge vers un atterrissage en catastrophe sur Coruscant. C'est une démonstration époustouflante des talents de pilote d'Anakin – et de son utilisation de la Force.

Bonne construction !

Jens Kronvold Frederiksen

Directeur de la création, LEGO® Star Wars™



MANO INVISIBLE™

STAR WARS

LA NAVE QUE PILOTEAMOS SIGUE ESTANDO EN UNA PIEZA

Estamos muy contentos de que este modelo llegue sano y salvo a nuestra Colección de Naves Espaciales con motivo de las celebraciones del 25 aniversario de LEGO® Star Wars™. De todas las espectaculares escenas de acción espacial de la saga *Star Wars*, pocas pueden compararse con la destrucción de la descomunal nave del General Grievous, la *Mano Invisible*, en *La Venganza de los Sith*. Mientras los Jedi frustran su intento de secuestrar al Canciller Supremo Palpatine y su nave se encuentra bajo un feroz ataque, Grievous lanza los pods de escape para salvar su propio pellejo robótico, dejando que Anakin Skywalker y Obi-Wan Kenobi piloteen lo que queda de ella hasta que logran aterrizar monumentalmente en Coruscant. Este episodio pone de manifiesto las impresionantes habilidades de pilotaje (y del uso de la Fuerza) de Anakin.

¡Que disfrutes construyendo!

Jens Kronvold Frederiksen

Coordinador creativo, LEGO® Star Wars™

AN ICONIC SEPARATIST FLAGSHIP

Manufactured by Free Dac Volunteers Engineering, the formidable *Providence*-class carrier/destroyer is the flagship of Separatist droid army commander General Grievous and his master, Count Dooku. At 1,088 meters (3,569 ft.) long, 347 meters (1,138 ft.) high and 198 meters (649 ft.) wide, the *Invisible Hand* easily accommodates a crew of 600, 1.5 million battle droids and more than 400 ground assault vehicles. When the Battle of Coruscant leaves its hull and critical compartments dangerously vulnerable, its re-entry into the atmosphere ultimately causes the starship to break in two.

UN VAISSEAU EMBLÉMATIQUE DE LA FLOTTE SÉPARATISTE

Fabriqu  par le Corps des ing nieurs volontaires libres de Dac, le redoutable porte-vaisseaux/Destroyer de classe *Providence* est le vaisseau amiral du commandant de l'arm e dro de s paratiste, le g n ral Grievous, et de son ma tre, le comte Dooku. Avec ses 1 088 m tres de long, 347 m tres de haut et 198 m tres de large, la *Main Invisible* peut facilement accueillir un  quipage de 600 personnes, 1,5 million de dro ides de combat et plus de 400 v hicules de combat au sol. La bataille de Coruscant ayant laiss  sa coque et ses compartiments critiques dangereusement vuln rables, le vaisseau finit par se scinder en deux lors de sa rentr e dans l'atmosph re.

UN IC NICO BUQUE INSIGNIA SEPARATISTA

Fabricado por el Cuerpo de Ingenieros Voluntarios de Dac Libre, el formidable carguero/destructor clase *Providencia* es el buque insignia del comandante del ej rcito droide separatista, el General Grievous, y de su maestro, el Conde Dooku. Con 1088 m de longitud, 347 m de altura y 198 m de anchura, la *Mano Invisible* alberga con facilidad a una tripulaci n de 600 personas, 1,5 millones de droides de batalla y m s de 400 veh culos de combate terrestres. Cuando la batalla de Coruscant deja su casco y compartimientos cr ticos peligrosamente vulnerables, su reingreso a la atm sfera acaba provocando que la nave se parta en dos.



SPRING THE TRAP

The characteristic torpedo-shaped hull is thick and solid for a Separatist destroyer. Only a few living passengers travel onboard, so the need for viewing portals is limited, and a dorsal sensor and communications masts allow General Grievous to direct his droid army from the command bridge. Both the interior and exterior design of this model incorporates authentic details and features. The massive main hangar spans the width of the vessel, with transparent panels that let you see through the model – and maybe spot a few Easter eggs.

ACTIVA ESA TRAMPA

El característico casco con forma de torpedo de la nave es bastante grueso y sólido, incluso para un destructor separatista. Solo viajan a bordo unos pocos pasajeros vivos, por lo que la necesidad de portales de visión es limitada, y un sensor dorsal y mástiles de comunicaciones permiten al General Grievous dirigir a su ejército droide desde el puente de mando. Tanto el diseño interior como el exterior de este modelo incorporan detalles y características de gran autenticidad. El enorme hangar principal ocupa toda la anchura de la nave, y el modelo cuenta con paneles transparentes que te permiten apreciar su interior y, tal vez, descubrir algunos huevos de Pascua.

ACTIONNEZ LE PIÈGE

La coque caractéristique en forme de torpille est épaisse et solide pour un Destroyer séparatiste. Seuls quelques passagers vivants voyagent à bord, ce qui limite le besoin de portails de visualisation. Un capteur dorsal et des mâts de communication permettent au général Grievous de diriger son armée de droïdes depuis la passerelle de commandement. La conception intérieure et extérieure de ce modèle incorpore des détails et des caractéristiques authentiques. L'immense hangar principal s'étend sur toute la largeur du vaisseau, et des panneaux transparents vous permettent de voir à travers le modèle – et peut-être de repérer quelques œufs de Pâques.



Join the 25th Anniversary
at LEGO.com/LSW-25



25
ANS DE
LEGO® STAR WARS™

25
AÑOS DE
LEGO® STAR WARS™



**STAR
WARS™**

© & ™ Lucasfilm Ltd.

Participez au 25^e anniversaire
sur LEGO.com/LSW-25

Participa en el 25 aniversario
en LEGO.com/LSW-25

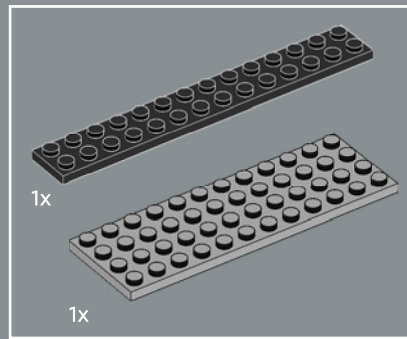

1

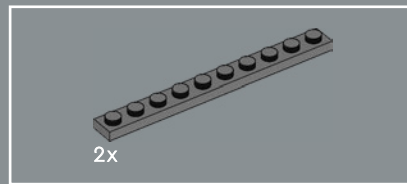
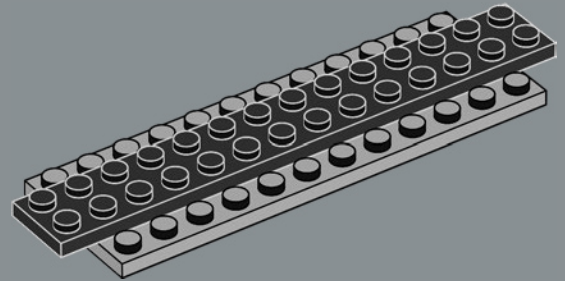

2

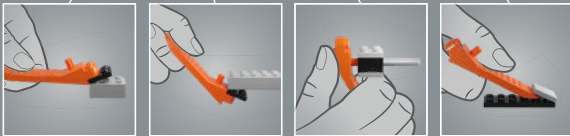
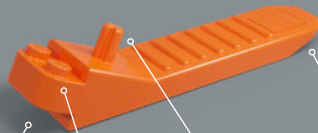
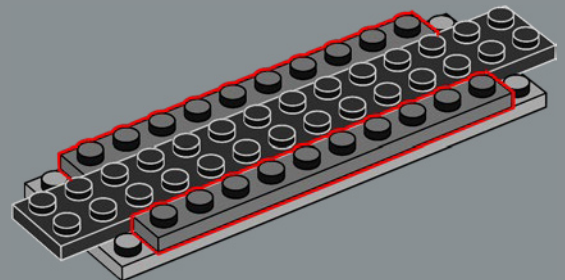

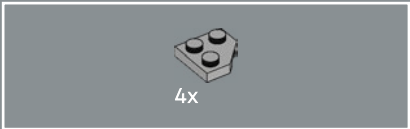

3

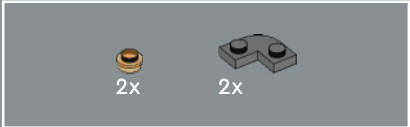
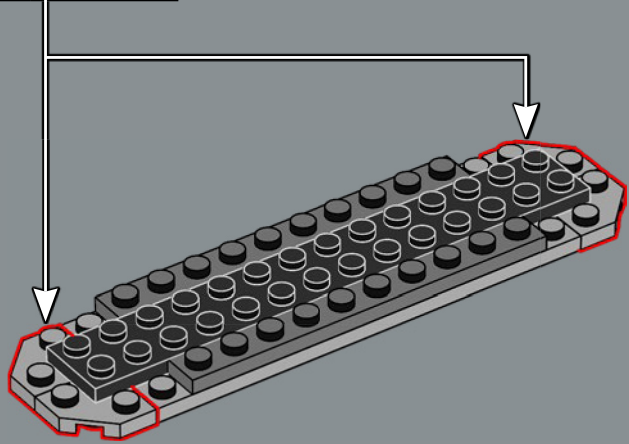
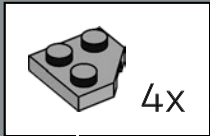

4

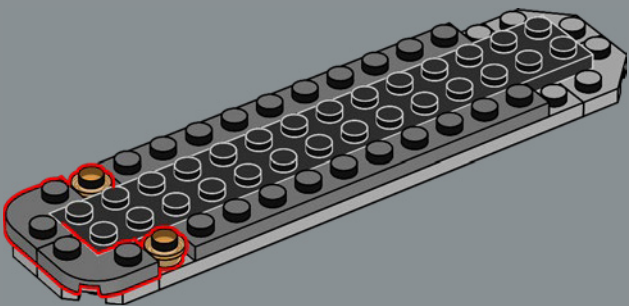



5

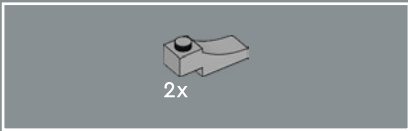
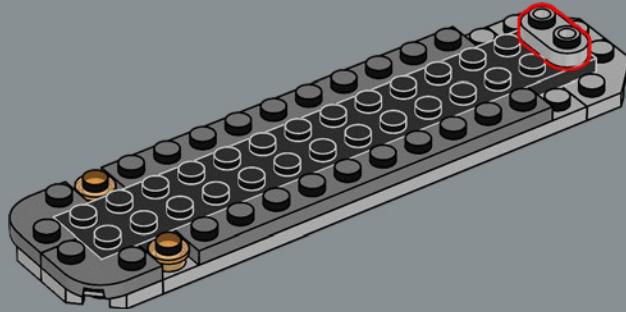

6

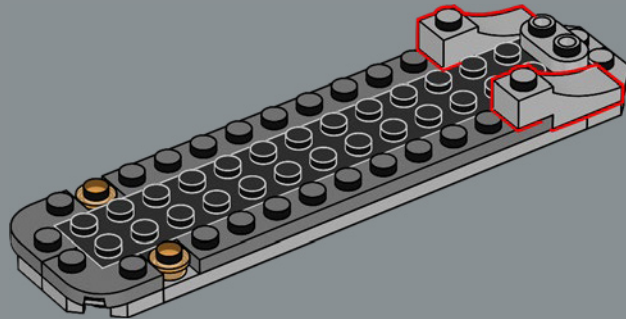



7

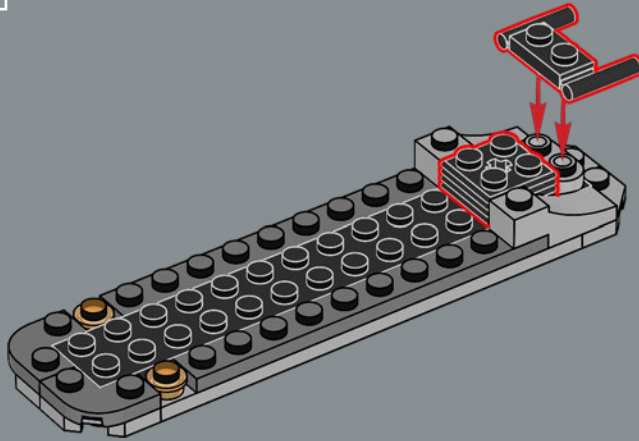

8

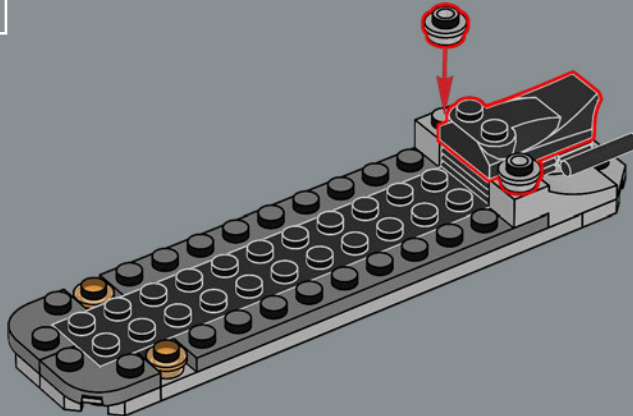

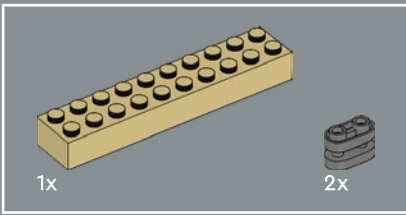

9

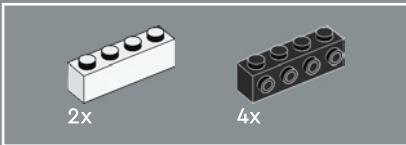
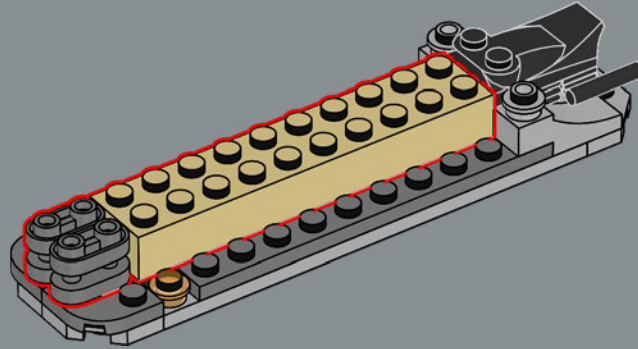

10

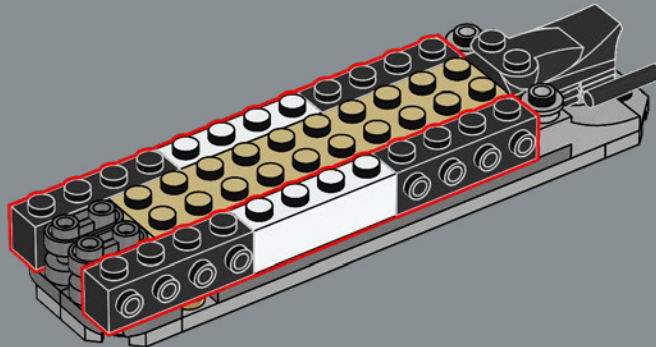

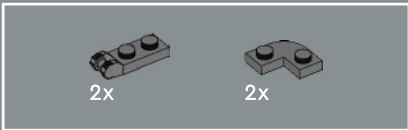

11

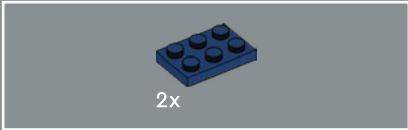
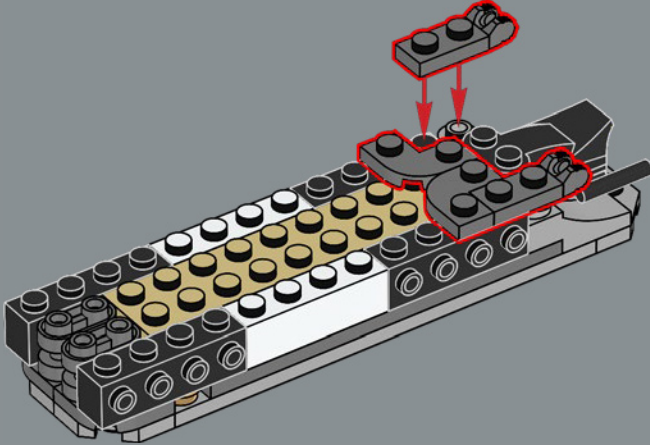

12

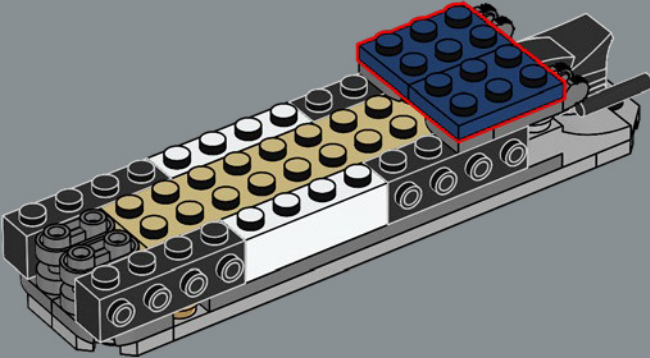



13

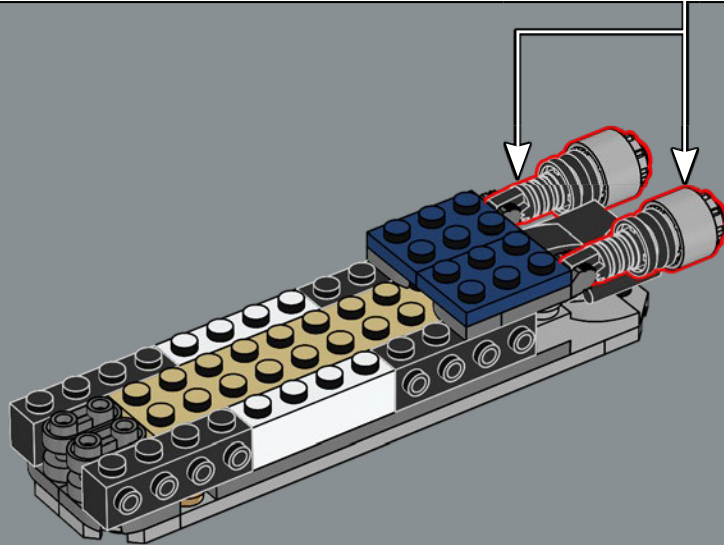
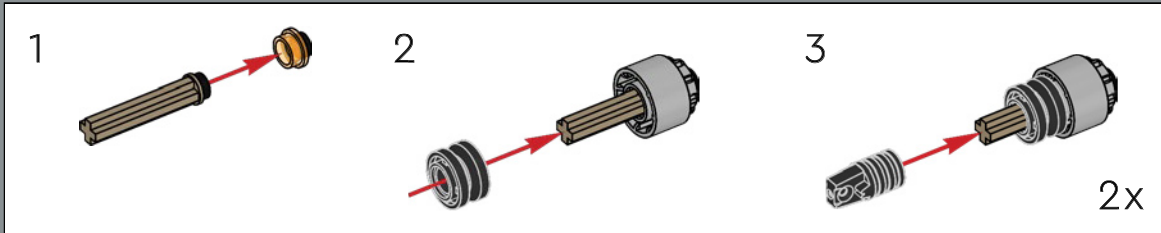

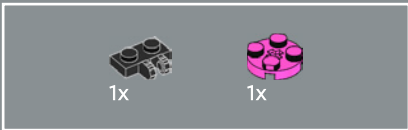

14

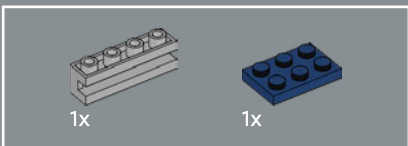
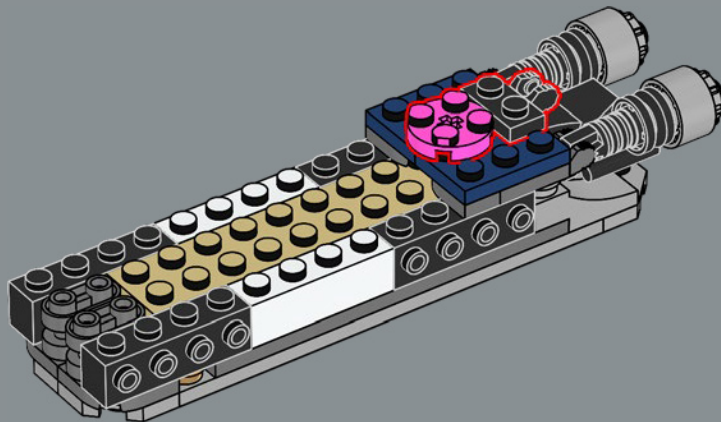

15

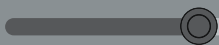
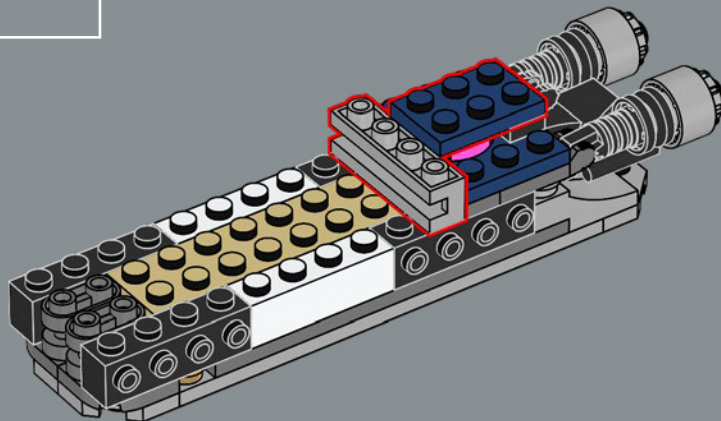

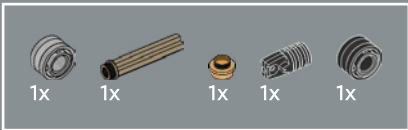

16

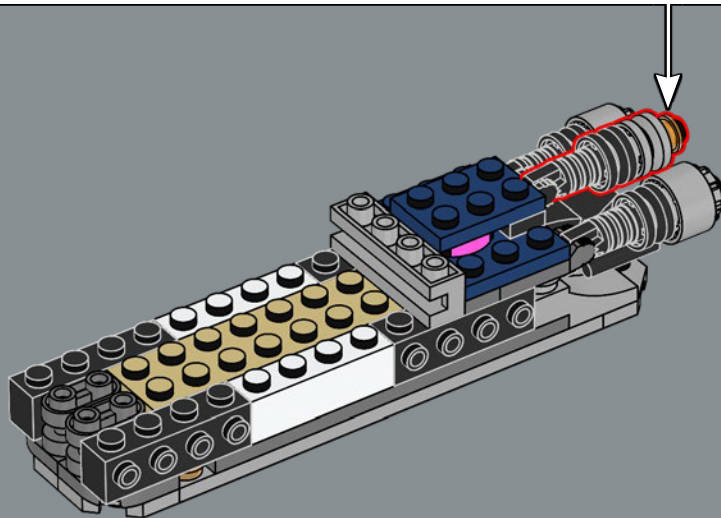
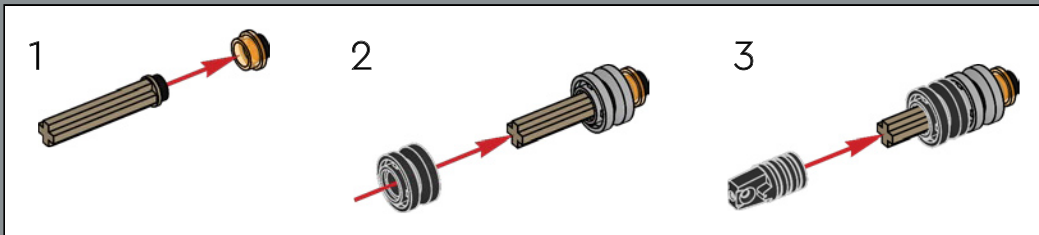

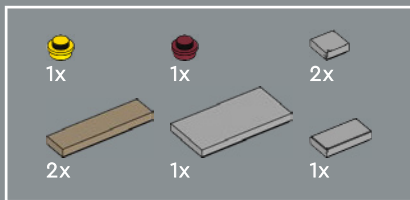

17

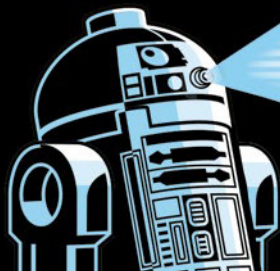
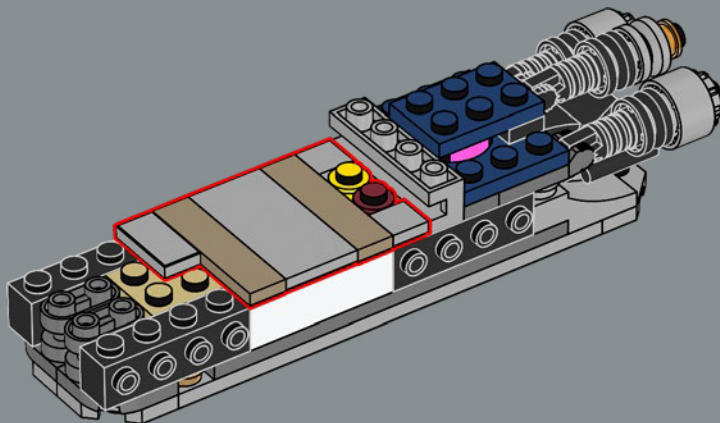

These two 1:1 bricks represent Anakin Skywalker and Obi-Wan Kenobi's Eta-2 Actis-class Jedi Interceptors after they breach the *Invisible Hand's* shields and land in the hangar bay.

Ces deux briques 1:1 représentent les intercepteurs Jedi de classe Eta-2 Actis d'Anakin Skywalker et d'Obi-Wan Kenobi après qu'ils ont franchi les boucliers de la *Main Invisible* et atterri dans le hangar.

Estos dos bricks a escala 1:1 representan a los interceptores Jedi Eta-2 clase Actis de Anakin Skywalker y Obi-Wan Kenobi después de que rompen los escudos de la *Mano Invisible* y aterrizan en el hangar.



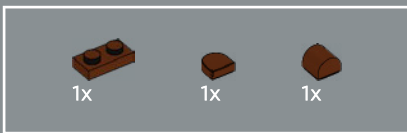

18

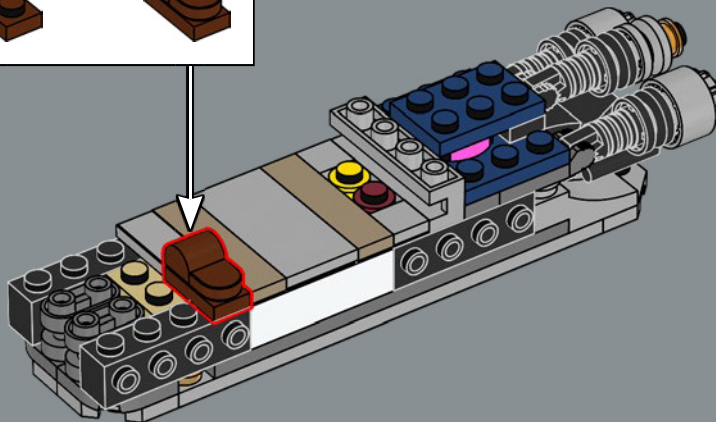
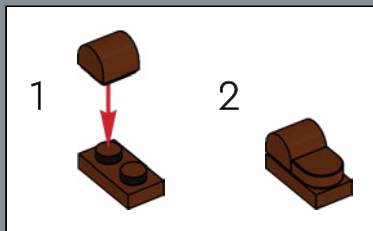

To highlight the scale of this model, this brown piece represents the MTT (Multi-Troop Transport) seen in the background of the hangar scene in *Revenge of the Sith*. These transports each hold over a hundred battle droids!

Pour illustrer l'échelle de ce modèle, cette pièce brune représente le TMT (Transport multi-troupes) que l'on voit à l'arrière-plan de la scène du hangar dans *La Revanche des Sith*. Ces transports contiennent chacun plus d'une centaine de droïdes de combat !

Para resaltar la escala de este modelo, esta pieza café representa el Transporte Multitropas (MTT) que se ve en el fondo de la escena del hangar en *La Venganza de los Sith*. ¡En cada uno de estos transportes caben más de cien droïdes de batalla!

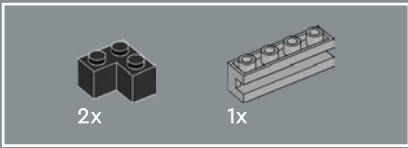

19

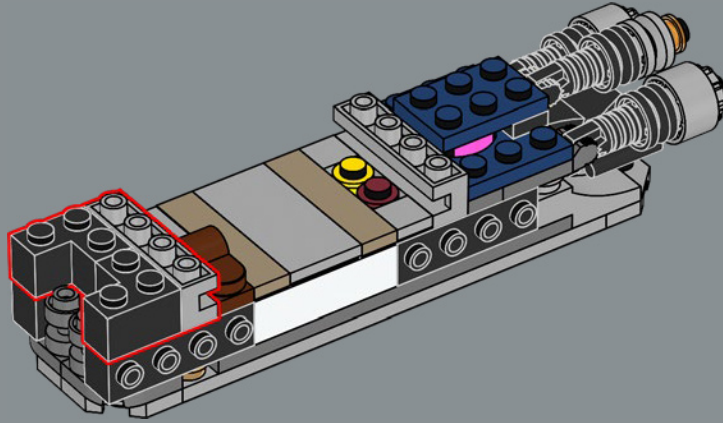

20

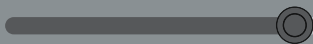
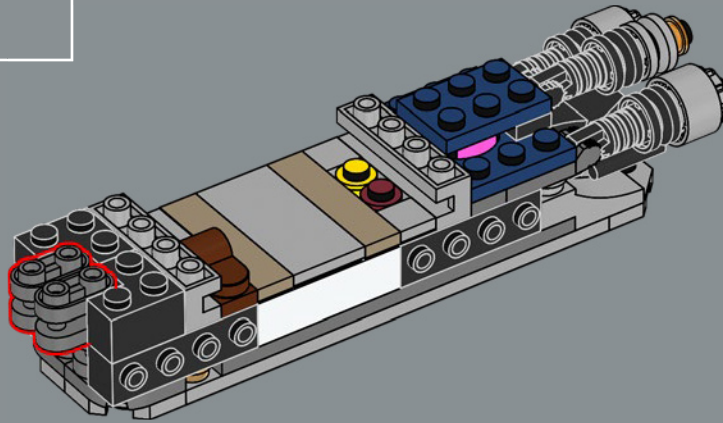

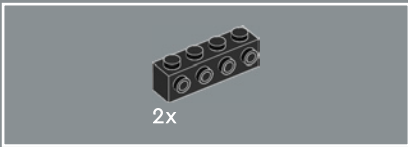

21

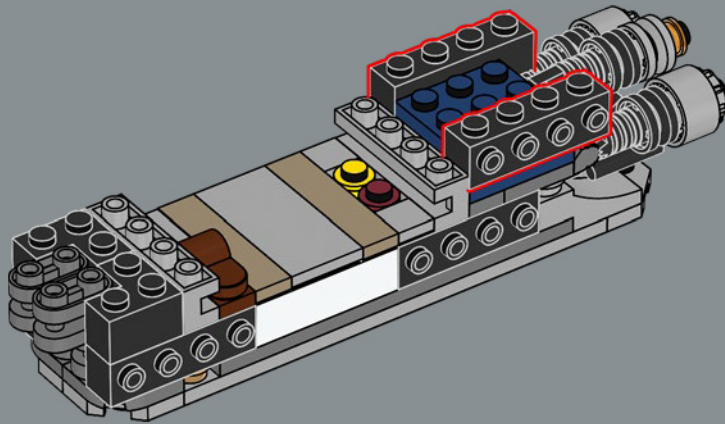

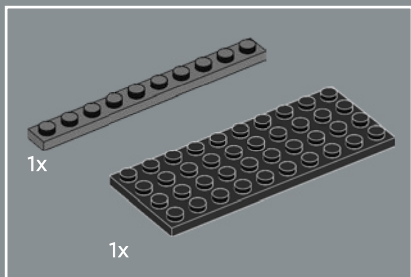

22

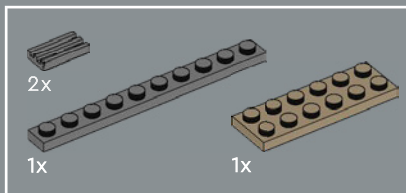
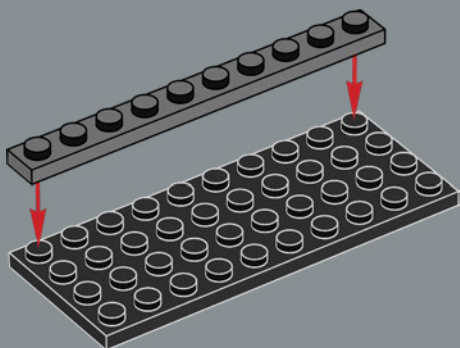

23

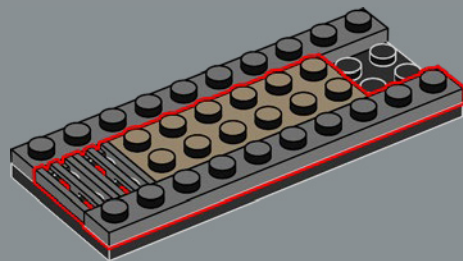

24

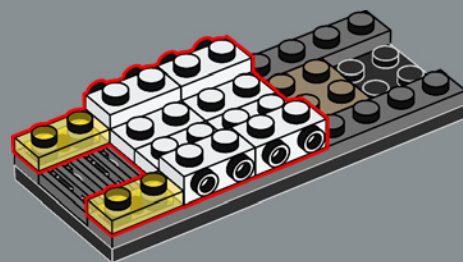

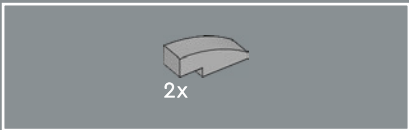

25

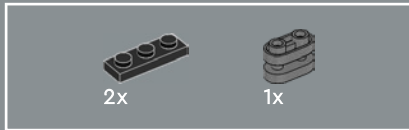
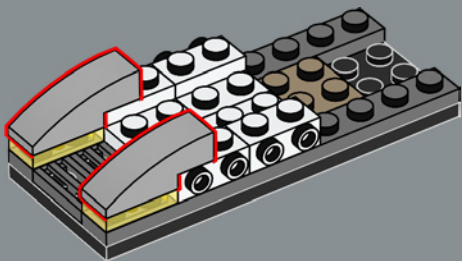

26

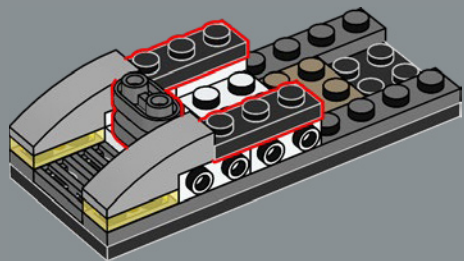

27

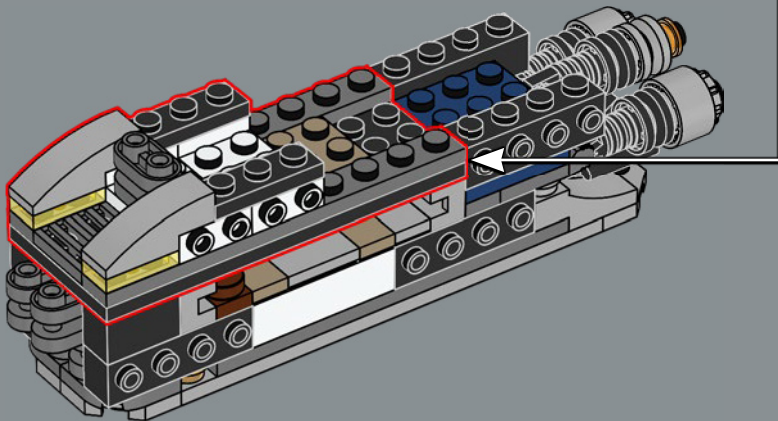

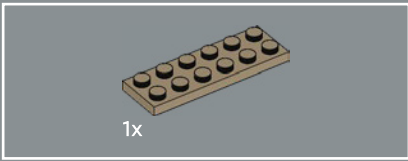

28

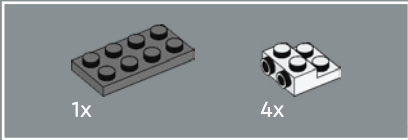
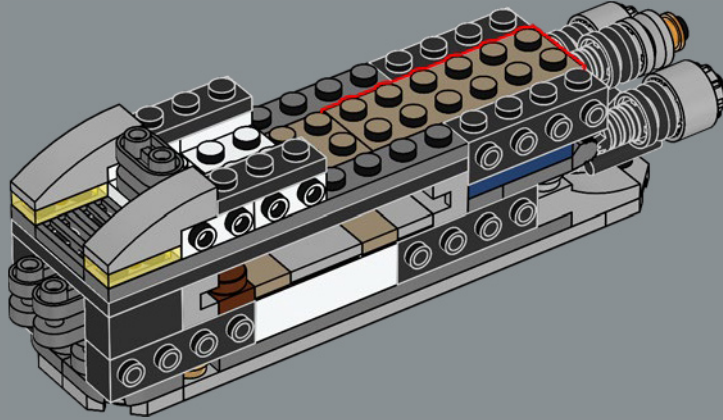

29

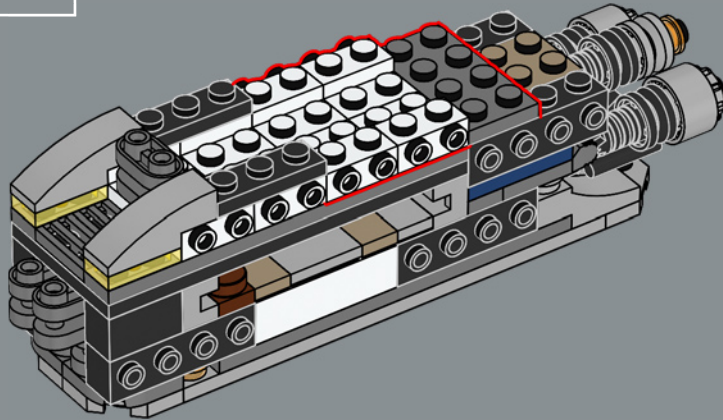

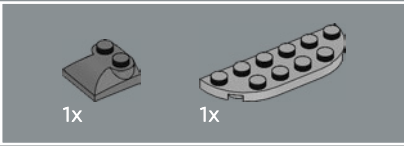

30

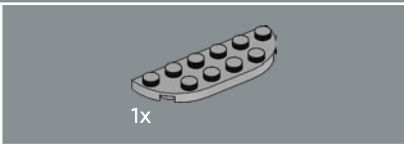
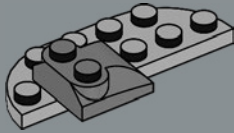

31

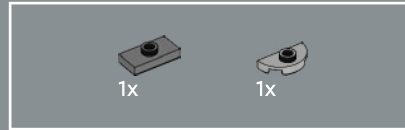
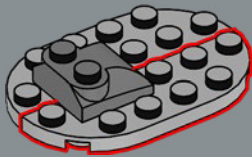

32

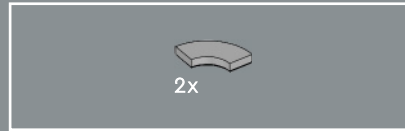
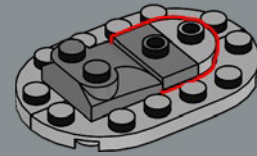

33

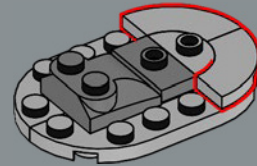



34

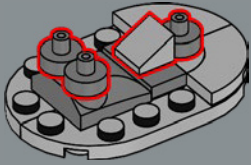

35

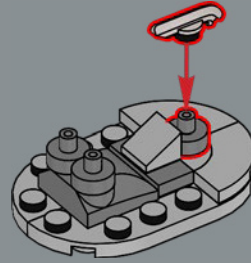

36

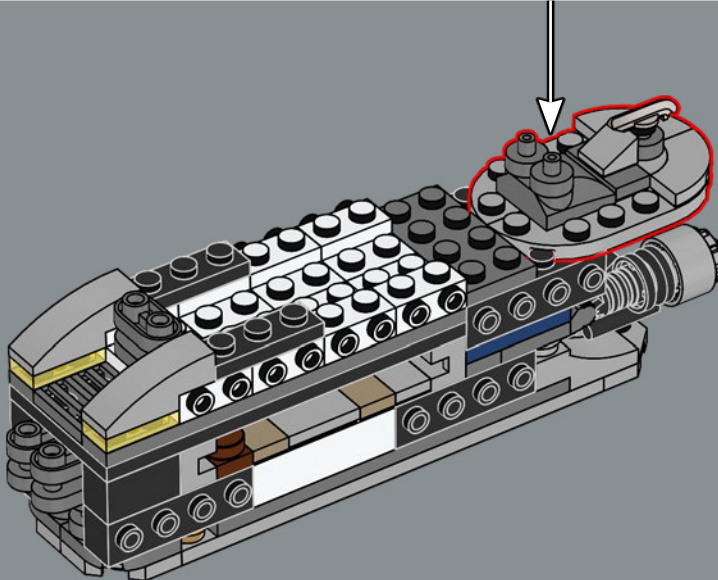

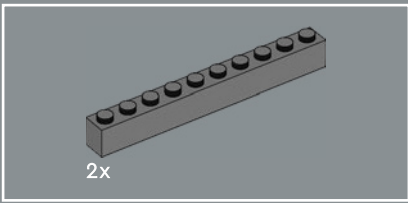

37

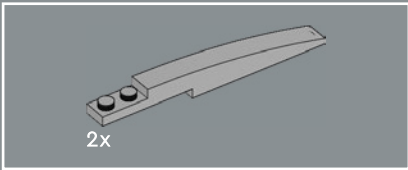
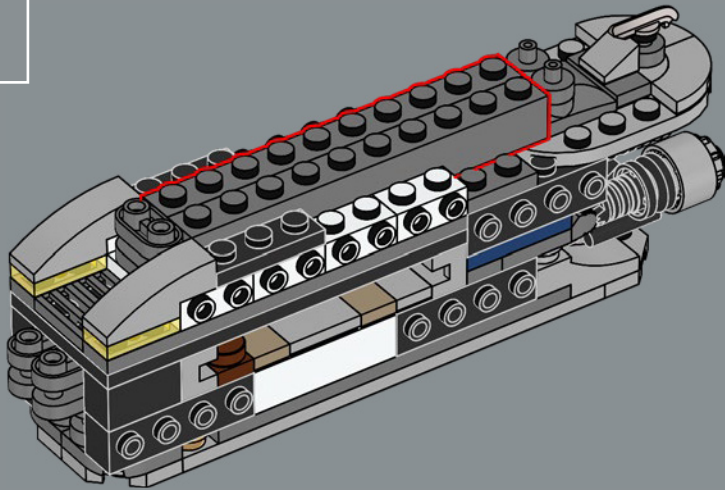

38

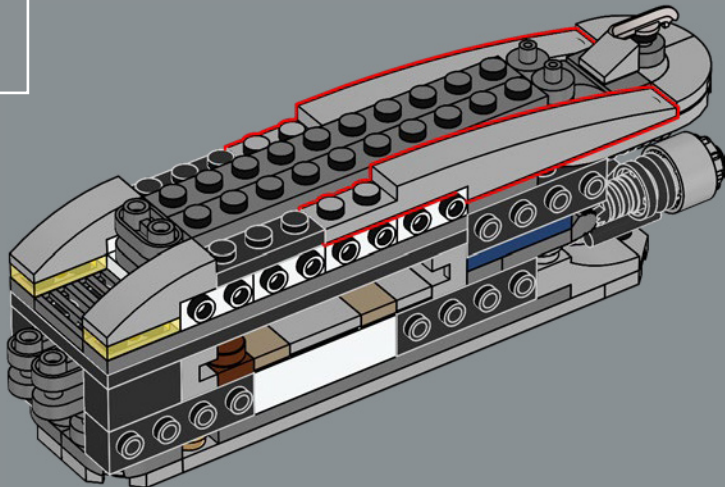



6x



4x

39

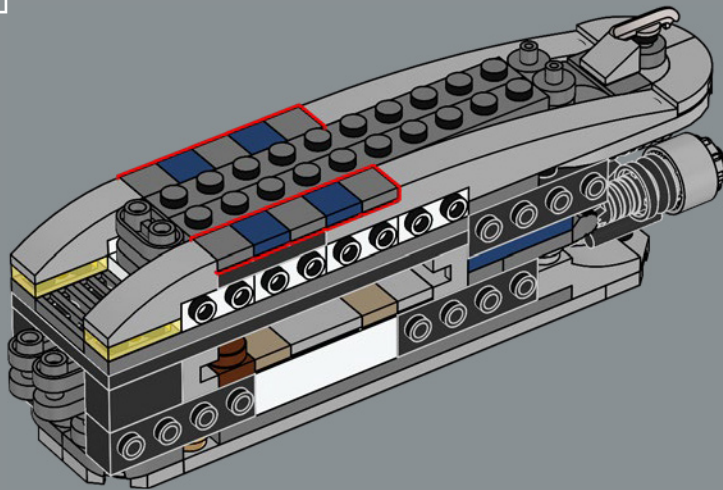

2x



1x

40

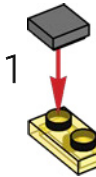
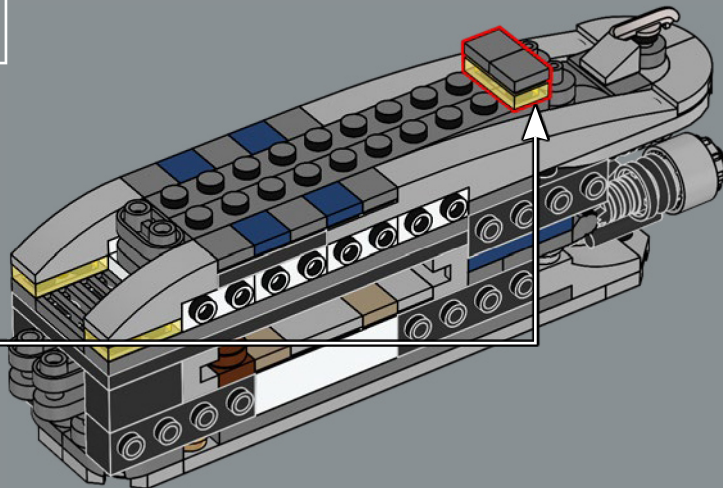

1

2



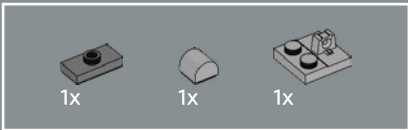

41

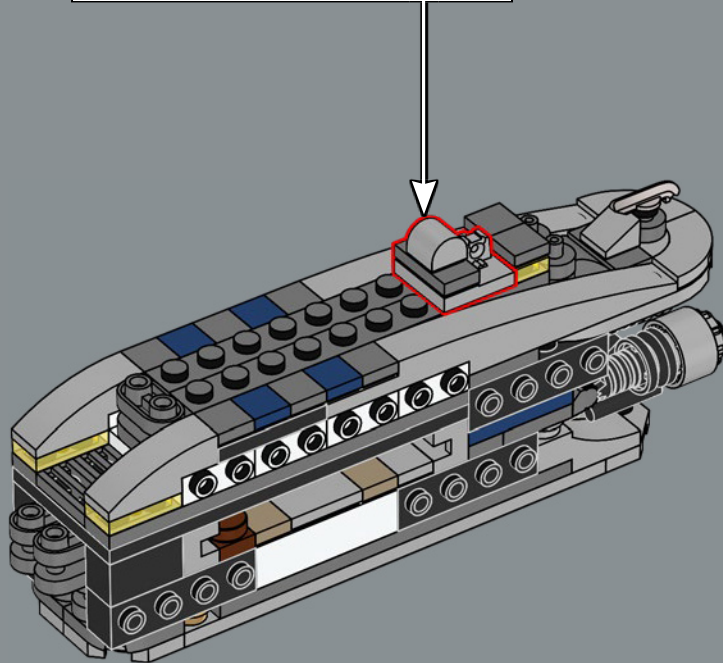
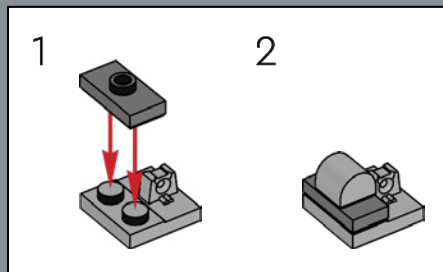

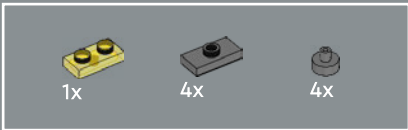

42

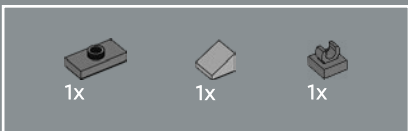
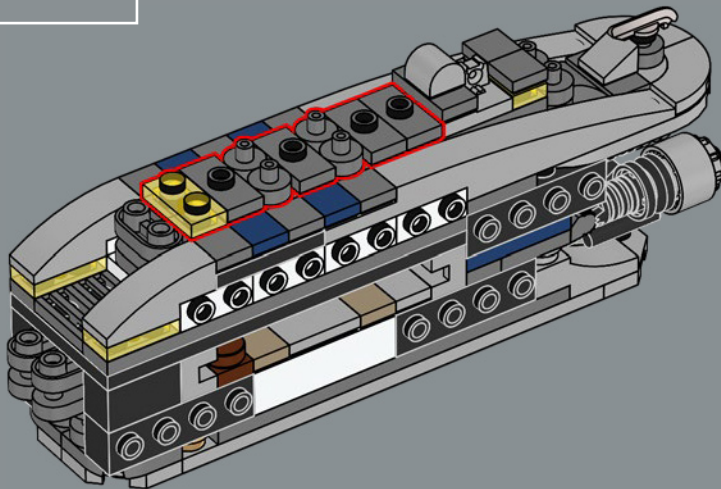

43

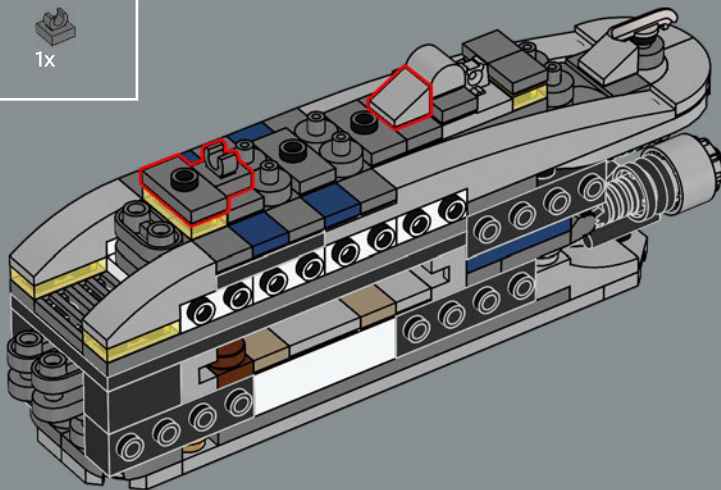

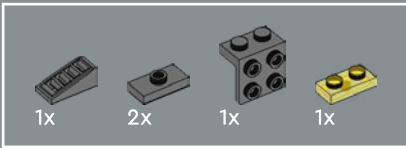

44

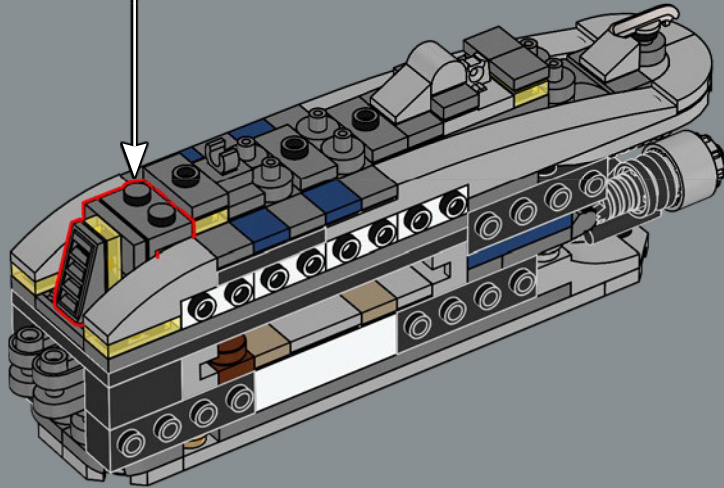
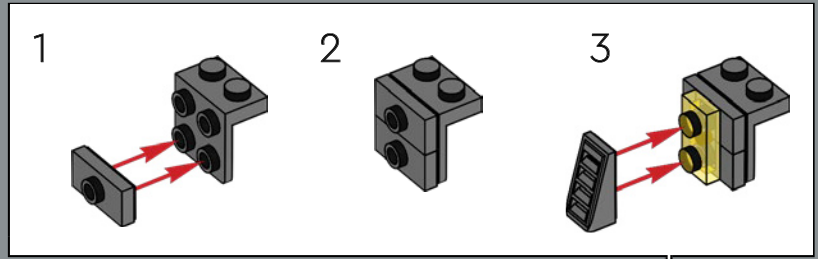

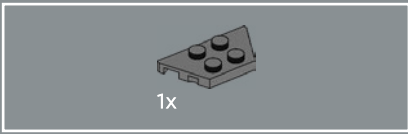

45

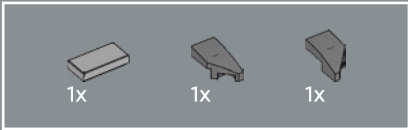
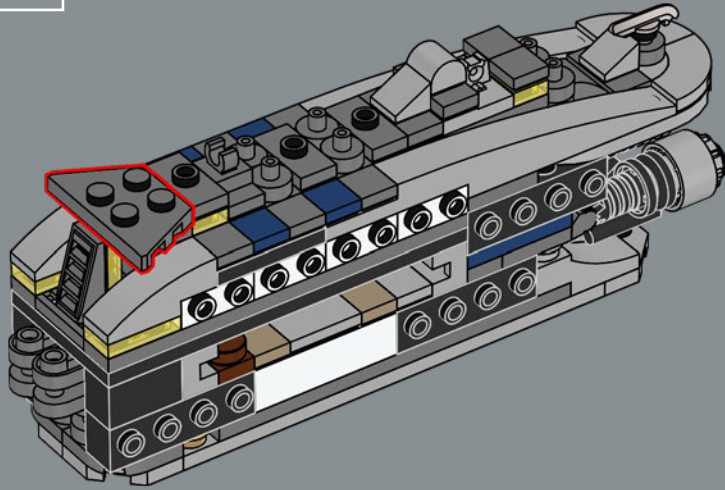

46

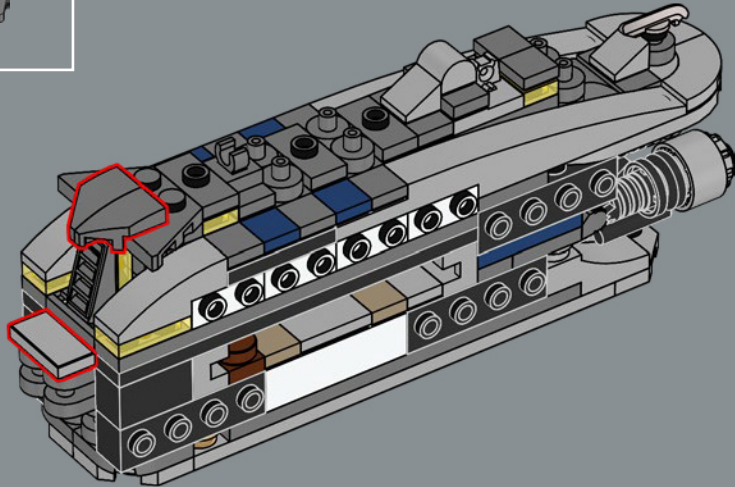



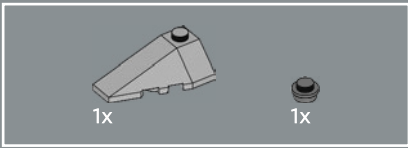

47

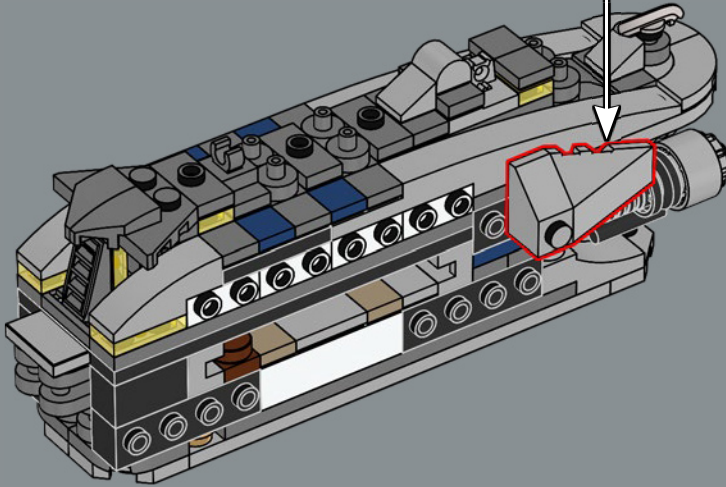
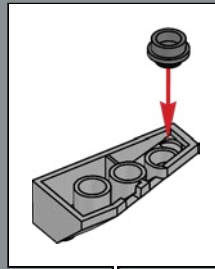

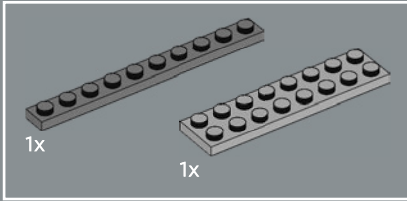
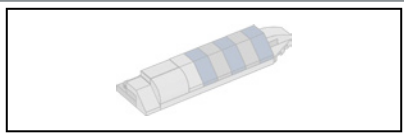

48

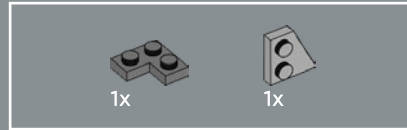
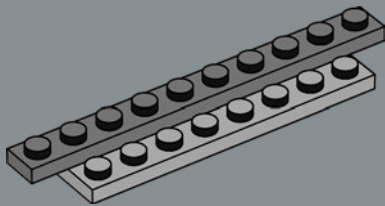

49

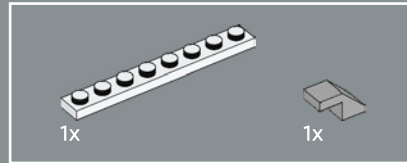
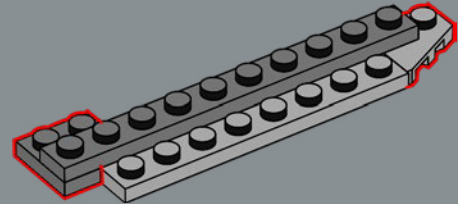

50

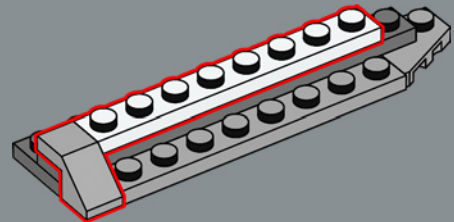

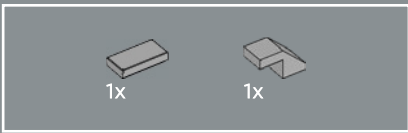

51

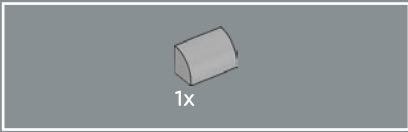
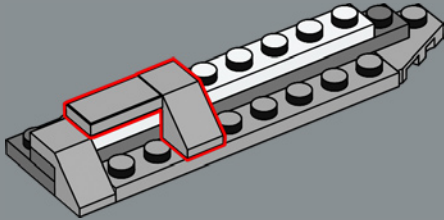

52

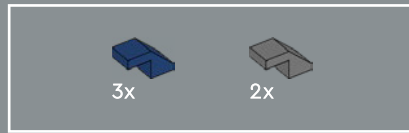
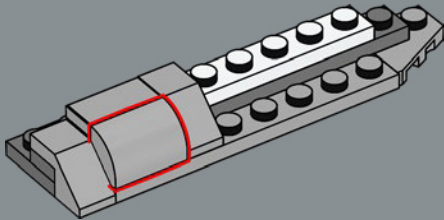

53

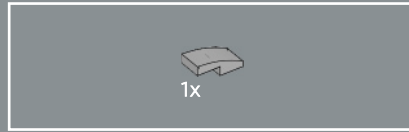
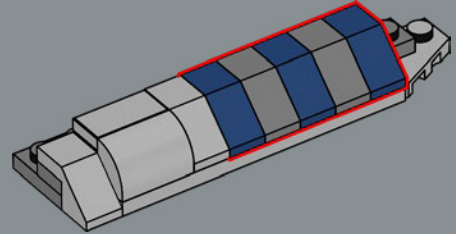

54

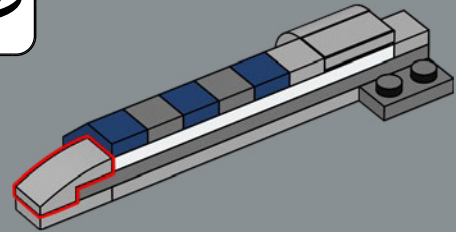

55

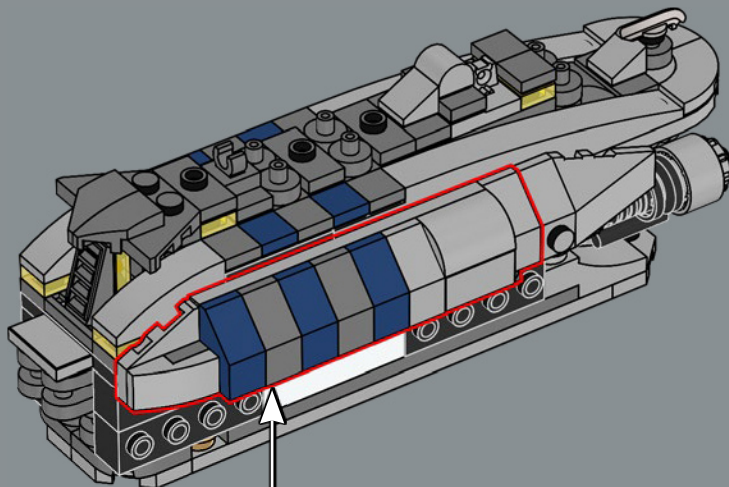

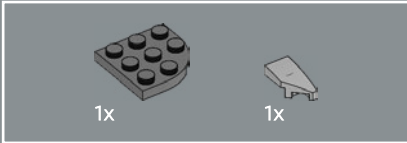
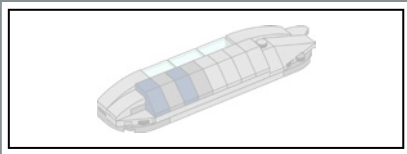

56

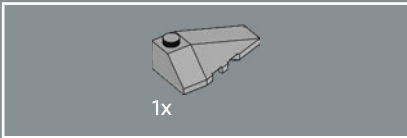
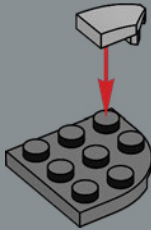

57

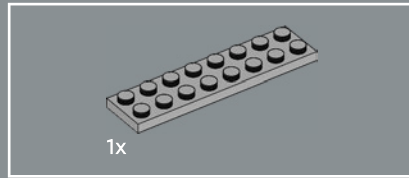
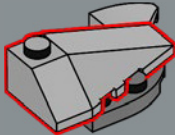

58

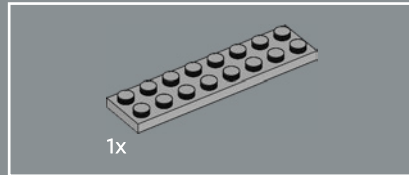
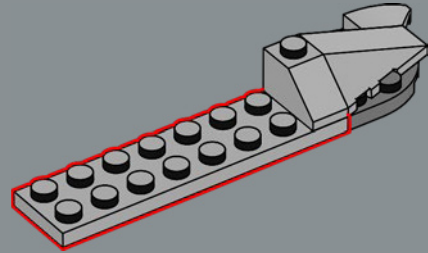

59

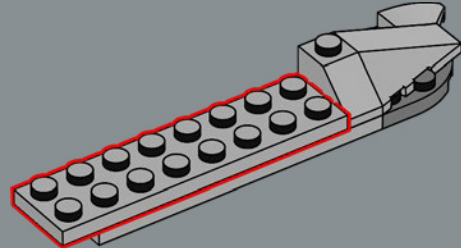

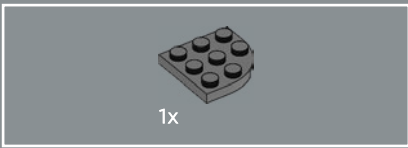

60

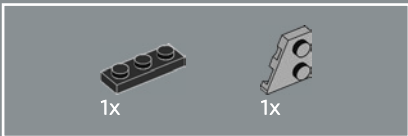
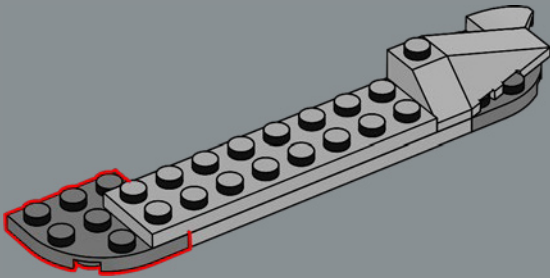

61

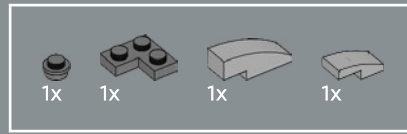
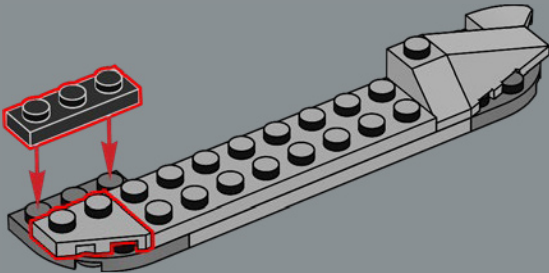

62

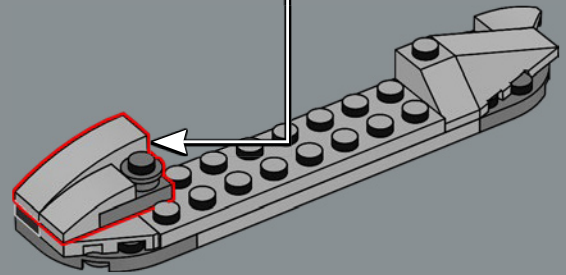
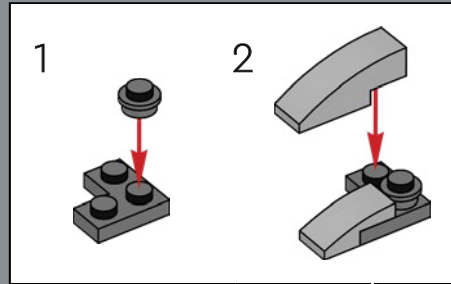

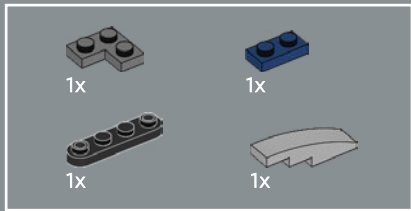

63

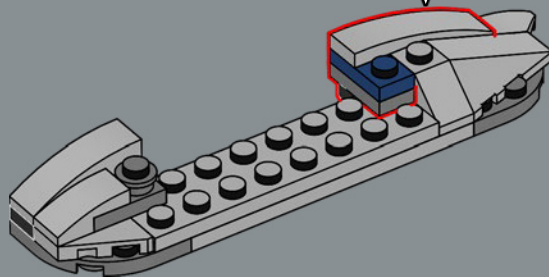
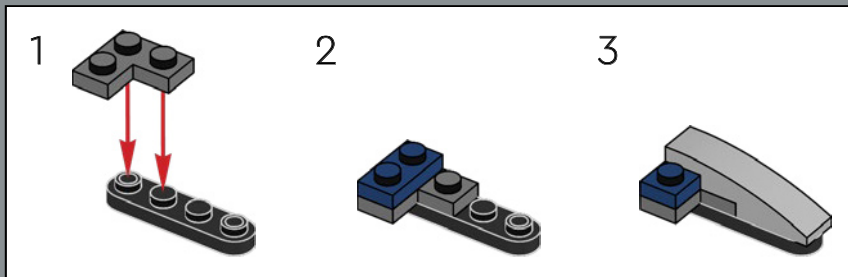

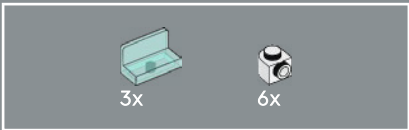

64

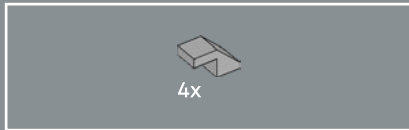
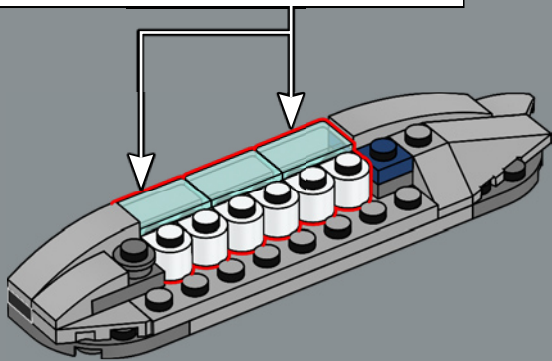
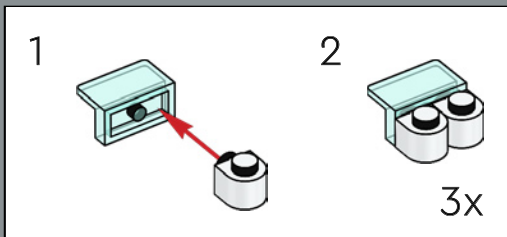

65

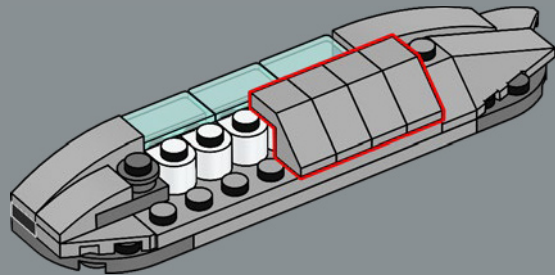

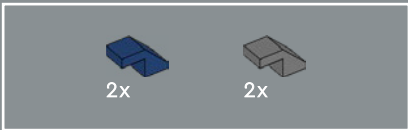

66

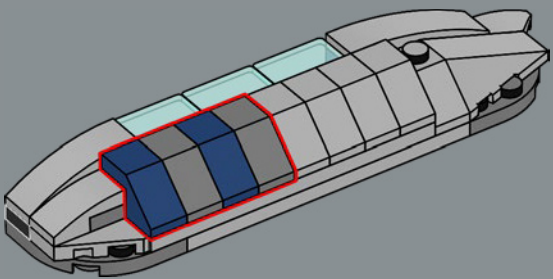

67

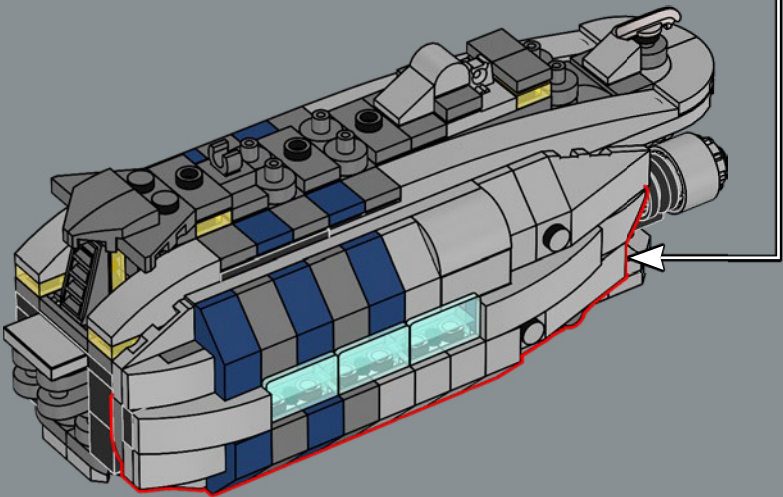

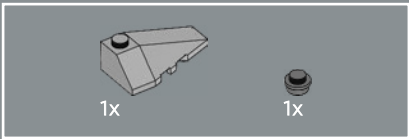

68

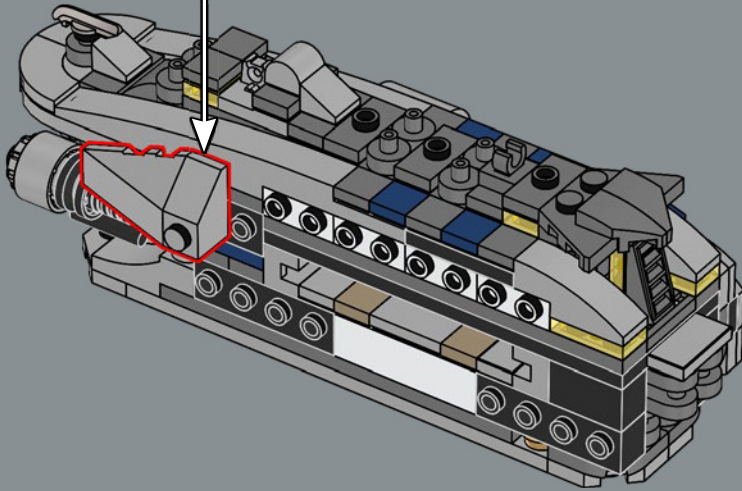
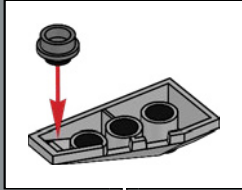

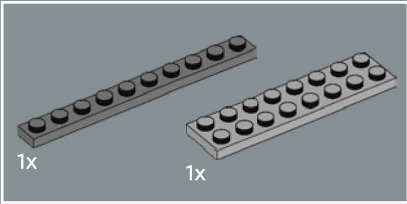
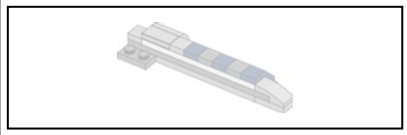

69

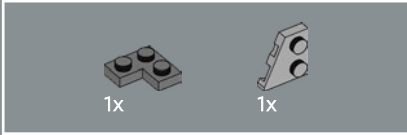
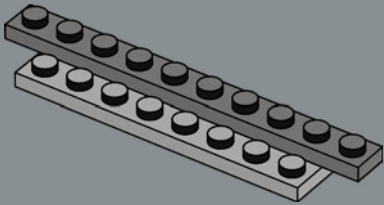

70

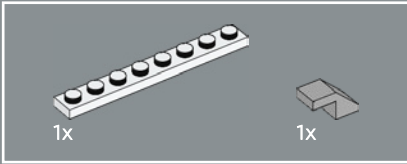
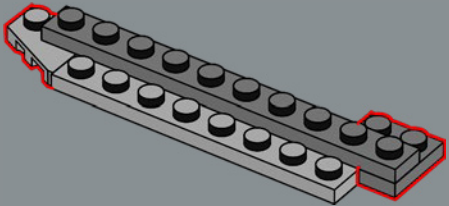

71

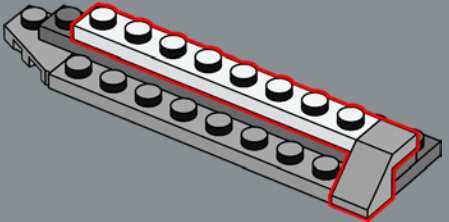

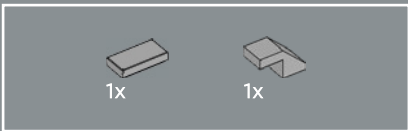

72

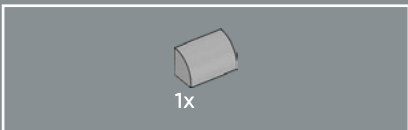
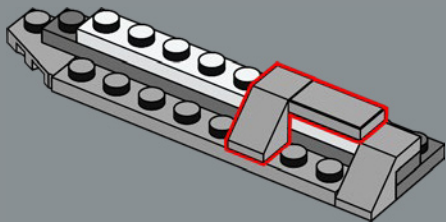

73

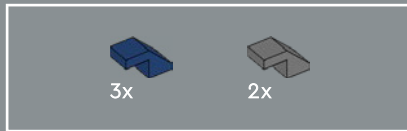
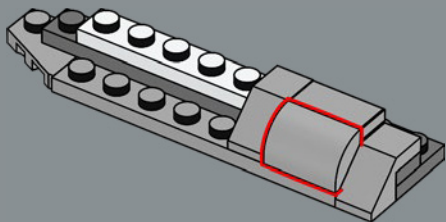

74

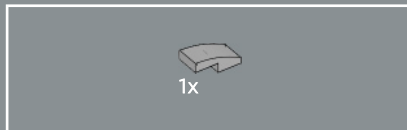
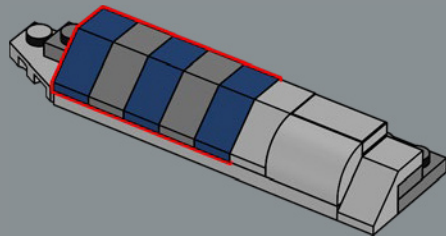

75

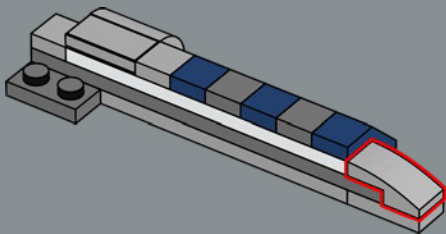

76

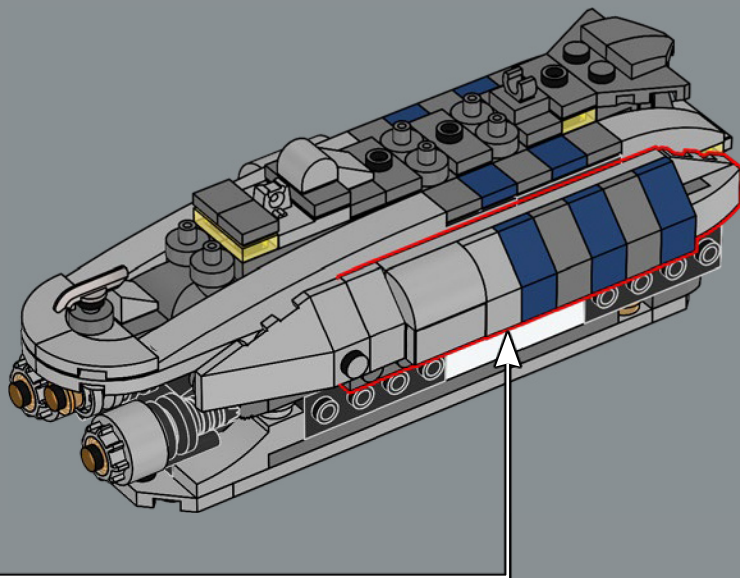

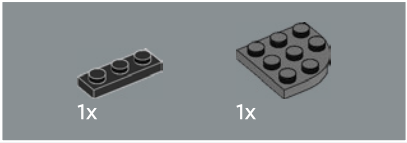
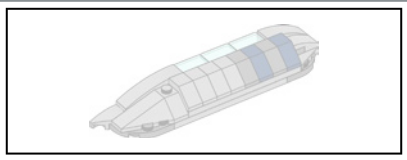

77

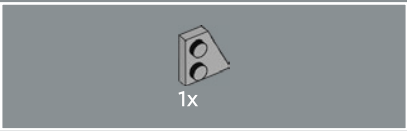
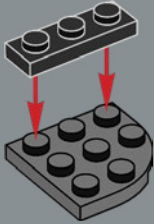

78

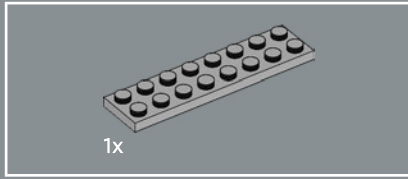
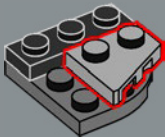

79

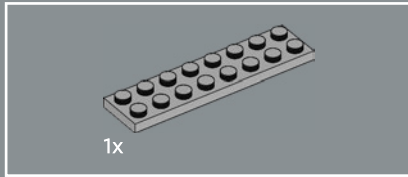
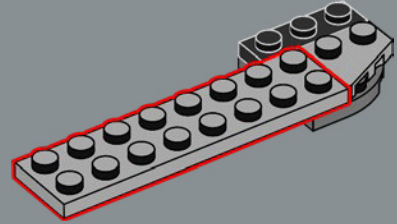

80

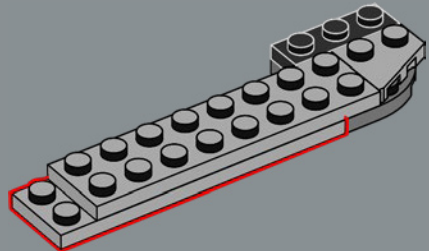

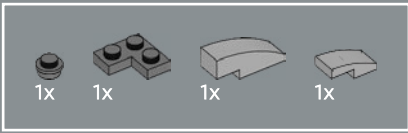

81

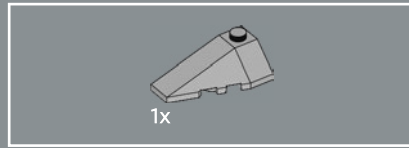
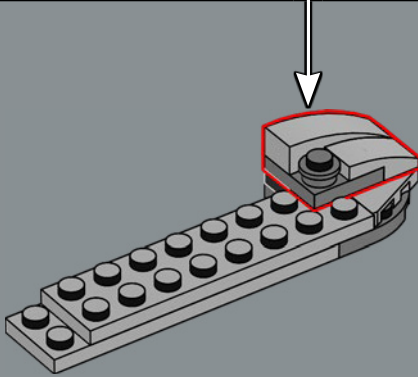
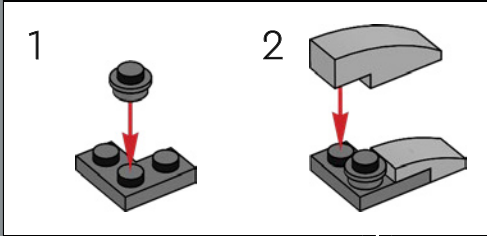

82

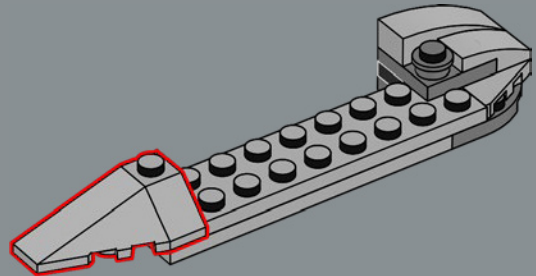

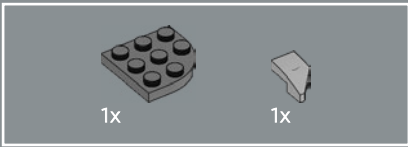

83

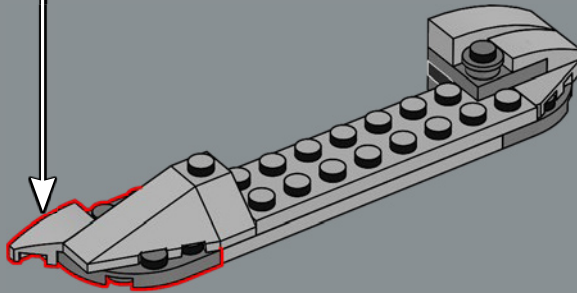
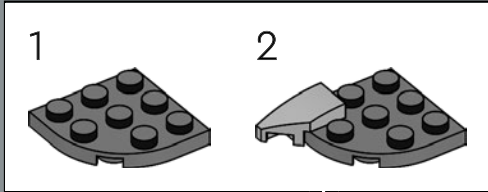

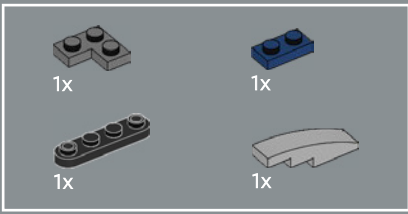

84

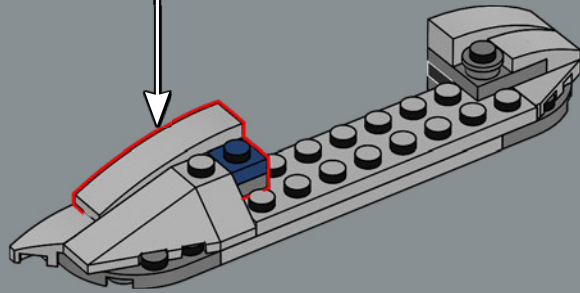
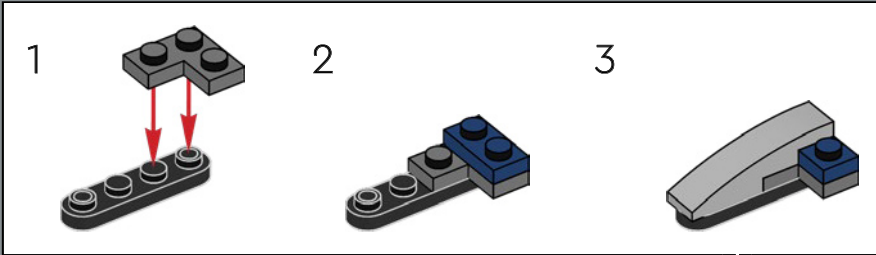

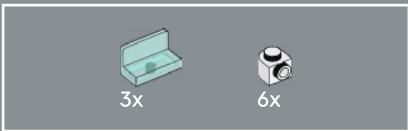

85

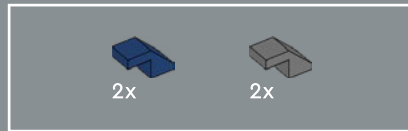
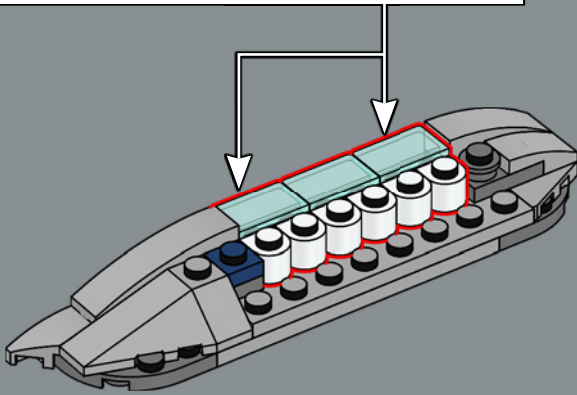
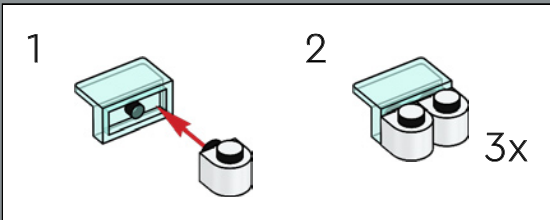

86

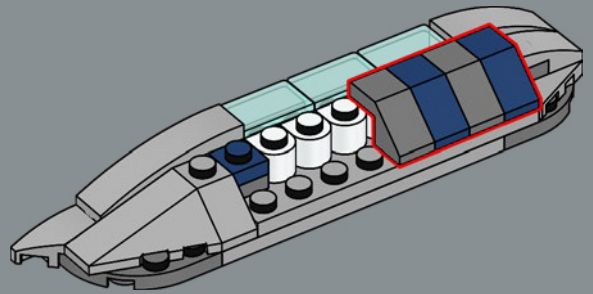



4x

87

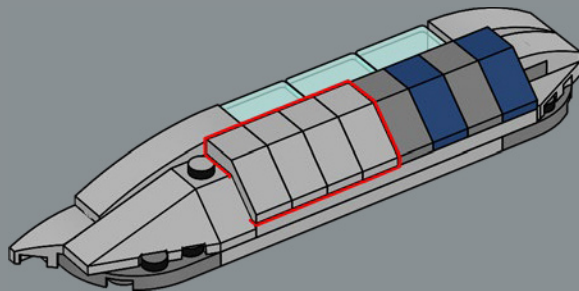

88

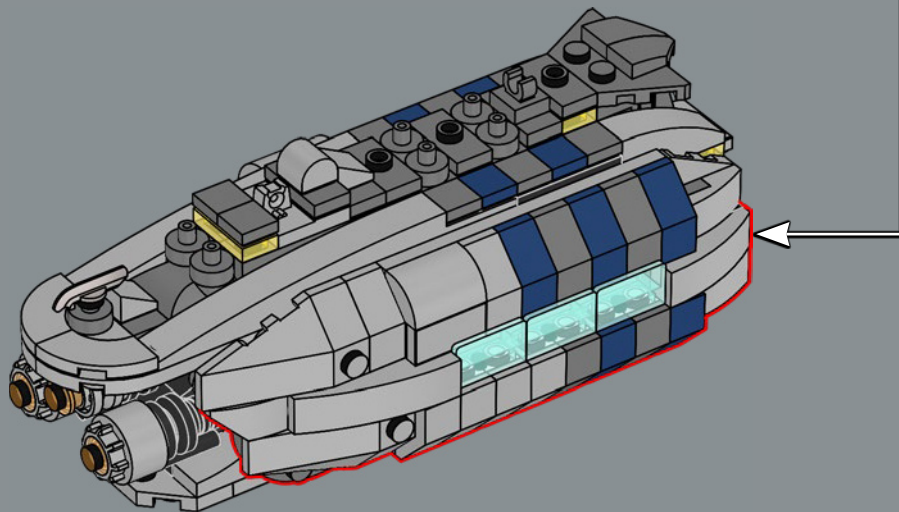

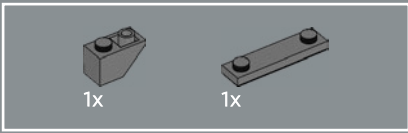

89

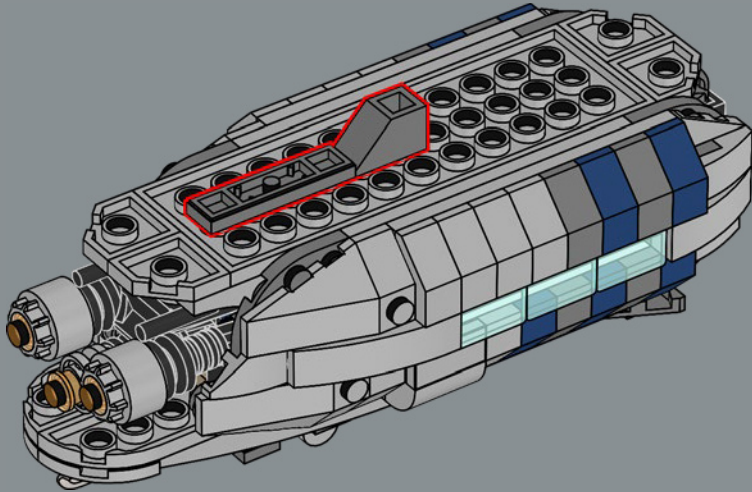

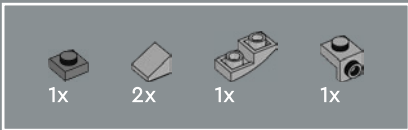

90

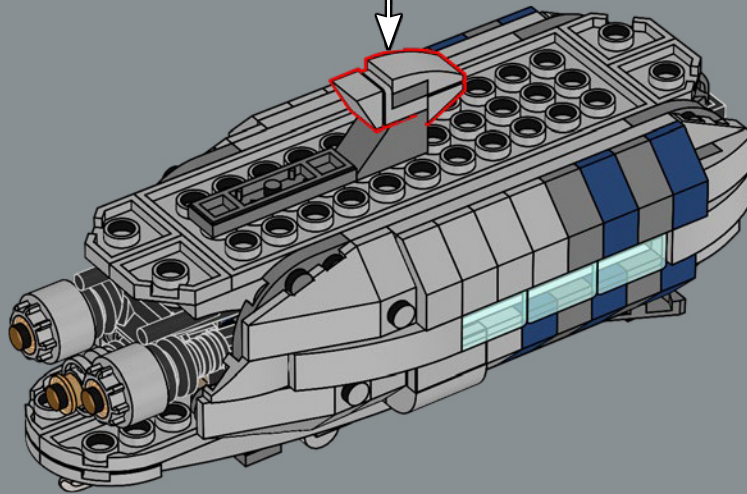
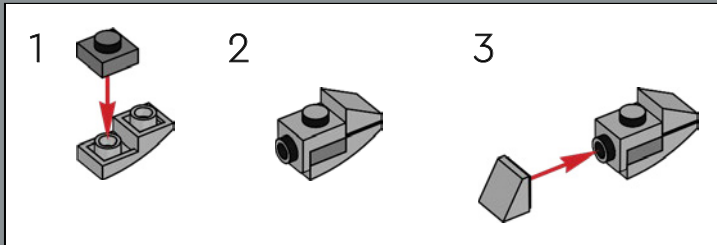

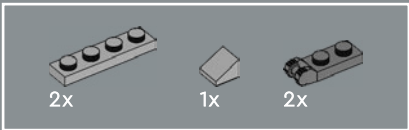

91

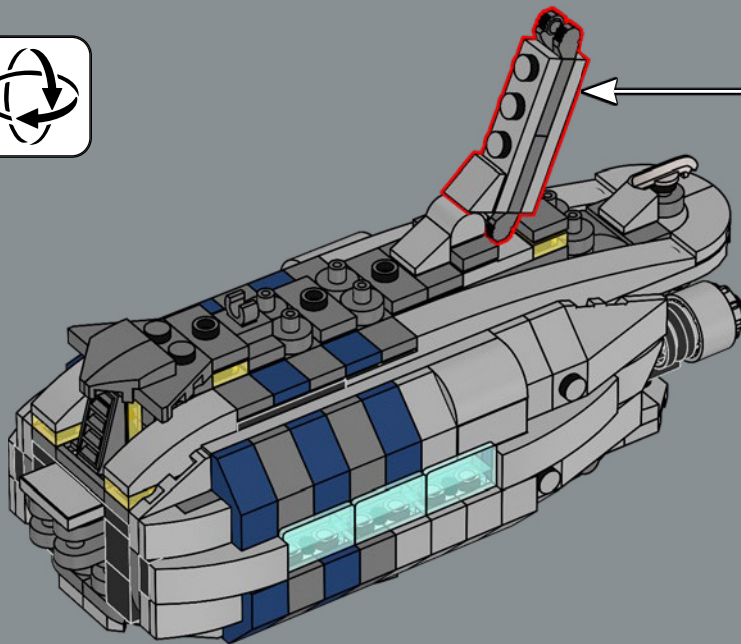
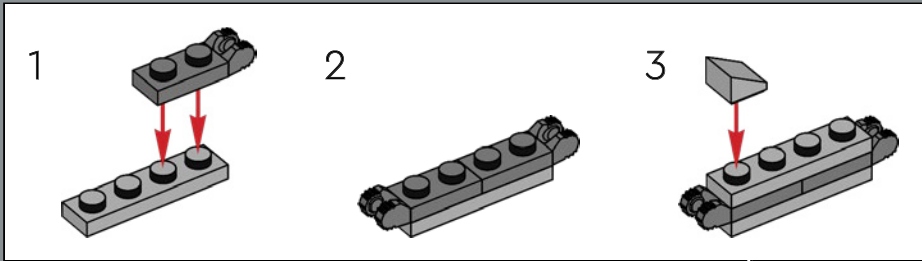

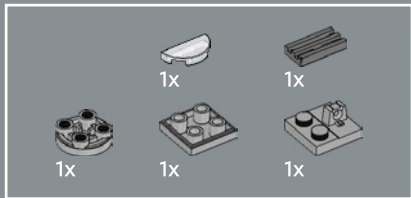

92

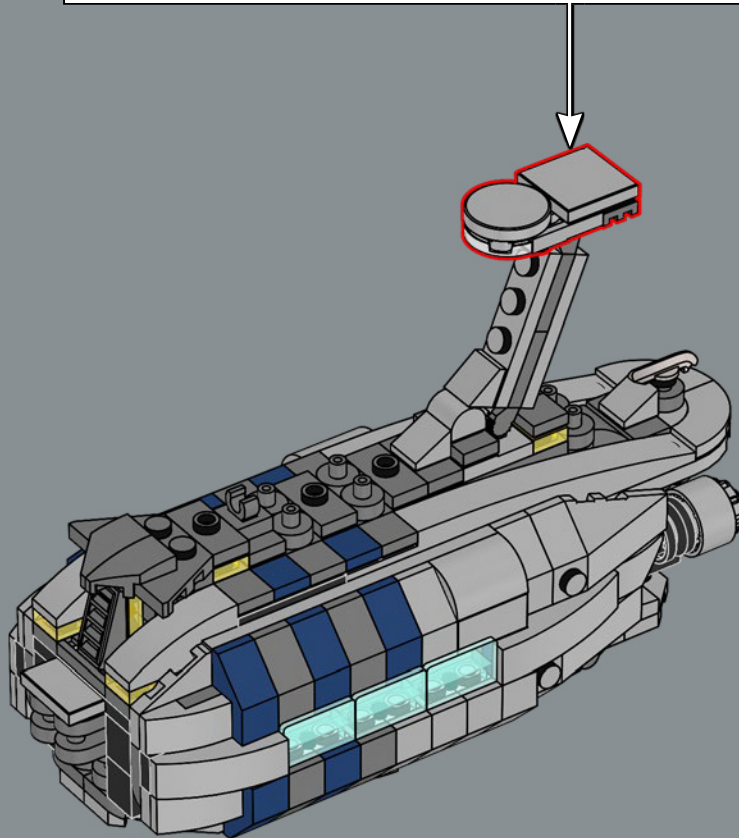
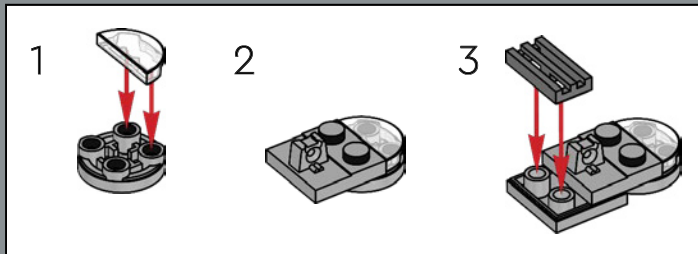



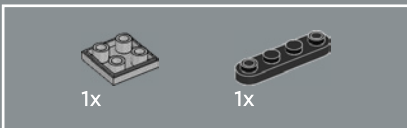
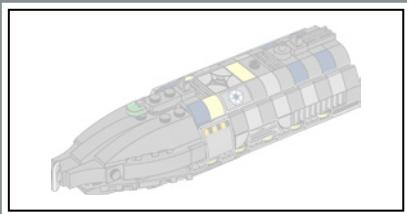

93

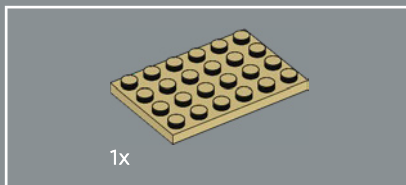
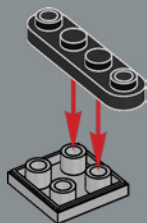

1x

94

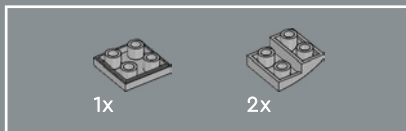
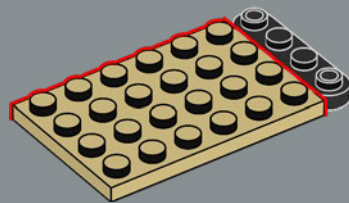

95

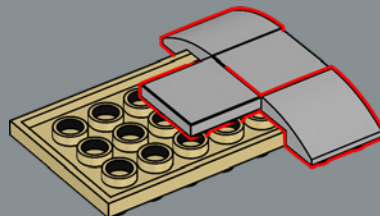

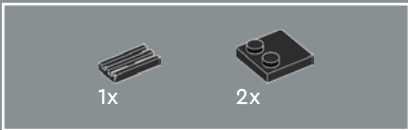

99

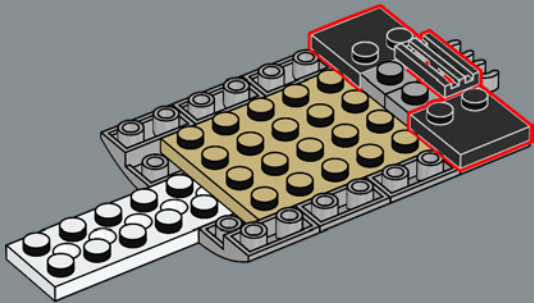

100

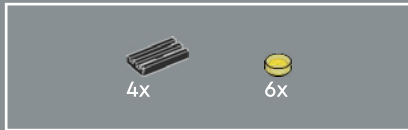
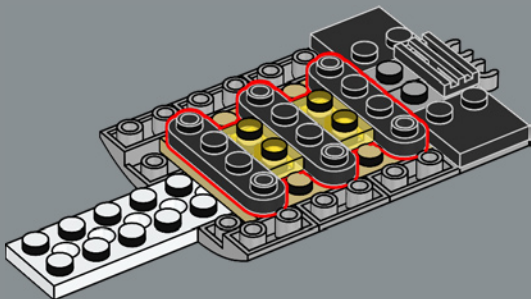

101

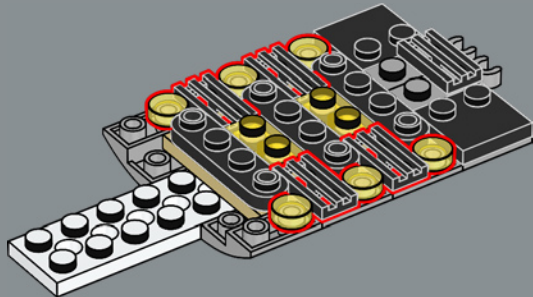

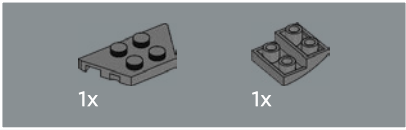
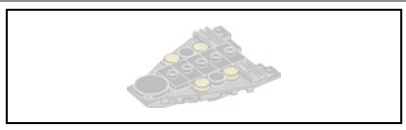

102

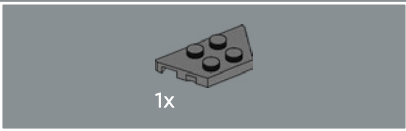
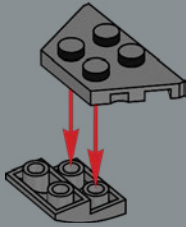

103

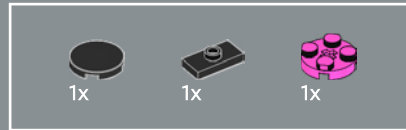

104

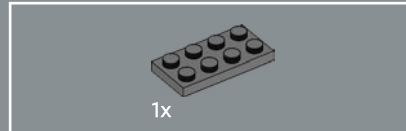
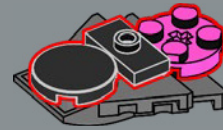

105



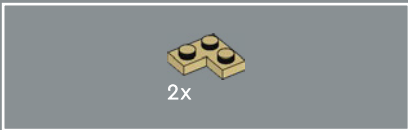

106



107

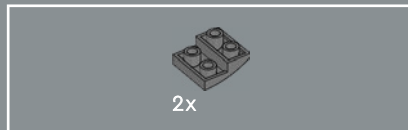
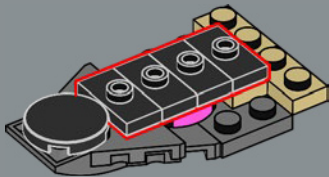

108

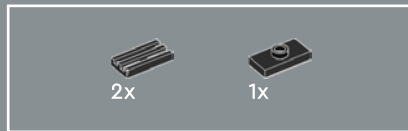
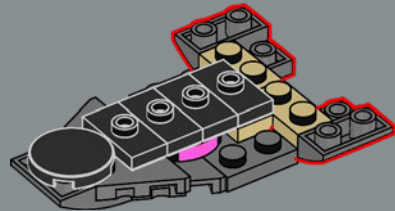

109

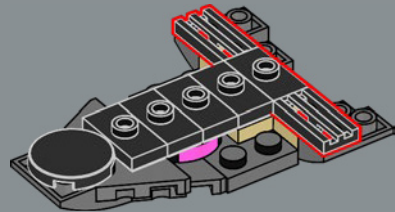

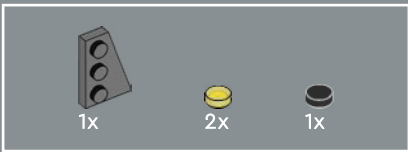

110

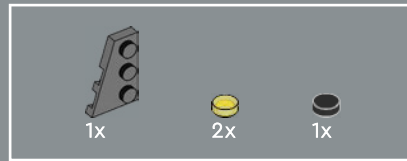
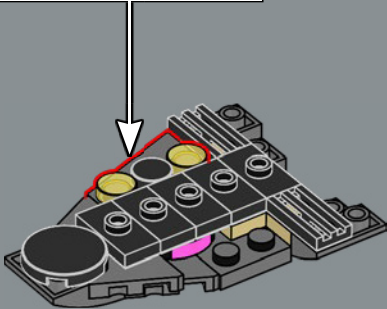
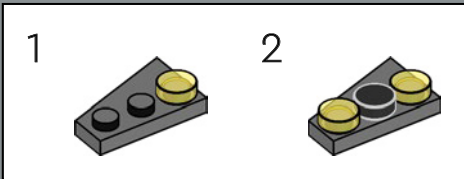

111

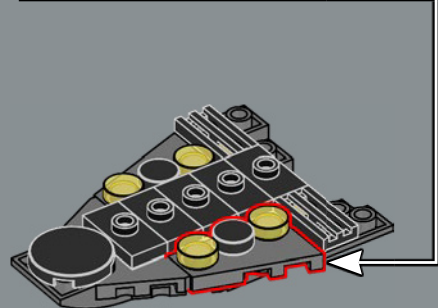
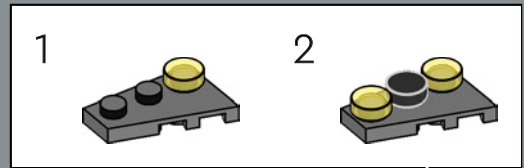

112

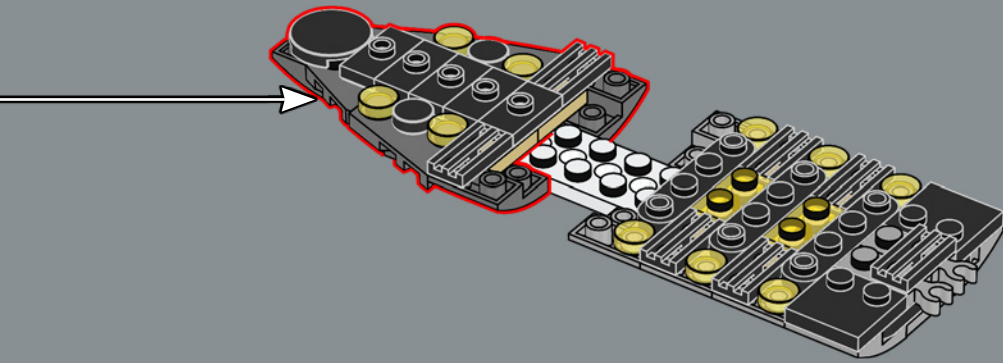

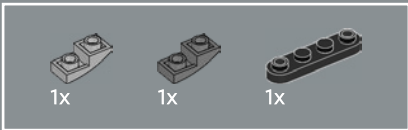

113

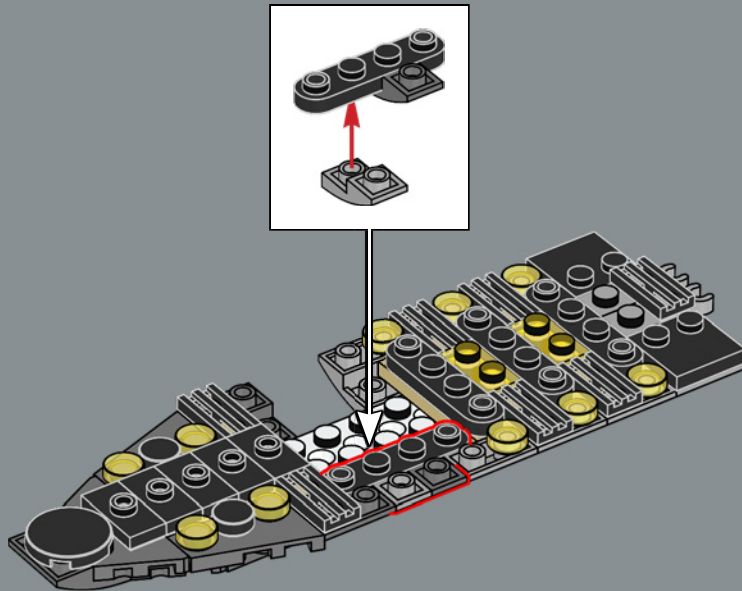

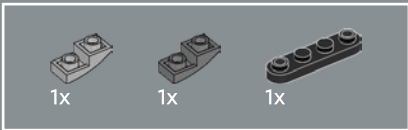

114

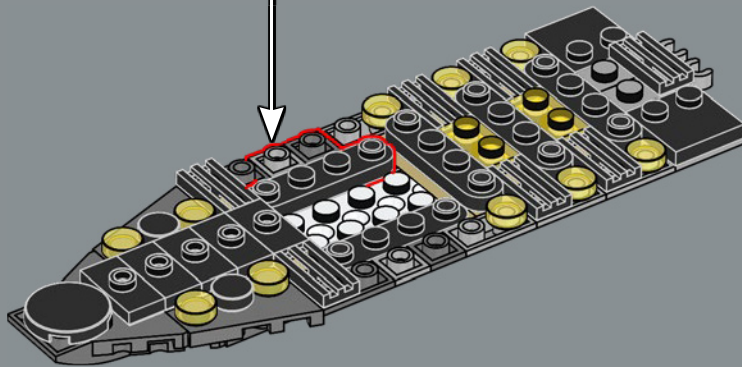
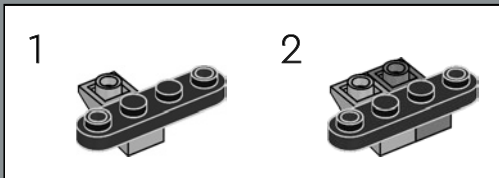

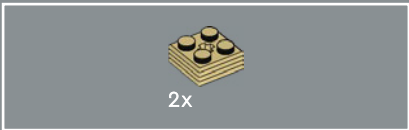

115

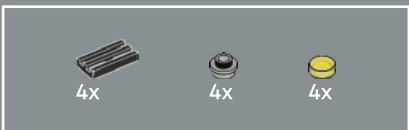
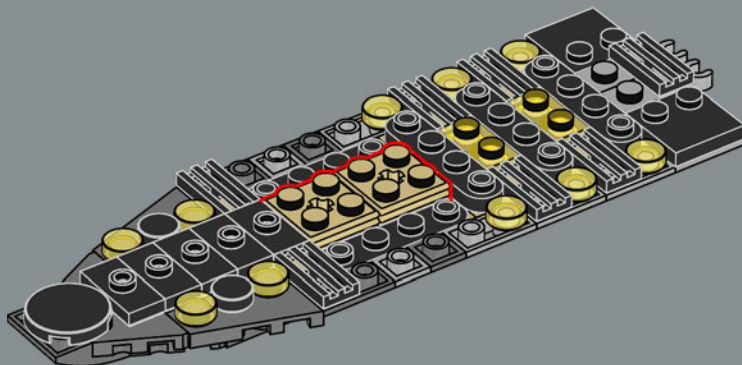

116

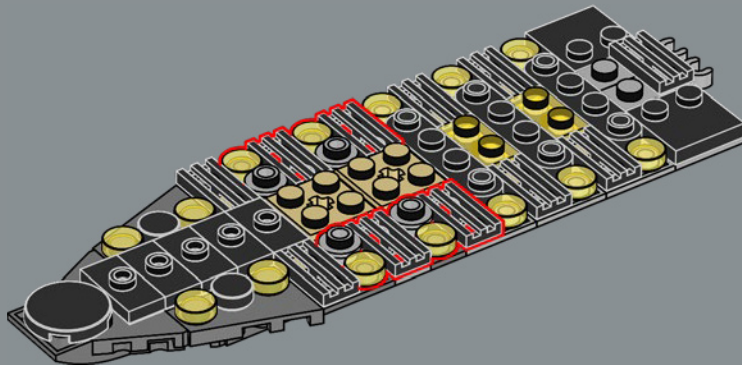

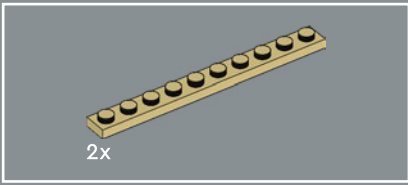

117

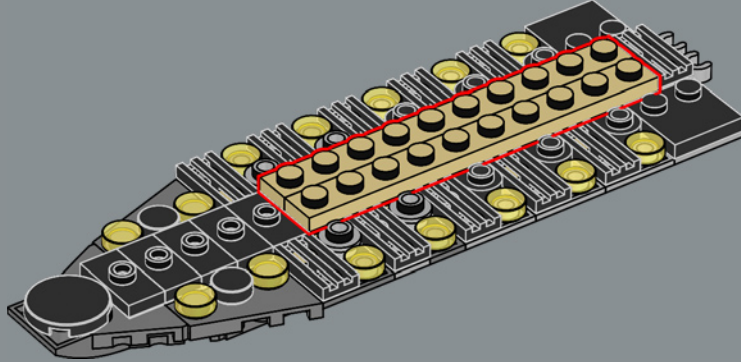

118

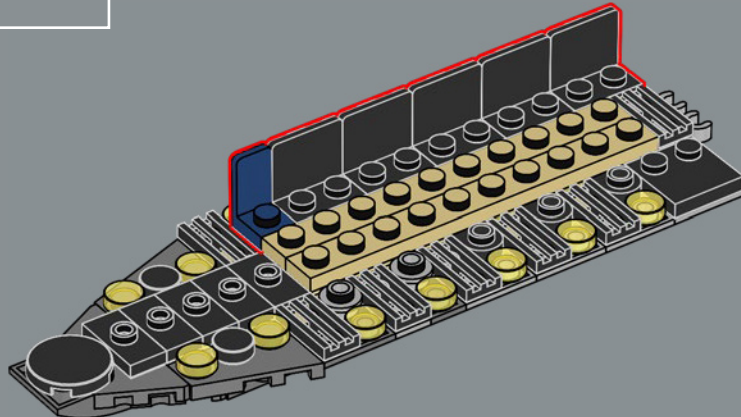



119

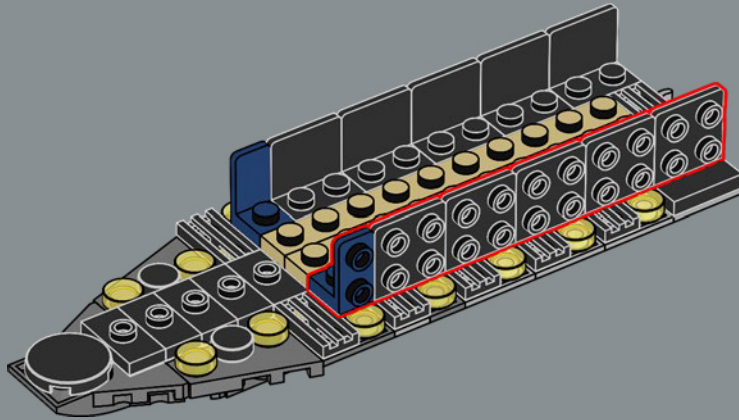

120

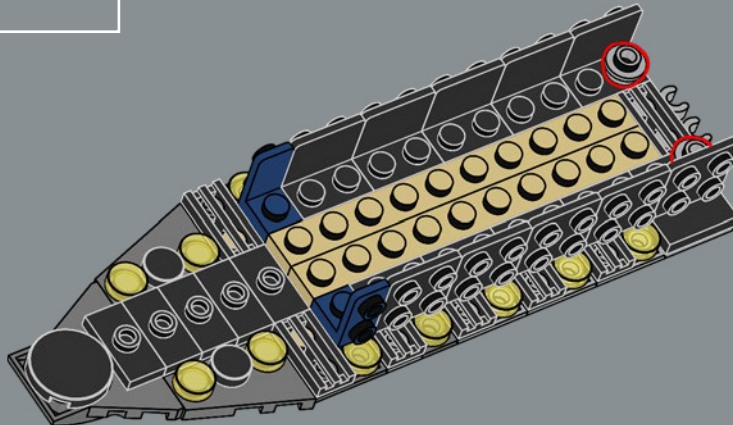

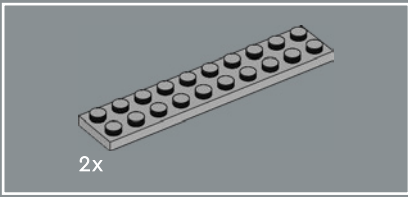

121

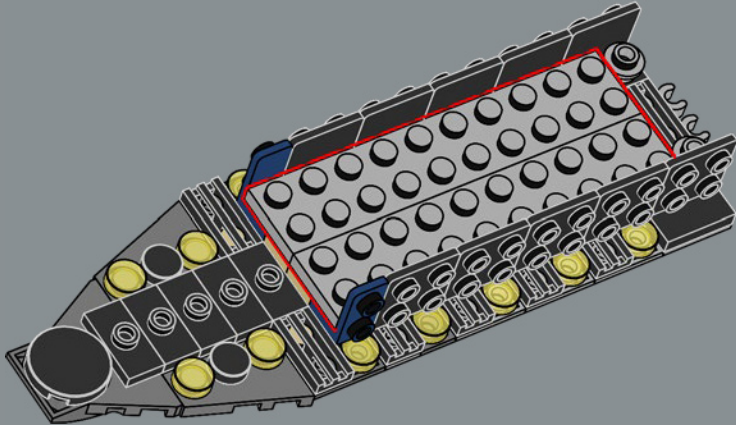



122

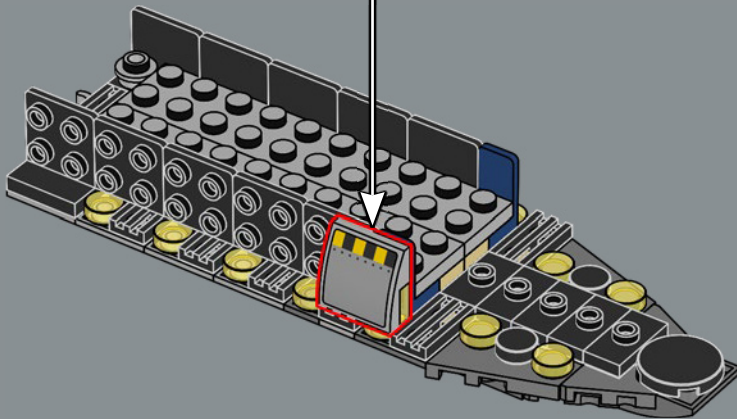
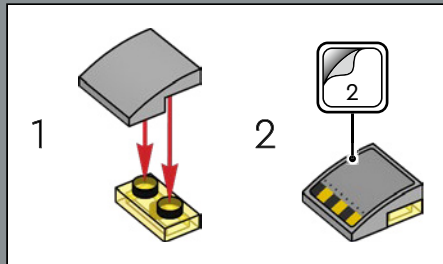



123

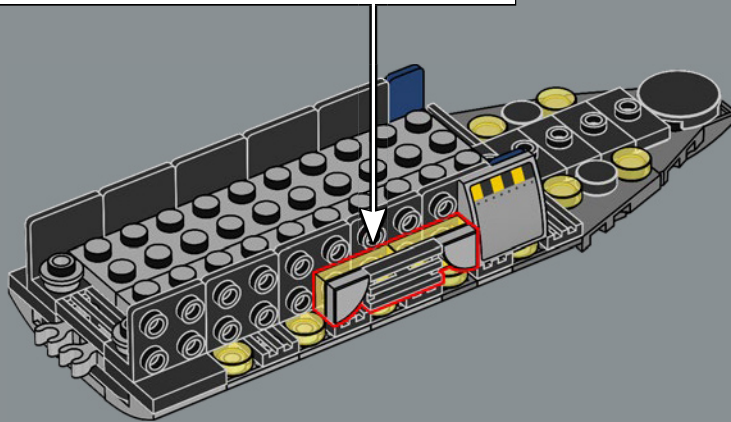
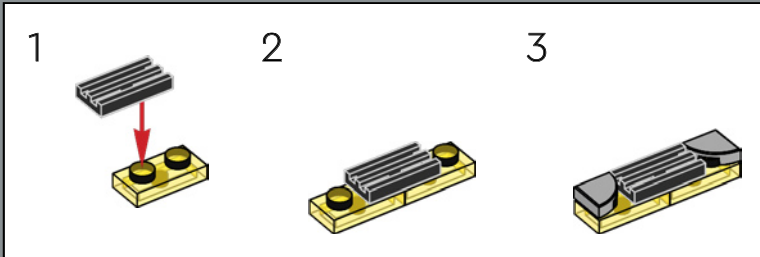



124

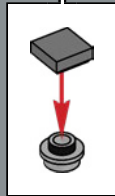
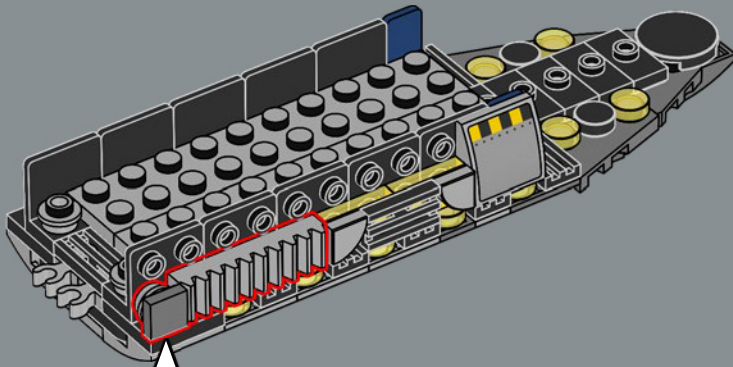

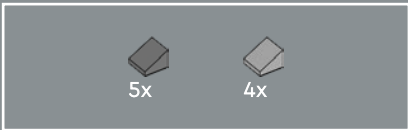

125

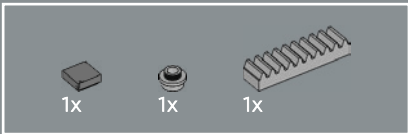
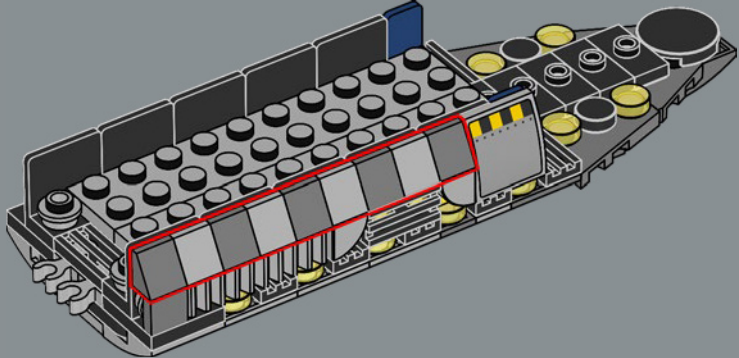

126

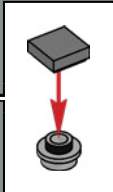
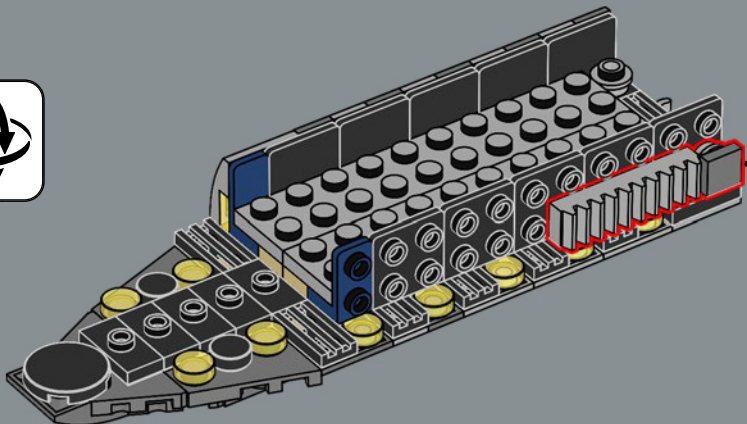



127

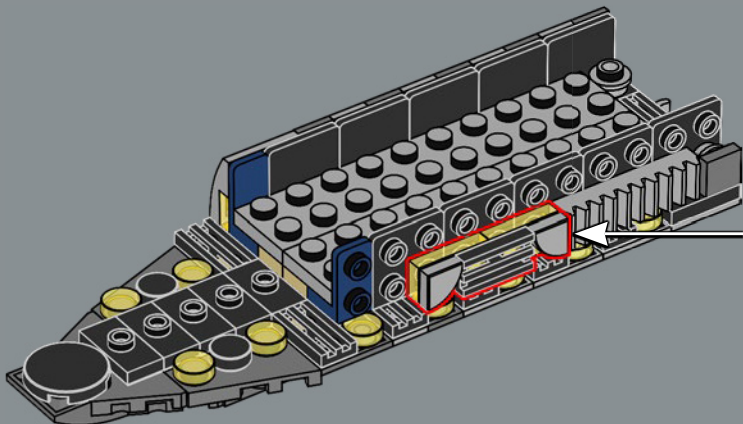
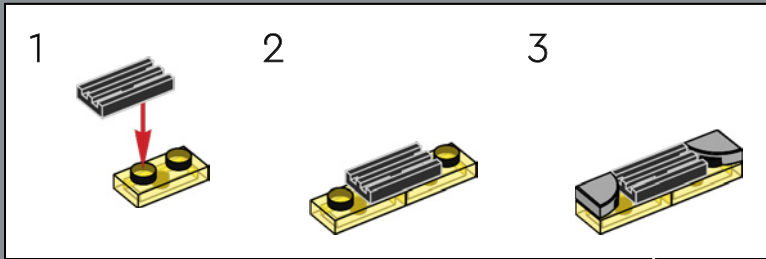



5x



4x

128

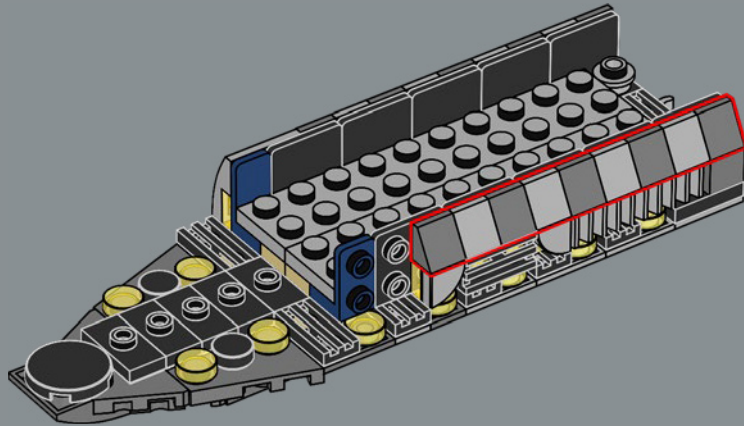

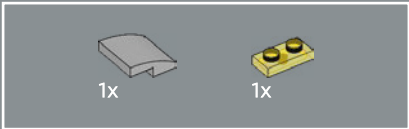

129

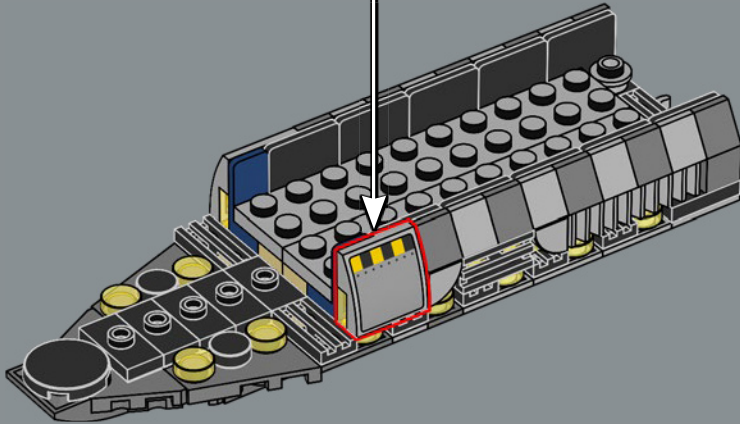
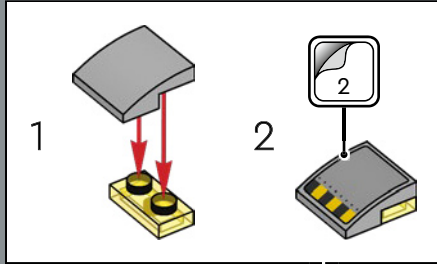



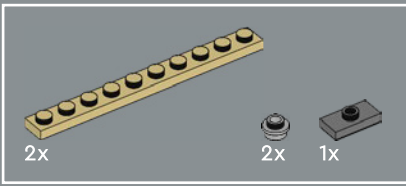

130

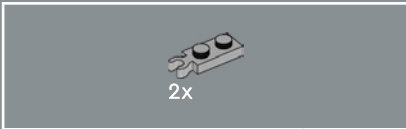
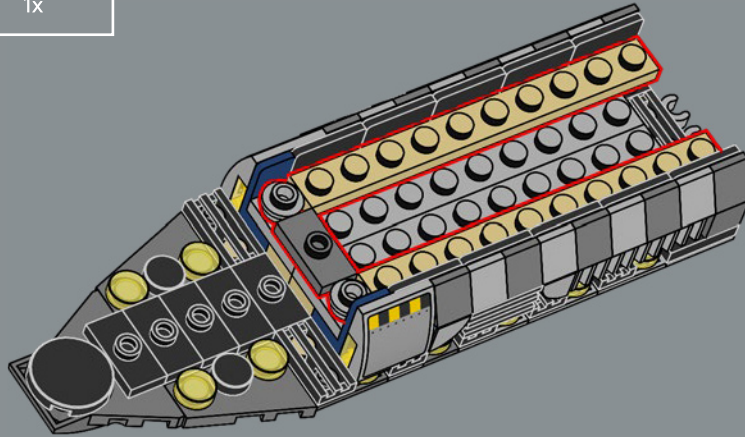

131

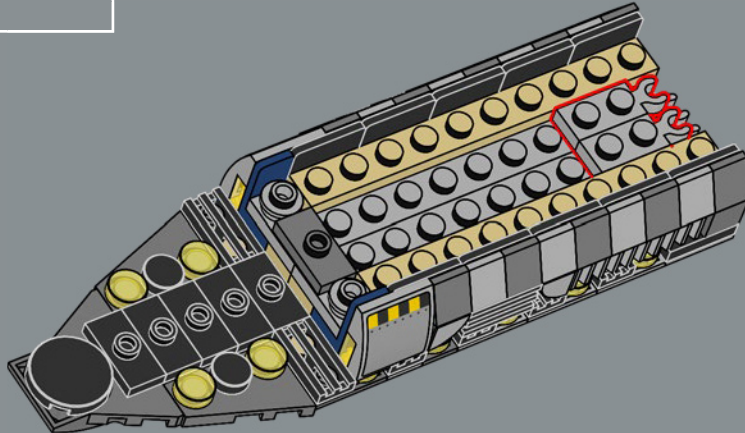

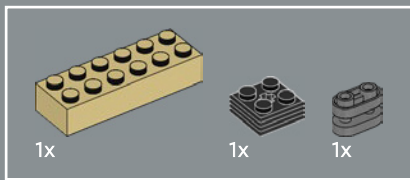

132

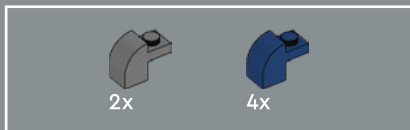
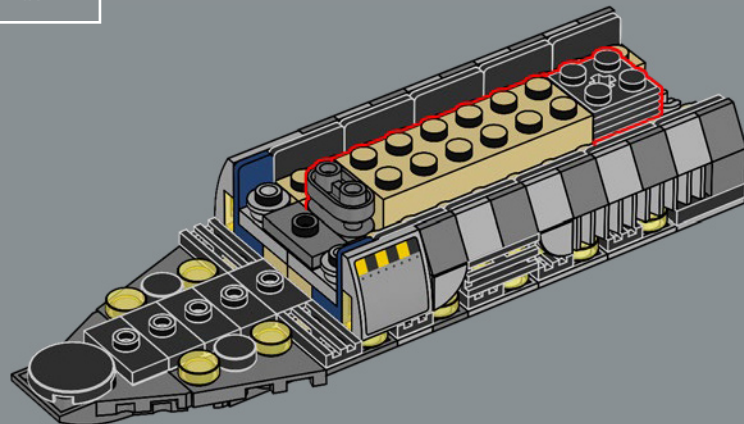

133

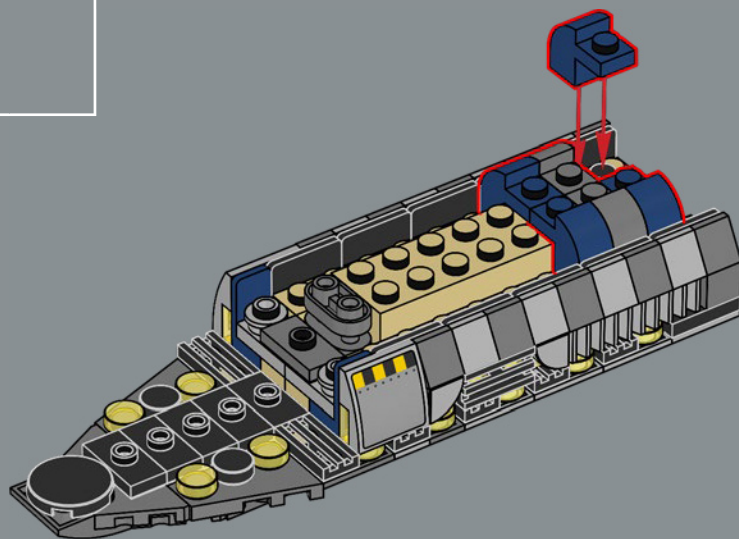

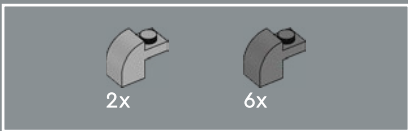

134

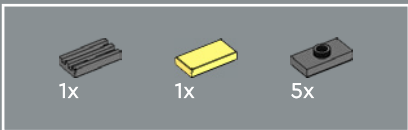
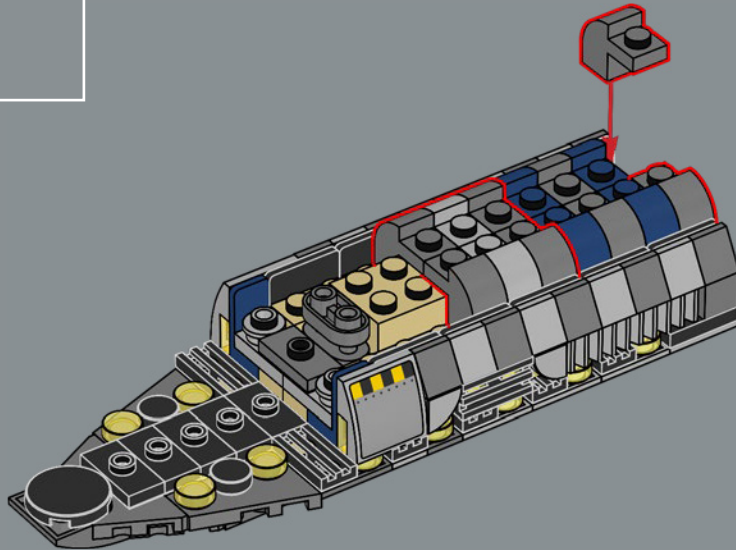

135

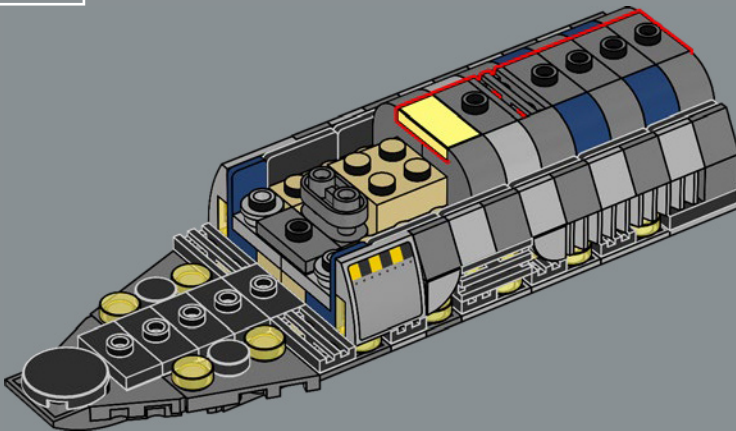



136

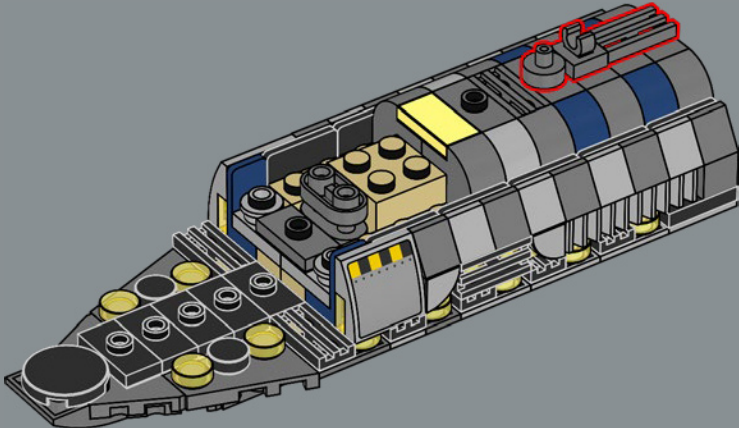



137

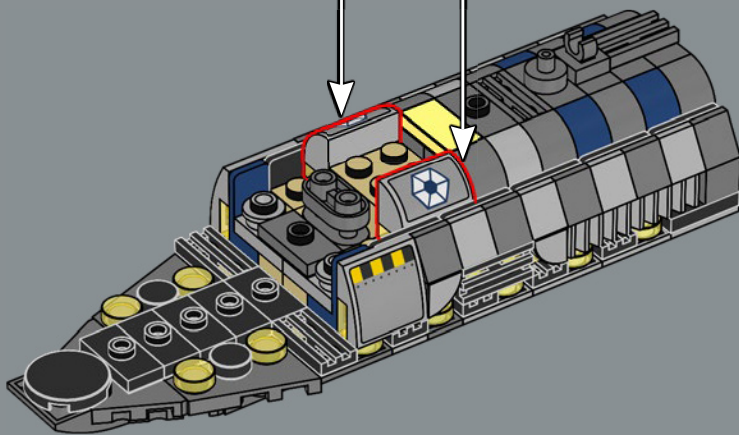
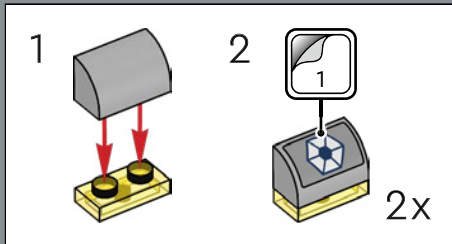

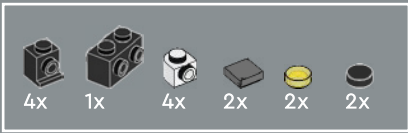

138

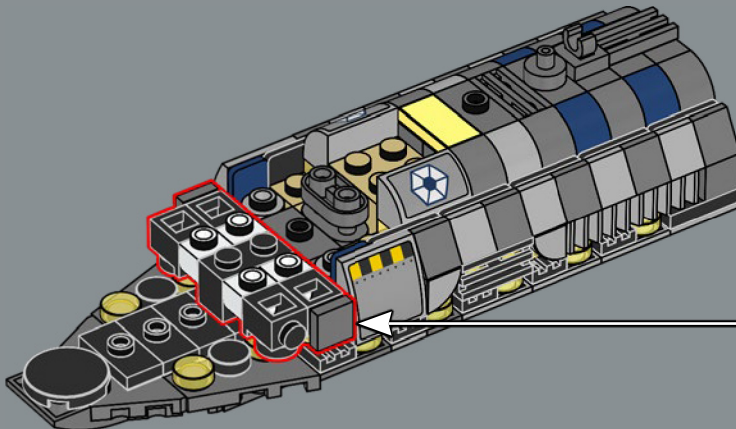
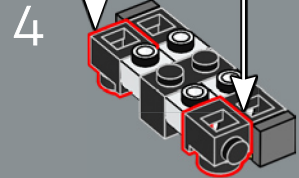
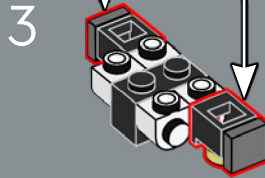
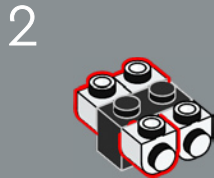
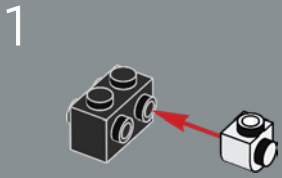
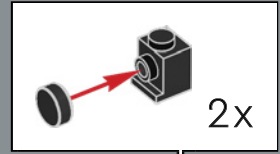
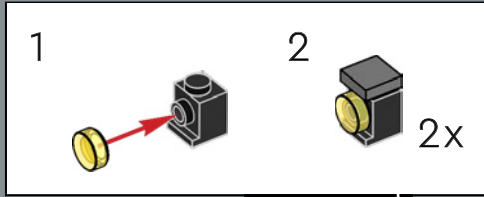



139

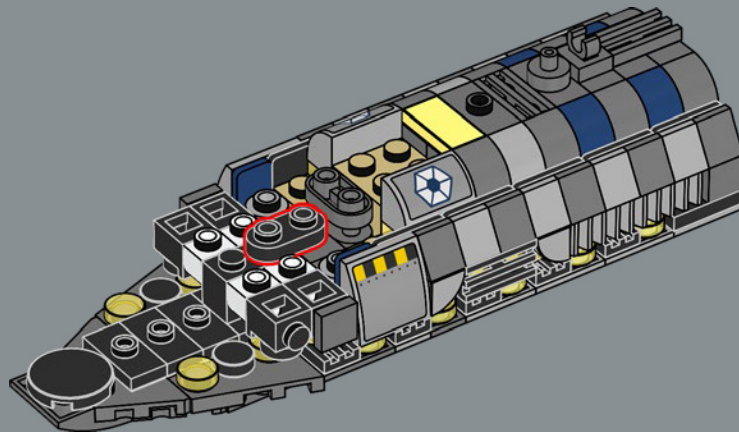

140

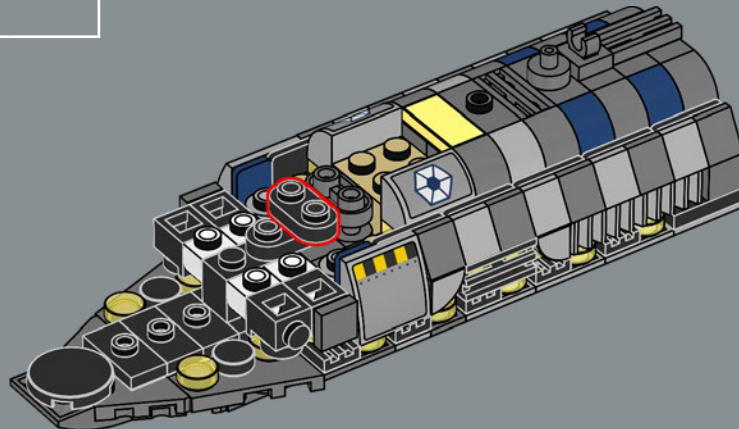

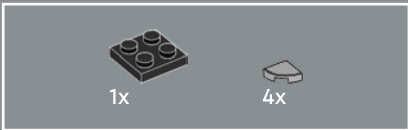

141

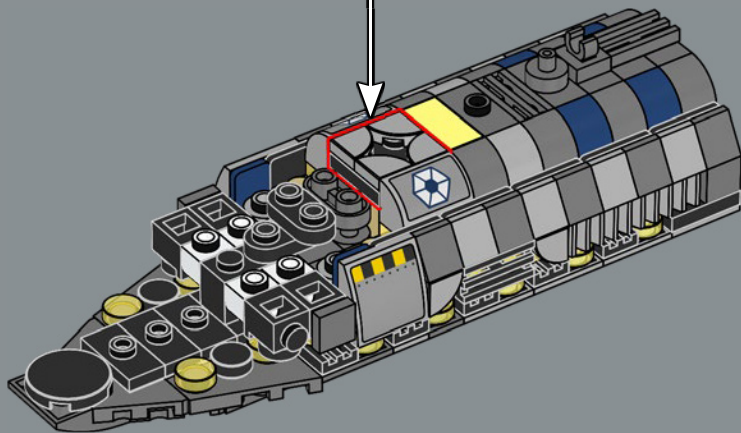
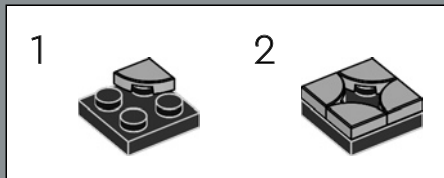



142

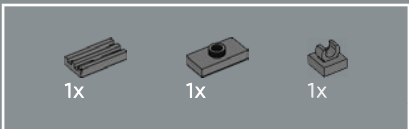
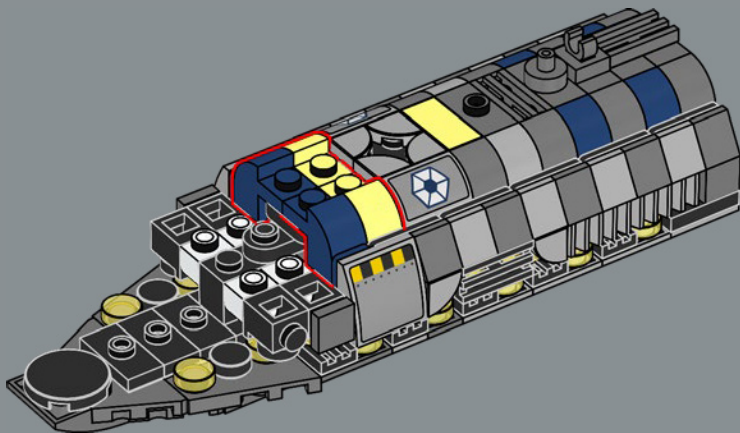

143

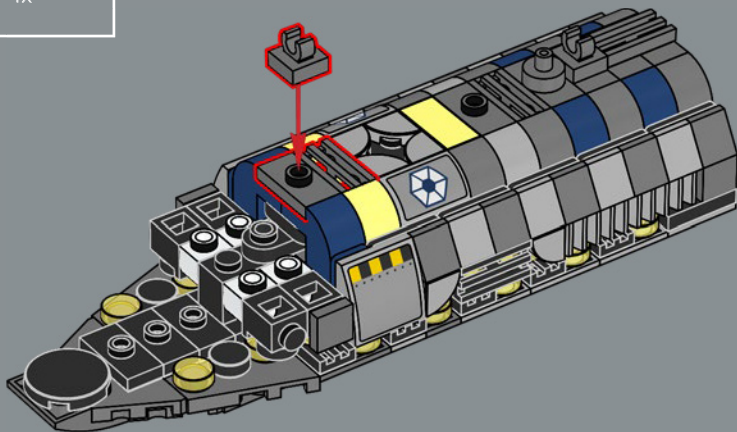



144

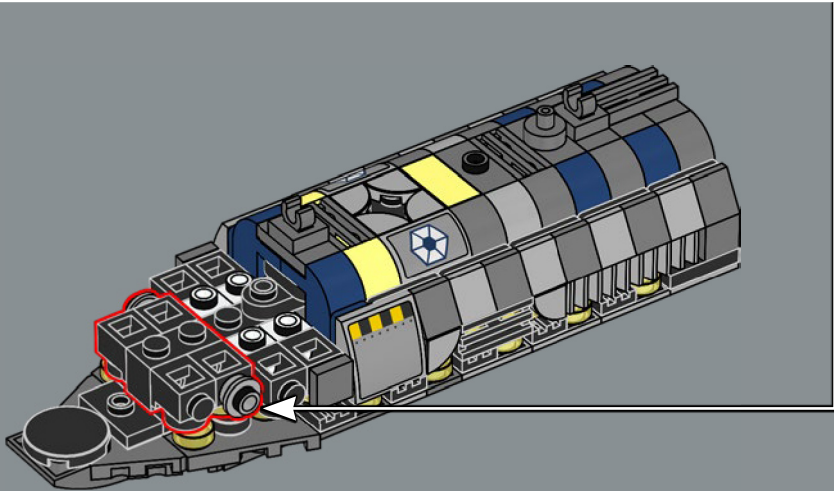
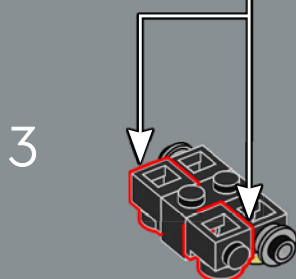
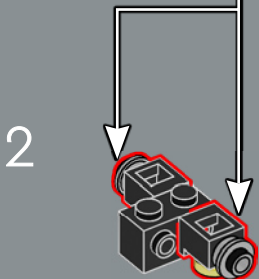
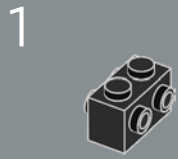
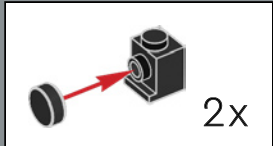
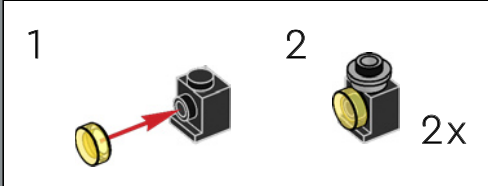

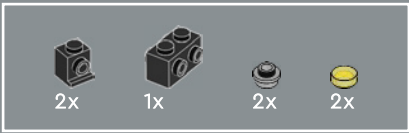

145

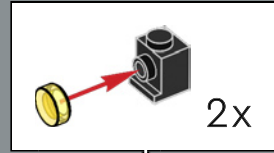

1

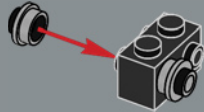

2

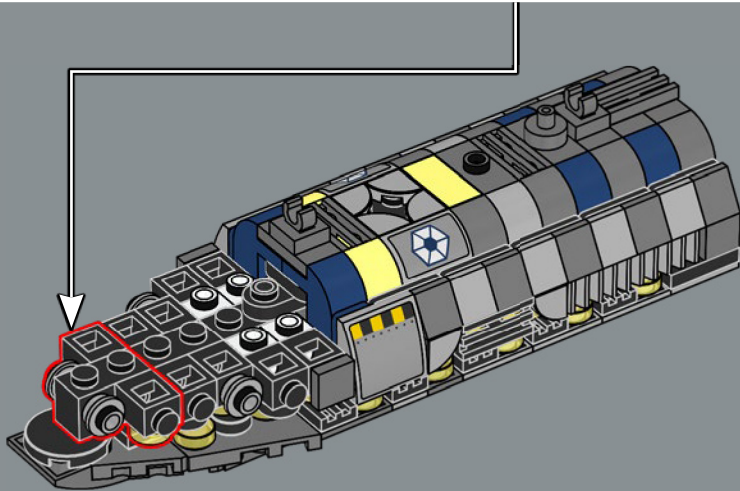
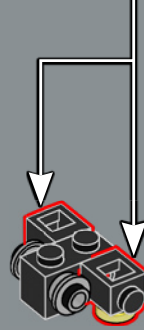

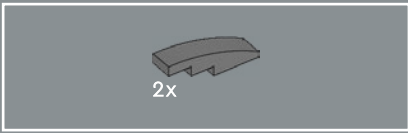

146

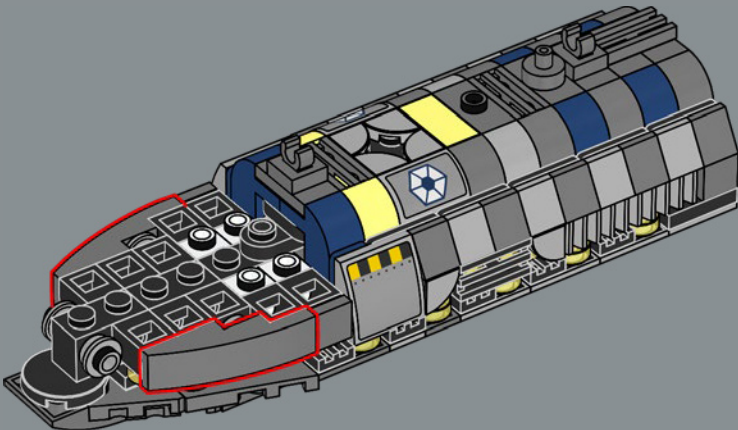

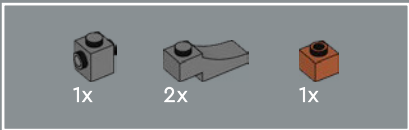

147

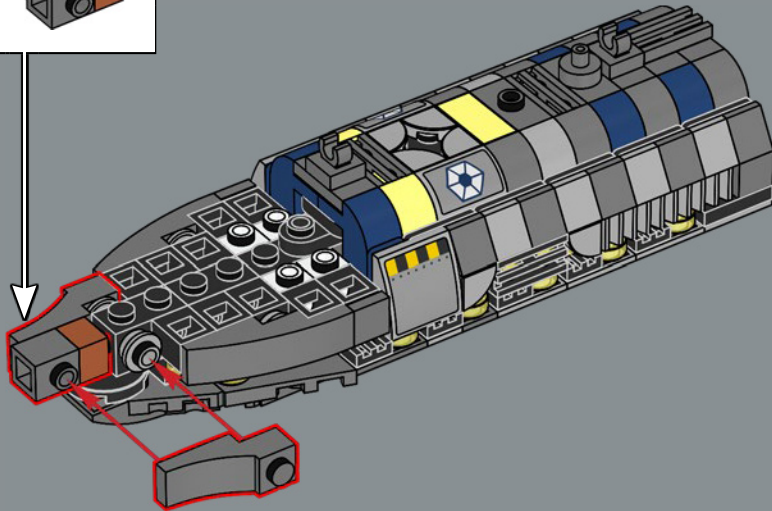
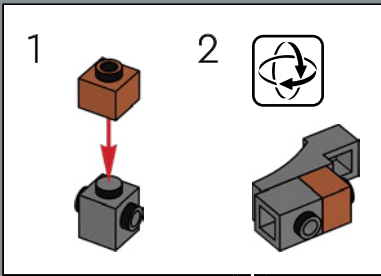

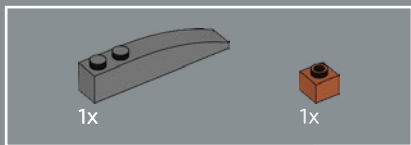

148

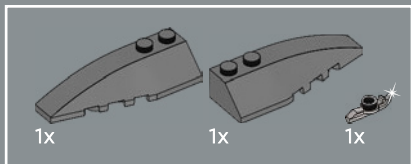
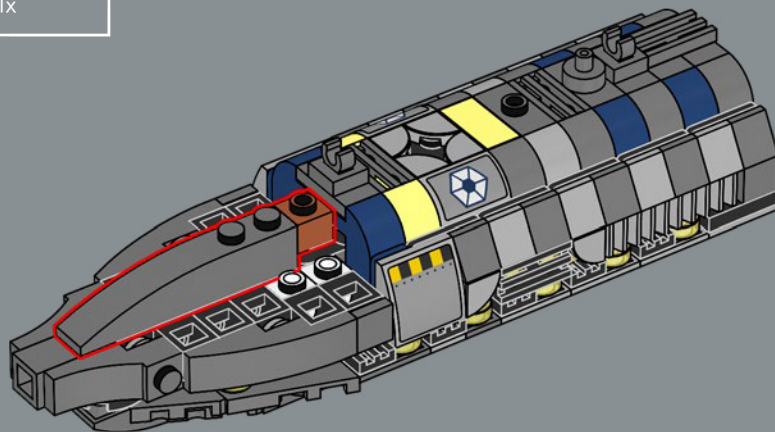

149

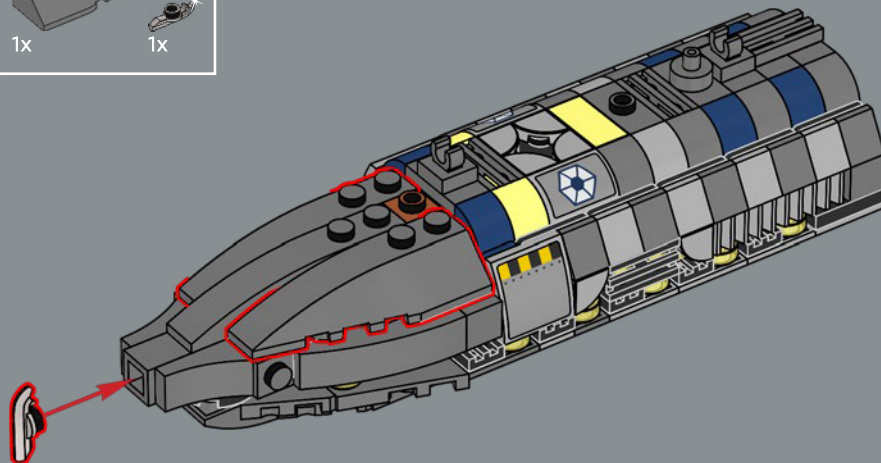

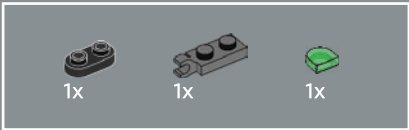

150

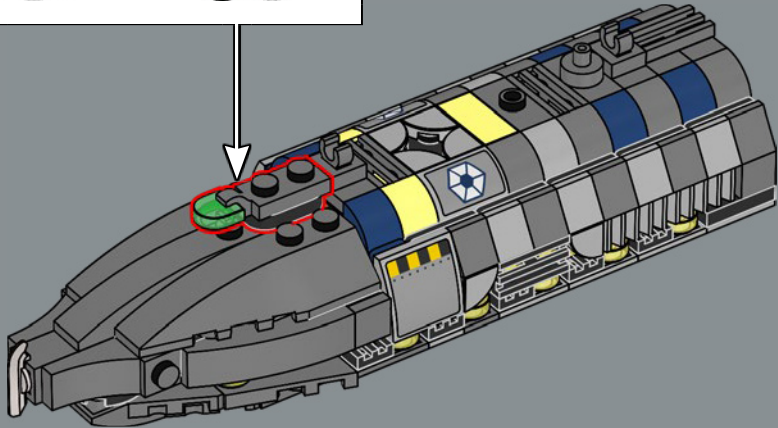
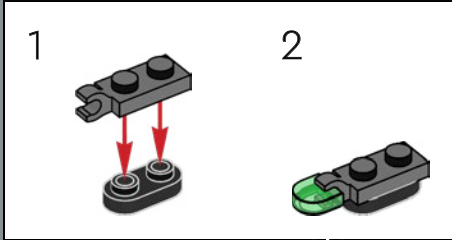

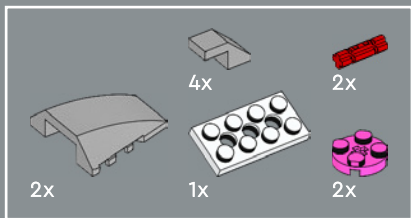

151

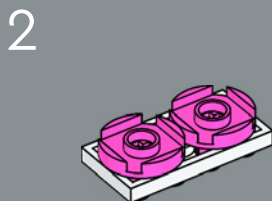
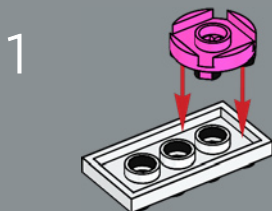

3

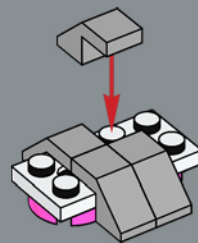

4

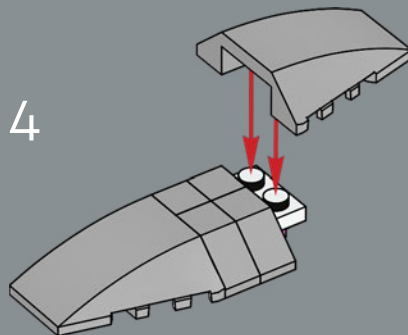

5

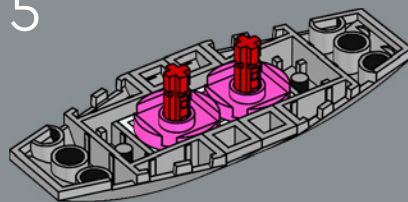

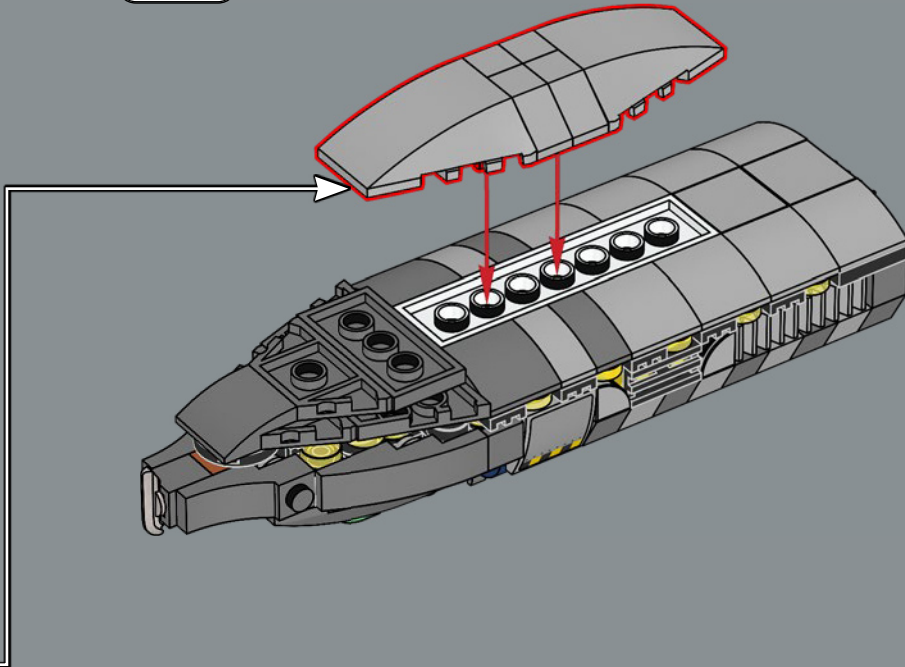

152

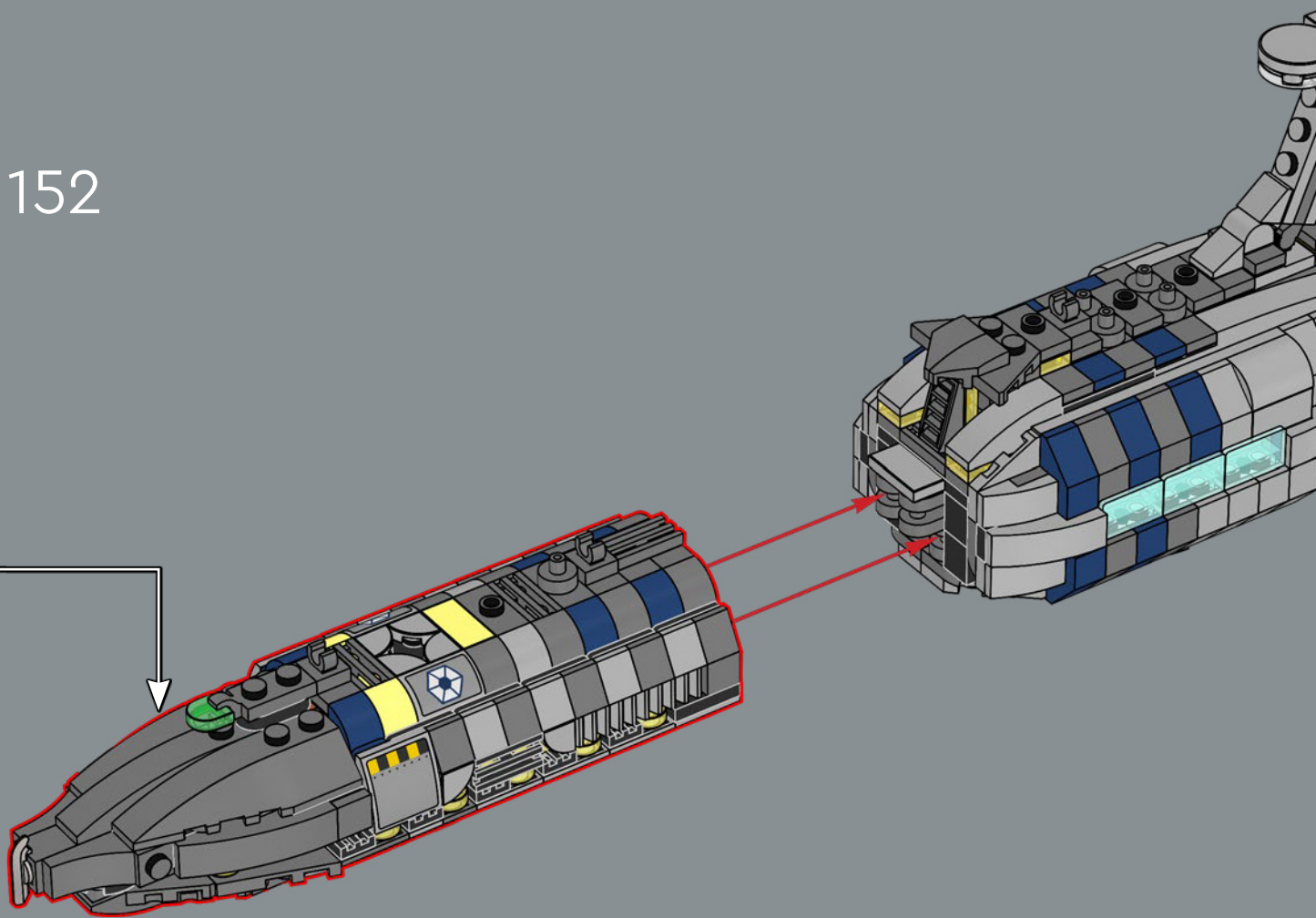

153

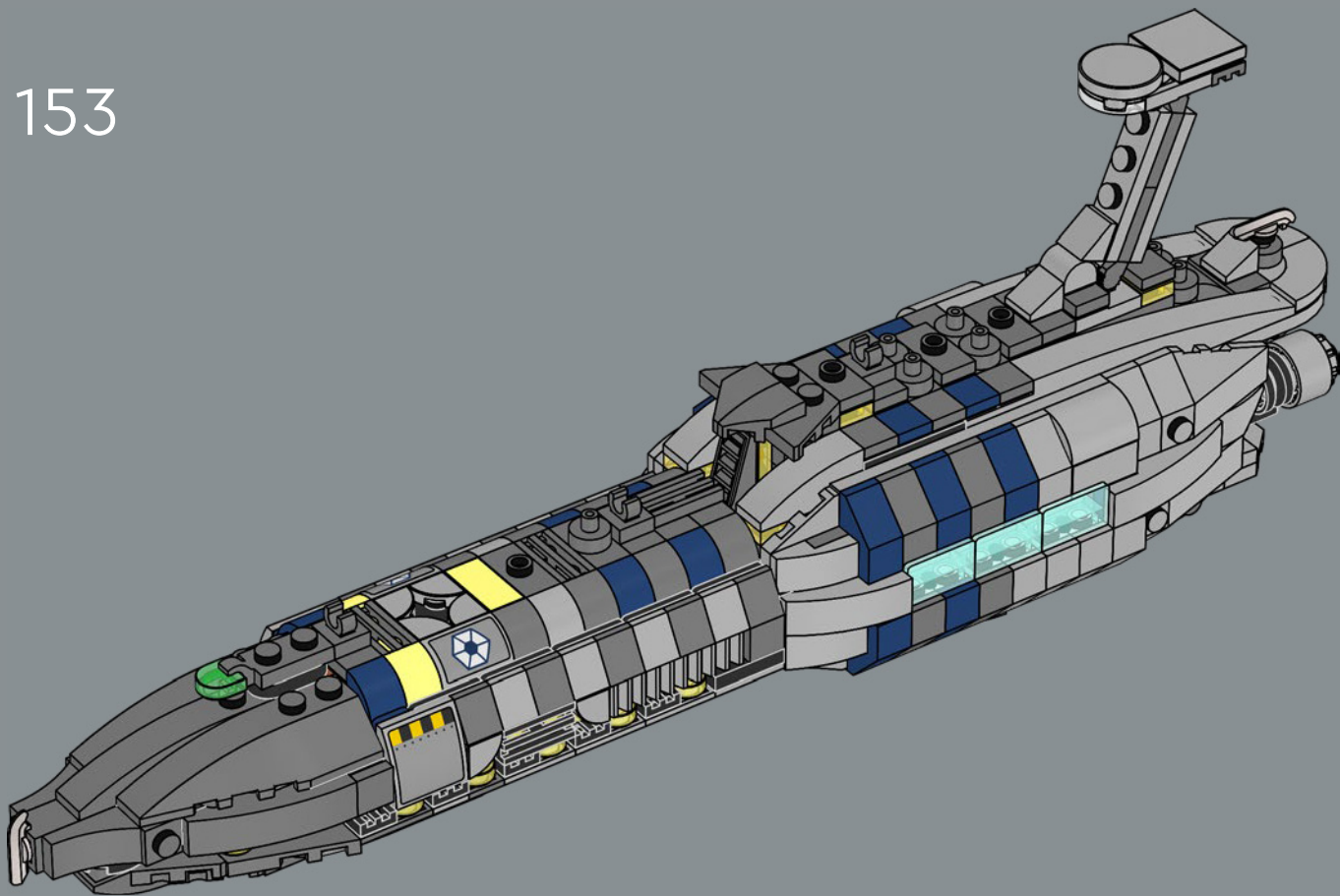

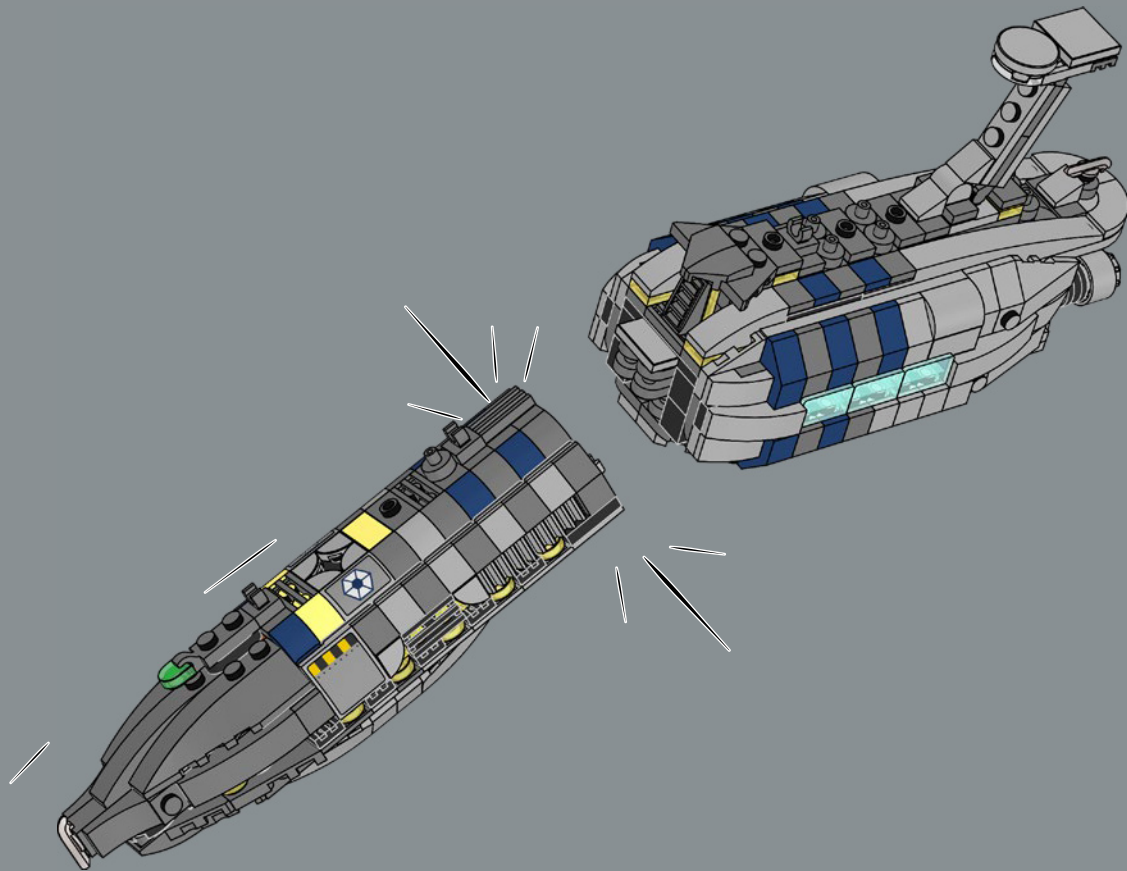

These connector bricks and clips allow the front half of the starship to be separated from the rear – in case you ever want to recreate the events of *Invisible Hand's* fiery landing!

Ces éléments de connexion permettent de séparer la moitié avant du vaisseau de l'arrière – au cas où vous voudriez recréer les événements de l'atterrissage enflammé de la *Main Invisible* !

Estos bricks y clips de conexión permiten separar la mitad delantera de la nave espacial de la trasera, ¡por si alguna vez quieres recrear los acontecimientos del agitado aterrizaje de la *Mano Invisible*!

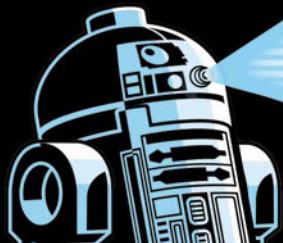



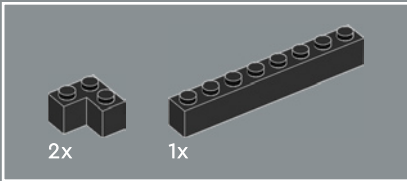
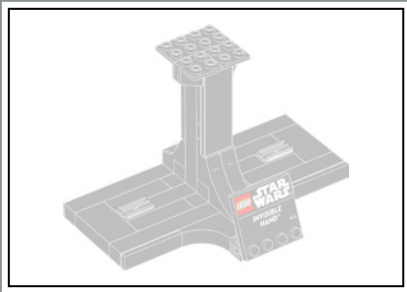

154

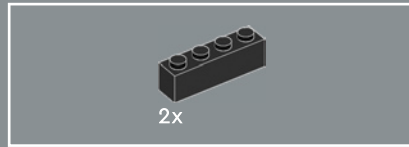
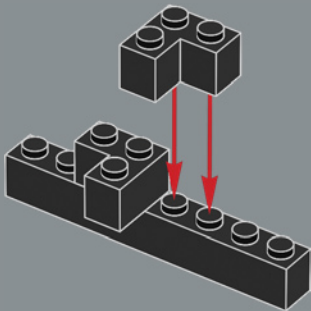

155

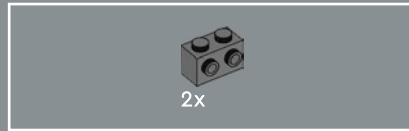
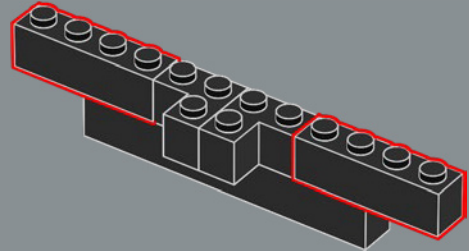

156

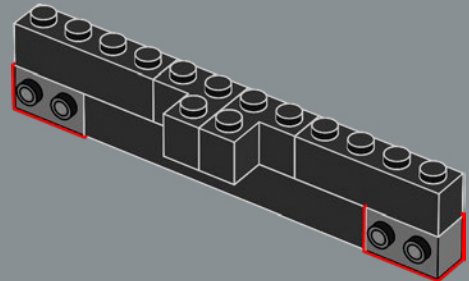

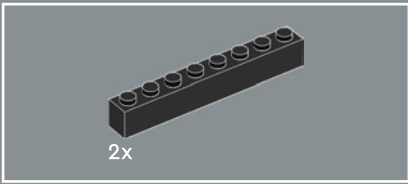

157

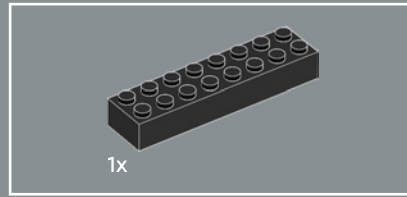
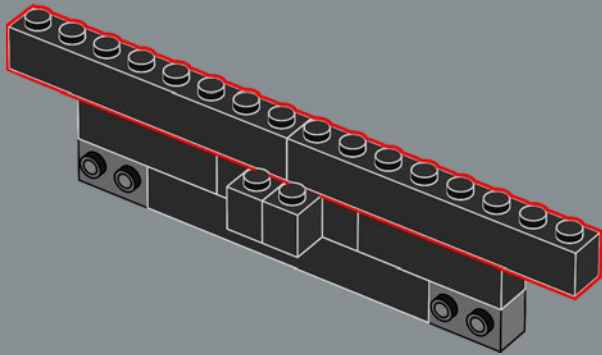

158

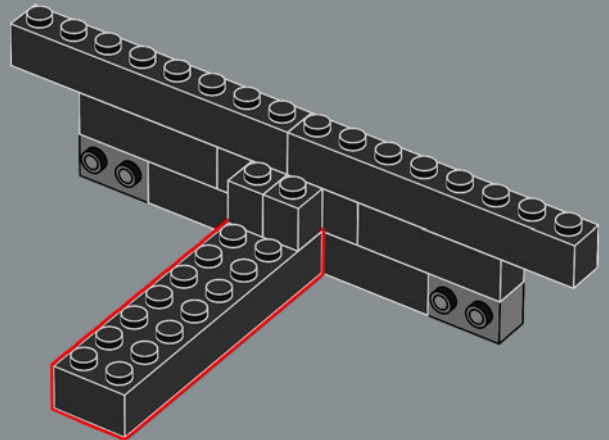

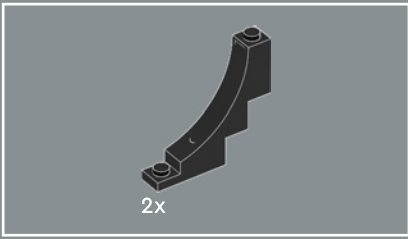

159

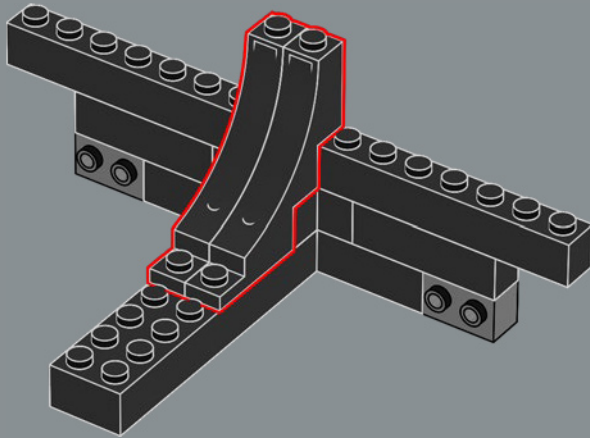

160

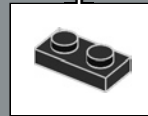
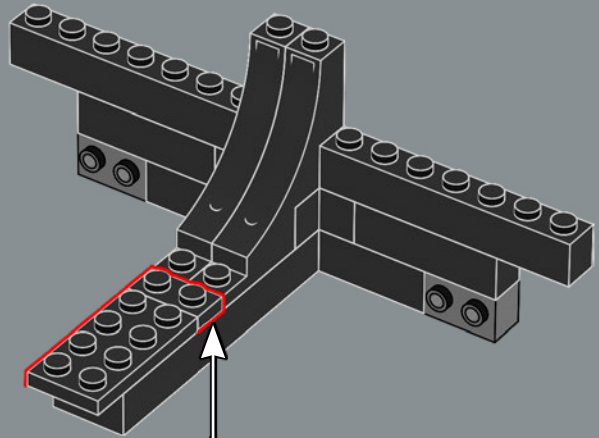

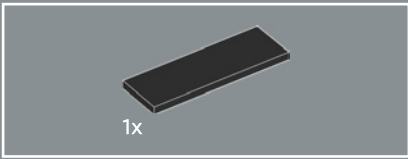

161

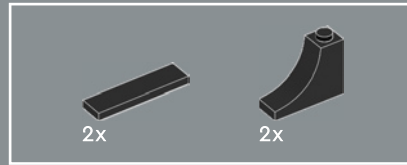
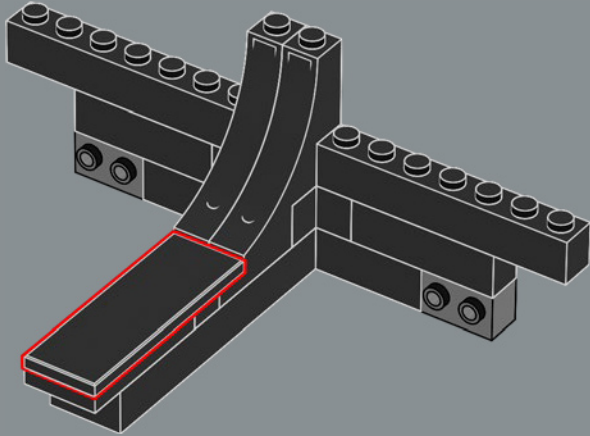

162

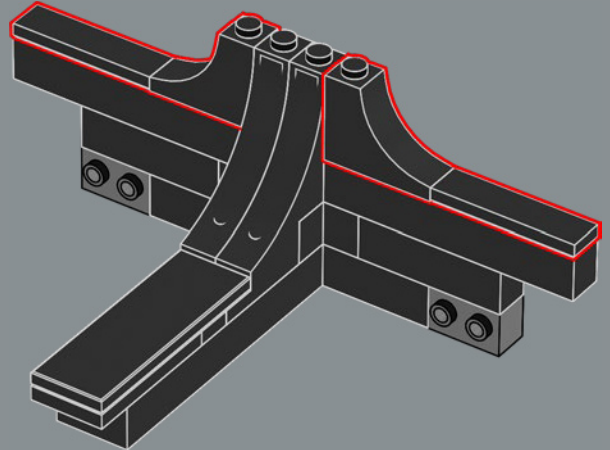

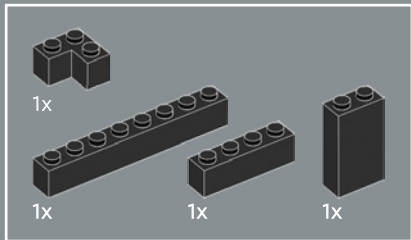

163

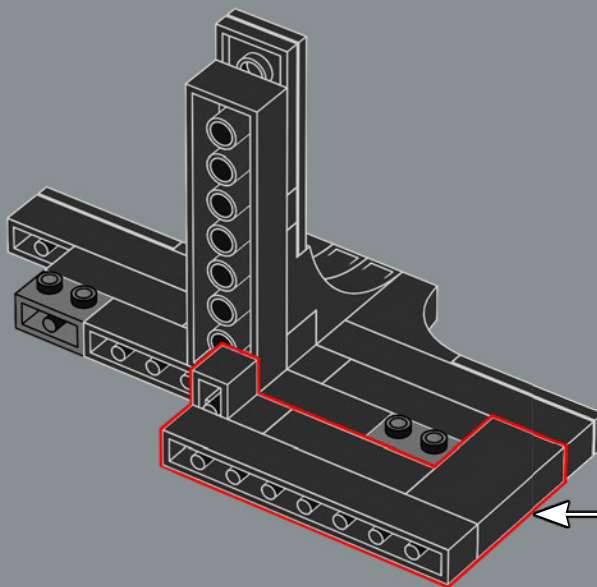
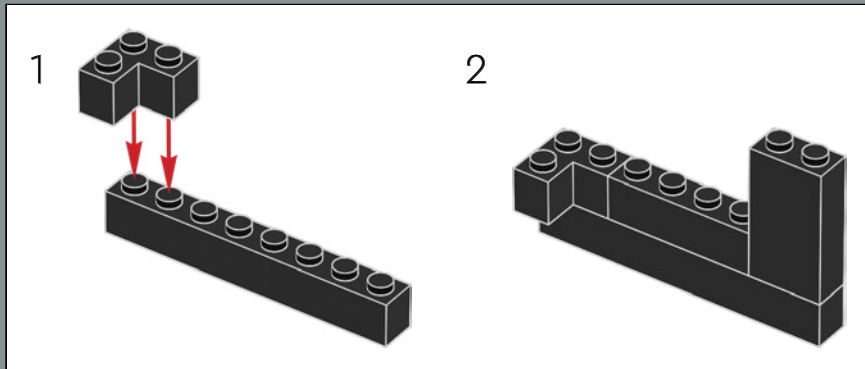

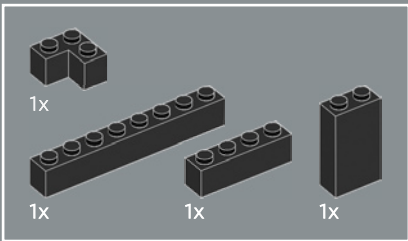

164

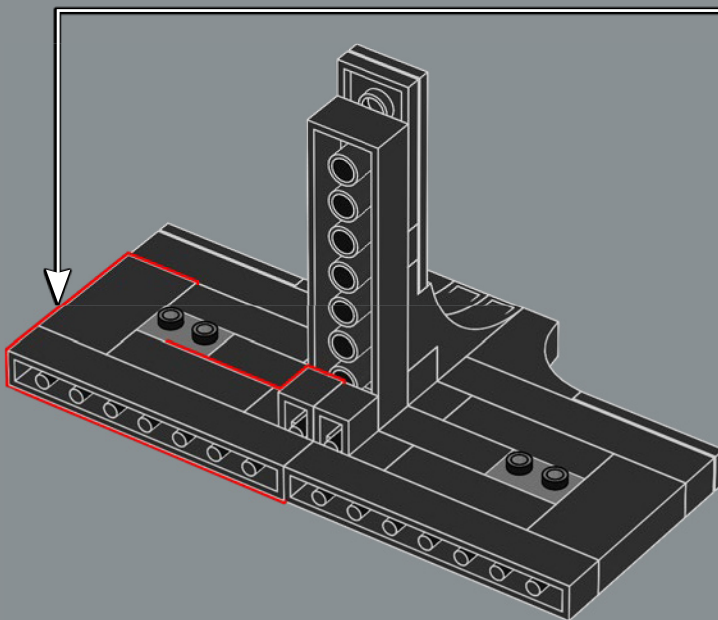
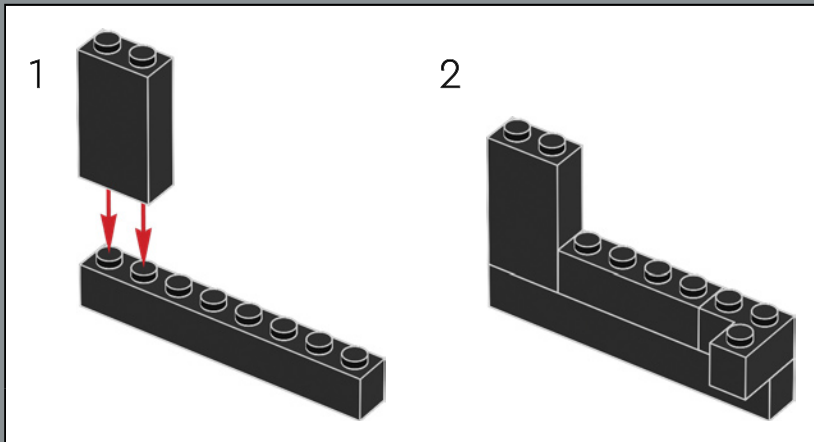

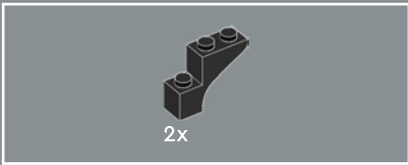

165

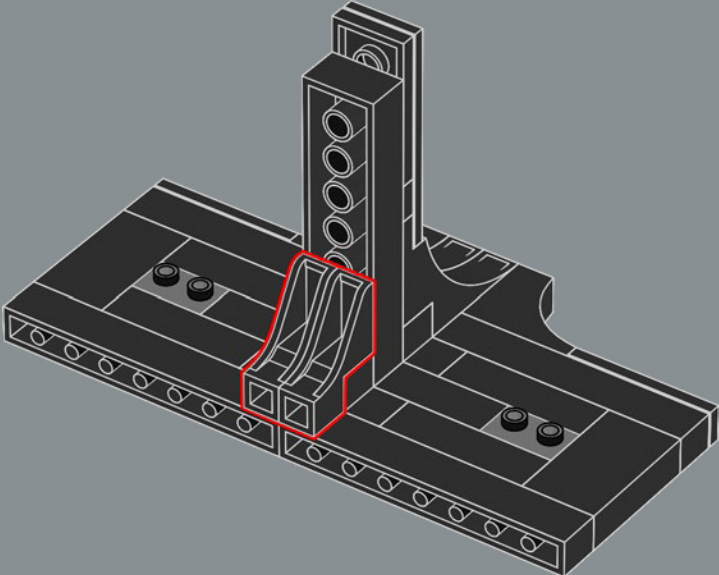



166

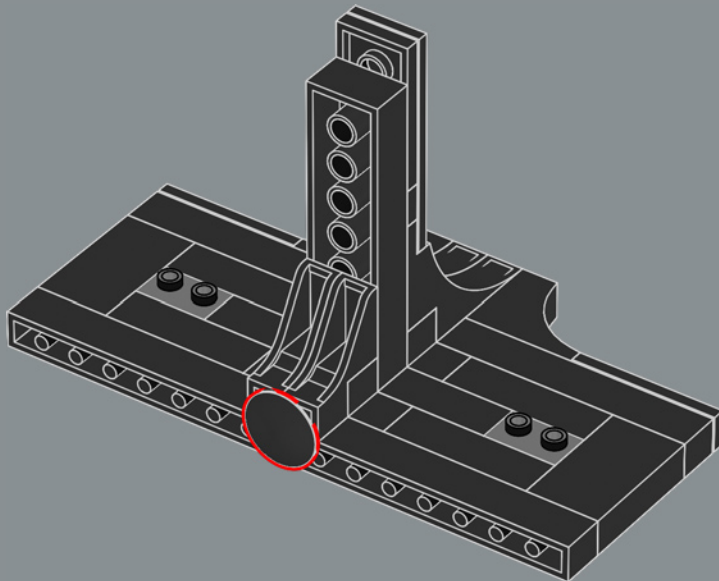

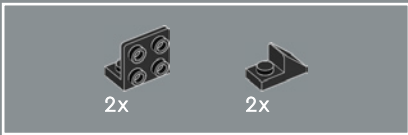

167

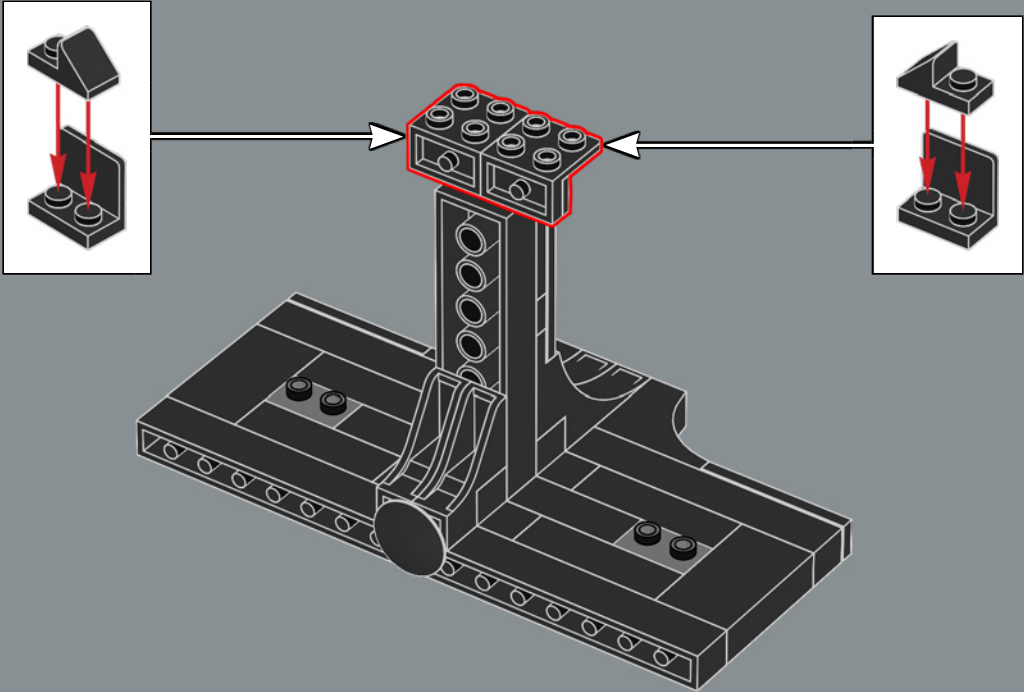

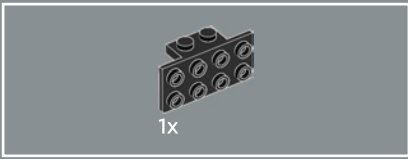

168

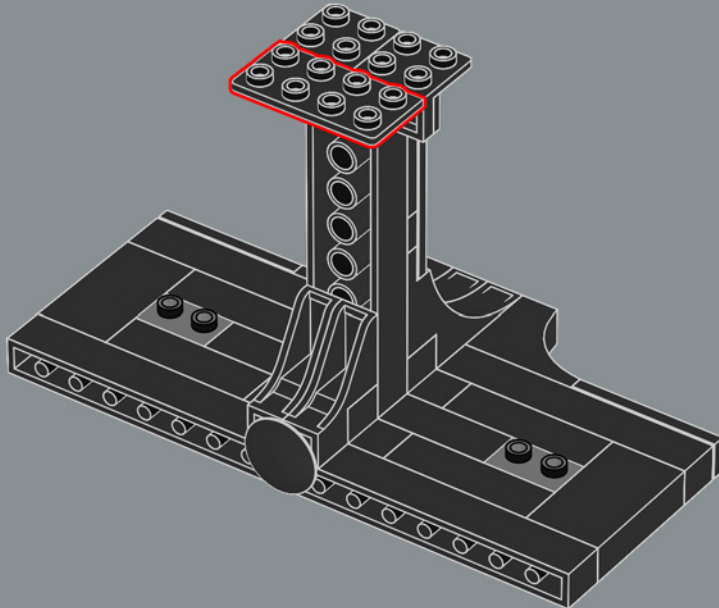

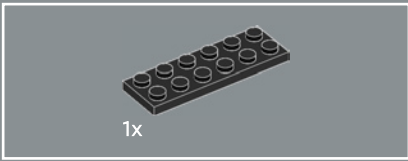

169

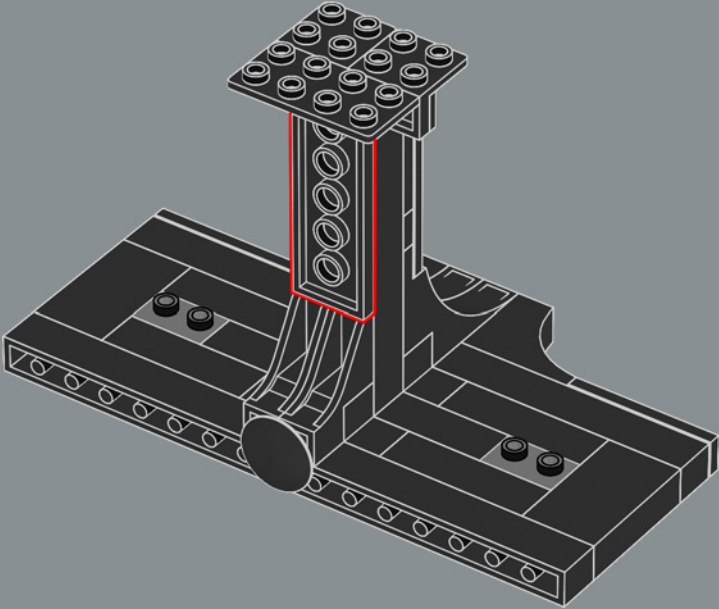

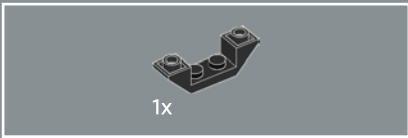

170

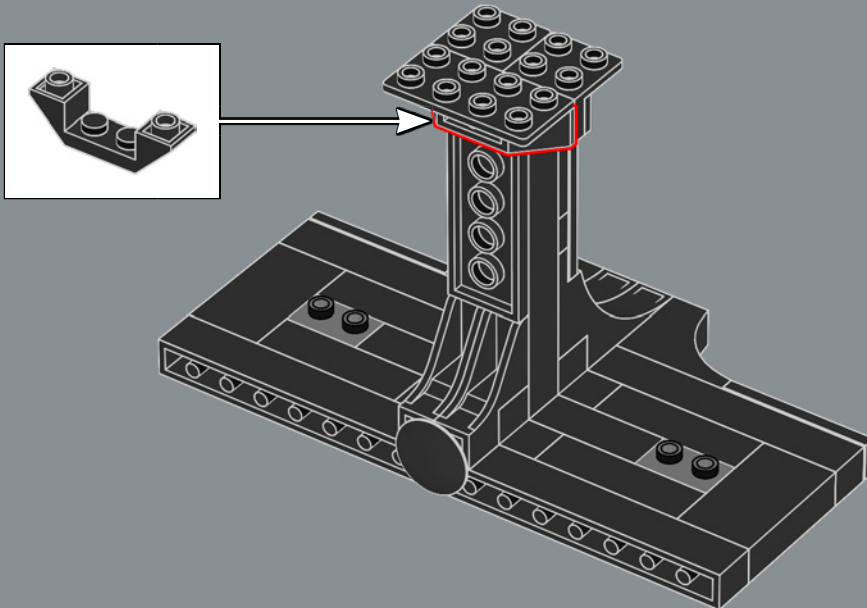

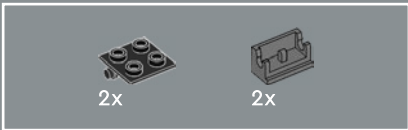

171

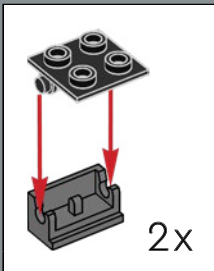
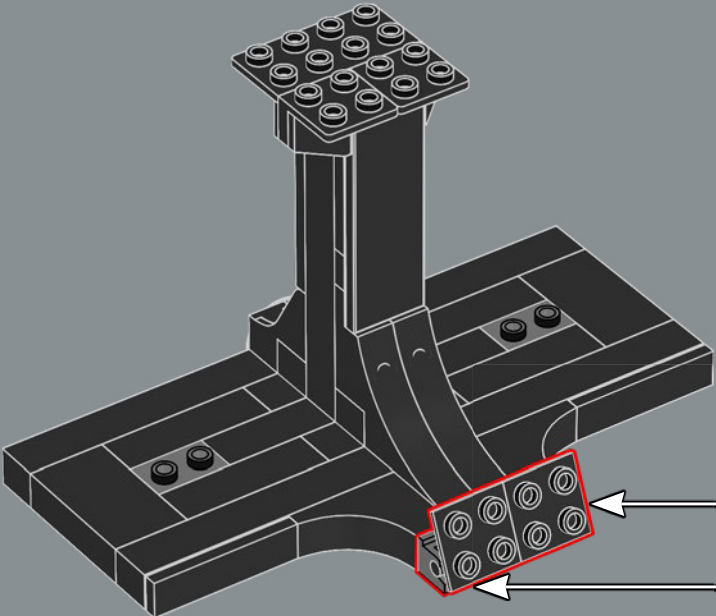

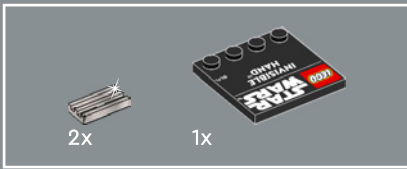

172

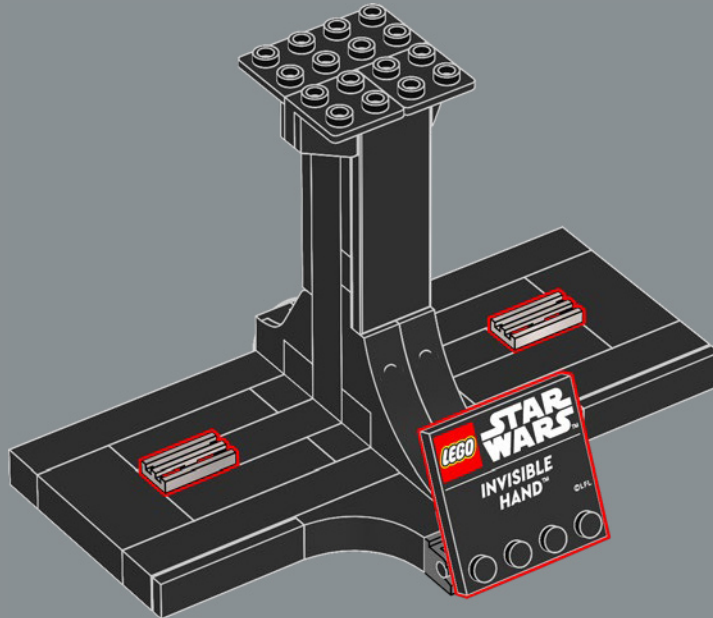

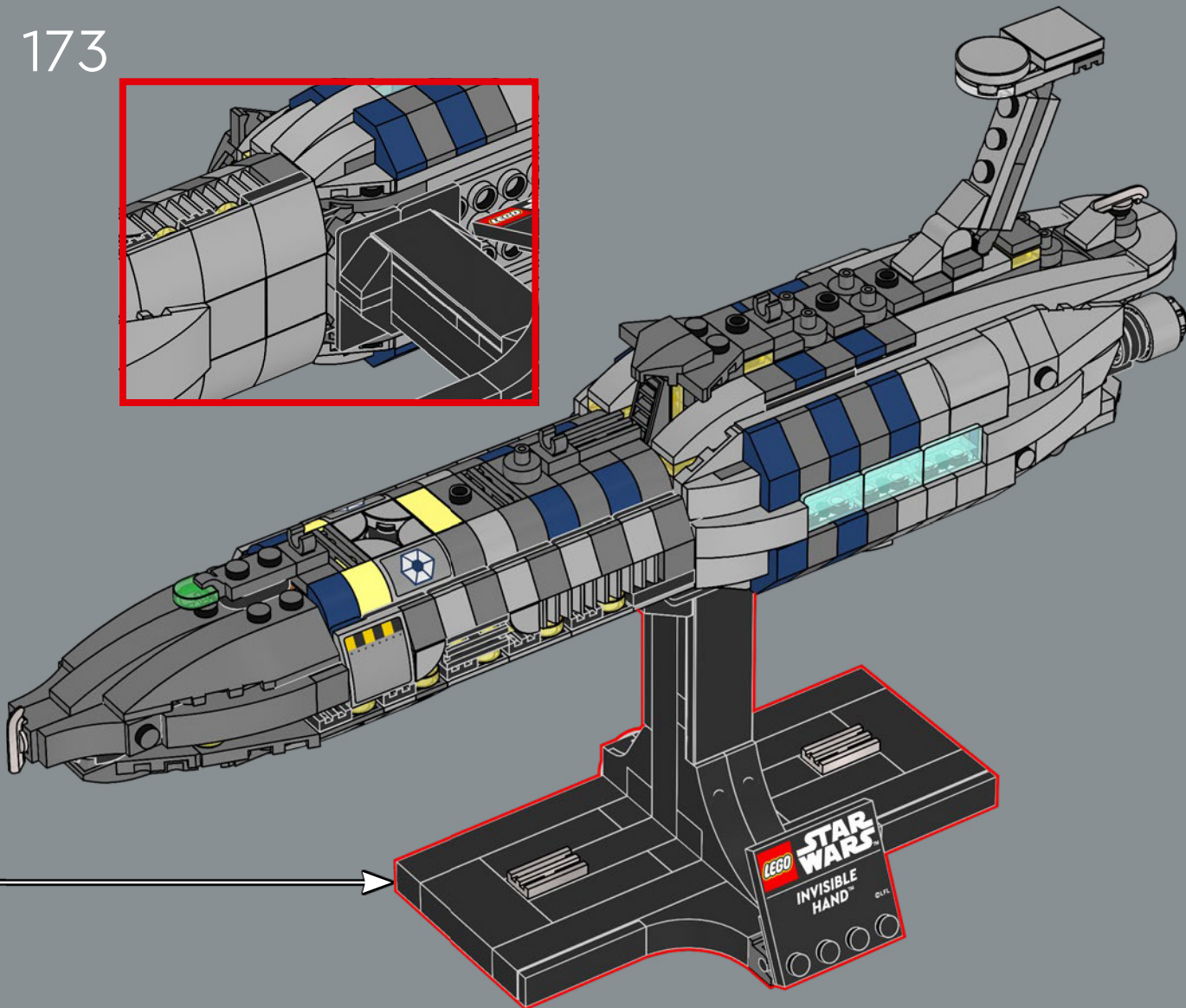
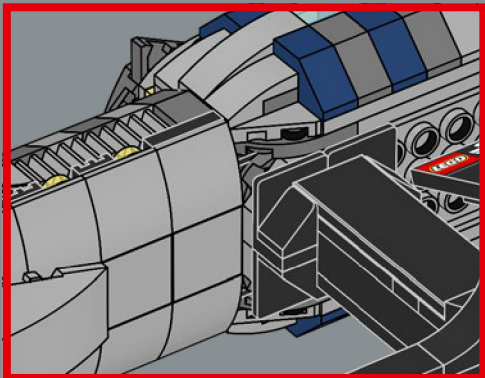

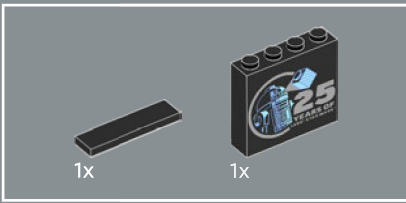

174

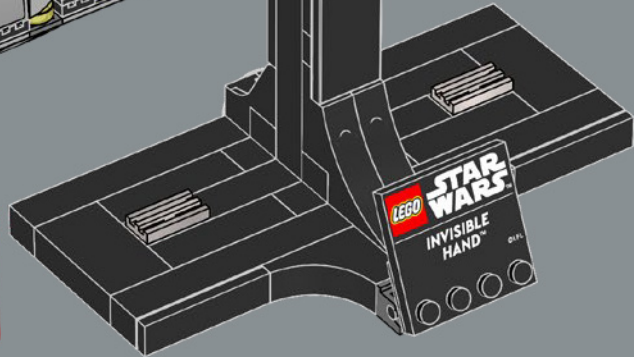
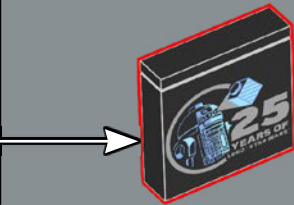
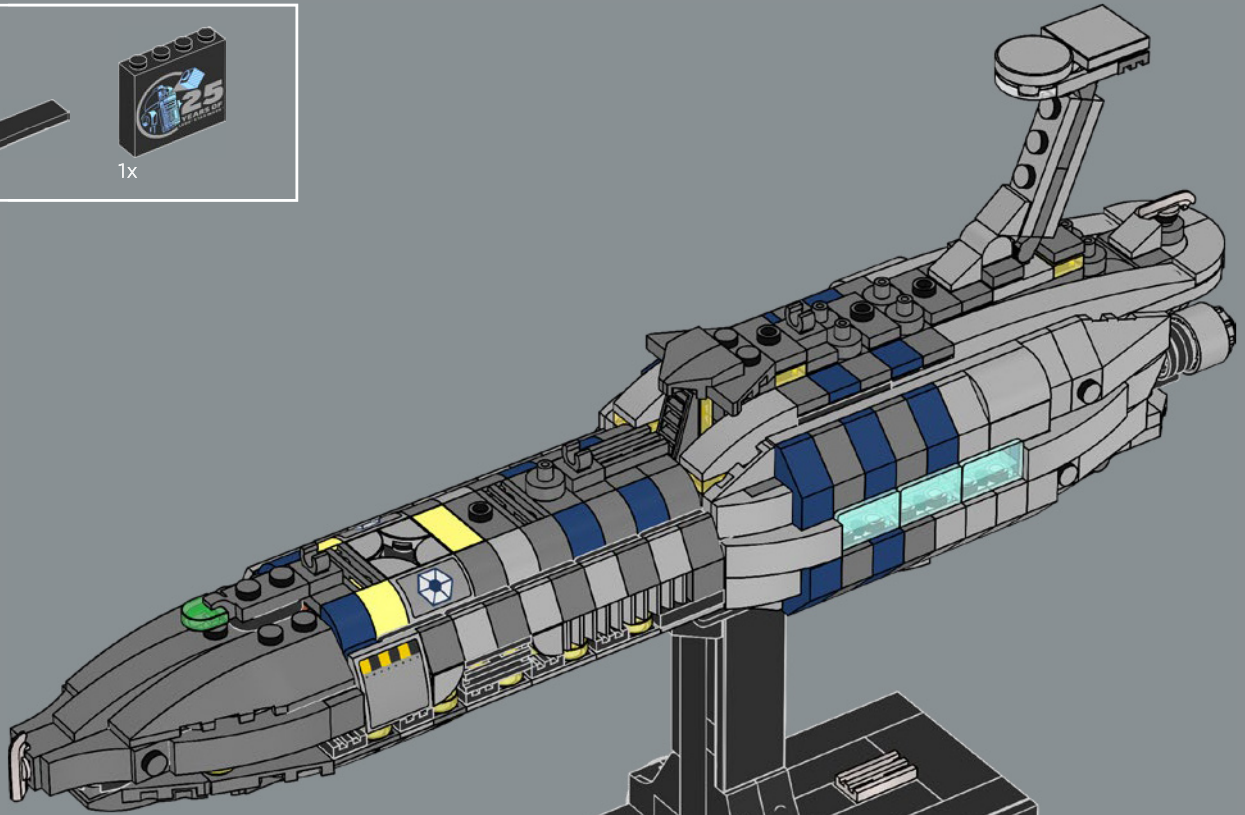

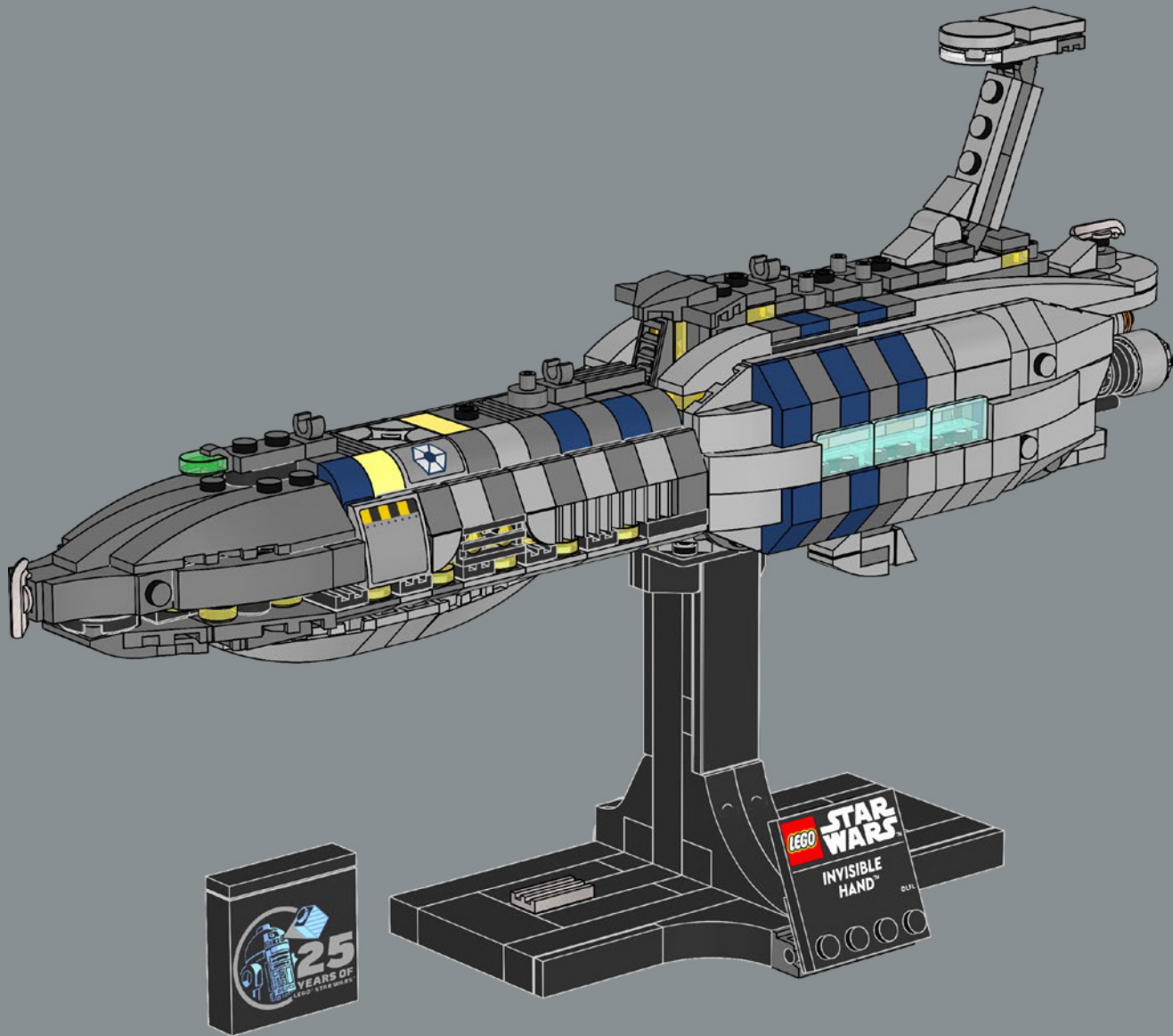



8x
6469441



2x
301001



1x
370901



2x
346001



1x
4527945



2x
6330903



2x
4114077

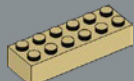

1x
4181134



1x
4114001

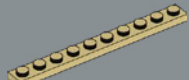

4x
4143409

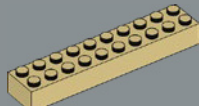

1x
6294678



16x
6446788



2x
4142865



1x
614124



6x
6284070



10x
407026



3x
6291068



3x
6265699



3x
6210270



1x
4278359



1x
6070695



3x
4253815



2x
6069000



1x
302326



1x
6266207



2x
6228588



13x
241226



5x
6092585



12x
6000650



2x
6325254



6x
235726



1x
302226



2x
6192346



2x
4124096



4x
362326



2x
4581280



2x
6154860



1x
6118829



8x
6428167



1x
383926



1x
4285883



6x
4162443



1x
6267482



4x
301026



3x
243126



1x
6483080



1x
302026



2x
4116854



1x
6472355



1x
379526

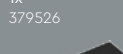

1x
6318582



5x
300826



1x
6037390

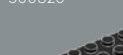

1x
303026

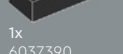

1x
6001494



2x
6450823



2x
4528981



10x
6166857



6x
6411363



3x
4530028

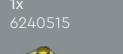

1x
6240515

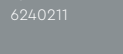

15x
6240211



2x
6382577



1x
6443797



6x
6246890



20x
6274740



1x
6482045



3x
6031821



2x
6175927



2x
4550329



4x
4631385



2x
6450823



2x
4528981



10x
6166857



6x
6411363



3x
4530028



5x
6240227



1x
6328180



1x
6371437



1x
4211150



16x
6168647



1x
6262085



13x
4521921



2x
4211415



8x
6176433



1x
6225139



1x
6248078



1x
4211758



2x
6163478



2x
6163477



1x
6248890

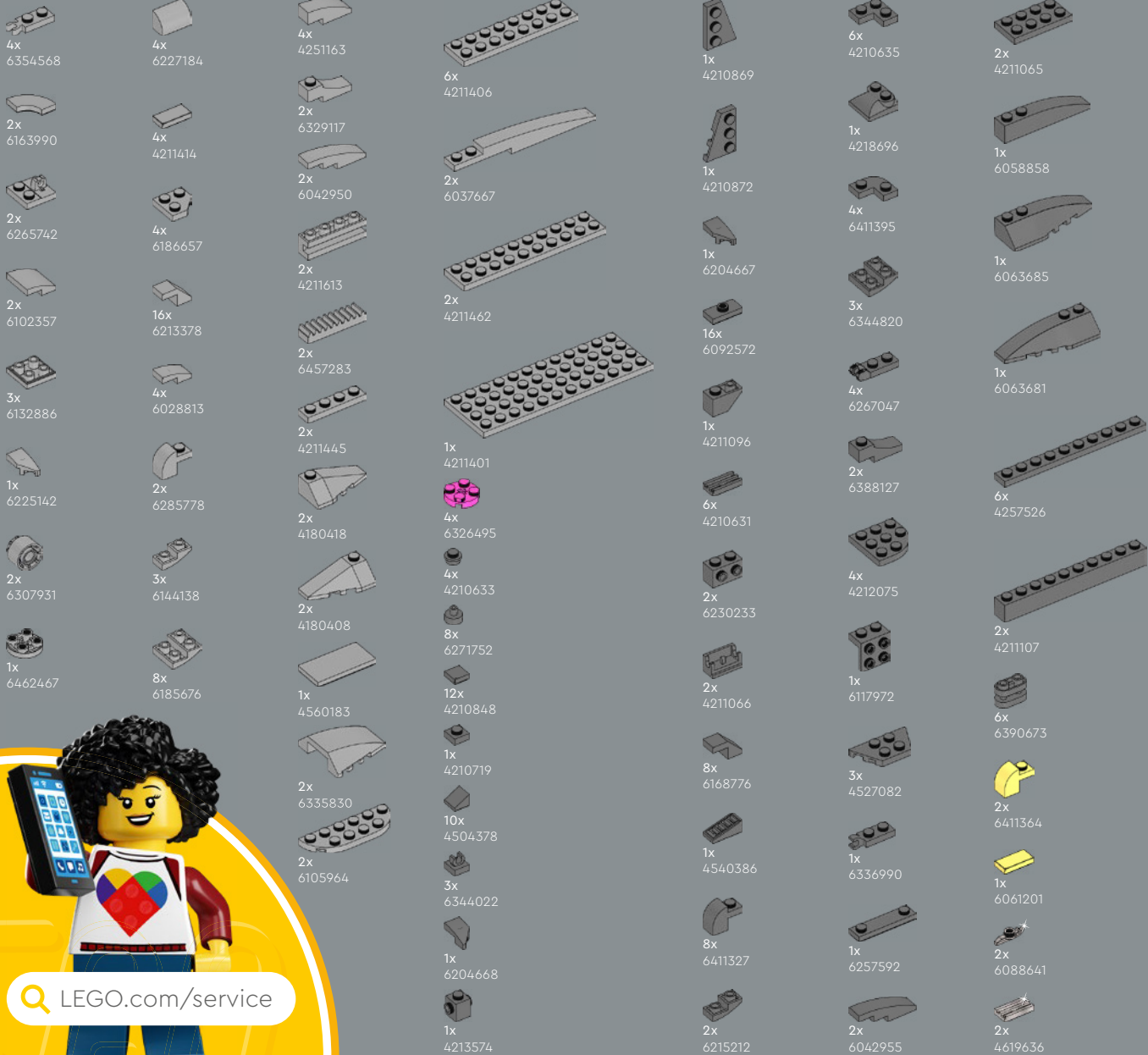

 [LEGO.com/service](https://www.LEGO.com/service)



SHARE YOUR FEEDBACK



SHARE YOUR FEEDBACK

Your feedback will help shape the future development of this product series.

Visit:

TEILE DEIN FEEDBACK

Dein Feedback trägt zur Weiterentwicklung dieser Produktreihe bei.

Geh auf:

PARTAGEZ VOS COMMENTAIRES

Vos commentaires nous aideront à concevoir les futurs produits de cette gamme.

Visitez :

CONDIVIDI IL TUO FEEDBACK

La tua opinione ci aiuterà a migliorare la creazione futura di questa linea di prodotti.

Visita:

COMPARTE TU OPINIÓN

Tu opinión contribuirá al futuro de esta serie de productos.

Visita:

请分享您的反馈

您的反馈将有助于我们在今后改进本产品系列。

请访问：

LEGO.COM/PRODUCTFEEDBACK

Terms and conditions apply.*

Es gelten die Teilnahmebedingungen.*

Des conditions s'appliquent.*

Termini e condizioni sono applicabili.*

Aplican términos y condiciones.*

条款和条件适用。*

*[LEGO.com/productfeedback-terms](https://www.lego.com/productfeedback-terms)

**STAR
WARS™**

LEGO and the LEGO logo are trademarks of the/sont des marques de commerce du/
son marcas registradas de LEGO Group. ©2024 The LEGO Group. 6509381

© & ™ Lucasfilm Ltd.