



76259





### **Get excited about our new packaging!**

We're switching from plastic to paper-based packaging. That's why you might find a mix of paper and plastic in our boxes!

### **Nos nouveaux emballages vous emballeront !**

Nous passons des emballages en plastique aux emballages à base de papier. C'est pourquoi vous pourriez trouver un mélange de papier et de plastique dans nos boîtes !

### **¡Te presentamos nuestros nuevos empaques!**

Estamos sustituyendo las bolsas de plástico por bolsas con base de papel. ¡Por eso, puedes encontrar una mezcla de papel y de plástico en nuestras cajas!

**[LEGO.com/sustainable-packaging](https://www.lego.com/sustainable-packaging)**



# BUILDER



Apple and the Apple logo are trademarks of Apple Inc., registered in the U.S. and other countries and regions. App Store is a service mark of Apple Inc. Google Play and the Google Play logo are trademarks of Google LLC. Tencent and the Tencent logo are trademarks of Tencent Inc.

Q [LEGO.com/devicecheck](https://www.lego.com/devicecheck)

**EN** Ask parents' permission before going online | **DE** Eltern um Erlaubnis bitten, bevor du online gehst | **FR** Demande l'autorisation d'un parent avant d'aller en ligne | **IT** Chiedi il permesso ai tuoi genitori prima di andare online | **ES** Pídeles permiso a tus papás antes de conectarte a Internet | **PT** Peça autorização aos pais antes de acederes online | **ZH** 上网前应先征得父母的同意 | **PL** Poproś rodziców o zgodę, zanim wejdziesz do Internetu | **CS** Než půjdeš na internet, požádej rodiče o svolení | **SK** Skôr než pôjdeš na internet, vypýtaj si povolenie od rodičov | **HU** Kérj szülői engedélyt, mielőtt online csatlakoznál! | **RO** Cere permisiunea părinților înainte de a te conecta online | **BG** Поискайте разрешение от родител, преди да влезете онлайн | **LV** Pirms došanās tiešsaistē palūdz atļauju vecākiem | **ET** Enne Interneti kasutamist küsi vanematelt luba | **LT** Prieš prisijungdami prie interneto, atsiklauskite tėvų

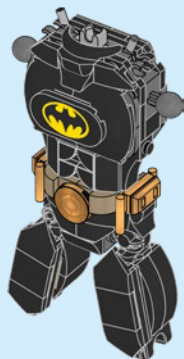

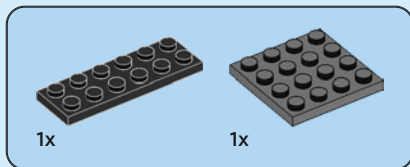

1

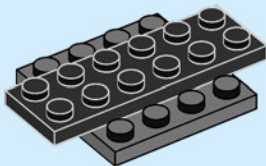



2x



2x

2

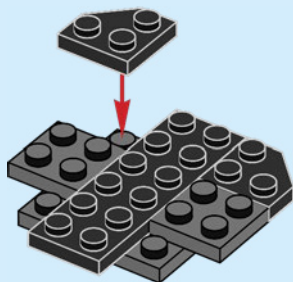

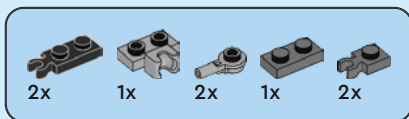

# 3

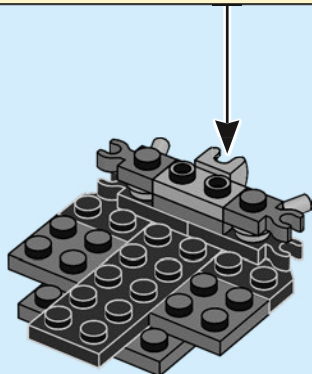
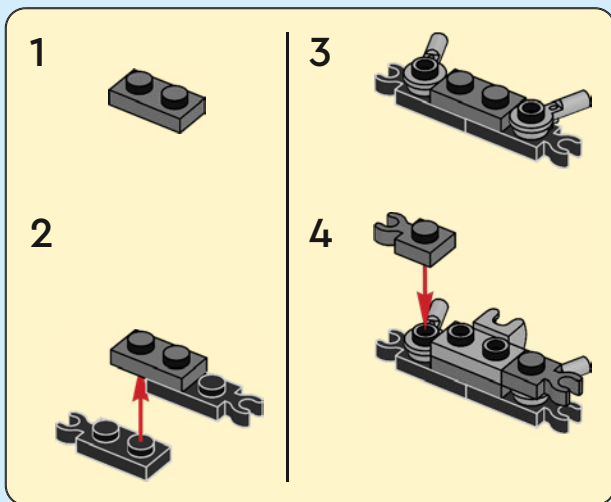

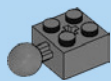

2x



1x

4

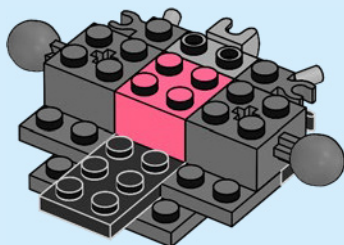

2x

5

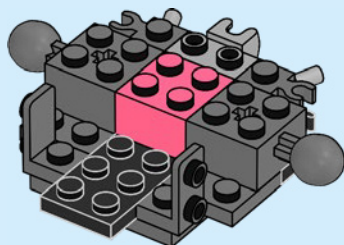





2x



1x

6

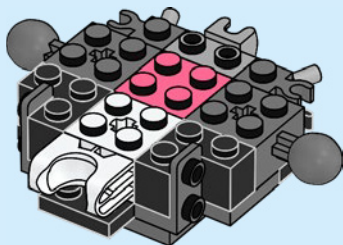

1x



2x

7

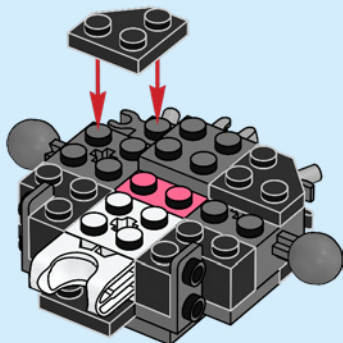

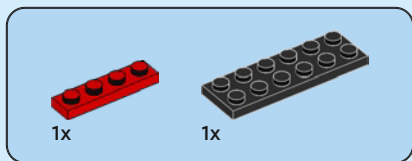

8

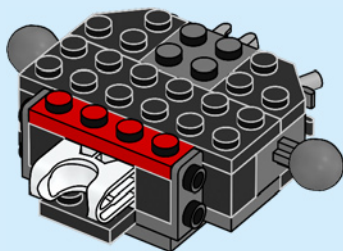

9

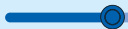
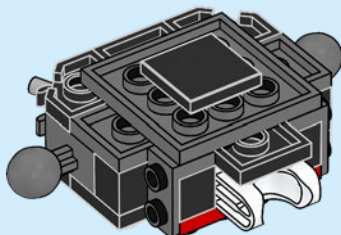

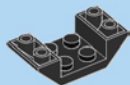

1x

10

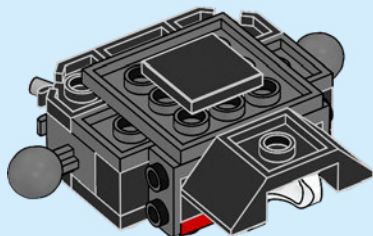

4x

11

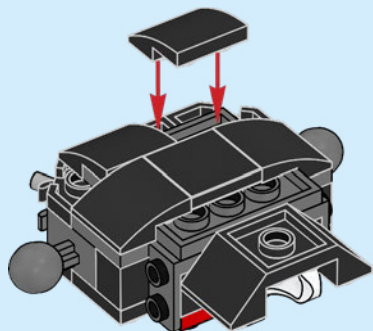

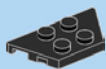

1x

# 12

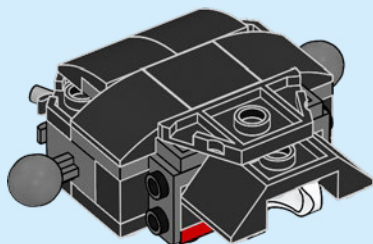

2x

# 13

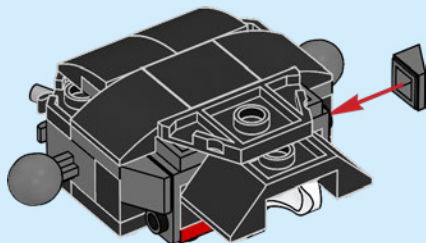



4x

14



4x

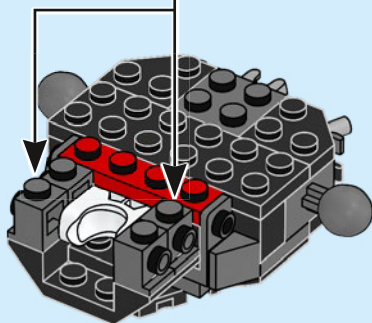



2x

15



2x

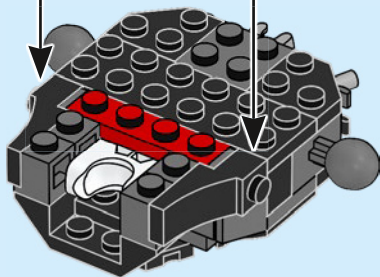

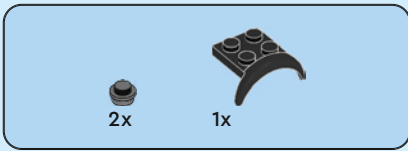

16

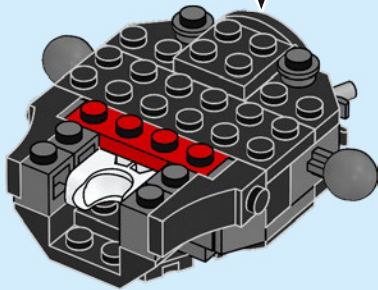

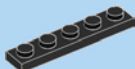

2x

# 17

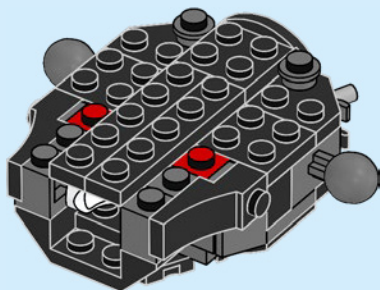

2x



2x

# 18

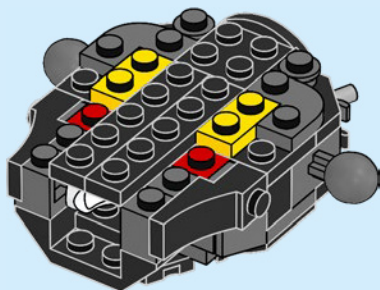





2x

# 19

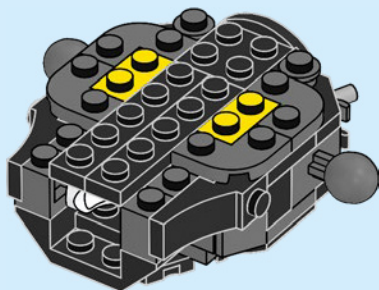

1x



1x

# 20

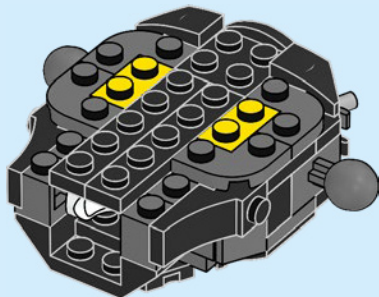

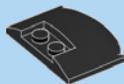

2x

21

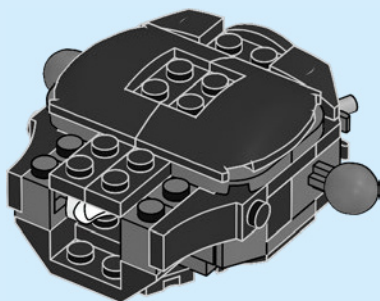

1x

22

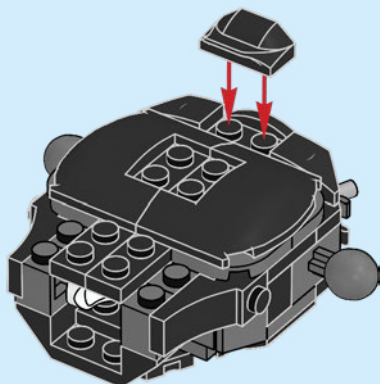



1x

# 23

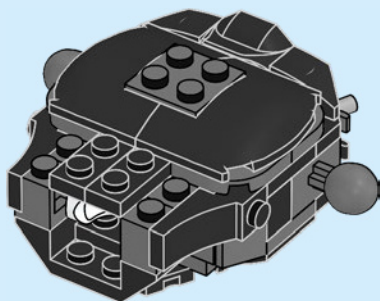

2x

# 24

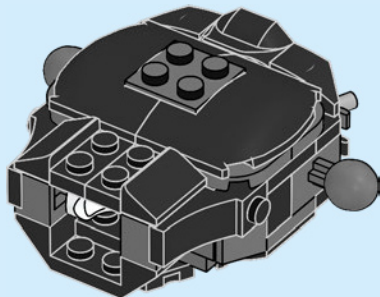



4x

# 25

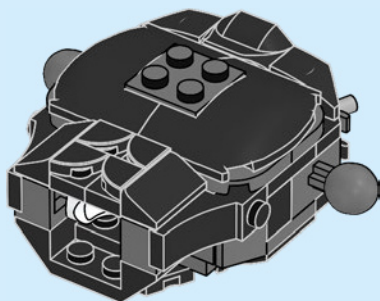

1x

# 26

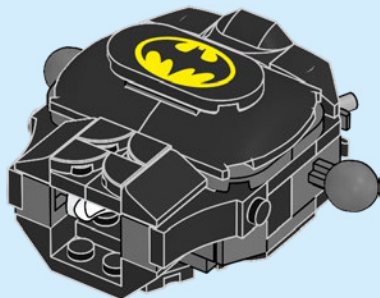

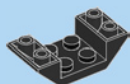
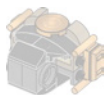

1x

27

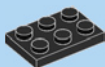
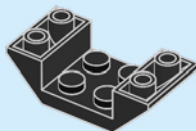

1x

28

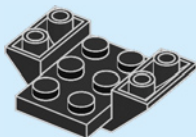



1x

# 29

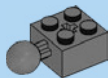
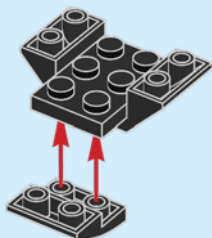

1x

# 30

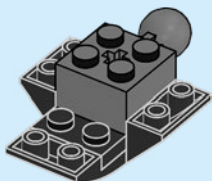



2x

# 31

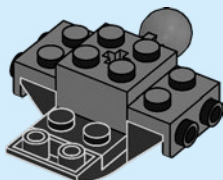

2x

# 32

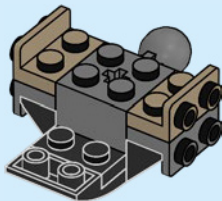



2x

# 33

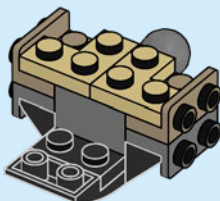

2x

# 34

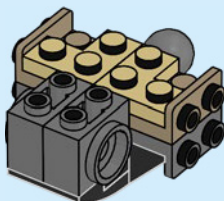



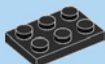

1x

# 35

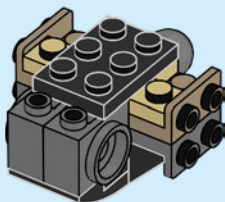

2x

# 36

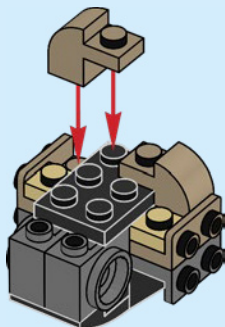

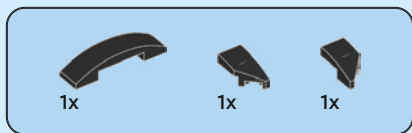

37

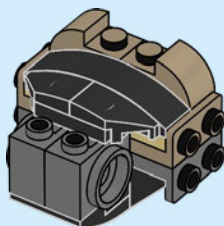

38

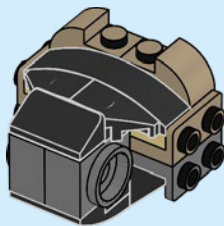

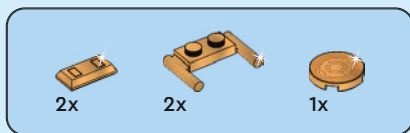

39

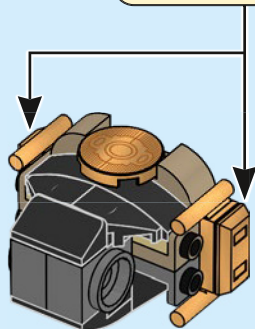
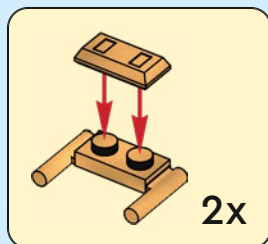

40

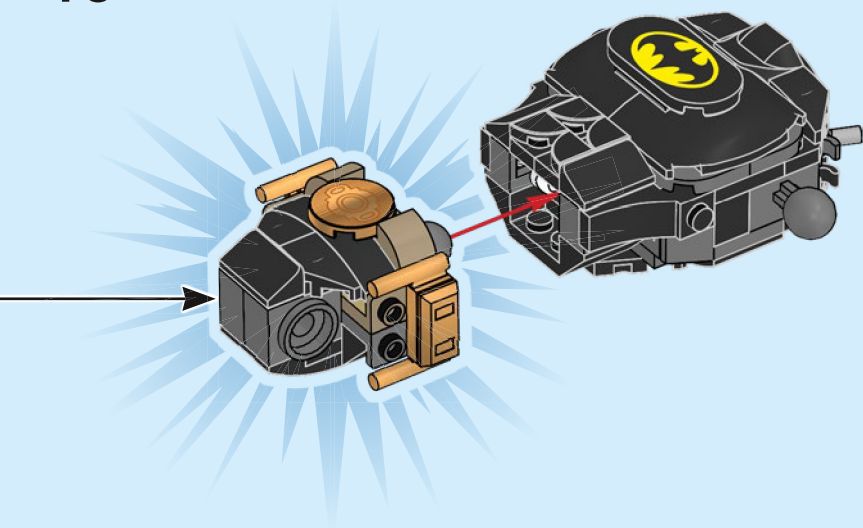

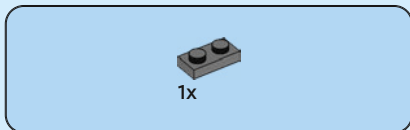
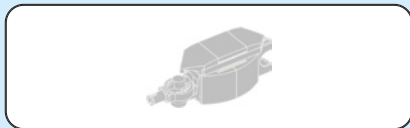

41

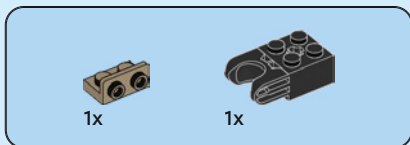
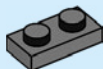

42

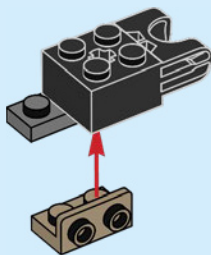



1x



1x

# 43

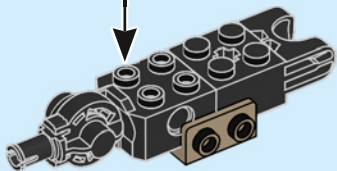
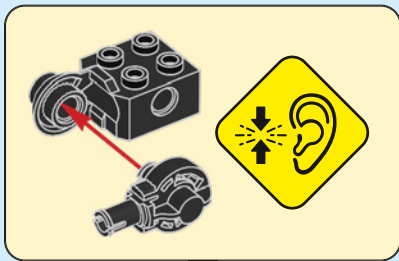

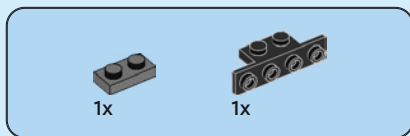

44

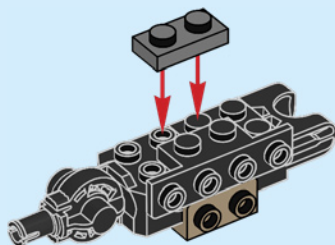

45

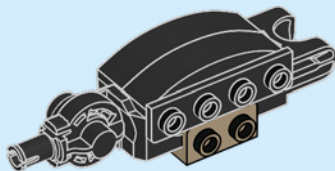

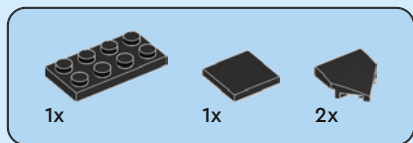

# 46

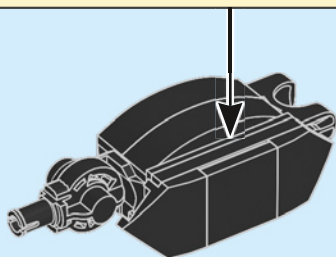
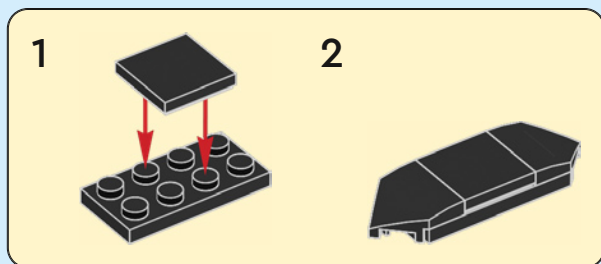





2x

47

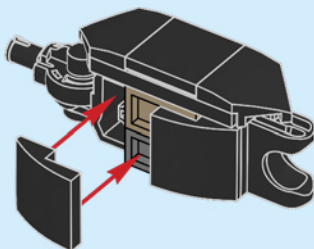

48

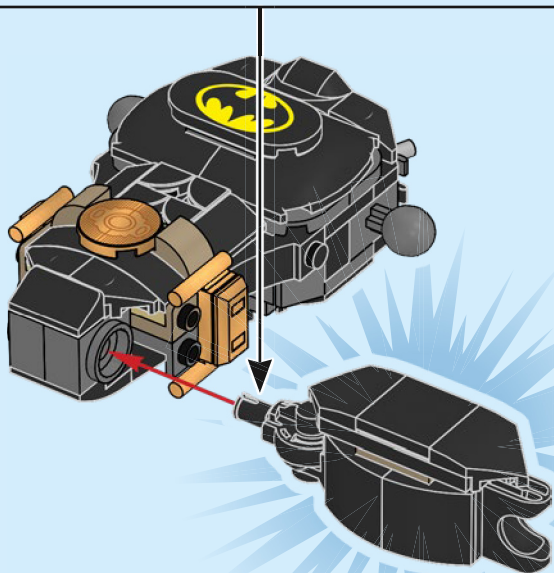

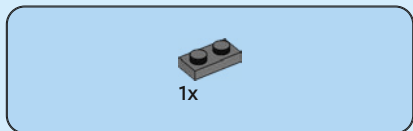
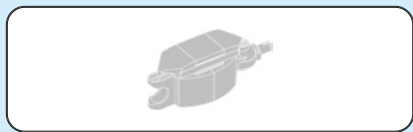

1x

# 49

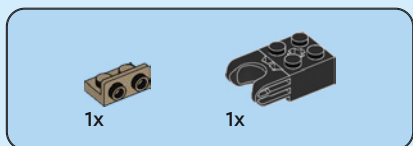

1x

1x

# 50

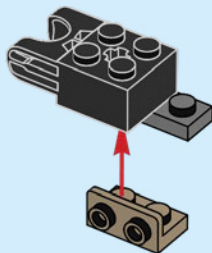

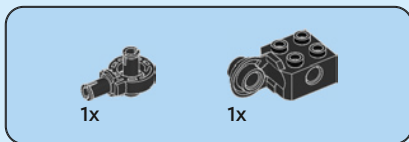

51

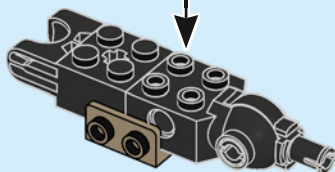
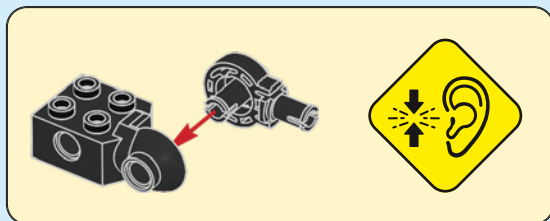



1x



1x

# 52

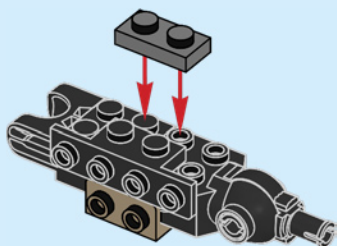

2x

# 53

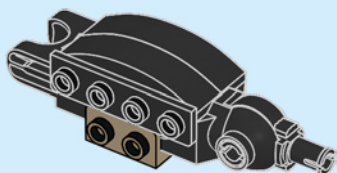

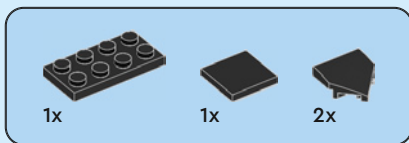

# 54

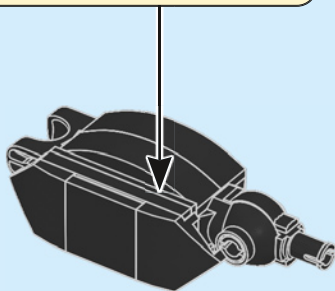
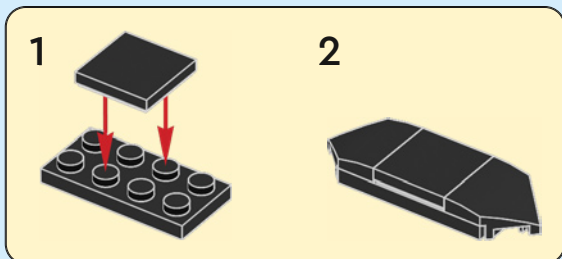



2x

55

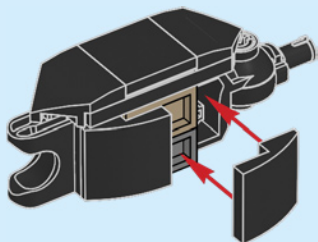

56

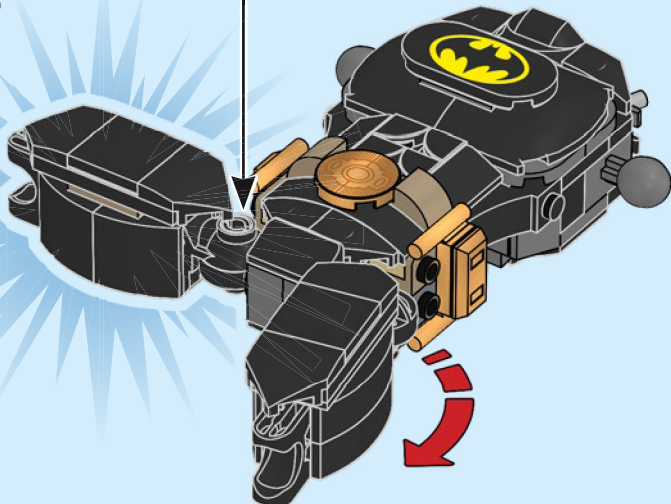



2x

57

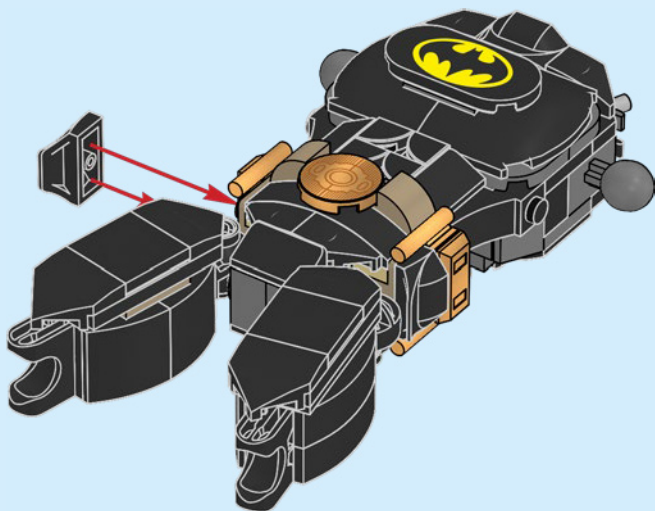







2x



1x



1x

58

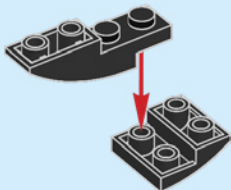

1x

59

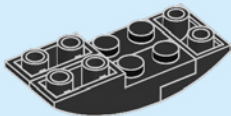

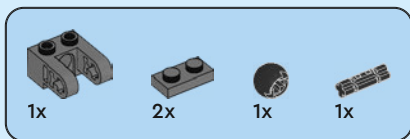

# 60

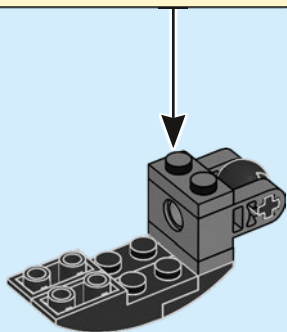
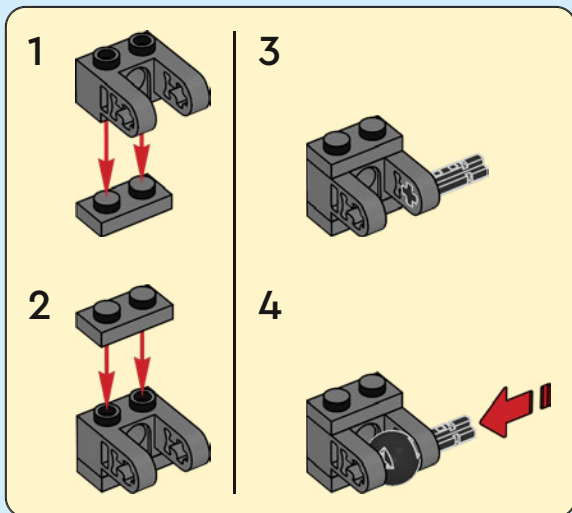



2x

61

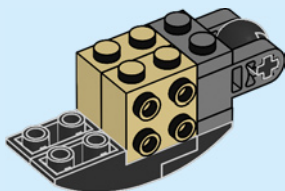

1x

62

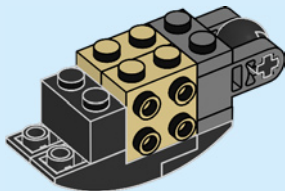



1x

# 63

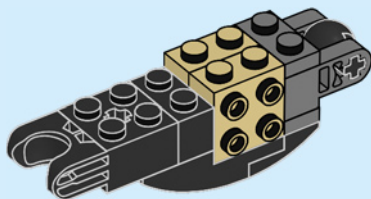

2x

# 64

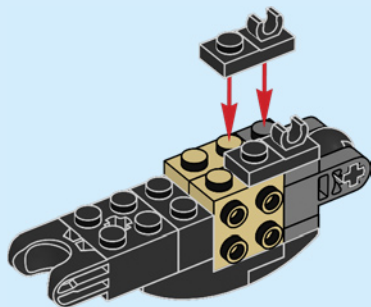



1x

65

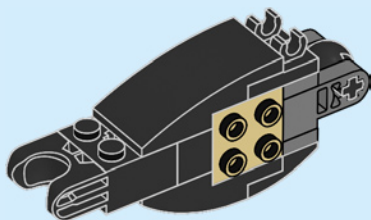

1x

66

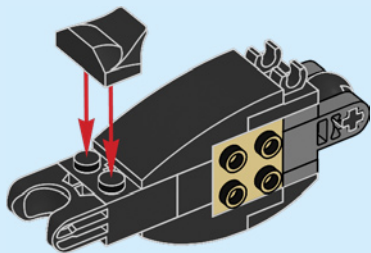

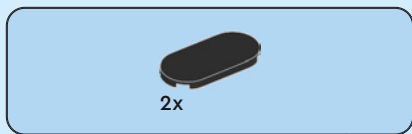

67

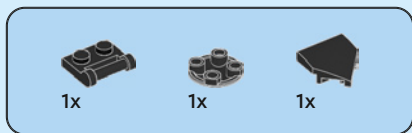
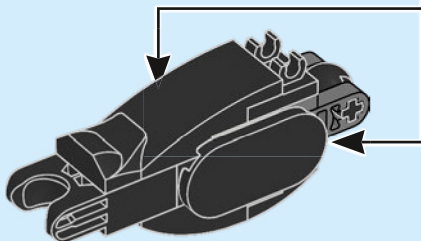

68

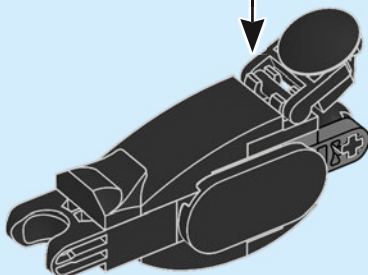
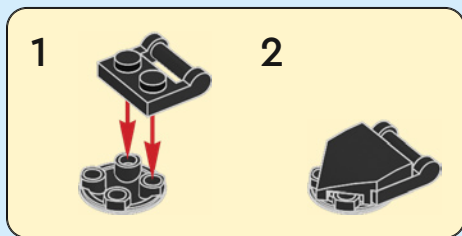

69

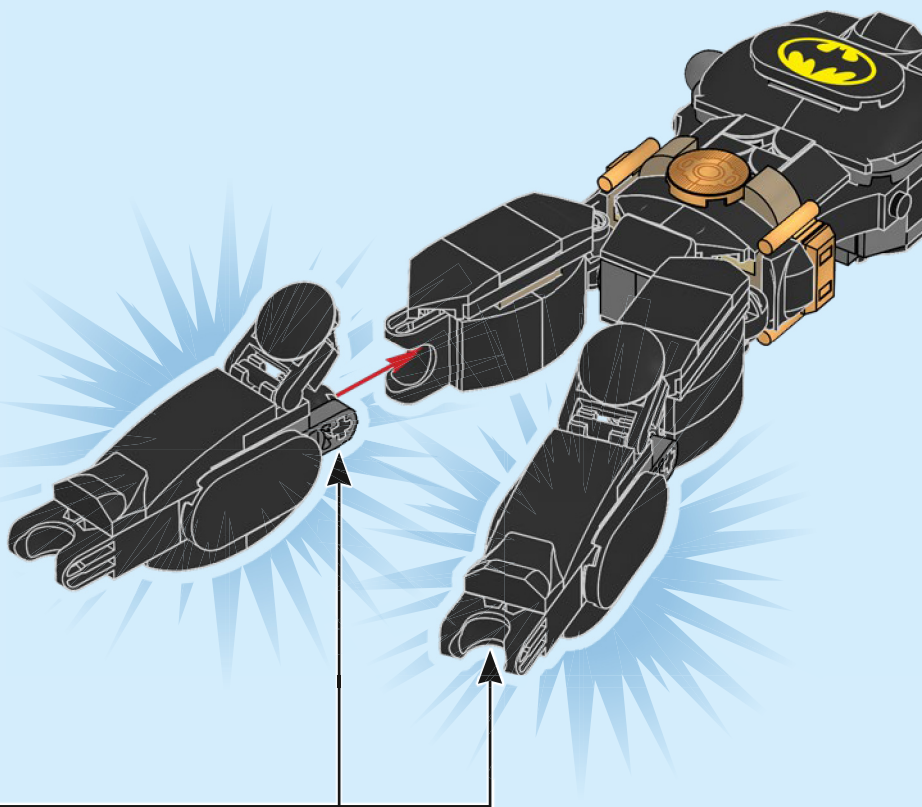



1x



1x

# 70

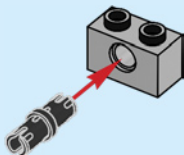

1x

# 71

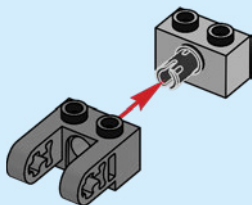





72

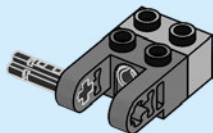

73

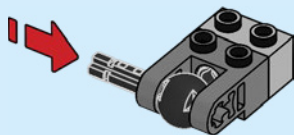



1x

# 74

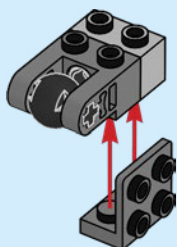

1x

# 75

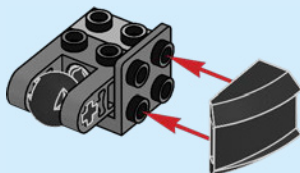



1x

76

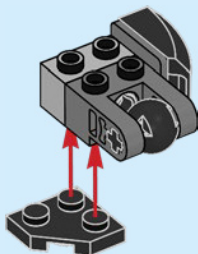

1x

77

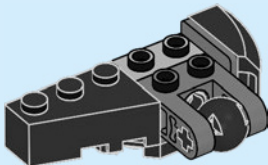



1x



1x

# 78

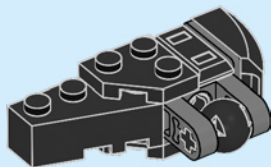

1x

# 79

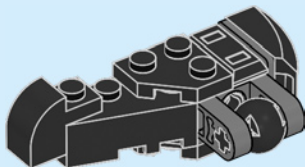



1x

# 80

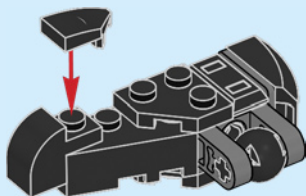

1x



1x



1x

# 81

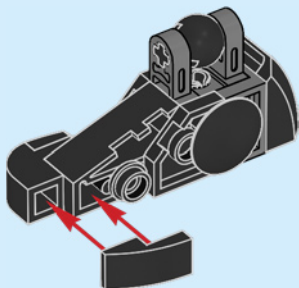

82

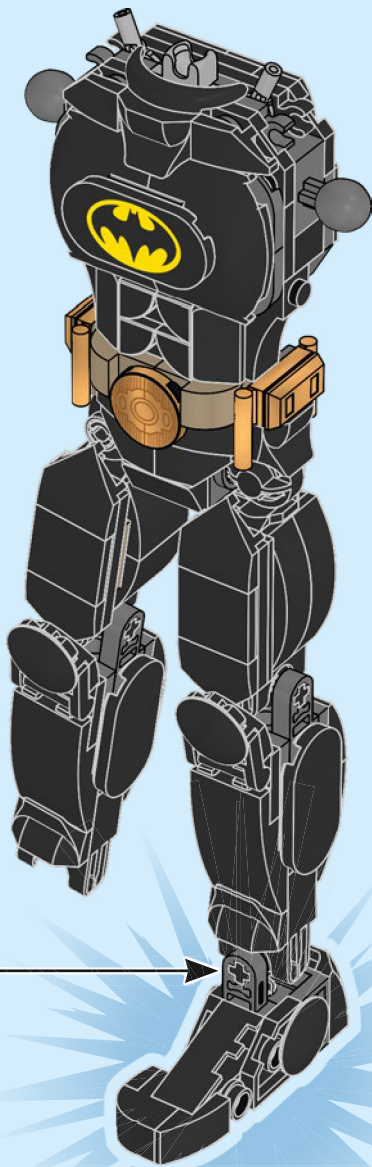

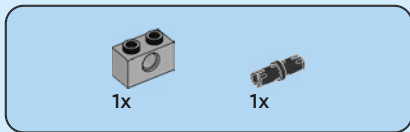

83

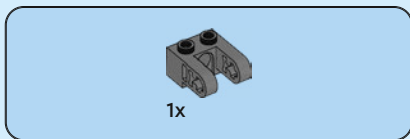
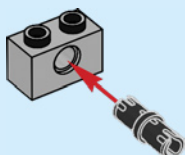

84

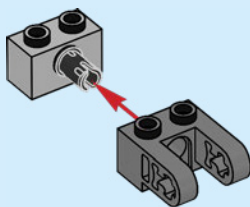



1x

# 85

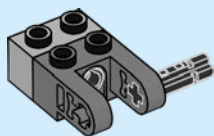

1x

# 86

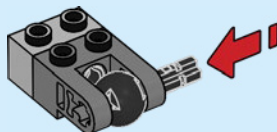





1x

87

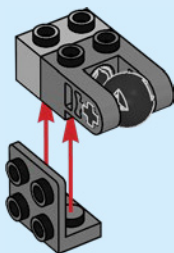

1x

88

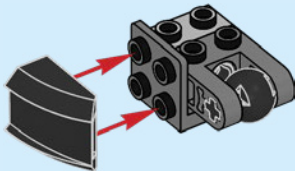



1x

# 89

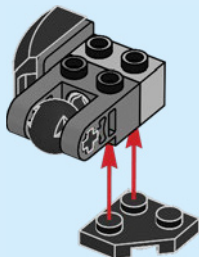

1x

# 90

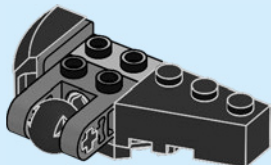

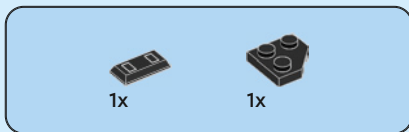

91

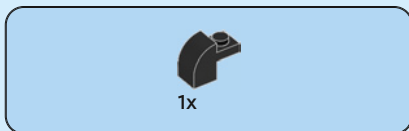
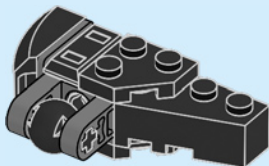

92

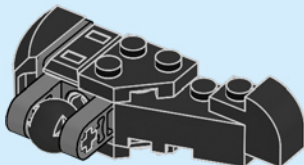



1x

93

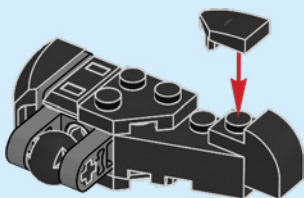

1x



1x



1x

94

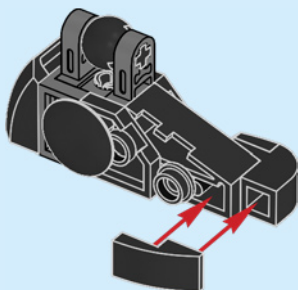

95

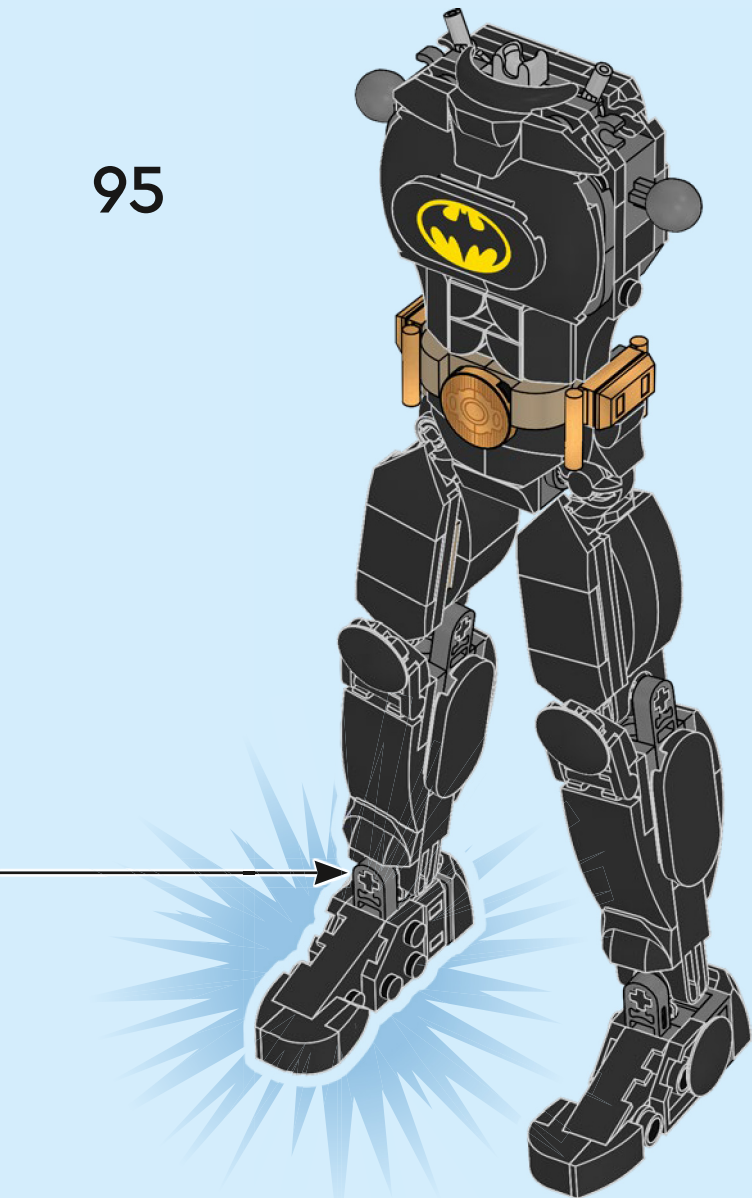



1x



1x

# 96

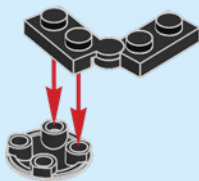



1x

# 97

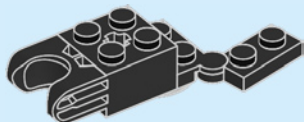

1x

# 98

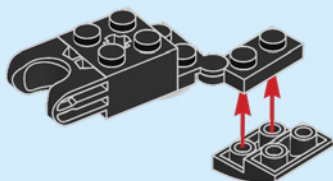



1x



1x

99

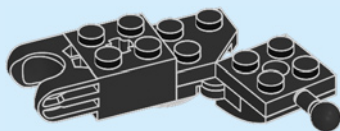

1x

100

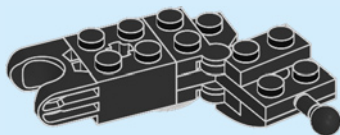



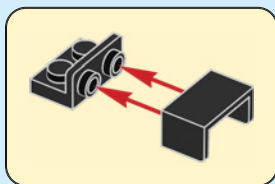
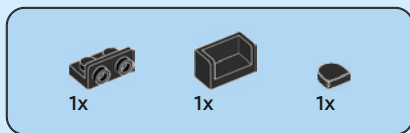

# 101

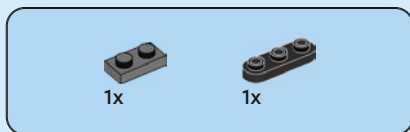
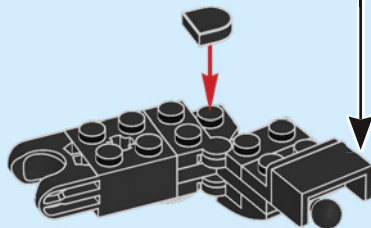

# 102

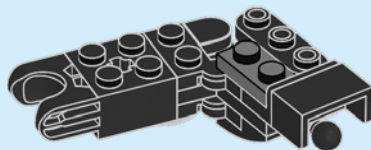

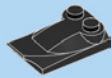

1x



1x

# 103

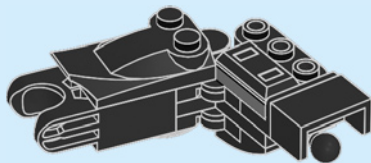

2x



1x

# 104

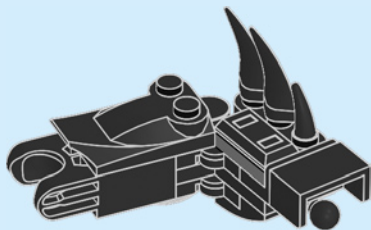

105

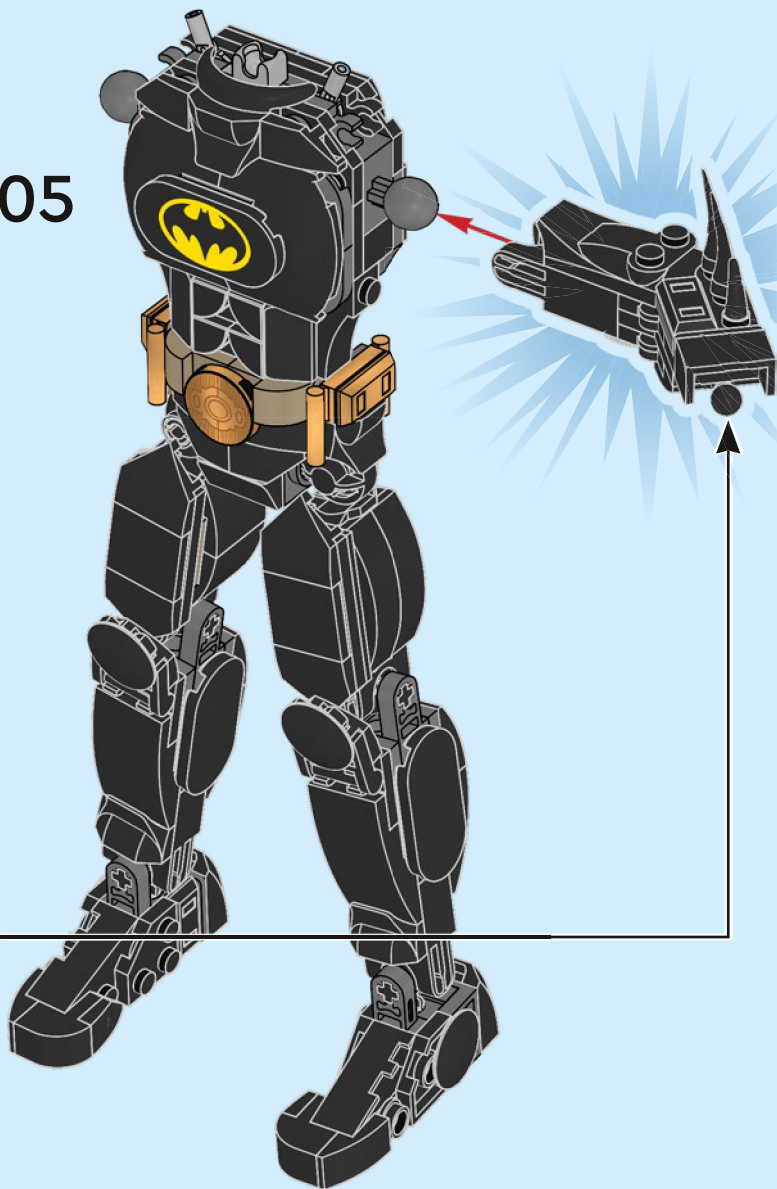

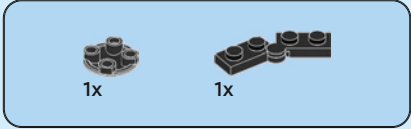

106

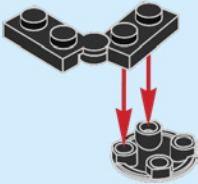



1x

# 107

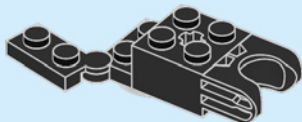

1x

# 108

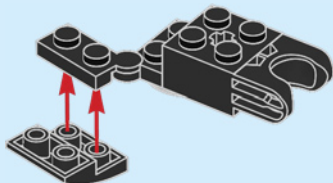



1x



1x

# 109

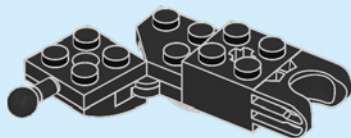

1x

# 110

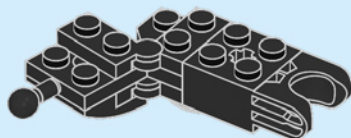

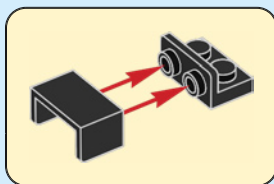
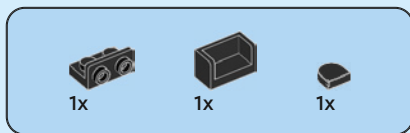

111

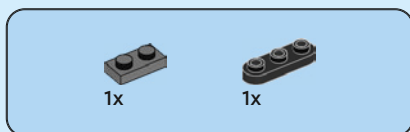
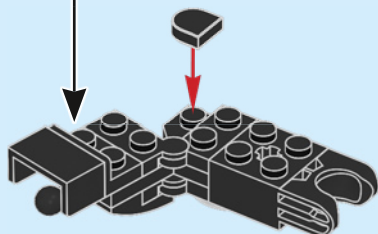

112

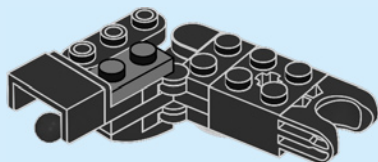

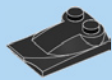

1x



1x

# 113

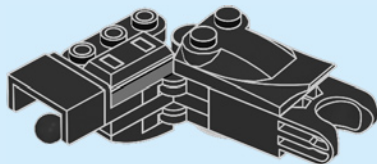

2x



1x

# 114

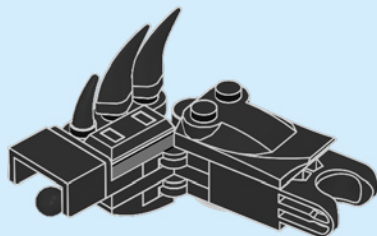



115

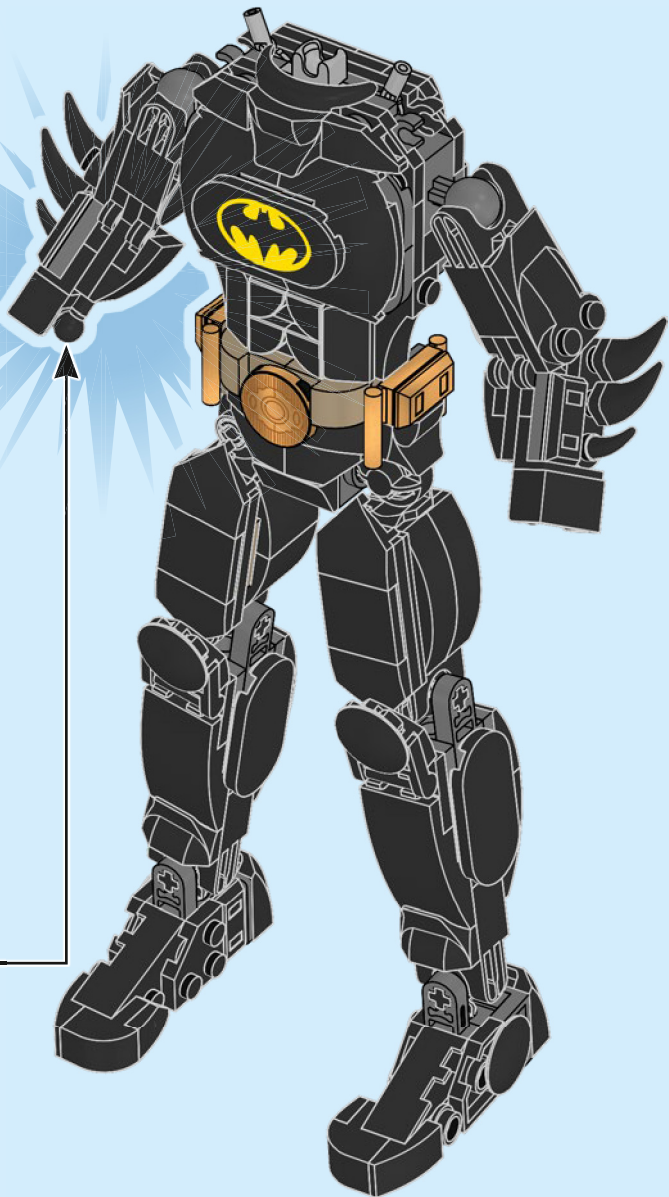



1x



1x

# 116

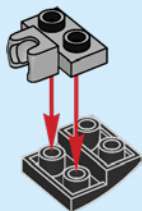

1x



1x

# 117

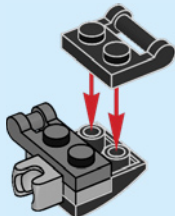



1x

# 118

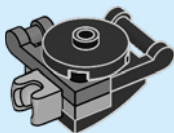

4x

# 119

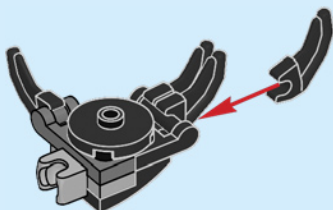

120

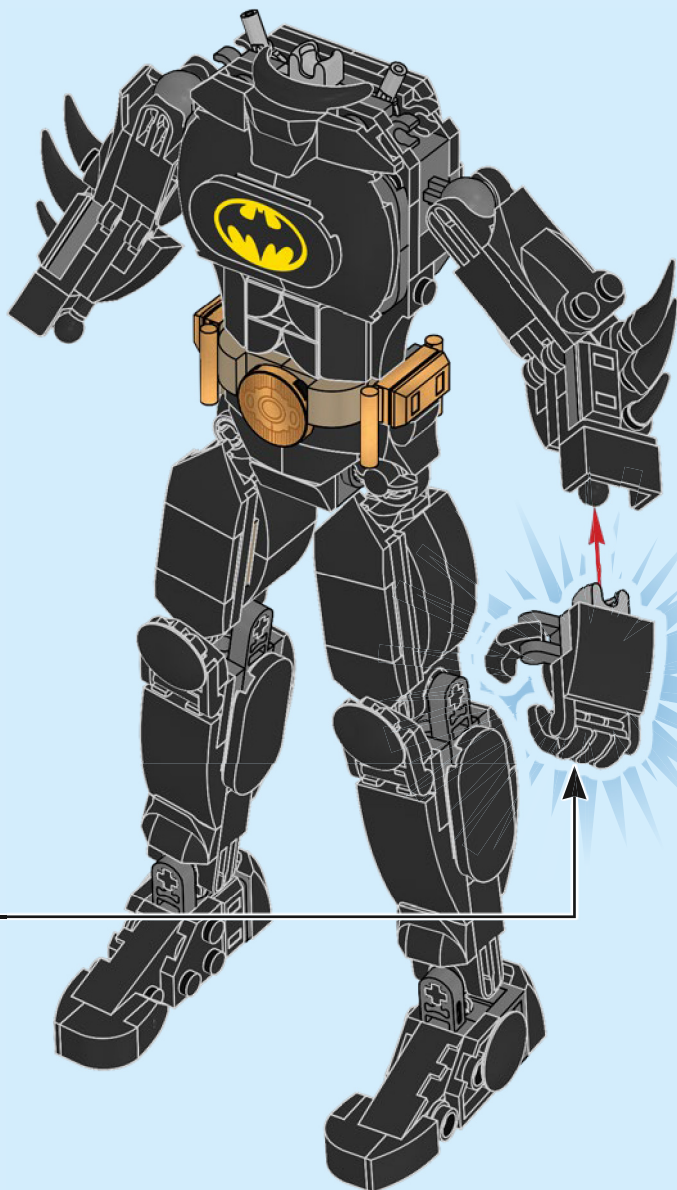

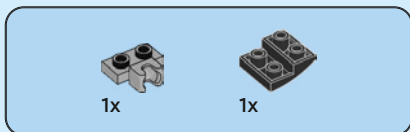

121

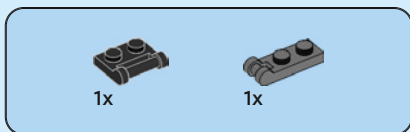
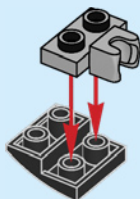

122

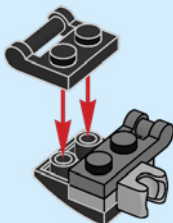



1x

# 123

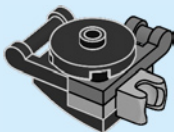

4x

# 124

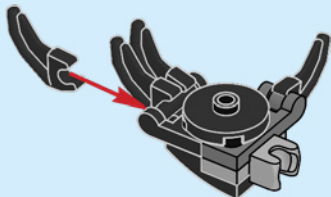

125

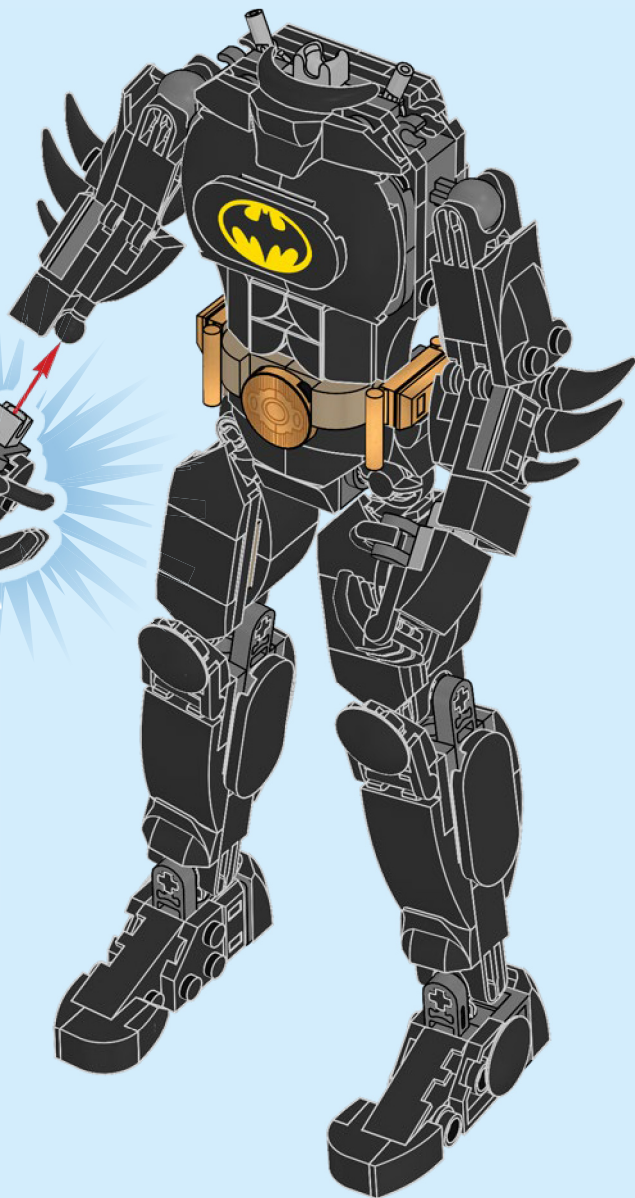

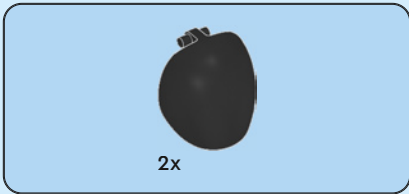

126

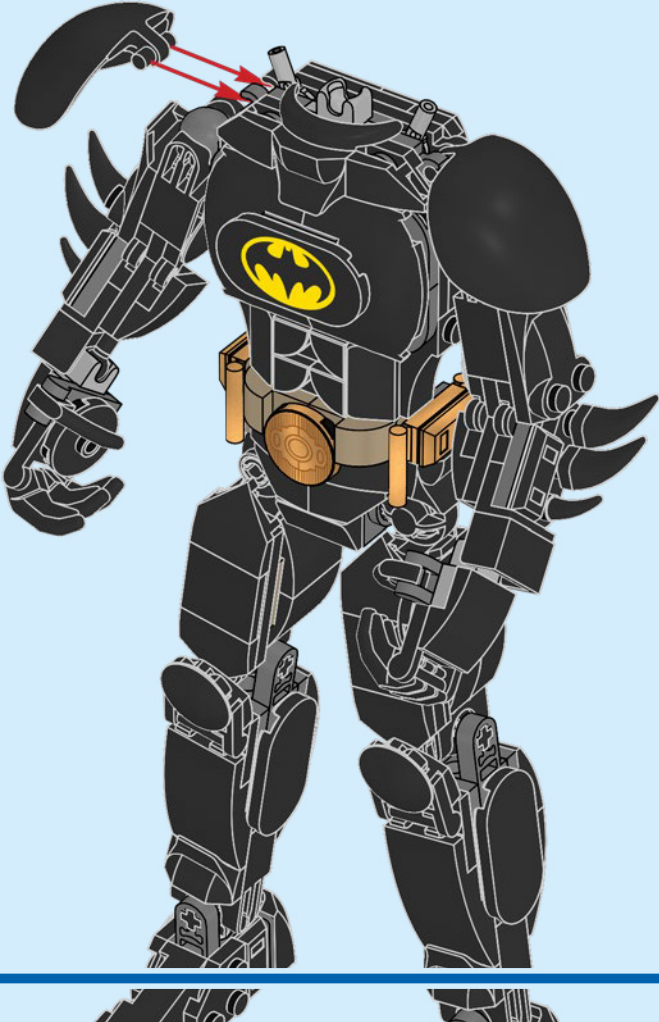



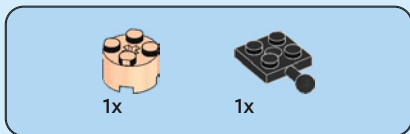

127

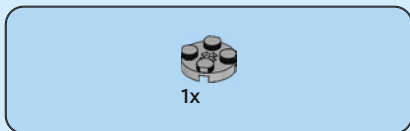
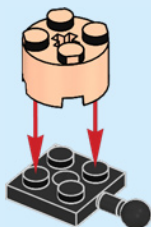

128

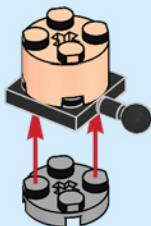

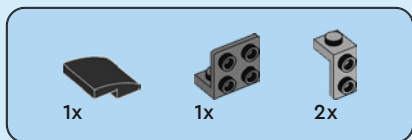

# 129

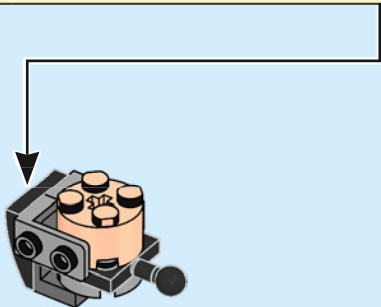
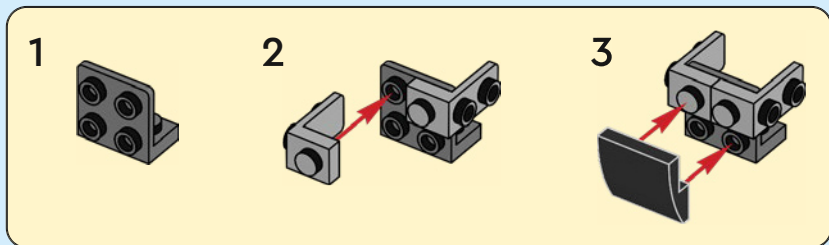



1x



1x



1x



1x

# 130

1

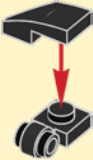

2

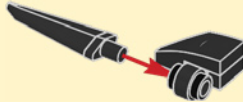

3

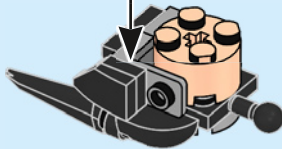
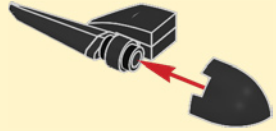



1x



1x

# 131

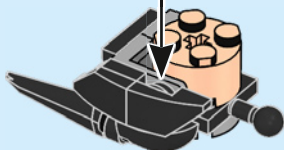
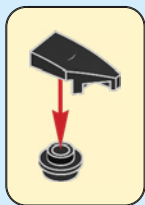



1x



1x



1x



1x

# 132

1

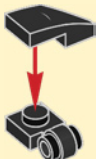

2



3

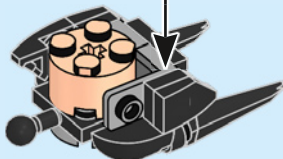
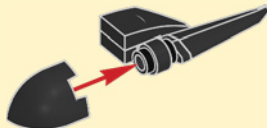



1x



1x

# 133

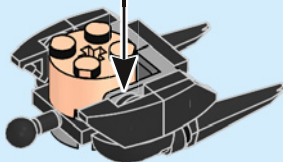
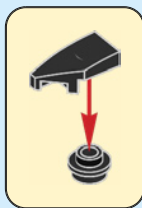

1x

# 134

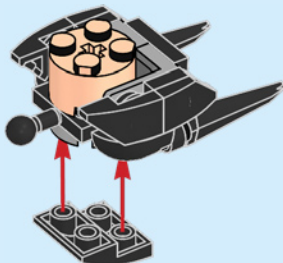

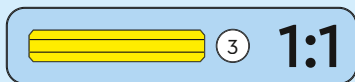
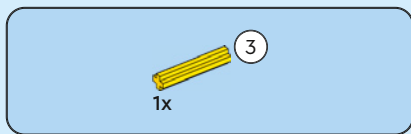

135

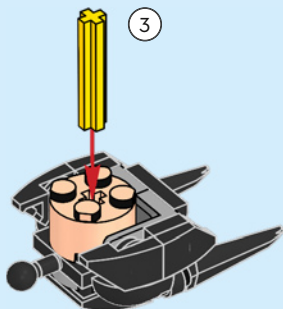

136







138

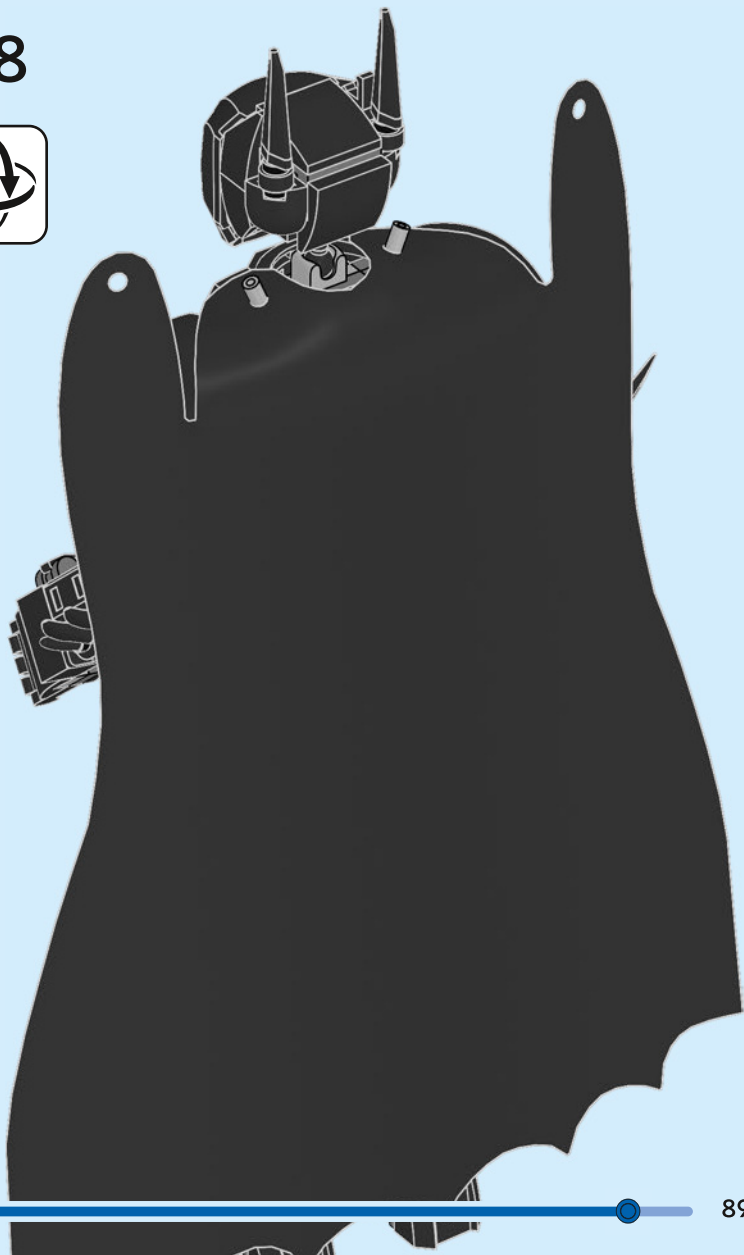

139

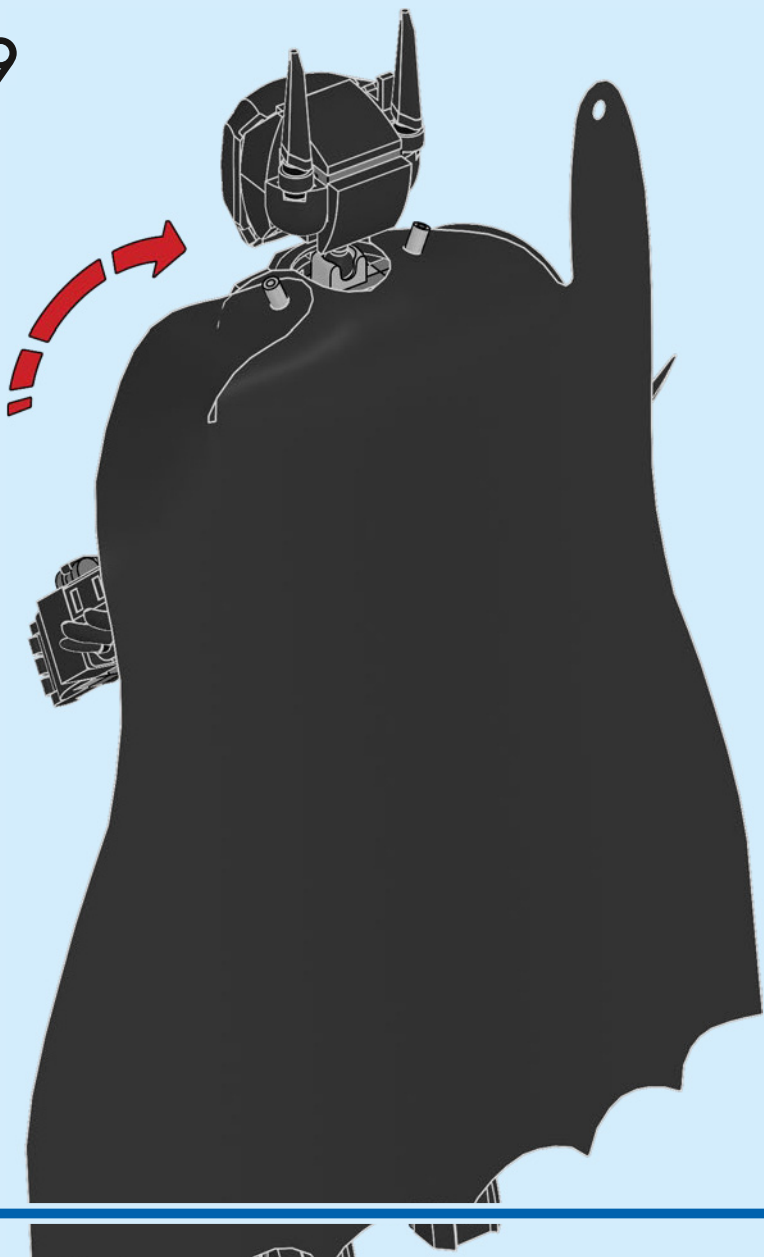

140

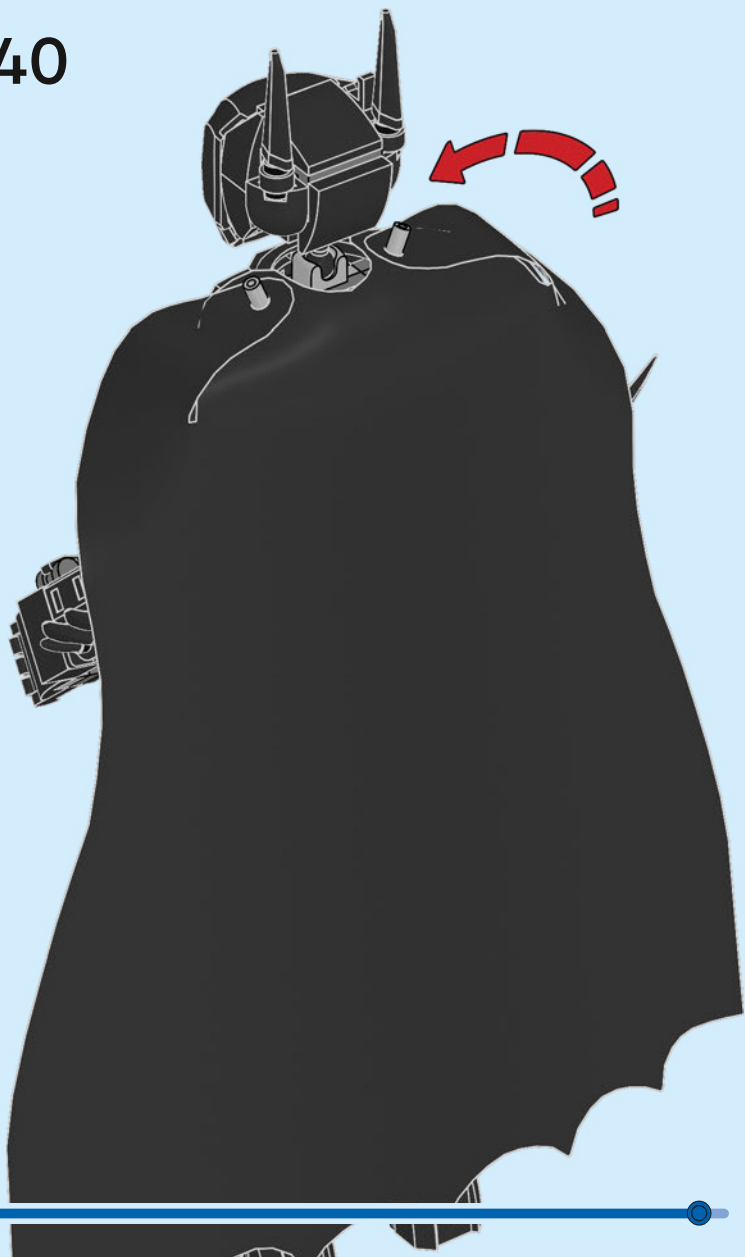



2x

141

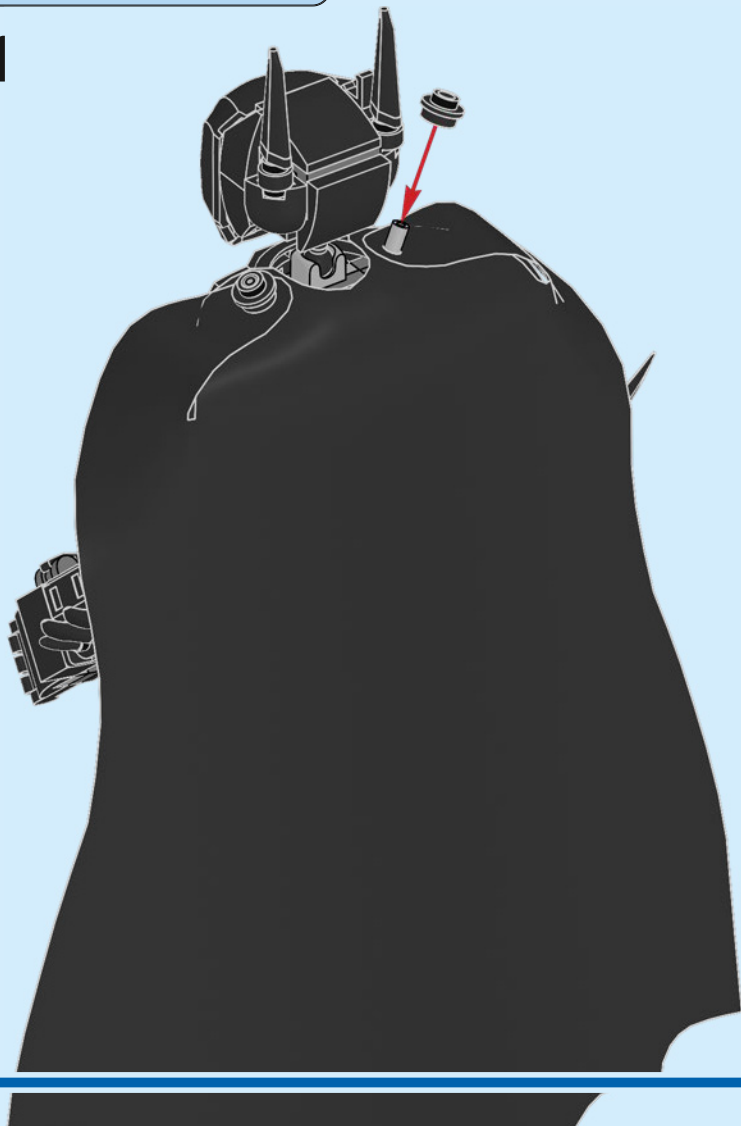



2x  
6270103

6x  
6168646

2x  
6256435

4x  
6270091

4x  
4286267

4x  
6172383

8x  
6420198

5x  
6181720

2x  
6436425

5x  
6181713

3x  
4548180

6x  
4278359

2x  
6279875

4x  
4109810

2x  
6281993

2x  
6195325

10x  
6174243

2x  
6248496

4x  
6156991

5x  
6375706

6x  
6308912

2x  
300426

4x  
6347310

2x  
6184784

2x  
6147050

2x  
6020193

2x  
6428168

4x  
4225201

2x  
6350725

2x  
4213374

16x  
6211476

2x  
235726

1x  
6013867

2x  
306826

1x  
6053077

2x  
4143875

3x  
6448318

2x  
6270085

2x  
6328095

1x  
4526931

2x  
6432392

1x  
6255875

2x  
6168620

1x  
4531412

2x  
302126

1x  
4527766

1x  
6444157

4x  
6331483

2x  
4285883

1x  
6438248

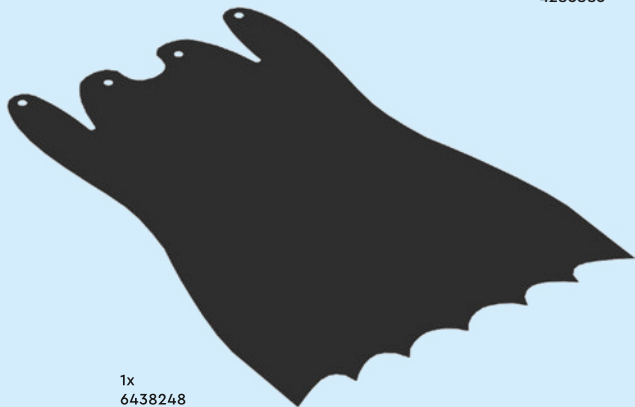



5x  
4613153



4x  
6039869



6x  
6360825



2x  
6302828



4x  
6416444



2x  
6386234



2x  
4647286



2x  
302026



2x  
4188534



1x  
6444156



2x  
6350415



2x  
379526



2x  
4210633



4x  
4211044



2x  
4504378



2x  
6336390



2x  
6296892



11x  
4211063



2x  
6398662



2x  
6214341



3x  
6308045



4x  
4211094



4x  
6411395



2x  
4521187



4x  
6324639



3x  
4497253



1x  
4243831



2x  
6362975



2x  
6227897



1x  
4211475



3x  
6043656



2x  
4211440



2x  
6360295



4x  
6250168



4x  
6214334



2x  
4114077



1x  
371021



1x  
6422920



1x  
6357786



1x  
6444158



2x  
6207933



2x  
6337403



2x  
302324



1x  
6130007



1x  
6360826



LEGO.com/service

YOU COULD

# WIN



Scan this QR code or go to **LEGO.COM/PRODUCTFEEDBACK** and give us your short feedback about this LEGO® set for a chance to win a cool LEGO prize.

Terms and Conditions apply\*

**EN: YOU COULD WIN.** Terms and Conditions apply\* **DE: Du könntest GEWINNEN.** Es gelten die Teilnahmebedingungen\* **FR: Tu pourrais GAGNER.** Des conditions s'appliquent\* **IT: Potresti VINCERE tu.** Termini e condizioni sono applicabili\* **ES: Puedes GANAR.** Aplican términos y condiciones\* **PT: Poderá GANHAR.** Aplicam-se termos e condições\* **ZH: 轻松获奖. 条款和条件适用\*** **PL: Szansa na WYGRANĄ.** Obowiązują warunki korzystania\* **CS: Máte šanci VYHRÁT.** Platí všeobecné smluvní podmínky\* **SK: Máte šancu VYHRAŤ.** Platia všeobecné zmluvné podmienky\* **HU: TE IS NYERHETSZ.** Felhasználási feltételek érvényesek\* **RO: Ai putea CÂȘTIGA.** Se aplică termeni și condiții\* **BG: Можете да СПЕЧЕЛИТЕ.** Има определени правила и условия\* **LV: Tu vari LAIMĒT.** Ir spēkā noteikumi un nosacījumi.\* **ET: Sul on võimalus VÕITA.** Kehtivad tingimused\* **LT: Jūs galite LAIMĖTI.** Taikomos sąlygos\*

\*[LEGO.com/productfeedback-terms](https://www.lego.com/productfeedback-terms)

LEGO and the LEGO logo are trademarks of the/son des marques de commerce du/son marcas registradas de LEGO Group. ©2023 The LEGO Group.  
BATMAN RETURNS and all related characters and elements © & ™ DC and Warner Bros. Entertainment Inc. WB SHIELD: © & ™ WBEI (s23)

6467930