

Harry Potter

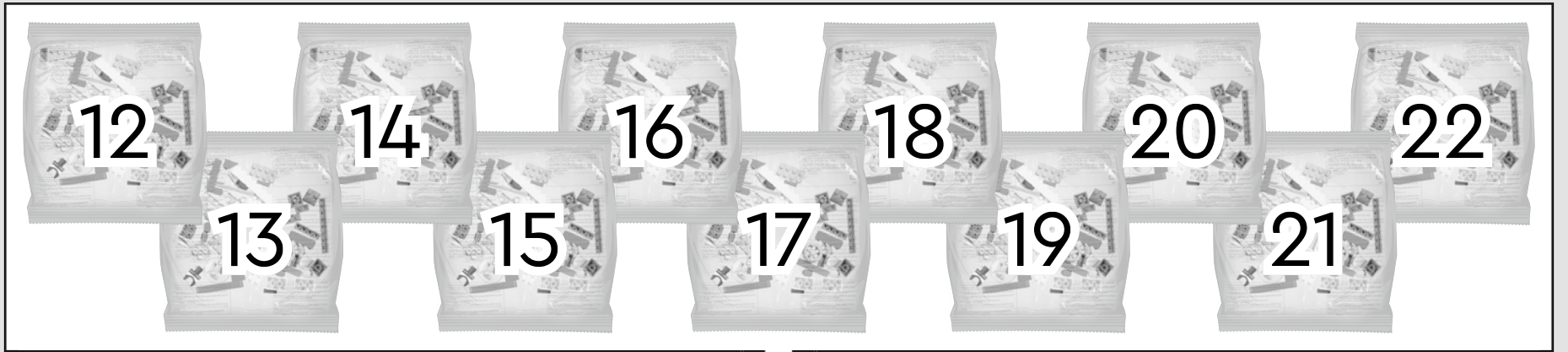

WIZARDING
WORLD





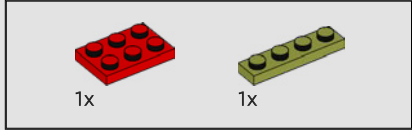
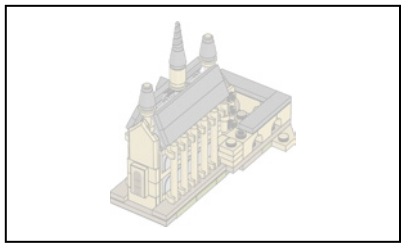

309

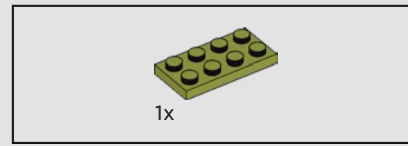
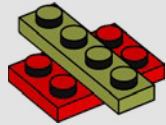

310

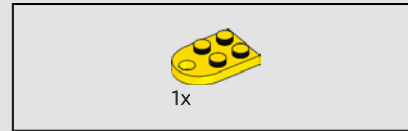
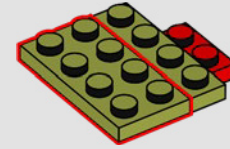

311

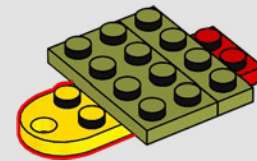

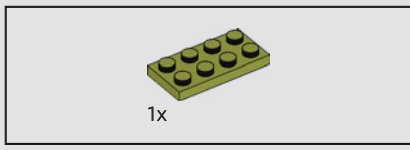

312

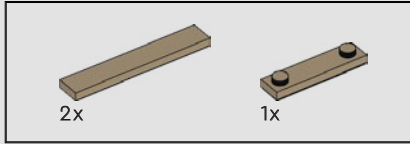
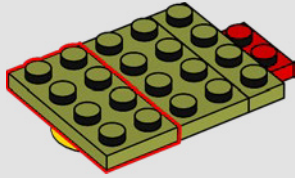

313

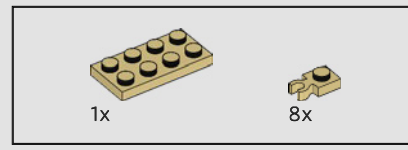
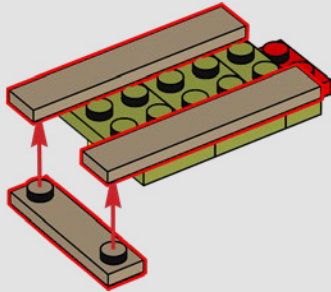

314

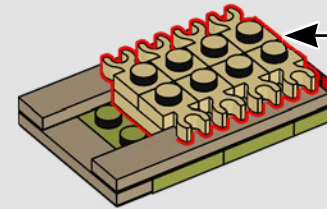
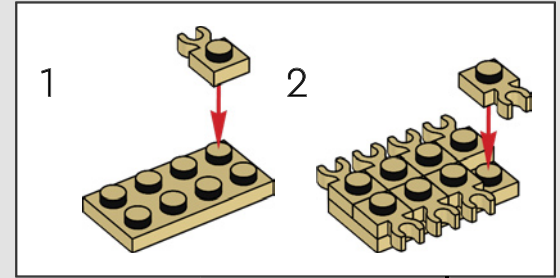

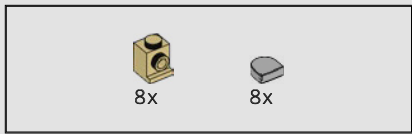

315

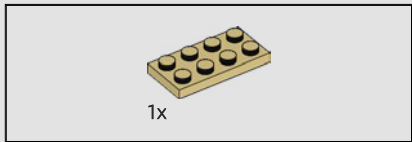
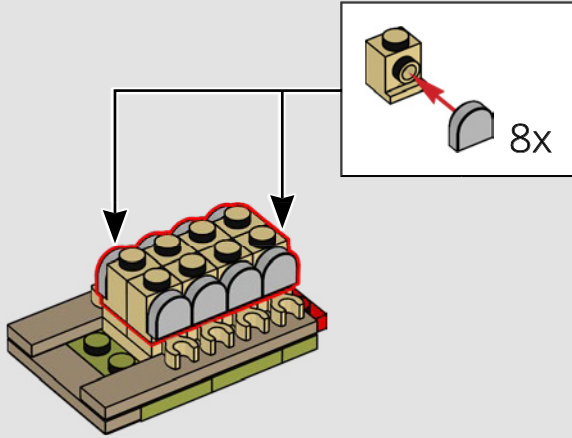

316

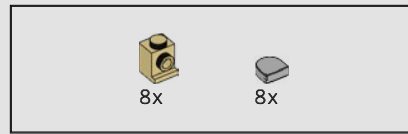
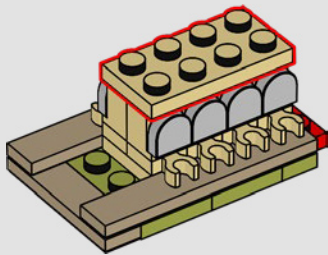

317

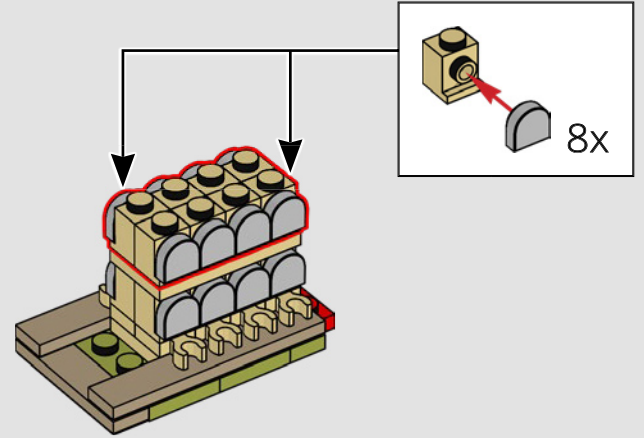

318

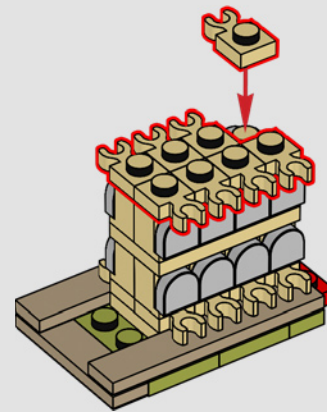

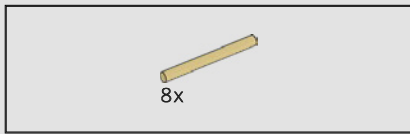

319

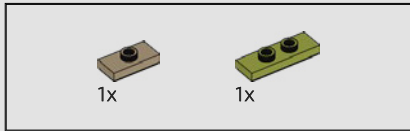
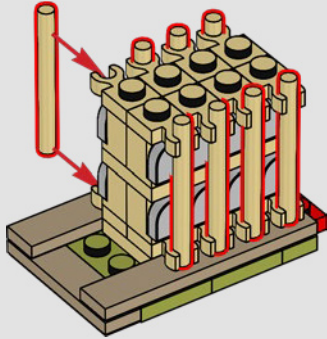

320

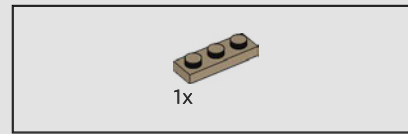
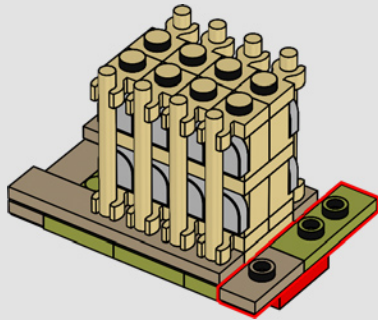

321

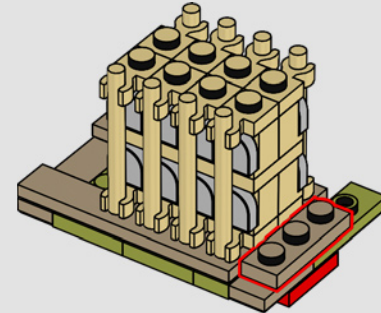

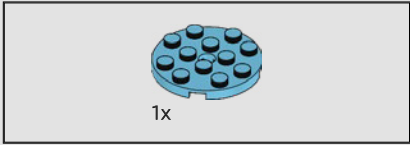
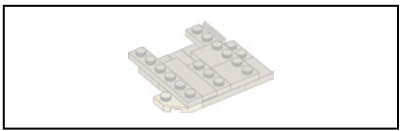

322

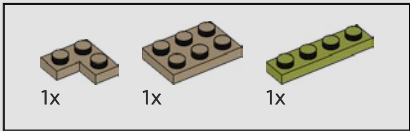
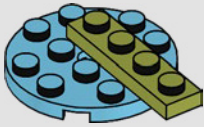

323

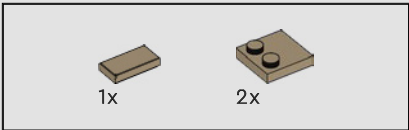
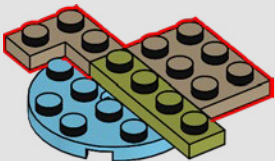

324

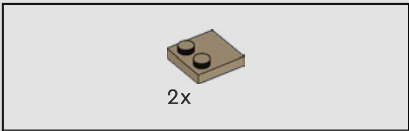
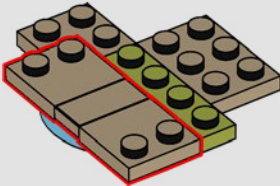

325

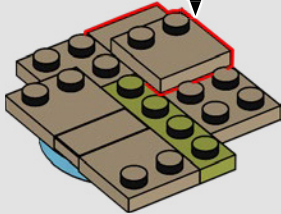
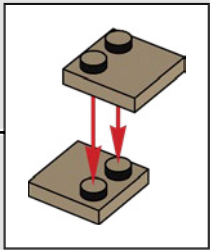

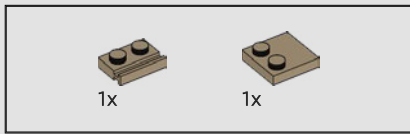

326

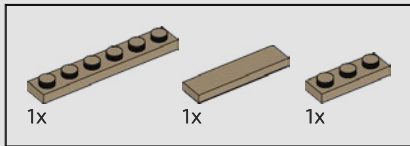
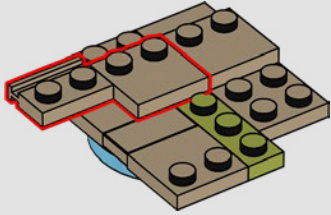

327

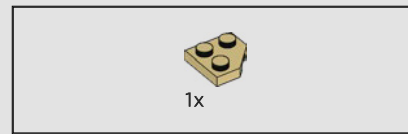
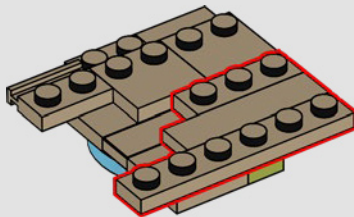

328

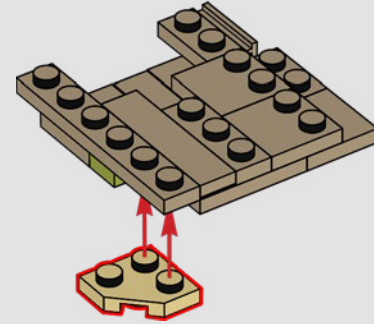
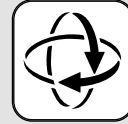

329

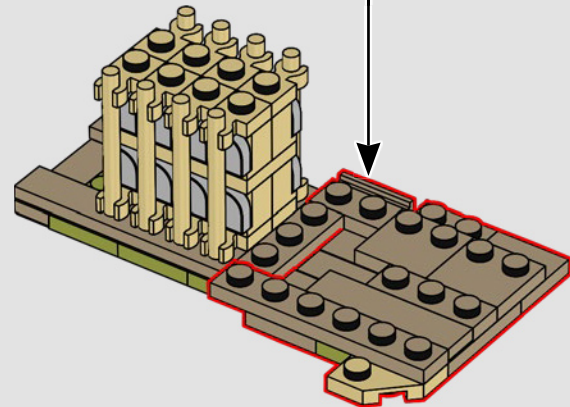

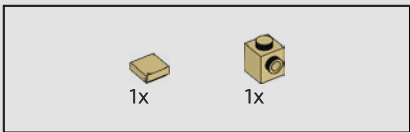

330

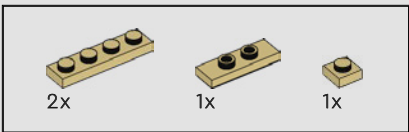
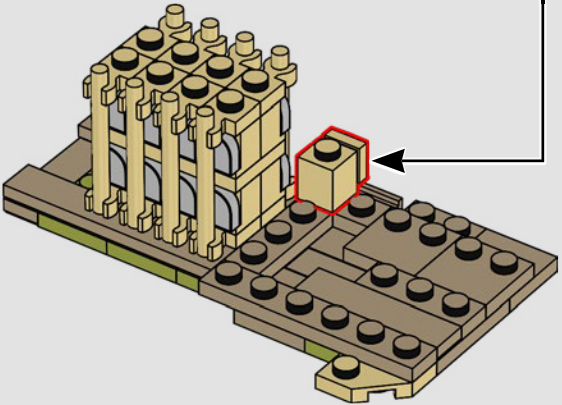
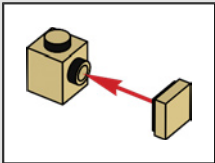

331

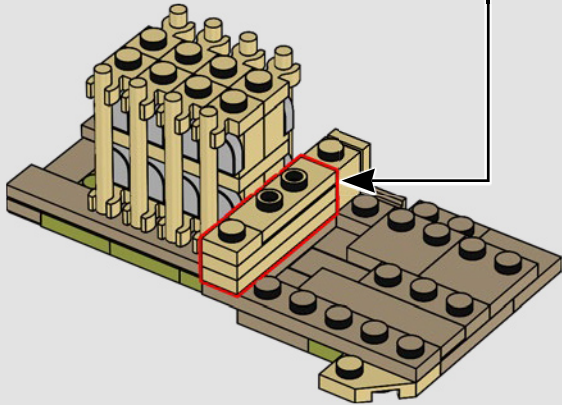
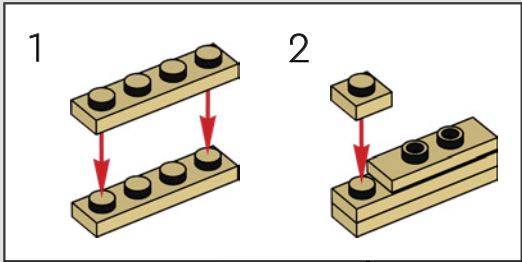

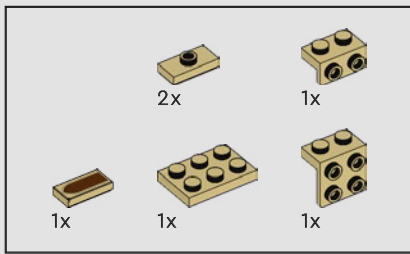

332

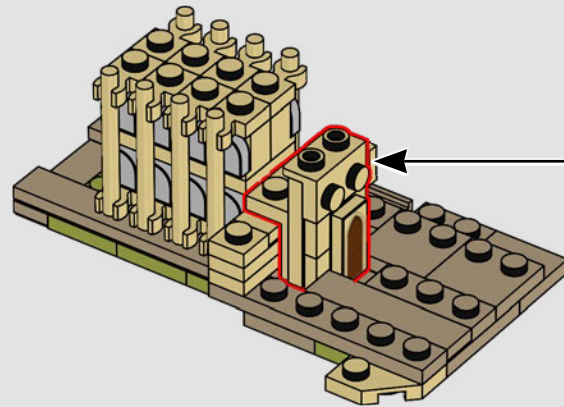
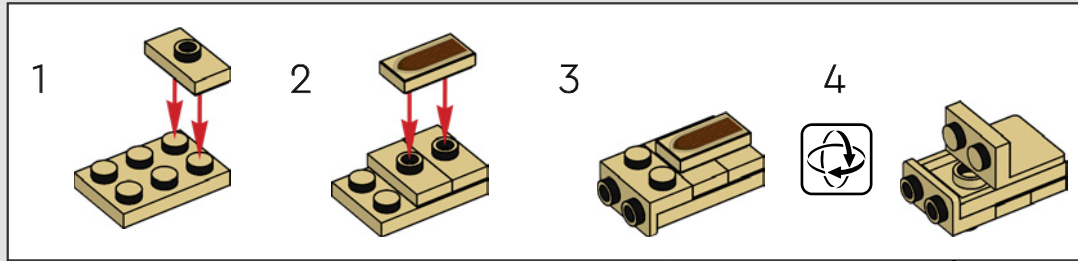



333

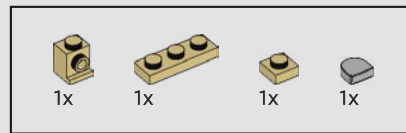
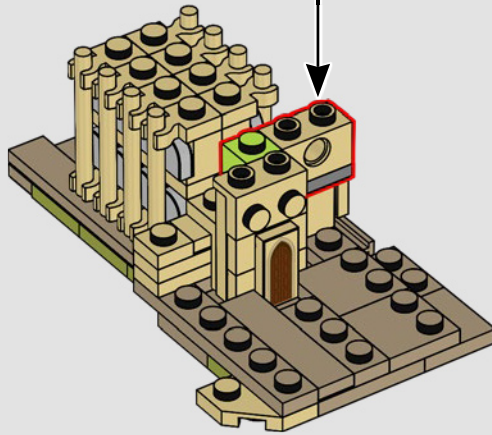
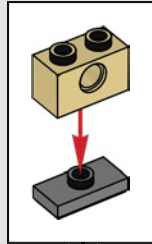

334

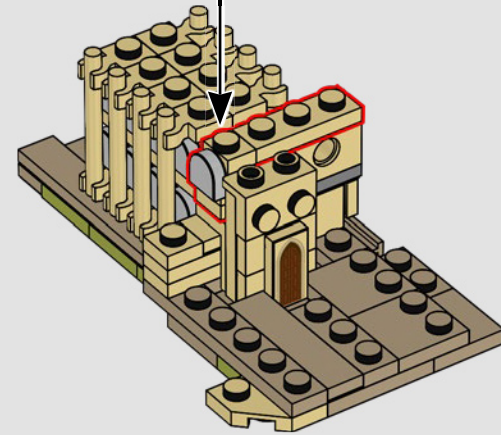
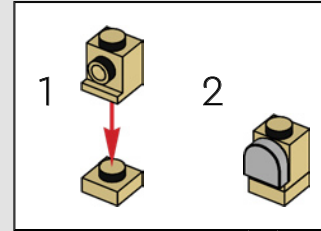



335

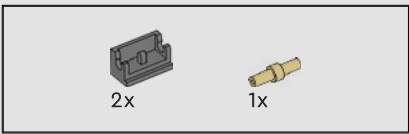
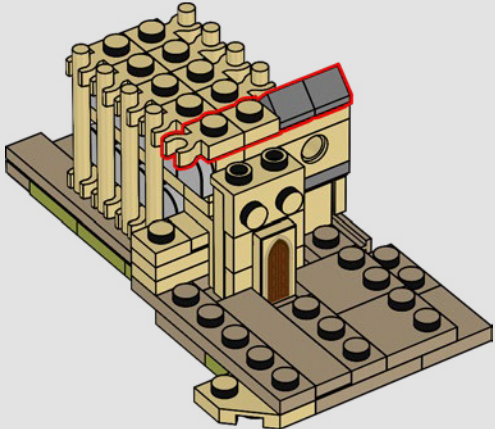

336

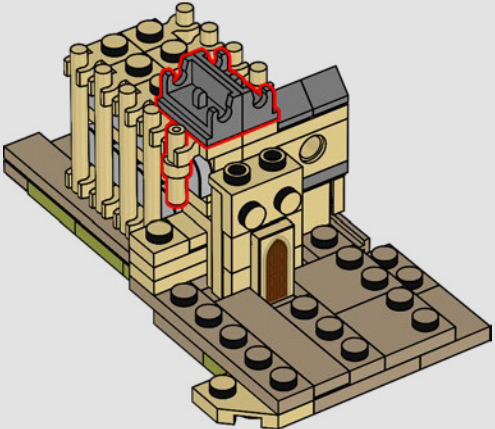

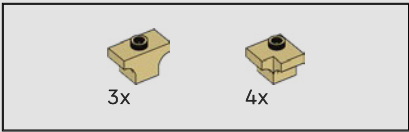

337

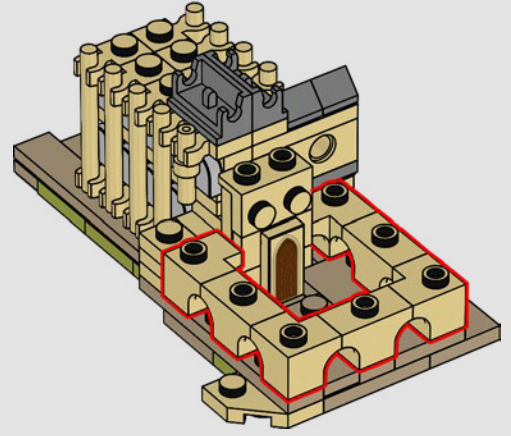

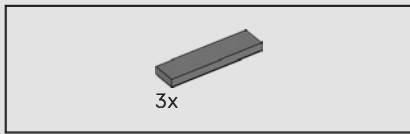

338

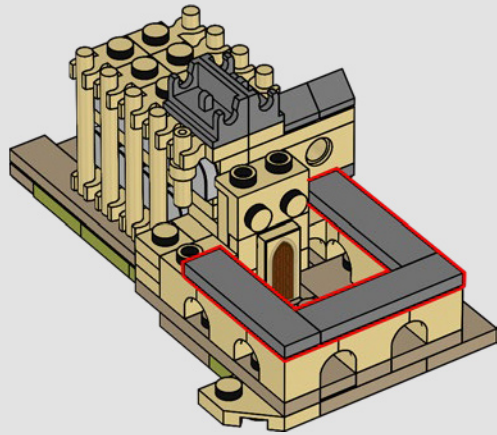

339

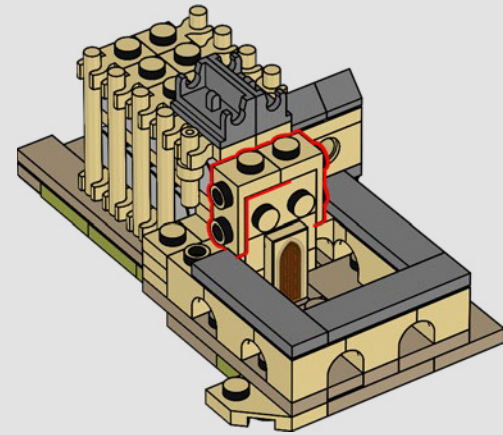

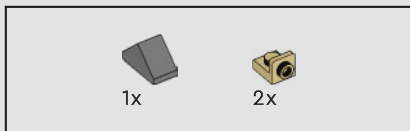

340

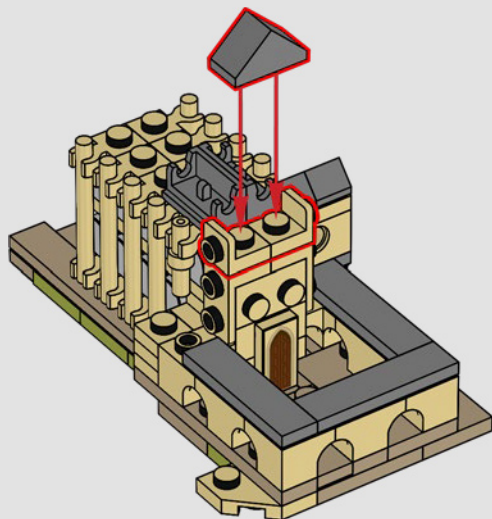

341

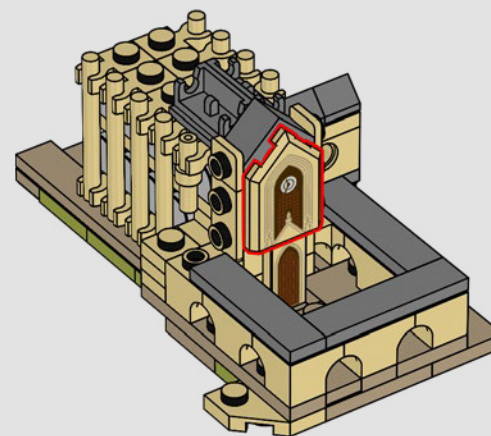

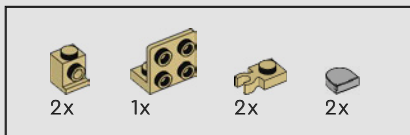

342

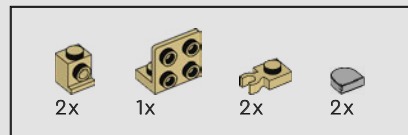
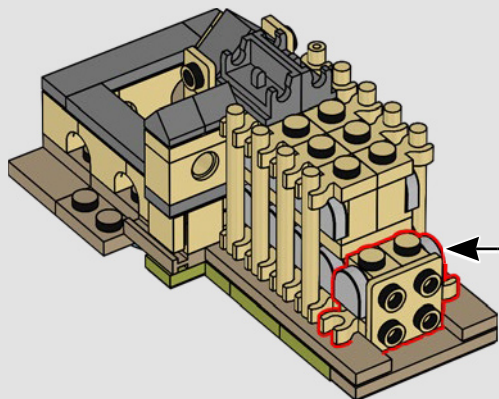
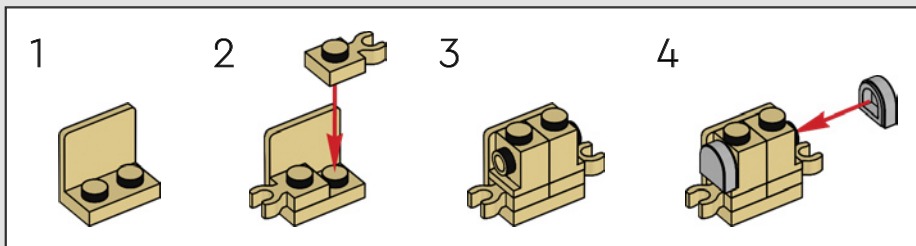

343

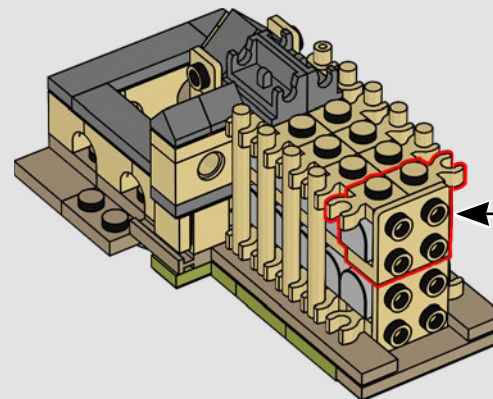
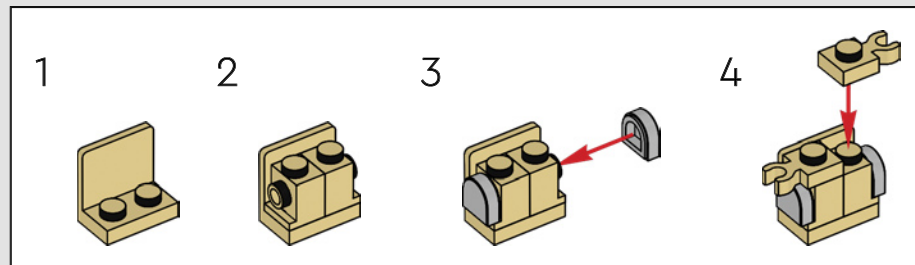

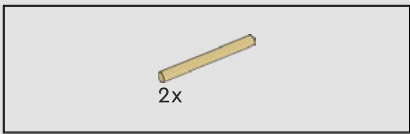

344

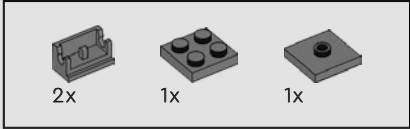
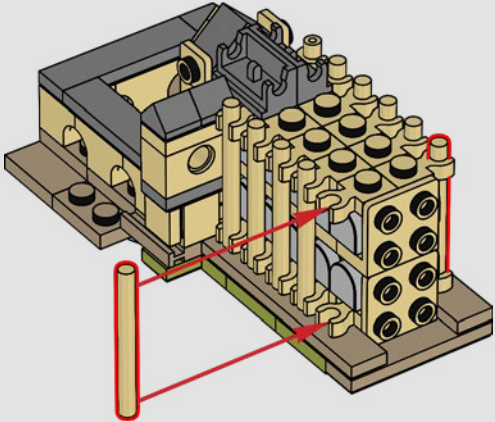

345

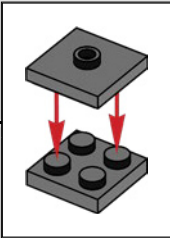
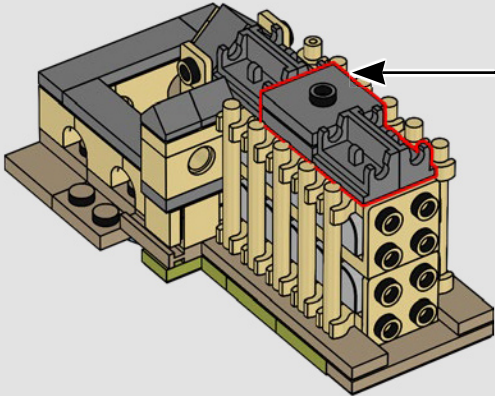

346

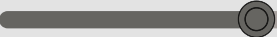
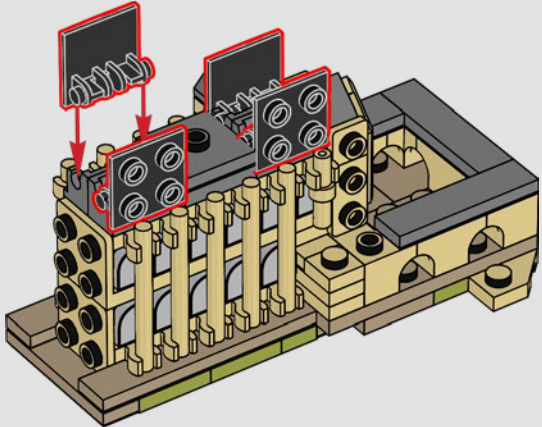

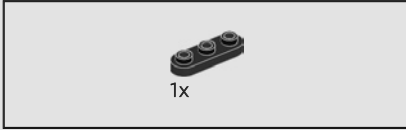
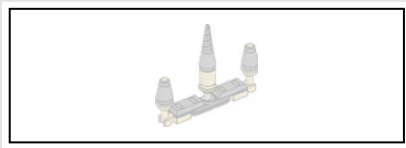

1x

347

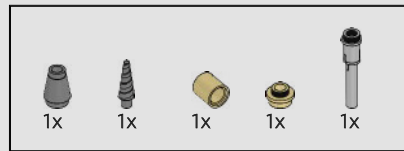

348

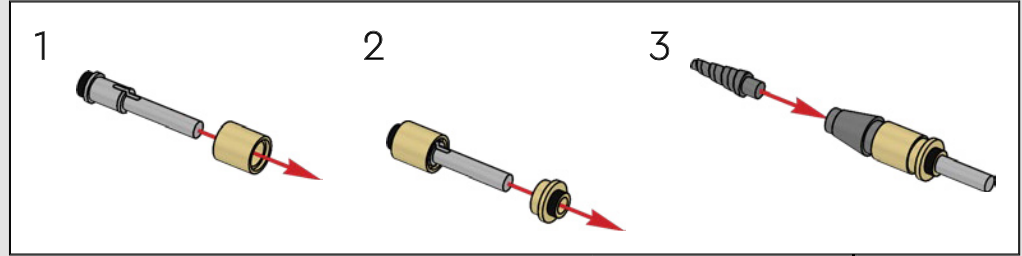



349

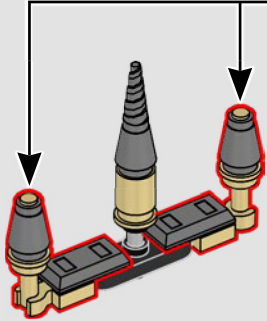
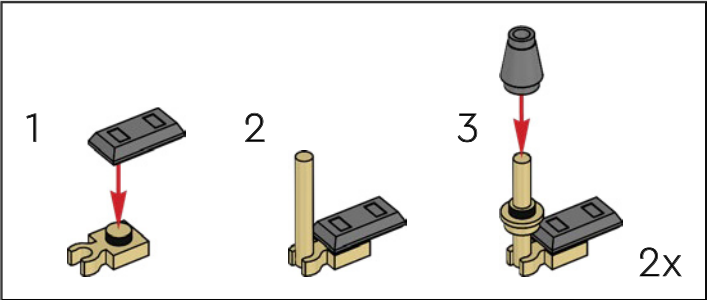

350

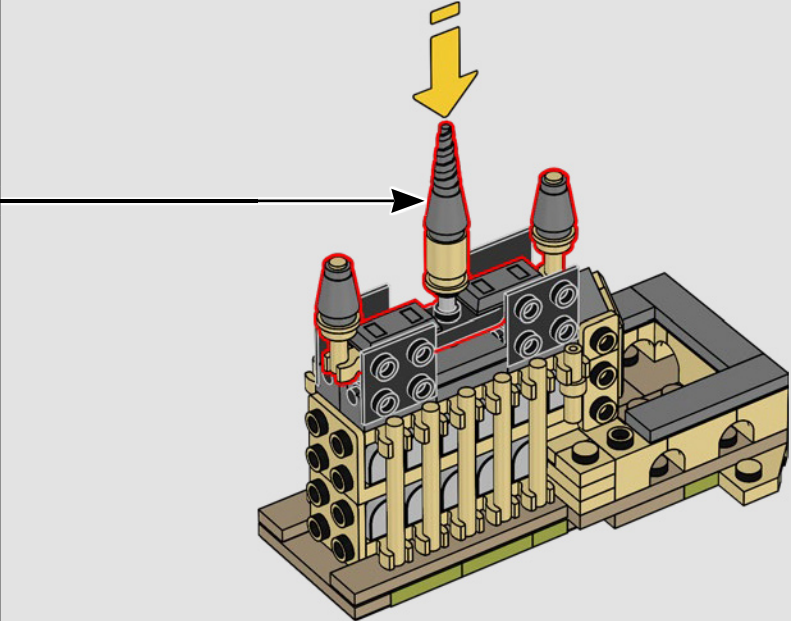

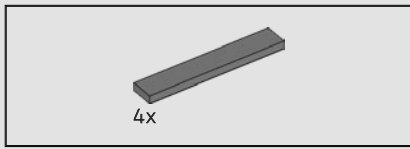

351

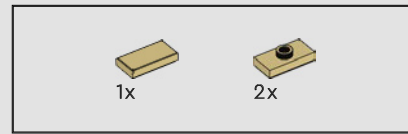
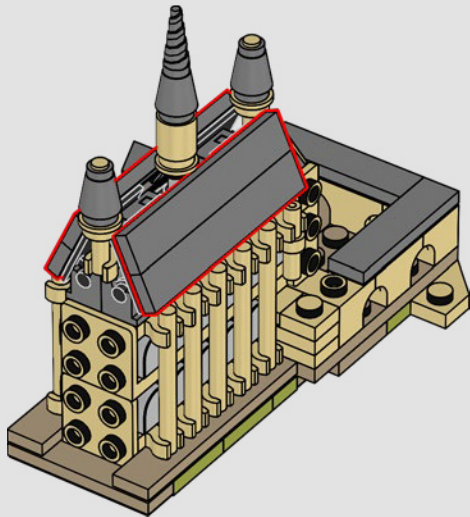

352

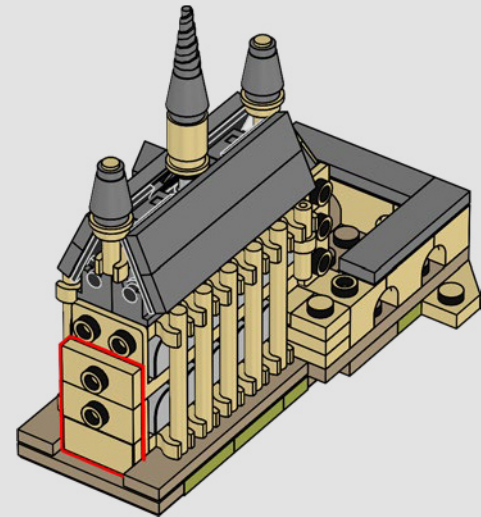

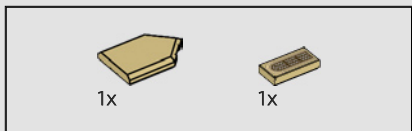

353

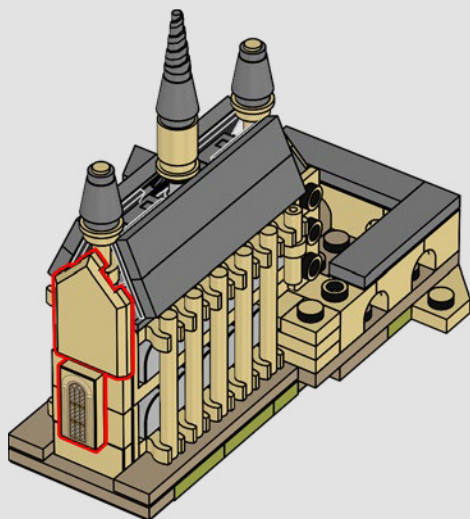

施过魔法后, 大礼堂的
天花板可以模仿夜空。

354

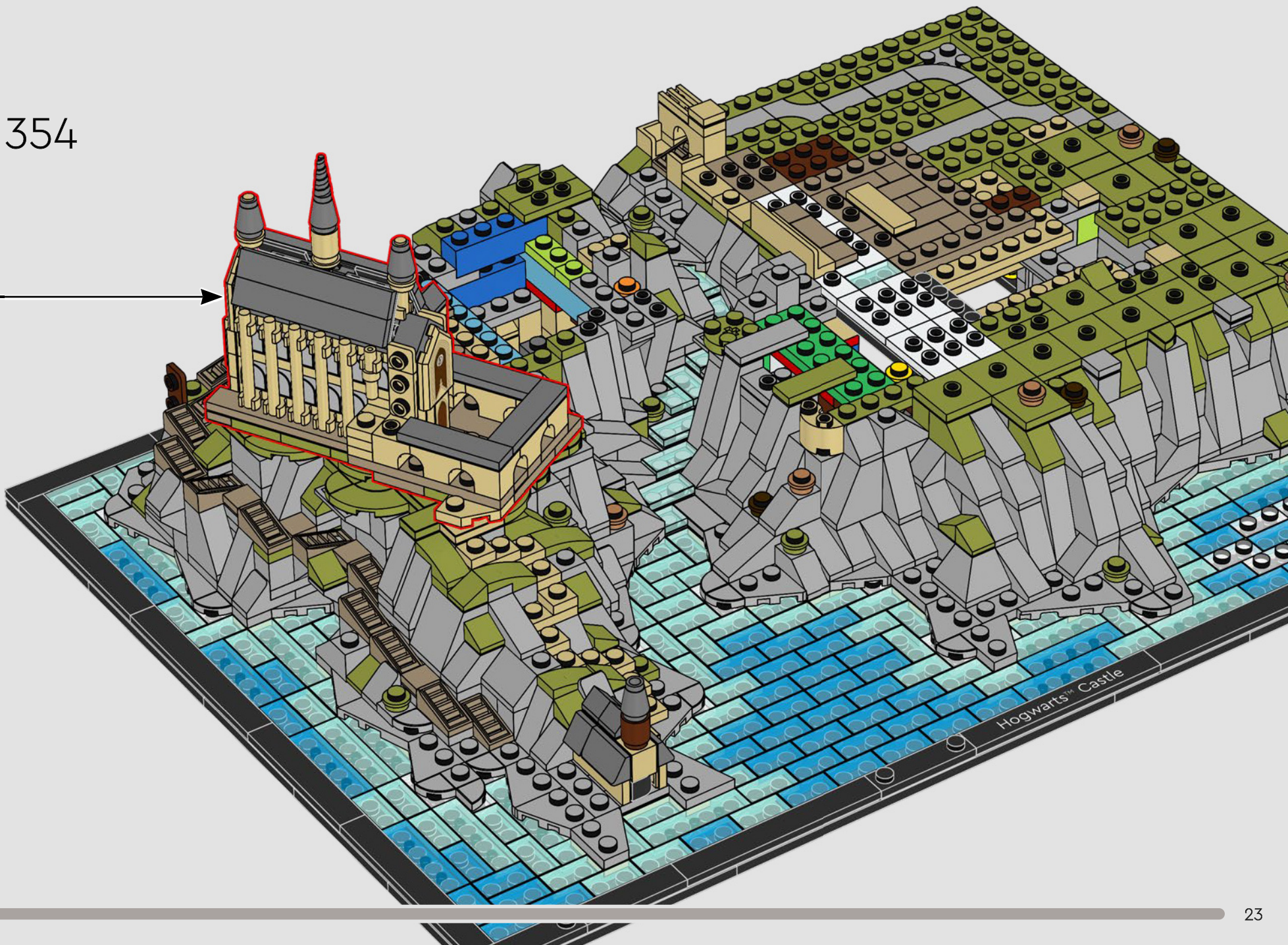

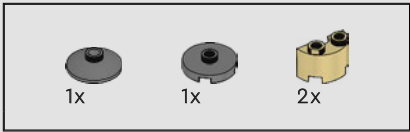

355

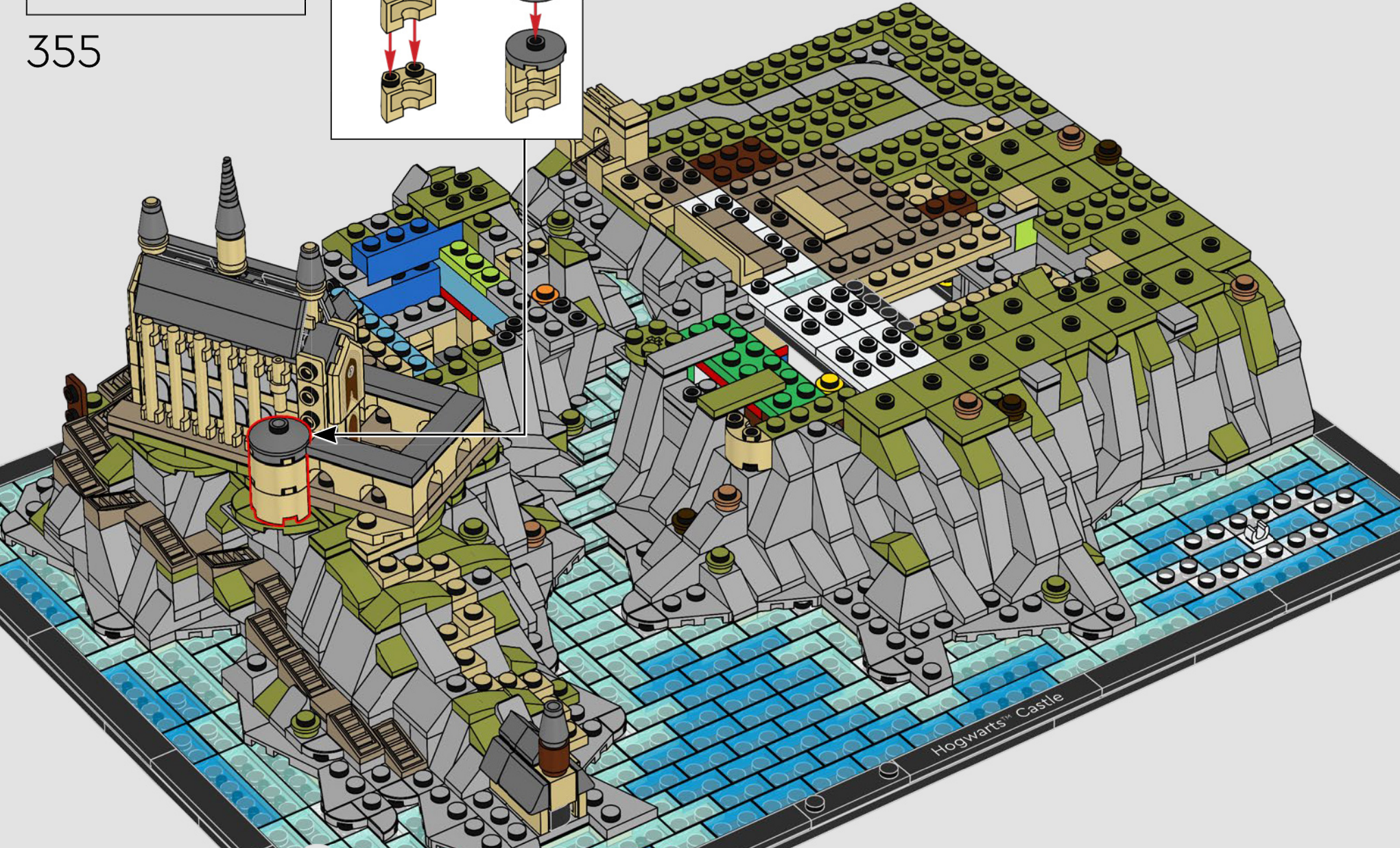
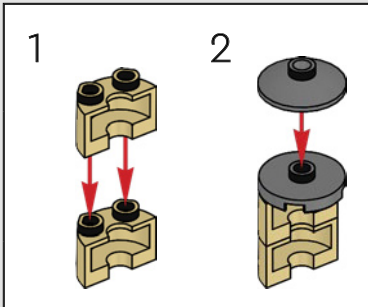

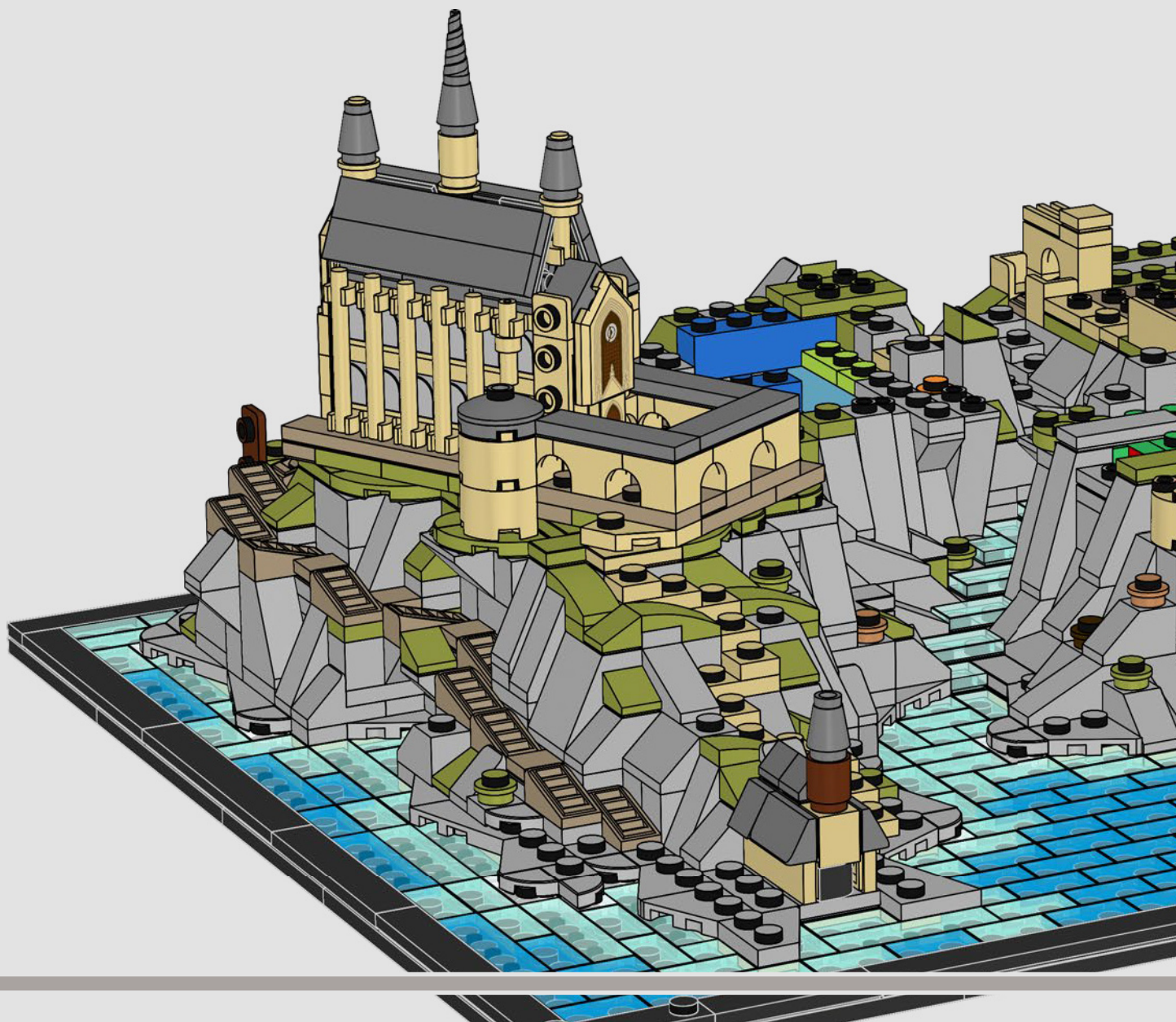

到达霍格沃茨后，一年级学生会立即被带到大礼堂，将由分院帽决定他们属于哪个学院。



356



这些树是由乐高®
水晶和冰淇淋组件
(以及一点魔法)
拼搭而成的。



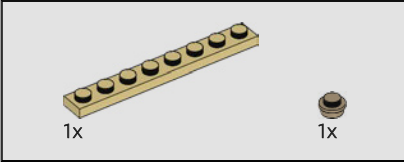
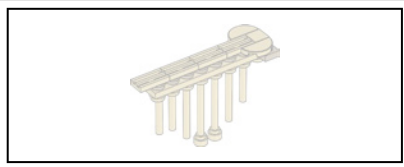

357

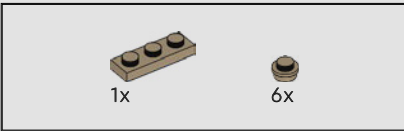
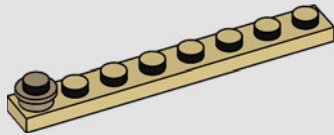

358

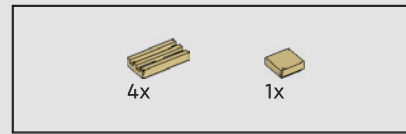
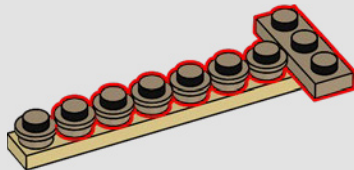

359

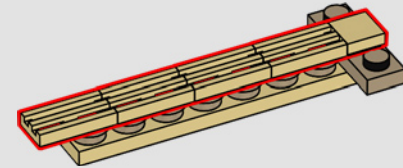

360

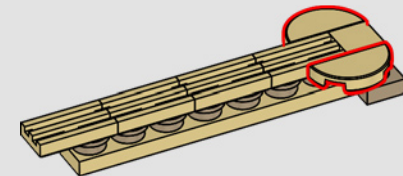

8x

361

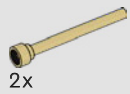
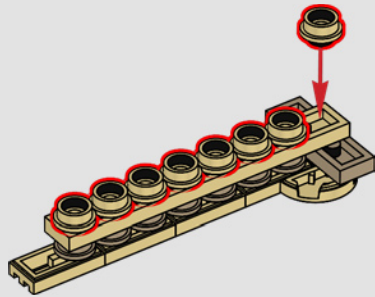

2x

362

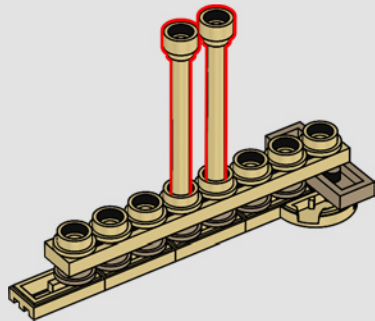

2x

3x

363

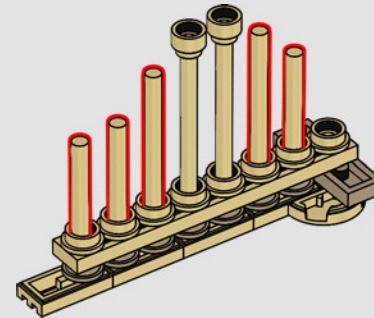

364



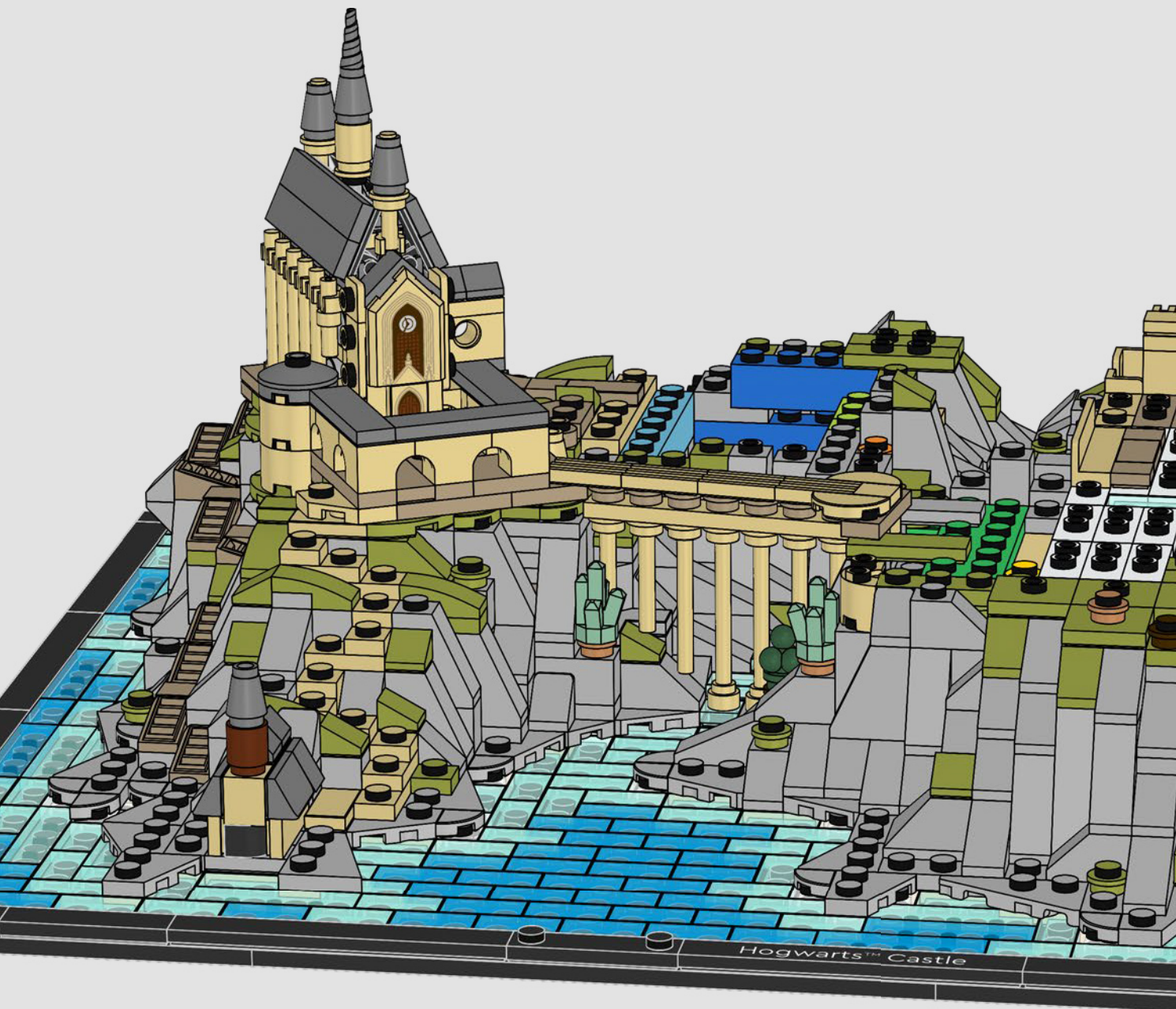

高架桥不仅是霍格沃茨™剪影的标志性部分，而且是霍格沃茨大战的中心位置：麦格教授向甲士施魔法，让他们履行对学校的职责，保护校内的所有人员，接着这些甲士们朝着高架桥走去。高架桥还出现在三强争霸赛第一项任务的关键时刻，匈牙利树蜂龙在桥下追逐哈利。



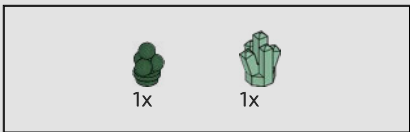

365





2x

366

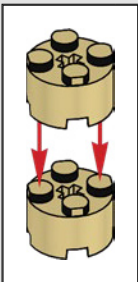
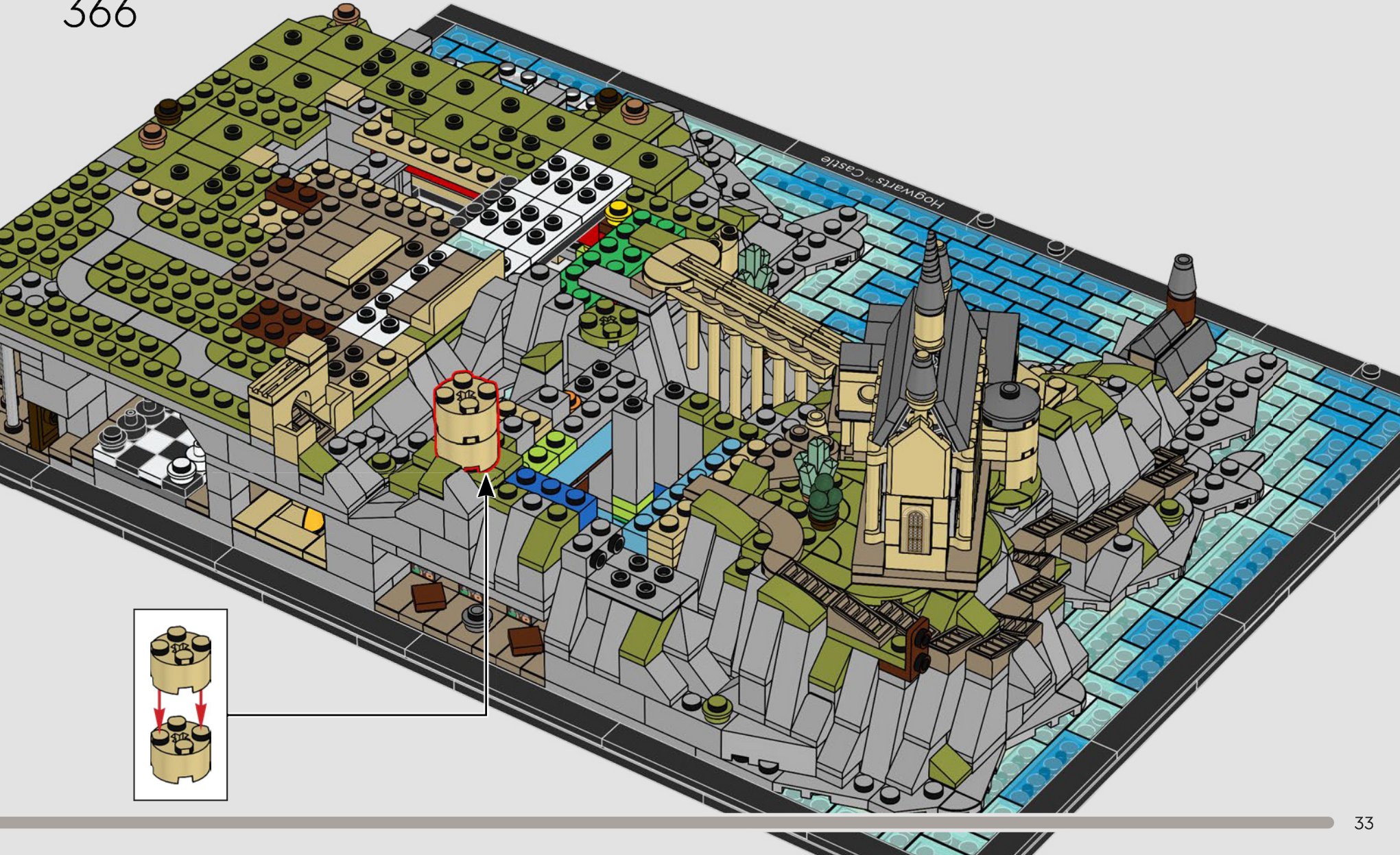

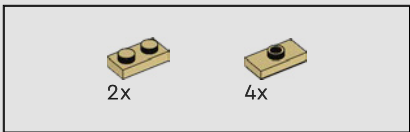

367

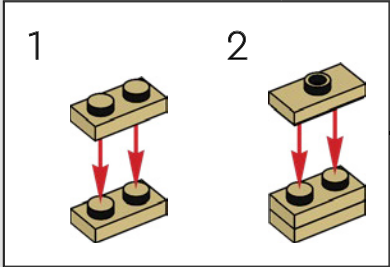
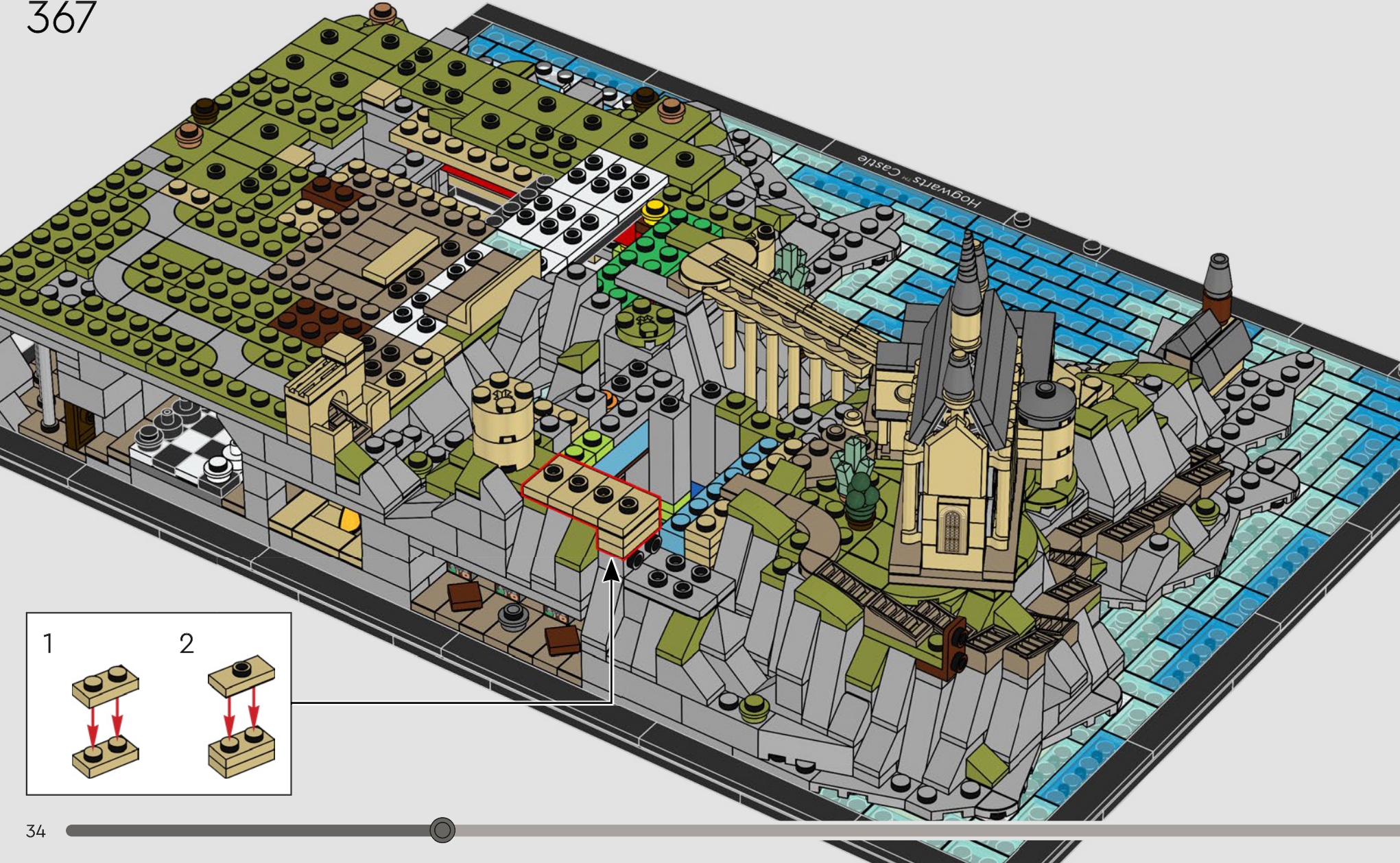

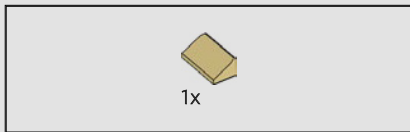

368

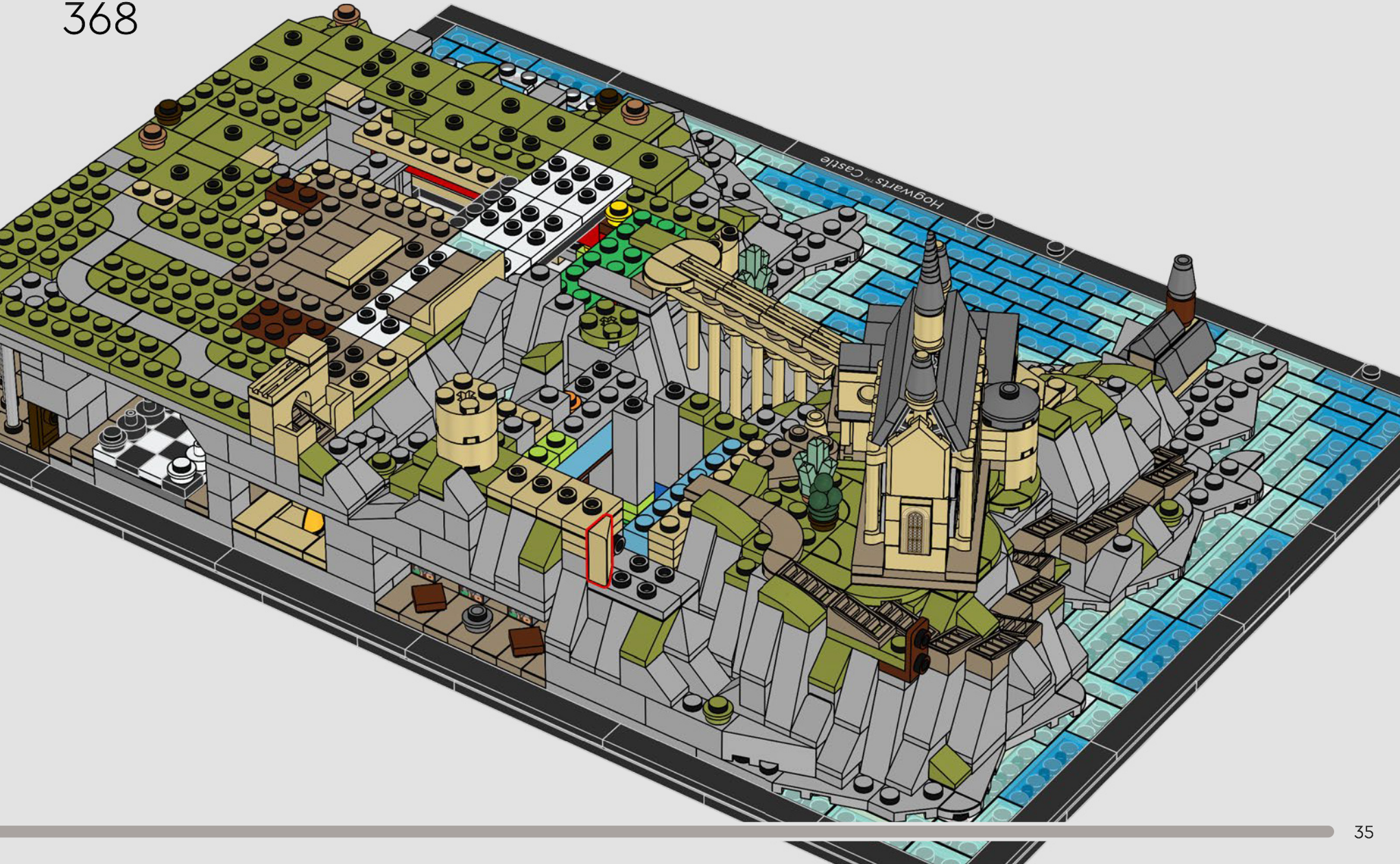

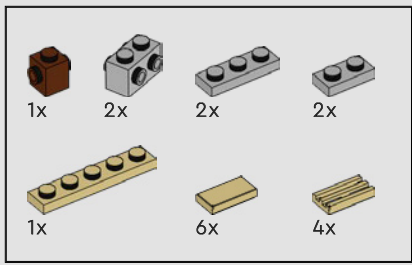

369

1

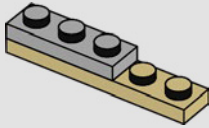

2

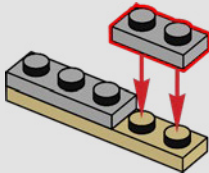

3

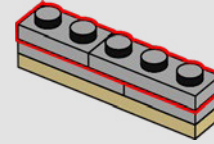

4

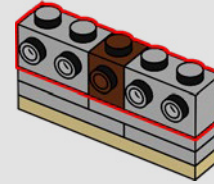

5

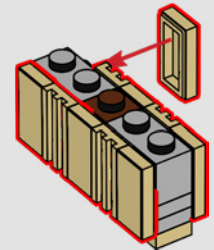

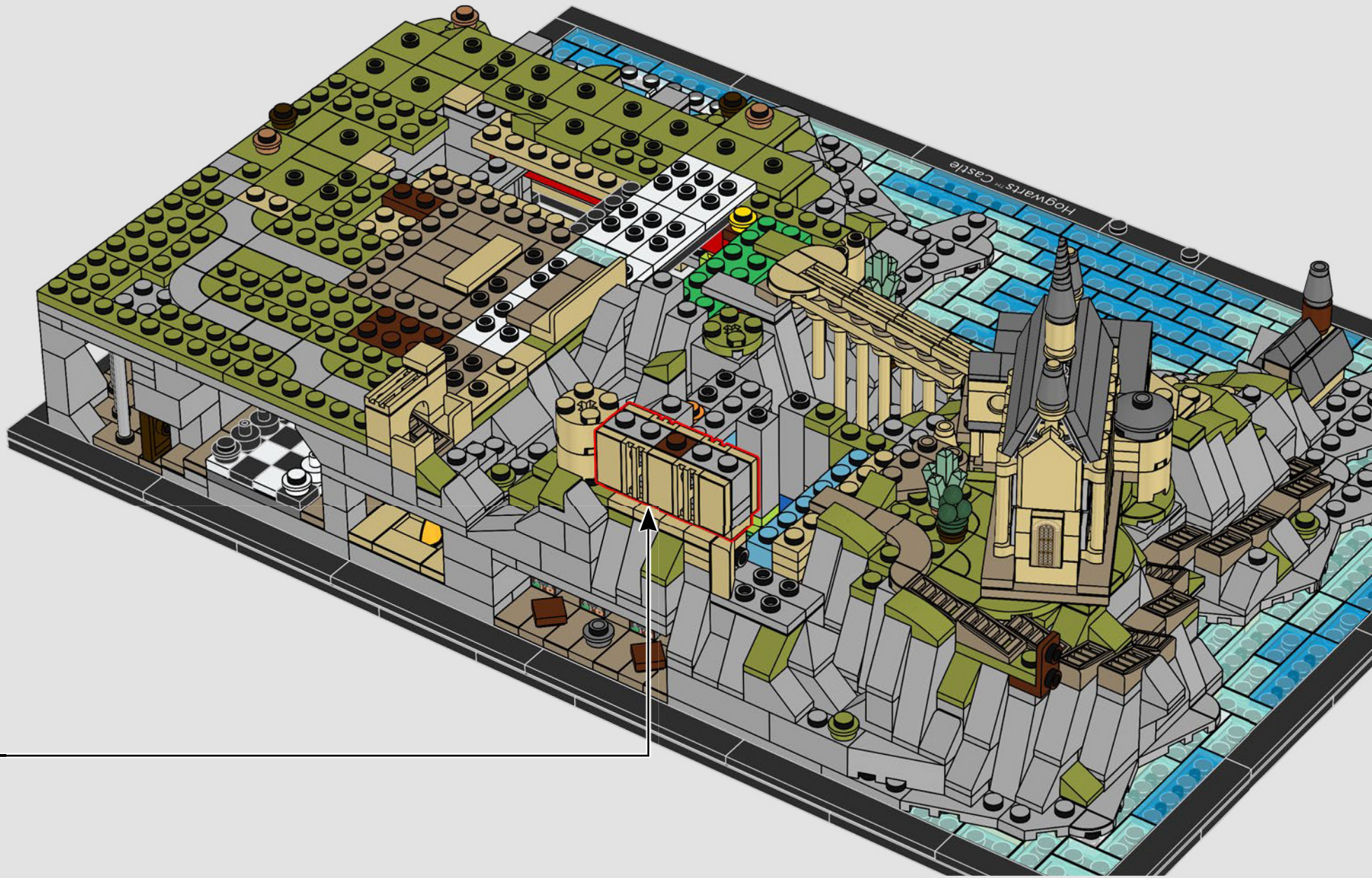

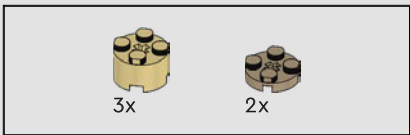

370

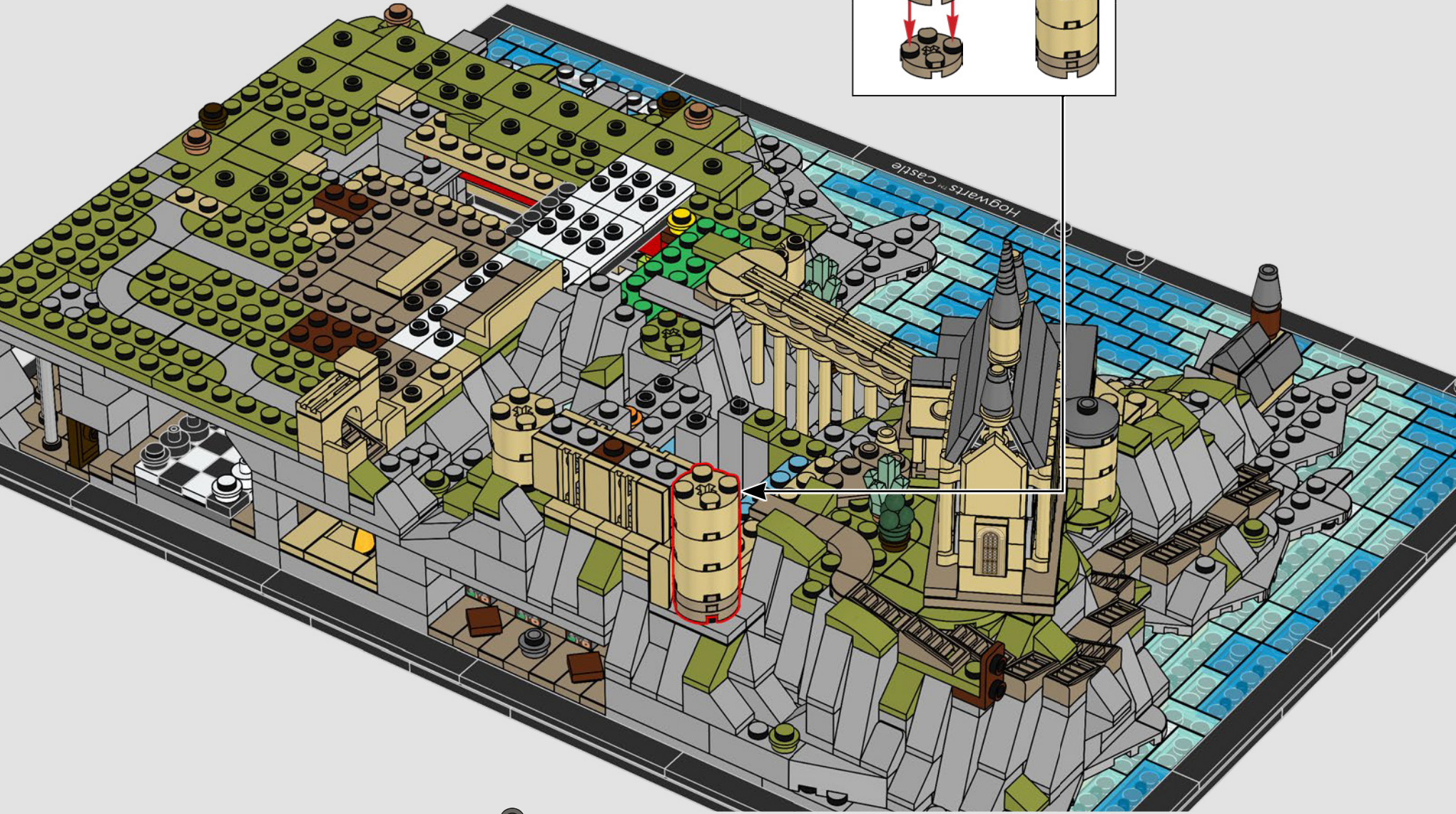
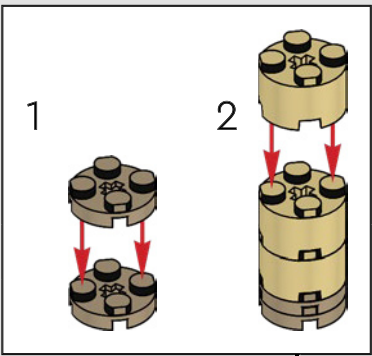

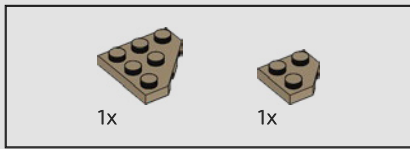

371

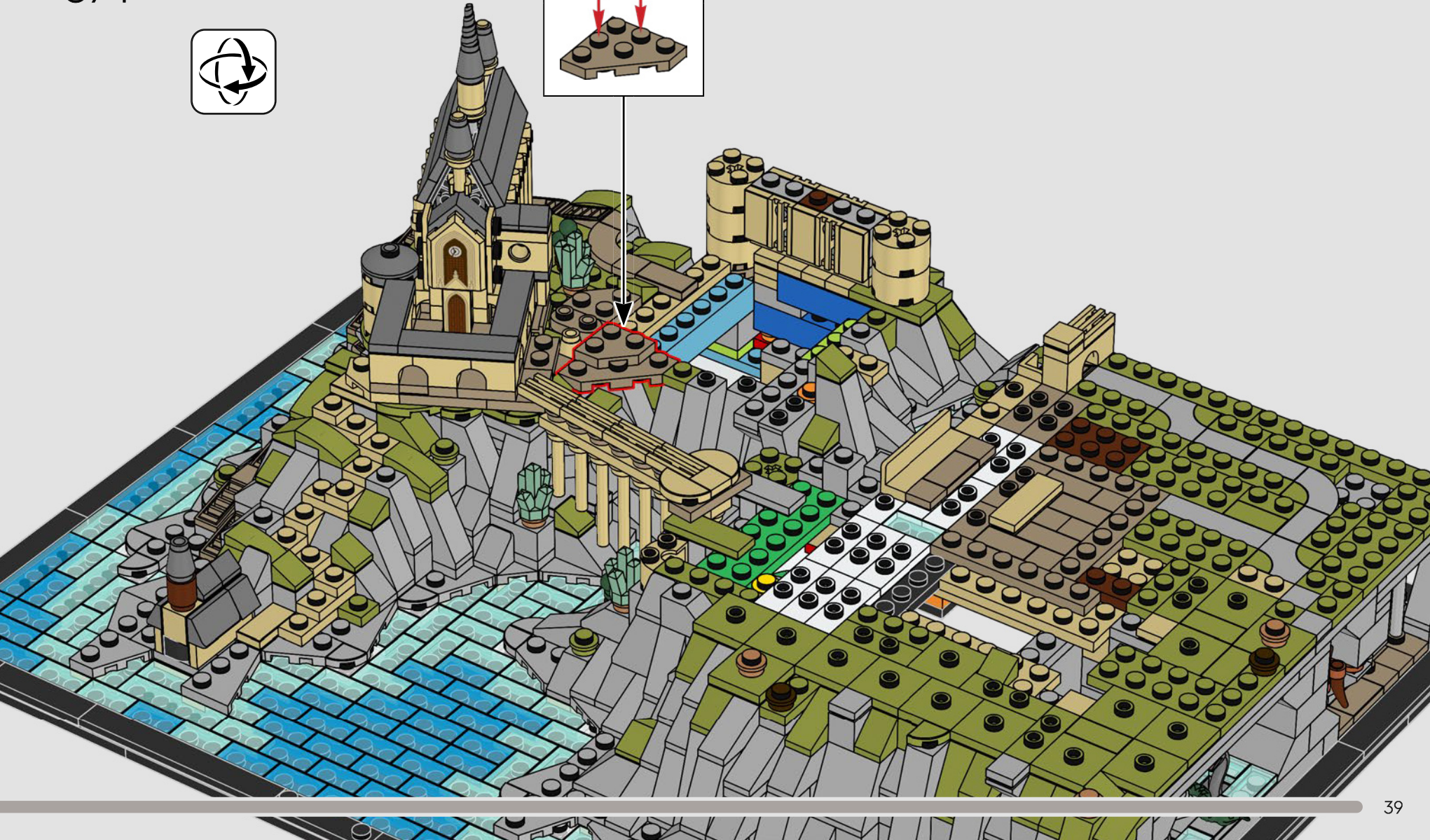
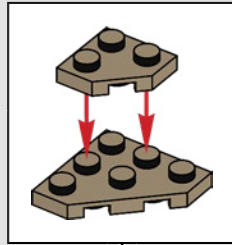

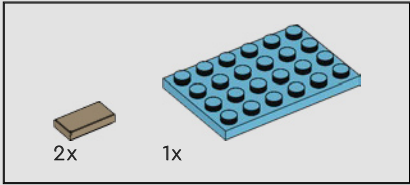
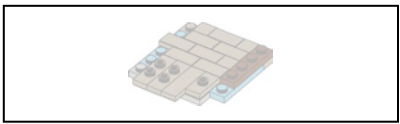

372

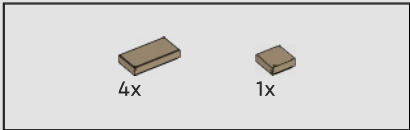
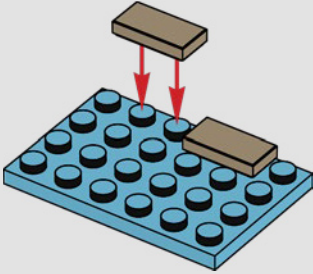

373

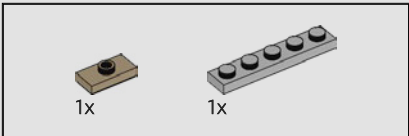
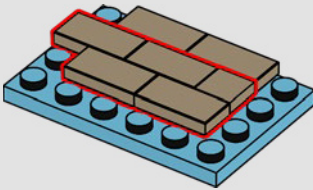

374

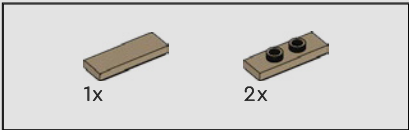
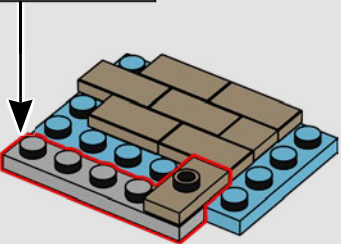
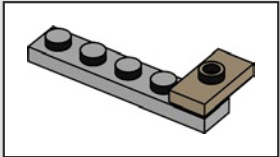

375

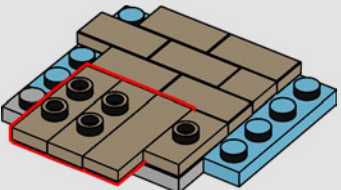

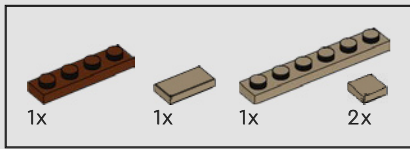

376

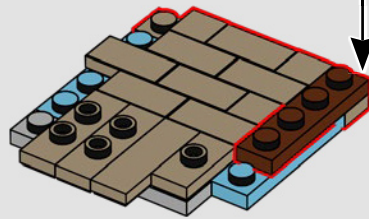
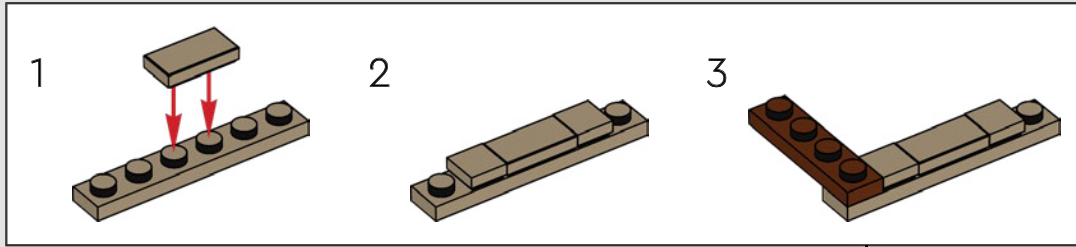

377



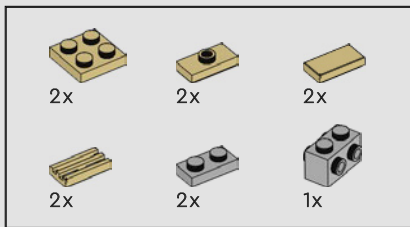

378

1

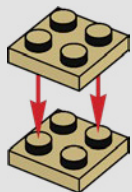

2

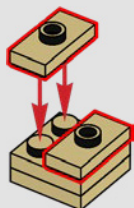

3

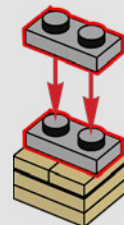

4

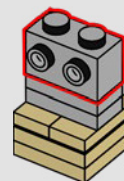

5

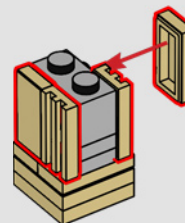



Hogwarts™ Castle

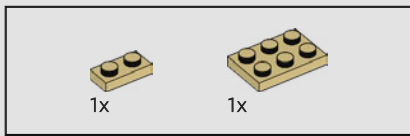

379

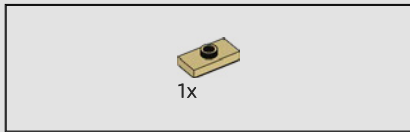
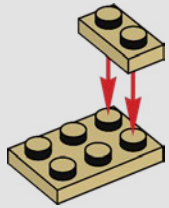

380

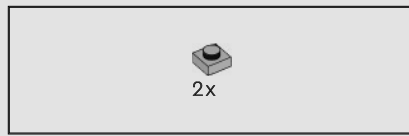
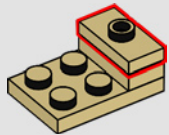

381

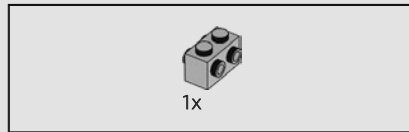
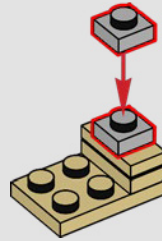

382

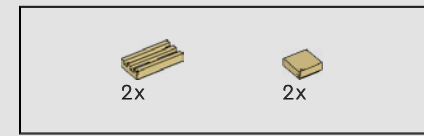
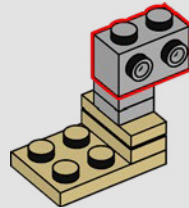

383

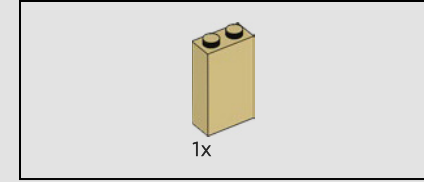
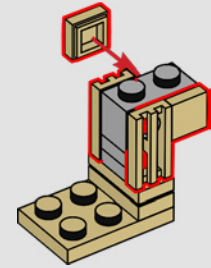

384

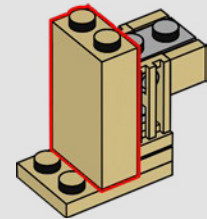

385

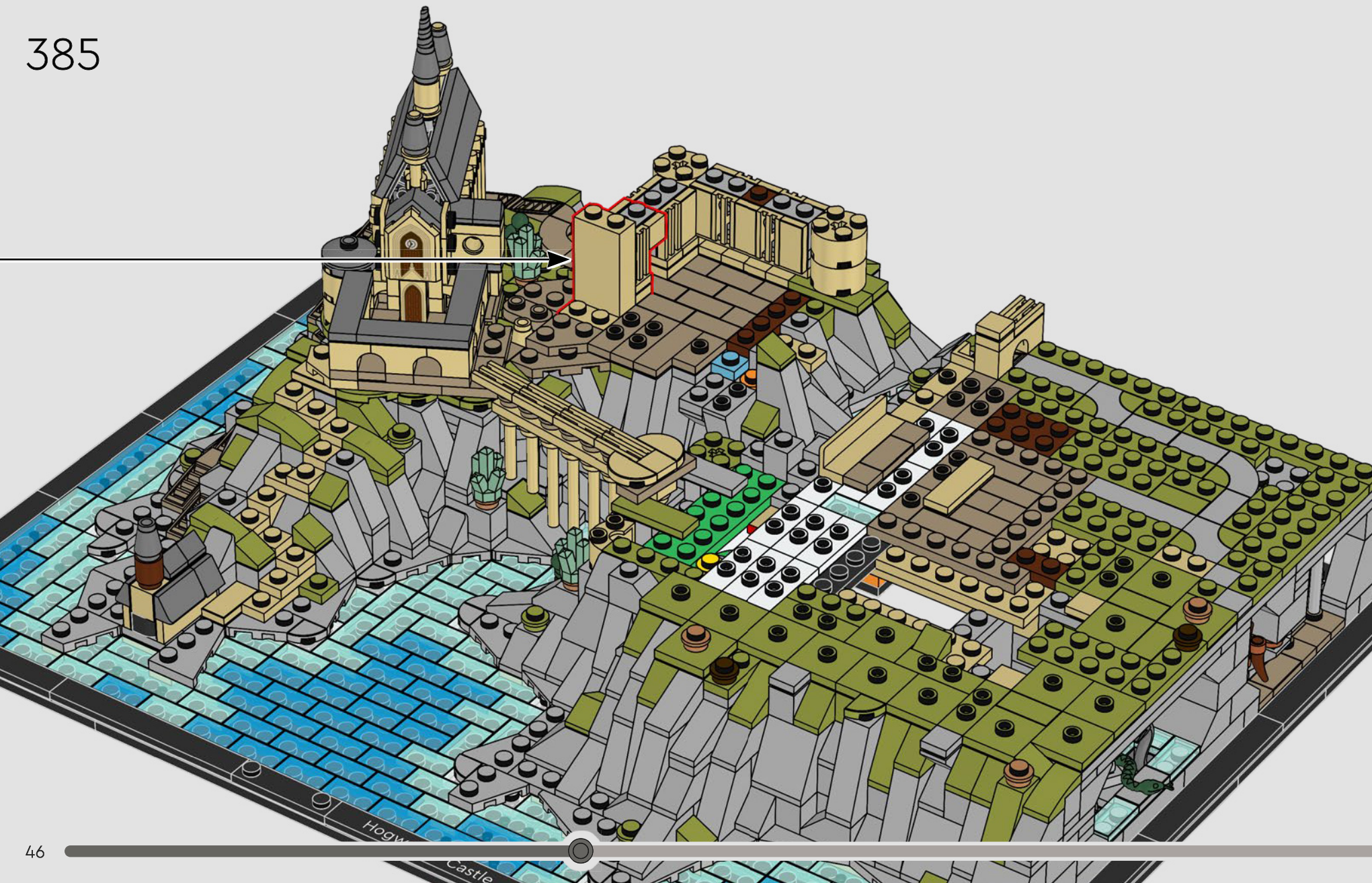

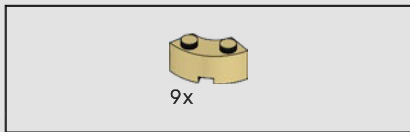

386

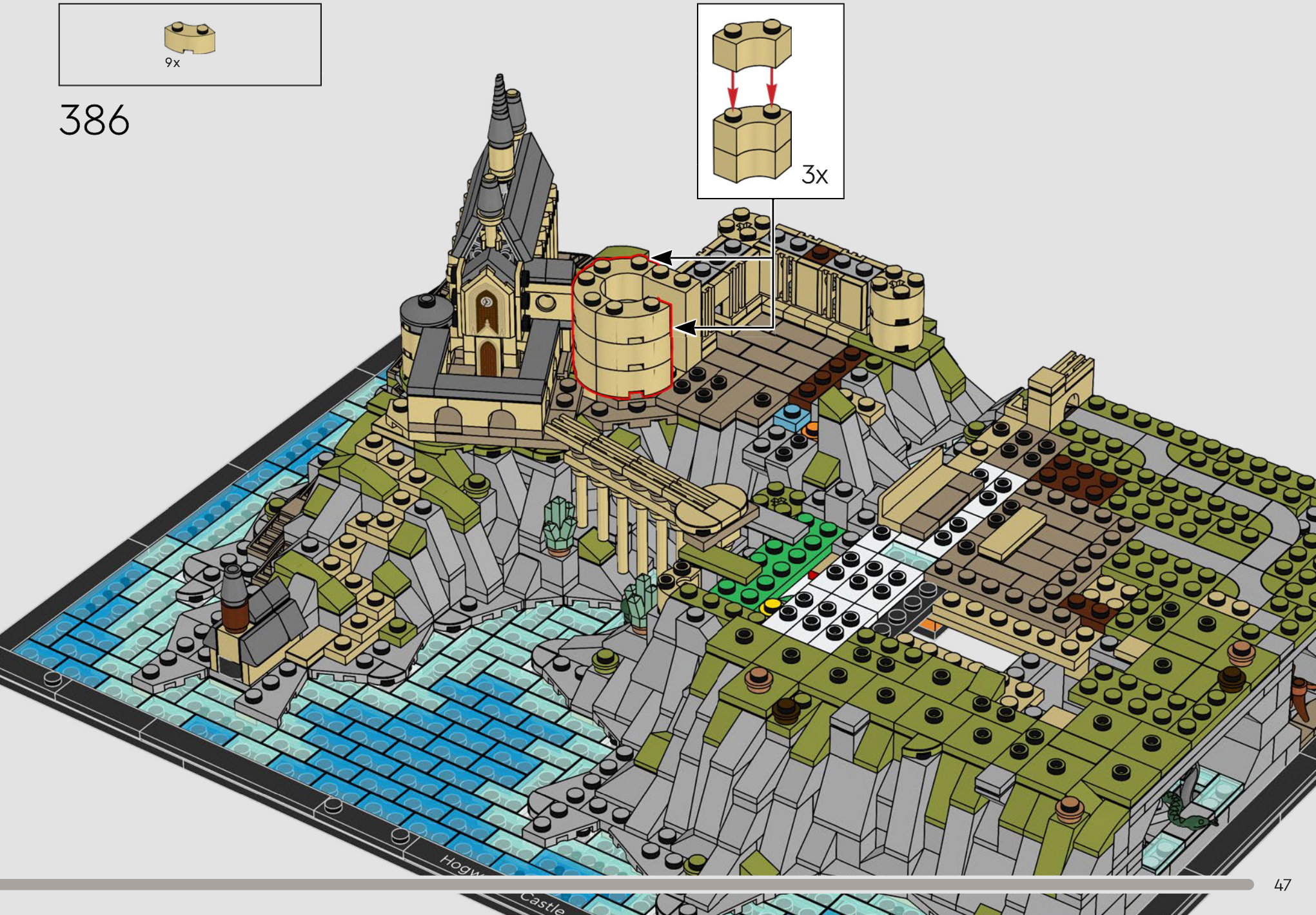
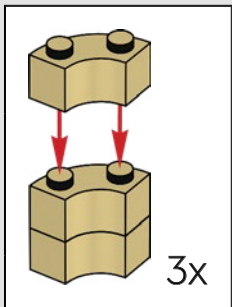

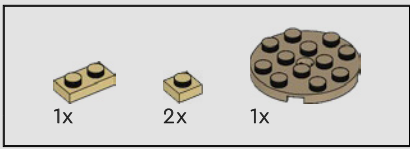

387

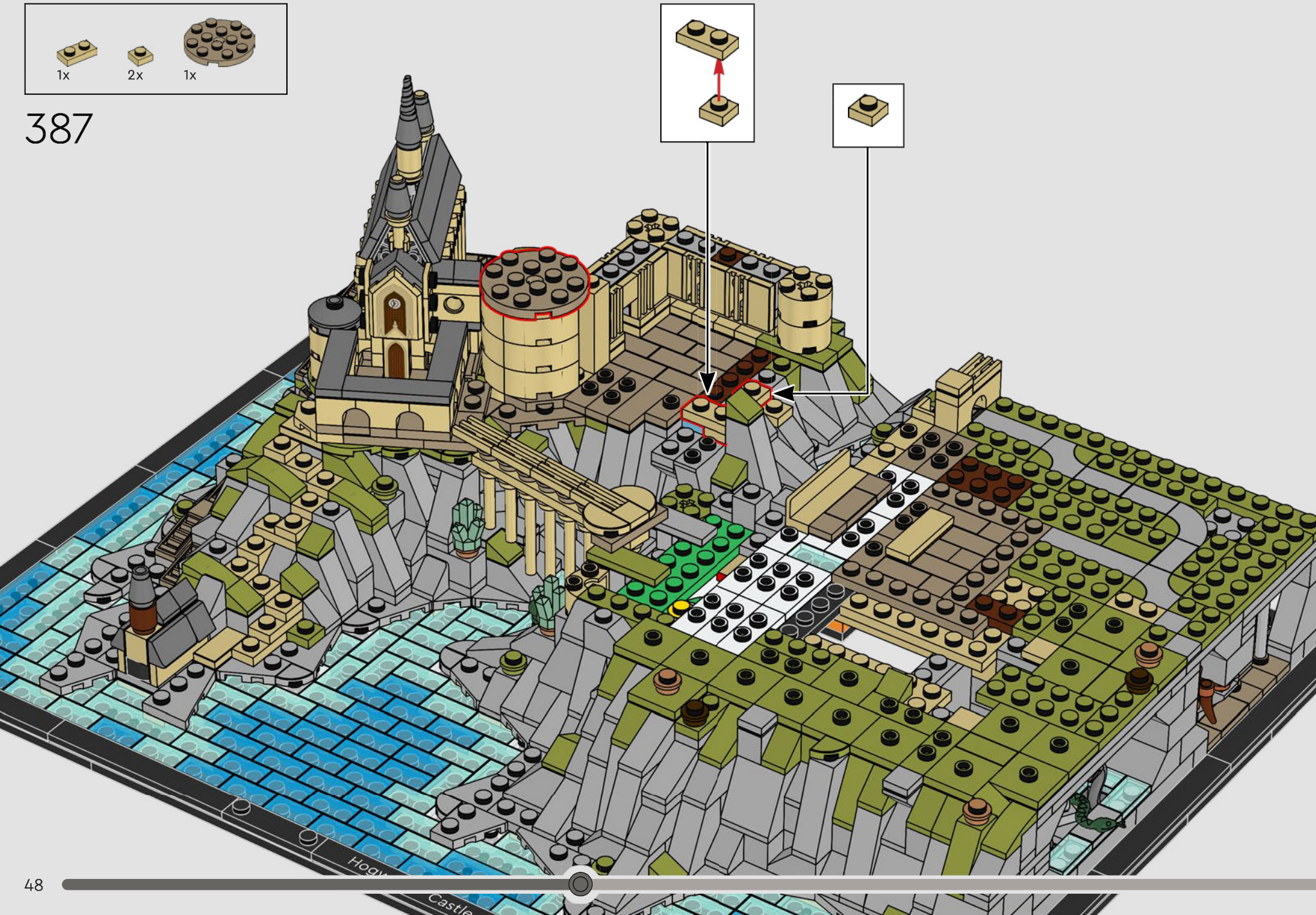
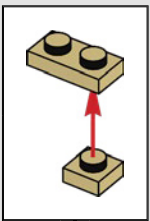

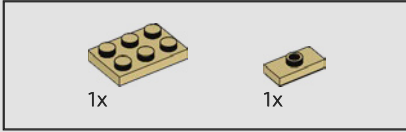
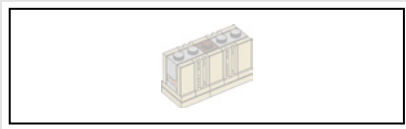

388

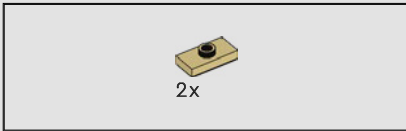
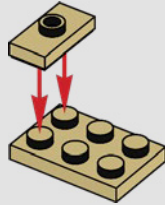

389

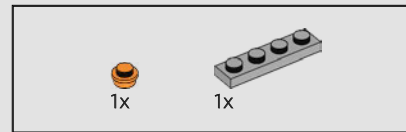
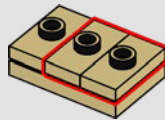

390

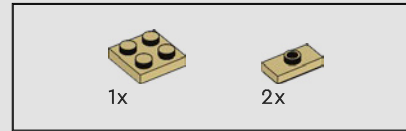
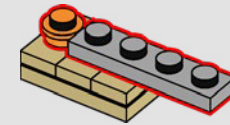

391

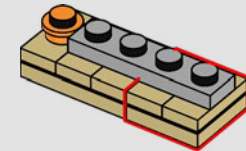
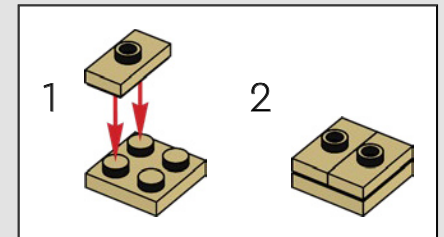

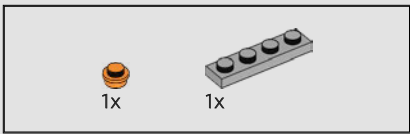

392

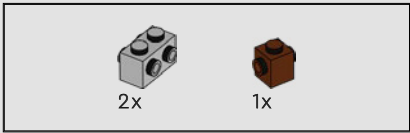
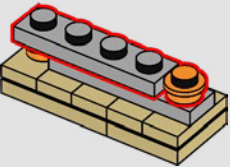

393

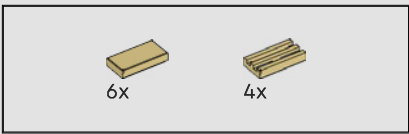
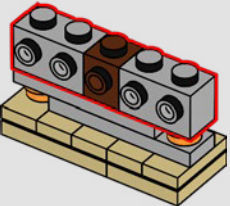

394

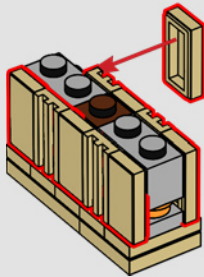

395

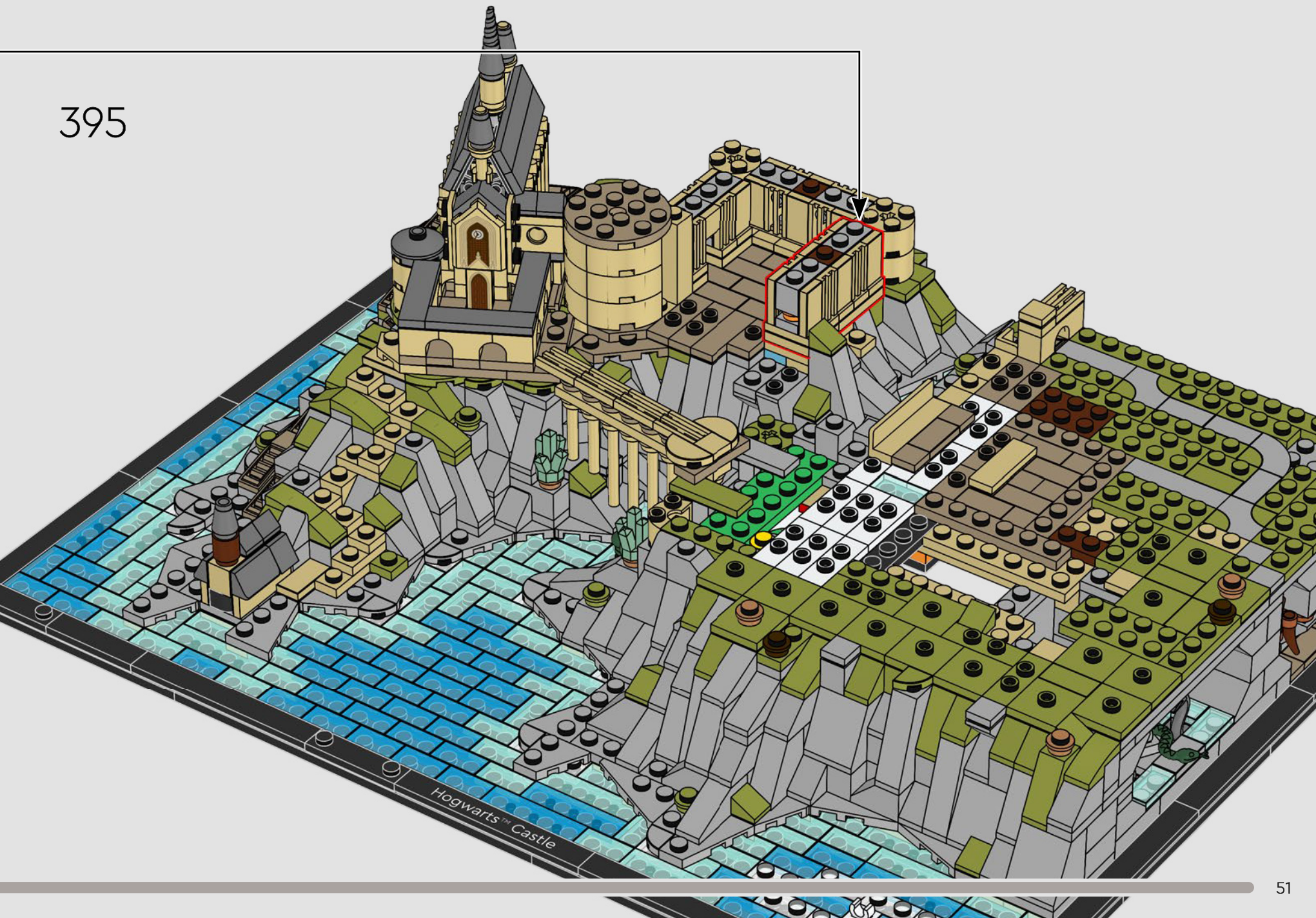

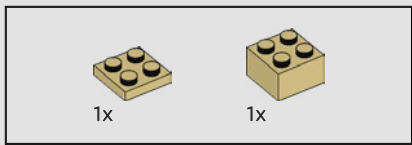

396

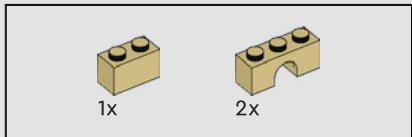
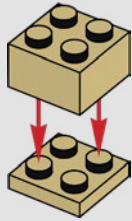

397

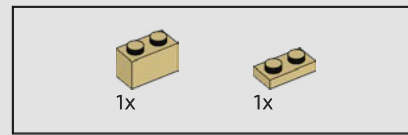
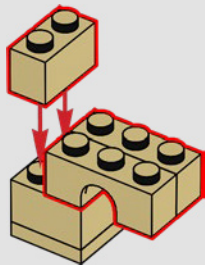

398

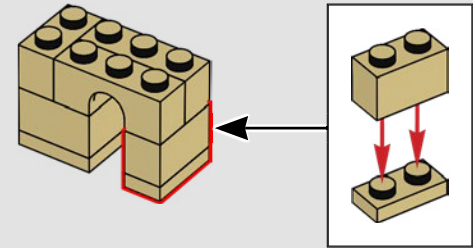

399

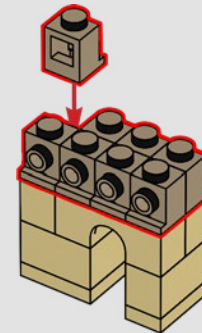

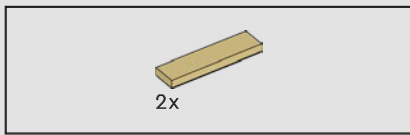

400

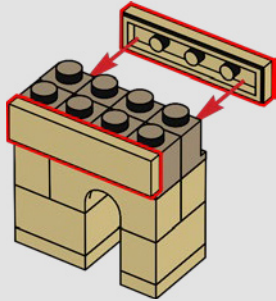

401

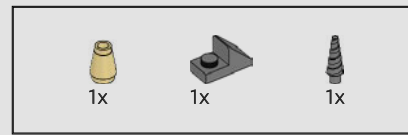
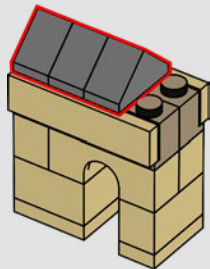

402

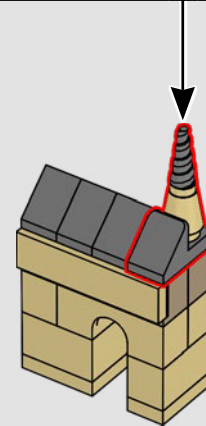
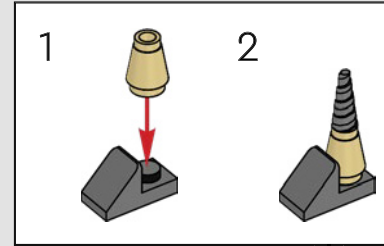

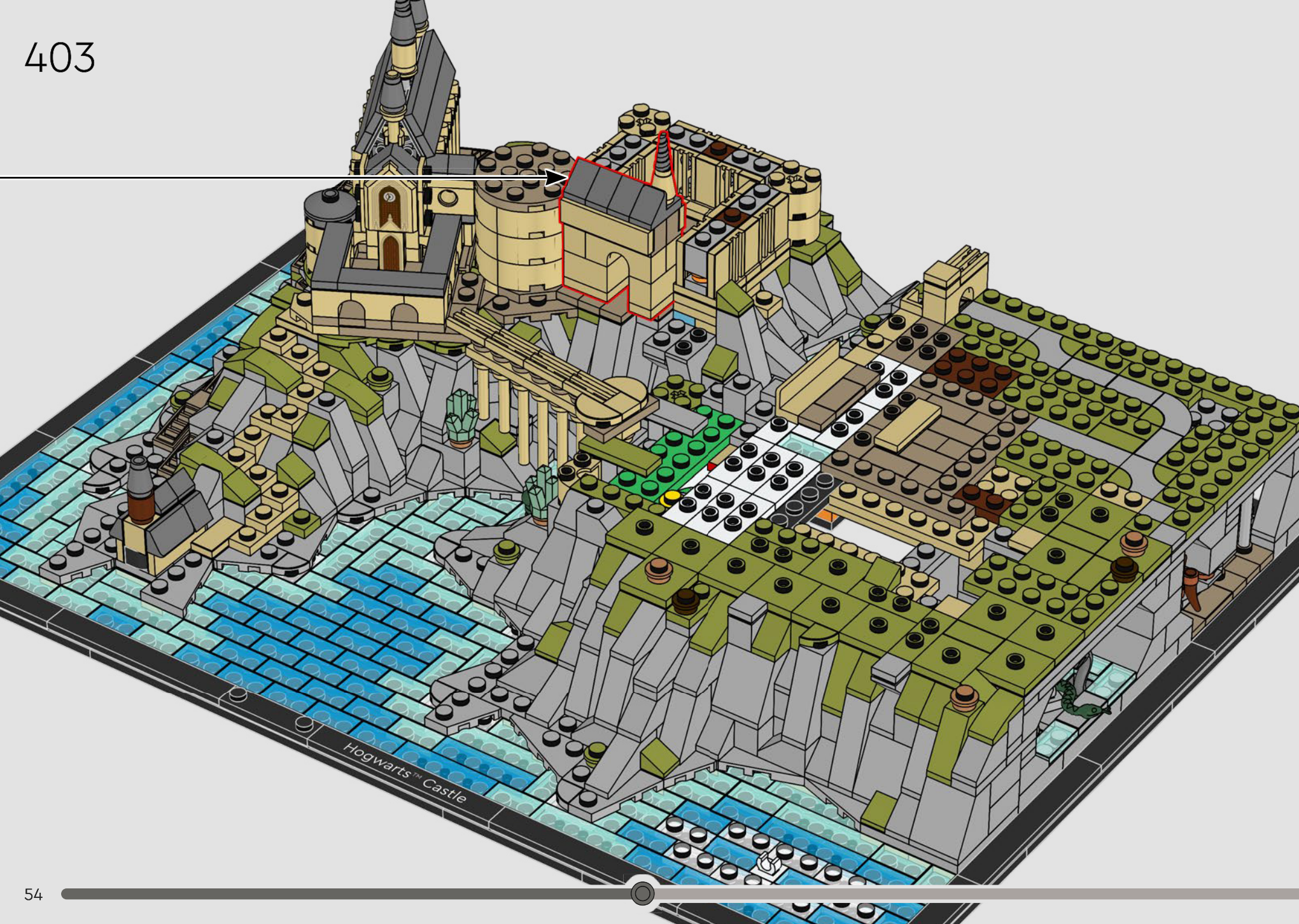

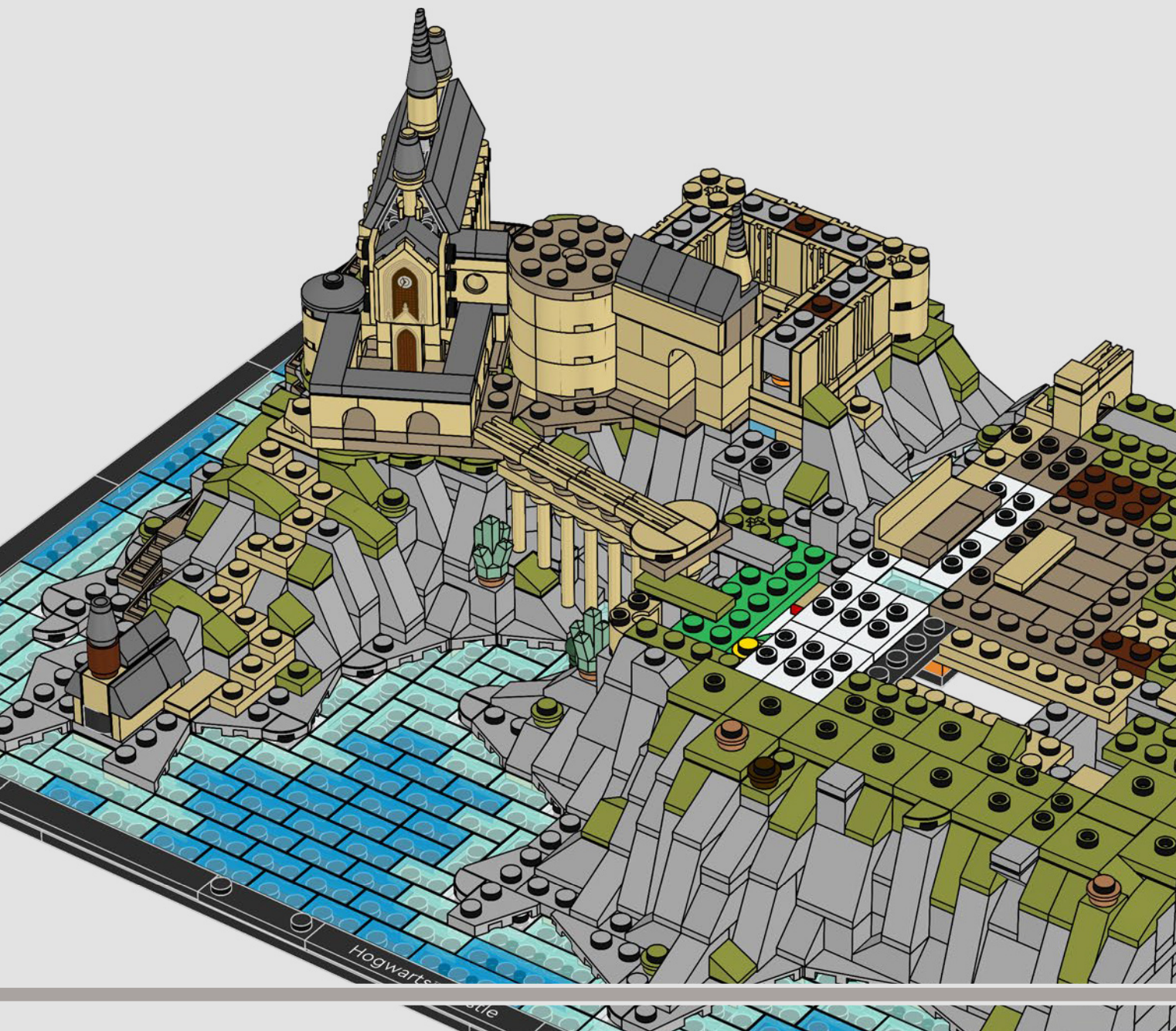

庭院 (Quad Courtyard) 是学生户外聚集的空间, 位于钟楼附近。

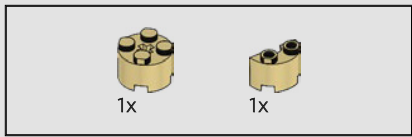

404

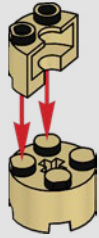

405

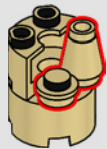

406

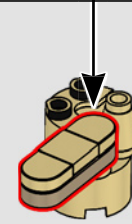
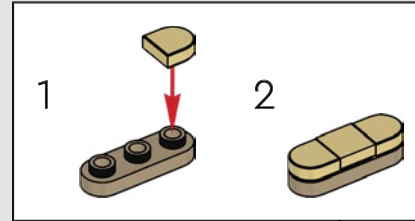

407

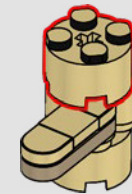

408



Hogwarts™ Castle





409



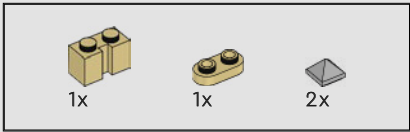

410

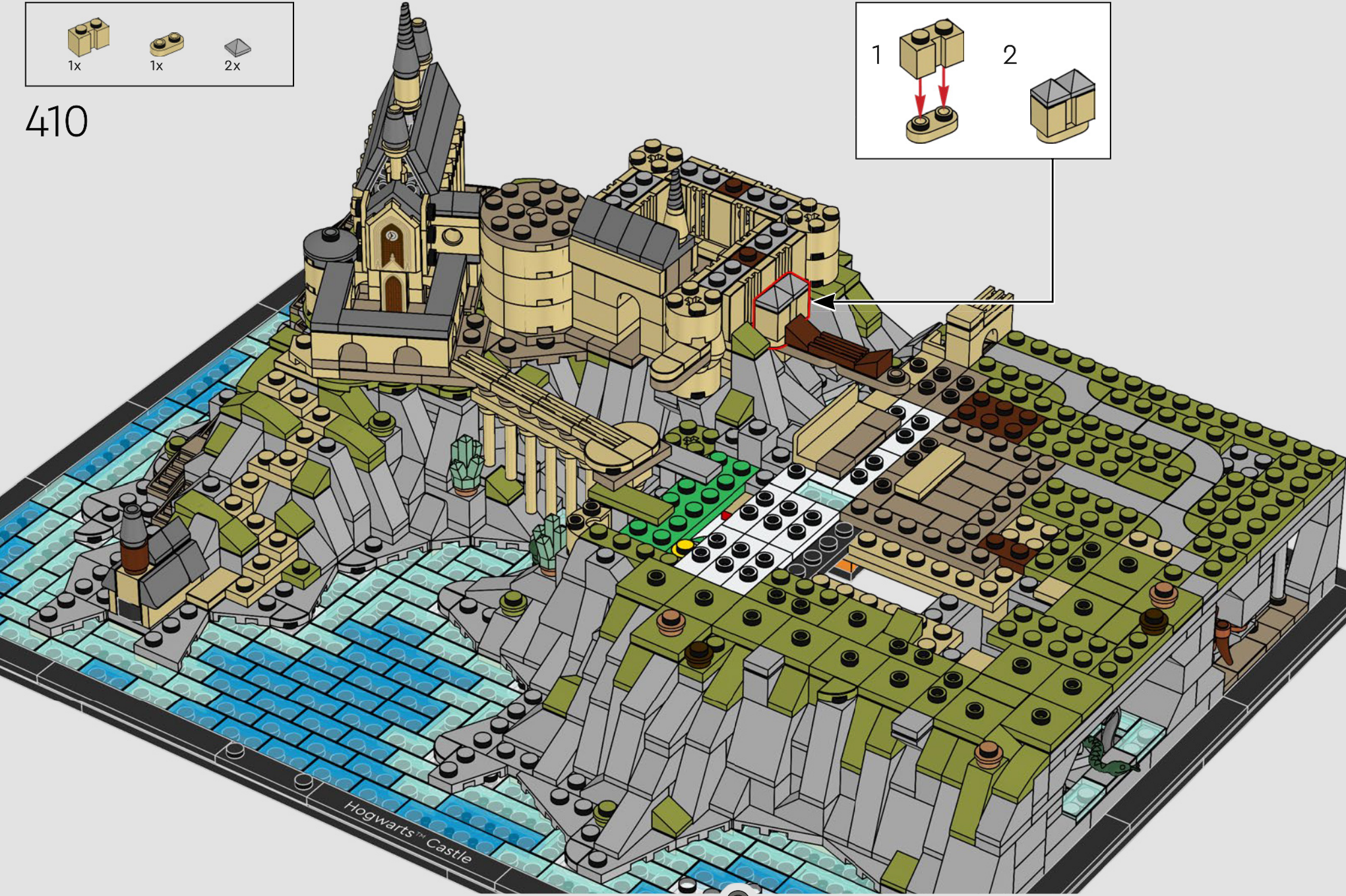
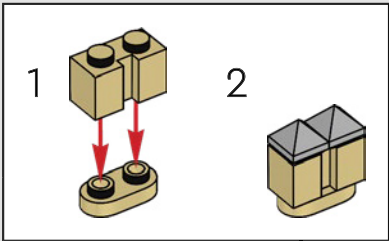

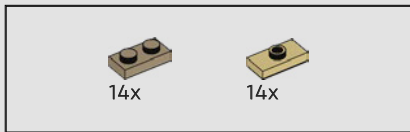

411

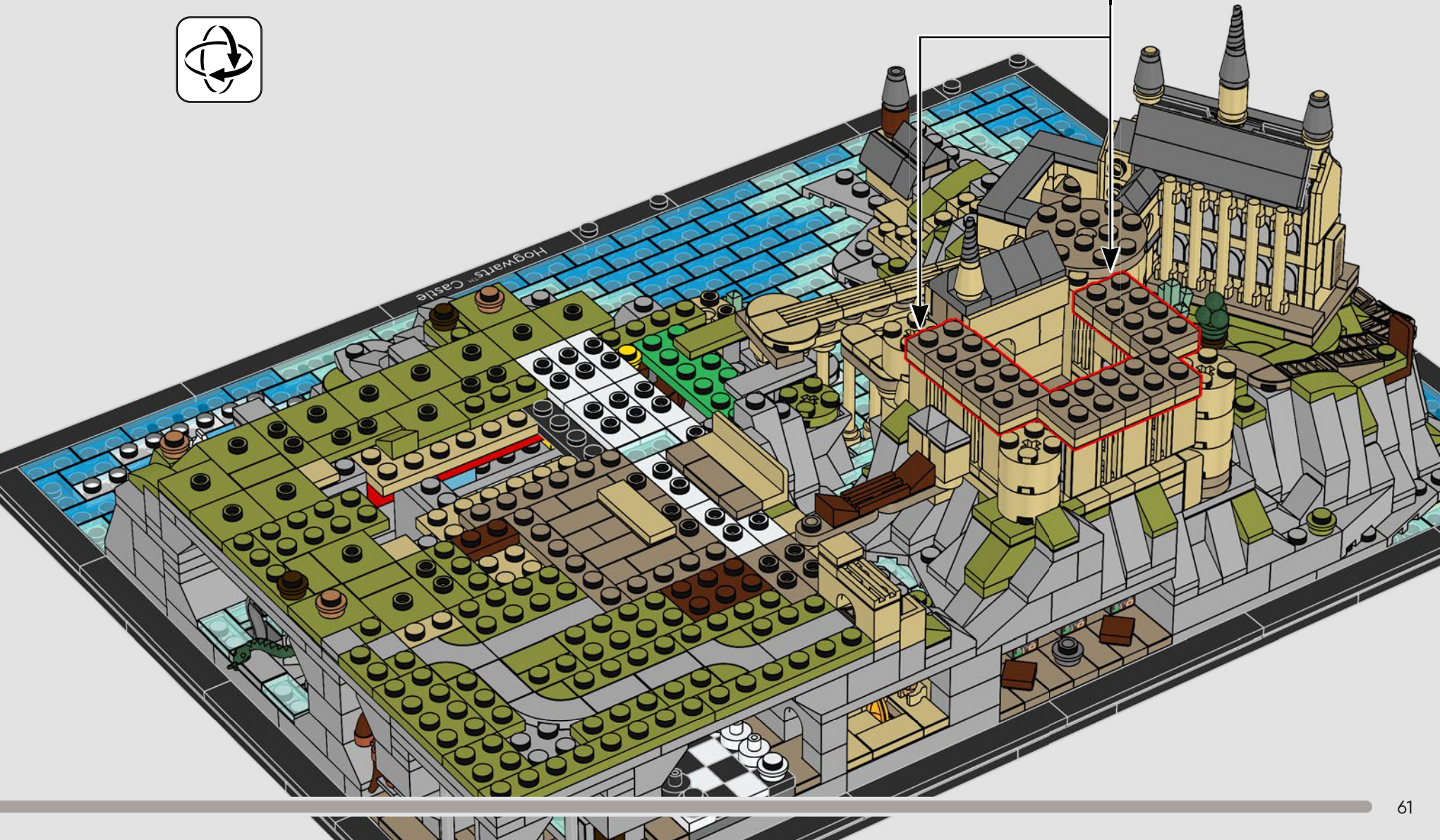
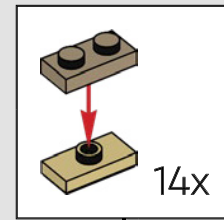

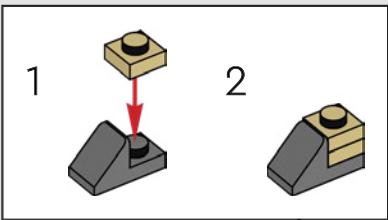
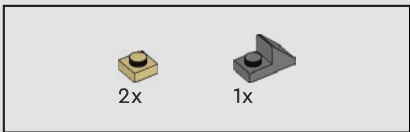

412

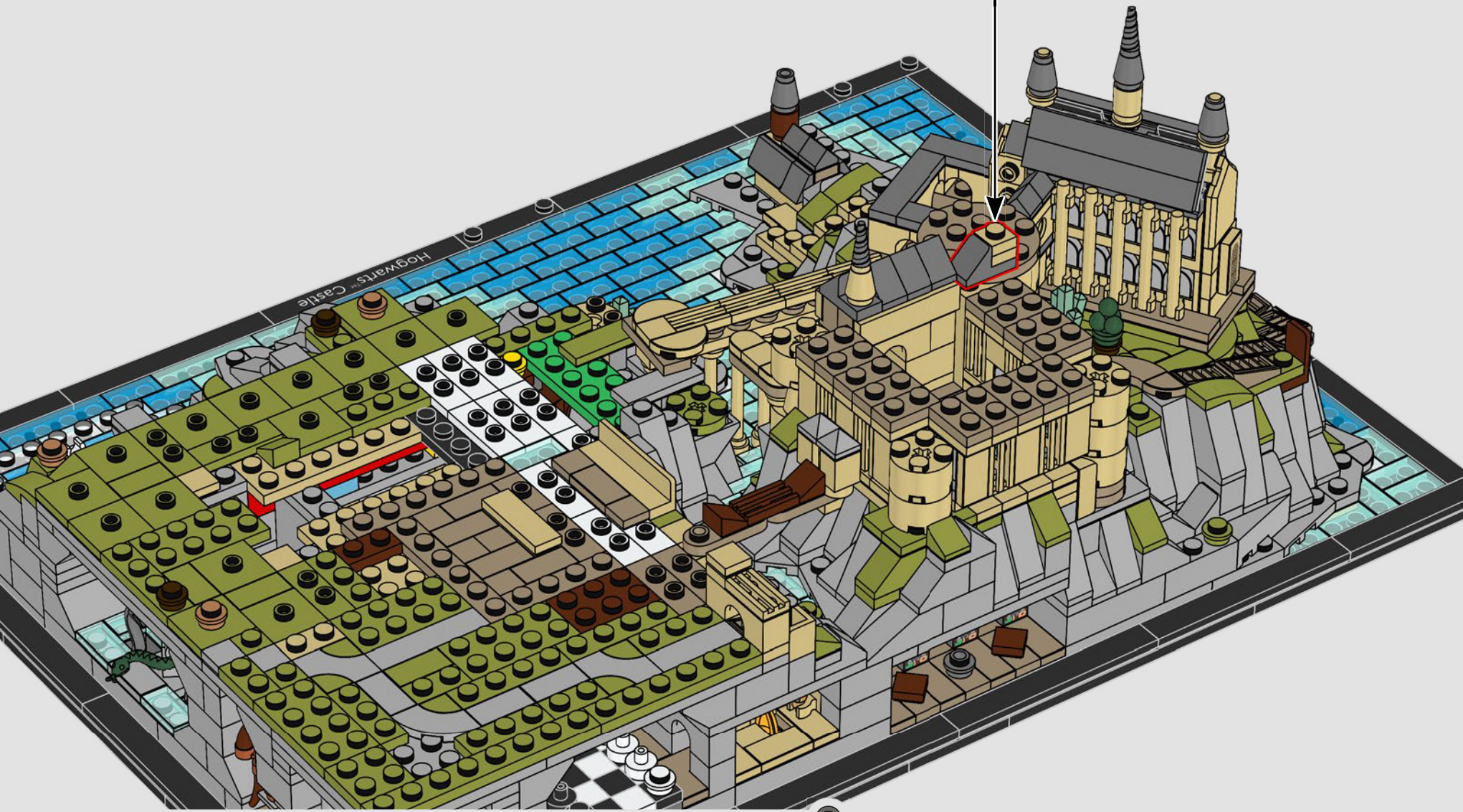

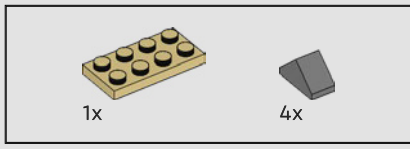

413

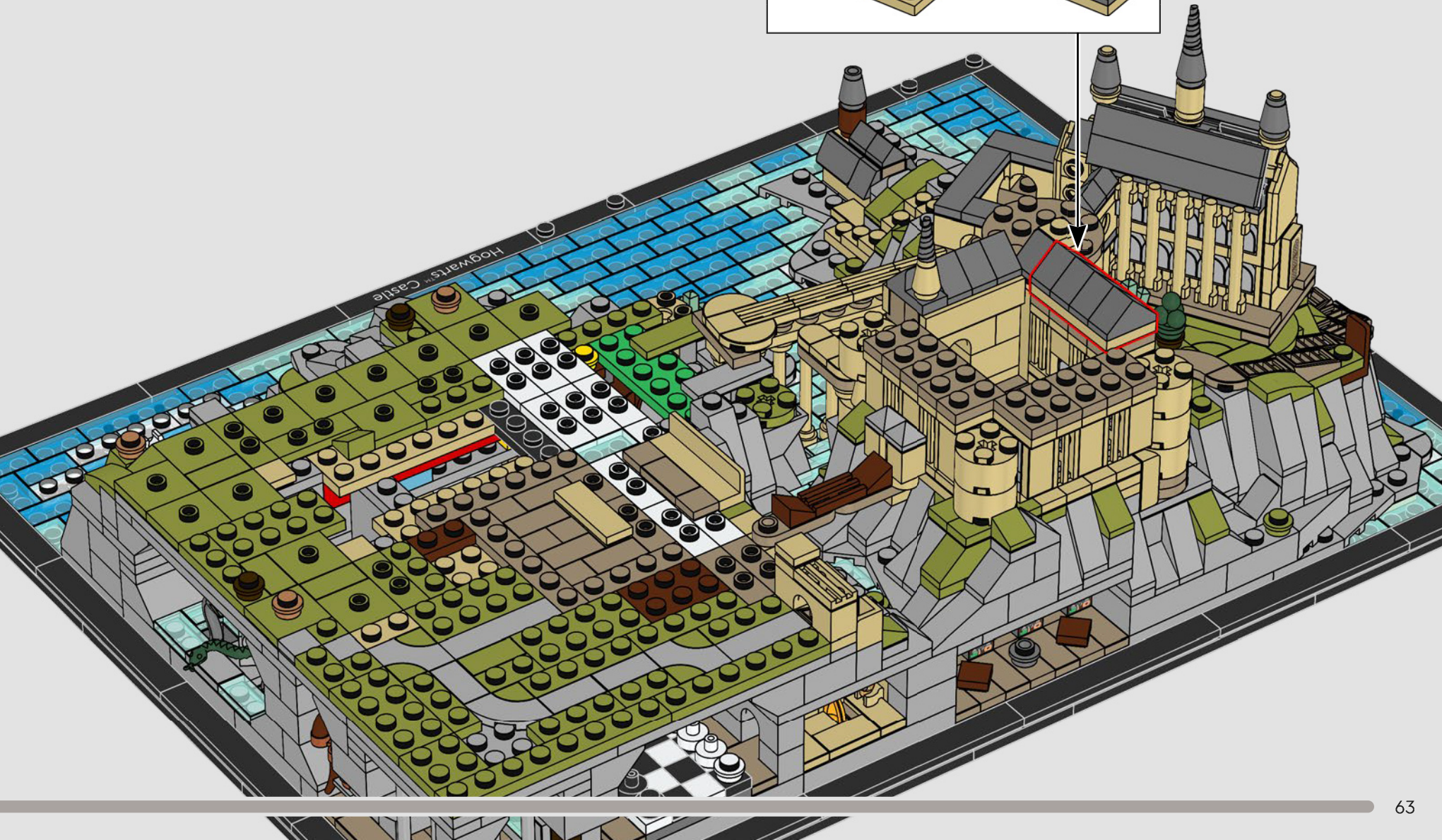
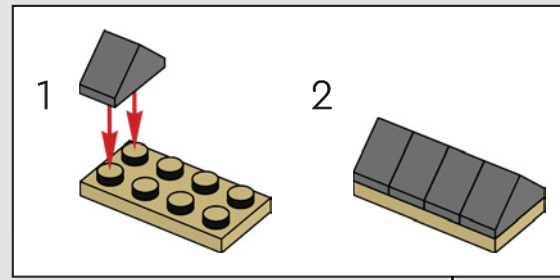

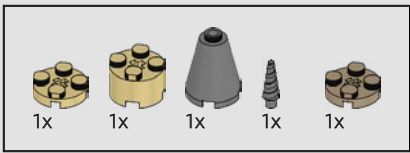

414

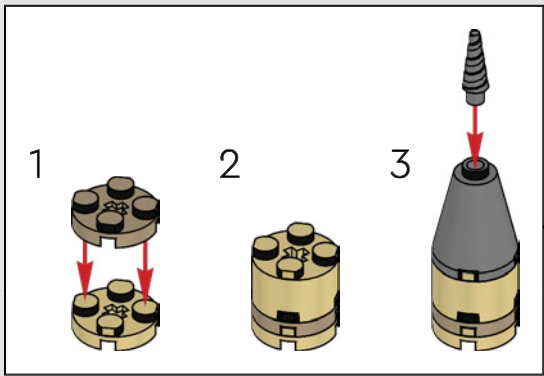

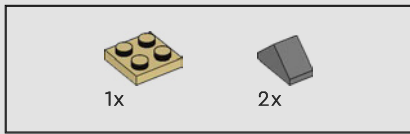

415

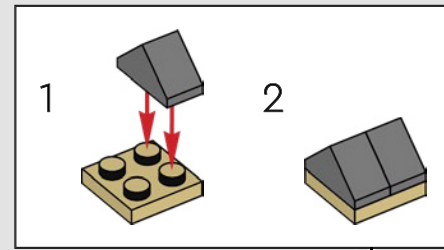

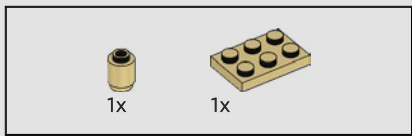

416

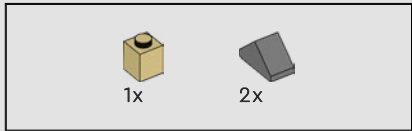
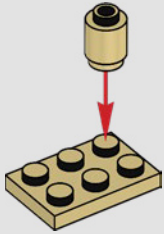

417

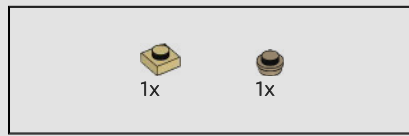
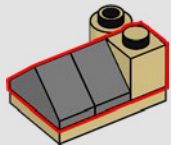

418

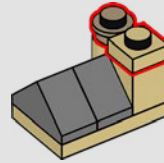

419

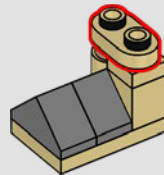

420

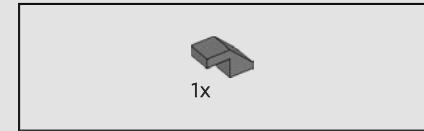
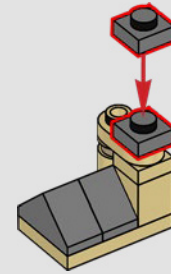

421

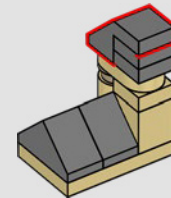

422

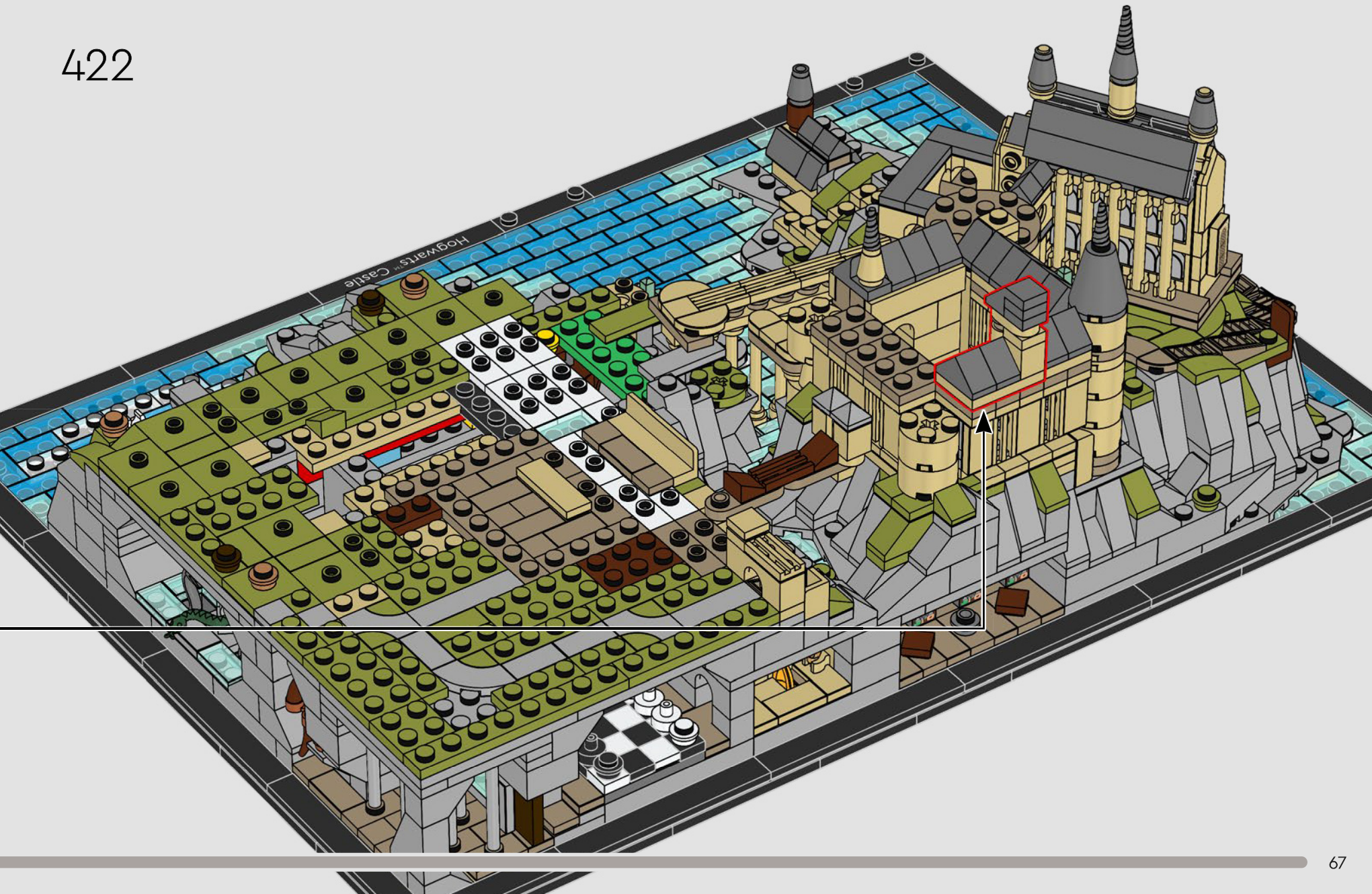

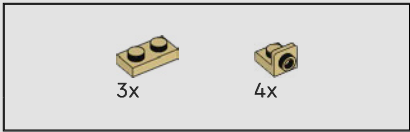

423

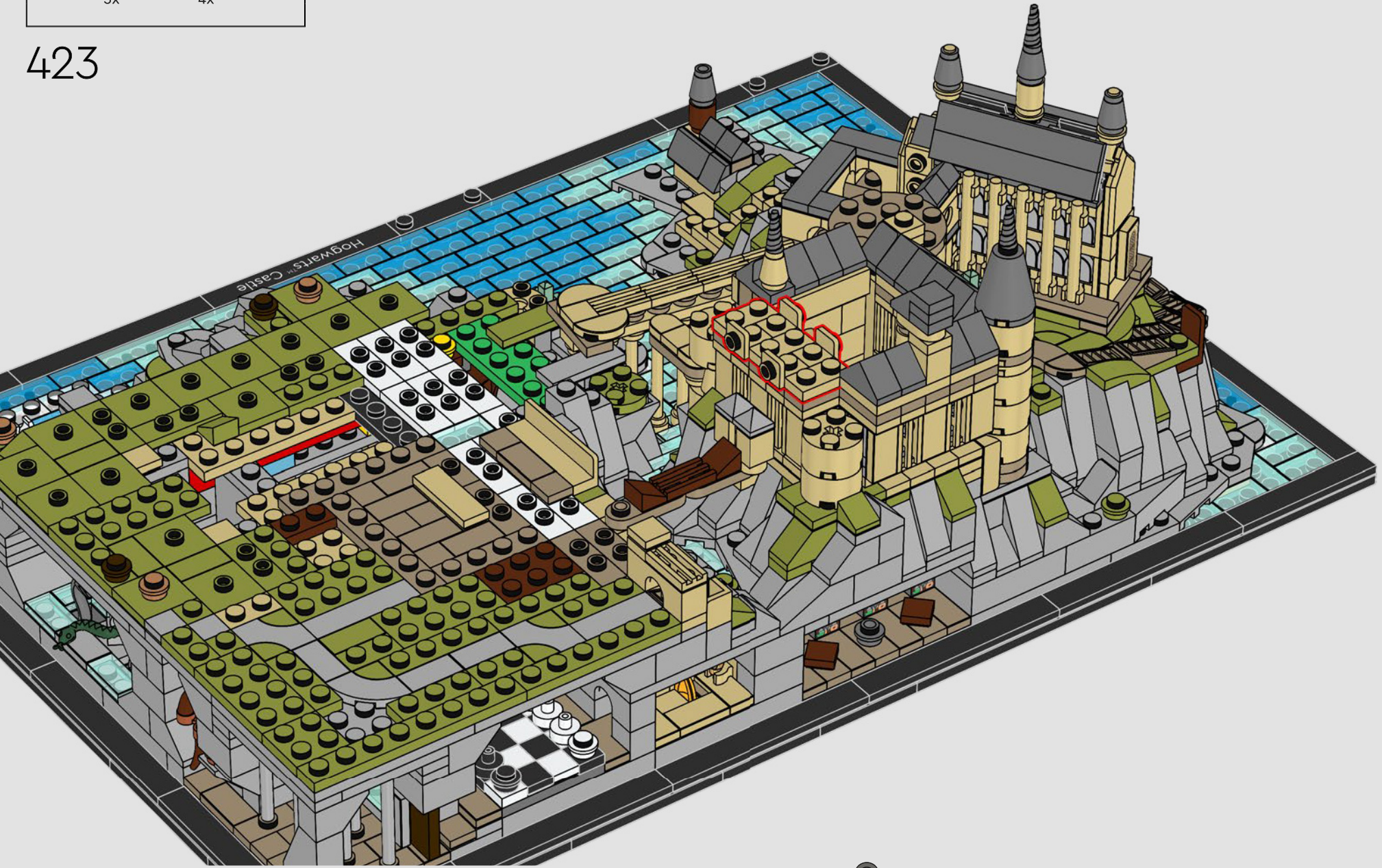

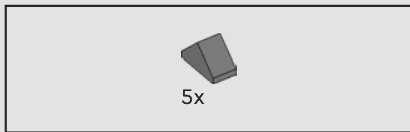

424



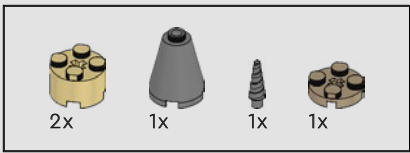

425

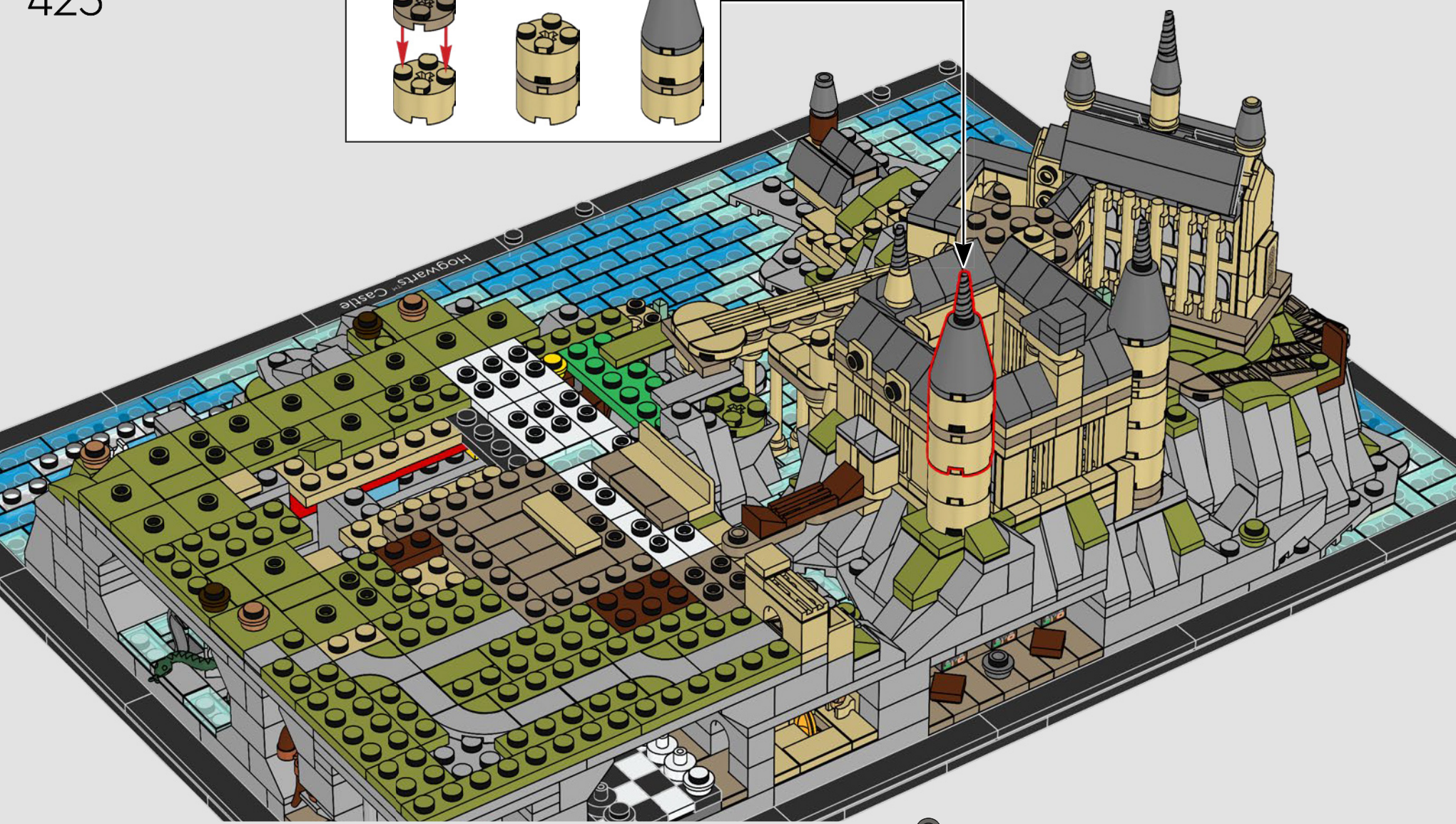
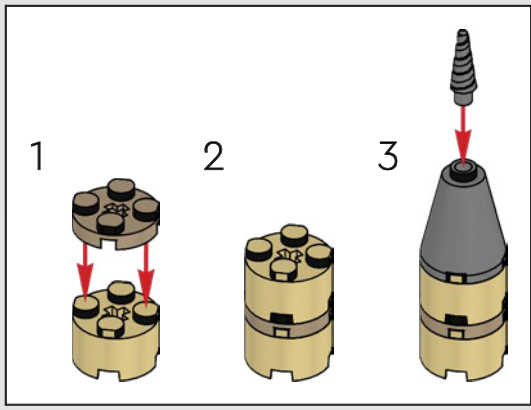

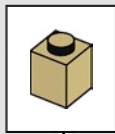
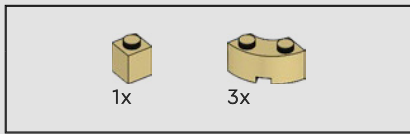

426

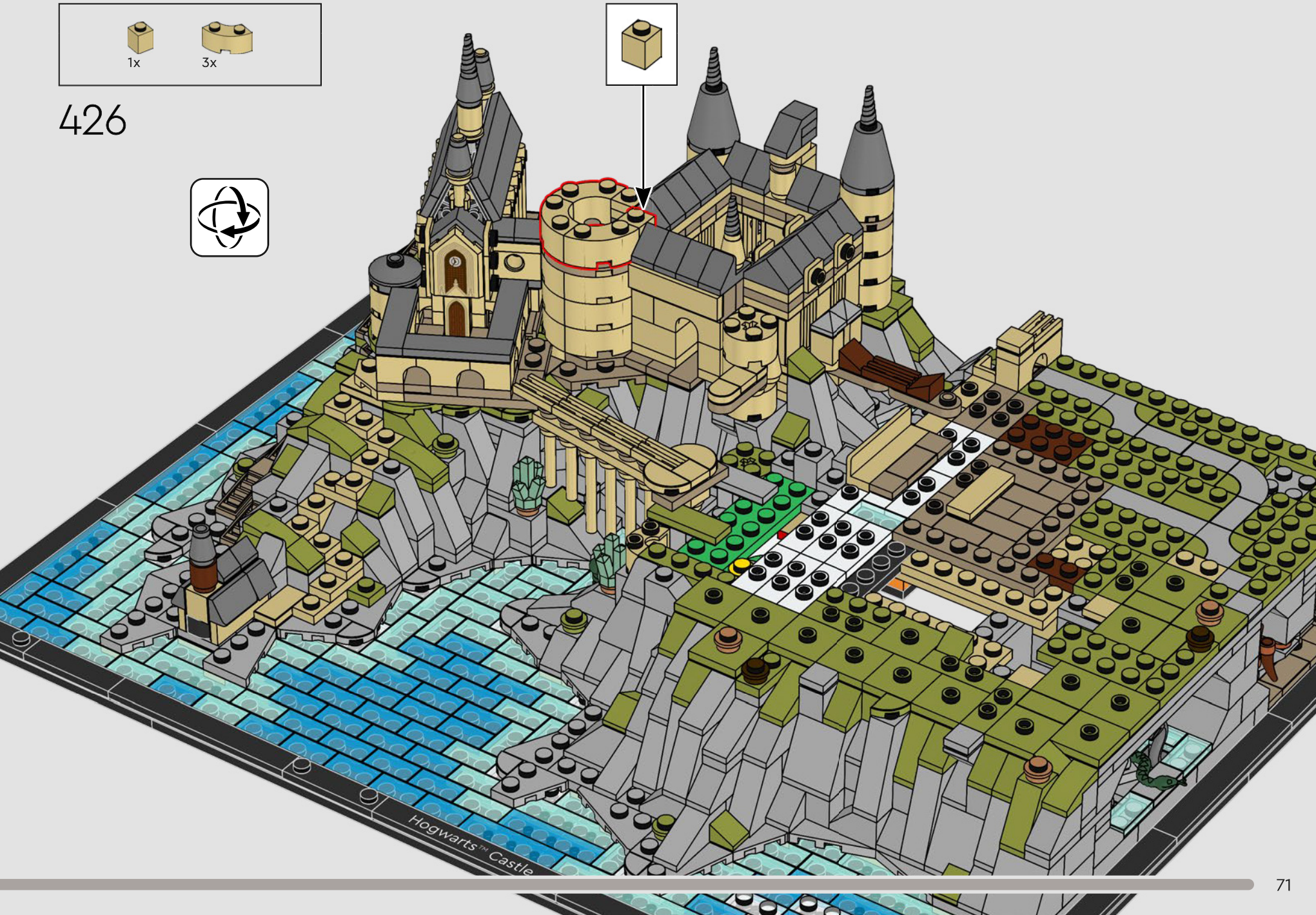

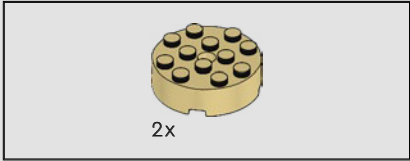
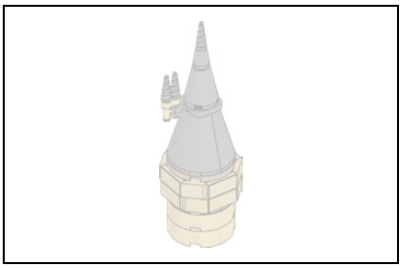

427

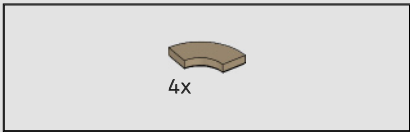
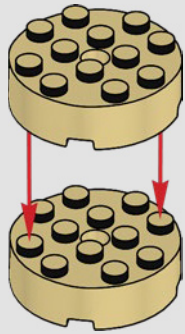

428

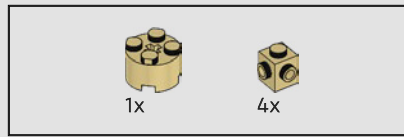
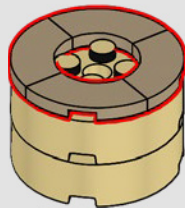

429

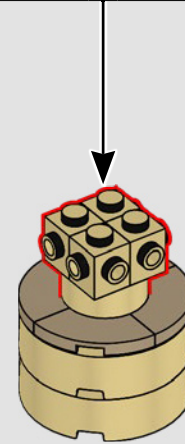
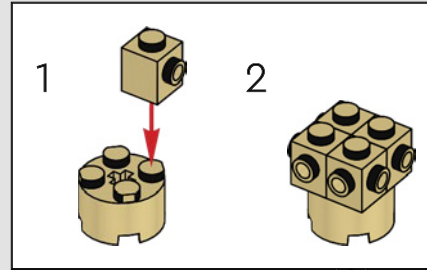

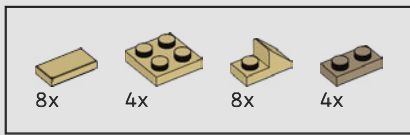

430

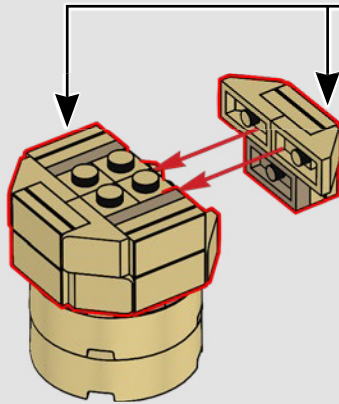
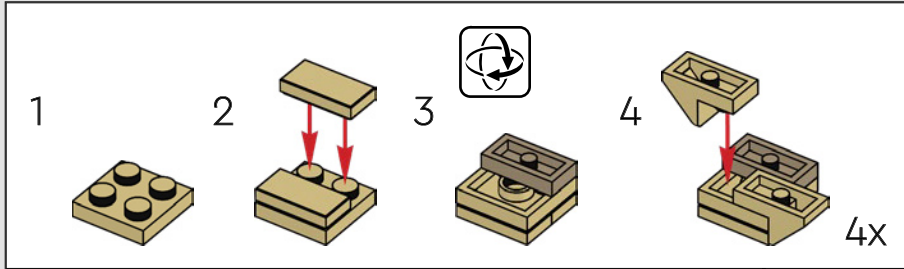

431

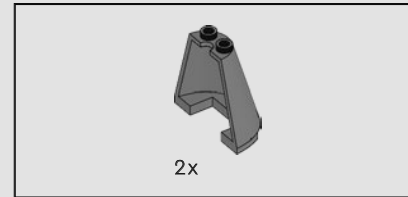
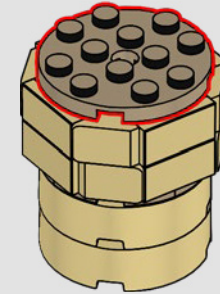

432

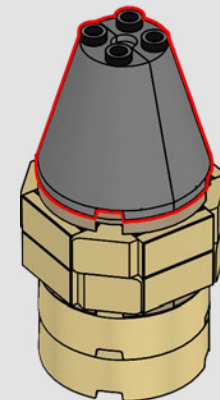

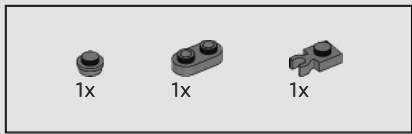

433

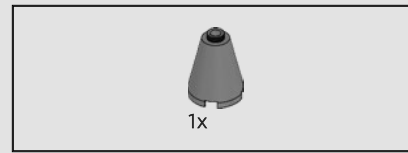
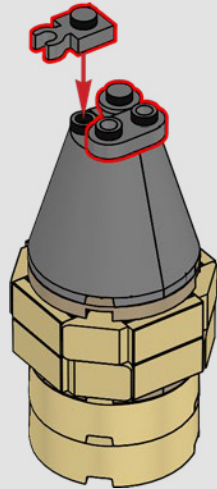

434

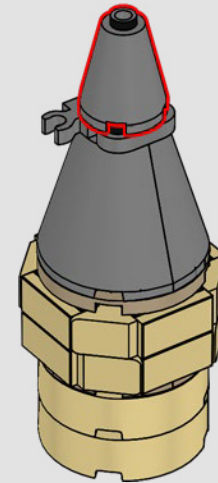

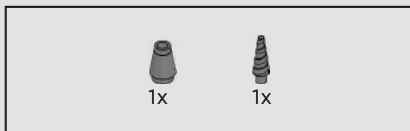

435

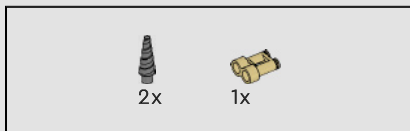
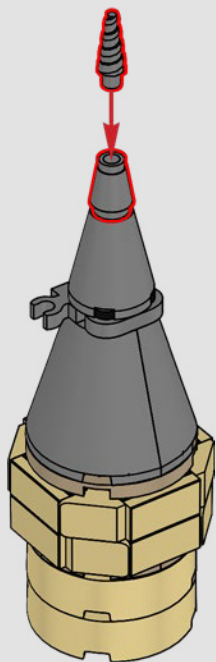

436

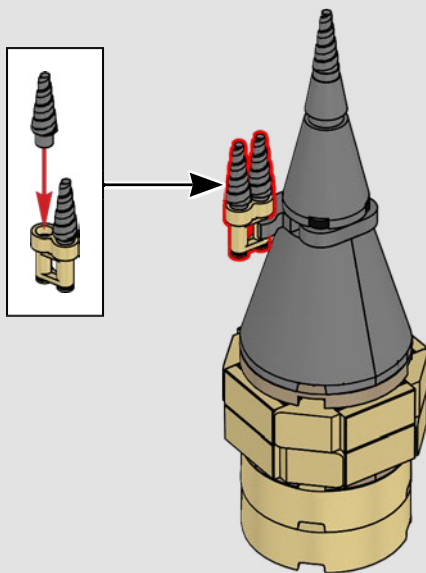

阿不思·邓布利多的办公室位于主塔上的小塔楼中, 由乐高®望远镜组件拼搭而成。

437

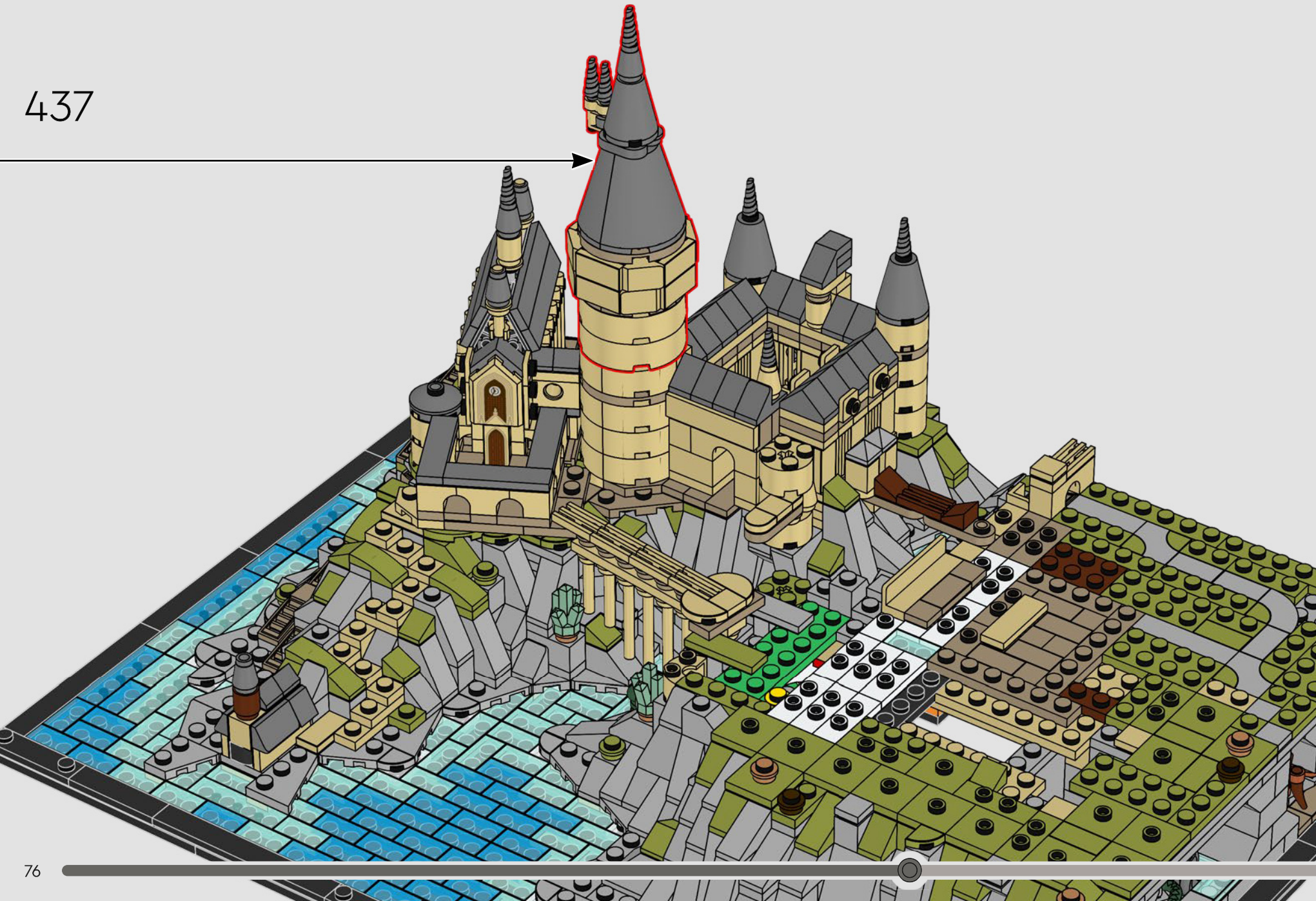



438

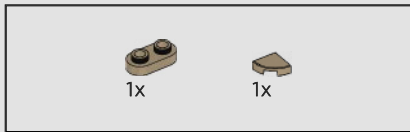
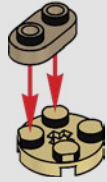

439

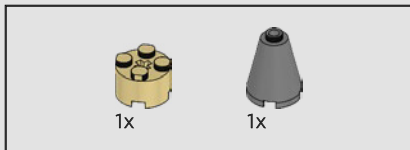

440

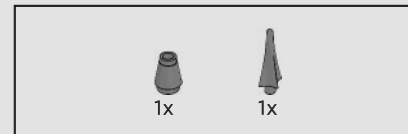
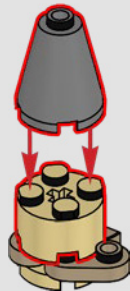

441

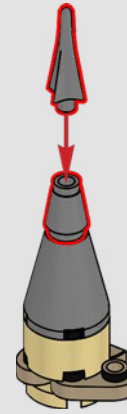

442

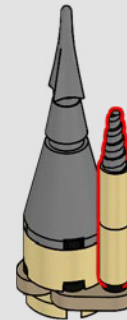
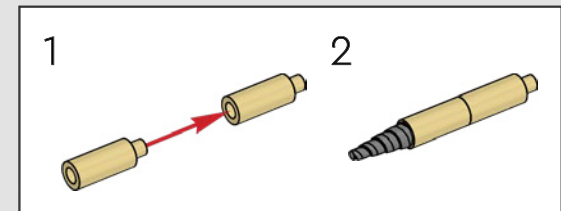

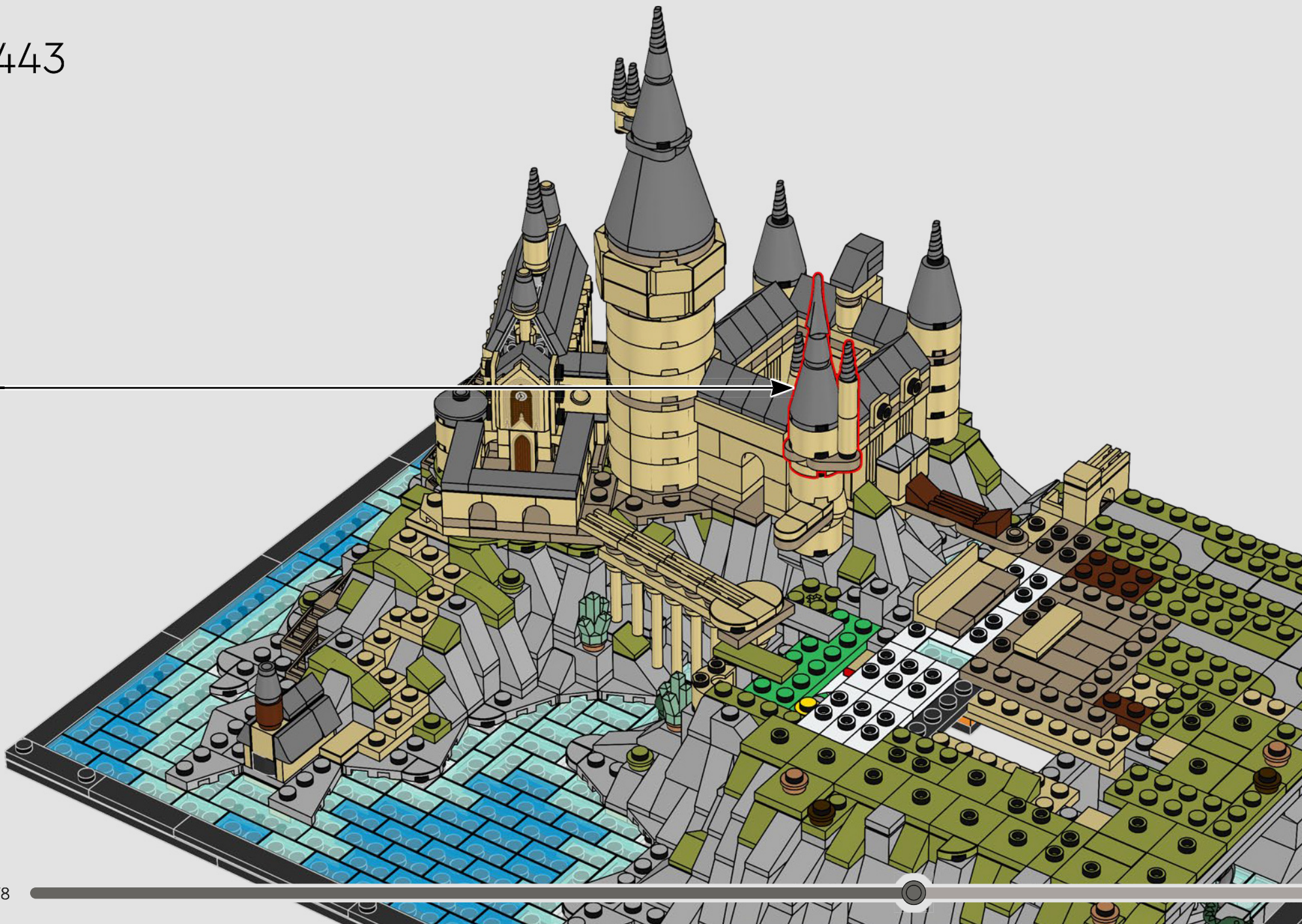



你不会认为从校长塔楼上“长出”的小塔楼是建筑学上的可持续结构吧——但当然，在霍格沃茨，一切皆有可能！



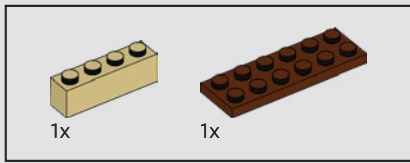

444

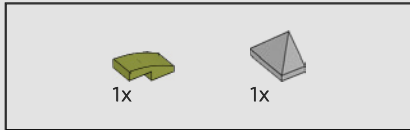
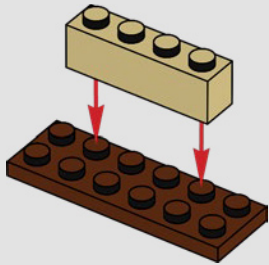

445

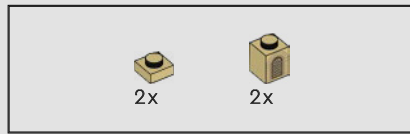
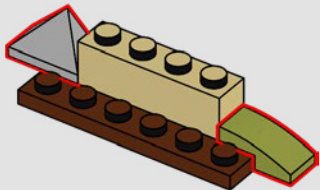

446

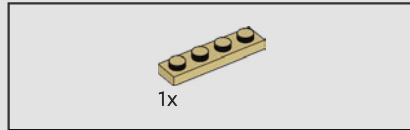
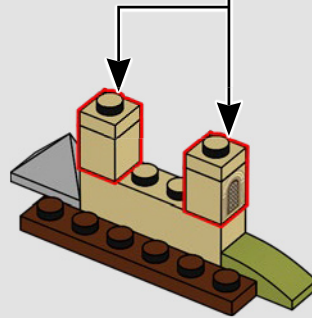
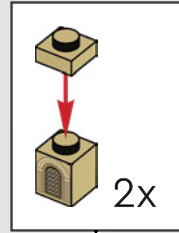

447

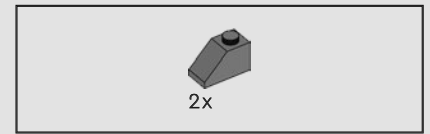
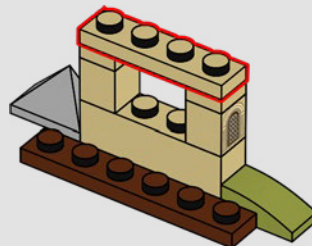

448

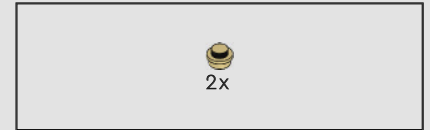
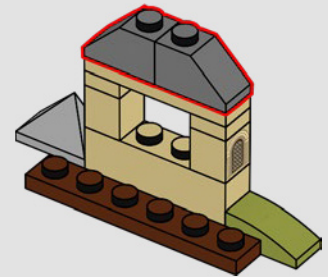

449

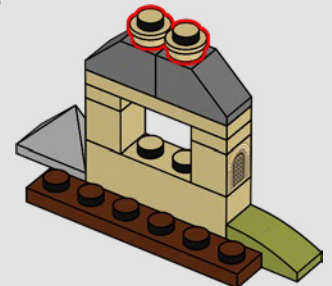

450

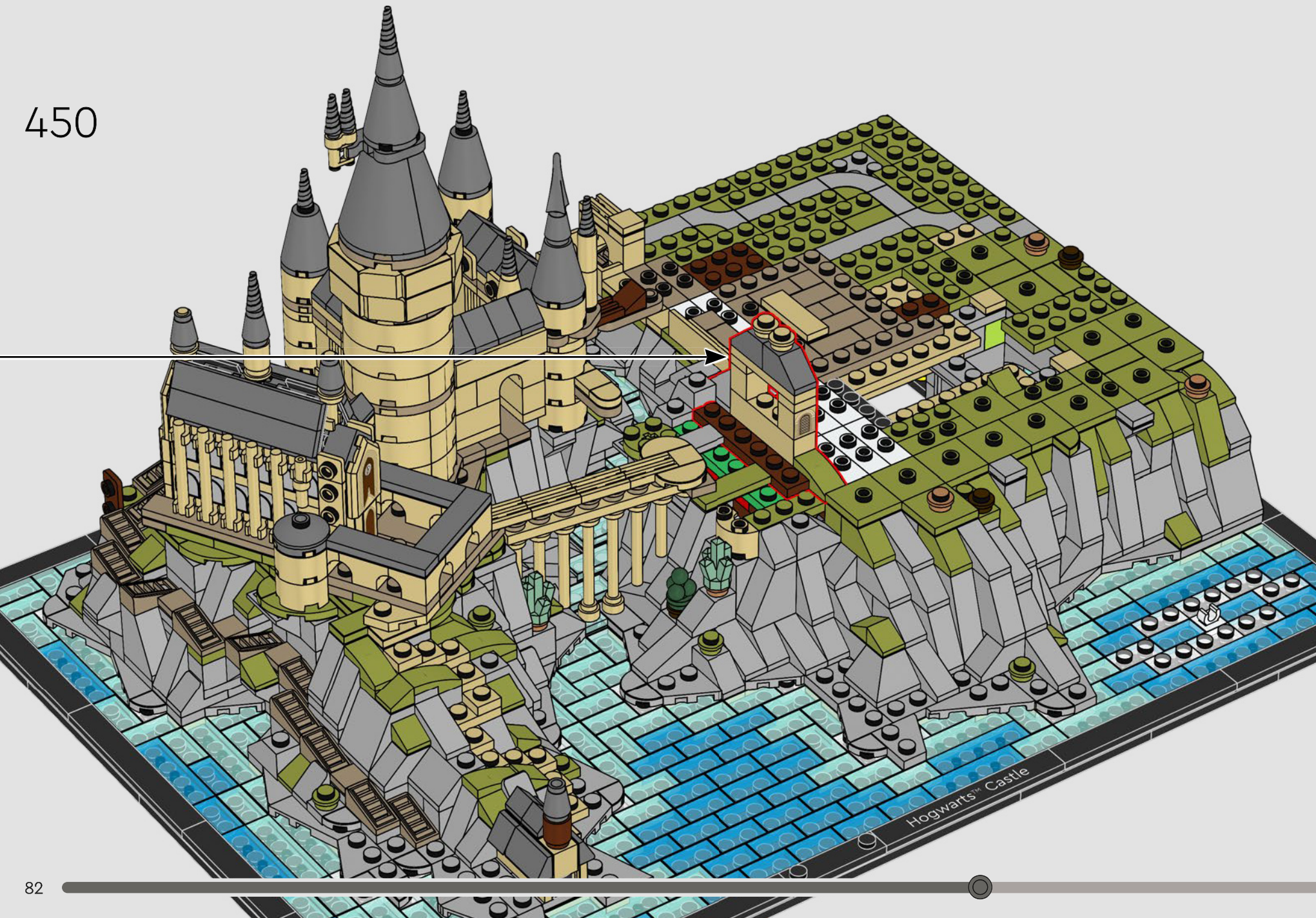

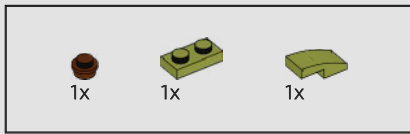

451

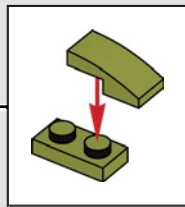
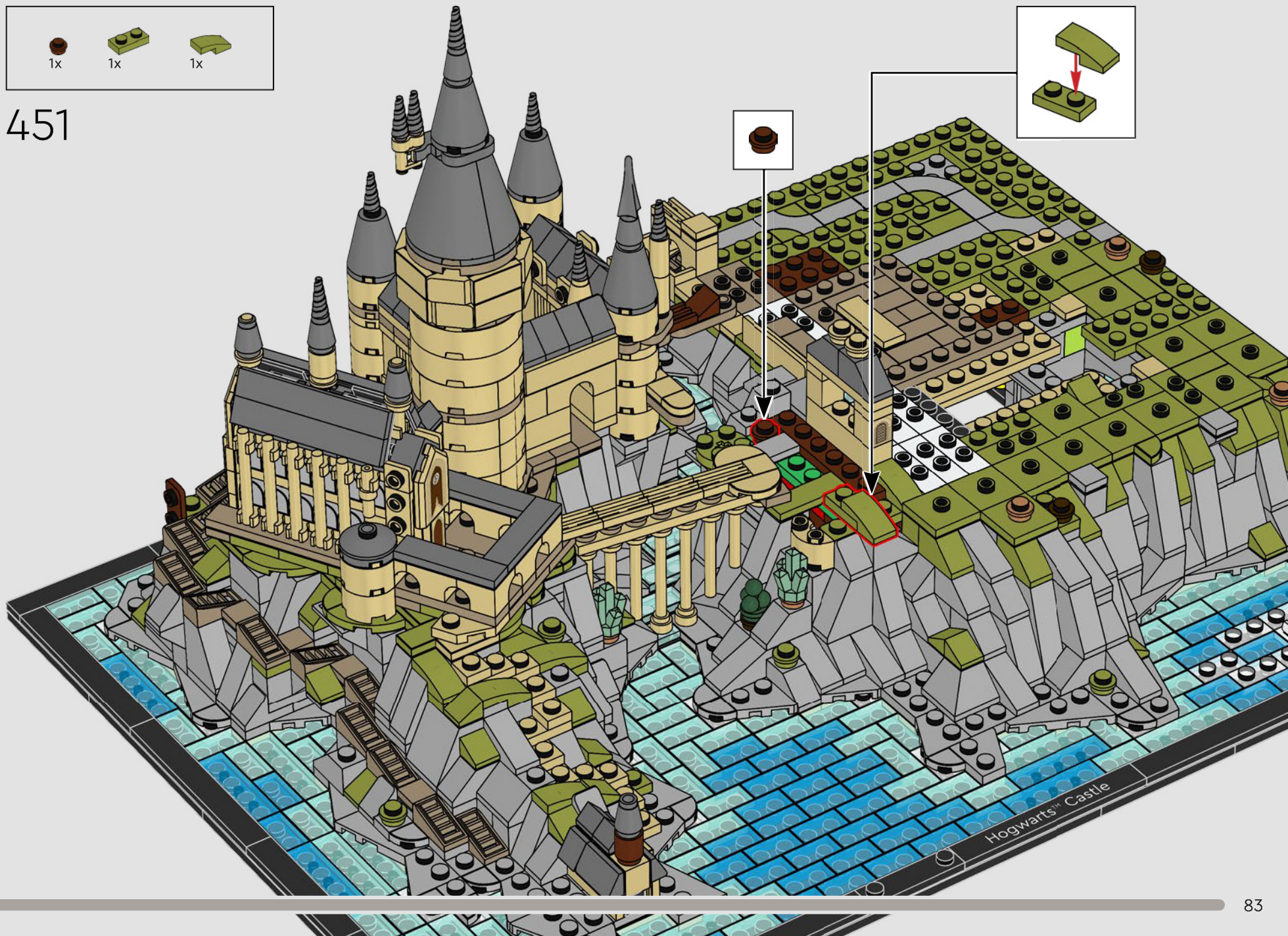

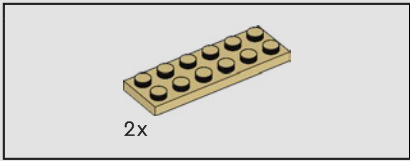

452

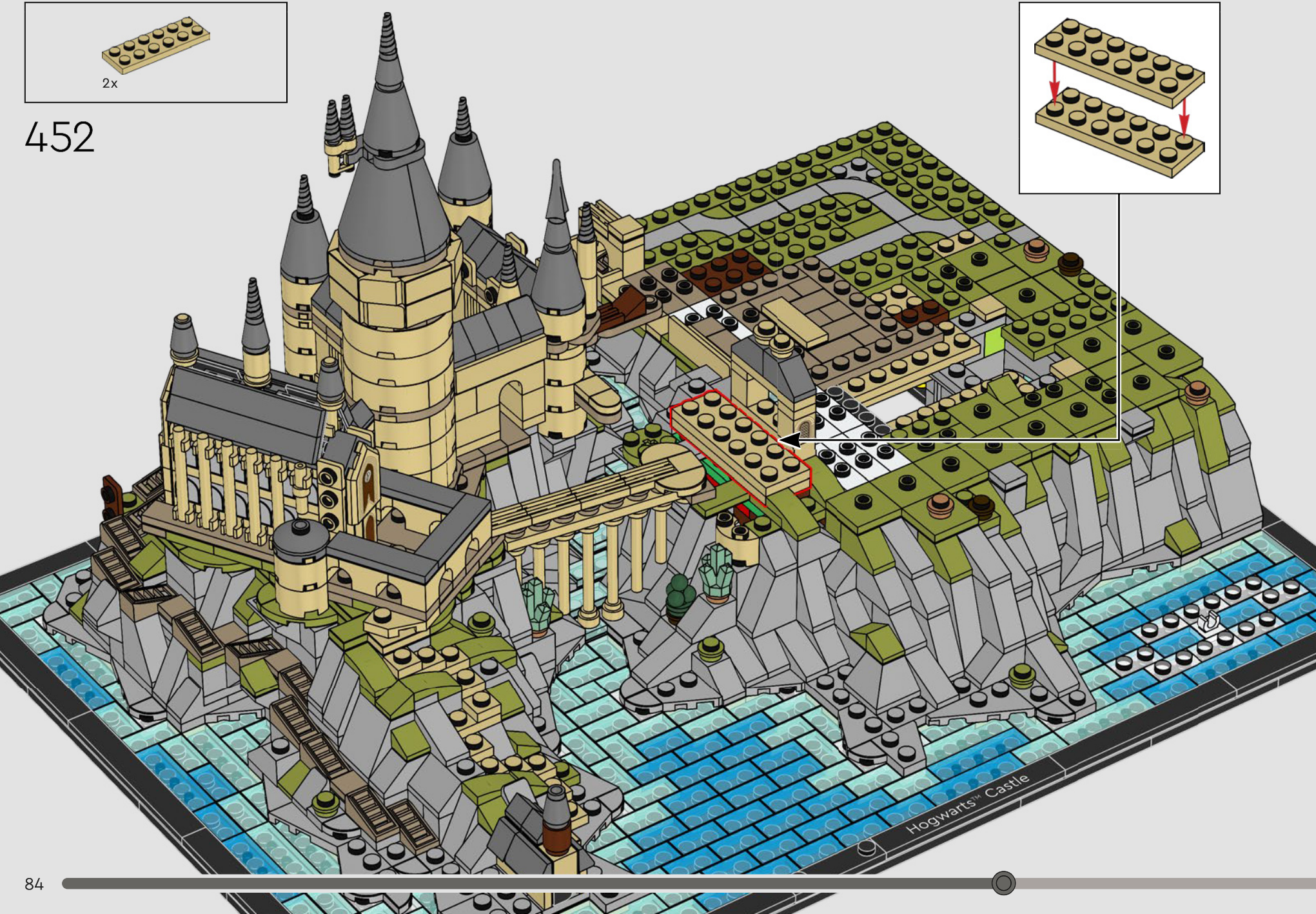
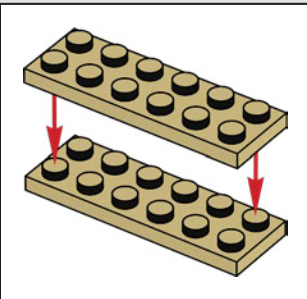

Hogwarts™ Castle



453

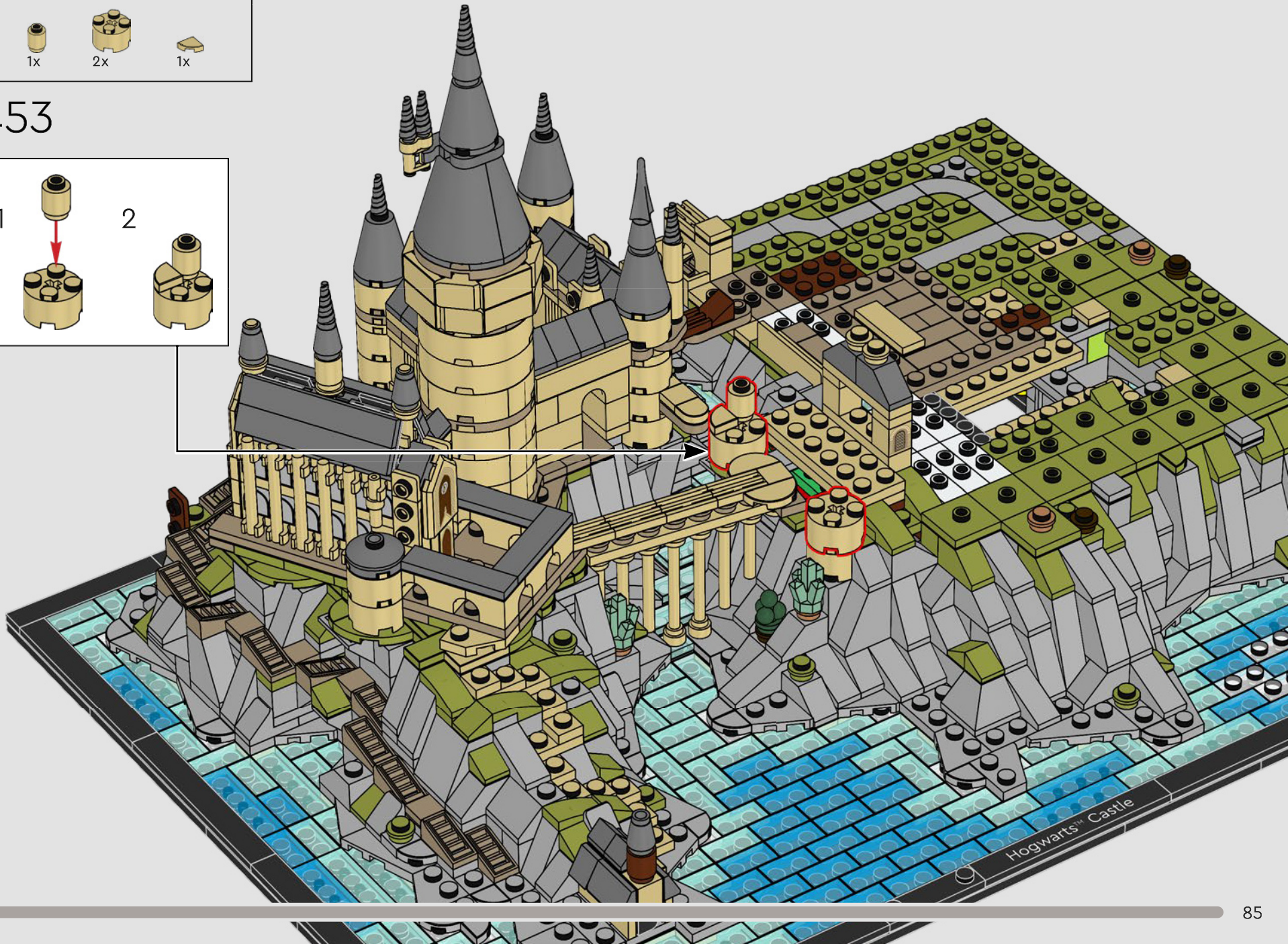
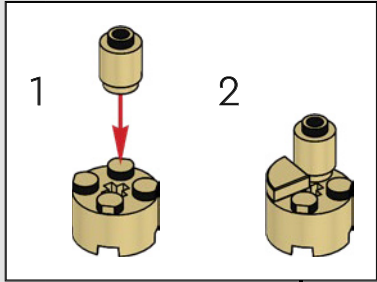



3x

454

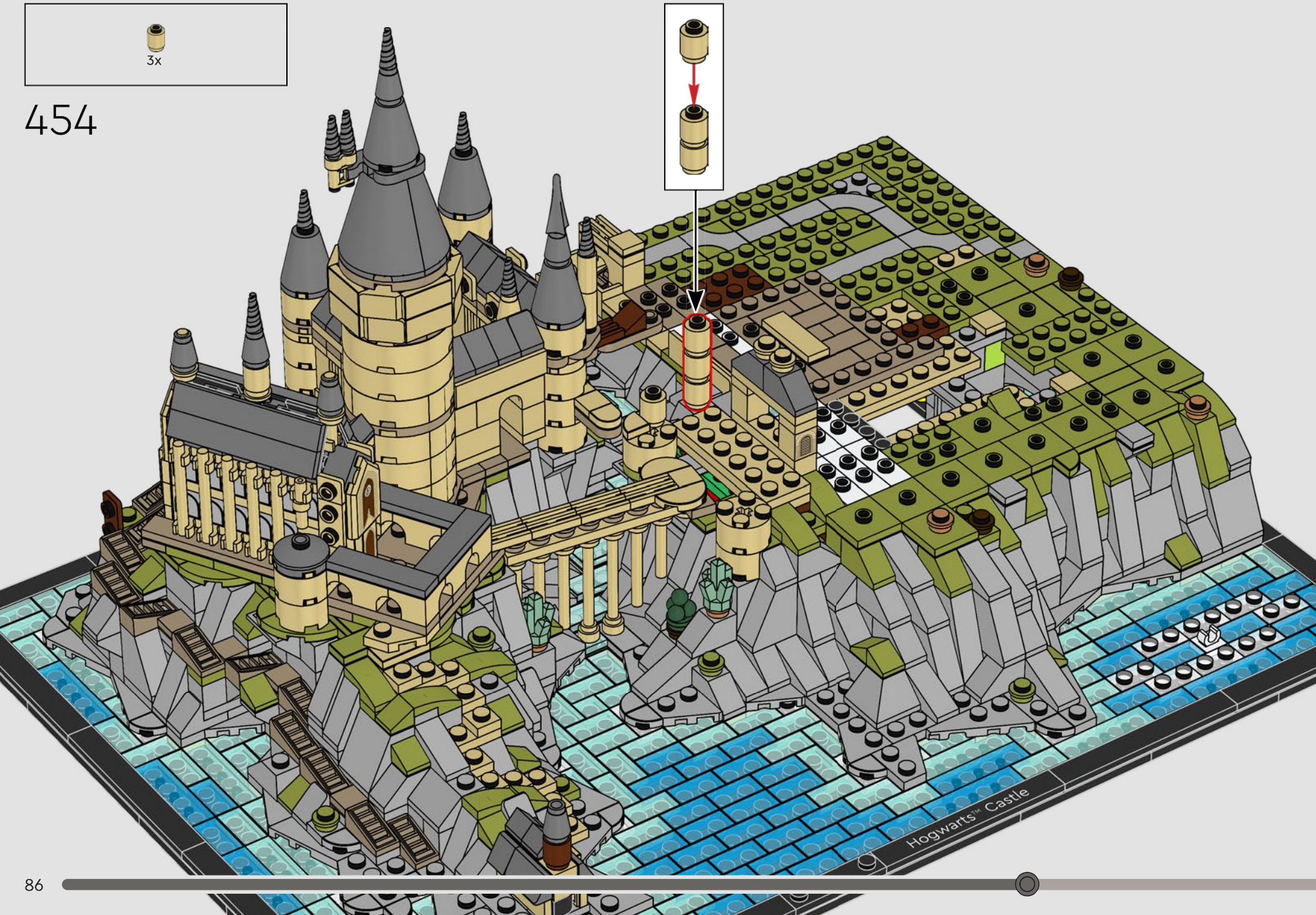
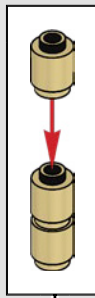

Hogwarts™ Castle

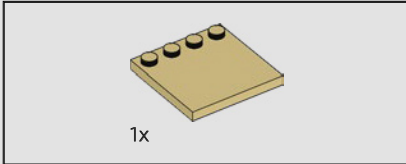
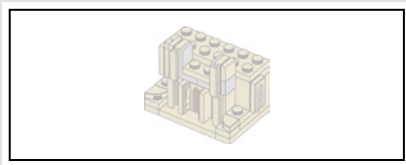

455

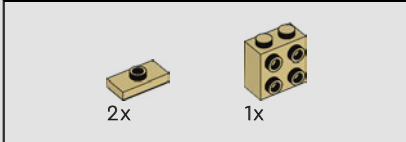
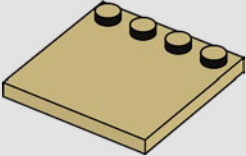

456

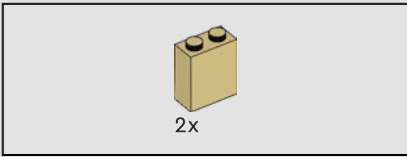
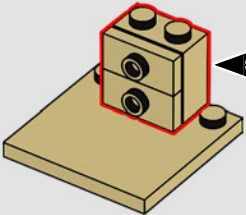
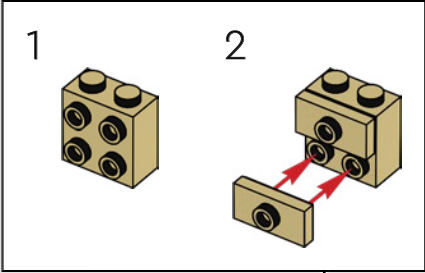

457

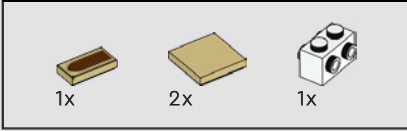
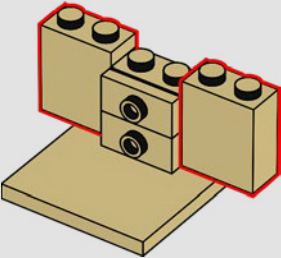

458

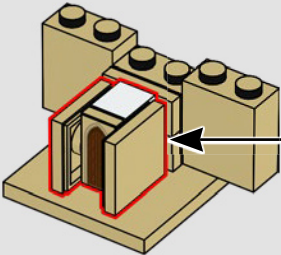
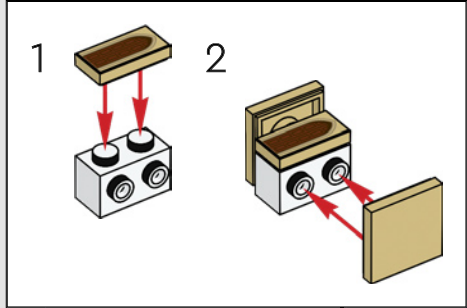

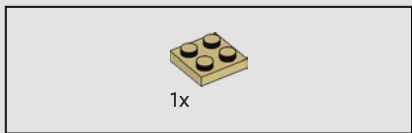

459

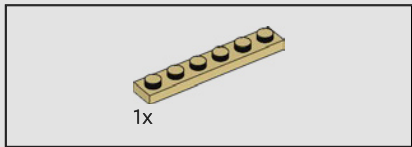
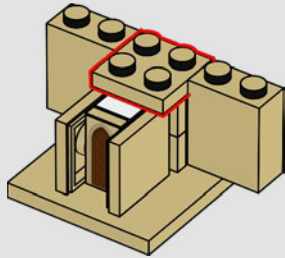

460

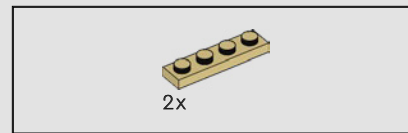
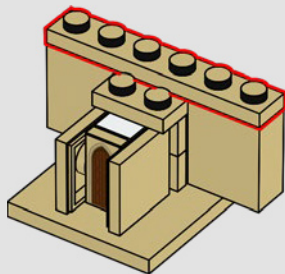

461

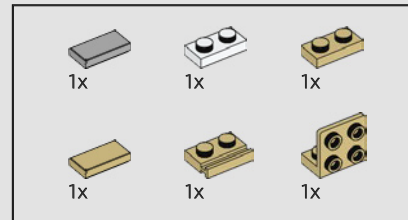
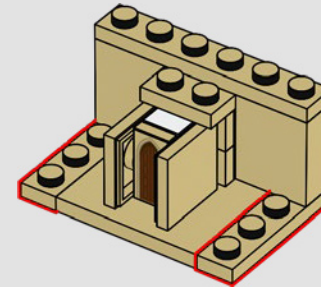

462

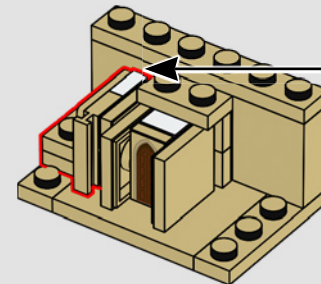
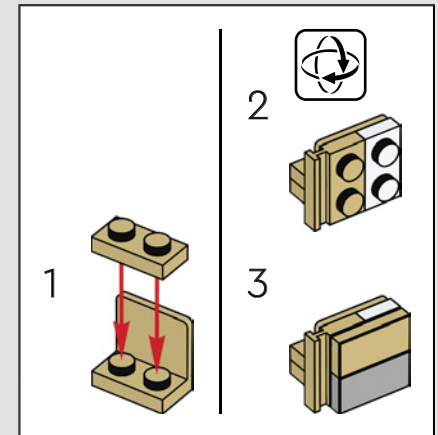

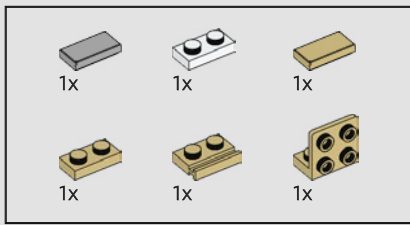

463

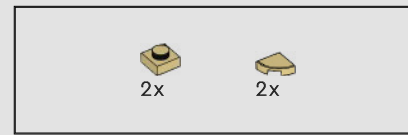
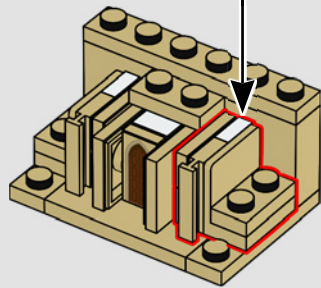
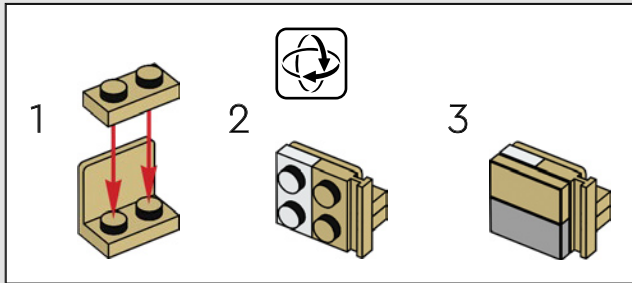

464

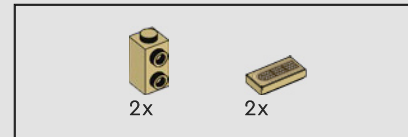
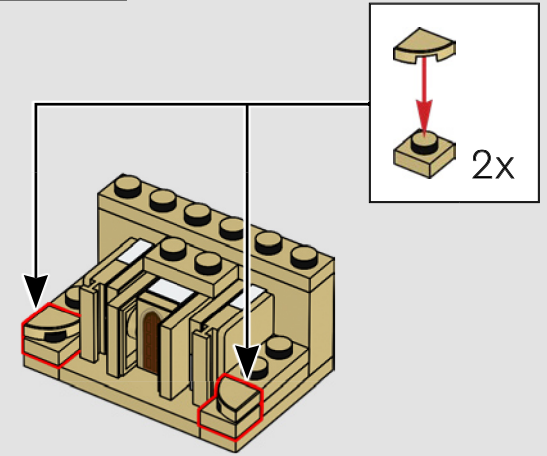

465

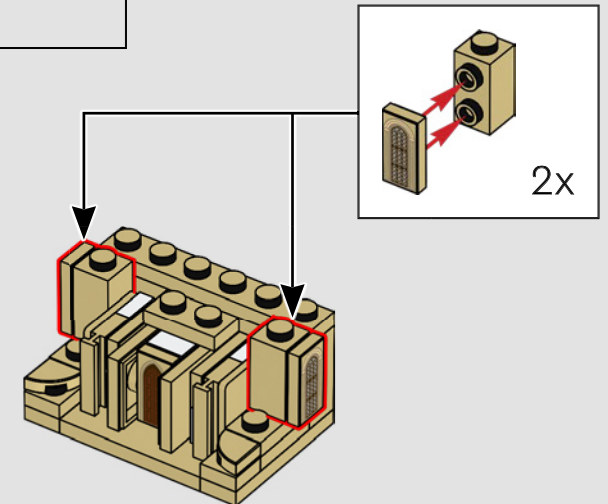

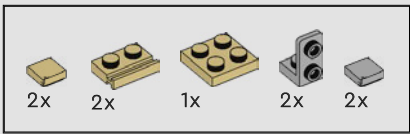

466

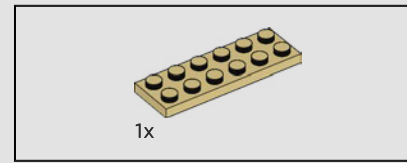
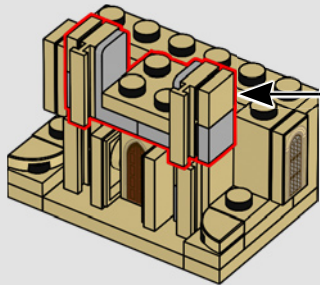
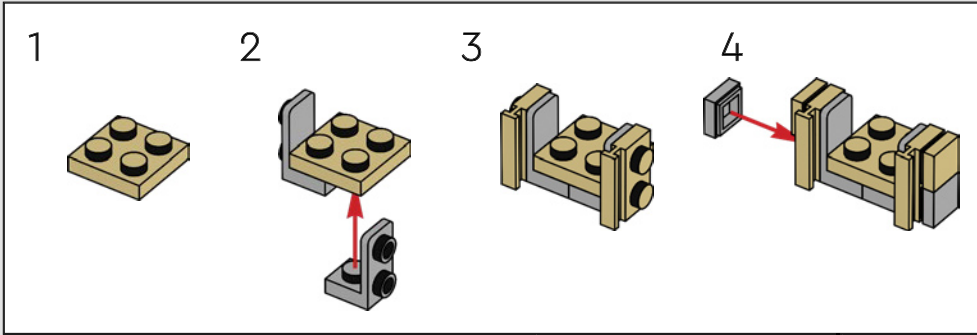

467

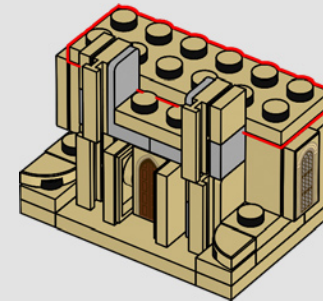

468

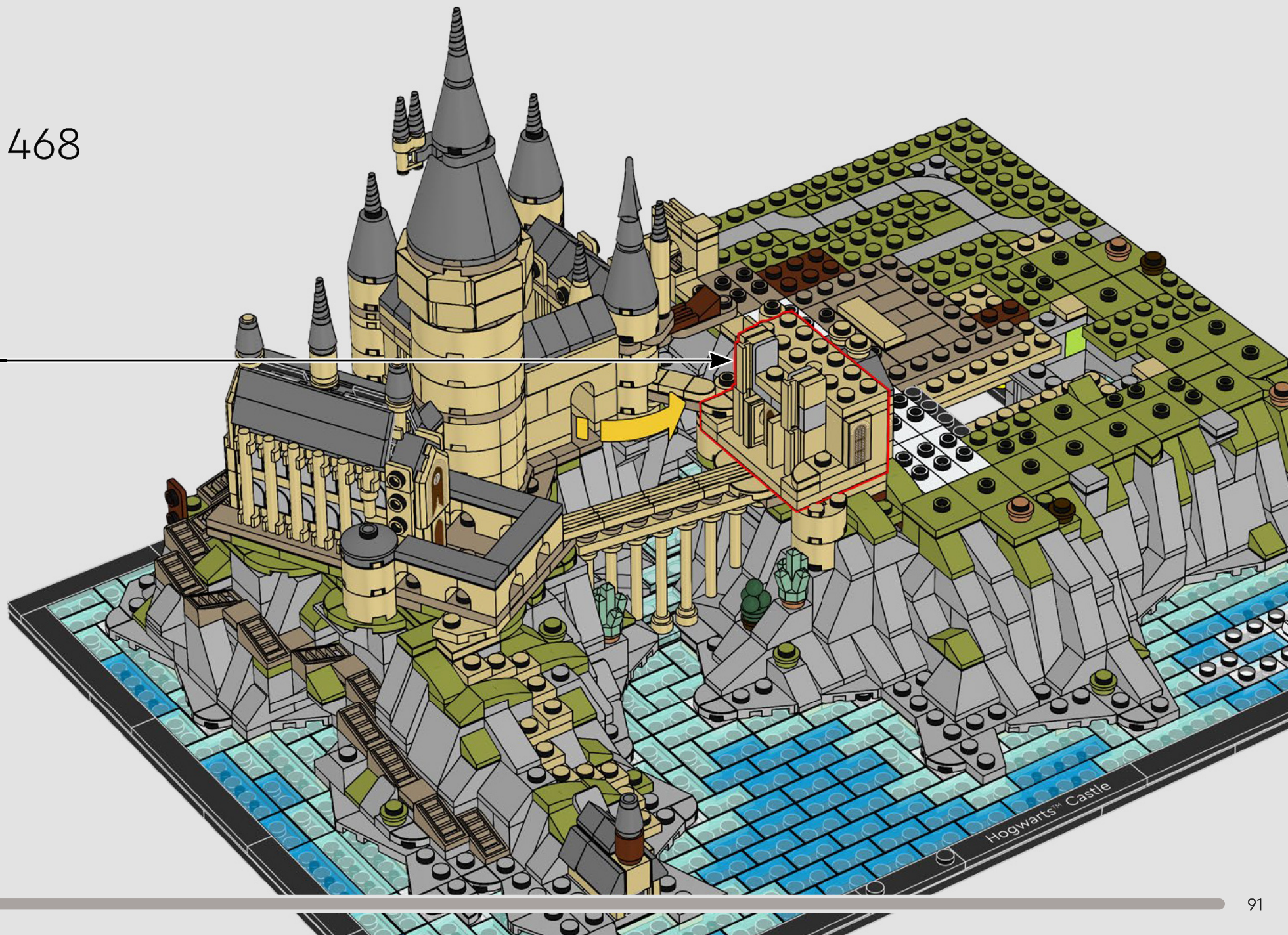

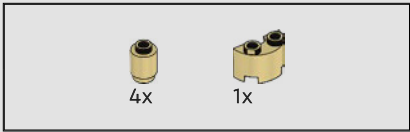

469

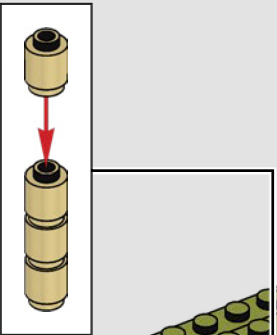



470

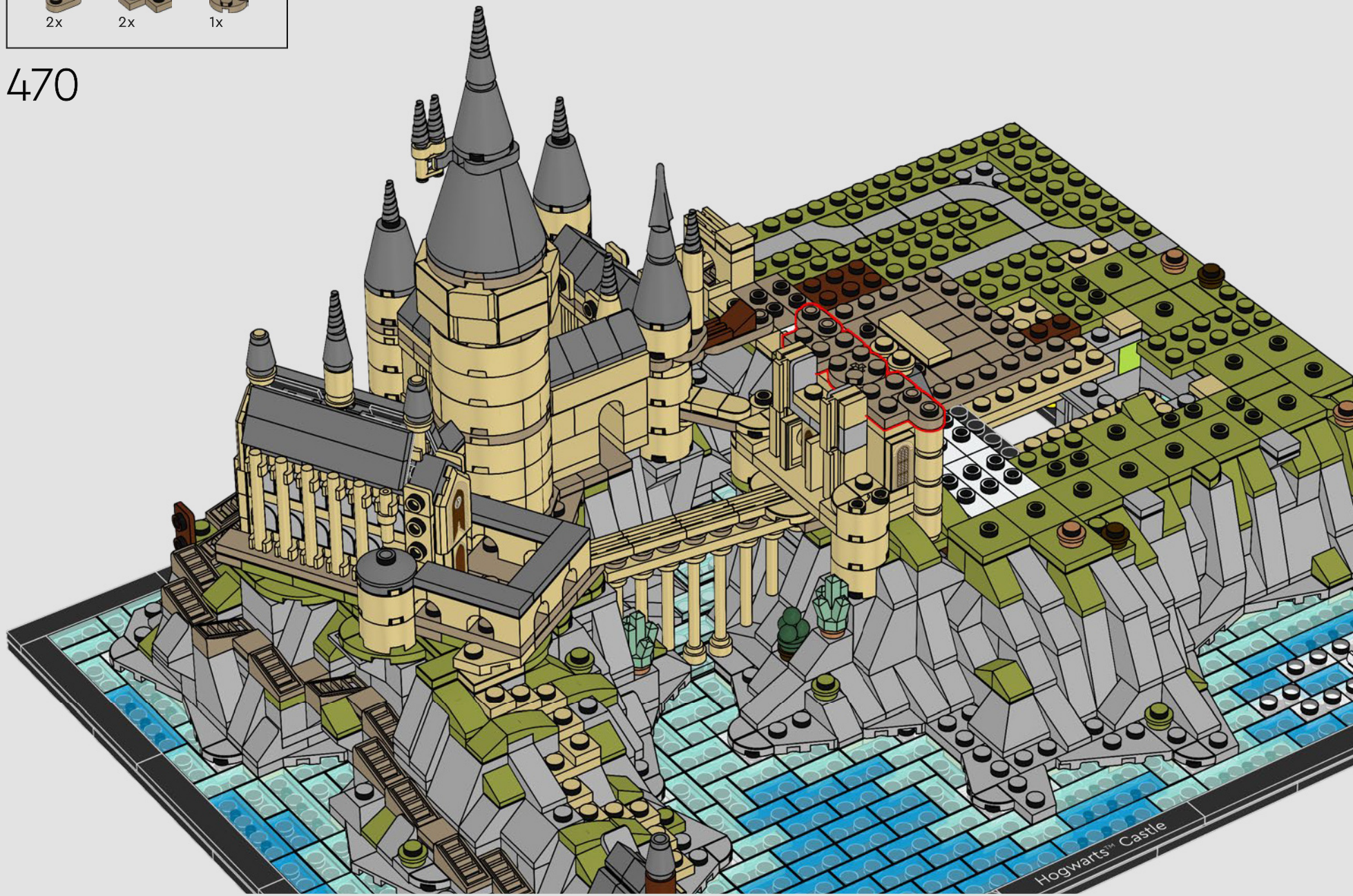

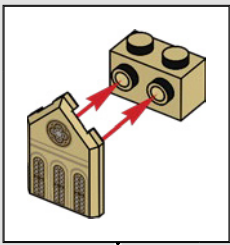
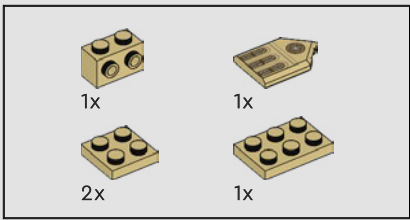

471

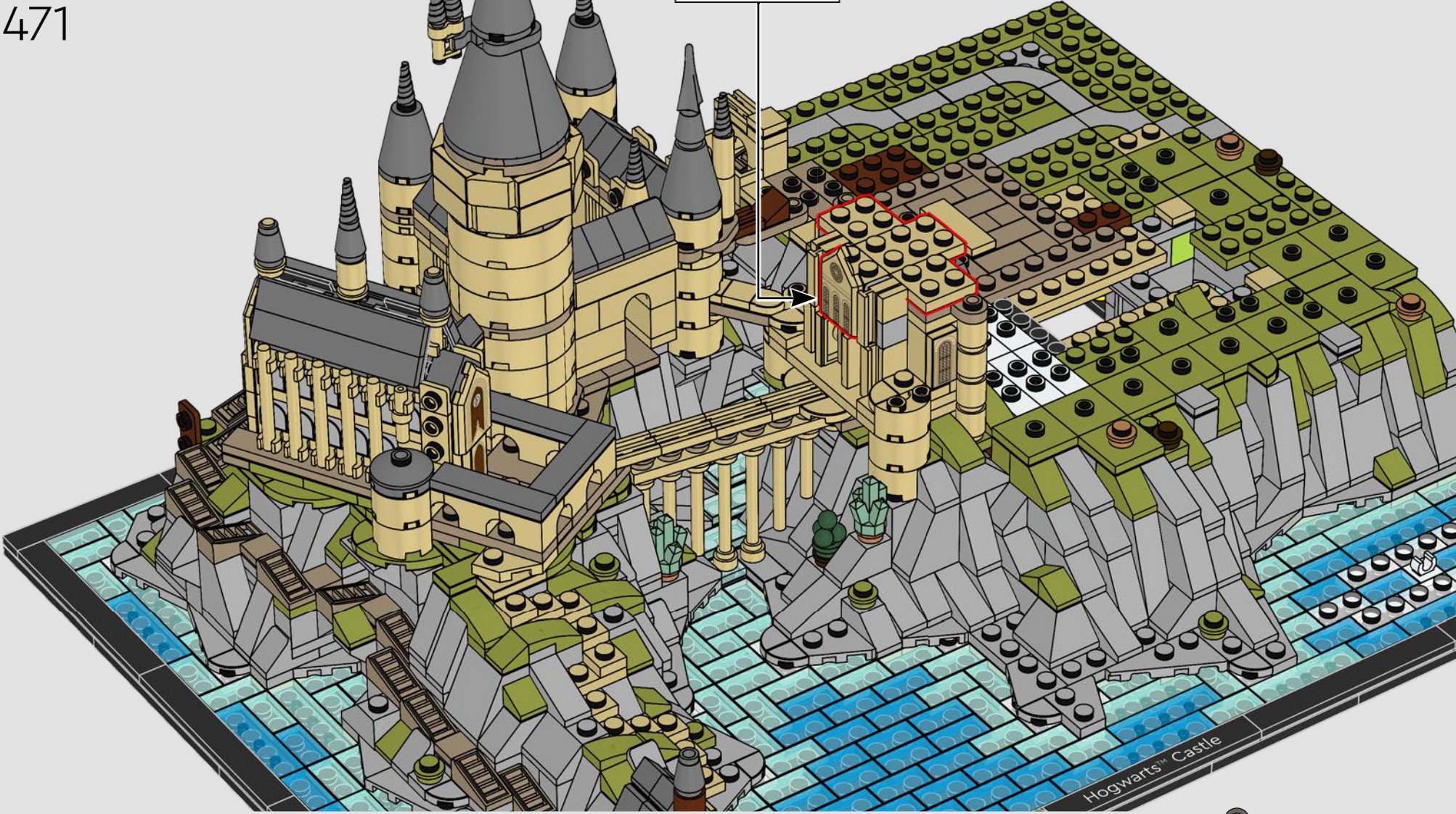

Hogwarts™ Castle

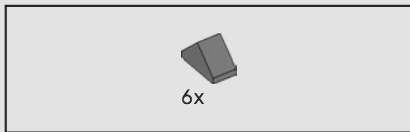

472

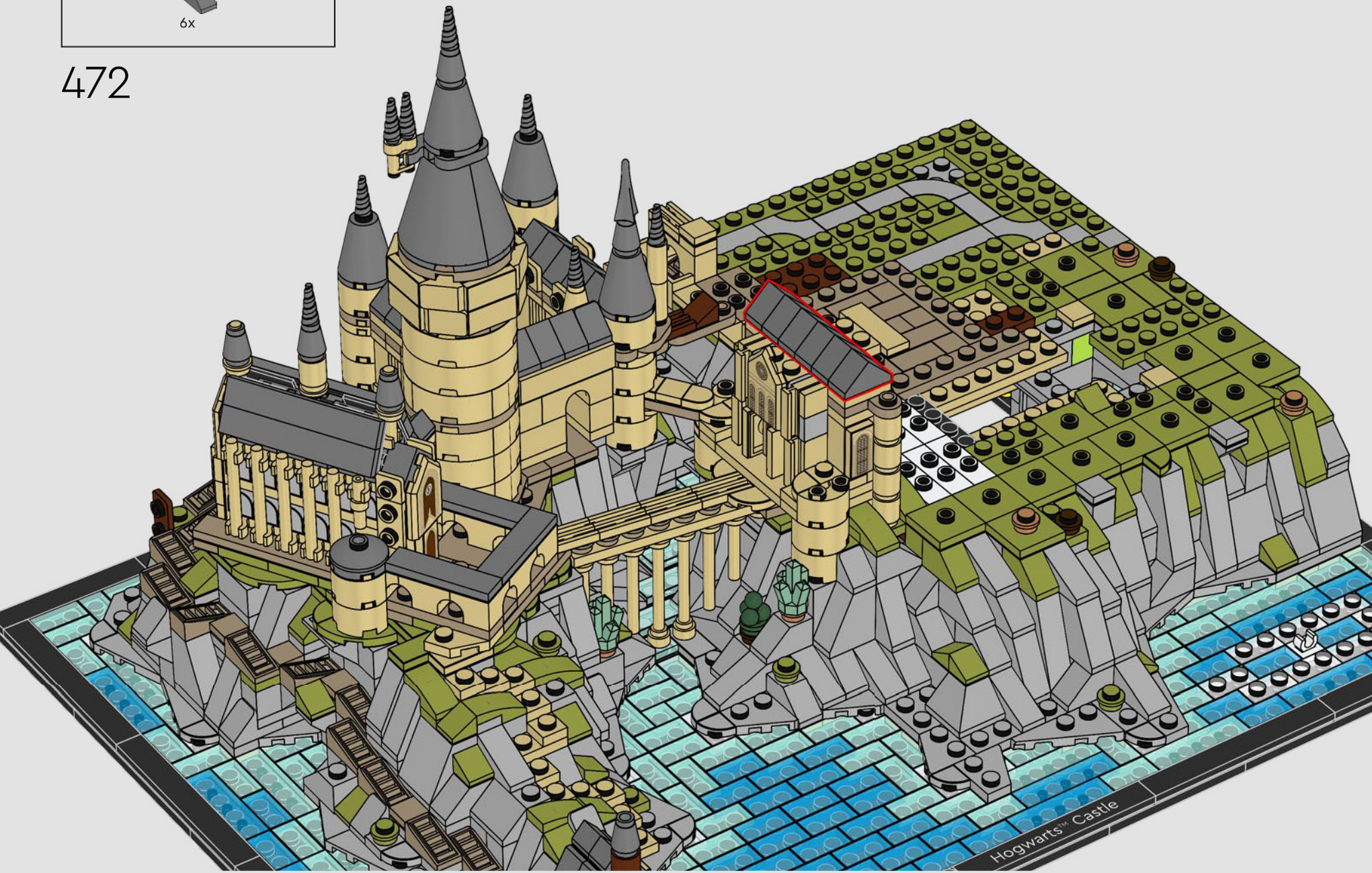

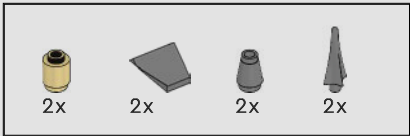

473

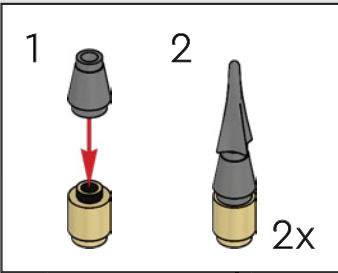

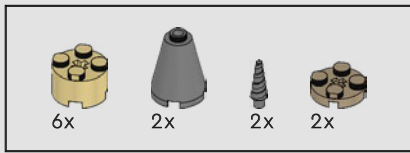

474

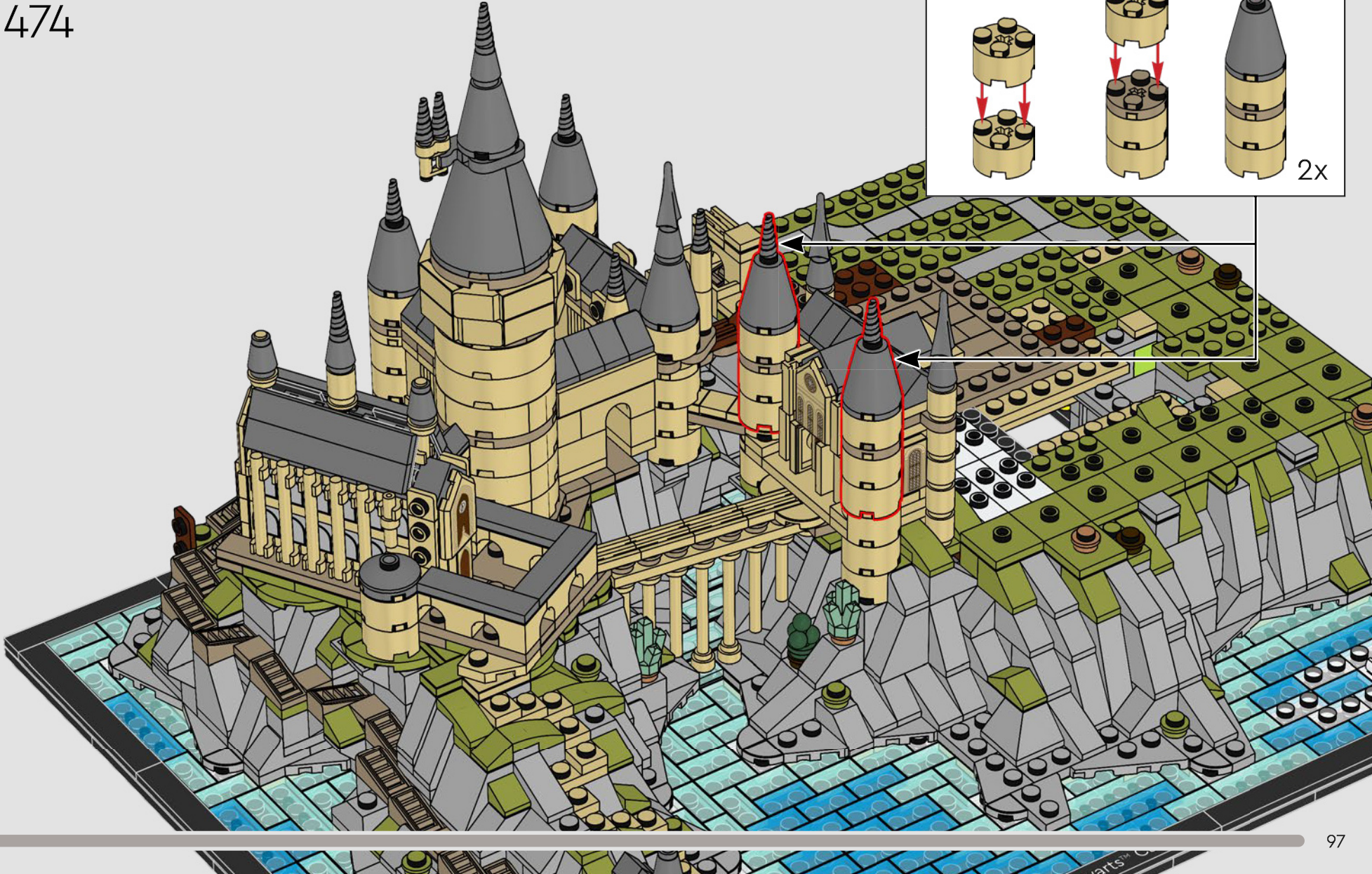
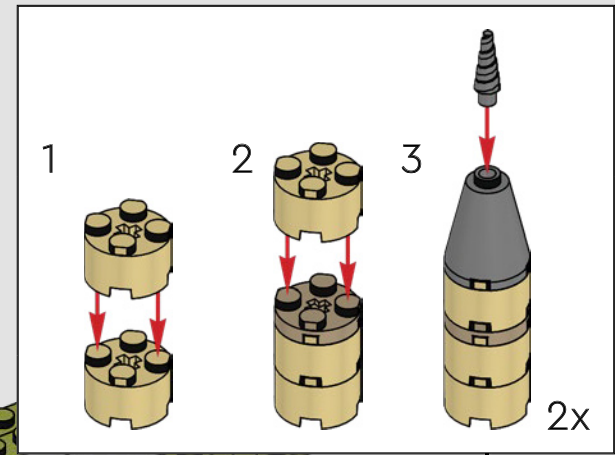

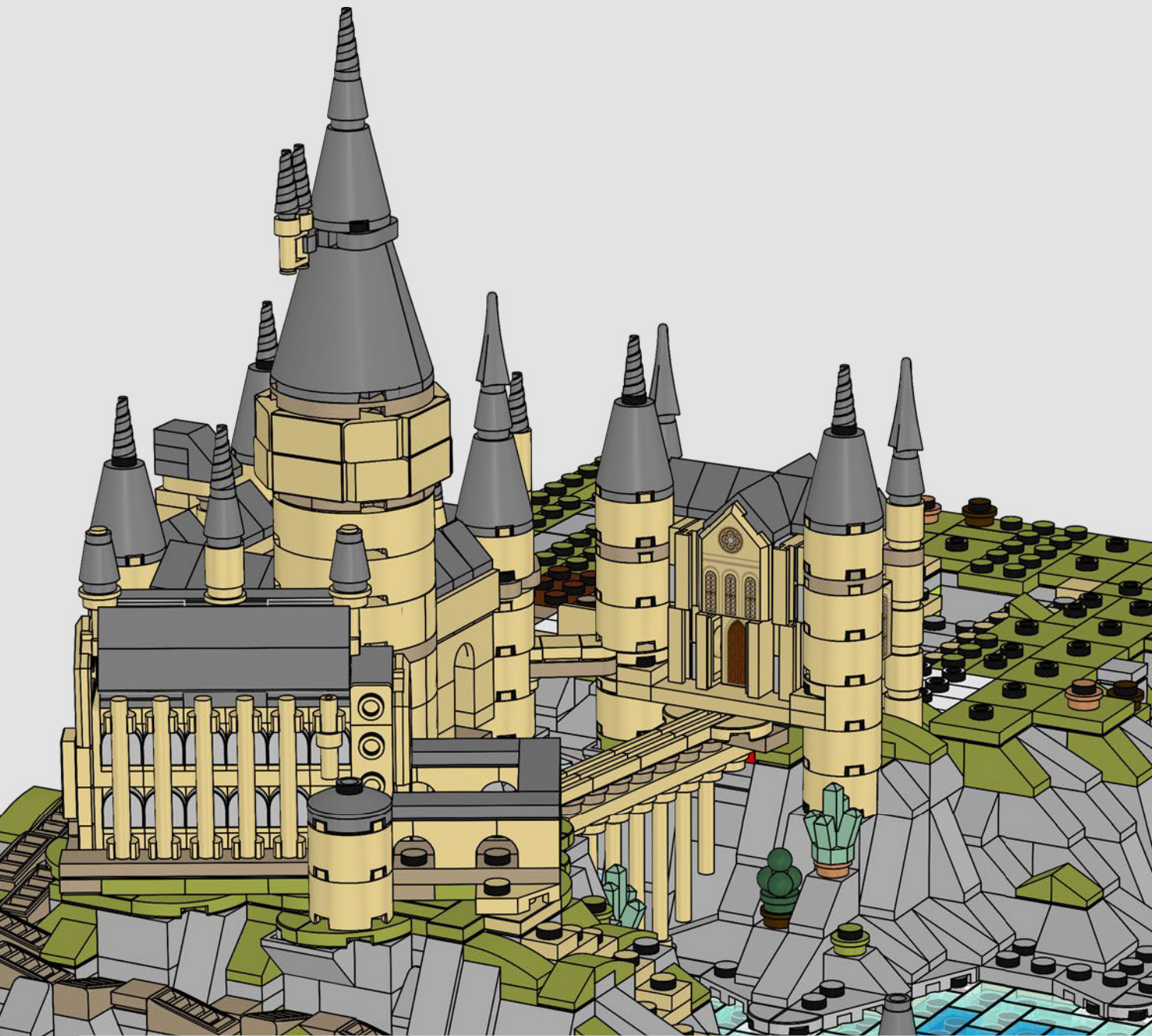

女厕所位于城堡的这一部分。也许哭泣的桃金娘会在你拼搭过程中停下来。只是要当心巨怪。



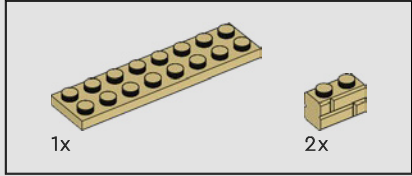
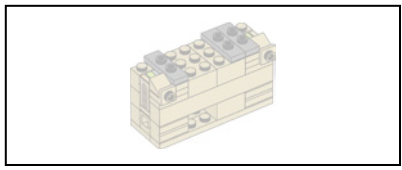

475

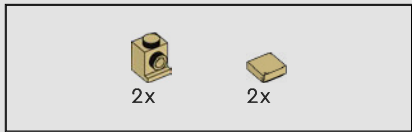
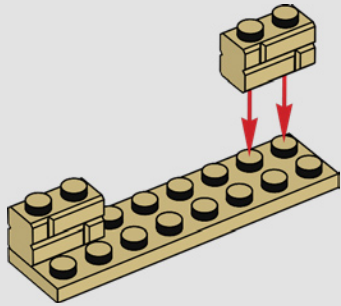

476

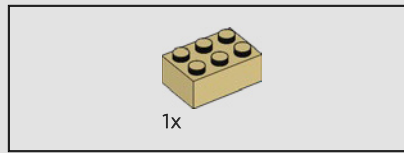
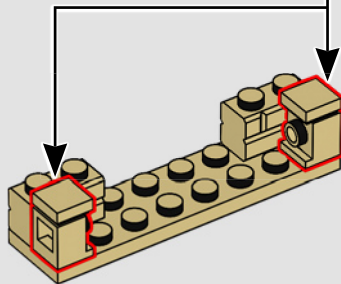
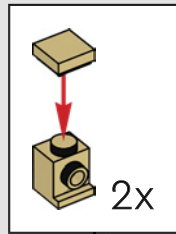

477

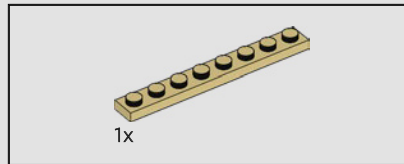
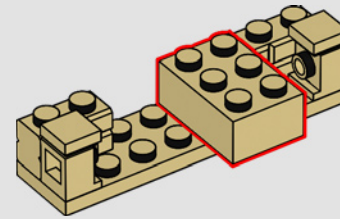

478

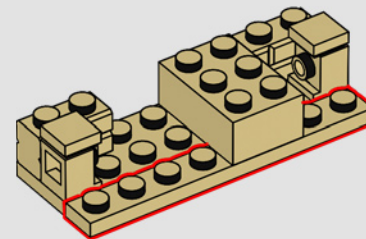

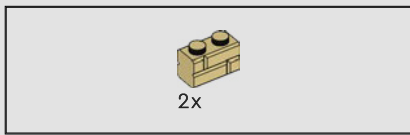

479

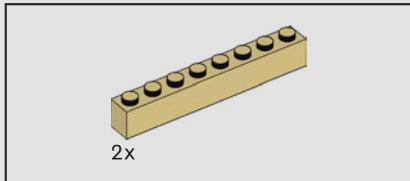
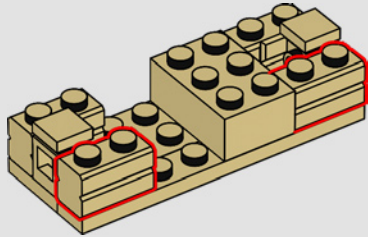

480

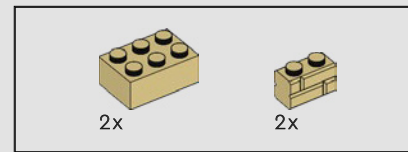
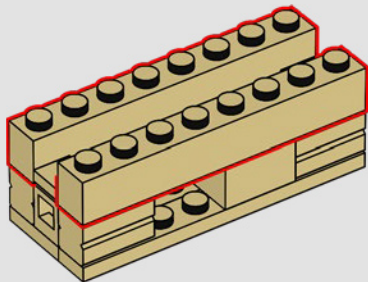

481

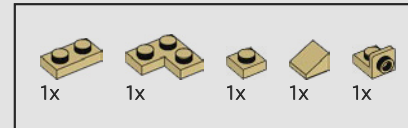
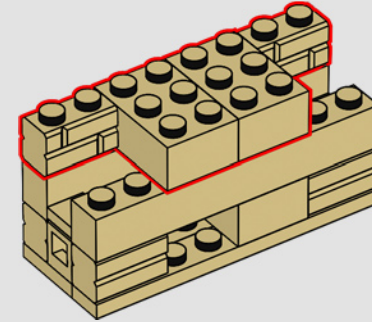

482

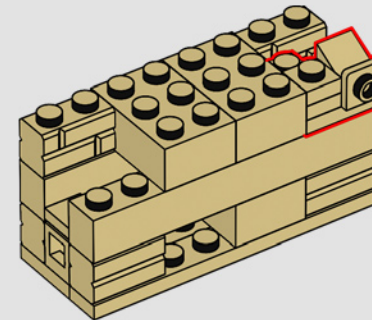
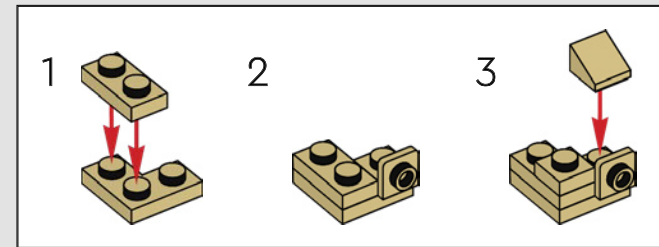

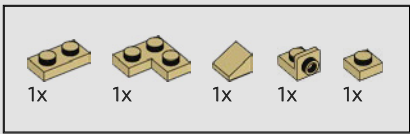

483

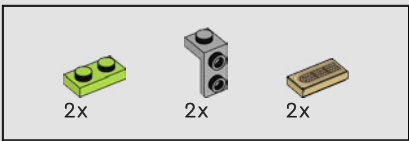
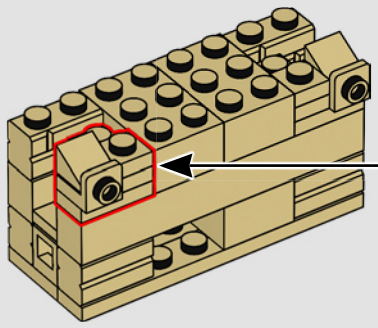
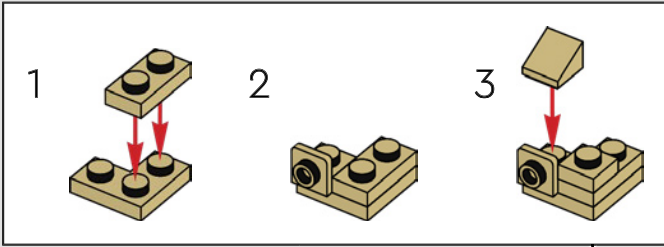

484

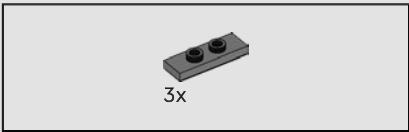
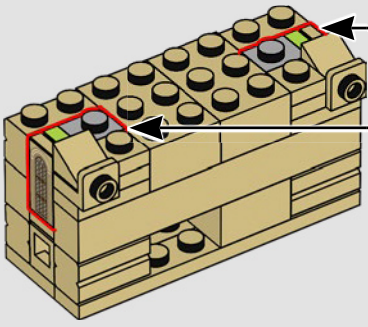
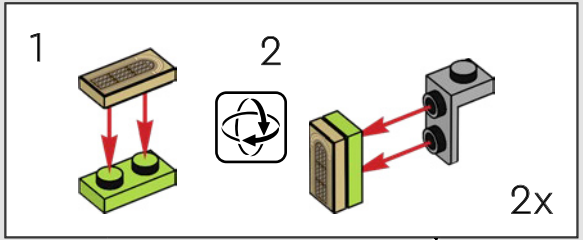

485

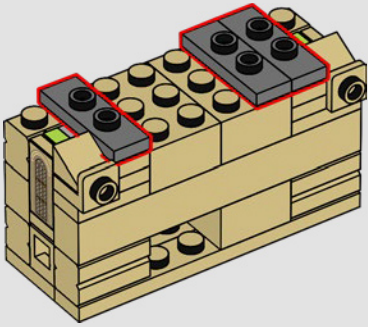

486

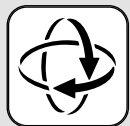

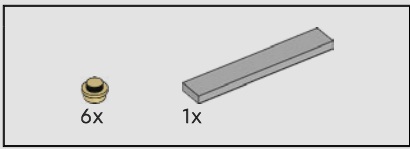

487

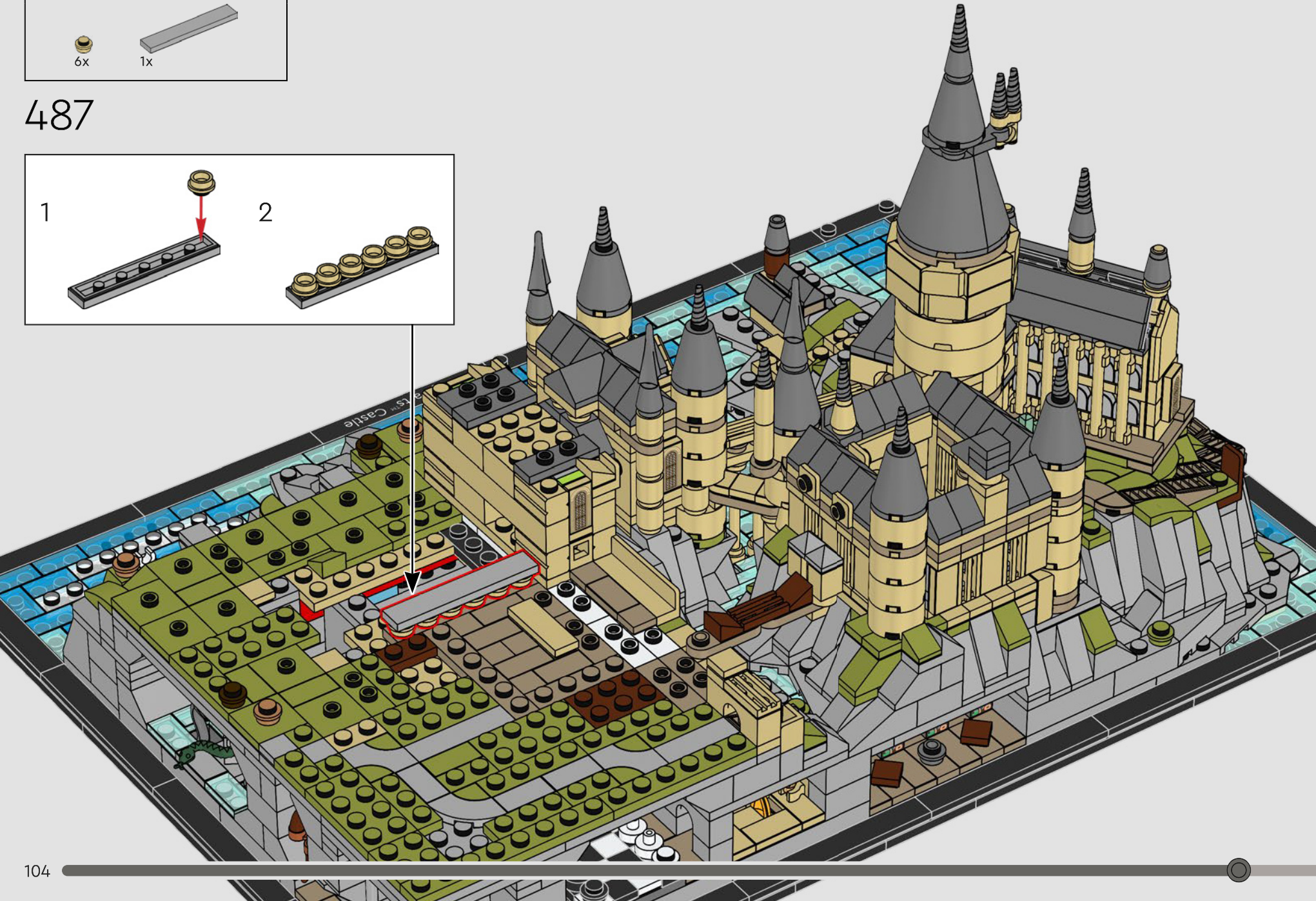
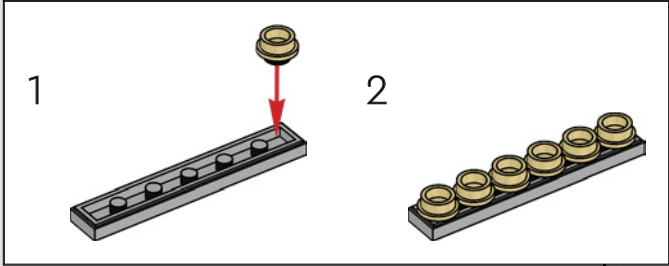

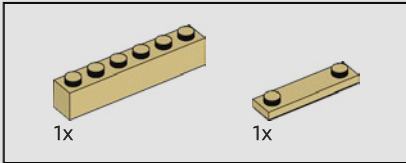
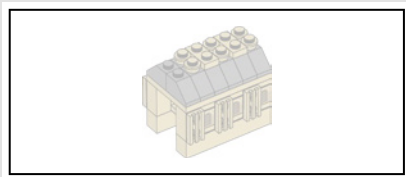

488

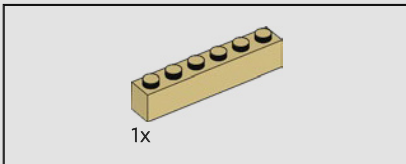
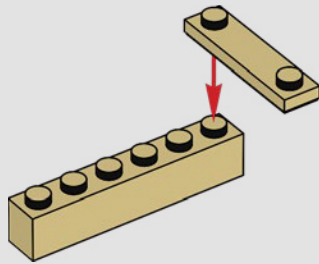

489

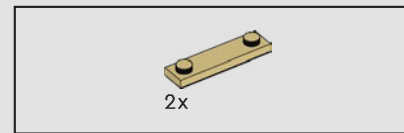
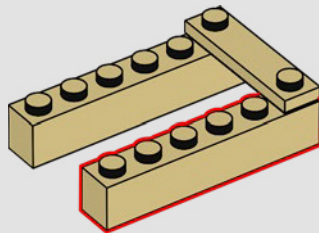

490

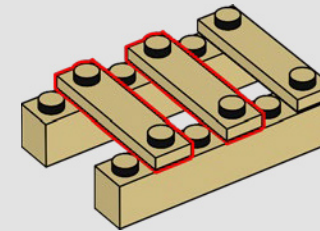

491

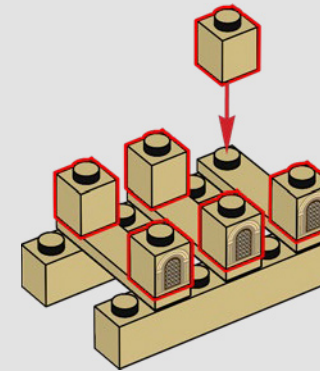

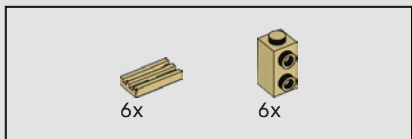

492

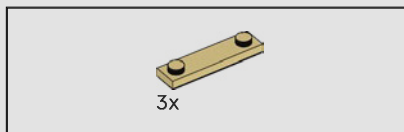
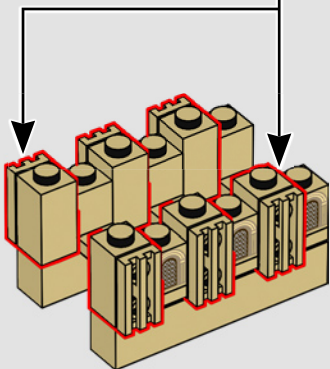
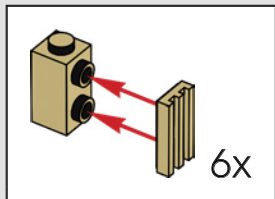

493

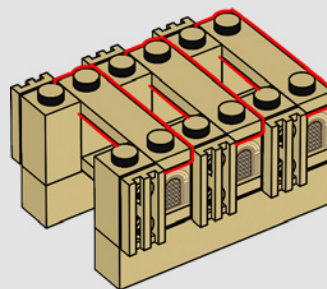

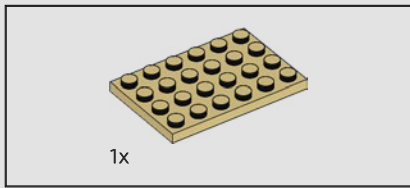

494

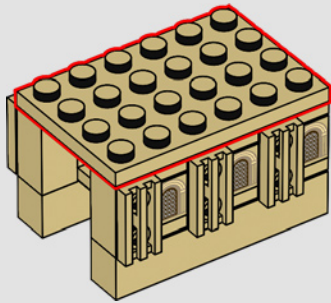

495

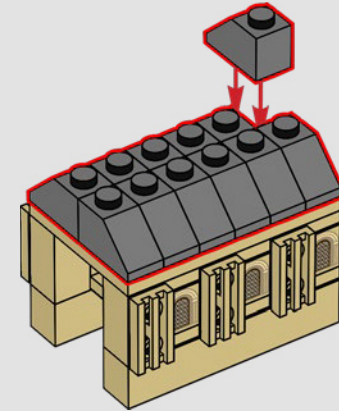

496

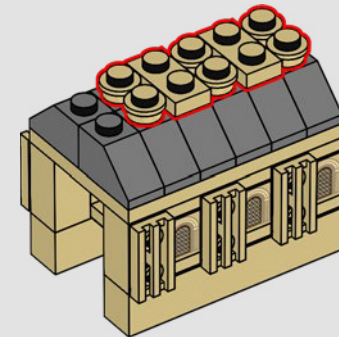

497

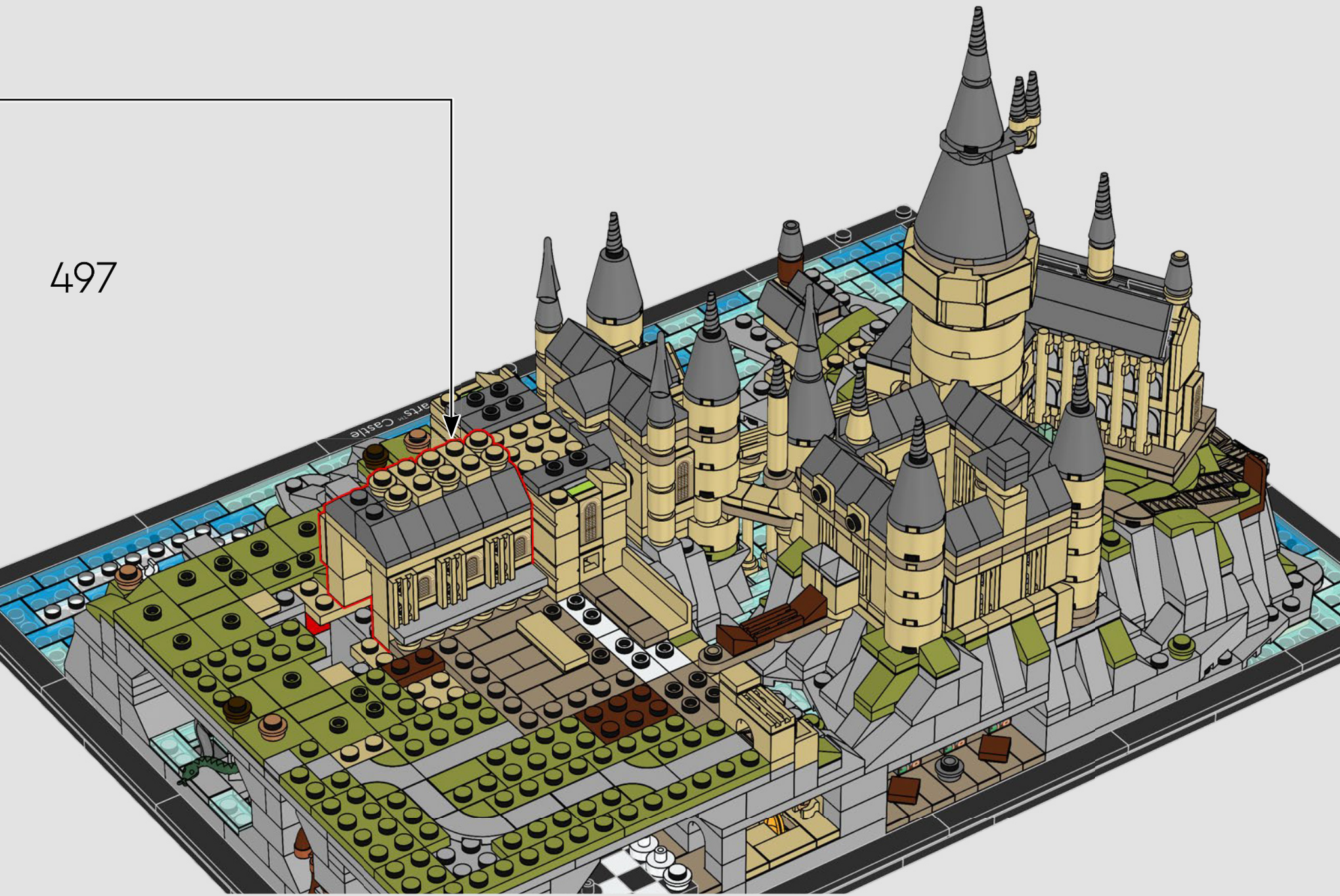

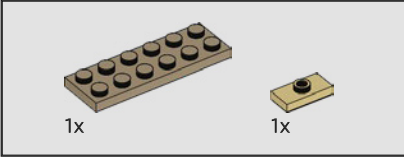
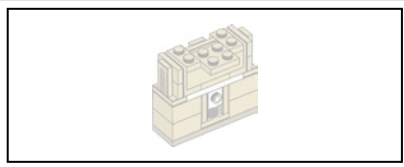

498

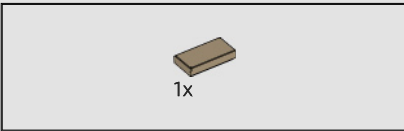
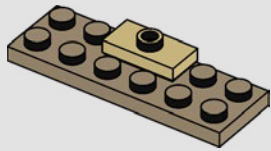

499

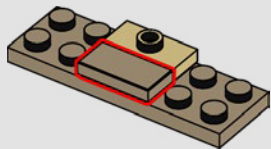

500

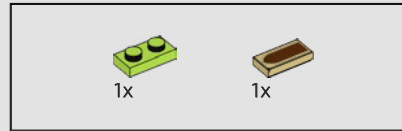
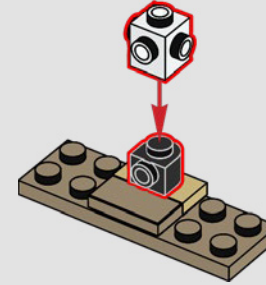

501

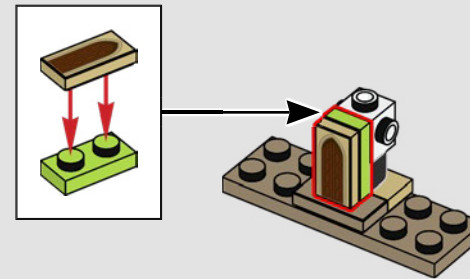

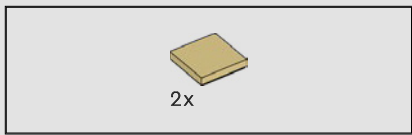

502

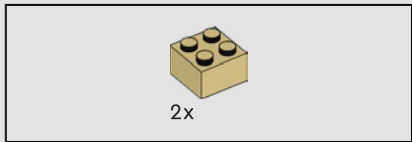
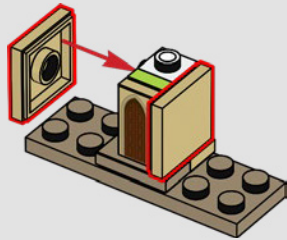

503

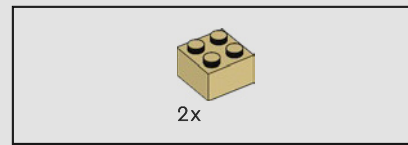
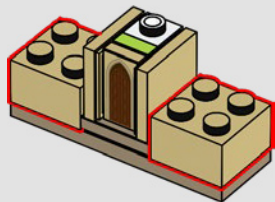

504

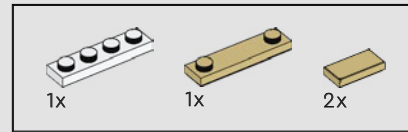
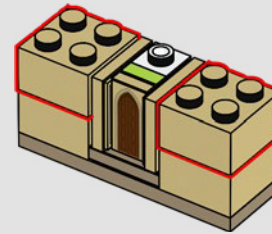

505

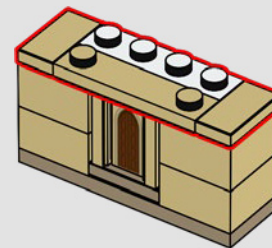

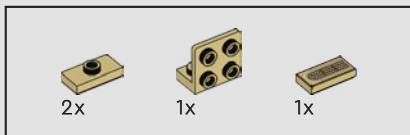

506

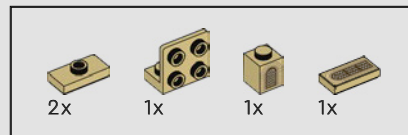
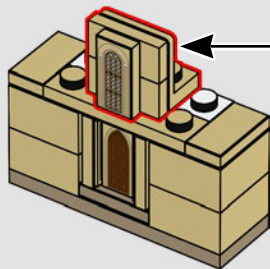
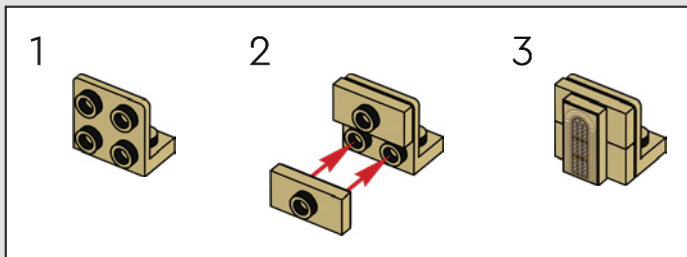

507

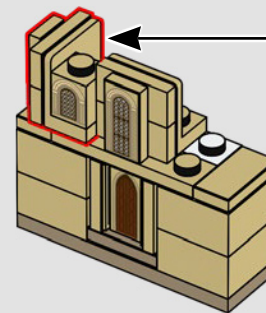
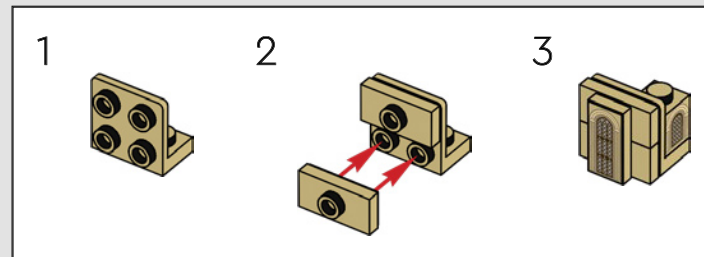

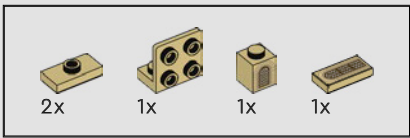

508

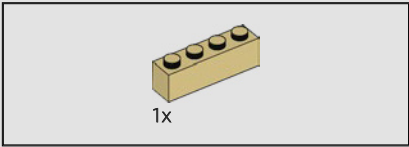
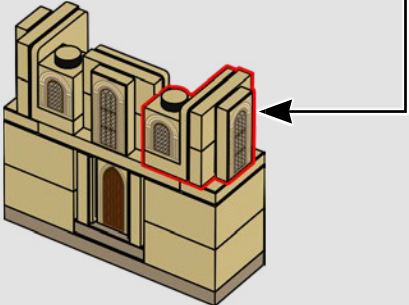
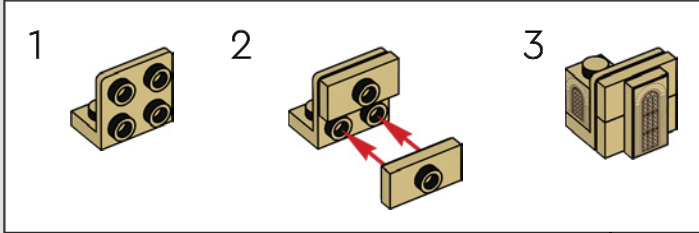

509

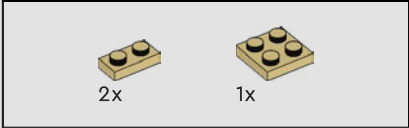
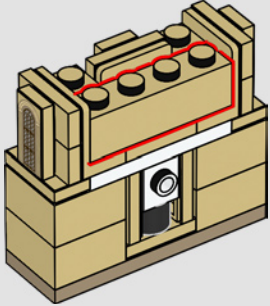

510

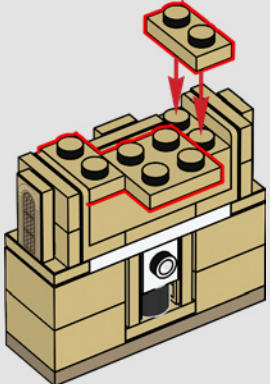

511





2x



2x



2x



2x



2x



2x



2x



2x



2x

512

1

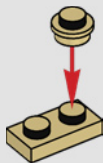

2

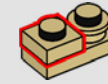

3

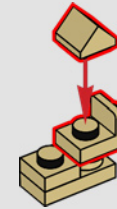

4

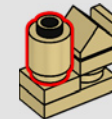

5

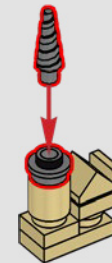

2x



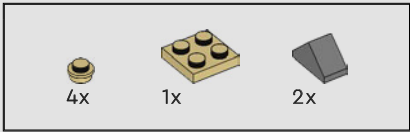

513

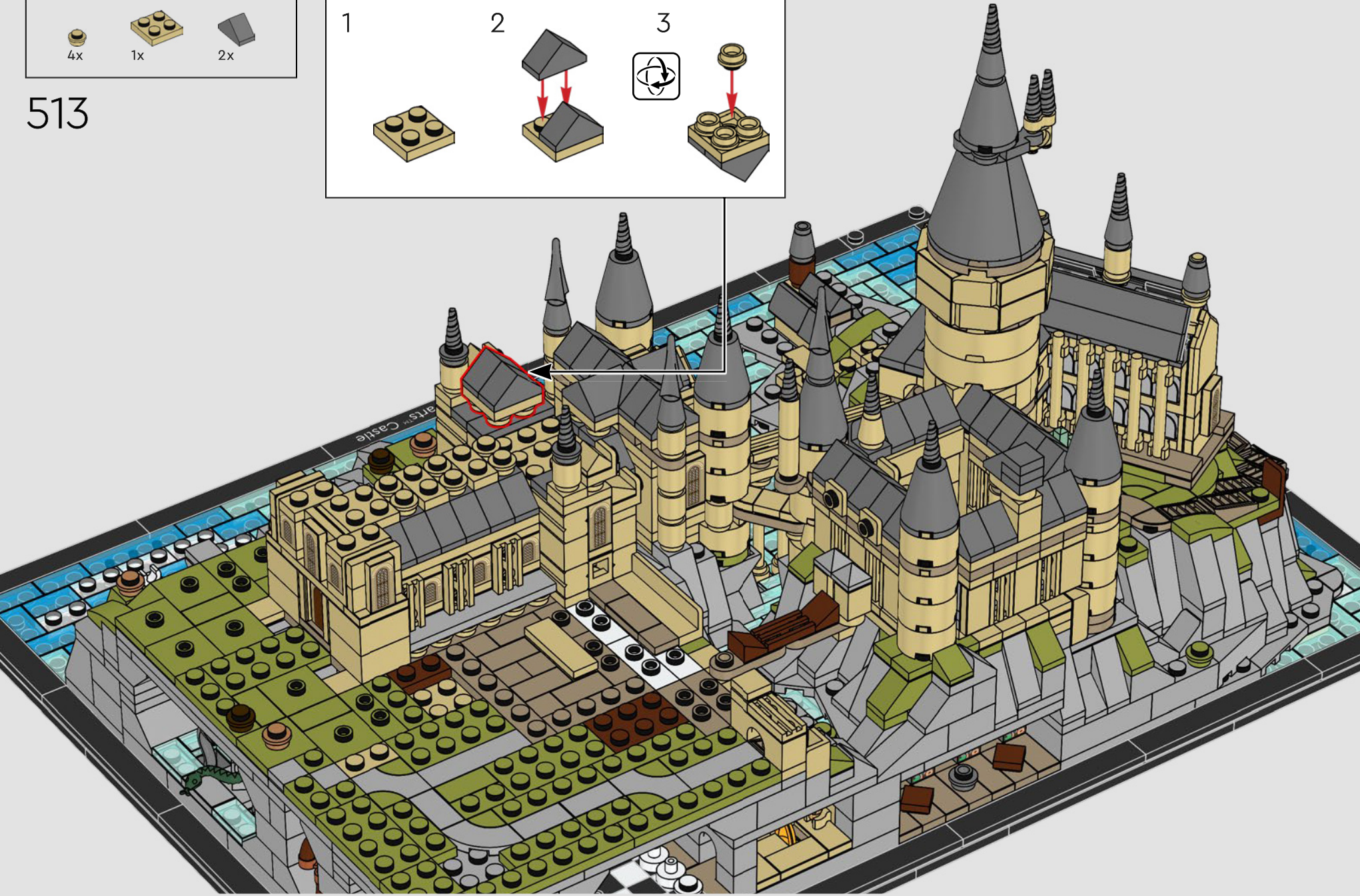
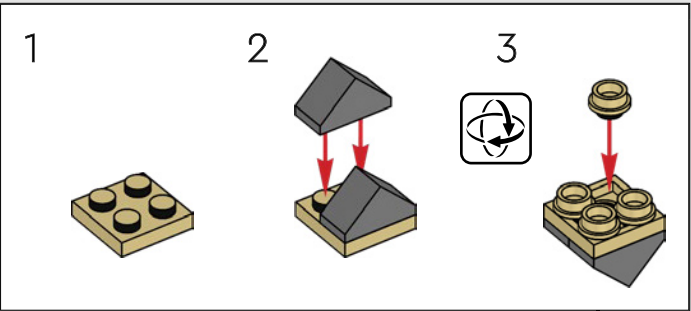

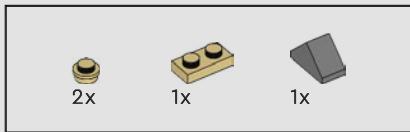

514

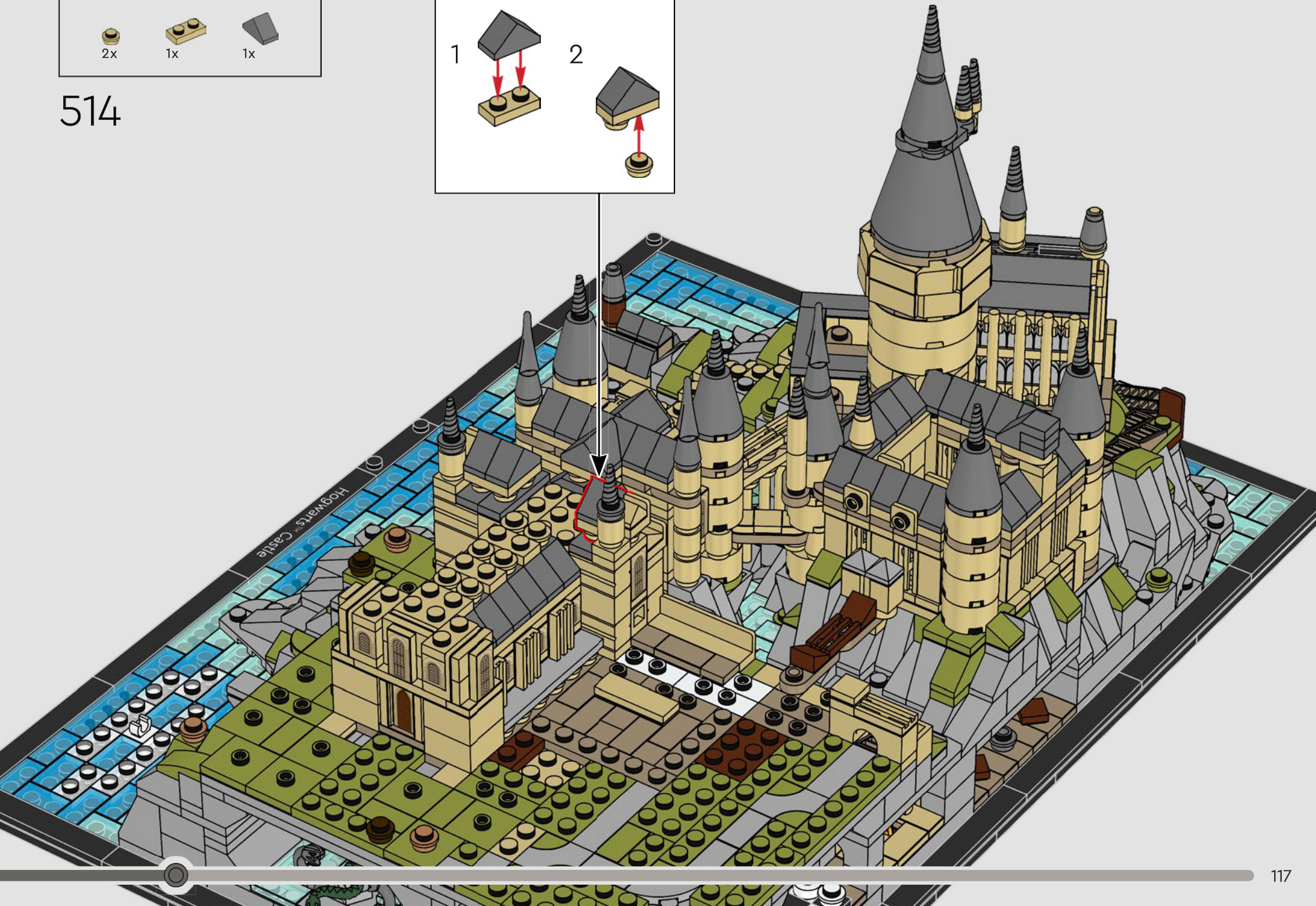
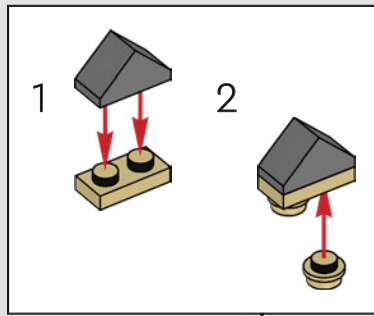

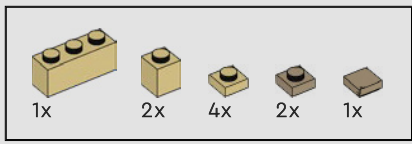

515

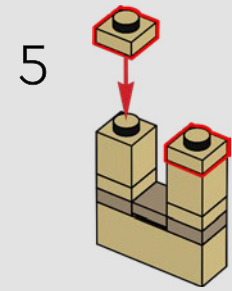
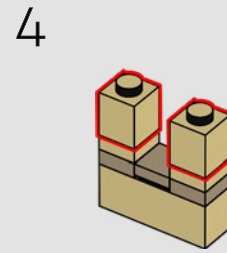
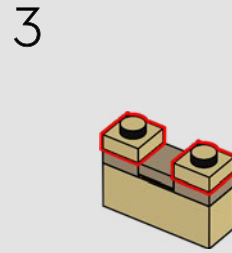
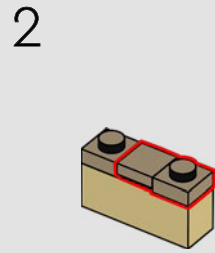
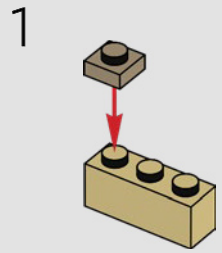

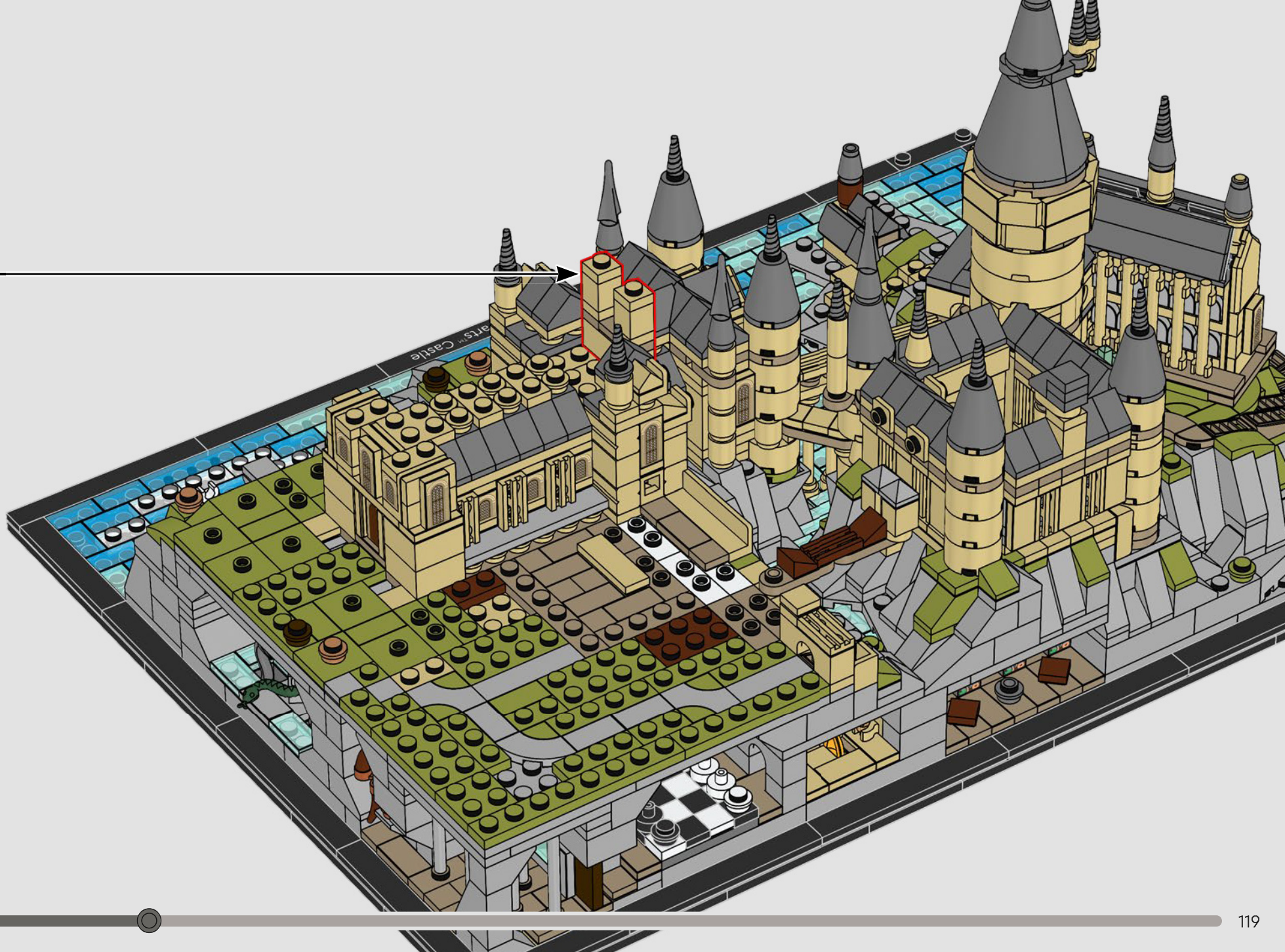

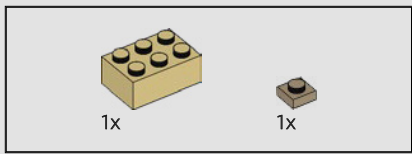

516

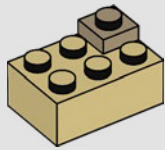

517

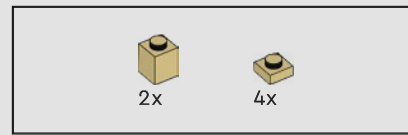
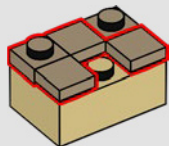

518

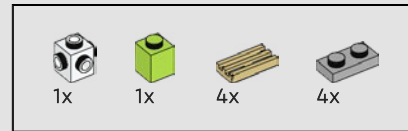
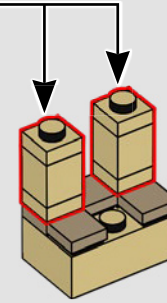
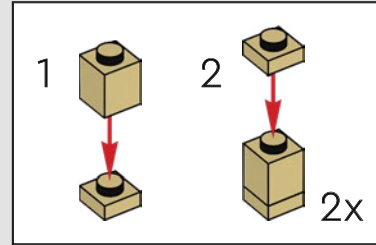

519

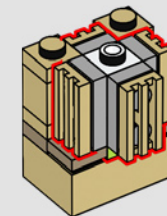
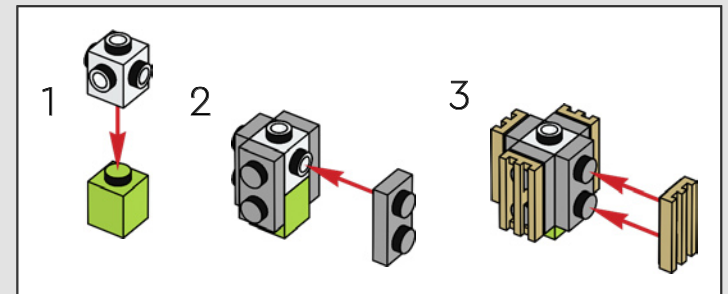

520

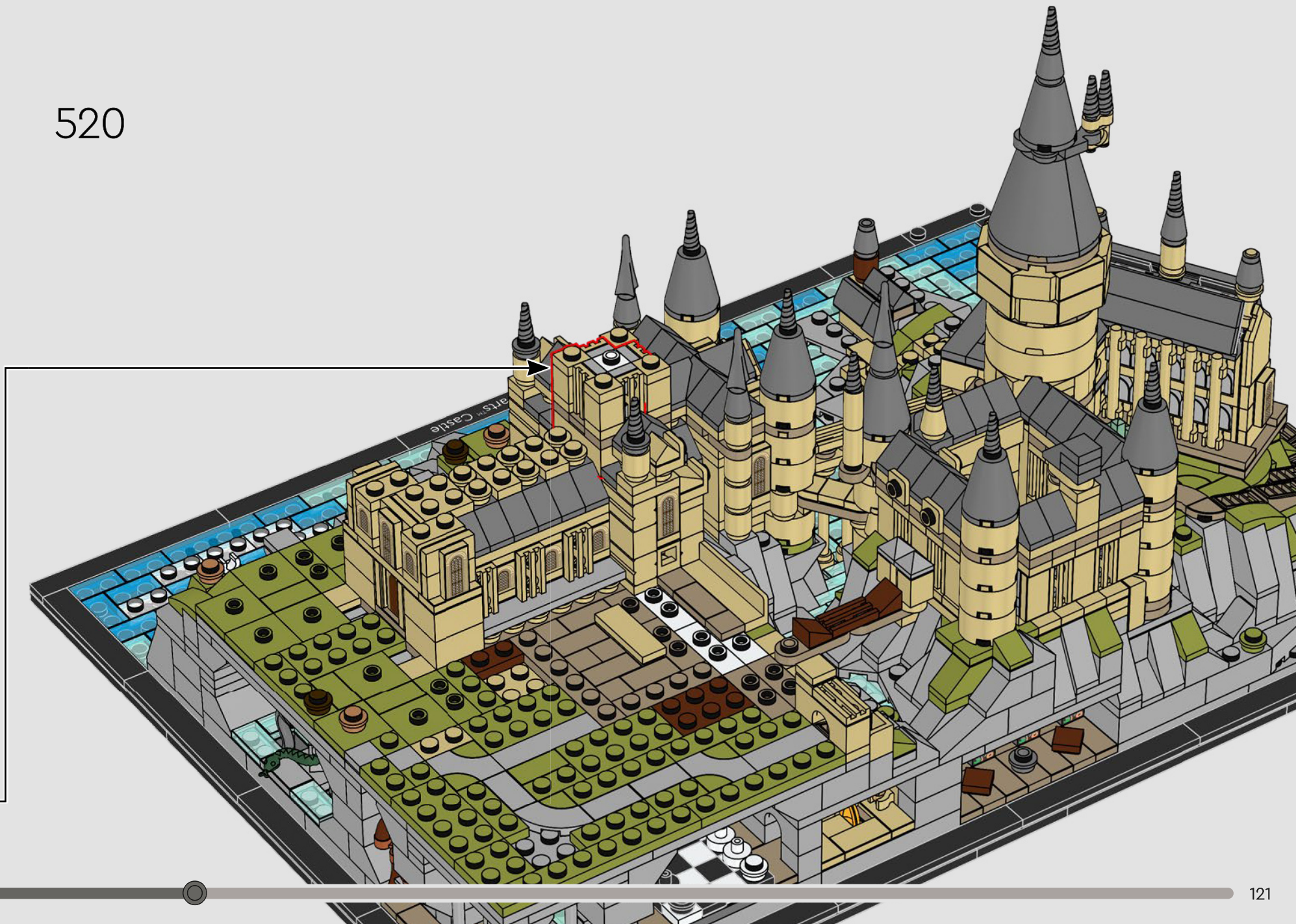

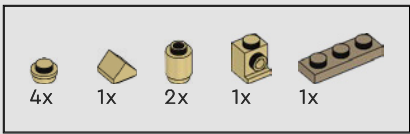

521

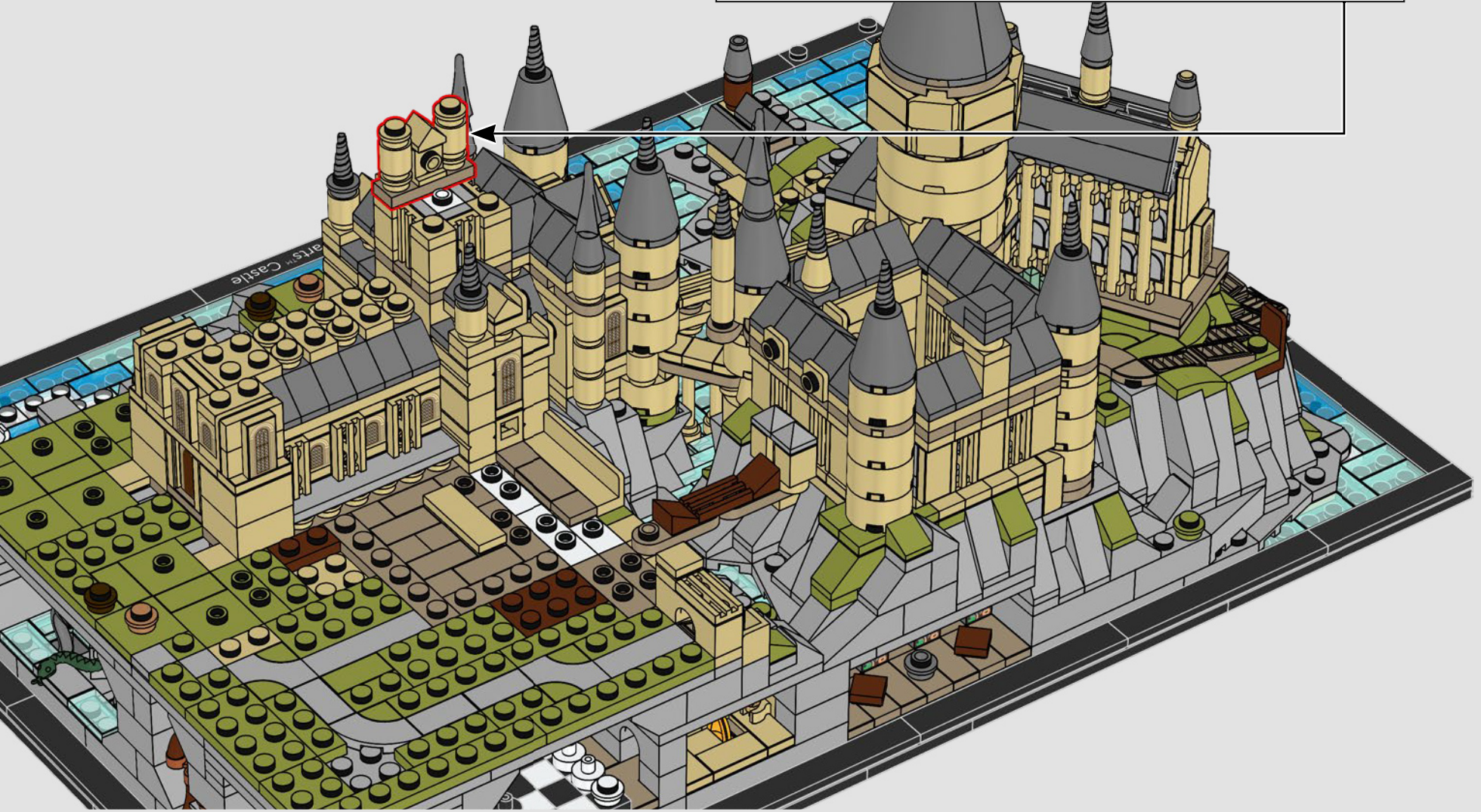
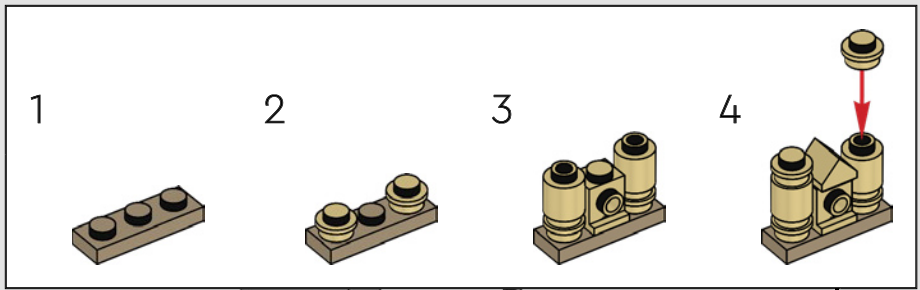

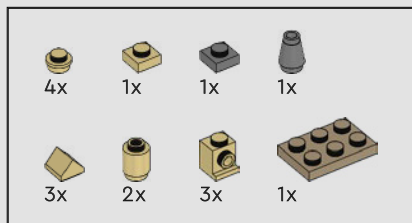

522

1

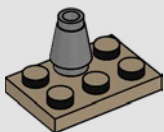

2

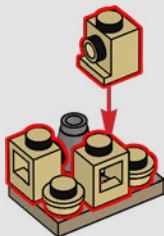

3

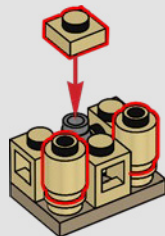

4

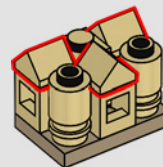

5

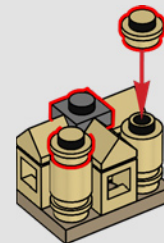

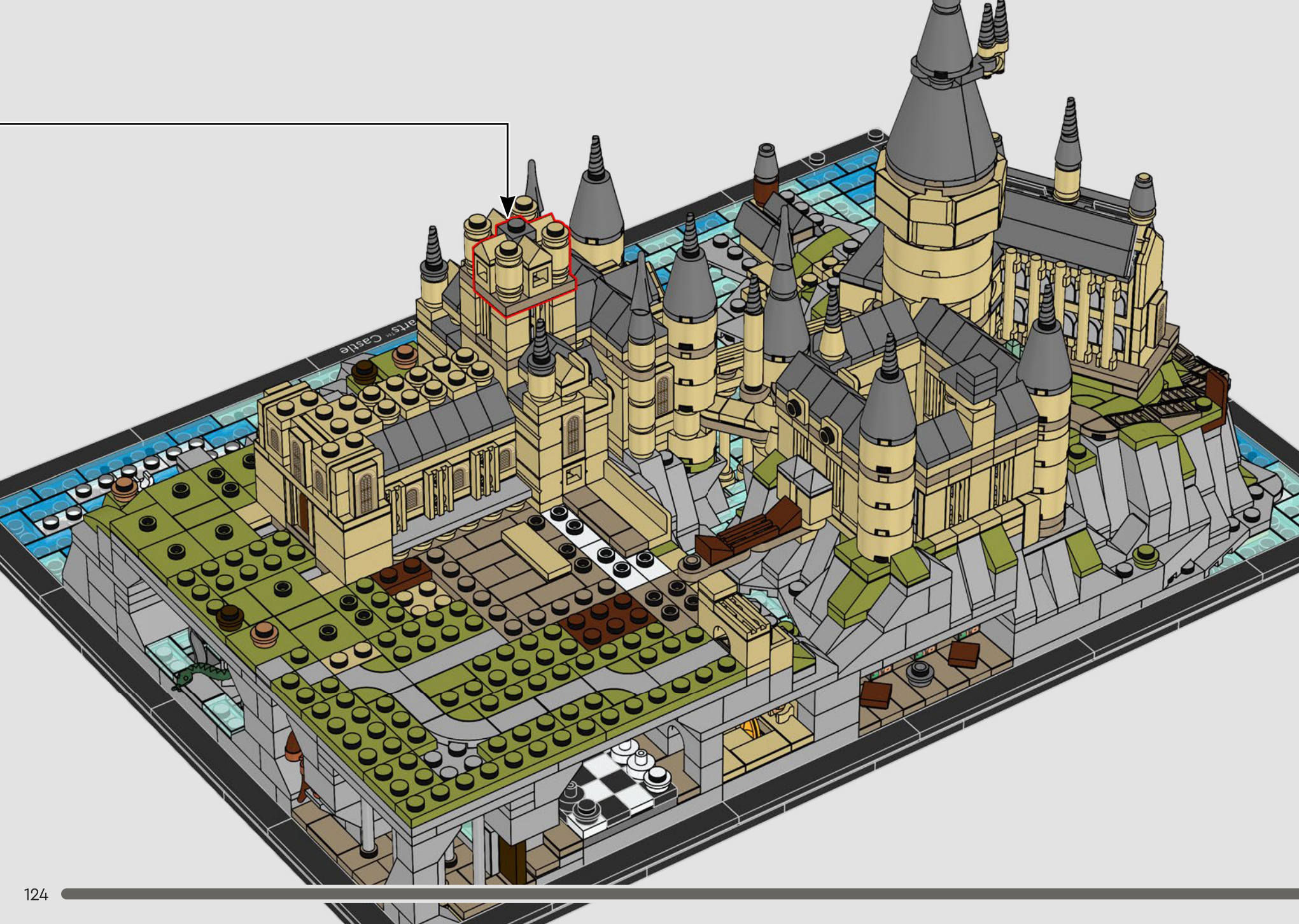

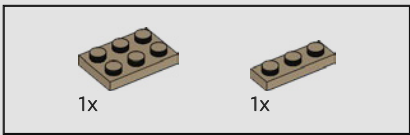

523



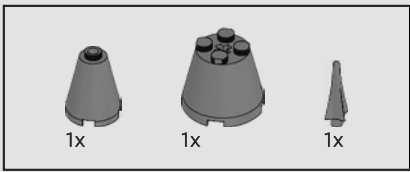

524

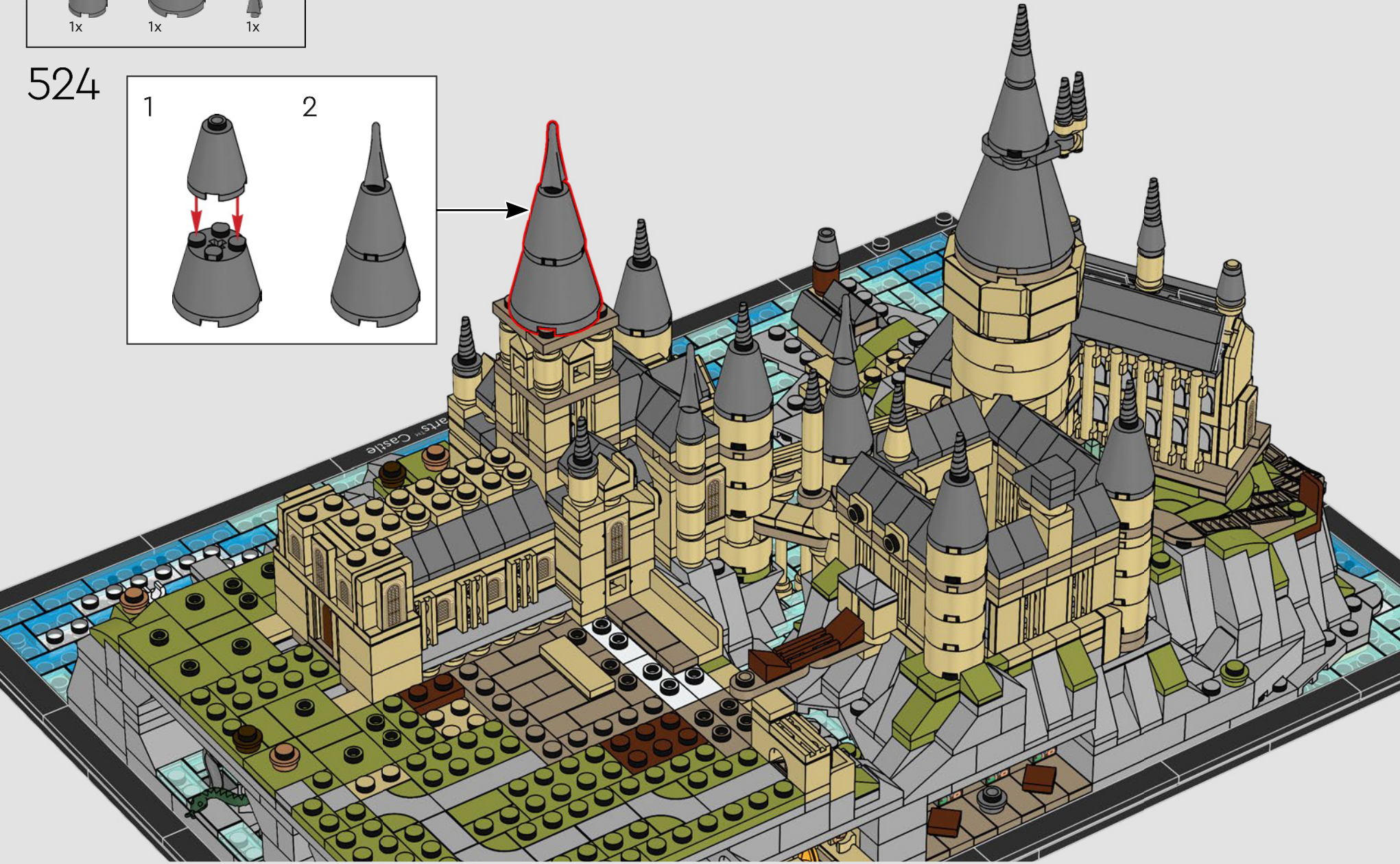
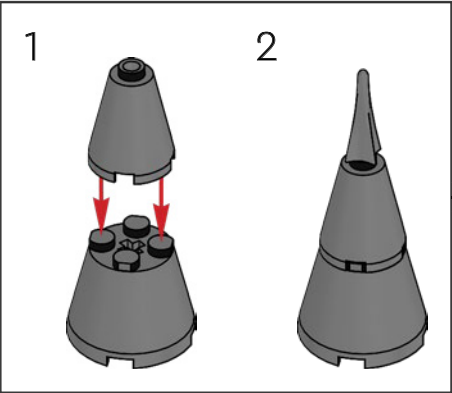

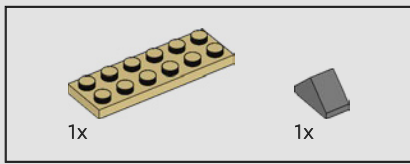

525

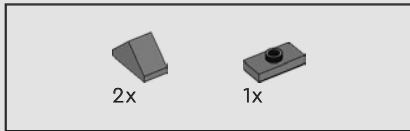
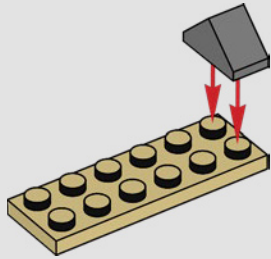

526

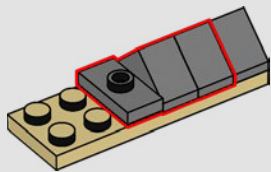

527

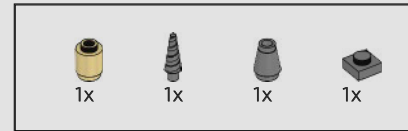
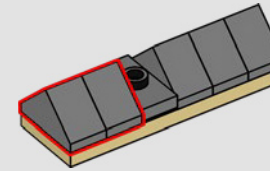

528

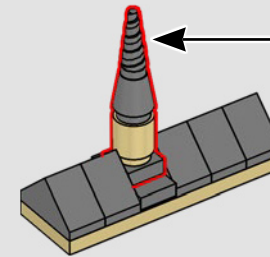
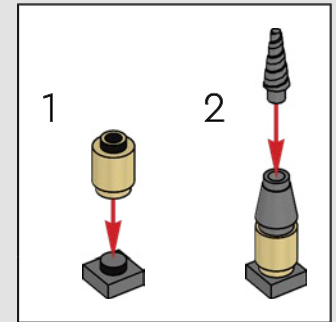

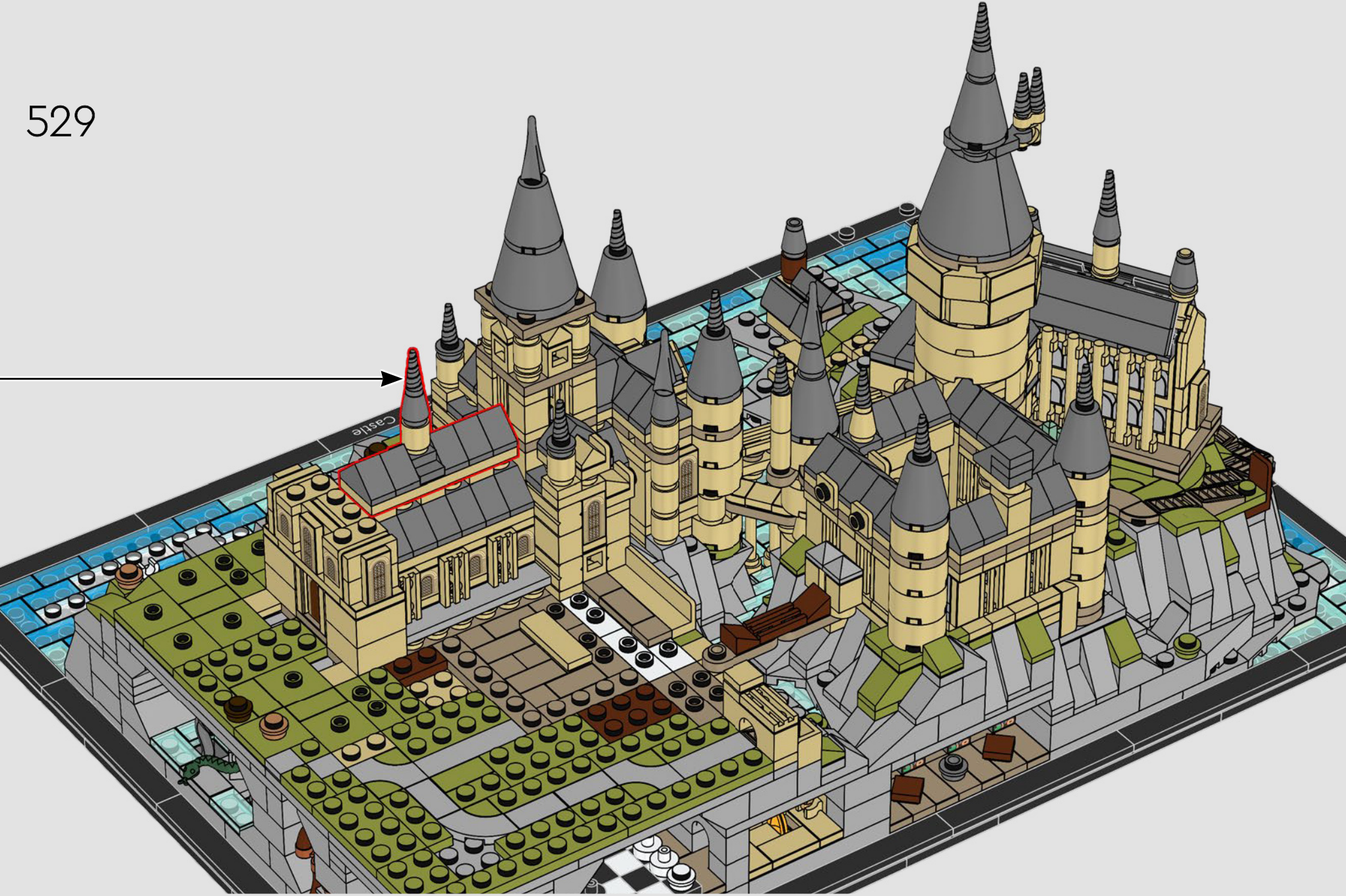

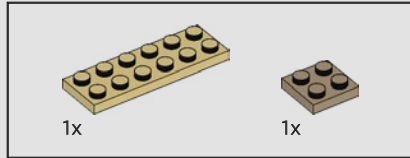
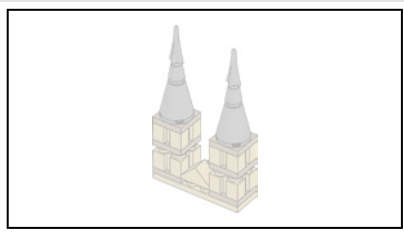

530

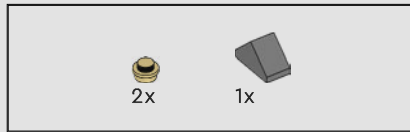
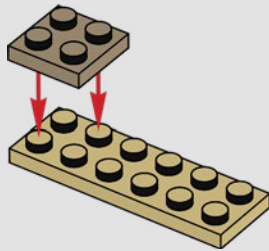

531

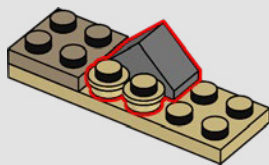

532

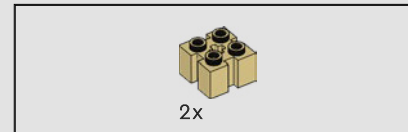
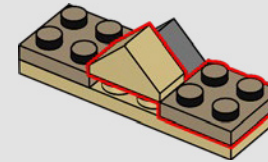

533

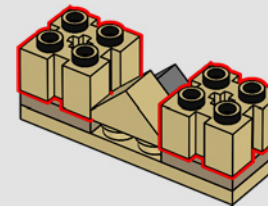



8x

534

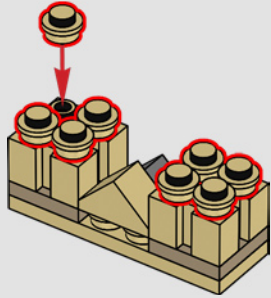

2x

535

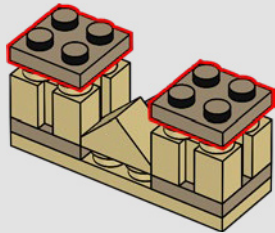

2x

536

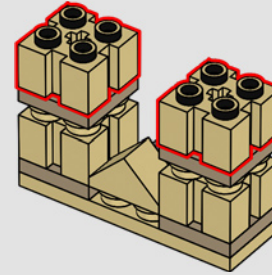

2x

537

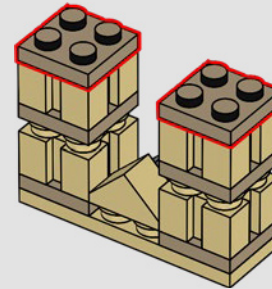

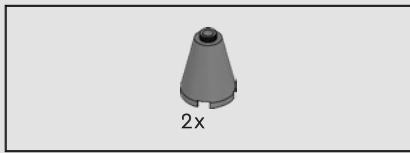

538

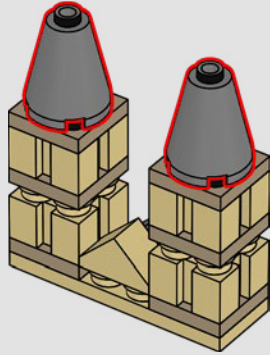

539

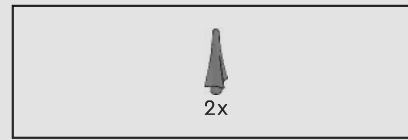
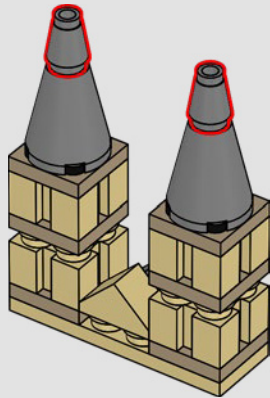

540

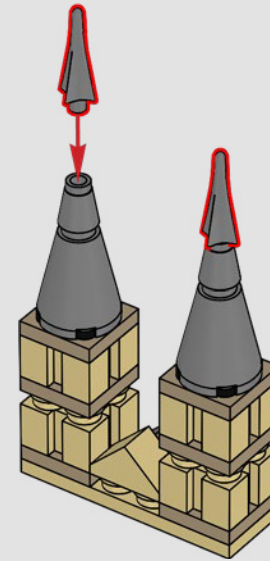



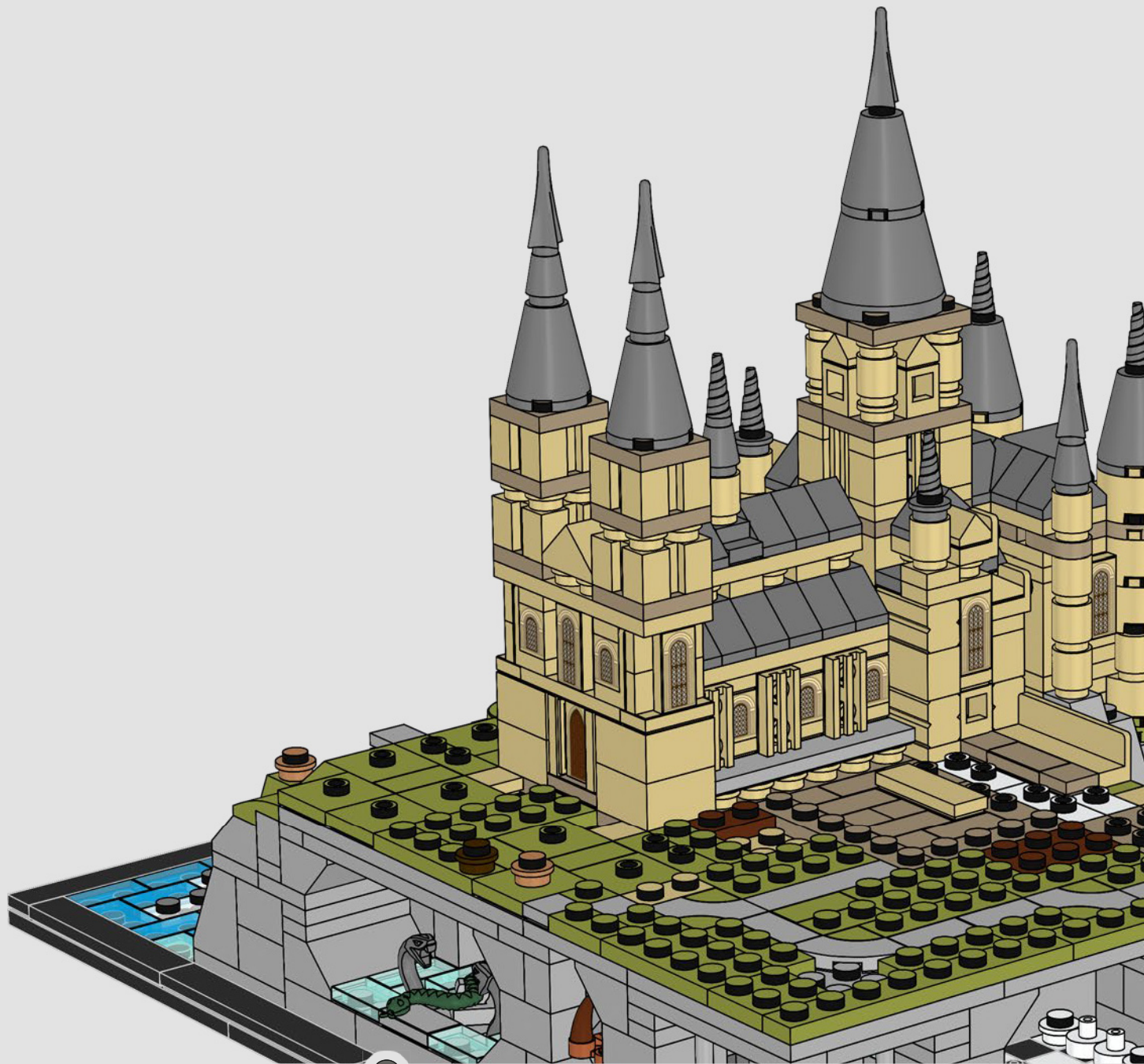

无论霍格沃茨学生最喜欢的科目是什么，他们都可能会在东翼度过大量时间，那里有许多教室。



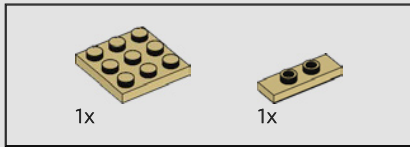
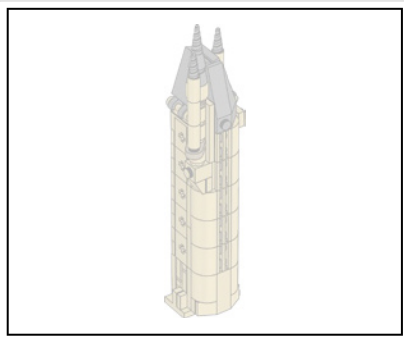

542

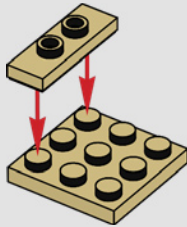

543

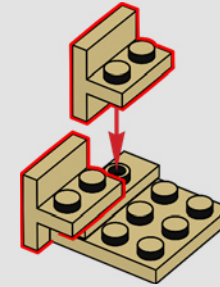

544

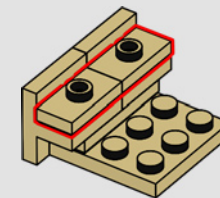



2x

545

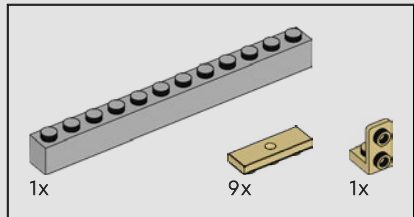
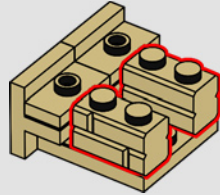

546

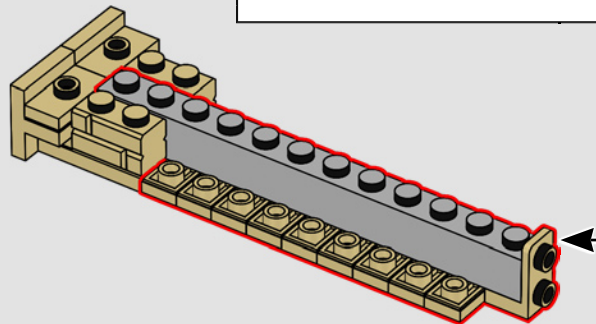
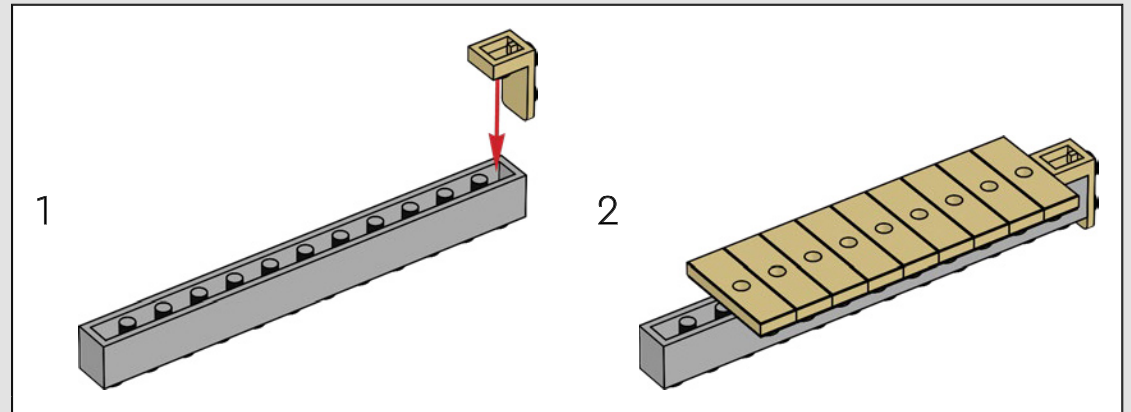

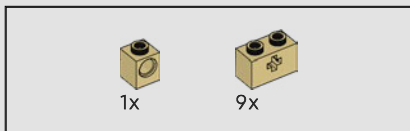

547

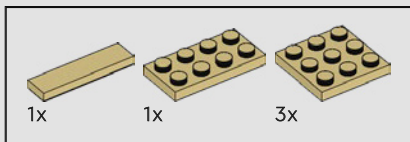
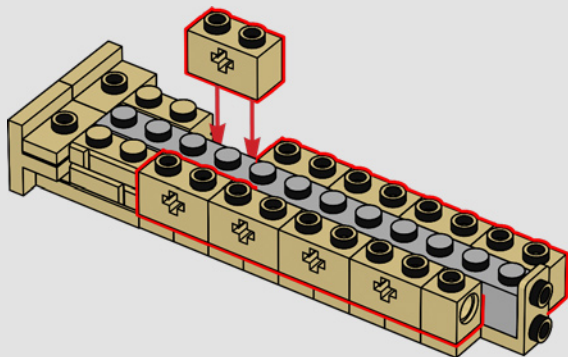

548

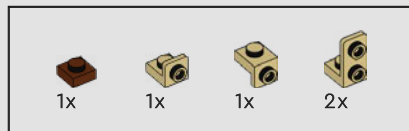
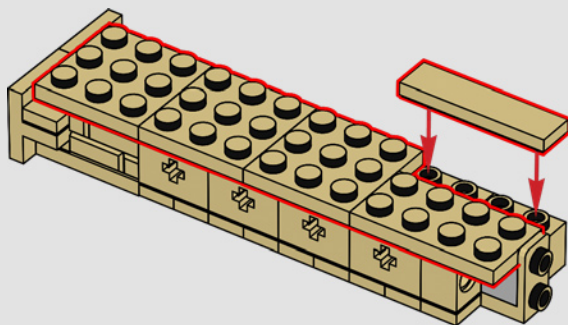

549

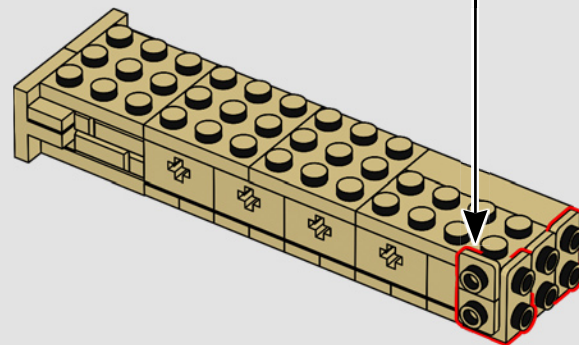
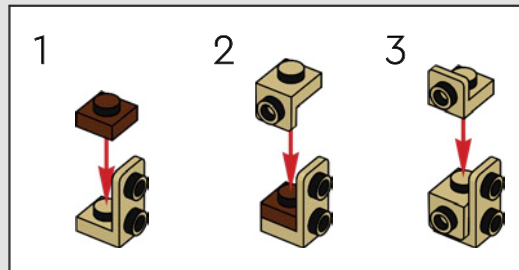

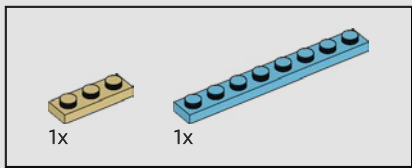

550

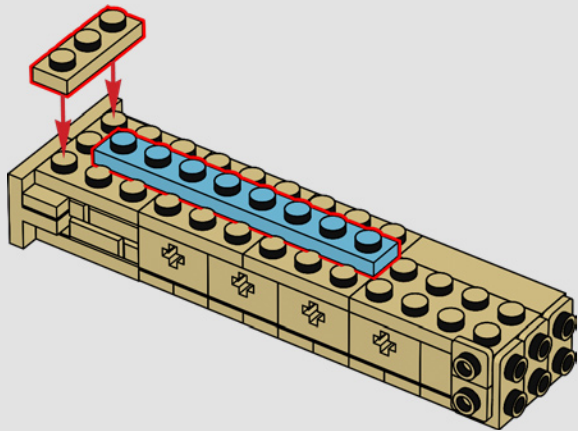

551

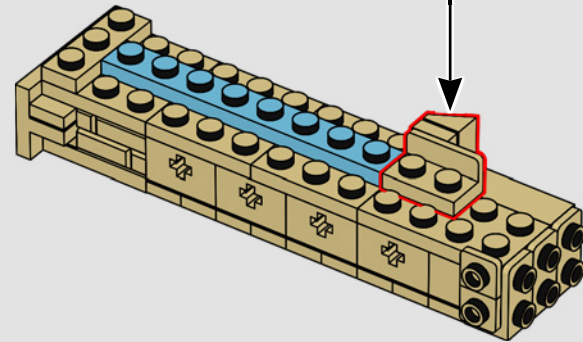
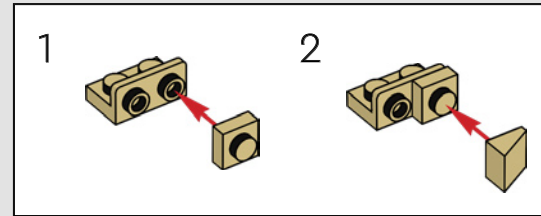

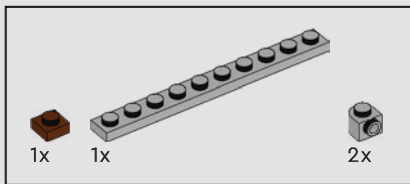

552

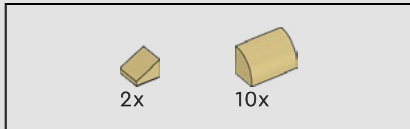
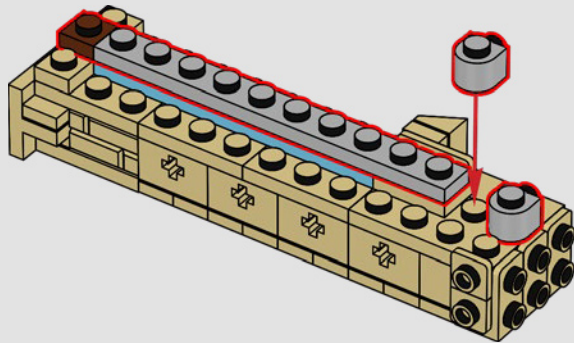

553

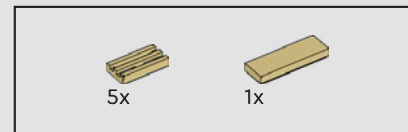
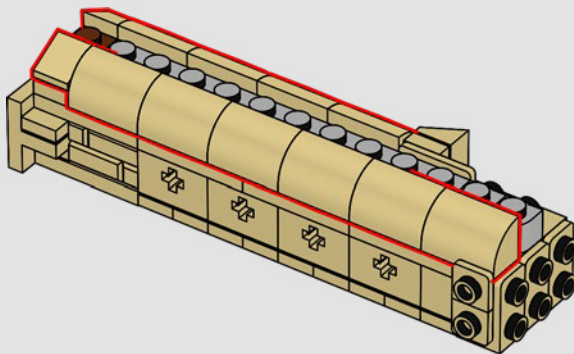

554

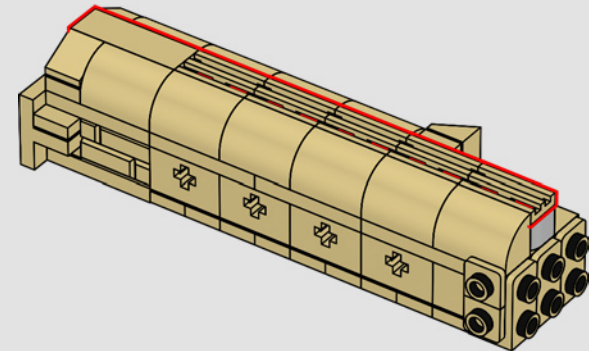



1x

555

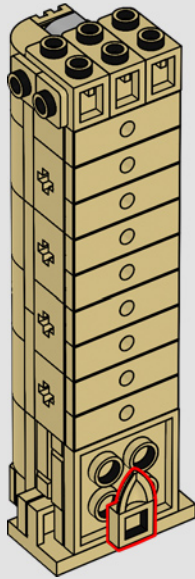

2x

556

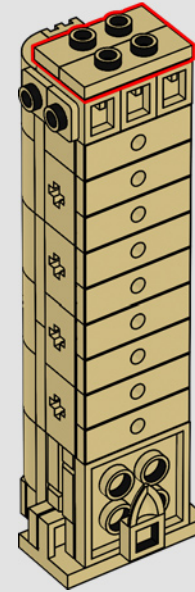

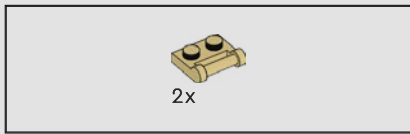

557

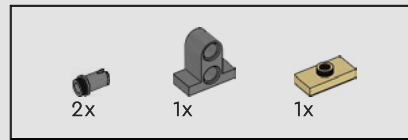
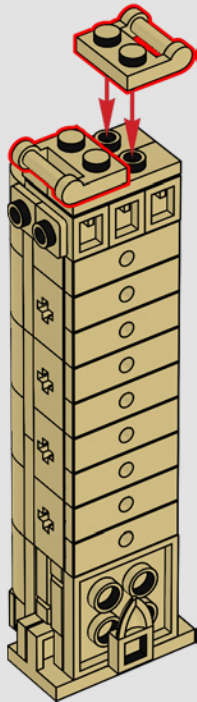

558

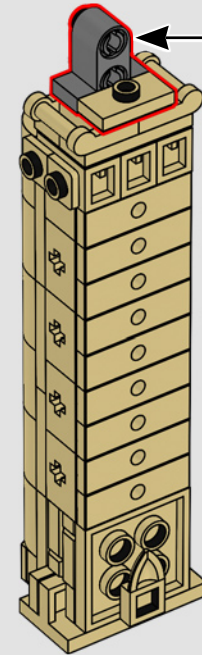
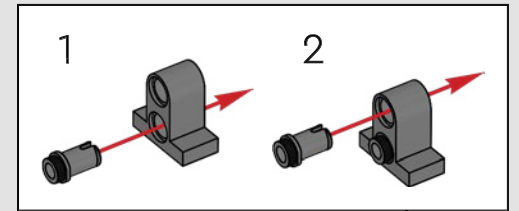



559

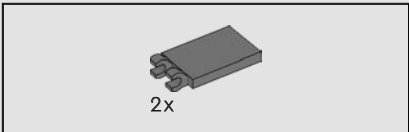

560

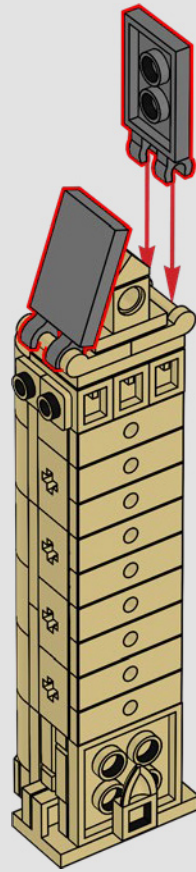



561

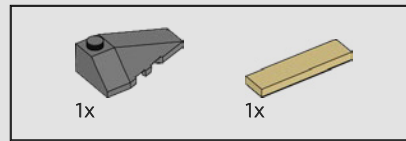
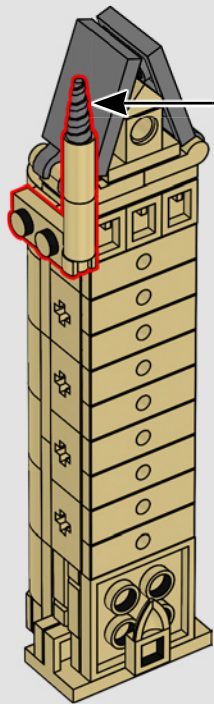
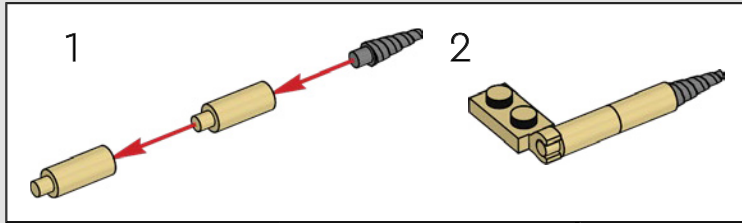

562

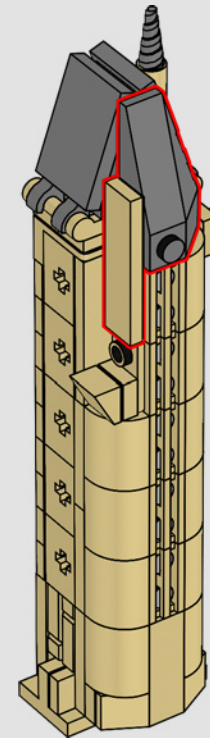
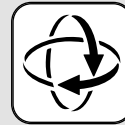

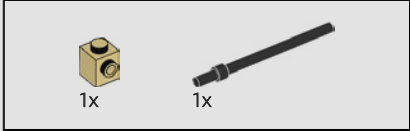
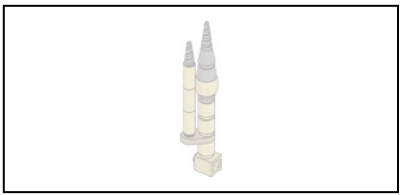

563

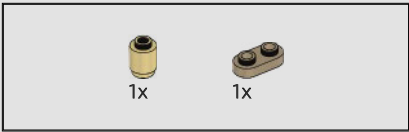

564



565





566

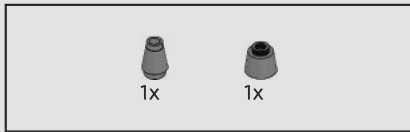

567

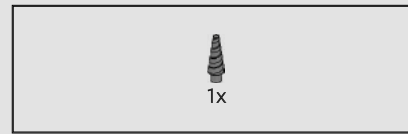
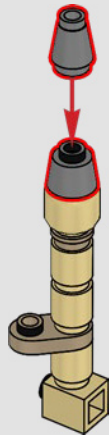

568

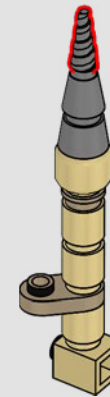

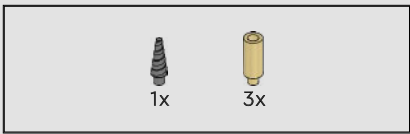

569

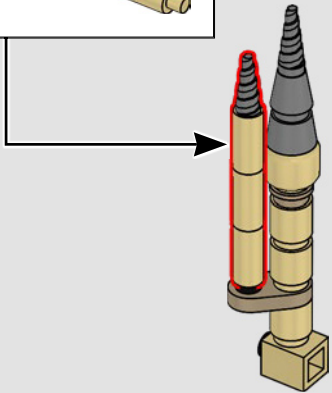
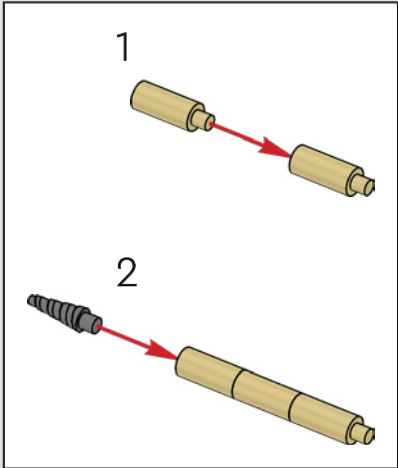

570

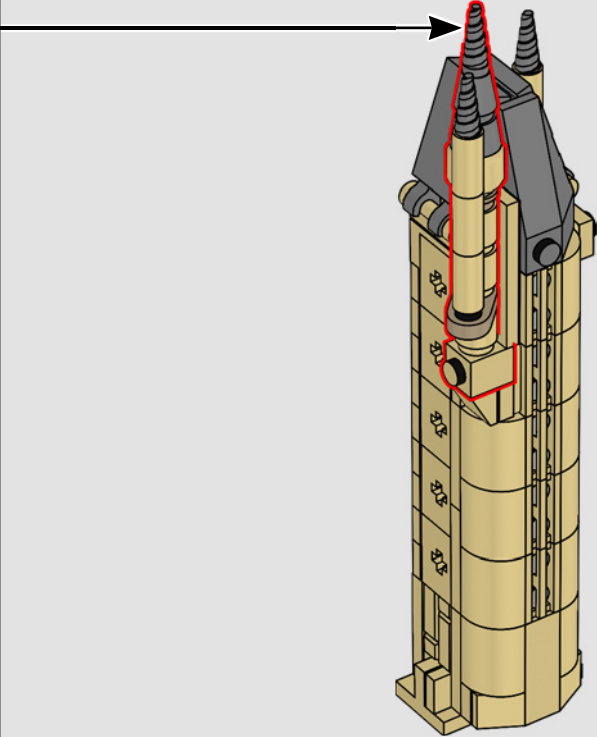

571



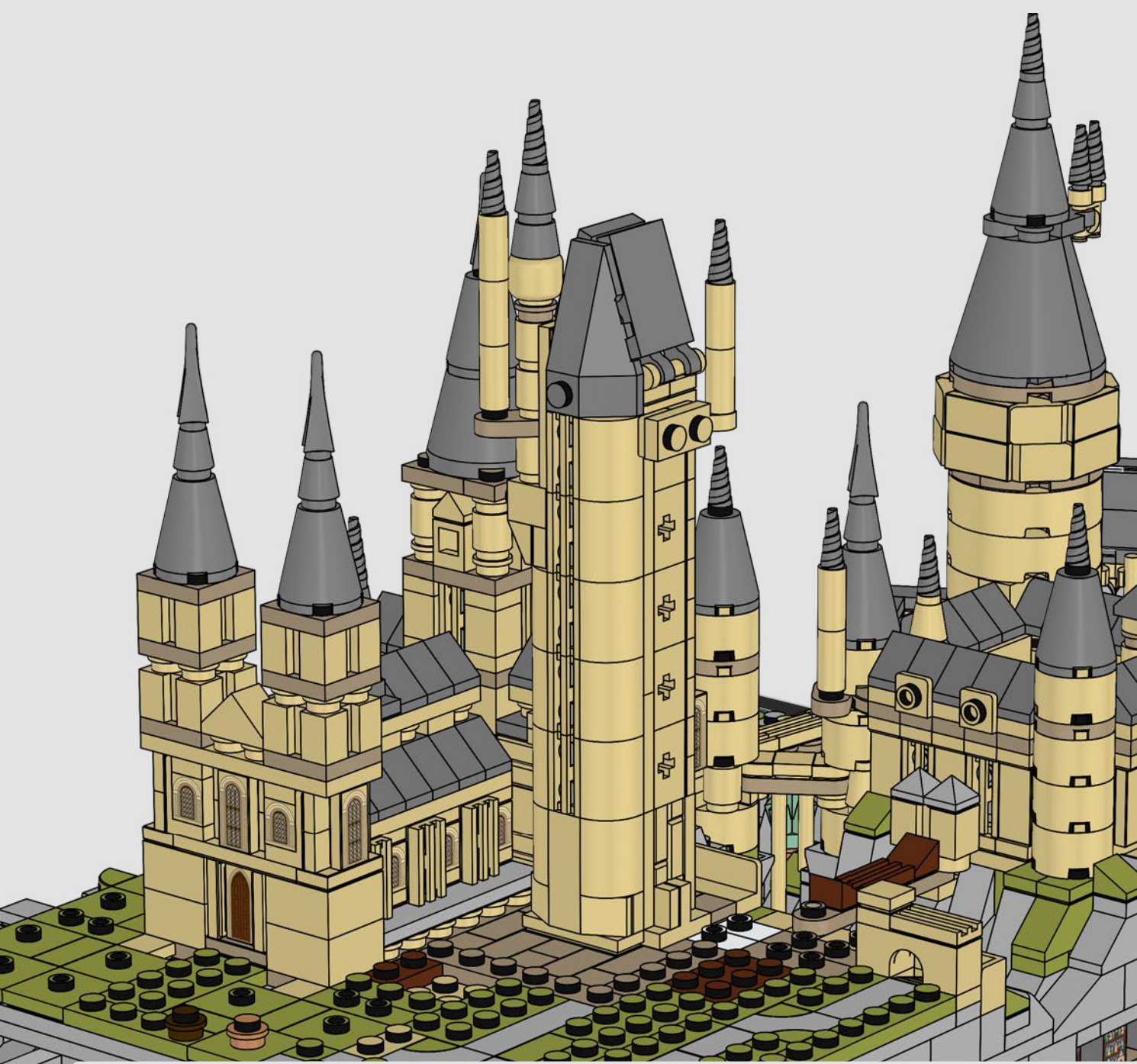

你可能会认为主塔是霍格沃茨城堡的最高点——但实际上是天文塔。





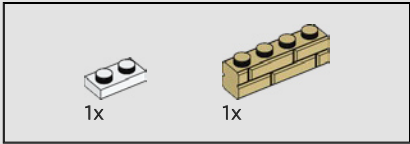
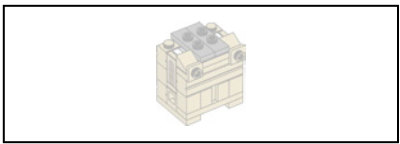

572

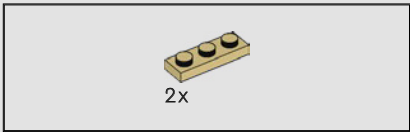
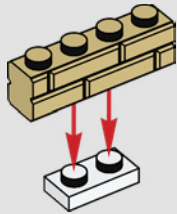

573

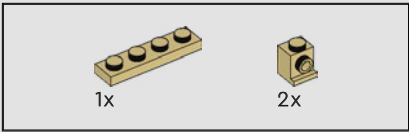
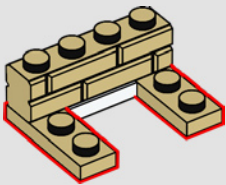

574

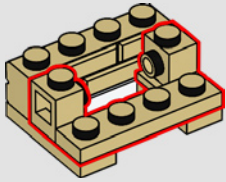

575

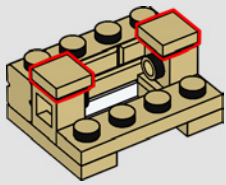

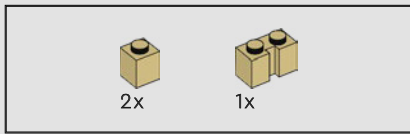

576

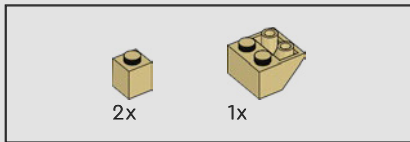
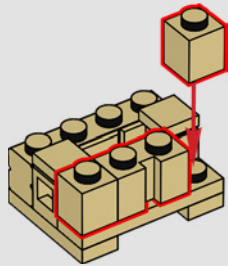

577

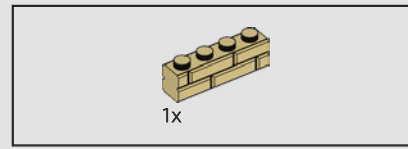
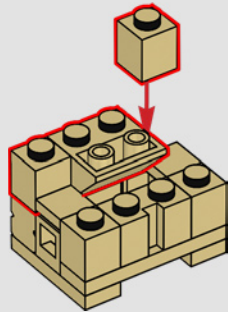

578

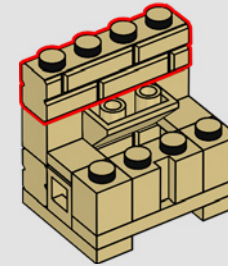

579

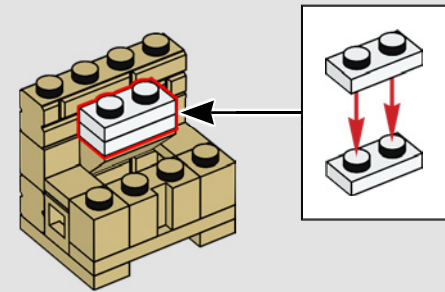

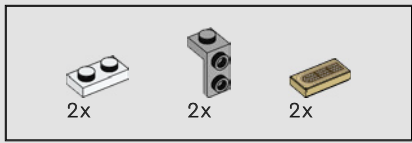

580

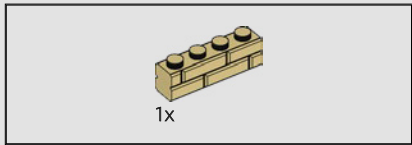
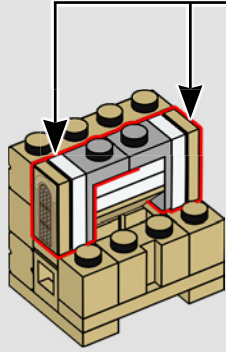
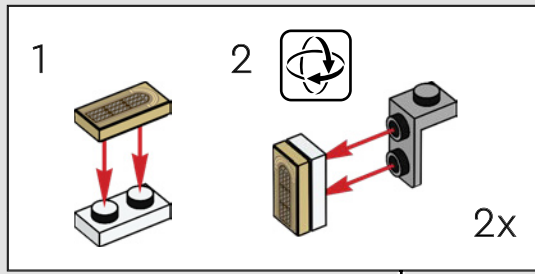

581

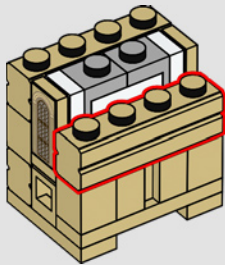

582

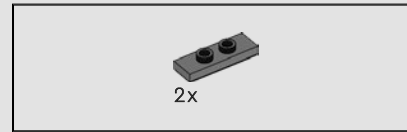
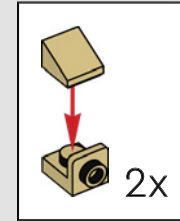
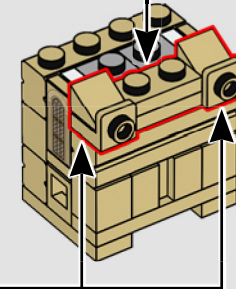
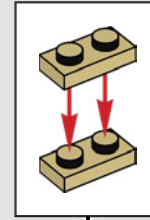

583

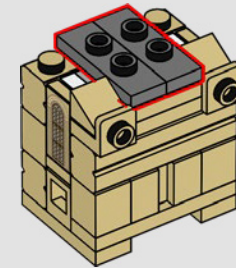

584

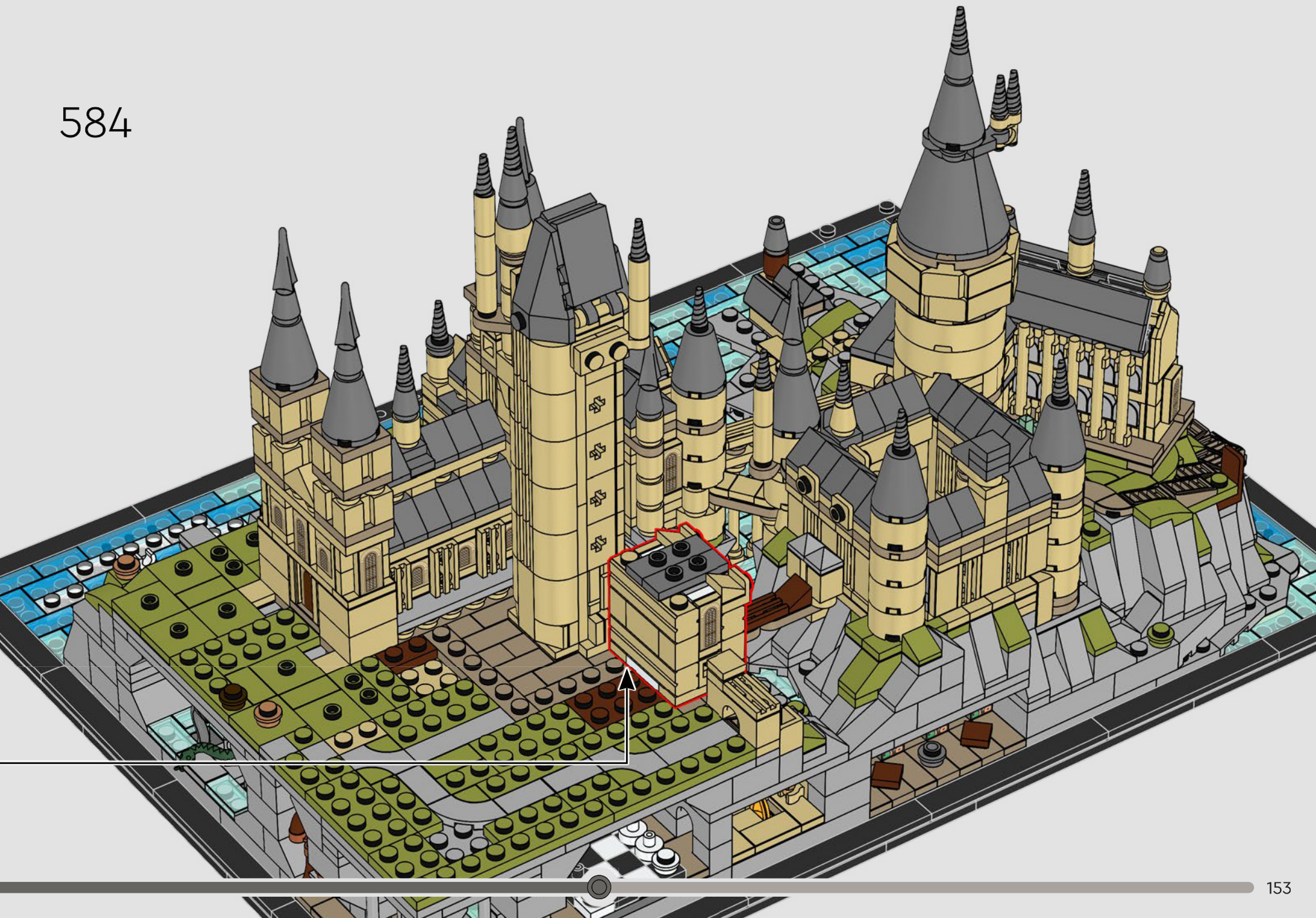

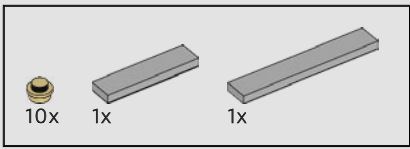

585

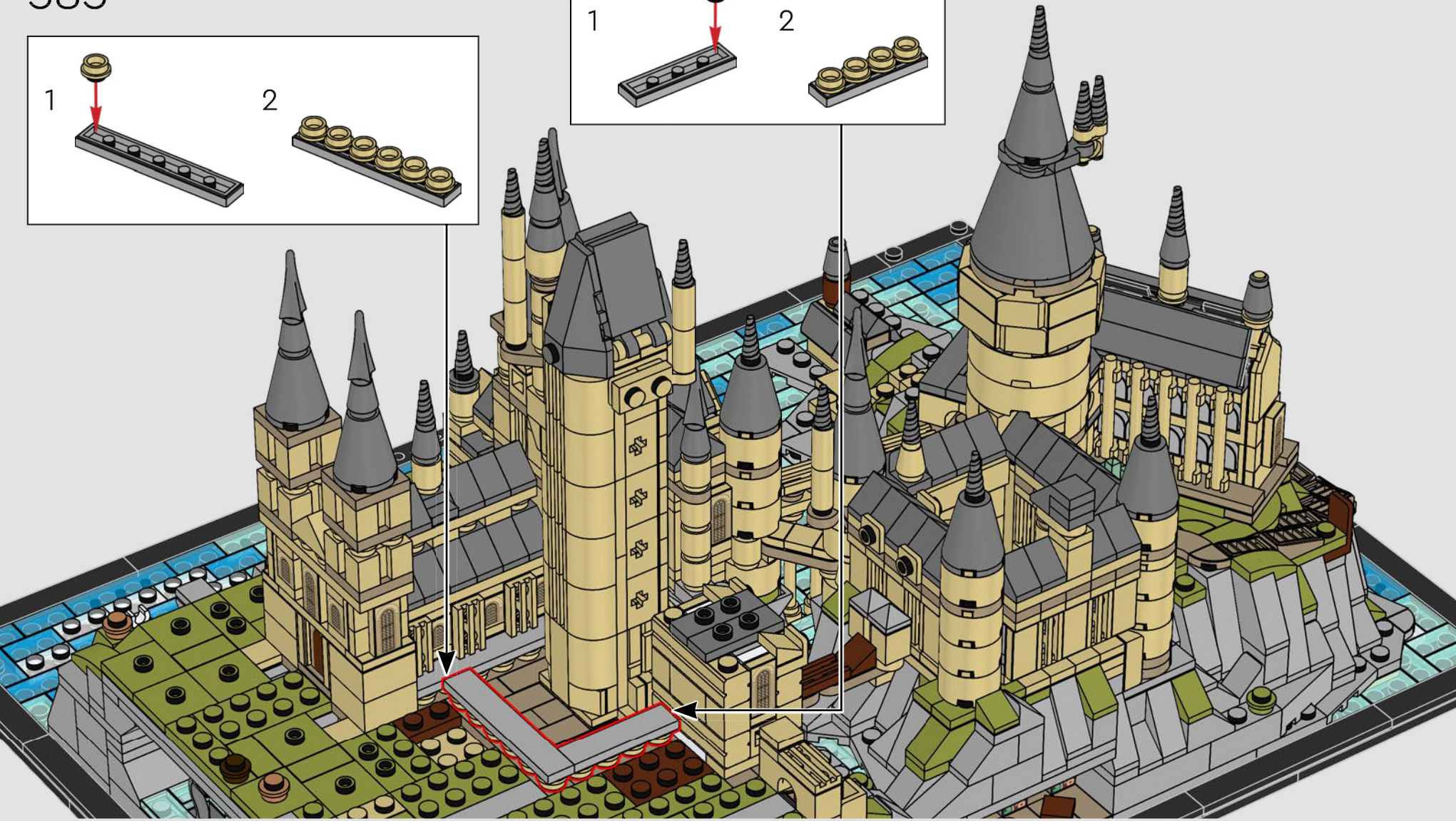
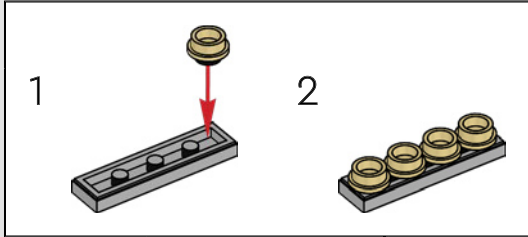
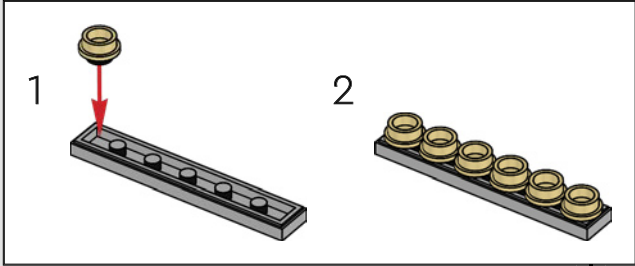

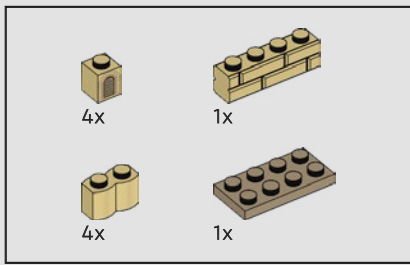

586

1

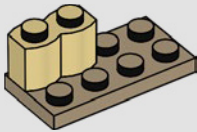

2

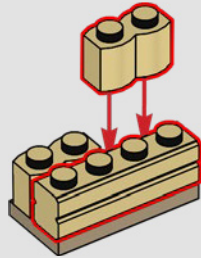

3

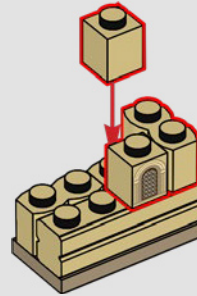

4

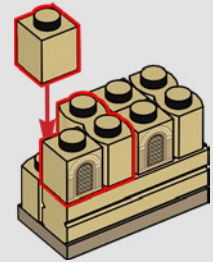





587



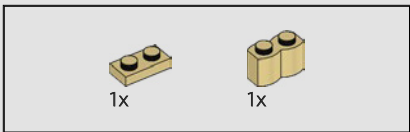

588

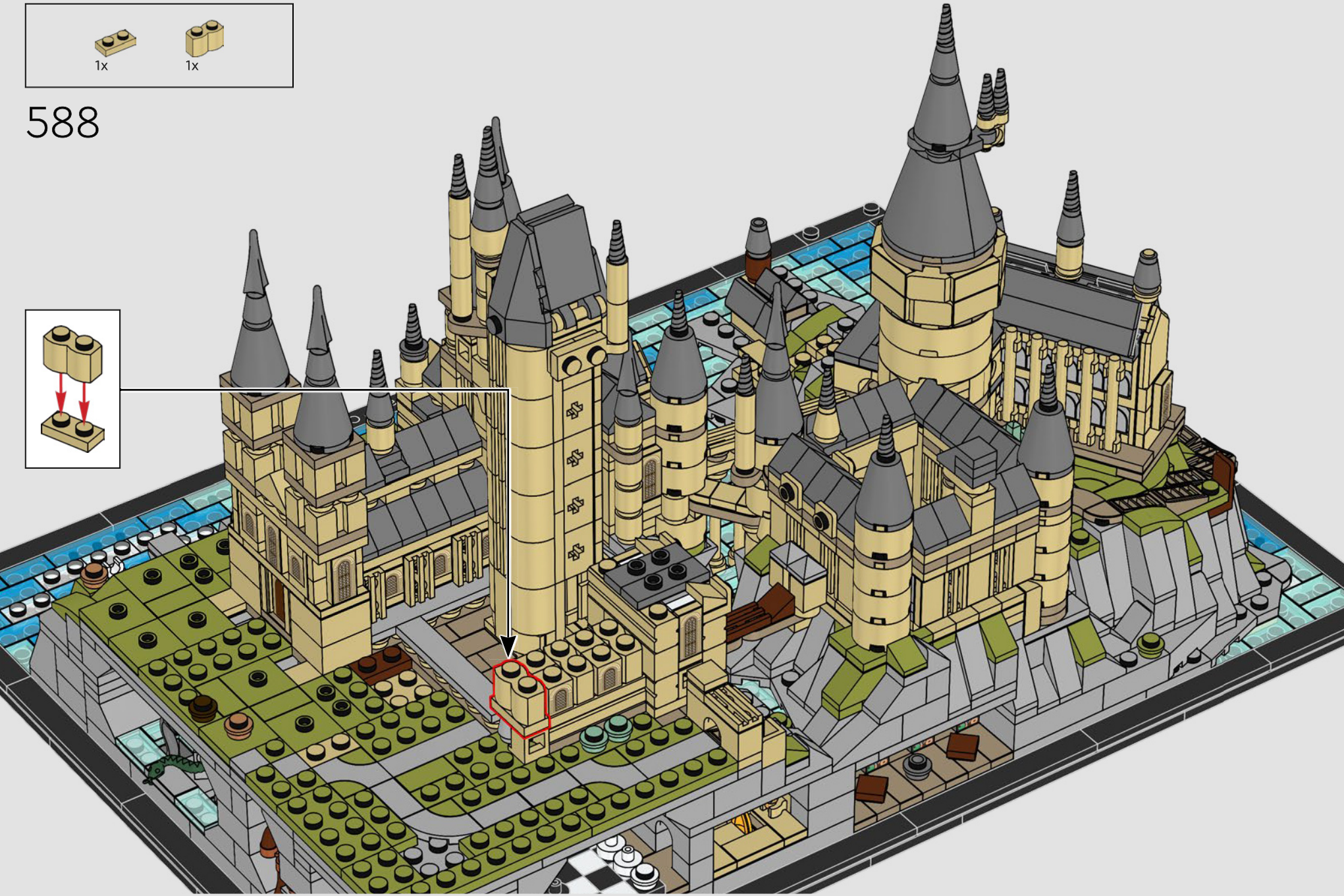
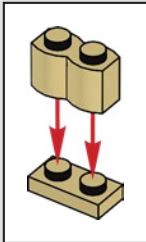

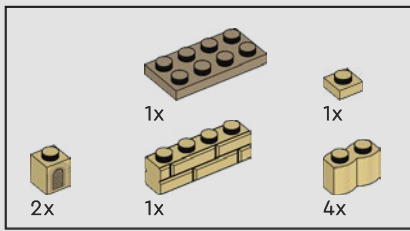

589

1

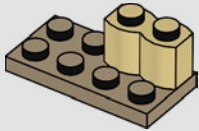

2

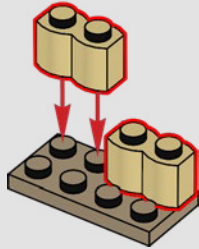

3

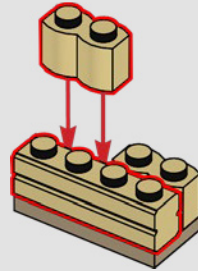

4

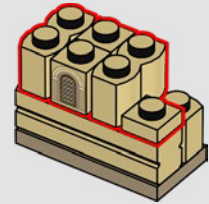

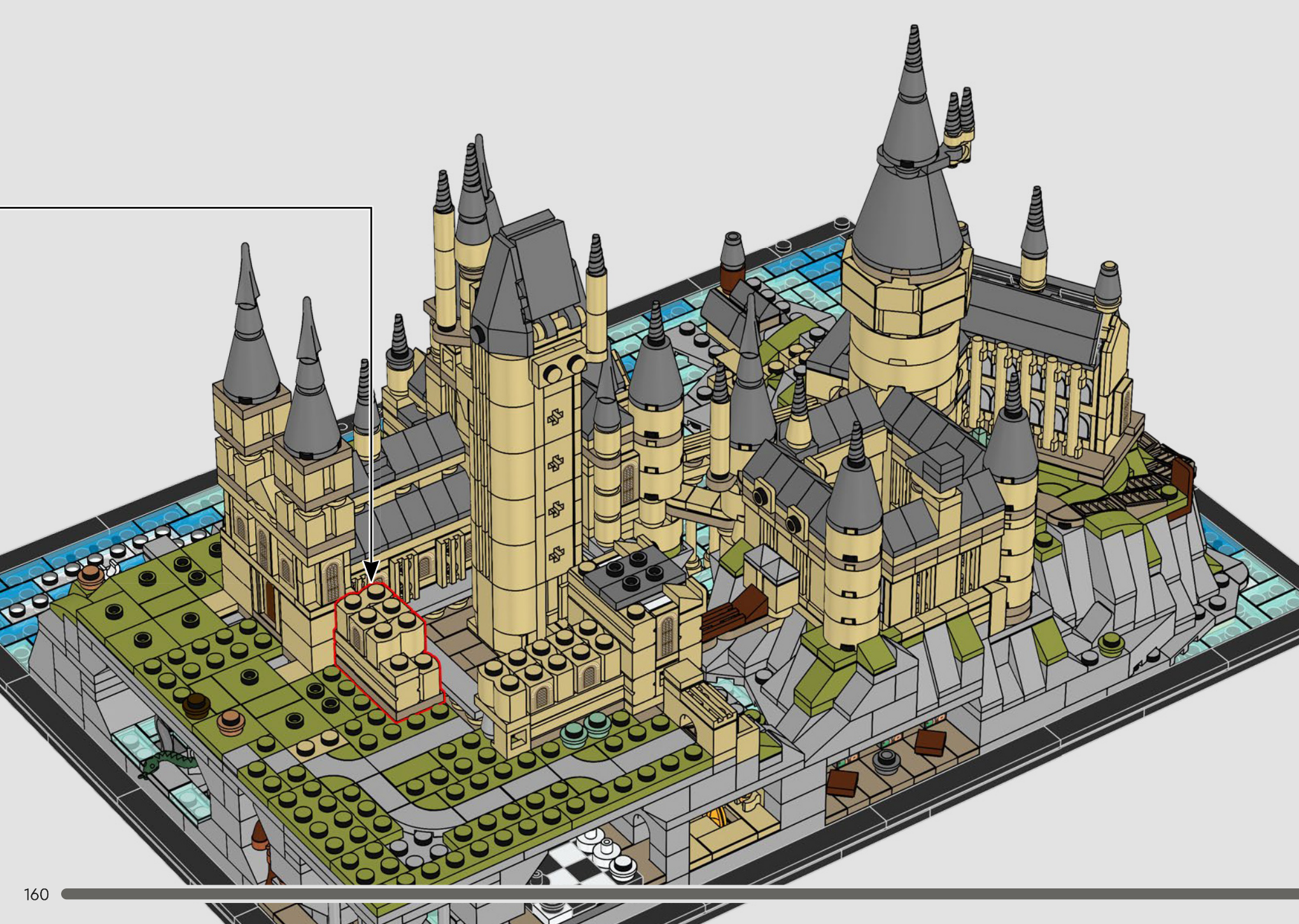

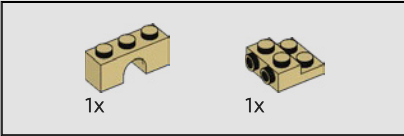
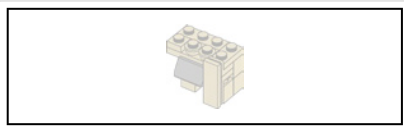

590

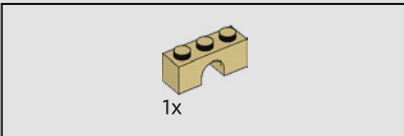
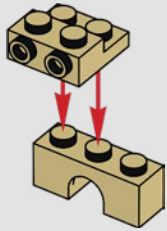

591

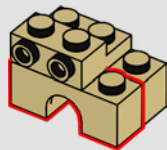

592

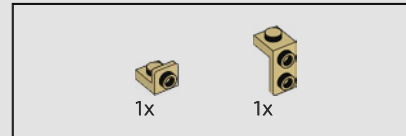
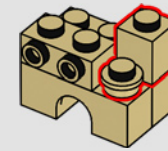

593

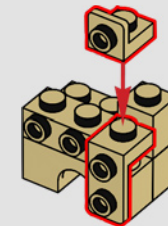

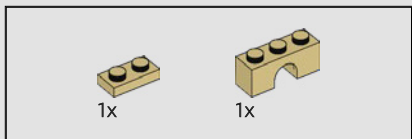

594

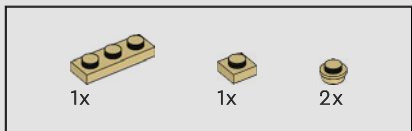
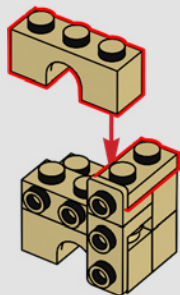

595

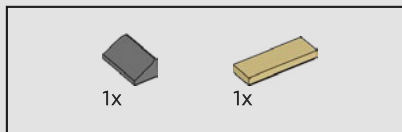
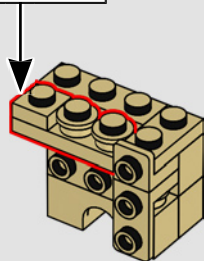
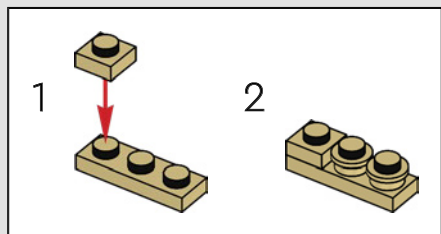

596

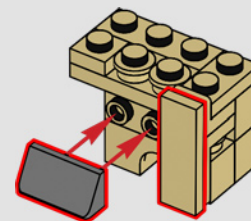

597



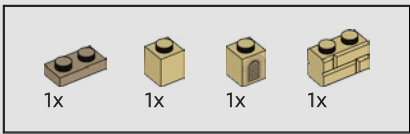

598

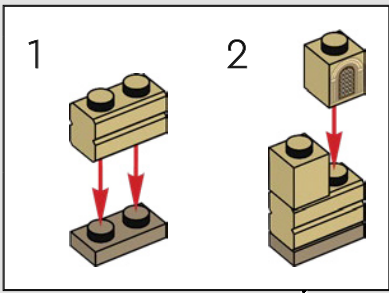

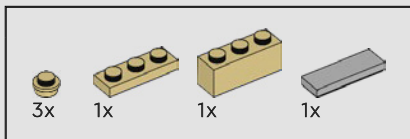

599

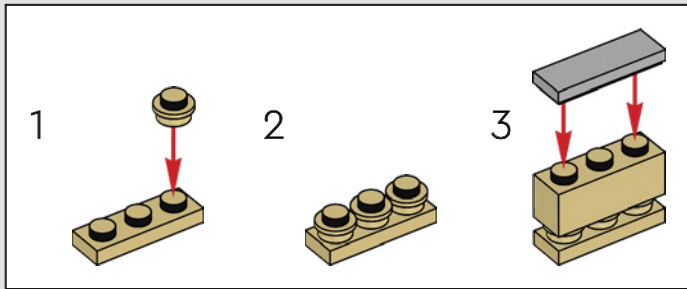

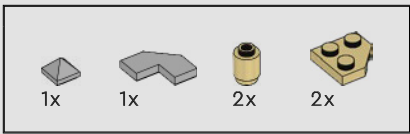

600

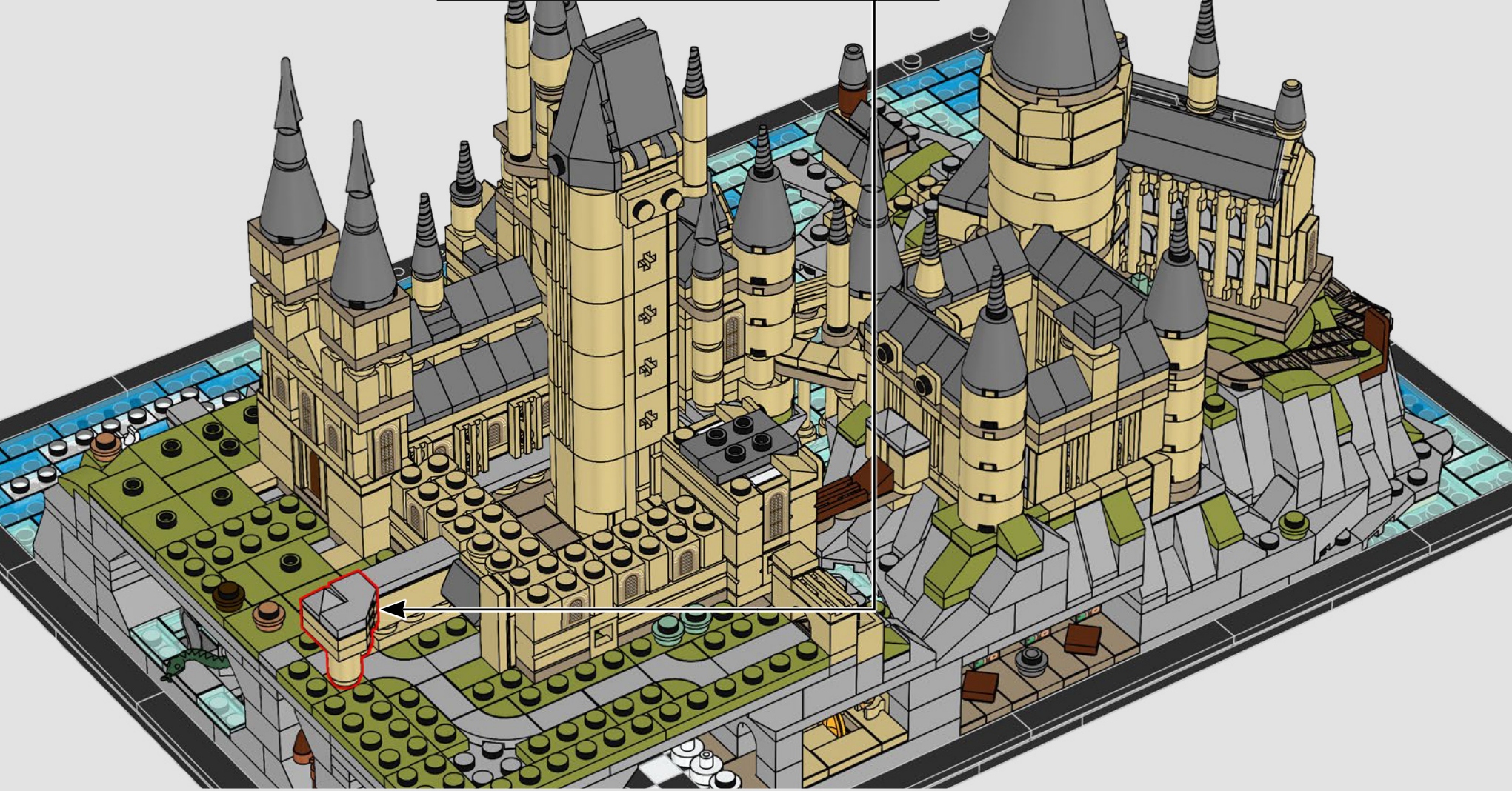
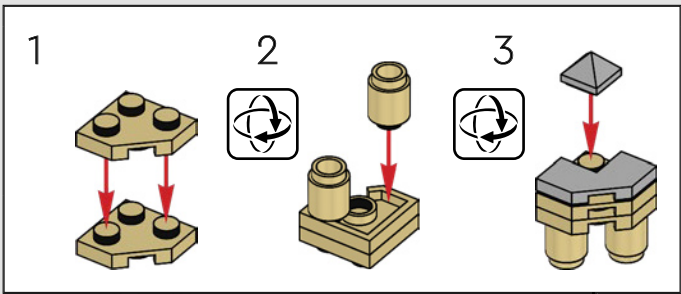

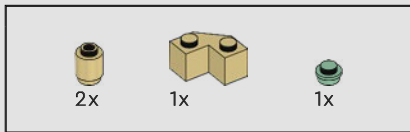

601

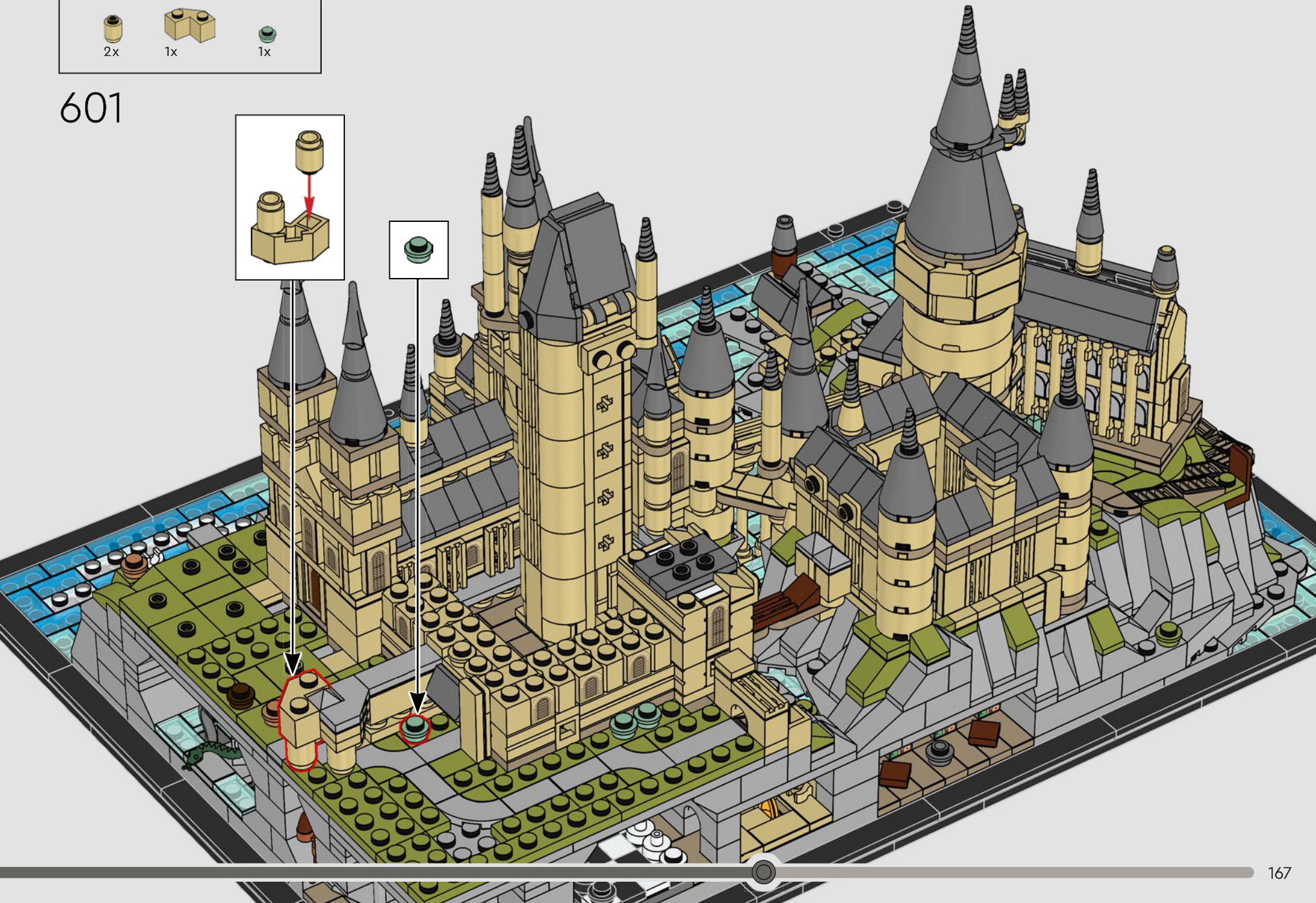
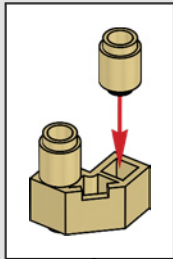



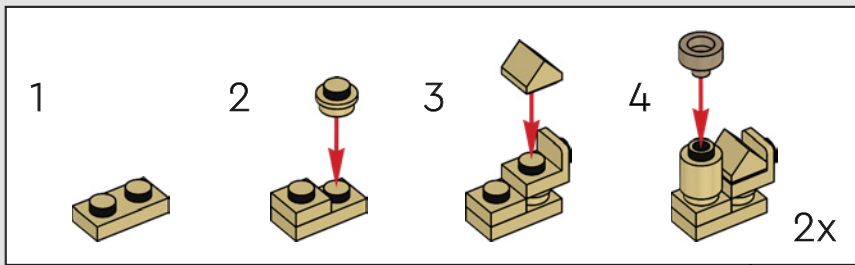
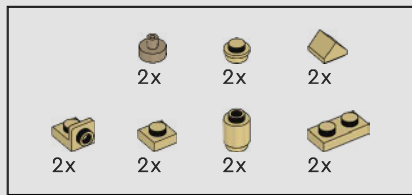

602

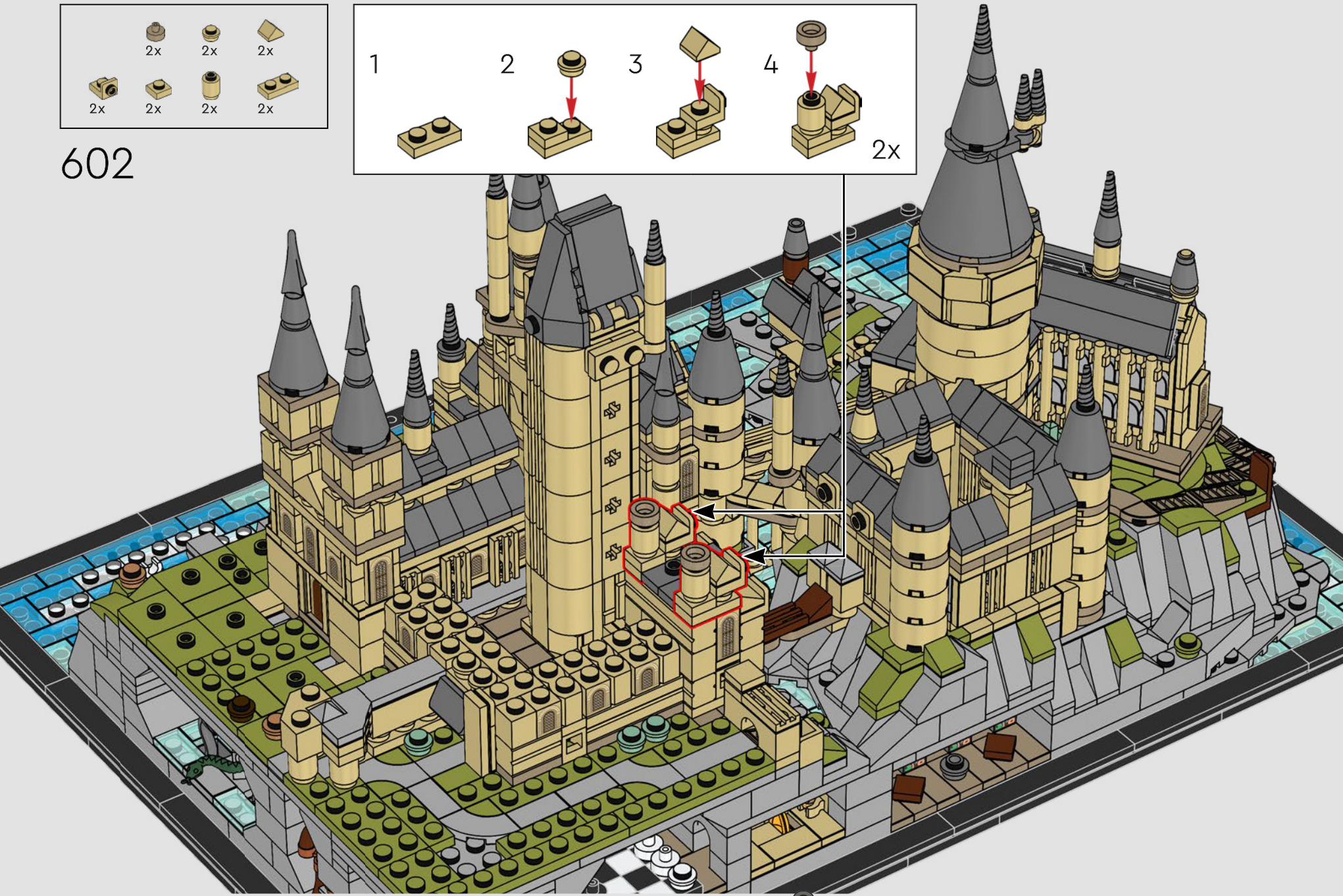

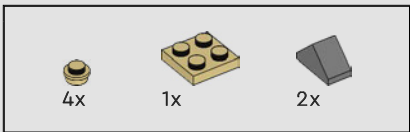

603

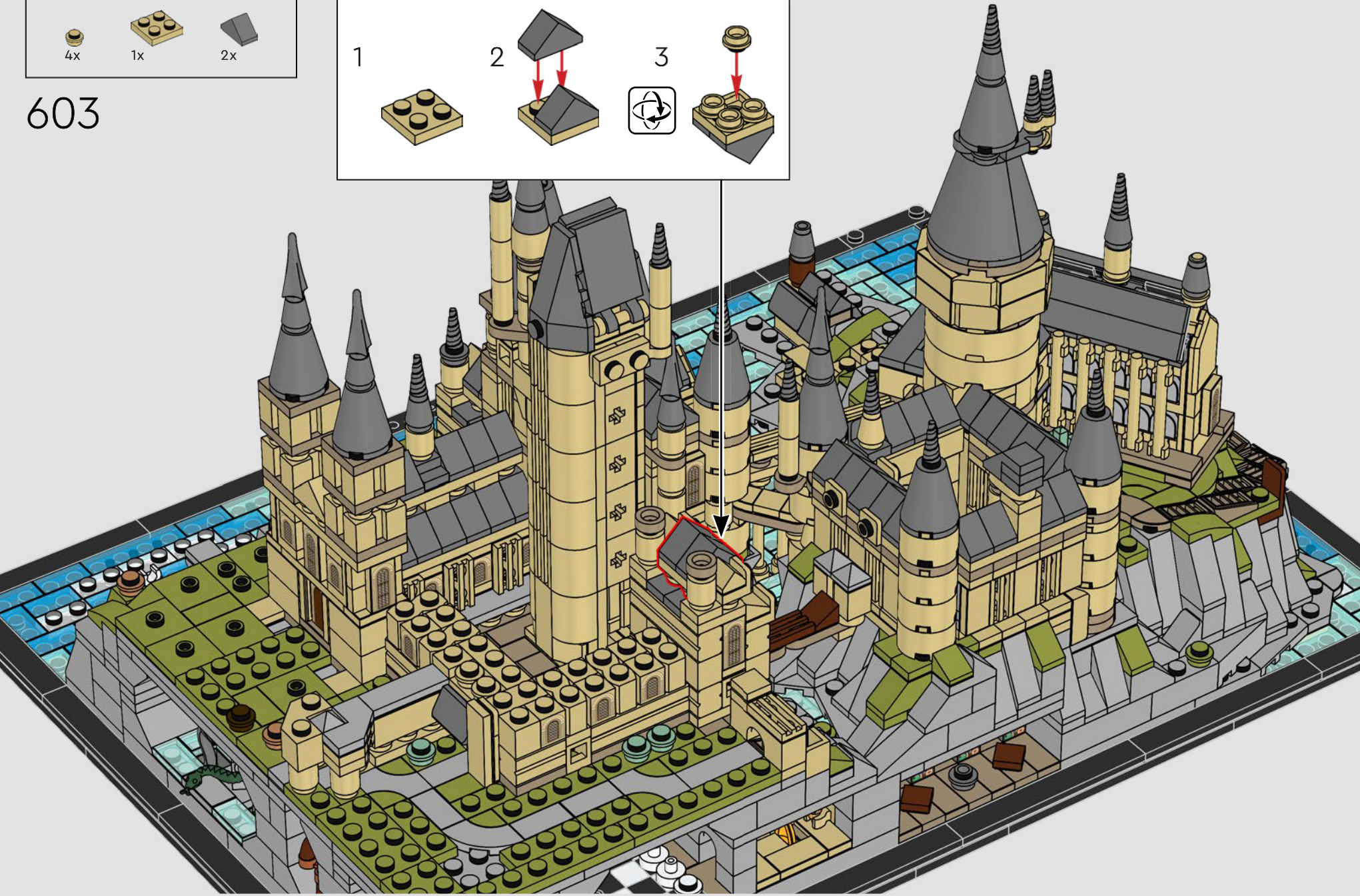
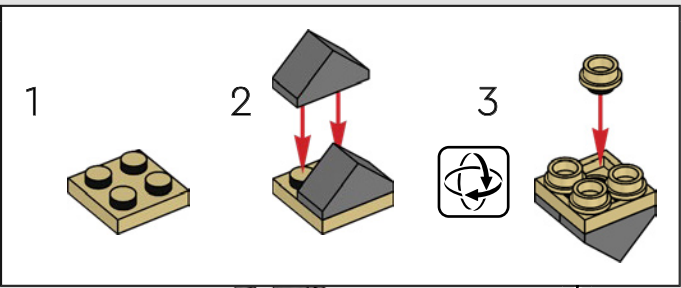

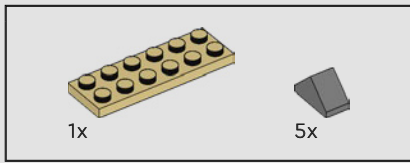

604

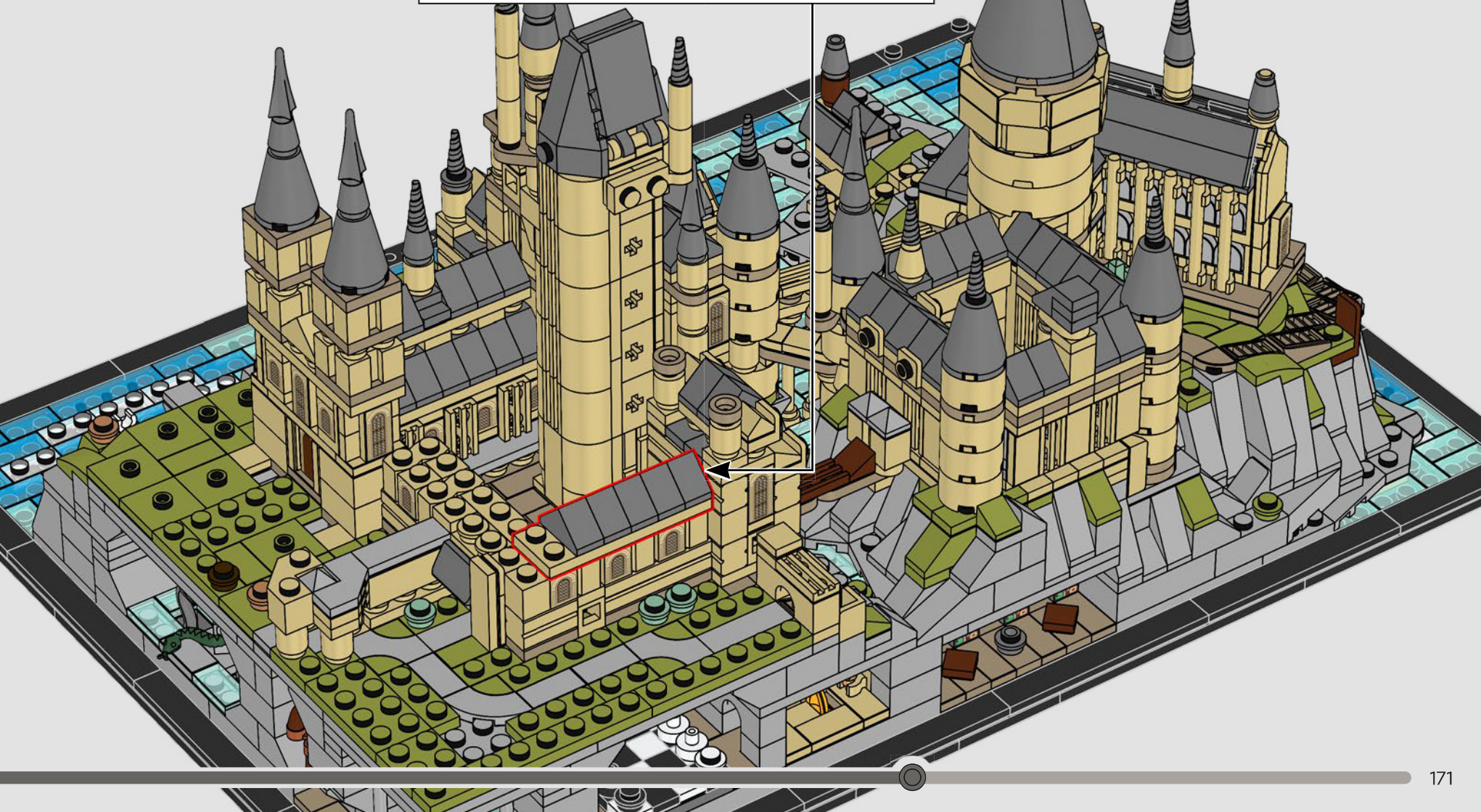
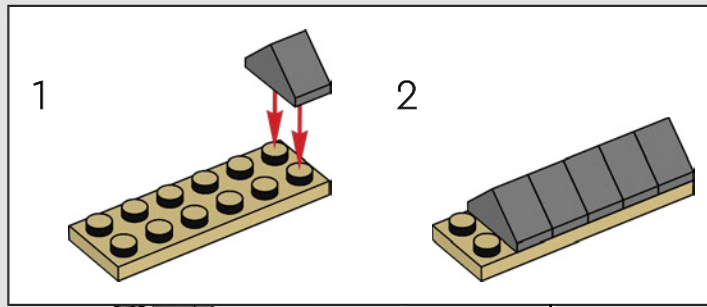

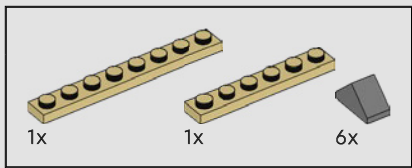

605

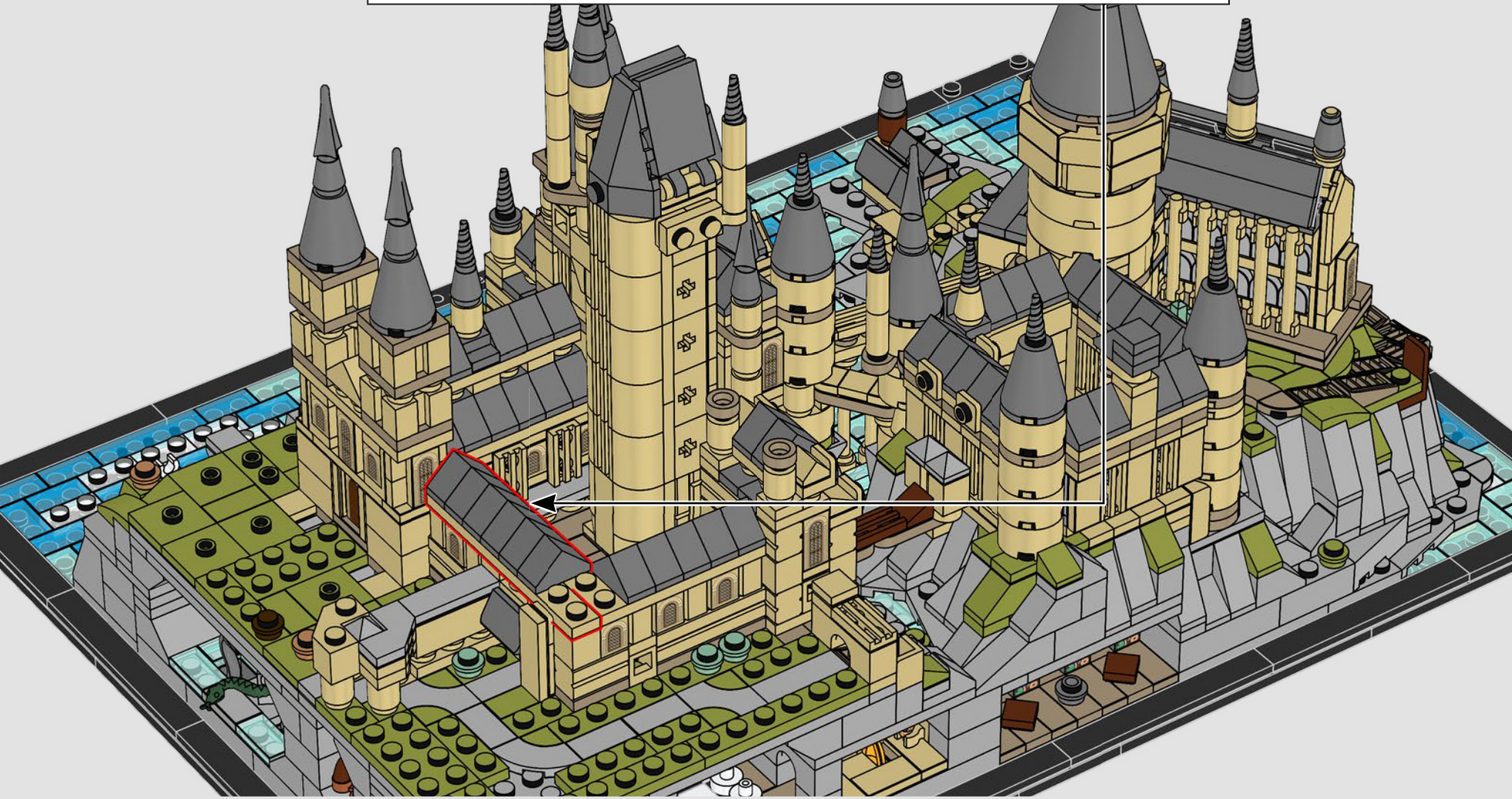
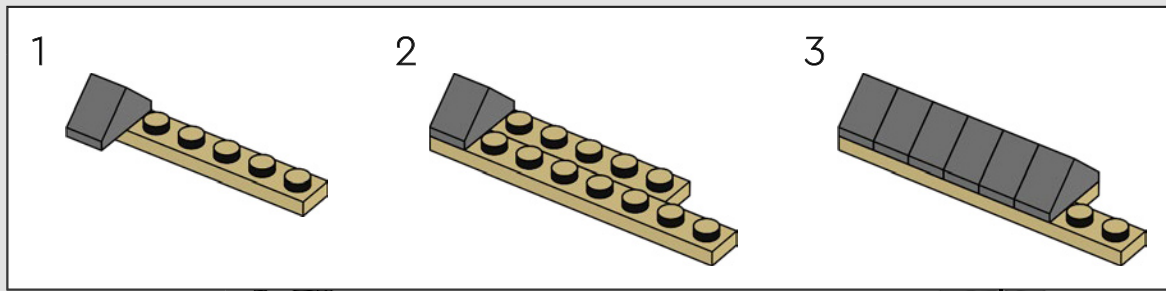

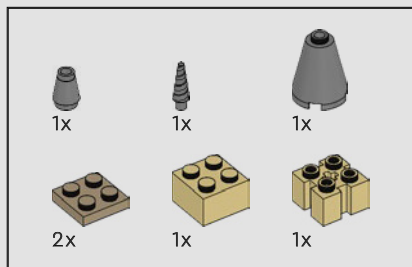

606

1

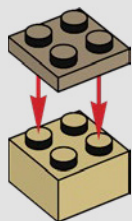

2

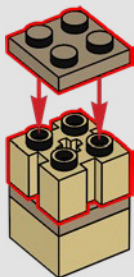

3

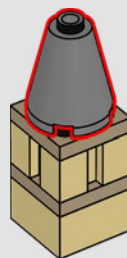

4

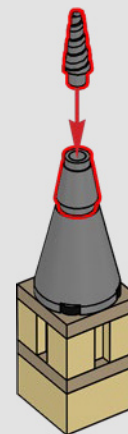



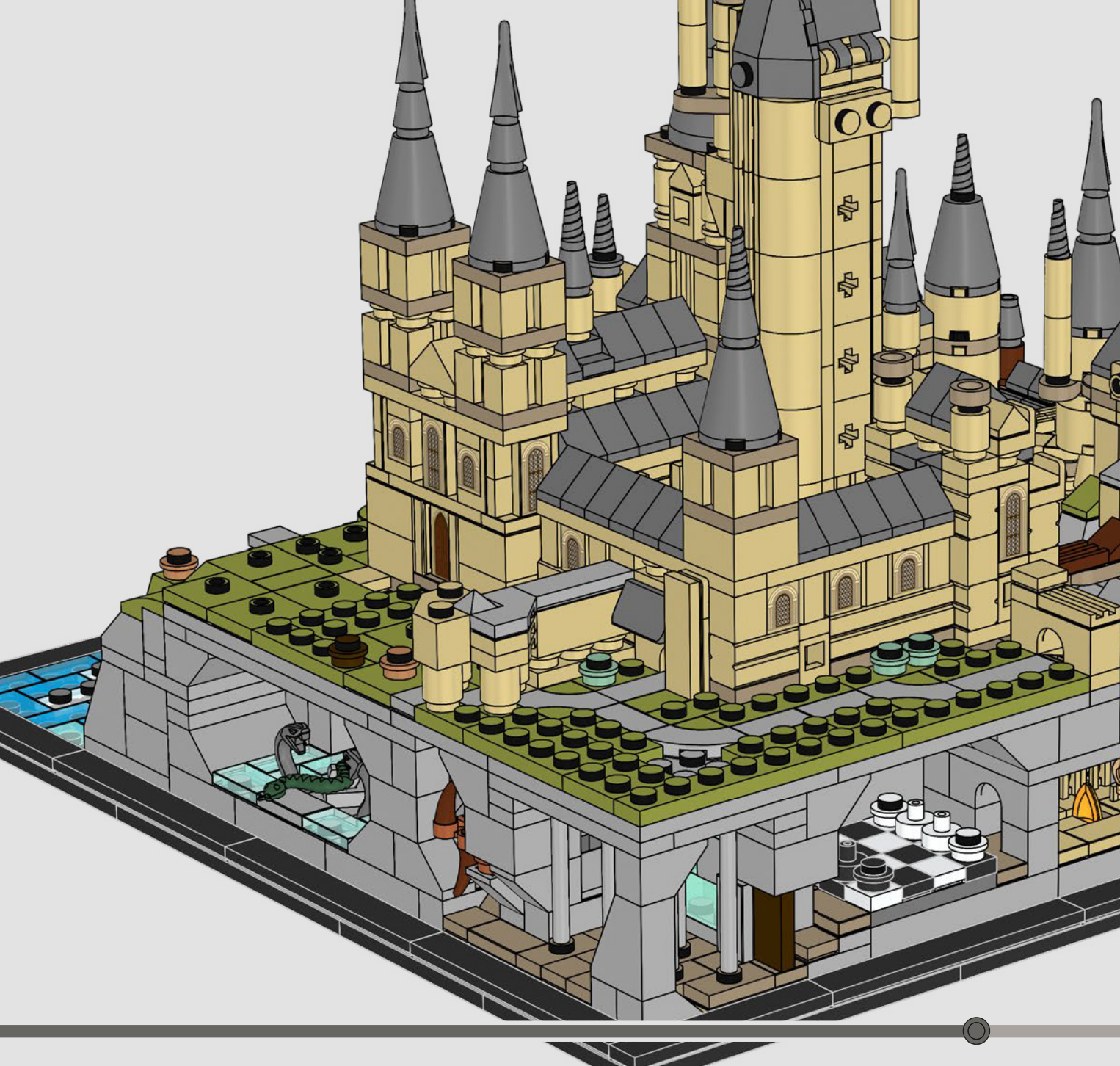

霍格沃茨是一座巨大的城堡，在那里找路可能非常困难。你知道这座城堡里有 142 段楼梯吗？随着楼梯的不断变化，你更不容易找到路。

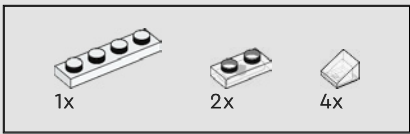

607

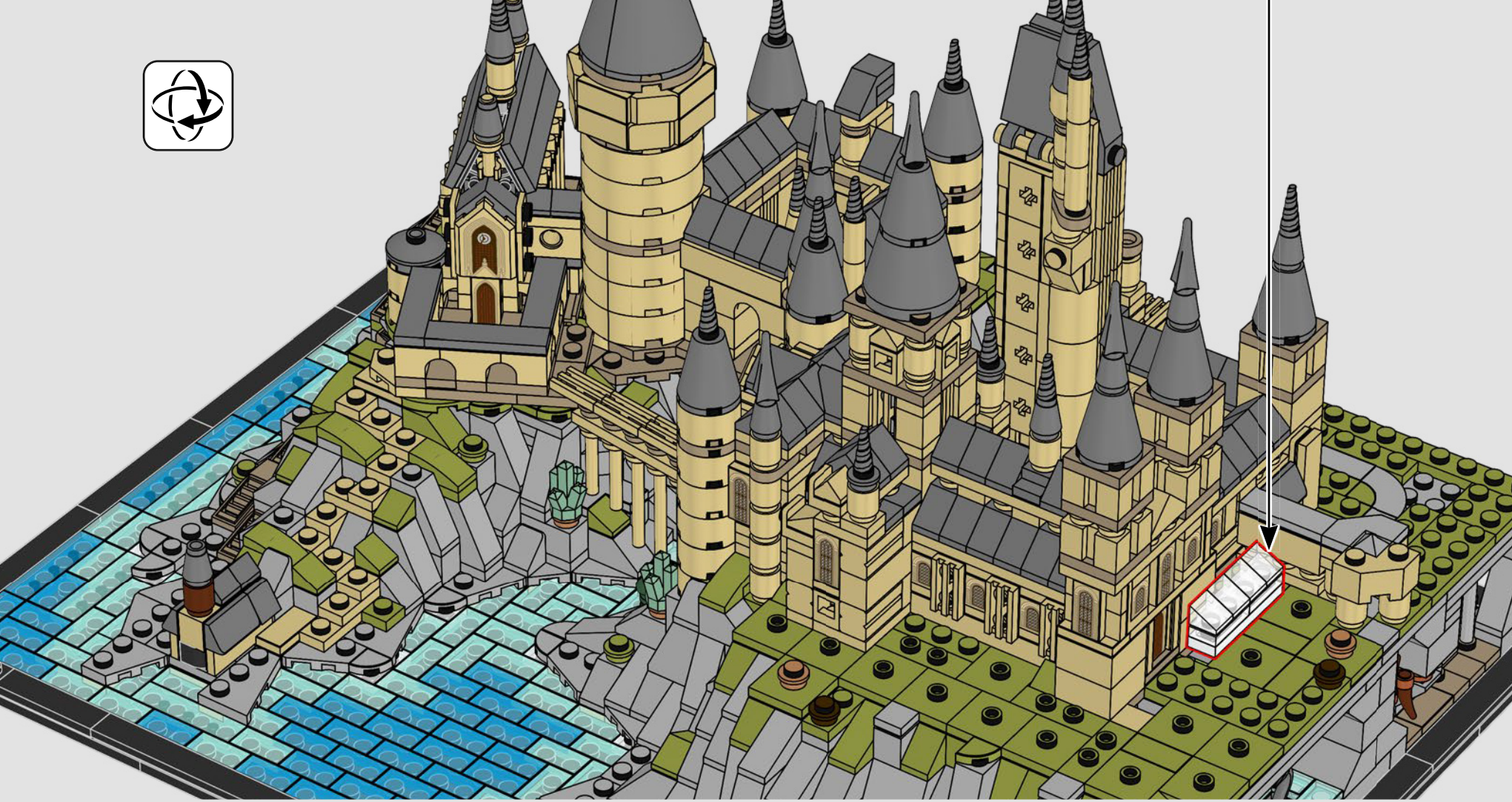
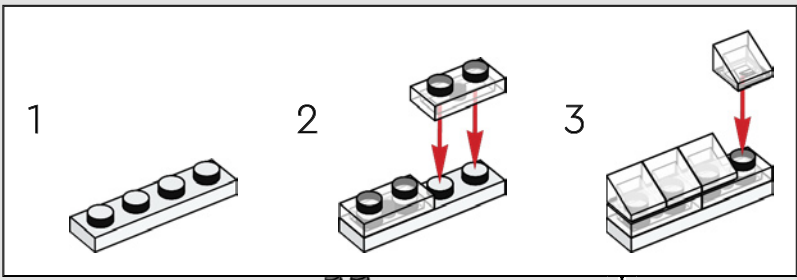

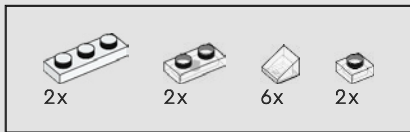

608

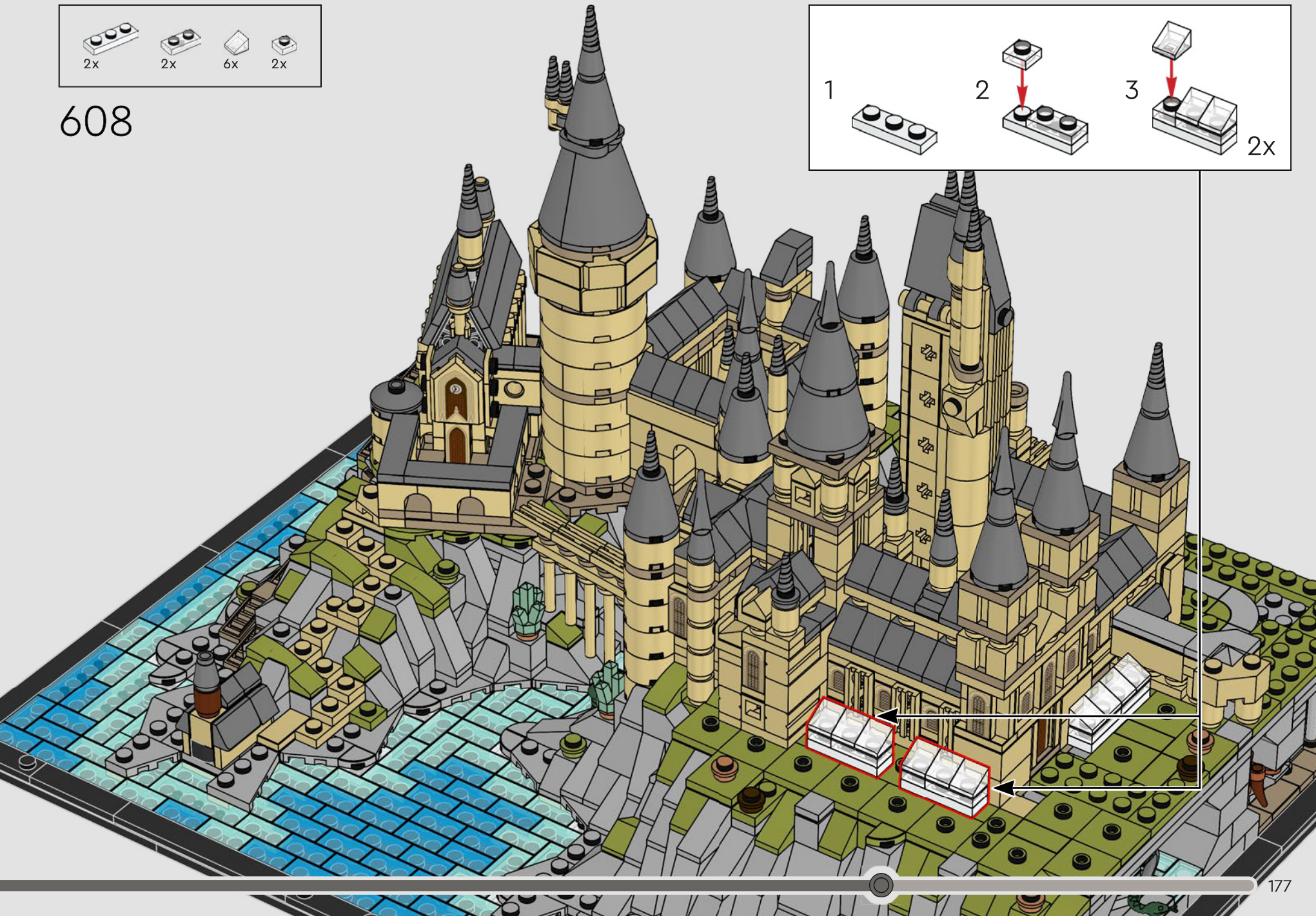
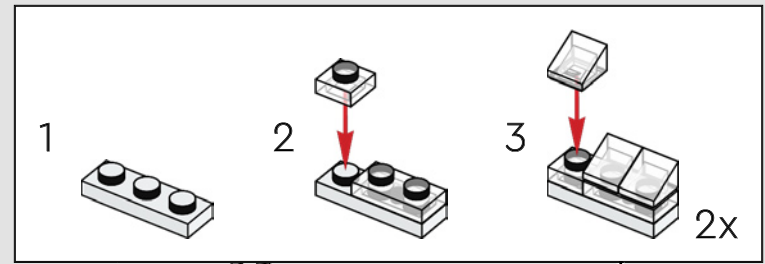



609

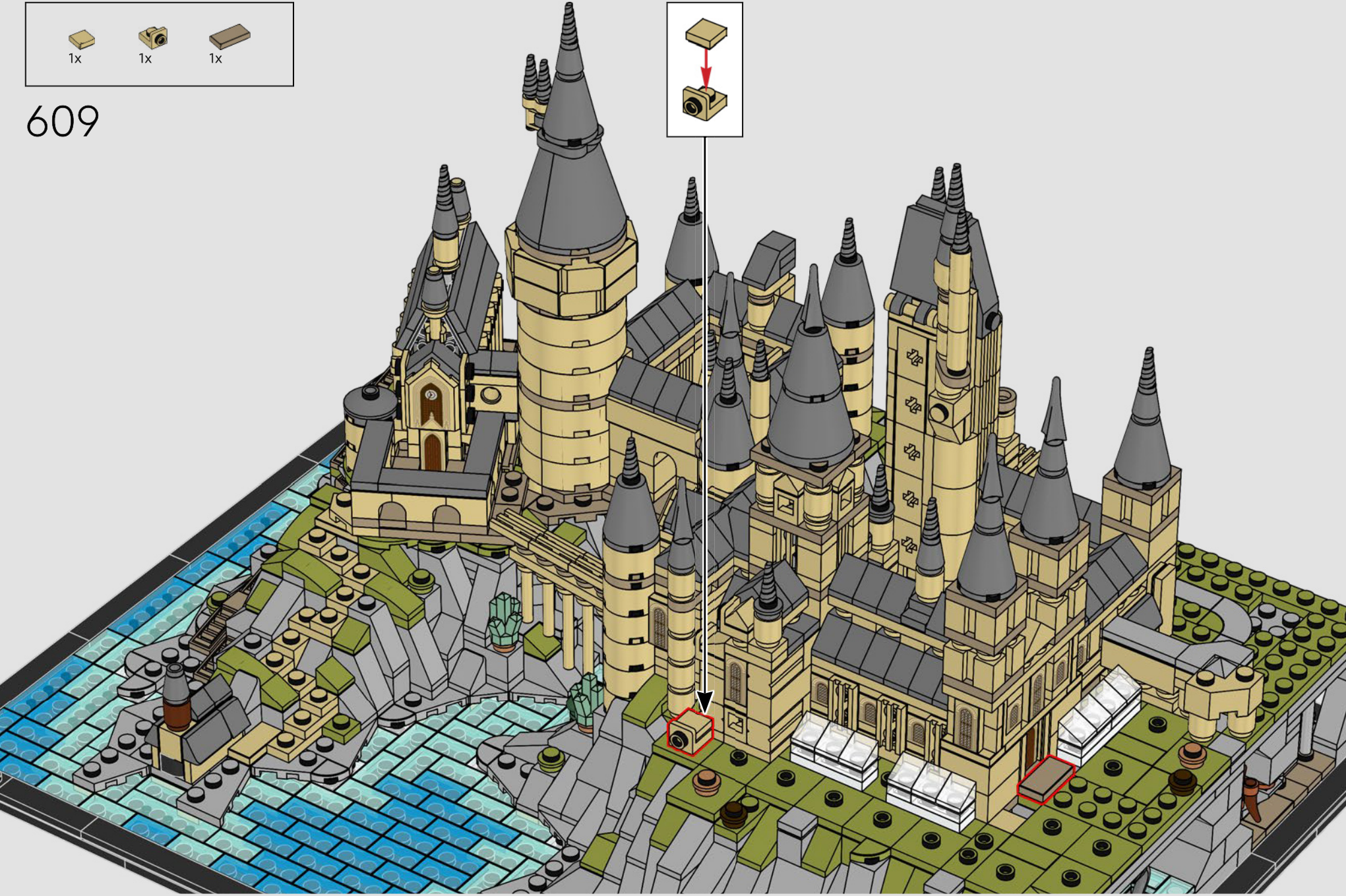
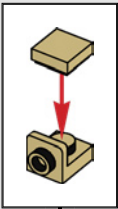



610

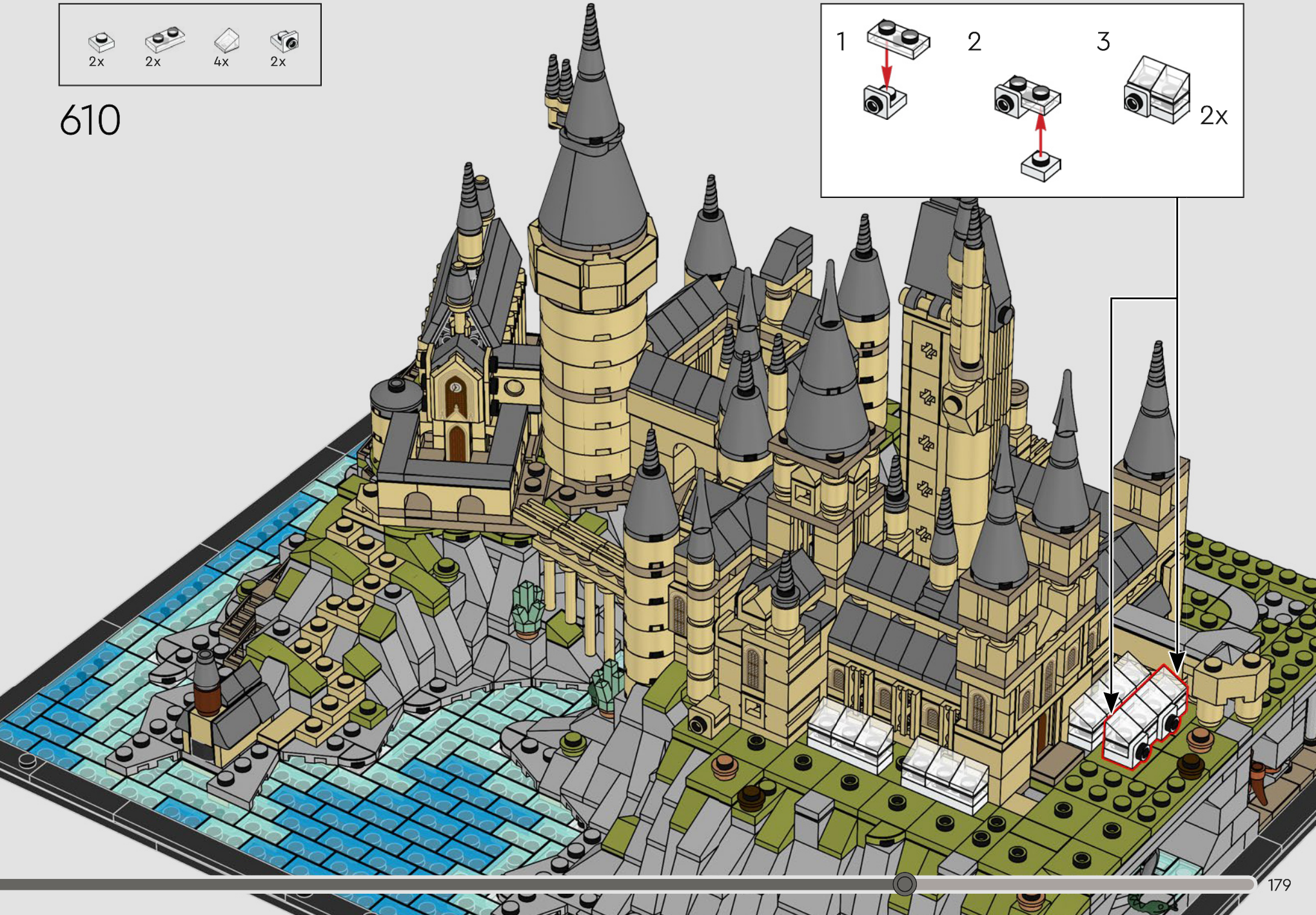
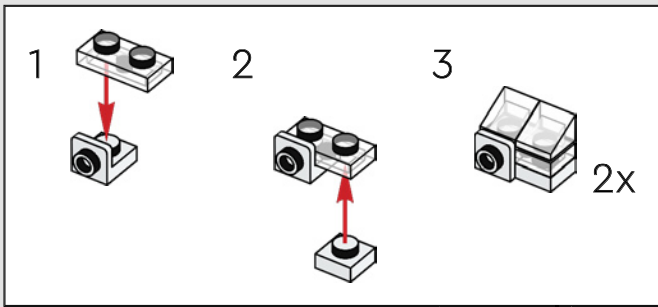

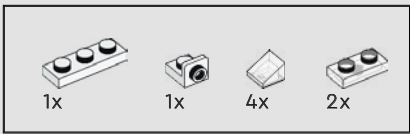

611

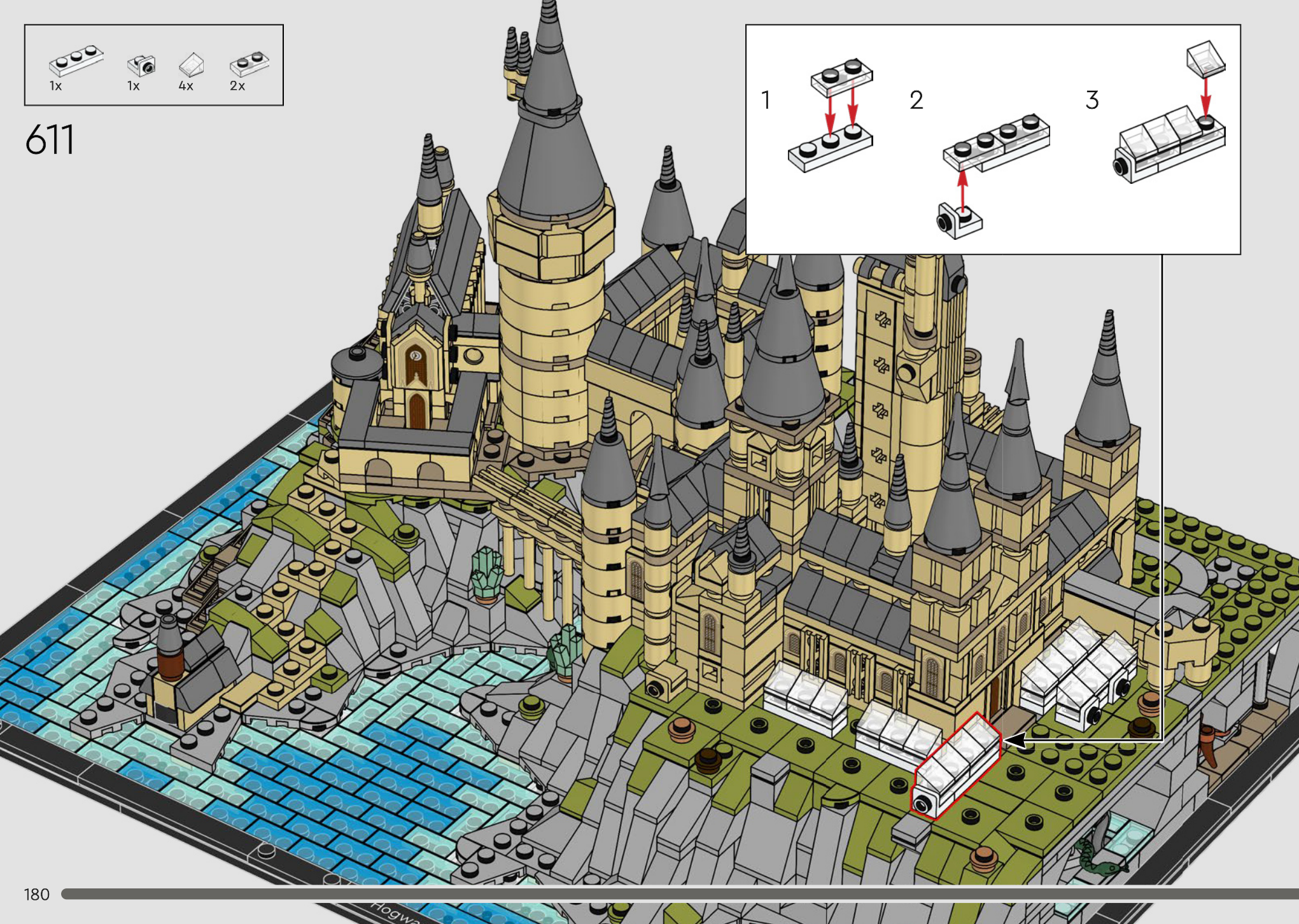
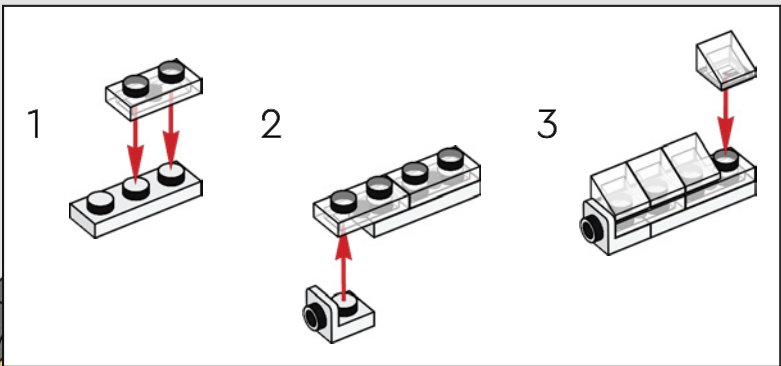

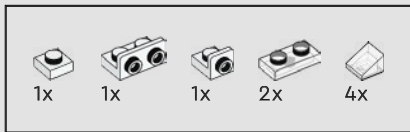

612

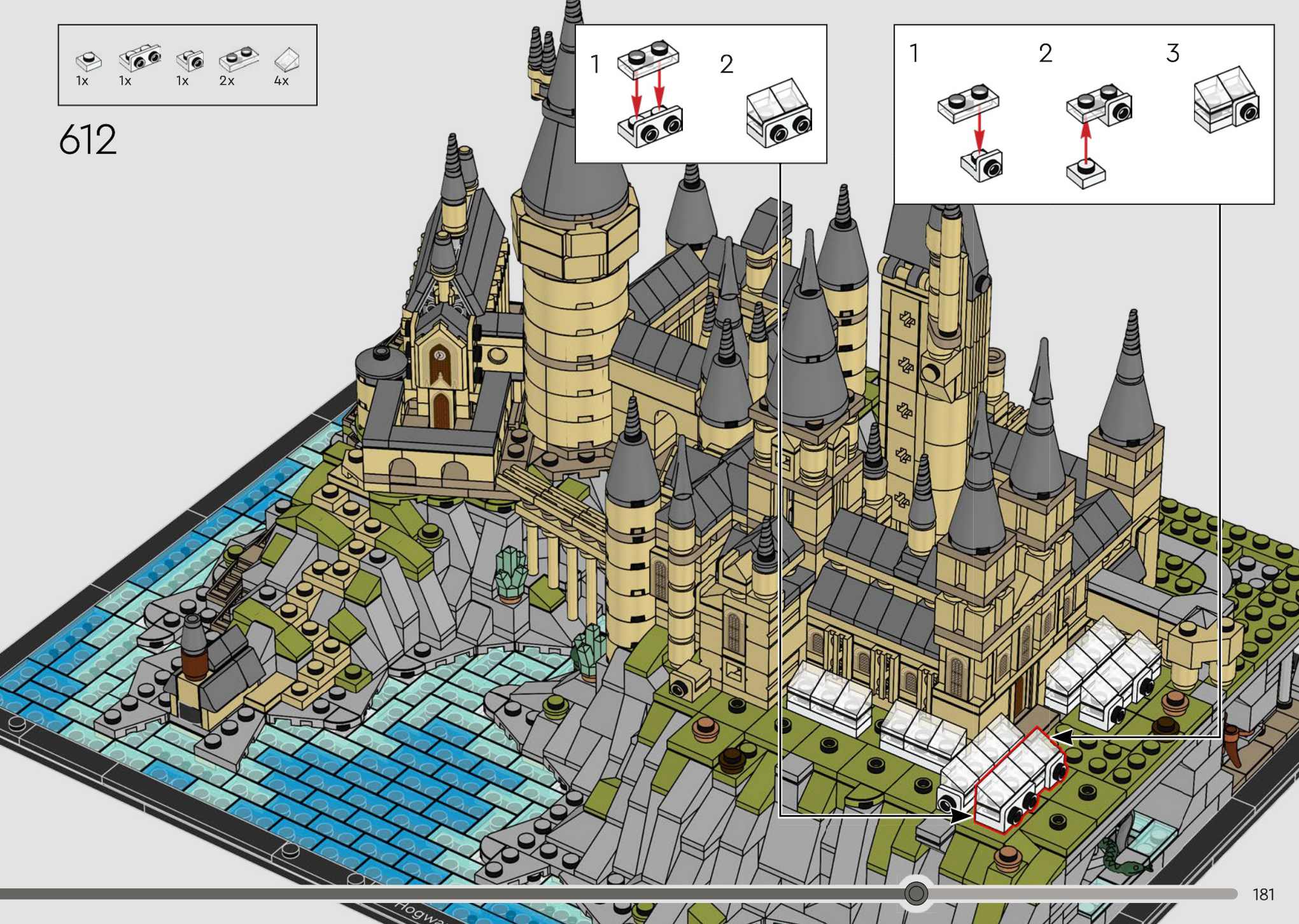
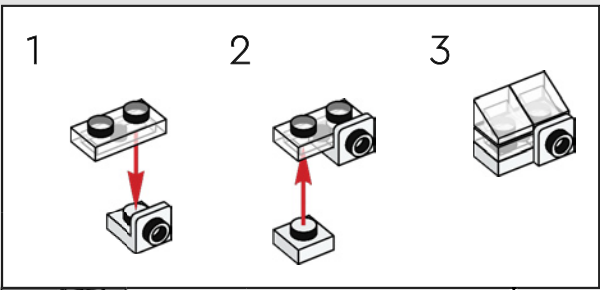
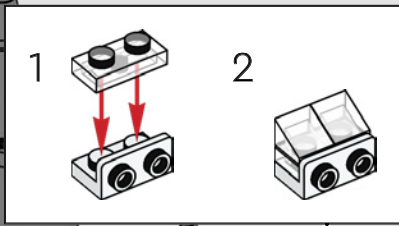

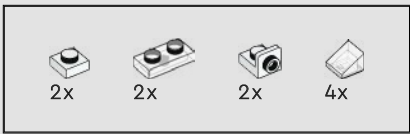

613

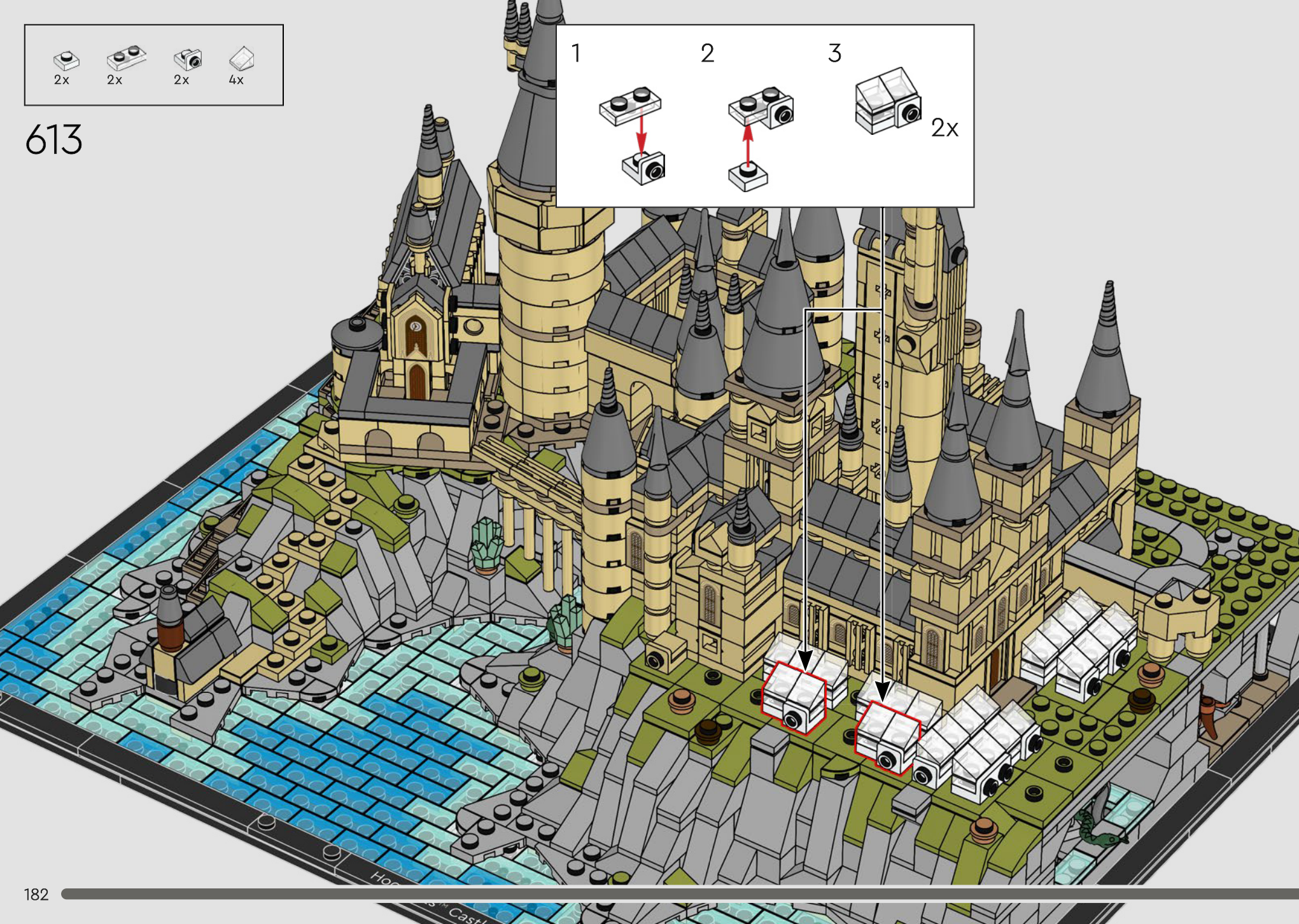
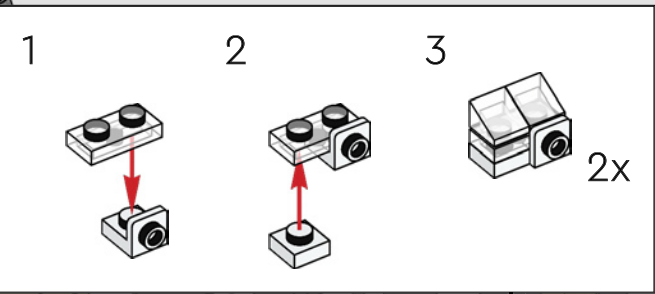



614

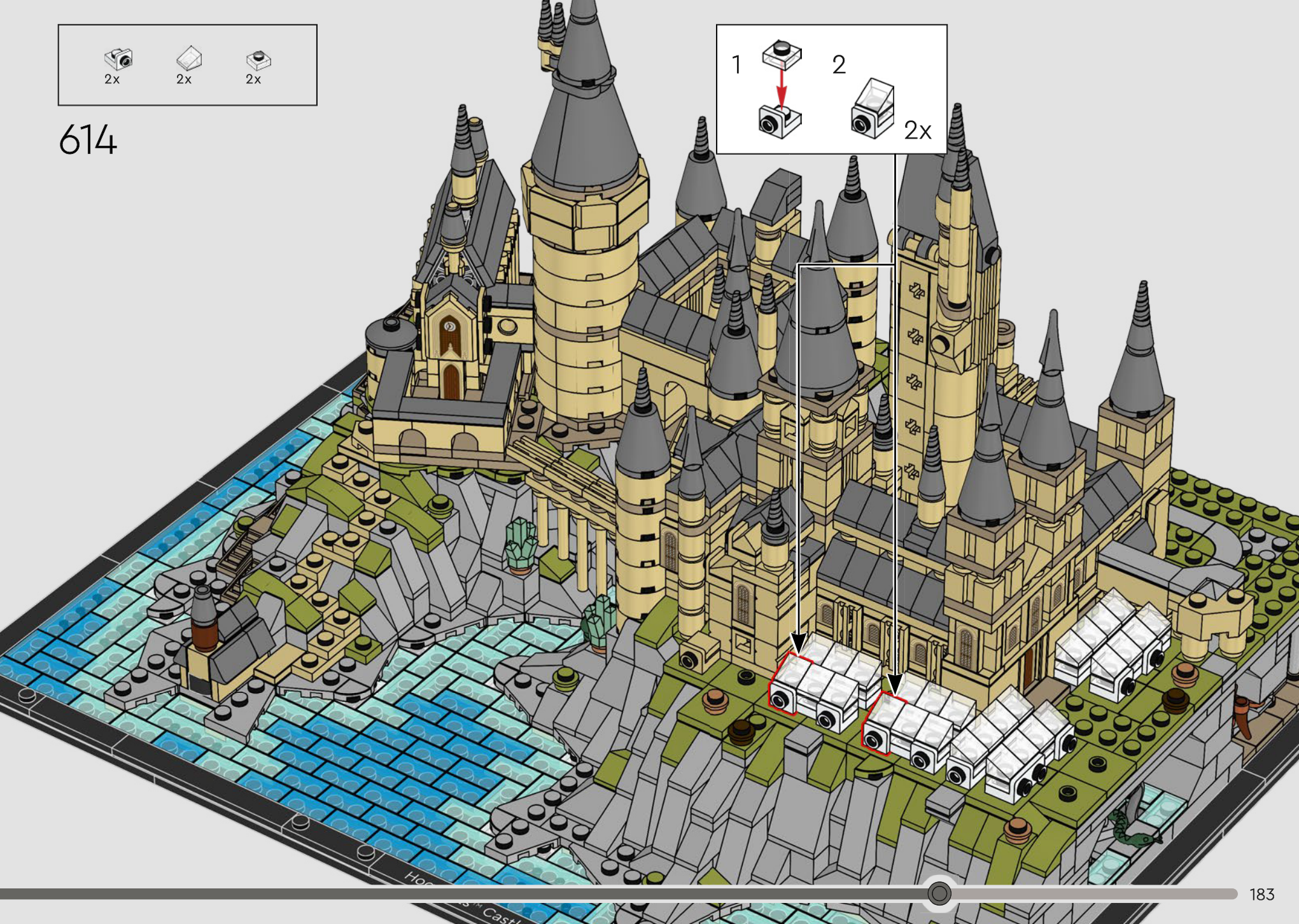
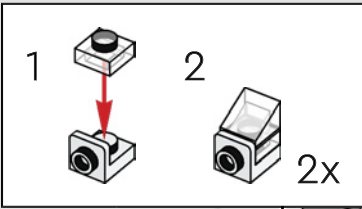

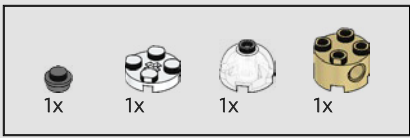

615

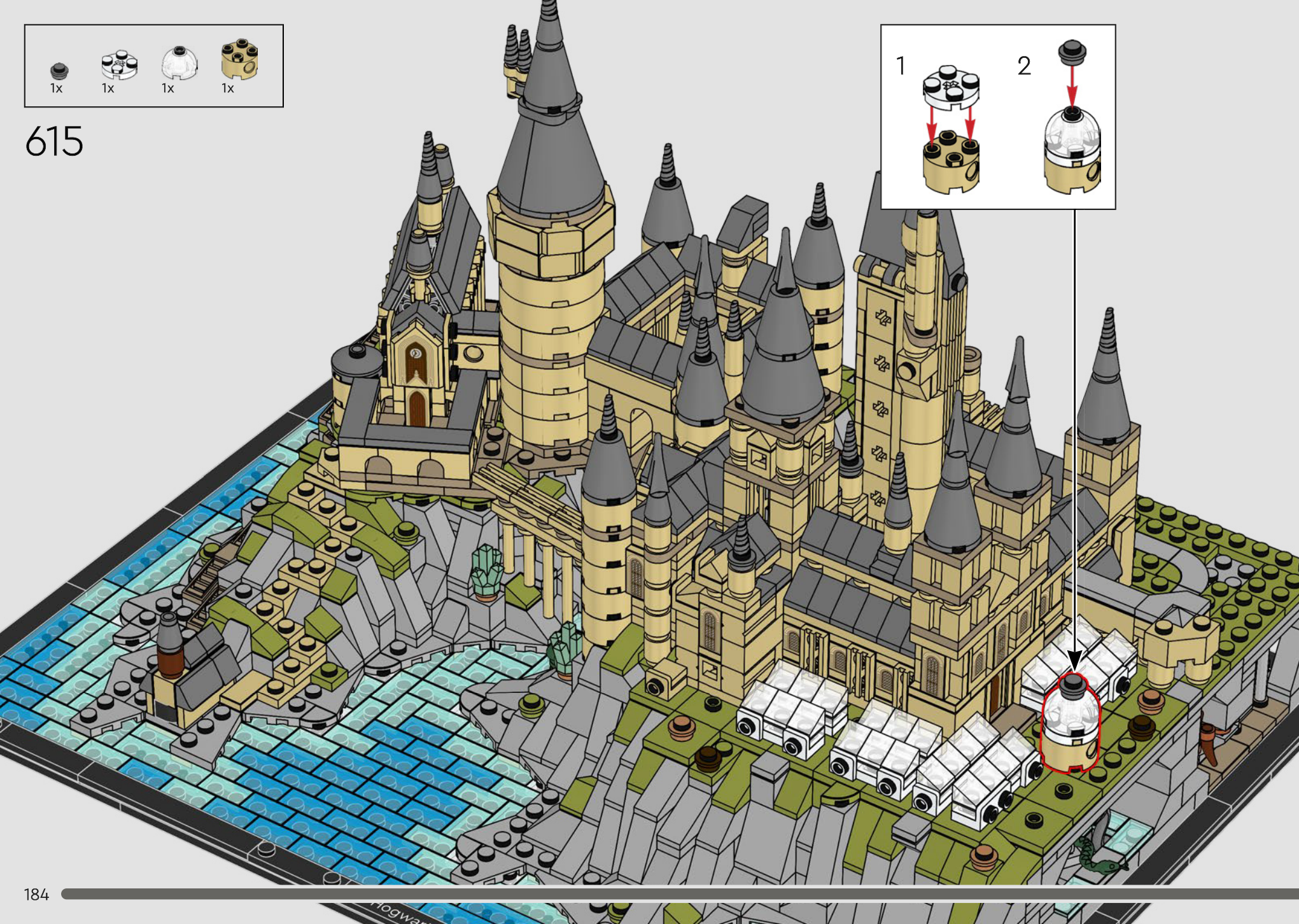
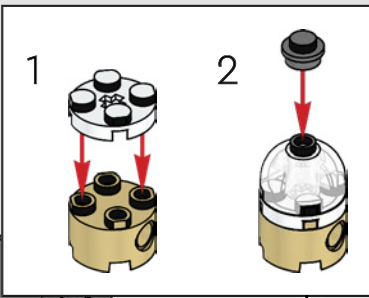

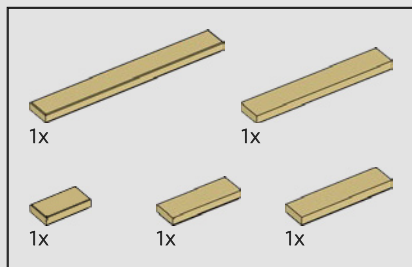

616

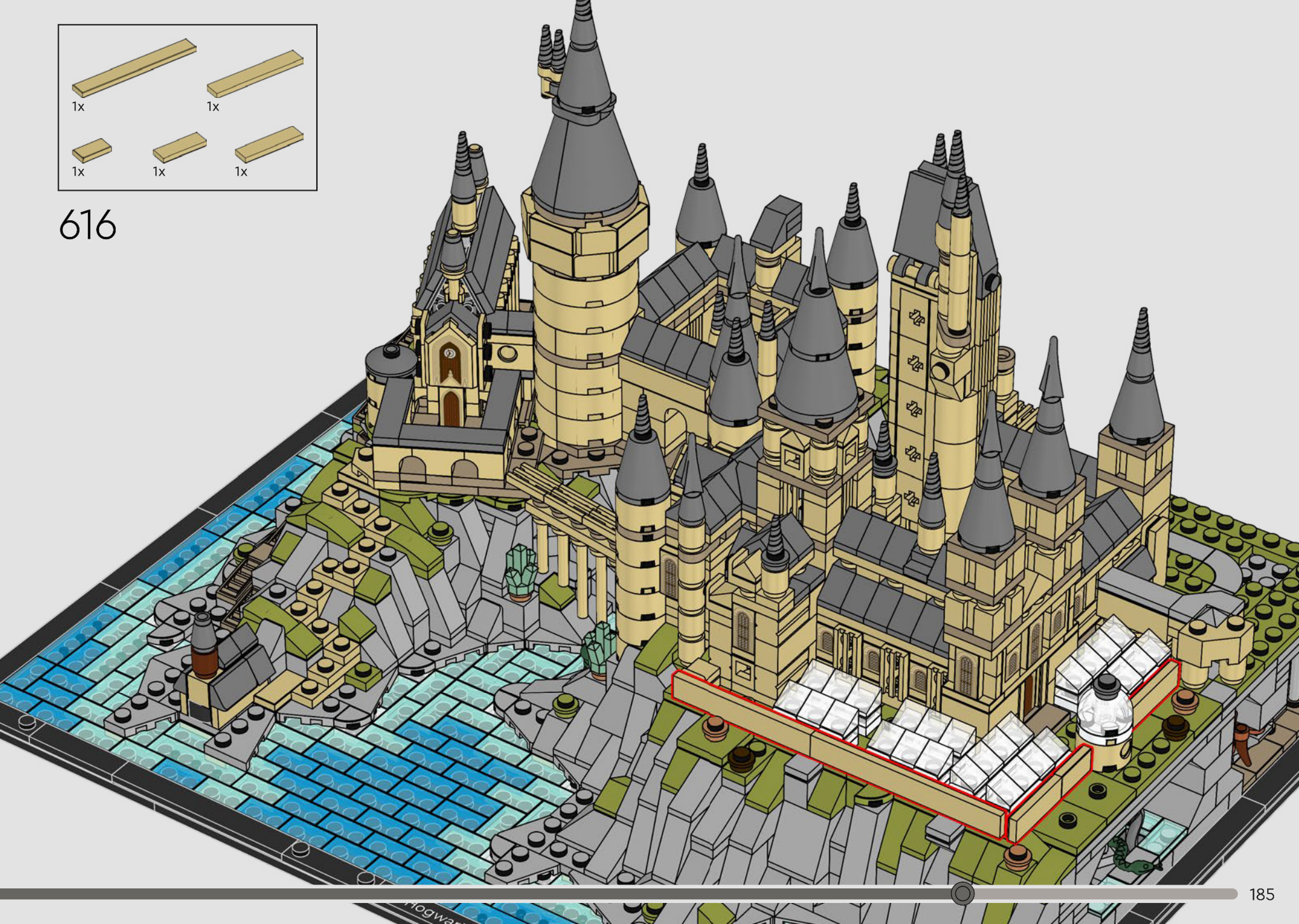

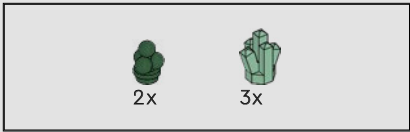

617

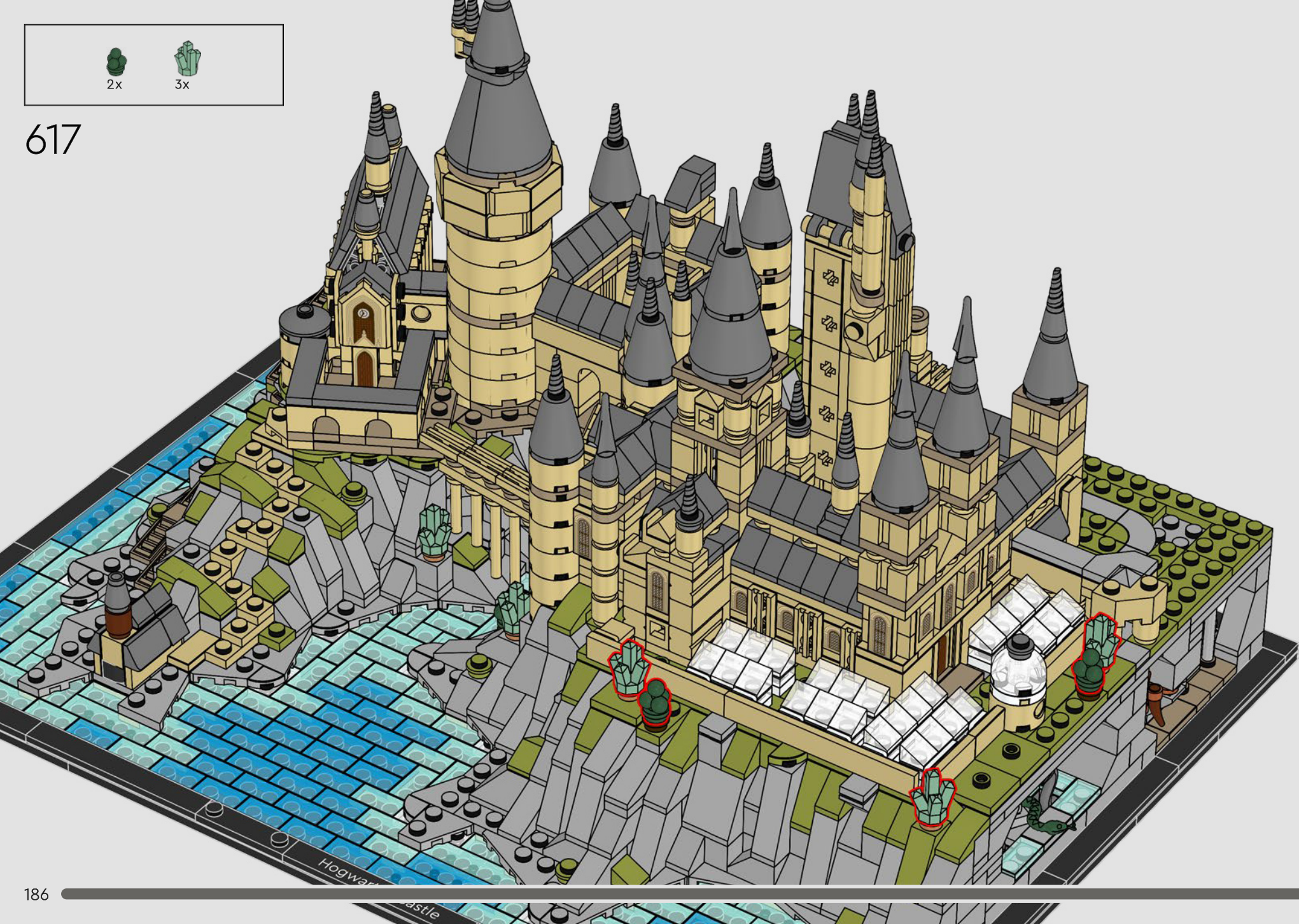

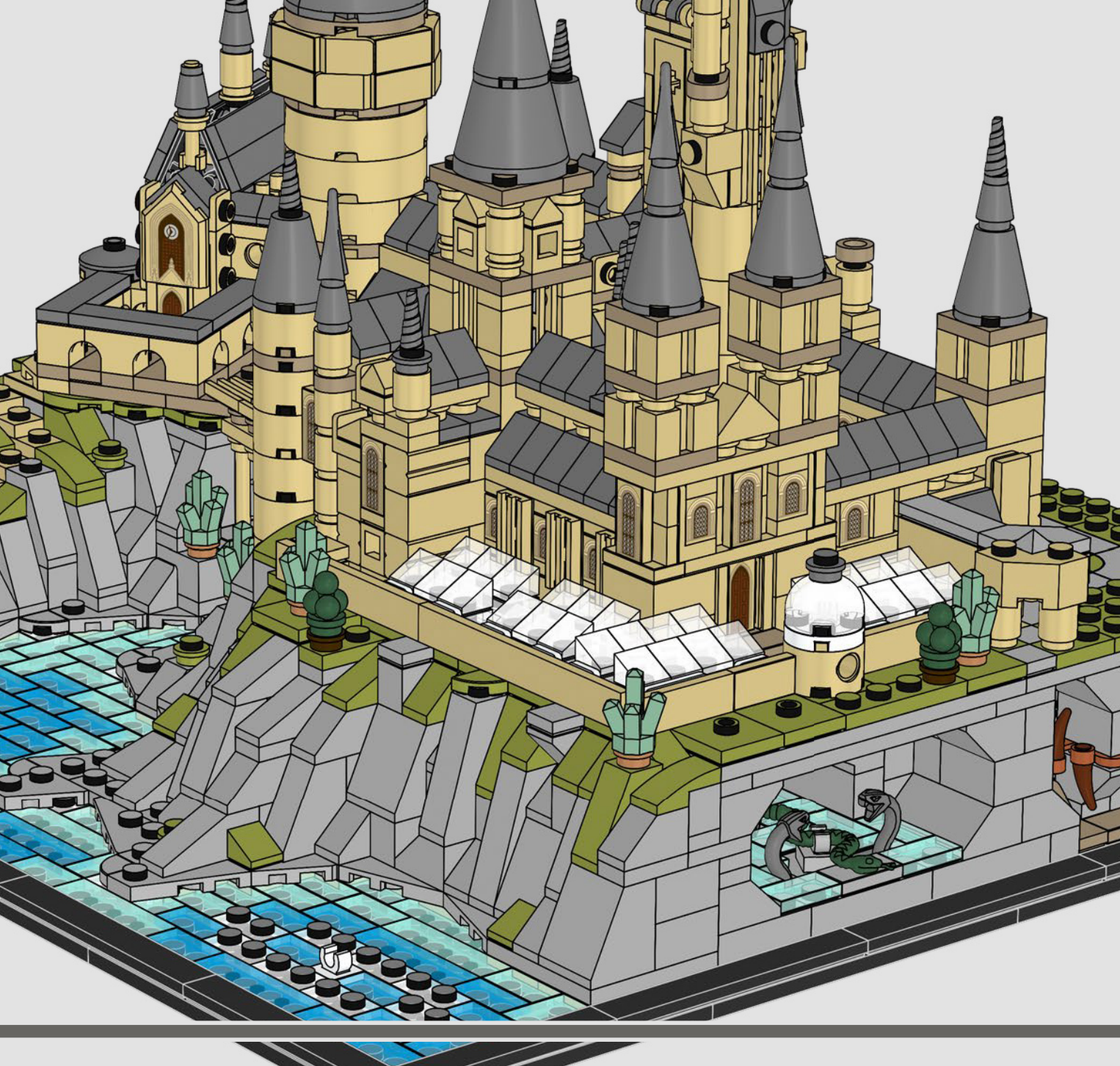

温室是霍格沃茨草药课教师斯普劳特教授指导学生安全地培育和使用魔法植物的地方。现在，如果每个人都能使用他们的耳罩就好了……

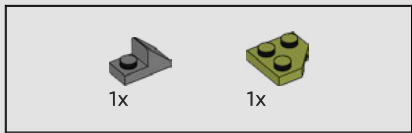

618

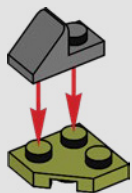

619

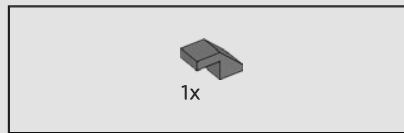
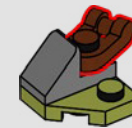

620

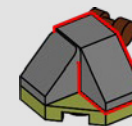

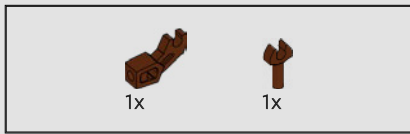

621

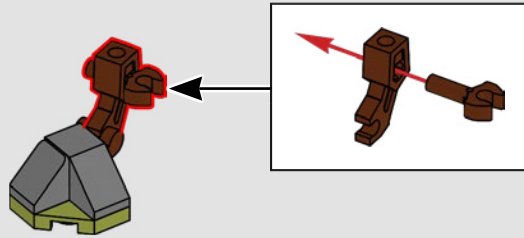

622



623

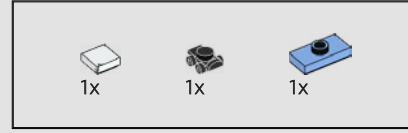
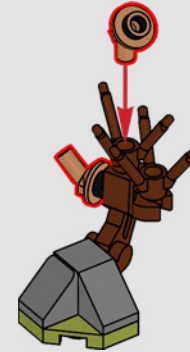

624

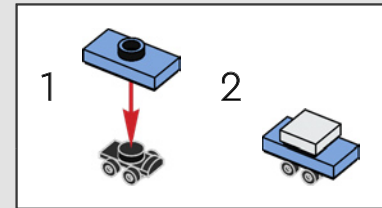



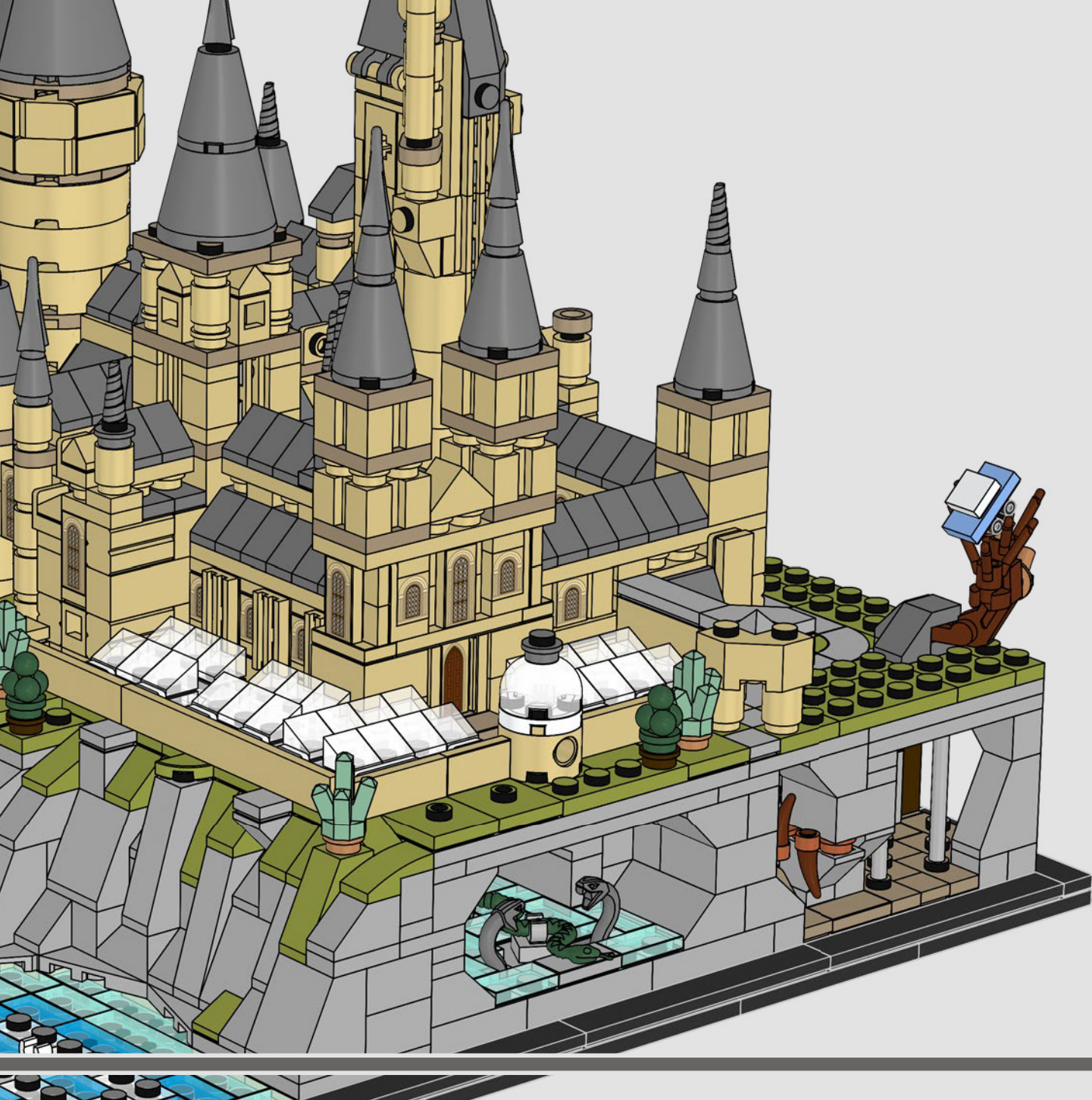

种植打人柳是为了在满月日狼人发作期间让卢平教授安全逃脱。打人柳隐藏着一条通往尖叫棚屋的秘密隧道，卢平将会一直待在那里，直到他变回人形。

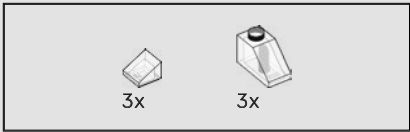

626

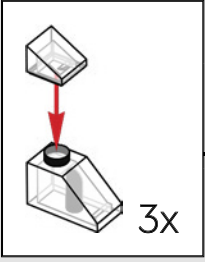
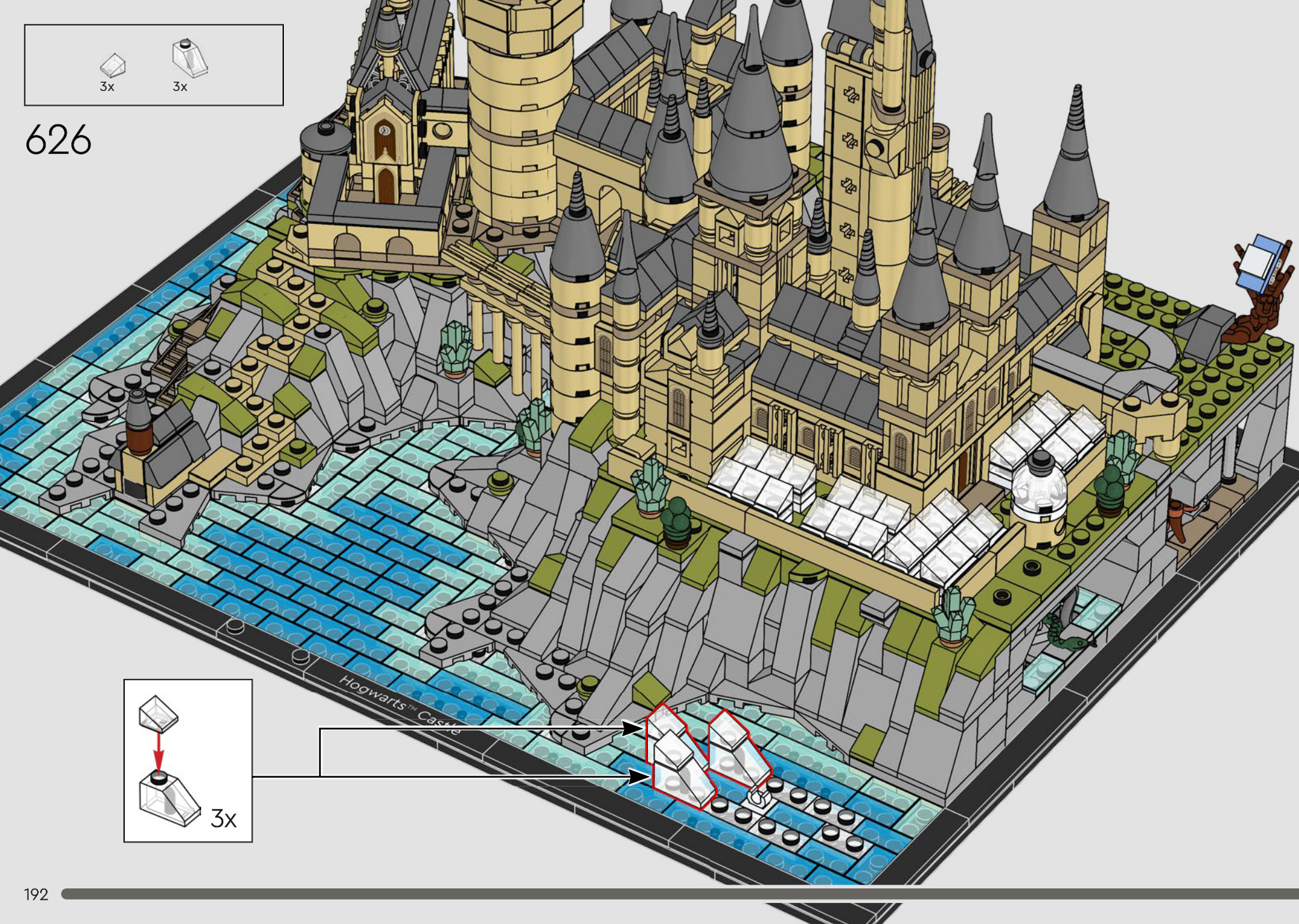



627

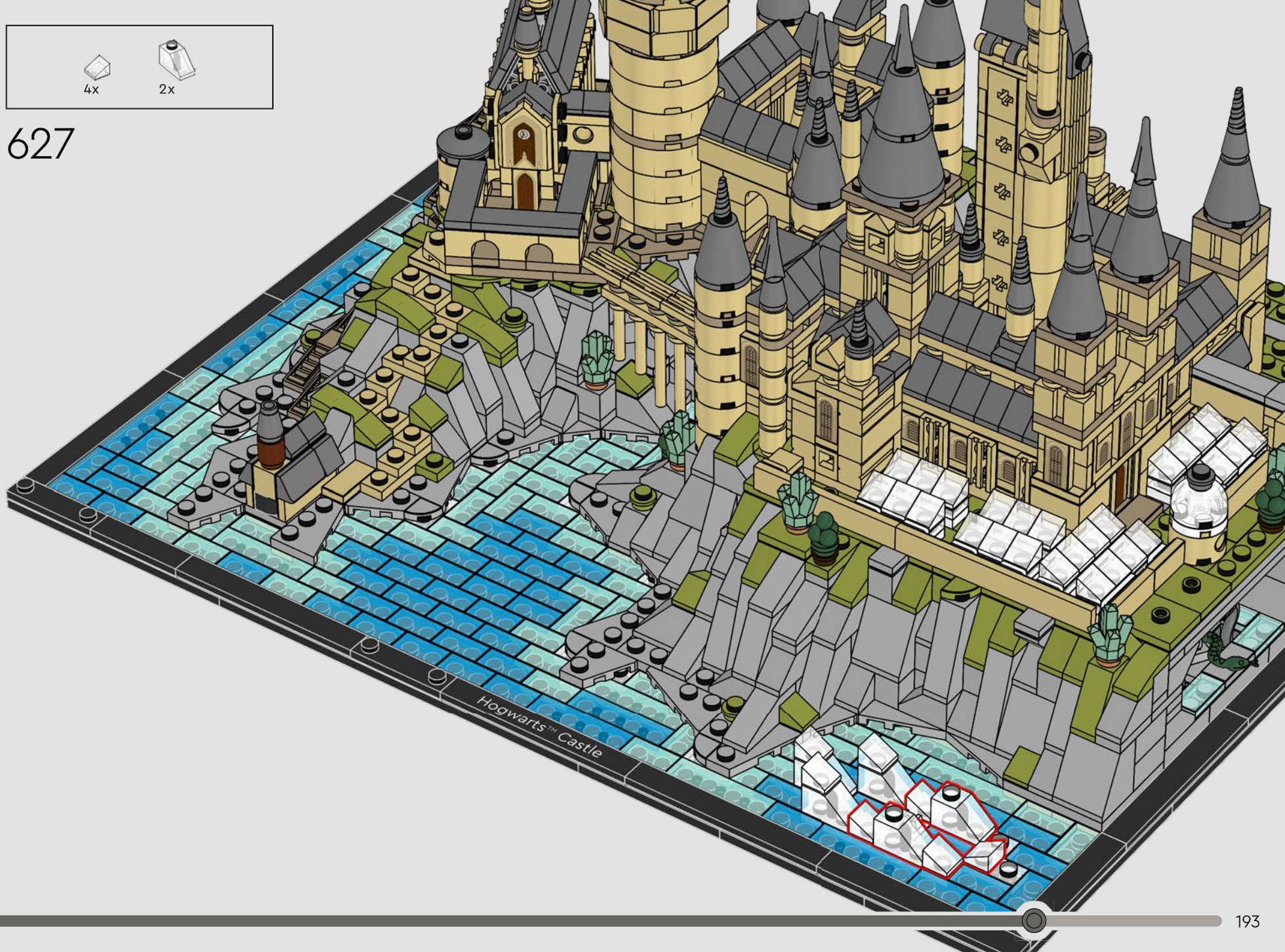

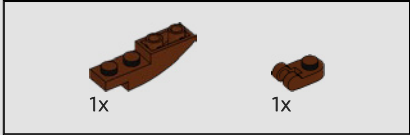
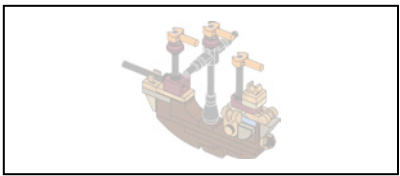

628

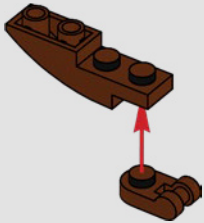

629

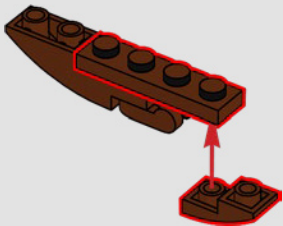

630

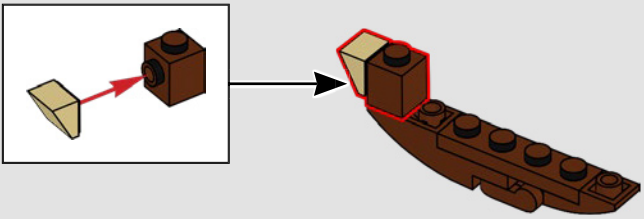

631

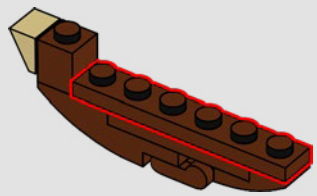

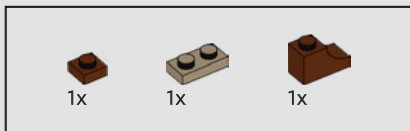

632

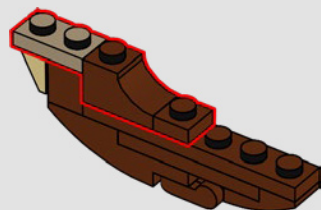

633

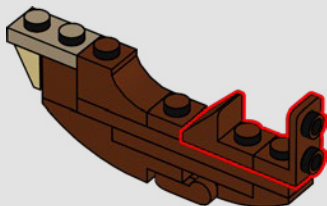

634

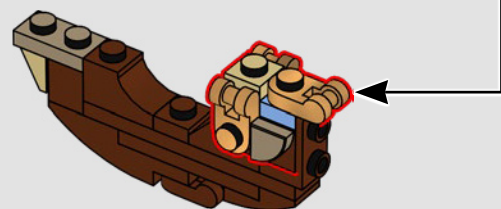
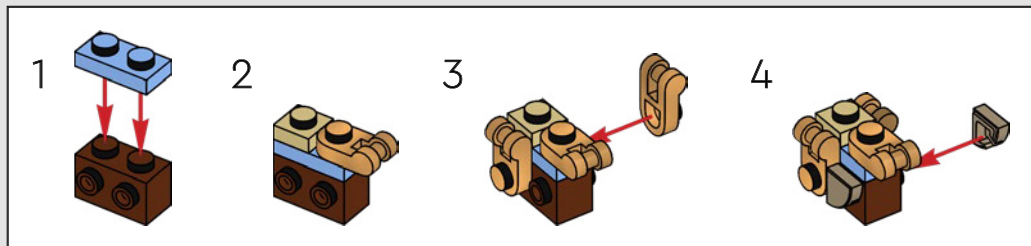

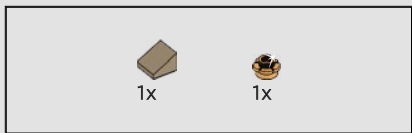

635

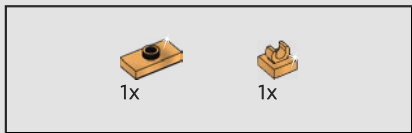
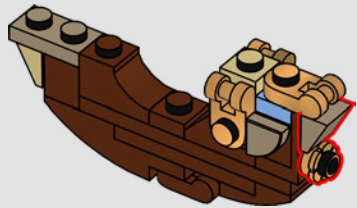

636

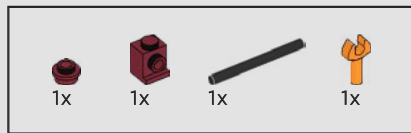
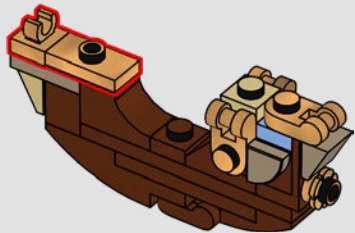

637

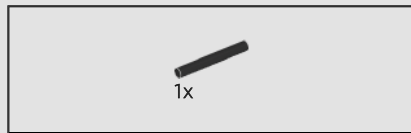
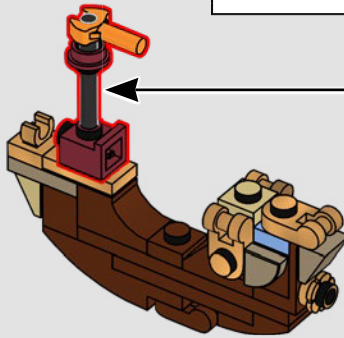
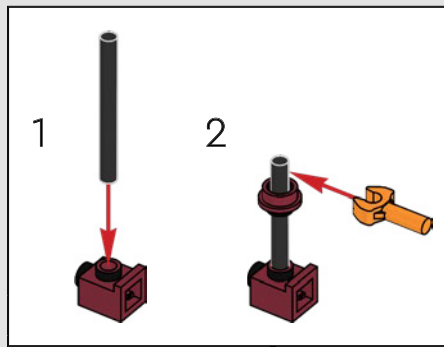

638

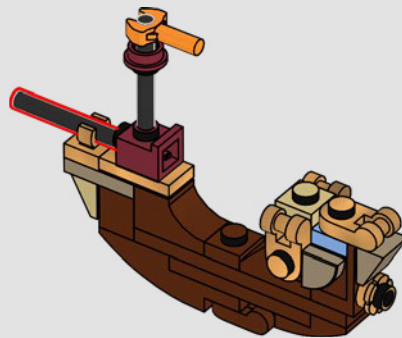

神奇的德姆斯特朗船被用来往于德姆斯特朗魔法学校和霍格沃茨魔法学校之间参加三强争霸赛的交通工具。但是你有没有想过这艘船是如何从北海进入黑湖的？



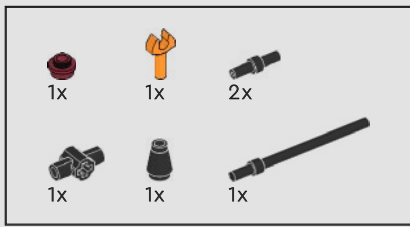

639

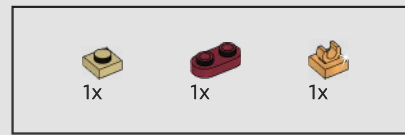
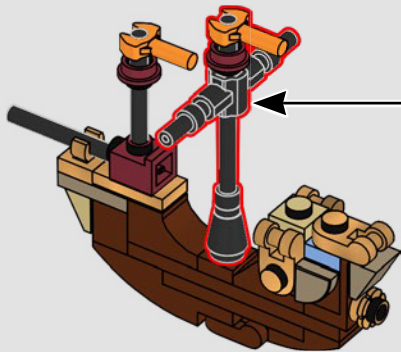
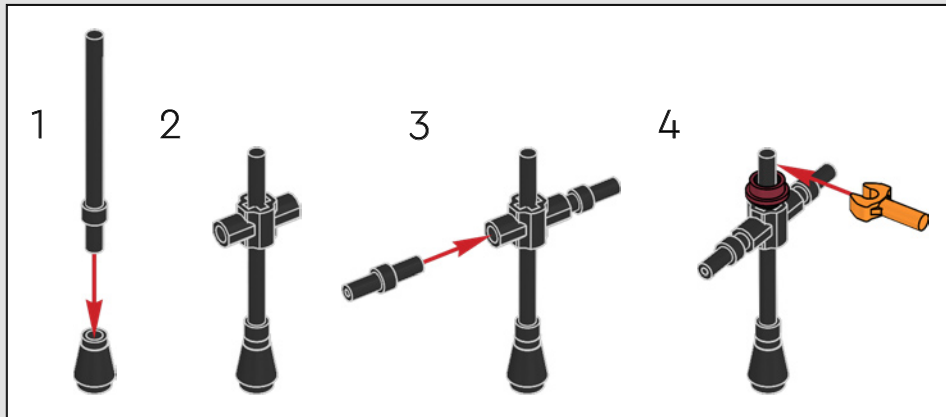

640

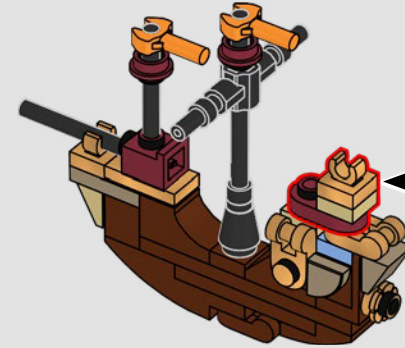
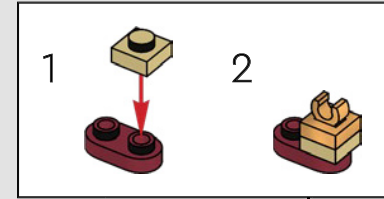

641

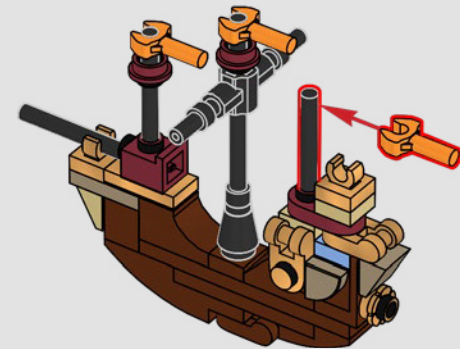



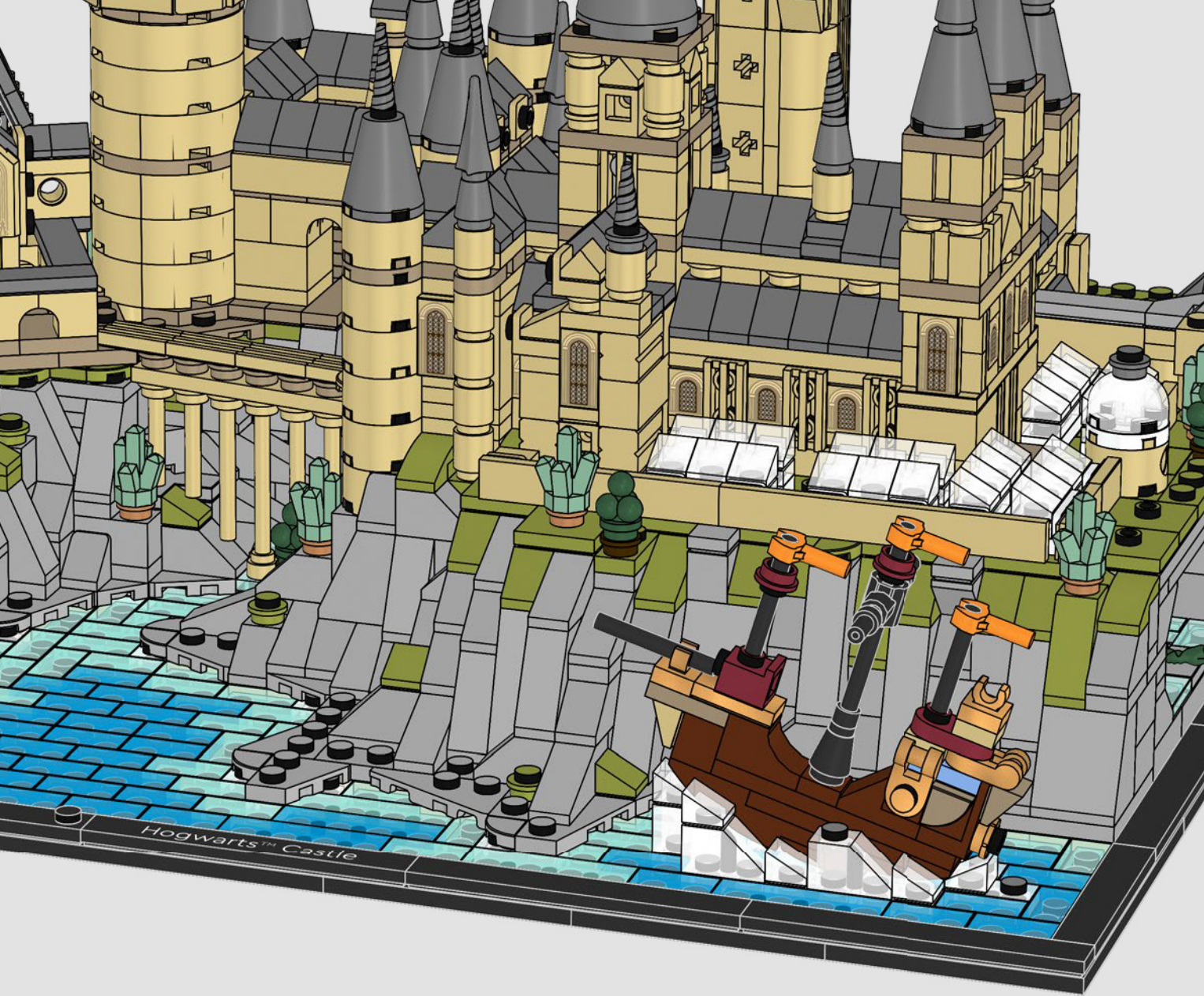

德姆斯特朗船通过一条在黑湖和其它水体之间架设的神奇捷径到达湖中——真的很神奇!

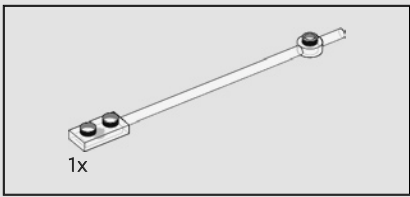

643

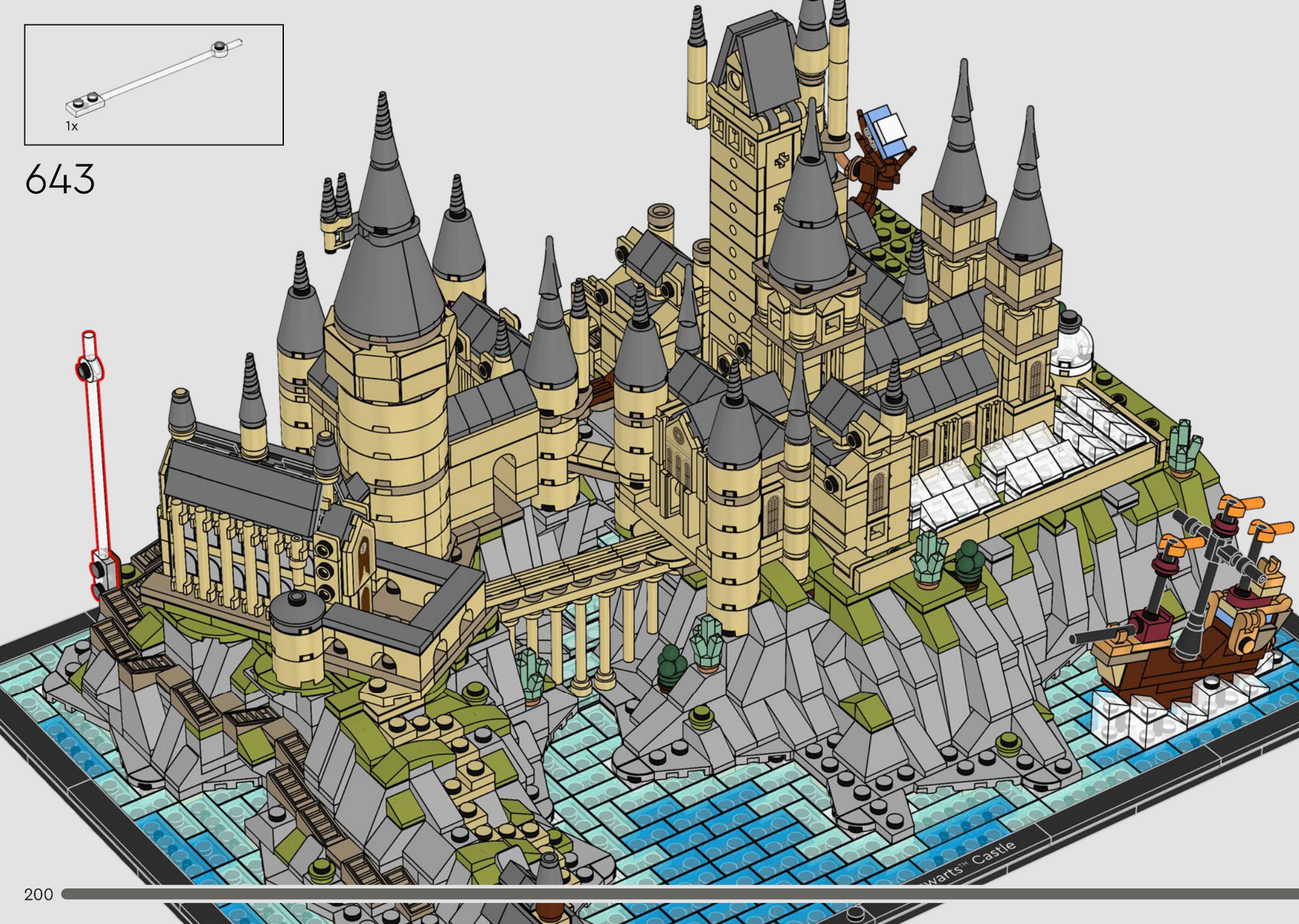

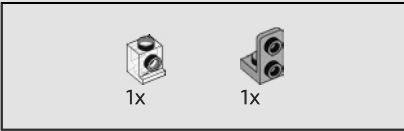

644

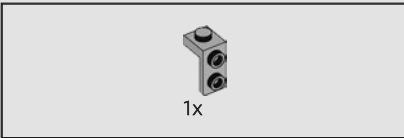
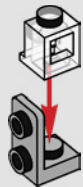

645



646

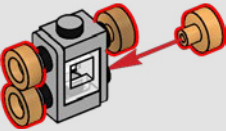



647

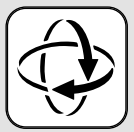
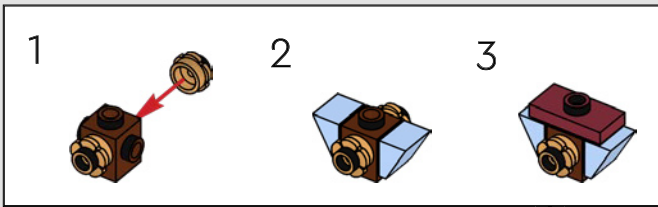

648

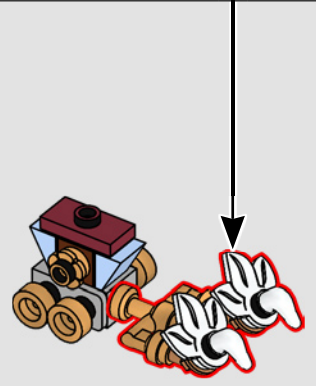
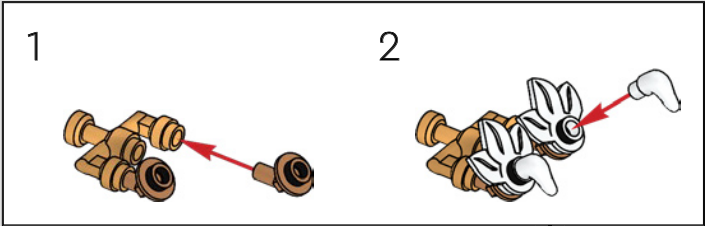

649

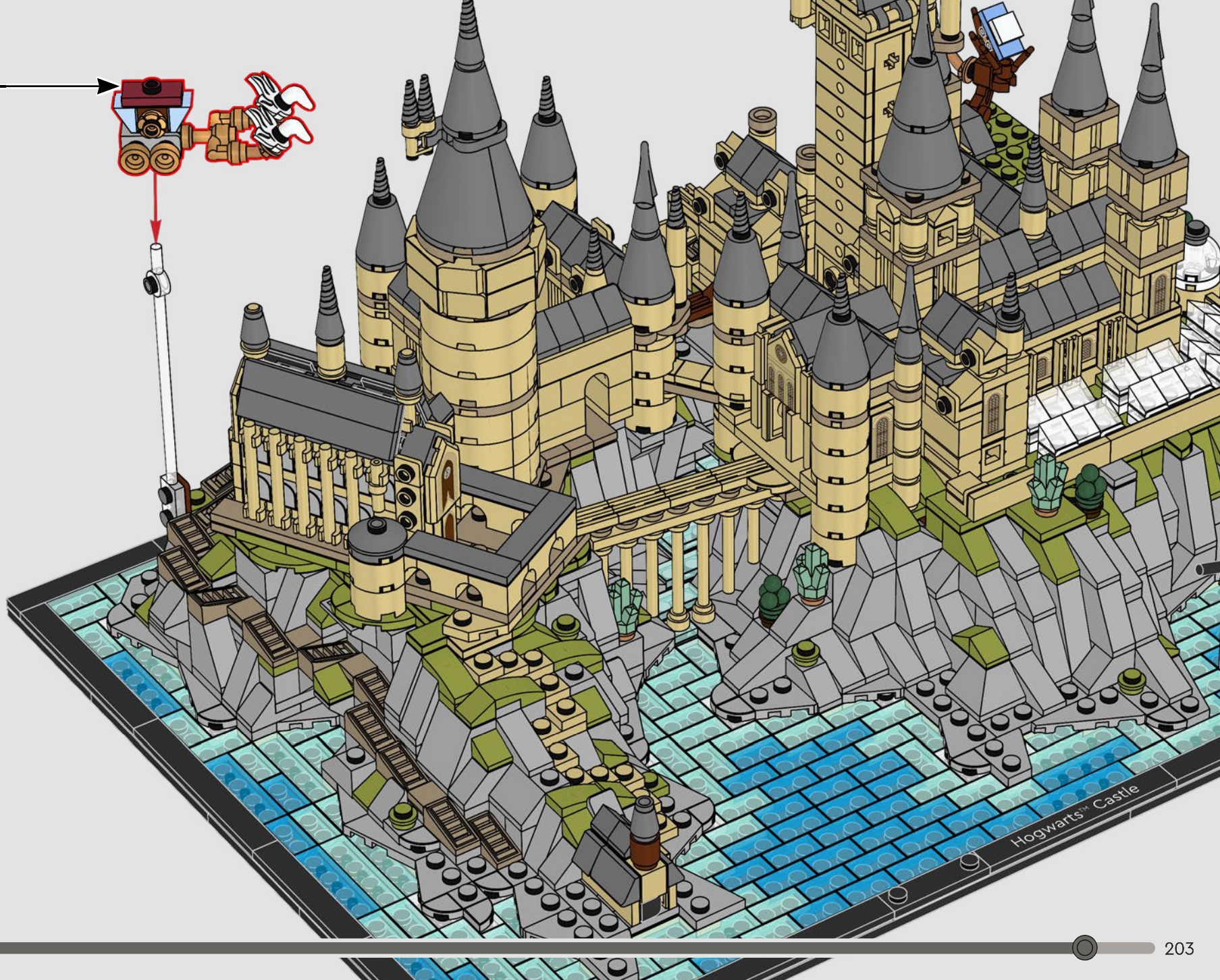

Hogwarts™ Castle

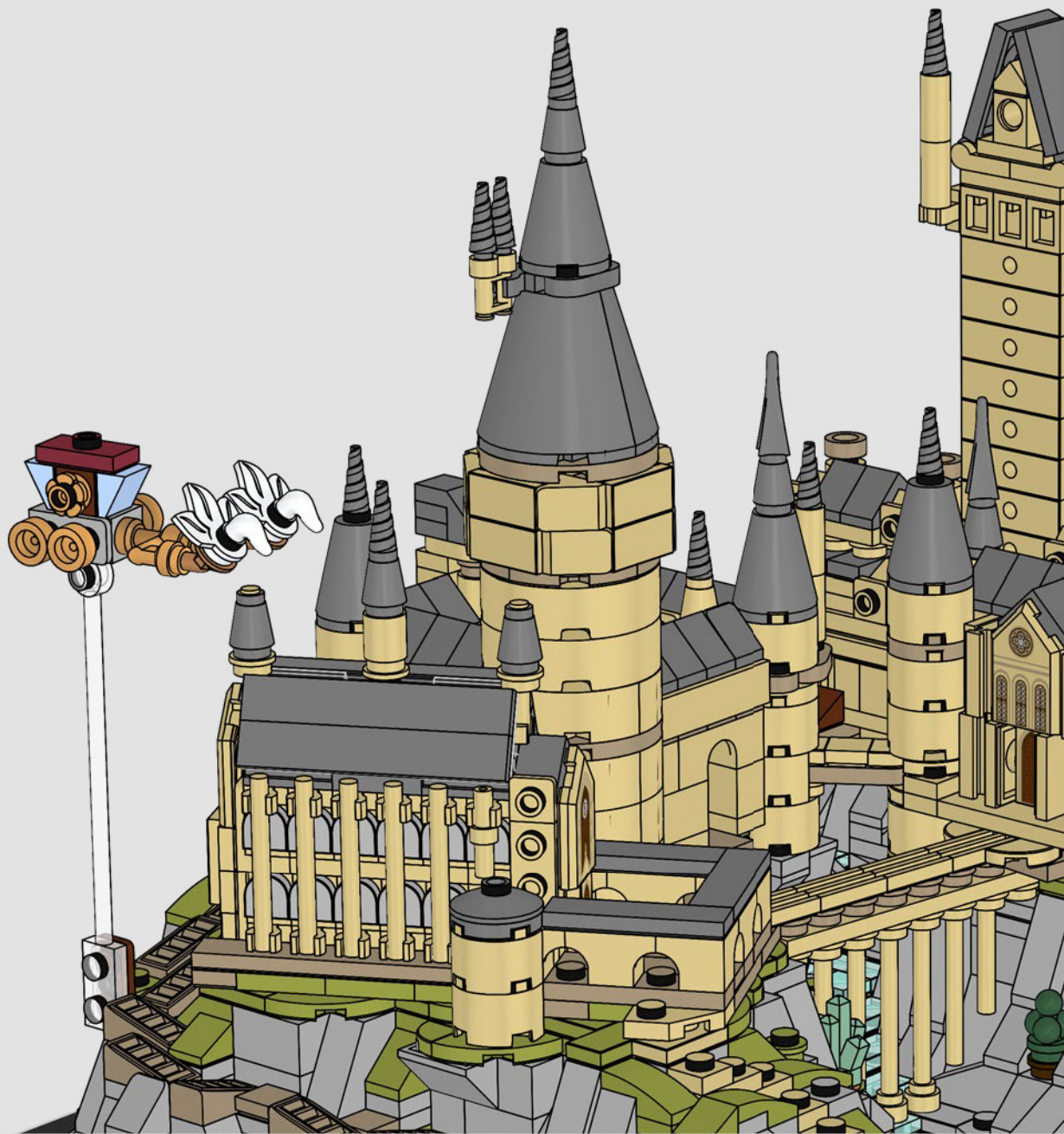

布斯巴顿魔法学校
飞行马车的飞马由
白色乐高®喇叭和树
叶组件拼搭而成。
注意到缰绳了吗？
它们实际上是经过
神奇转变的烛台！

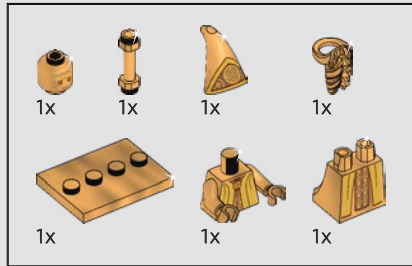

650

1

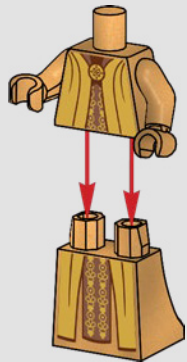

2

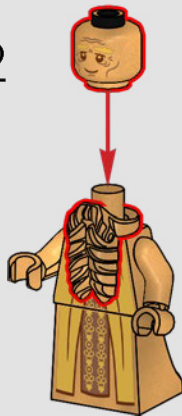

3

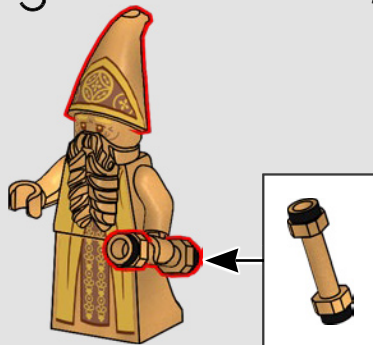

4



专为此套装设计了
霍格沃茨城堡的建
筑师小人仔,其带有
新的胡须,手里拿着
霍格沃茨模型和蓝
图卷轴。

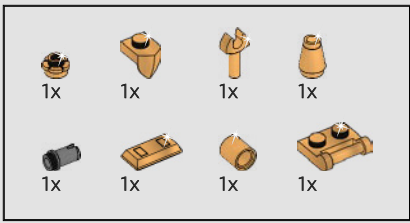

651

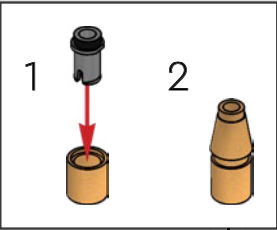

1

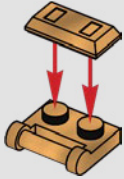

2

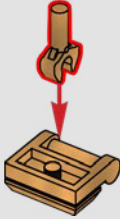

3

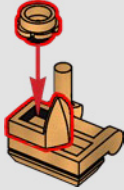

4

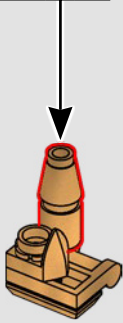



霍格沃茨城堡的建筑师
活跃于十世纪之交的几
年间。人们对他的生活
或其它作品知之甚少。



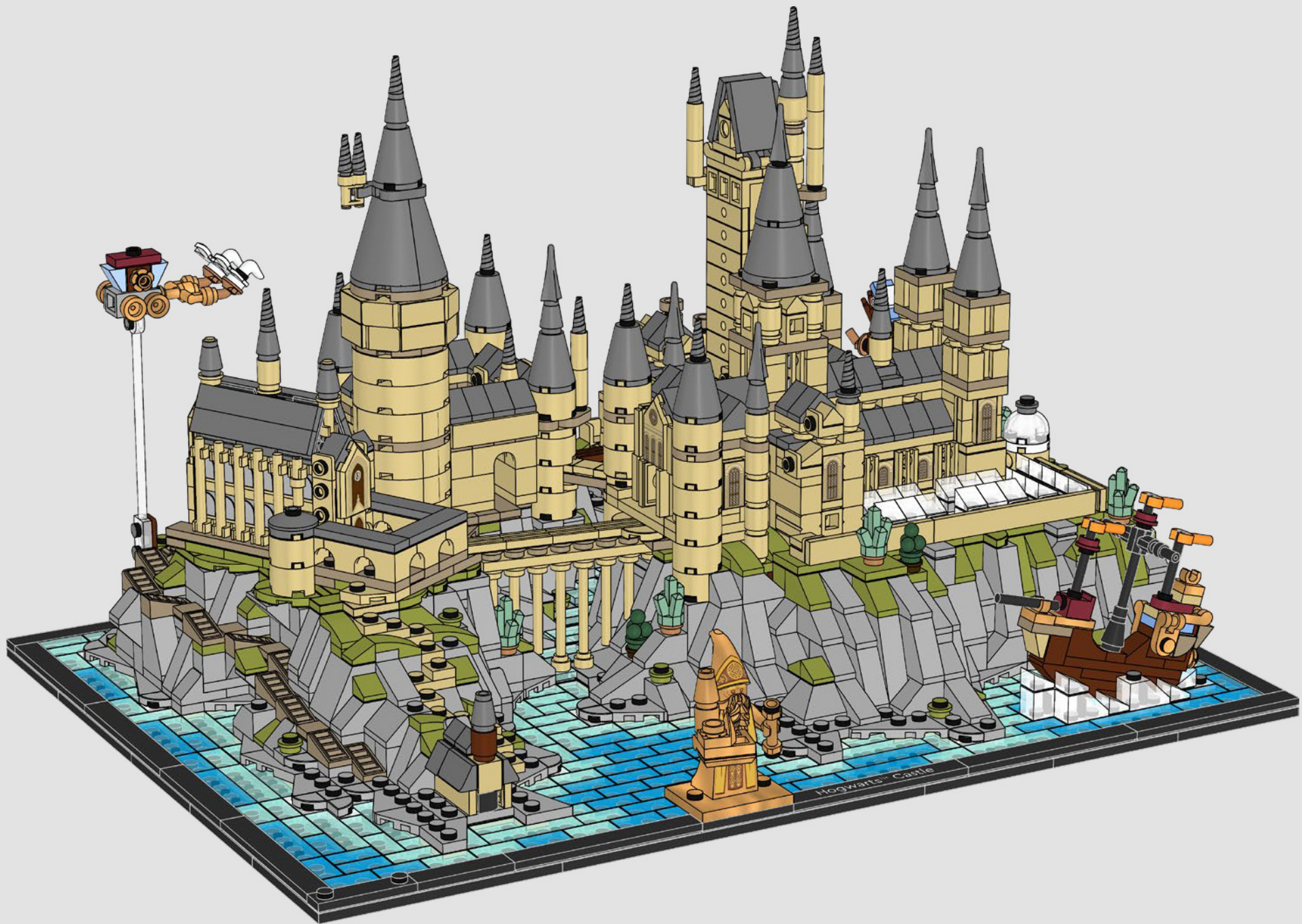



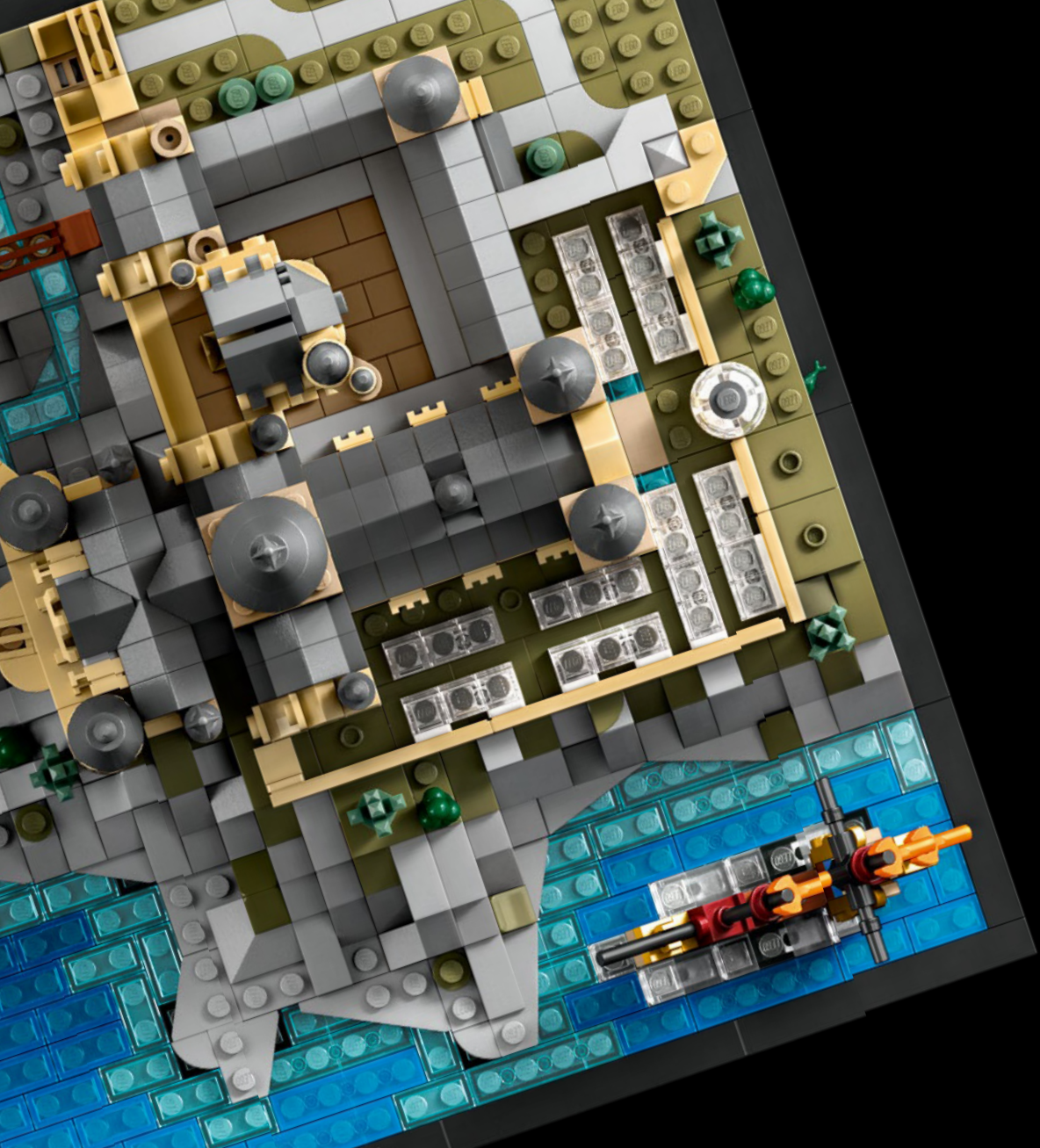

Hogwarts™ Castle



- 2x 614101
- 2x 6186681
- 2x 6328195
- 5x 307001
- 9x 302401
- 1x 6348055
- 8x 6242241
- 2x 4111971
- 2x 6382783
- 1x 6044691
- 1x 403201
- 1x 4667575
- 7x 302301
- 1x 6070698
- 3x 362301
- 11x 6195371
- 1x 4550745
- 1x 246501
- 3x 300201
- 2x 371001
- 2x 300101
- 1x 6222425
- 1x 366601
- 7x 6454936
- 27x 4117070
- 3x 4529237
- 63x 4161734
- 11x 6443061
- 2x 6353196
- 1x 4569547
- 1x 6167923
- 19x 4113915
- 20x 6454440
- 30x 4118793
- 9x 6230284
- 41x 4159553
- 16x 4125253
- 10x 4516055
- 8x 6232135
- 2x 4612603
- 3x 6145570
- 3x 4529237
- 63x 4161734
- 11x 6443061
- 2x 6353196
- 17x 6365720
- 3x 6374151
- 1x 4213568
- 1x 4224793
- 1x 6360037
- 1x 6454941
- 2x 6212758
- 5x 6351413
- 2x 6408047
- 1x 6447501
- 1x 6262018
- 1x 4624086
- 2x 4140562
- 2x 4579260
- 2x 4179771
- 4x 6175968
- 17x 6365720
- 3x 6374151
- 1x 4213568
- 1x 4224793
- 1x 6360037
- 1x 6454941
- 2x 6212758
- 5x 6351413
- 2x 6408047
- 1x 6447501
- 1x 6262018
- 1x 4624086
- 2x 4140562
- 2x 4579260
- 2x 4179771
- 4x 6175968
- 9x 4218749
- 3x 6357613
- 6x 6236425
- 40x 4113917
- 34x 4114026
- 9x 6148262
- 43x 6092587
- 36x 4124456
- 10x 6455327
- 3x 6236914
- 8x 6069165
- 4x 4109995
- 1x 6024495
- 1x 6214334
- 2x 4159279
- 5x 6236423
- 1x 6445058
- 3x 6455326
- 10x 6391523
- 9x 6219794
- 2x 6103001
- 1x 4205107
- 7x 6174925
- 1x 6313611
- 1x 617975
- 1x 6249809
- 2x 6253003
- 4x 4160483
- 1x 6374166
- 2x 4217562
- 5x 6443062
- 2x 4124455
- 6x 4114077
- 6x 4114306
- 2x 6221467
- 5x 6454937
- 16x 4114084
- 4x 4185177
- 1x 4188866
- 1x 6148265
- 12x 6055868
- 1x 6469454
- 1x 6458487
- 1x 6454439
- 11x 4121921
- 6x 6131896
- 2x 4162465
- 7x 4618651
- 1x 6058093
- 4x 6211966
- 9x 6410762
- 1x 6245271
- 1x 4543858
- 12x 6116614
- 9x 4118790
- 4x 4159739
- 2x 6175367
- 10x 4113233
- 5x 6232136
- 7x 6257600
- 5x 4550324
- 23x 6352222
- 2x 4113916
- 1x 6213676
- 2x 6294592
- 4x 6115031
- 2x 6454935
- 10x 4114309
- 1x 6351905
- 7x 4124067
- 6x 4112982
- 1x 4157277
- 3x 4243824
- 1x 6383728
- 7x 4113993
- 2x 4181134
- 4x 4114324
- 2x 4159774
- 1x 4544139
- 4x 4114001
- 4x 4113988
- 1x 6075179
- 1x 4624185
- 2x 447721
- 2x 611121
- 4x 614121
- 2x 362221
- 1x 302121
- 5x 371021
- 2x 6372124
- 4x 6315780
- 1x 6347604
- 5x 242023
- 5x 301023
- 2x 366623
- 17x 614124
- 6x 362224
- 3x 362324
- 1x 4188313
- 1x 6457333
- 1x 6350055
- 1x 6454443
- 3x 6212377
- 1x 6207933
- 1x 6092594
- 1x 6326425
- 1x 6454437
- 1x 4585493
- 1x 6378168
- 4x 6209691
- 1x 4529247
- 1x 6186672
- 1x 6453281
- 1x 6454435
- 1x 6256803
- 2x 6262138
- 1x 6415995
- 1x 6083975

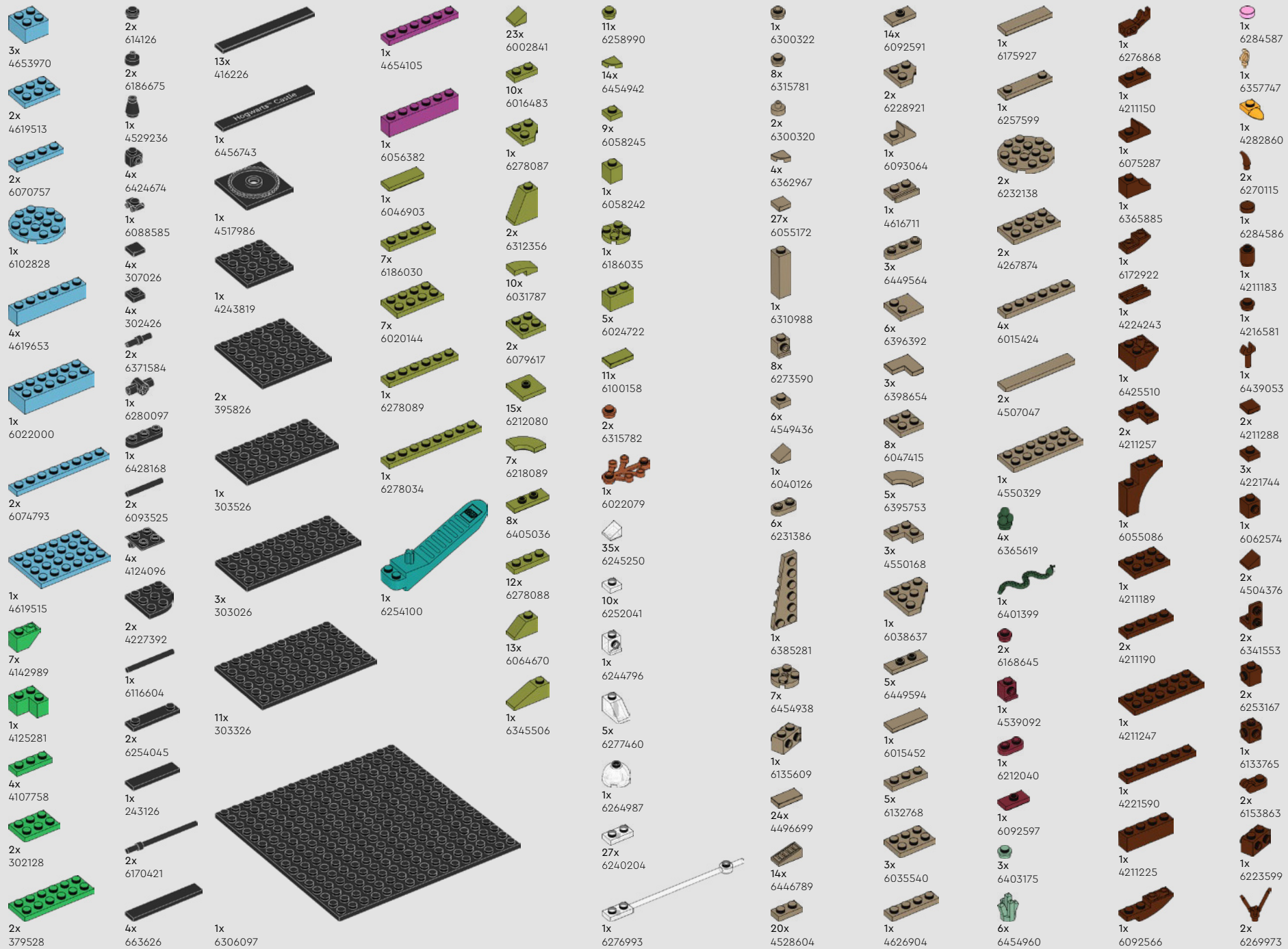

- 1x 4210763
- 2x 6168776
- 4x 4211066
- 2x 6331866
- 3x 4211094
- 1x 6126083
- 1x 6201630
- 10x 6092666
- 1x 6115080
- 1x 4211010
- 2x 6174938
- 17x 6445056
- 6x 6269969
- 15x 4529240
- 2x 6331689
- 1x 4210867
- 2x 4211100
- 8x 4210719
- 1x 4243831
- 1x 6186635
- 2x 4211103
- 3x 6231765
- 2x 4210633
- 1x 6431826
- 3x 6395635
- 4x 6454438
- 1x 4211098
- 5x 6343852
- 4x 4210651
- 4x 6262021
- 2x 4504378
- 2x 6234583
- 2x 6235153
- 7x 6167641
- 4x 6400315
- 51x 6251289
- 8x 6252050
- 1x 4179825
- 1x 6092601
- 1x 6221607
- 1x 6296892
- 45x 4226221
- 3x 4567887
- 14x 4211135
- 1x 4211088
- 3x 6069164
- 2x 6092572
- 3x 4211053
- 1x 4211105
- 1x 4529241
- 1x 6284071
- 3x 6448793
- 21x 6250597
- 1x 6455328
- 5x 4521921
- 23x 4211389
- 5x 6362975
- 12x 6176433
- 3x 6345639
- 2x 6433942
- 12x 6163478
- 6x 4211415
- 2x 4211489
- 1x 4526932
- 9x 4211394
- 1x 6420741
- 6x 4211791
- 5x 4211794
- 1x 6234738
- 18x 4211399
- 1x 6225242
- 46x 4211614
- 1x 6347715
- 3x 6258381
- 2x 4568637
- 2x 6075075
- 15x 4211488
- 2x 6211969
- 1x 4211428
- 7x 6116608
- 4x 6066097
- 5x 6186657
- 1x 4216248
- 3x 6308012
- 4x 6065824
- 1x 4651063
- 1x 6469440
- 1x 6269049
- 40x 4515374
- 12x 4211437
- 6x 4657459
- 2x 6211773
- 10x 4211445
- 13x 6093859
- 11x 4211494
- 46x 4211398
- 9x 4211414
- 2x 6170387
- 1x 4211564
- 2x 6123809
- 5x 4234535
- 8x 4211353
- 2x 4211410
- 1x 6163990
- 11x 4211396
- 2x 4211356
- 1x 6213378
- 13x 6435857
- 14x 4211349
- 11x 4211387
- 1x 4216250
- 3x 4211397
- 1x 6177078
- 1x 6126082
- 18x 4211429
- 8x 4211386
- 2x 6435930
- 1x 6306729
- 4x 6163477
- 1x 4645397
- 3x 4558169
- 1x 6075066
- 3x 4211438
- 2x 4211393
- 1x 4618874
- 2x 4243797
- 2x 4211549
- 1x 6015347
- 7x 4211385
- 2x 4211395
- 1x 6372029
- 1x 4211392
- 6x 4211404
- 1x 6037399
- 1x 4211474
- 3x 4251149
- 2x 4211521
- 2x 4211407
- 3x 6059033
- 3x 4211452
- 1x 4211795
- 2x 4211425
- 6x 4157103
- 3x 6439042
- 3x 4173805
- 16x 4121739
- 17x 4220634
- 23x 4164037
- 10x 6254256
- 85x 6251295
- 3x 6343877
- 11x 6252049
- 1x 4211522
- 1x 4211402
- 1x 4211405

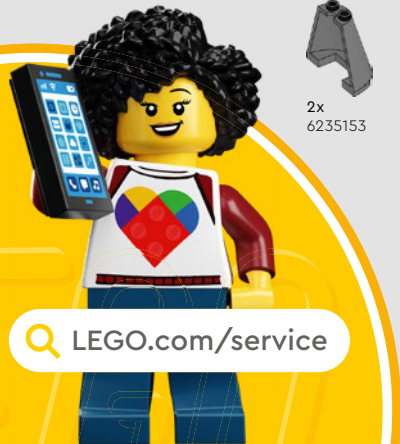

 [LEGO.com/service](https://www.LEGO.com/service)



YOU COULD WIN



YOU COULD WIN

Your feedback will help shape the future development of this product series.

Visit:

DU KÖNNTEST GEWINNEN

Dein Feedback trägt zur Weiterentwicklung dieser Produktreihe bei.

Geh auf:

VOUS POURRIEZ GAGNER

Vos commentaires nous aideront à concevoir les futurs produits de cette gamme.

Visitez :

POTRESTI VINCERE TU

La tua opinione ci aiuterà a migliorare la creazione futura di questa linea di prodotti.

Visita:

PUEDES GANAR

Tu opinión contribuirá al futuro de esta serie de productos.

Visita:

轻松获奖

您的反馈将有助于我们在今后改进本产品系列。

请访问:

LEGO.com/productfeedback

You also have the chance to win a LEGO® set.

Terms and conditions apply.*

Außerdem hast du die Chance, ein LEGO® Set zu gewinnen.

Es gelten die Teilnahmebedingungen.*

Vous pourriez également gagner un ensemble LEGO®.

Des conditions s'appliquent.*

Hai anche la possibilità di vincere un set LEGO®.

Termini e condizioni sono applicabili.*

También tienes la oportunidad de ganar un set LEGO®.

Aplican términos y condiciones.*

您还有机会赢取乐高®套装。

条款和条件适用。*

*LEGO.com/productfeedback-terms

II

LEGO and the LEGO logo are trademarks of the LEGO Group. ©2023 The LEGO Group.

WIZARDING WORLD and all related trademarks, characters, names, and indicia are
© & ™ Warner Bros. Entertainment Inc. Publishing Rights © JKR. (s23)