

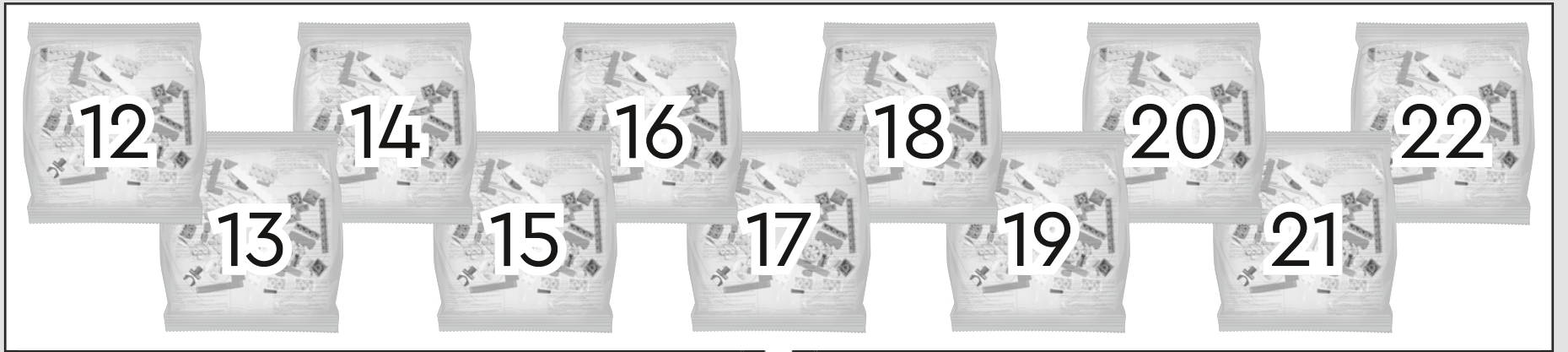

Harry Potter



WIZARDING
WORLD





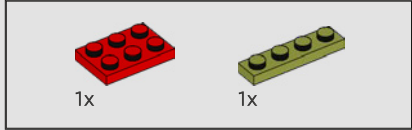
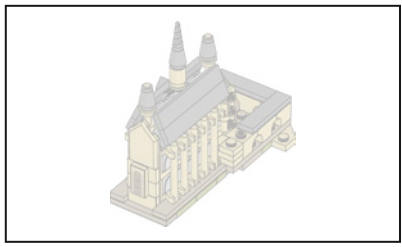

309

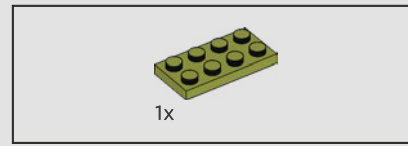
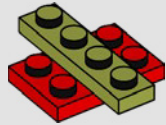

310

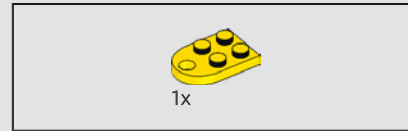
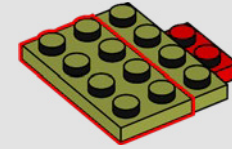

311

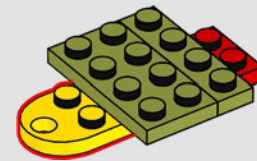

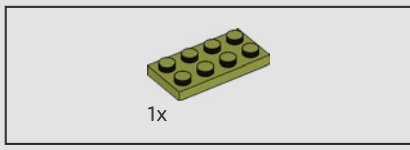

312

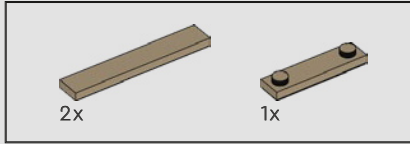
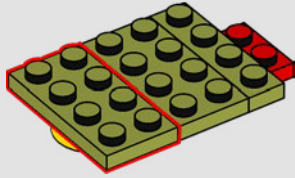

313

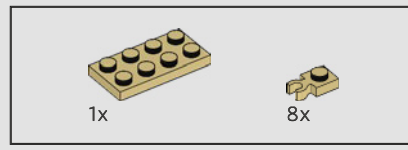
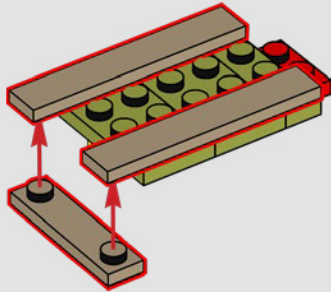

314

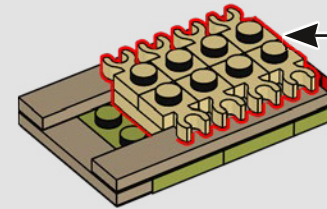
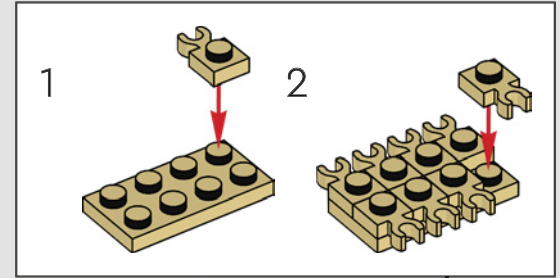

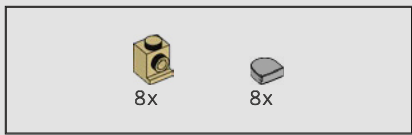

315

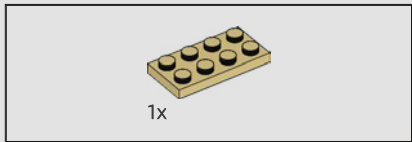
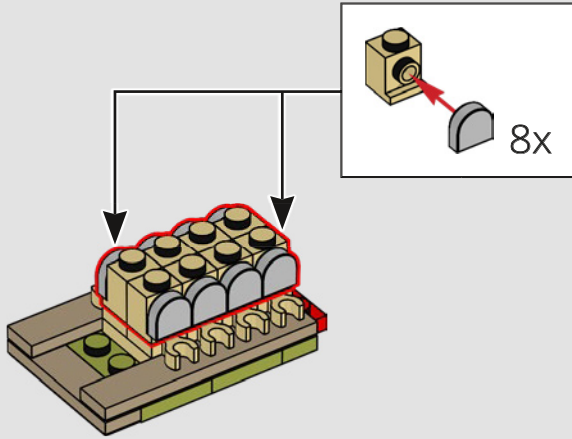

316

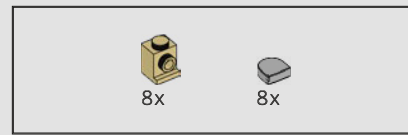
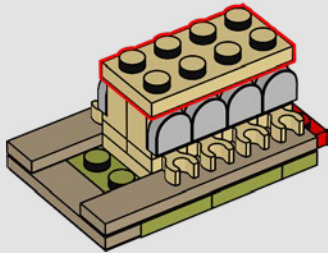

317

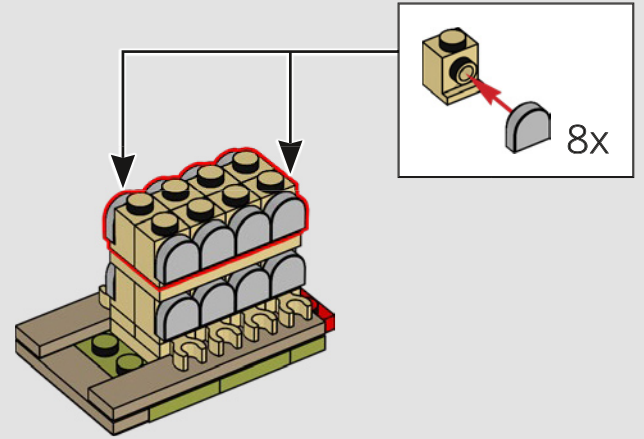

318

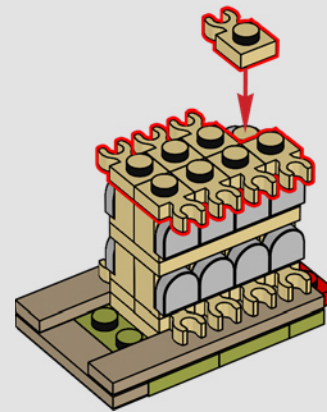

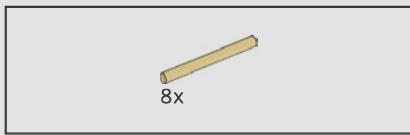

319

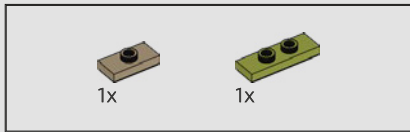
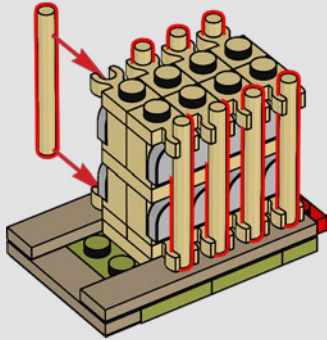

320

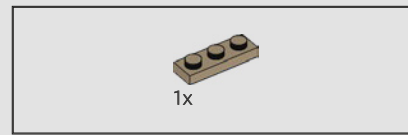
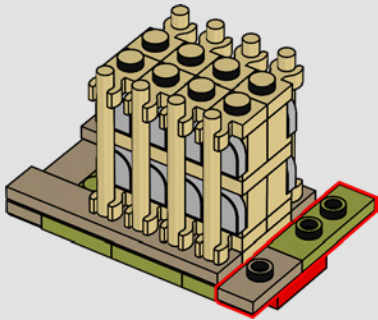

321

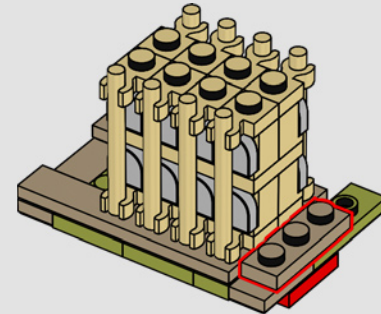

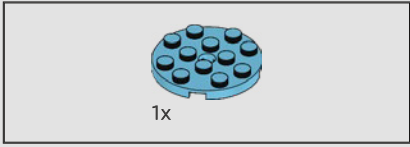
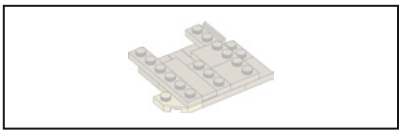

322

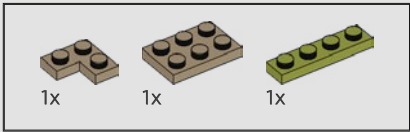
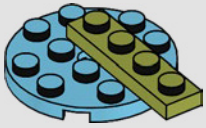

323

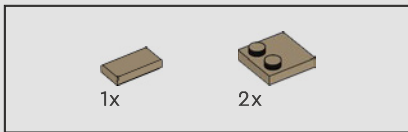
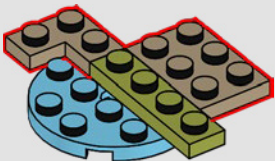

324

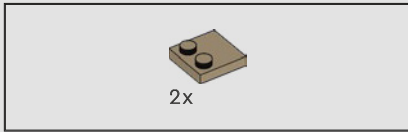
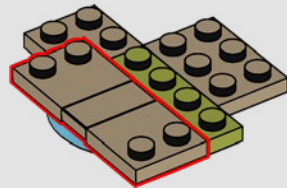

325

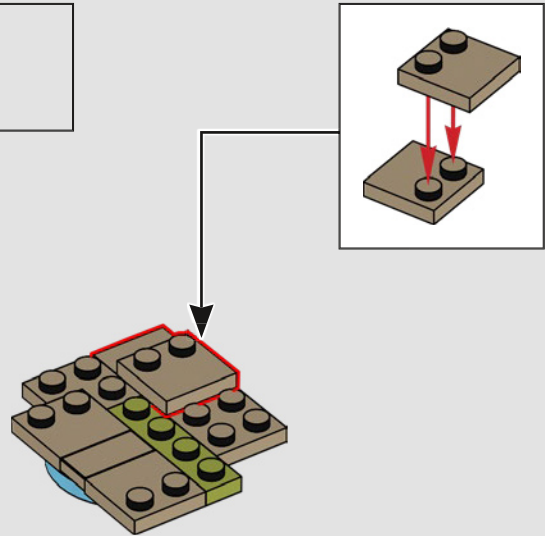

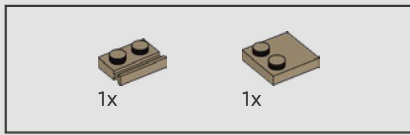

326

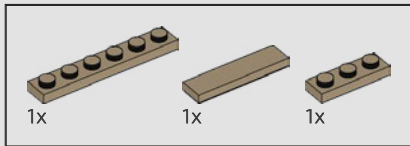
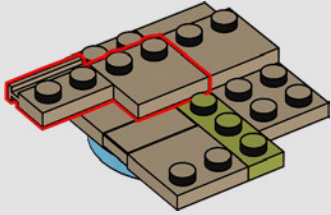

327

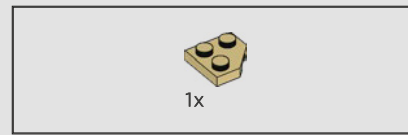
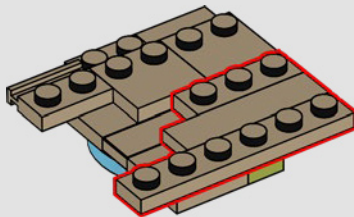

328

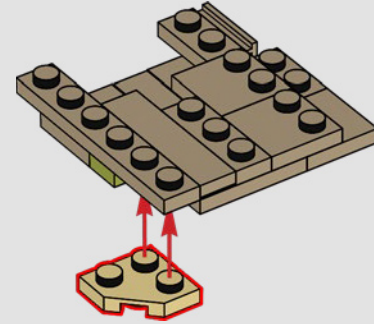

329

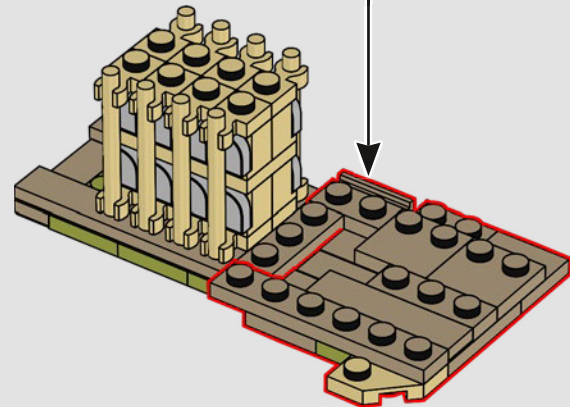

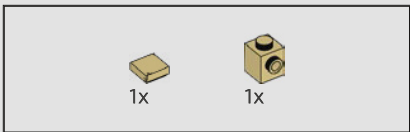

330

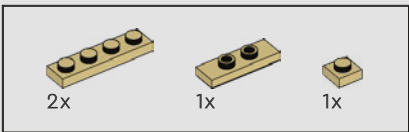
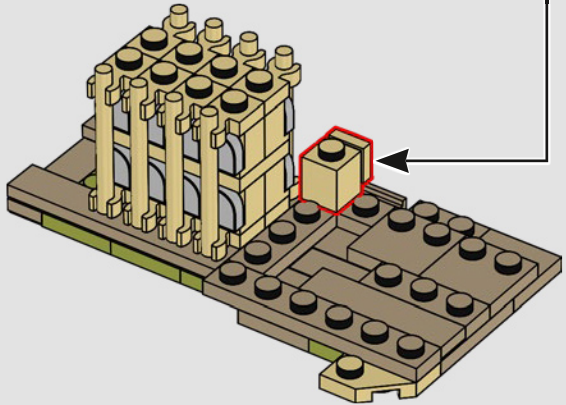
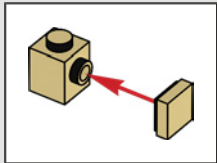

331

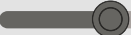
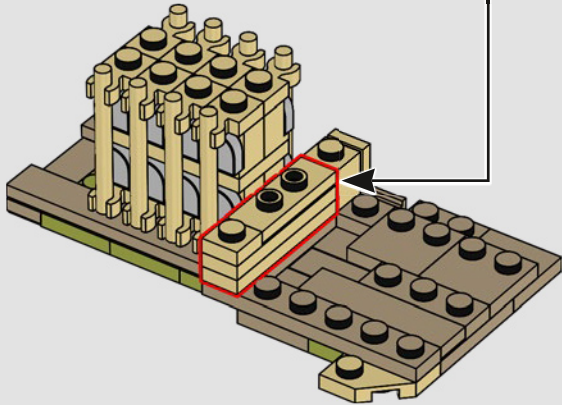
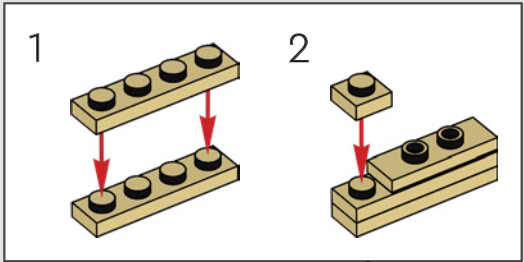

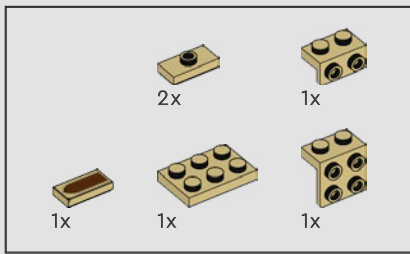

332

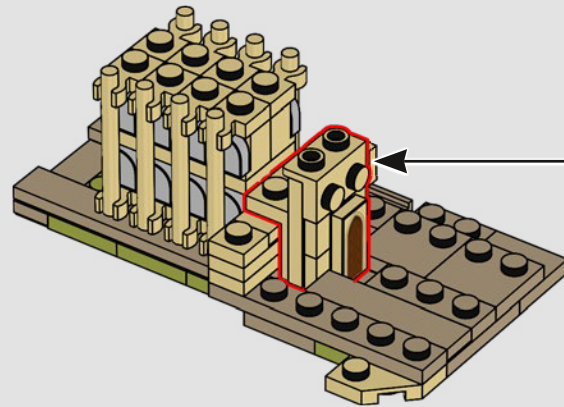
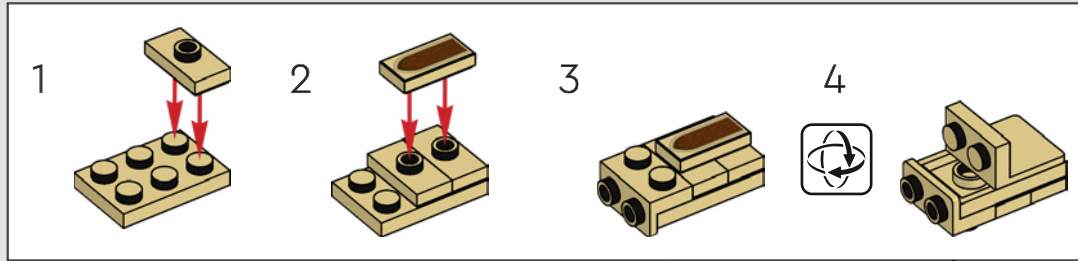



333

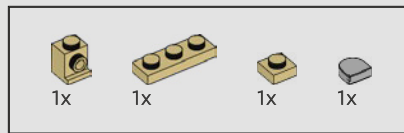
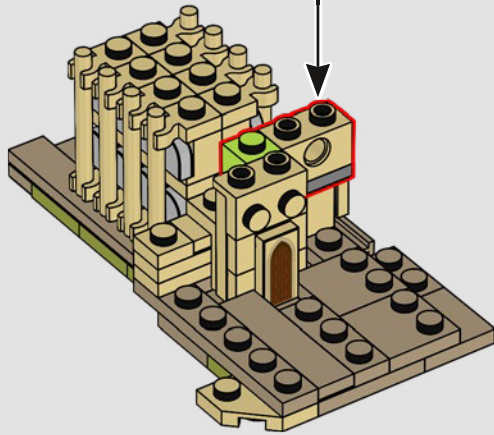
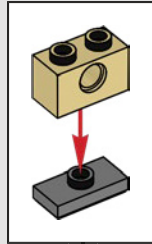

334

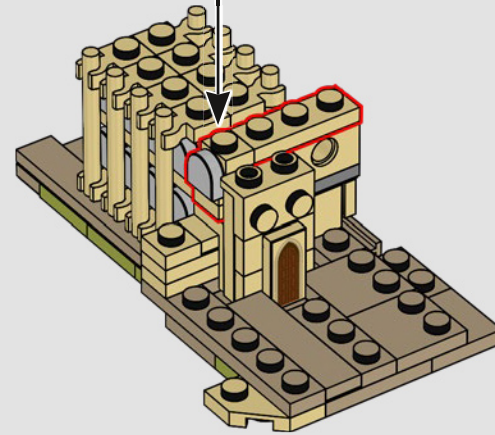
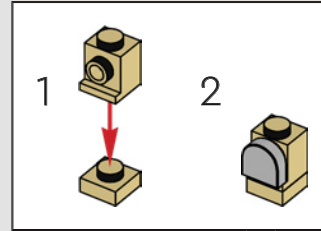



335

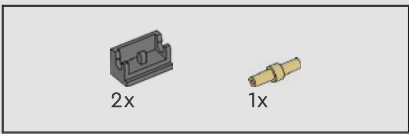
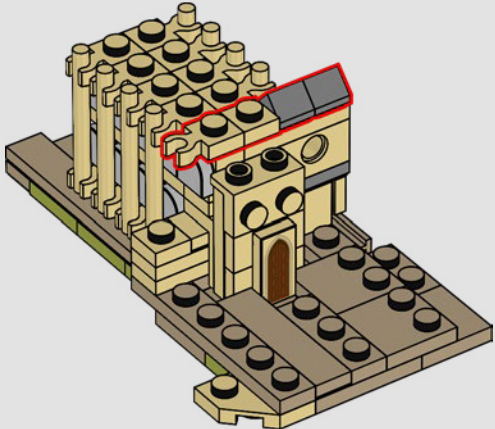

336

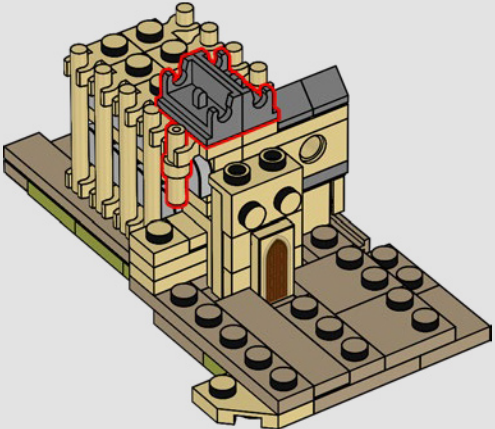

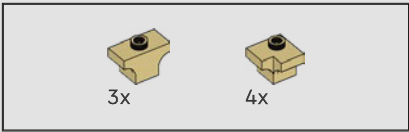

337

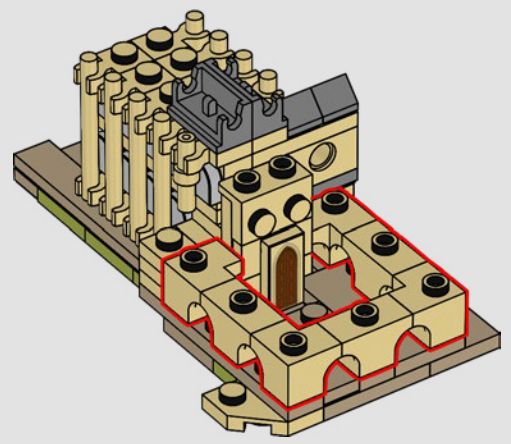

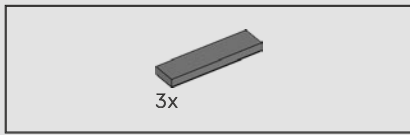

338

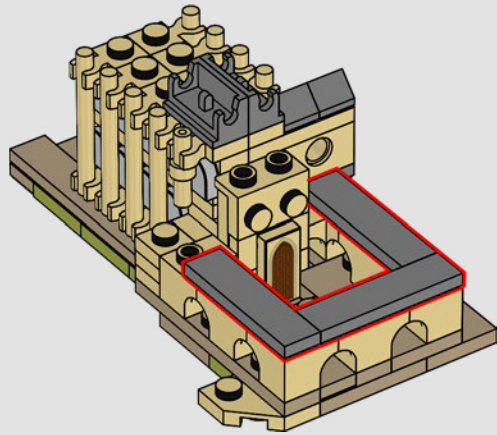

339

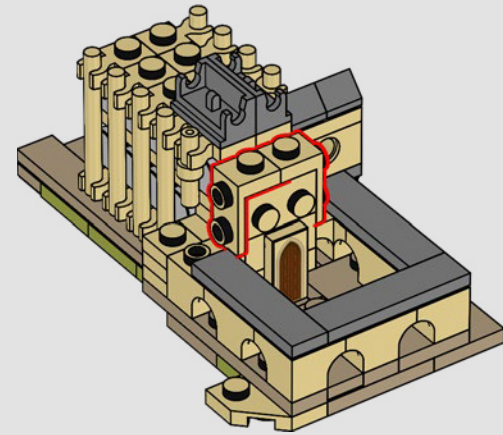



340

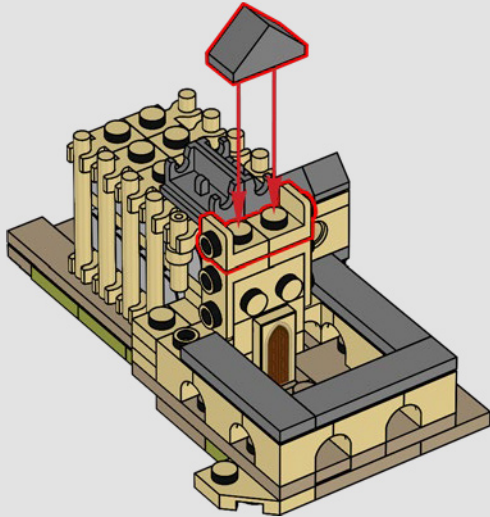

341

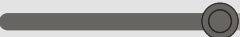
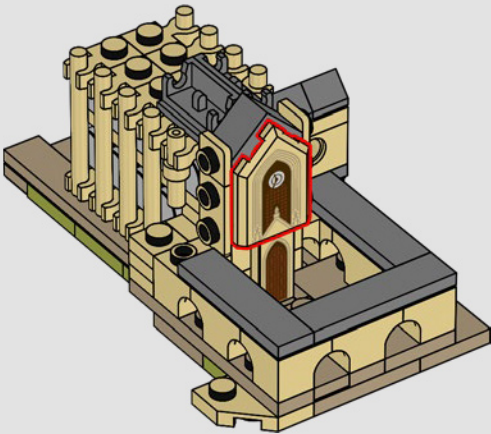

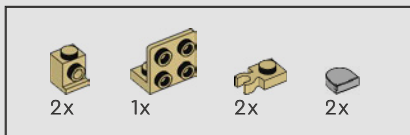

342

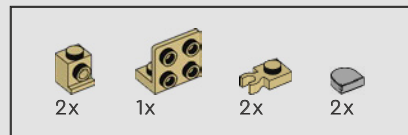
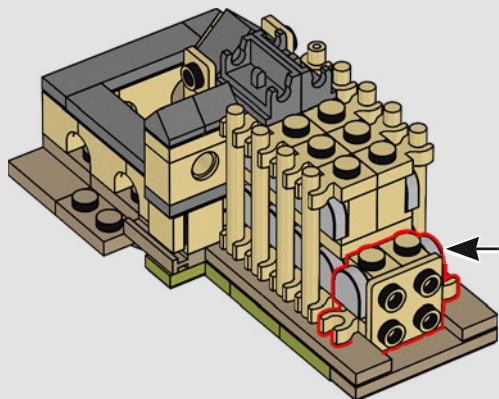
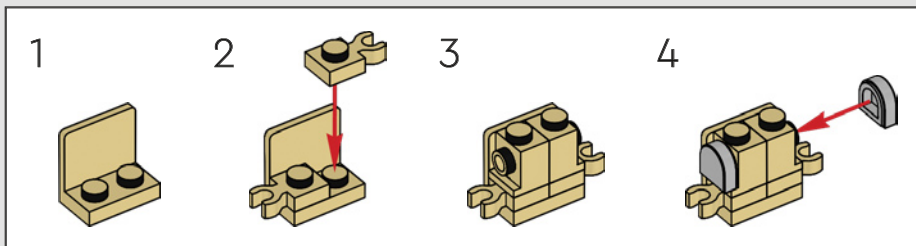

343

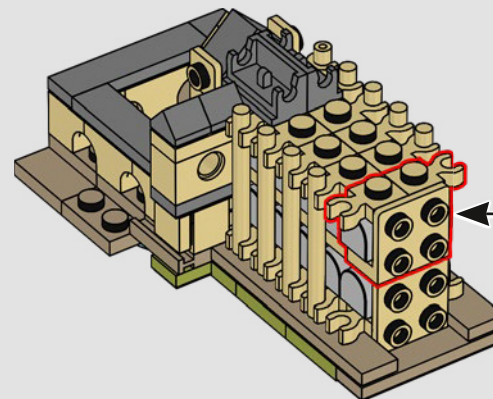
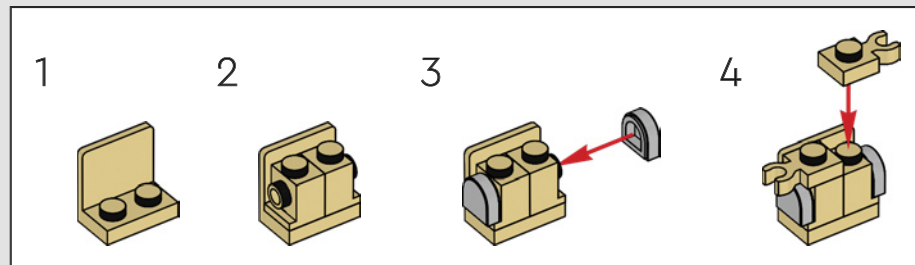

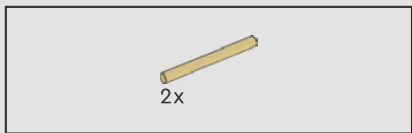

344

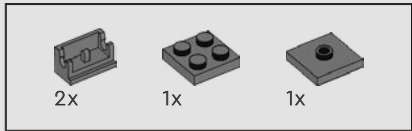
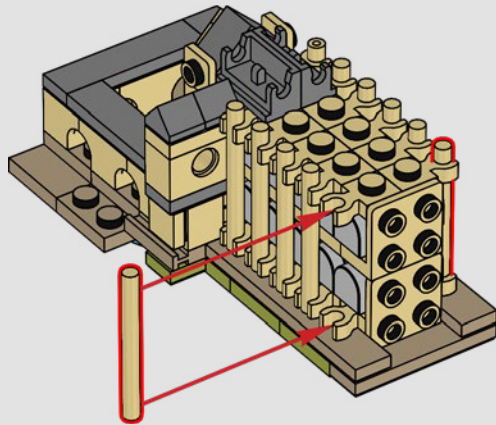

345

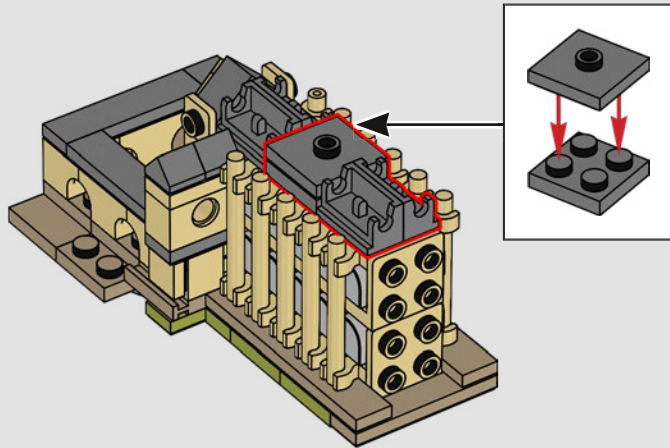

346

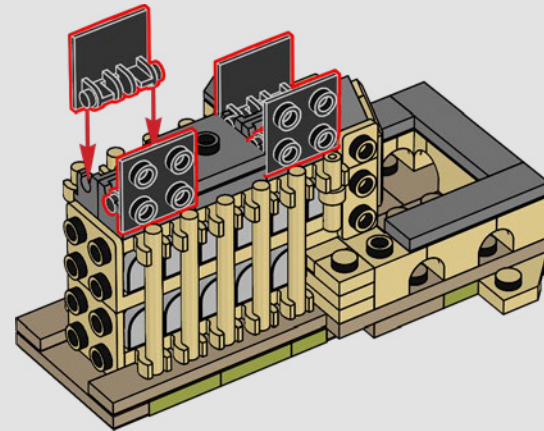

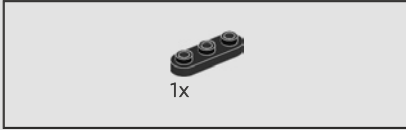
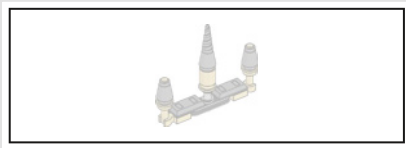

1x

347

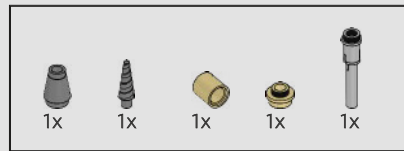

348

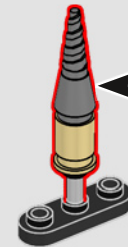
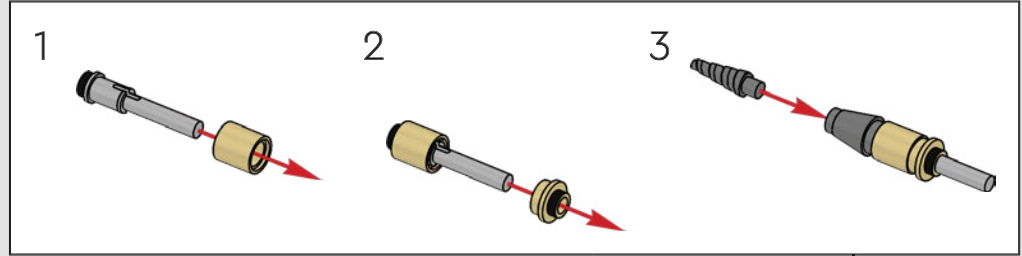



349

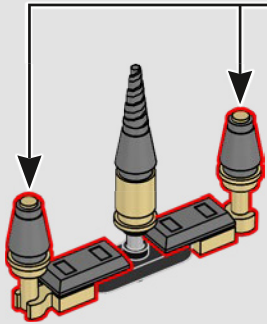
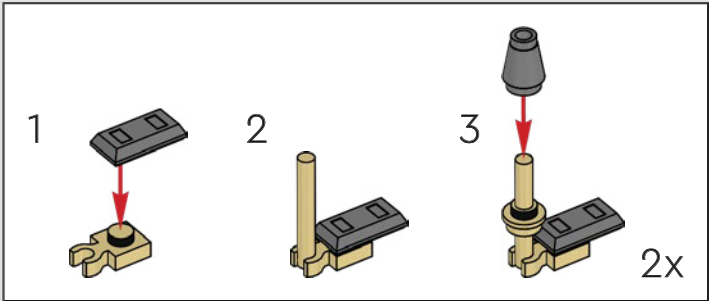

350

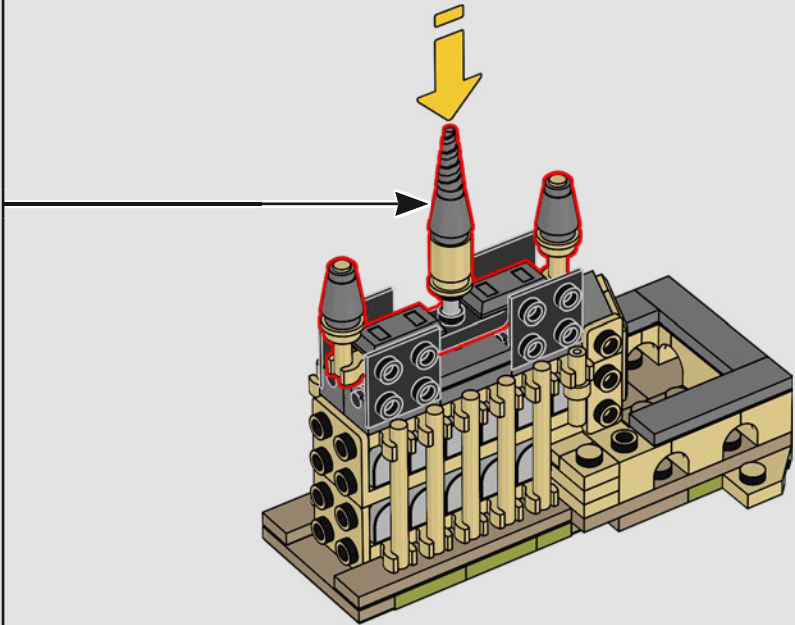

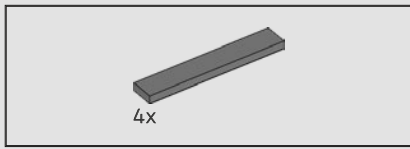

351

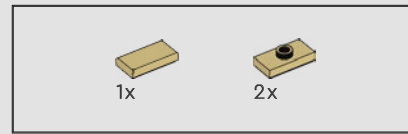
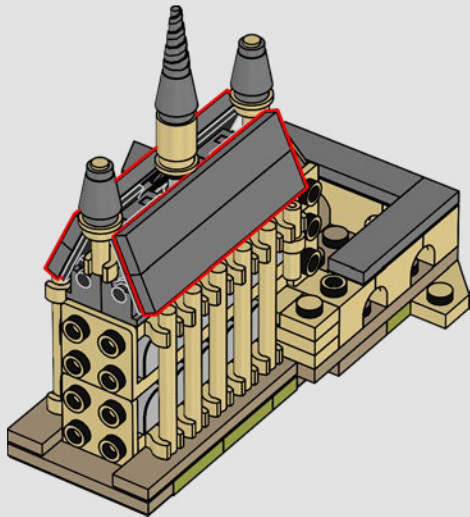

352

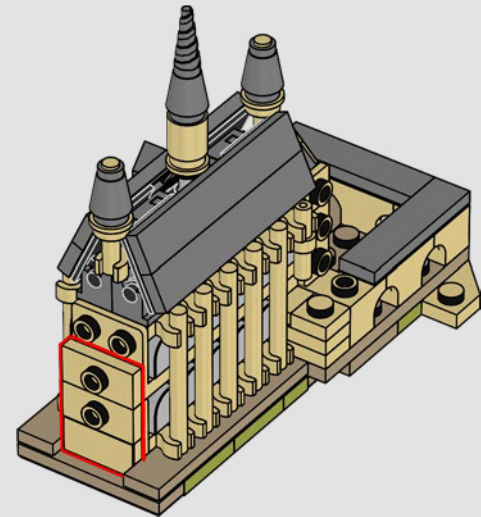

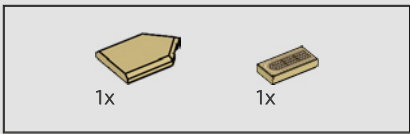

353

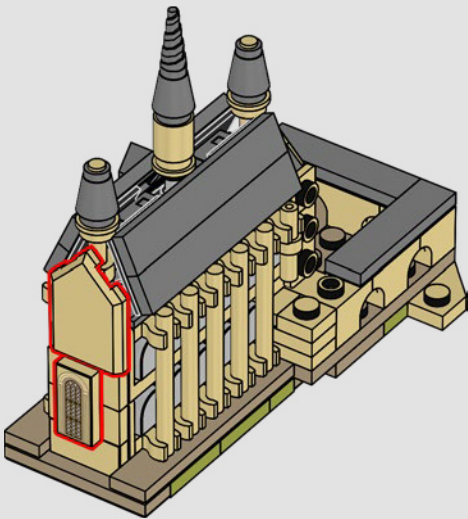

The ceiling in the Great Hall can be enchanted to mimic the night sky.

Le plafond de la Grande Salle peut être enchanté pour imiter le ciel nocturne.

El techo del Gran Comedor se puede encantar para que parezca un cielo nocturno.



354



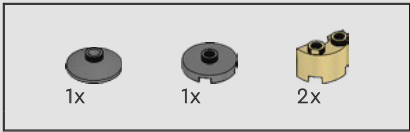

355

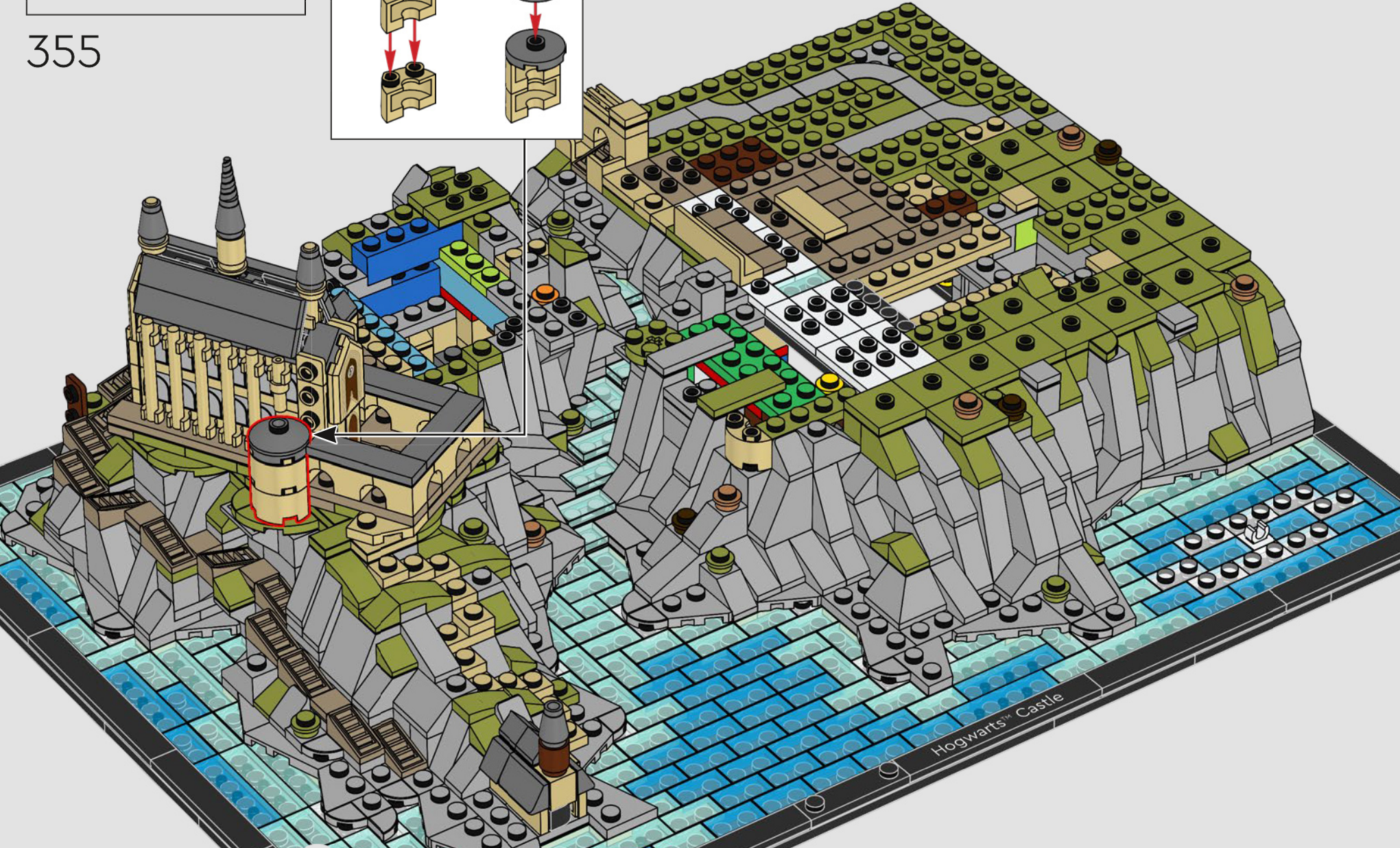
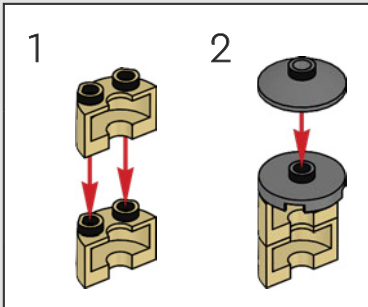

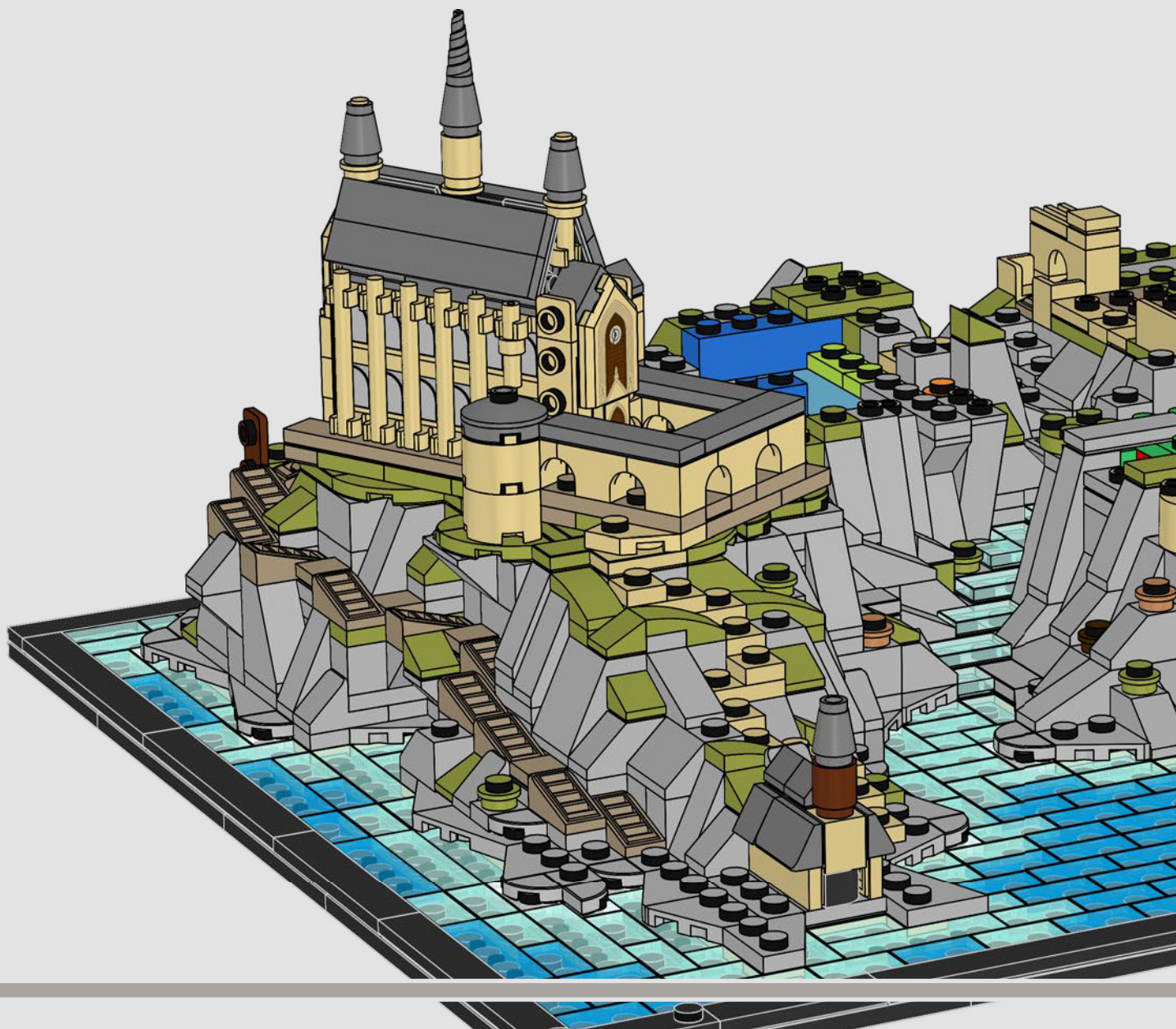

Immediately after arriving at Hogwarts™, first-year students are shown to the Great Hall where The Sorting Hat™ determines which house will be their home away from home.

Immédiatement après leur arrivée à Poudlard, les élèves de première année sont conduits dans la Grande Salle, où le Choixpeau déterminera à quelle maison chacun va appartenir.

Inmediatamente después de llegar a Hogwarts™, los alumnos del primer año son conducidos al Gran Comedor, donde el Sombrero Seleccionador determina qué casa será su hogar.



356



The trees are built with LEGO® crystal and ice cream elements (and a little magic).

Les arbres sont construits avec des éléments de cristal et de glace LEGO® (et un soupçon de magie).

Los árboles están contruidos con elementos LEGO® que representan cristales y helado (y un poco de magia).



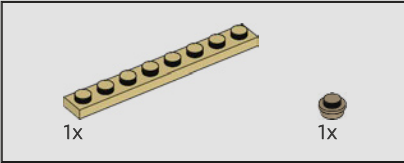
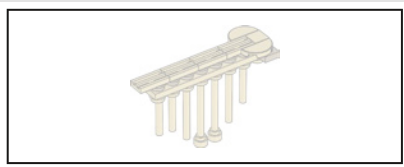

357

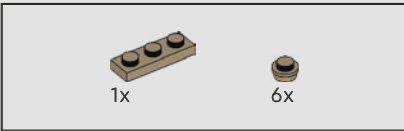
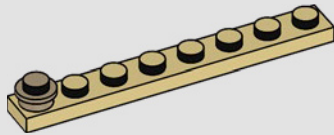

358

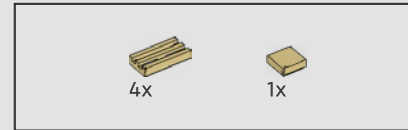
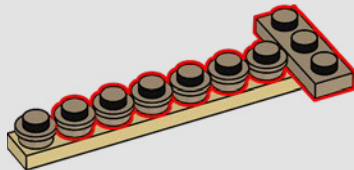

359

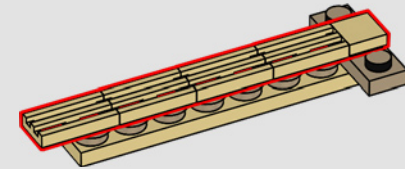

360

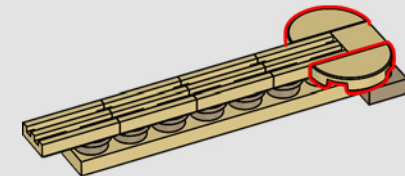

8x

361

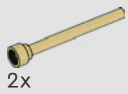
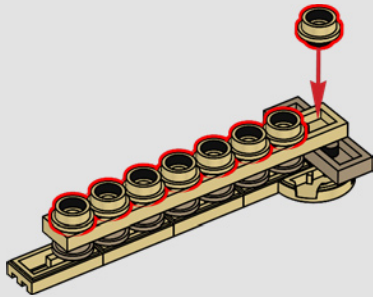

2x

362

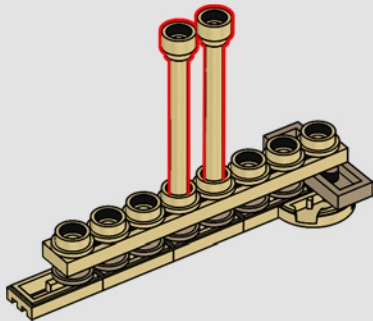

2x

3x

363

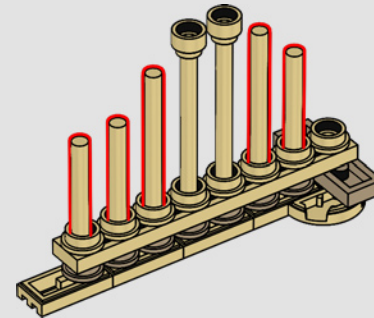

364



Hogwarts™ Castle

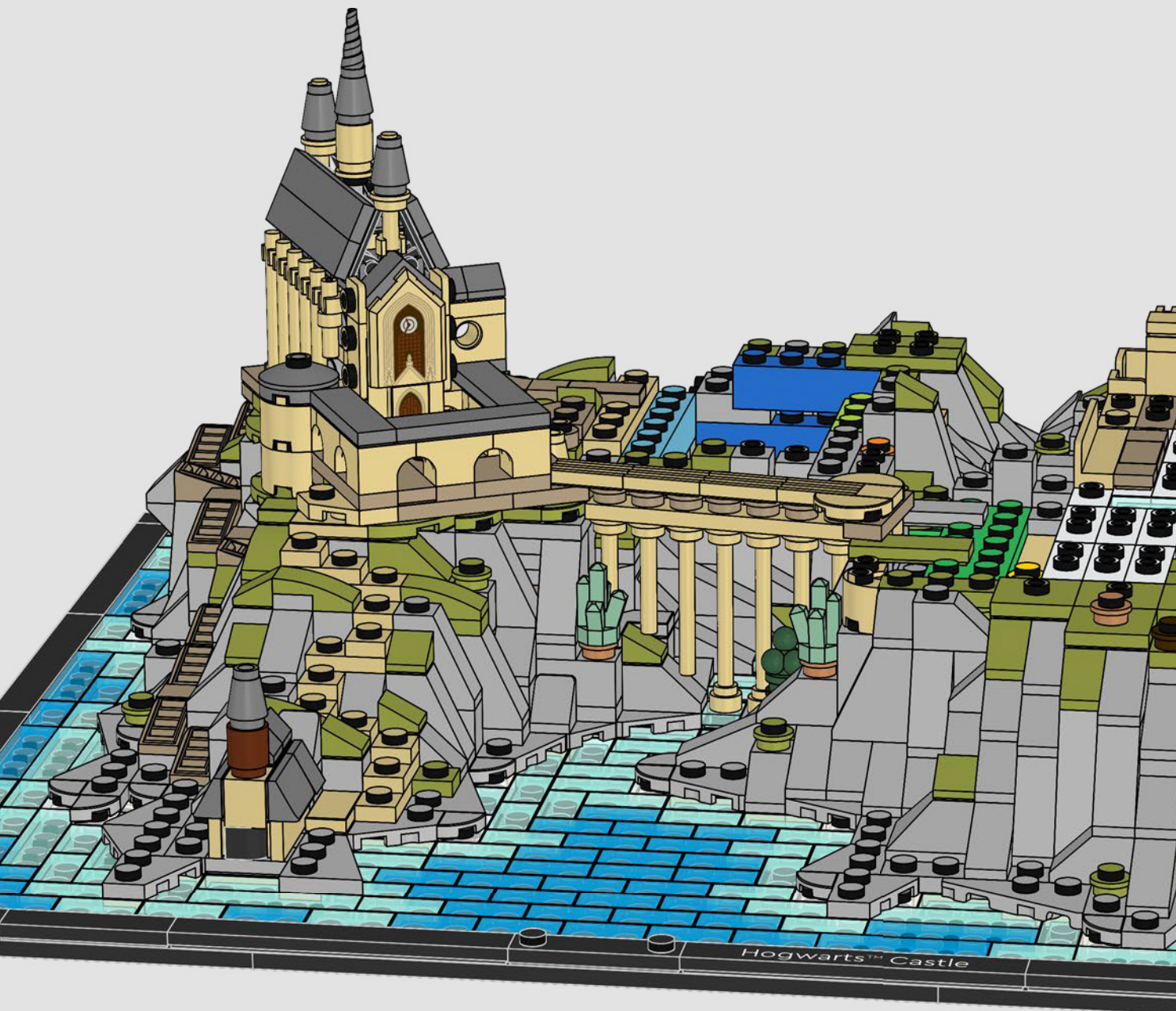

The Viaduct Bridge is not only iconic to the Hogwarts™ silhouette, but it is a central location during the Battle of Hogwarts: when Professor McGonagall™ enchants the suits of armor to do their duty to the school and protect everyone inside, they head toward the bridge. It is also a key moment during the First Task of the Triwizard Tournament, when the Hungarian Horntail soars underneath it to chase Harry.

Le viaduc est non seulement un élément emblématique de la silhouette de Poudlard, mais aussi un lieu crucial lors de la bataille de Poudlard : lorsque les armures sont enchantées par le professeur McGonagall pour « faire leur devoir envers l'école » et protéger tous ceux qui se trouvent à l'intérieur, celles-ci se dirigent vers le viaduc. Il est également témoin de la première épreuve du Tournoi des Trois Sorciers, lorsque le Magyar à pointes vole en dessous de lui pour poursuivre Harry.

El puente del viaducto no solo constituye un elemento característico de la silueta de Hogwarts™, sino que es también el escenario de algunos momentos clave de la batalla que tiene lugar en el castillo: cuando la Profesora McGonagall lanza el hechizo a las armaduras, les pide que cumplan su deber para con la escuela y protejan a quienes están adentro mientras emprenden el camino hacia el puente. También cobra especial protagonismo durante la primera prueba del Torneo de los Tres Magos, cuando el Colacuerno Húngaro pasa por debajo persiguiendo a Harry.





365





2x

366

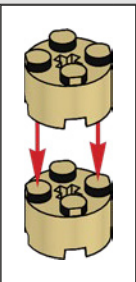
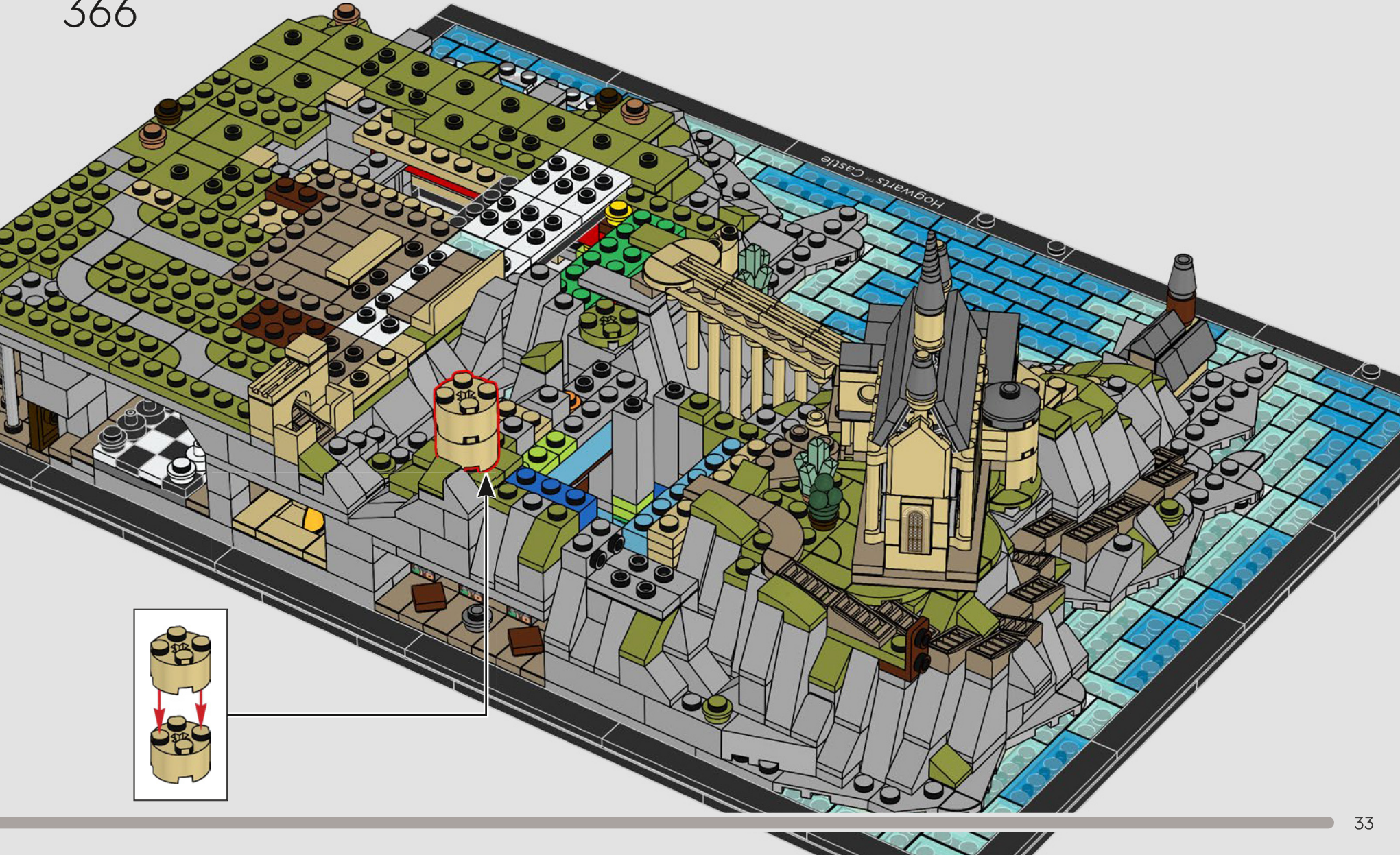

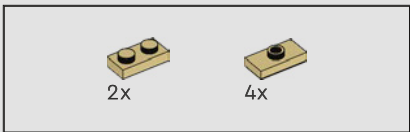

367

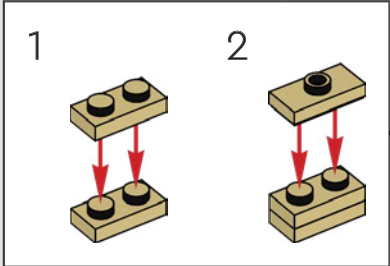
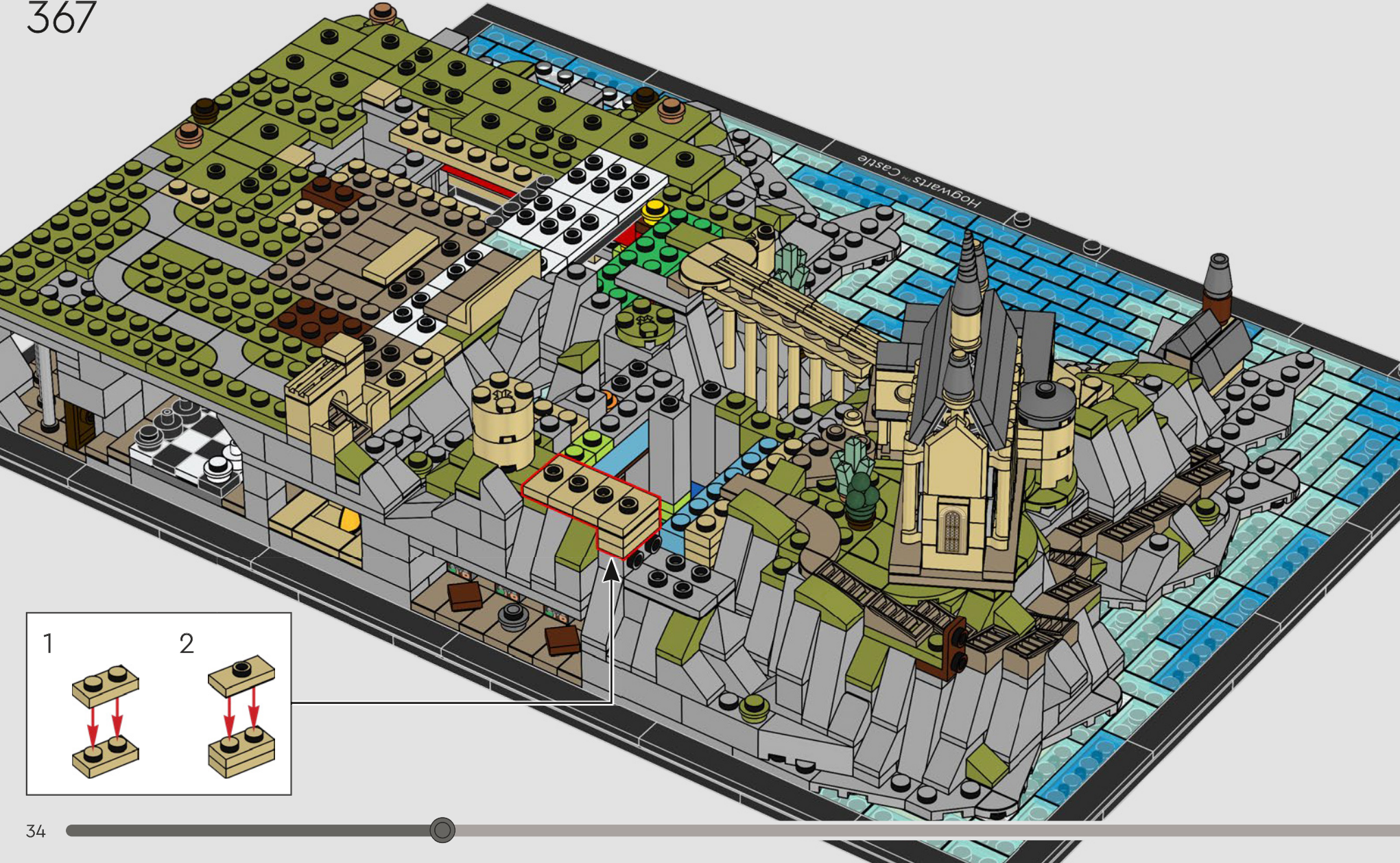

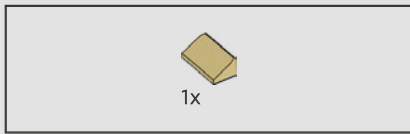

368

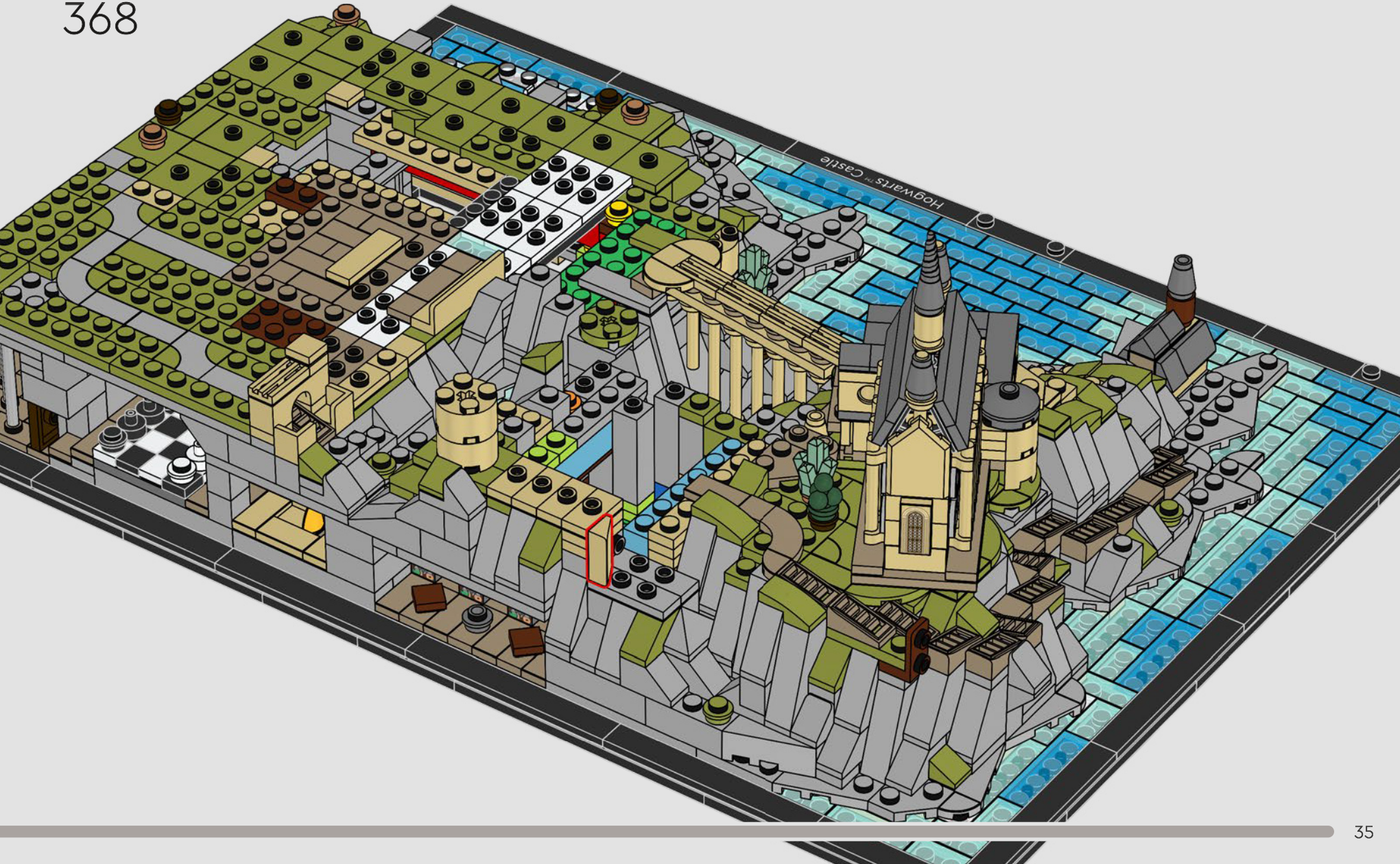

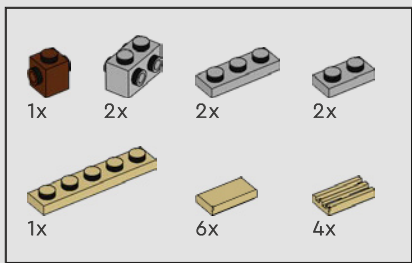

369

1

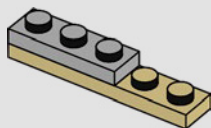

2

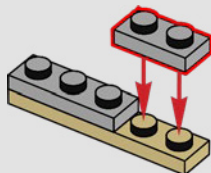

3

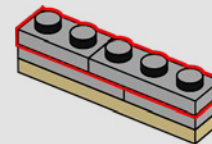

4

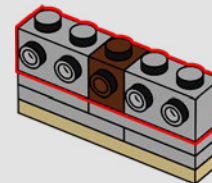

5

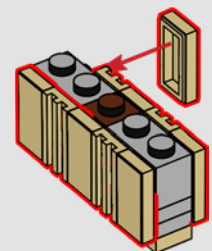

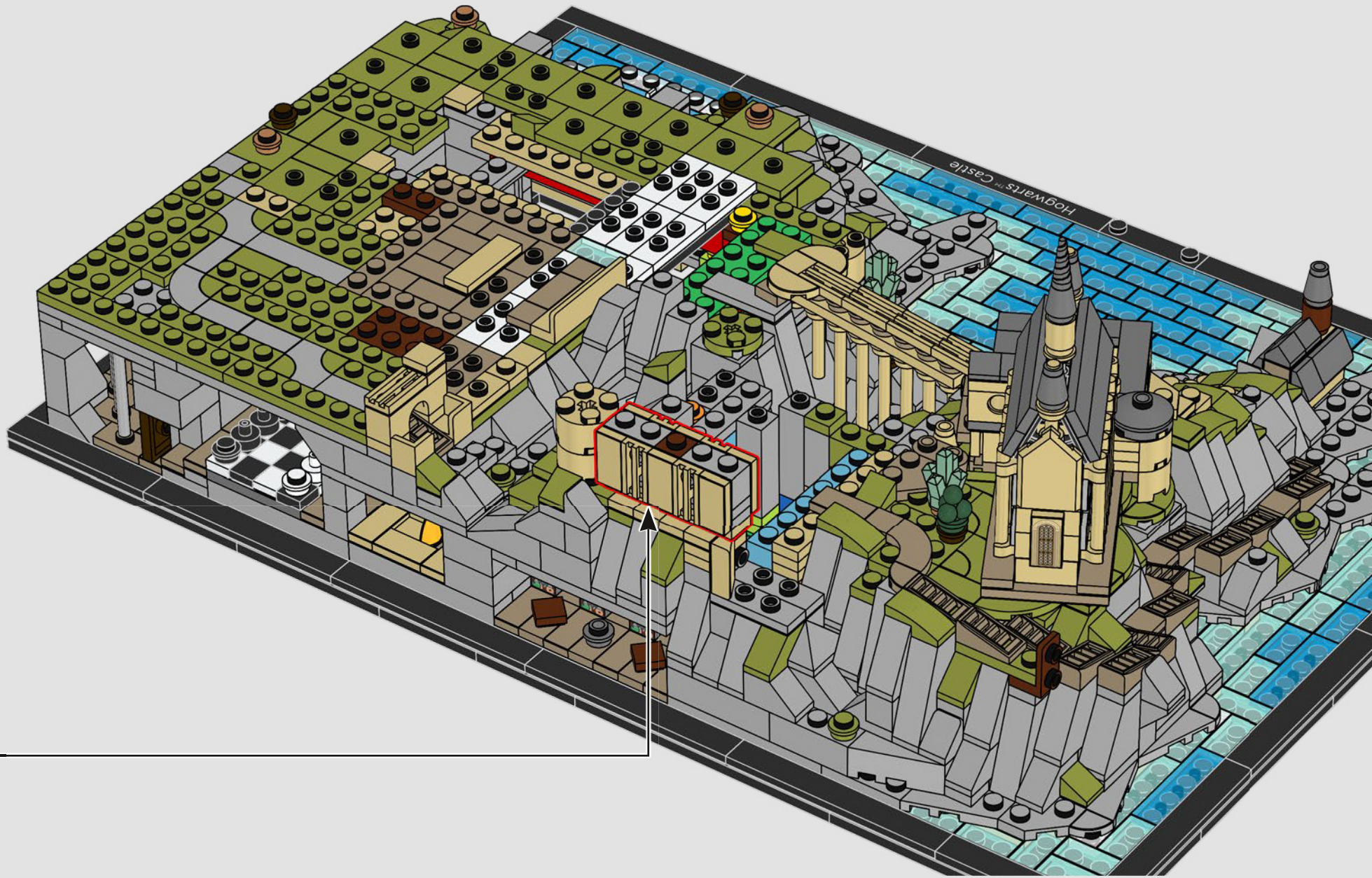

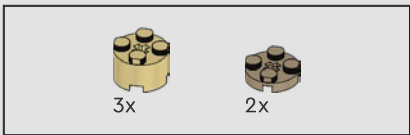

370

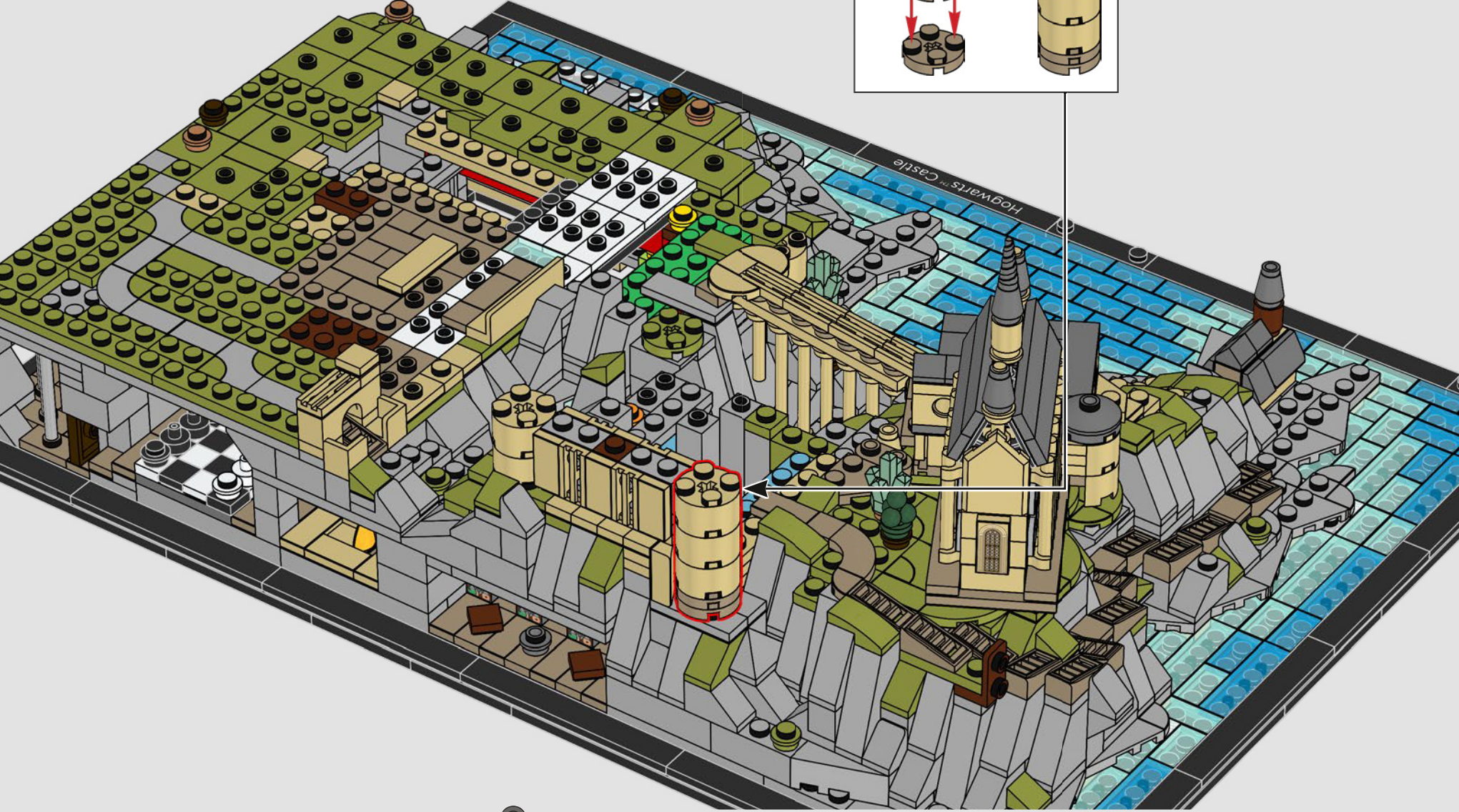
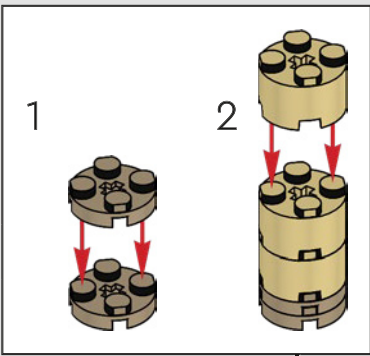

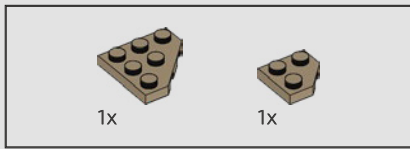

371

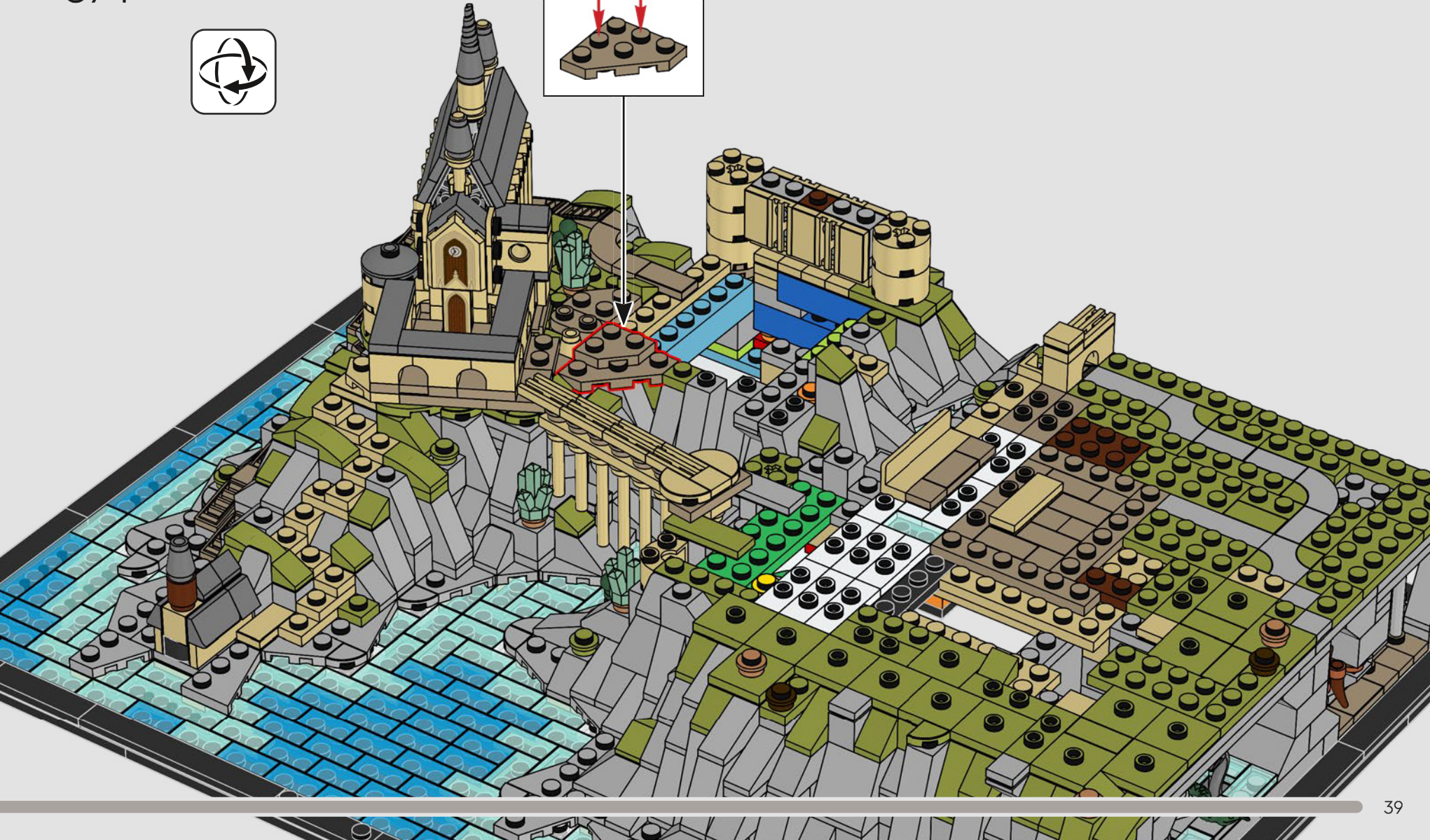
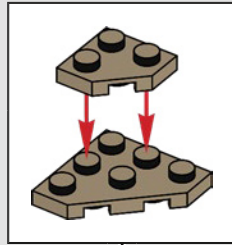

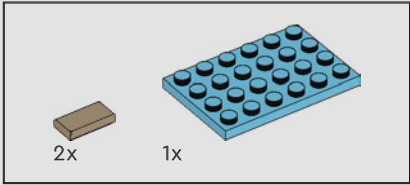
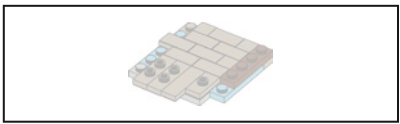

372

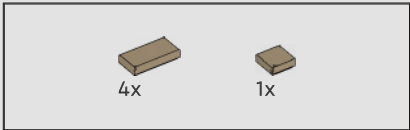
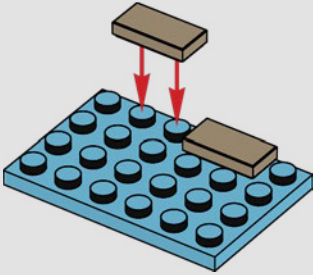

373

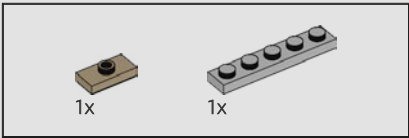
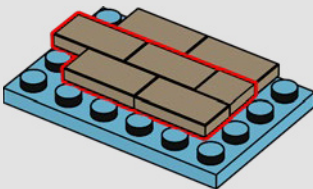

374

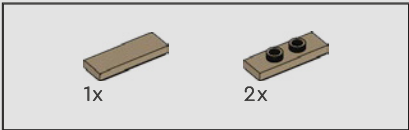
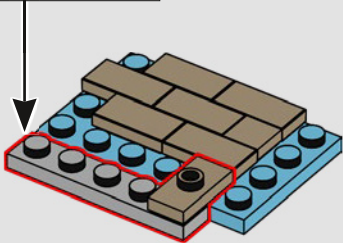
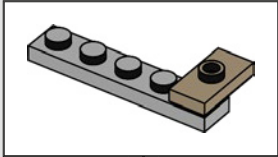

375

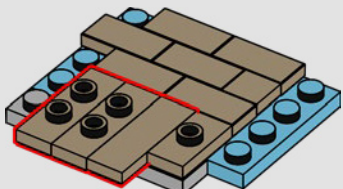

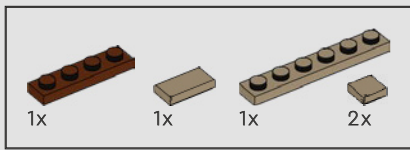

376

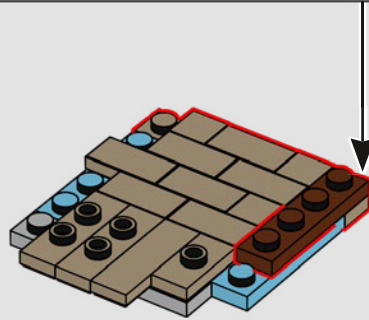
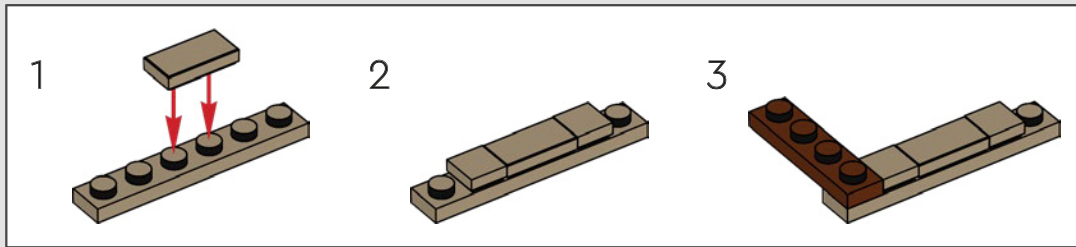

377



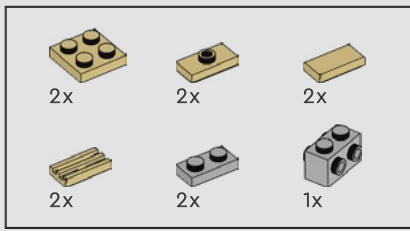

378

1

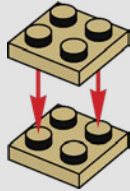

2

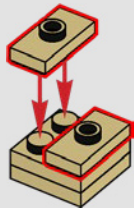

3

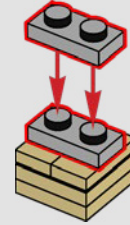

4

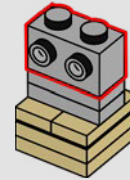

5

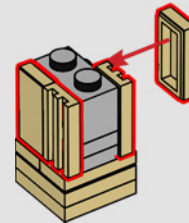



Hogwarts™ Castle

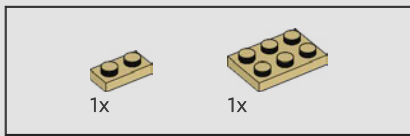

379

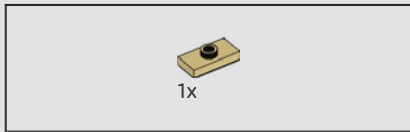
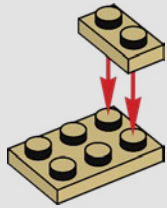

380

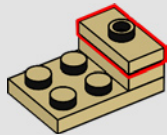

381

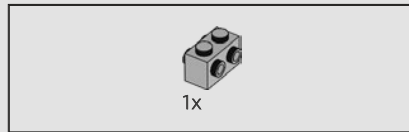
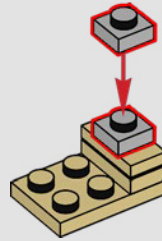

382

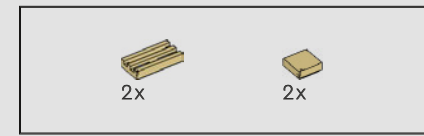
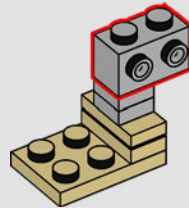

383

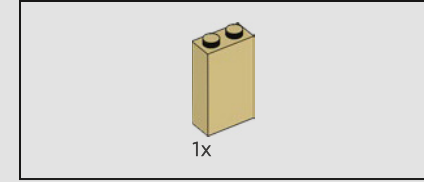
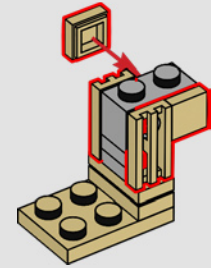

384

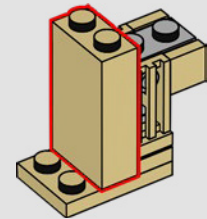

385

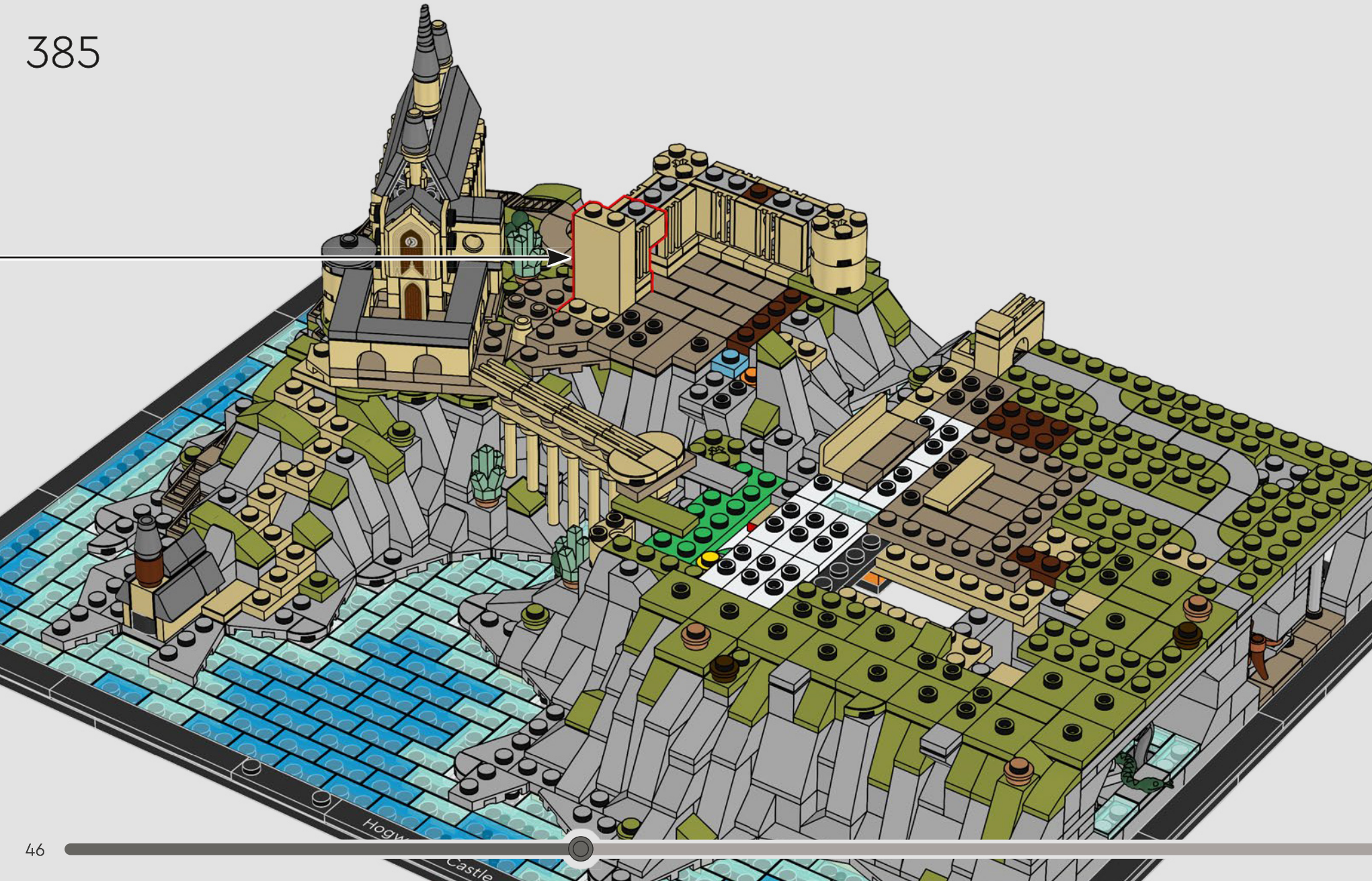

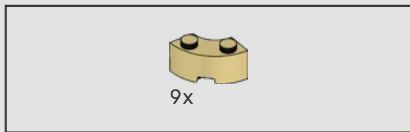

386

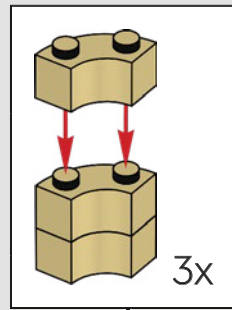

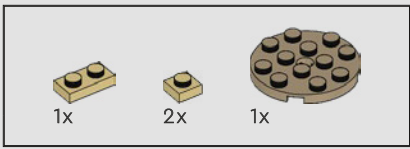

387

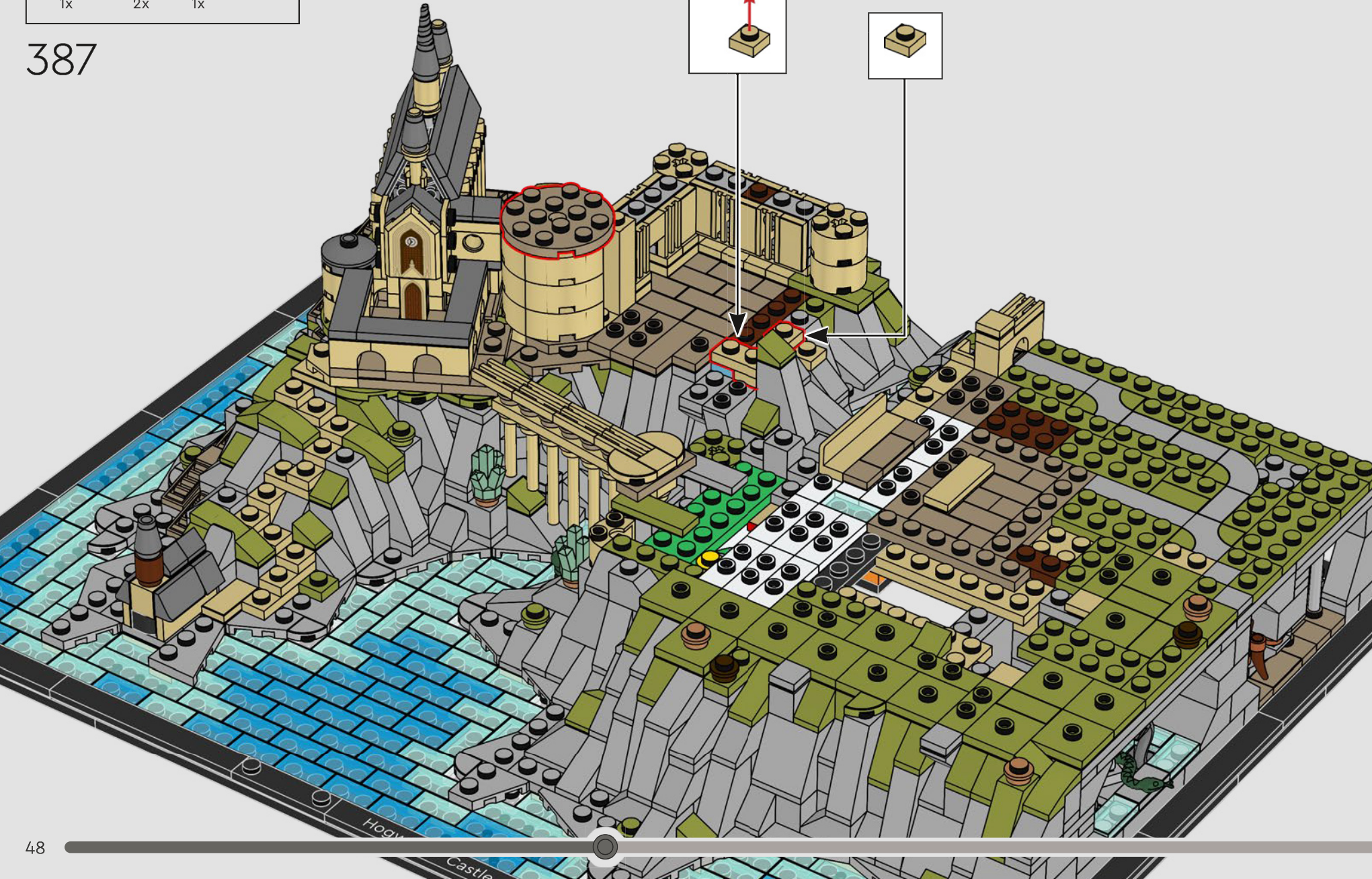
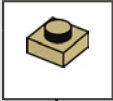
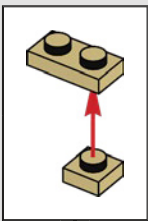

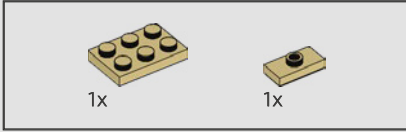
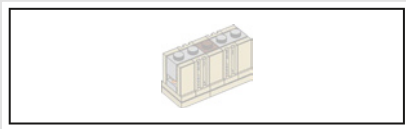

388

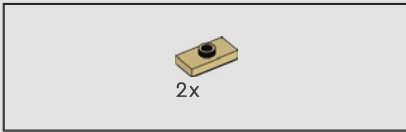
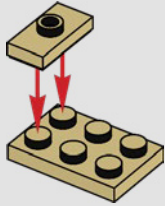

389

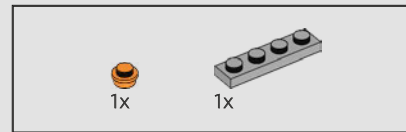
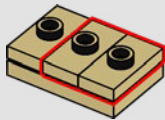

390

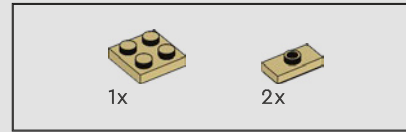
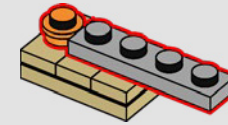

391

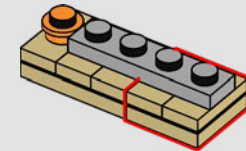
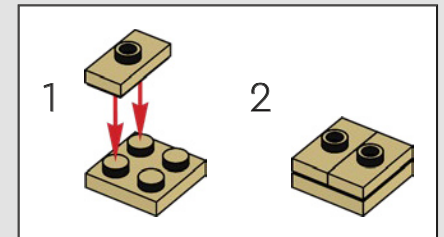

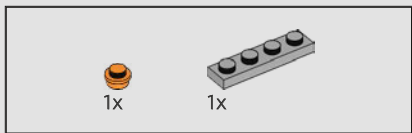

392

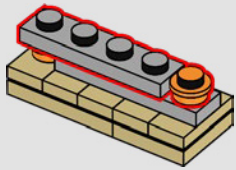

393

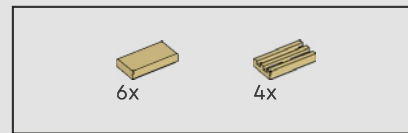
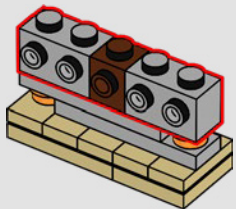

394

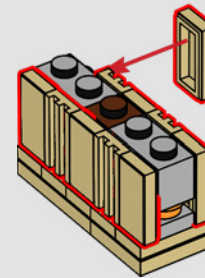

395

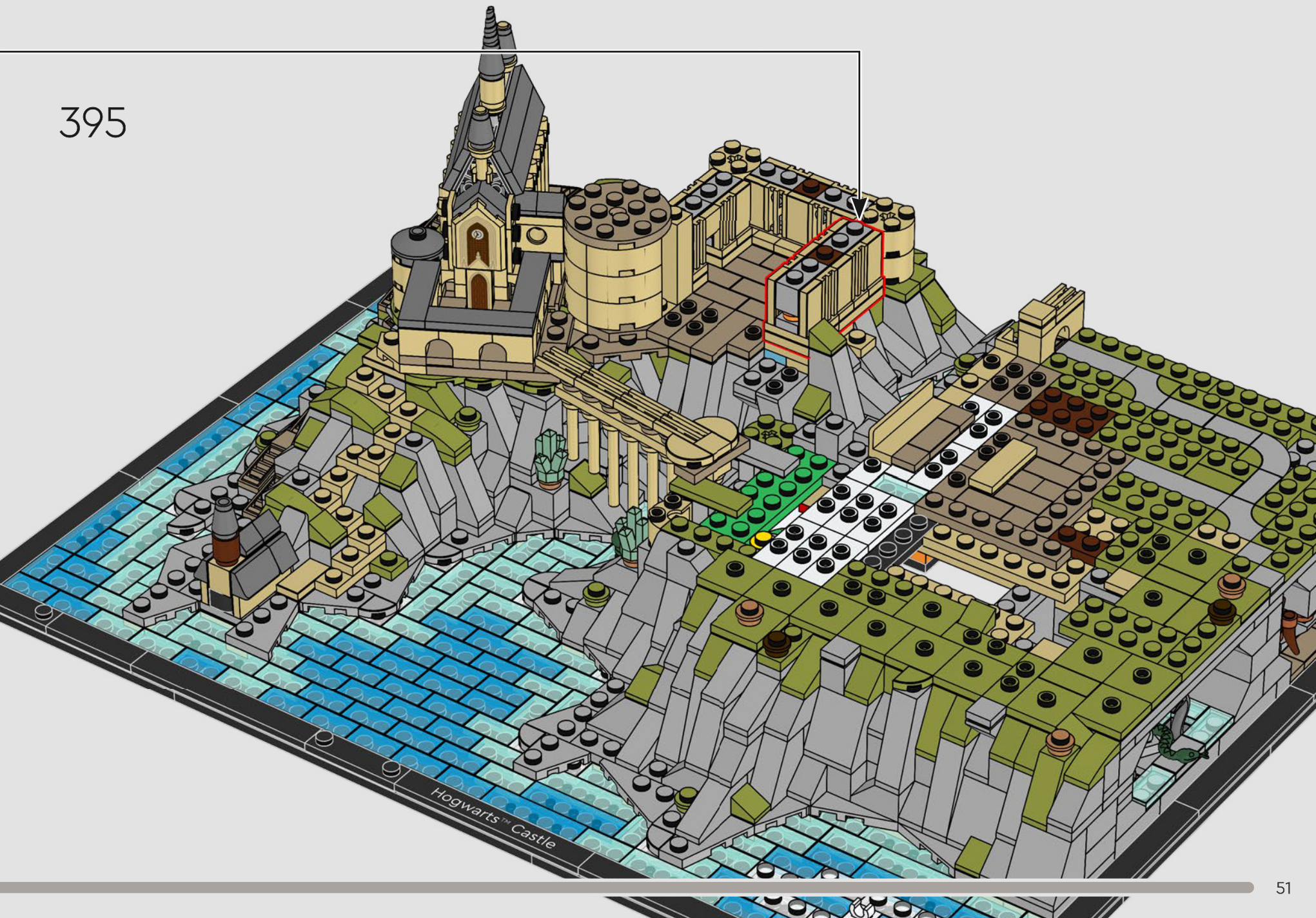

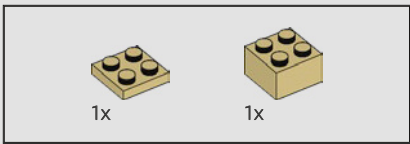

396

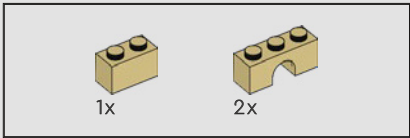
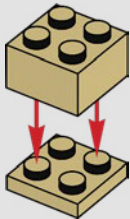

397

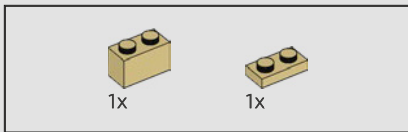
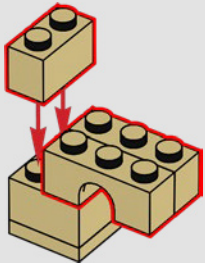

398

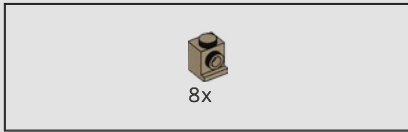
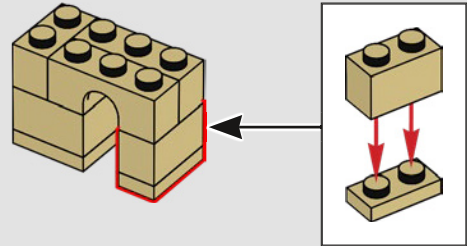

399

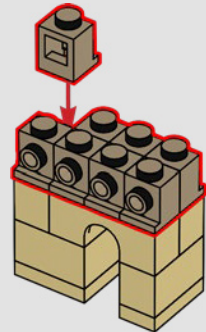

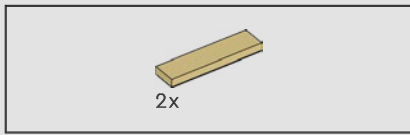

400

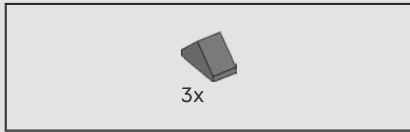
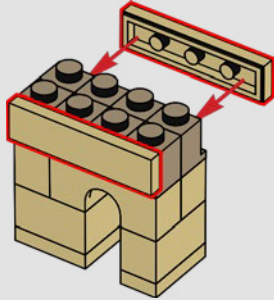

401

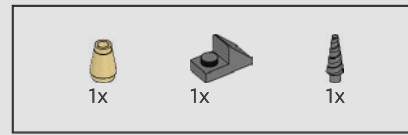
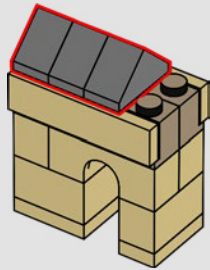

402

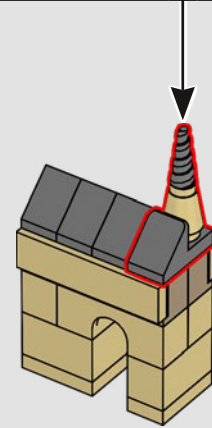
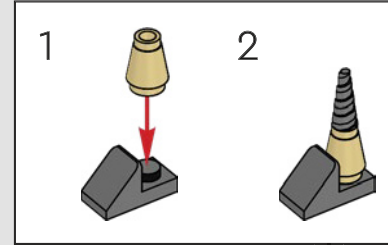

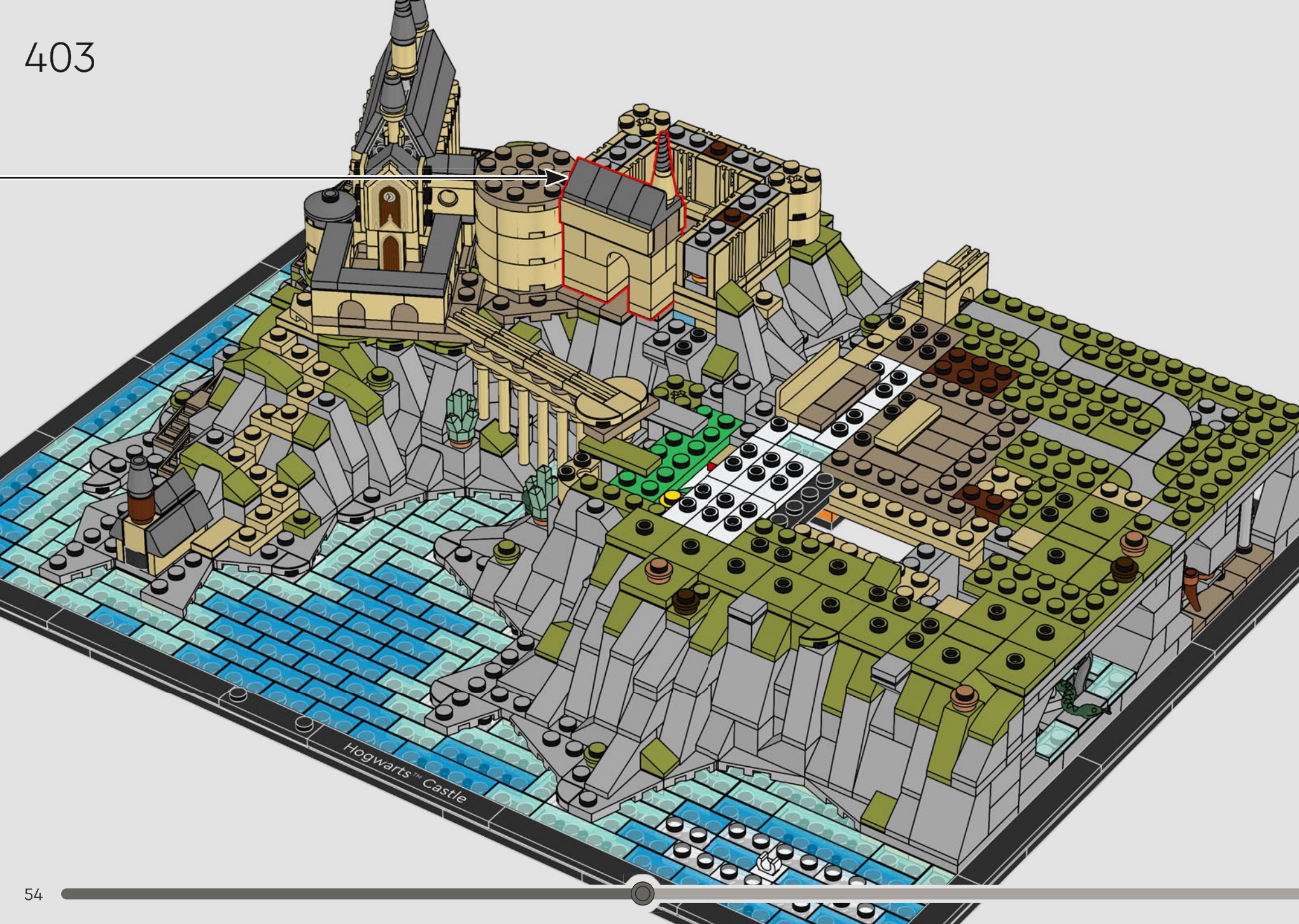

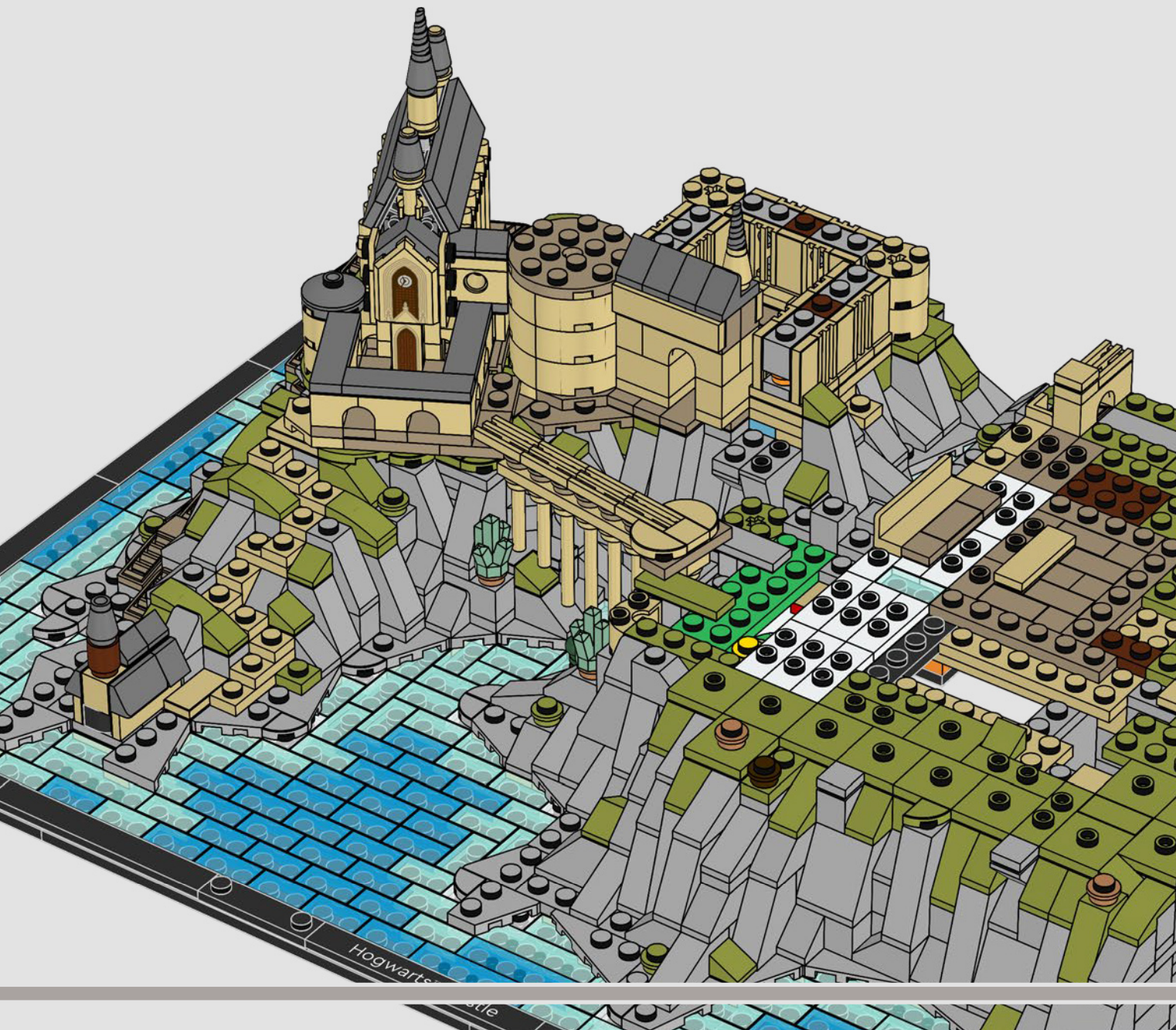

The Quad Courtyard is an outdoor meeting space for students nestled near the Clock Tower.

Située près de la tour de l'horloge, la cour pavée est un espace de rencontre en plein air pour les élèves.

El patio empedrado es un espacio de reunión exterior para los alumnos, ubicado cerca de la Torre del Reloj.



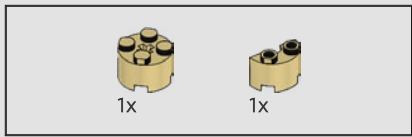

404

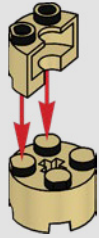

405

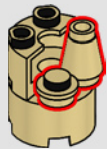

406

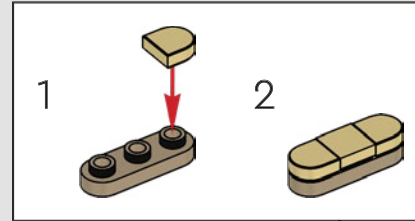

407

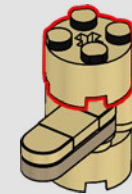

408

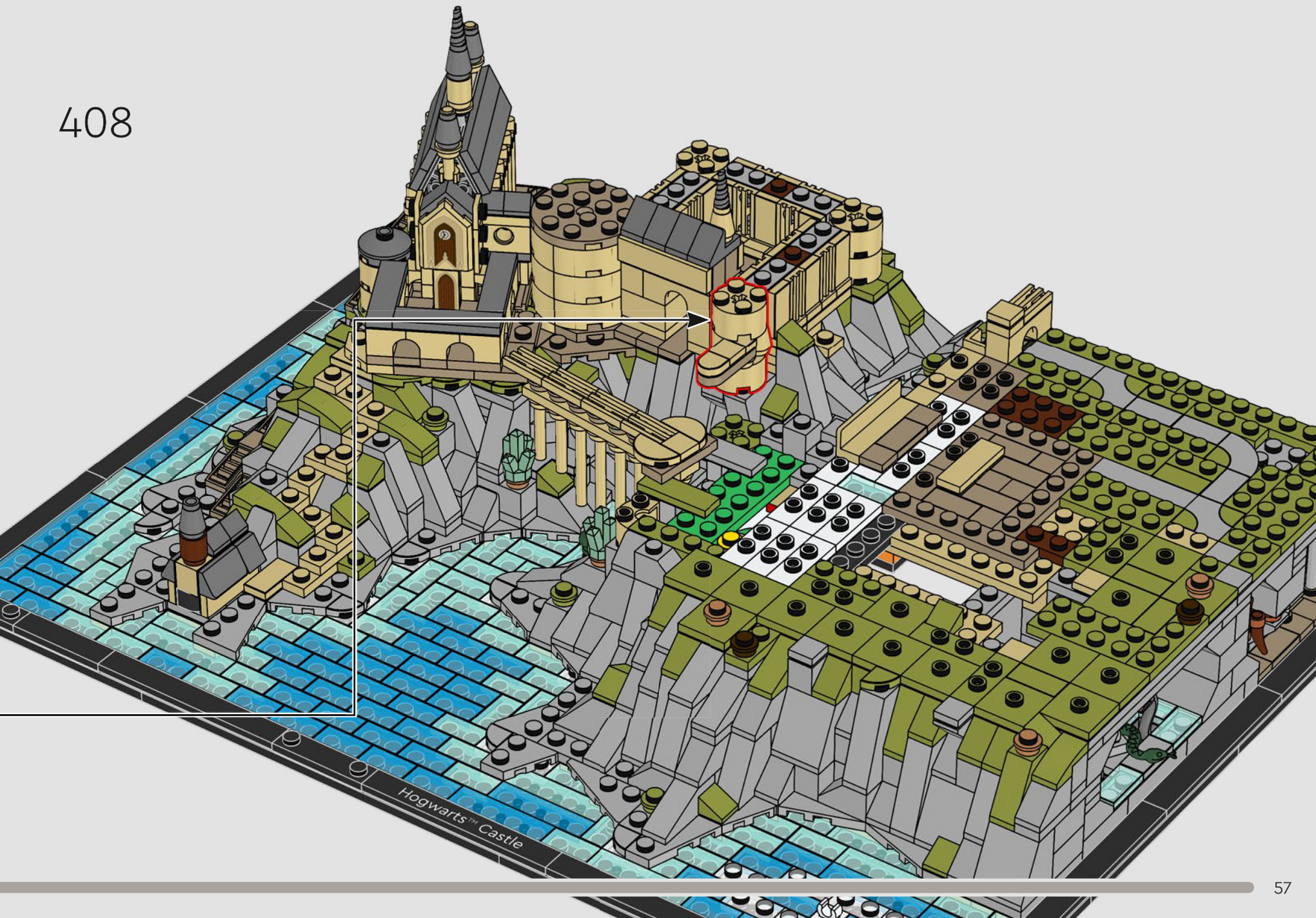





409

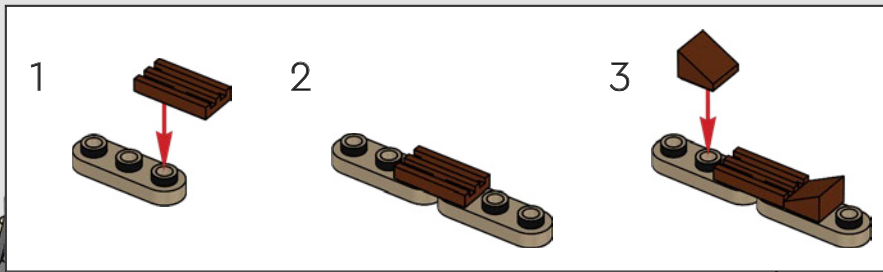



410

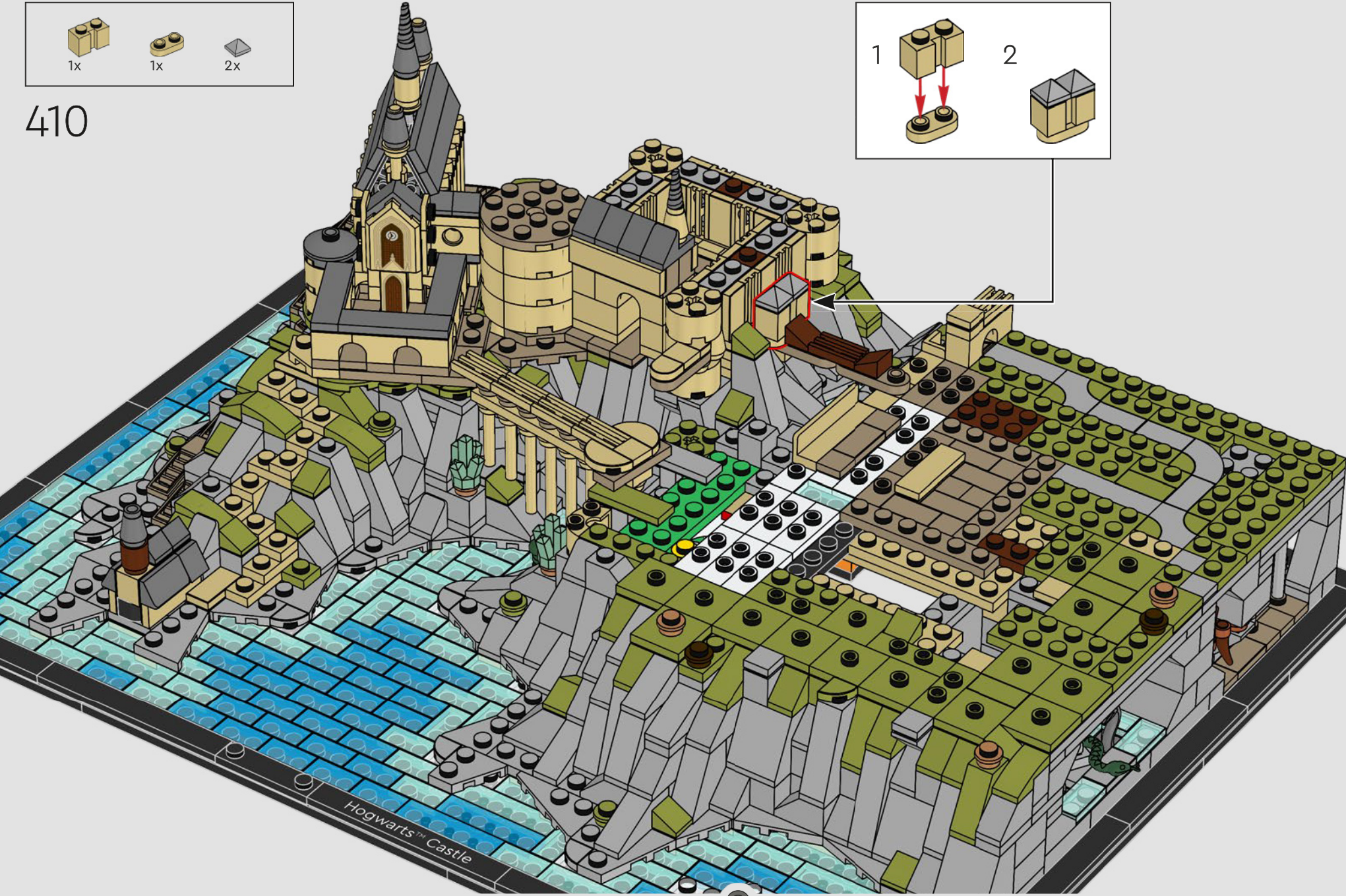
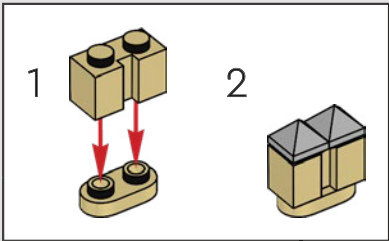

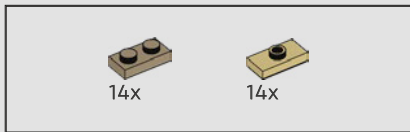

411

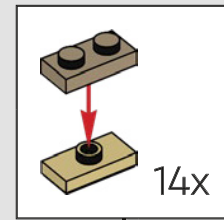

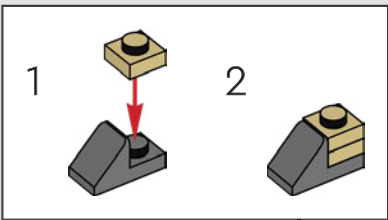
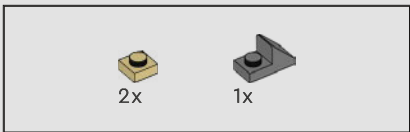

412

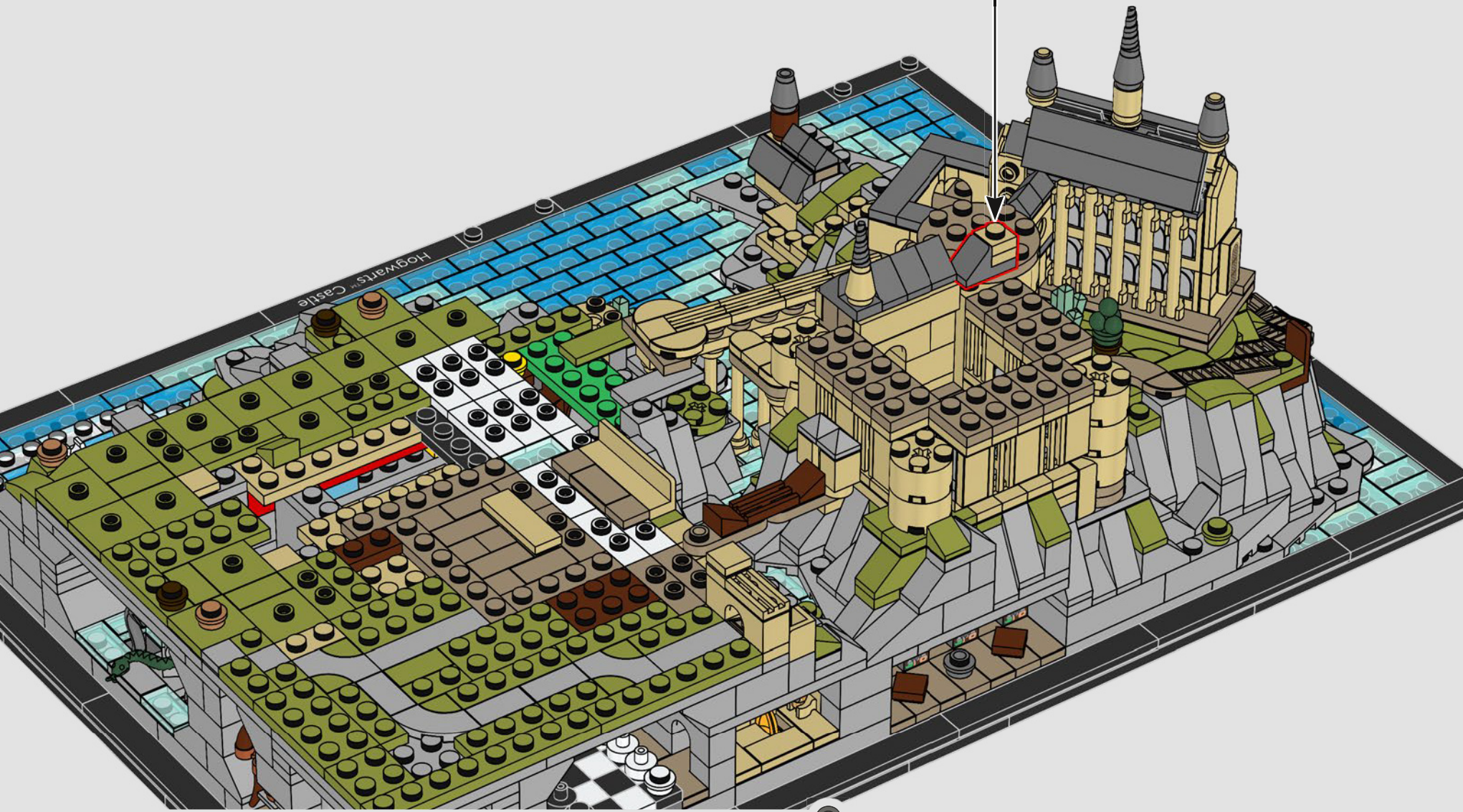

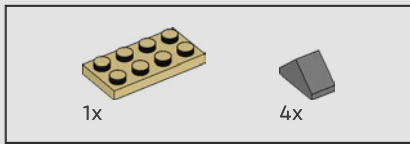

413

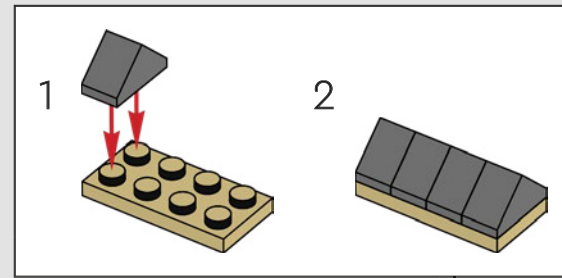

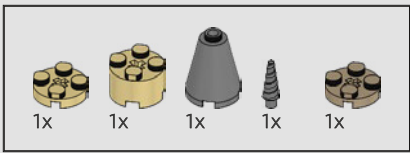

414

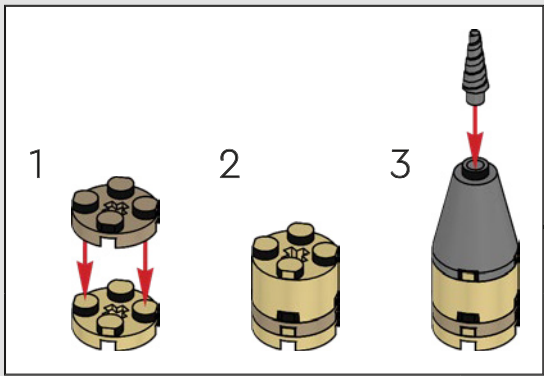

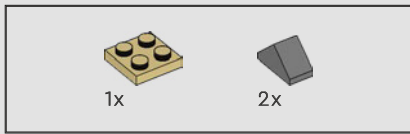

415

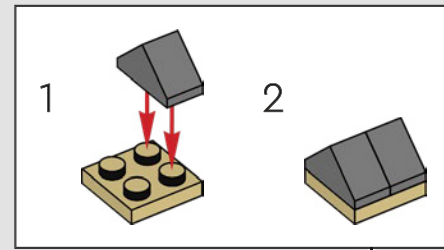

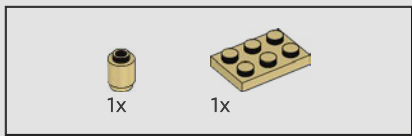

416

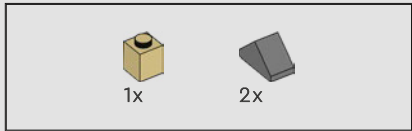
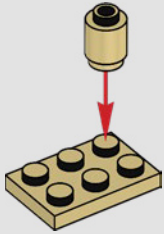

417

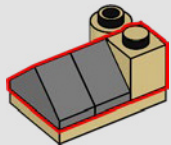

418

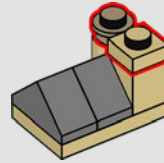

419

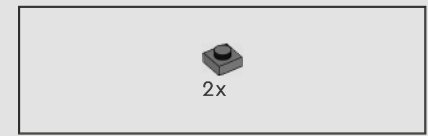
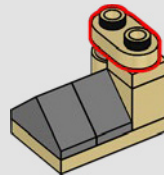

420

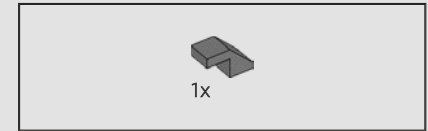
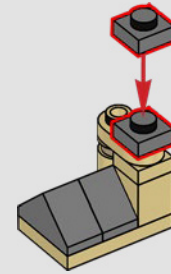

421

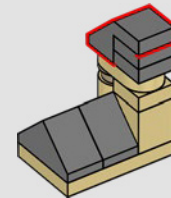

422

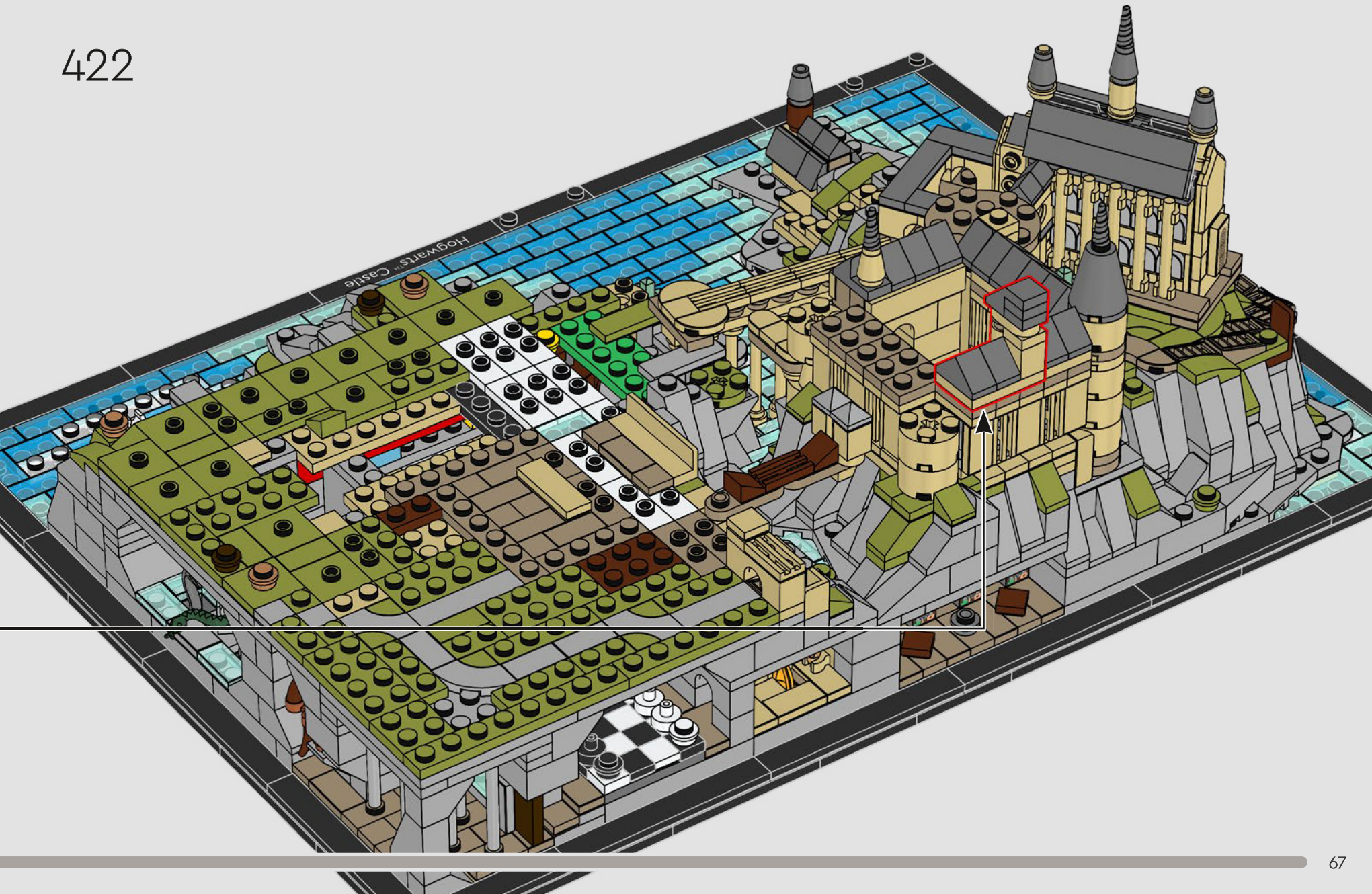

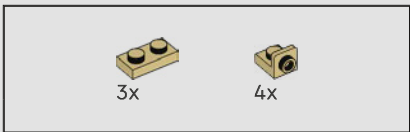

423



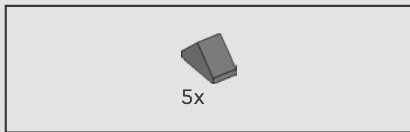

424



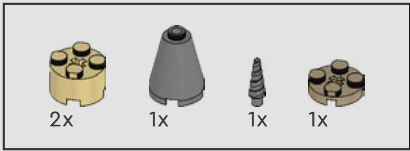

425

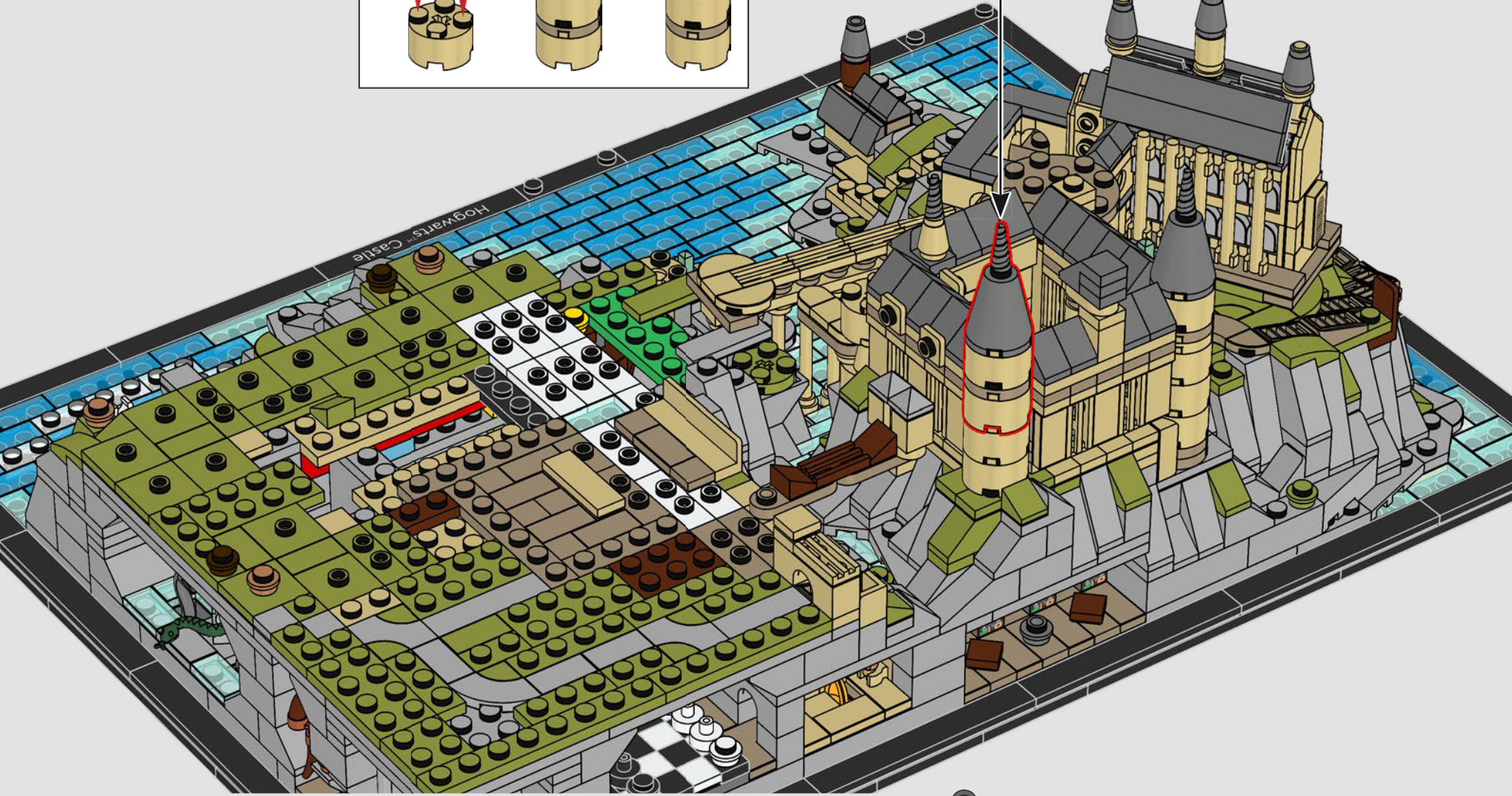
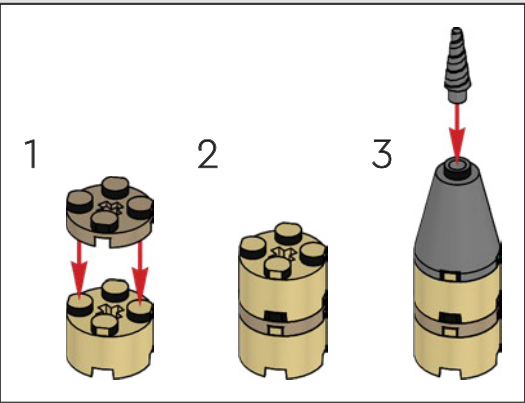

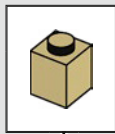
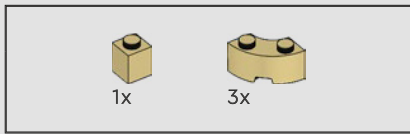

426

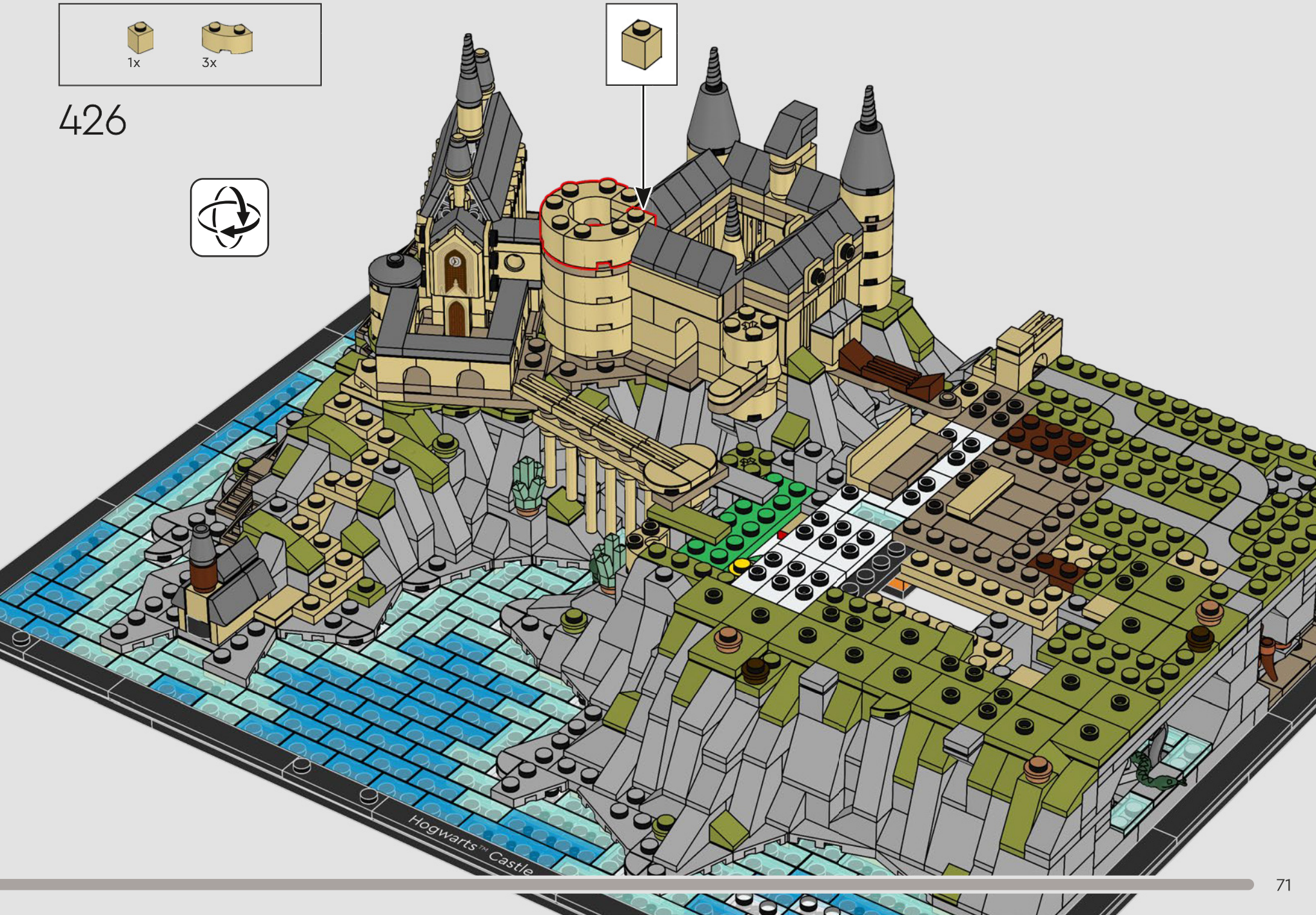

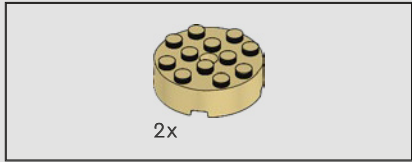
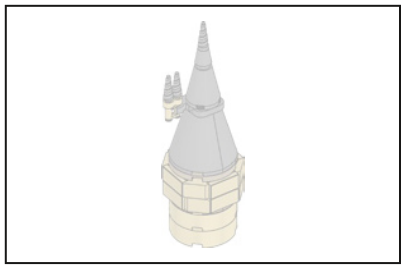

427

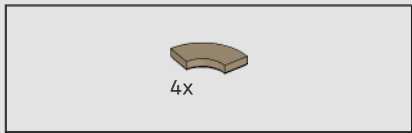
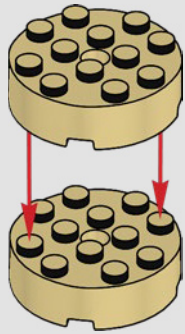

428

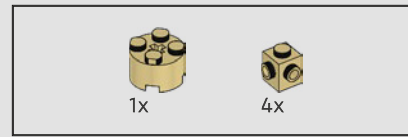
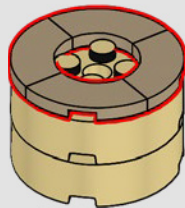

429

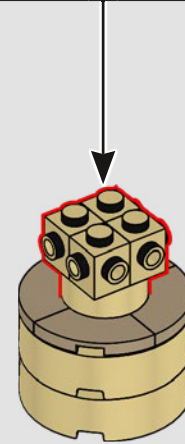
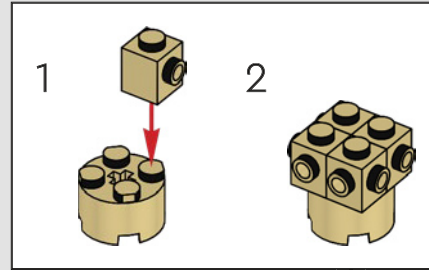

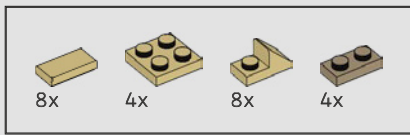

430

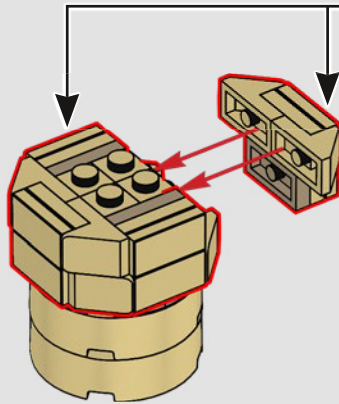
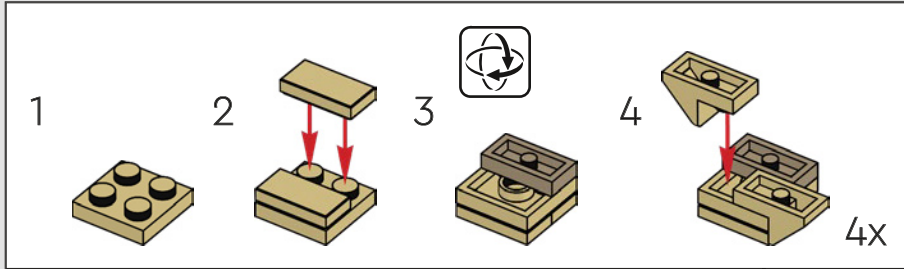

431

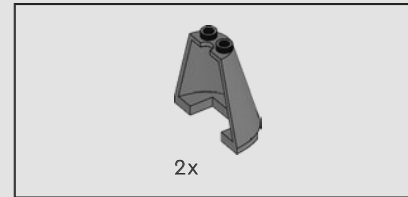
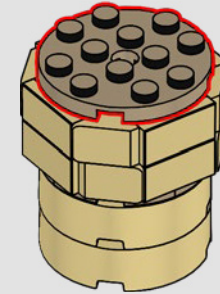

432

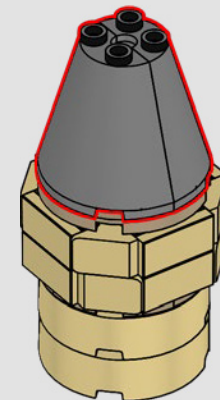

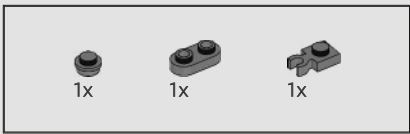

433

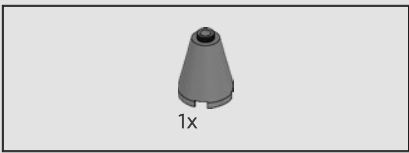
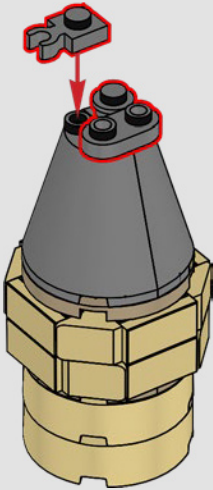

434

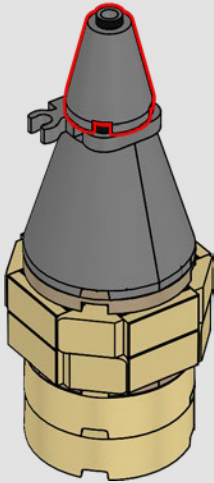

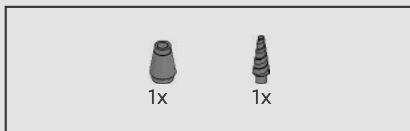

435

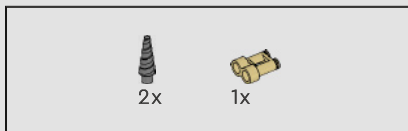
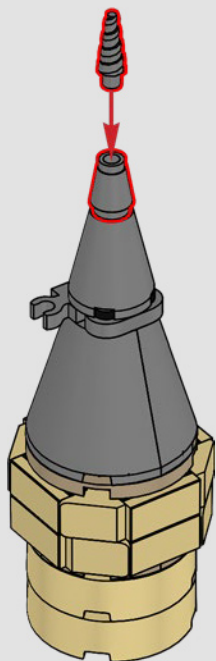

436

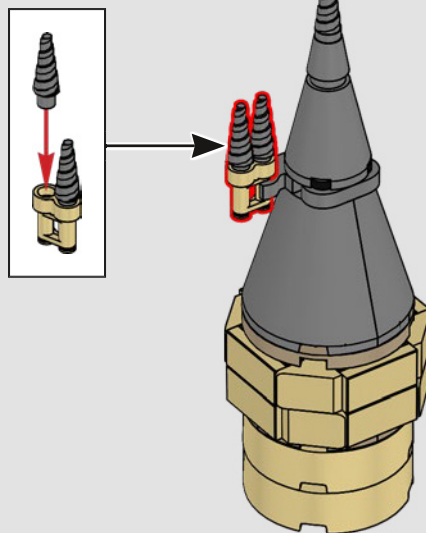

The office of Albus Dumbledore™, the small towers on the main tower, is built with a LEGO® telescope element.

Le bureau d'Albus Dumbledore™, formé des petites tours disposées au sommet de la tour principale, est construit avec un élément de télescope LEGO®.

La oficina de Albus Dumbledore™ (las pequeñas torres de la torre principal) están construida con elementos LEGO® que representan telescopios.



437

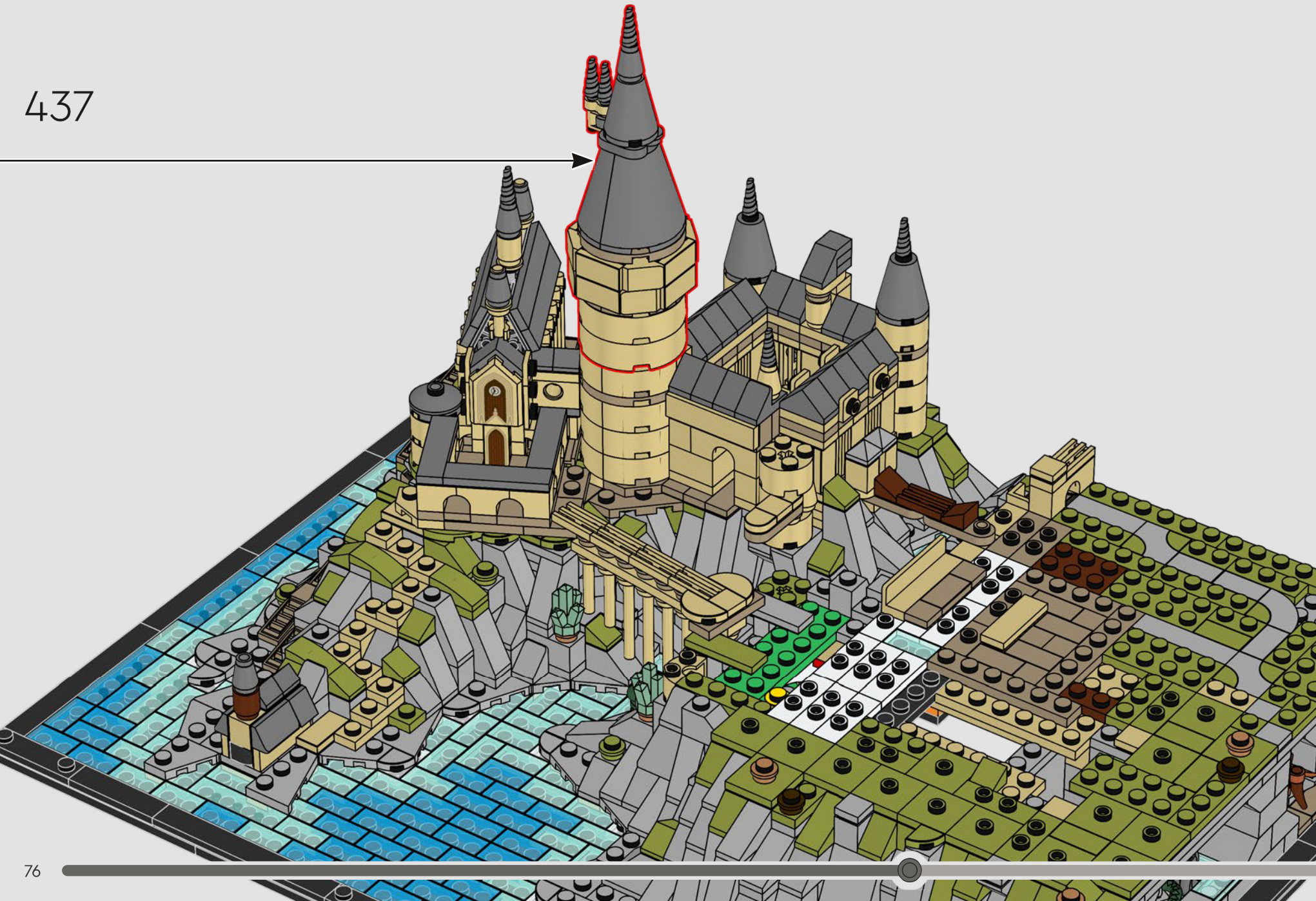



438

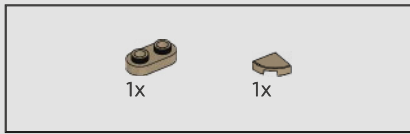
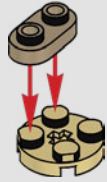

439

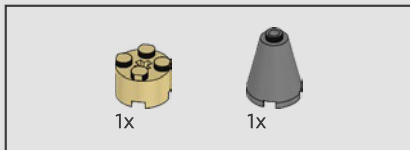

440

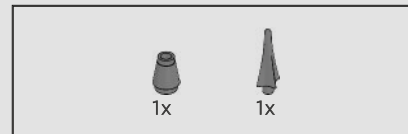
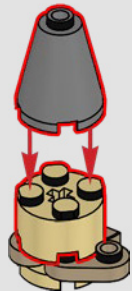

441

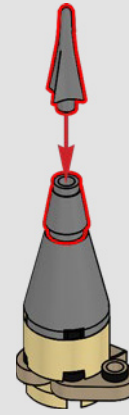

442

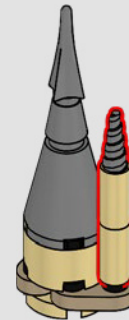
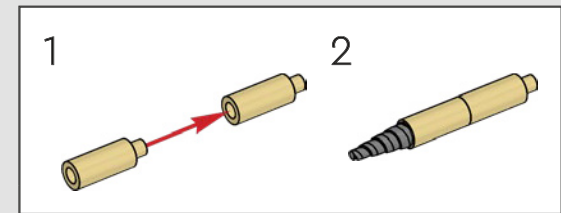

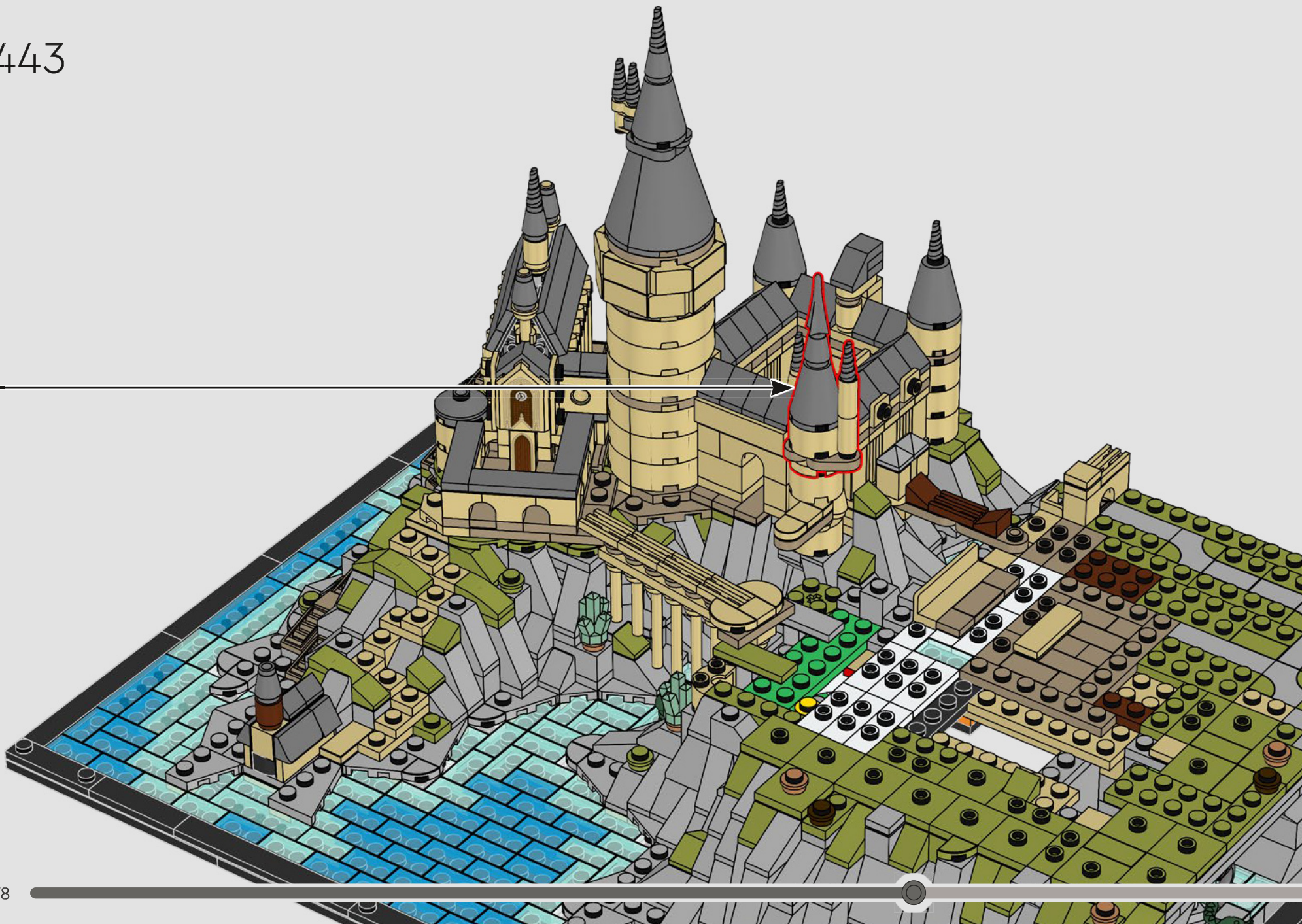



You wouldn't think the sprouting towers on the Headmaster's Tower could be an architecturally sustainable structure – but of course, at Hogwarts™ everything is possible!

On ne croirait pas que les tours saillantes de la tour du directeur puissent être une structure architecturale durable... mais à Poudlard, tout est possible !

No te imaginarías que las torres que brotan de la torre principal pudieran ser una estructura arquitectónicamente sostenible... Pero, claro, ¡en Hogwarts™ todo es posible!





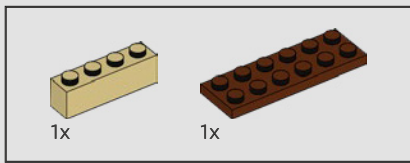

444

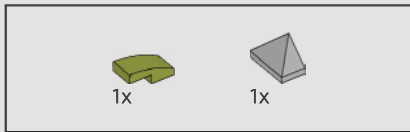
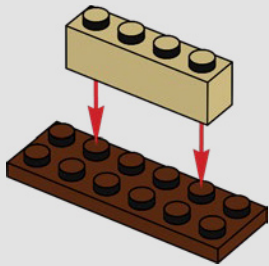

445

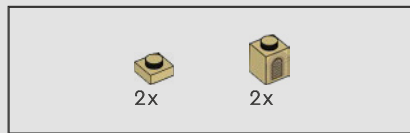
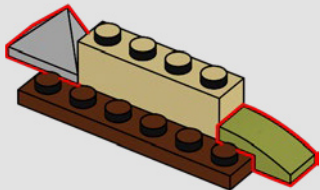

446

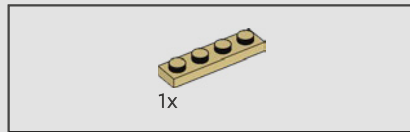
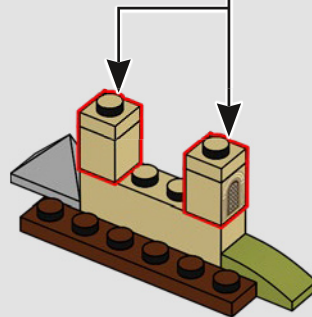
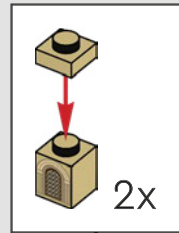

447

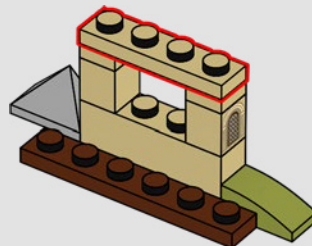

448

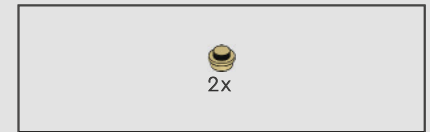
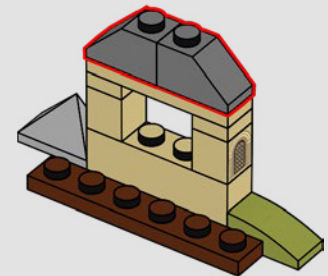

449

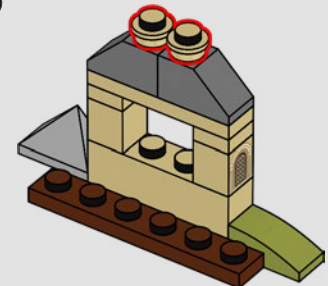

450

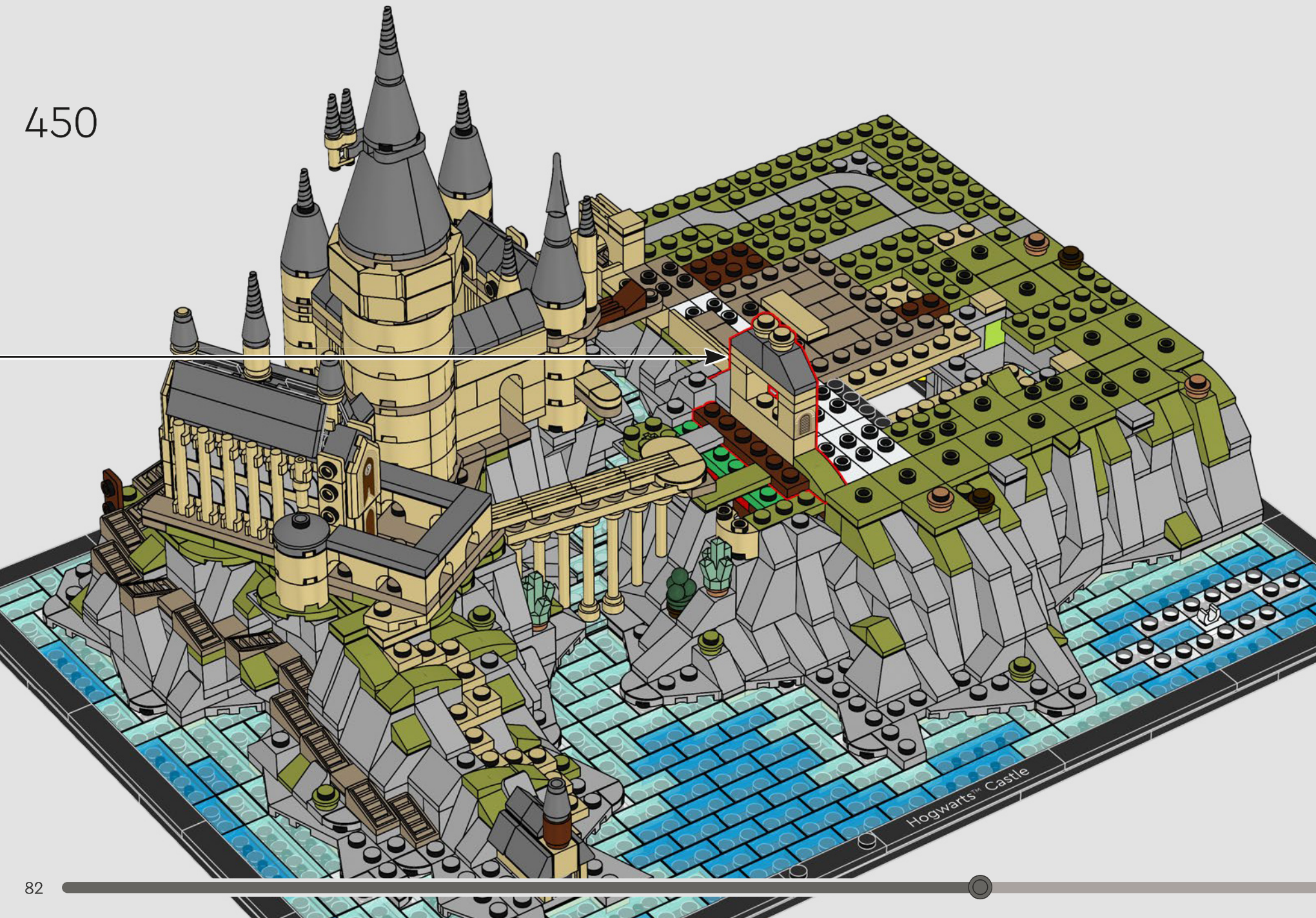

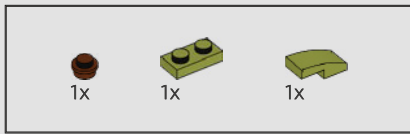

451

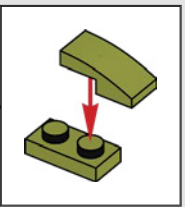
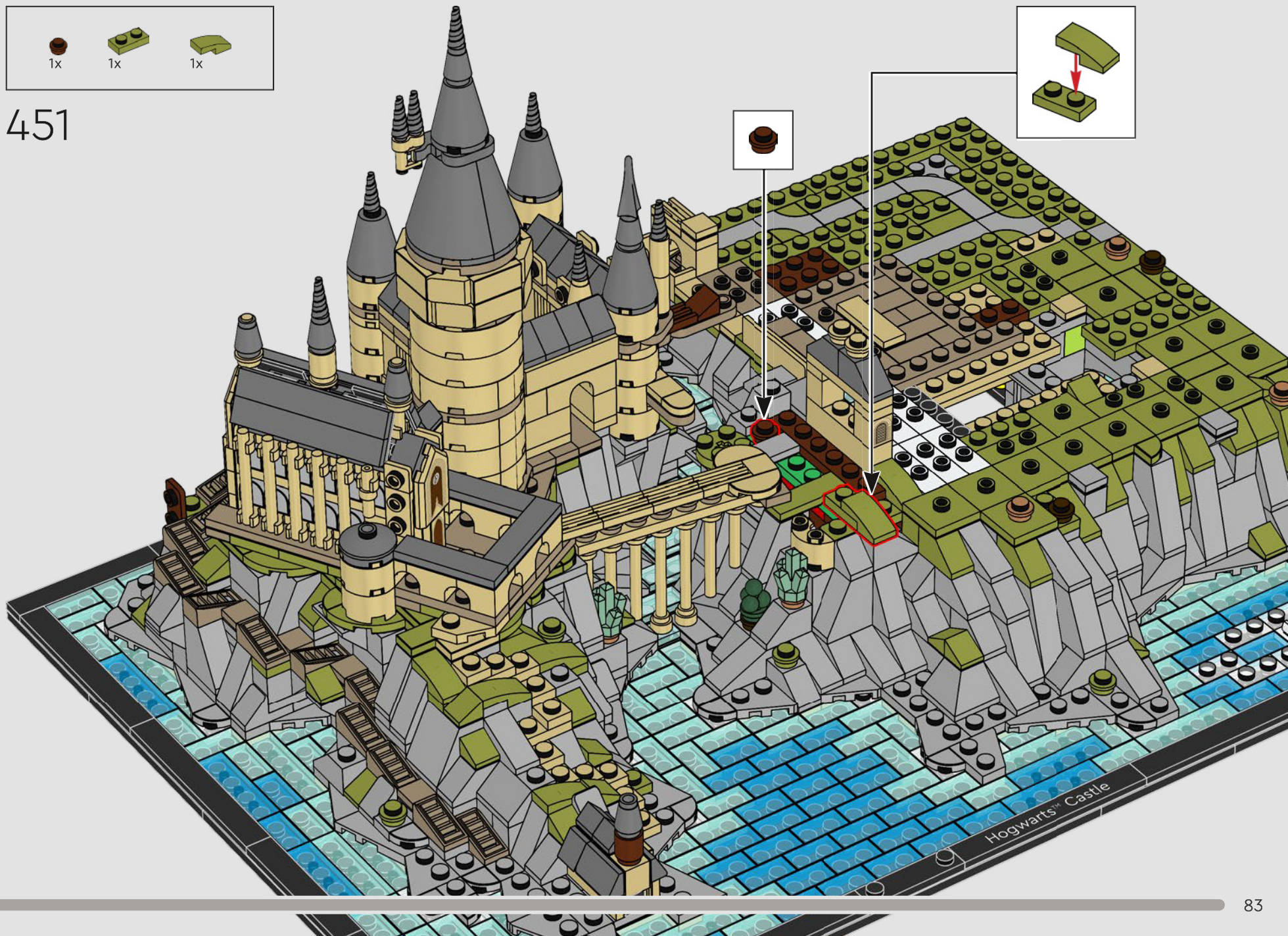

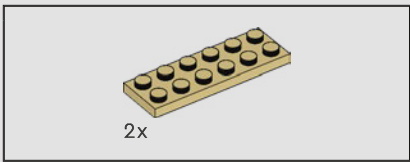

452

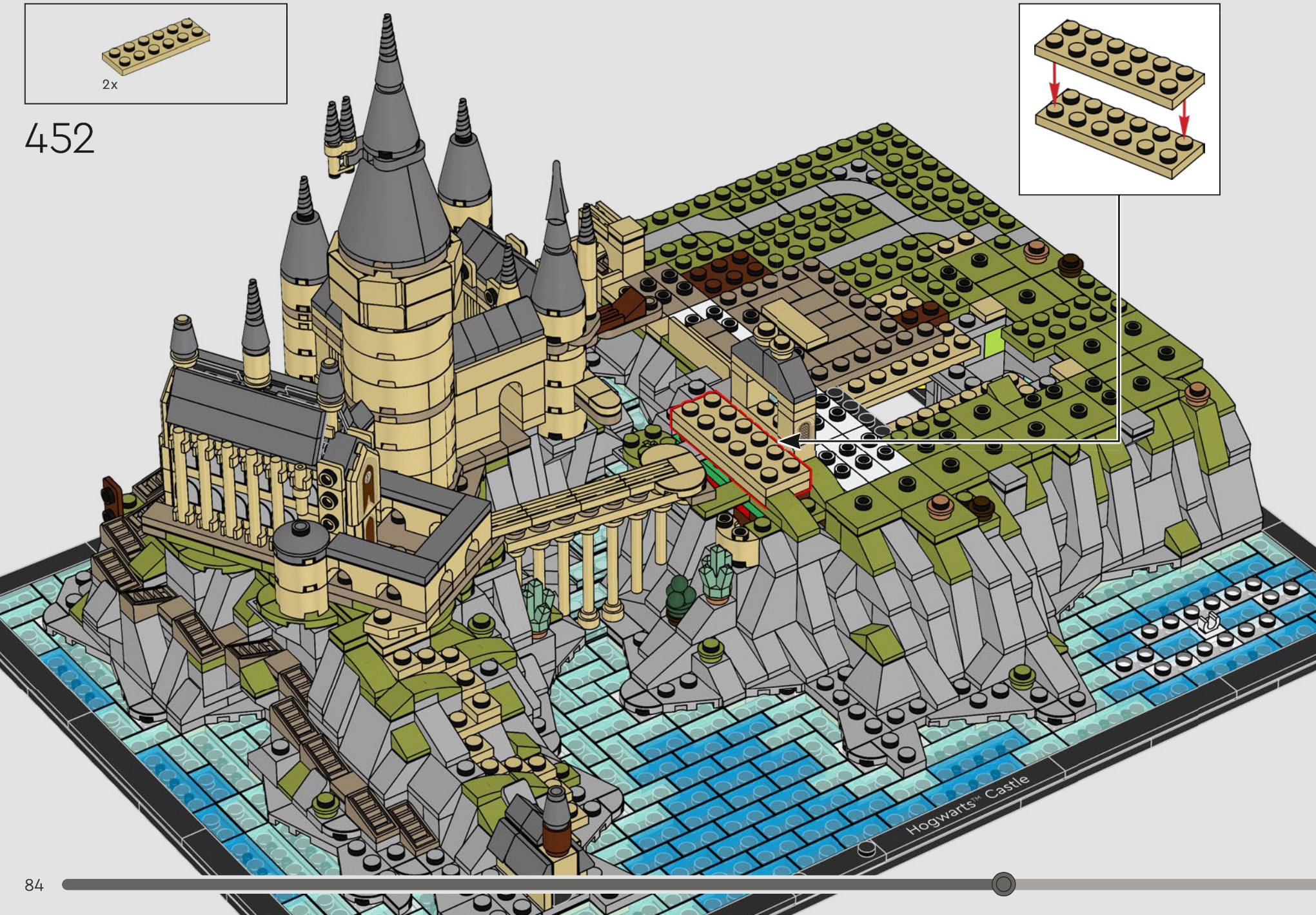
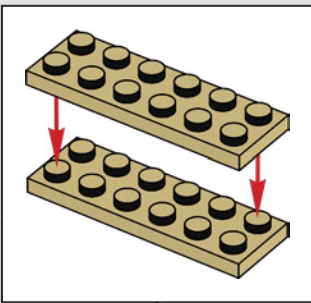



453

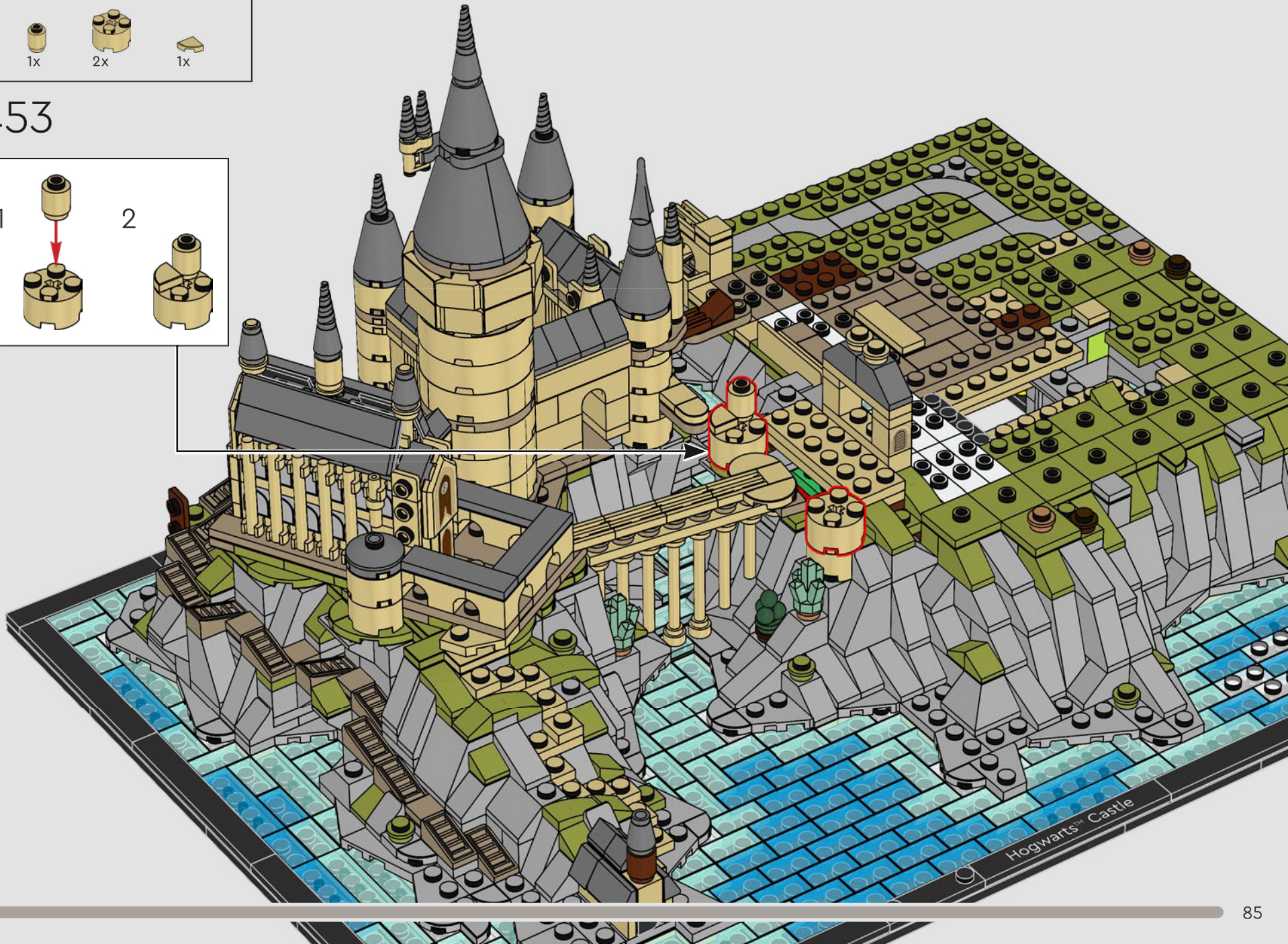
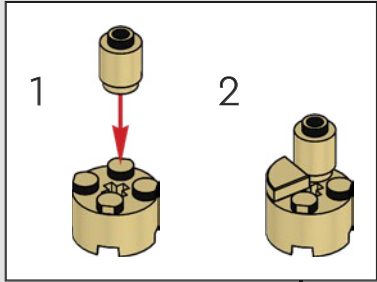



3x

454

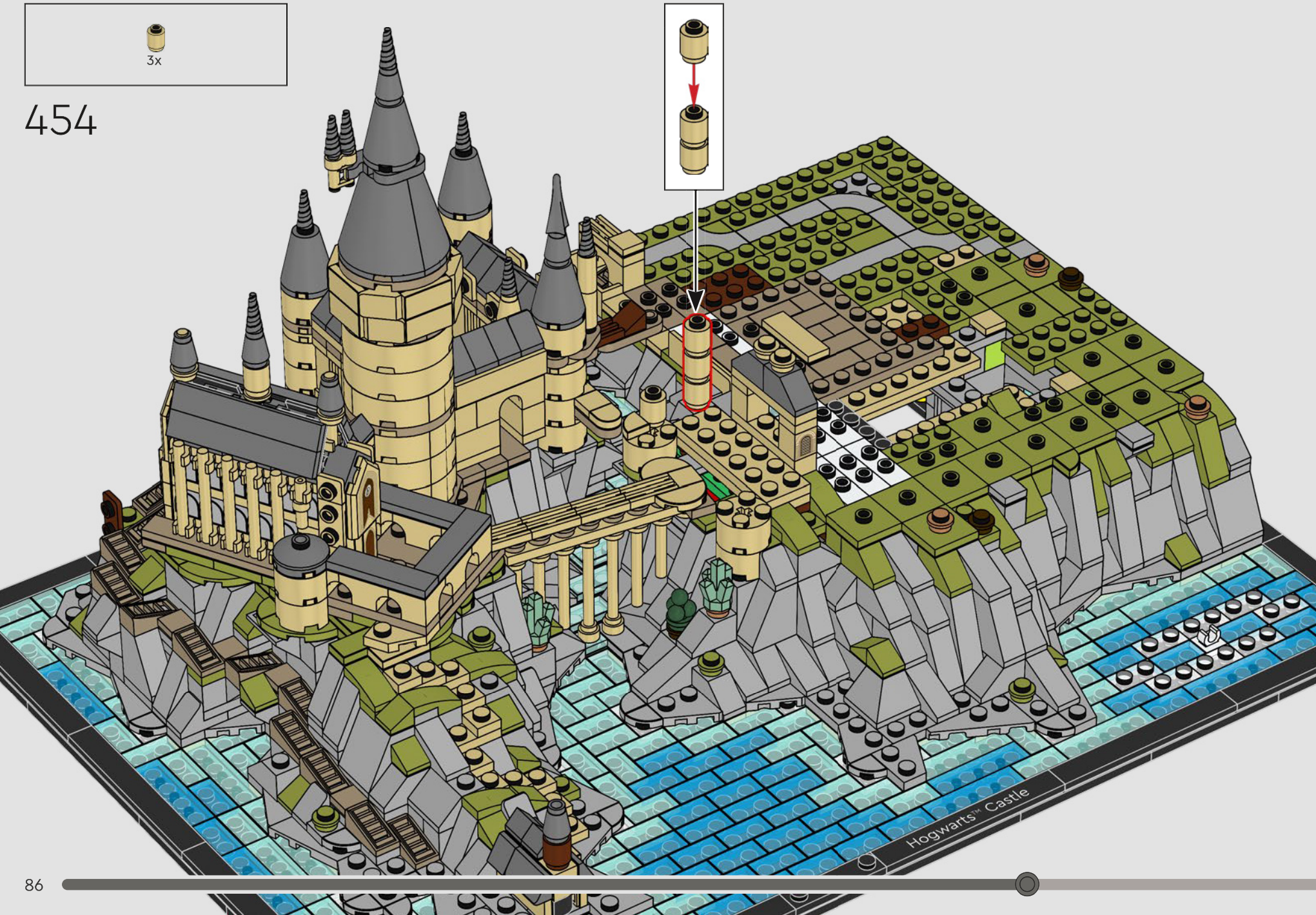
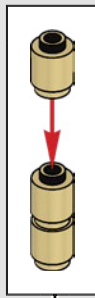

Hogwarts™ Castle

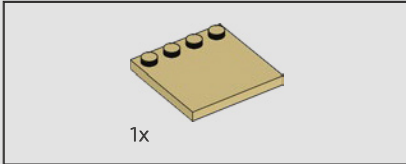
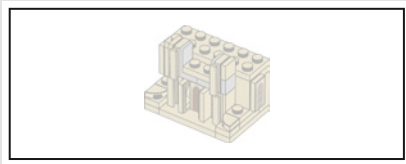

455

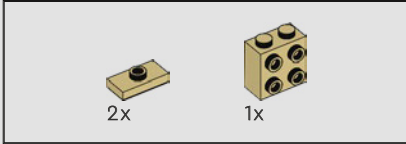
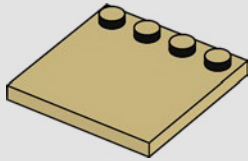

456

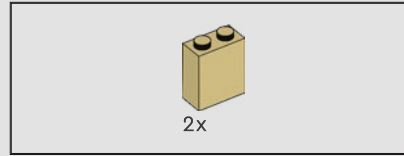
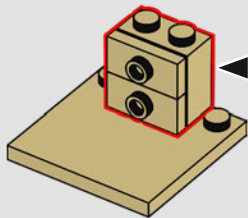
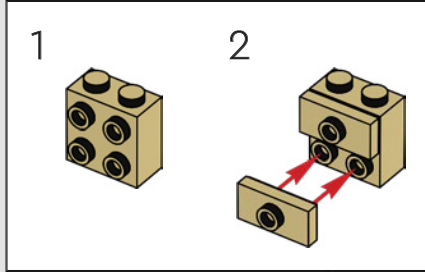

457

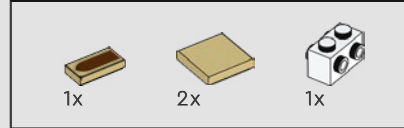
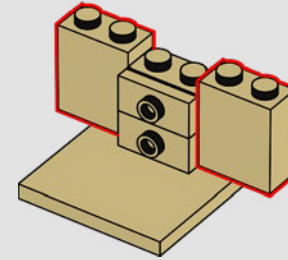

458

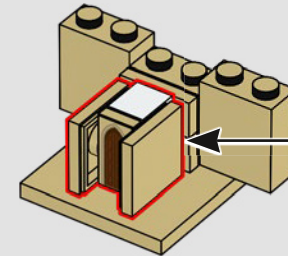
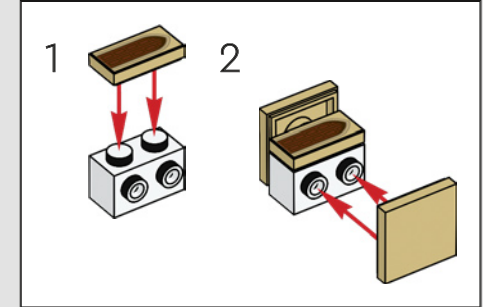

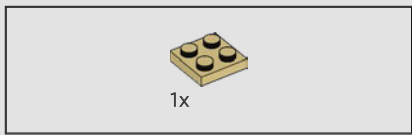

459

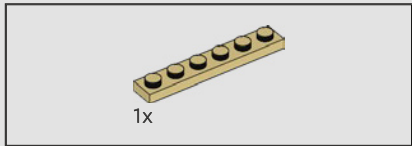
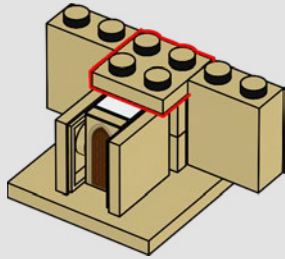

460

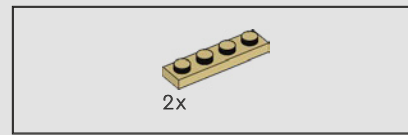
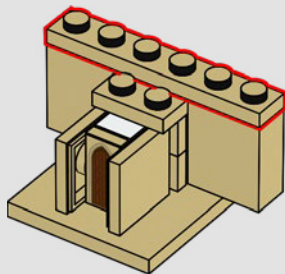

461

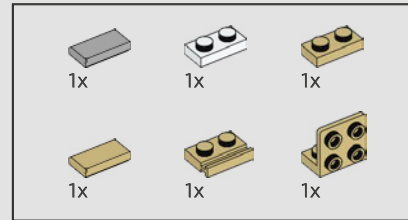
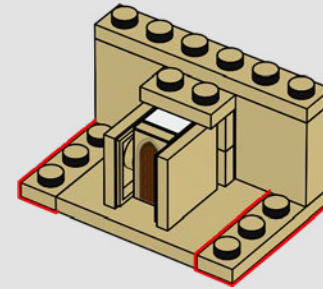

462

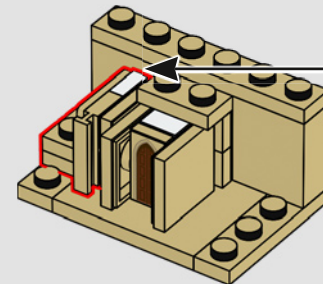
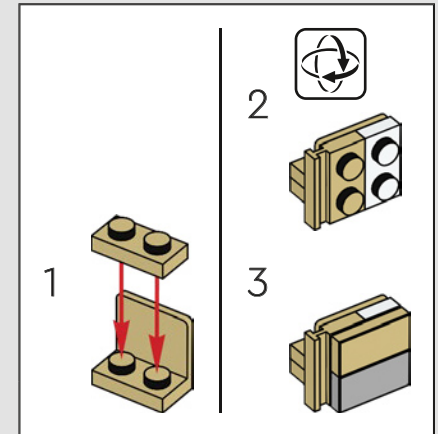

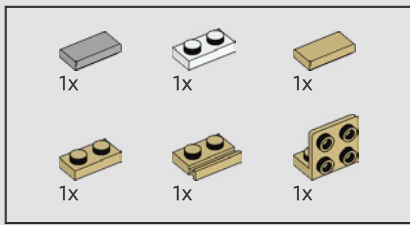

463

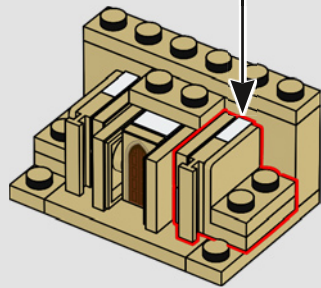
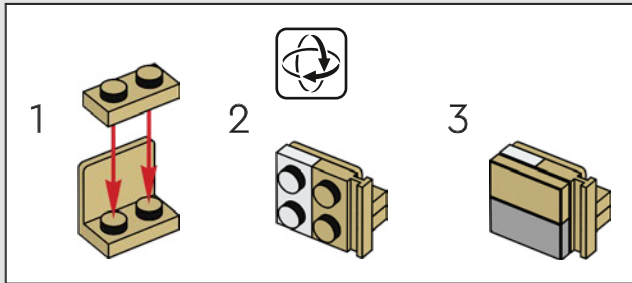

464

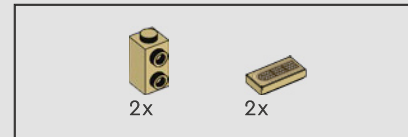
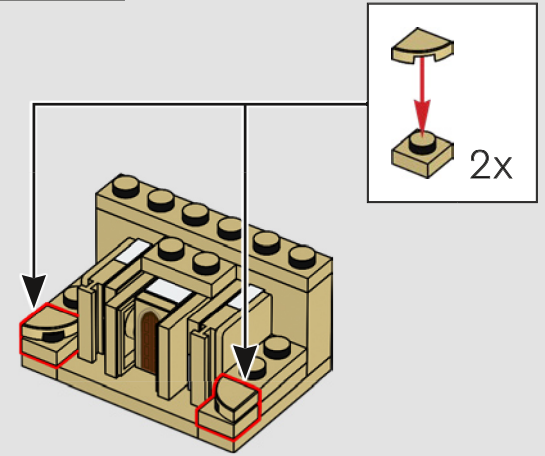

465

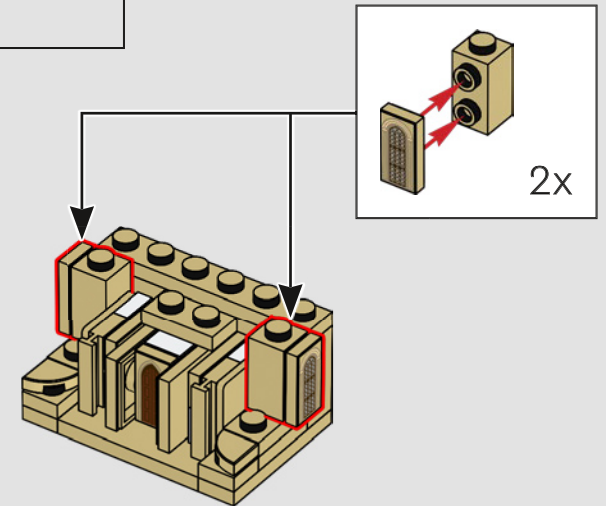

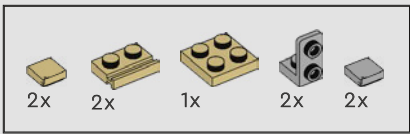

466

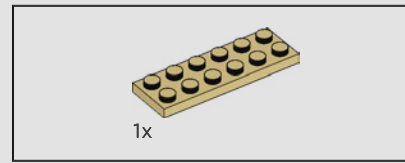
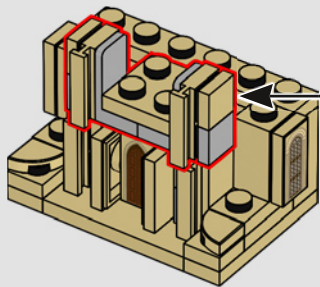
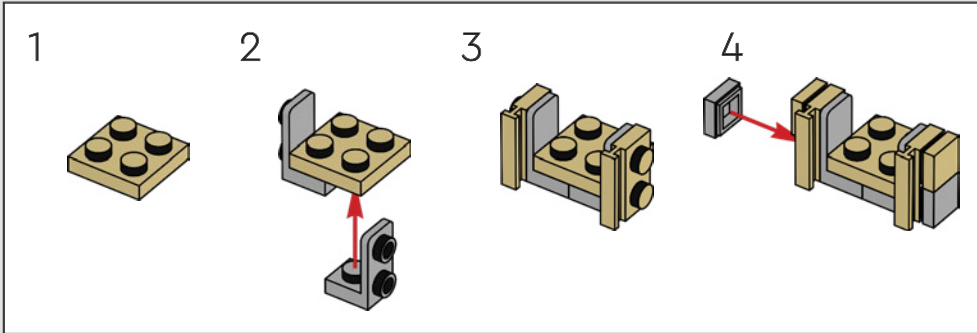

467

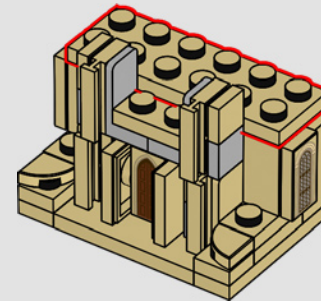

468

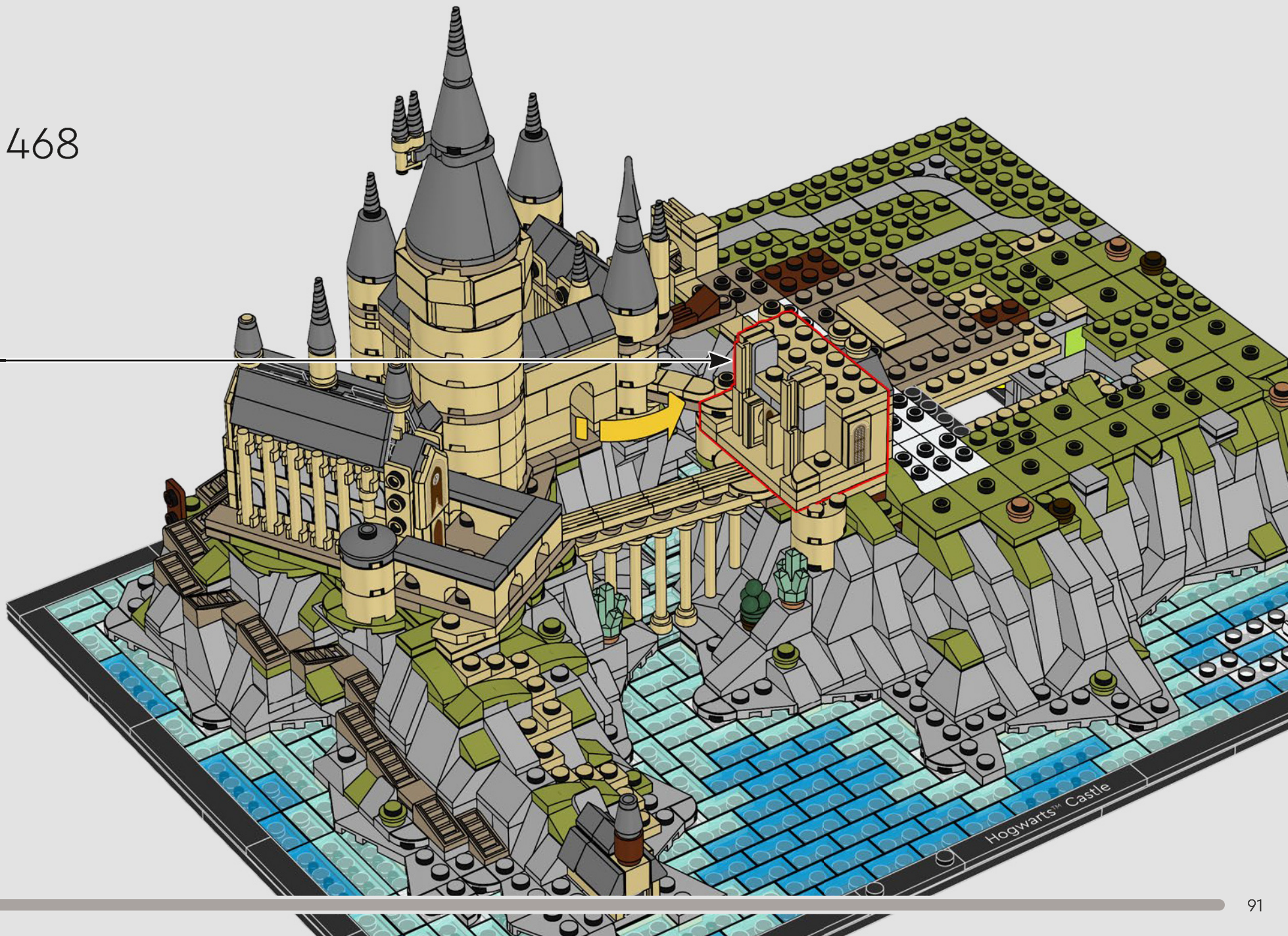

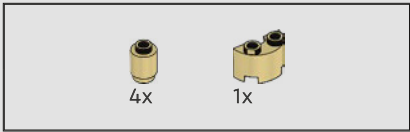

469

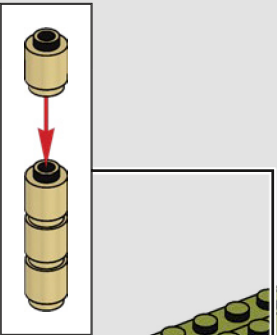



470

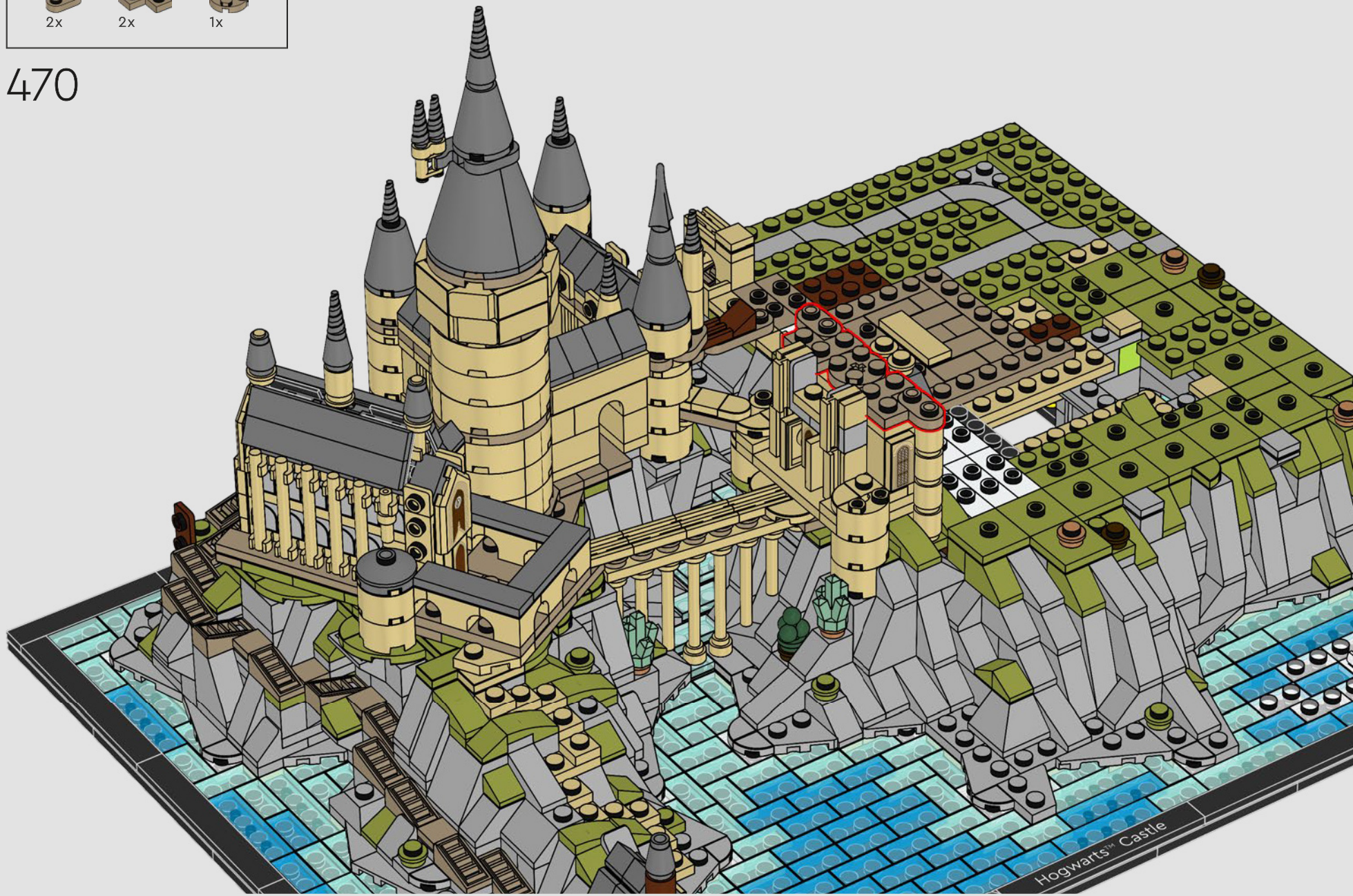

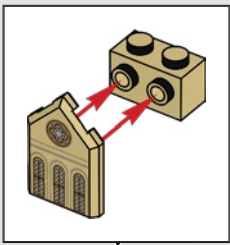
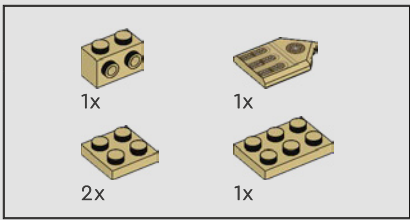

471

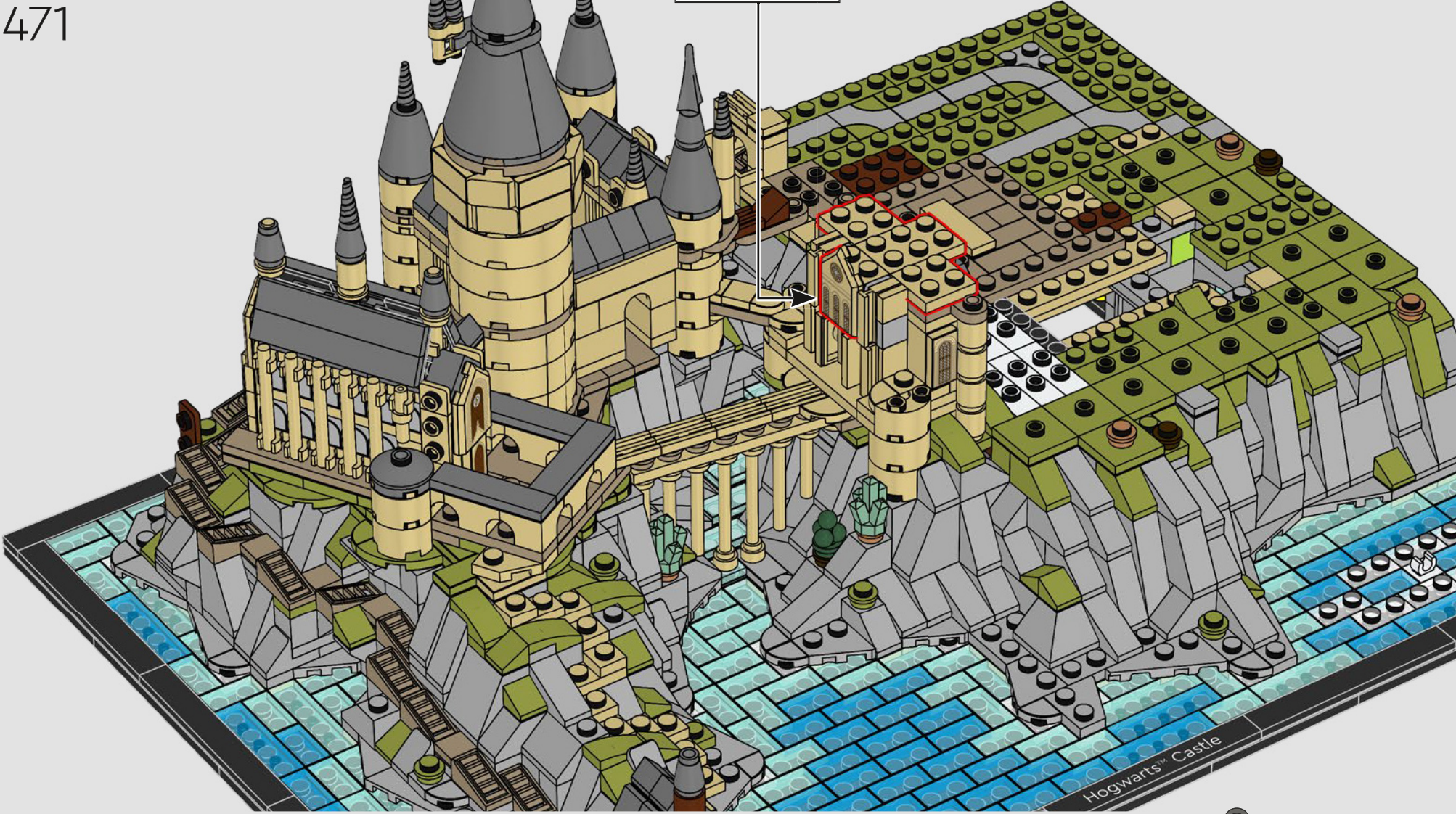

Hogwarts™ Castle

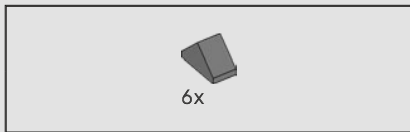

472

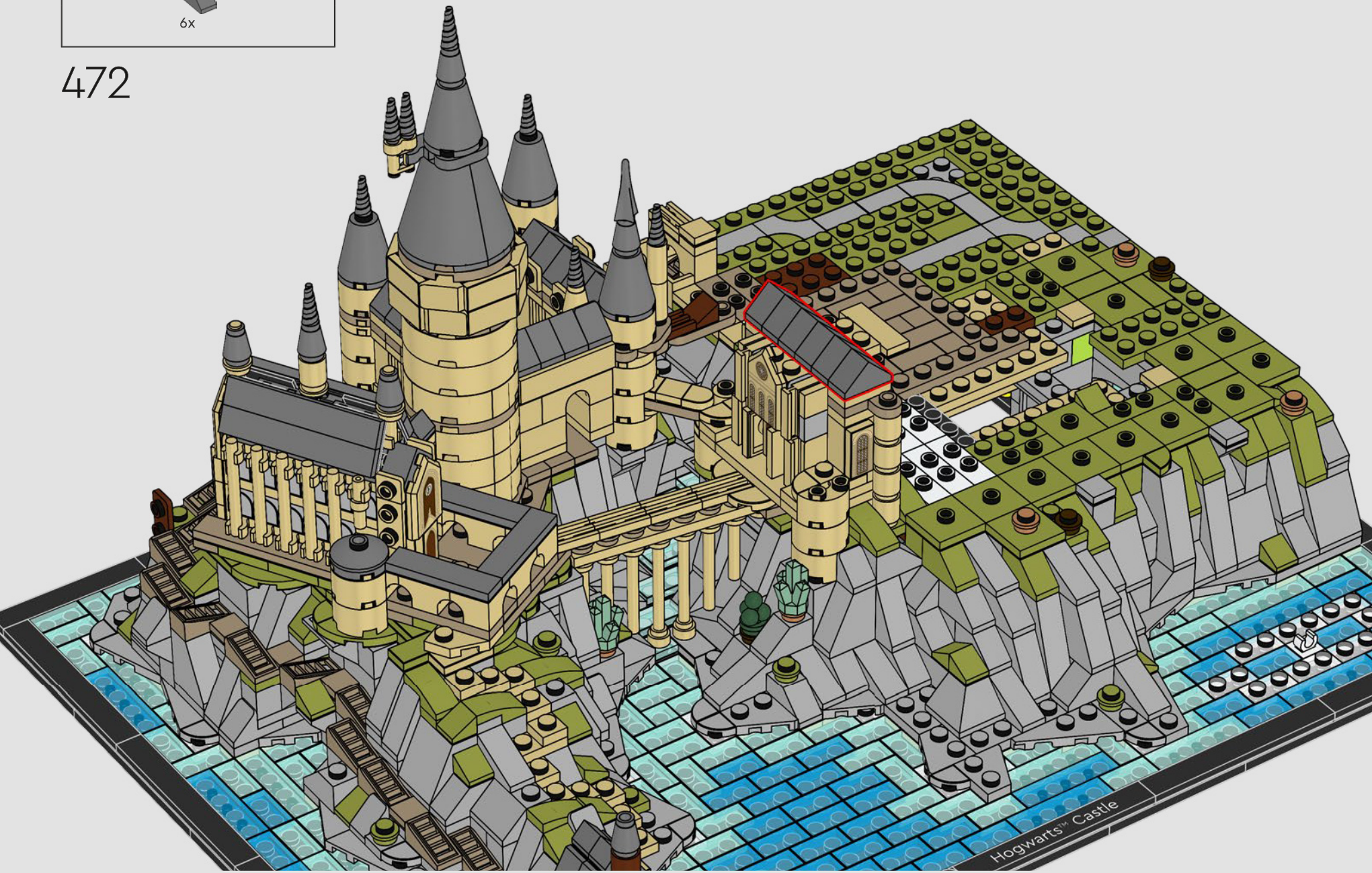

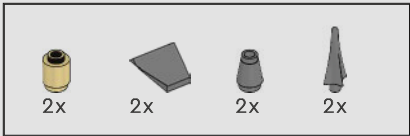

473

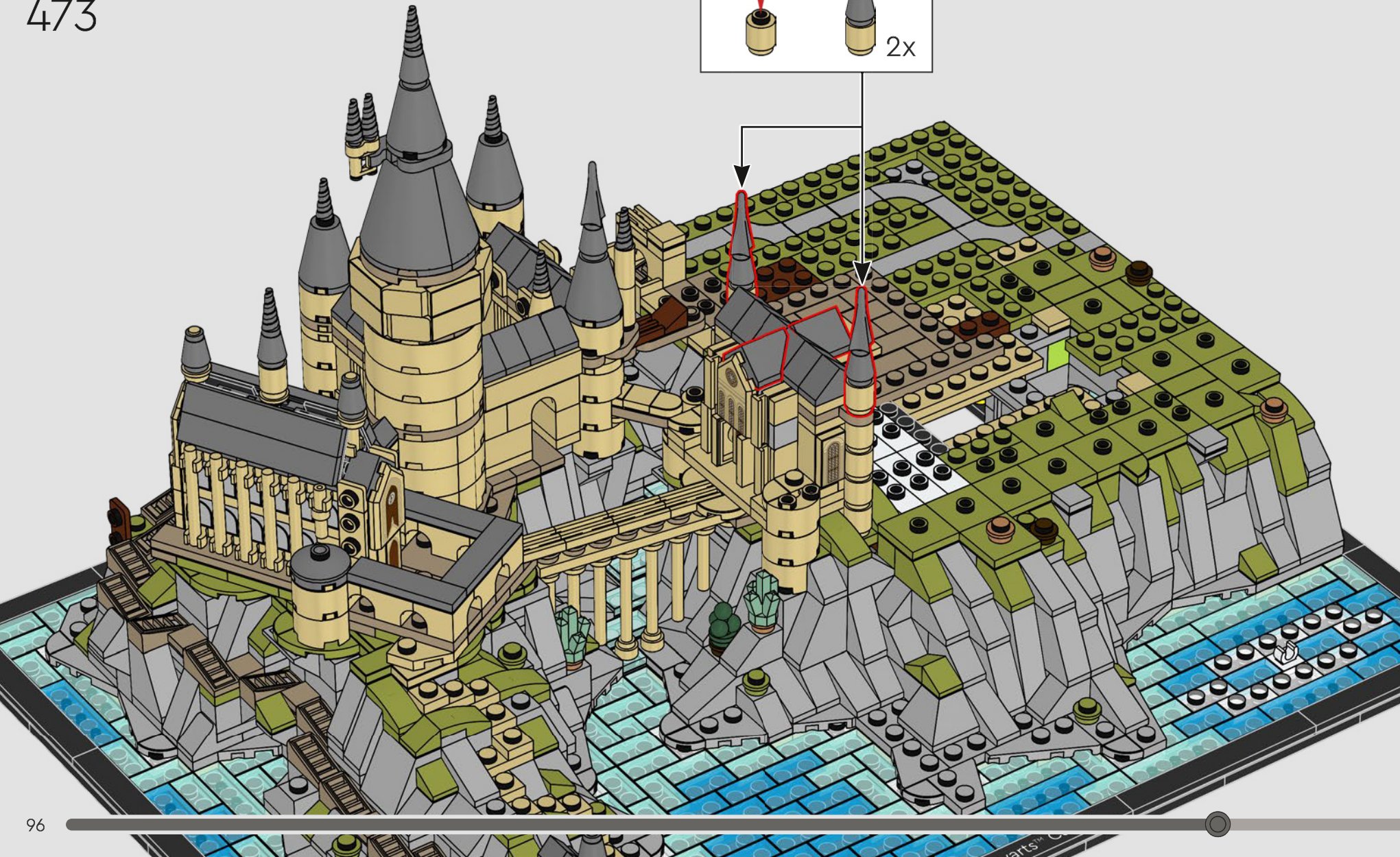
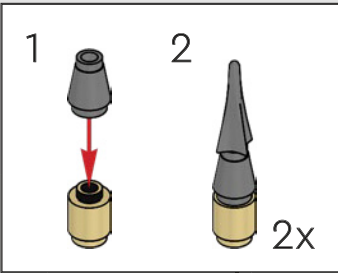

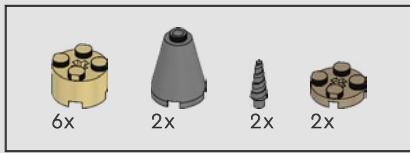

474

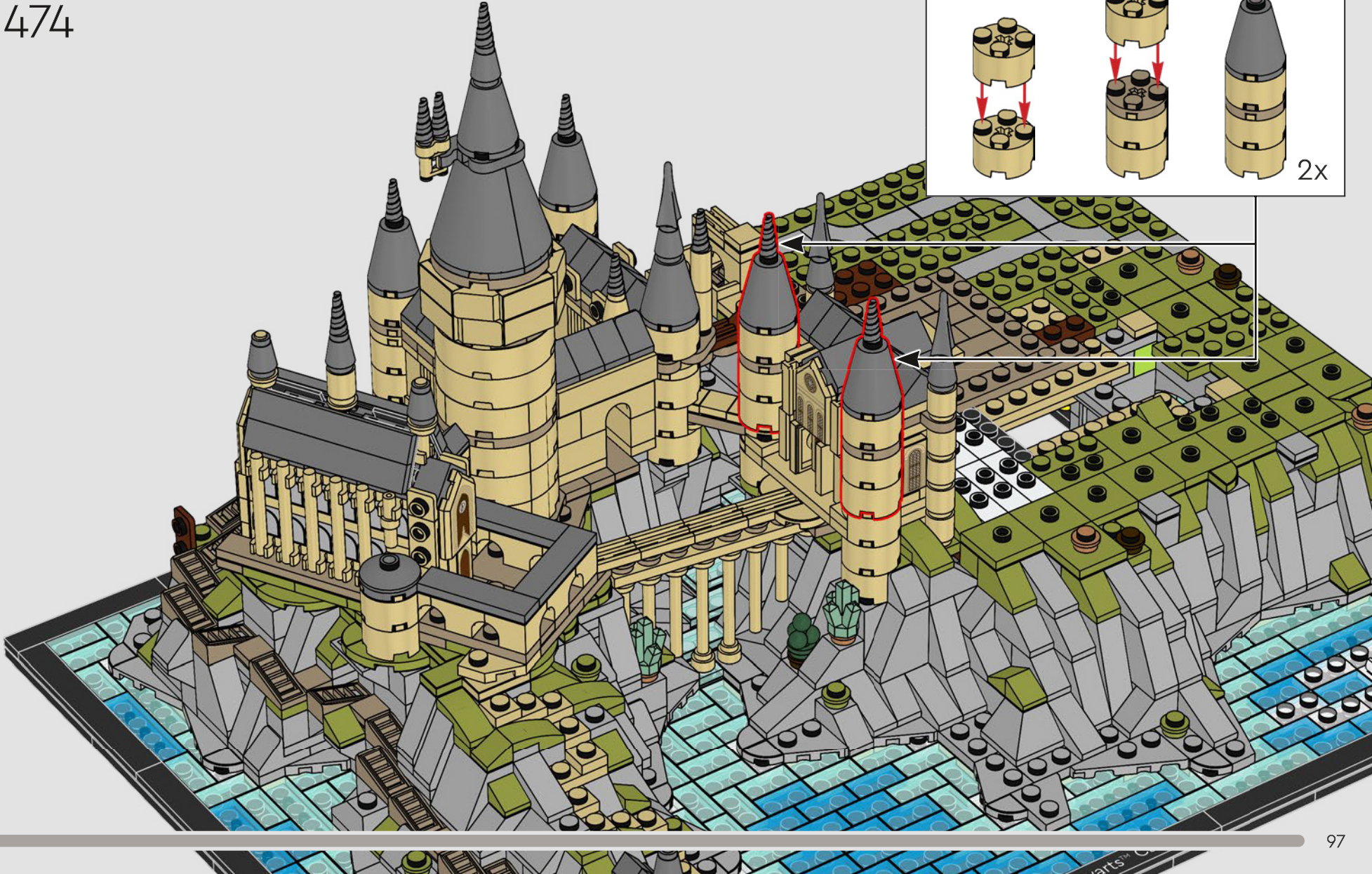
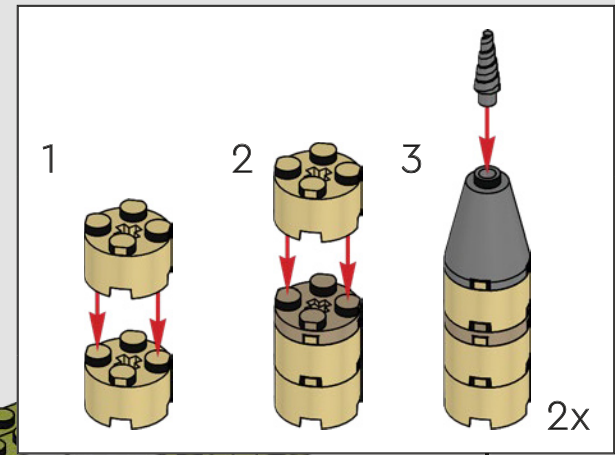

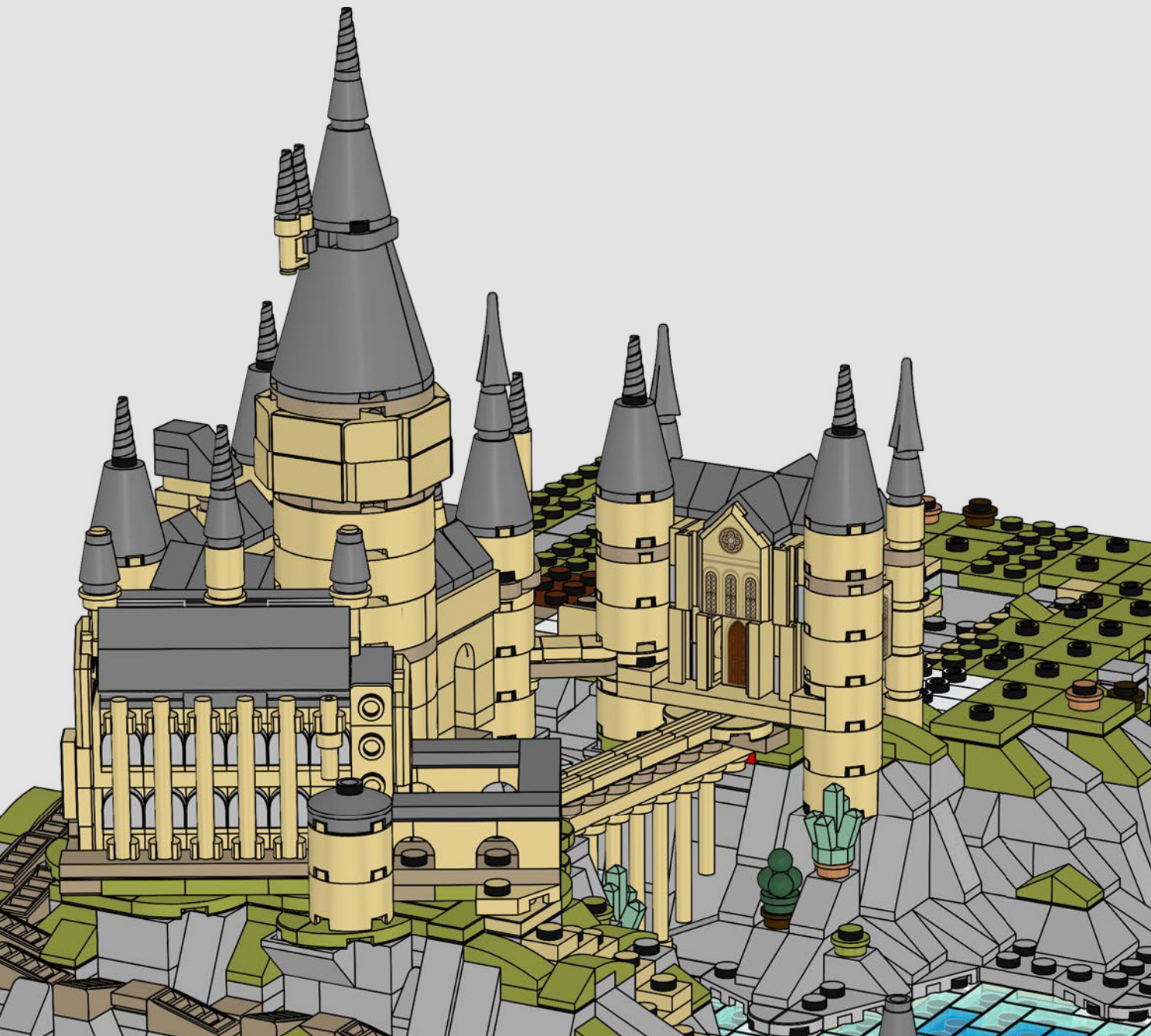

The girls' lavatories are located in this part of the castle. Maybe Moaning Myrtle™ will stop by as you build. Just watch out for trolls.

Les toilettes des filles sont situées dans cette partie du château. Peut-être que Mimi Geignarde viendra faire un tour pendant que vous construisez. Mais faites attention aux trolls !

Los baños de chicas se encuentran en esta parte del castillo. Quizá Myrtle, la Llorona, se pase por aquí mientras construyes. Solo ten cuidado con los troles.





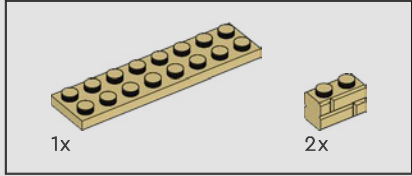
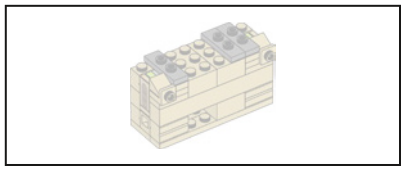

475

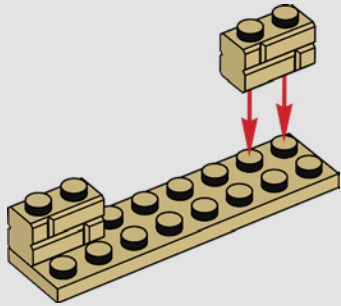

476

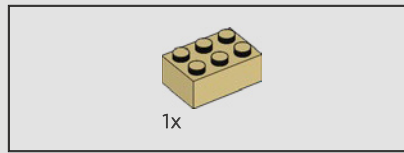
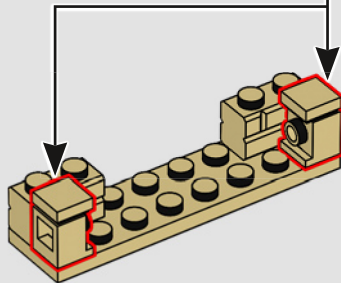
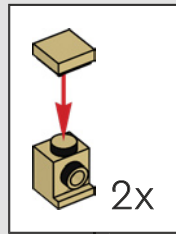

477

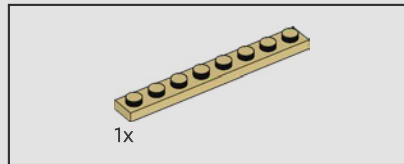
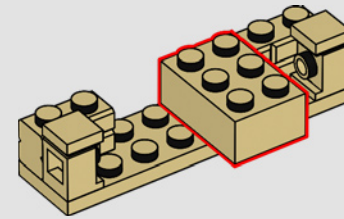

478

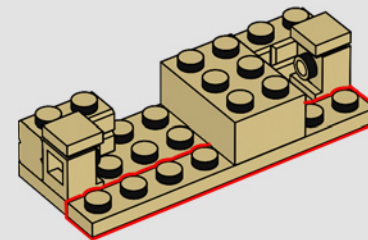

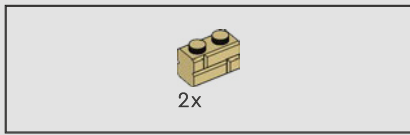

479

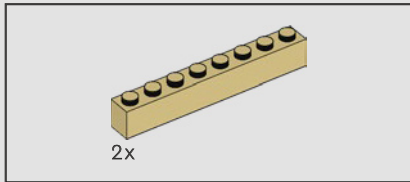
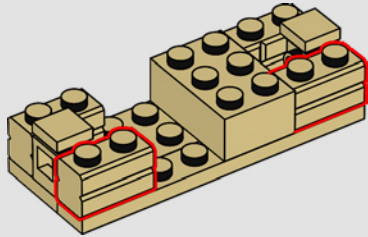

480

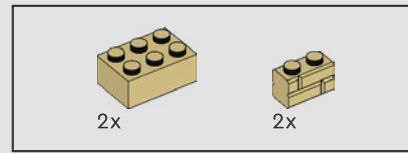
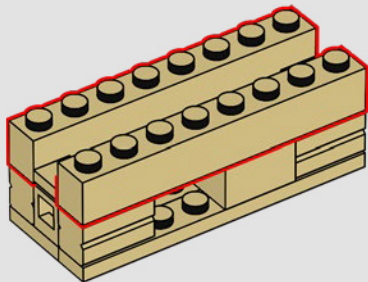

481

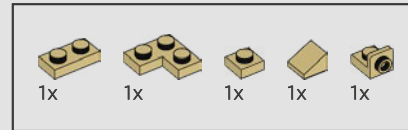
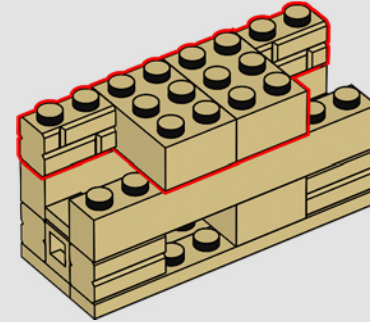

482

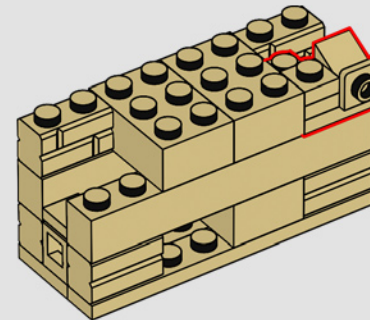
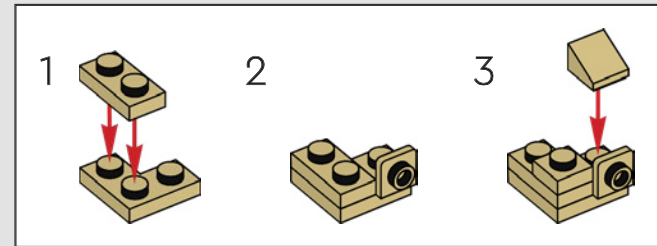

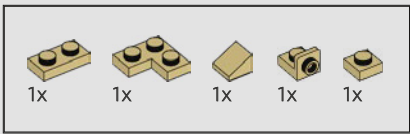

483

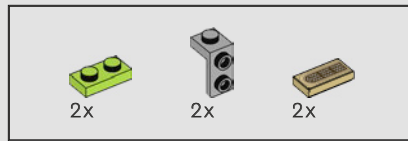
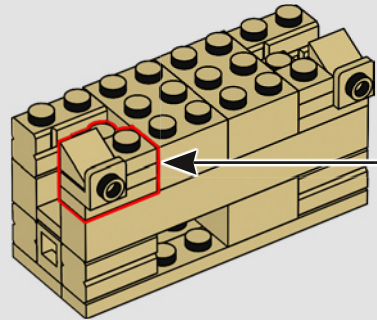
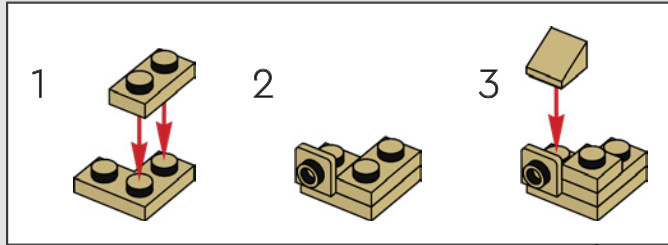

484

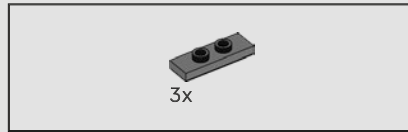
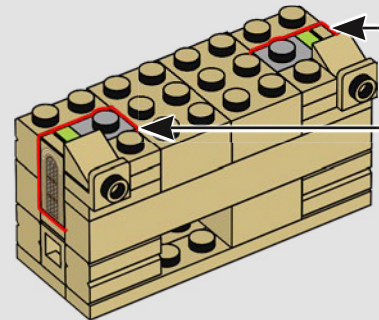
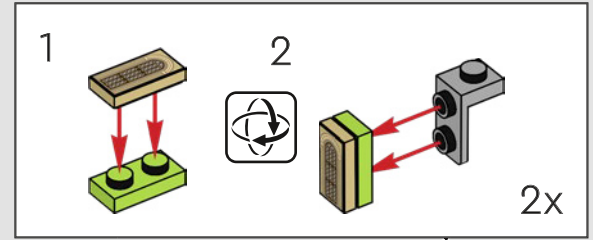

485

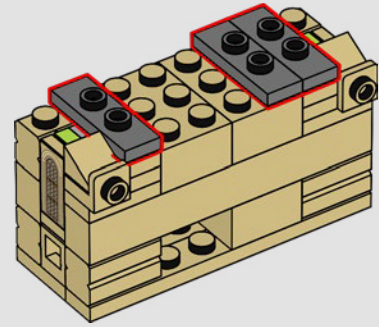

486



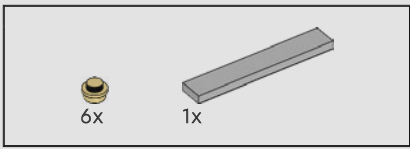

487

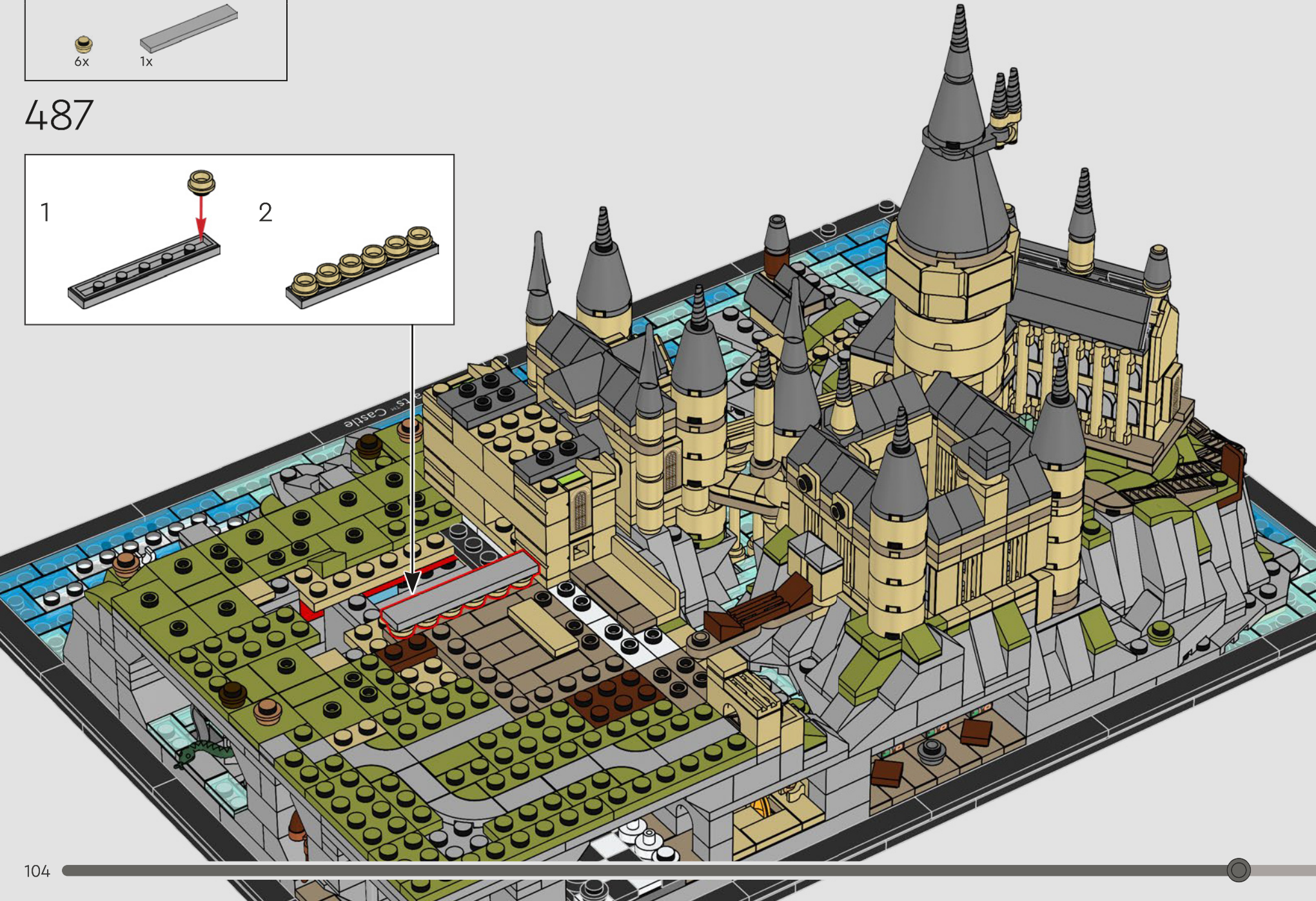
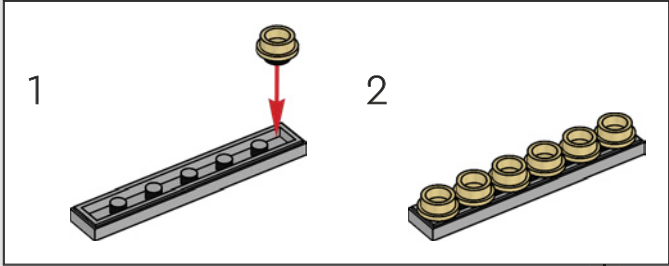

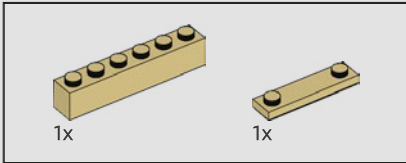
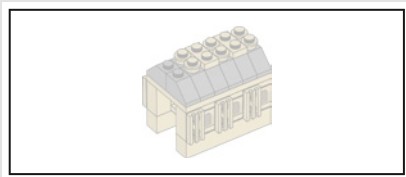

488

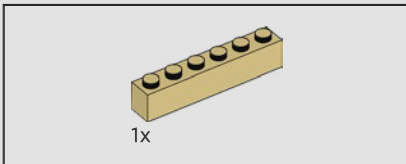
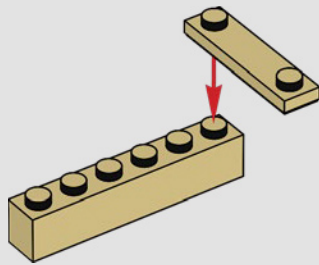

489

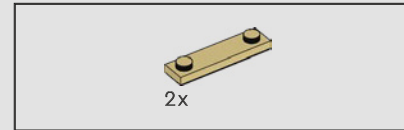
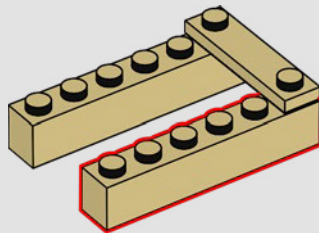

490

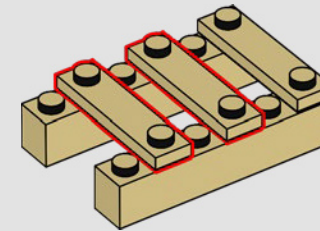

491

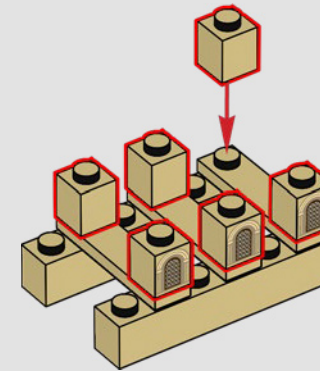

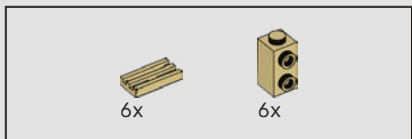

492

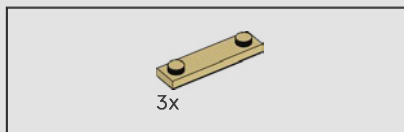
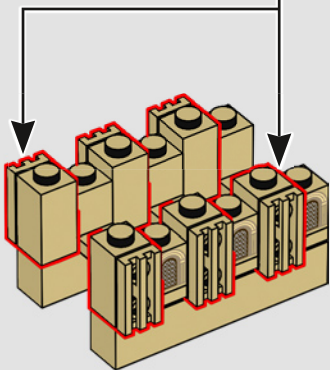
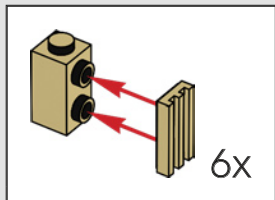

493

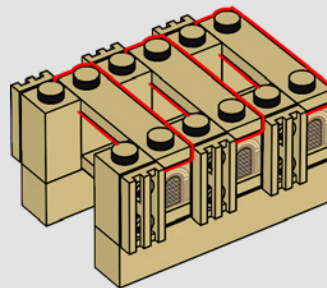

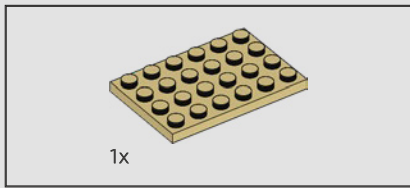

494

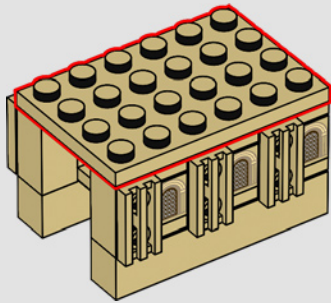

495

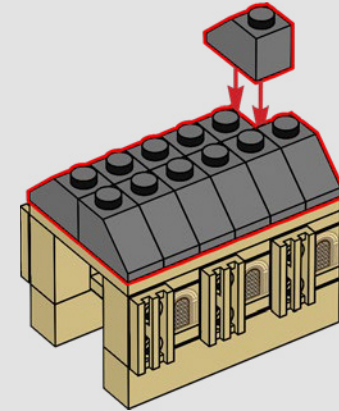

496

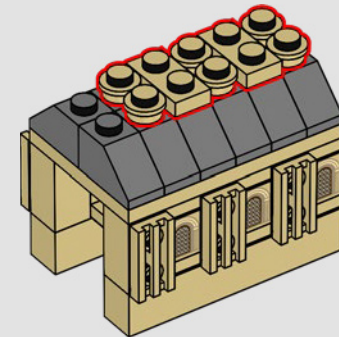

497

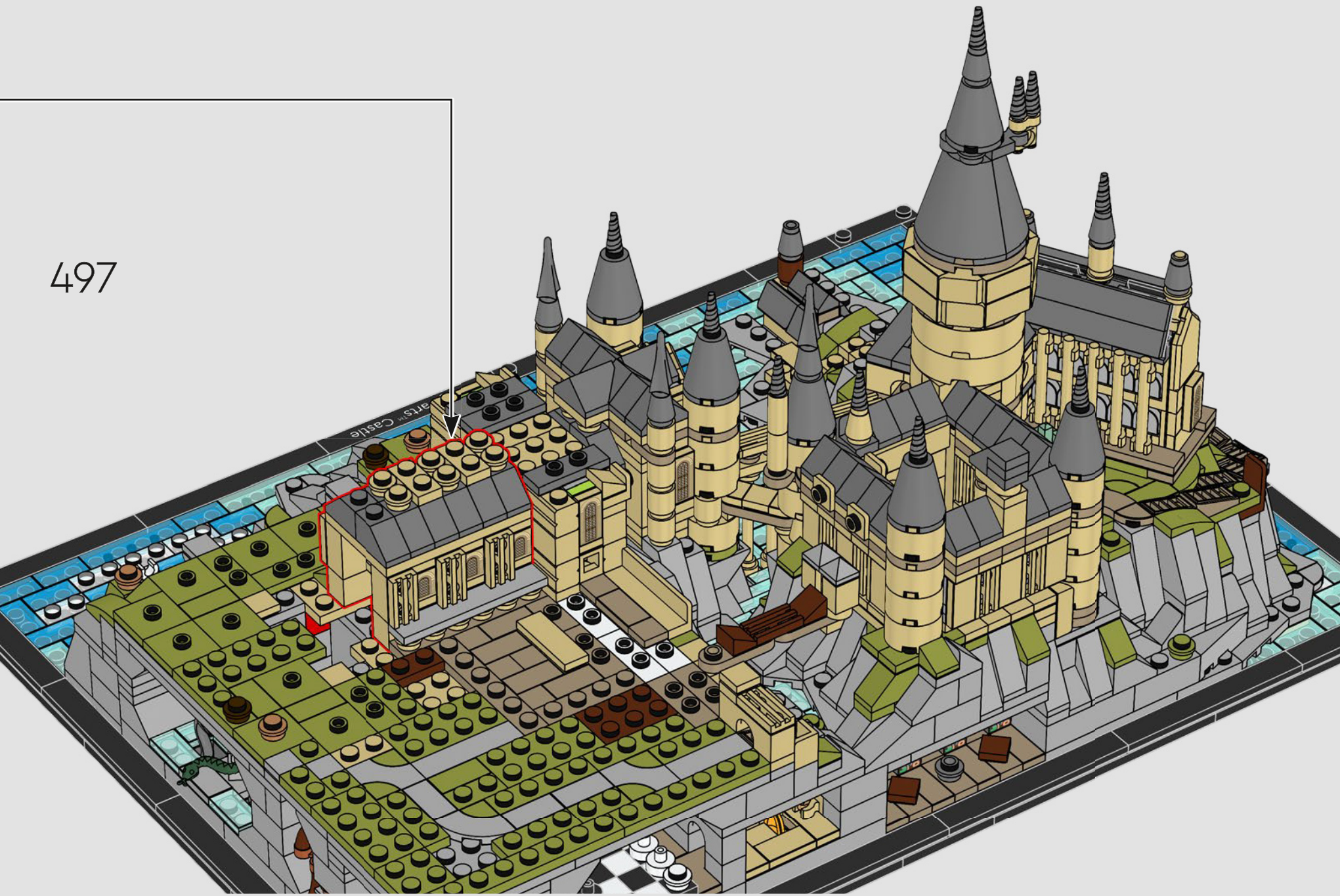

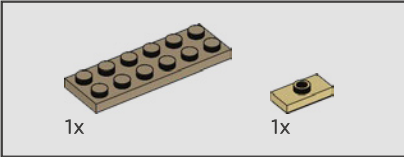
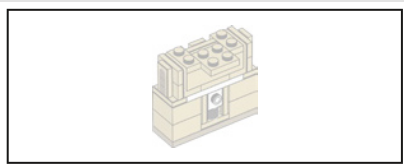

498

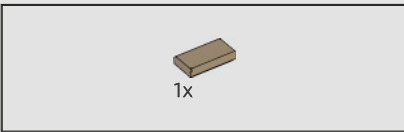
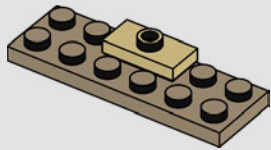

499

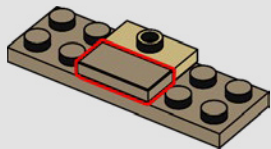

500

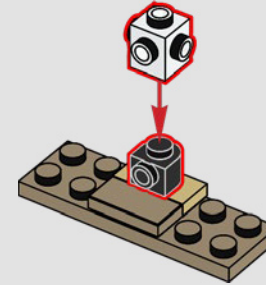

501

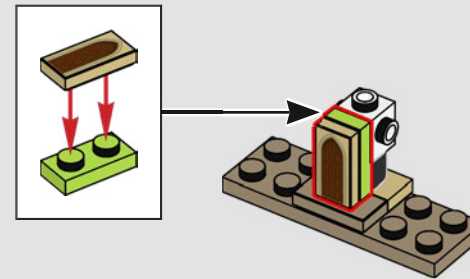

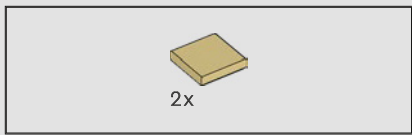

502

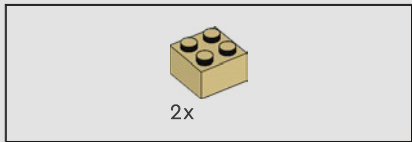
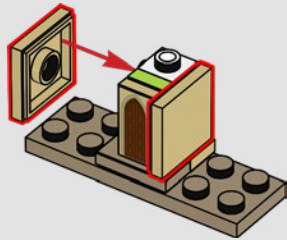

503

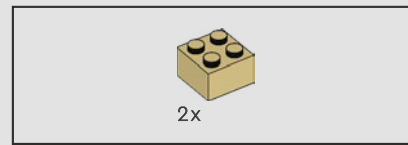
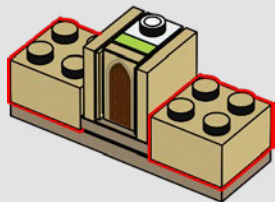

504

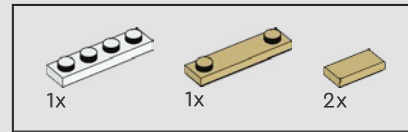
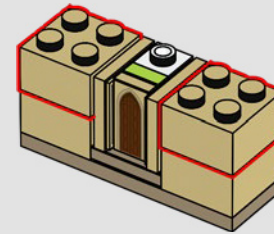

505

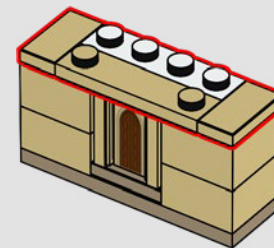

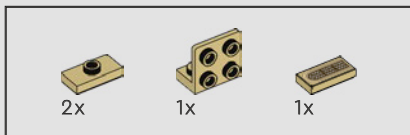

506

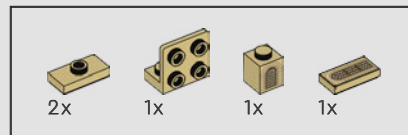
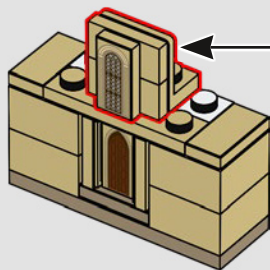
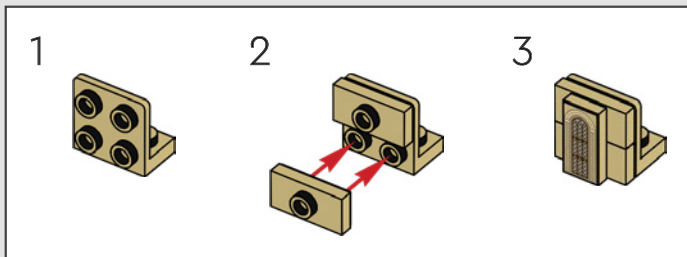

507

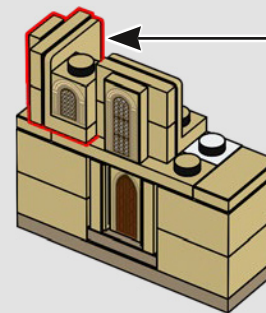
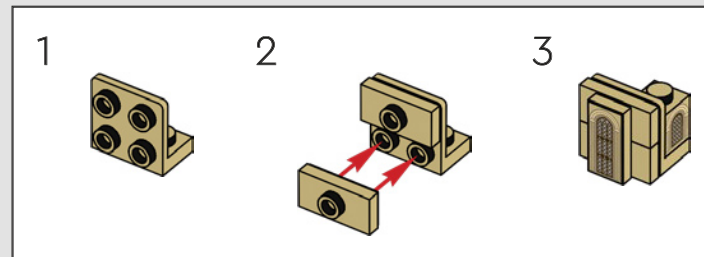

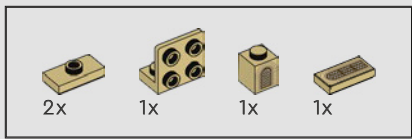

508

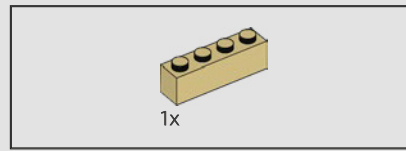
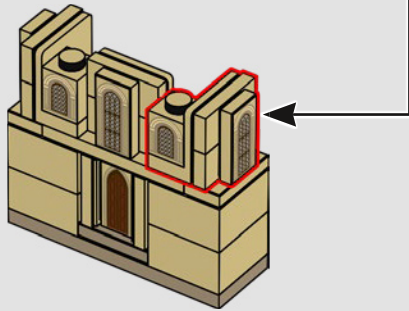
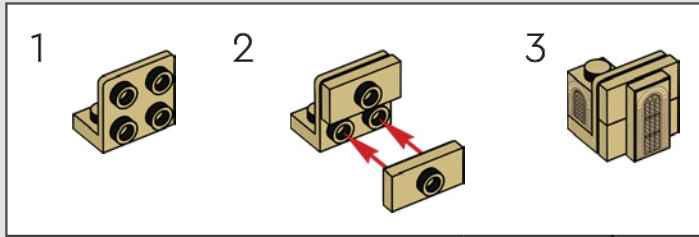

509

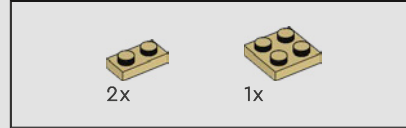
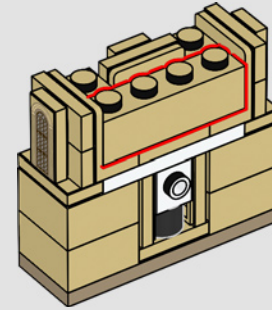

510

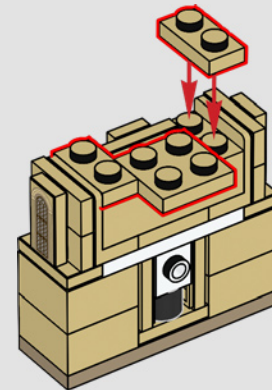

511





2x



2x



2x



2x



2x



2x



2x



2x



2x

512

1

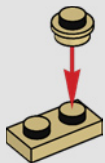

2

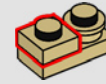

3

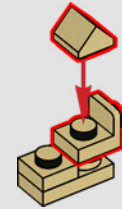

4

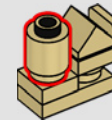

5

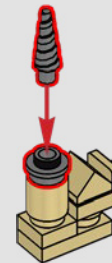

2x



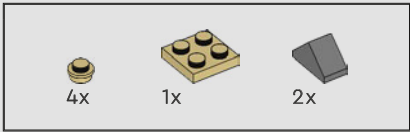

513

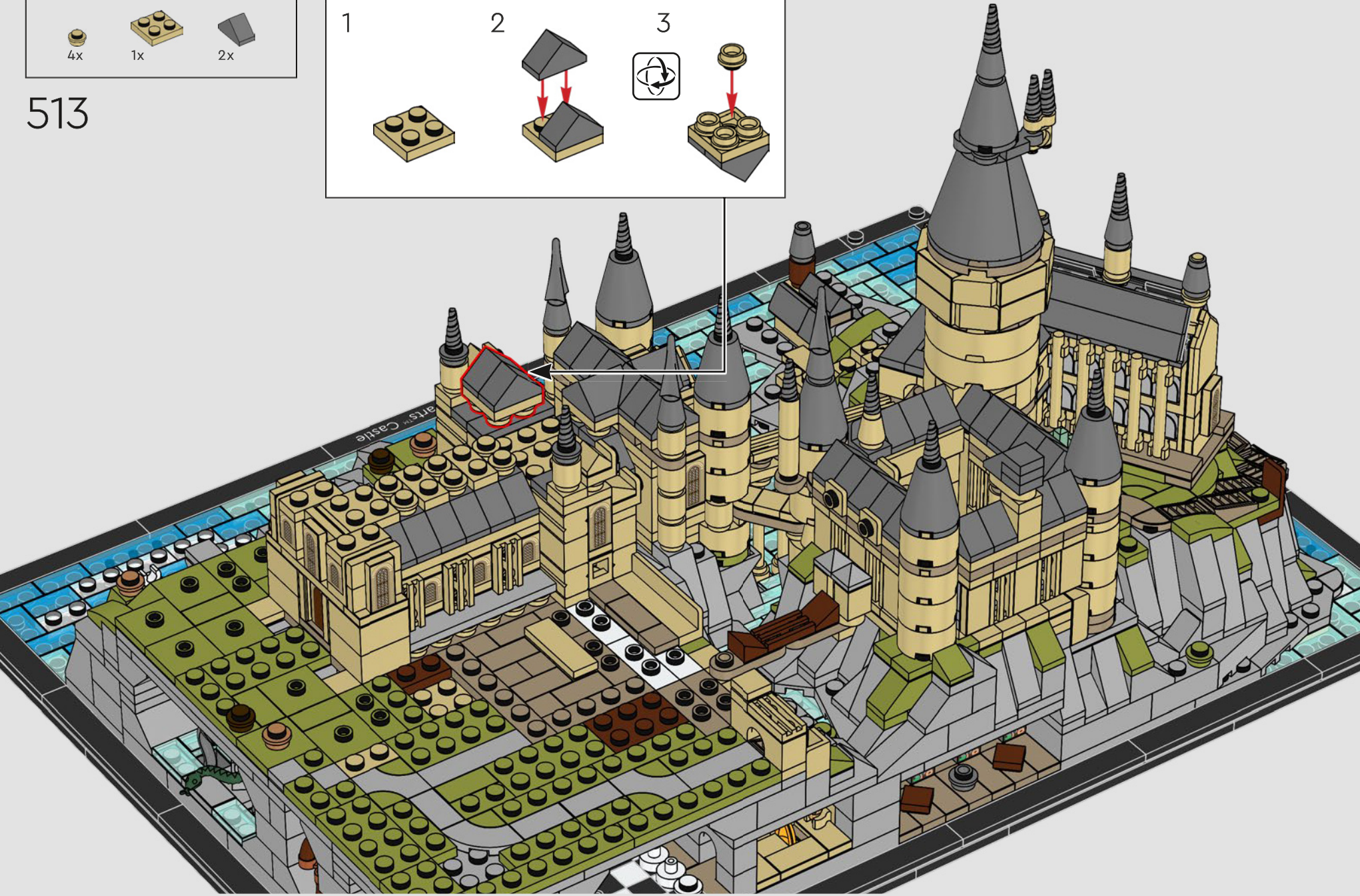
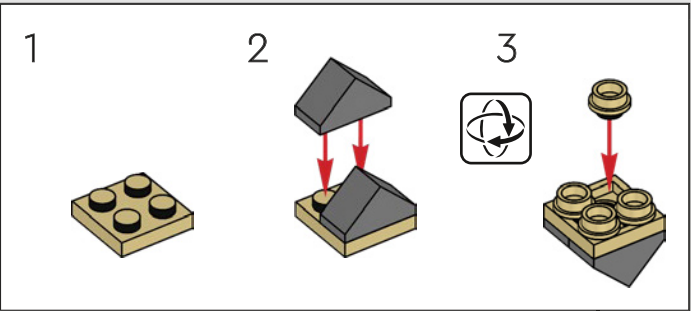

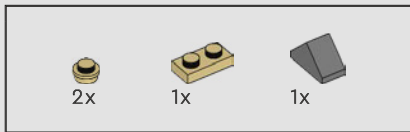

514

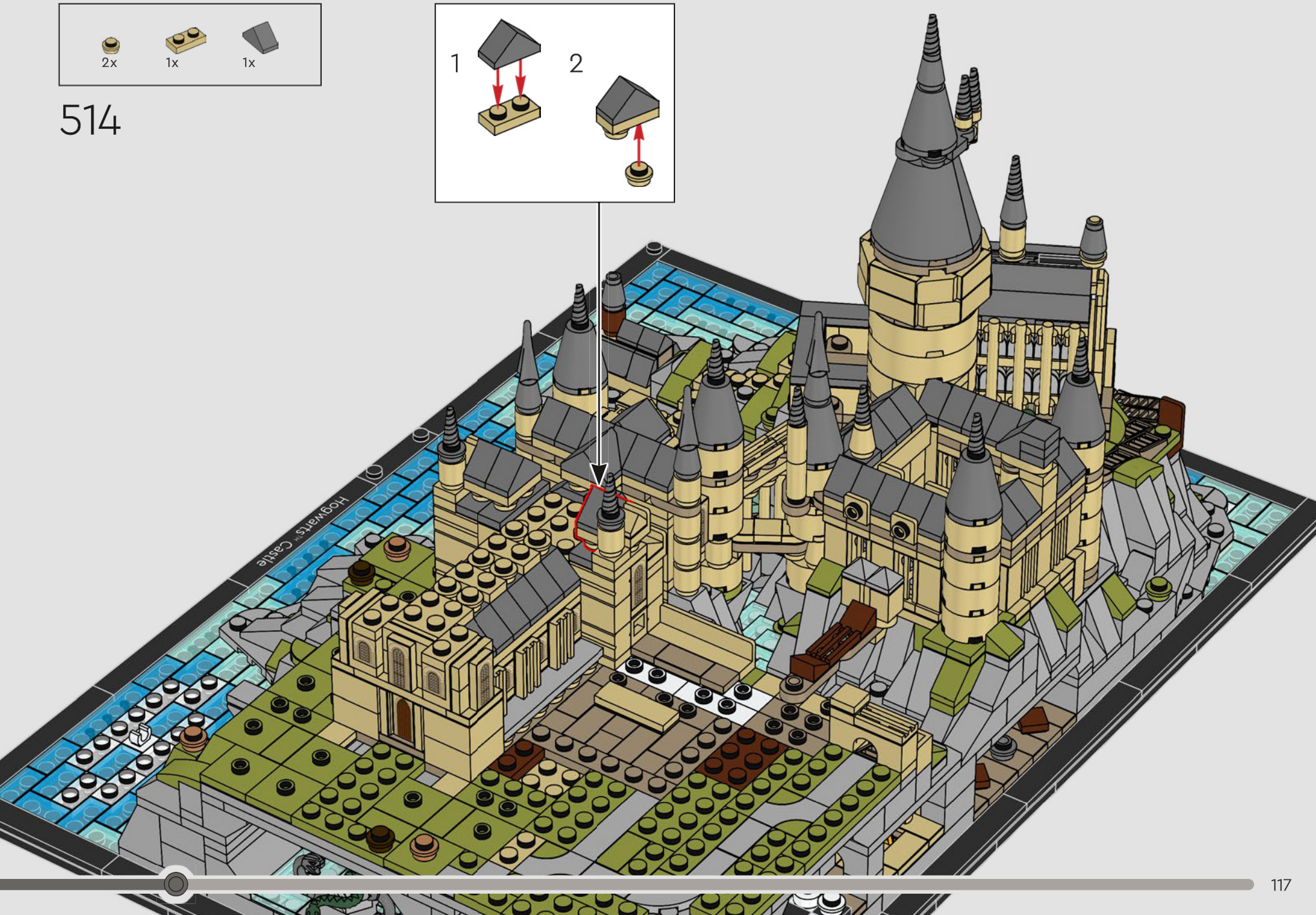
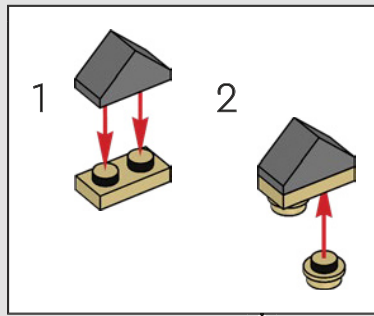

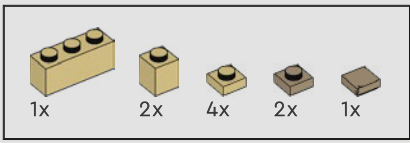

515

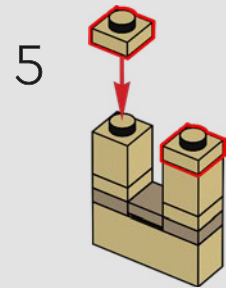
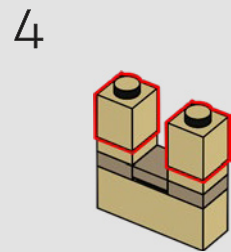
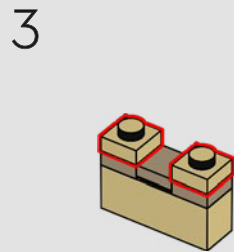
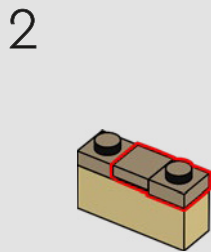
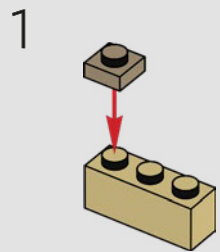

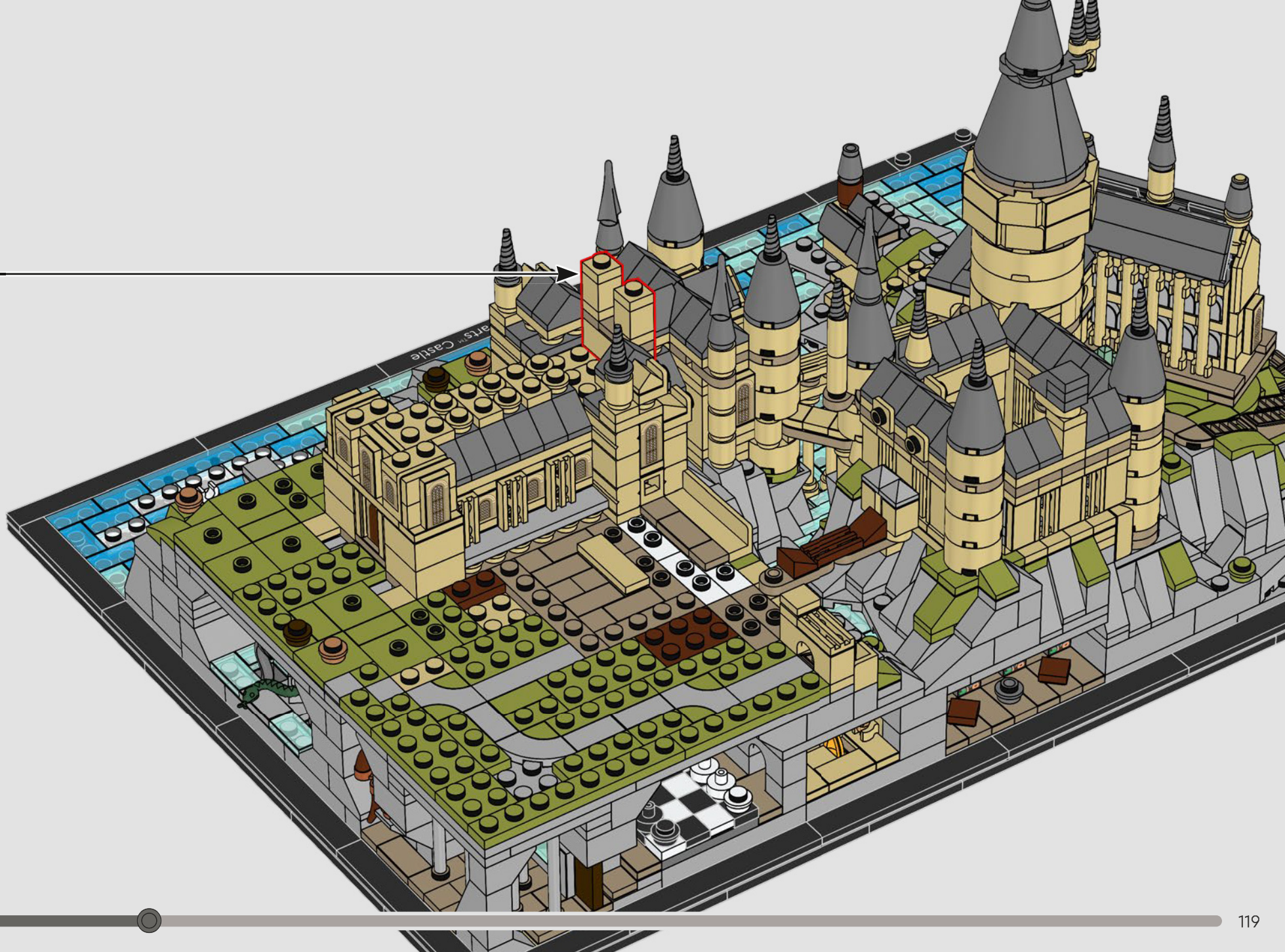

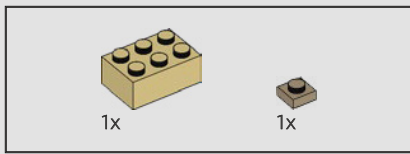

516

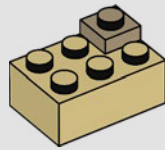

517

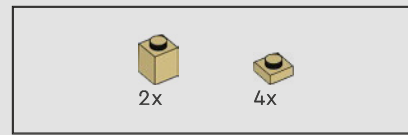
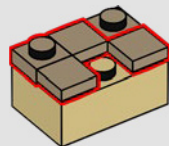

518

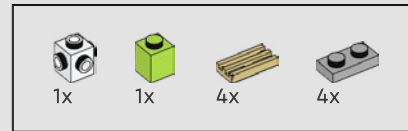
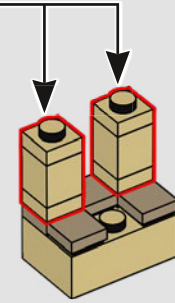
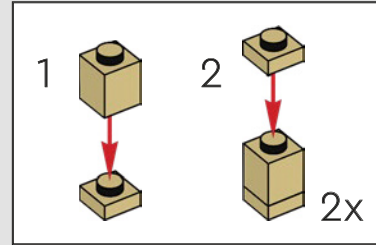

519

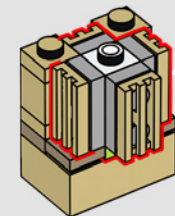
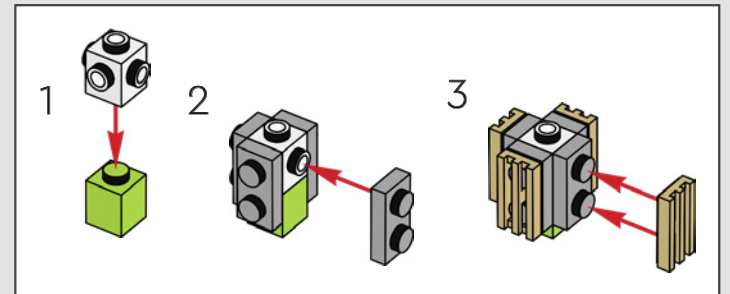

520

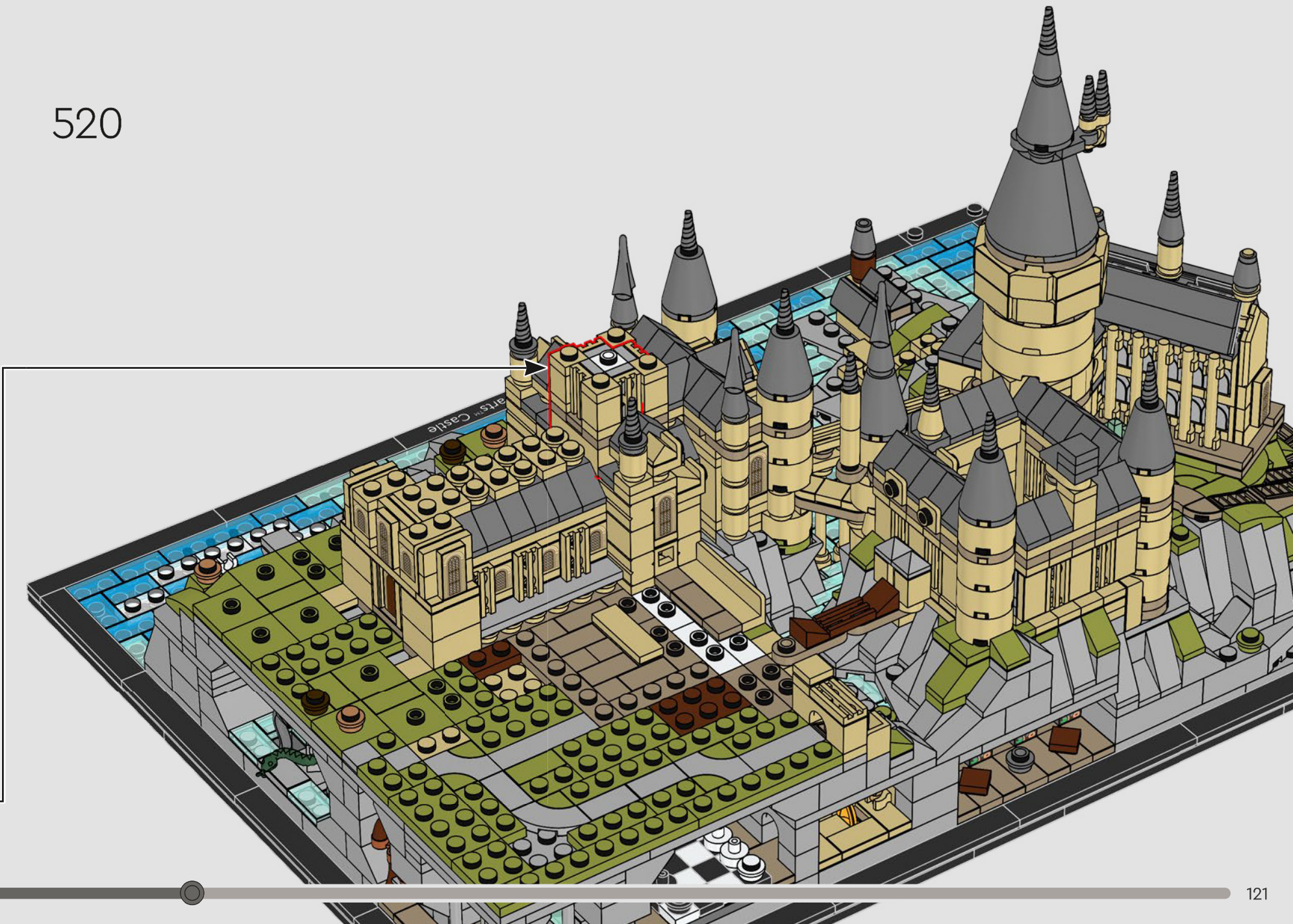

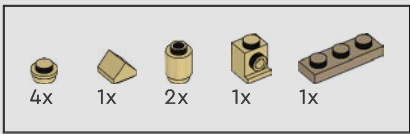

521

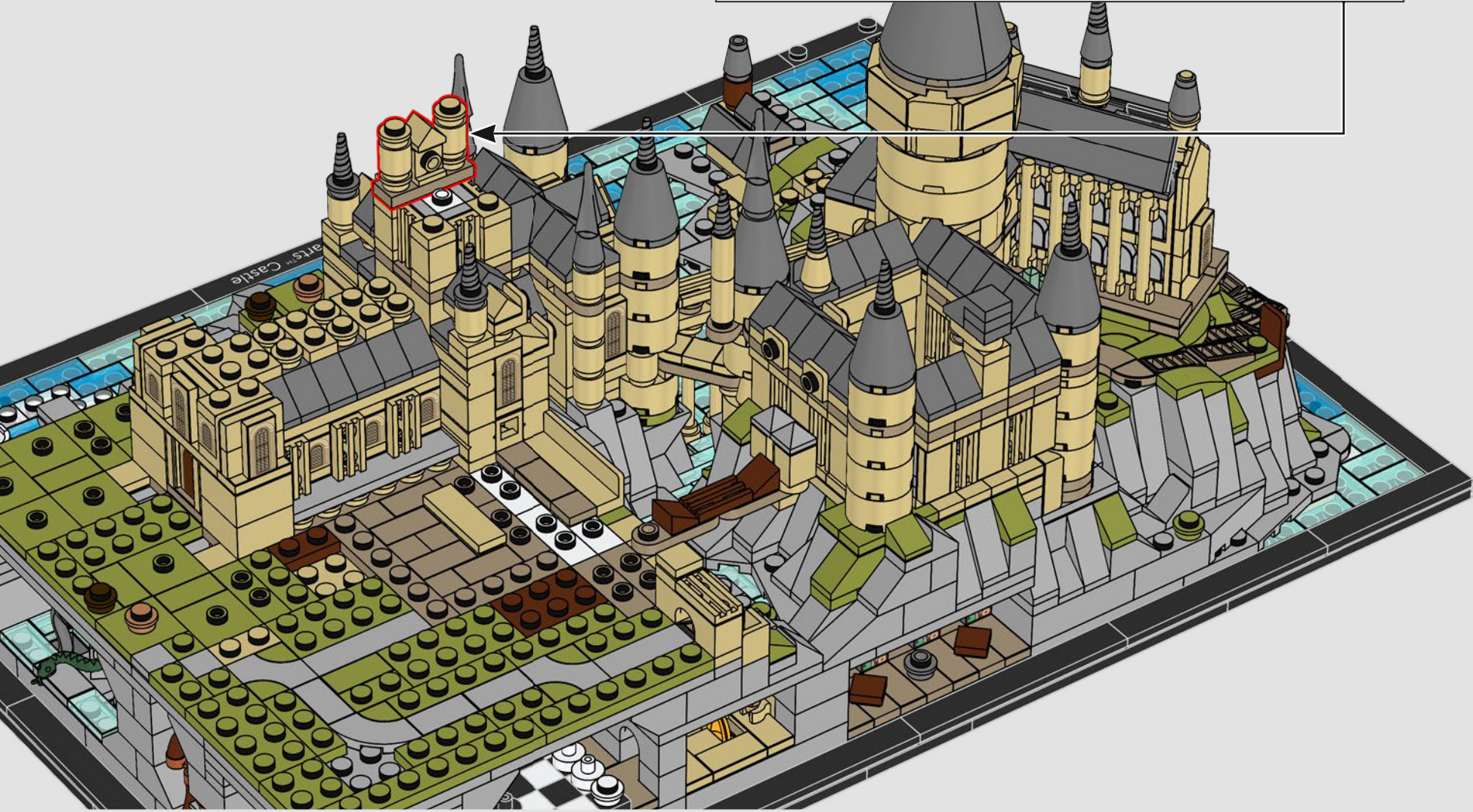
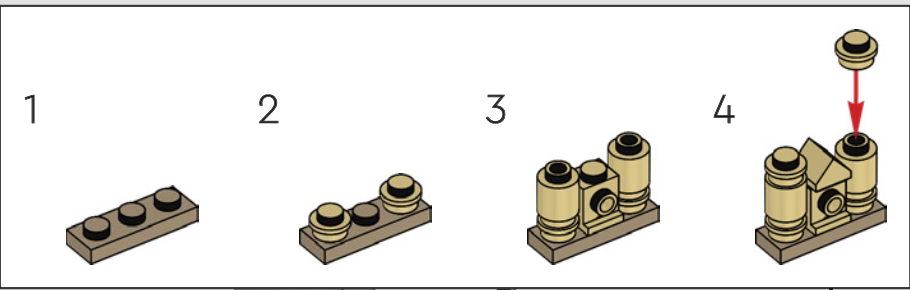

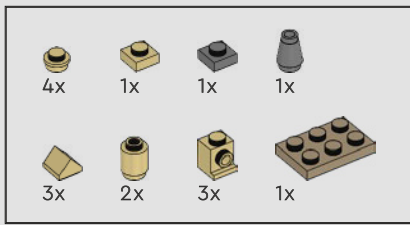

522

1

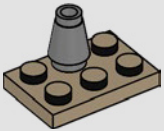

2

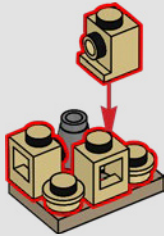

3

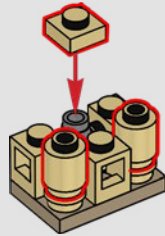

4

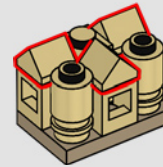

5

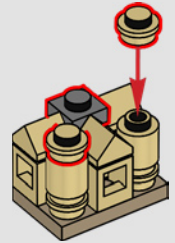

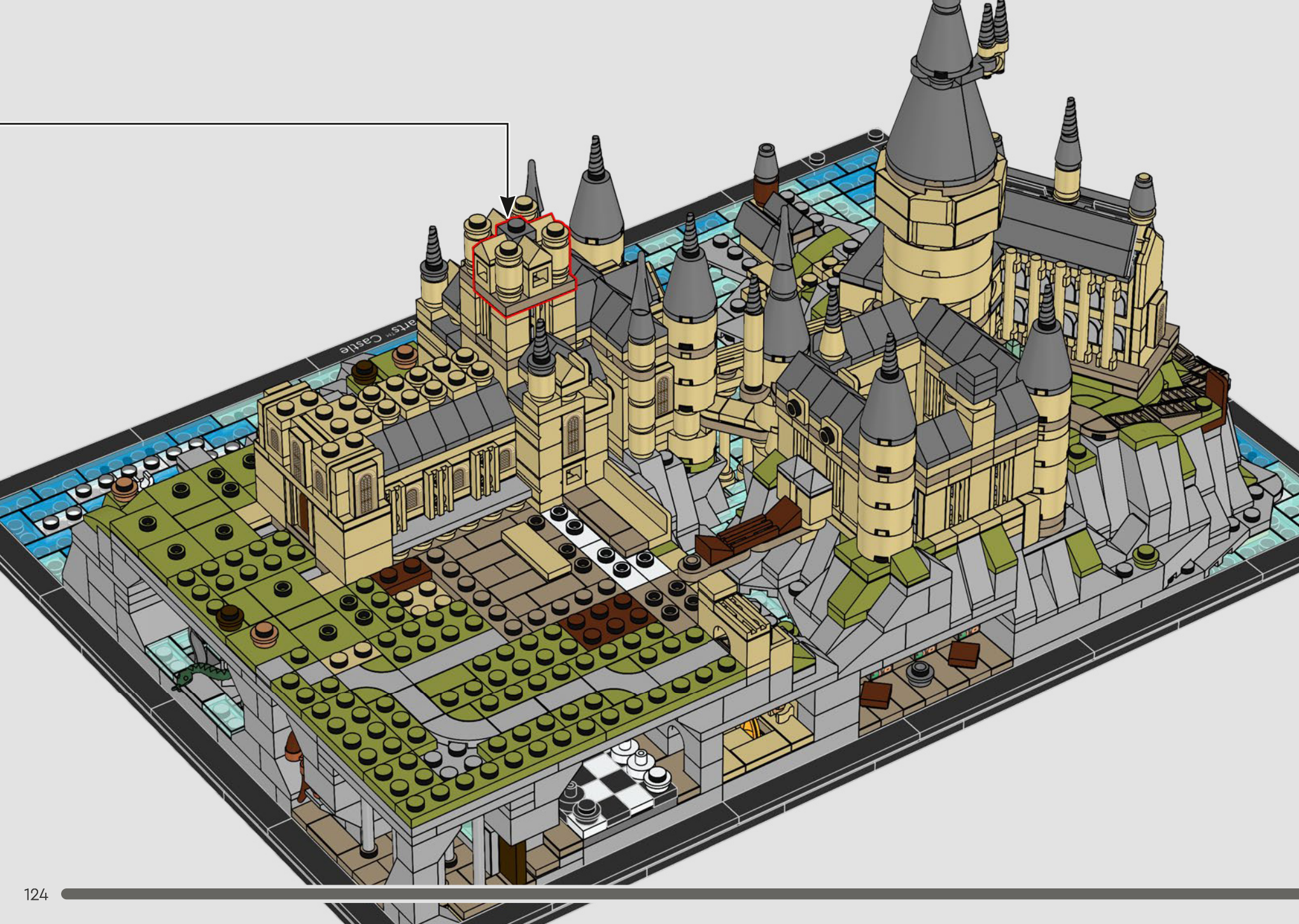

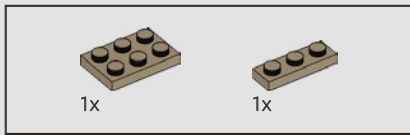

523



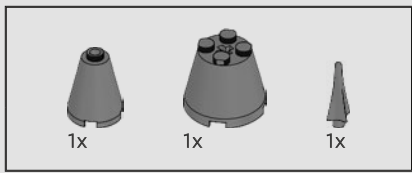

524

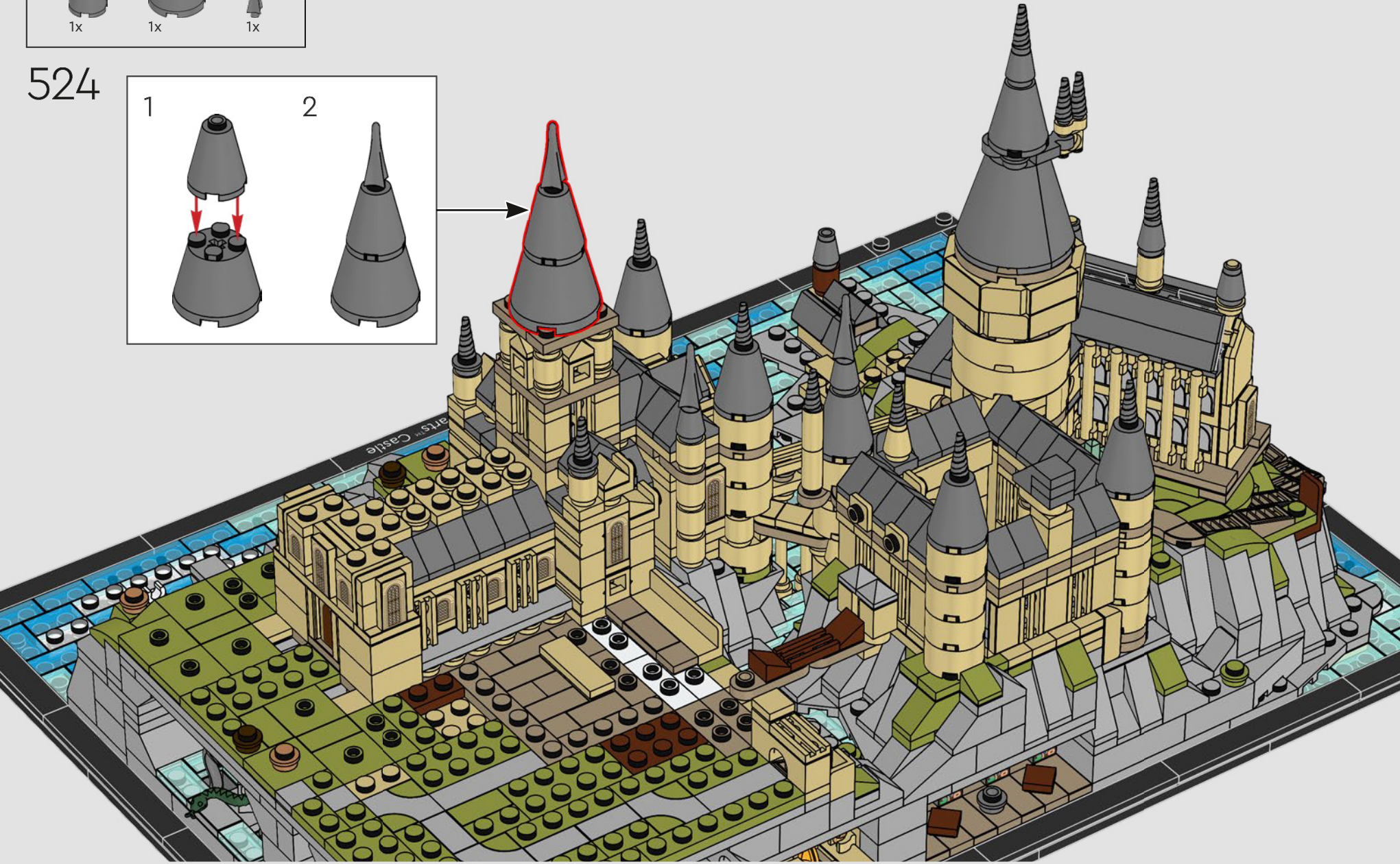
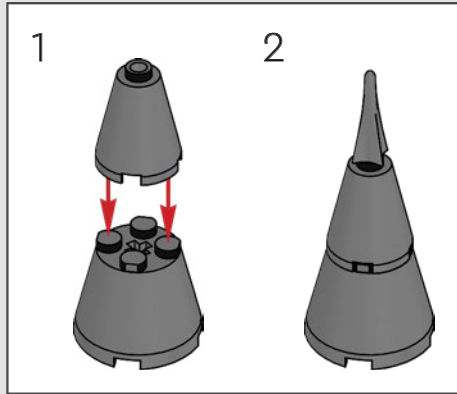

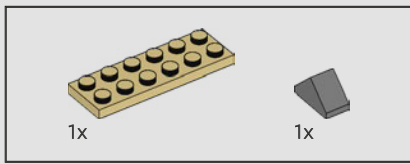

525

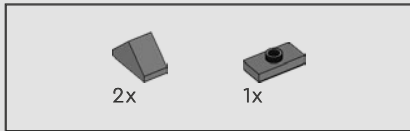
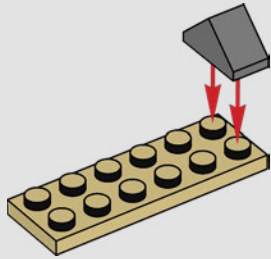

526

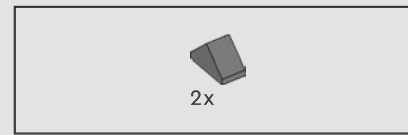
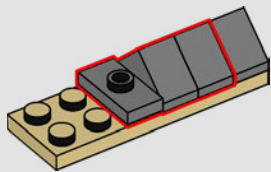

527

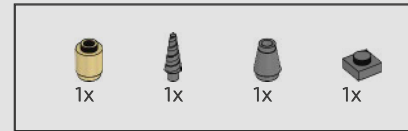
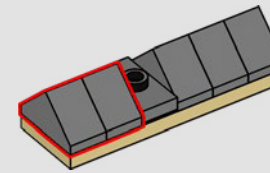

528

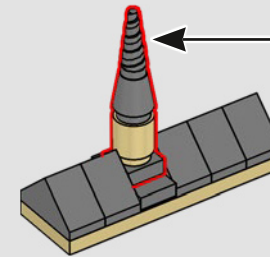
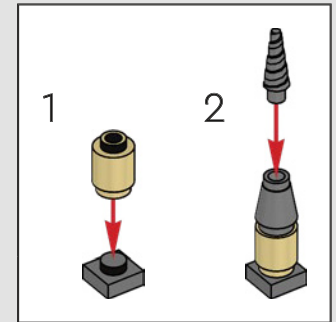

529

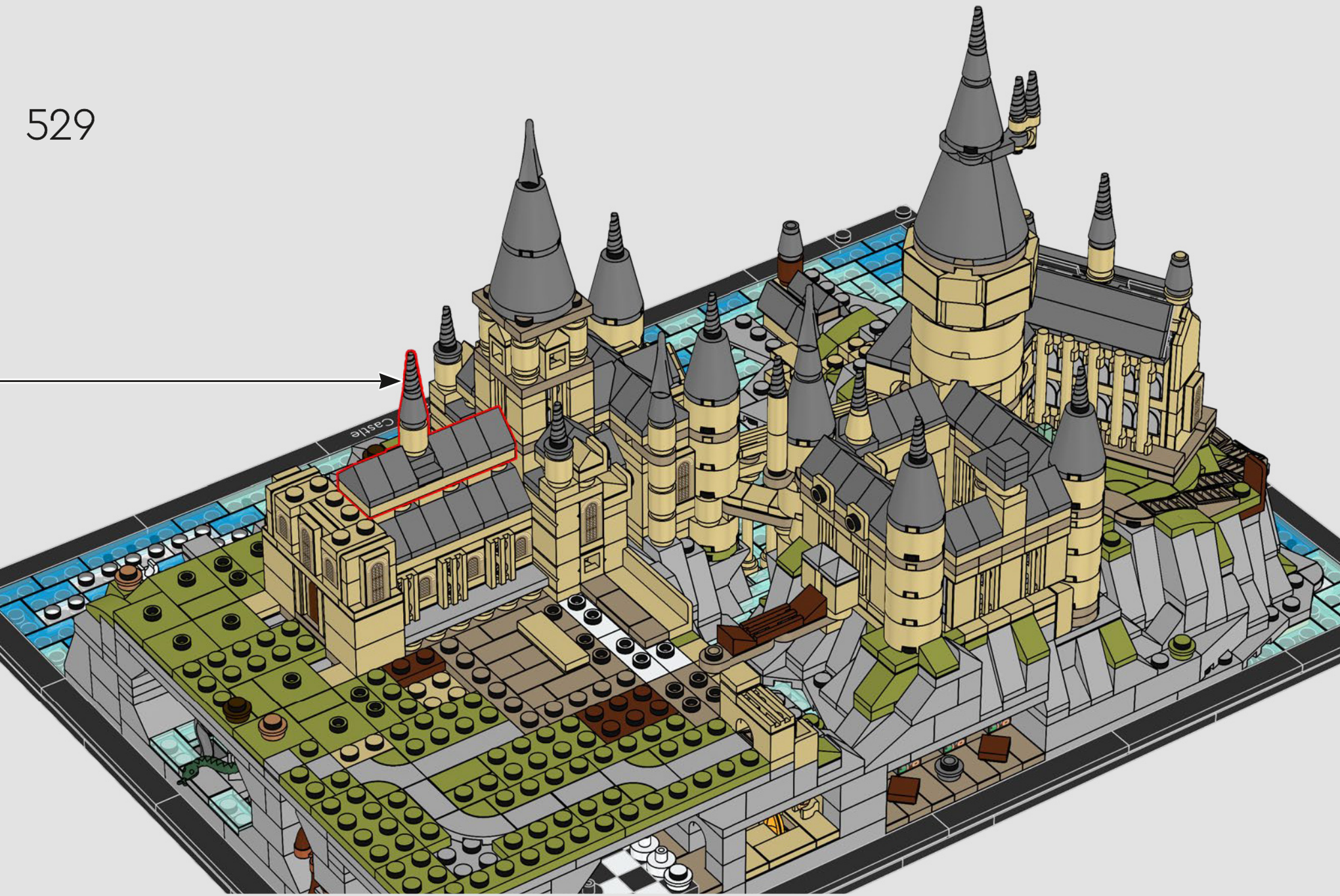

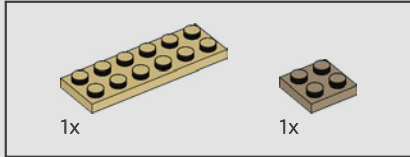
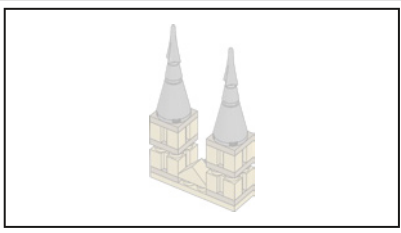

530

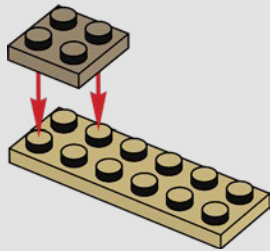

531

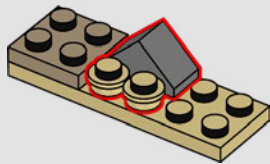

532

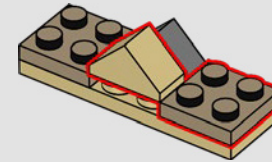

533

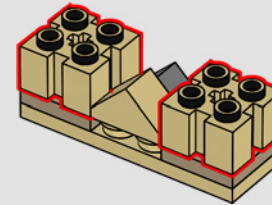



8x

534

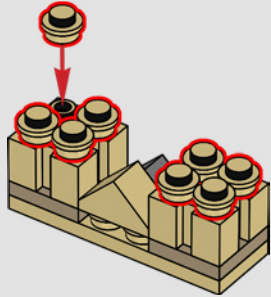

2x

535

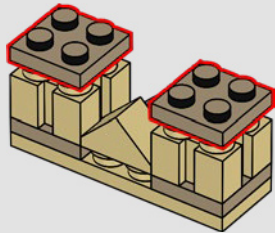

2x

536

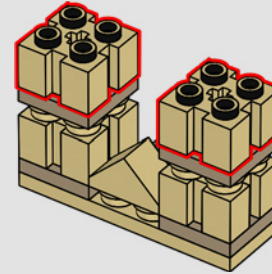

2x

537

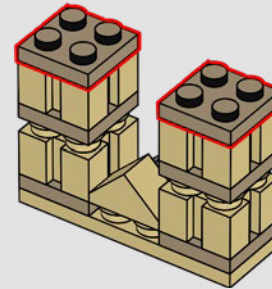

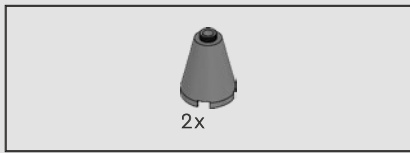

538

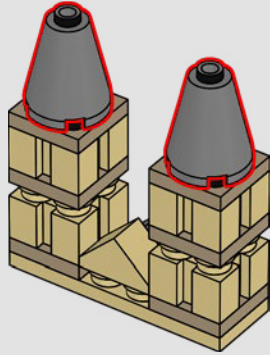

539

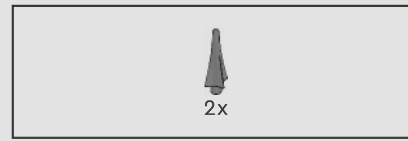
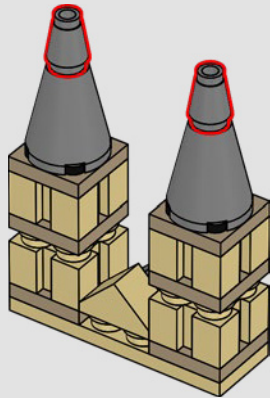

540

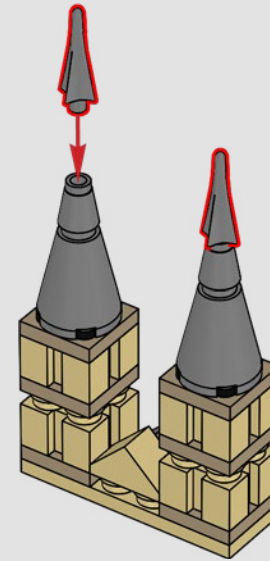

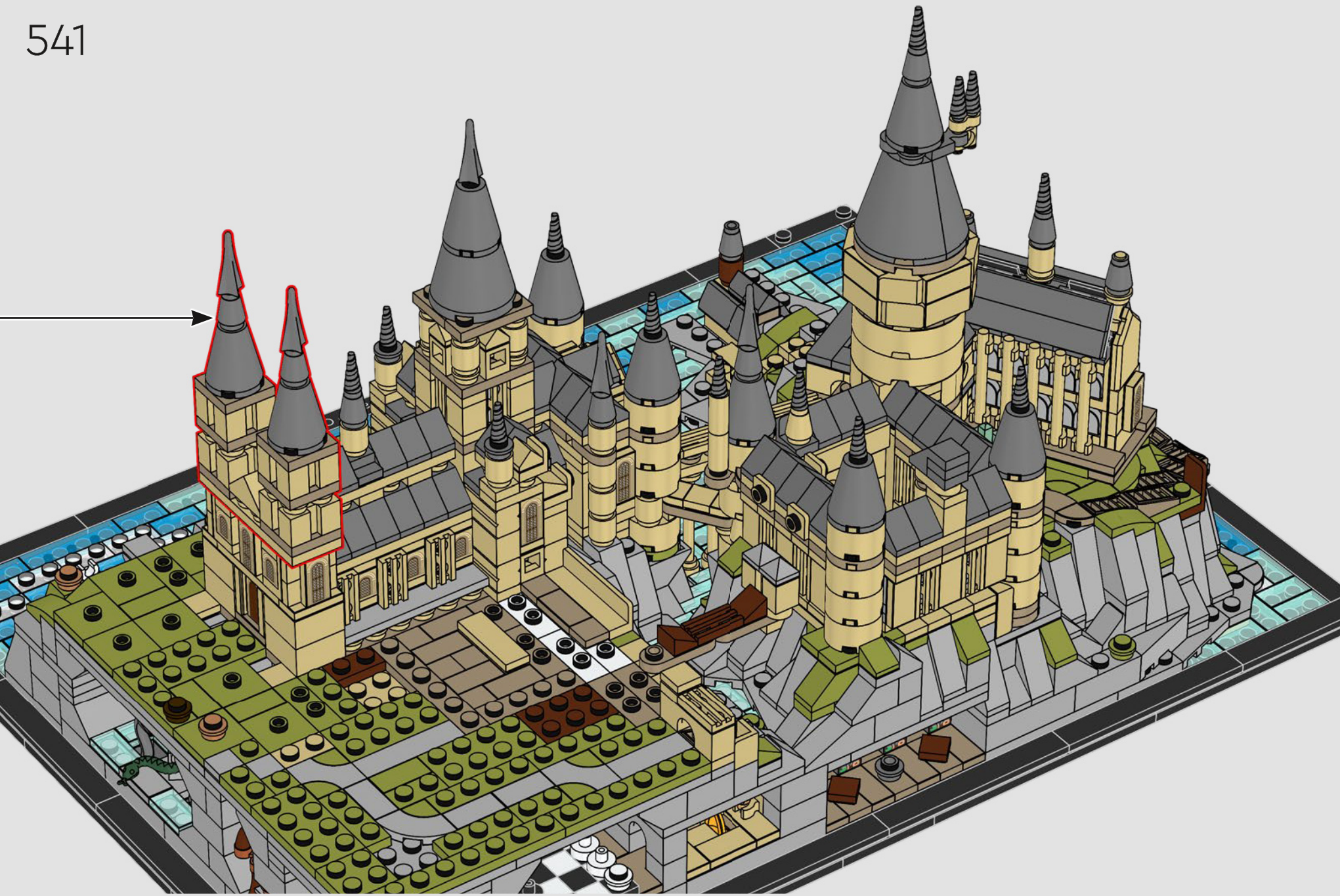

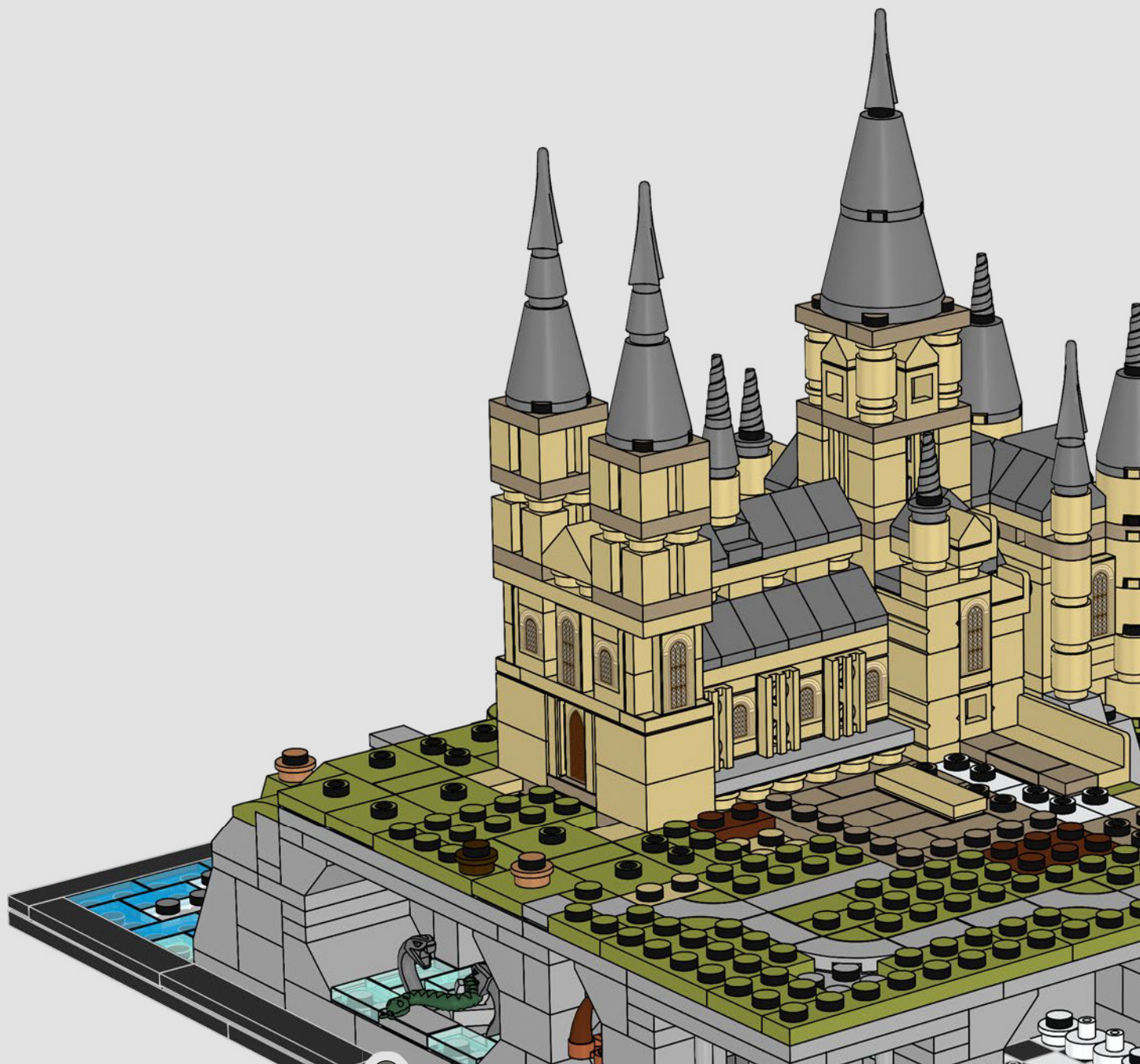

No matter what a Hogwarts™ student's favorite subjects are, they will likely spend a great deal of their time in the East Wing, where many of the classrooms are located.

Quelles que soient les matières préférées d'un élève de Poudlard, il passera probablement une grande partie de son temps dans l'aile Est, où se trouvent de nombreuses salles de classe.

No importa cuáles sean las materias favoritas de un estudiante de Hogwarts™, lo más probable es que pase gran parte de su tiempo en el ala este, donde se encuentran muchas de las aulas.





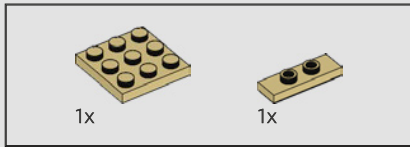
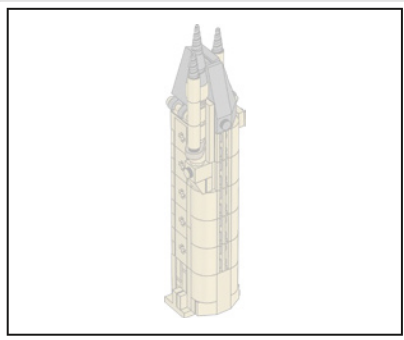

542

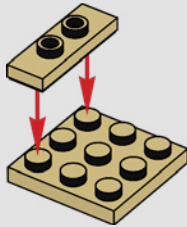

543

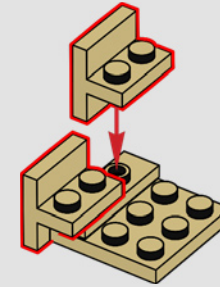

544

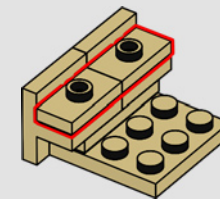



2x

545

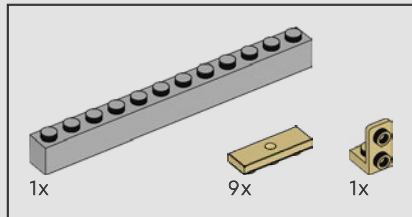
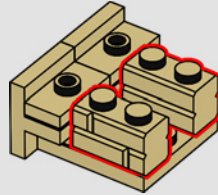

546

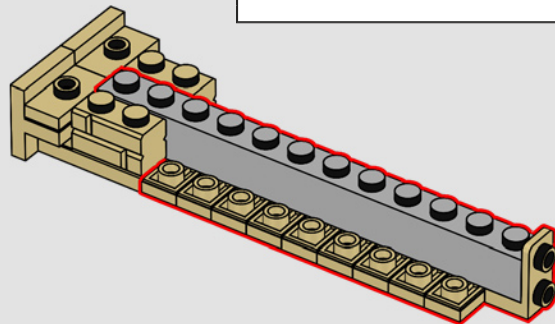
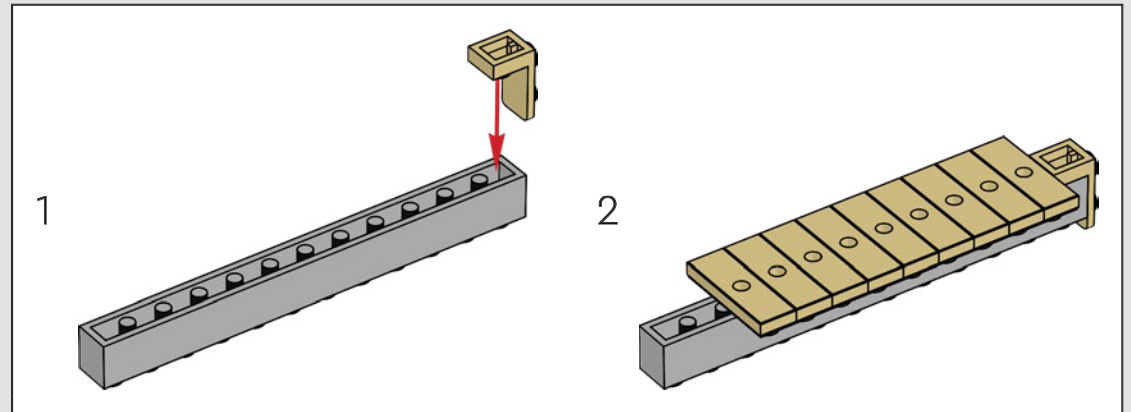

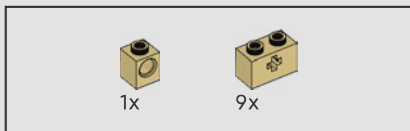

547

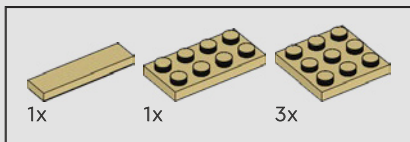
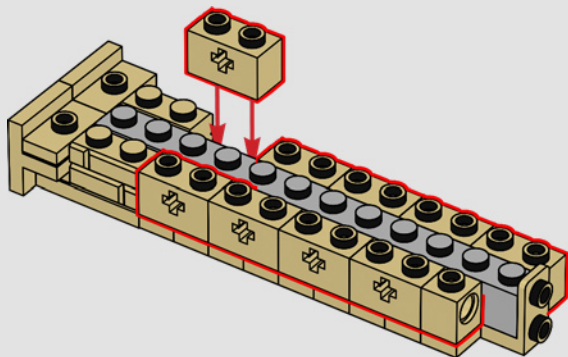

548

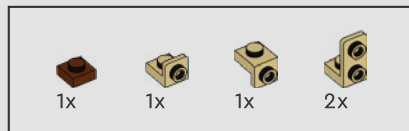
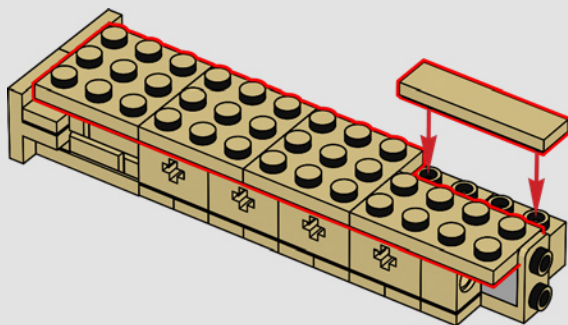

549

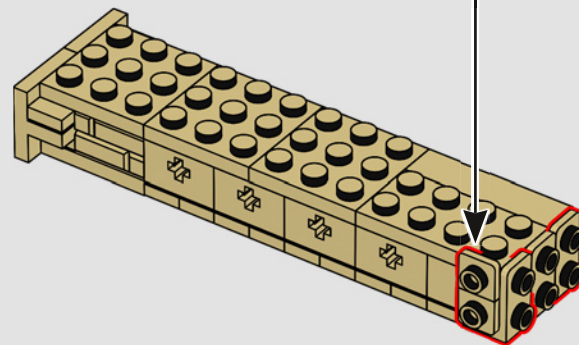
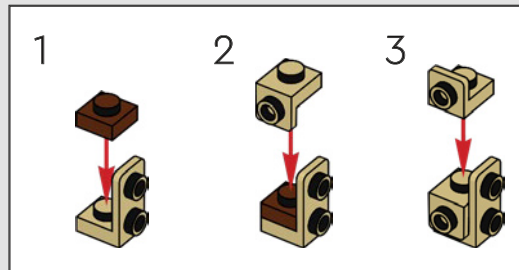

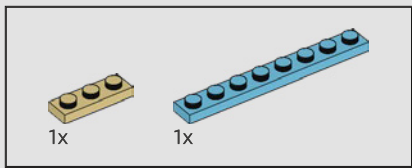

550

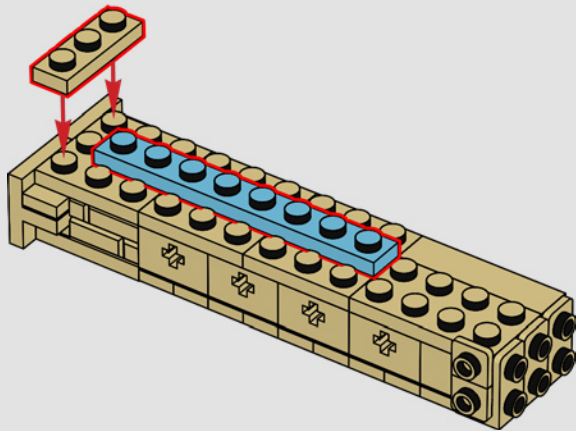

551

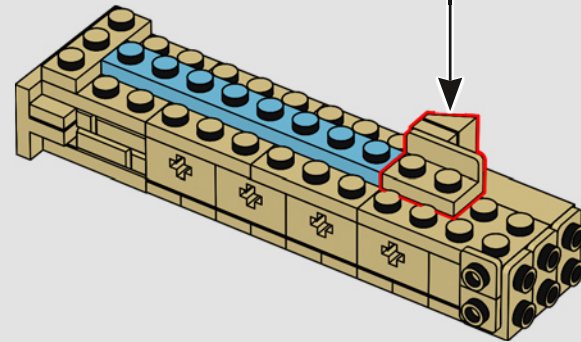
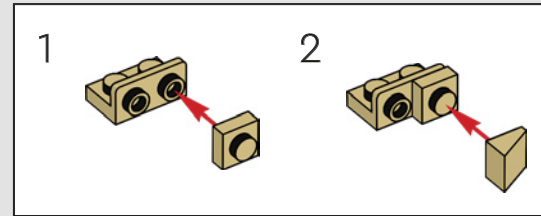

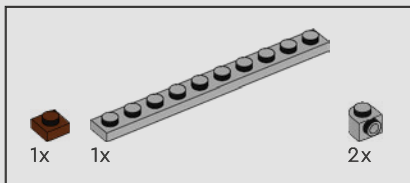

552

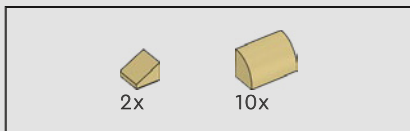
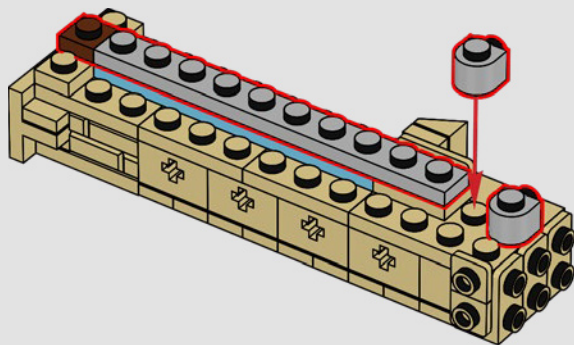

553

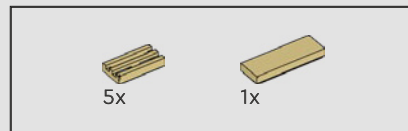
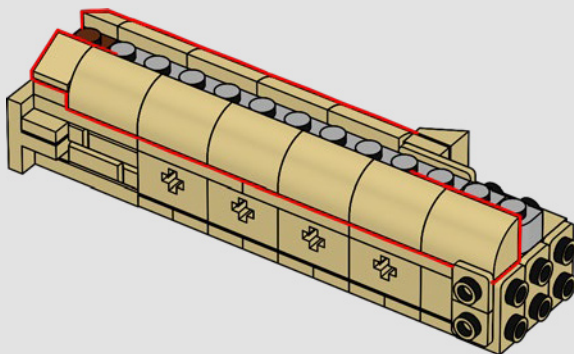

554

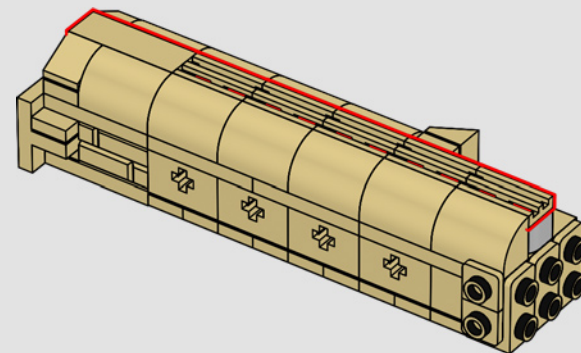



1x

555

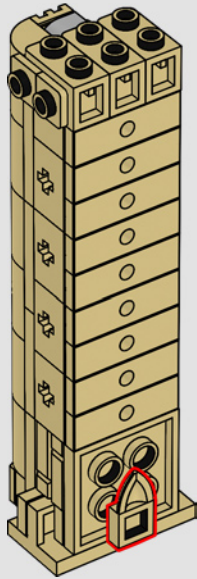

2x

556

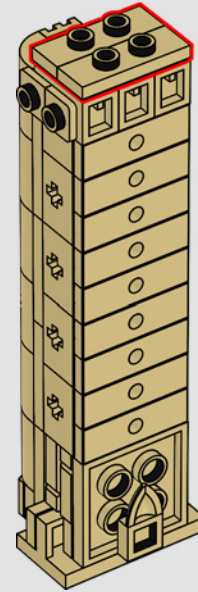

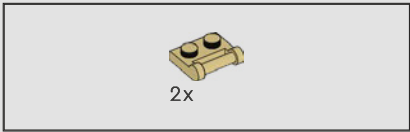

557

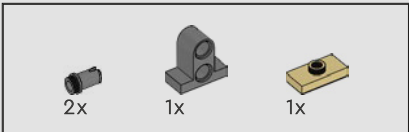
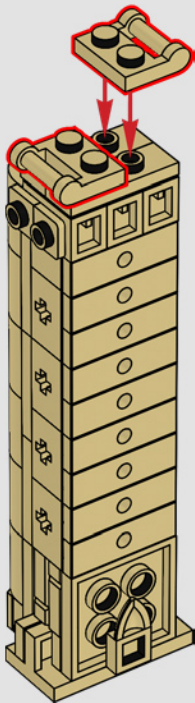

558

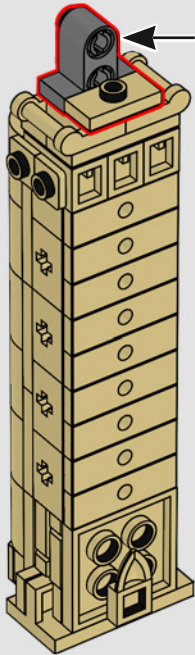
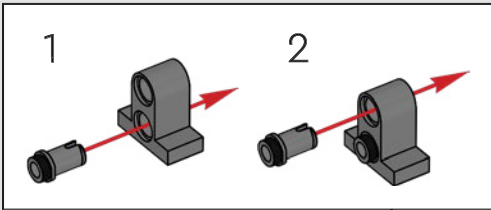



559

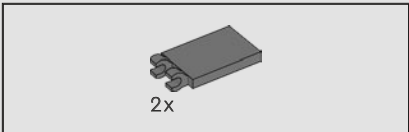

560

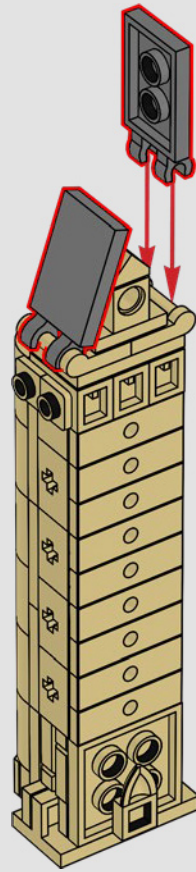



561

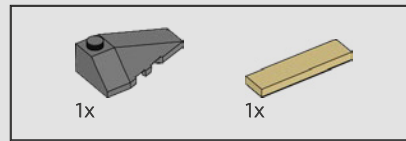
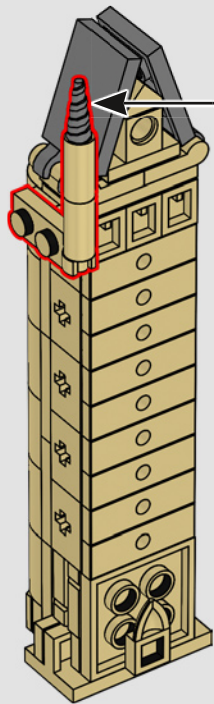
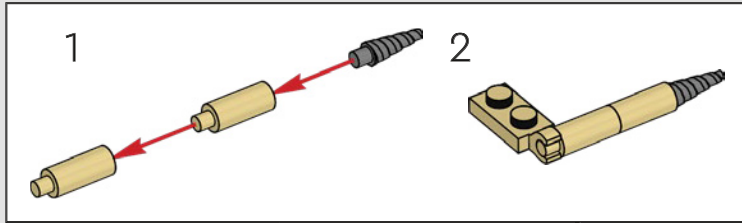

562

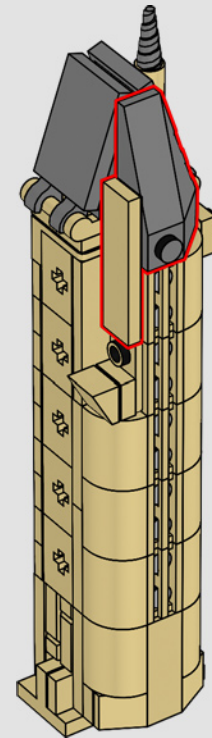

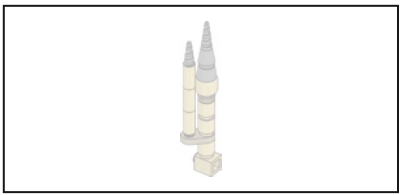

563

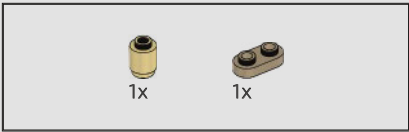

564



565





566

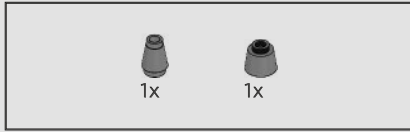

567

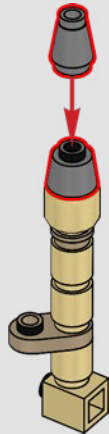

568

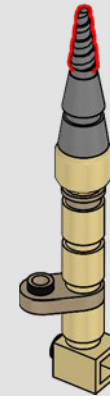

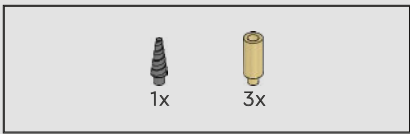

569

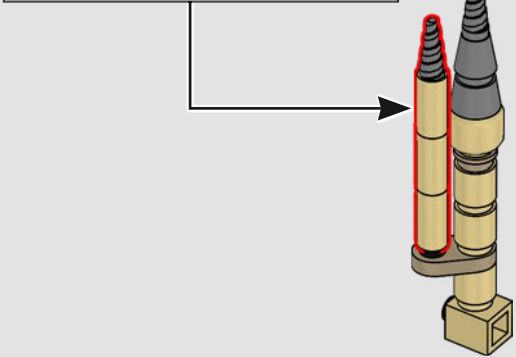
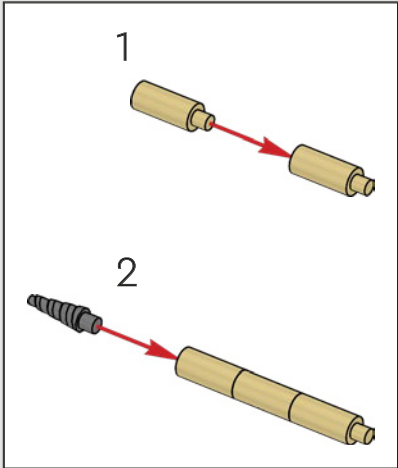

570

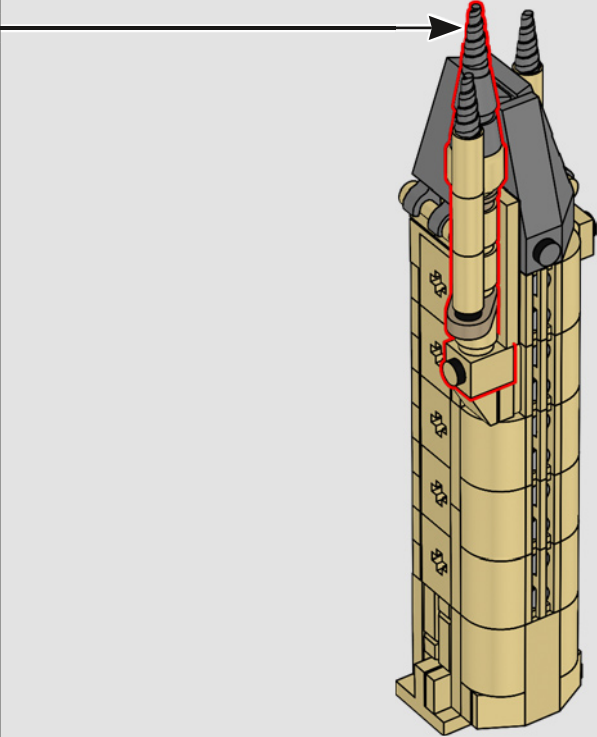

571

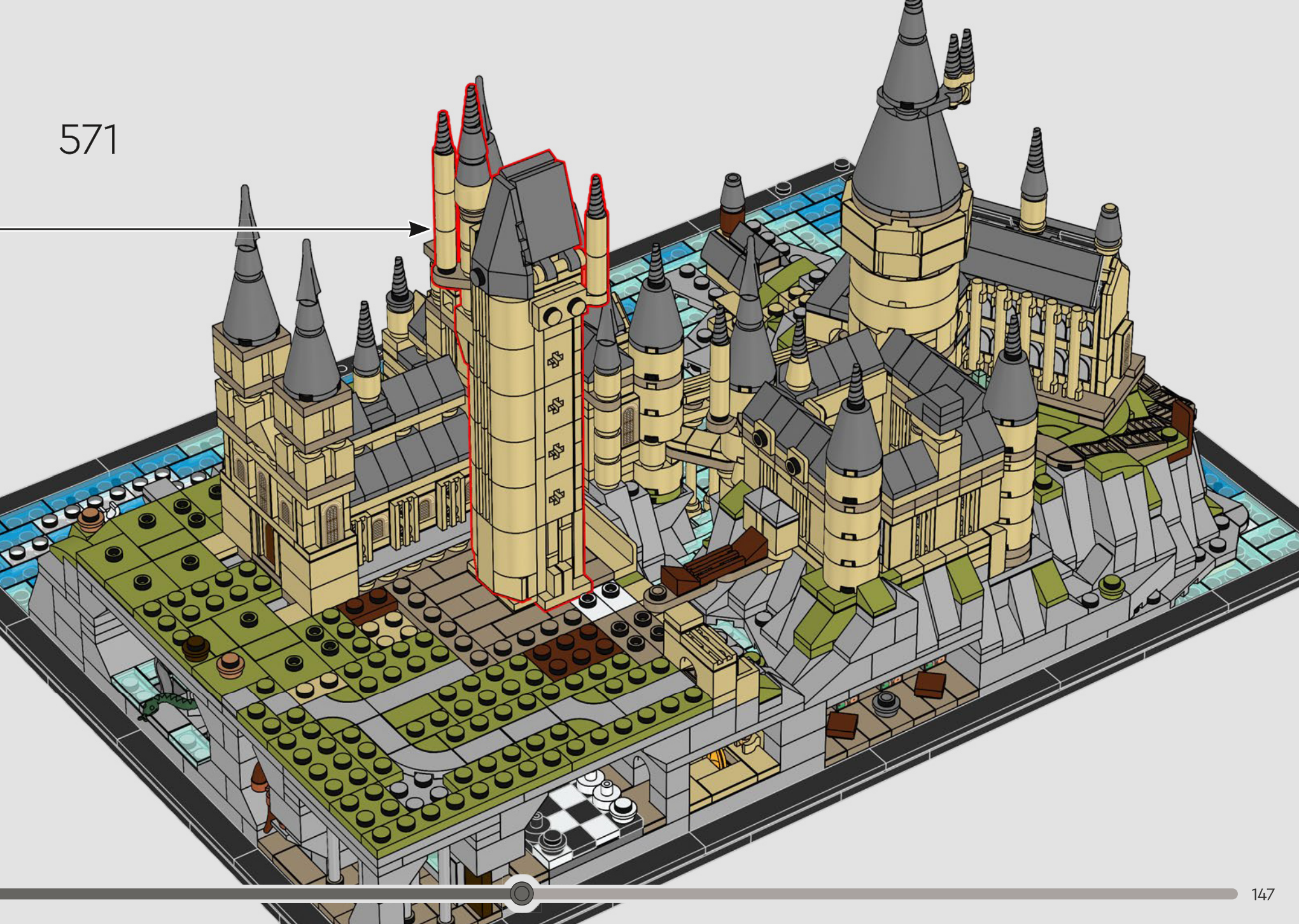

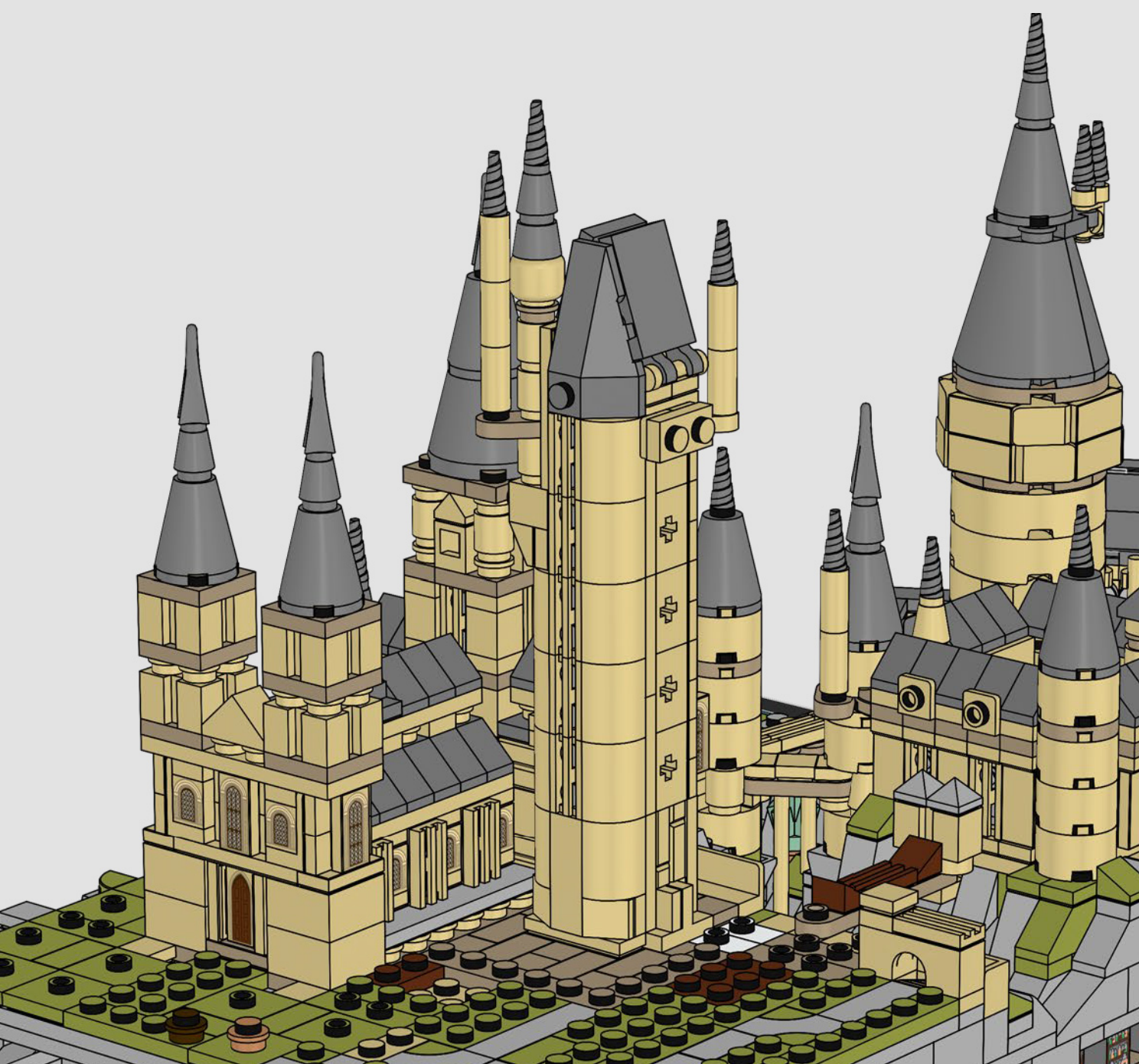

You might think the main tower would be the tallest point of the Hogwarts™ castle – but it is actually the Astronomy Tower.

Vous pourriez penser que le point le plus haut du château de Poudlard™ est la tour principale, mais il s'agit en fait de la tour d'astronomie.

Se podría pensar que la torre principal sería el punto más alto del Castillo de Hogwarts™, pero, en realidad, lo es la Torre de Astronomía.





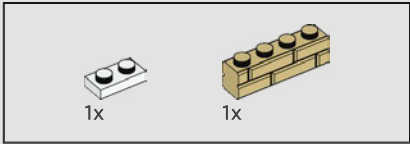
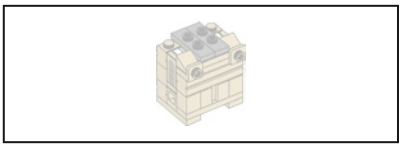

572

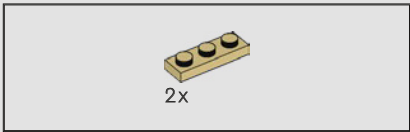
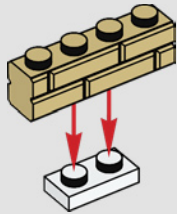

573

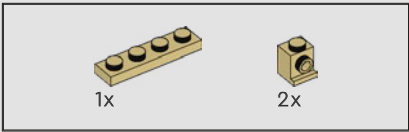
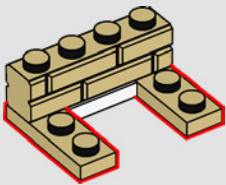

574

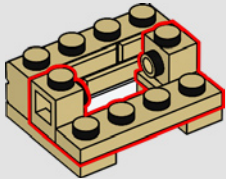

575

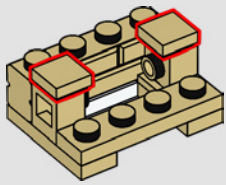

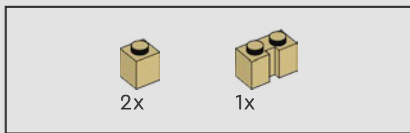

576

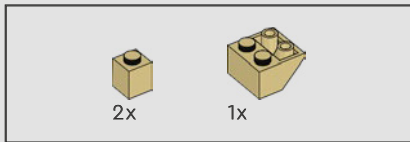
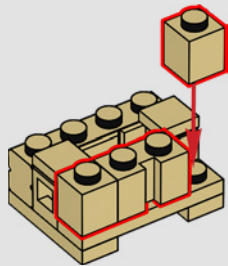

577

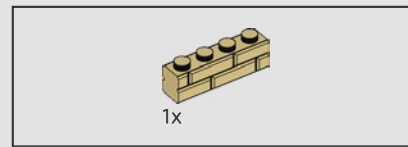
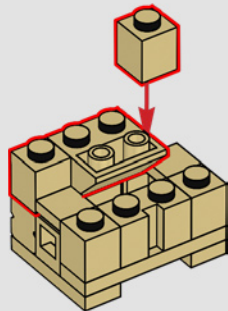

578

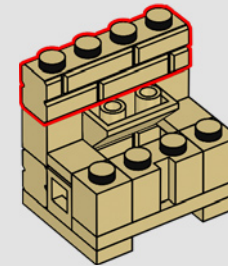

579

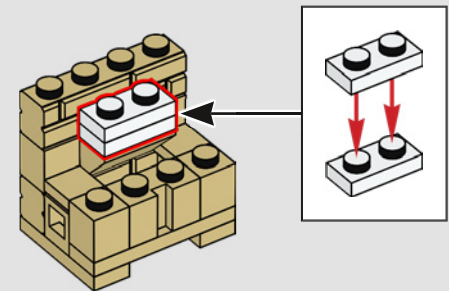

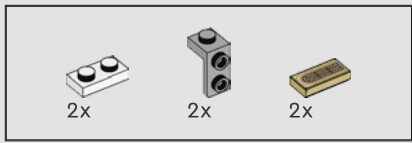

580

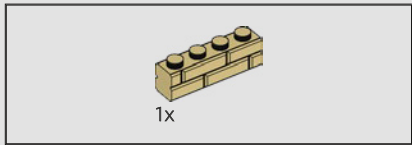
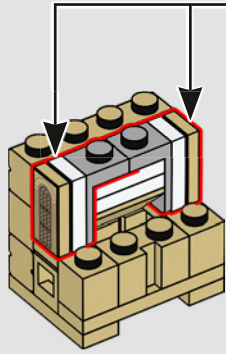
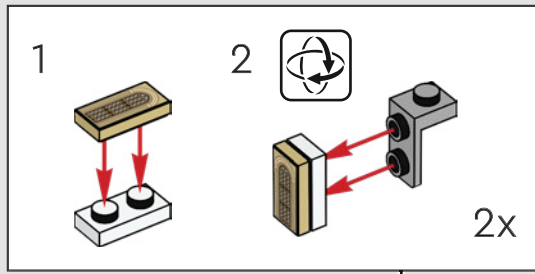

581

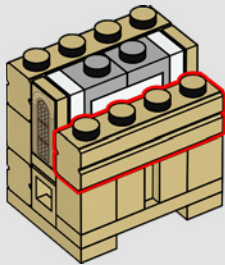

582

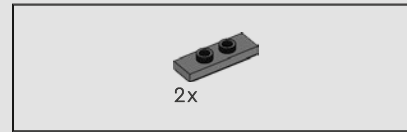
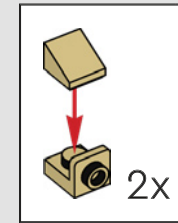
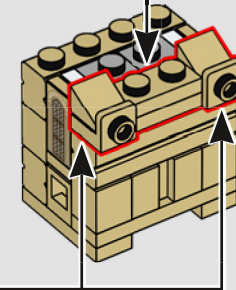
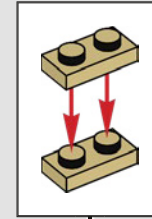

583

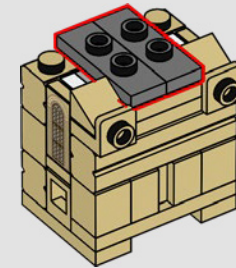

584

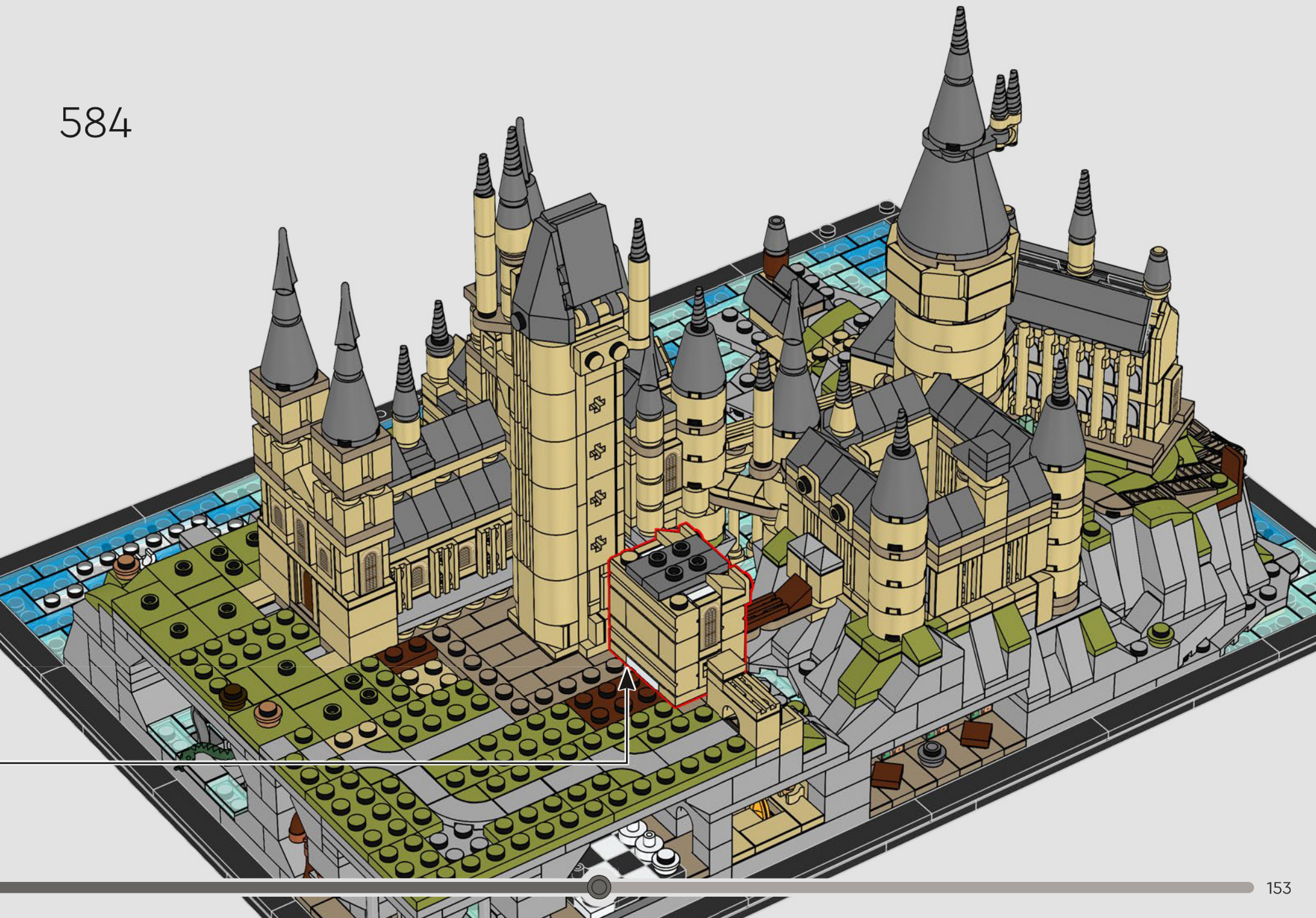

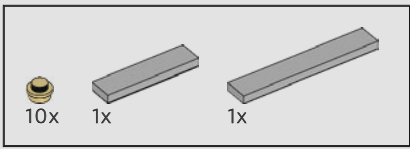

585

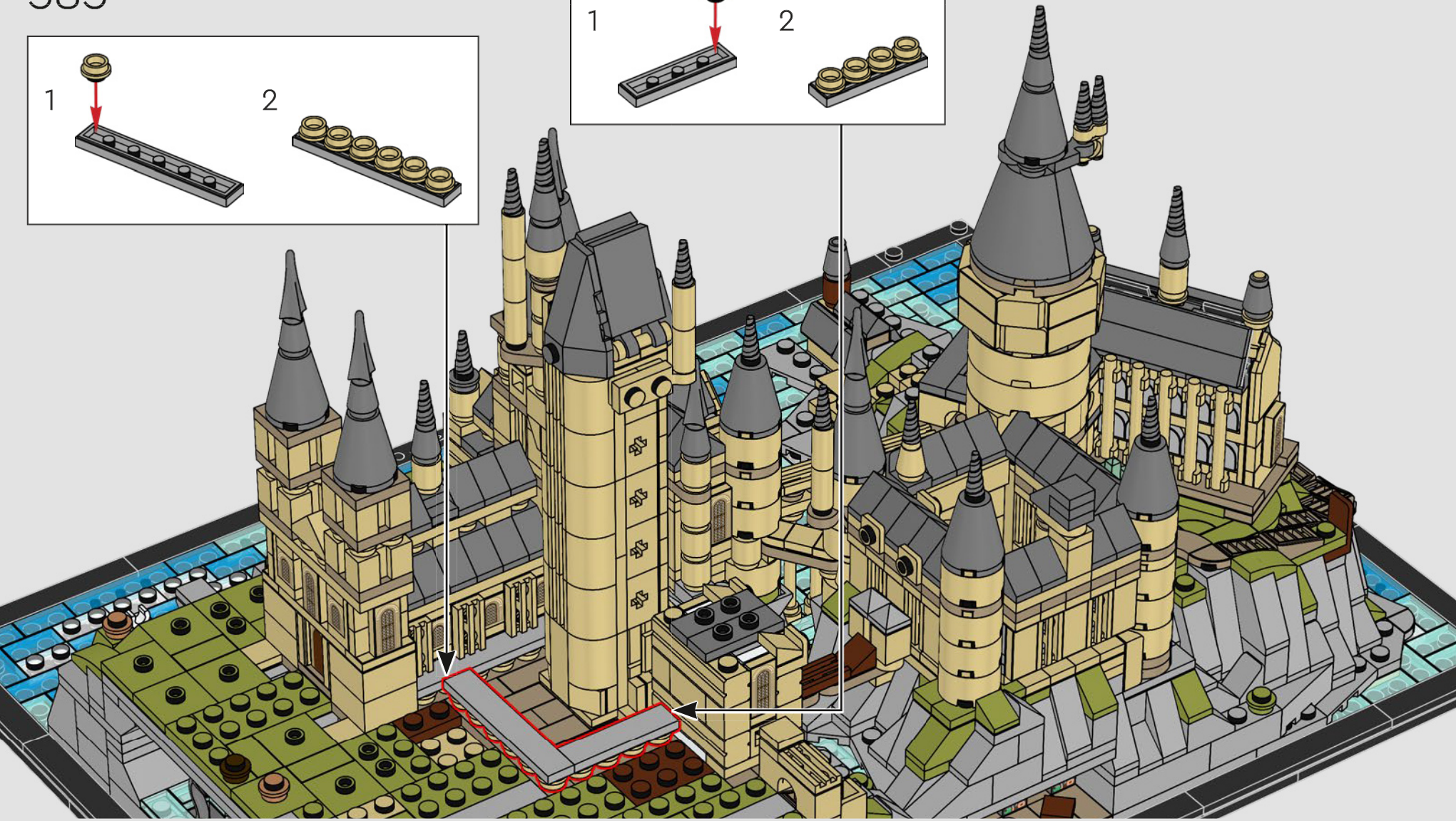
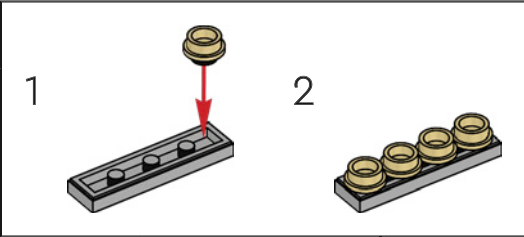
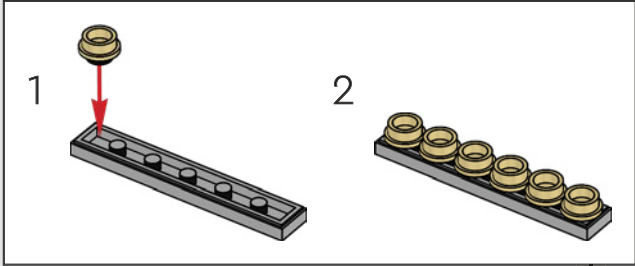

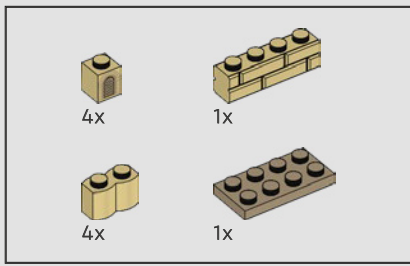

586

1

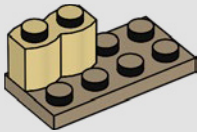

2

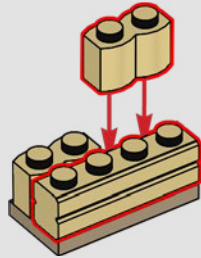

3

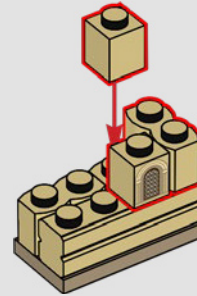

4

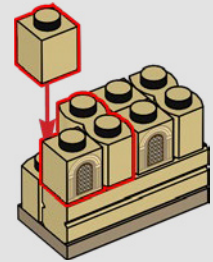





587



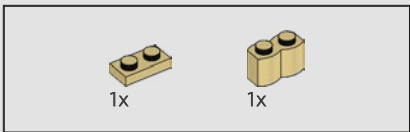

588

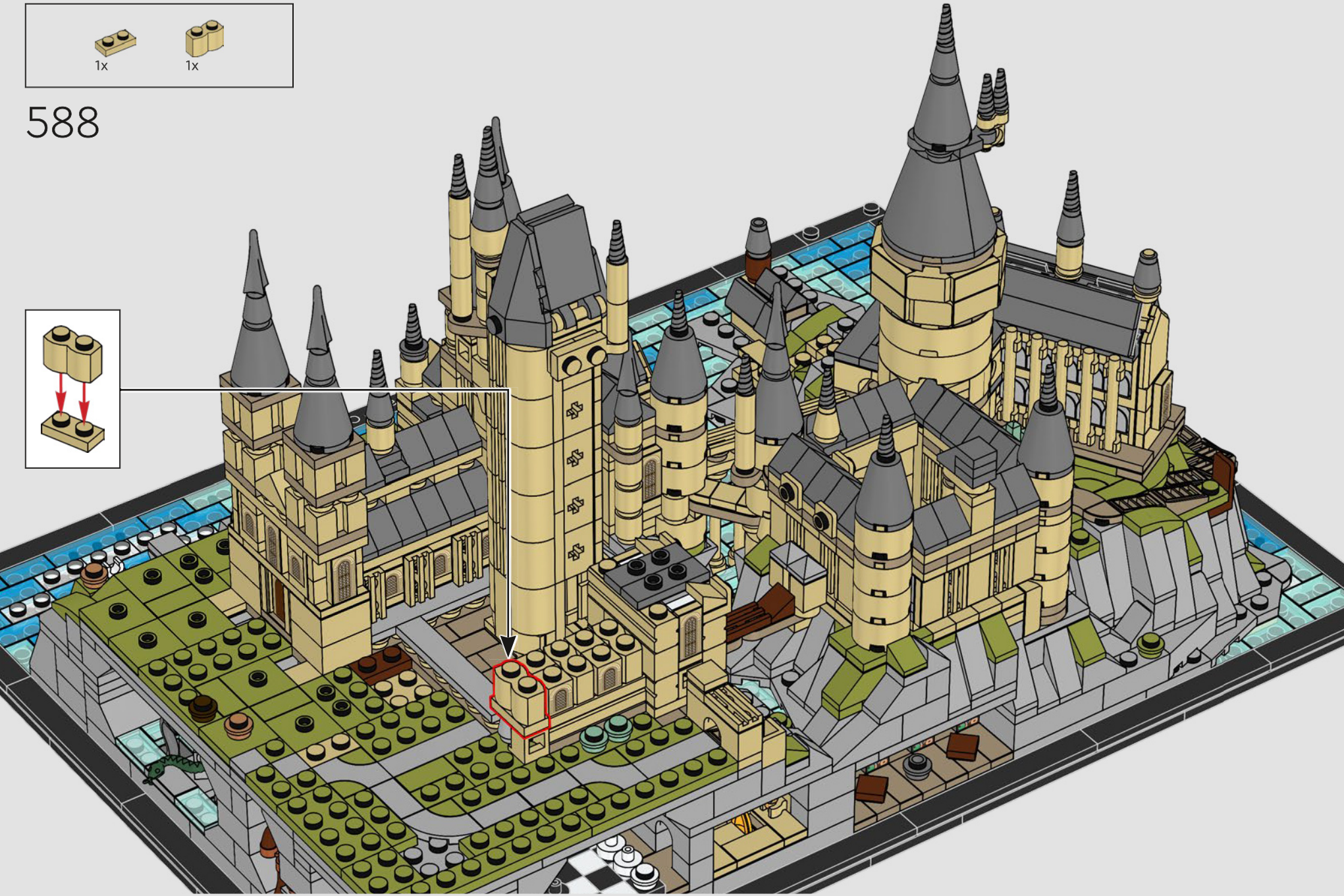
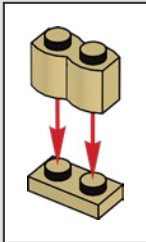

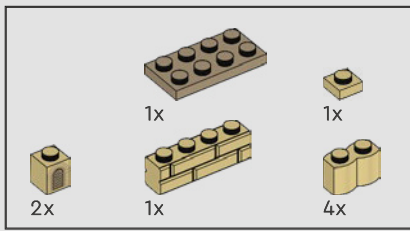

589

1

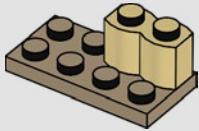

2

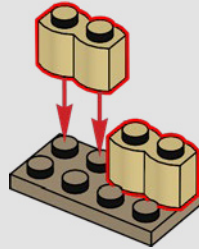

3

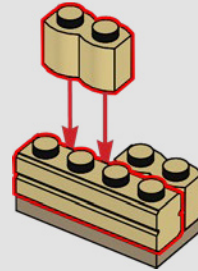

4

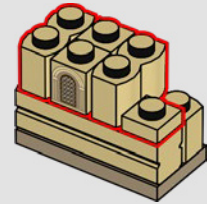

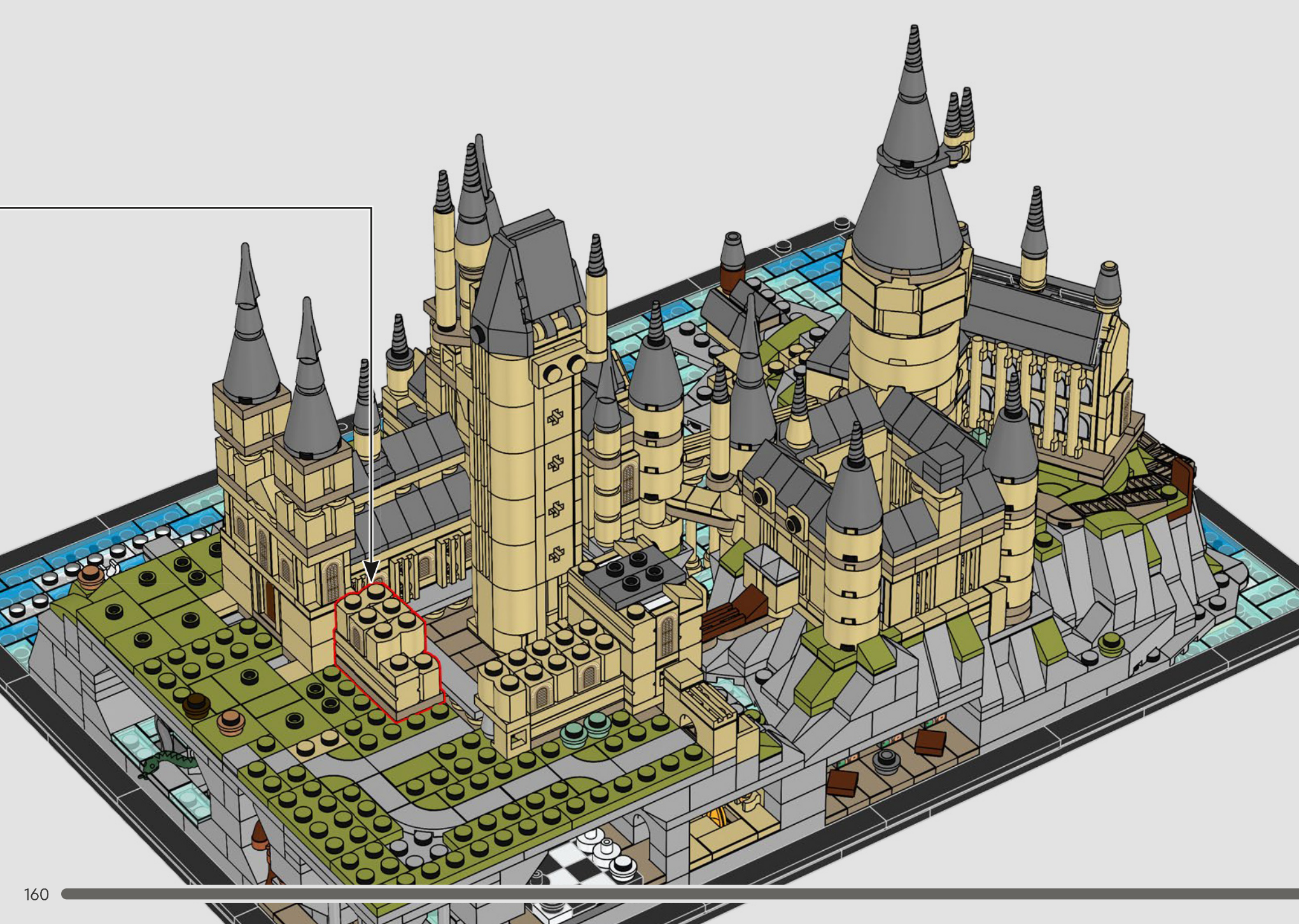

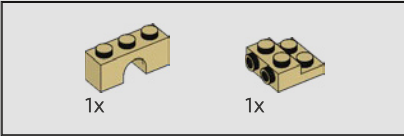
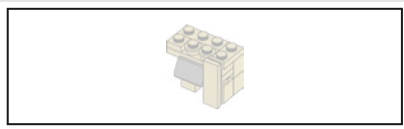

590

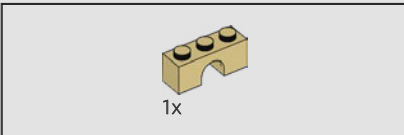
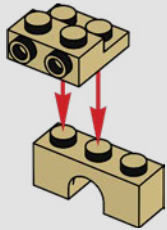

591

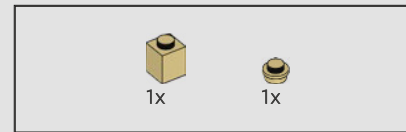
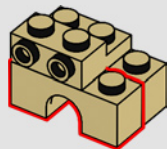

592

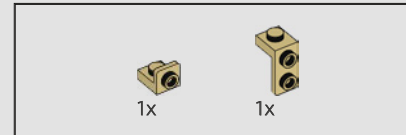
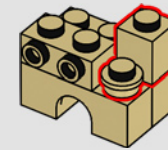

593

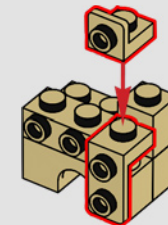

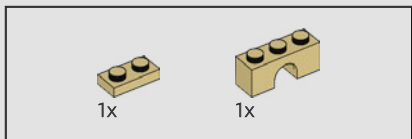

594

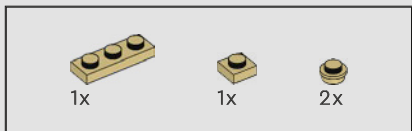
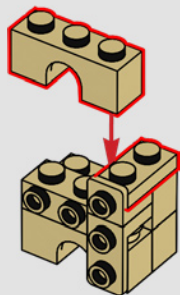

595

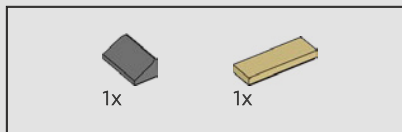
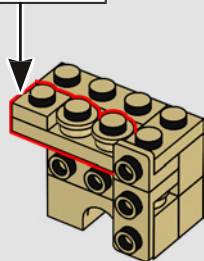
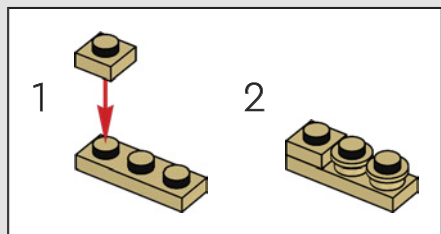

596

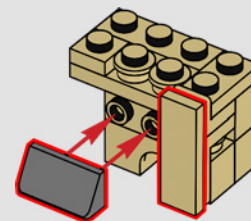

597



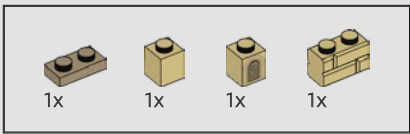

598

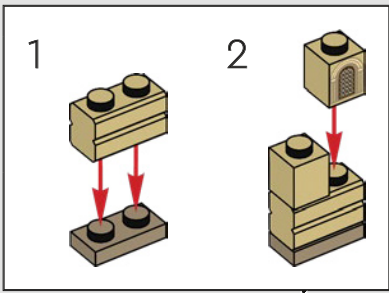

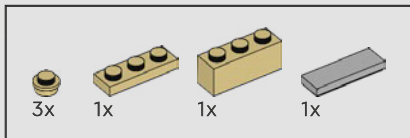

599

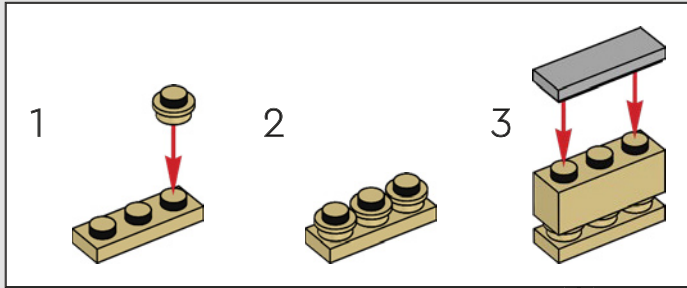

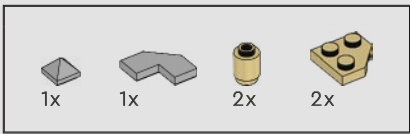

600

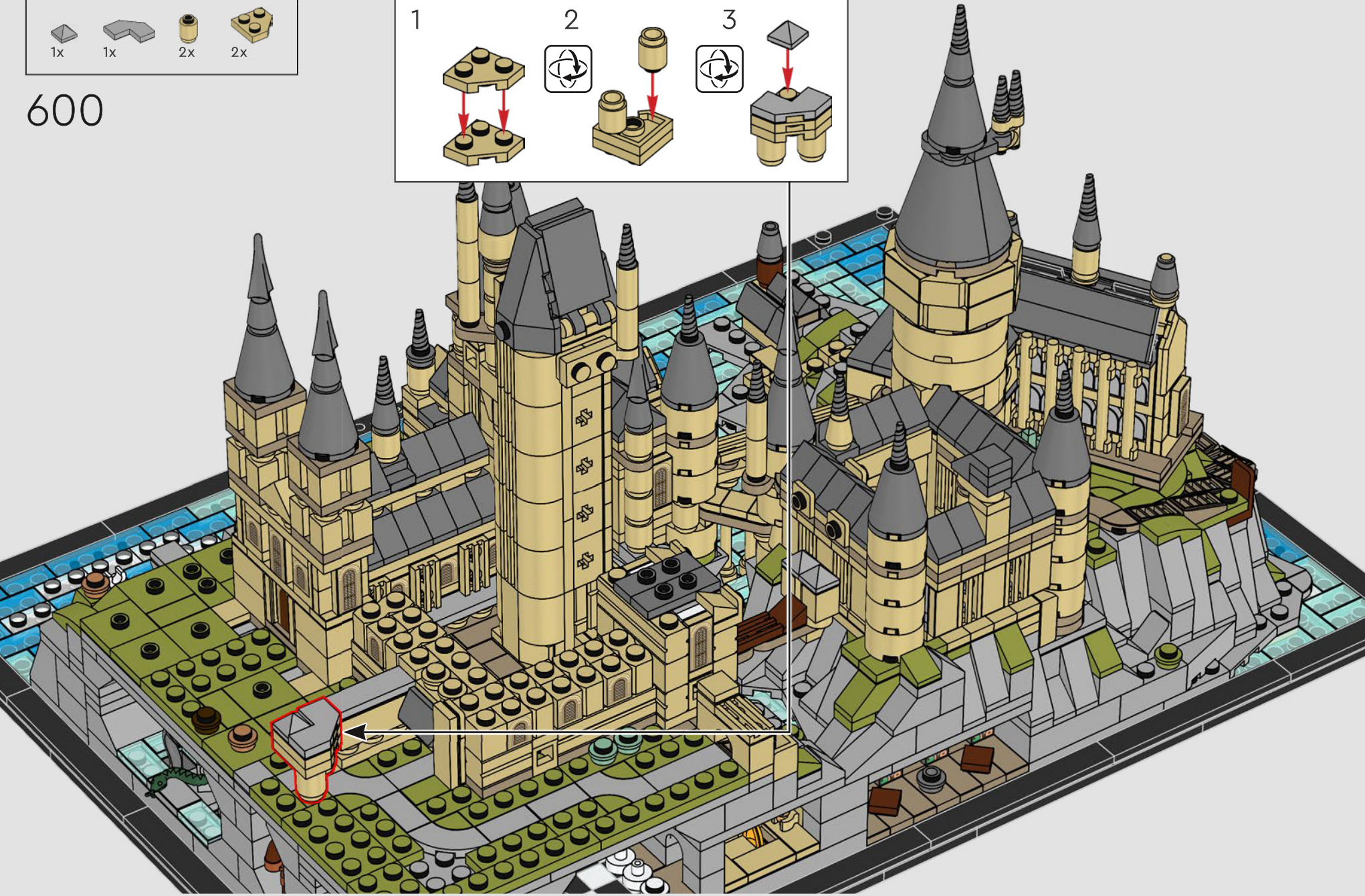
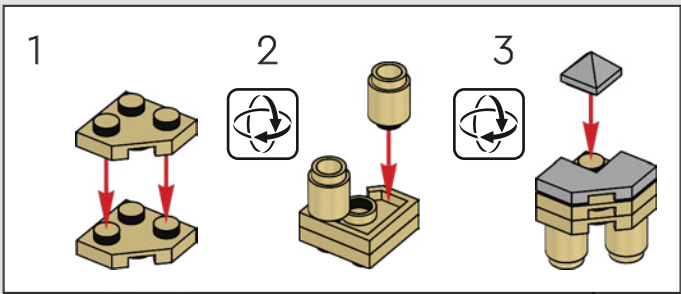

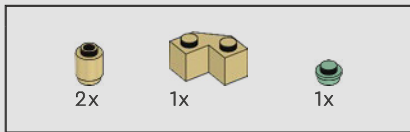

601

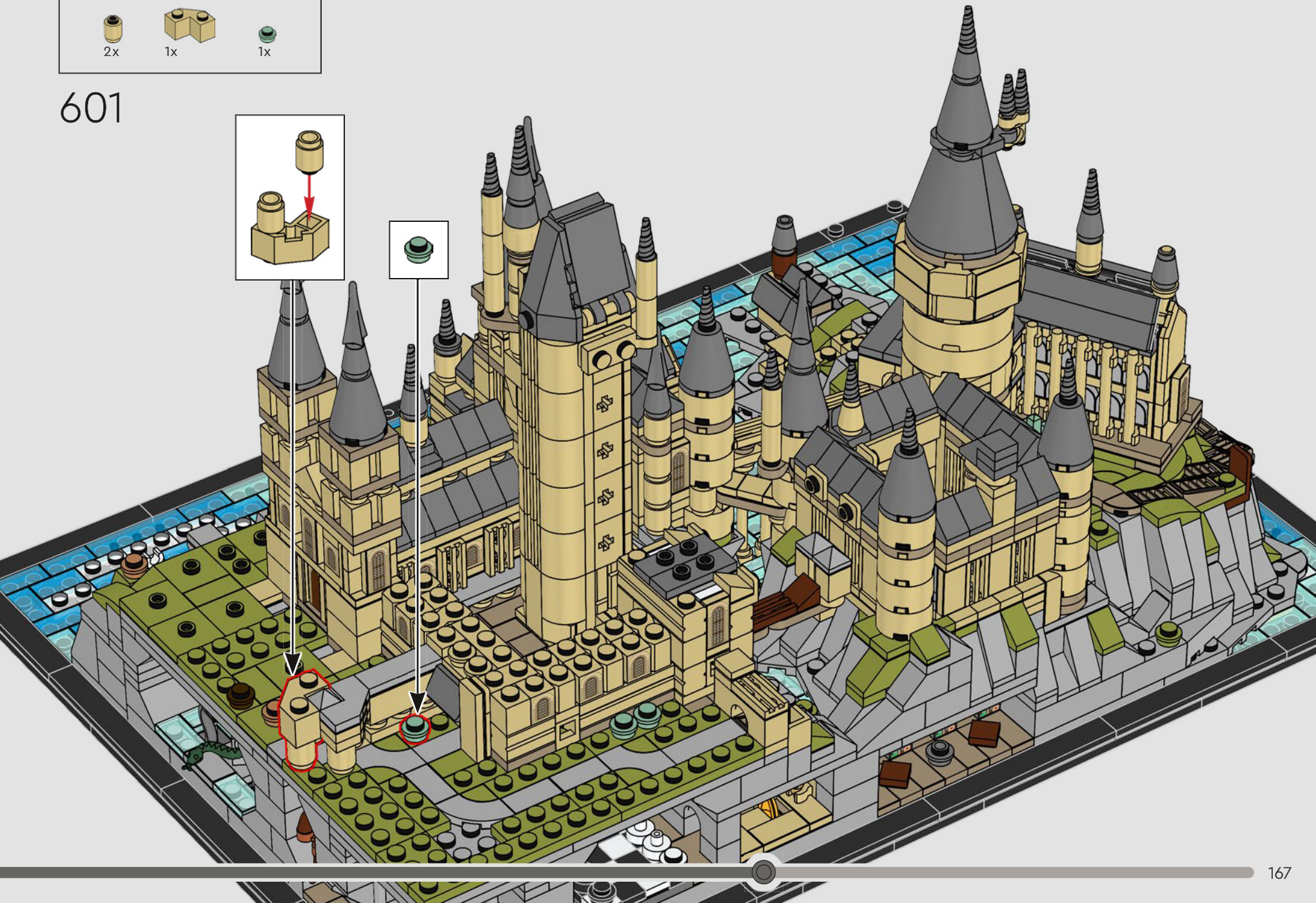
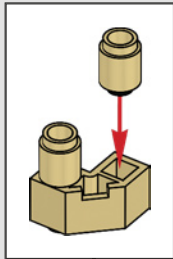



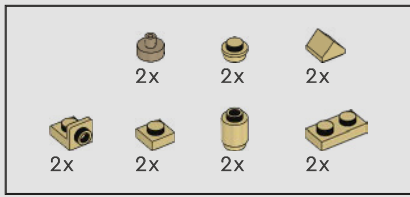

602

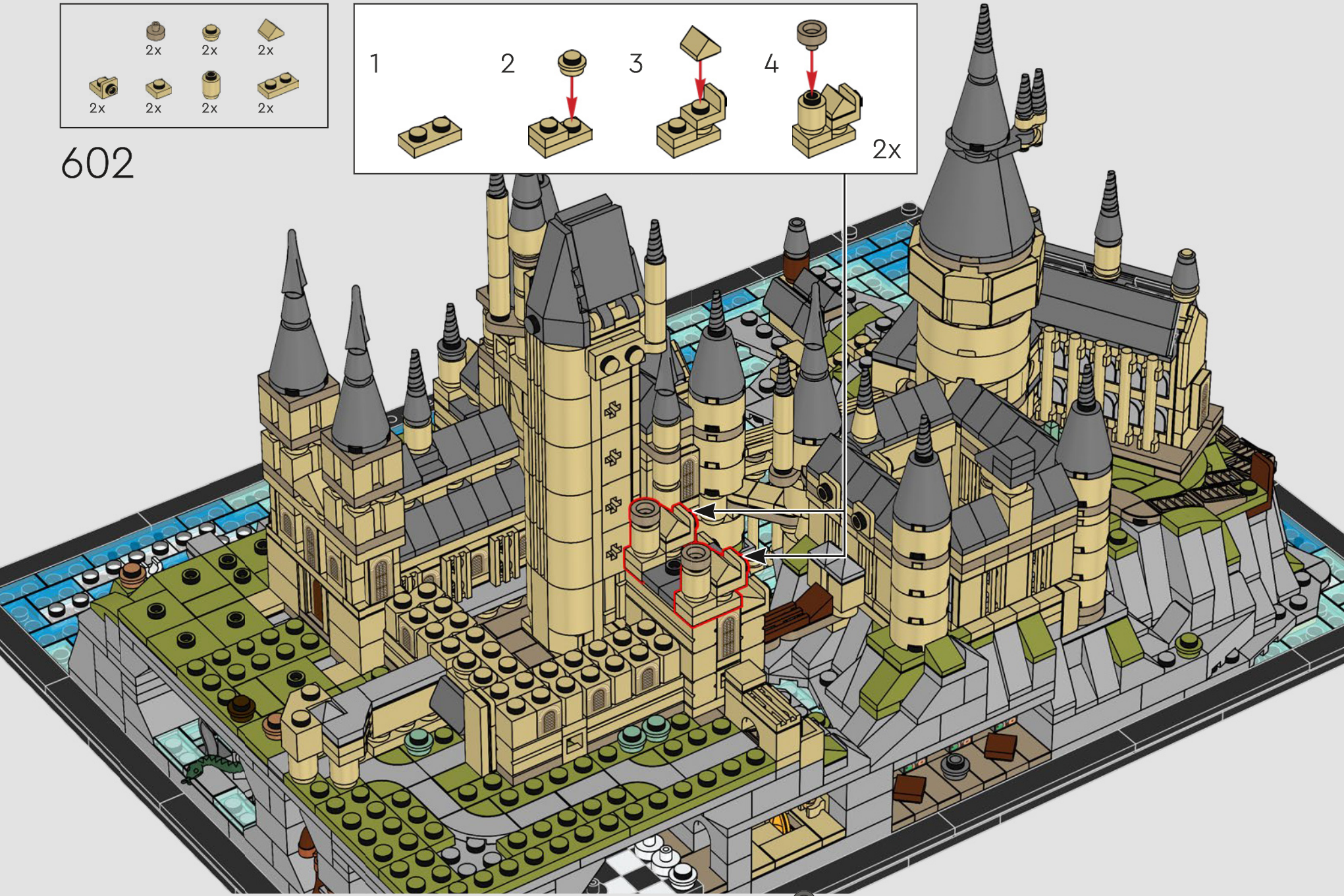
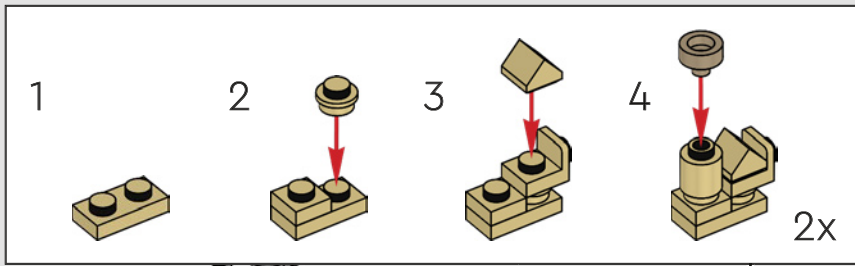

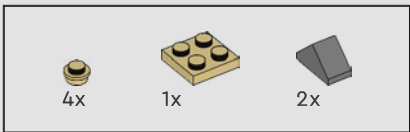

603

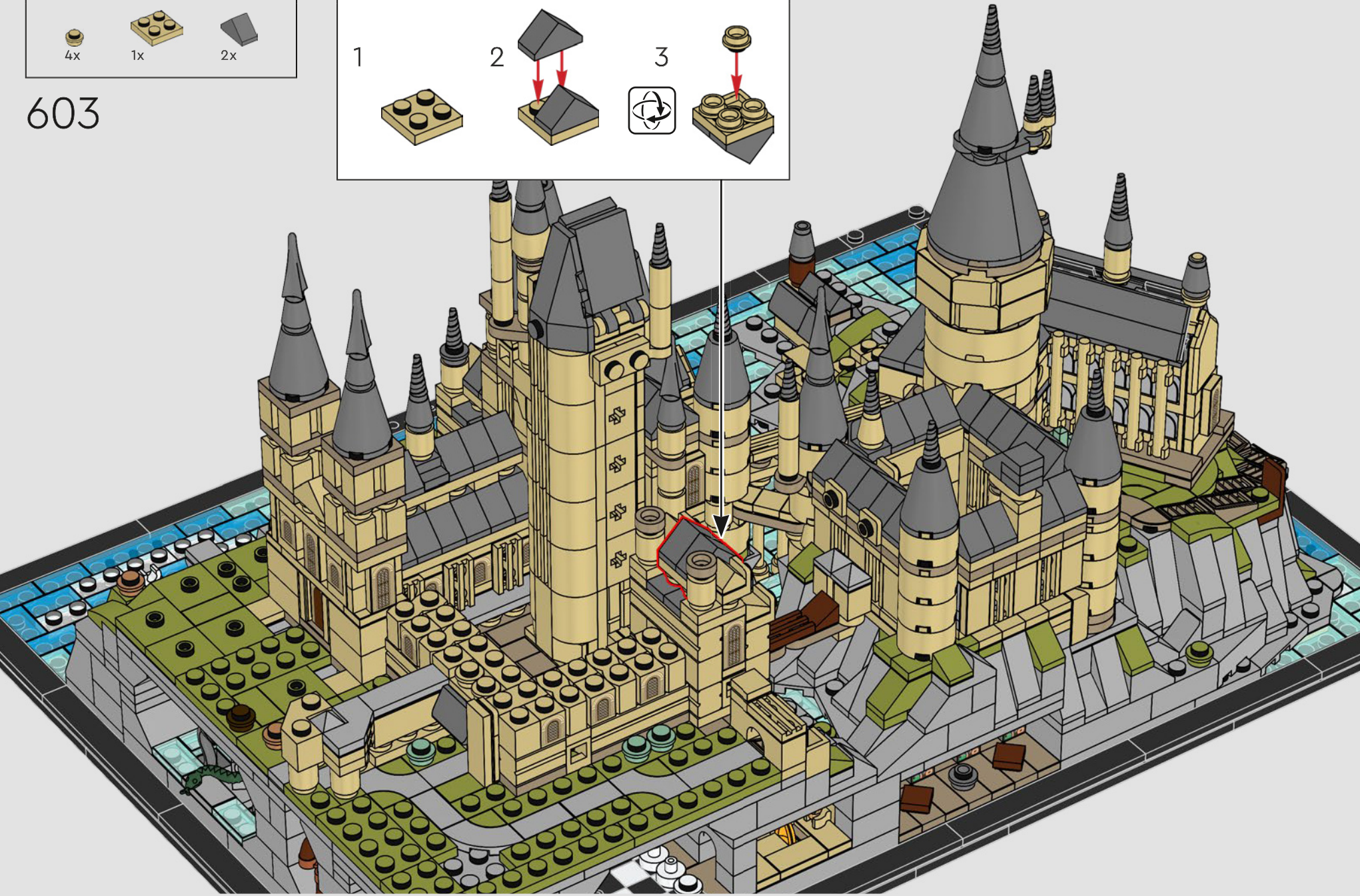
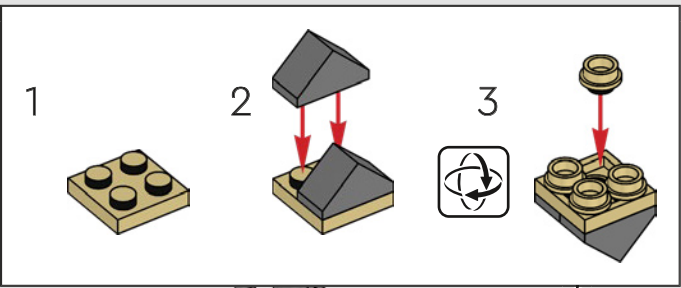

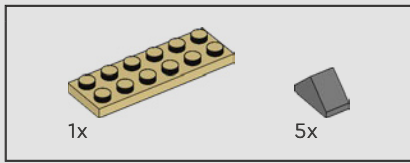

604

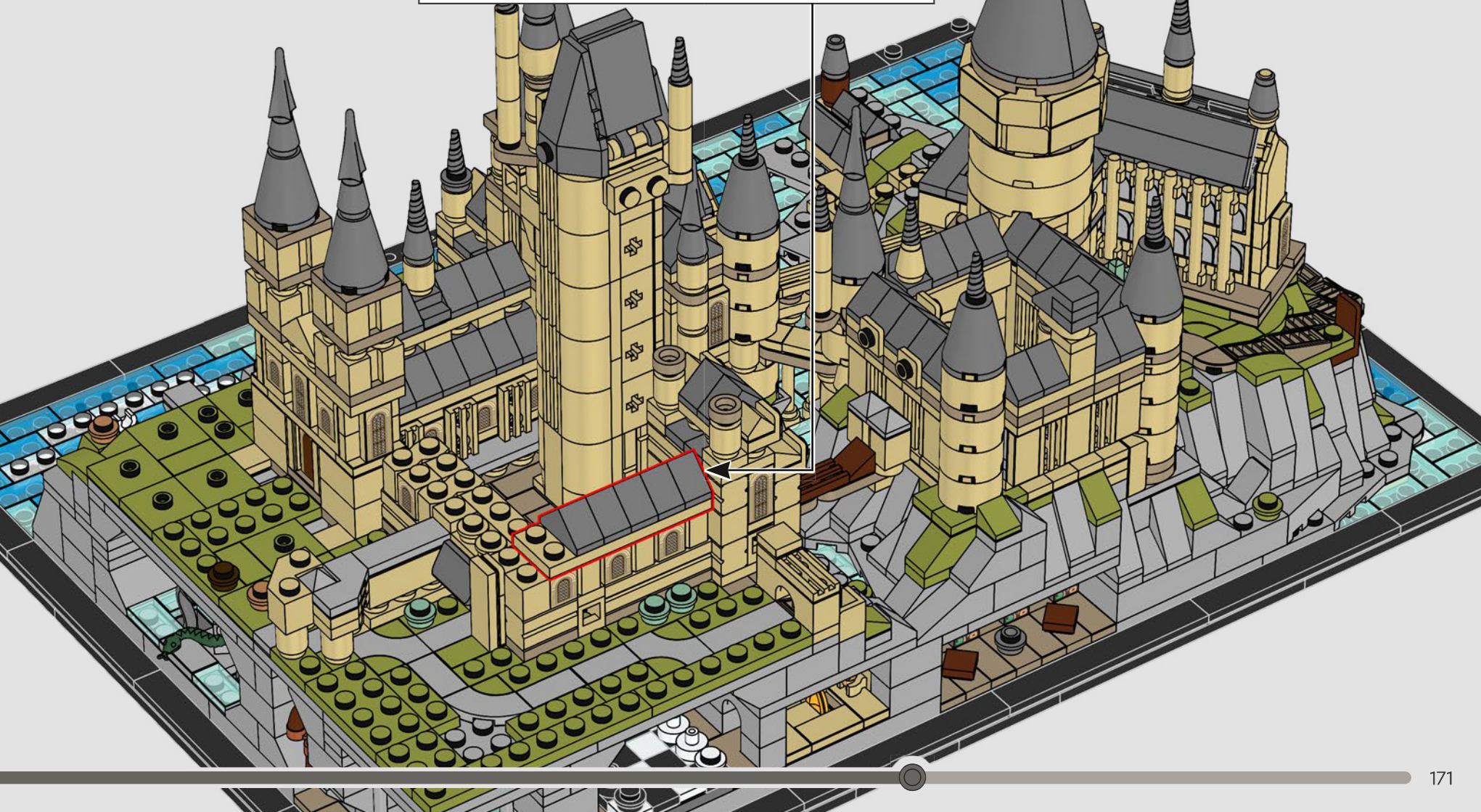
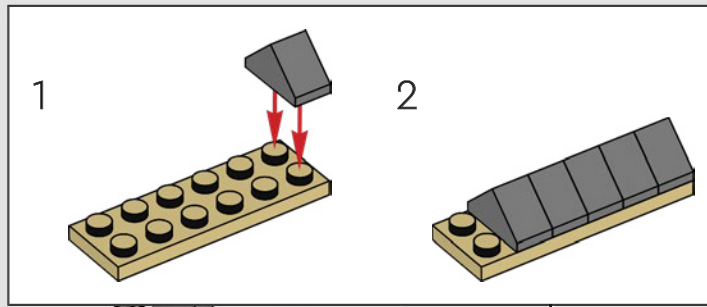

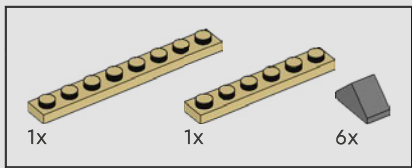

605

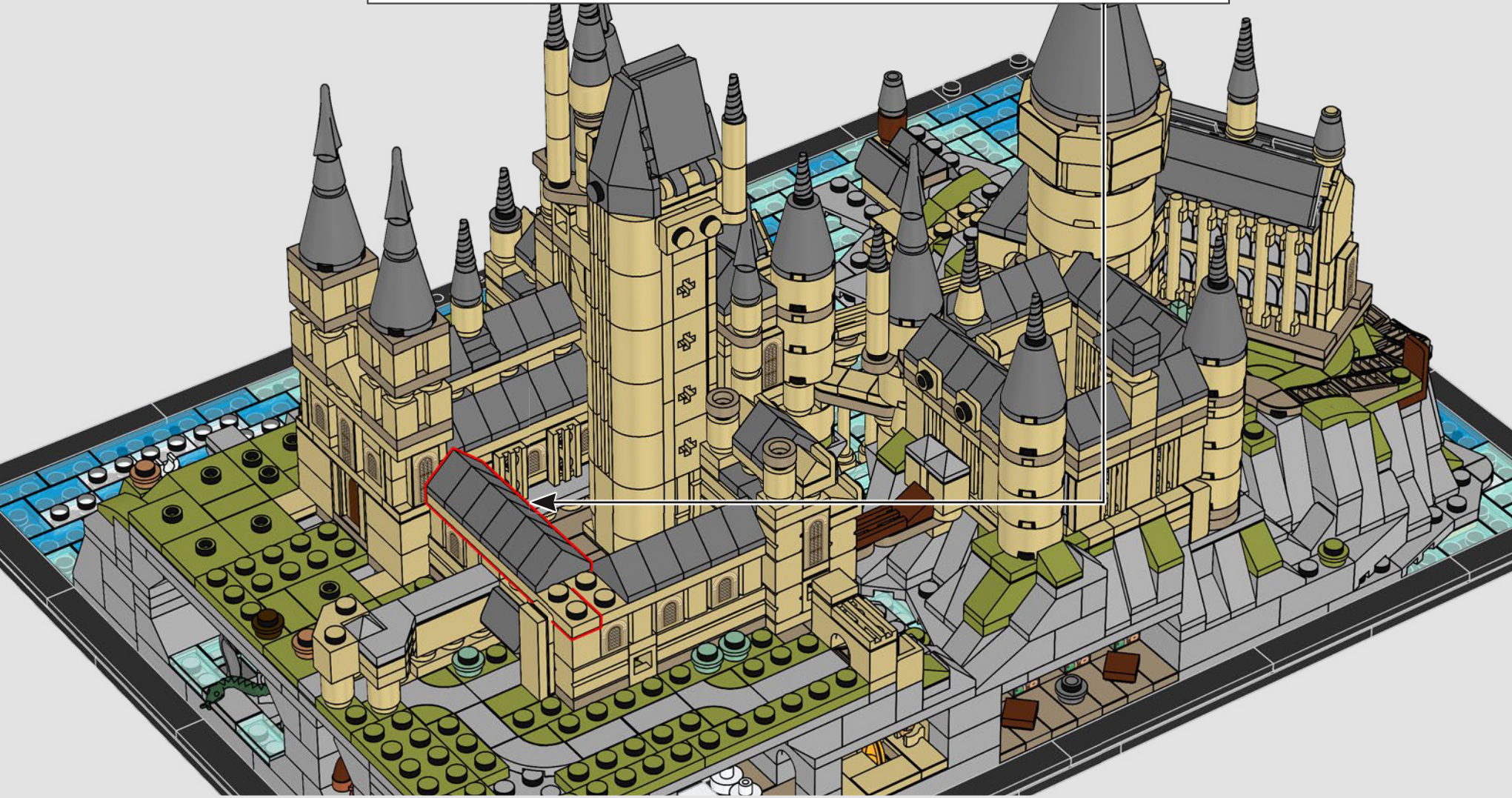
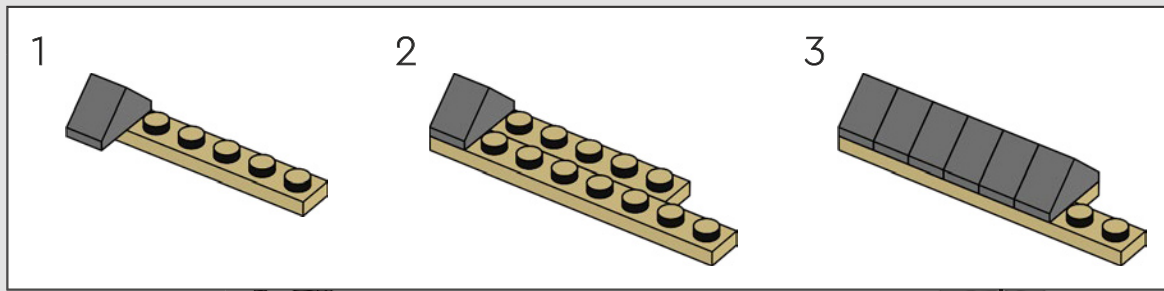

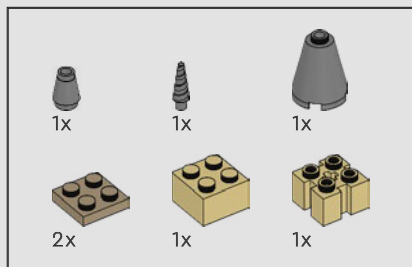

606

1

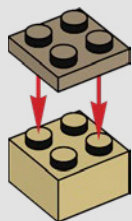

2

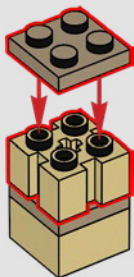

3

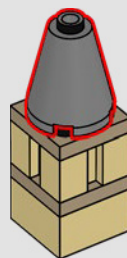

4

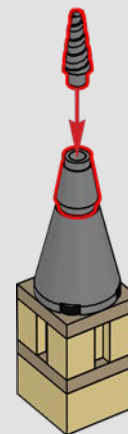



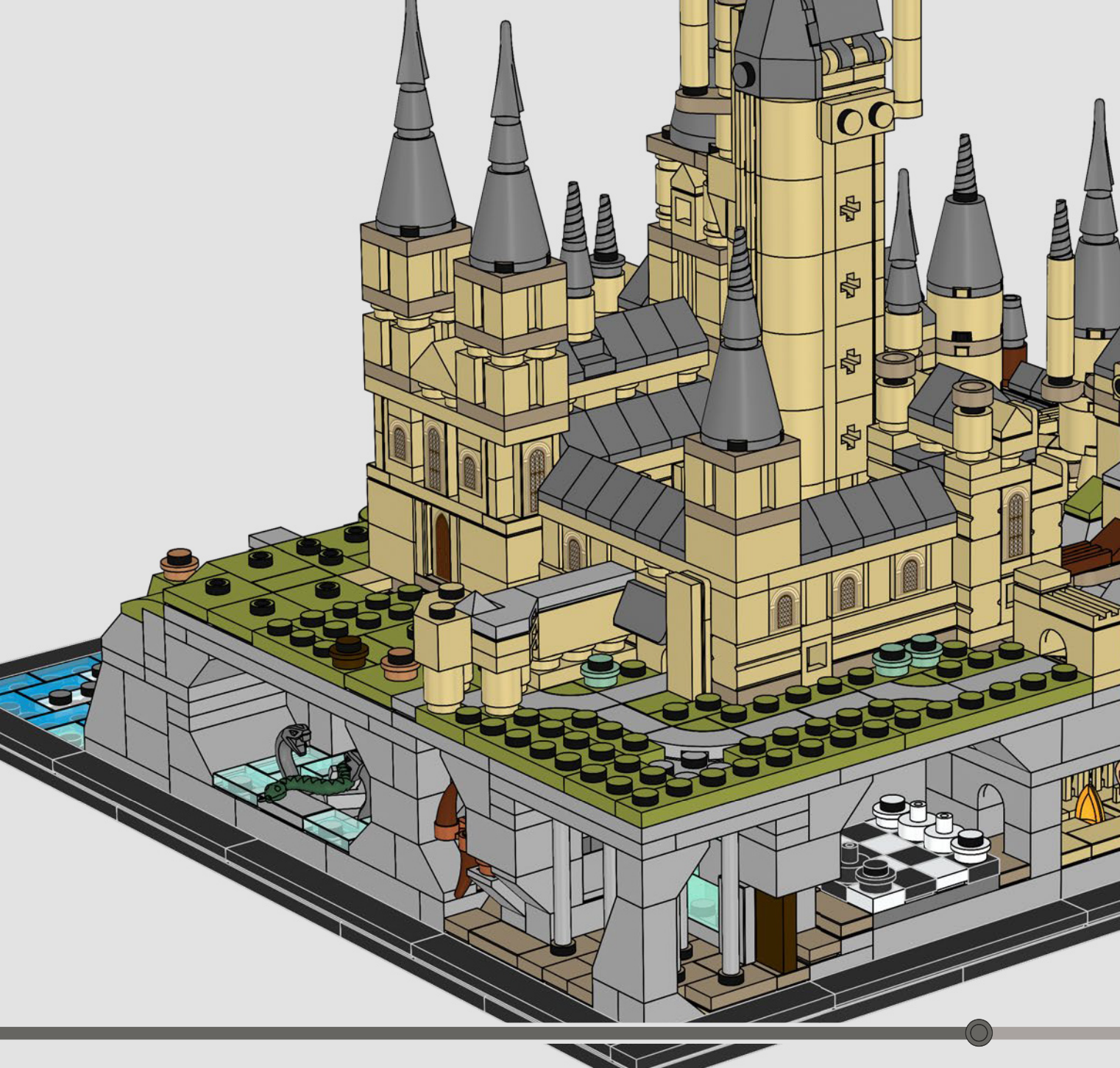

Hogwarts™ is a huge castle, where it can be tricky to find your way. But did you know that the castle has 142 staircases? With the staircases constantly changing, it doesn't make it easier finding your way around.

Poudlard est un immense château où il peut être difficile de trouver son chemin. Mais saviez-vous que le château compte 142 escaliers ? Comme les escaliers changent constamment, il n'est pas facile de trouver son chemin.

Hogwarts™ es un castillo enorme en el que puede ser difícil orientarse, ¿pero sabías que tiene 142 escaleras? ¡El hecho de que cambien constantemente no hace más fácil encontrar el camino hacia tu destino!



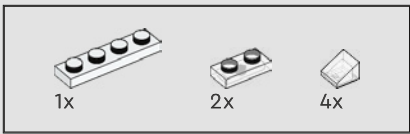

607

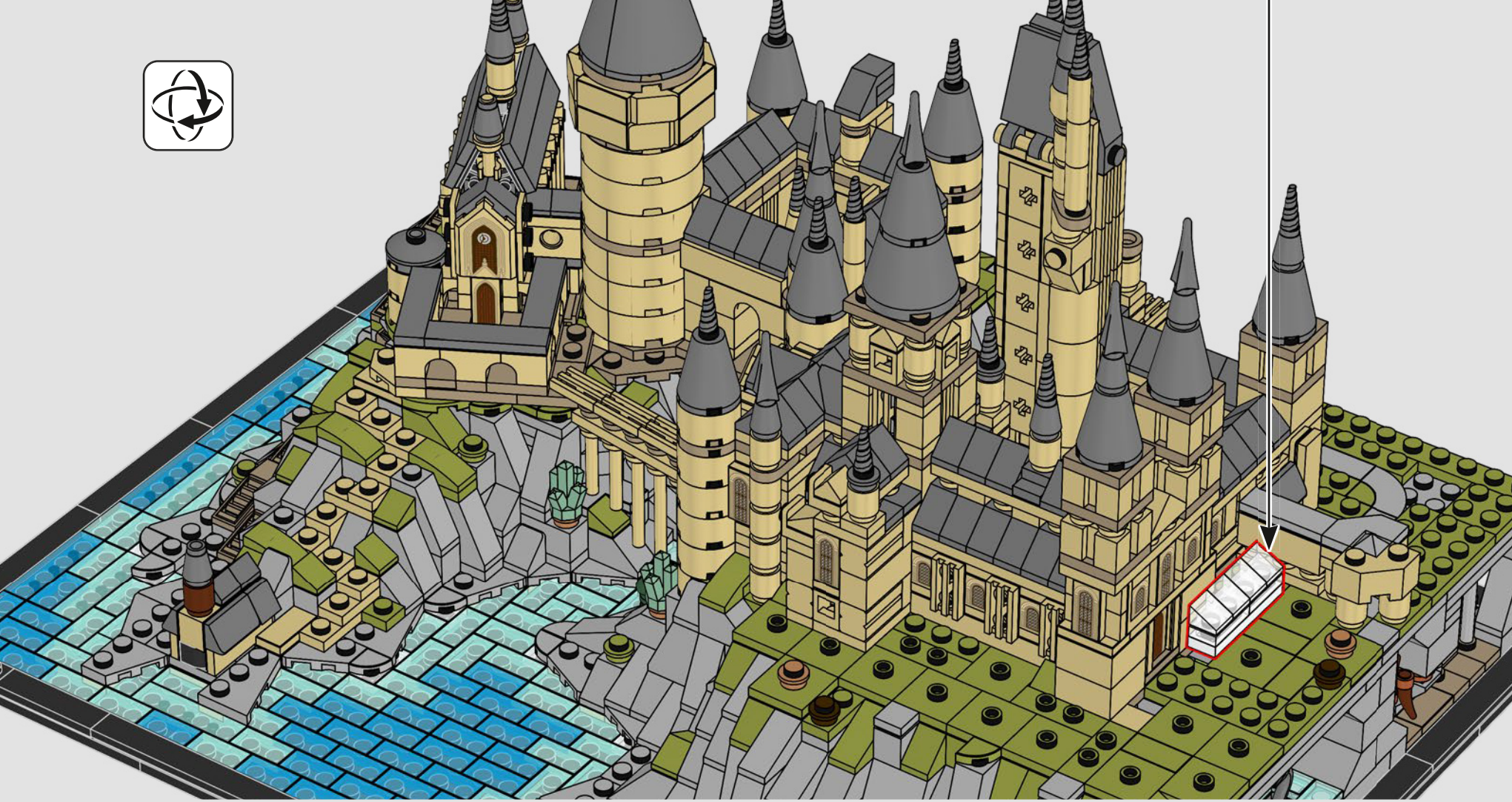
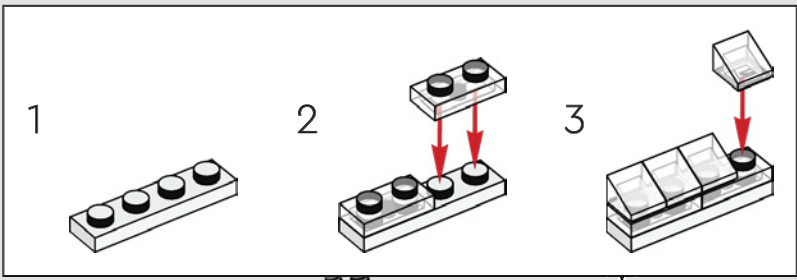

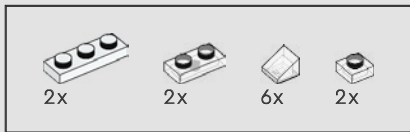

608

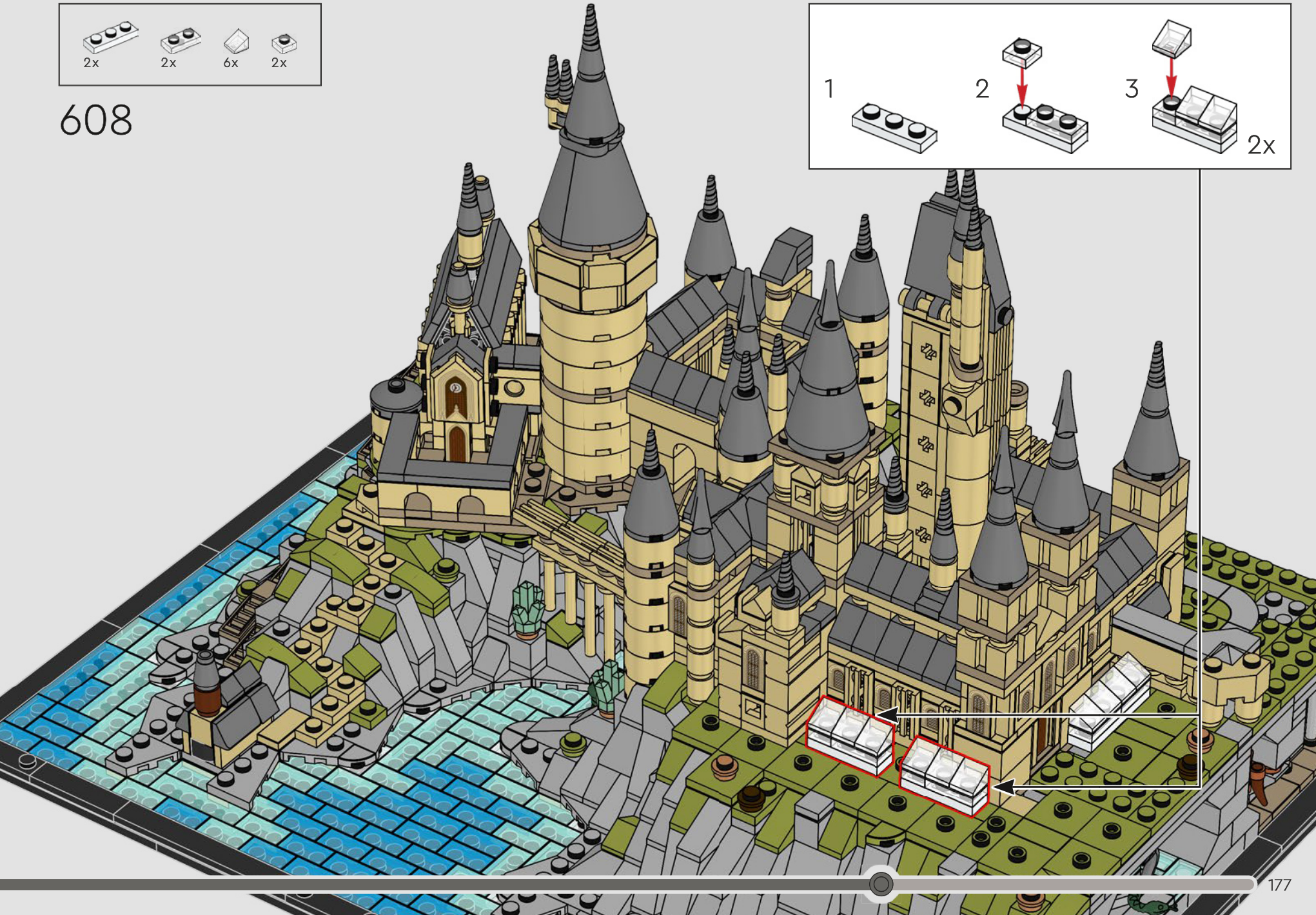
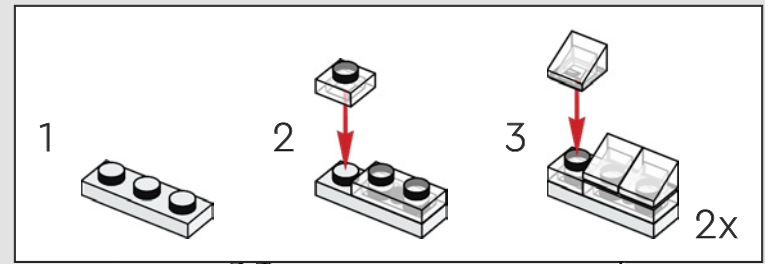



609

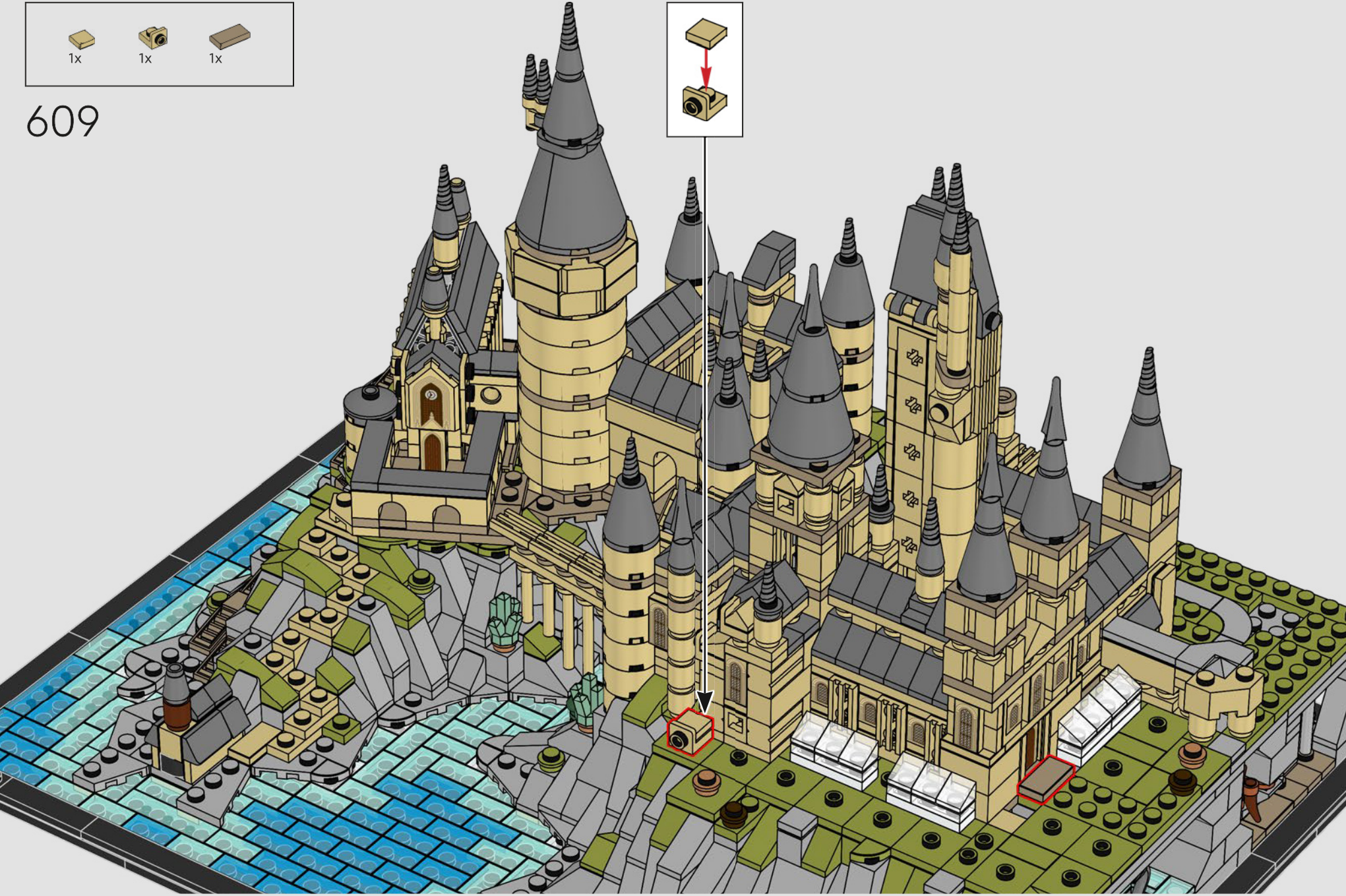
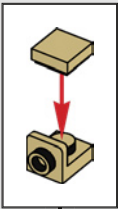



610

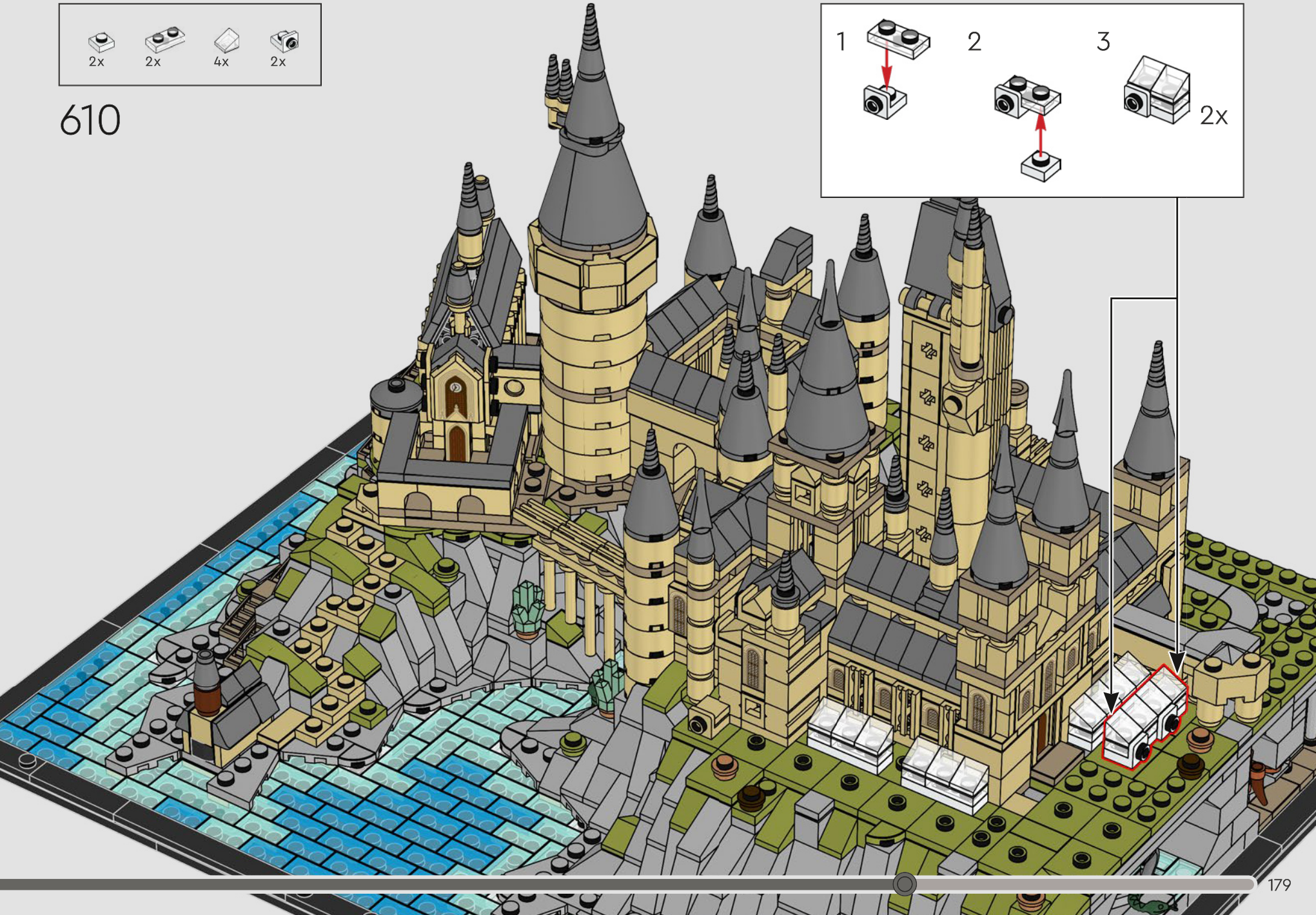
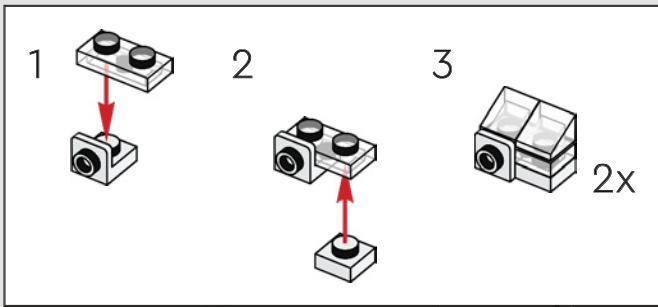

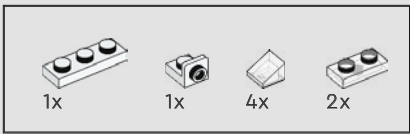

611

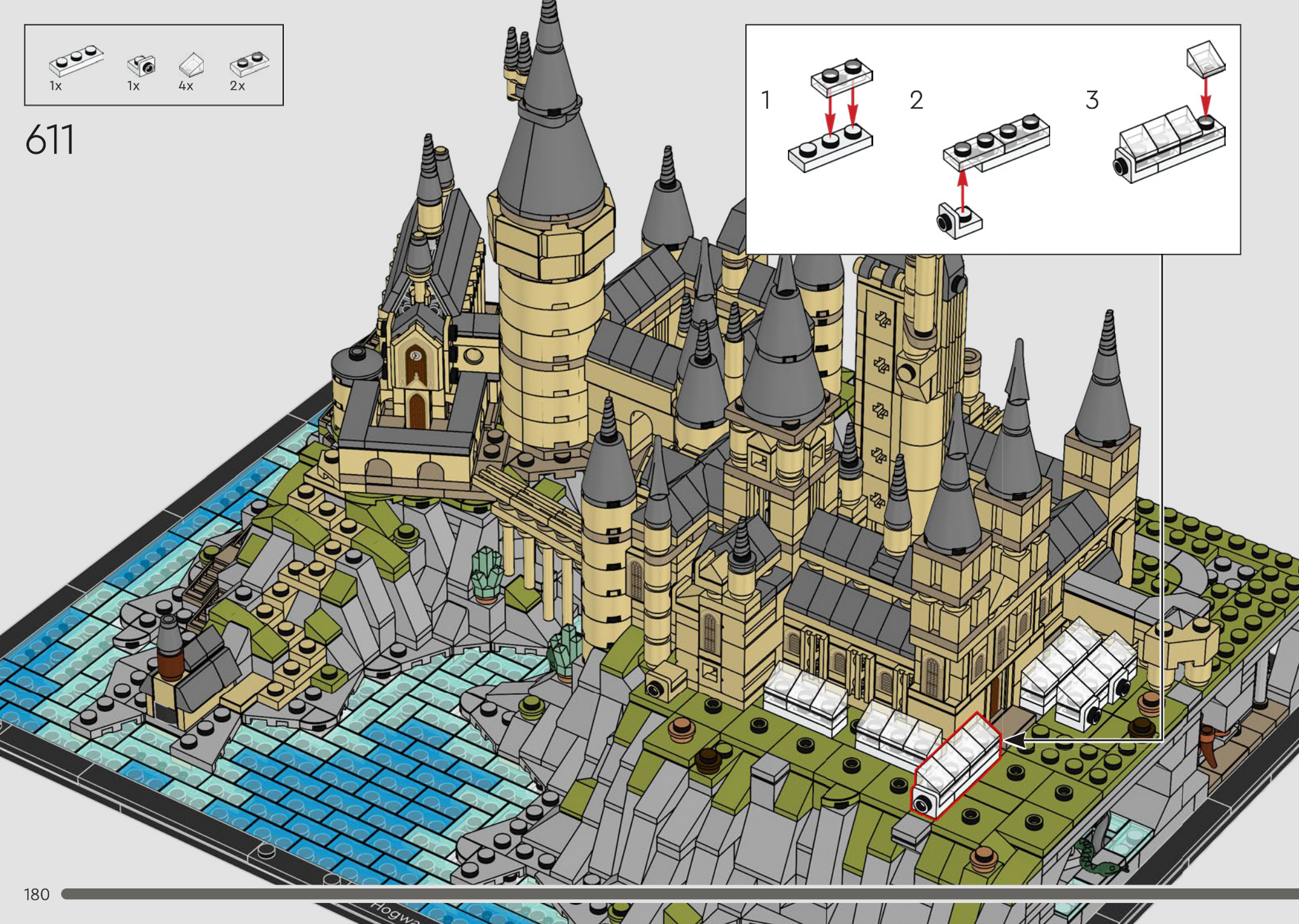
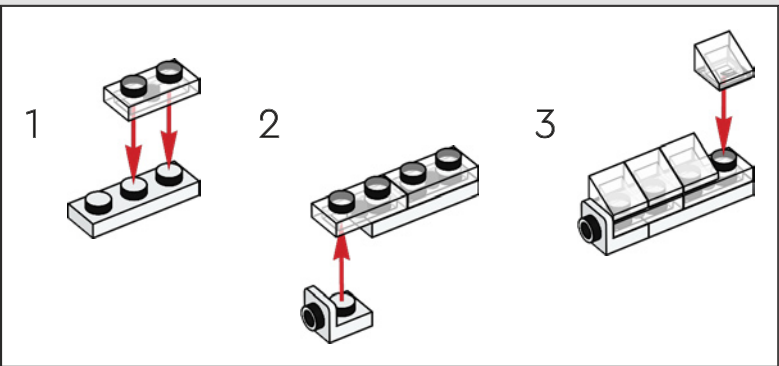

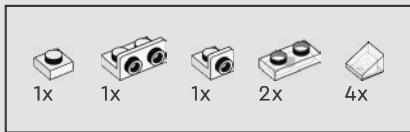

612

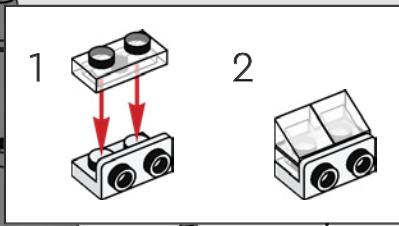

2

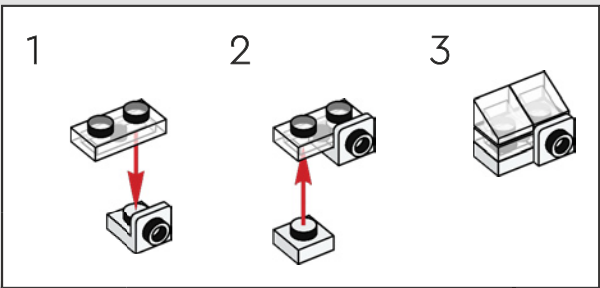

2

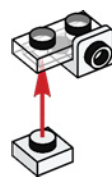

3

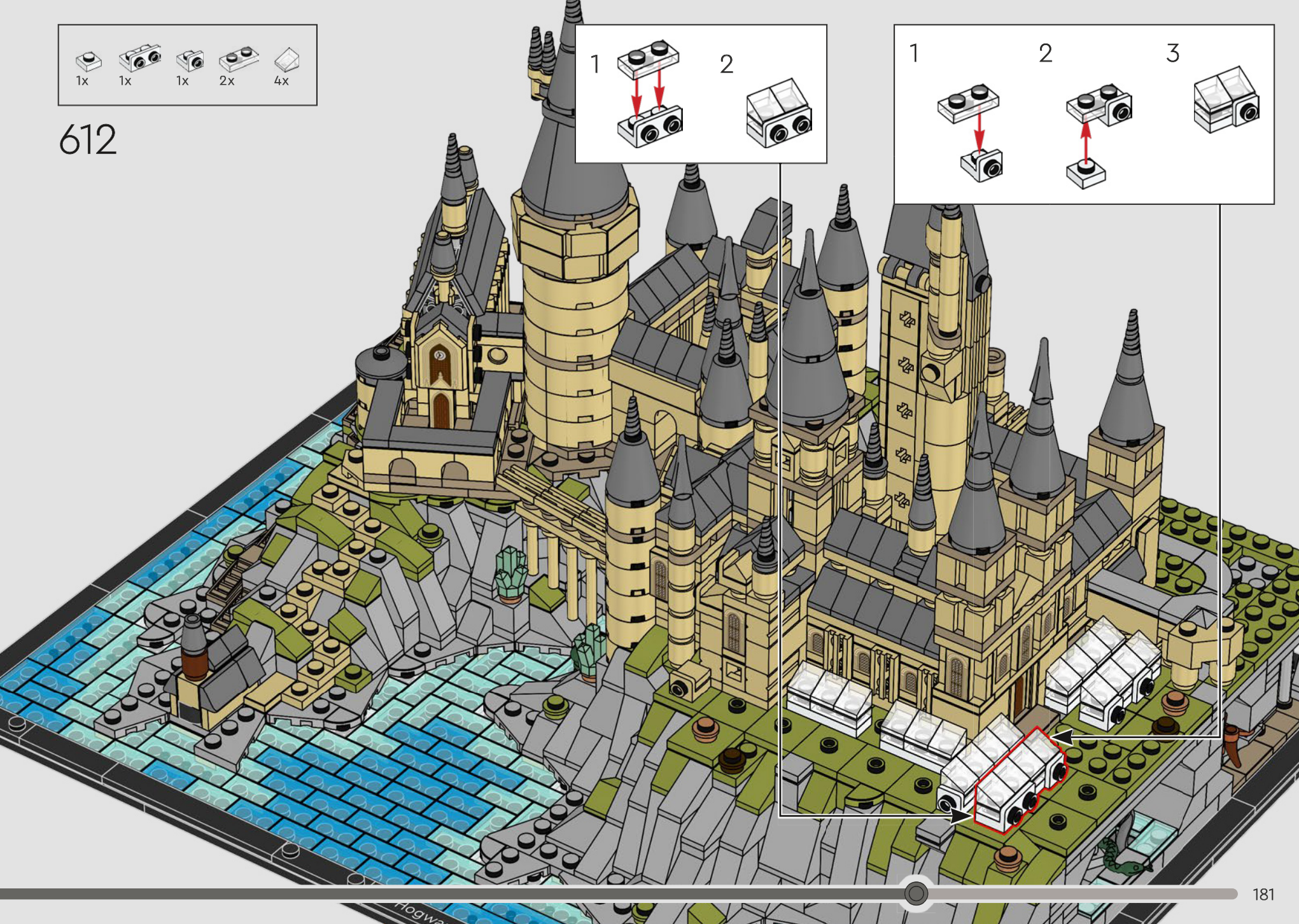

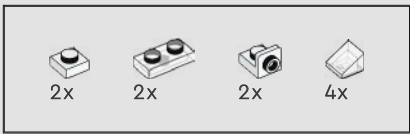



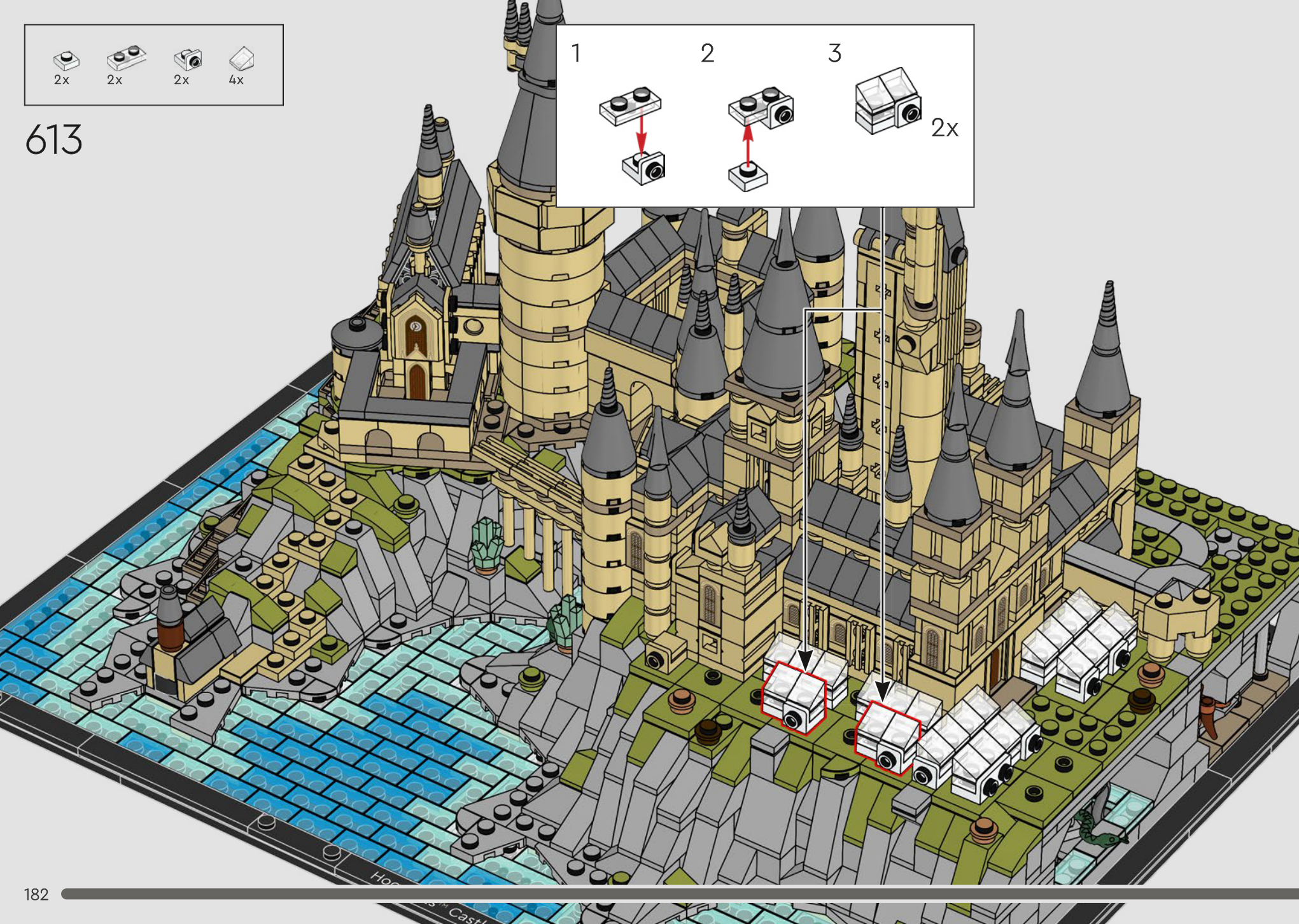
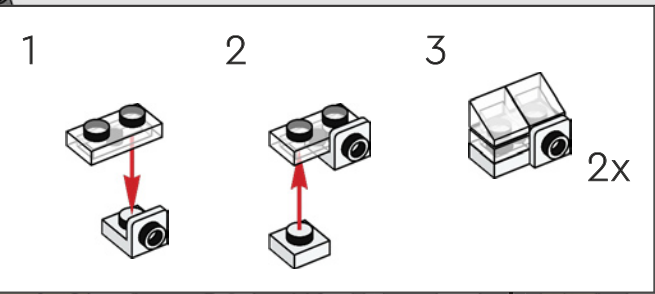

613



2x  2x  2x 

614

1  2  2x 



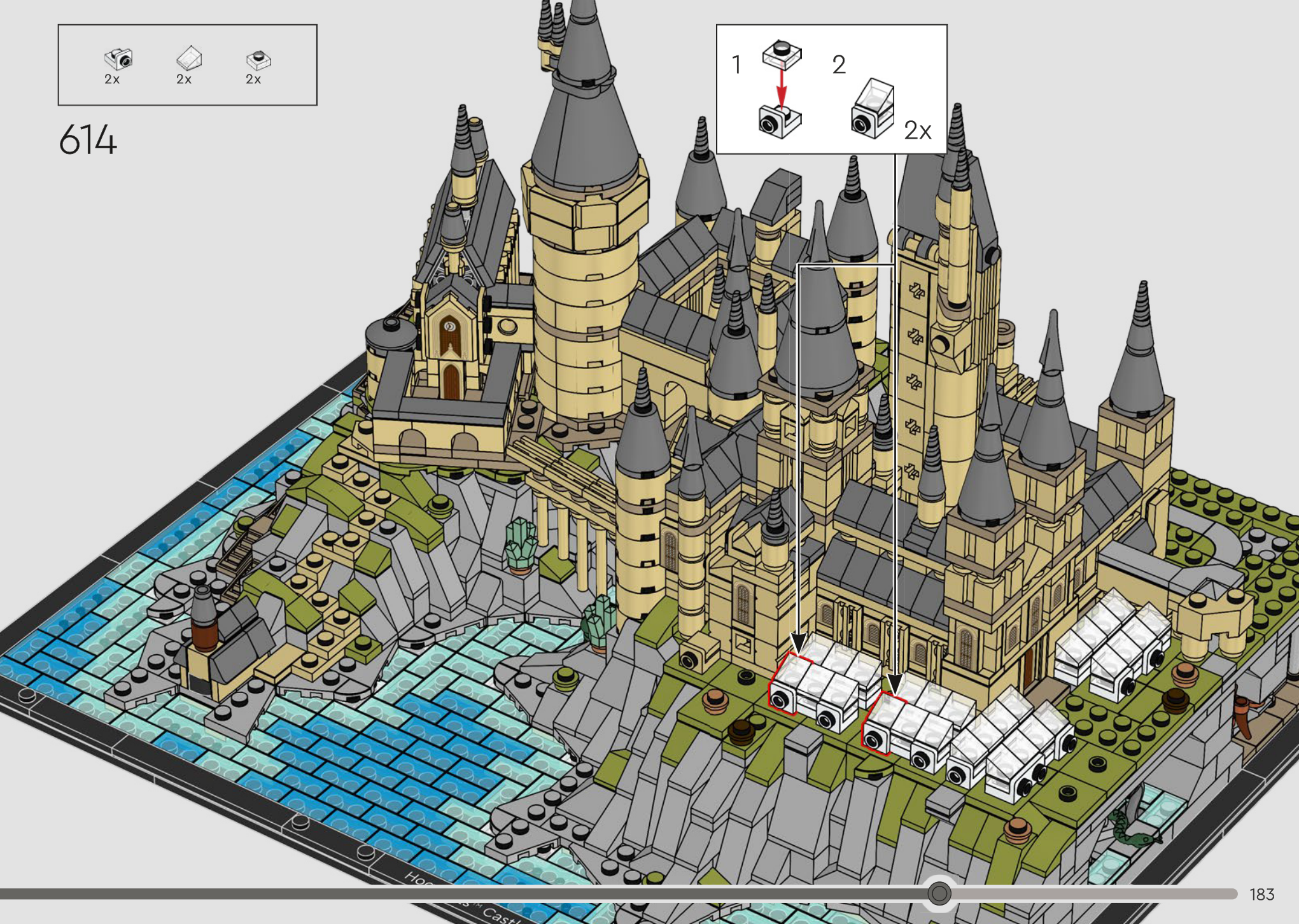

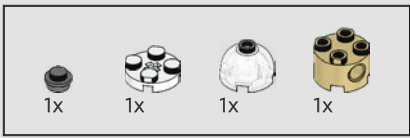

615

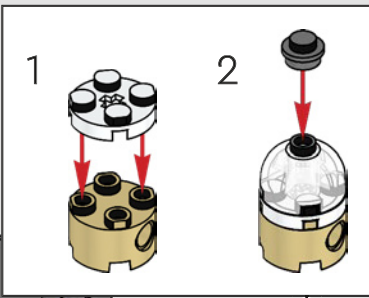

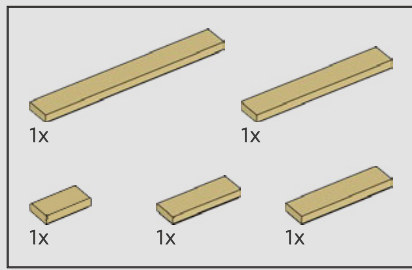

616

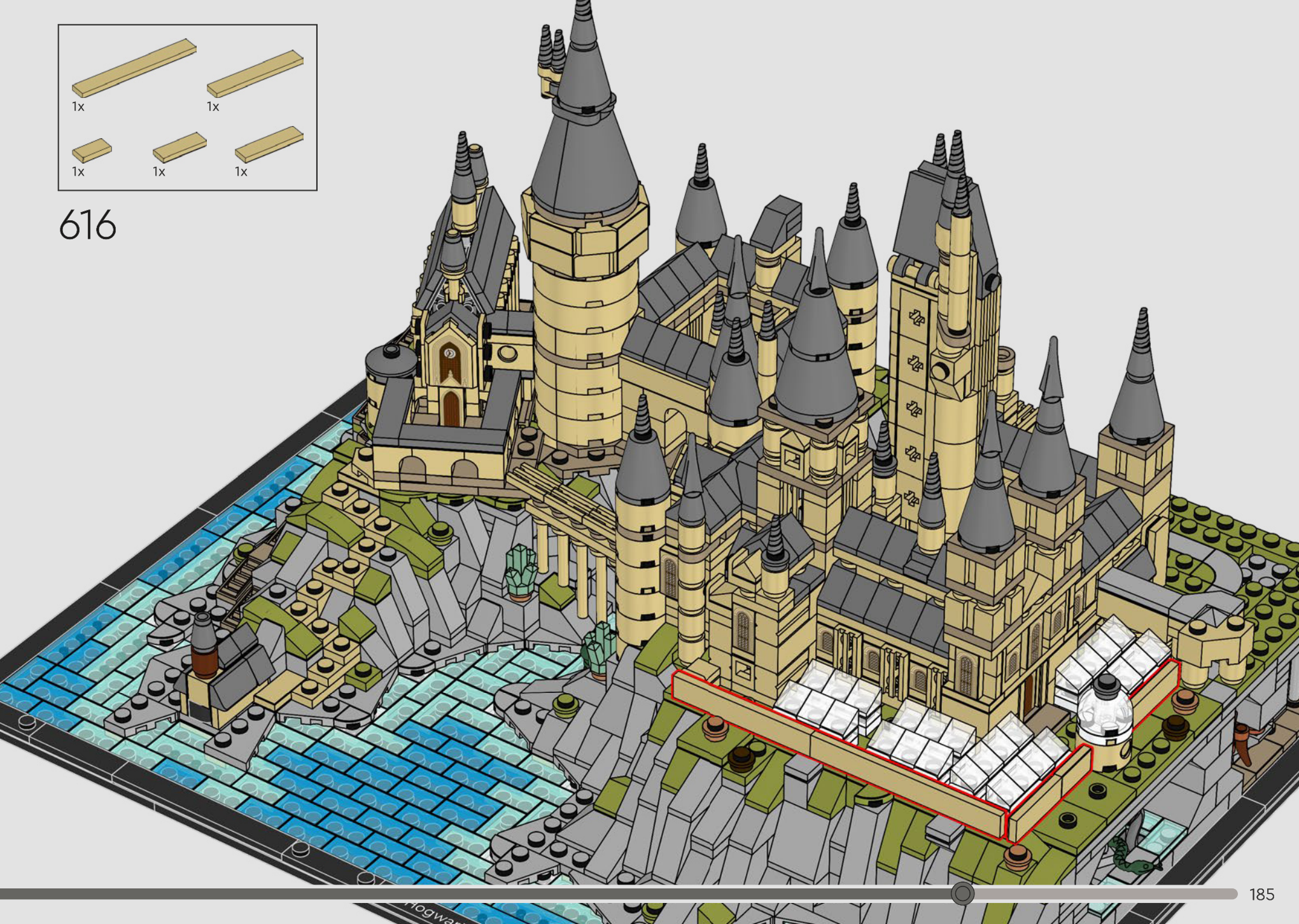

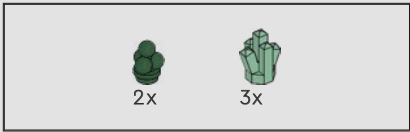

617

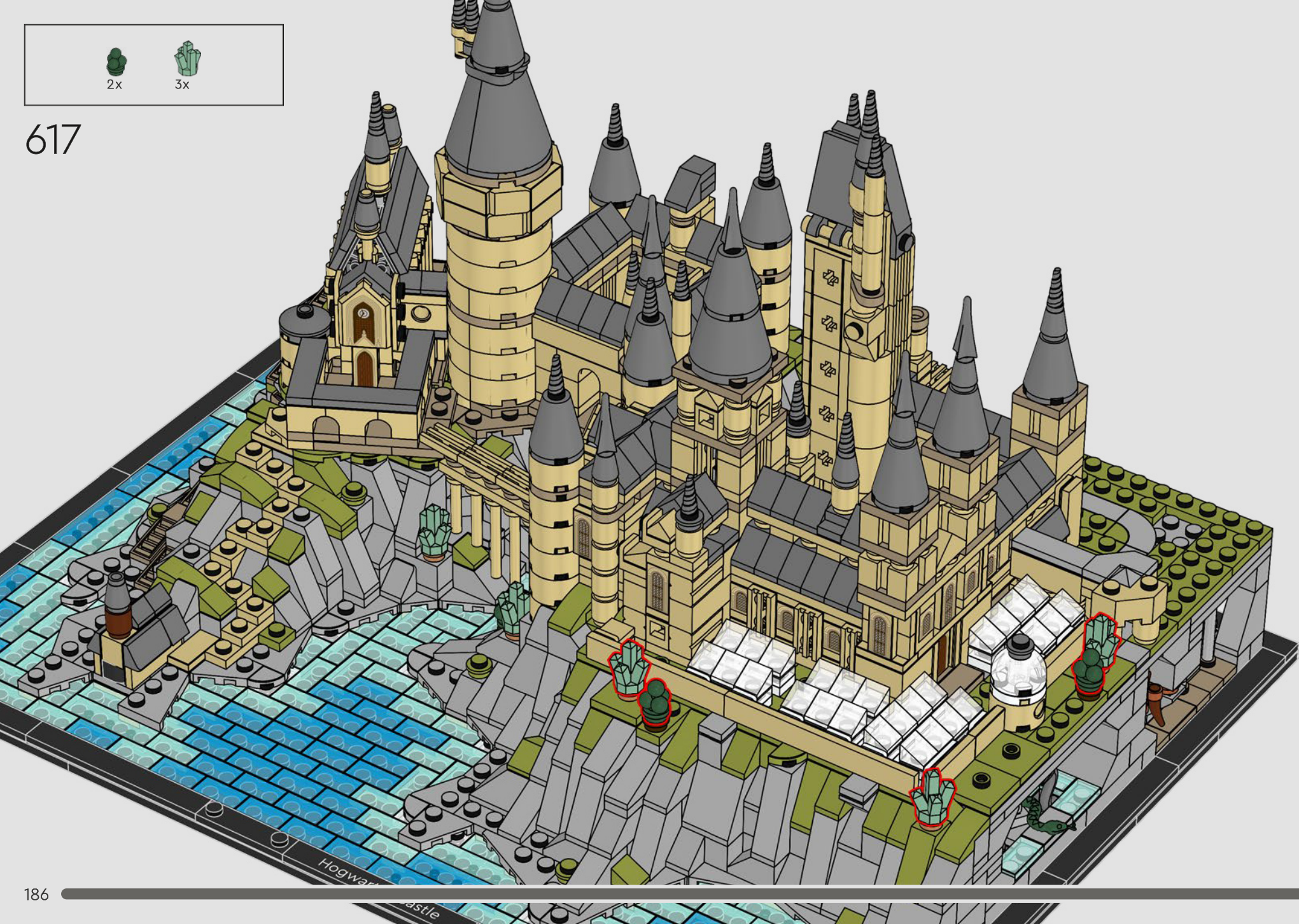

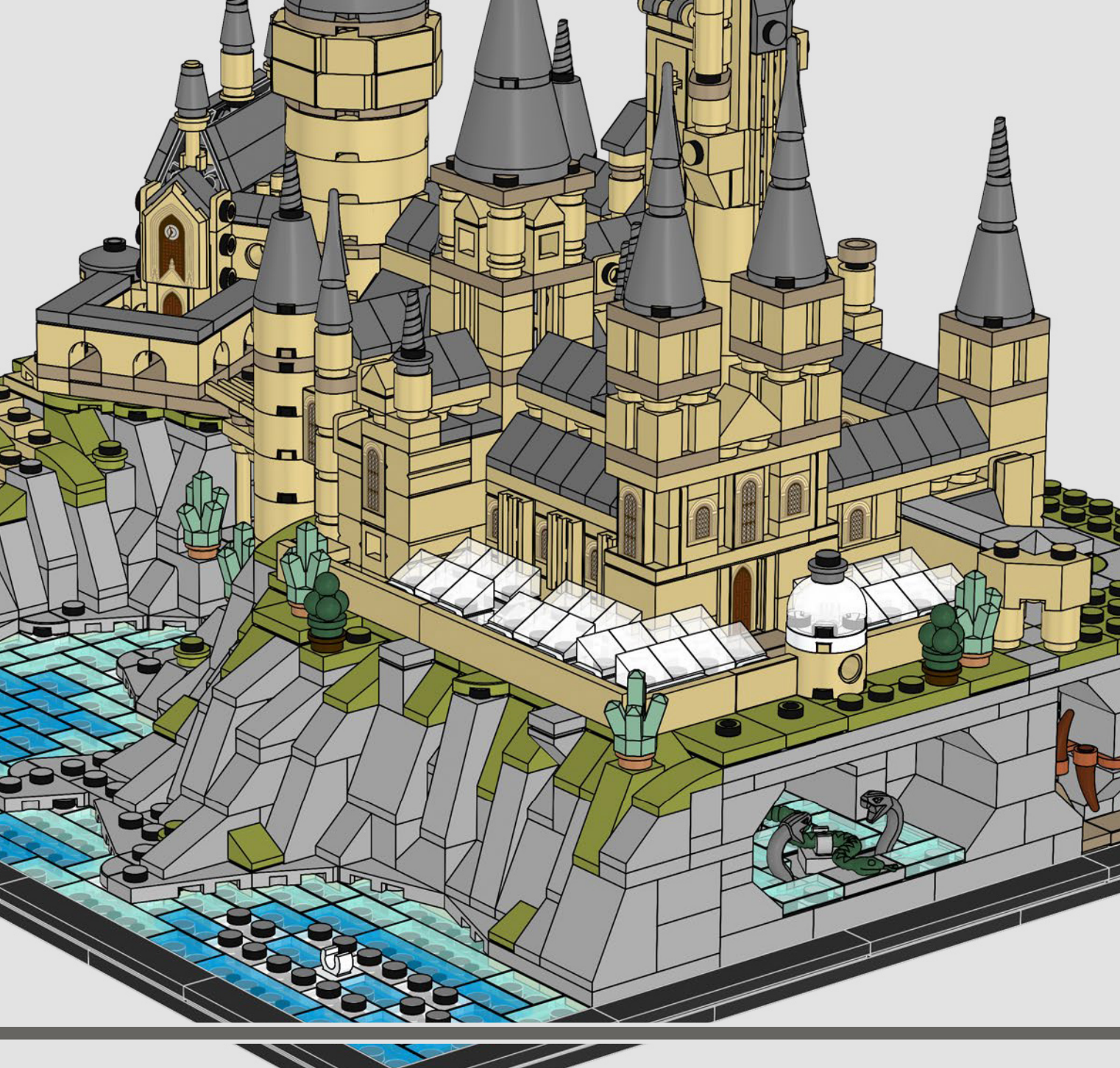

The greenhouses are where Professor Sprout, Head of the Hogwarts™ Herbology department, guides students safely through the care and use of magical plants. Now, if only everyone would use their earmuffs...

Les serres sont l'endroit où la professeure Chourave, responsable du département de botanique de Poudlard, guide prudemment les étudiants à travers le traitement et l'utilisation des plantes magiques. Maintenant, si seulement tout le monde utilisait ses cache-oreilles...

Los invernaderos son el lugar donde la Profesora Sprout, jefa del Departamento de Herbología de Hogwarts™, guía a los alumnos con seguridad en el cuidado y uso de las plantas mágicas. Ahora, que si todo el mundo usara sus orejeras...

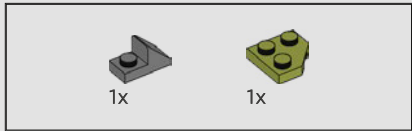

618

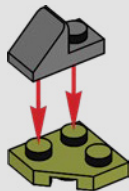

619

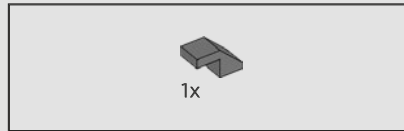
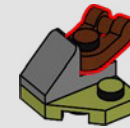

620

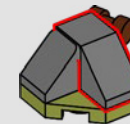

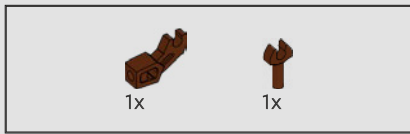

621

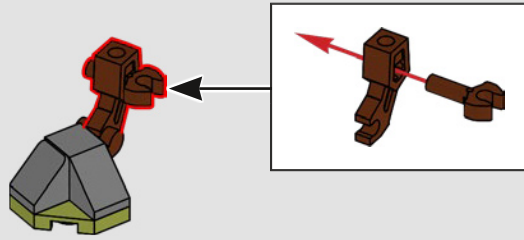

622



623

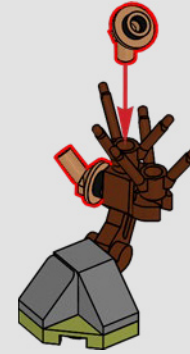

624

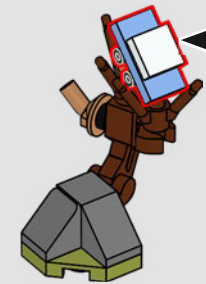
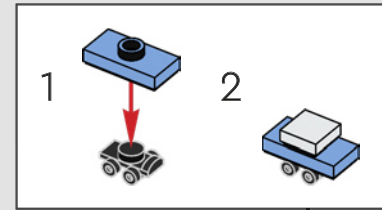



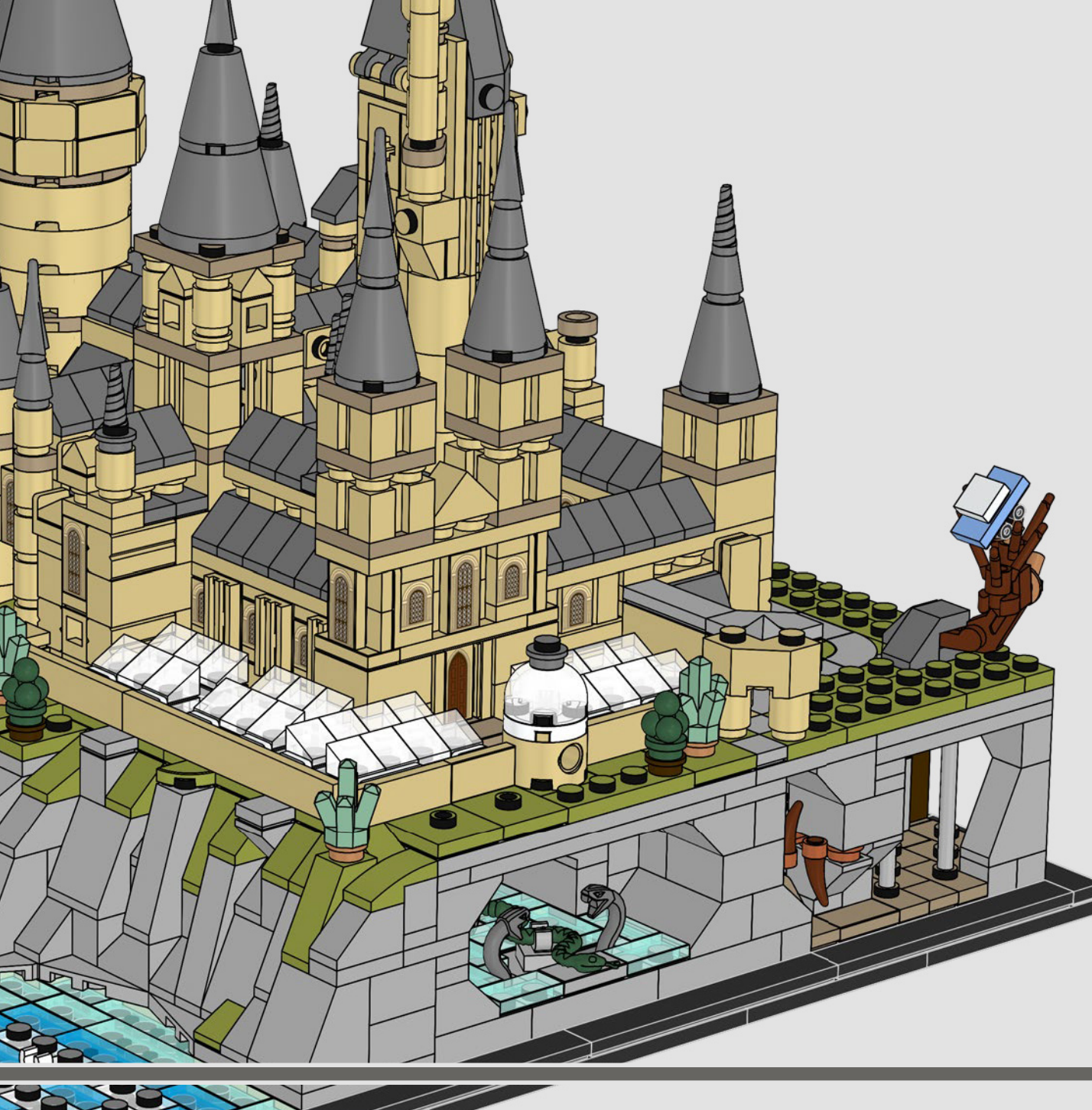

The Whomping Willow™ was planted to give Professor Lupin a safe escape during his full-moon werewolf episodes. It hides a secret tunnel leading to the Shrieking Shack where Lupin would stay until he transformed back into human form.

Le Saule cogneur a été planté pour permettre au professeur Lupin de s'échapper facilement pendant ses transformations en loup-garou les soirs de pleine lune. Il dissimule un tunnel secret menant à la Cabane hurlante, où Lupin restait caché jusqu'à ce qu'il reprenne forme humaine.

El Sauce Boxeador fue plantado para dar al Profesor Lupin un escape seguro durante sus episodios de hombre lobo por efecto de la luna llena. Esconde un túnel secreto que conduce a la Casa de los Gritos, donde Lupin permanecía hasta recuperar su forma humana.



626

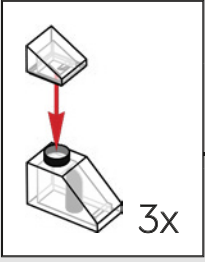
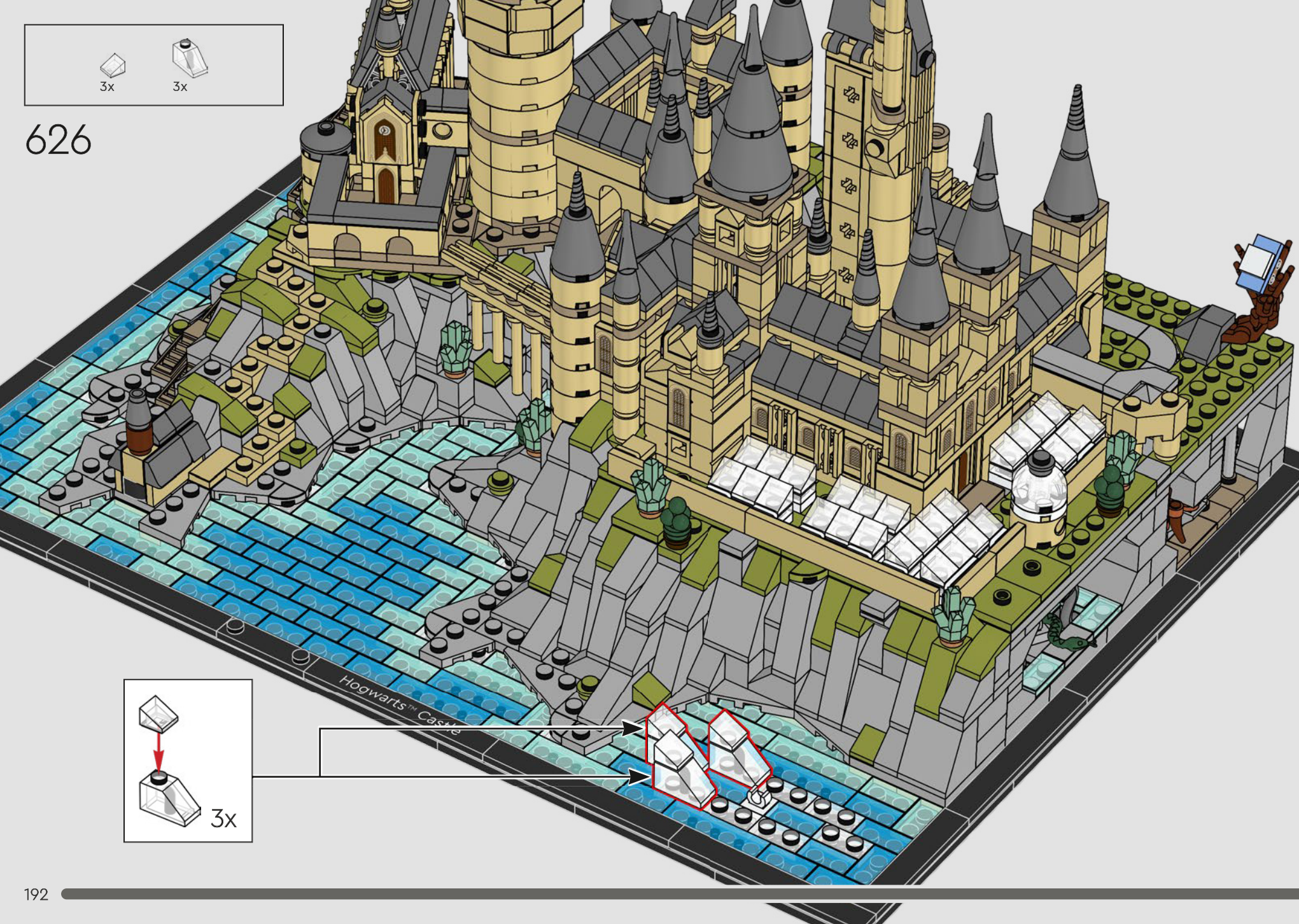



627

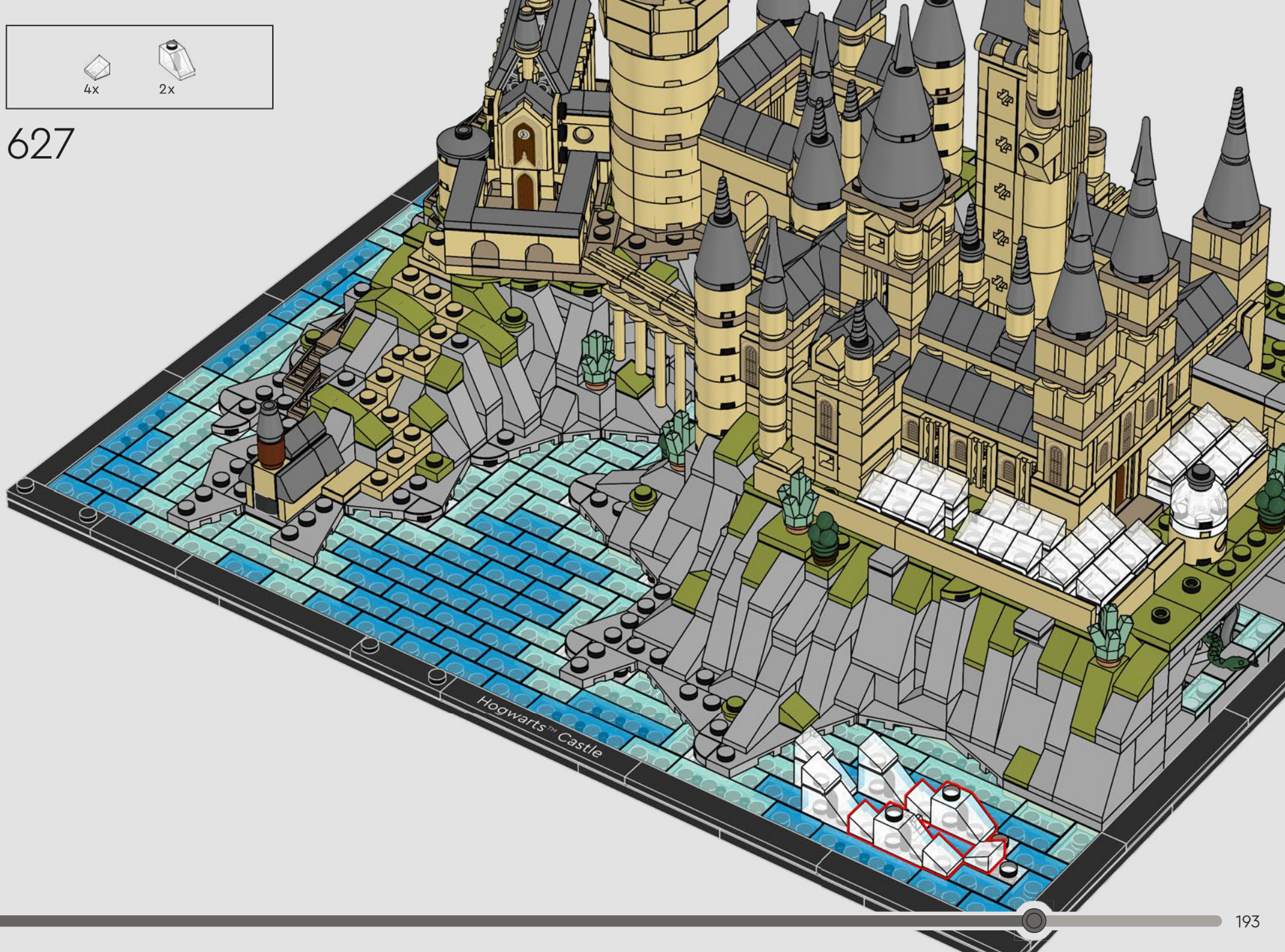

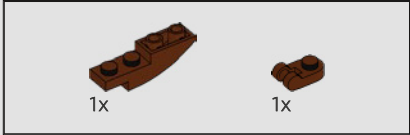
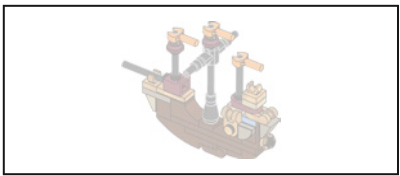

628

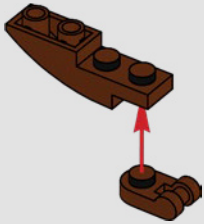

629

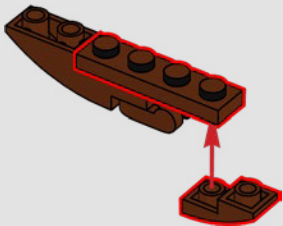

630

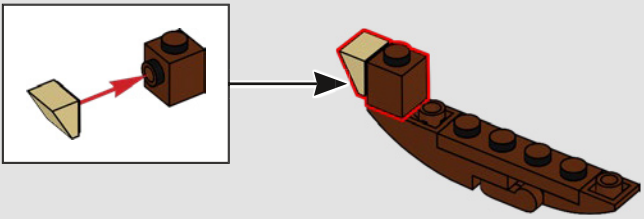

631

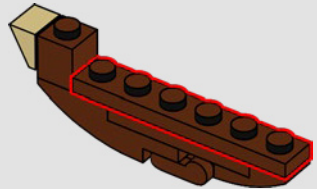

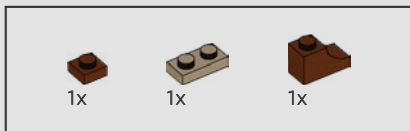

632

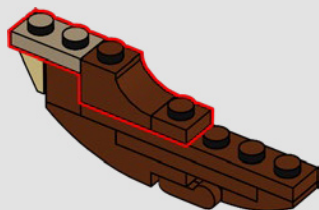

633

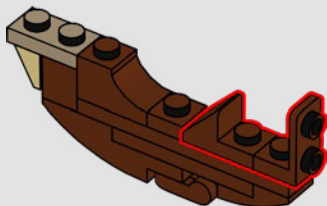

634

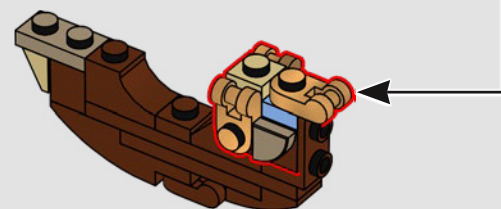
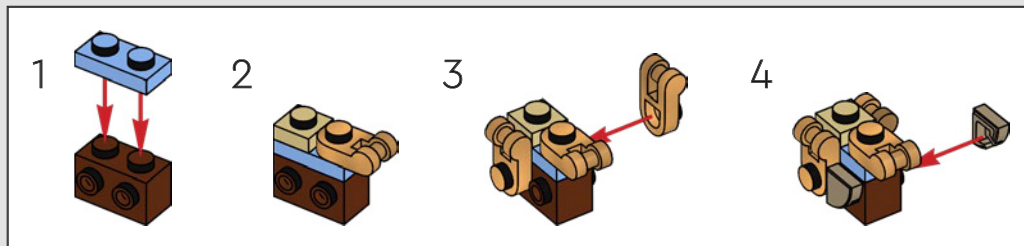

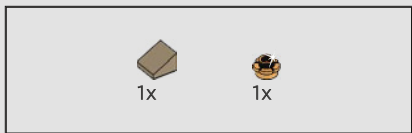

635

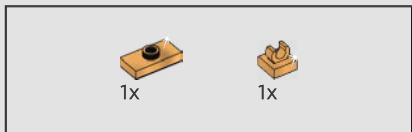
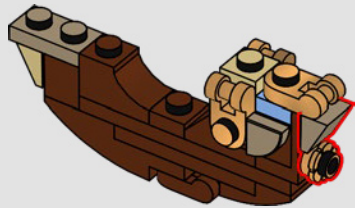

636

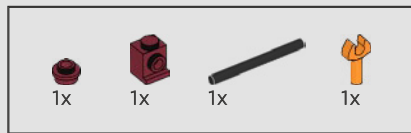
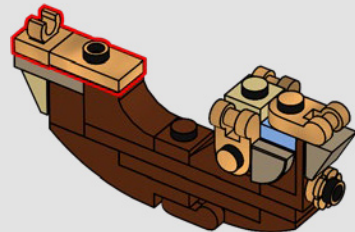

637

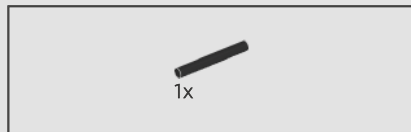
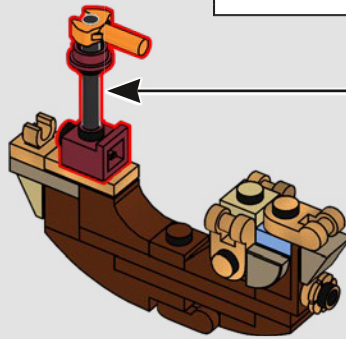
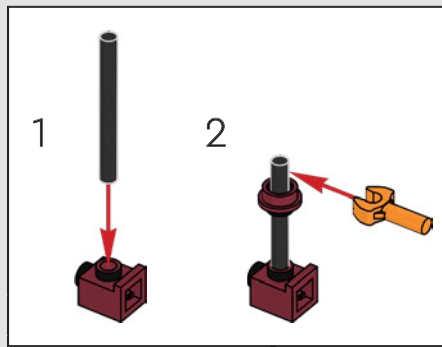

638

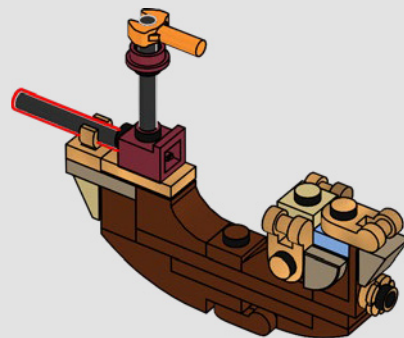

The magical Durmstrang Ship was used to travel between the Durmstrang Institute and Hogwarts™ for the Triwizard Tournament. But have you ever wondered how the ship got from the North Sea into the Black Lake?

Le navire magique de Durmstrang était utilisé pour les déplacements entre l'Institut Durmstrang et Poudlard lors du Tournoi des Trois Sorciers. Mais vous êtes-vous déjà demandé comment le navire a pu passer de la mer du Nord au lac noir ?

El barco mágico de Durmstrang se usaba para viajar a Hogwarts™ desde el Instituto Durmstrang cuando se requería su participación en el Torneo de los Tres Magos. ¿Pero te has preguntado alguna vez cómo llegaba el barco desde el mar del Norte hasta el Lago Negro?



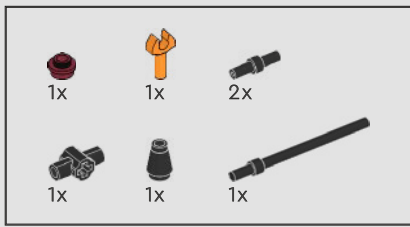

639

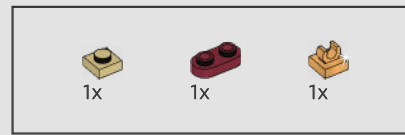
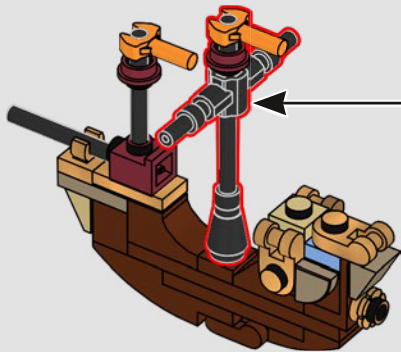
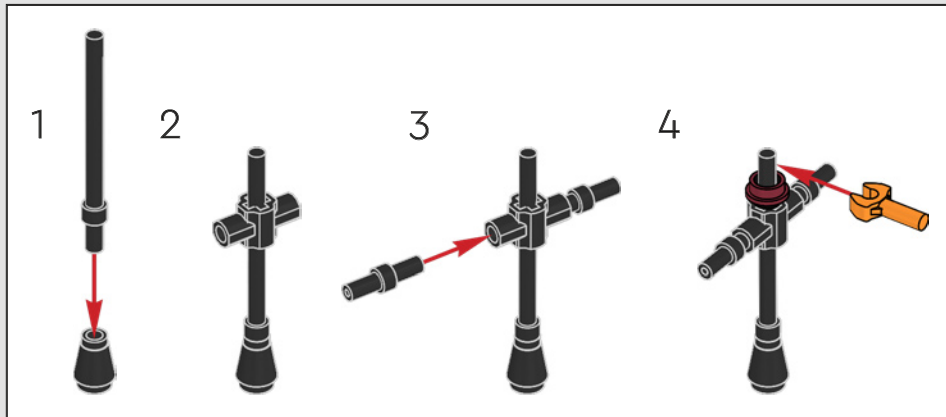

640

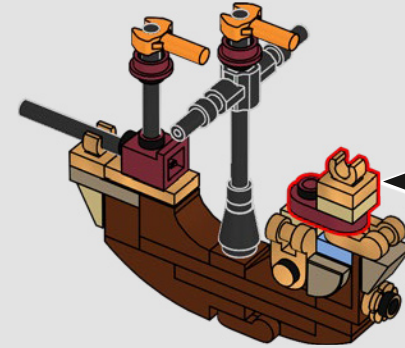
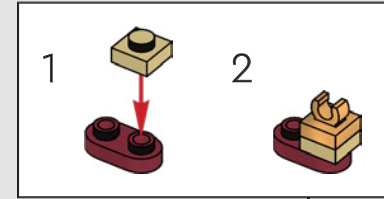

641

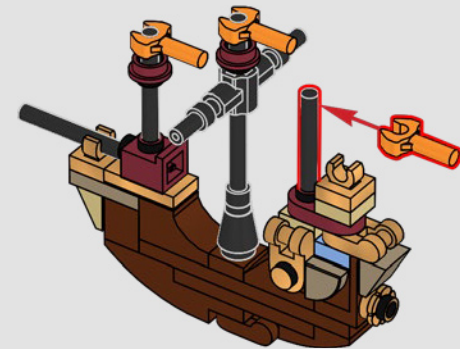



Hogwarts™ Castle

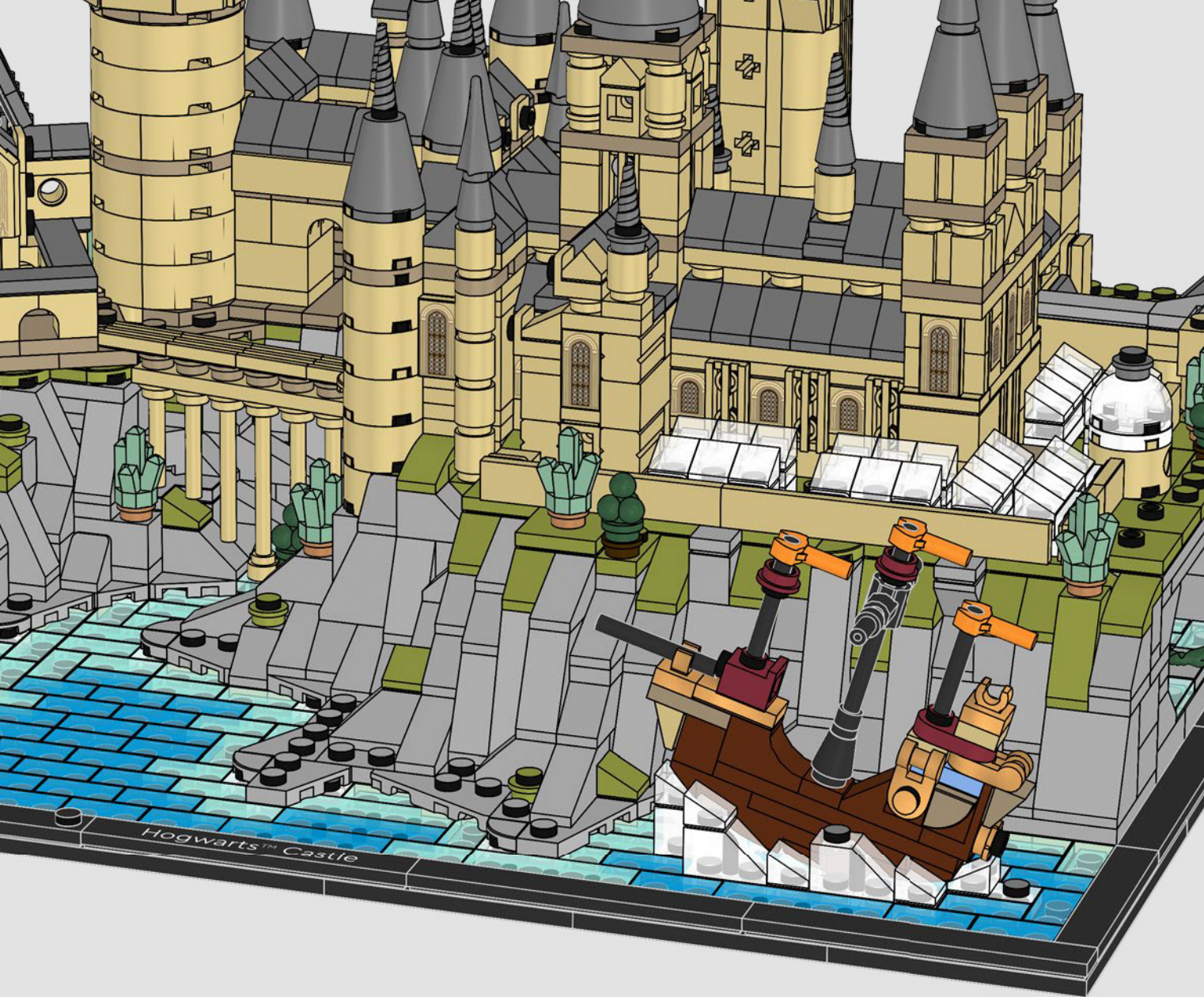

The Durmstrang Ship arrived in the lake through a magical shortcut created between the lake and other bodies of water – truly magical!

Le navire de Durmstrang est arrivé au lac en empruntant un raccourci magique créé entre le lac et d'autres plans d'eau – vraiment magique !

El barco de Durmstrang alcanzaba el lago a través de un atajo mágico creado entre este y otros cuerpos de agua. ¡Eso sí que es magia!



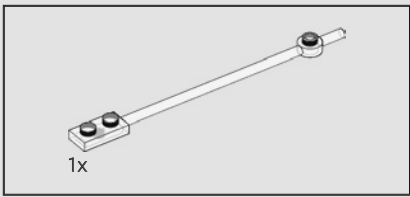

643





647

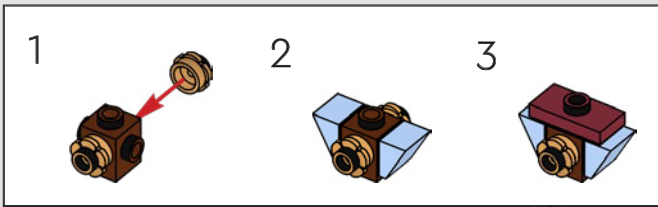

648

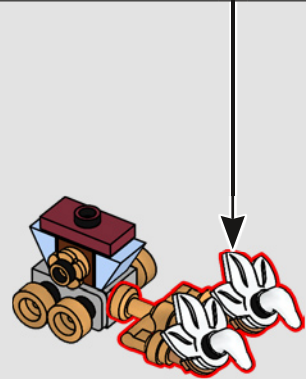
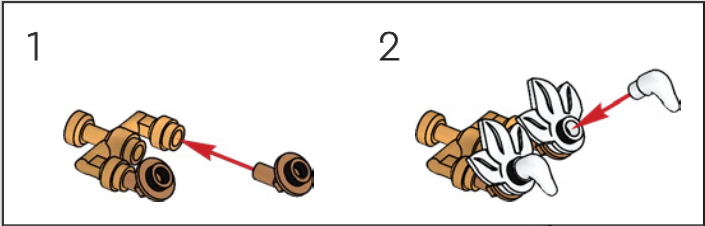

649

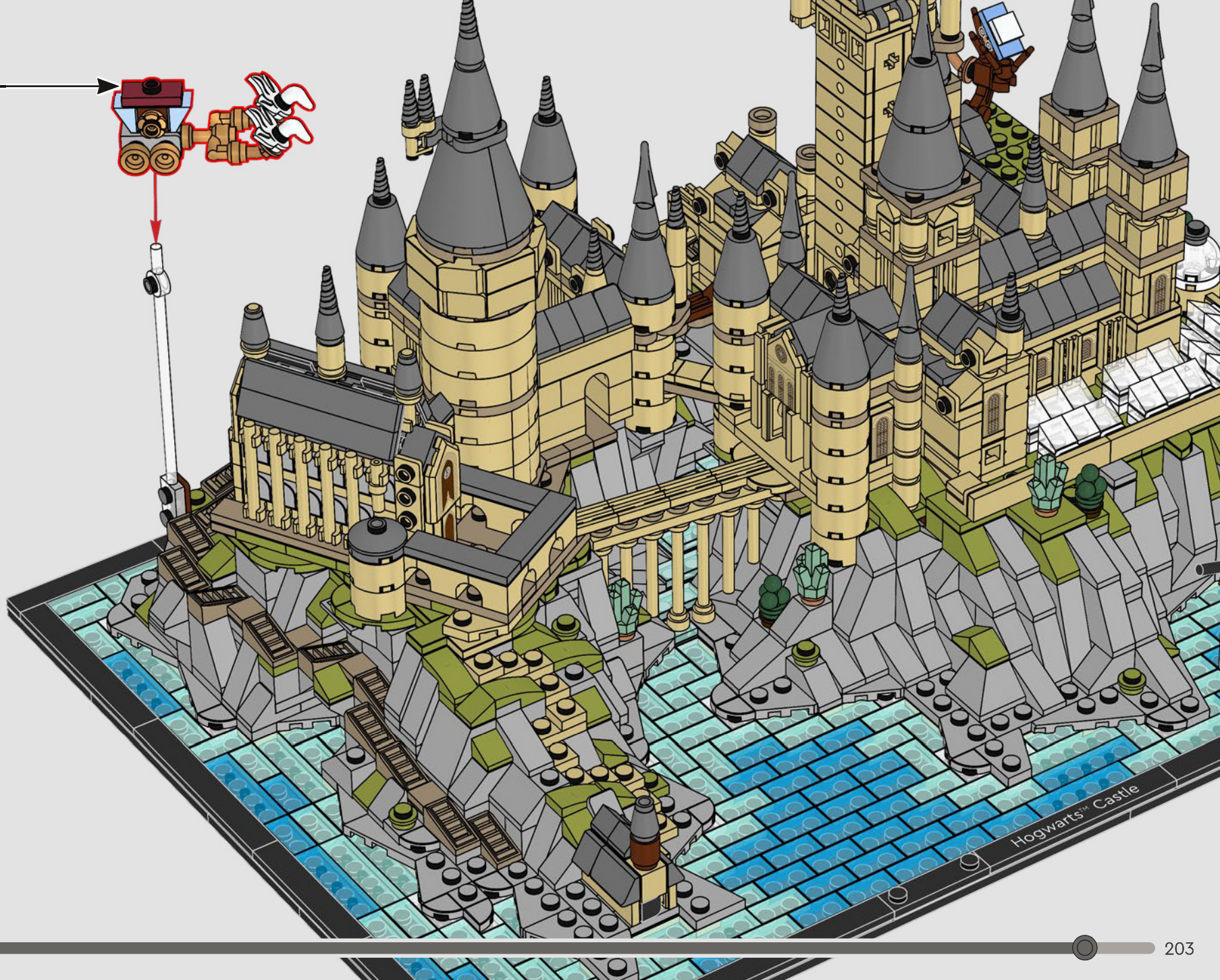

Hogwarts™ Castle

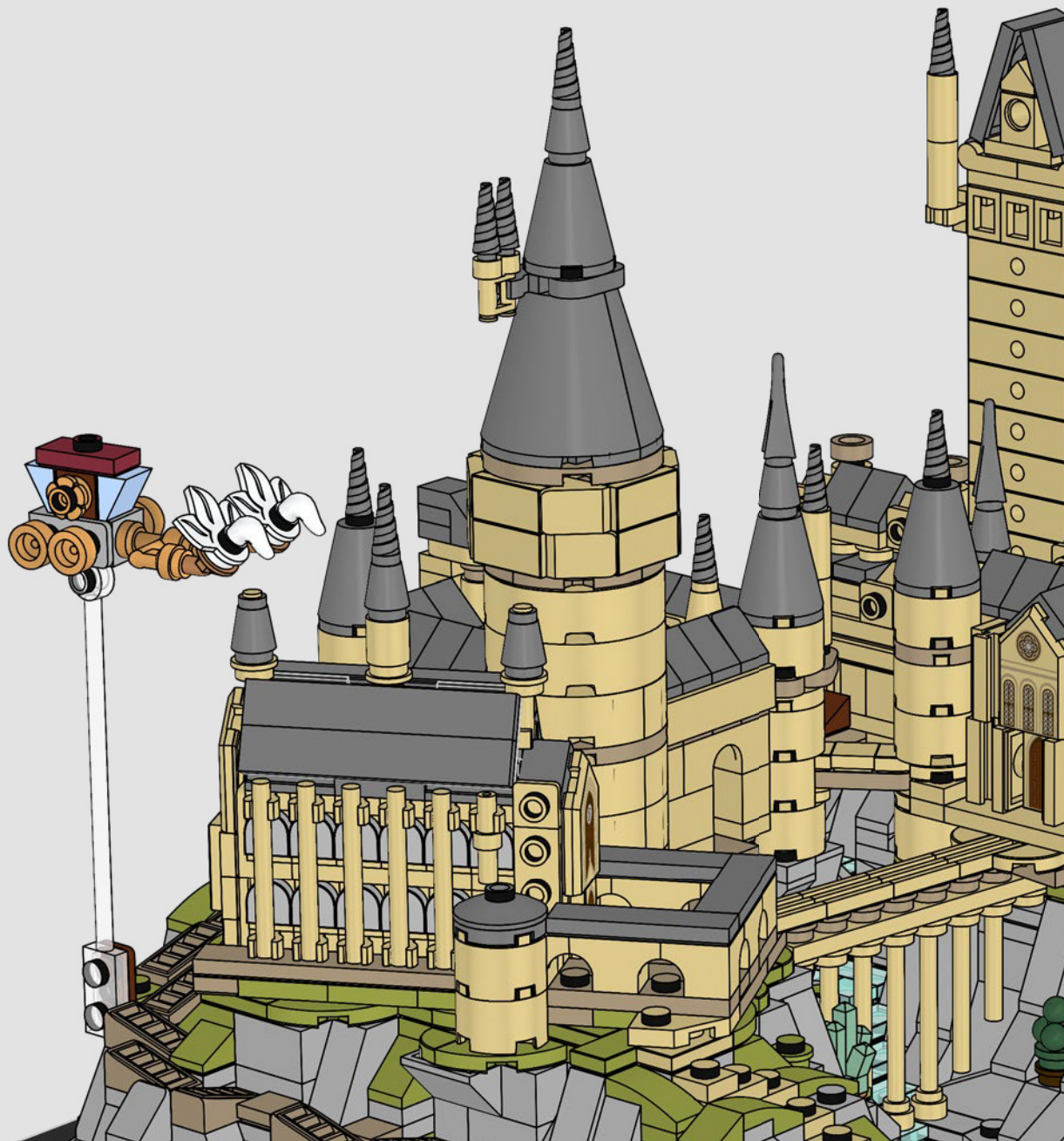

The Pegasus of the Beauxbatons' Carriage is built with white LEGO® horn and leaf elements. Notice the reins? They are actually a magically transformed candleholder!

Le Pégase du carrosse de Beauxbâtons est construit avec des éléments de corne et de feuille LEGO® blancs. Vous voyez les rênes ? Ce sont en fait des bougeoirs transformés comme par magie !

El pegaso del carruaje de Beauxbatons está construido con elementos LEGO® blancos que representan cuernos y hojas. ¿Ya te fijaste en las riendas? En realidad, ¡son un candelabro transformado como por arte de magia!

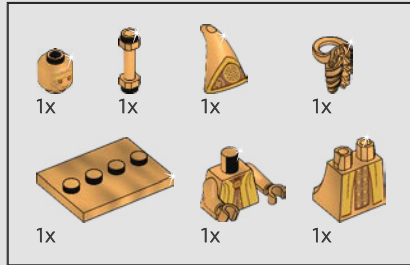

650

1

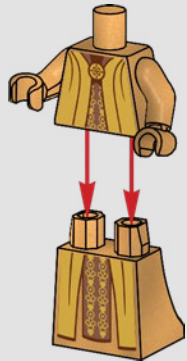

2

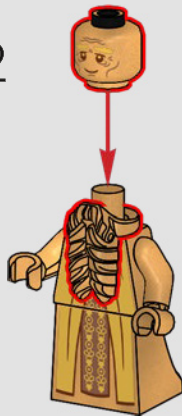

3

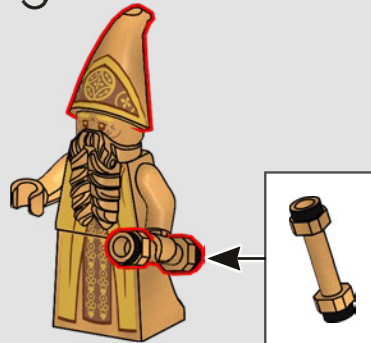

4



The Architect of Hogwarts™ Castle minifigure was created exclusively for this set, with a new beard element, and a Hogwarts model and blueprint scroll in his hand.

La figurine de l'architecte du château de Poudlard a été créée exclusivement pour cet ensemble, avec un nouvel élément de barbe ainsi qu'une maquette et un plan de Poudlard dans sa main.

La minifigura del Arquitecto de Hogwarts™ se creó exclusivamente para este set con un nuevo elemento que representa su barba y un modelo de Hogwarts y un plano enrollado en la mano.

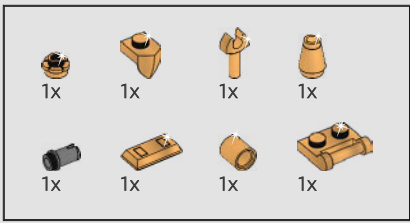

651

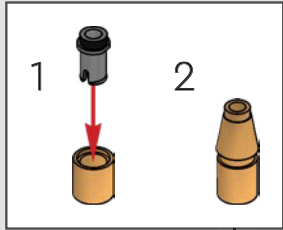

1

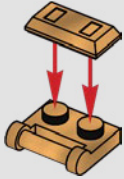

2

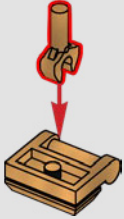

3

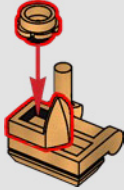

4





The Architect of Hogwarts™ Castle was active in the years around the turn of the tenth century. Not much is known about his life or other works.

L'architecte du château de Poudlard a œuvré dans les années autour du tournant du 10^e siècle. On en sait très peu sur sa vie et ses autres réalisations.

El Arquitecto de Hogwarts™ estuvo activo en los años cercanos al cambio del siglo X. No se sabe mucho sobre su vida u otras obras.





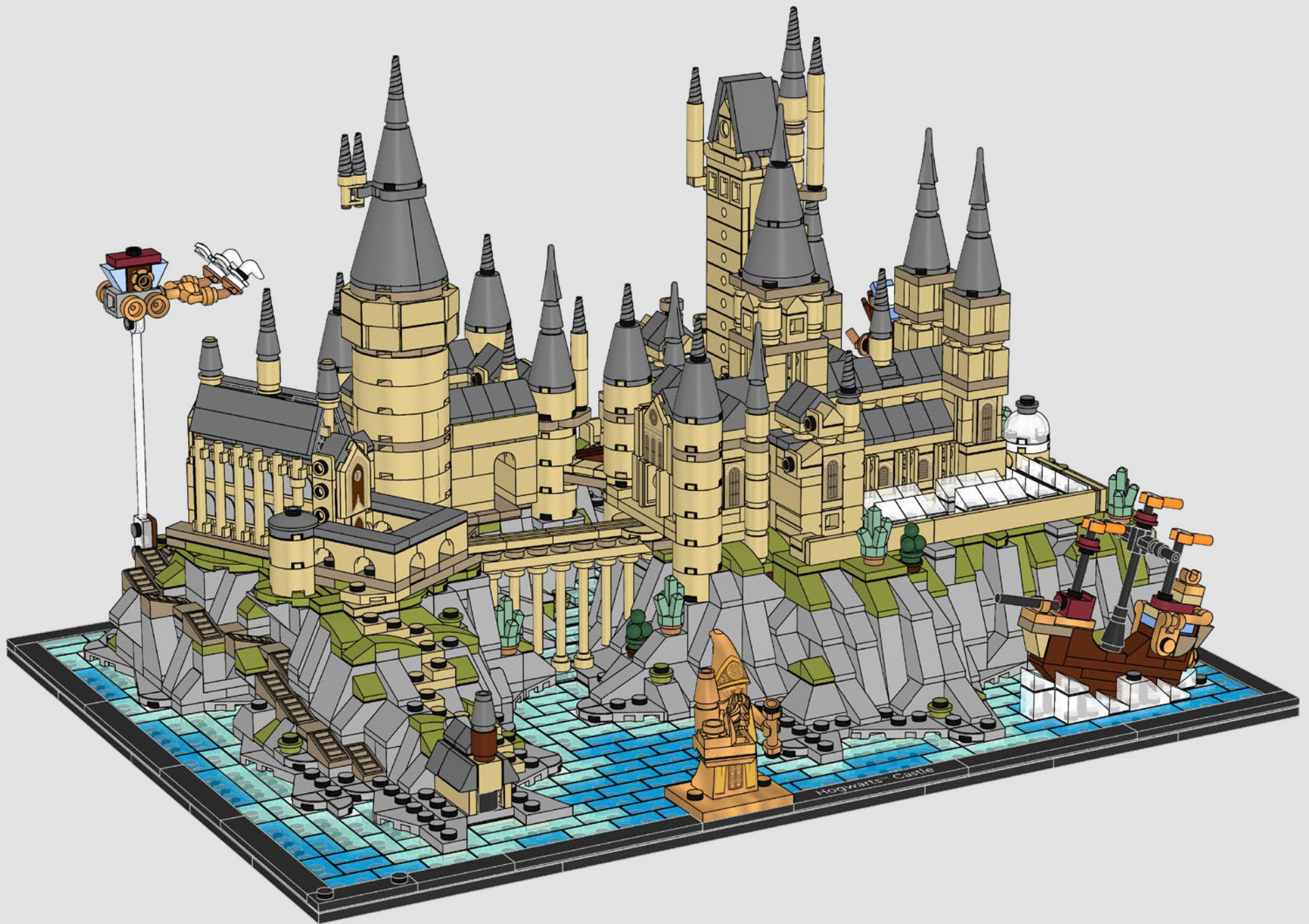



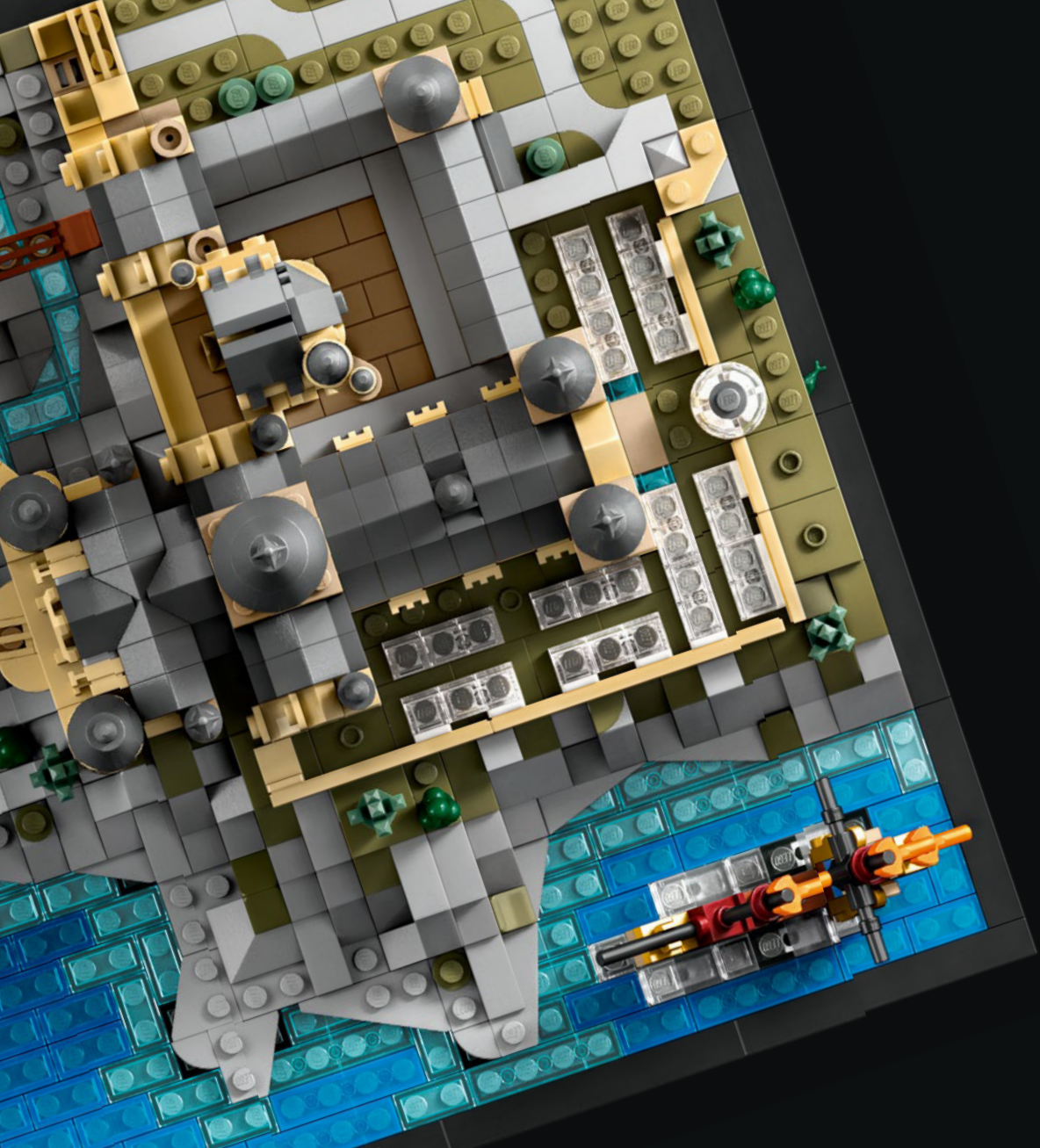

Hogwarts™ Castle



- 2x 614101
- 2x 6186681
- 2x 6328195
- 5x 307001
- 9x 302401
- 1x 6348055
- 8x 6242241
- 2x 4111971
- 2x 6382783
- 1x 6044691
- 1x 403201
- 1x 4667575
- 7x 302301
- 1x 6070698
- 3x 362301
- 11x 6195371
- 1x 4550745
- 1x 246501
- 3x 300201
- 2x 371001
- 2x 300101
- 1x 6222425
- 1x 366601
- 7x 6454936
- 27x 4117070
- 3x 4529237
- 63x 4161734
- 11x 6443061
- 2x 6353196
- 1x 4569547
- 1x 6167923
- 19x 4113915
- 20x 6454440
- 30x 4118793
- 9x 6230284
- 41x 4159553
- 16x 4125253
- 10x 4516055
- 8x 6232135
- 2x 4612603
- 3x 6145570
- 3x 4529237
- 63x 4161734
- 11x 6443061
- 2x 6353196
- 1x 4569547
- 1x 6167923
- 1x 4213568
- 1x 4224793
- 1x 6360037
- 1x 6454941
- 2x 6212758
- 5x 6351413
- 2x 6408047
- 1x 6447501
- 1x 6262018
- 1x 4624086
- 2x 4140562
- 2x 4579260
- 2x 4179771
- 4x 6175968
- 17x 6365720
- 3x 6374151
- 1x 6374192
- 1x 4213568
- 1x 4224793
- 1x 6360037
- 1x 6454941
- 2x 6212758
- 5x 6351413
- 2x 6408047
- 1x 6447501
- 1x 6262018
- 1x 4624086
- 2x 4140562
- 2x 4579260
- 2x 4179771
- 4x 6175968
- 17x 6365720
- 3x 6374151
- 6x 6236425
- 40x 4113917
- 34x 4114026
- 9x 6148262
- 43x 6092587
- 36x 4124456
- 10x 6455327
- 3x 6236914
- 8x 6069165
- 4x 4109995
- 1x 6024495
- 1x 6214334
- 2x 4159279
- 5x 6236423
- 1x 6445058
- 3x 6455326
- 10x 6391523
- 9x 6219794
- 2x 6103001
- 1x 4205107
- 7x 6174925
- 1x 6313611
- 1x 6117975
- 1x 6249809
- 2x 6253003
- 4x 4160483
- 1x 6374166
- 2x 4217562
- 5x 6443062
- 2x 4124455
- 6x 4114077
- 6x 4114306
- 2x 6221467
- 5x 6454937
- 16x 4114084
- 4x 4185177
- 1x 4188866
- 1x 6148265
- 12x 6055868
- 1x 6469454
- 1x 6458487
- 1x 6454439
- 11x 4121921
- 6x 6131896
- 2x 4162465
- 7x 4618651
- 1x 6058093
- 4x 6211966
- 9x 6410762
- 1x 6245271
- 1x 4543858
- 12x 6116614
- 9x 4118790
- 4x 4159739
- 2x 6175367
- 10x 4113233
- 5x 6232136
- 7x 6257600
- 5x 4550324
- 23x 6352222
- 2x 4113916
- 1x 6213676
- 2x 6294592
- 4x 6115031
- 2x 6454935
- 10x 4114309
- 1x 6351905
- 7x 4124067
- 6x 4112982
- 1x 4157277
- 3x 4243824
- 1x 6383728
- 7x 4113993
- 2x 4181134
- 4x 4114324
- 2x 4159774
- 1x 4544139
- 4x 4114001
- 4x 4113988
- 1x 6075179
- 1x 4624185
- 2x 447721
- 2x 611121
- 4x 614121
- 2x 362221
- 1x 302121
- 5x 371021
- 2x 6372124
- 4x 6315780
- 1x 6347604
- 5x 242023
- 5x 301023
- 2x 366623
- 17x 614124
- 6x 362224
- 3x 362324
- 1x 4188313
- 1x 6457333
- 1x 6350055
- 1x 6454443
- 3x 6212377
- 1x 6207933
- 1x 6092594
- 1x 6326425
- 1x 6454437
- 1x 4585493
- 1x 6378168
- 4x 6209691
- 1x 4529247
- 1x 6186672
- 1x 6453281
- 1x 6454435
- 1x 6256803
- 2x 6262138
- 1x 6415995
- 1x 6083975

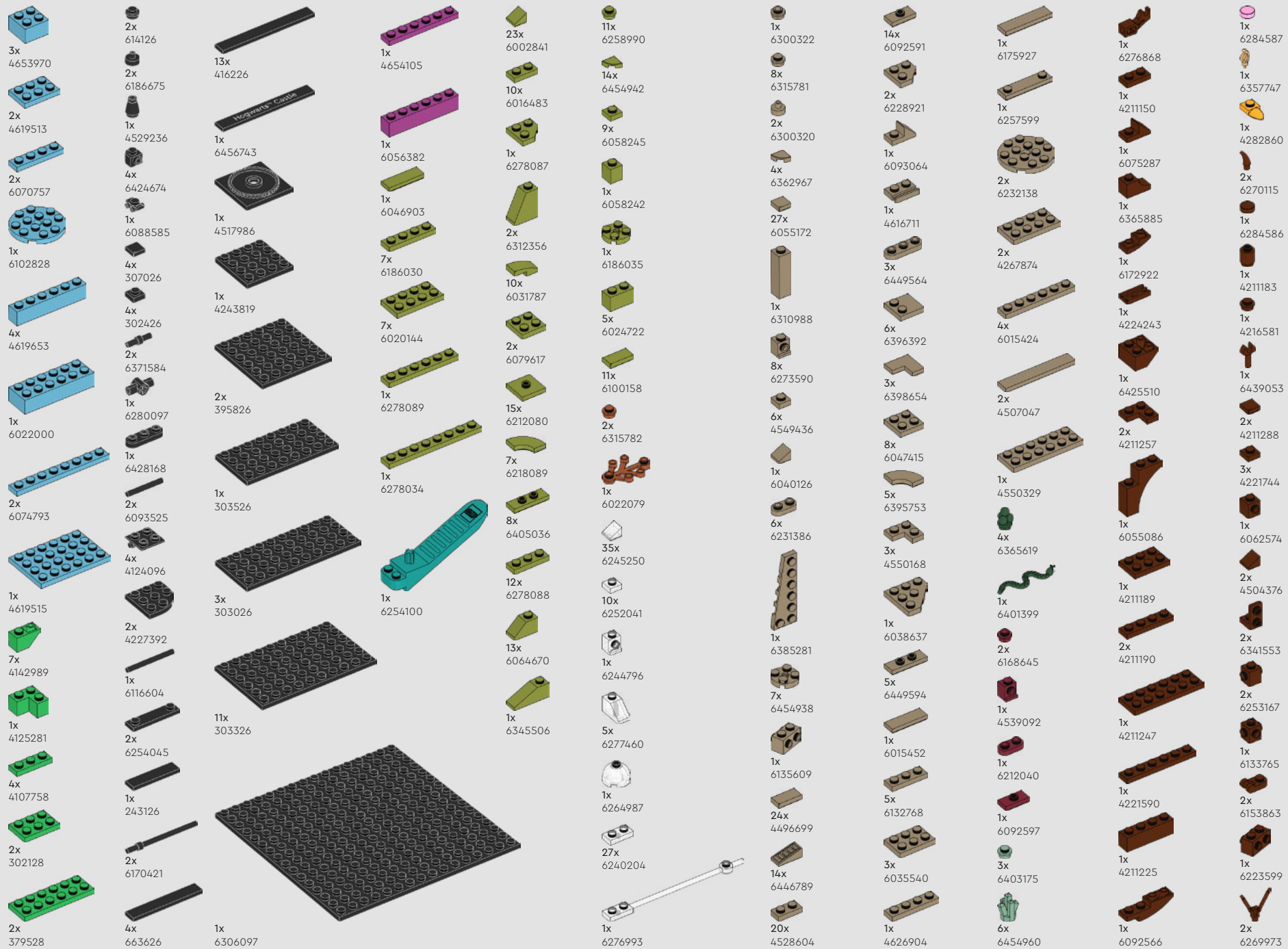

- 1x 4210763
- 2x 6168776
- 4x 4211066
- 2x 6331866
- 3x 4211094
- 1x 6126083
- 1x 6201630
- 10x 6092666
- 1x 6115080
- 1x 4211010
- 2x 6174938
- 17x 6445056
- 6x 6269969
- 15x 4529240
- 2x 6331689
- 1x 4210867
- 2x 4211100
- 8x 4210719
- 1x 4243831
- 1x 6186635
- 2x 4211103
- 3x 6231765
- 2x 4210633
- 1x 6431826
- 3x 6395635
- 4x 6454438
- 1x 4211098
- 5x 6343852
- 4x 4210651
- 4x 6262021
- 2x 4504378
- 2x 6234583
- 2x 6235153
- 7x 6167641
- 4x 6400315
- 51x 6251289
- 8x 6252050
- 1x 4179825
- 1x 6092601
- 1x 6221607
- 1x 6296892
- 45x 4226221
- 3x 4567887
- 14x 4211135
- 1x 4211088
- 3x 6069164
- 2x 6092572
- 3x 4211053
- 1x 4526932
- 9x 4211394
- 1x 4529241
- 1x 6284071
- 3x 6448793
- 21x 6250597
- 1x 6455328
- 5x 4521921
- 23x 4211389
- 5x 6362975
- 12x 6176433
- 3x 6345639
- 2x 6433942
- 12x 6163478
- 6x 4211415
- 2x 4211489
- 1x 4526932
- 9x 4211394
- 1x 6420741
- 6x 4211791
- 5x 4211794
- 1x 6234738
- 18x 4211399
- 1x 6225242
- 46x 4211614
- 1x 6347715
- 3x 6258381
- 2x 4568637
- 2x 6075075
- 15x 4211488
- 2x 6211969
- 12x 4211428
- 7x 6116608
- 4x 6066097
- 5x 6186657
- 1x 4216248
- 3x 6308012
- 4x 6065824
- 1x 4651063
- 1x 6469440
- 1x 6269049
- 40x 4515374
- 12x 4211437
- 6x 4657459
- 2x 6211773
- 10x 4211445
- 13x 6093859
- 11x 4211494
- 46x 4211398
- 9x 4211414
- 2x 6170387
- 1x 4211564
- 2x 6123809
- 5x 4234535
- 8x 4211353
- 2x 4211410
- 1x 6163990
- 11x 4211396
- 2x 4211356
- 1x 6213378
- 13x 6435857
- 14x 4211349
- 11x 4211387
- 1x 4216250
- 3x 4211397
- 1x 6177078
- 1x 6126082
- 18x 4211429
- 8x 4211386
- 2x 6435930
- 1x 6306729
- 4x 6163477
- 1x 4645397
- 3x 4558169
- 1x 6075066
- 3x 4211438
- 2x 4211393
- 1x 4618874
- 2x 4243797
- 2x 4211549
- 1x 6015347
- 7x 4211385
- 2x 4211395
- 1x 6372029
- 1x 4211392
- 6x 4211404
- 1x 6037399
- 1x 4211474
- 3x 4251149
- 2x 4211521
- 2x 4211407
- 3x 6059033
- 3x 4211452
- 1x 4211795
- 2x 4211425
- 6x 4157103
- 3x 6439042
- 3x 4173805
- 16x 4121739
- 17x 4220634
- 23x 4164037
- 10x 6254256
- 85x 6251295
- 3x 6343877
- 11x 6252049
- 1x 4211522
- 1x 4211402
- 1x 4211405



 [LEGO.com/service](https://www.LEGO.com/service)



YOU COULD WIN



YOU COULD WIN

Your feedback will help shape the future development of this product series.

Visit:

DU KÖNNTEST GEWINNEN

Dein Feedback trägt zur Weiterentwicklung dieser Produktreihe bei.

Geh auf:

VOUS POURRIEZ GAGNER

Vos commentaires nous aideront à concevoir les futurs produits de cette gamme.

Visitez :

POTRESTI VINCERE TU

La tua opinione ci aiuterà a migliorare la creazione futura di questa linea di prodotti.

Visita:

PUEDES GANAR

Tu opinión contribuirá al futuro de esta serie de productos.

Visita:

轻松获奖

您的反馈将有助于我们在今后改进本产品系列。

请访问:

[LEGO.com/productfeedback](https://www.lego.com/productfeedback)

You also have the chance to win a LEGO® set.

Terms and conditions apply.*

Außerdem hast du die Chance, ein LEGO® Set zu gewinnen.

Es gelten die Teilnahmebedingungen.*

Vous pourriez également gagner un ensemble LEGO®.

Des conditions s'appliquent.*

Hai anche la possibilità di vincere un set LEGO®.

Termini e condizioni sono applicabili.*

También tienes la oportunidad de ganar un set LEGO®.

Aplican términos y condiciones.*

您还有机会赢取乐高®套装。

条款和条件适用。*

*[LEGO.com/productfeedback-terms](https://www.lego.com/productfeedback-terms)

II

LEGO and the LEGO logo are trademarks of the/sont des marques de commerce du/
son marcas registradas de LEGO Group. ©2023 The LEGO Group. 6502947

WIZARDING WORLD and all related trademarks, characters, names, and indicia are
© & ™ Warner Bros. Entertainment Inc. Publishing Rights © JKR. (s23)