



# SONIC™

THE HEDGEHOG

76996



LEGO® Builder



### **Get excited about our new packaging!**

We're switching from plastic to paper-based packaging. That's why you might find a mix of paper and plastic in our boxes!

### **Nos nouveaux emballages vous emballeront !**

Nous passons des emballages en plastique aux emballages à base de papier. C'est pourquoi vous pourriez trouver un mélange de papier et de plastique dans nos boîtes !

### **¡Te presentamos nuestros nuevos empaques!**

Estamos sustituyendo las bolsas de plástico por bolsas con base de papel. ¡Por eso, puedes encontrar una mezcla de papel y de plástico en nuestras cajas!

**[LEGO.com/sustainable-packaging](https://www.lego.com/sustainable-packaging)**



# BUILDER



Apple and the Apple logo are trademarks of Apple Inc., registered in the U.S. and other countries and regions. App Store is a service mark of Apple Inc. Google Play and the Google Play logo are trademarks of Google LLC. Tencent and the Tencent logo are trademarks of Tencent Inc.

LEGO.com/devicecheck

**EN** Ask parents' permission before going online | **DE** Eltern um Erlaubnis bitten, bevor du online gehst | **FR** Demande l'autorisation d'un parent avant d'aller en ligne | **IT** Chiedi il permesso ai tuoi genitori prima di andare online | **ES** Pídeles permiso a tus papás antes de conectarte a Internet | **PT** Pede autorização aos pais antes de acederes online | **ZH** 上网前应先征得父母的同意 | **PL** Poproś rodziców o zgodę, zanim wejdiesz do Internetu | **CS** Než půjdeš na internet, požádej rodiče o svolení | **SK** Skôr než pôjdeš na internet, vypýtaj si povolenie od rodičov | **HU** Kérj szülői engedélyt, mielőtt online csatlakoznál! | **RO** Cere permisiunea părinților înainte de a te conecta online | **BG** Поискайте разрешение от родител, преди да влезете онлайн | **LV** Pirms došanās tiešsaistē palūdz atļauju vecākiem | **ET** Enne Interneti kasutamist küsi vanematelt luba | **LT** Prieš prisijungdami prie interneto, atsklauskite tėvų

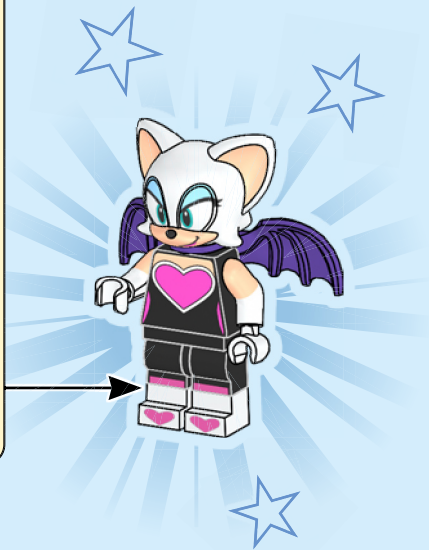
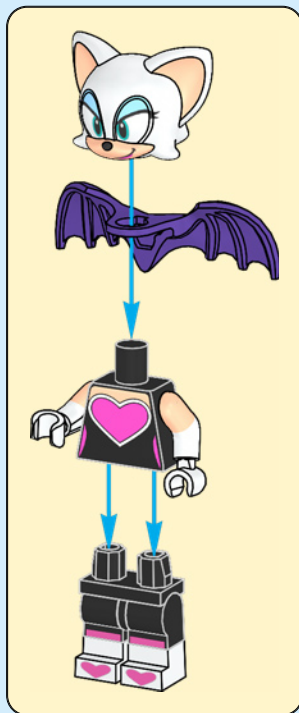

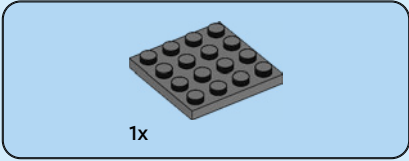

1x

1

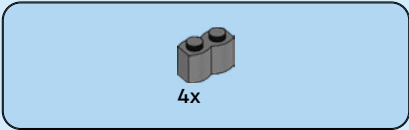
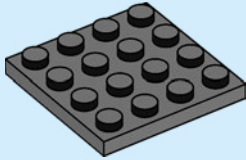

4x

2

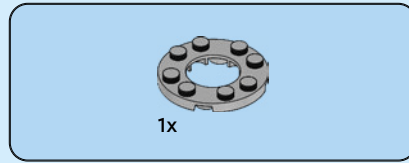
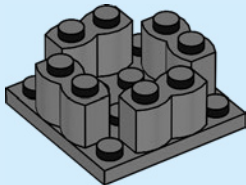

1x

3

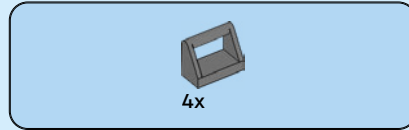
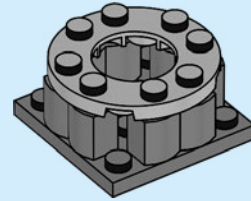

4x

4

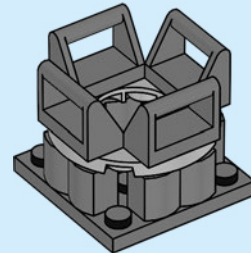

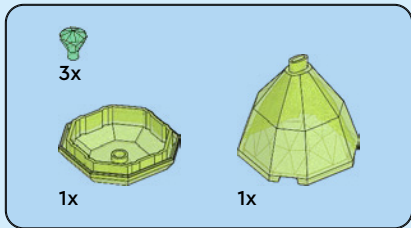

5

1

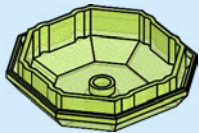

2

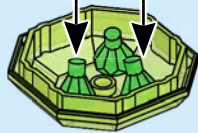

3

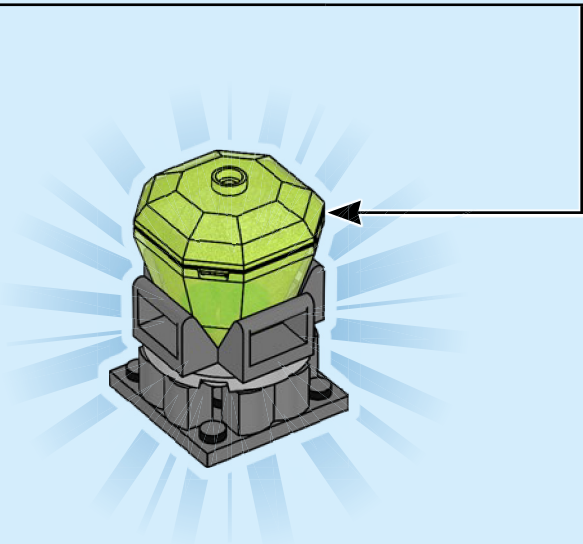
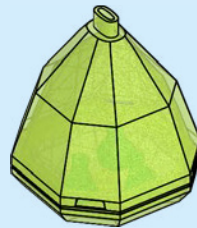

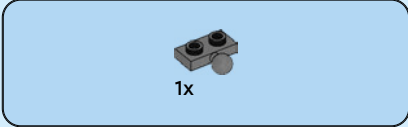
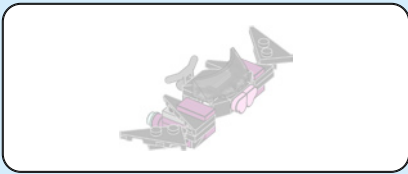

1

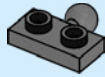

2

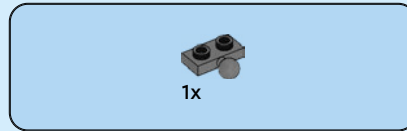
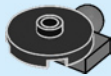

3

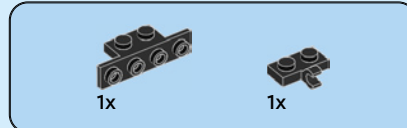
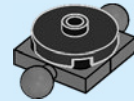

4

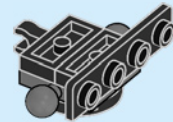
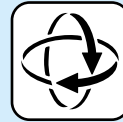



1x

5

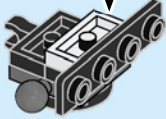

1x

6

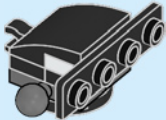

1x

7

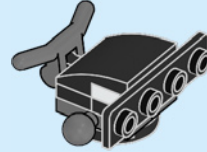

1x

8

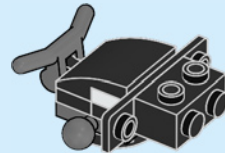





2x

9

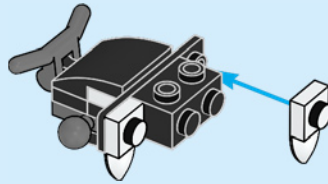

2x



2x

10

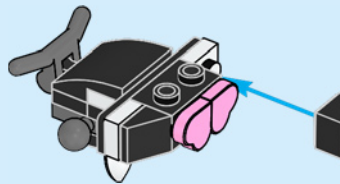

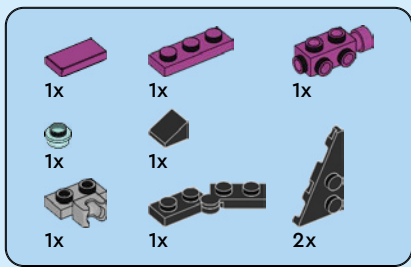

# 11

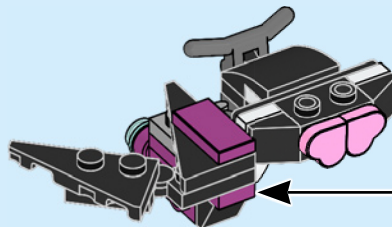
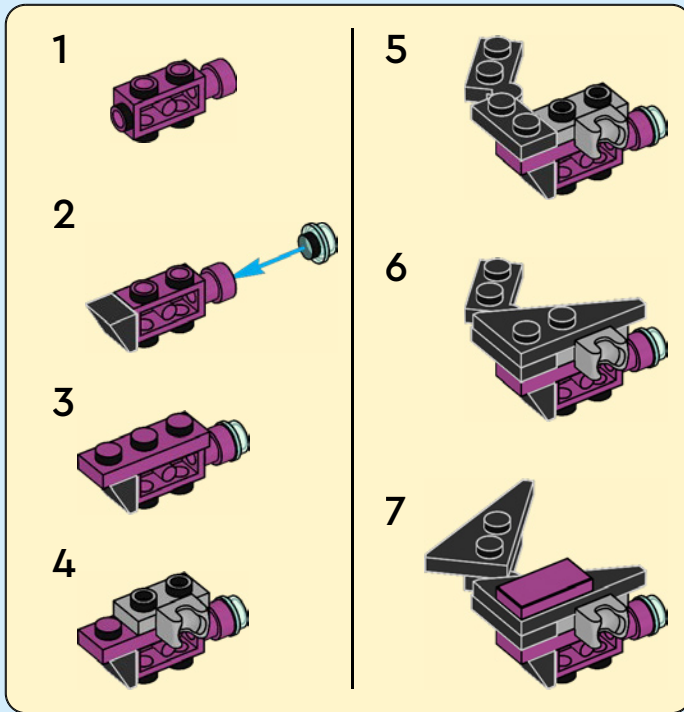

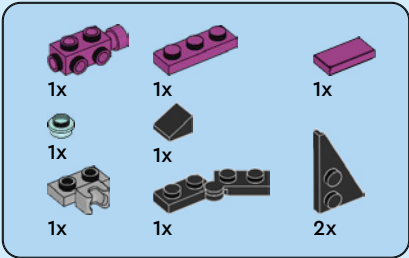

# 12

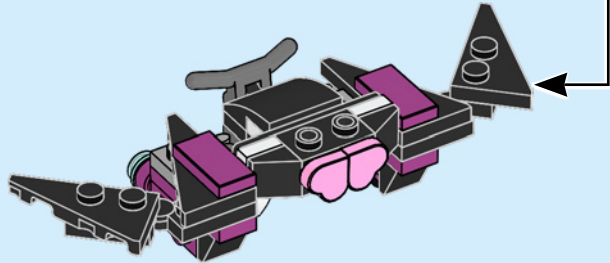
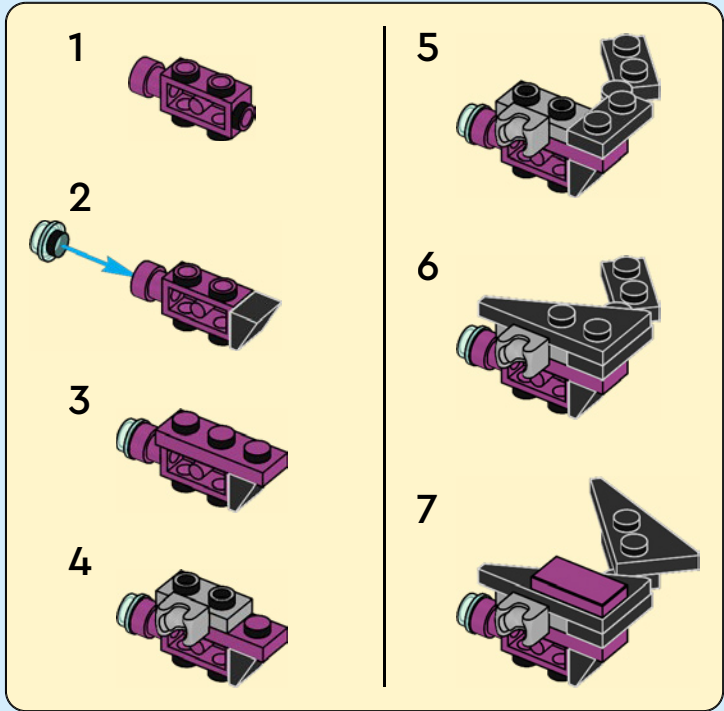

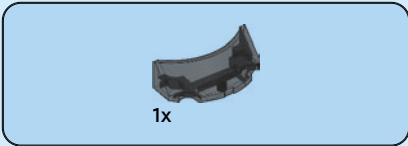

13

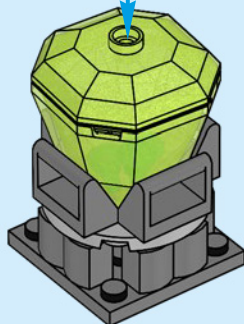

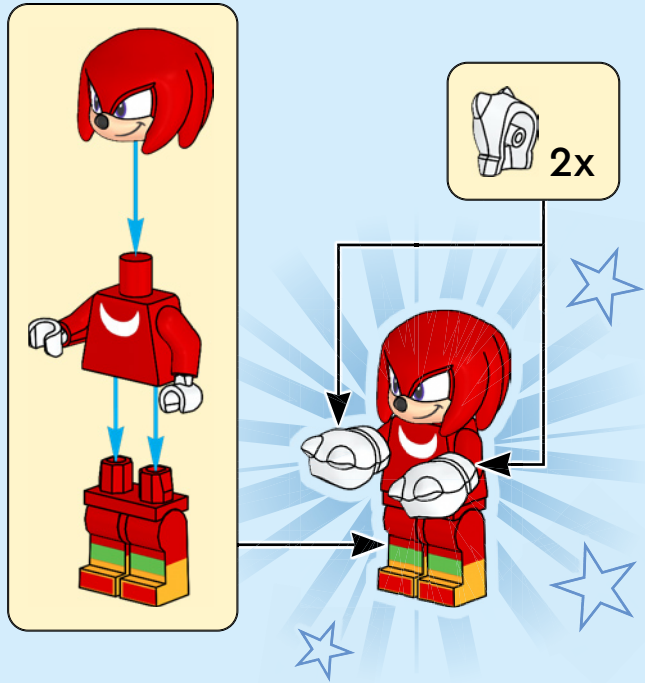

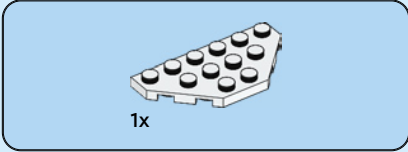
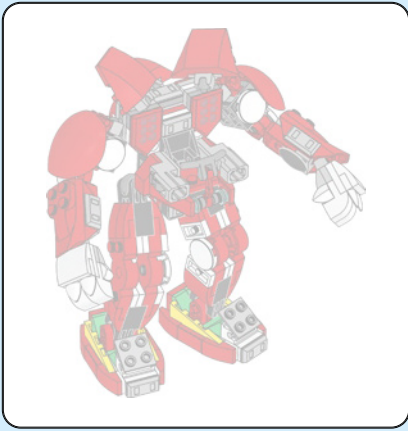

1x

1

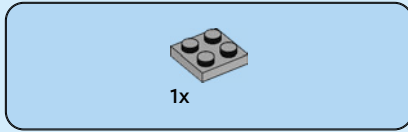
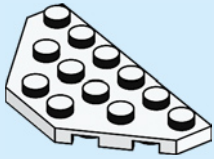

1x

2

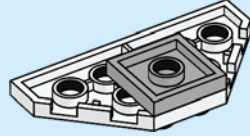

2x

3

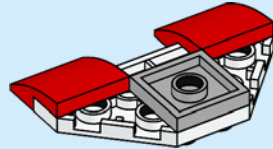

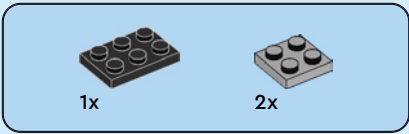

4

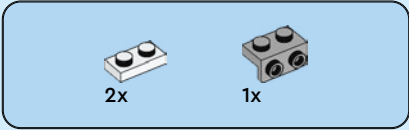
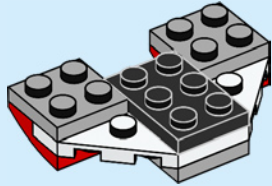

5

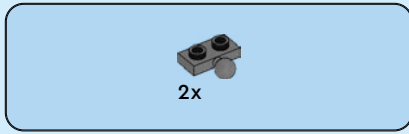
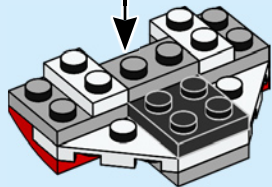
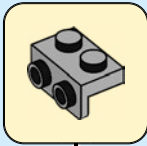

6

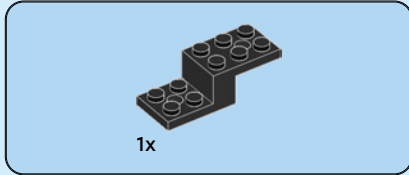
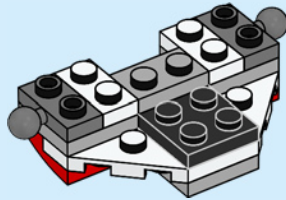

7

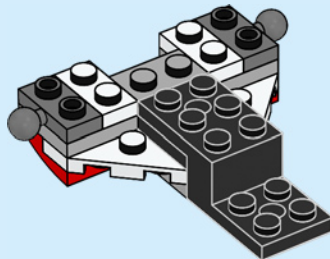



2x

8

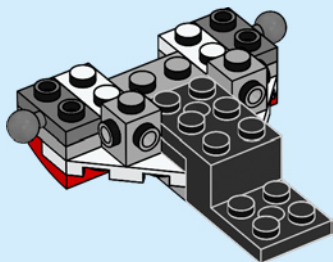

1x

9

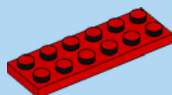
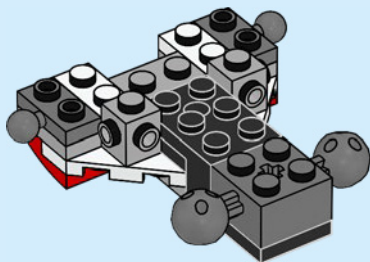

1x



2x

10

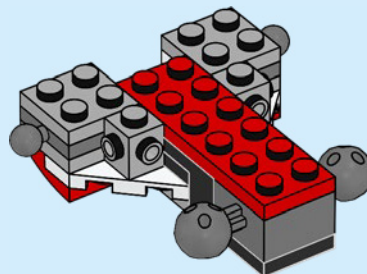





11

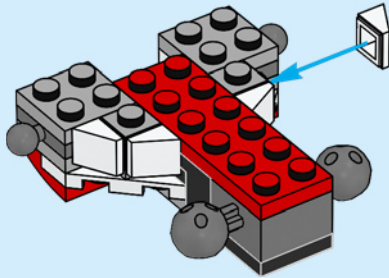

12

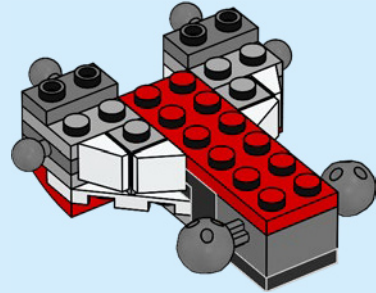

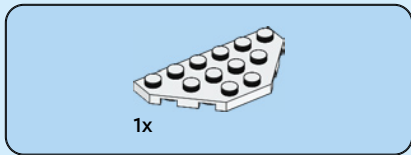

13

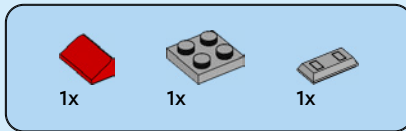
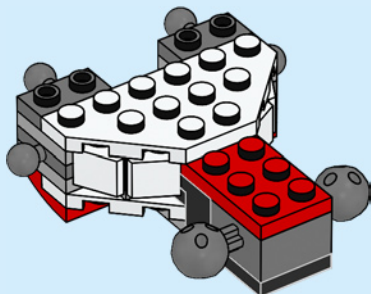

14

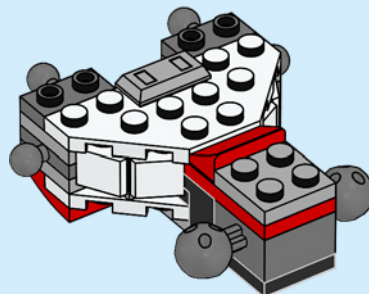

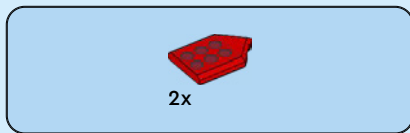

15

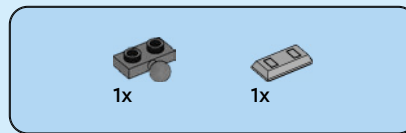
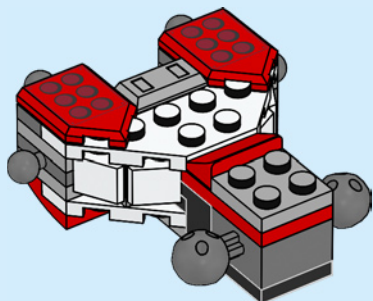

16

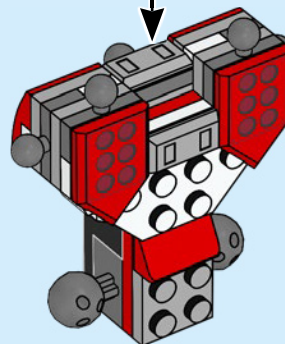
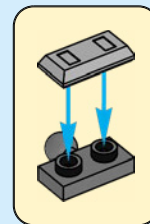
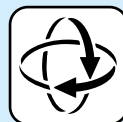

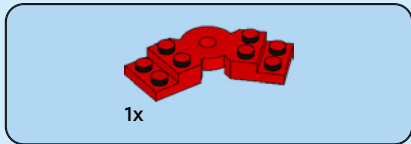
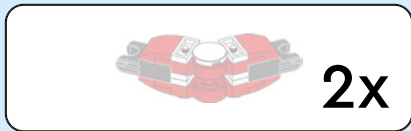

17

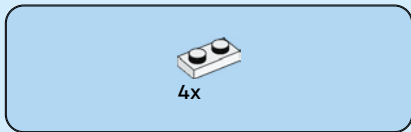
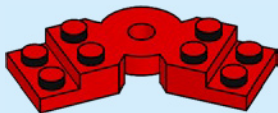

18

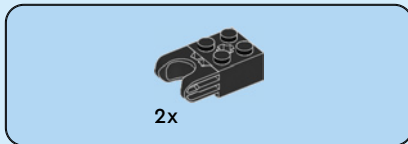
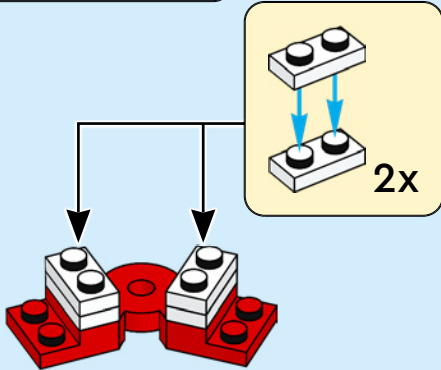

19

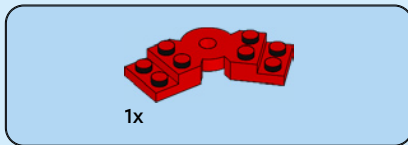

20

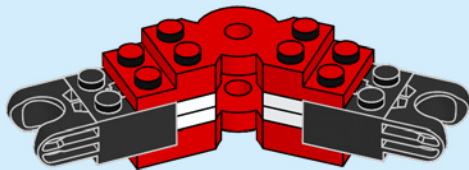



21

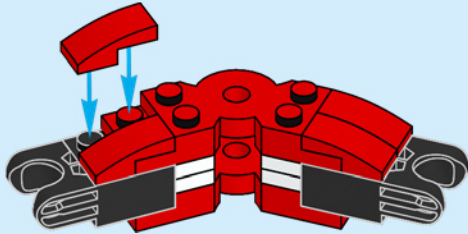

22

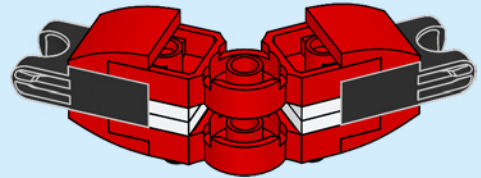



2x

23

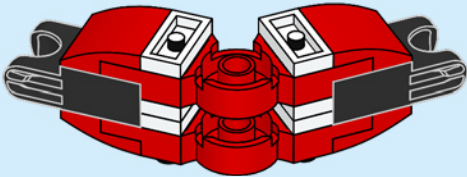

1x

24

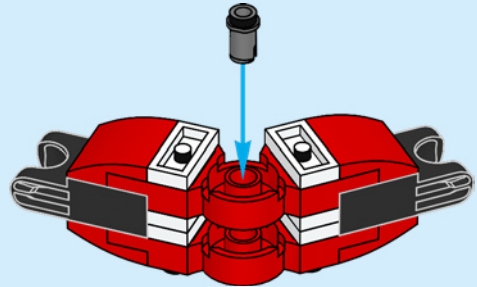



1x

25

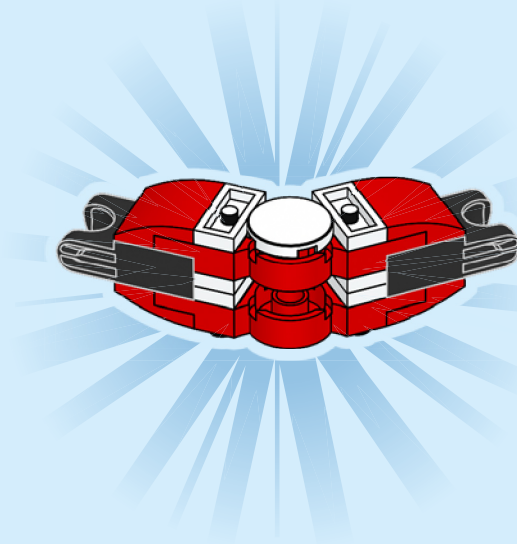

2x

26

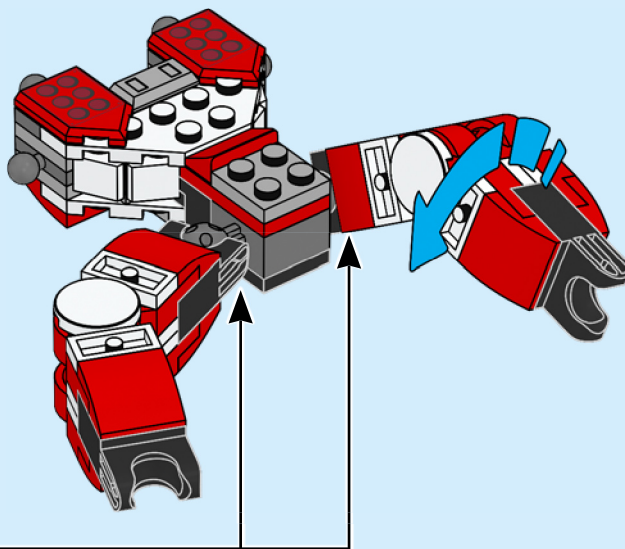





2x



1x

27



2x

28

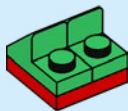

2x

29

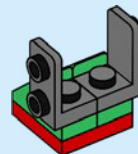

1x

30

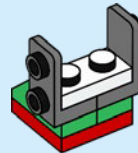

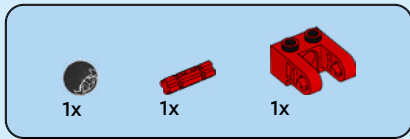

31

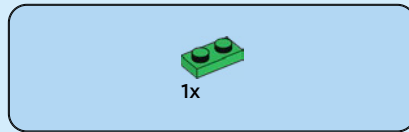
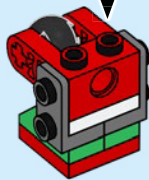
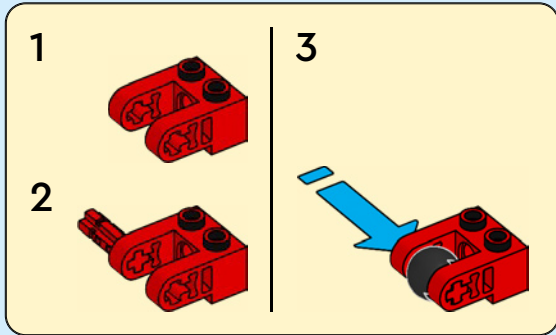

32

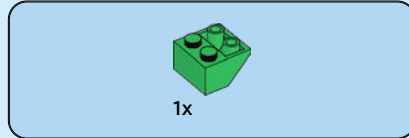
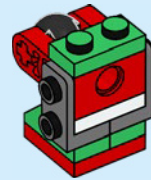

33

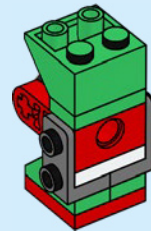



2x

34

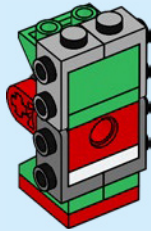

2x

35

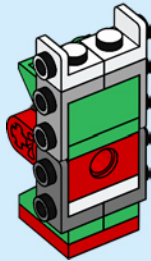

2x



1x

36

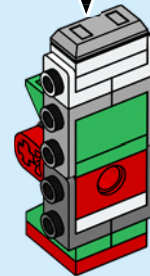
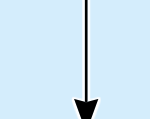
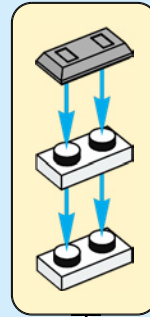

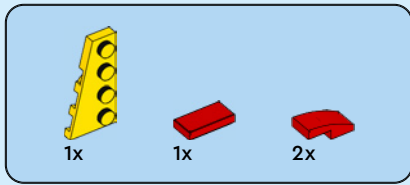

37

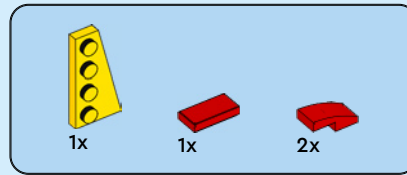
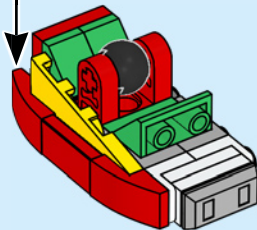
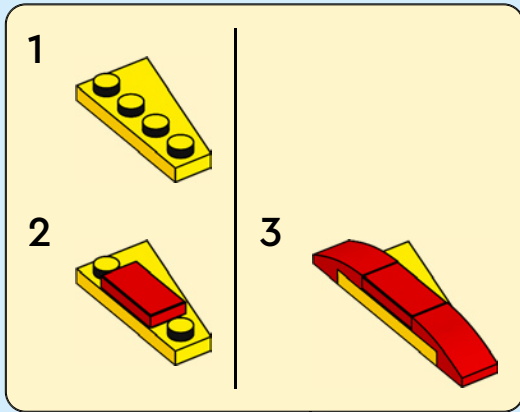

38

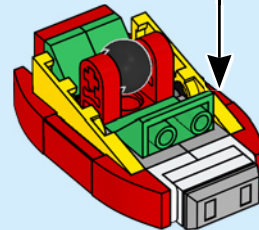
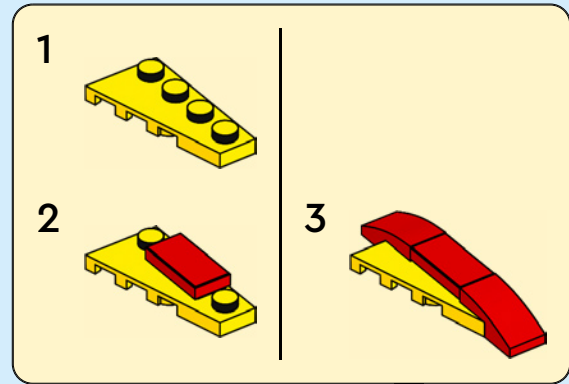



1x

39

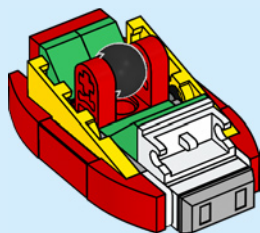

1x

40

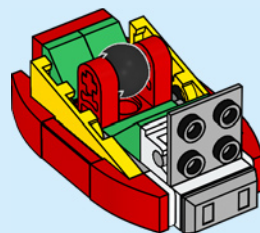

2x



41

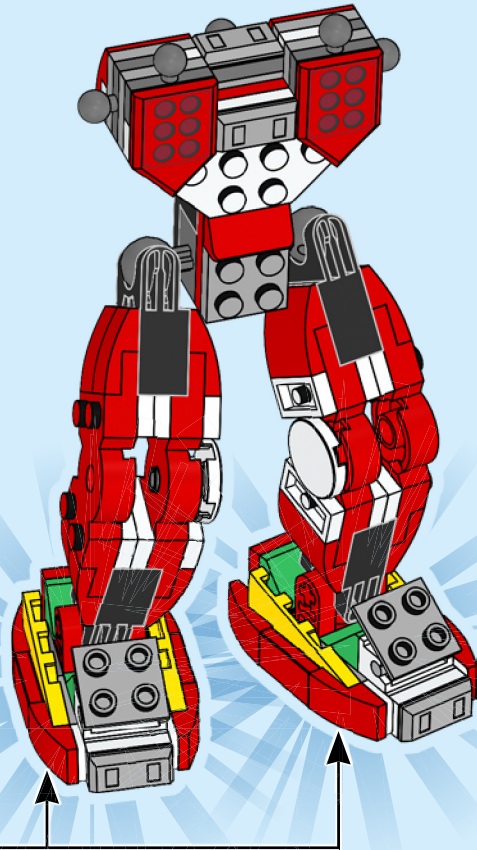



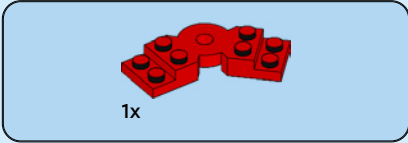
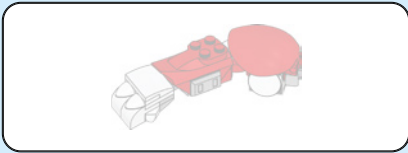

42

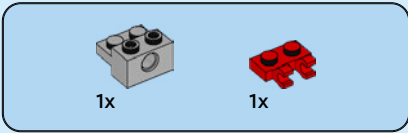
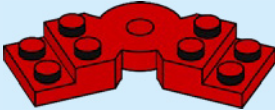

43

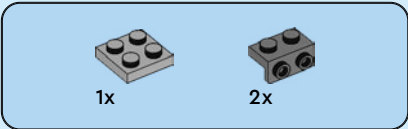
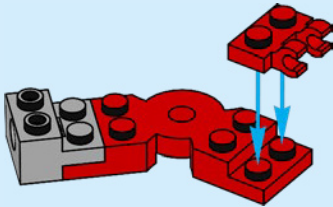

44

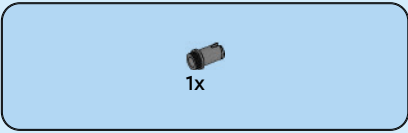
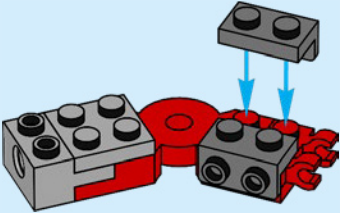

45

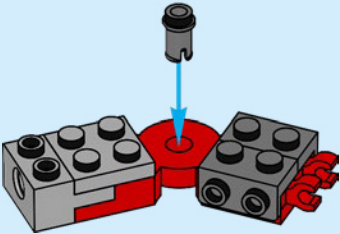



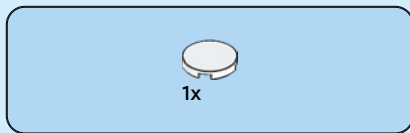

46

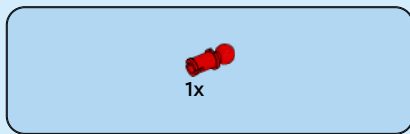

47

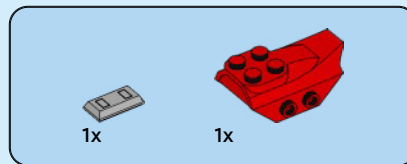
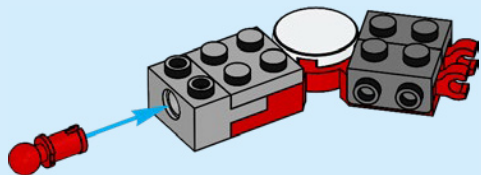

48

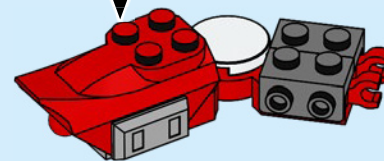
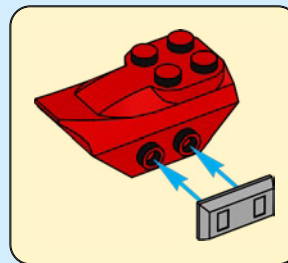

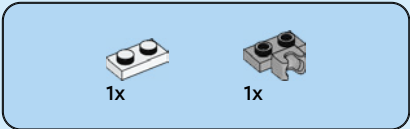

49

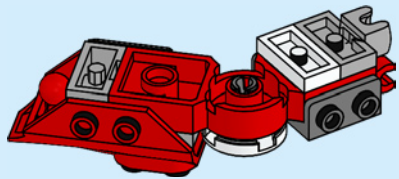

50

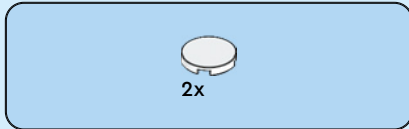
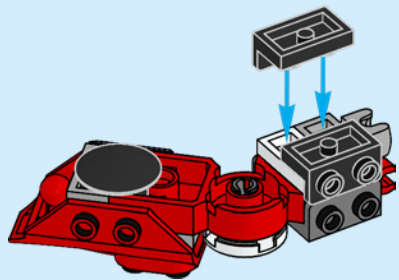

51

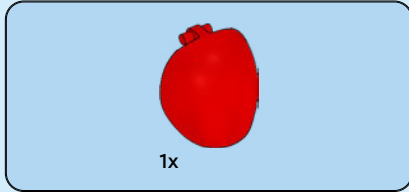
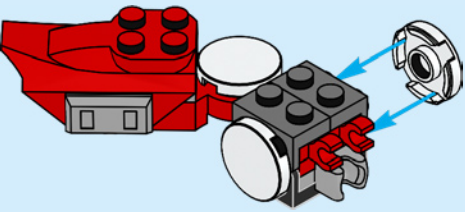

52

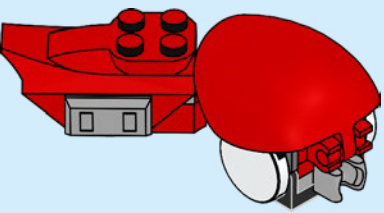

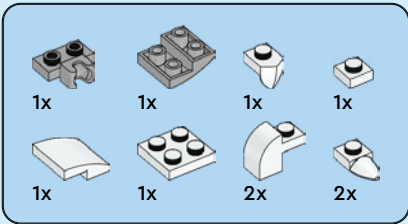

# 53

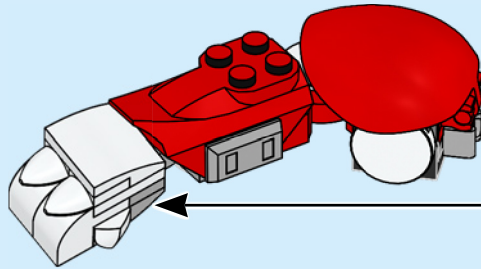
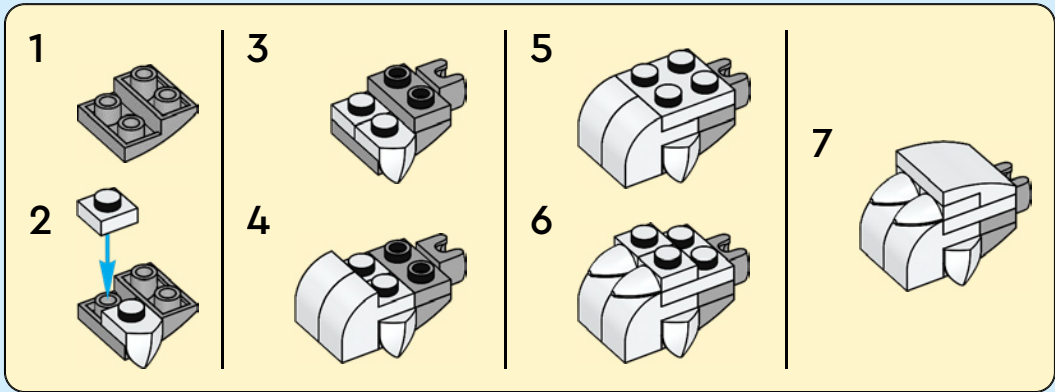

54

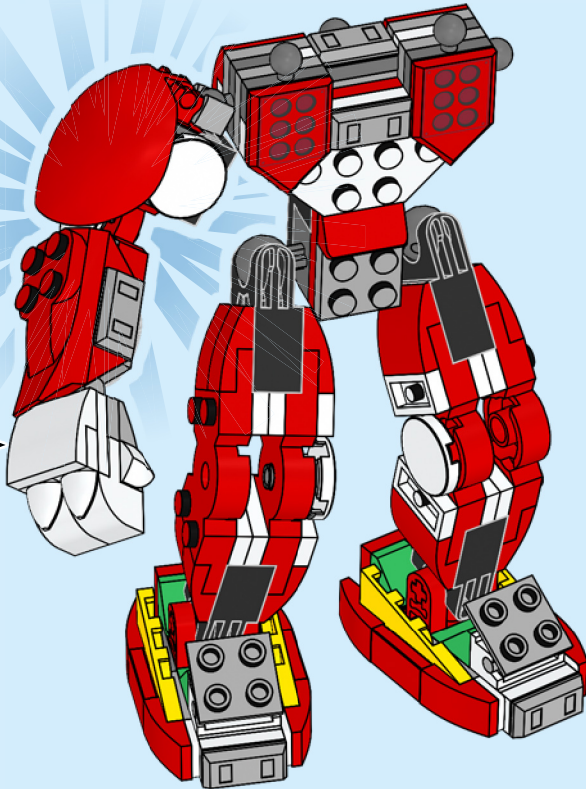

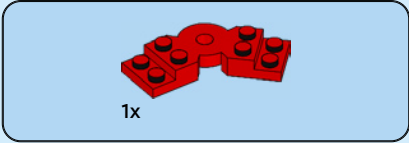
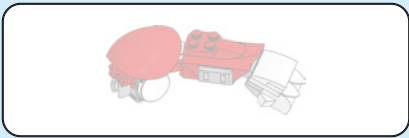

55

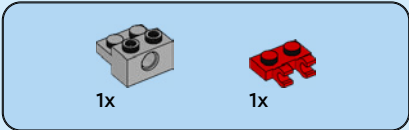
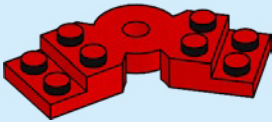

56

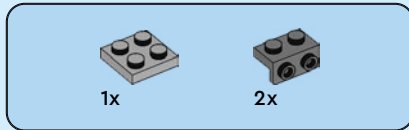
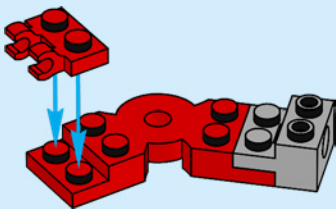

57

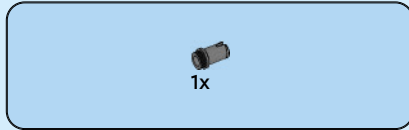
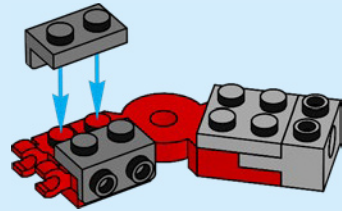

58

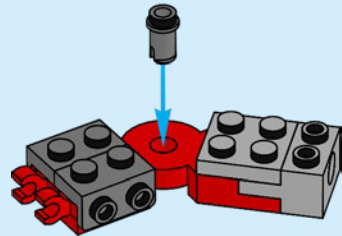

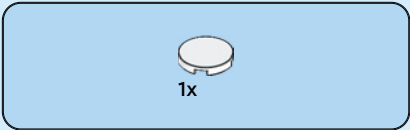

59

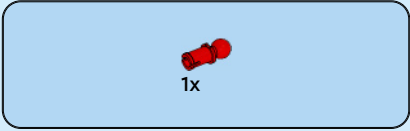
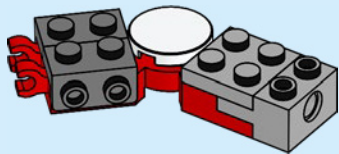

60

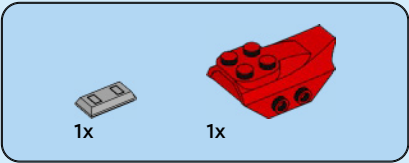
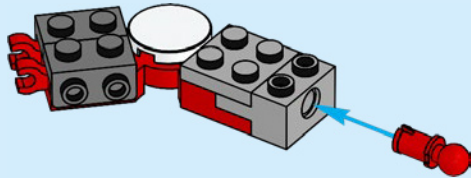

61

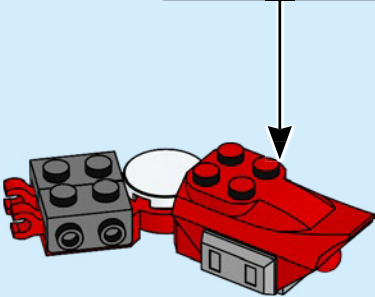
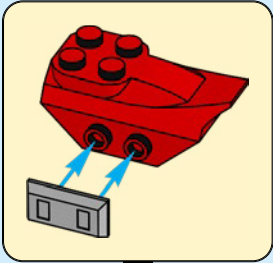



1x



1x

62

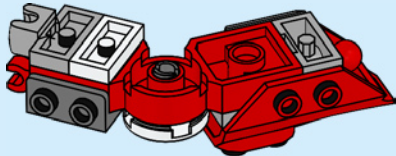

1x



2x

63

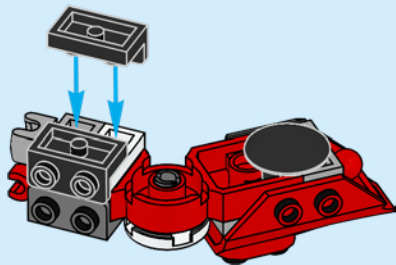

2x

64

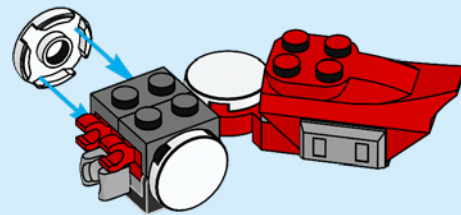

1x

65

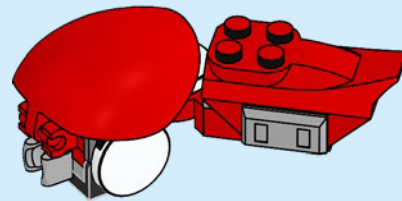

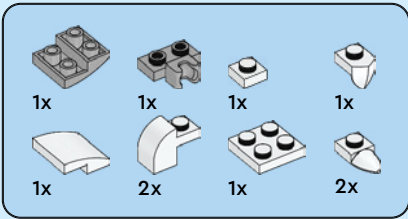

66

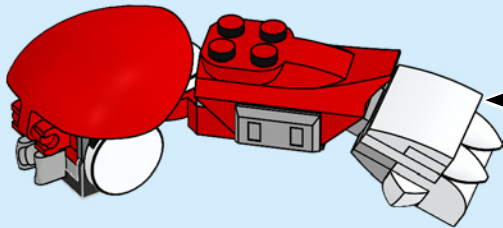
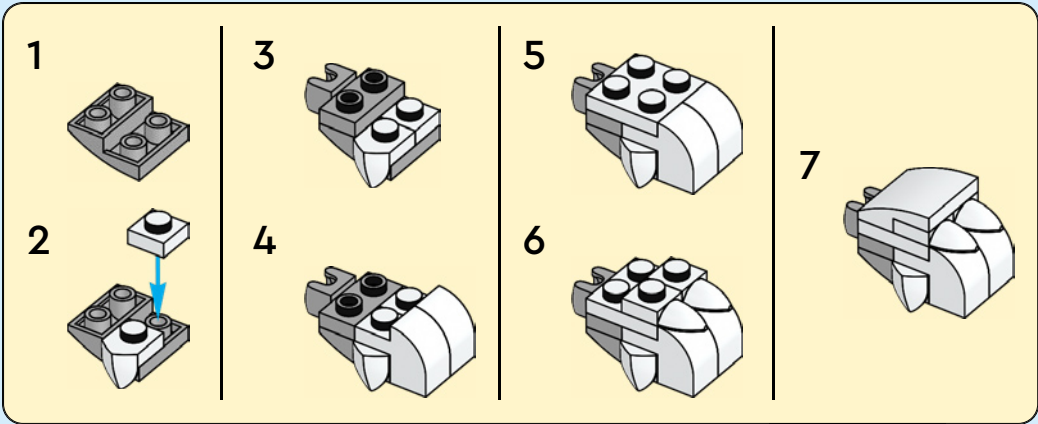



67

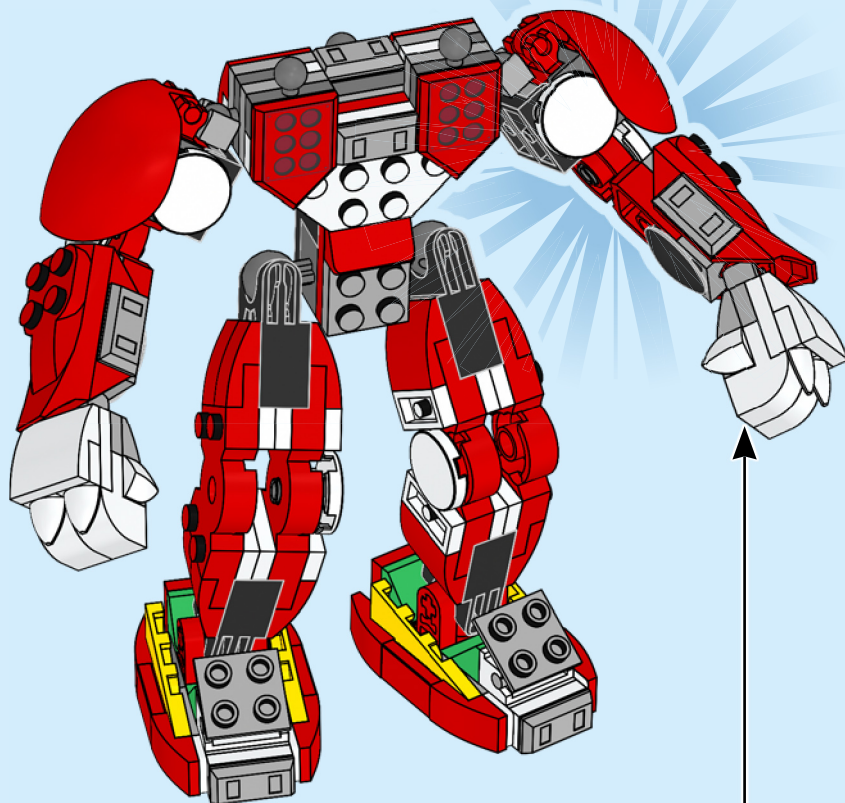

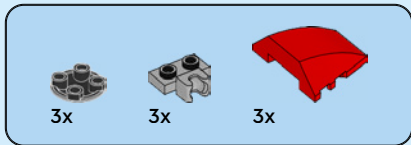

68

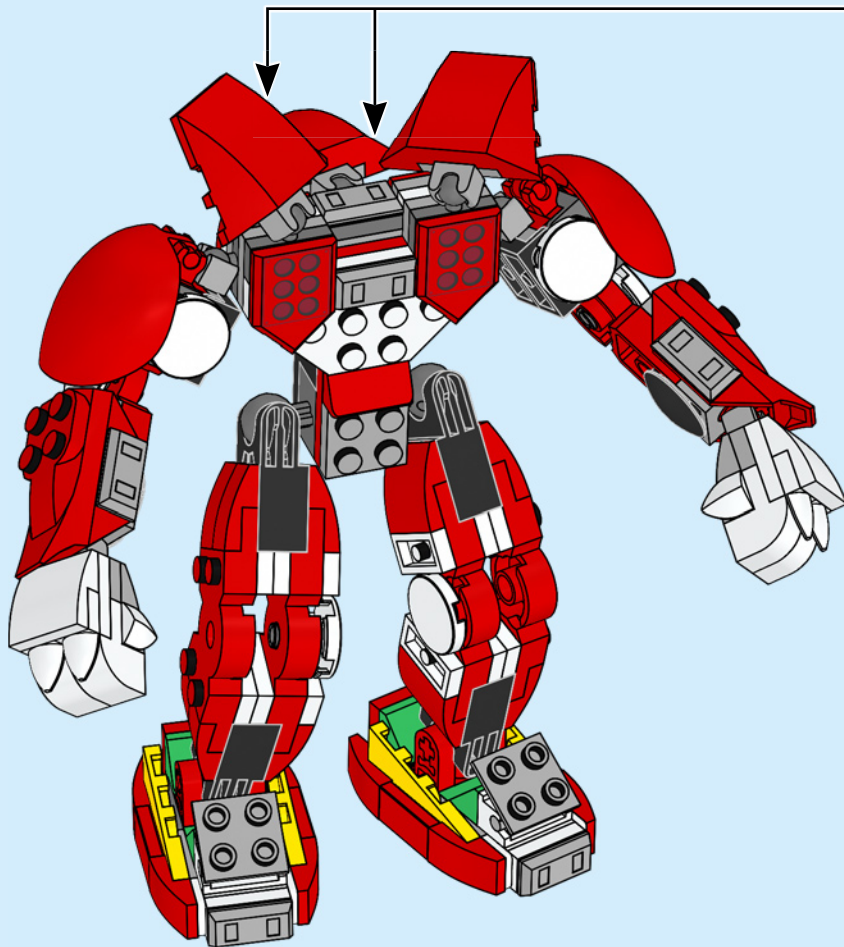

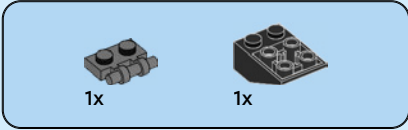
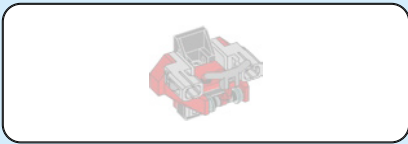

1x

1x

69

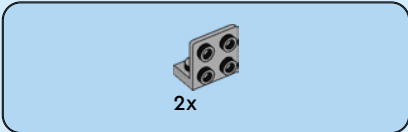
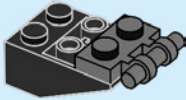

2x

70

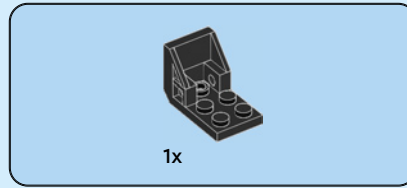
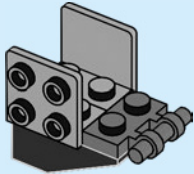

1x

71

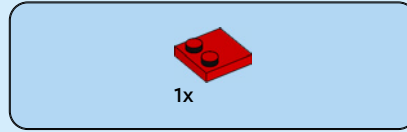
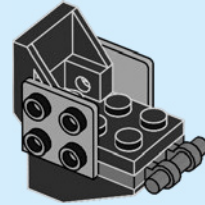

1x

72

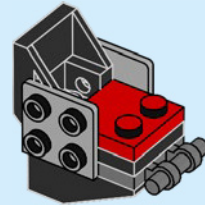

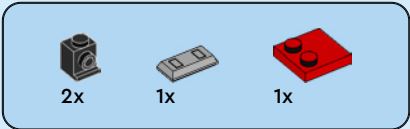

73

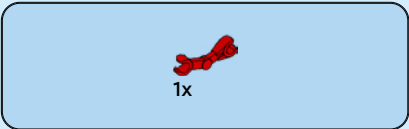
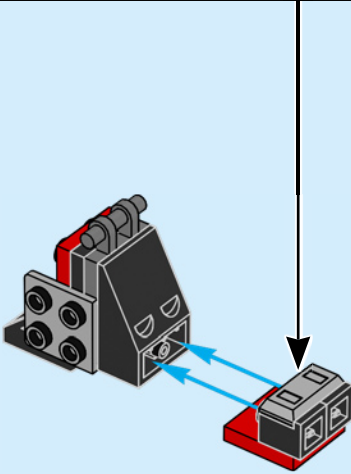
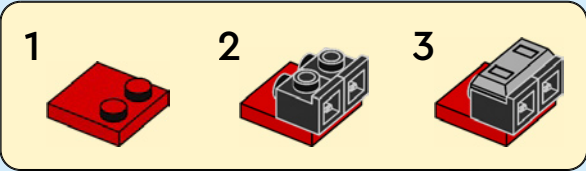

74

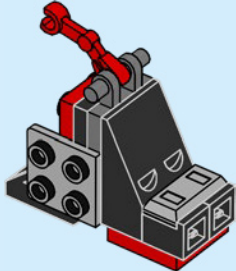



1x

75

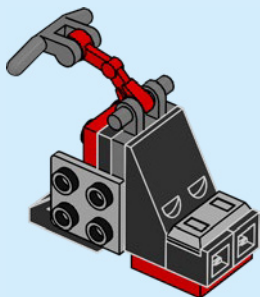

2x

76

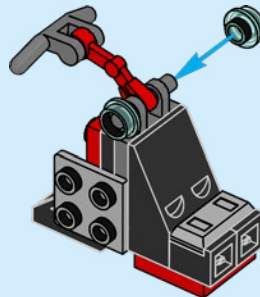

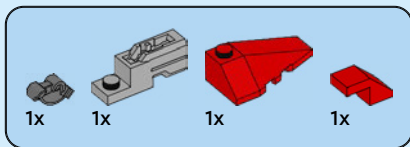

77

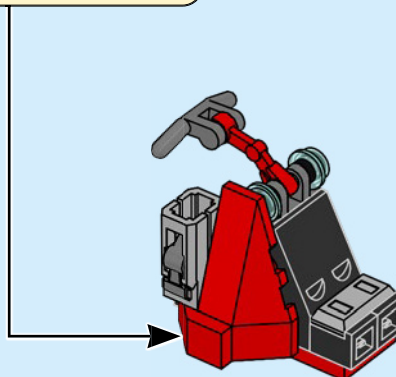
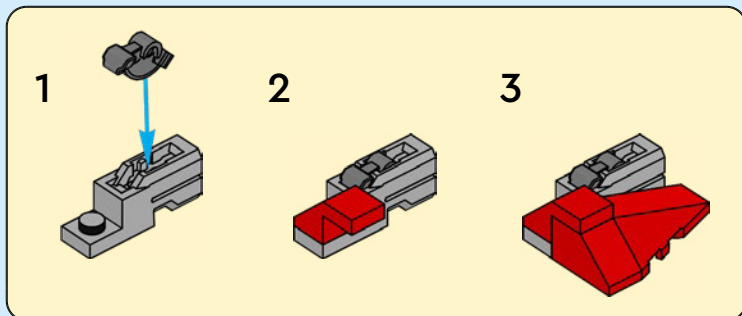

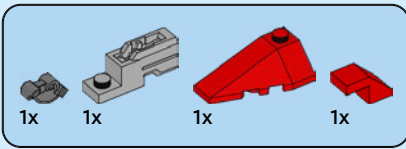

78

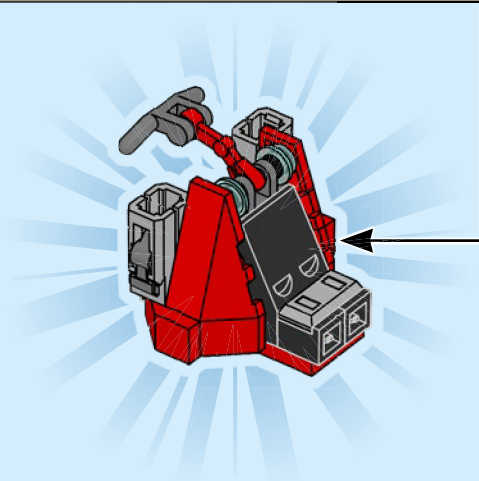
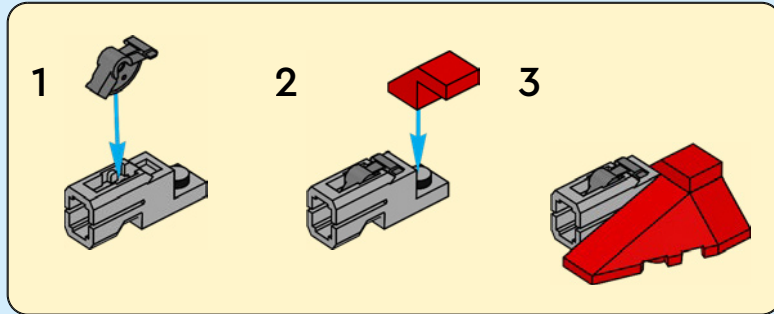

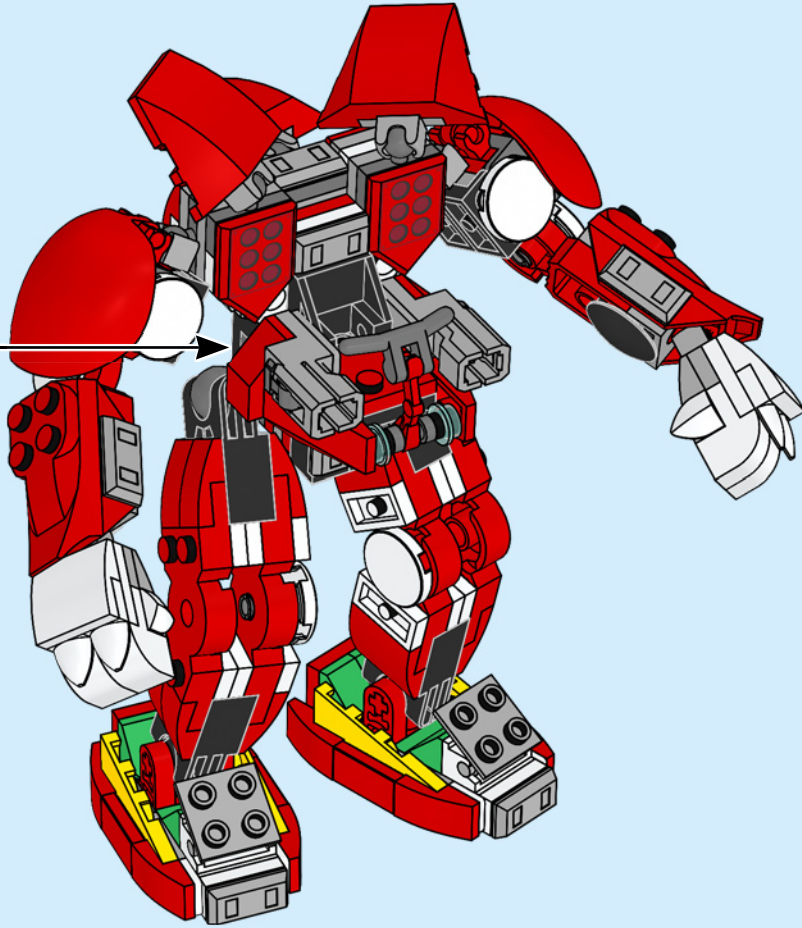





4x

80

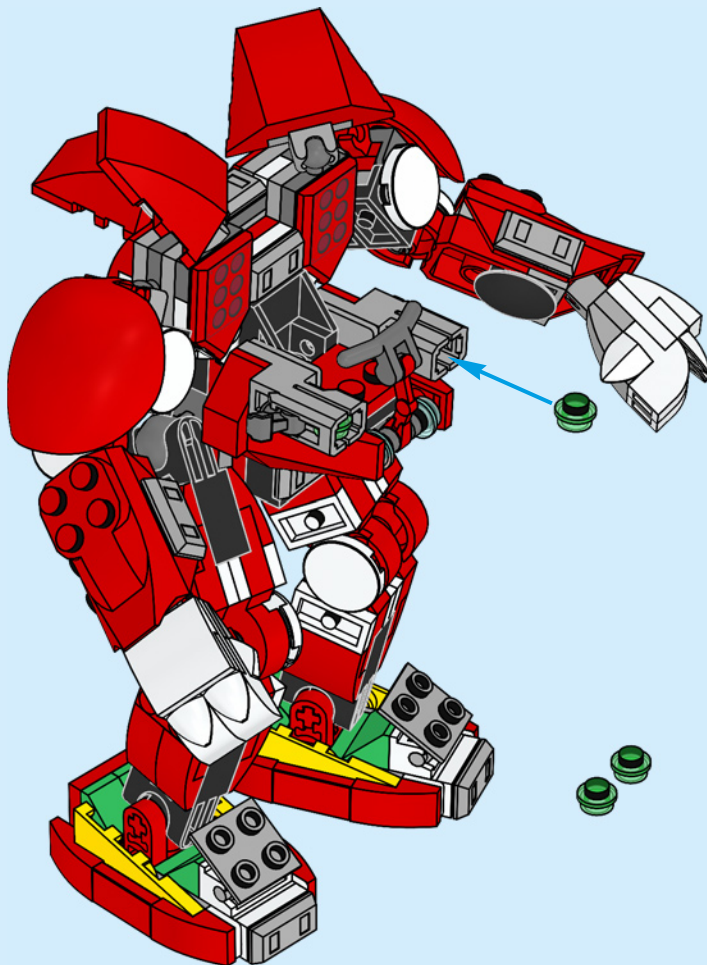

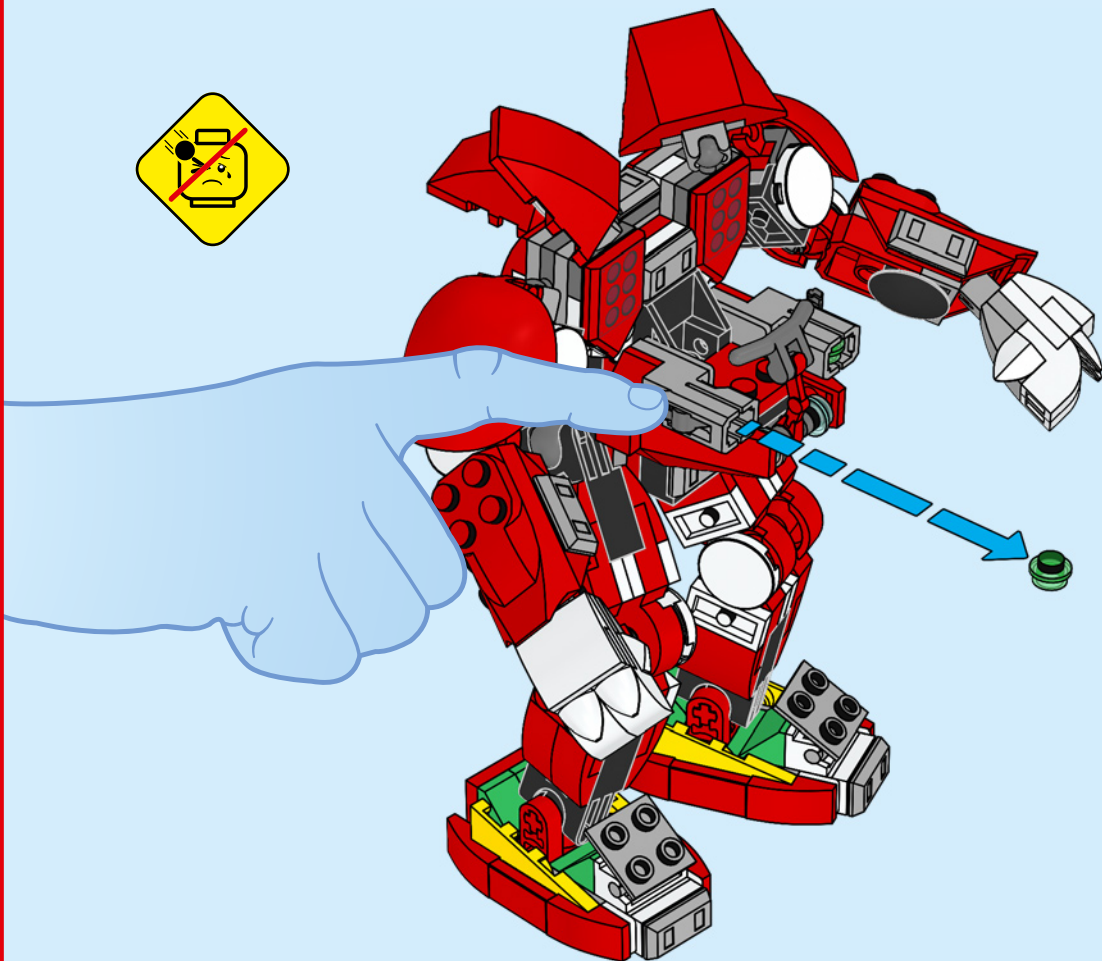

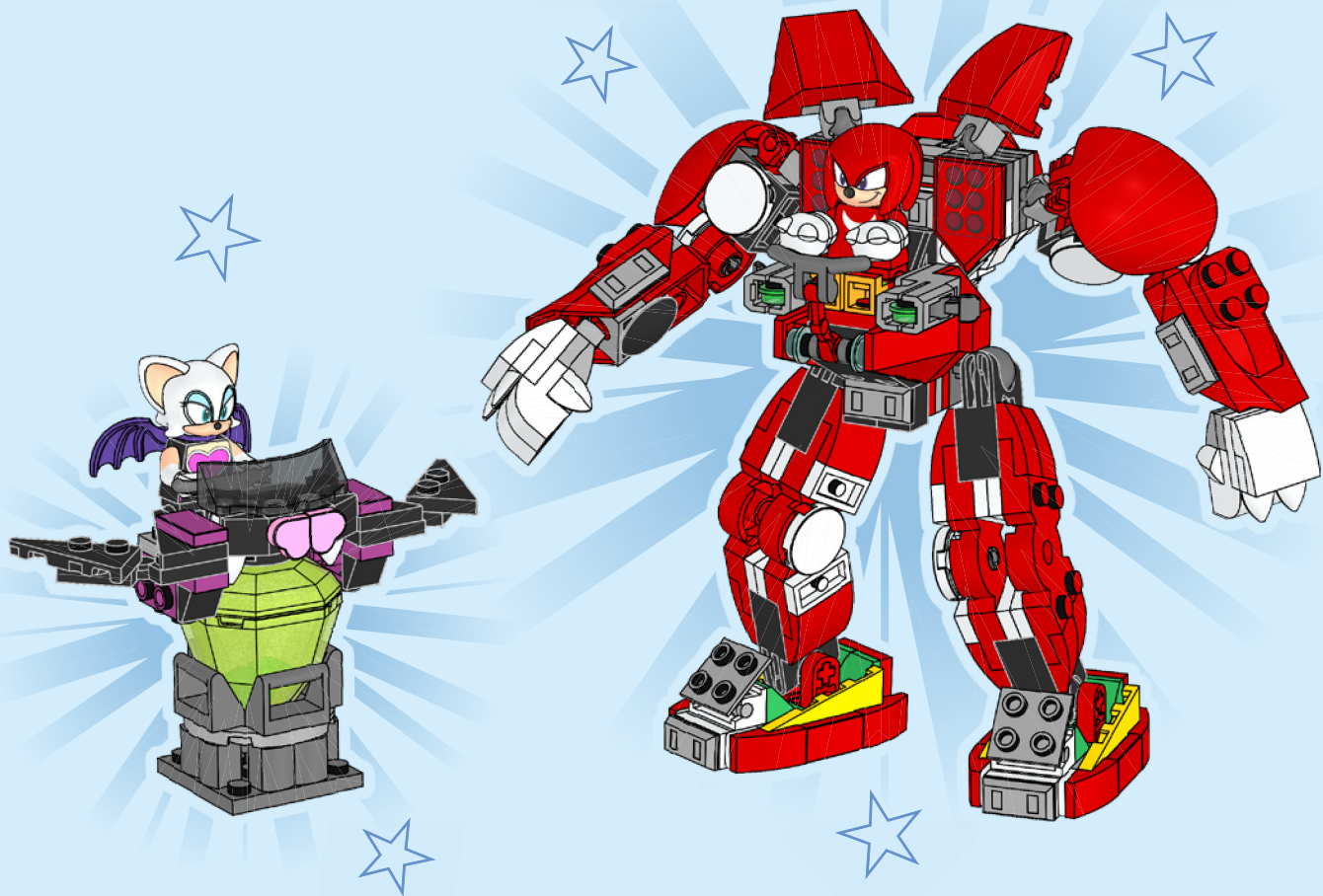



# SONIC™

## THE HEDGEHOG

EXPLORE MORE  
DÉCOUVRIR PLUS  
EXPLORA MÁS



[LEGO.com/sonic](https://LEGO.com/sonic)



©SEGA. All rights reserved. SEGA is registered in the U.S. Patent and Trademark Office. SEGA and SONIC THE HEDGEHOG are either registered trademarks or trademarks of SEGA CORPORATION.



76990



76991



76992



76993



76994



Rebuild  
the  
world™



  
2x  
6431337

  
4x  
4504369

  
2x  
302401

  
2x  
6046905

  
4x  
6242241

  
6x  
4224792

  
8x  
6044691

  
23x  
302301

  
2x  
393701

  
4x  
6285777

  
2x  
302201

  
2x  
6047220

  
2x  
241901

  
2x  
6360104

  
1x  
4651524

  
2x  
4142865

  
1x  
6474314

  
2x  
6275178

  
16x  
6029946

  
4x  
306921

  
1x  
6370686

  
2x  
6360036

  
1x  
6474313

  
6x  
6442314

  
2x  
6219819

  
2x  
302221

  
2x  
6474306

  
1x  
6474530

  
2x  
6371957

  
2x  
6391203

  
1x  
6431123

  
3x  
6215396

  
1x  
6431121

  
2x  
6371695

  
1x  
379521

  
6x  
6375427

  
2x  
4161331

  
2x  
4160868

  
2x  
4286267

  
4x  
4504382

  
2x  
407026

  
2x  
6295295

  
2x  
6295293

  
5x  
4278359

  
1x  
6195325

  
1x  
6474309

  
1x  
6138173

  
1x  
6313116

  
4x  
6020193

  
1x  
6211476

  
2x  
6039194

  
1x  
6435928

  
1x  
6168620

  
1x  
6021678

  
1x  
302126

  
4x  
6360825

  
2x  
6416444

  
4x  
6226931

  
2x  
302328

  
2x  
4142717

  
2x  
4611415

  
2x  
6322832

  
2x  
6022048

  
2x  
6240225

  
2x  
6283590

  
2x  
6267495

  
4x  
6362975

  
9x  
6043656

  
7x  
6134378

  
2x  
4654580

  
1x  
4654582

  
8x  
4211397

  
2x  
6326478

  
2x  
6185676

  
2x  
4211881

  
2x  
6360382

  
1x  
6167798

  
4x  
6240221

  
3x  
6247788

  
4x  
6336390

  
4x  
4211095

  
4x  
4211039

  
7x  
6039479

  
4x  
6214341

  
2x  
4261908

  
1x  
4210660

  
1x  
6065816

  
1x  
4243831

  
4x  
6395635

  
2x  
6360675

  
1x  
6469306

  
1x  
6376546

  
1x  
6376539

  
1x  
6445335

  
2x  
6275466

  
1x  
6480282

  
1x  
6480128

 [LEGO.com/service](https://www.lego.com/service)



YOU COULD **WIN**

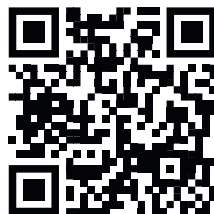

Scan this QR code or go to **LEGO.COM/PRODUCTFEEDBACK** and give us your short feedback about this LEGO® set for a chance to win a cool LEGO prize.

Terms and Conditions apply\*

**EN: YOU COULD WIN.** Terms and Conditions apply\* **DE: Du könntest GEWINNEN.** Es gelten die Teilnahmebedingungen\* **FR: Tu pourrais GAGNER.** Des conditions s'appliquent\* **IT: Potresti VINCERE tu.** Termini e condizioni sono applicabili\* **ES: Puedes GANAR.** Aplican términos y condiciones\* **PT: Poderá GANHAR.** Aplicam-se termos e condições\* **ZH: 轻松获奖. 条款和条件适用\*** **PL: Szansa na WYGRANĄ.** Obowiązują warunki korzystania\* **CS: Máte šanci VYHRÁT.** Platí všeobecné smluvní podmínky\* **SK: Máte šancu VYHRAŤ.** Platia všeobecné zmluvné podmienky\* **HU: TE IS NYERHETSZ.** Felhasználási feltételek érvényesek\* **RO: Ai putea CÂȘTIGA.** Se aplică termeni și condiții\* **BG: Можете да СПЕЧЕЛИТЕ.** Има определени правила и условия\* **LV: Tu vari LAIMĒT.** Ir spēkā noteikumi un nosacījumi.\* **ET: Sul on võimalus VÕITA.** Kehtivad tingimused\* **LT: Jūs galite LAIMĖTI.** Taikomos sąlygos\*

\*[LEGO.com/productfeedback-terms](https://www.lego.com/productfeedback-terms)

LEGO and the LEGO logo are trademarks of the/son des marques de commerce du/son marcas registradas de LEGO Group.  
©2024 The LEGO Group.  
©SEGA. All rights reserved. SEGA is registered in the U.S. Patent and Trademark Office.  
SEGA and SONIC THE HEDGEHOG are either registered trademarks or trademarks of SEGA CORPORATION.