



THE LONE RANGER



79109



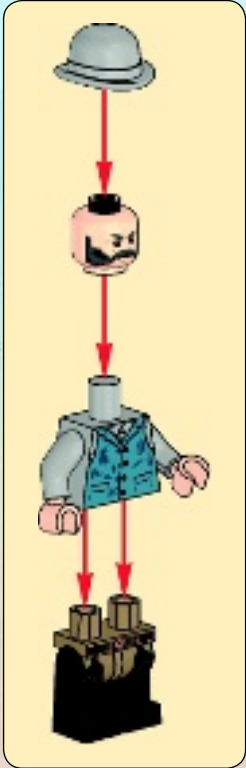



1x

1



2x

2

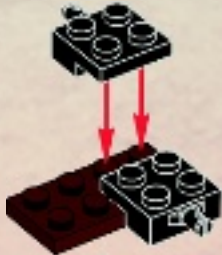

2x



2x

3



1x

4



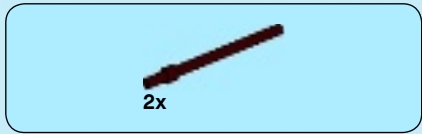

5

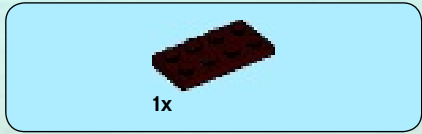

6

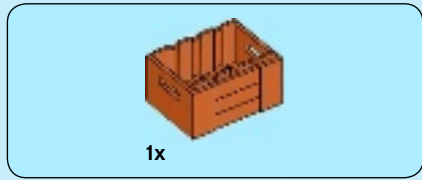

7

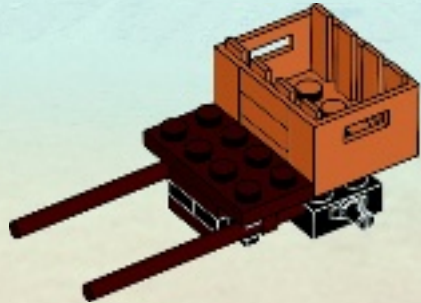



2x

8

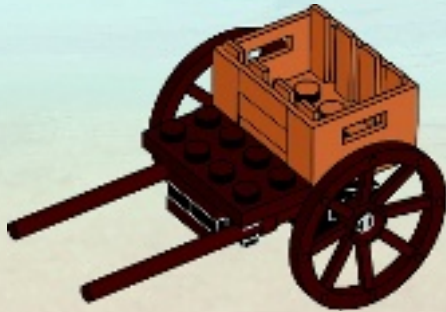

2x



1x

9

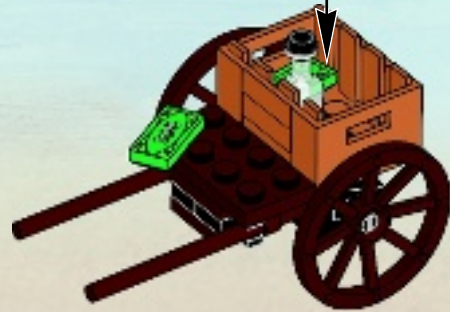

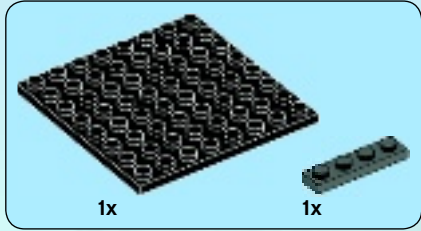

1

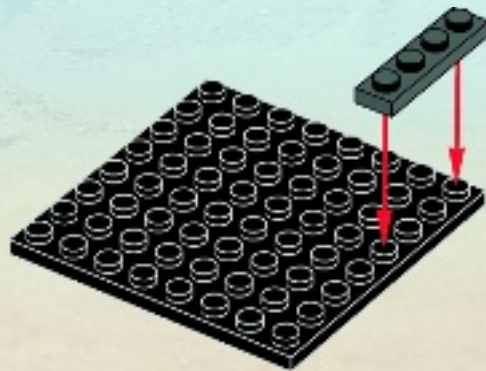

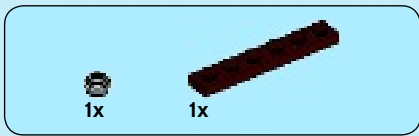

2

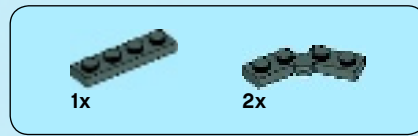
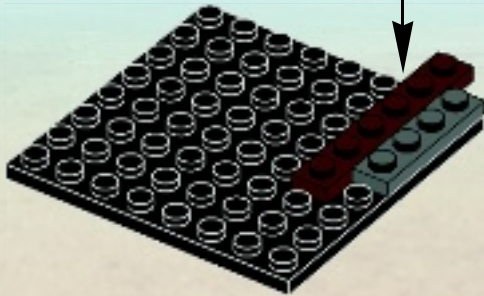
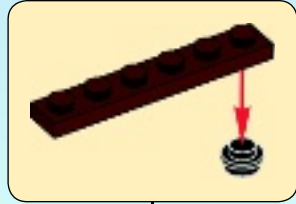

3

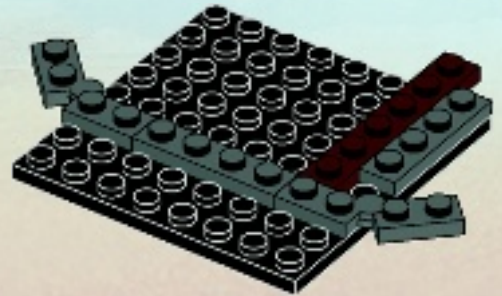



4

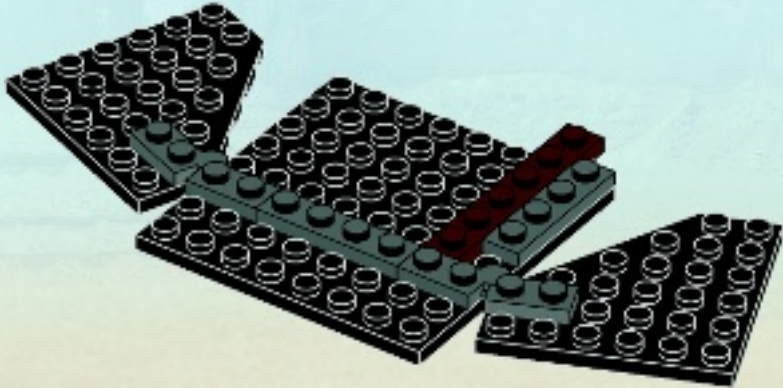

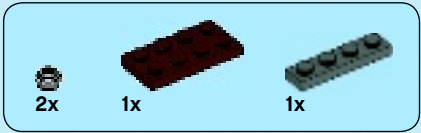

5

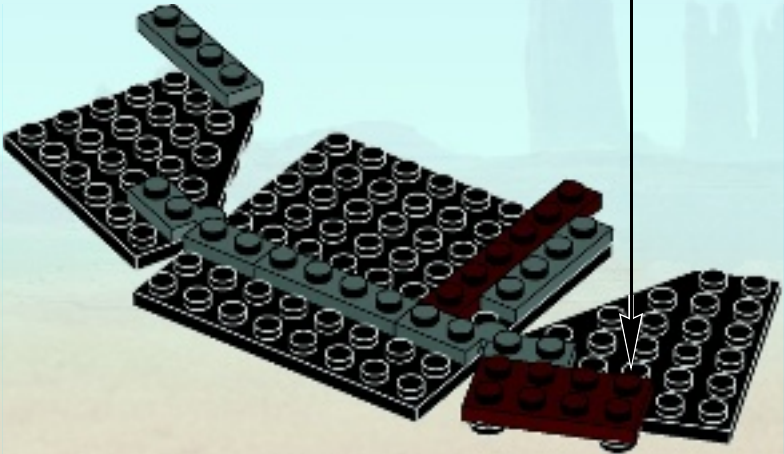
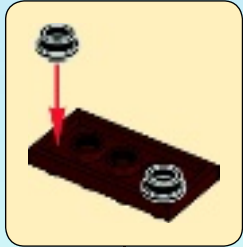

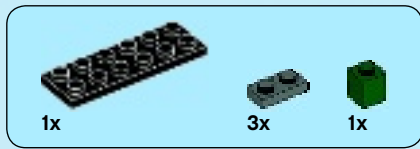

6

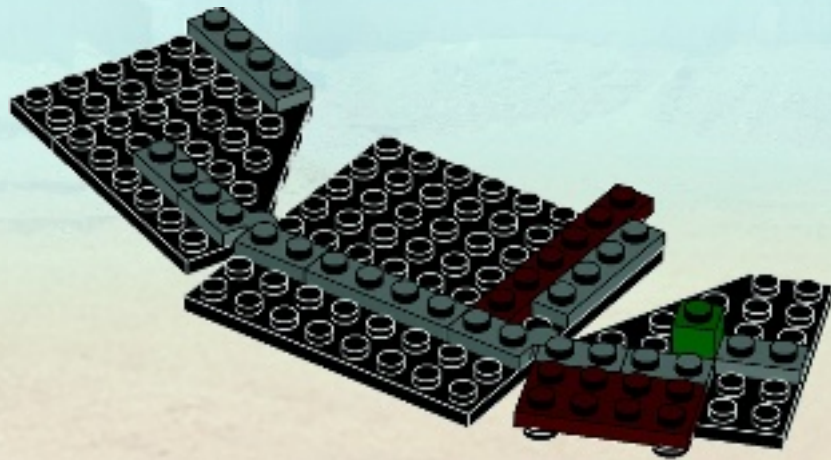

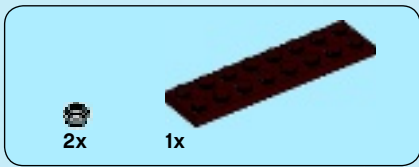

7

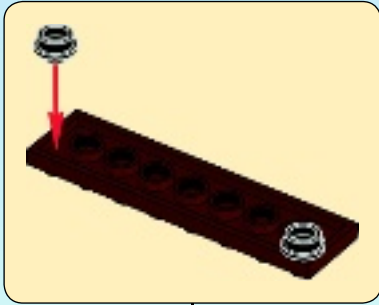



2x



2x

8

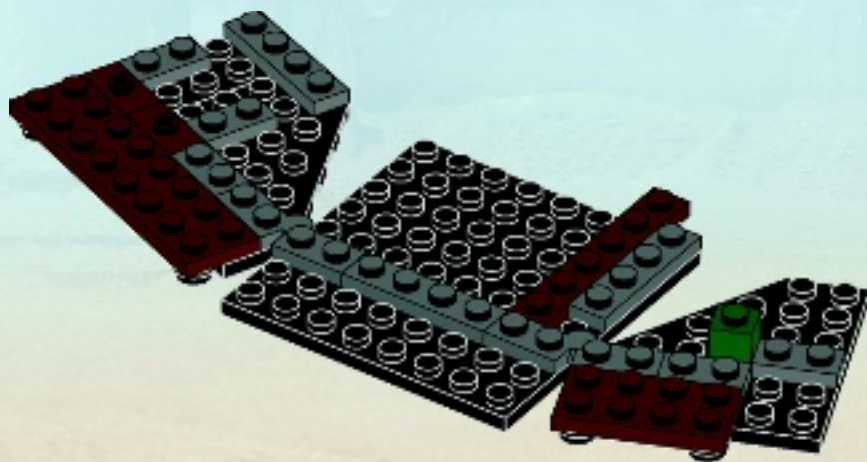



2x



3x

9

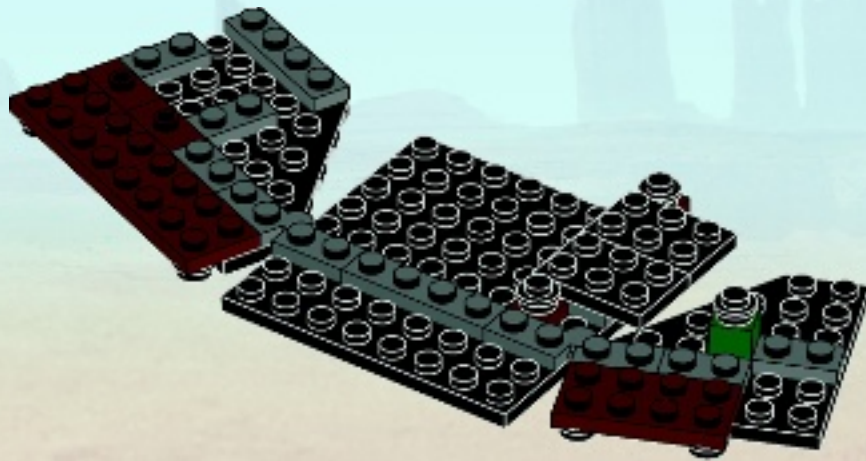



1x

10

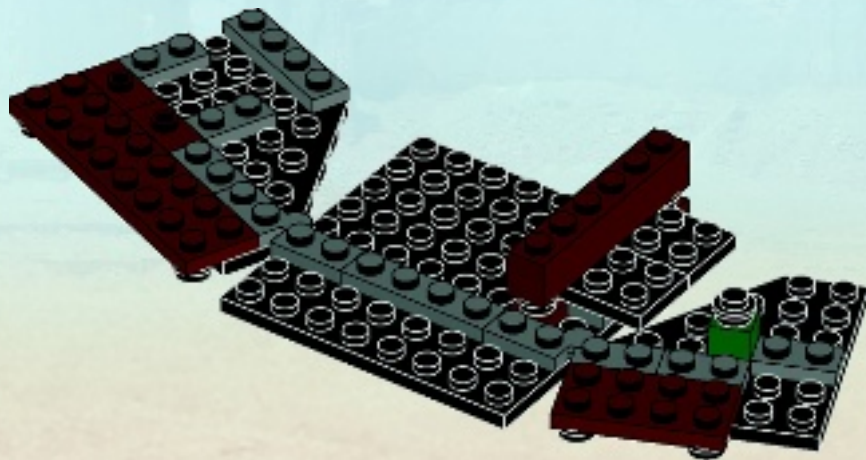



2x

11

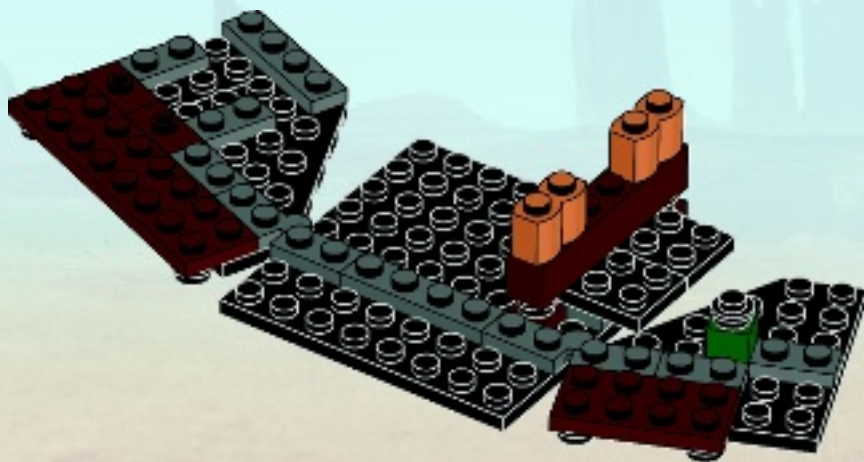



14x

12

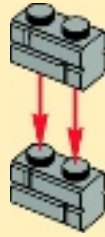

7x

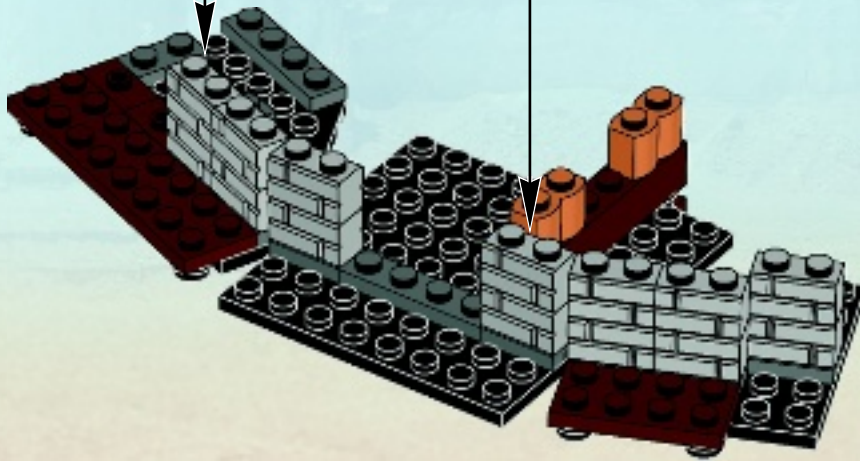

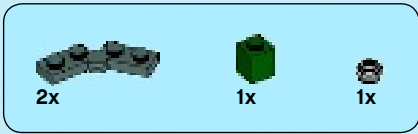

13

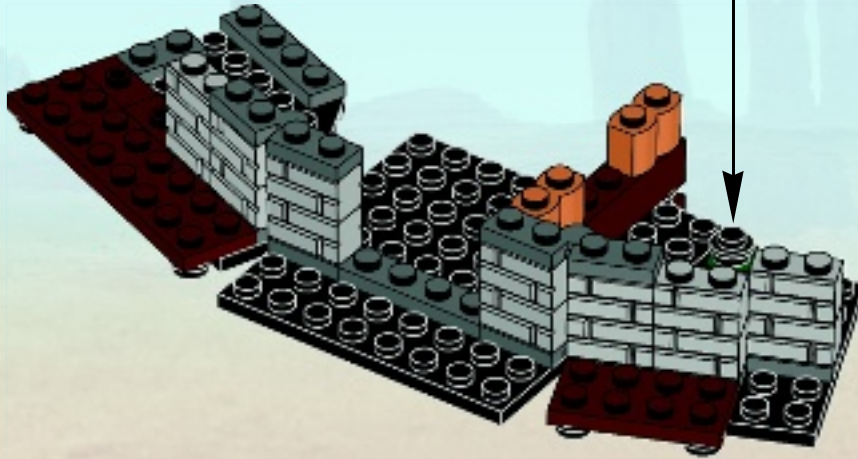
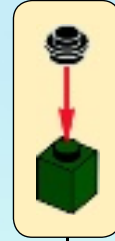

3x

1x

14

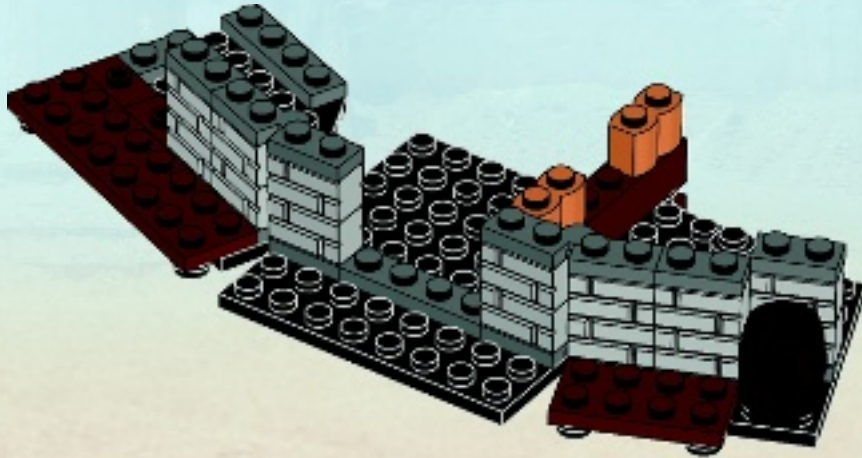



3x



5x

15

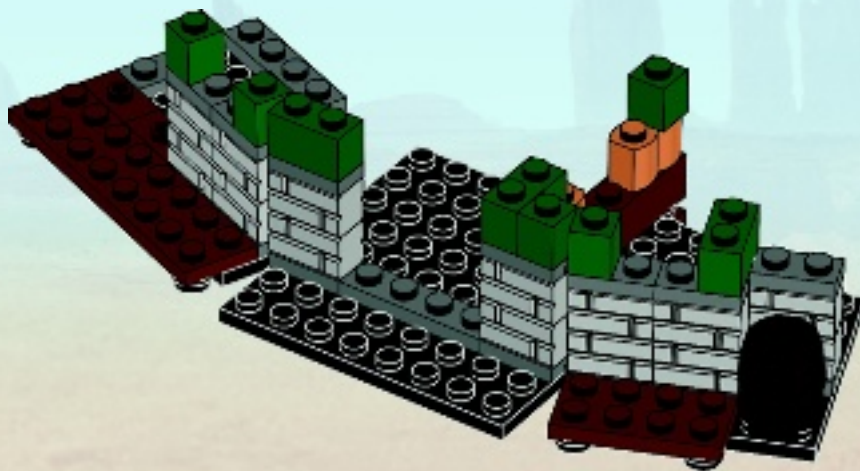



2x



1x

16

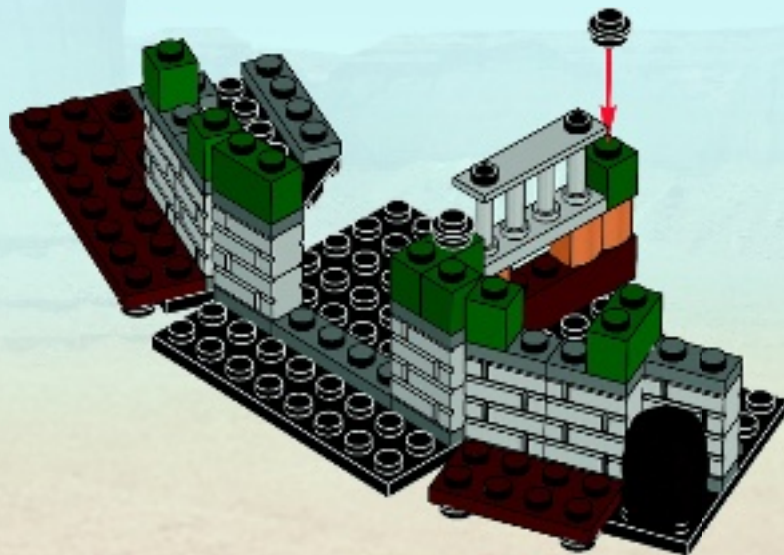



2x



2x

17

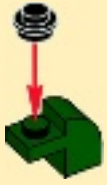

2x

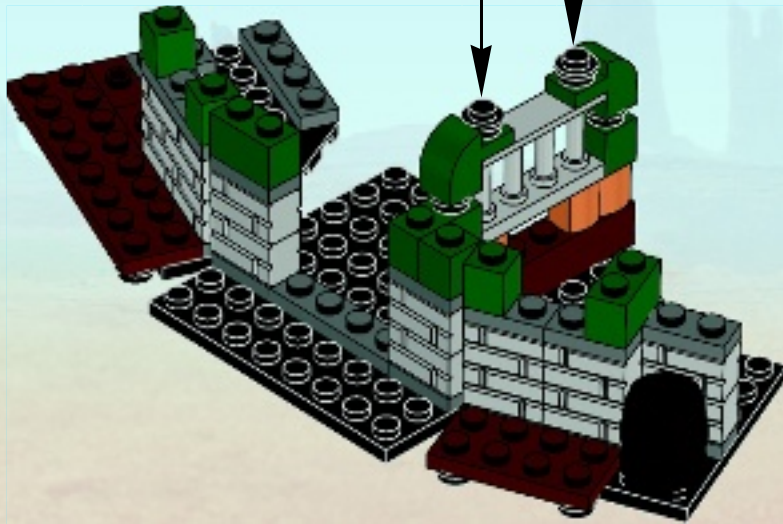



6x

18



3x

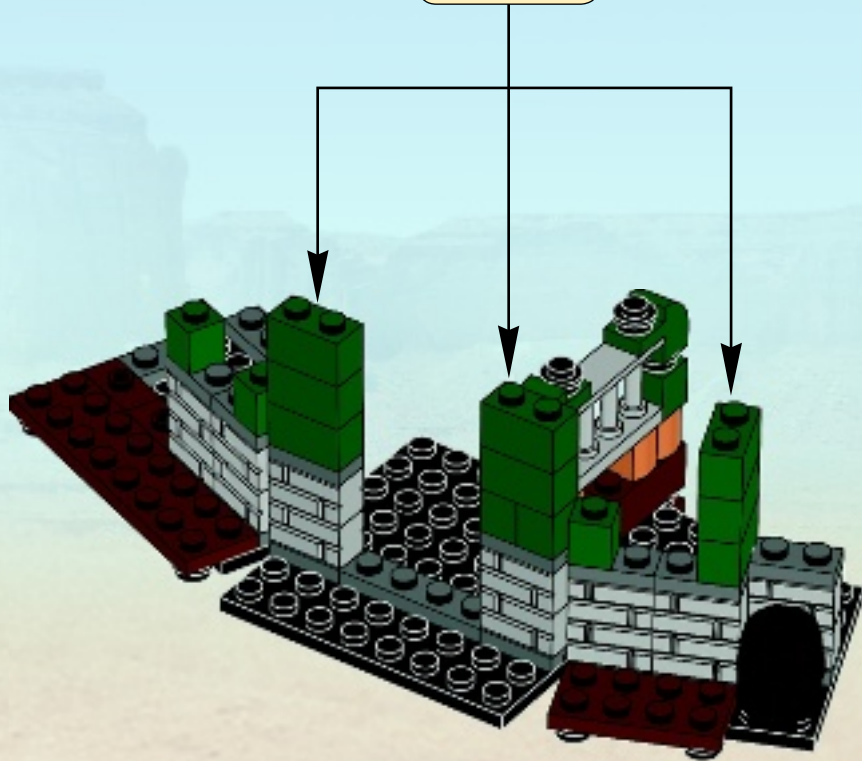



6x

19



3x

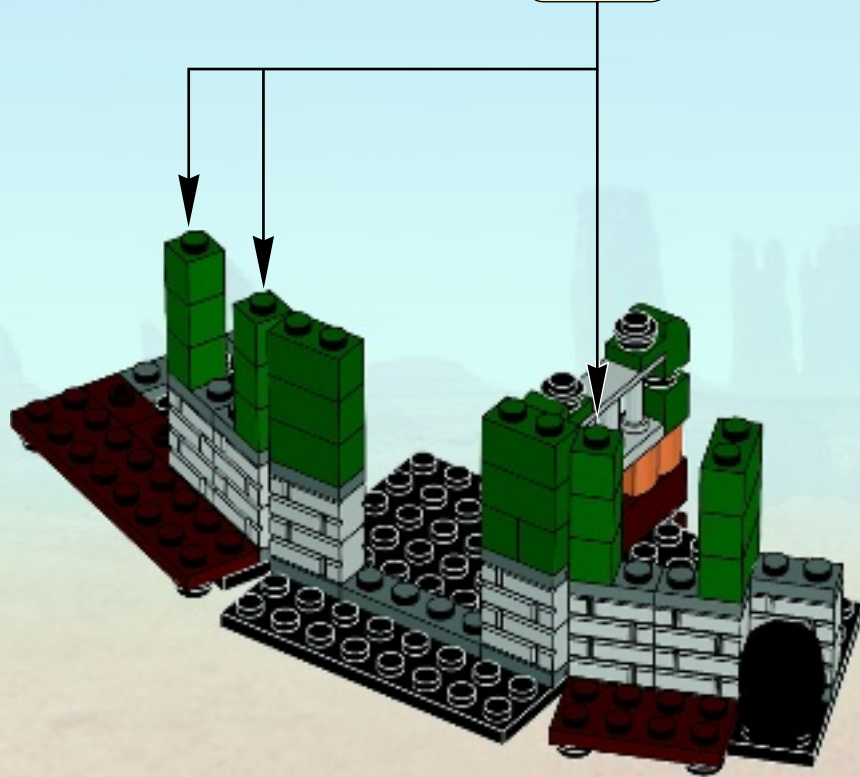

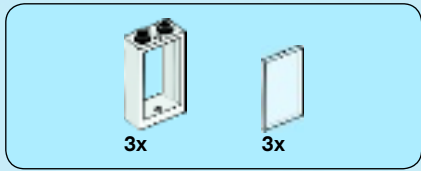

20

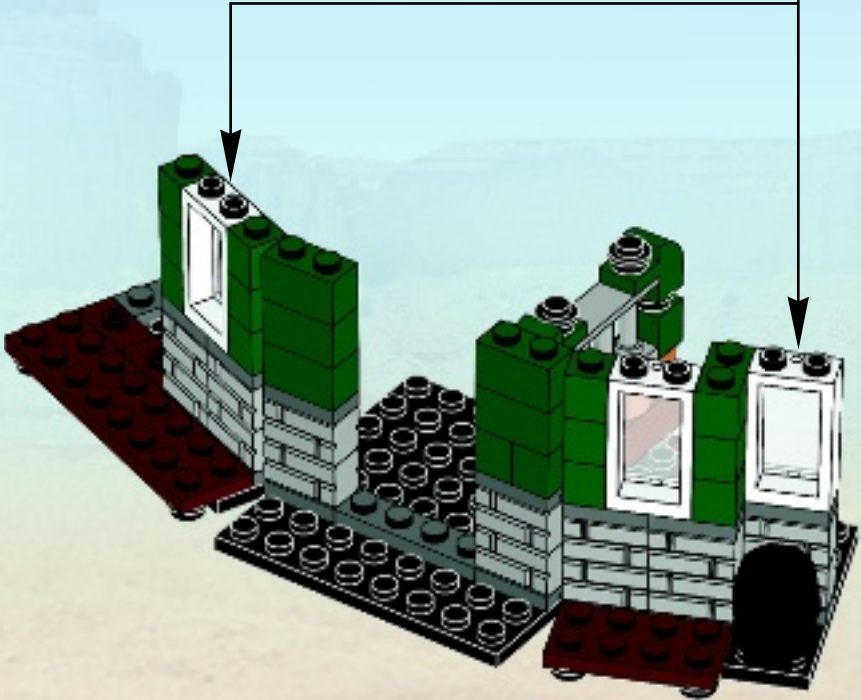
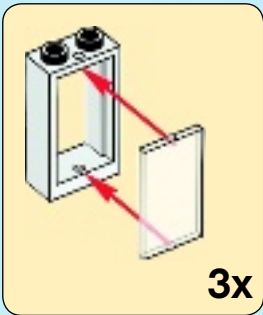



2x



2x

21

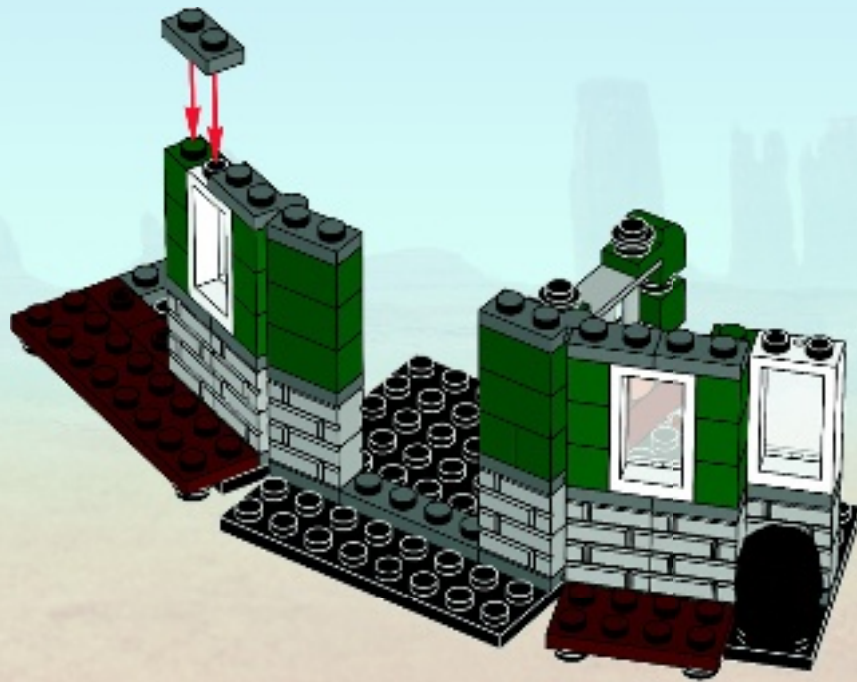



6x

22

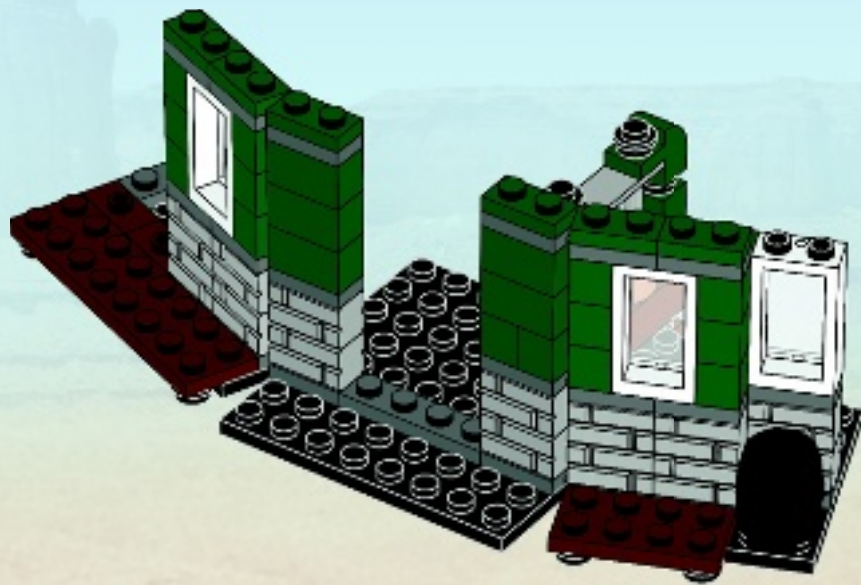

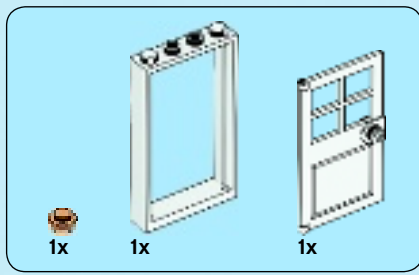

23

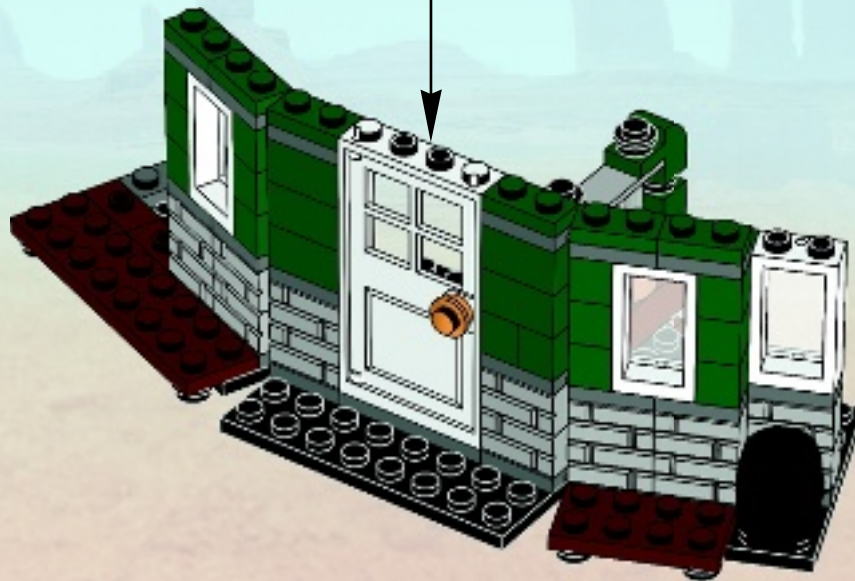
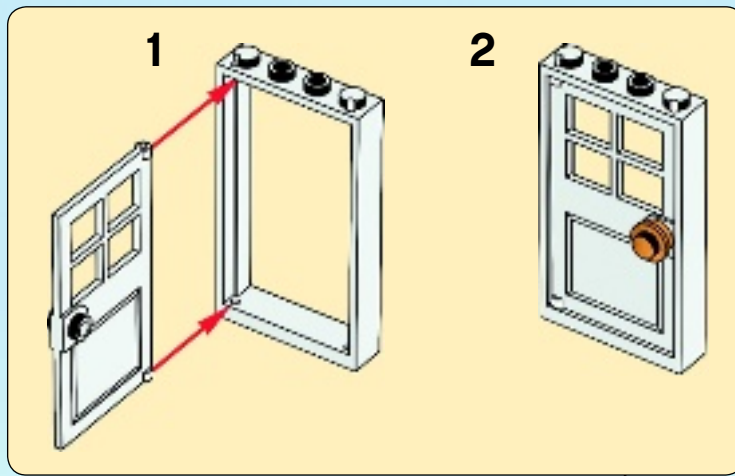



3x

24



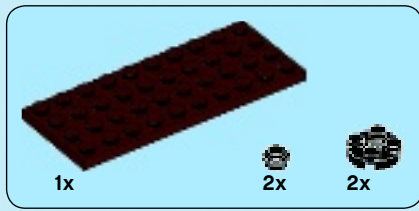

25

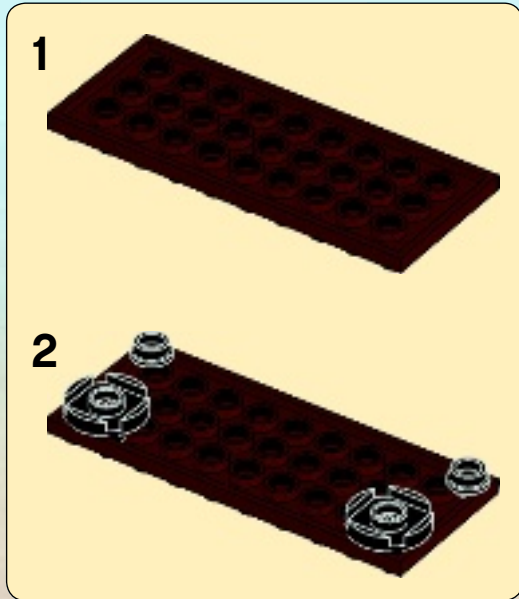

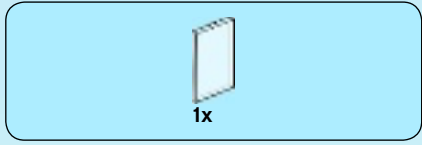

1



2

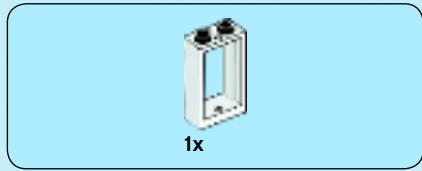
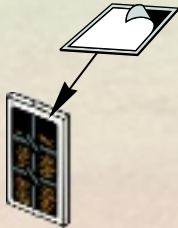

3

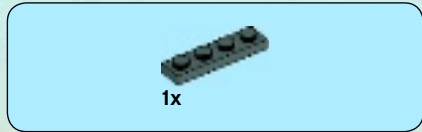
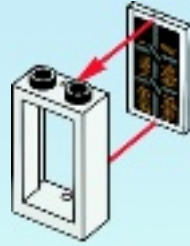

4





5

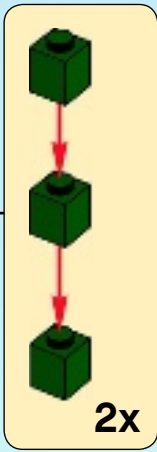
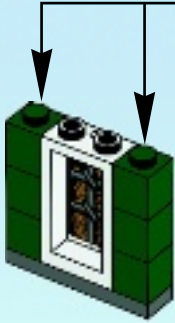

6



7

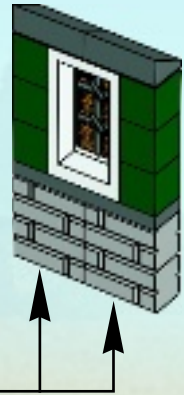
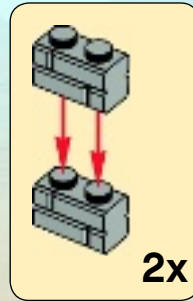

26



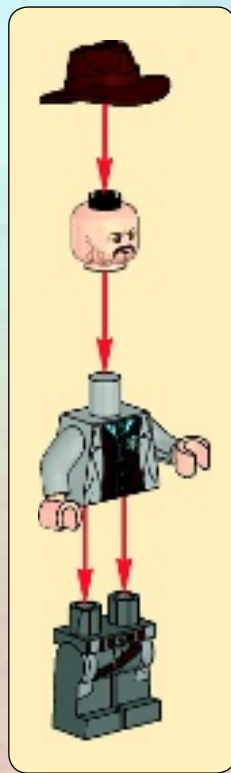
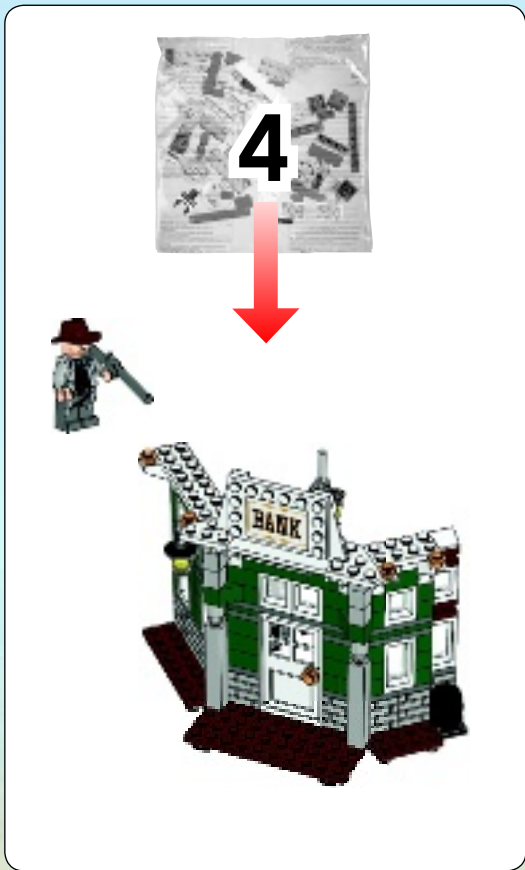



27

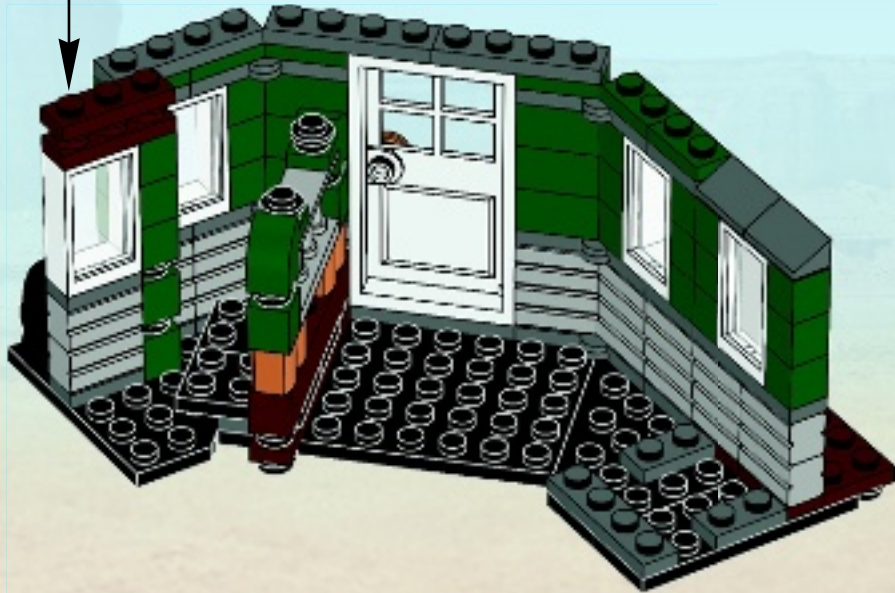
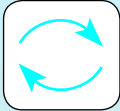
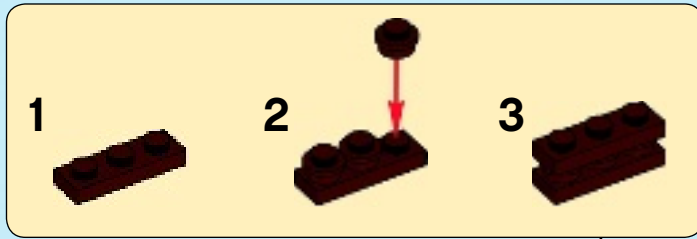

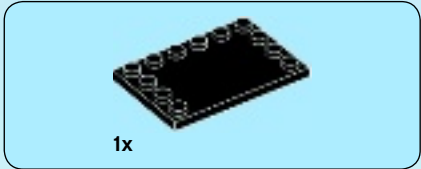

1

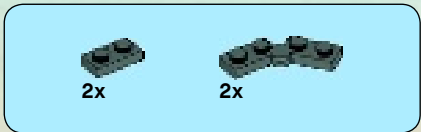

2

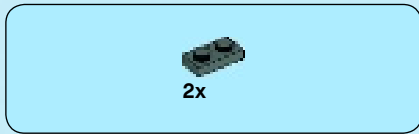
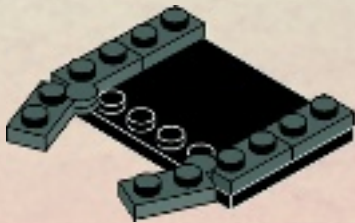

3

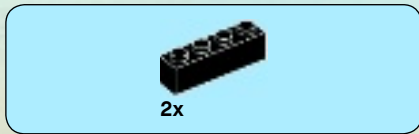
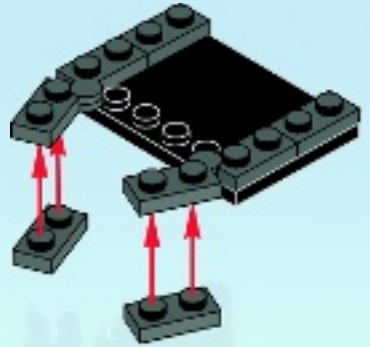

4

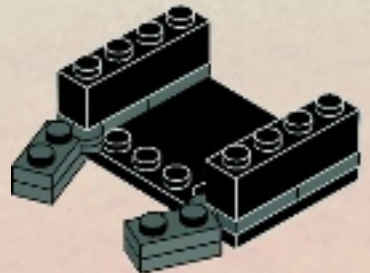



2x



2x



2x

5

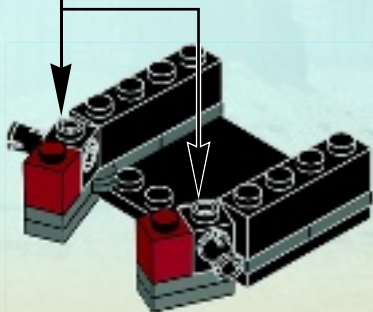
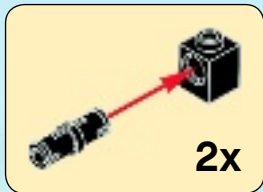

1x



1x

6

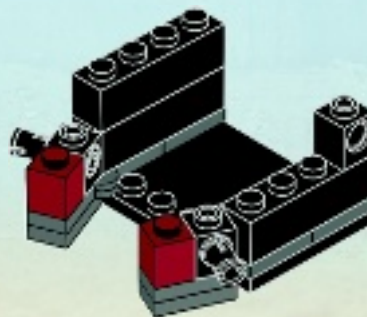



3x



2x

7

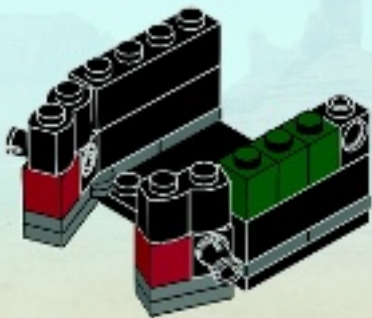

2x



2x

8

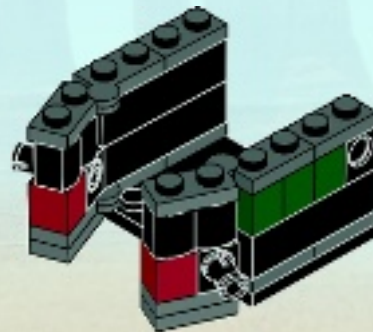



1x



2x

9

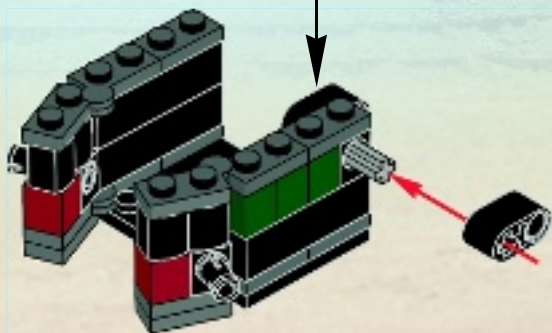
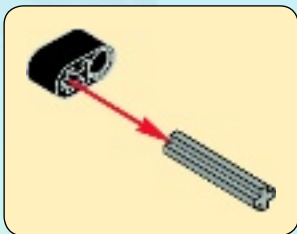

4x

10

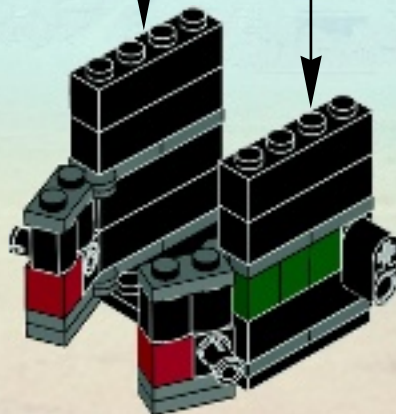
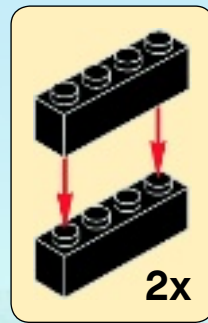



11

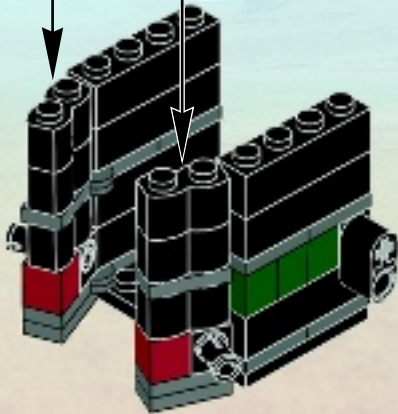
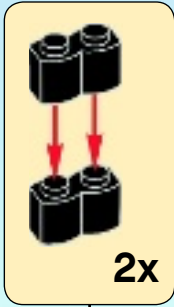

12

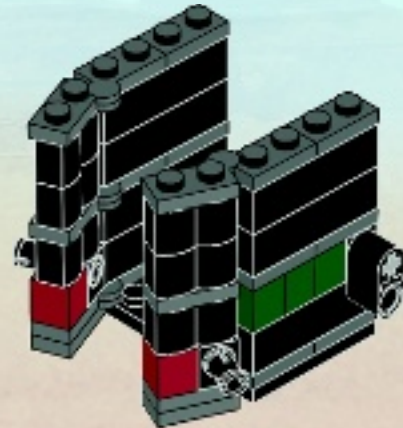



13

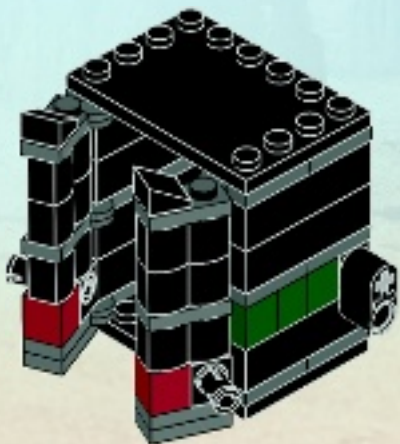

14

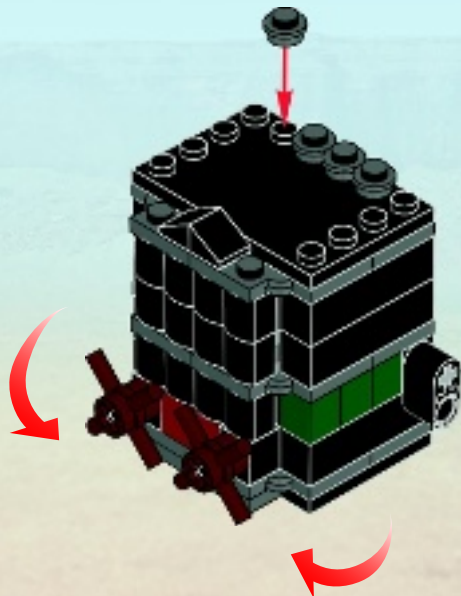

28

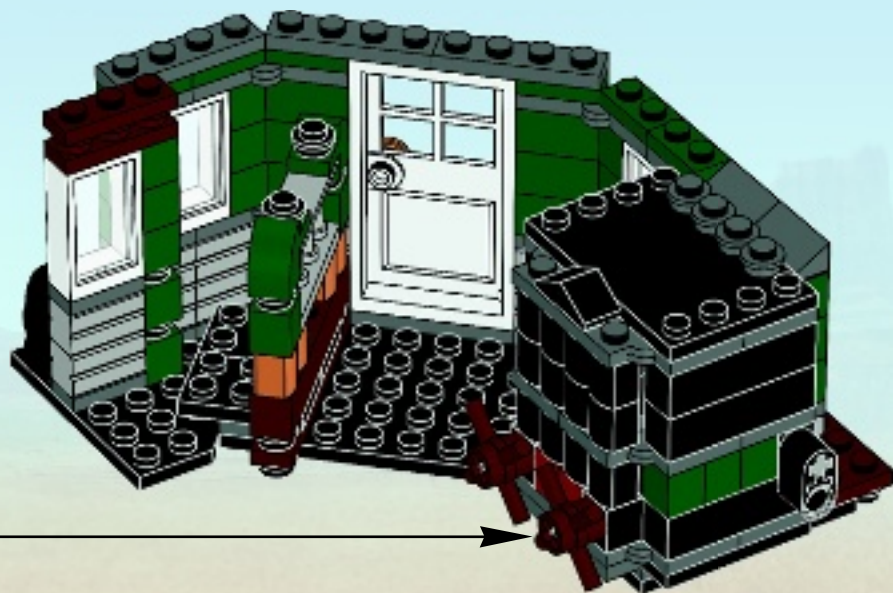



1x

29

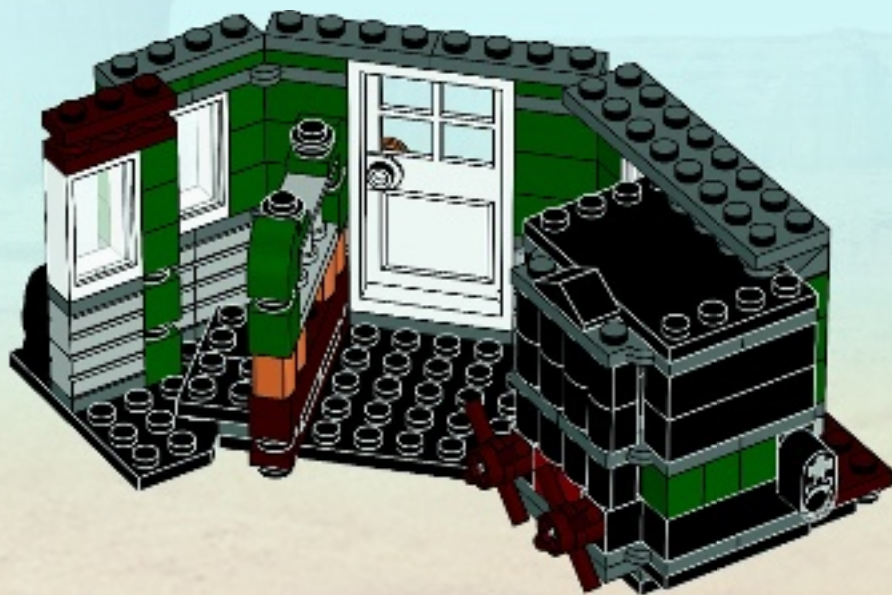



30

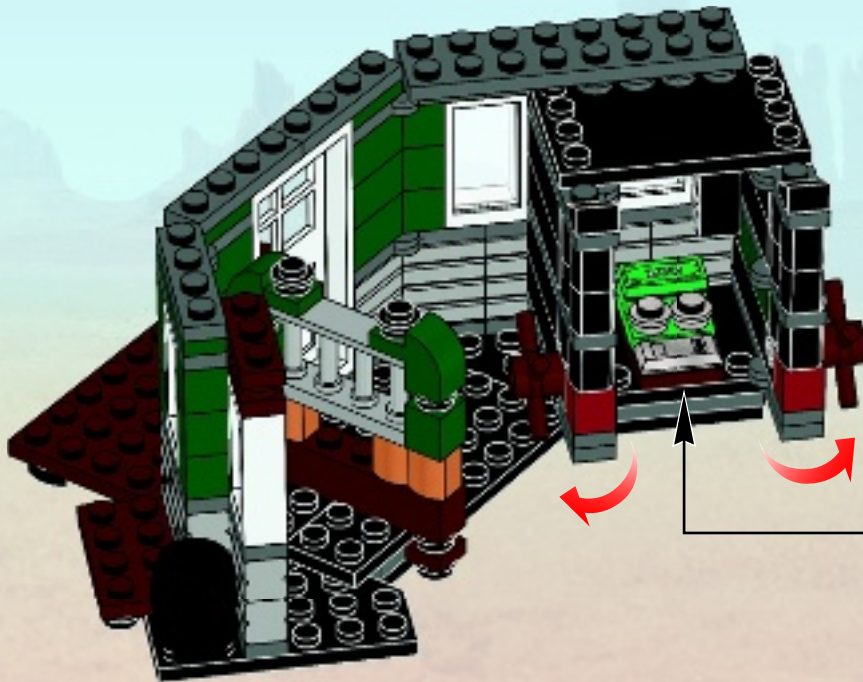
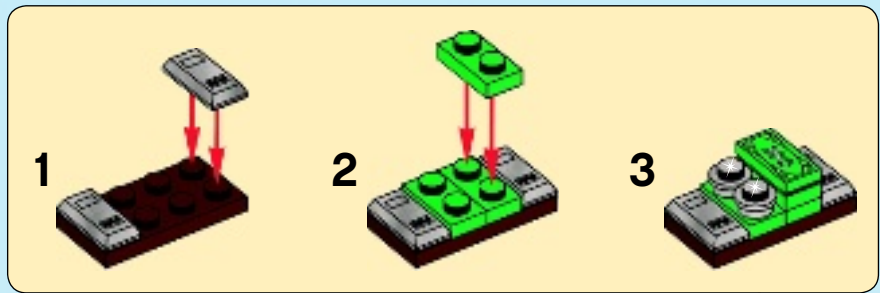



2x



3x

31

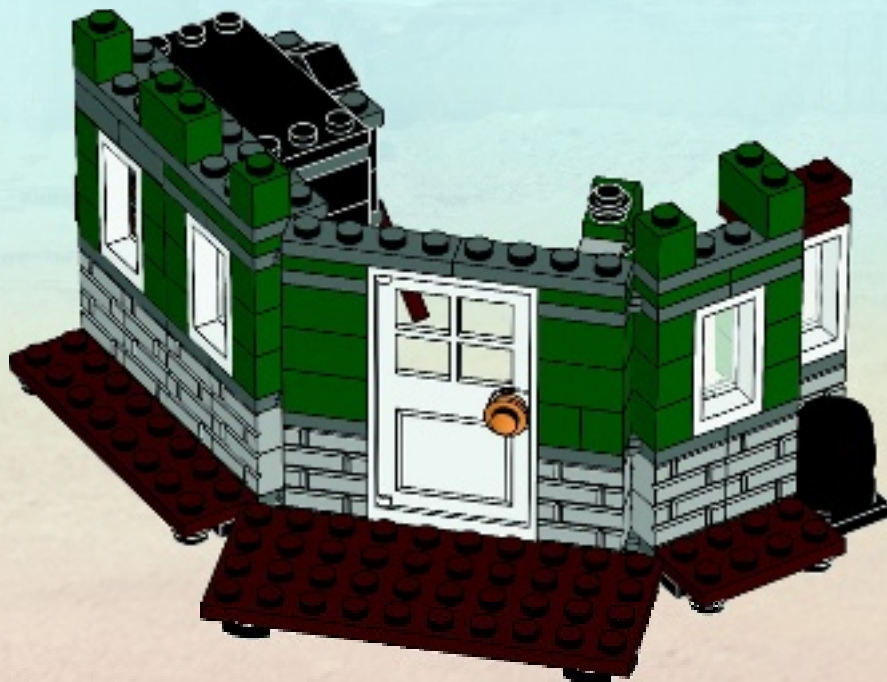
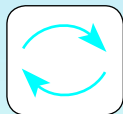

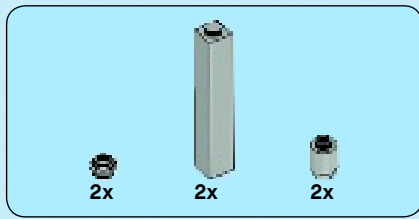

32

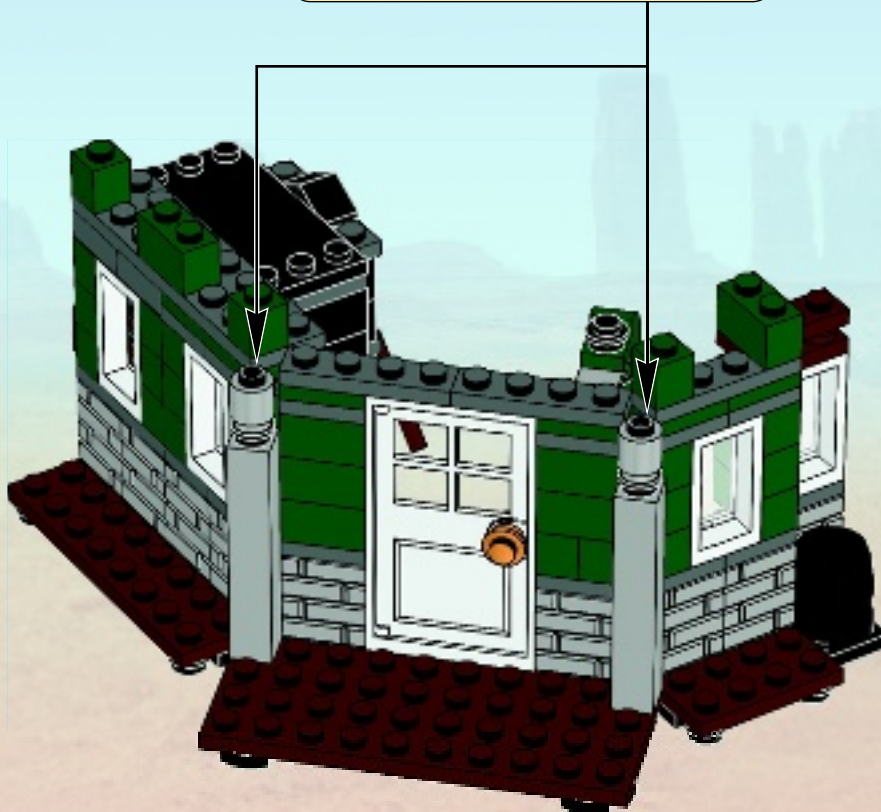
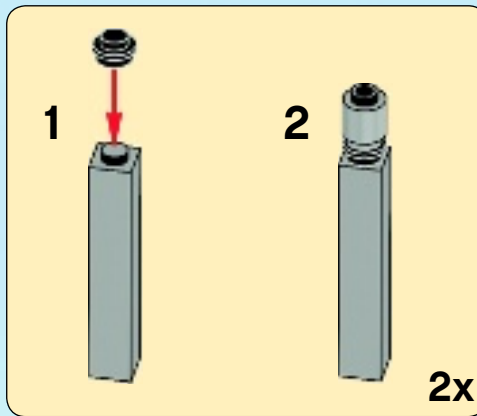



2x



2x

33





3x



4x



1x

34

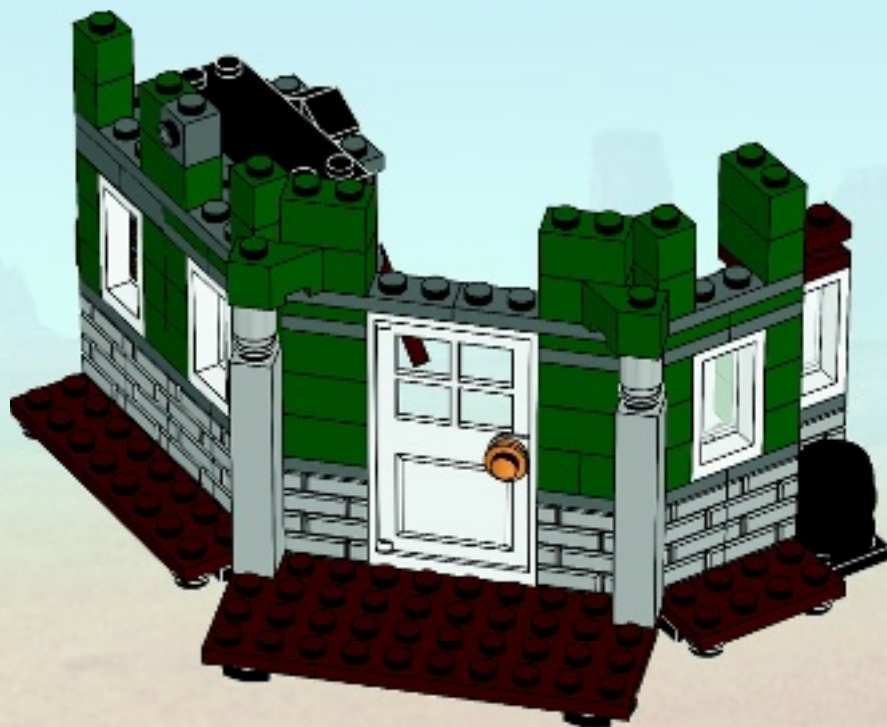

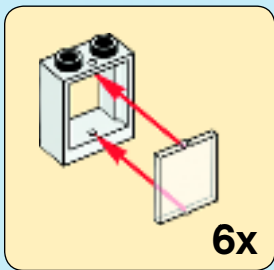
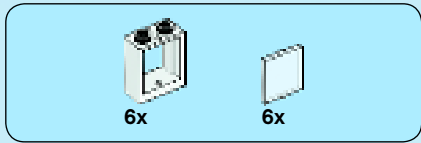

35

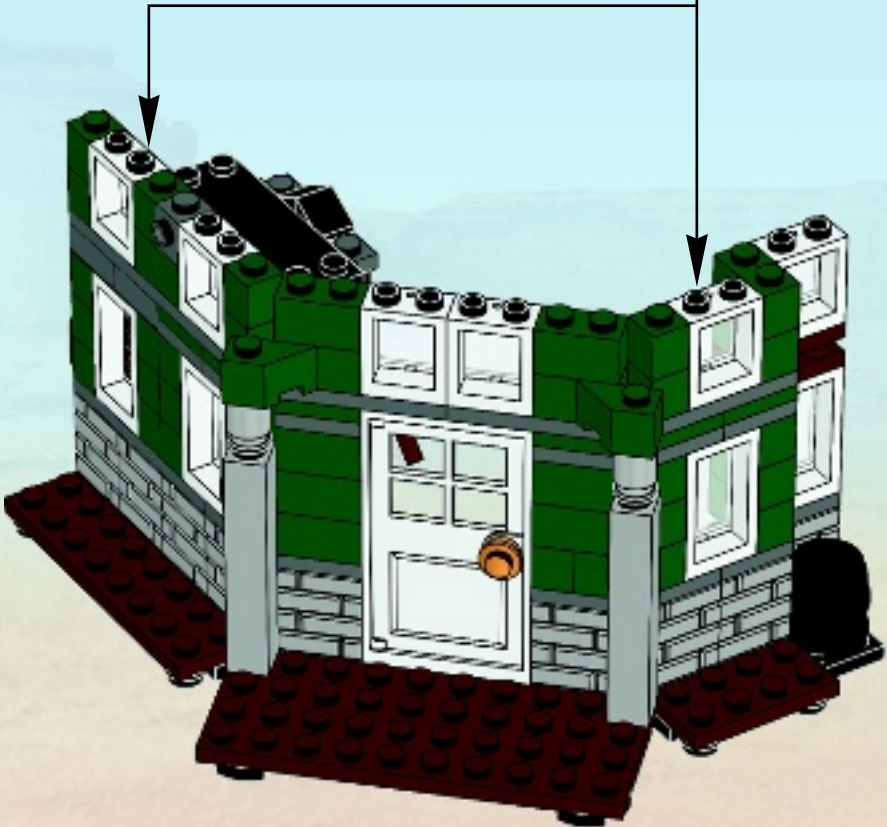

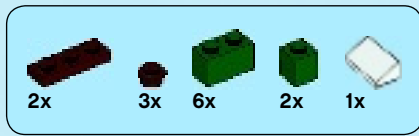

36

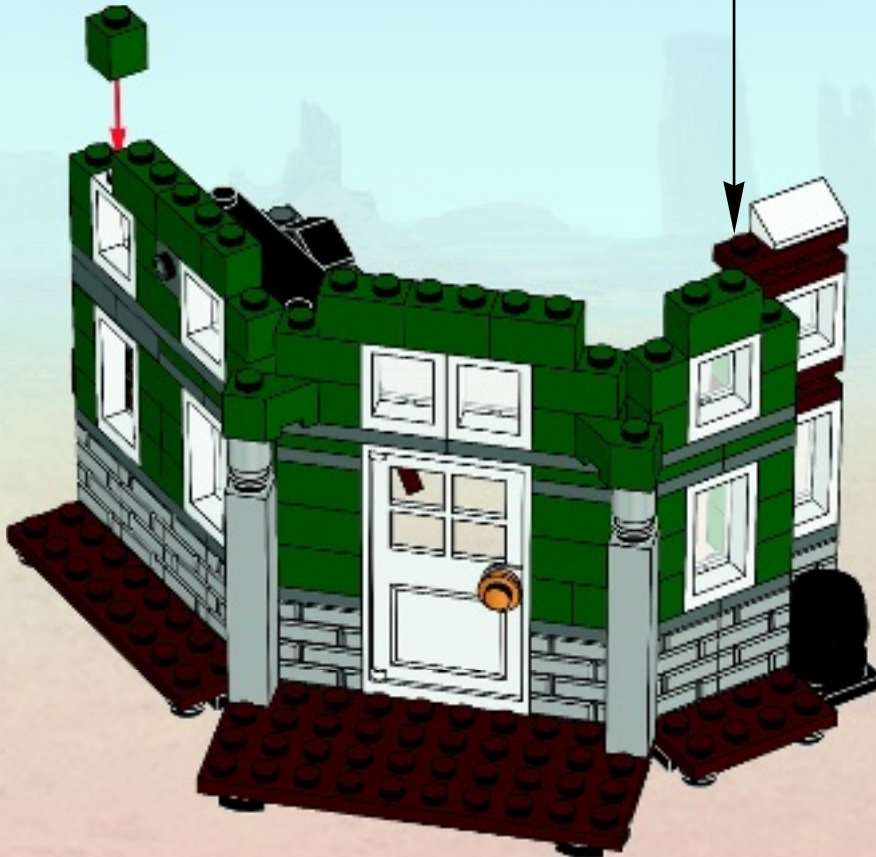
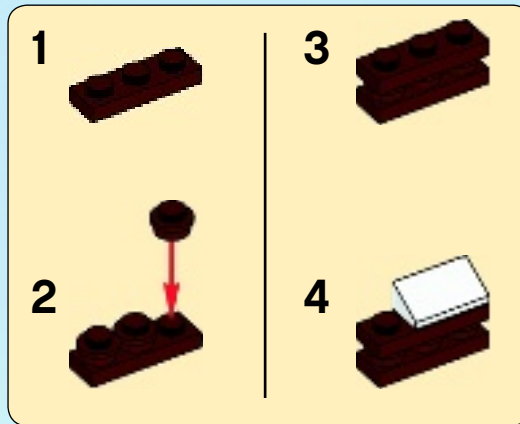

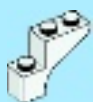

6x

37

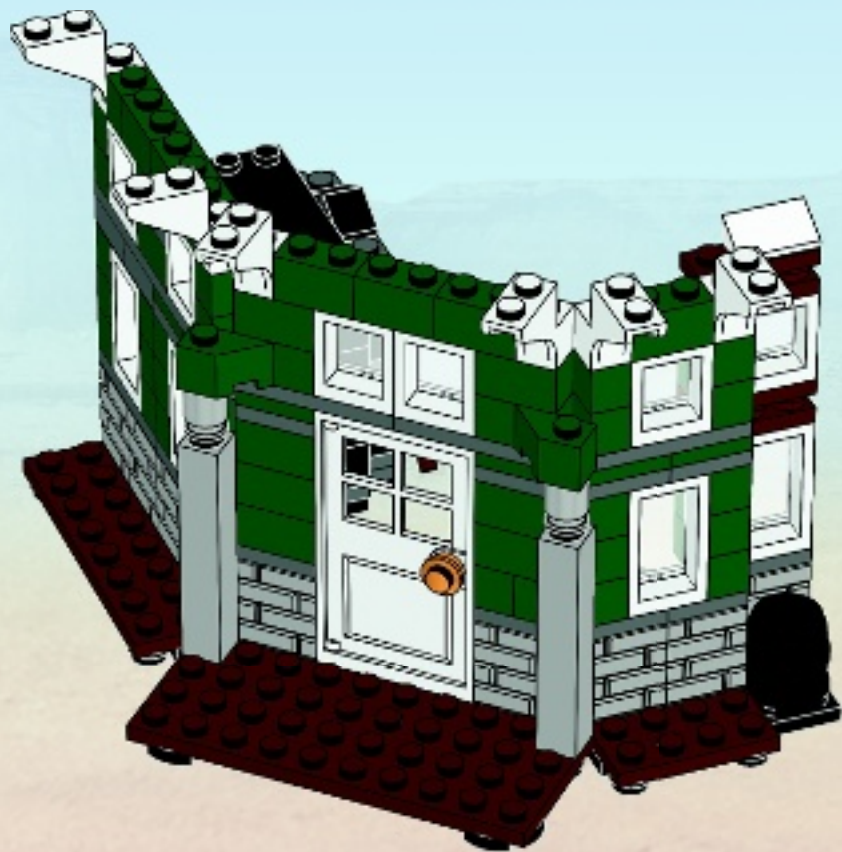

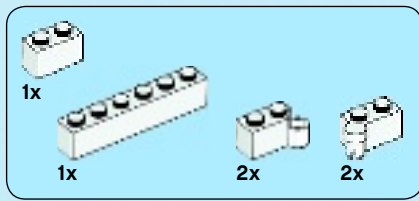

38

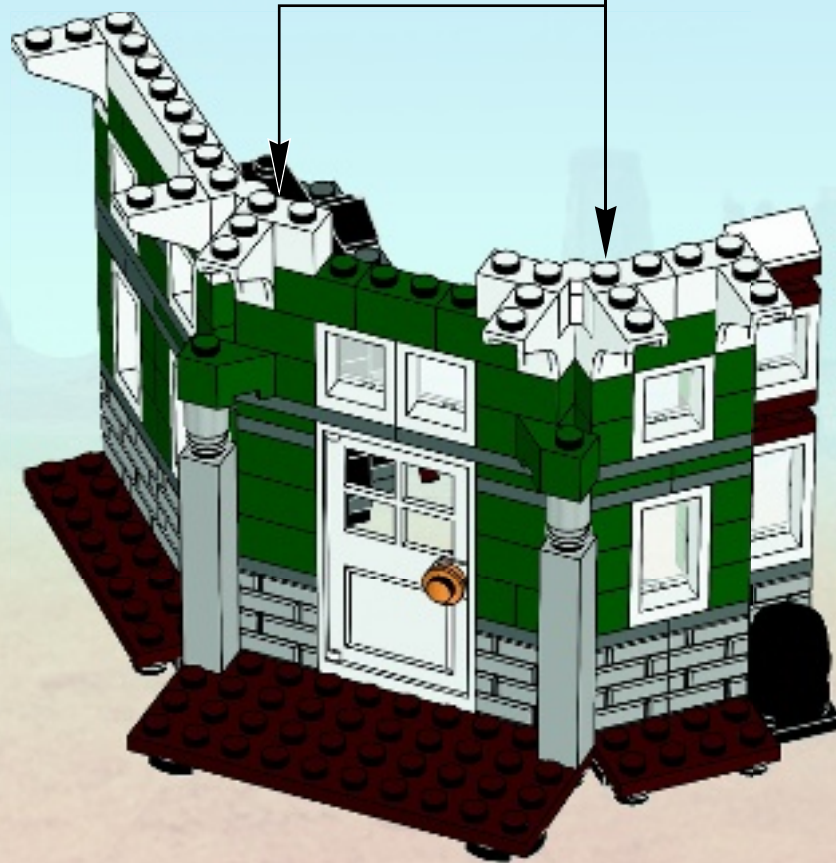
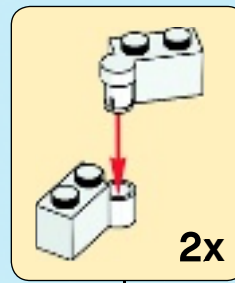



6x



2x

39



2x

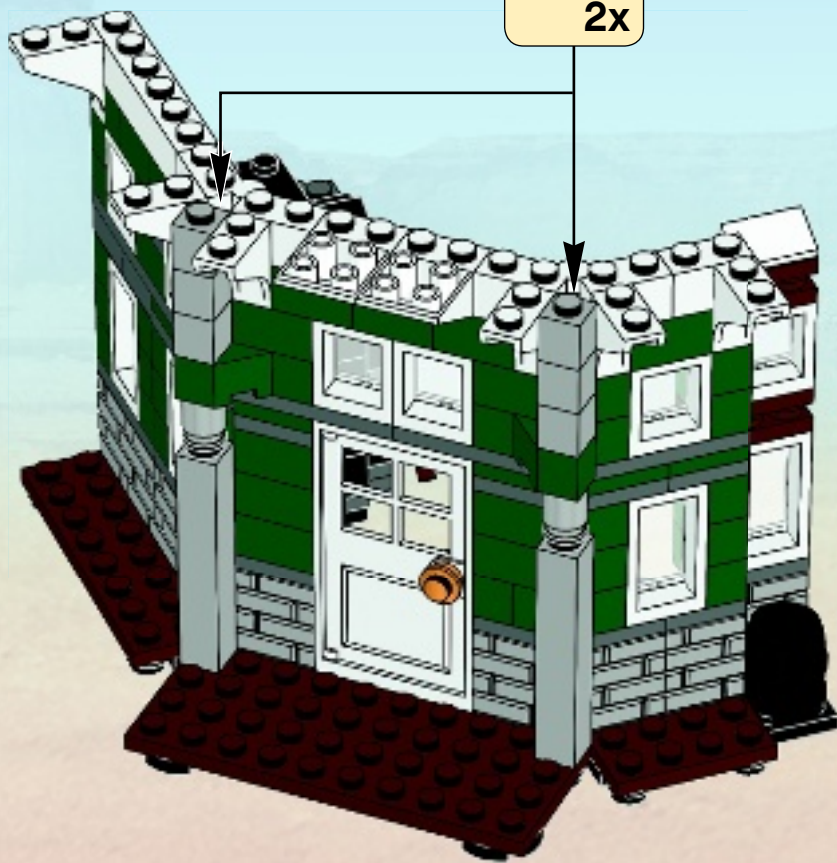



3x



1x

40

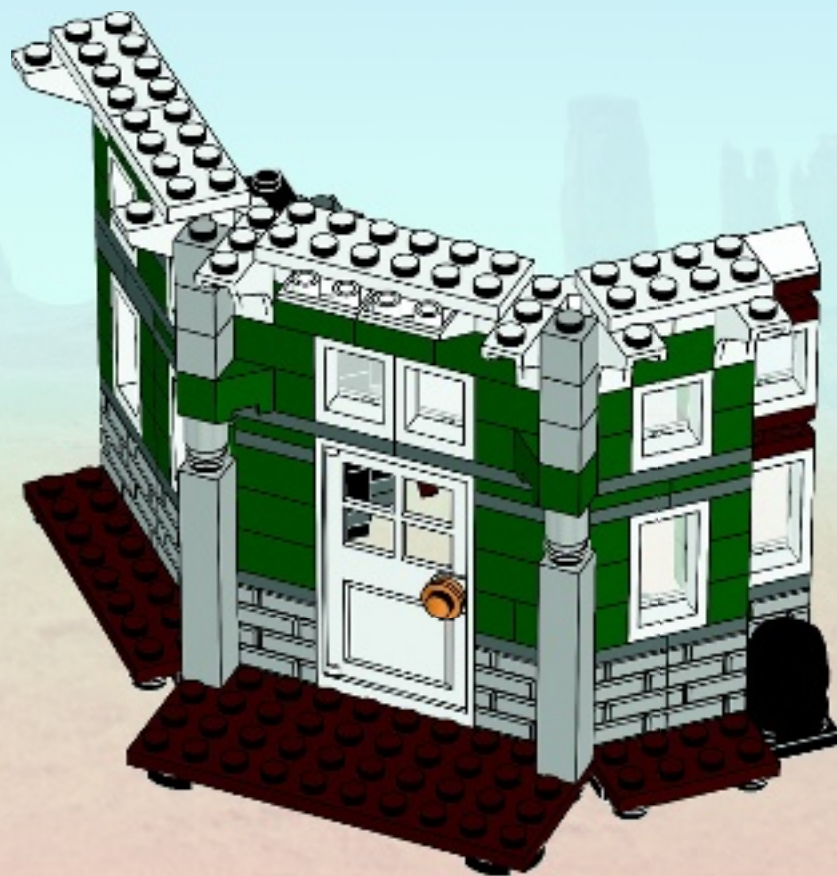

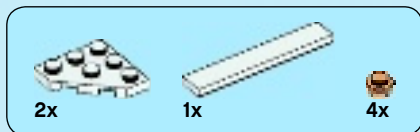

41

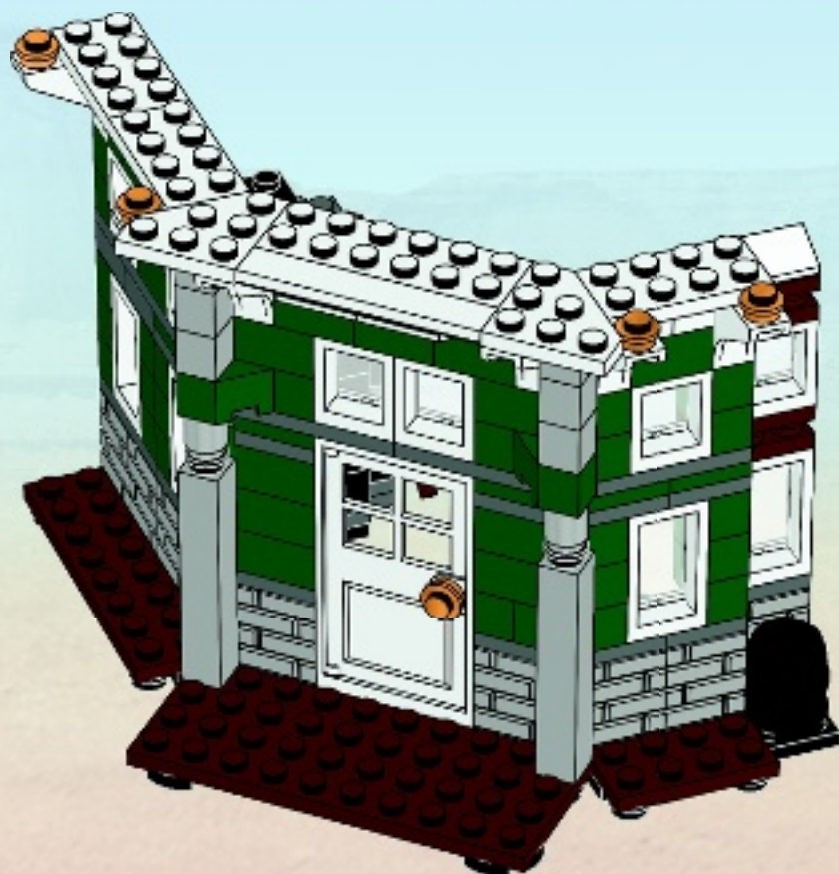



1x



2x

42

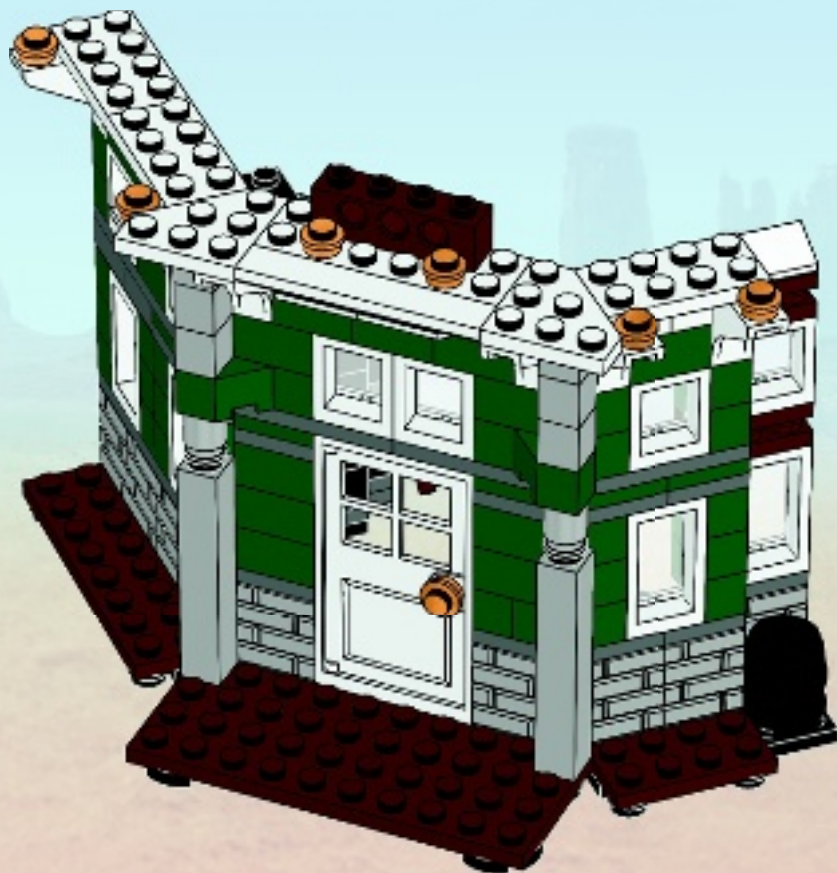



1x



1x

43





2x



2x

44

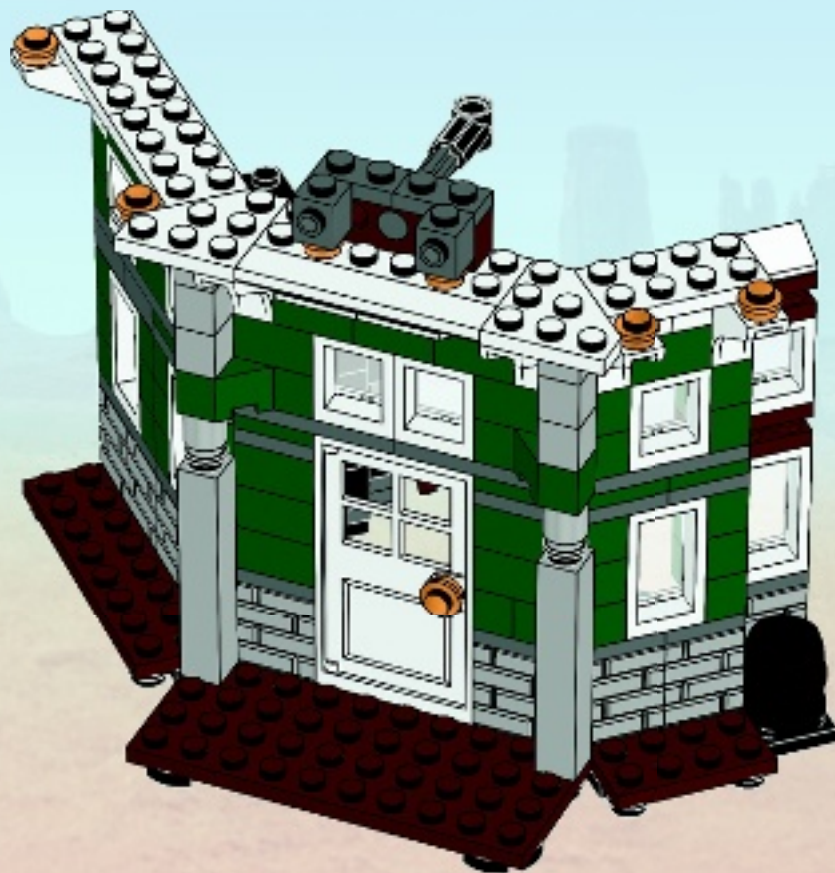



1x

45

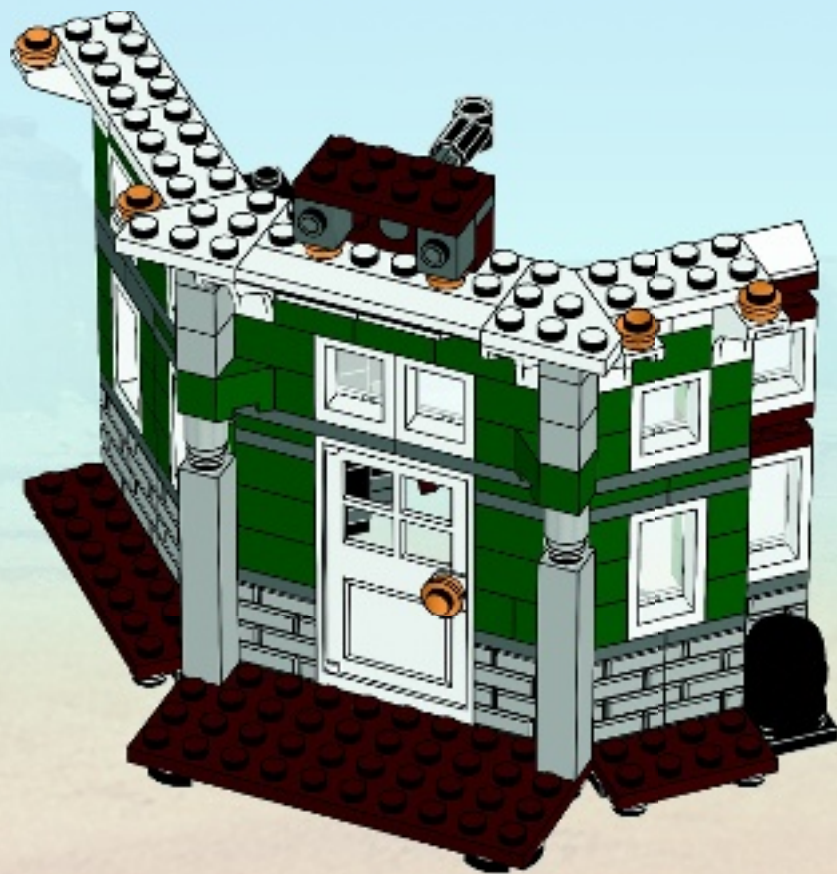

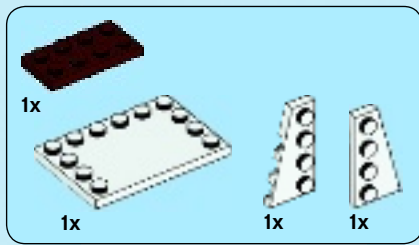

46

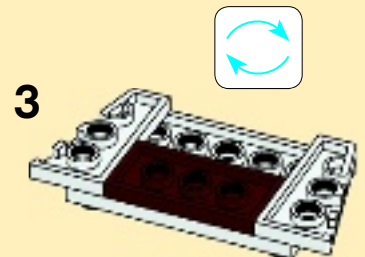
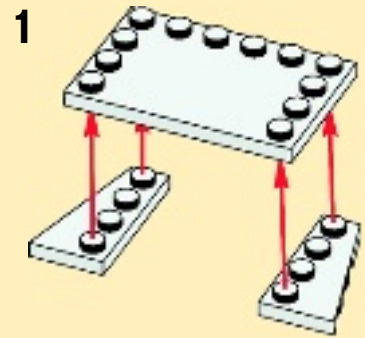



1x



1x



1x



1x

47

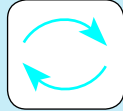

1



2



3

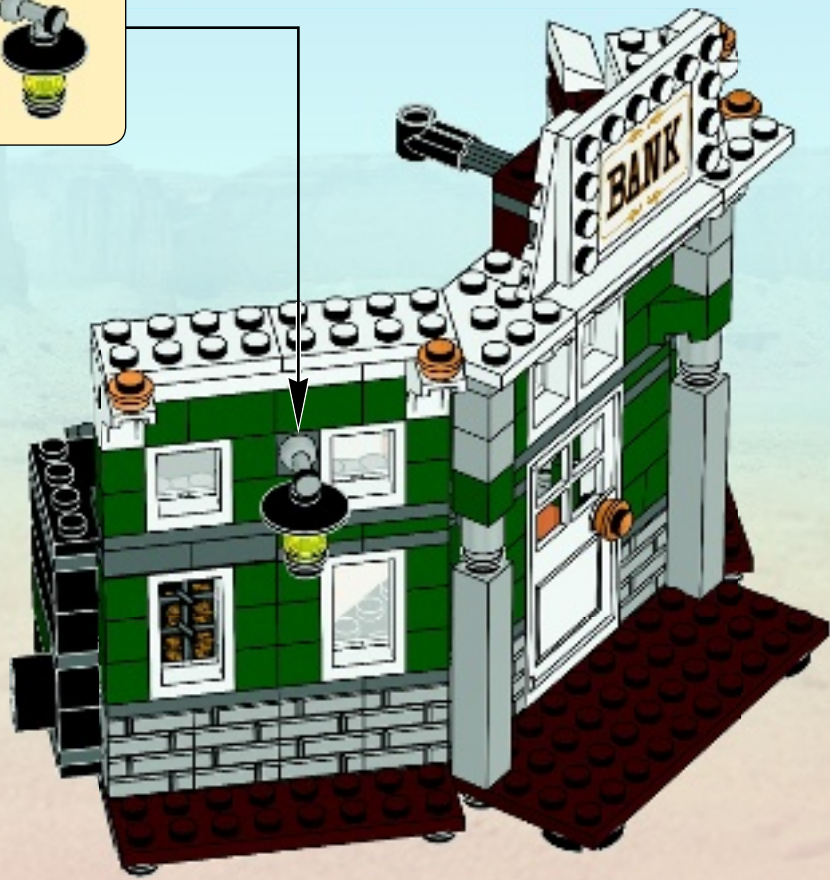

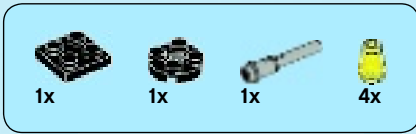

48

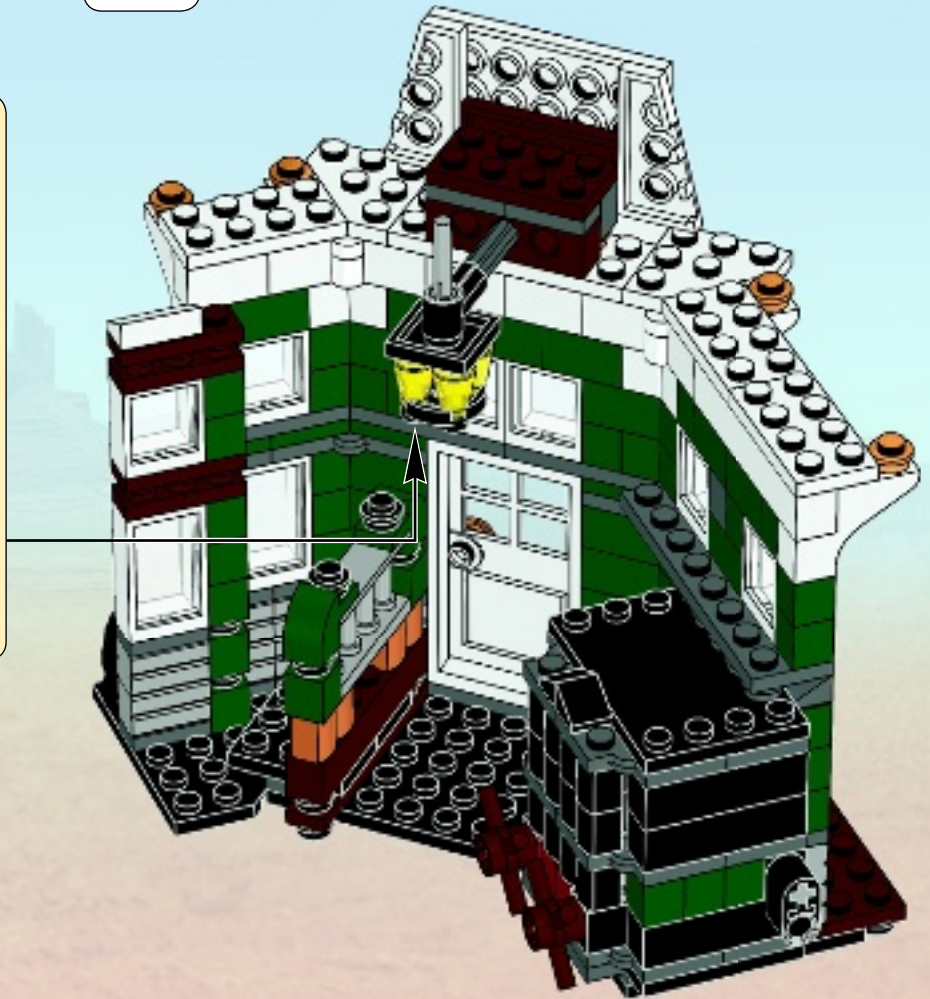
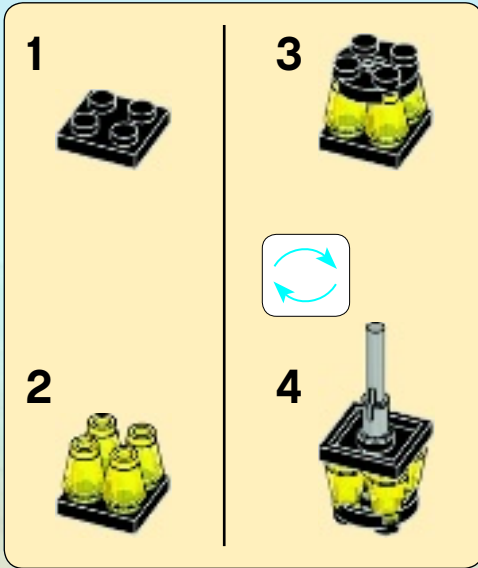
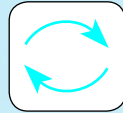

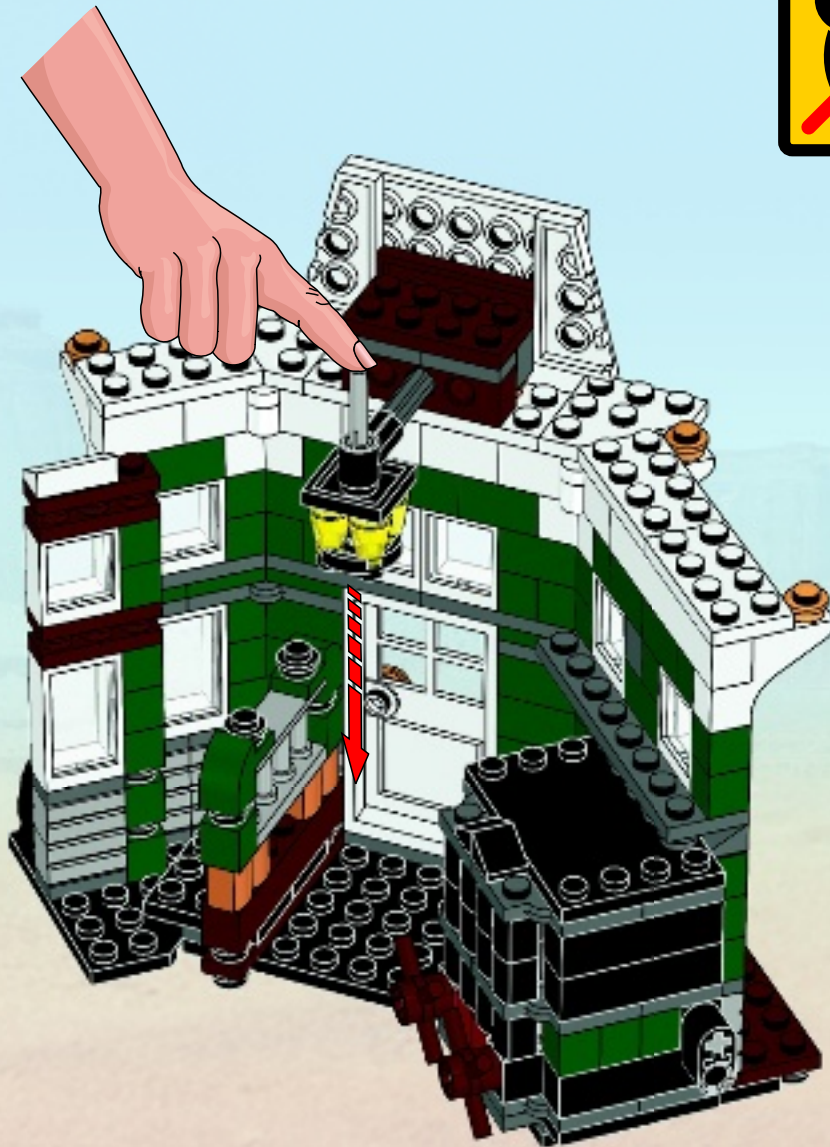

49

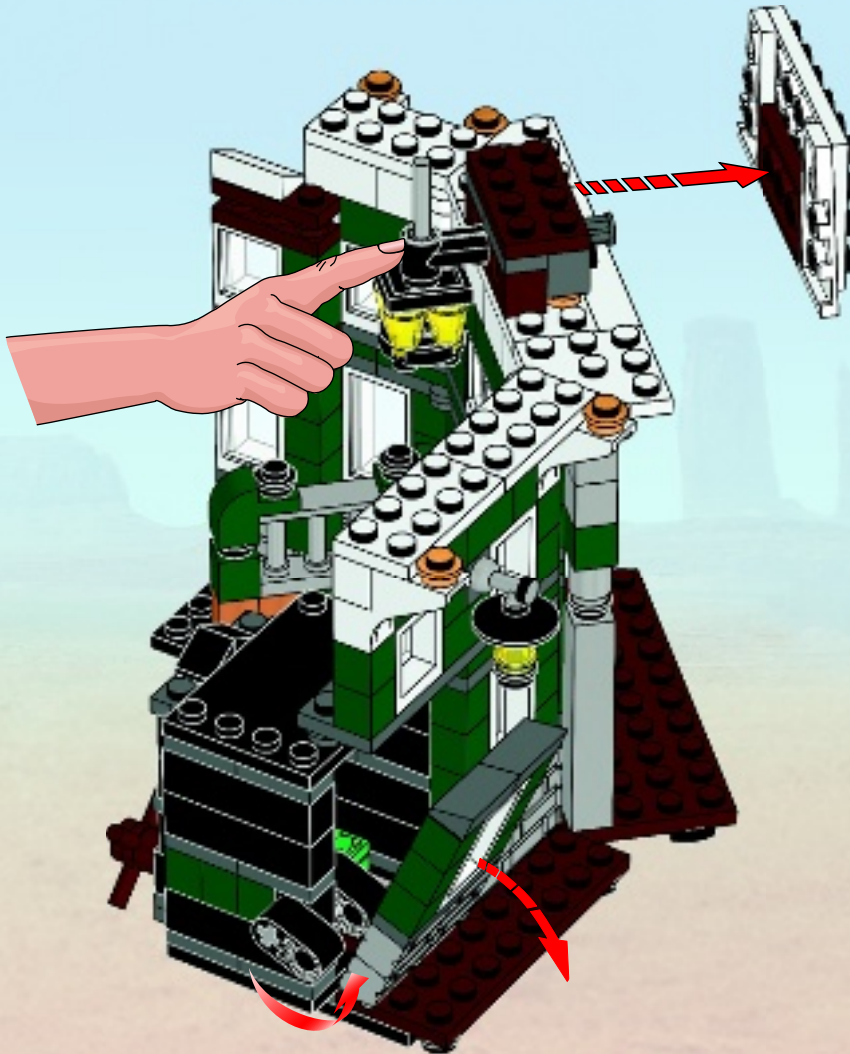

50

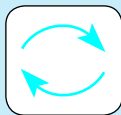



2x
4538780

6x
4159553

10x
4109995

4x
4118866

1x
6048857



3x
4113233

1x
4114084

2x
4217562

1x
4624086

8x
4113915

1x
4624185

1x
4609726

6x
4568956

1x
4161326

1x
4160857

1x
6032362



2x
6011456

2x
383101

1x
4547489

1x
300401

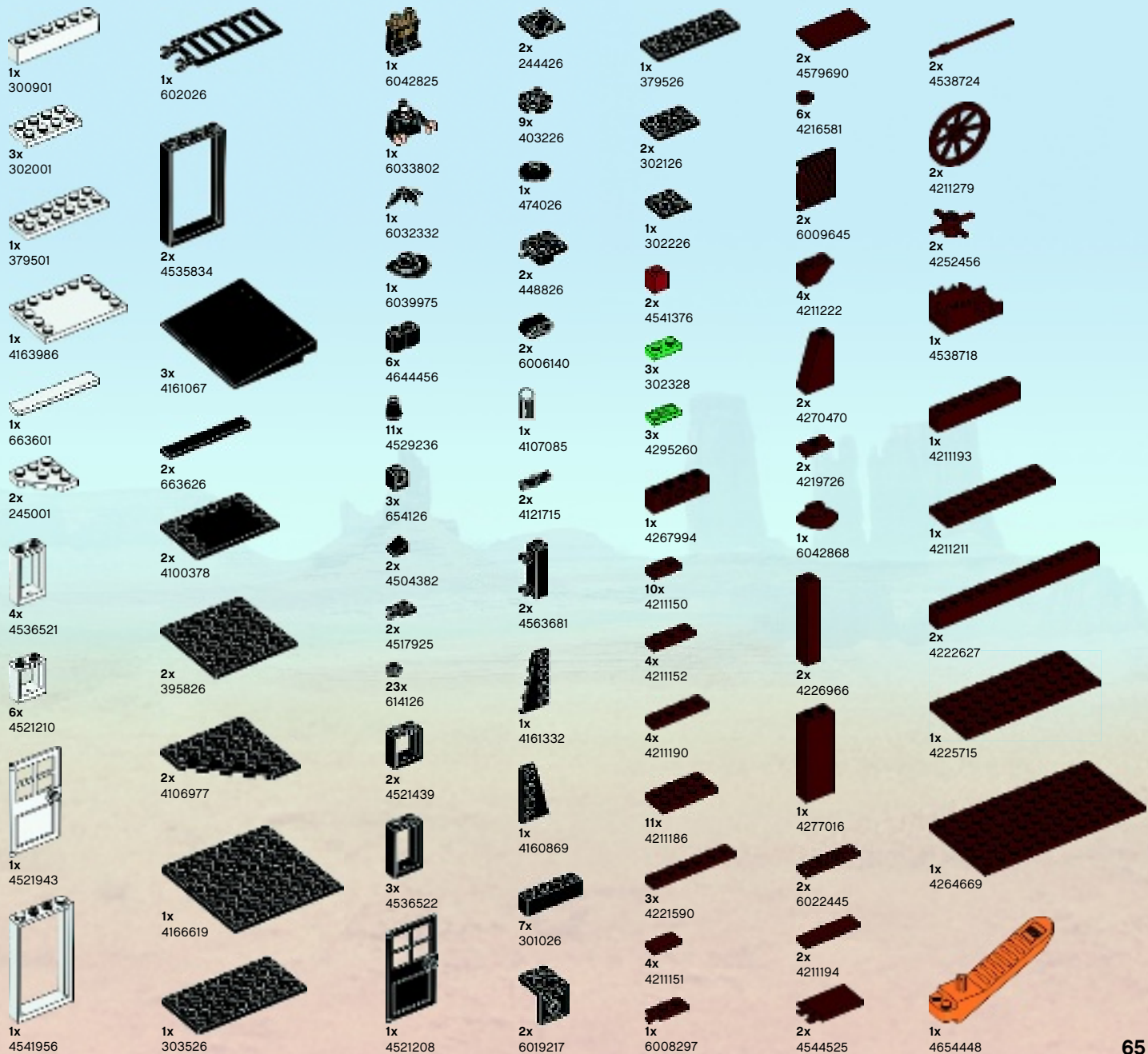
2x
4500469





Customer Service
Kundenservice
Service Consommateurs
Servicio Al Consumidor
LEGO.com/service or dial

00800 5346 5555 : 
1-800-422-5346 : 



Disney THE
LONE RANGER



LEGO.com/TheLoneRanger





WIN!

Go to www.LEGOsurvey.com/product
to fill out a survey for a chance
to win a cool LEGO® Product.
No purchase necessary.
Open to all residents where not prohibited.



www.LEGOsurvey.com/product

GEWINNE! WIN!

Nimm an der Umfrage auf
www.LEGOsurvey.com/product
teil und hab die Chance ein cooles
LEGO® Produkt zu gewinnen!

Die Teilnahme am Gewinnspiel führt zu keinerlei
Kaufverpflichtungen. Teilnahme in allen nicht
ausgeschlossenen Ländern möglich.

Ga naar www.LEGOsurvey.com/product, vul een
enquêteformulier in en maak
kans op een cool LEGO® product.

Geen aankoopverplichting,
iedereen mag deelnemen, uitgezonderd
ingezetenden van landen waar een
enquêteverbod geldt.

GAGNE! 当てよう!

Visite www.LEGOsurvey.com/product
pour répondre à un
questionnaire et avoir une chance de
gagner un produit LEGO® très cool!

Aucune obligation d'achat.
Ouvert à tous les résidents des pays
autorisés.

www.LEGOsurvey.com/product にアクセスして、
アンケートにご記入ください。当選者にはレゴ®
製品を差し上げます。

お買い上げの必要はありません。

禁止されていない限り、すべての皆様にご利用いただけます。

6051537 / 6051538



LEGO and the LEGO logo are trademarks of the/son des marques de commerce de/
son marcas registradas de LEGO Group. ©2013 The LEGO Group.
© Disney Enterprises, Inc. and Jerry Bruckheimer, Inc. LONE RANGER TM & © Classic Media.