



MONKIE KID 悟空小侠

80038



1



Get excited about our new packaging!

We're switching from plastic to paper-based packaging. That's why you might find a mix of paper and plastic in our boxes!

Nos nouveaux emballages vous emballeront !

Nous passons des emballages en plastique aux emballages à base de papier. C'est pourquoi vous pourriez trouver un mélange de papier et de plastique dans nos boîtes !

¡Te presentamos nuestros nuevos empaques!

Estamos sustituyendo las bolsas de plástico por bolsas con base de papel. ¡Por eso, puedes encontrar una mezcla de papel y de plástico en nuestras cajas!

[LEGO.com/sustainable-packaging](https://www.lego.com/sustainable-packaging)



乐高®拼搭指引



LEGO® Building Instructions



Download on the
App Store



GET IT ON
Google Play



腾讯应用宝
安卓应用商店

Check for compatibility
Kompatibilität prüfen
Vérifier la compatibilité
Controlla la compatibilità
Comprueba tu compatibilidad
Verificar a compatibilidade
Ellenőrizd a kompatibilitást
Pārbaudīt saderību
Verificarea compatibilității
检查兼容性

[LEGO.com/devicecheck](https://www.lego.com/devicecheck)

Apple and the Apple logo are trademarks of Apple Inc.
Google Play and the Google Play logo are trademarks of Google LLC.
Tencent and the Tencent logo are trademarks of Tencent Inc.

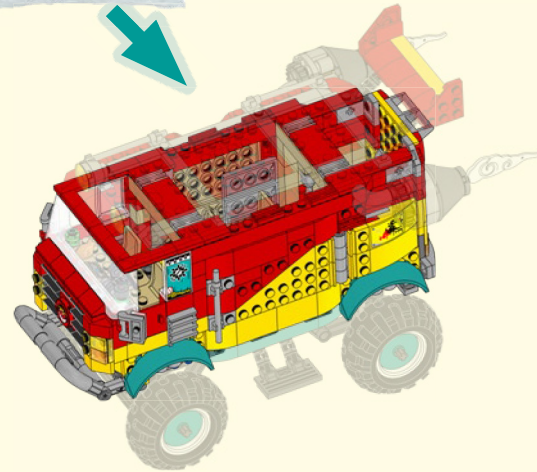
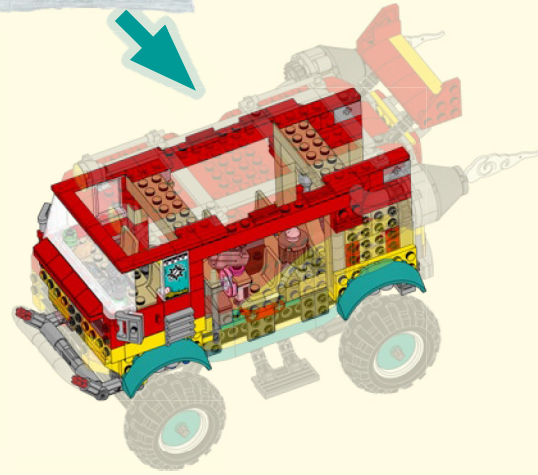
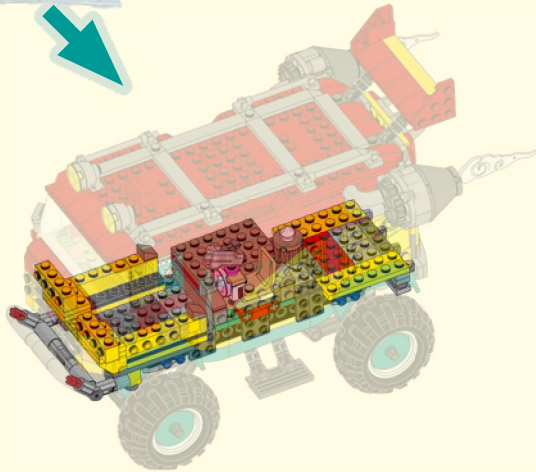
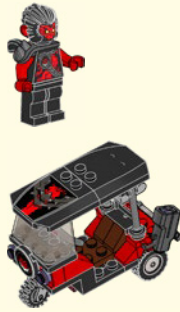

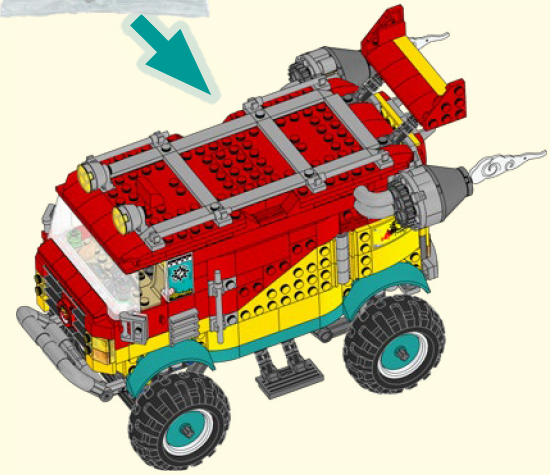
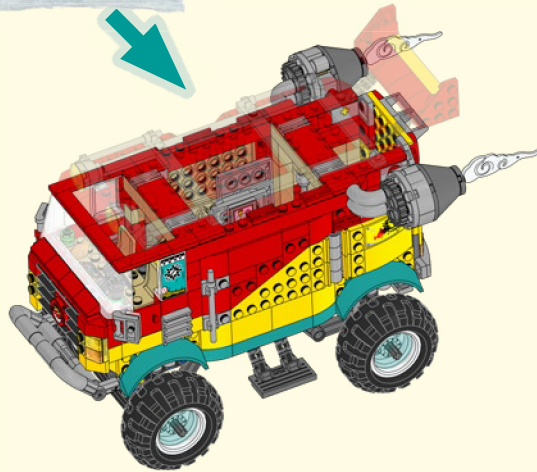
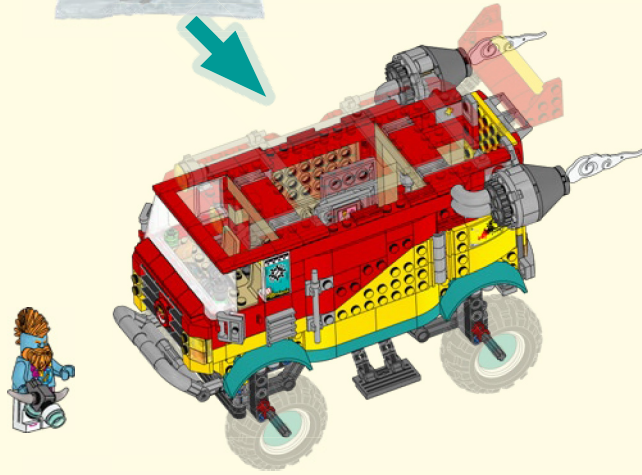

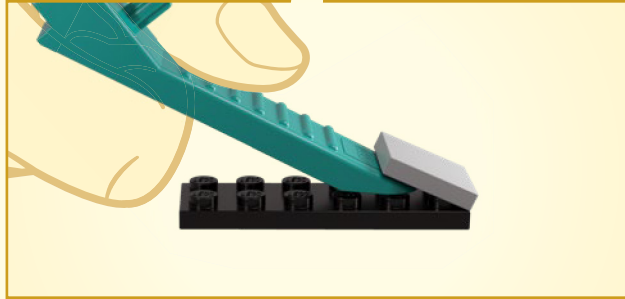
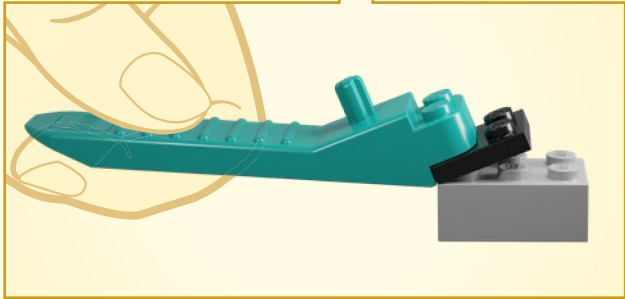
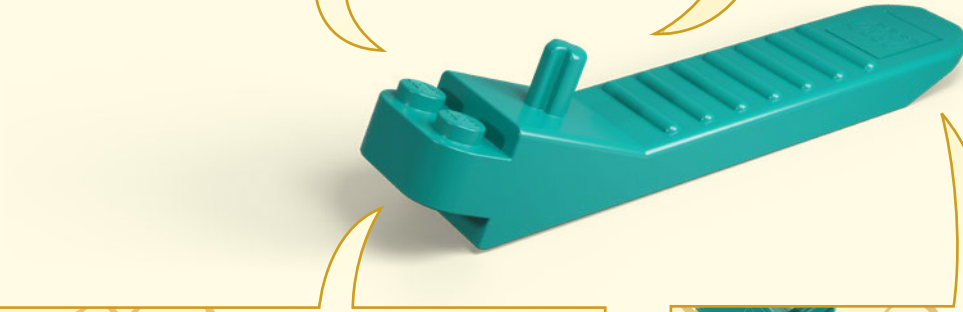
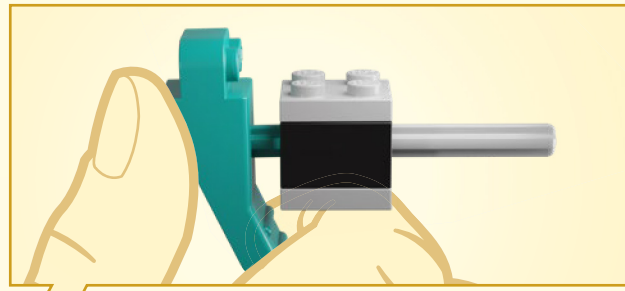
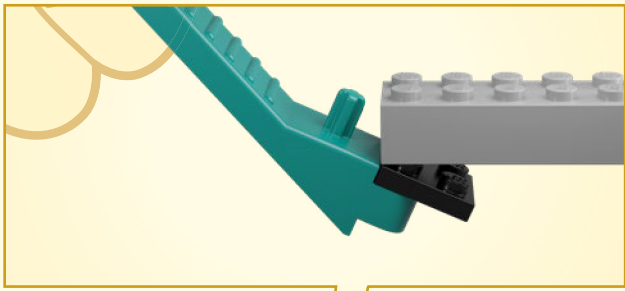

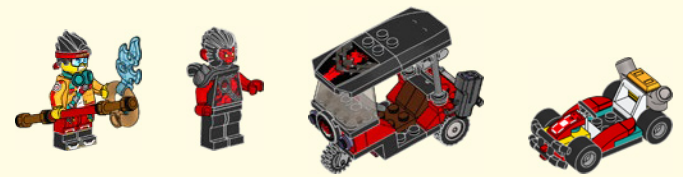

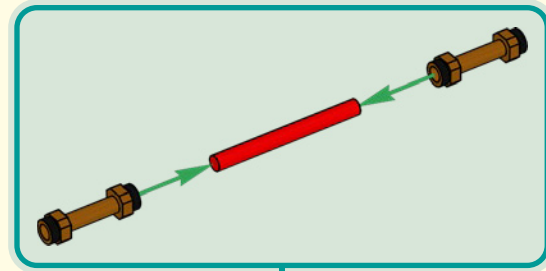
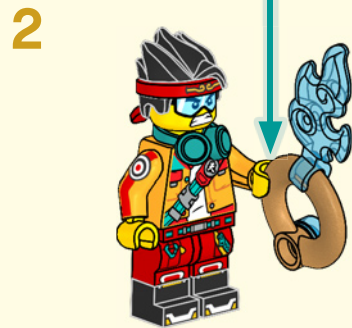
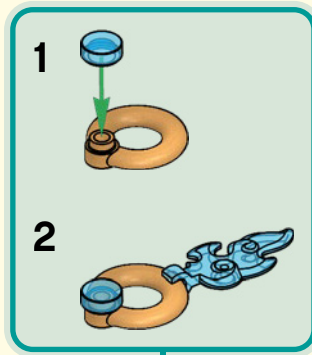
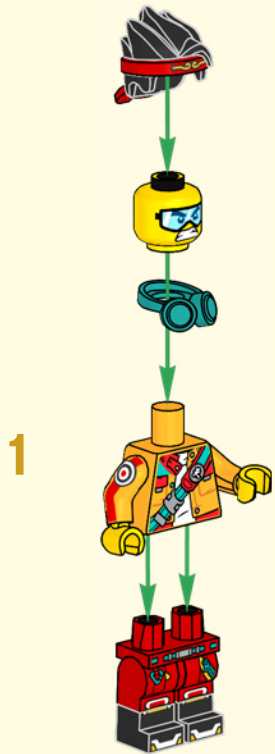
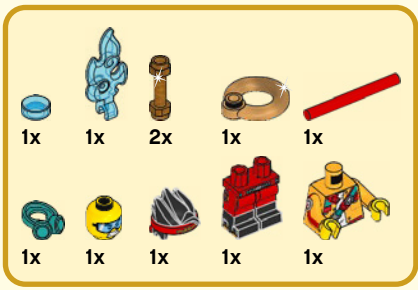

MONKIE KID



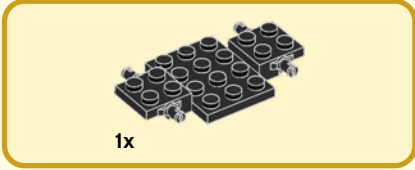
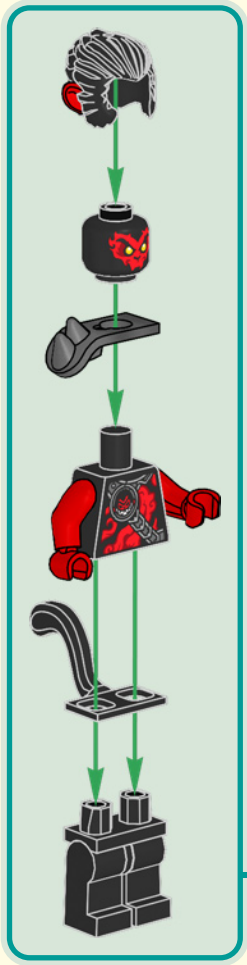
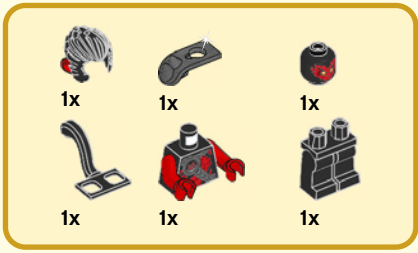

1

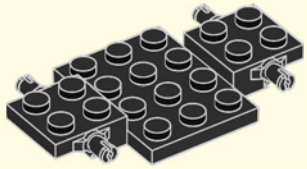

2

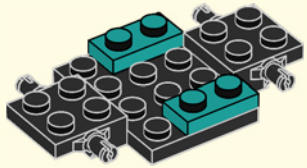



3

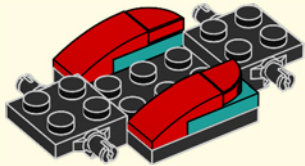

4

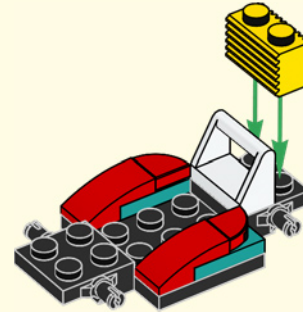

5

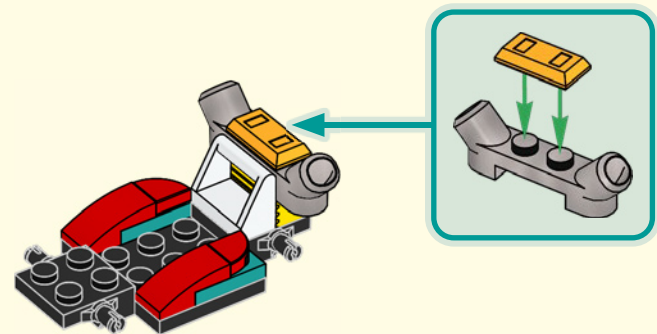



1x



2x

6

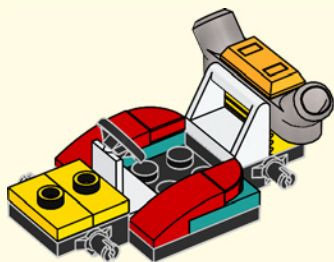

1x

7

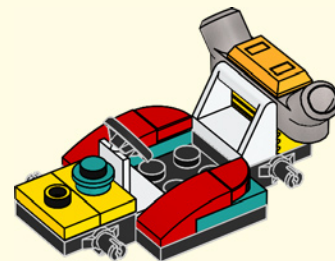

1x

8

1

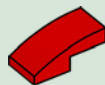

2



13





1x

9

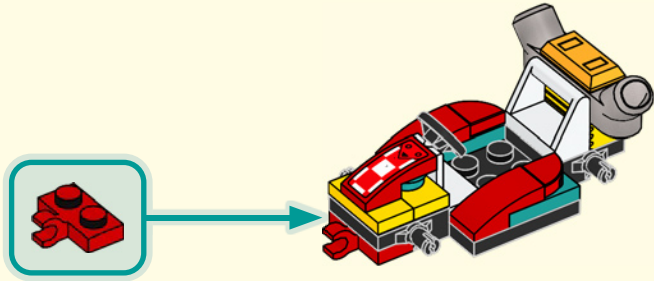

4x



4x

10

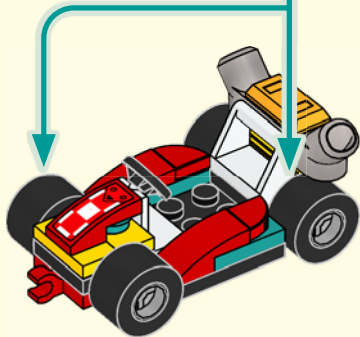
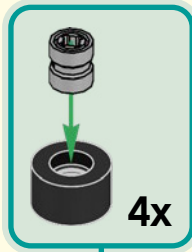

1x

11



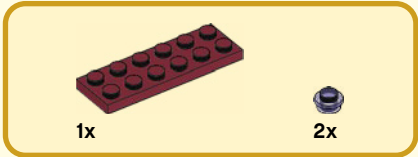

1

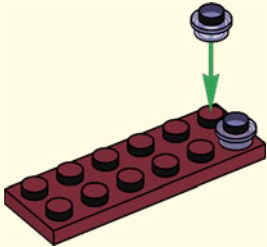

2

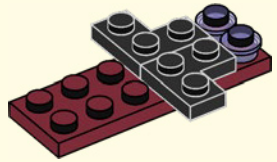

3

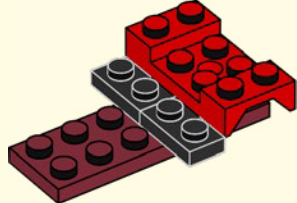

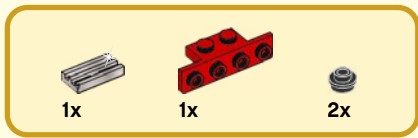

4

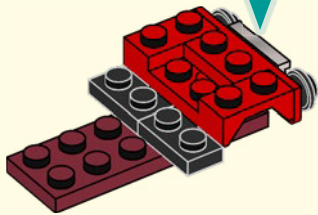
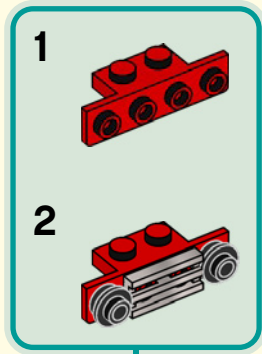

5

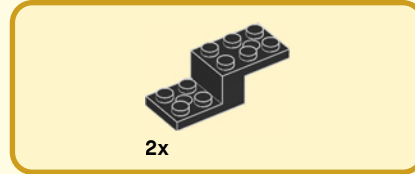
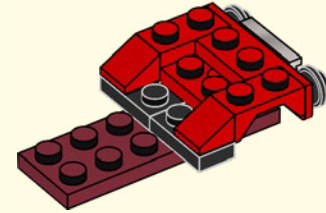

6

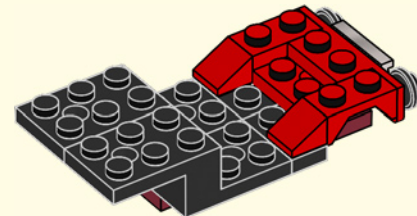



1x

7

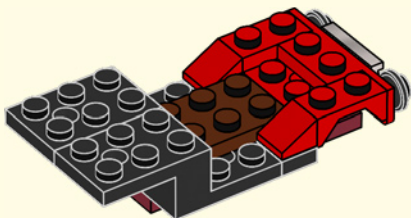

2x

8

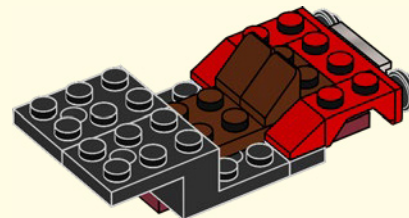

1x



1x

9

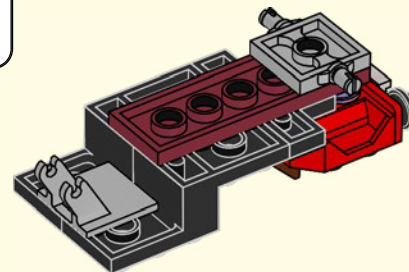



10

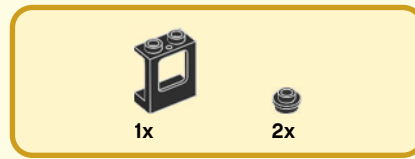
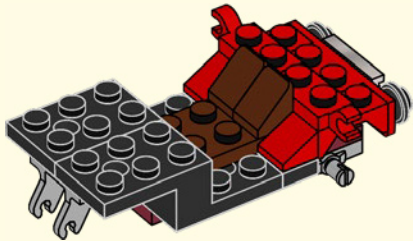

11

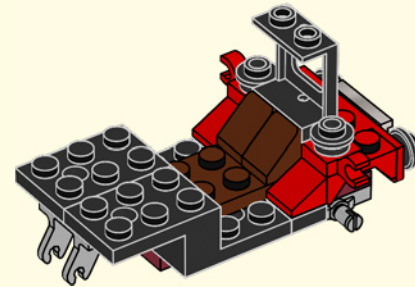



12

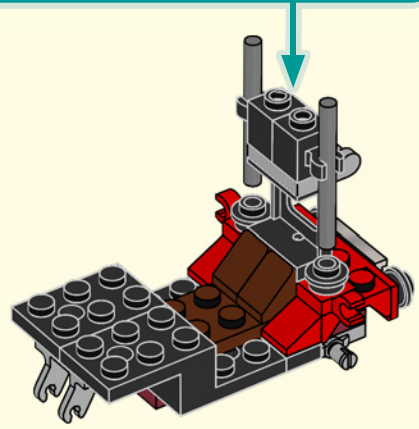
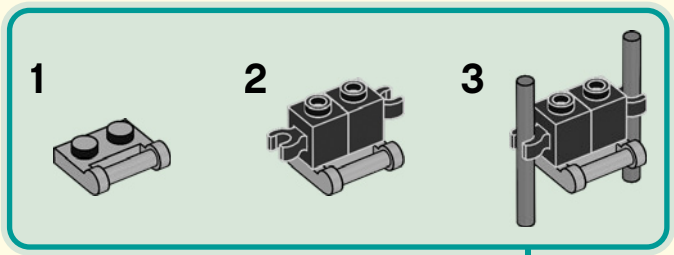

13

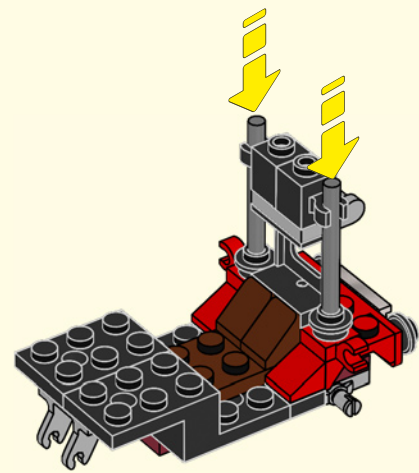

14

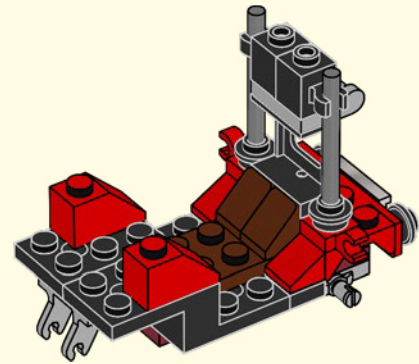



15

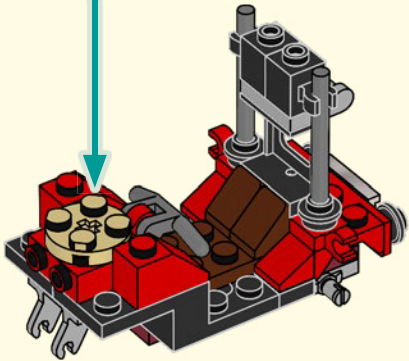
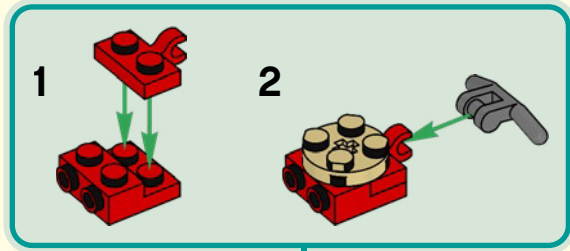

16

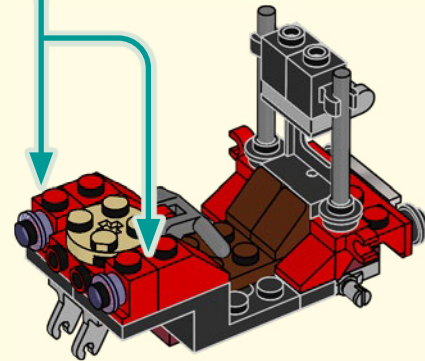
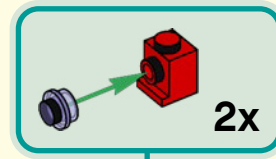

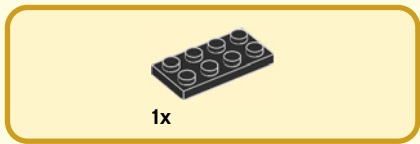

17

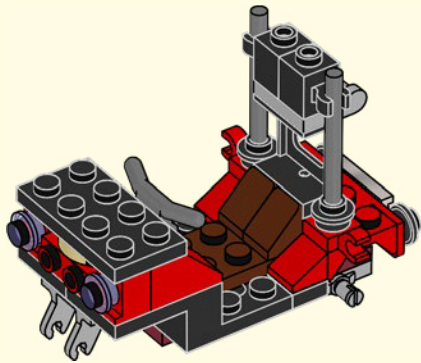

18

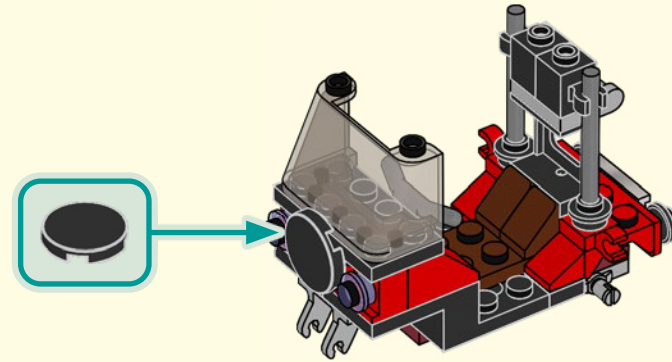

19

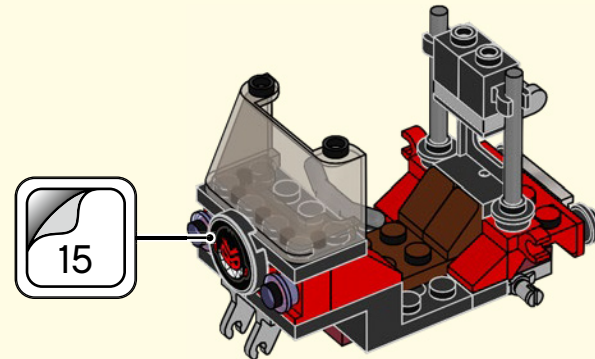

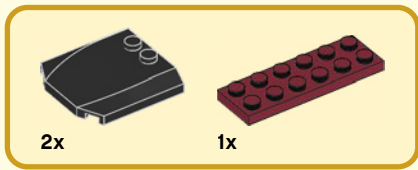

20

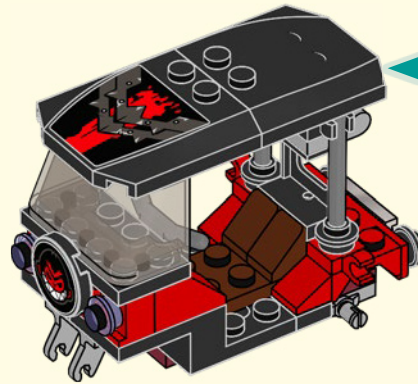
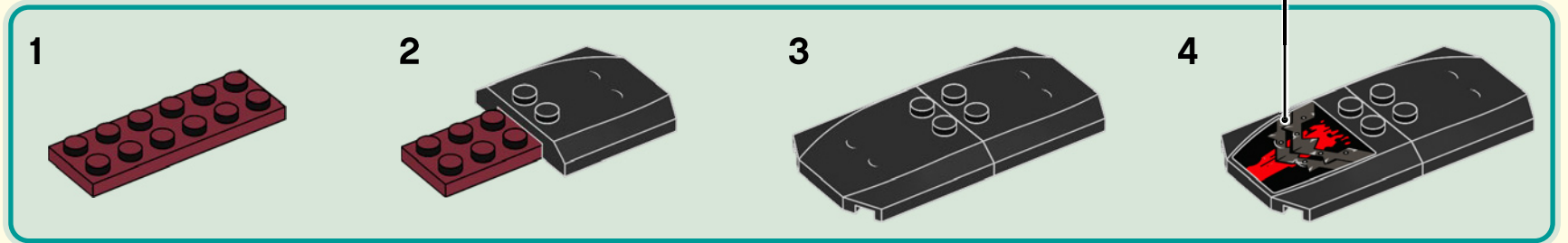



21

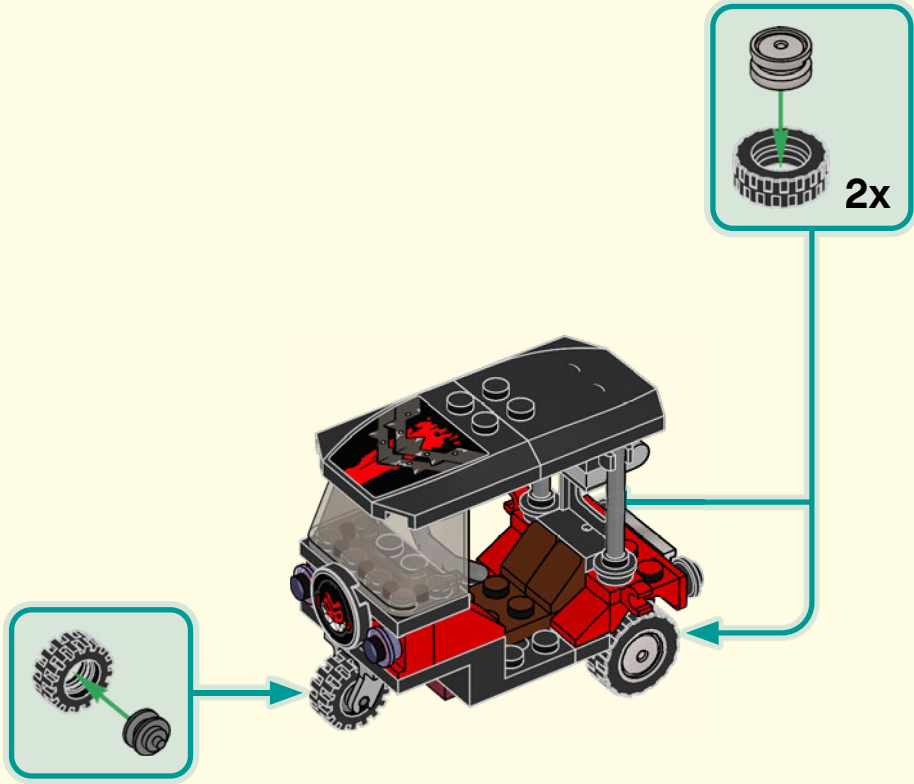

22

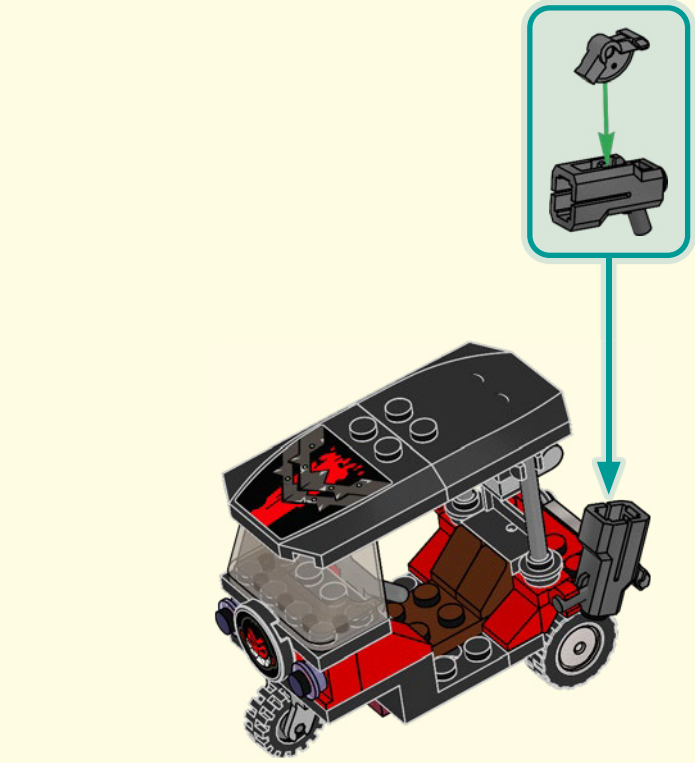



2x

23

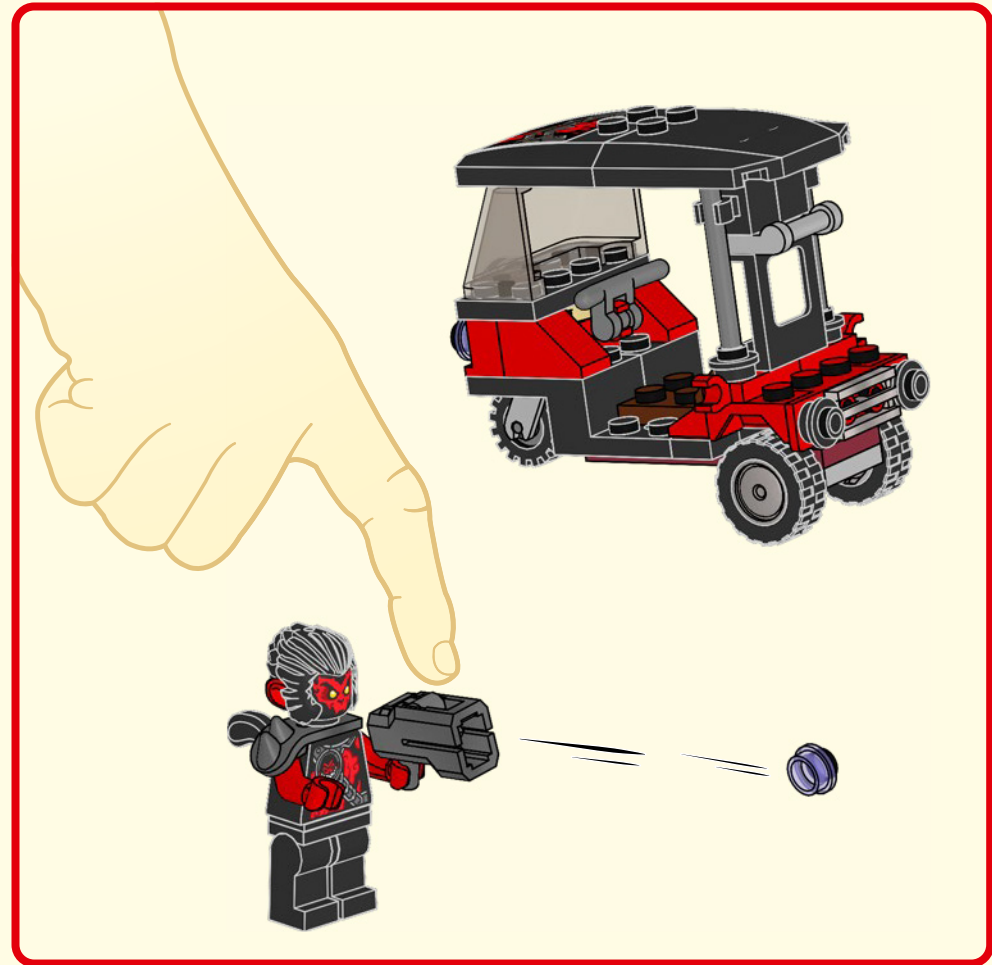

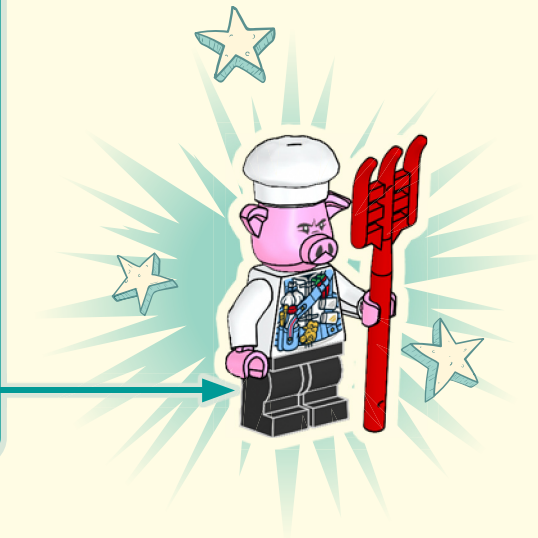
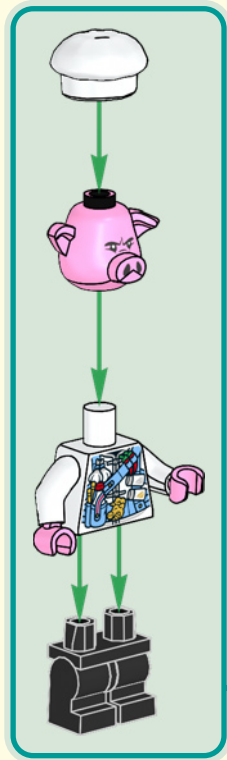
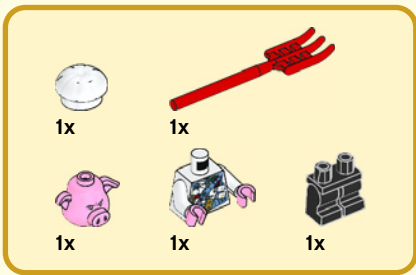

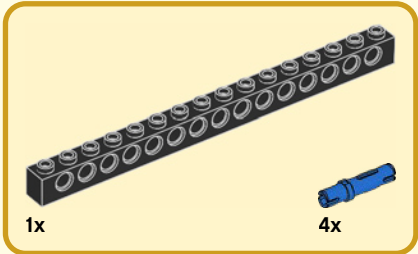
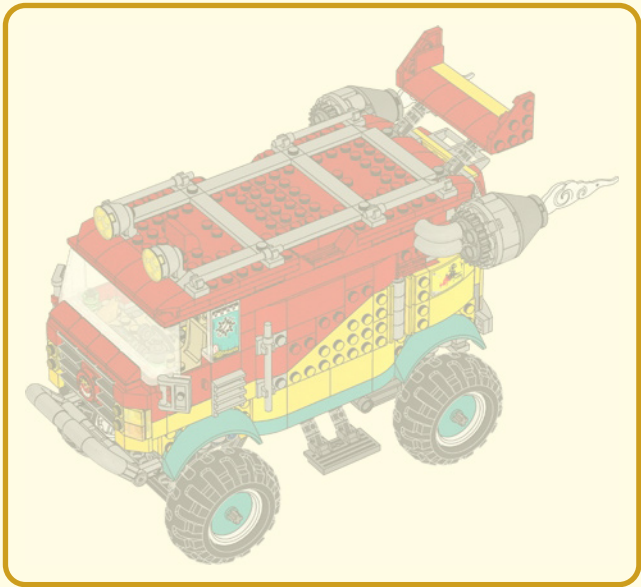

1

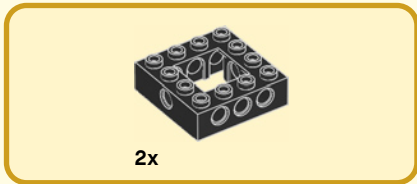
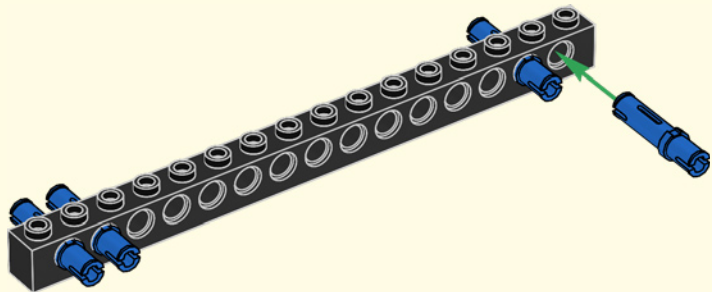

2

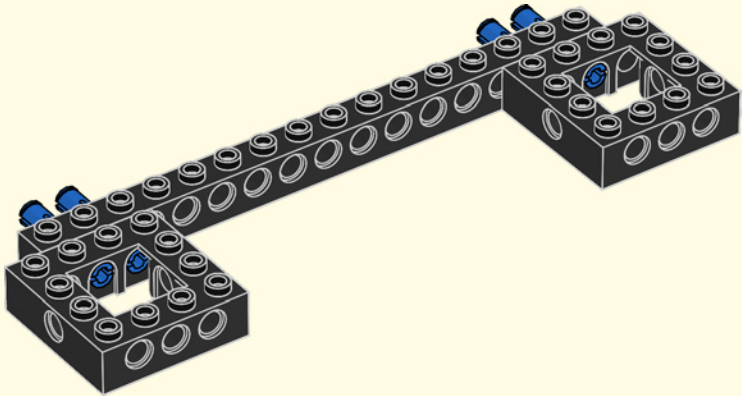

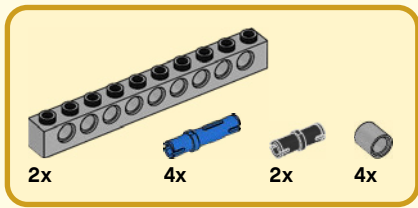

3

1

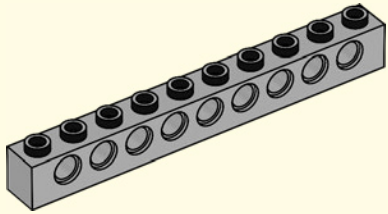

2

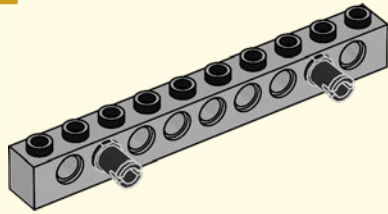

3

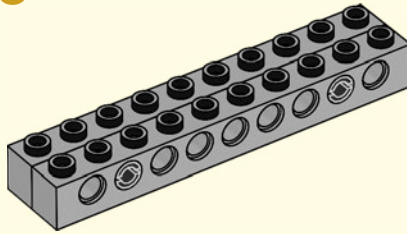

4

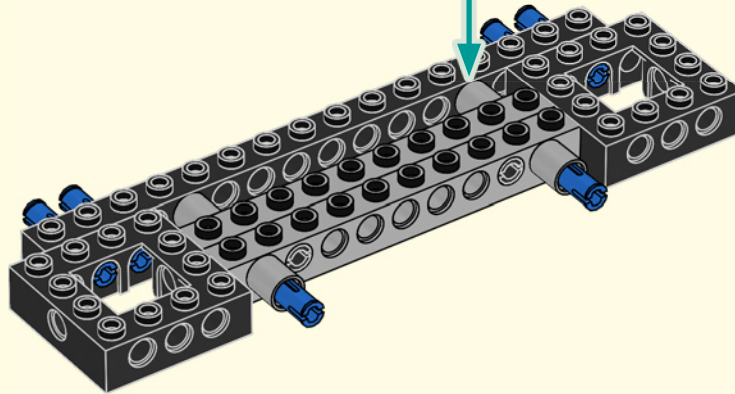
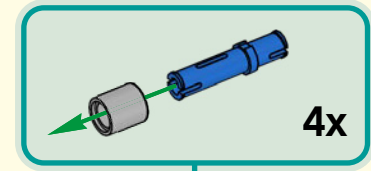
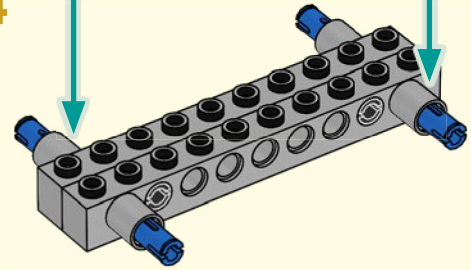



4

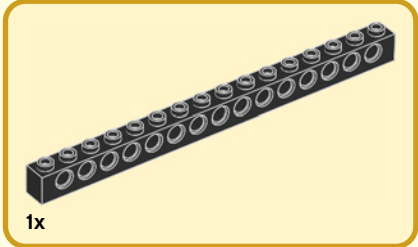
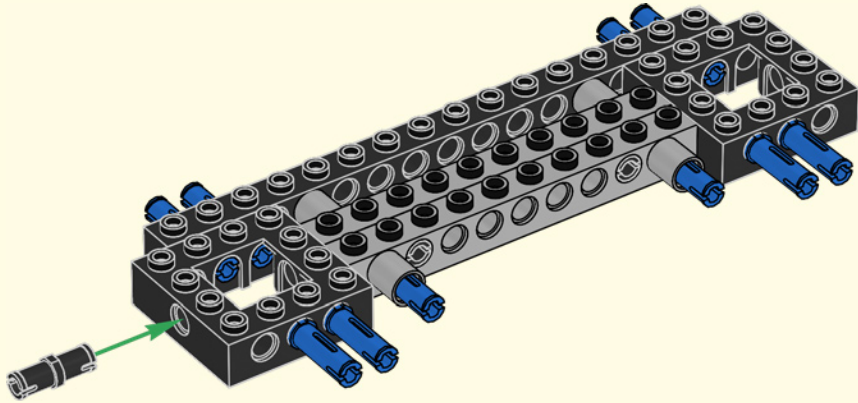

5

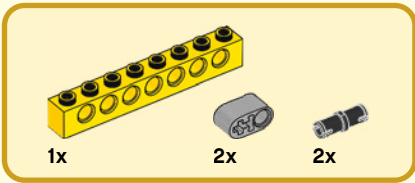
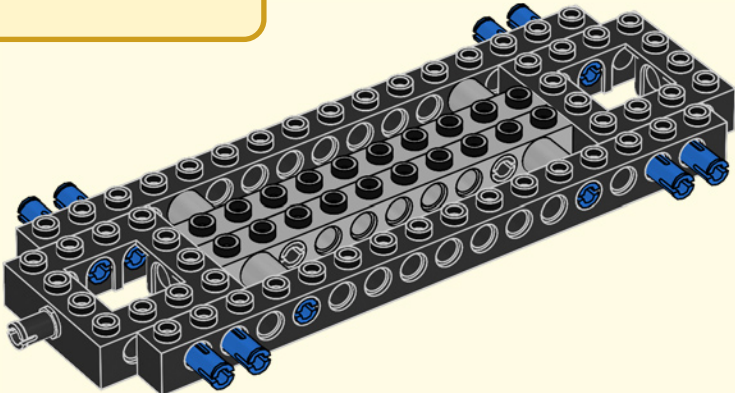

6

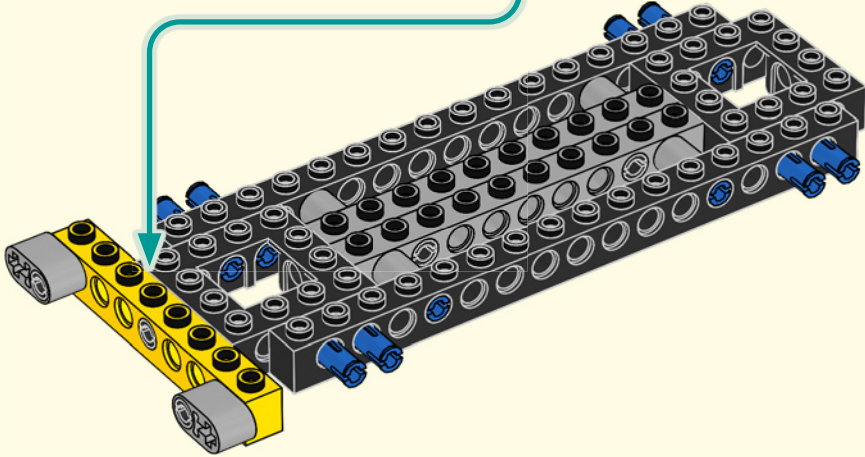
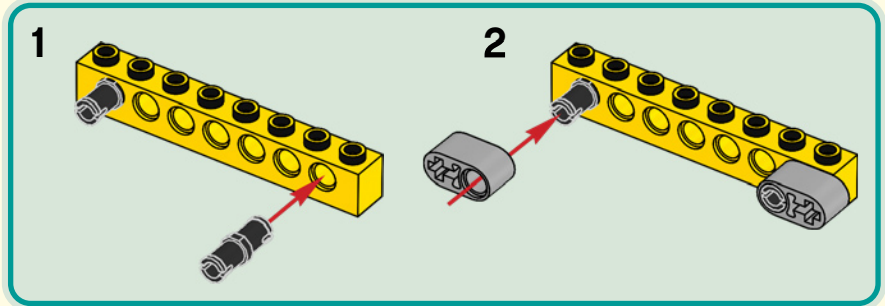

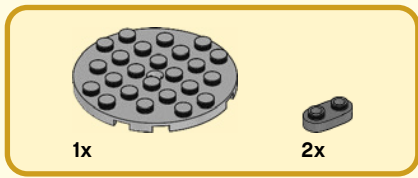

7

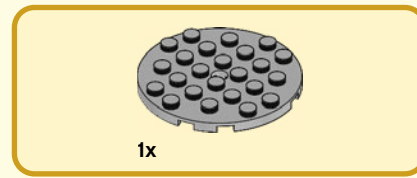
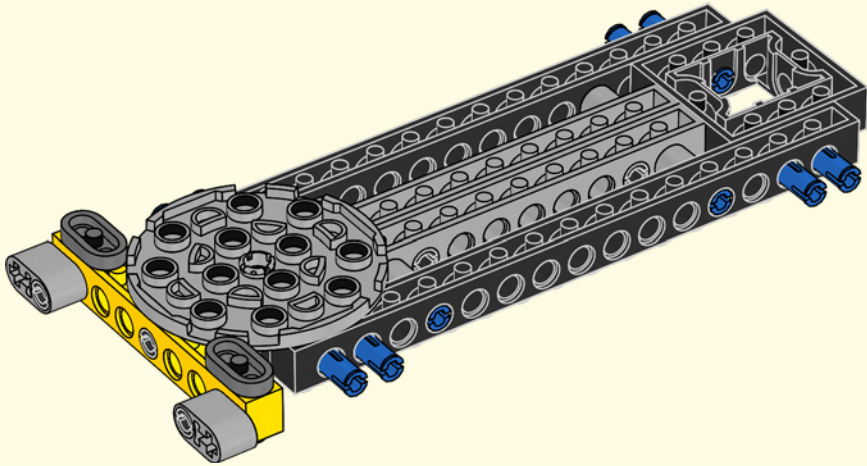

8

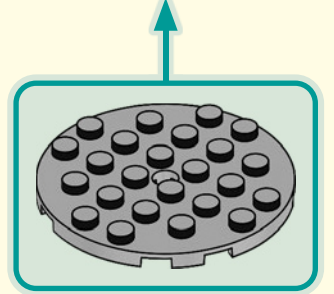
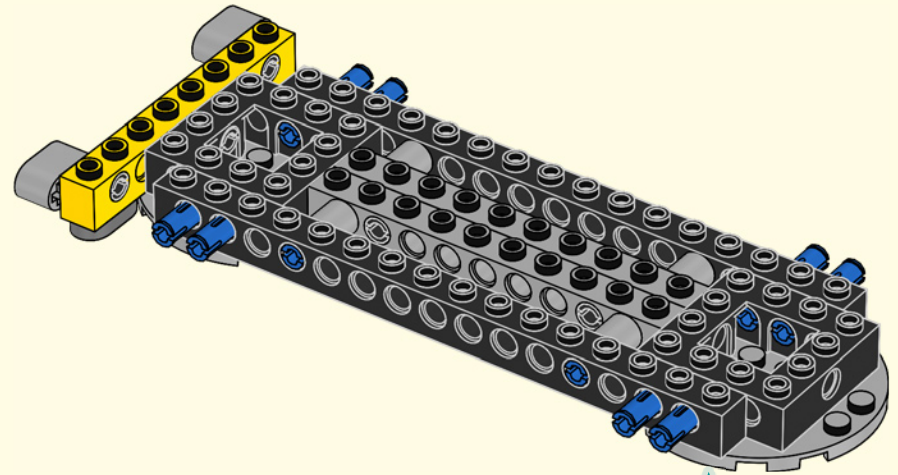
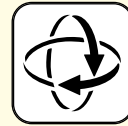

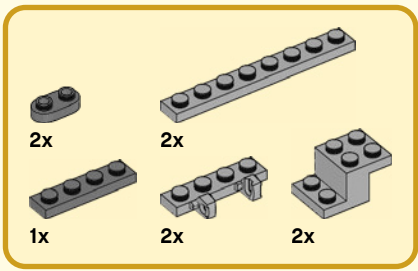

9

1

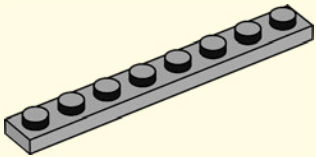

2

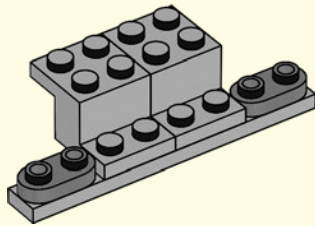

3

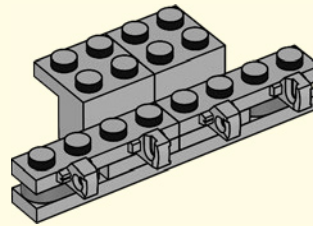

4

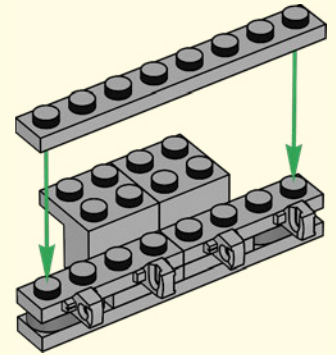

5

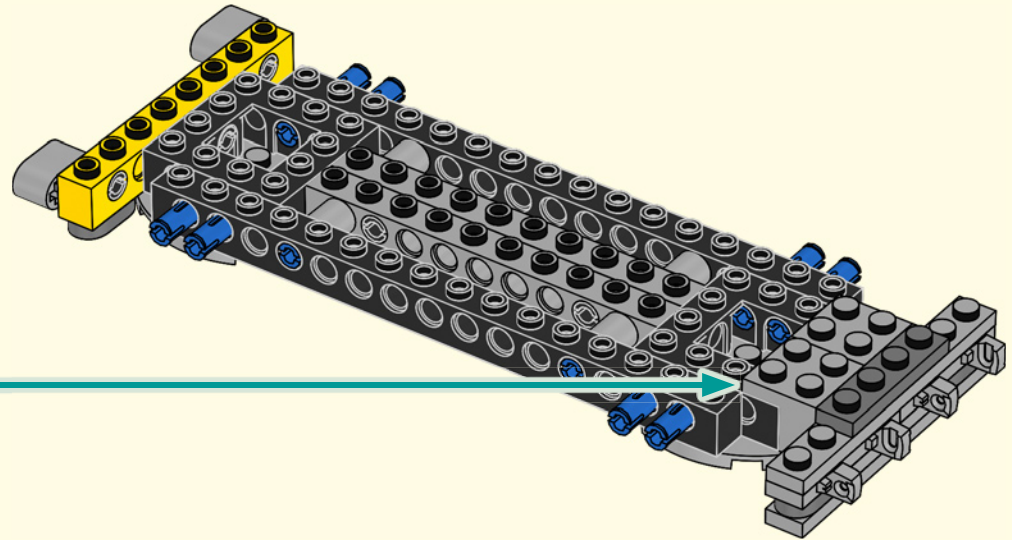
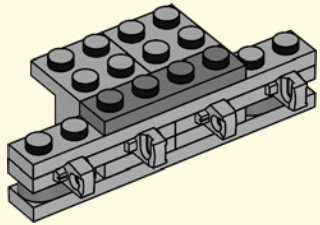

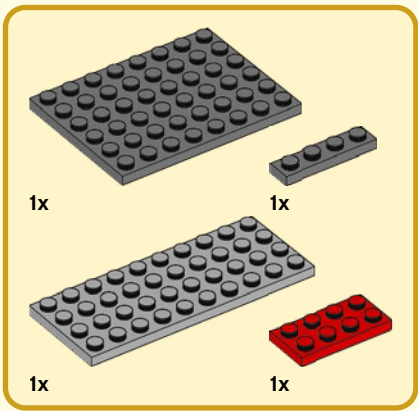

10

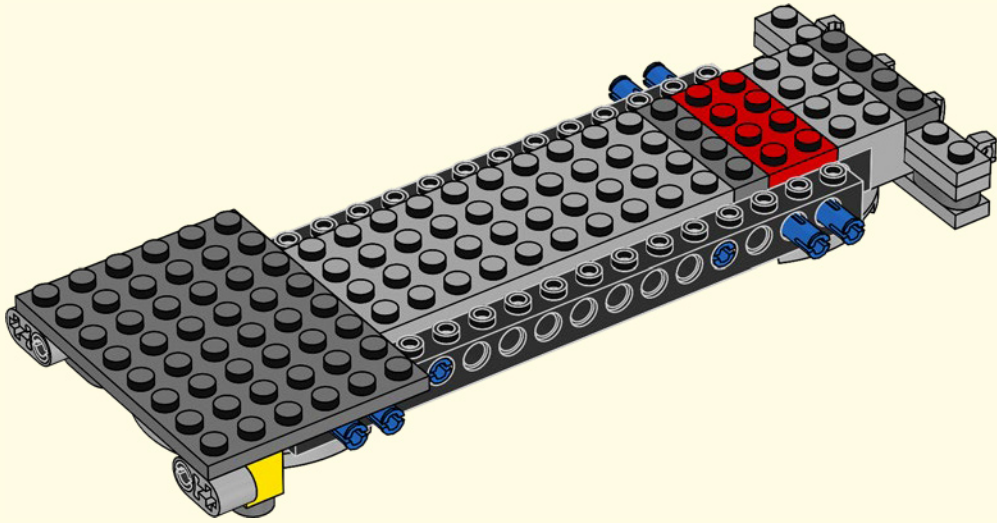

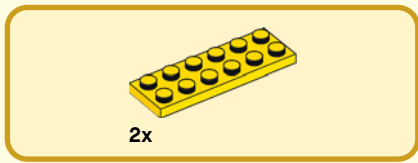

11

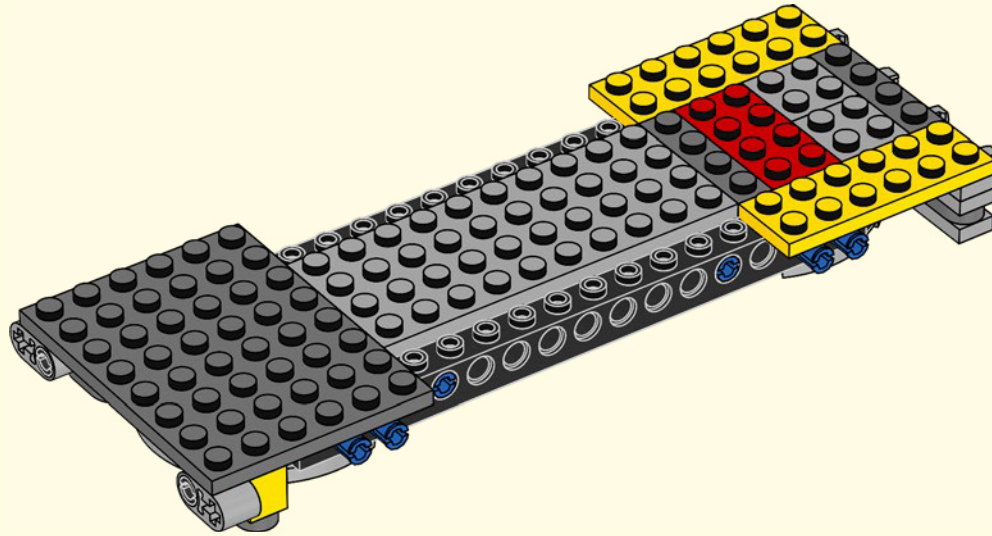

12

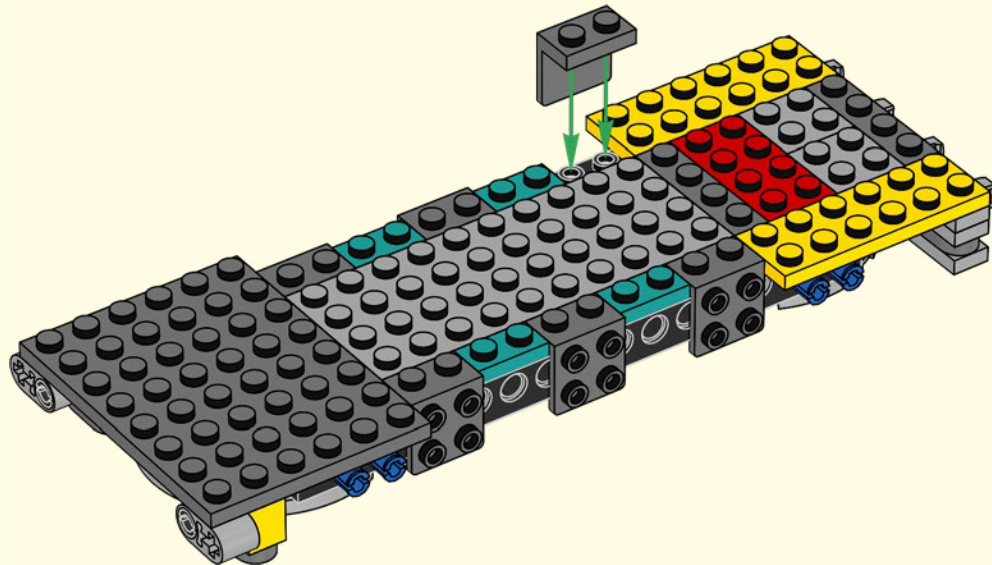

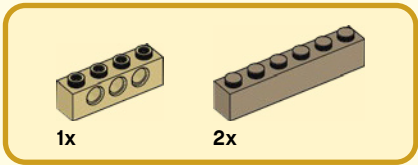

13

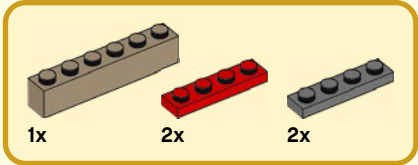
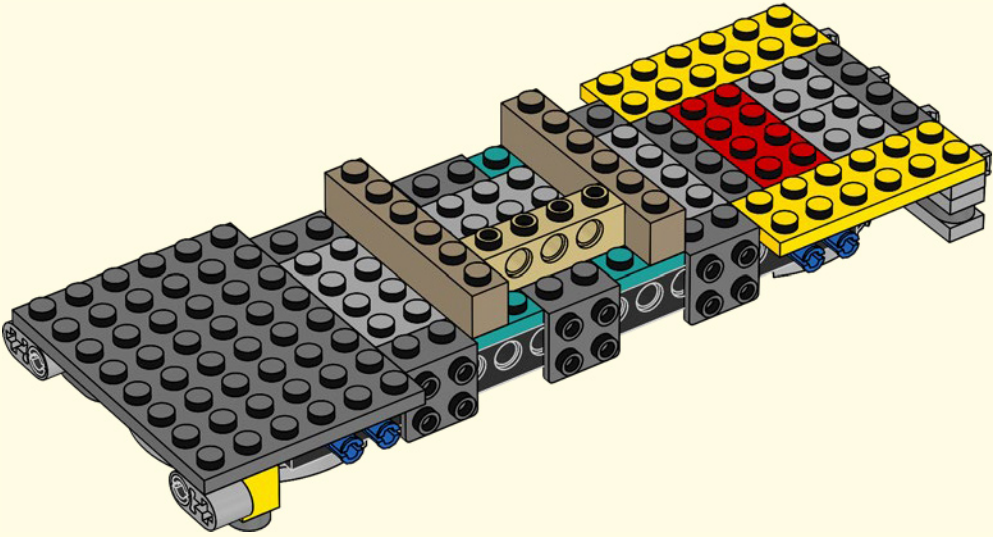

14

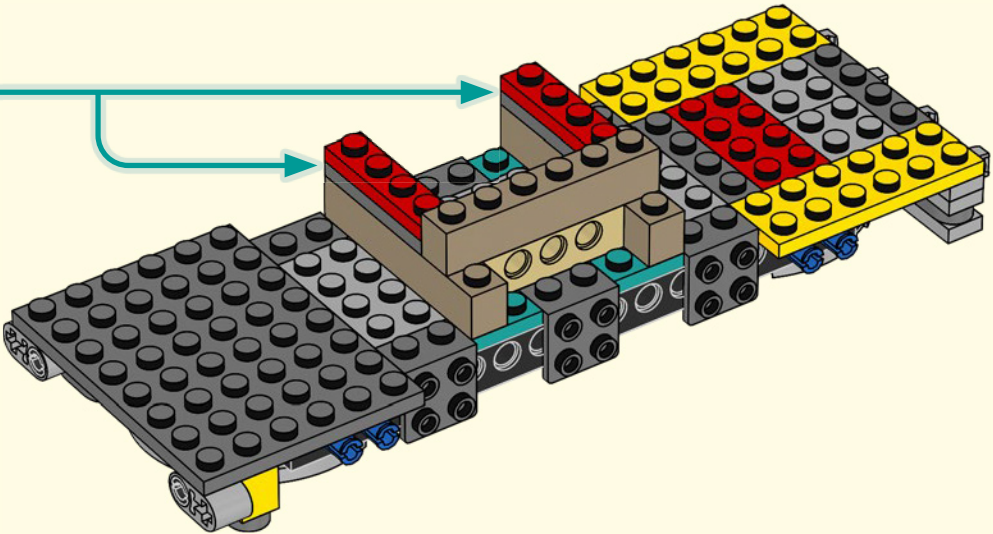
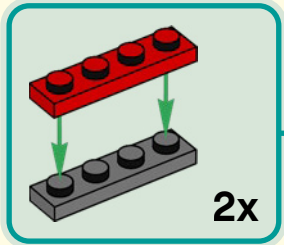



2x

15

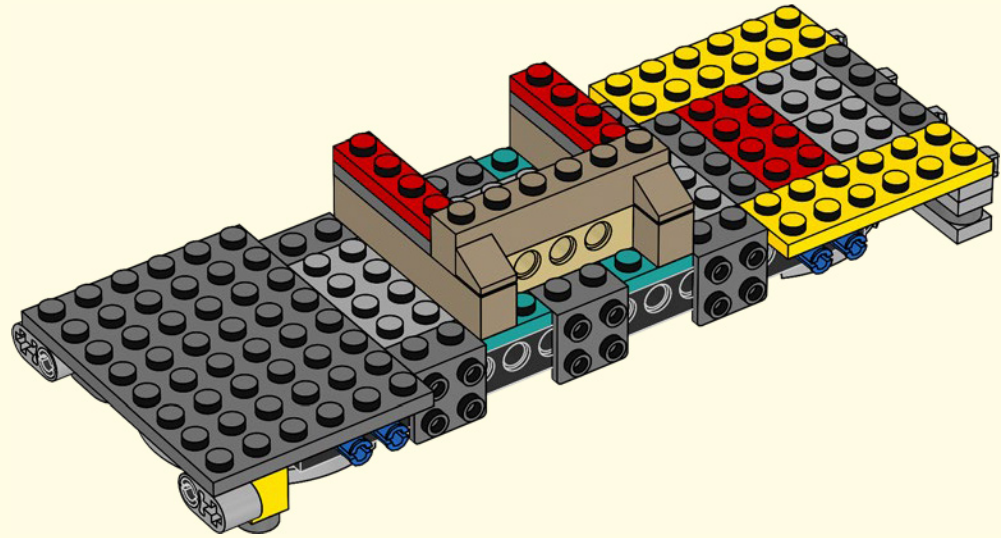

4x

16

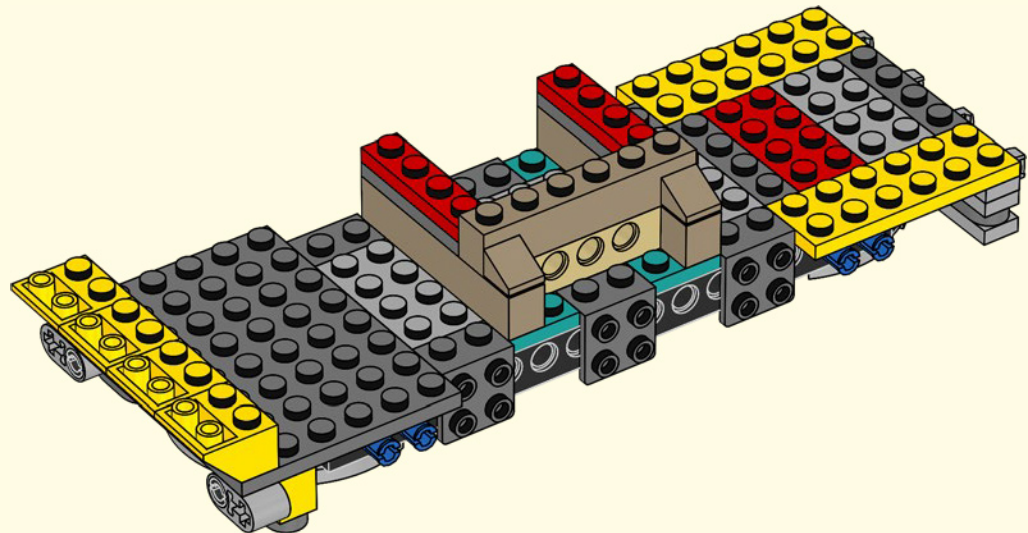

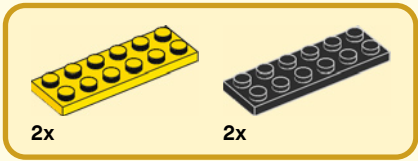

17

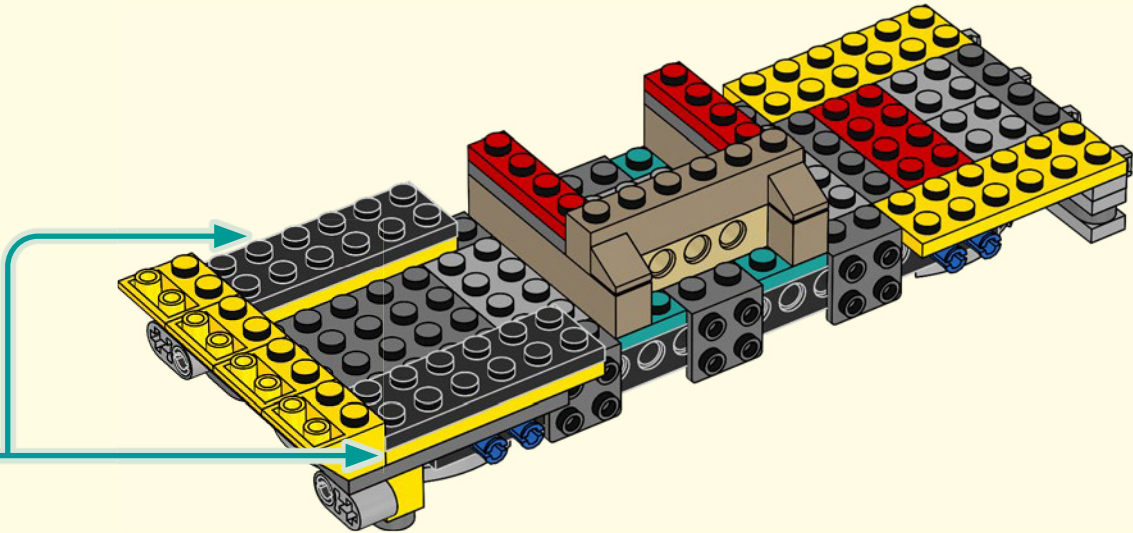
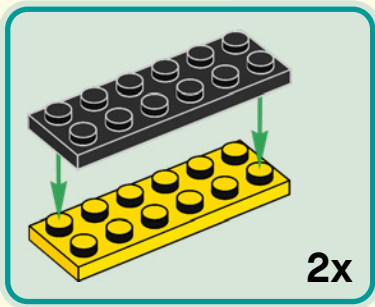

18

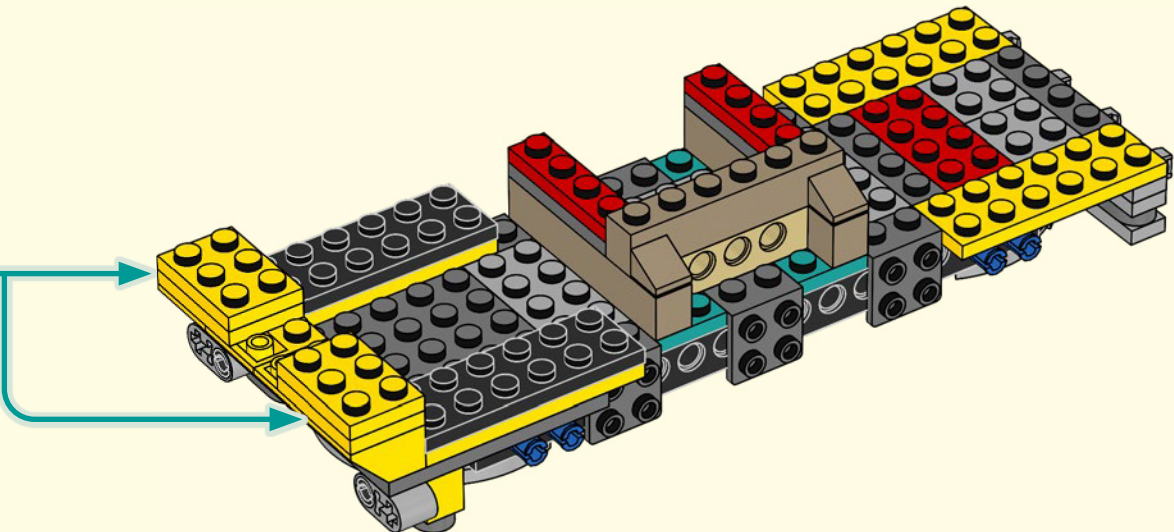
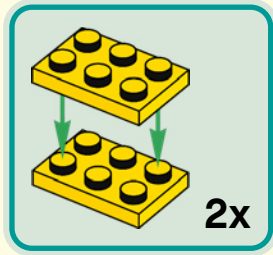

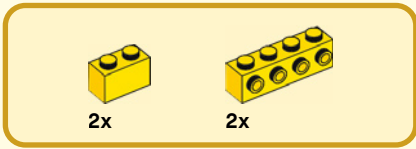

19

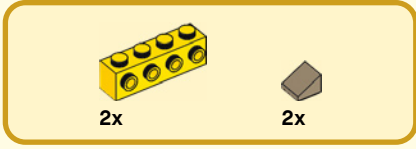
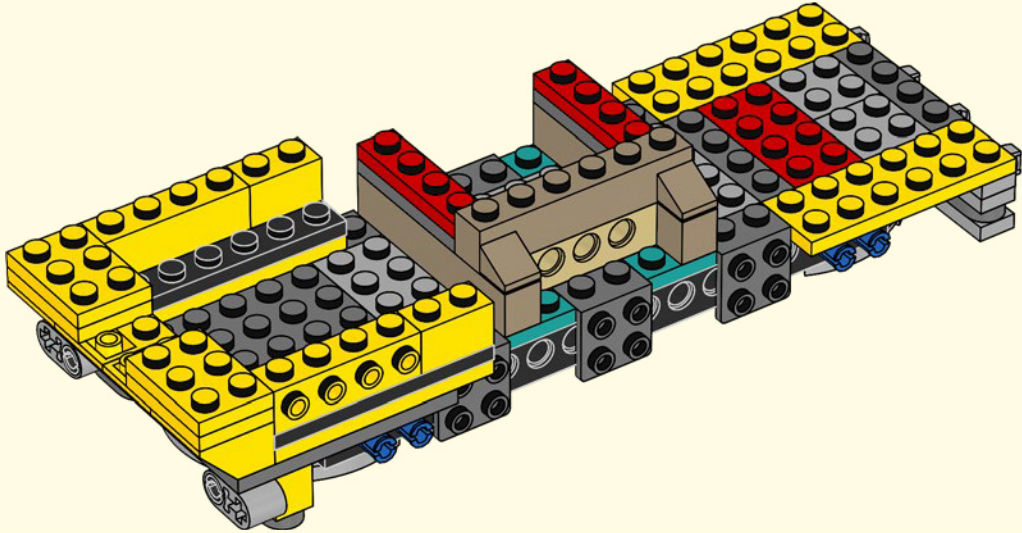

20

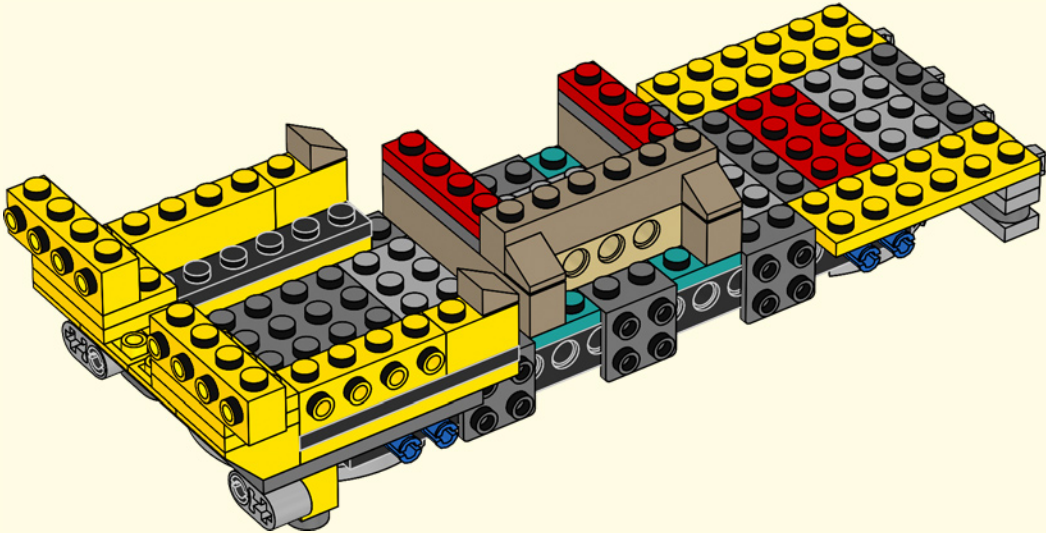

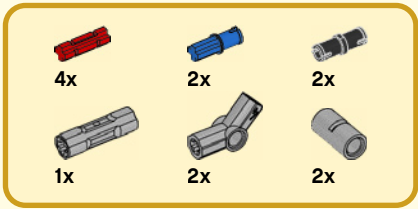

21

1

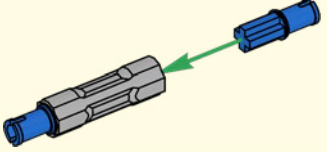

2

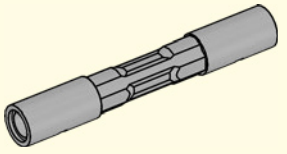

3

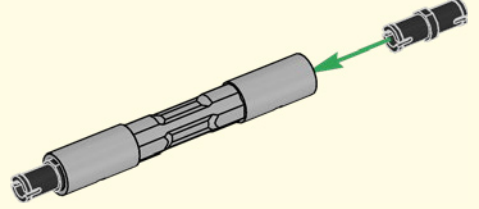

4

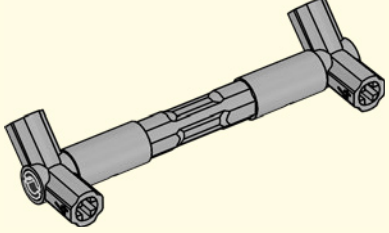

5

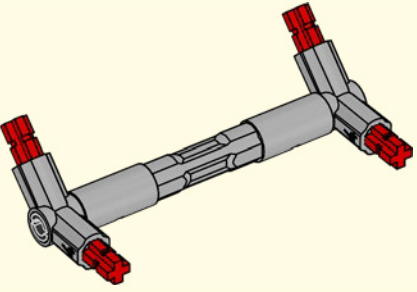

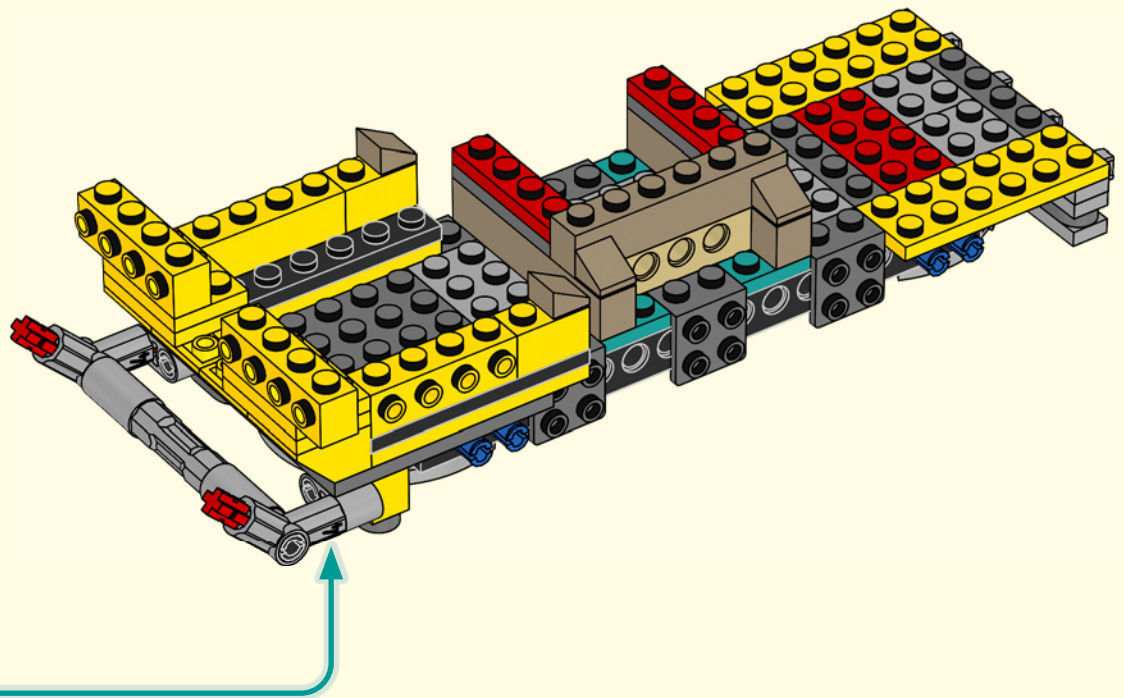

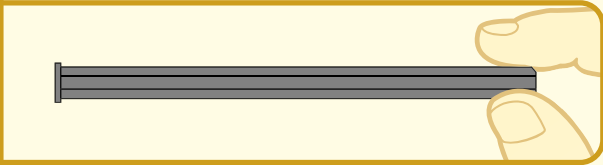
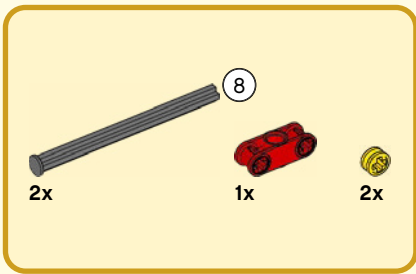

22

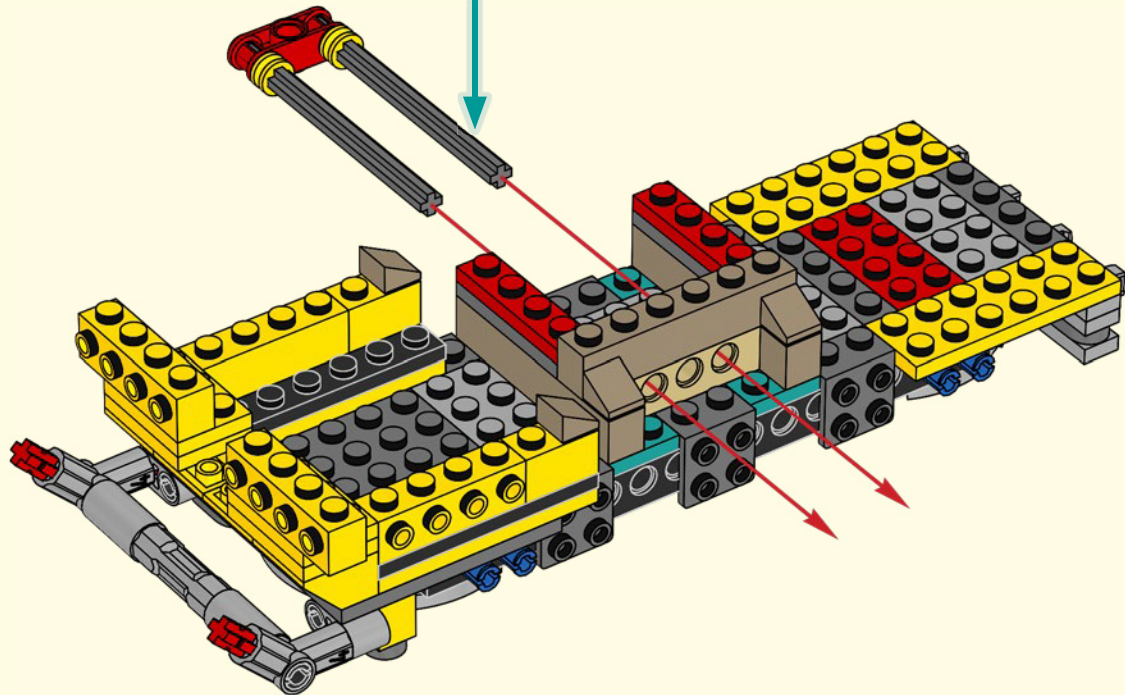
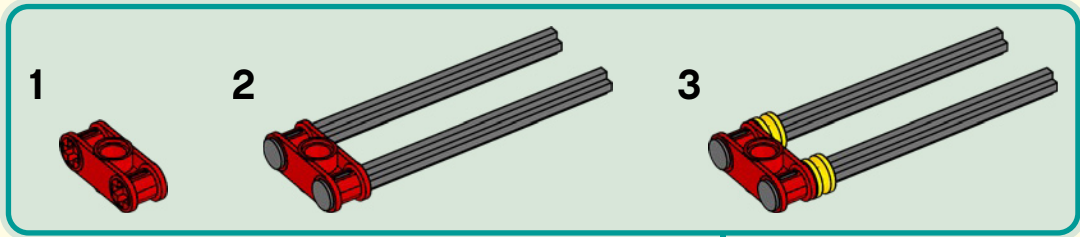

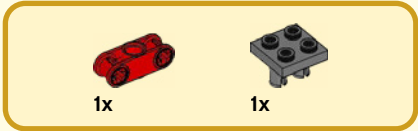

23

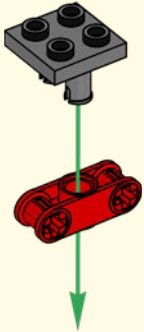

24

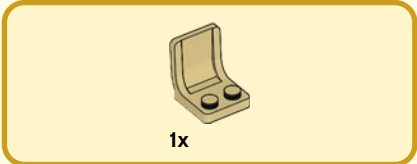
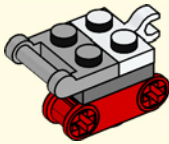

25

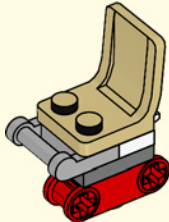

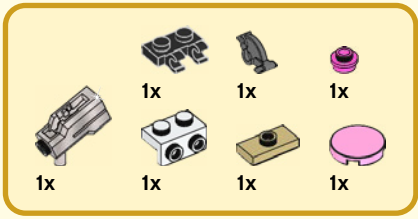

26



1

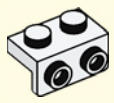

2

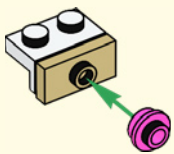

3

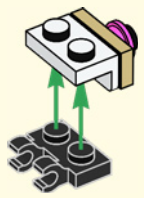

4

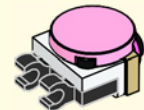

5

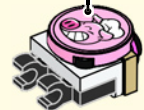

6

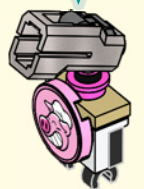
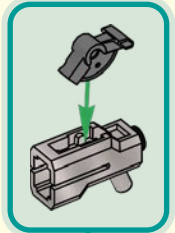



27

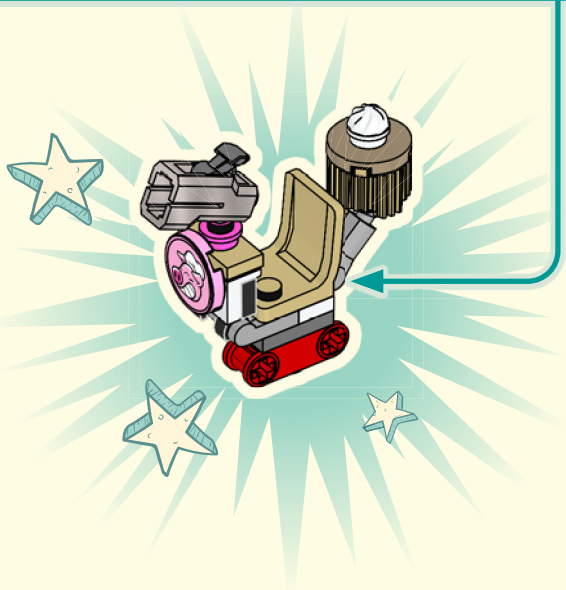
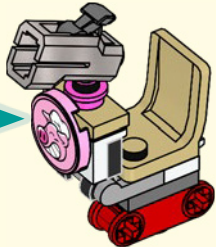
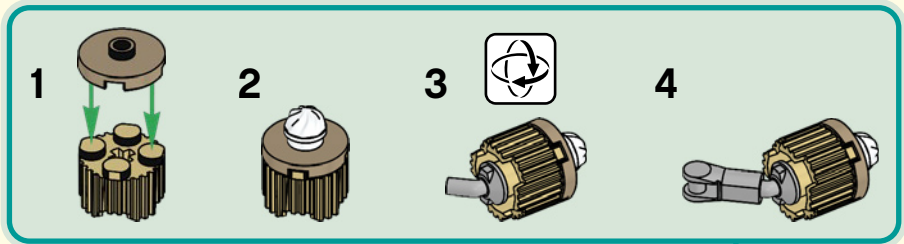

28

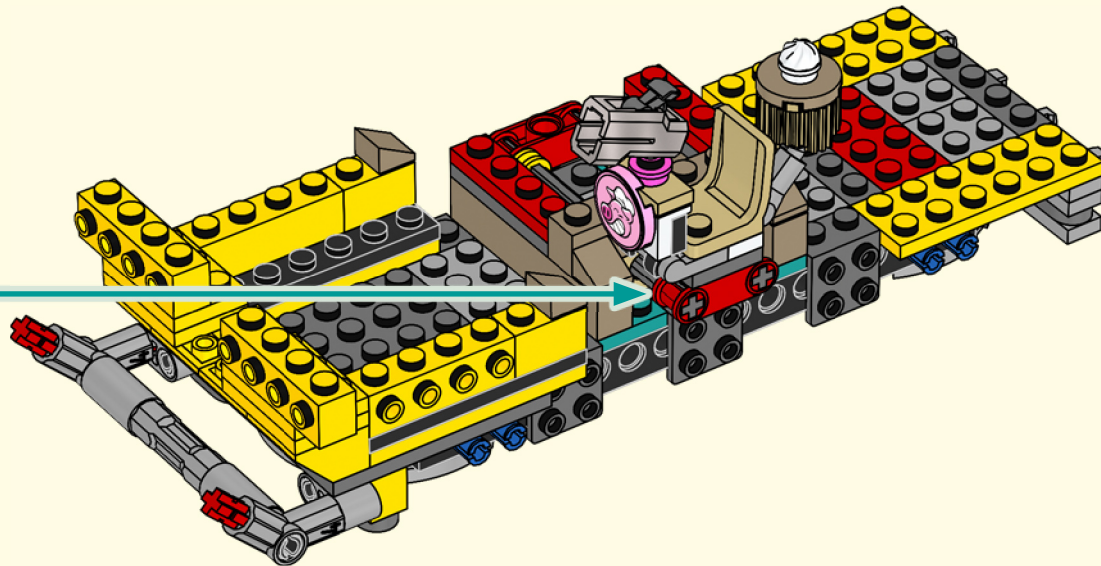

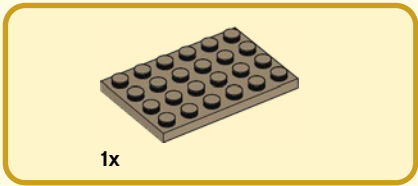

29

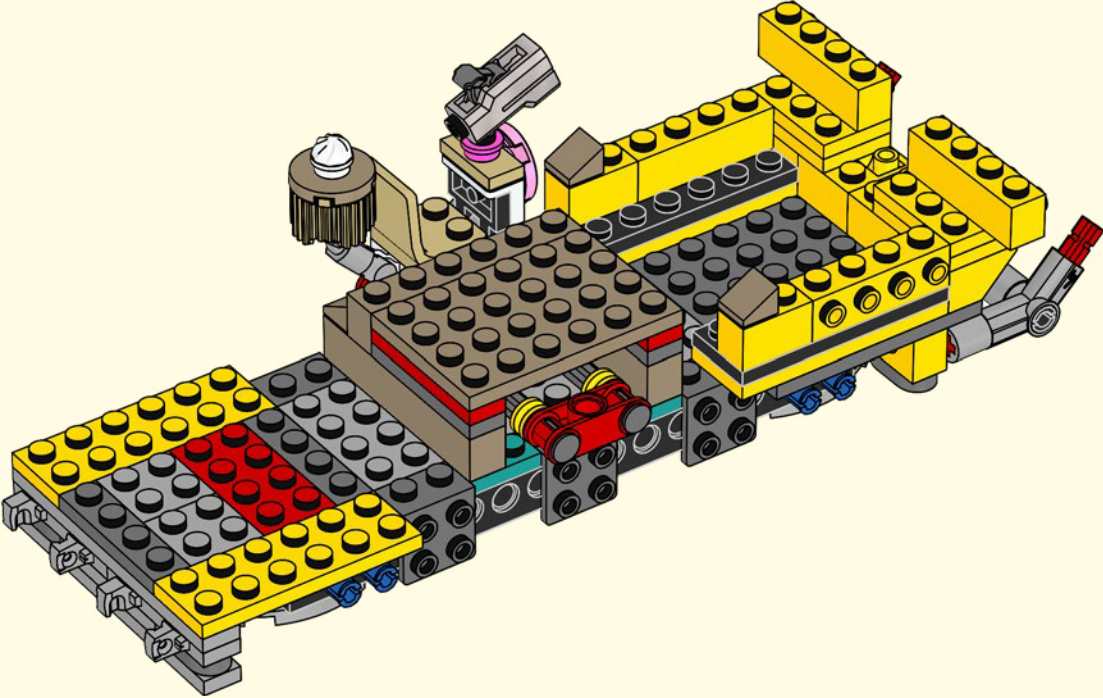

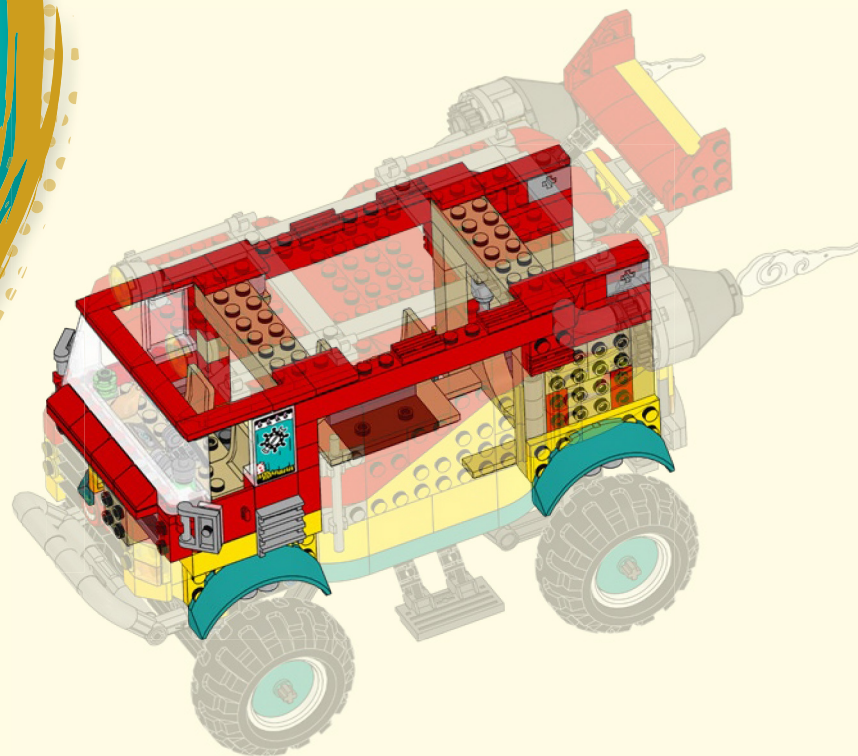

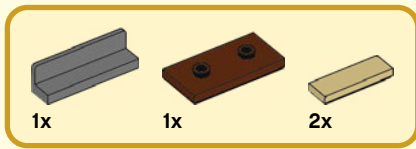

30

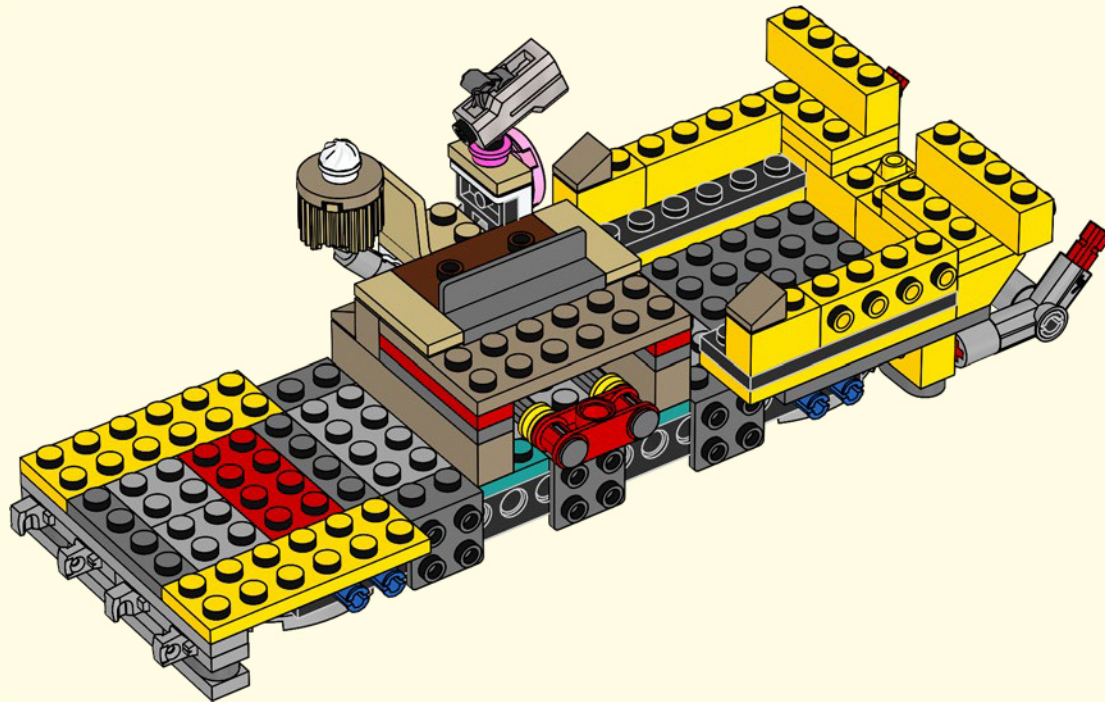



2x



2x

31

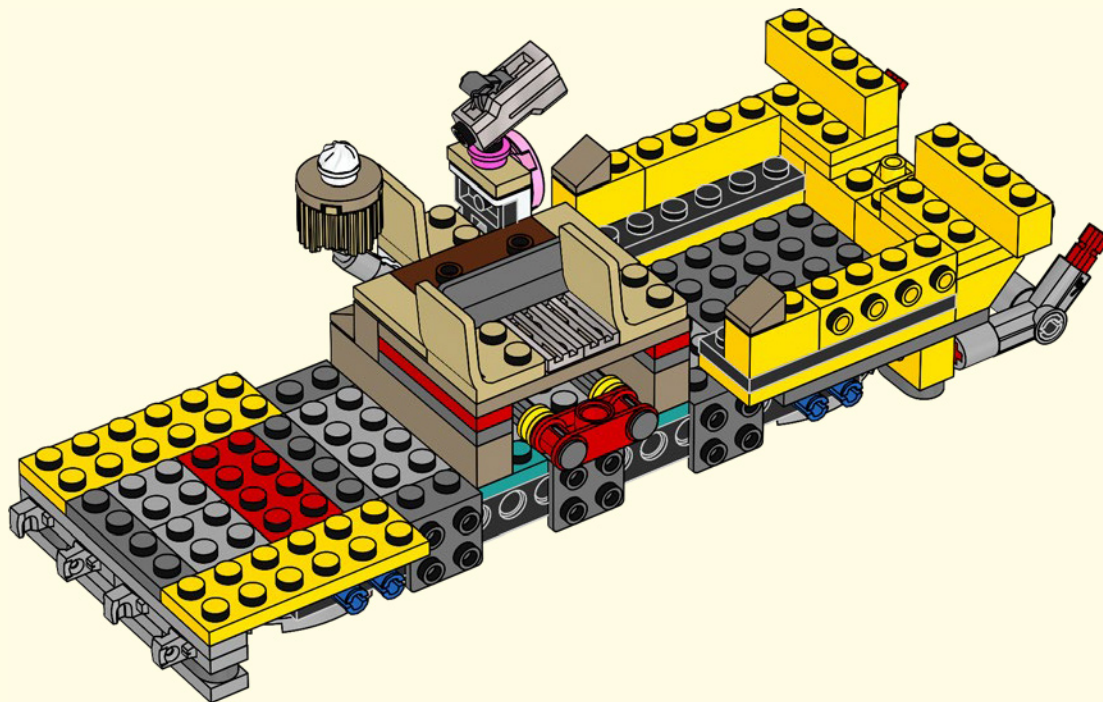



32

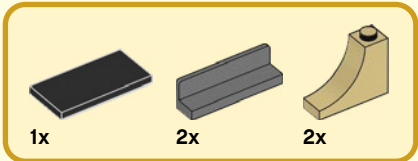
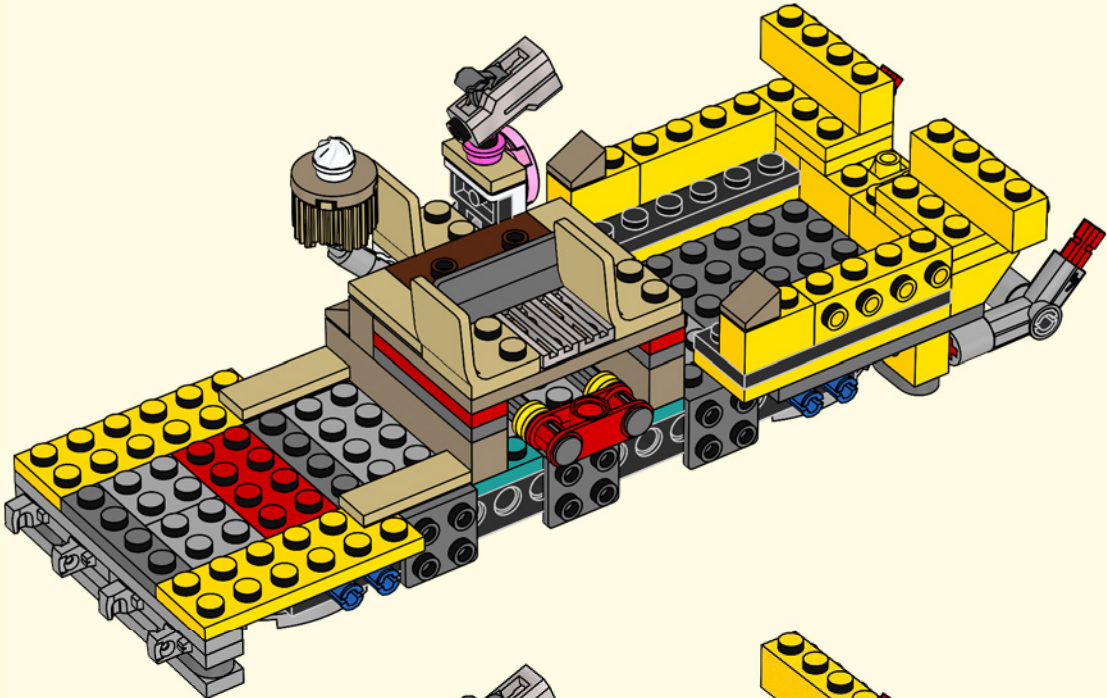

33

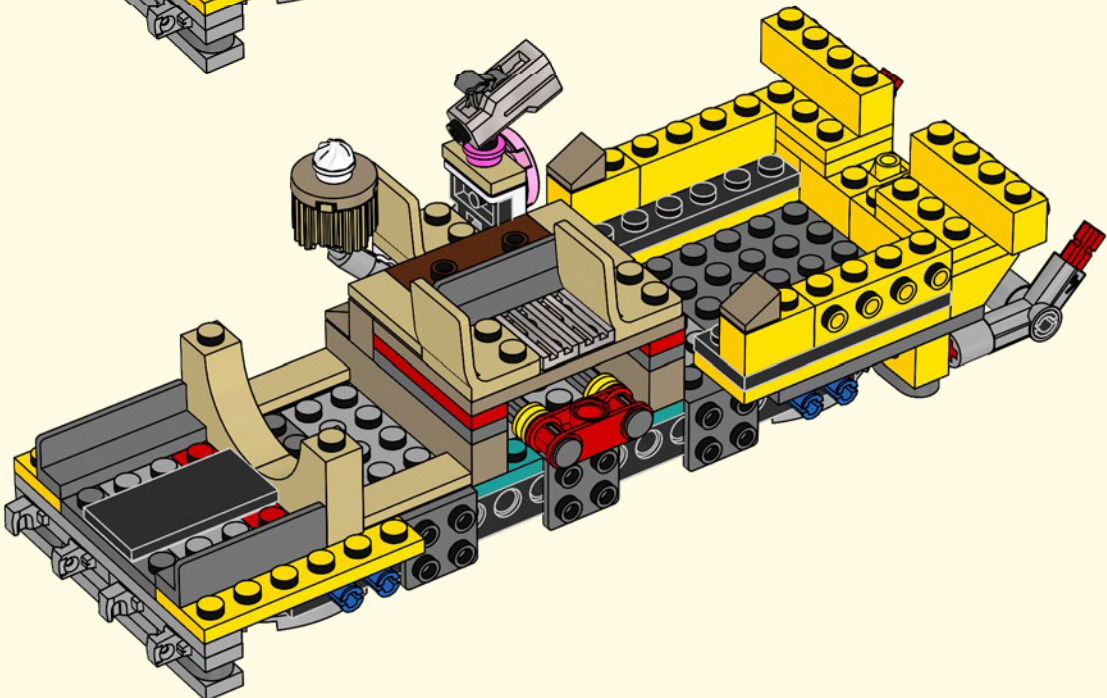

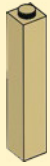

2x

34

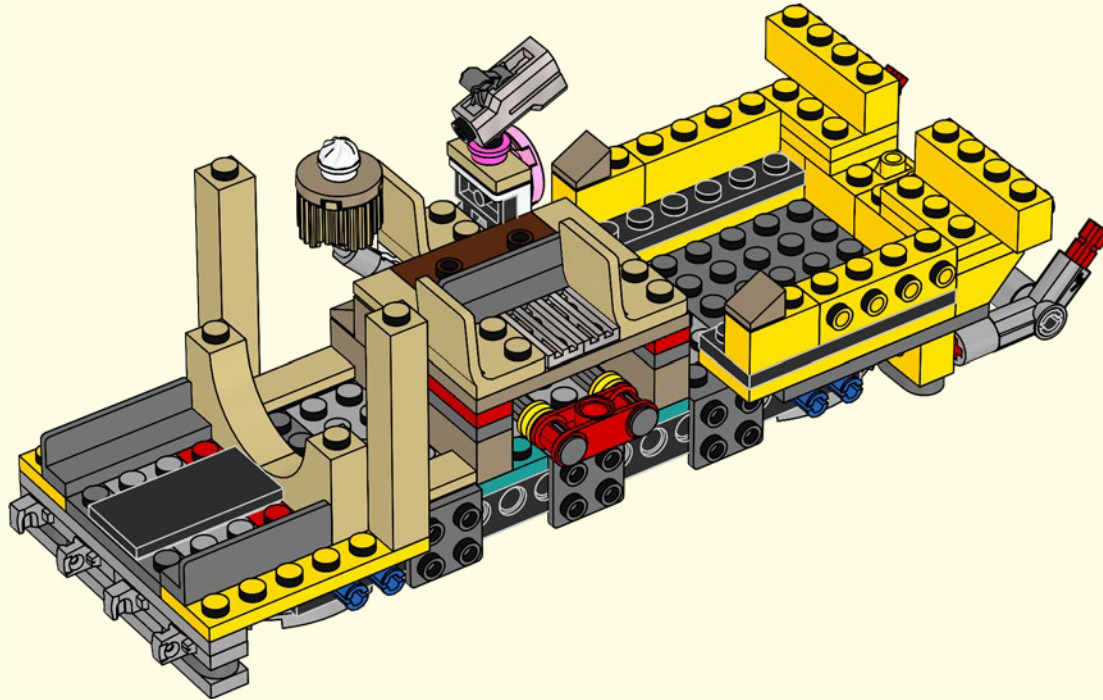



4x

35

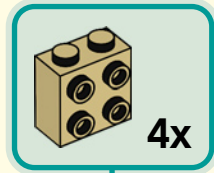

4x

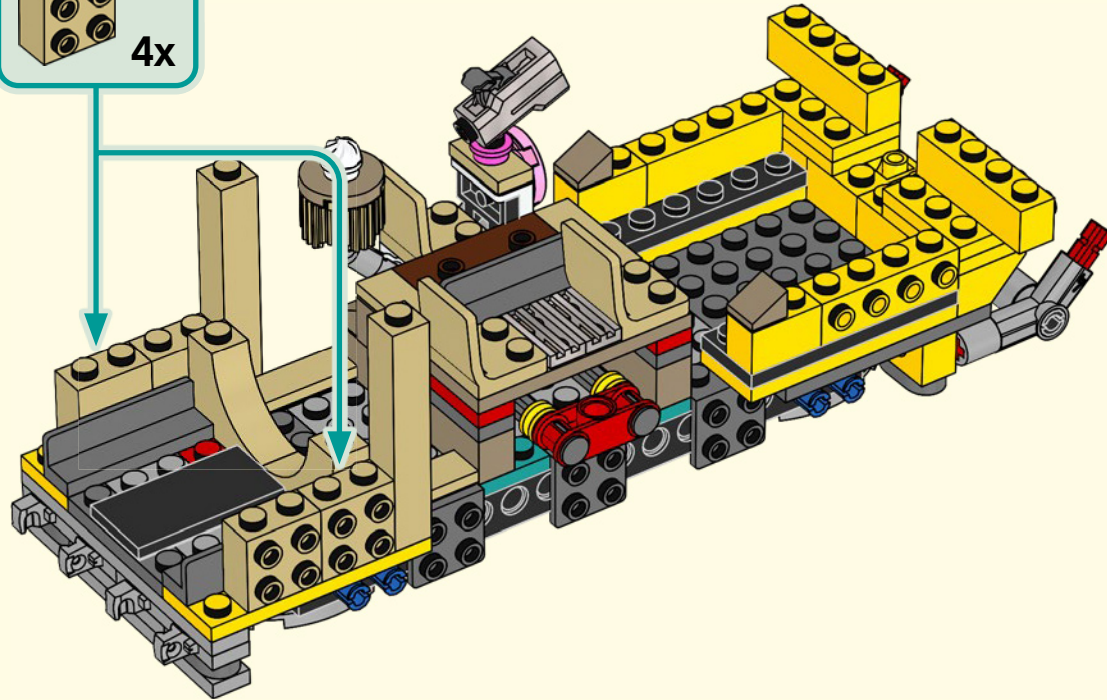

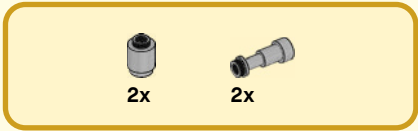

36

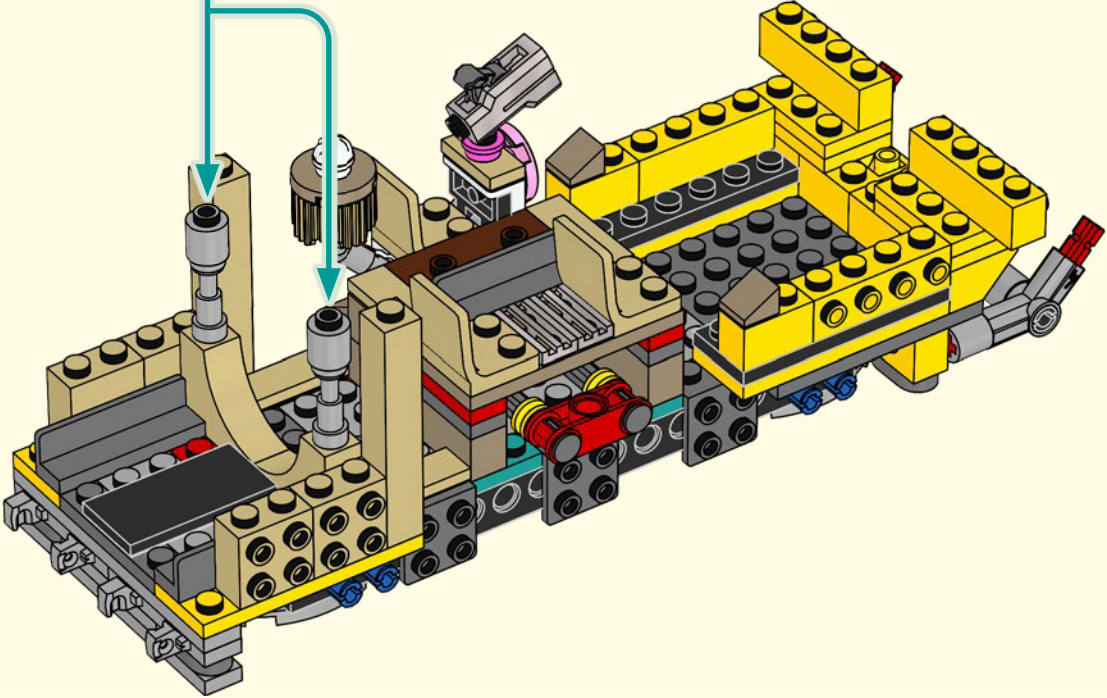
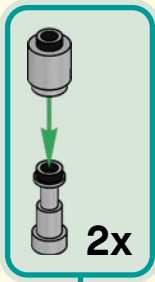



4x



2x

37

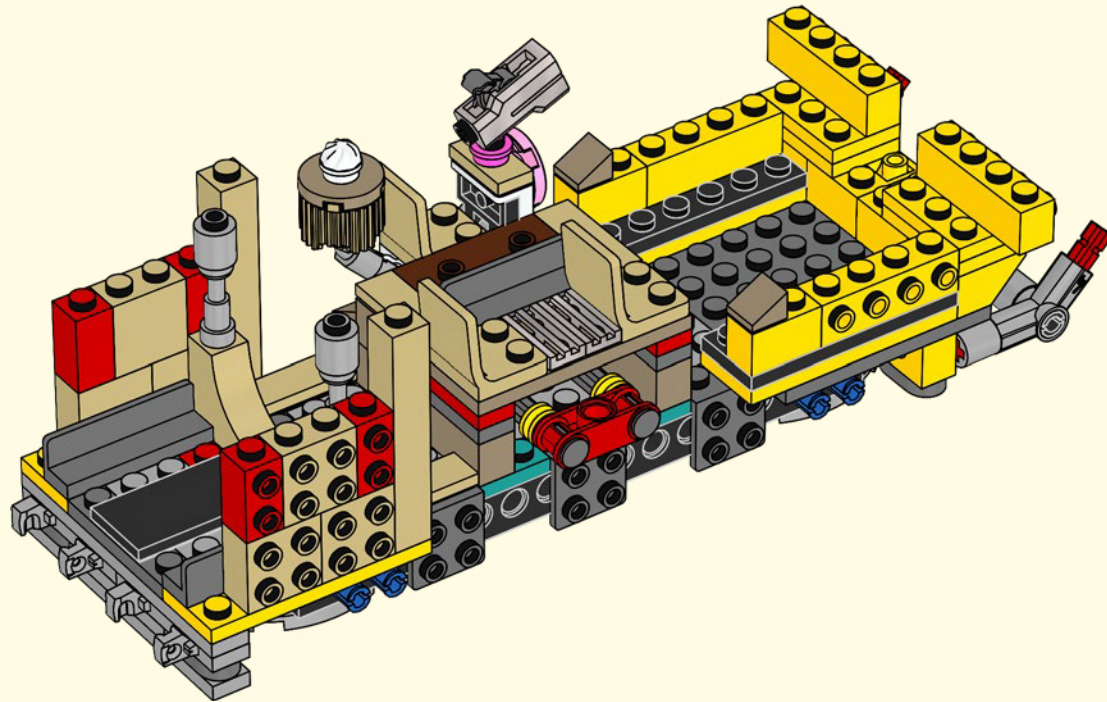



4x

38

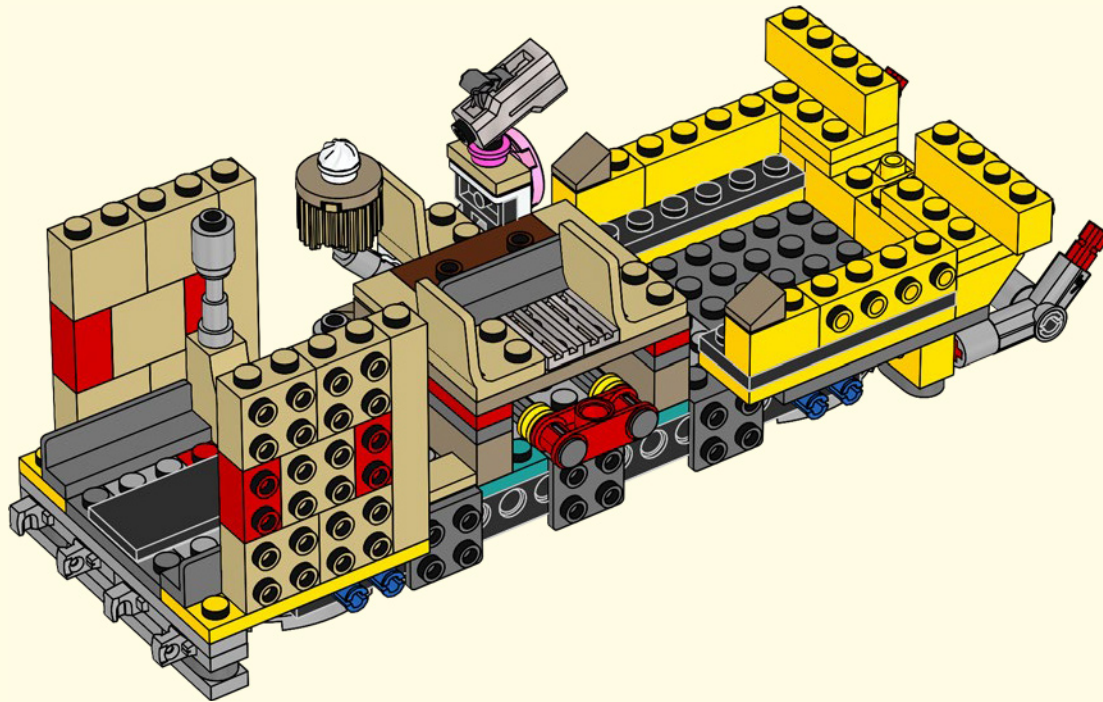

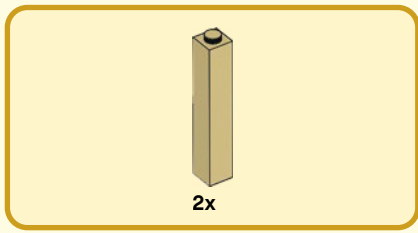

39

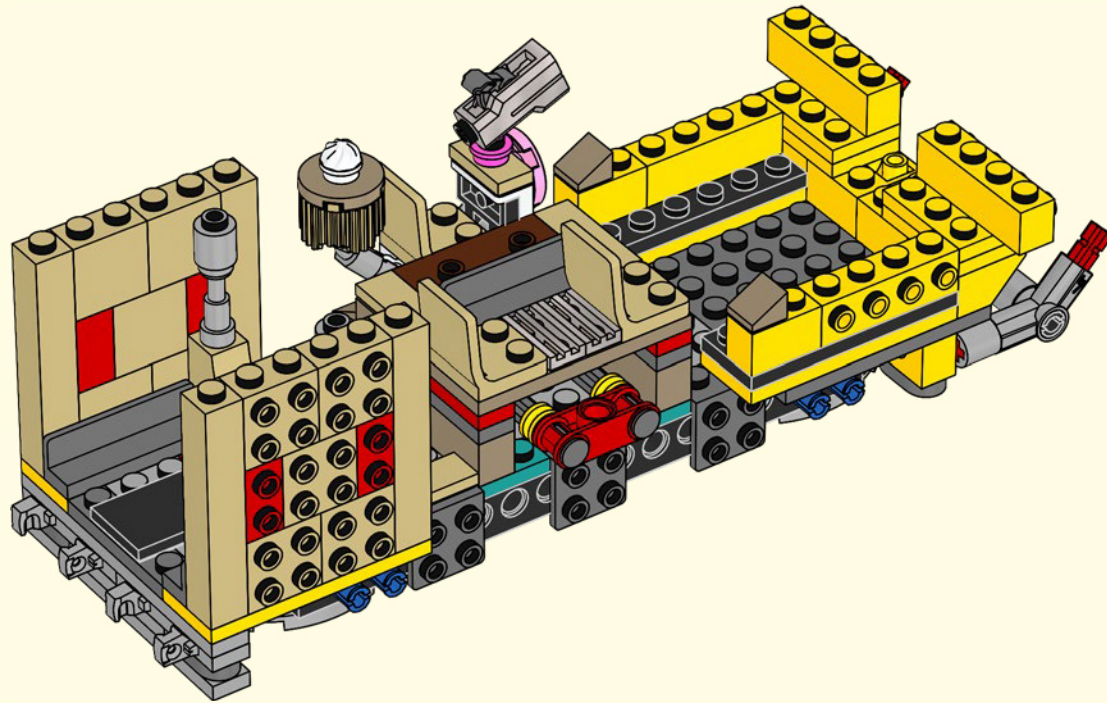

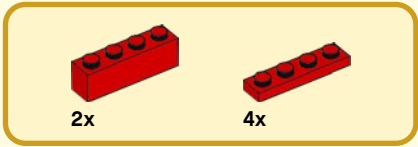

40

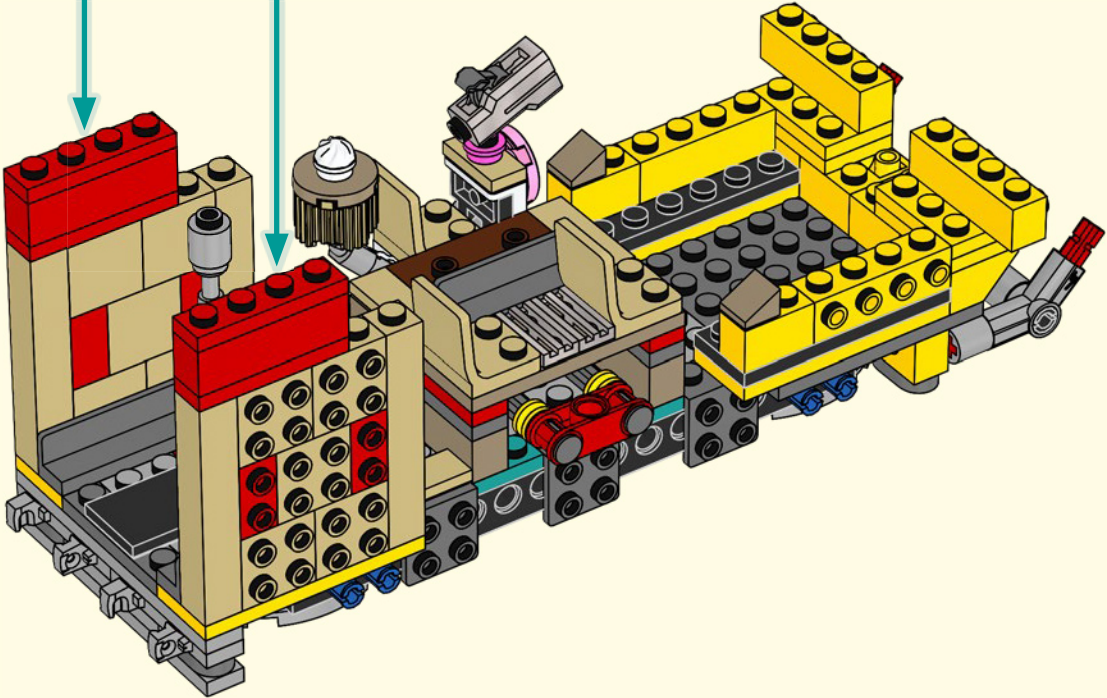
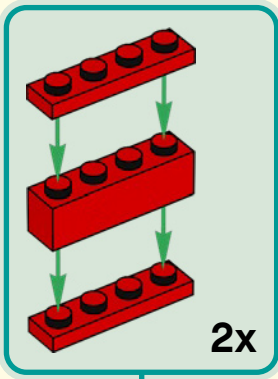

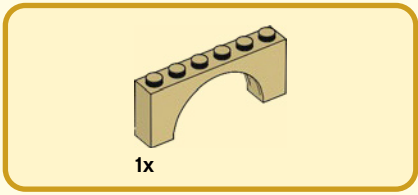

41

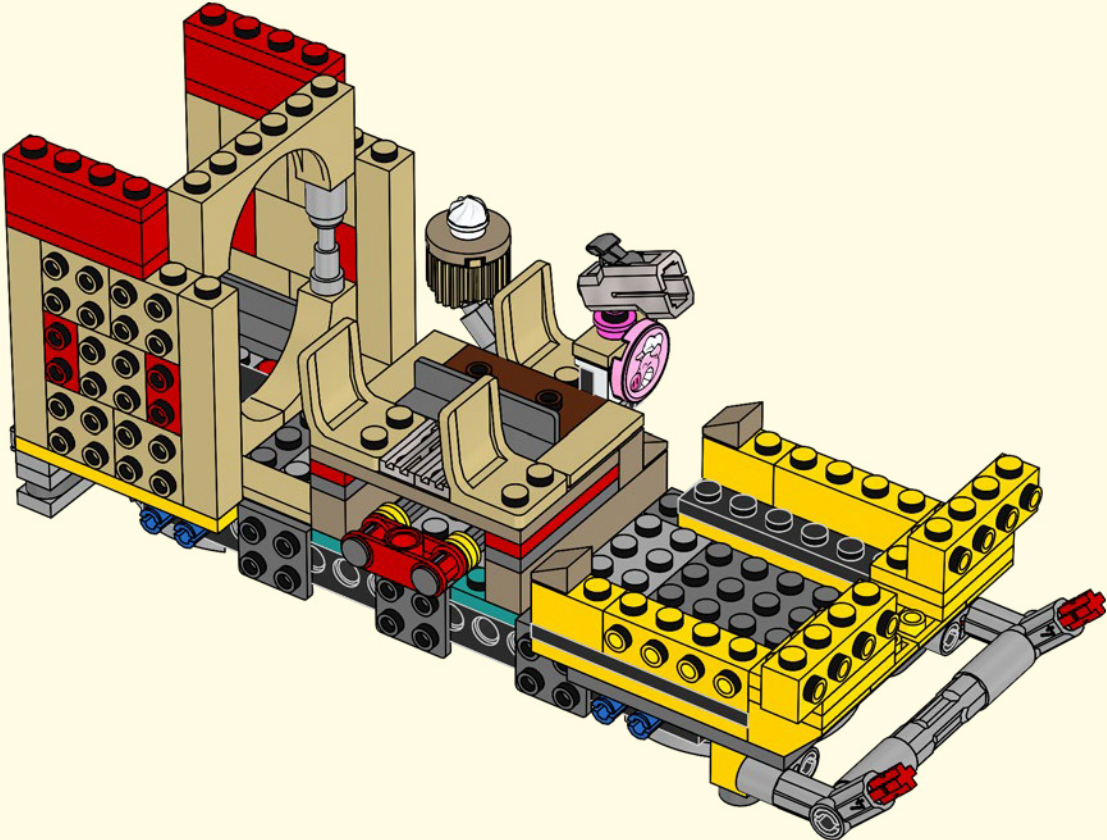



42

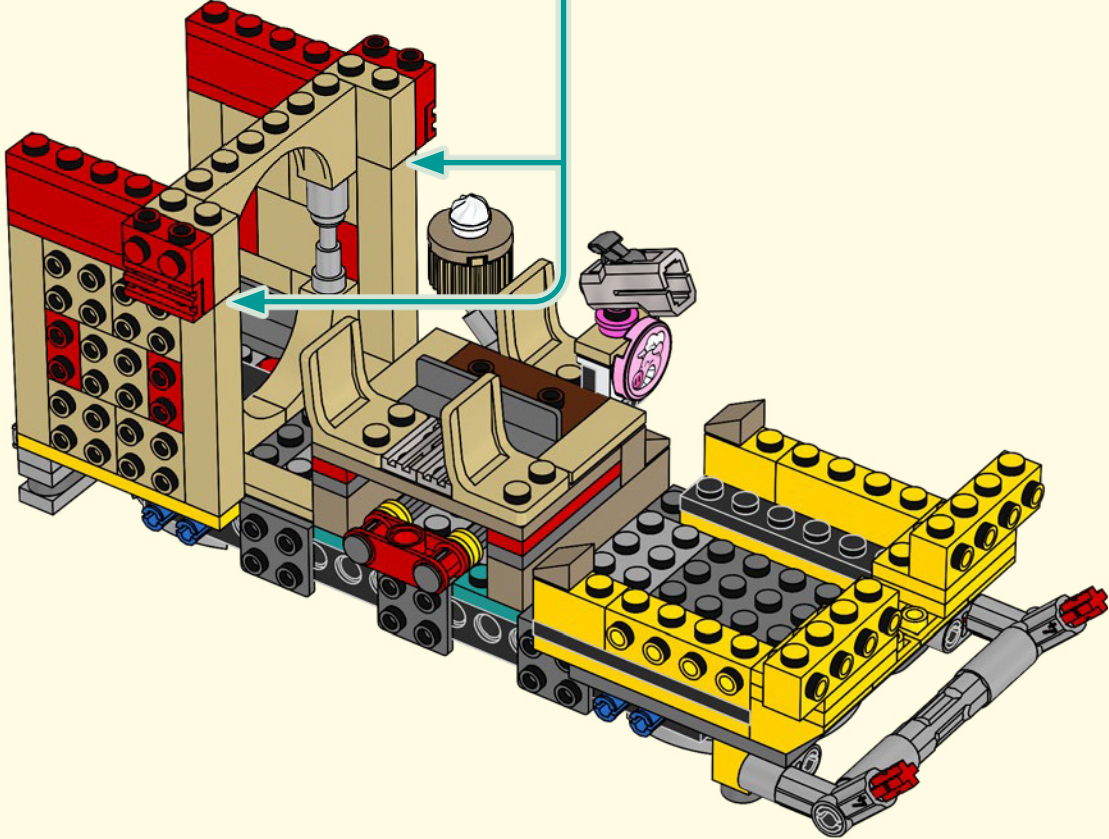
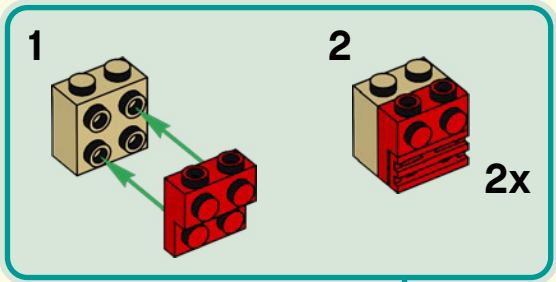

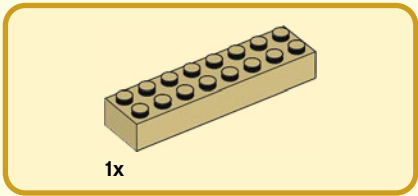

43

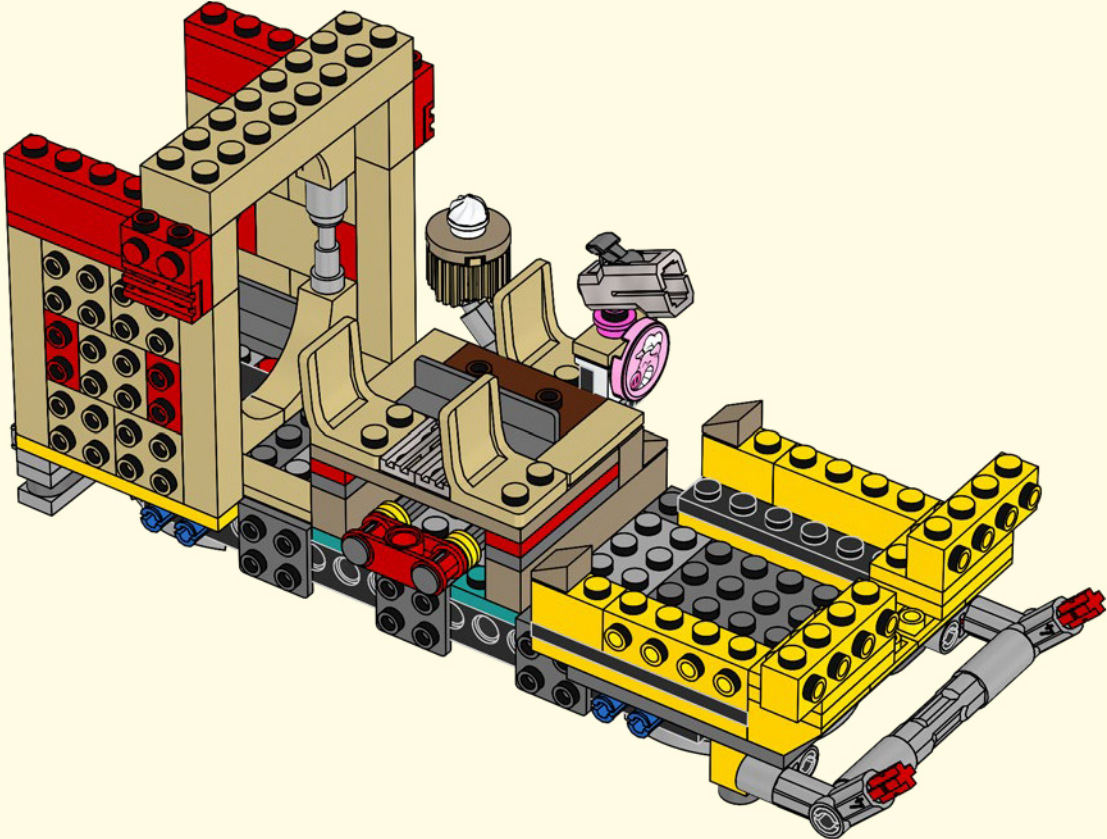



44

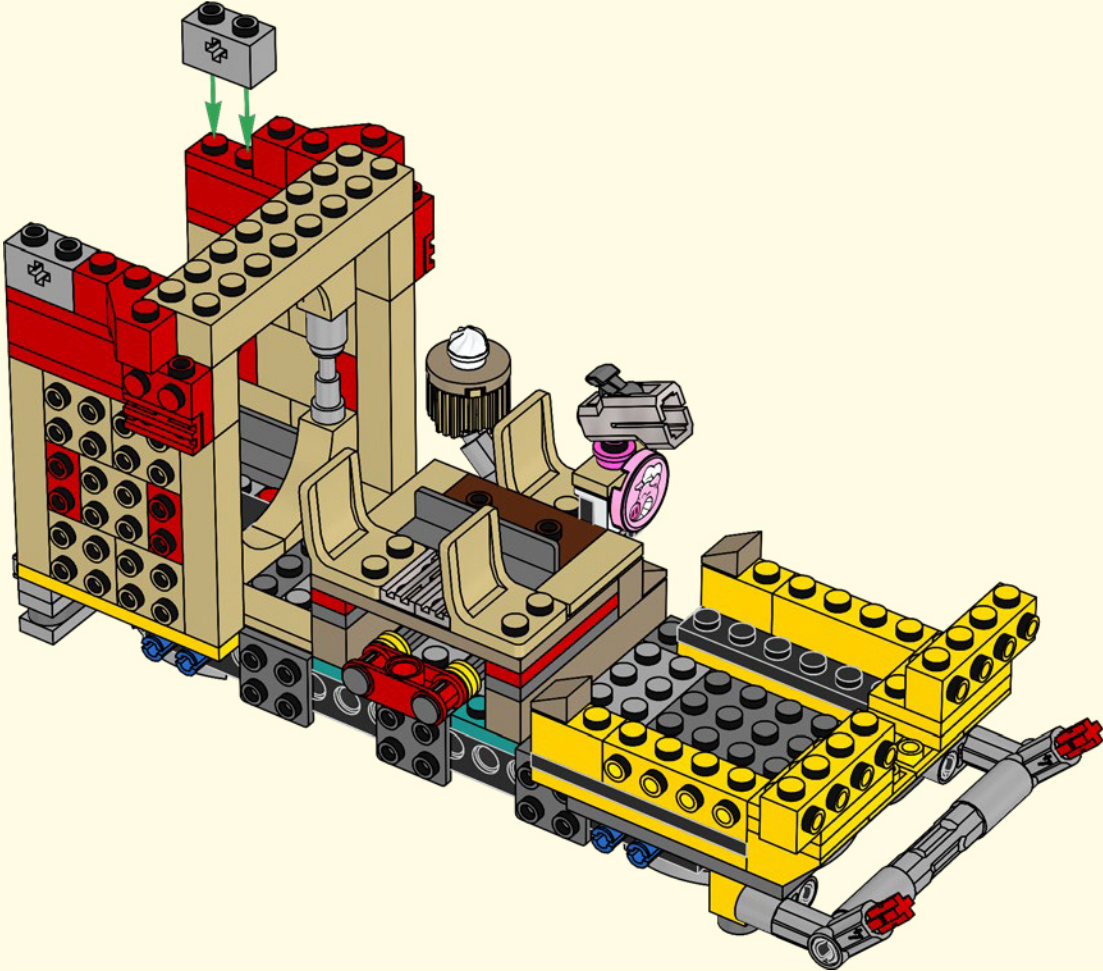



45

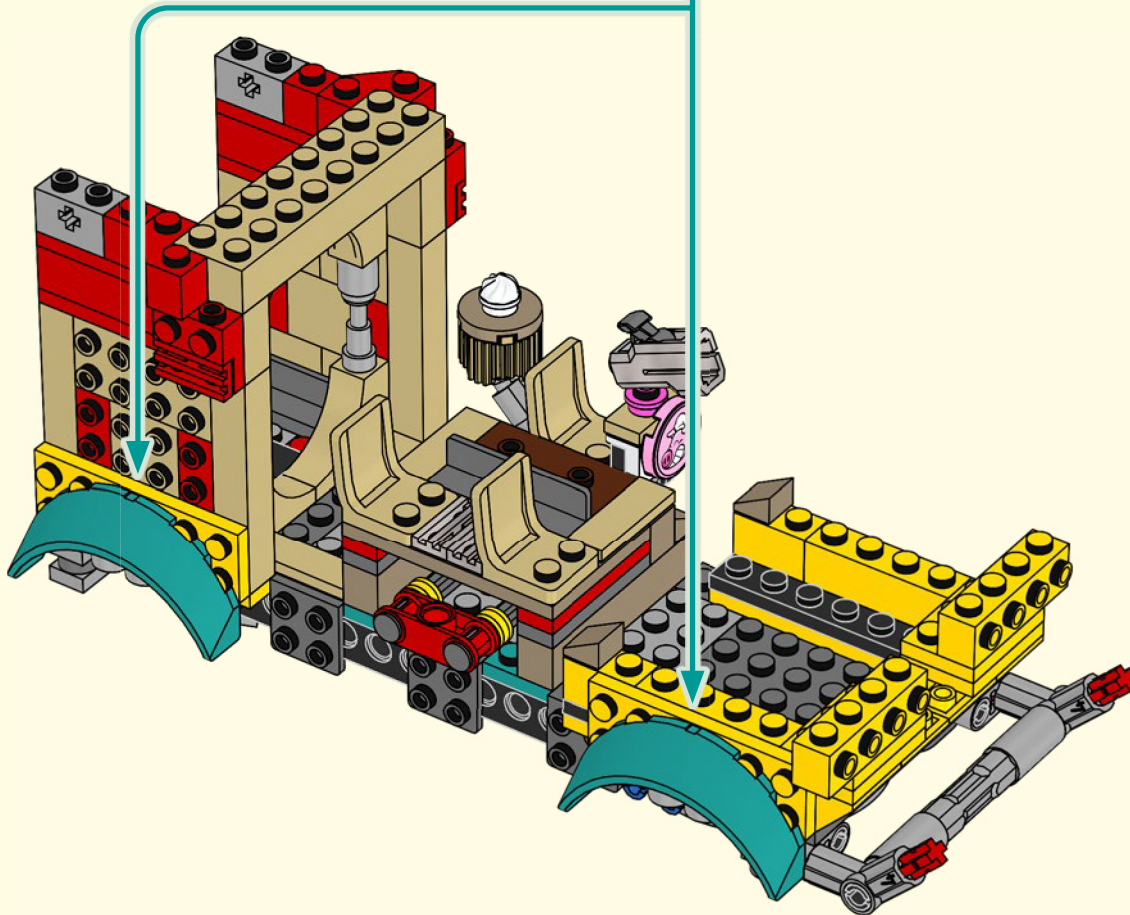
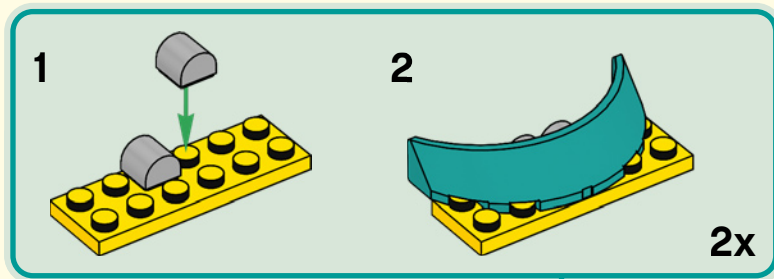

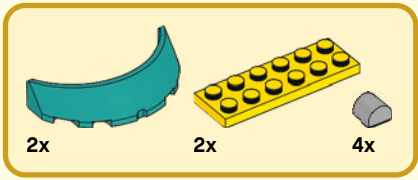

46

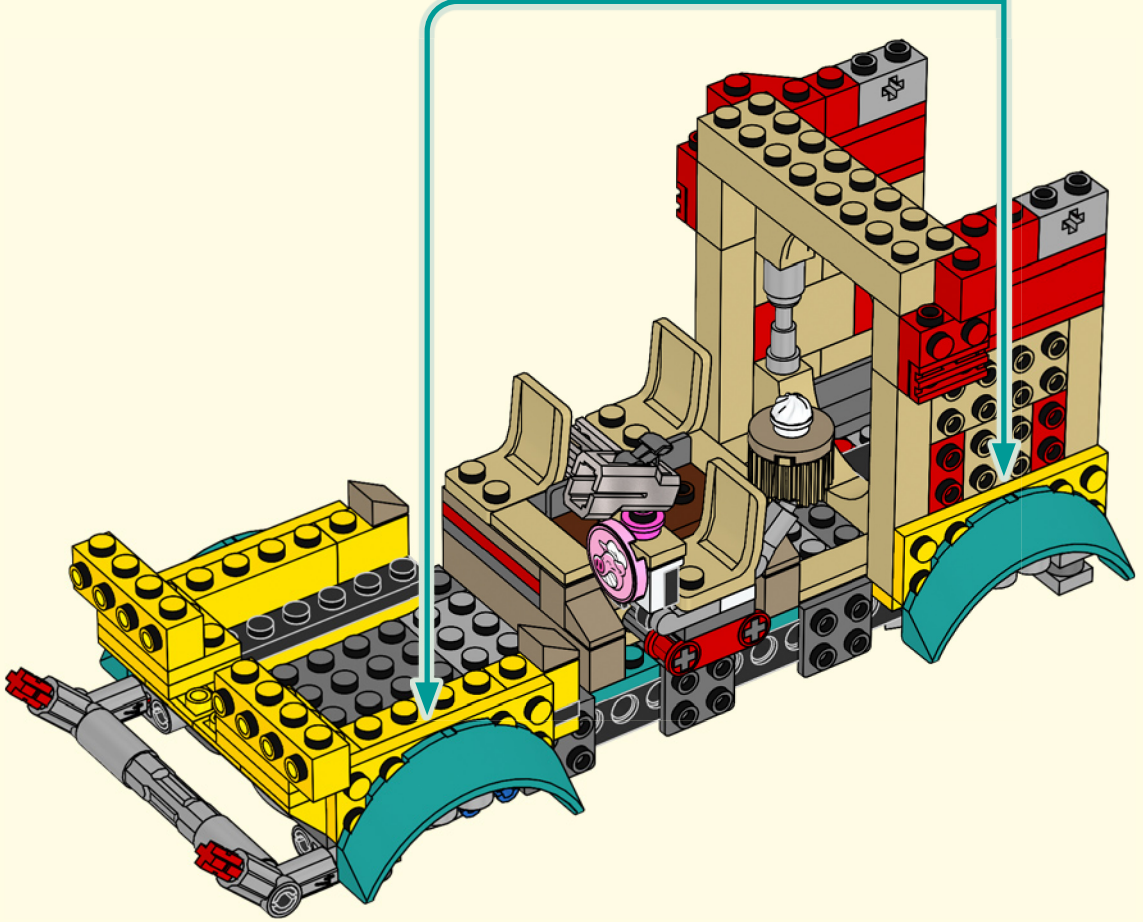
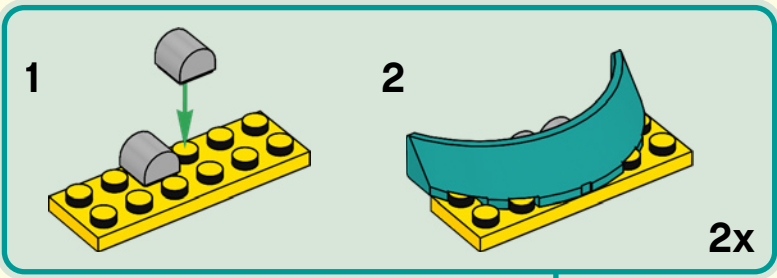

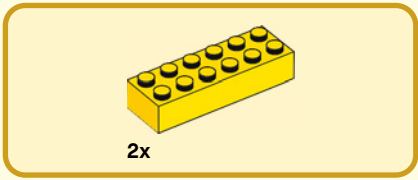

47

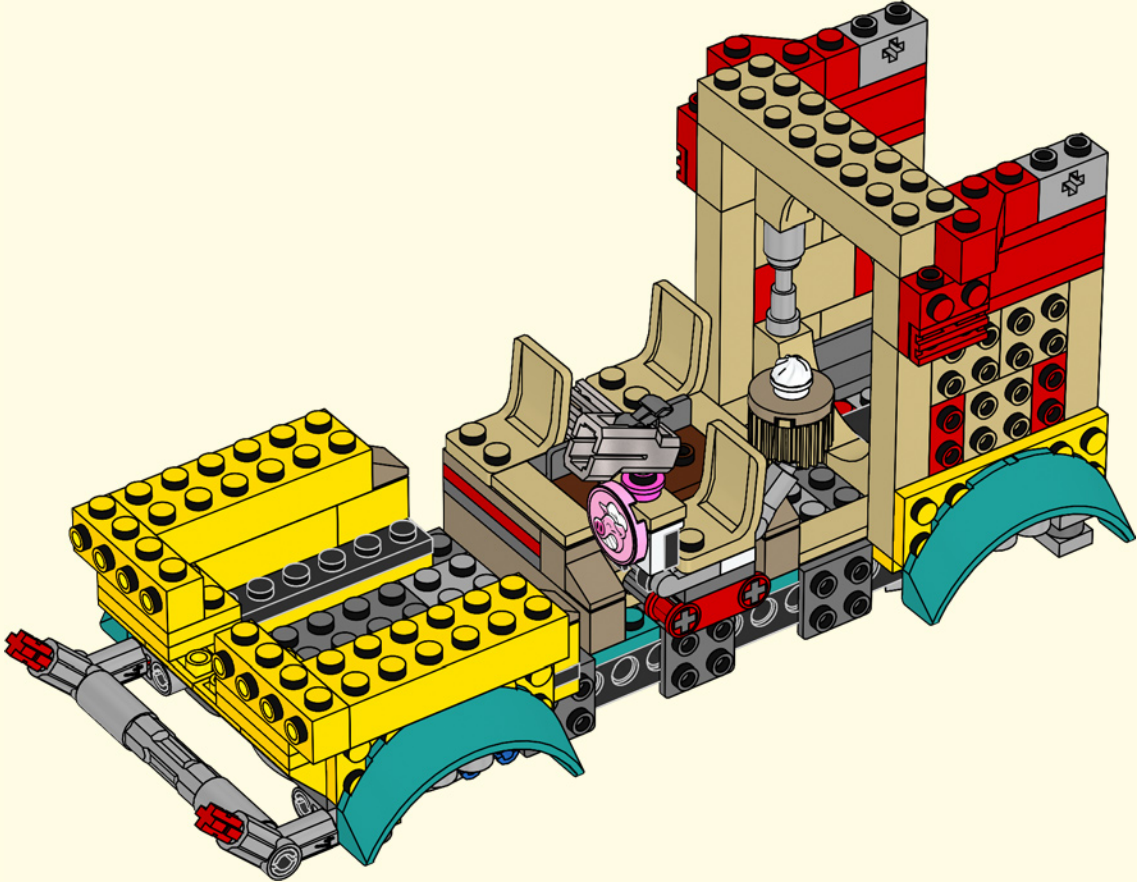

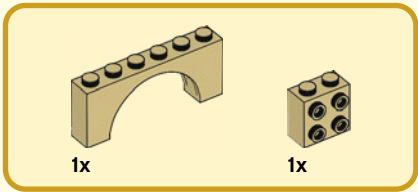

48

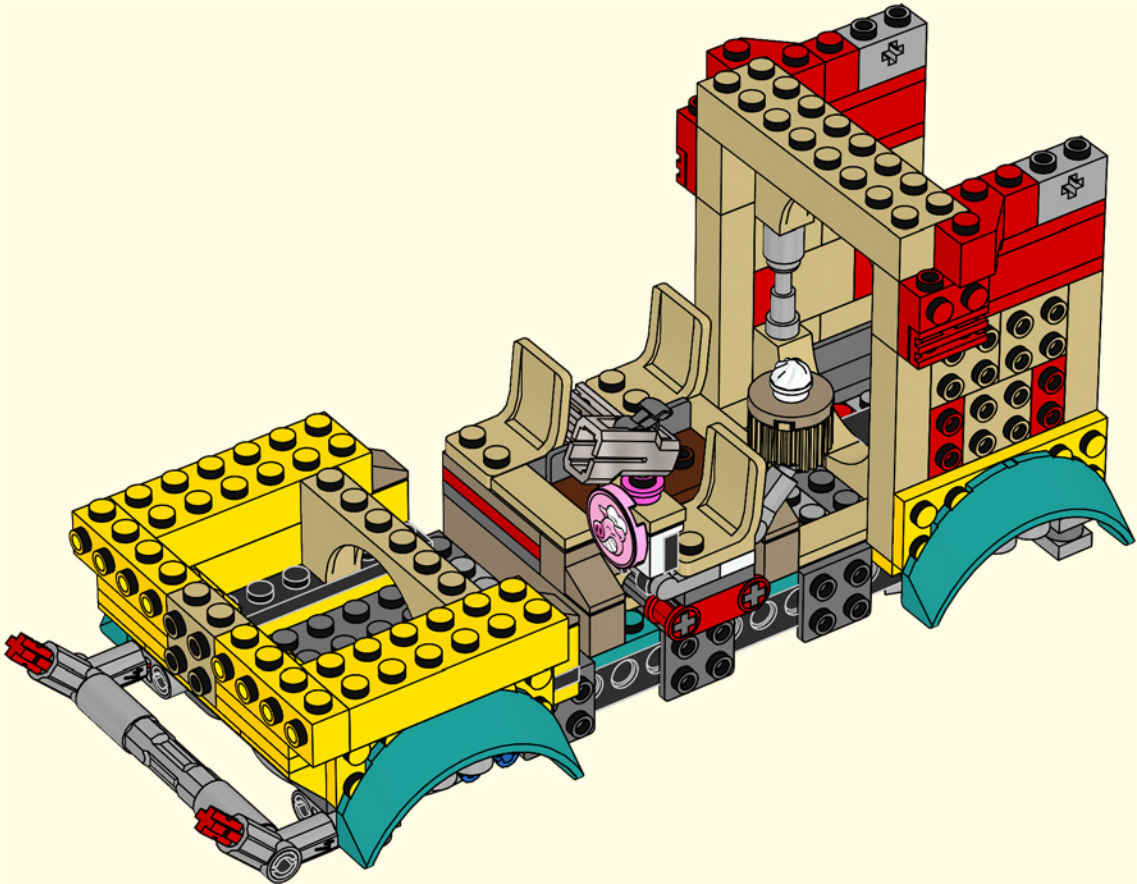



2x

49

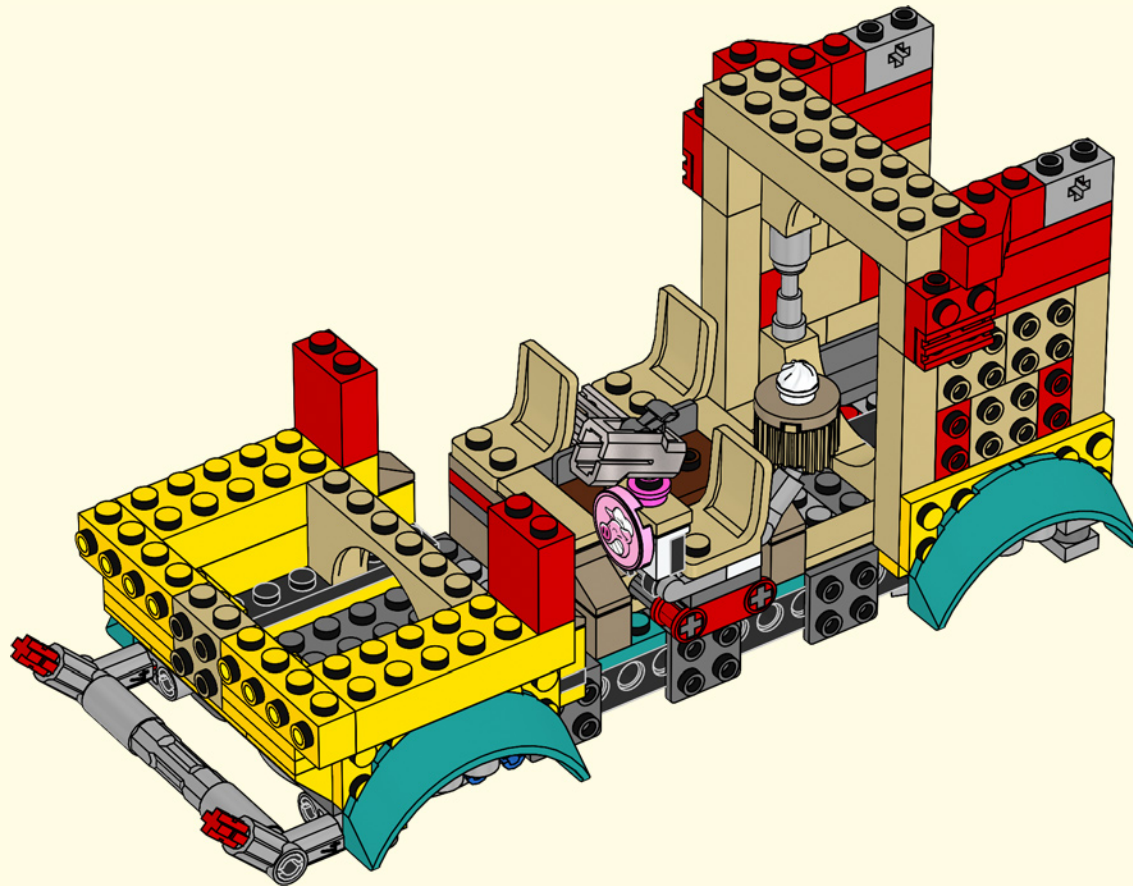



2x



2x

50

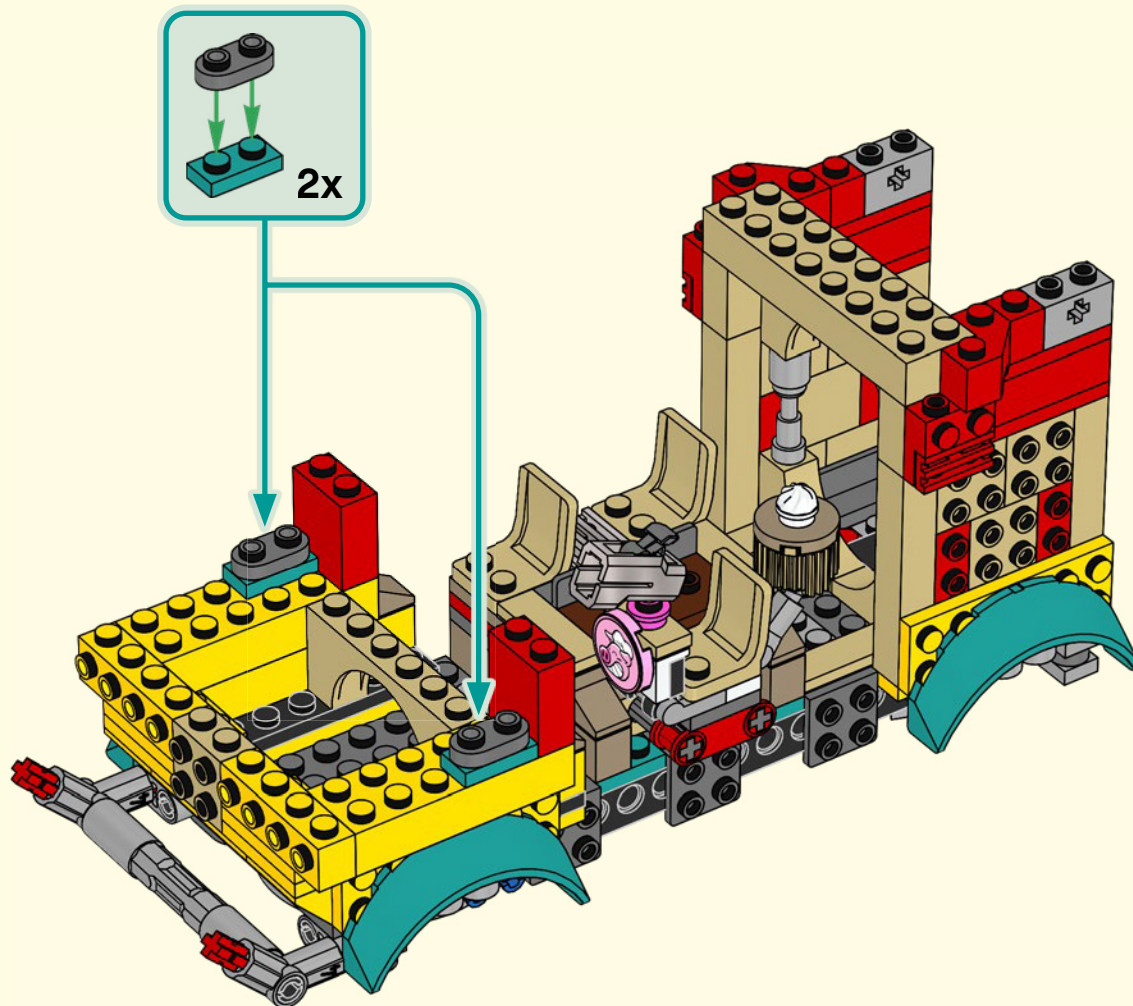

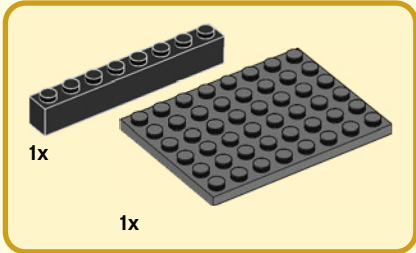
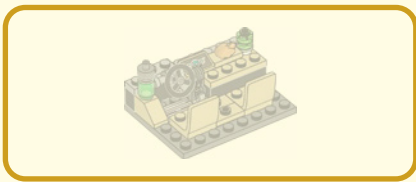

51

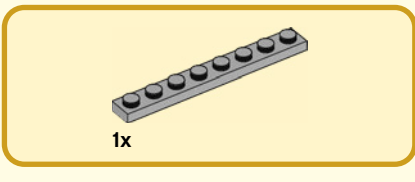
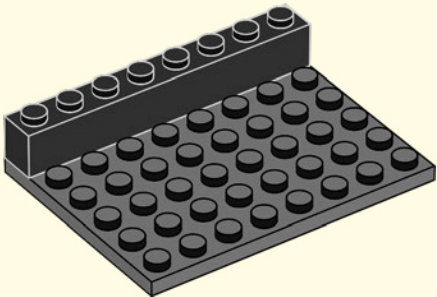

52

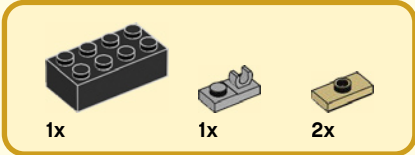
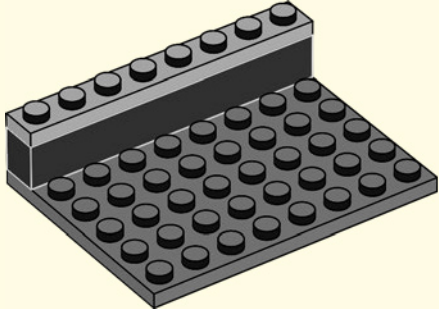

53

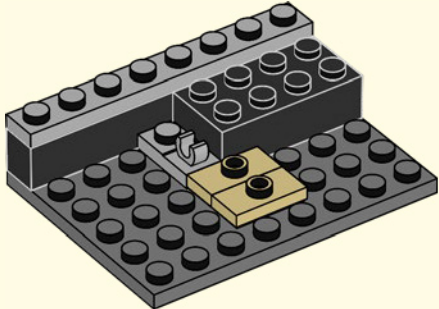



1x



1x

54

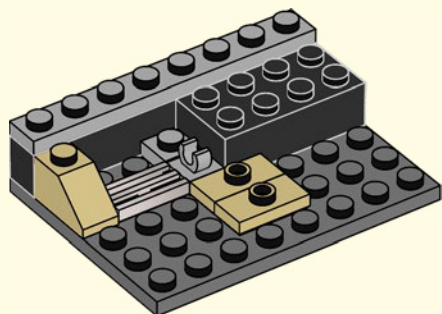

1x



1x

55

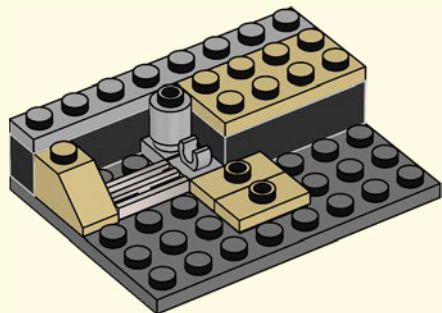

1x



1x



2x

56

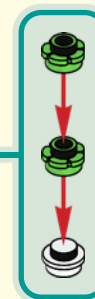
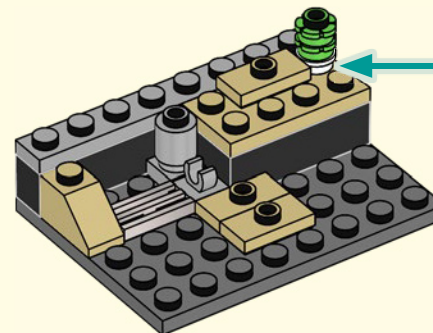

1x



1x



1x

57

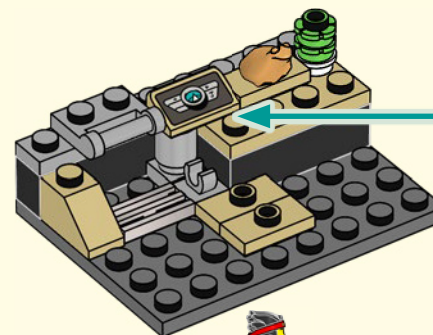



1x

58

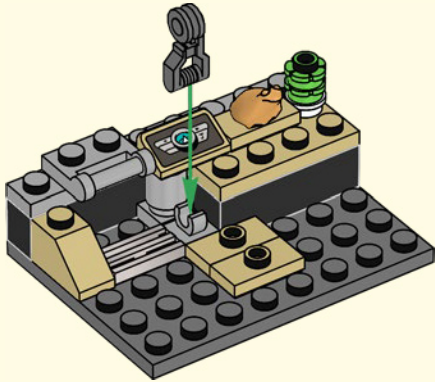

1x



1x

59

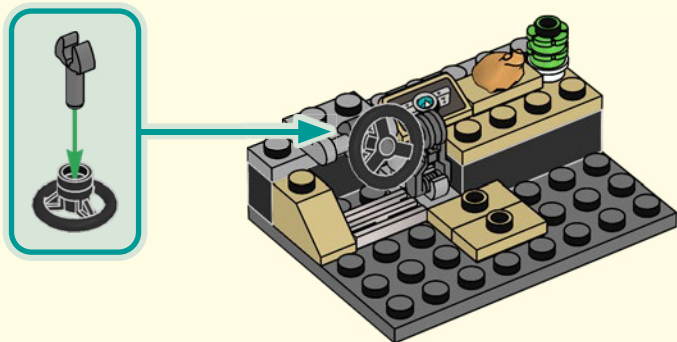

2x

60

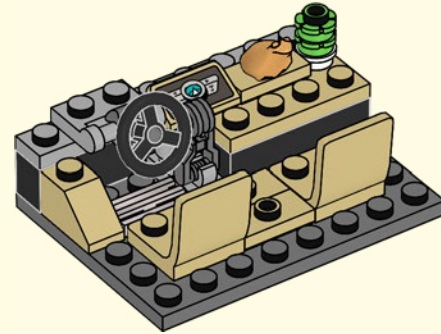

1x



1x



1x

61

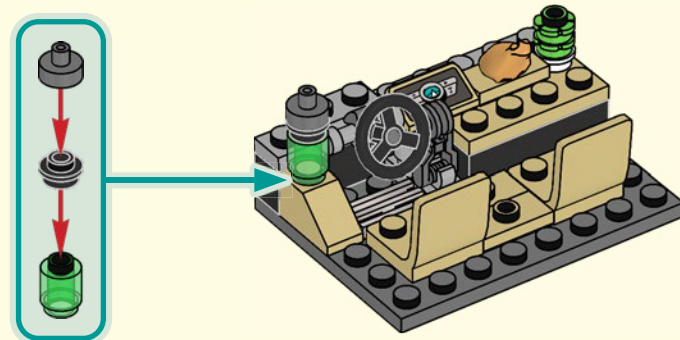

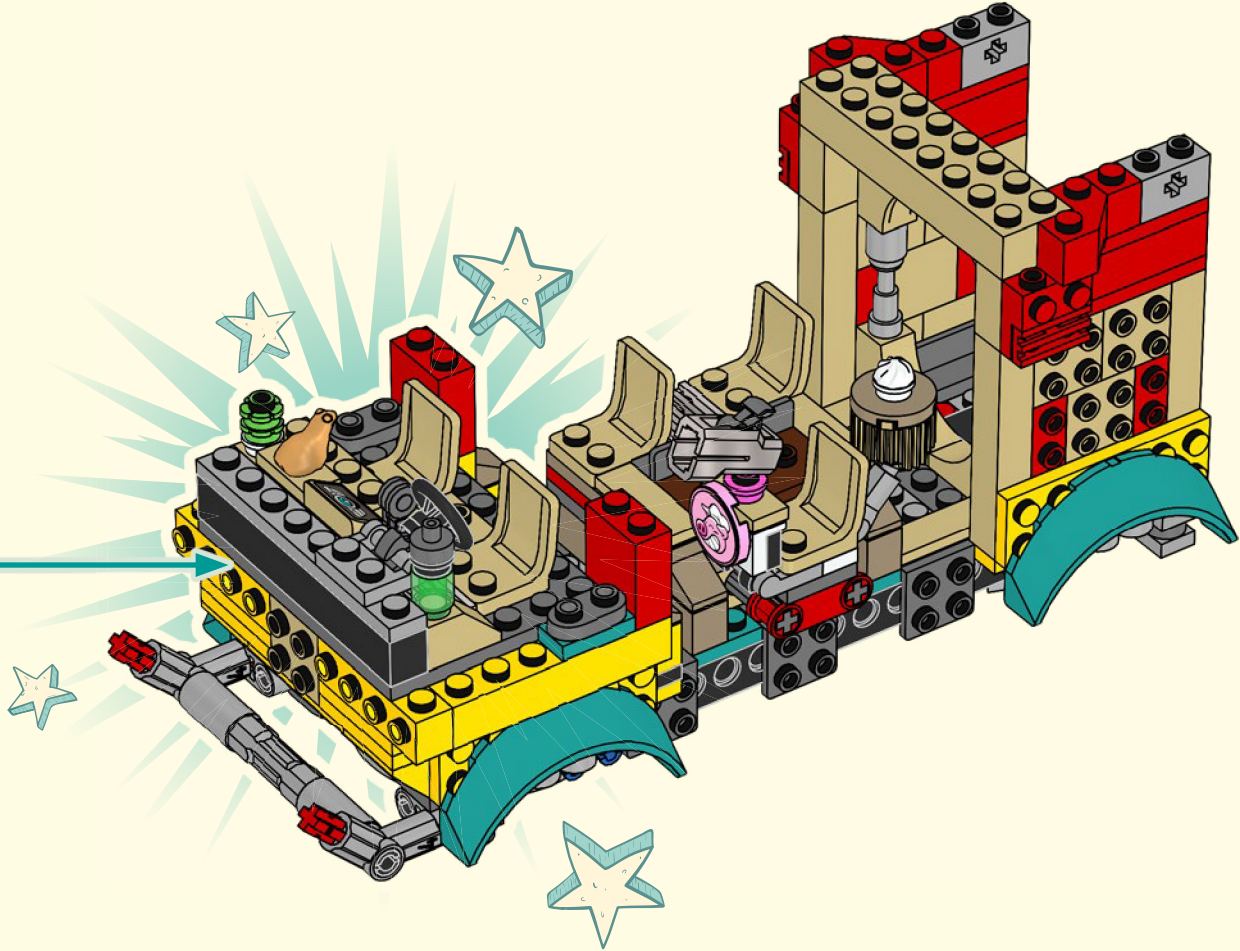



2x

63

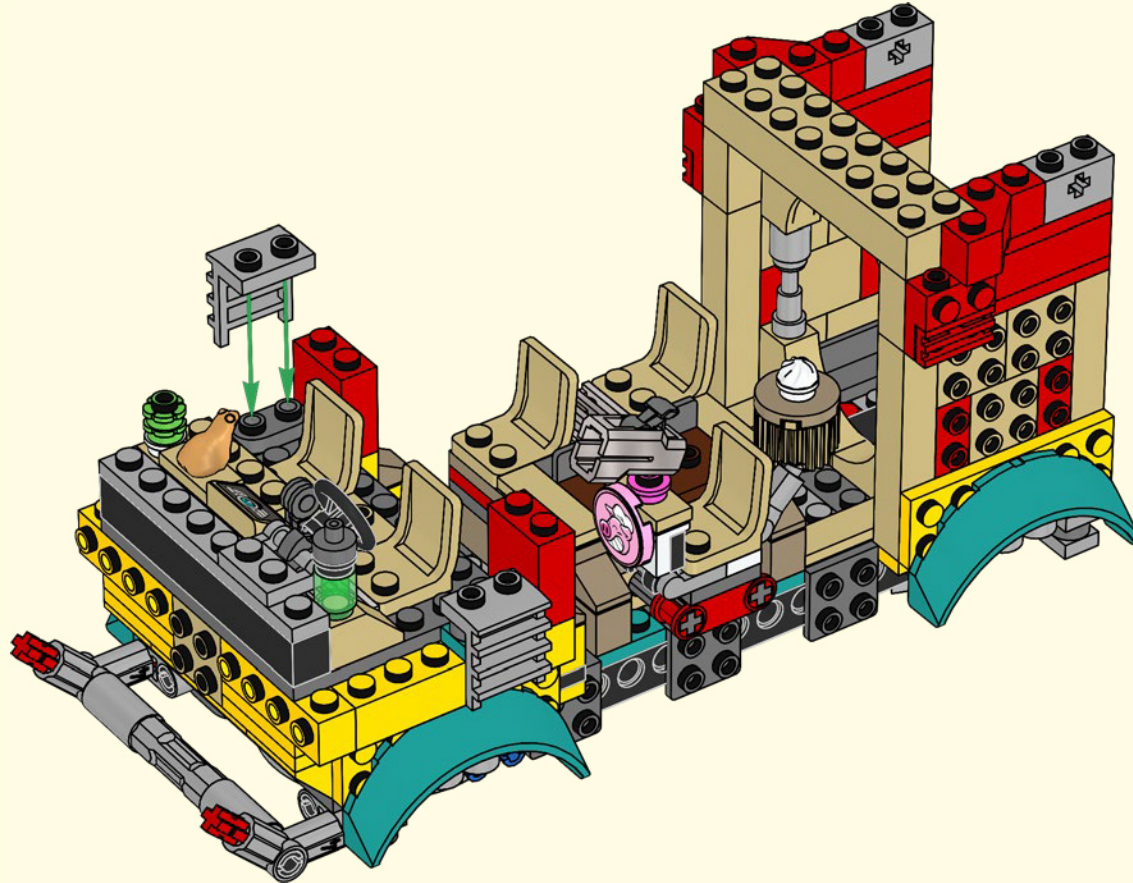

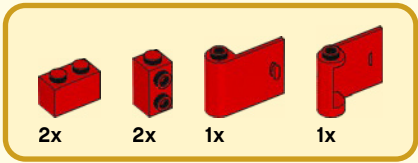

64

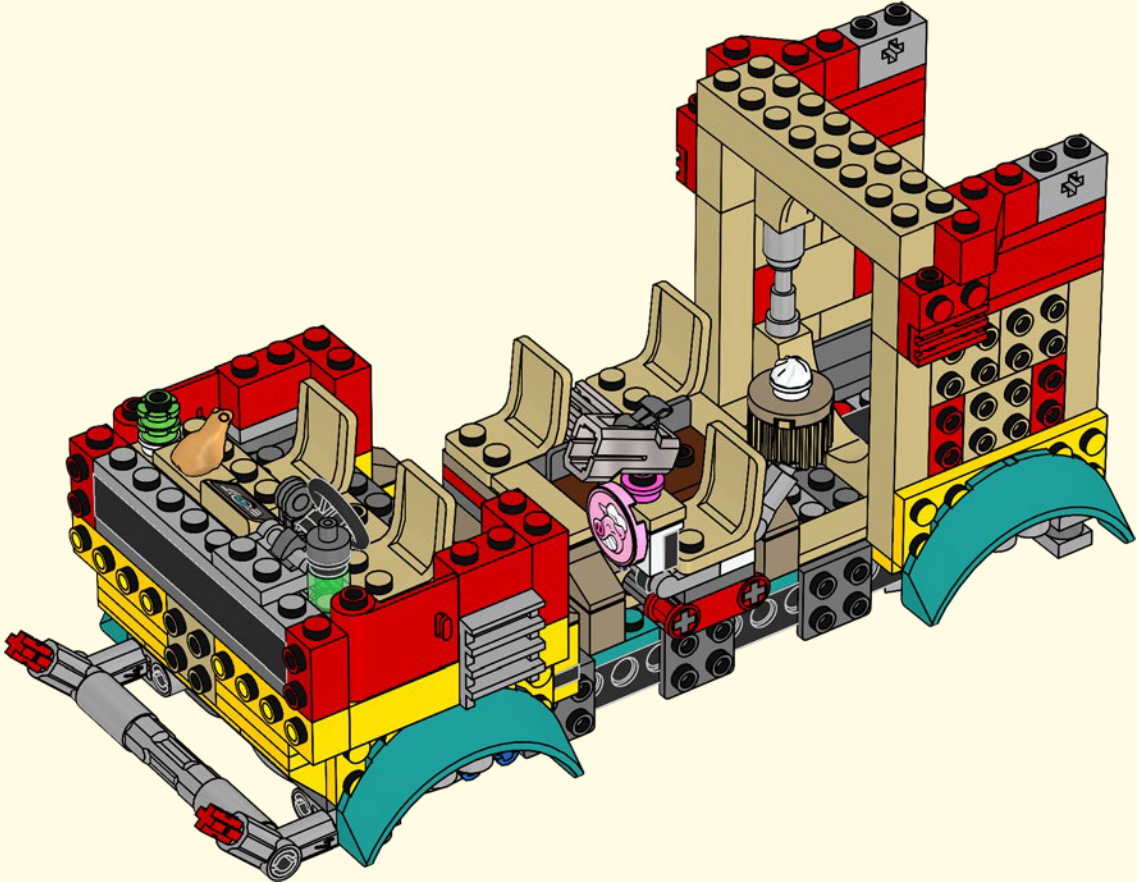

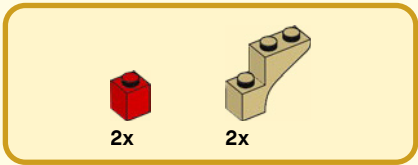

65

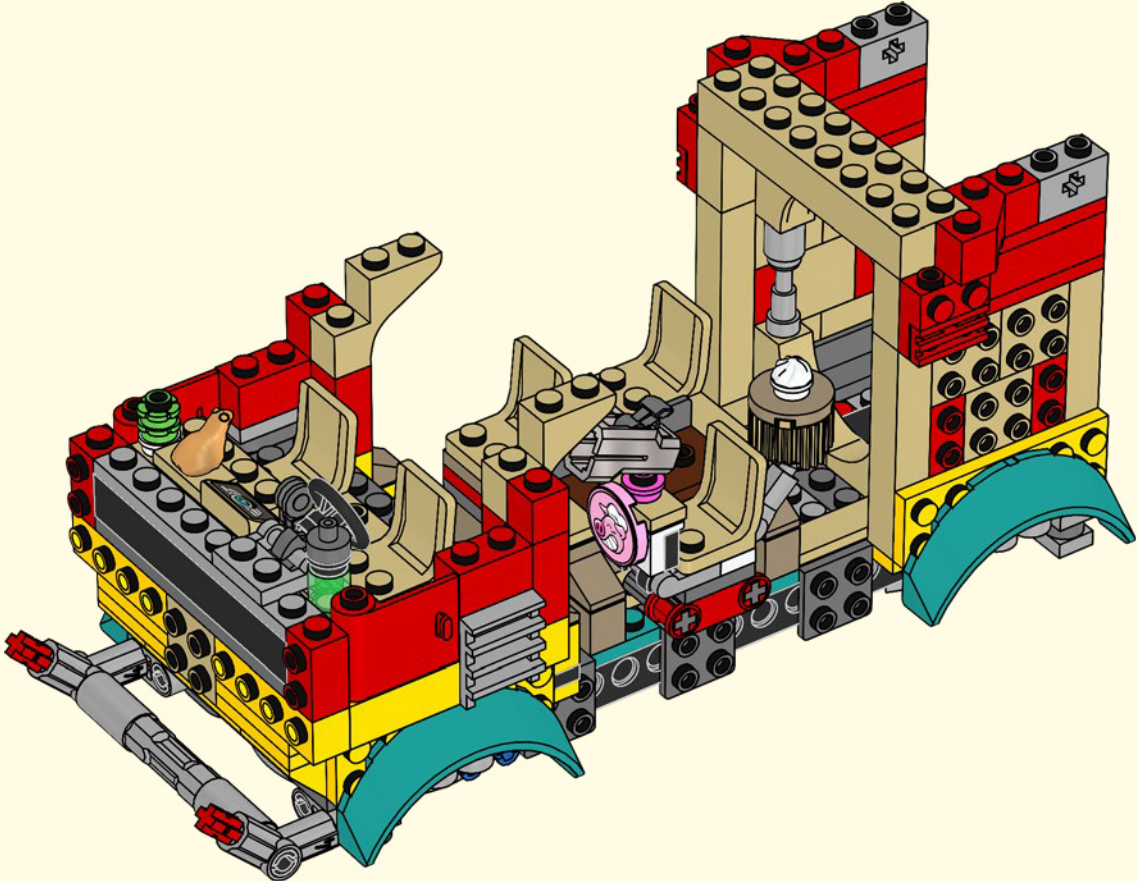



2x

66

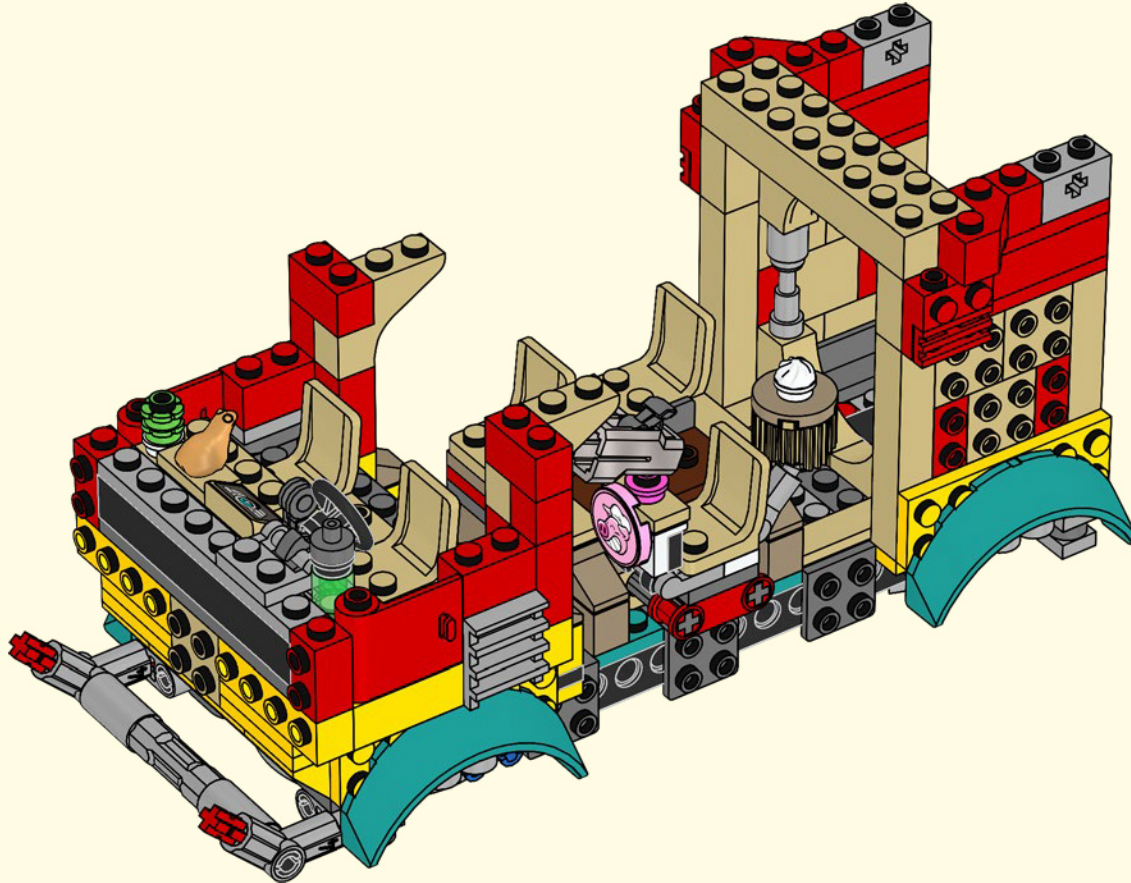

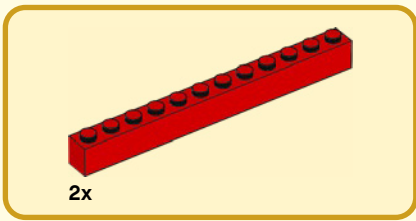

67

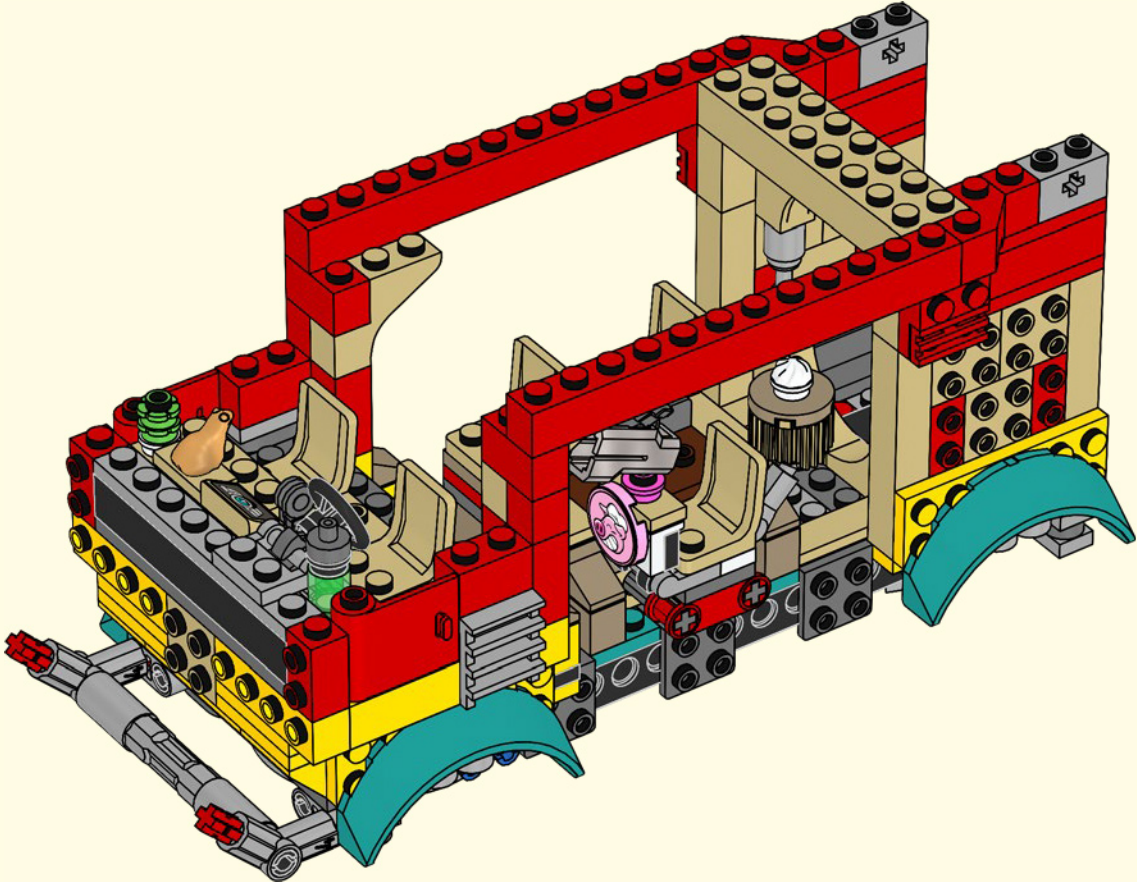

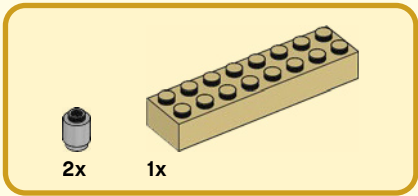

68

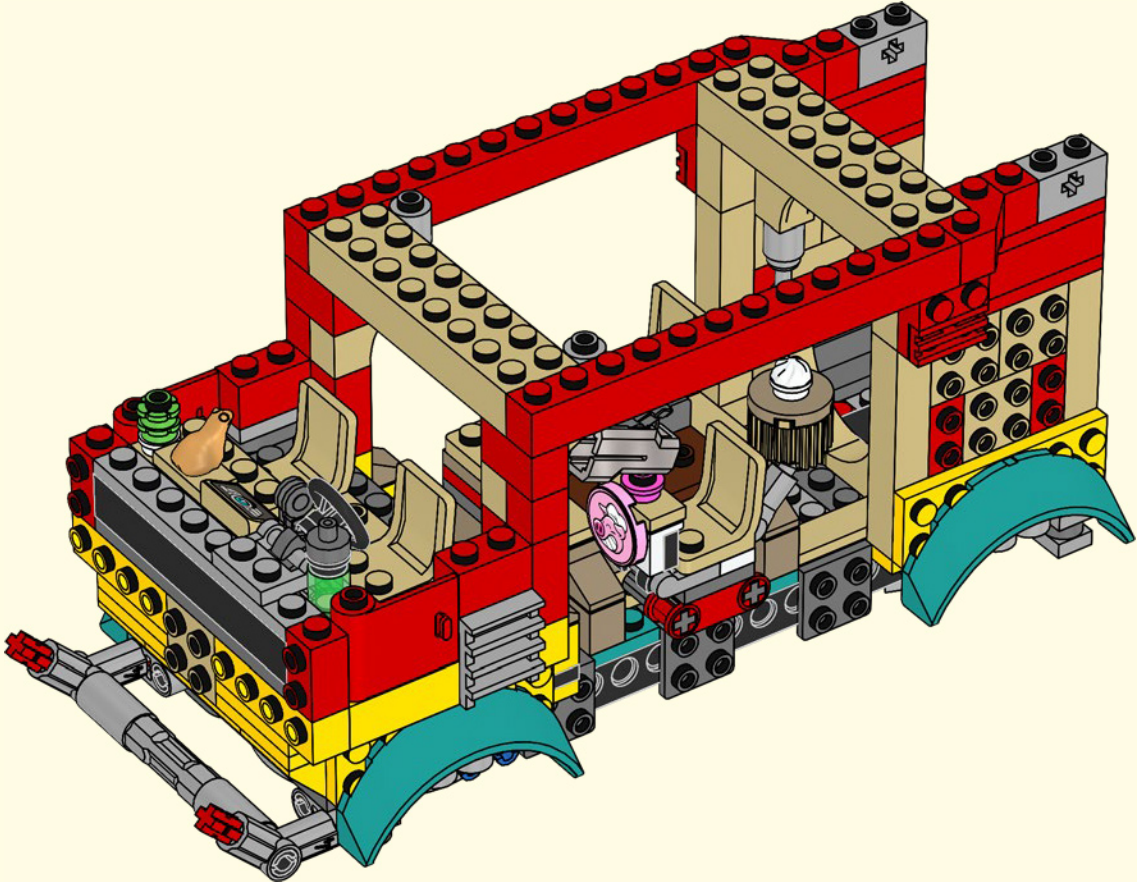



69

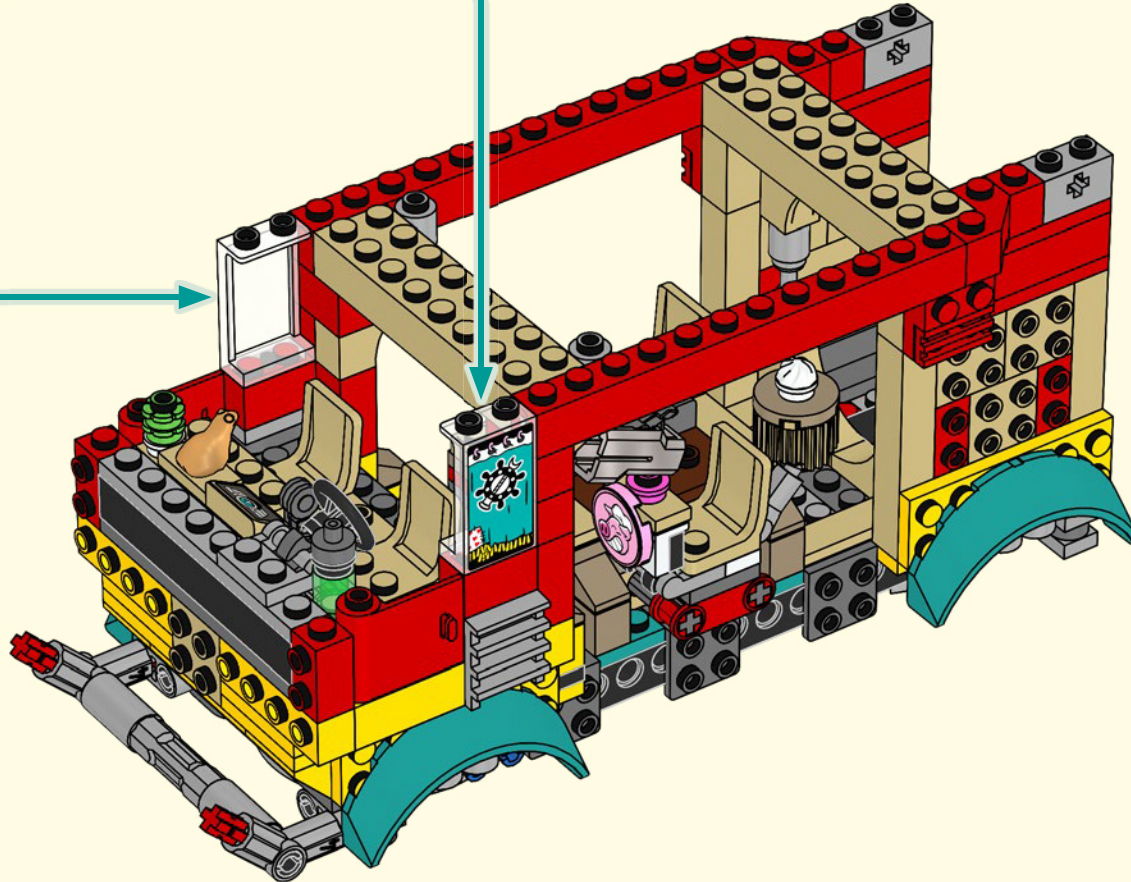
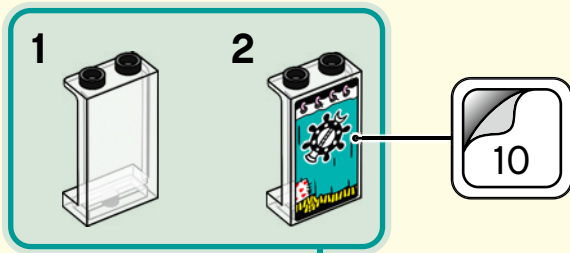

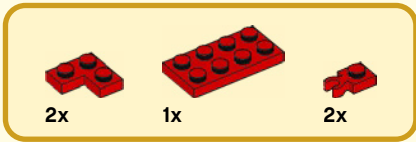

70

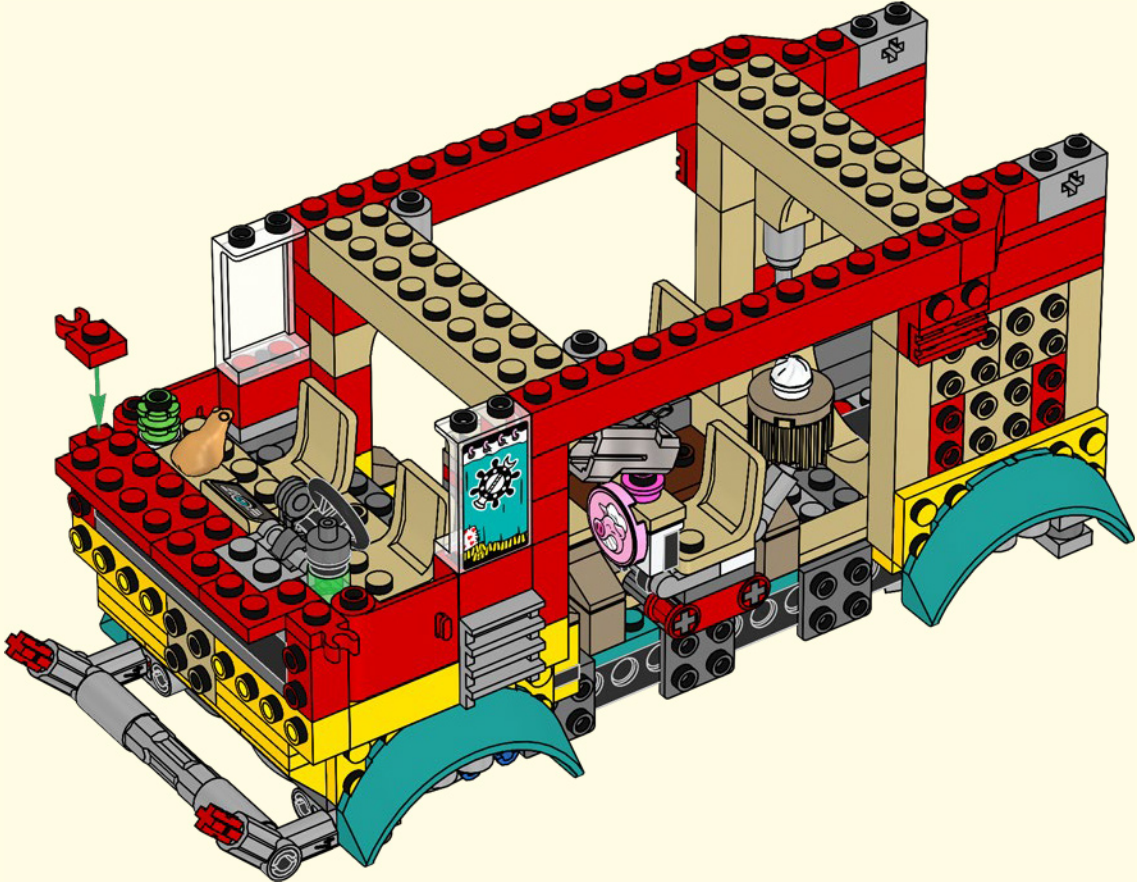

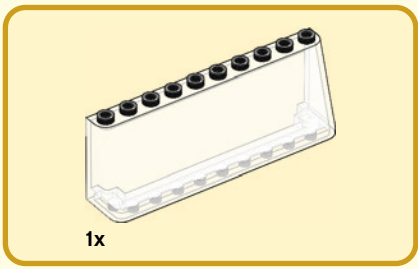

71

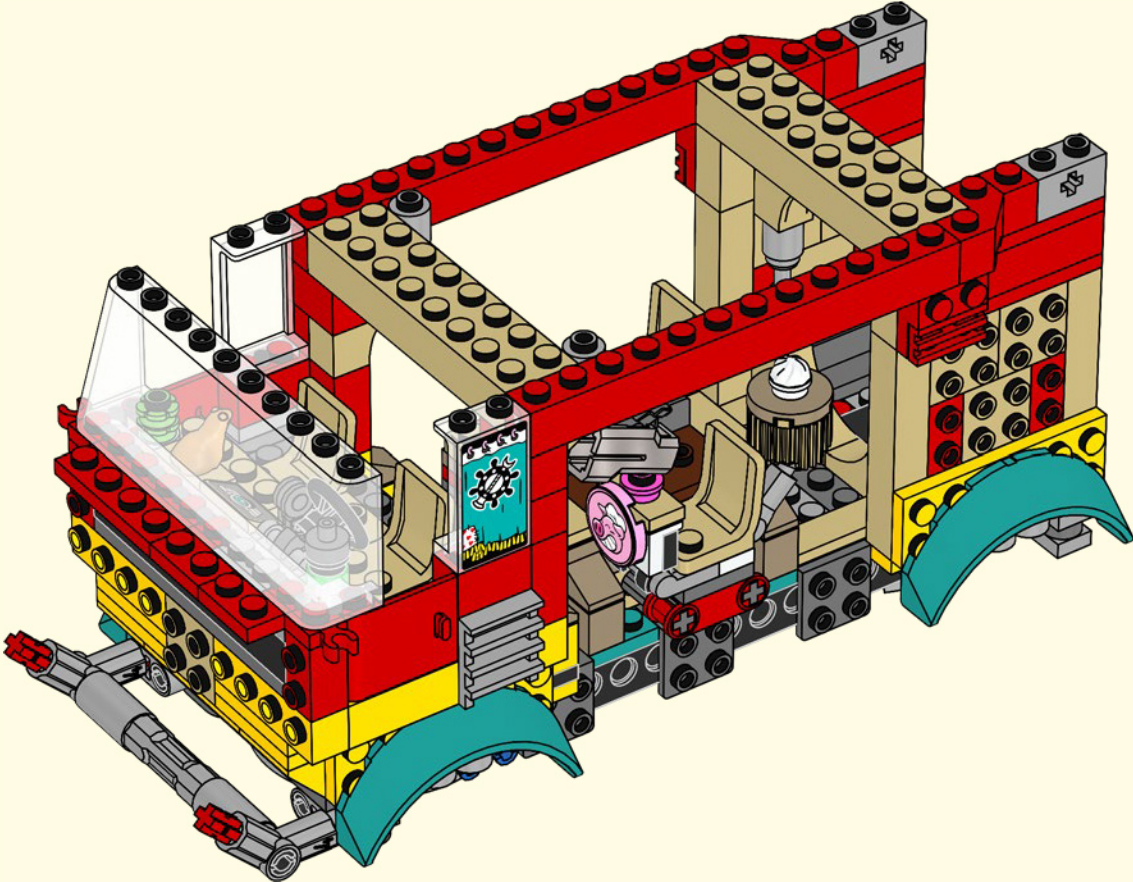



2x



2x

72

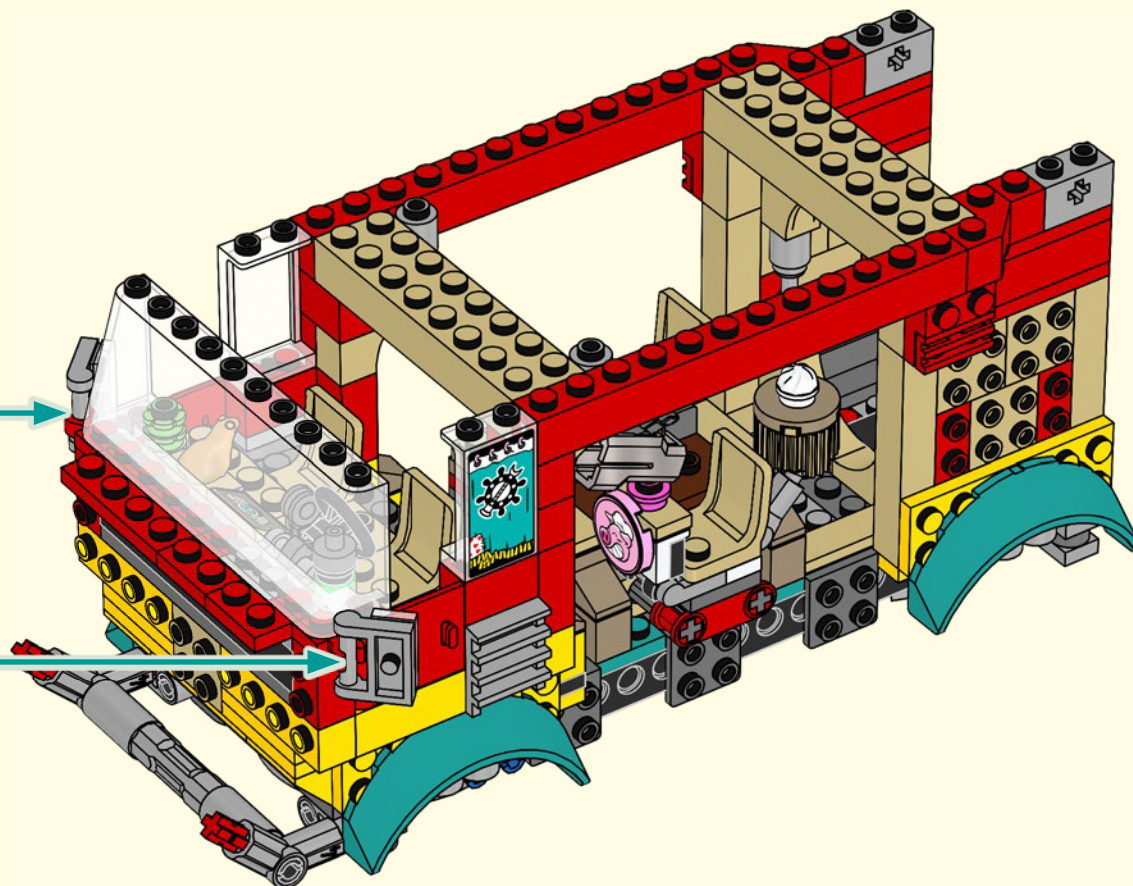
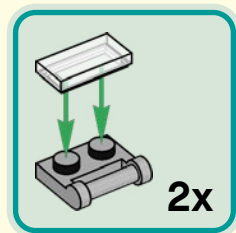



4x

73

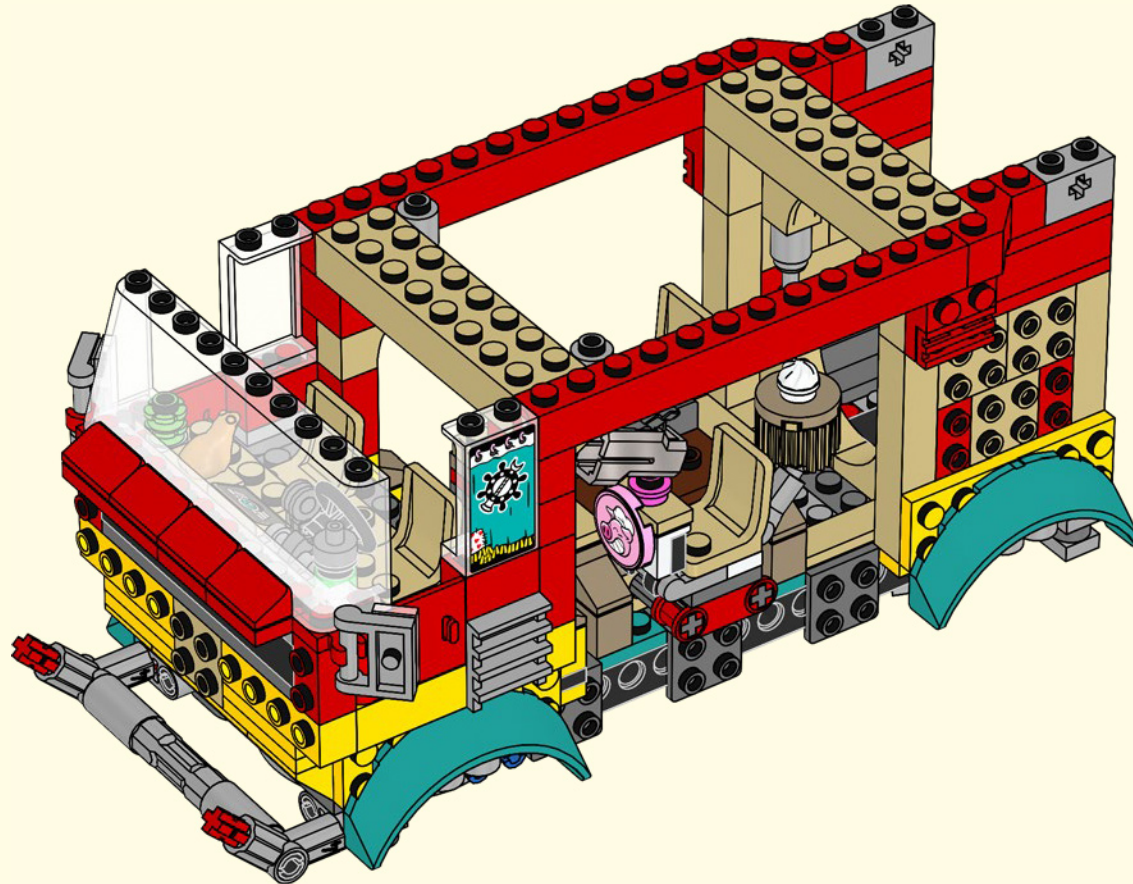

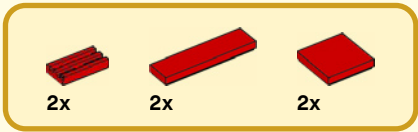

74

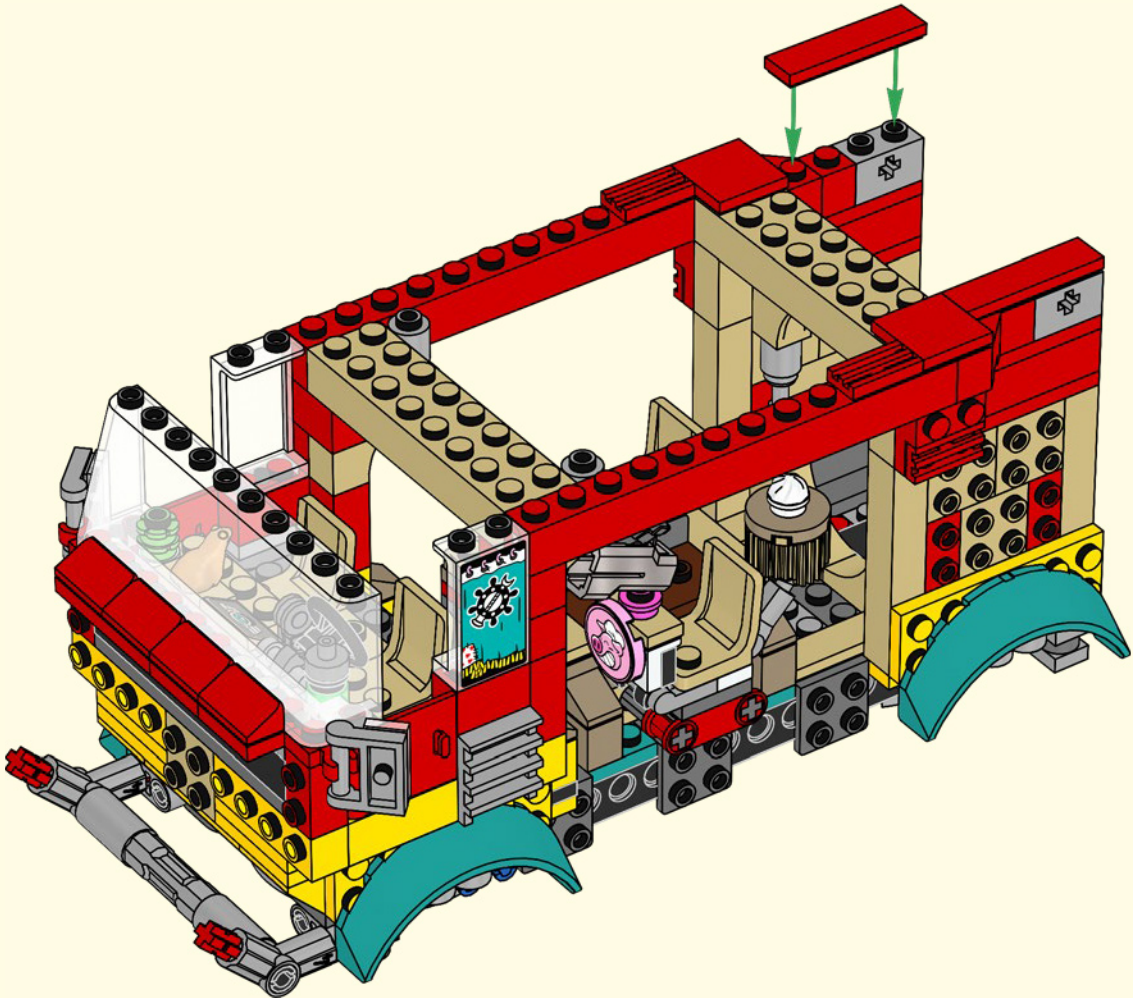

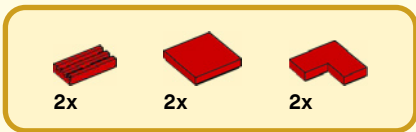

75

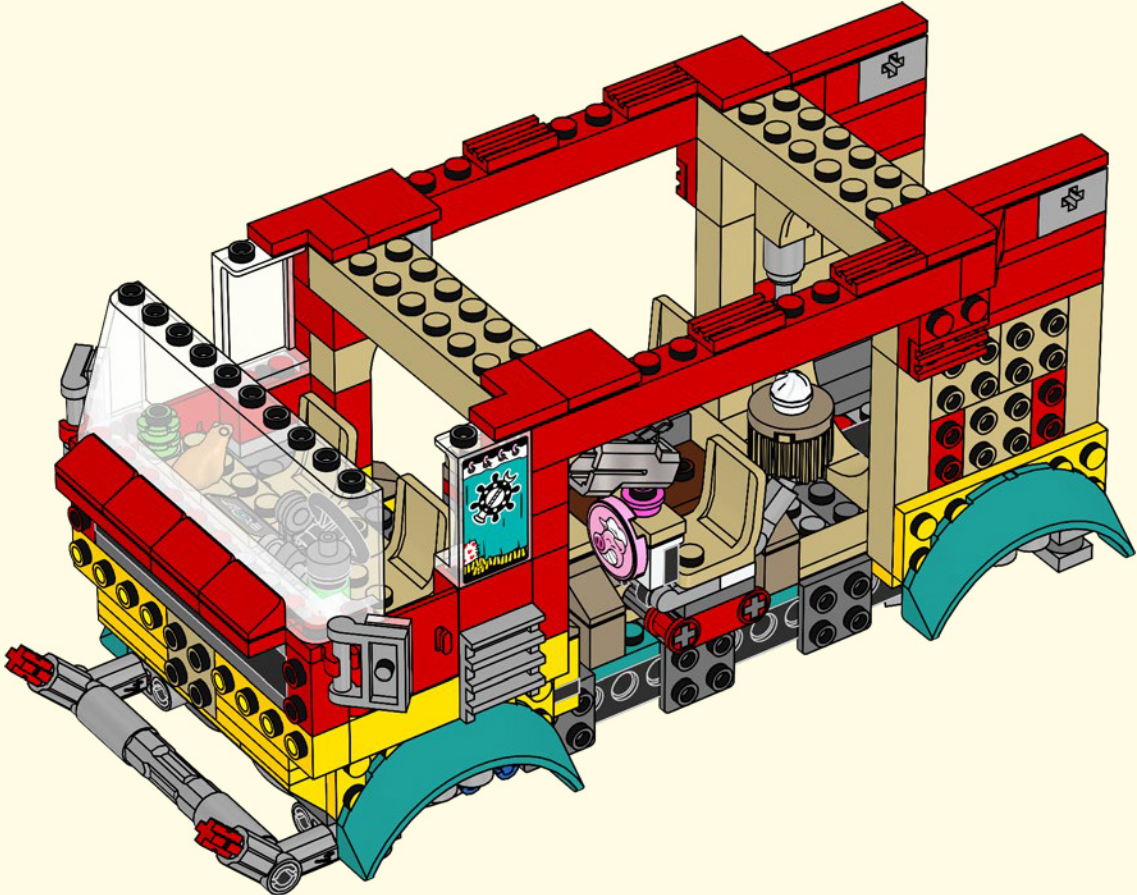



4x

76

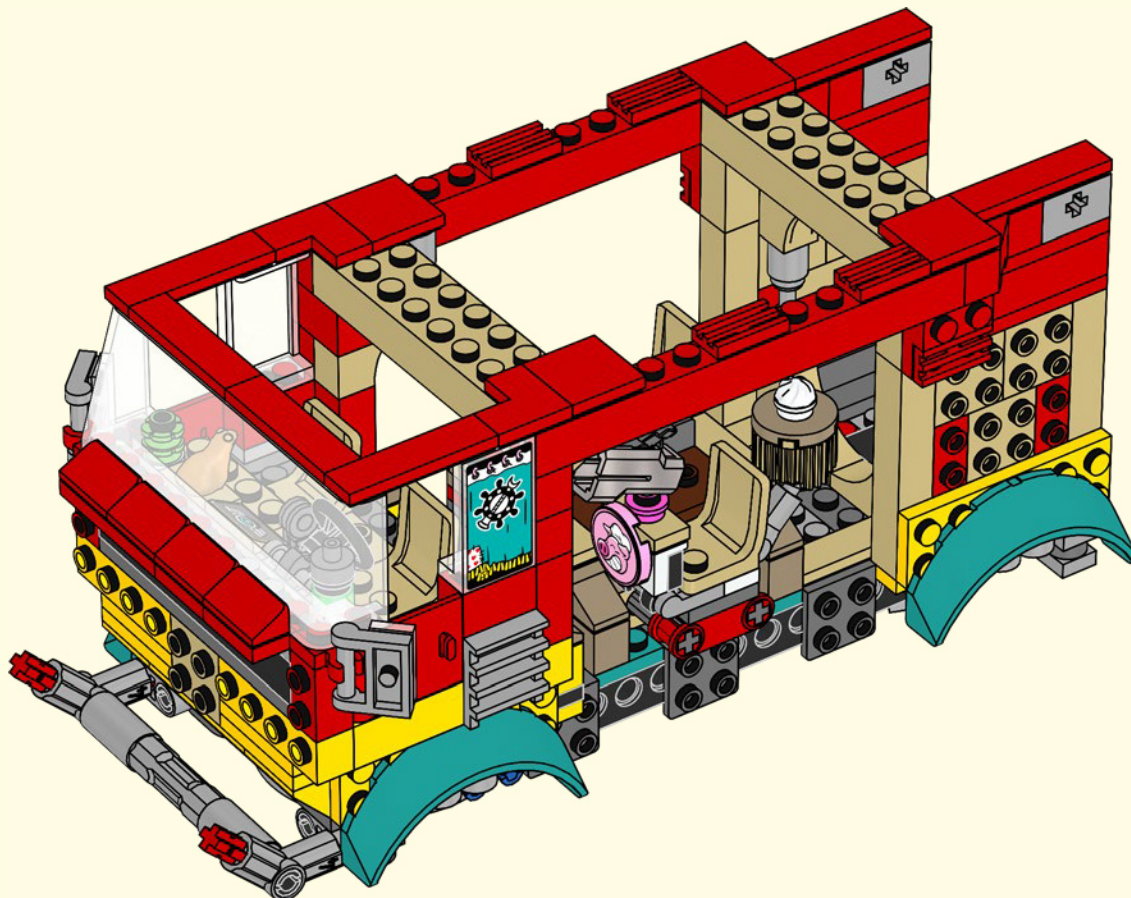

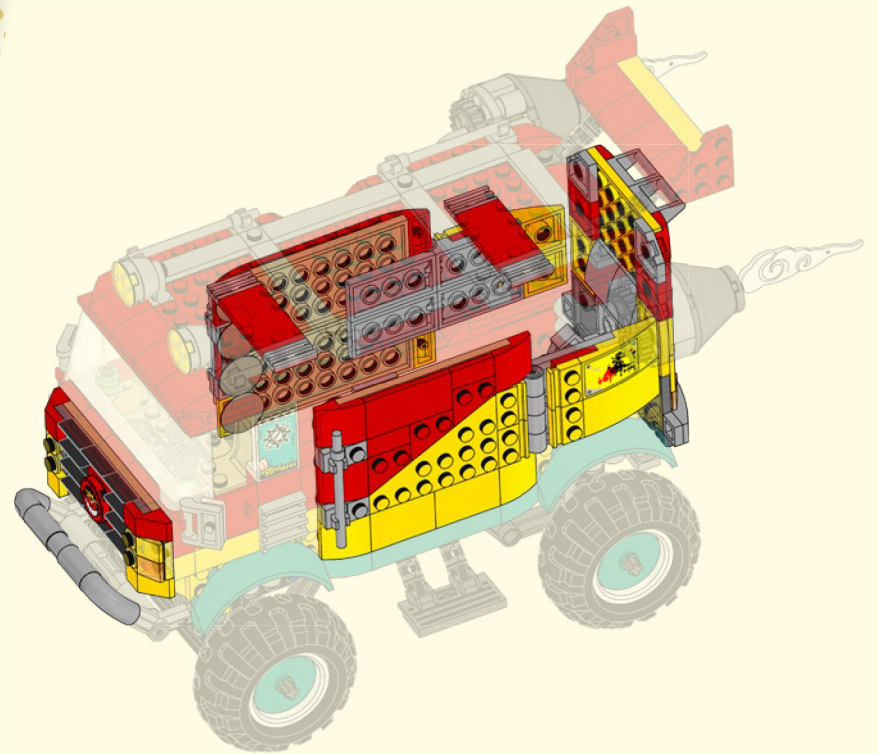



2x



4x

77

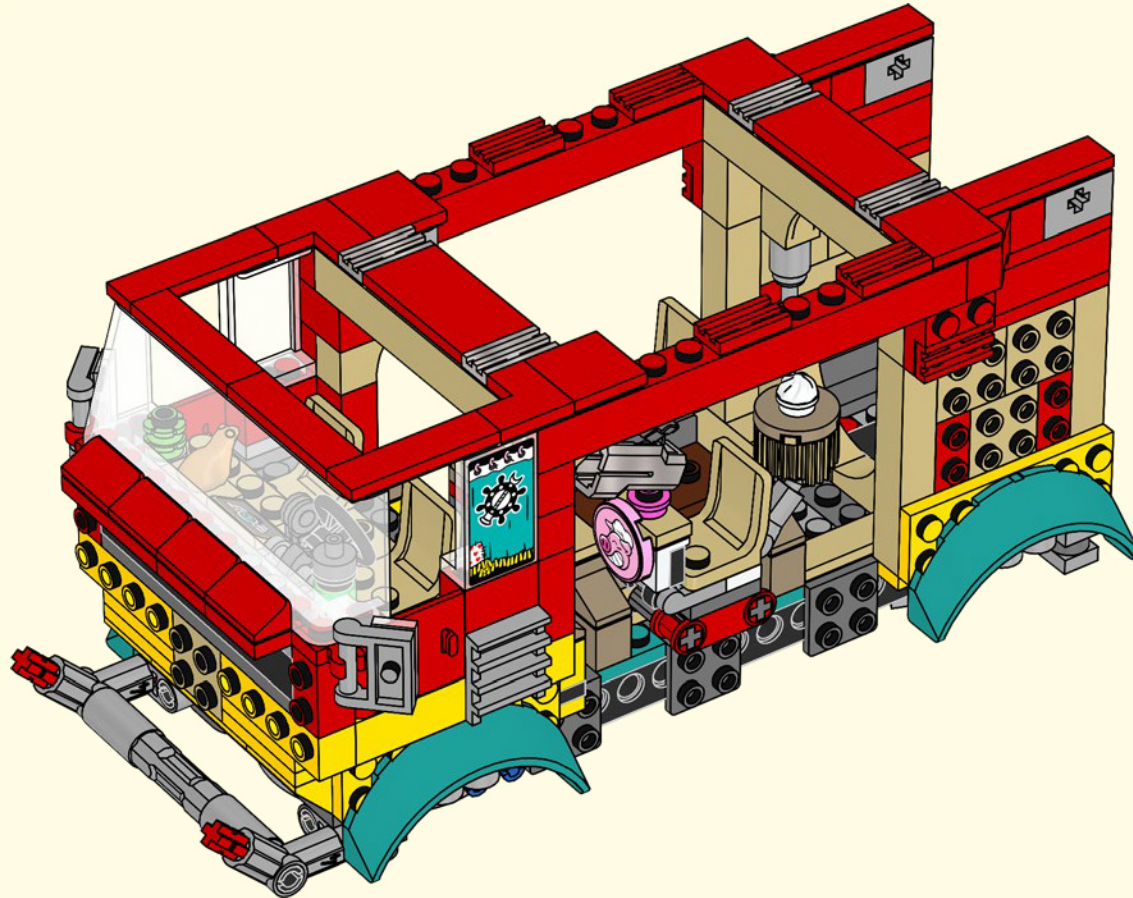



78

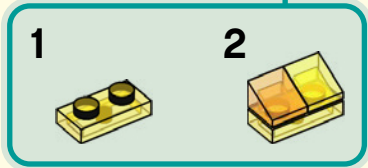
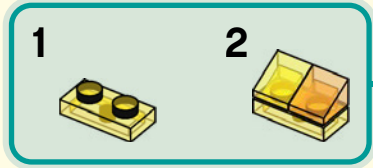
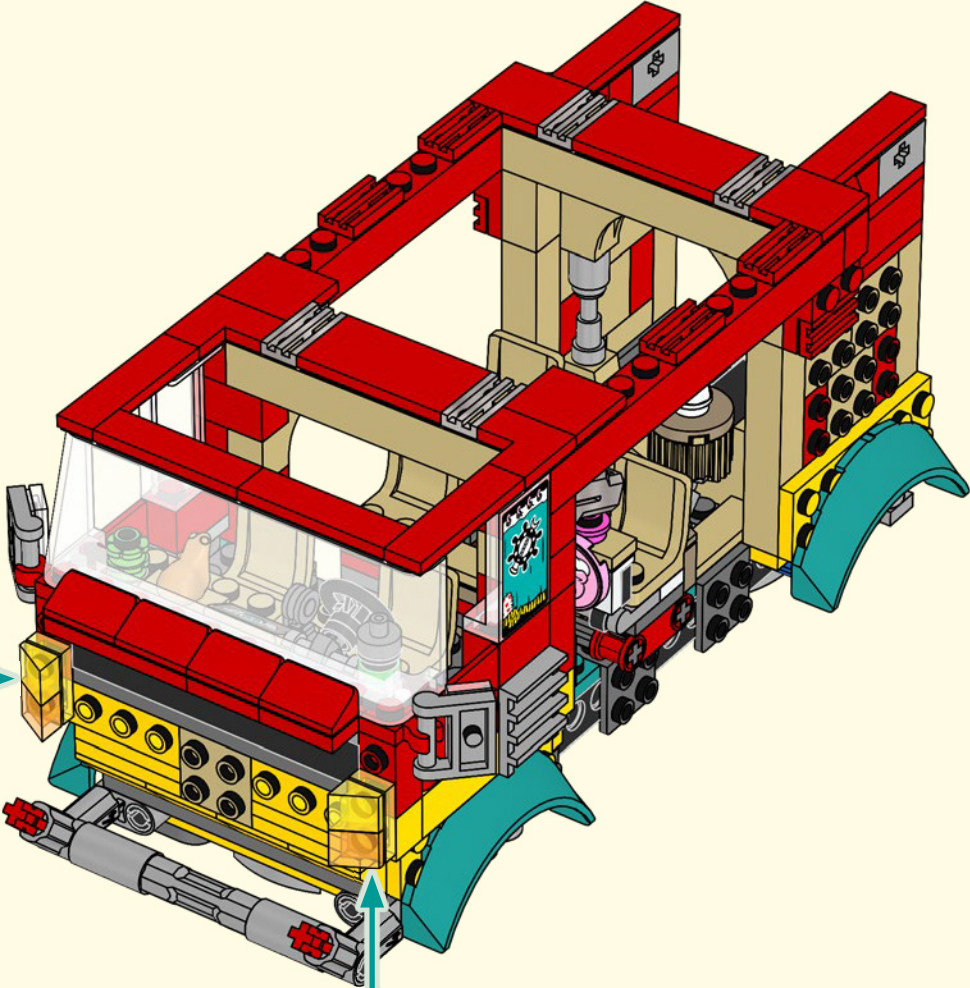

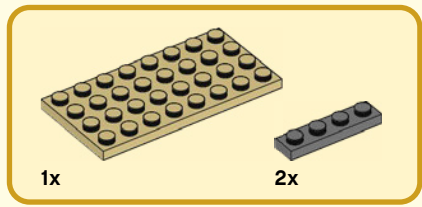

79

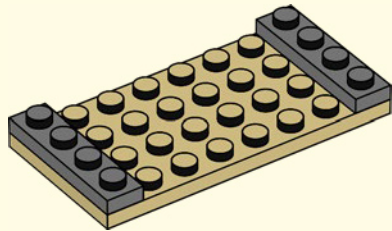

80

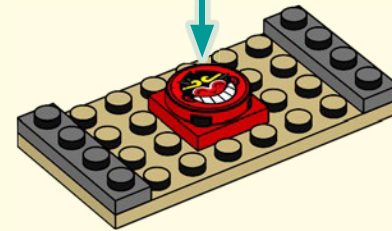
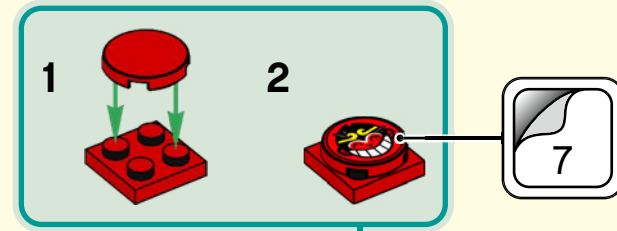

81





4x

82

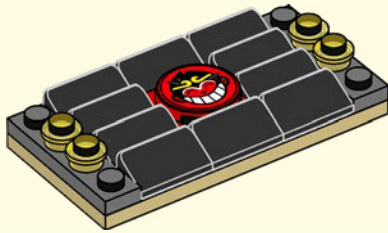

2x



2x

83

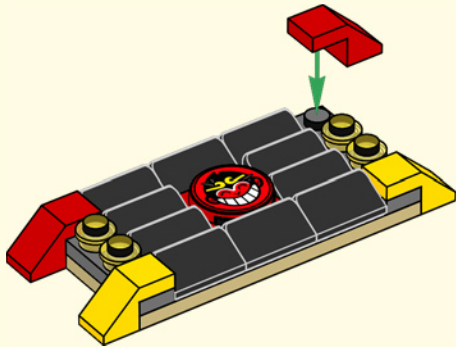

84

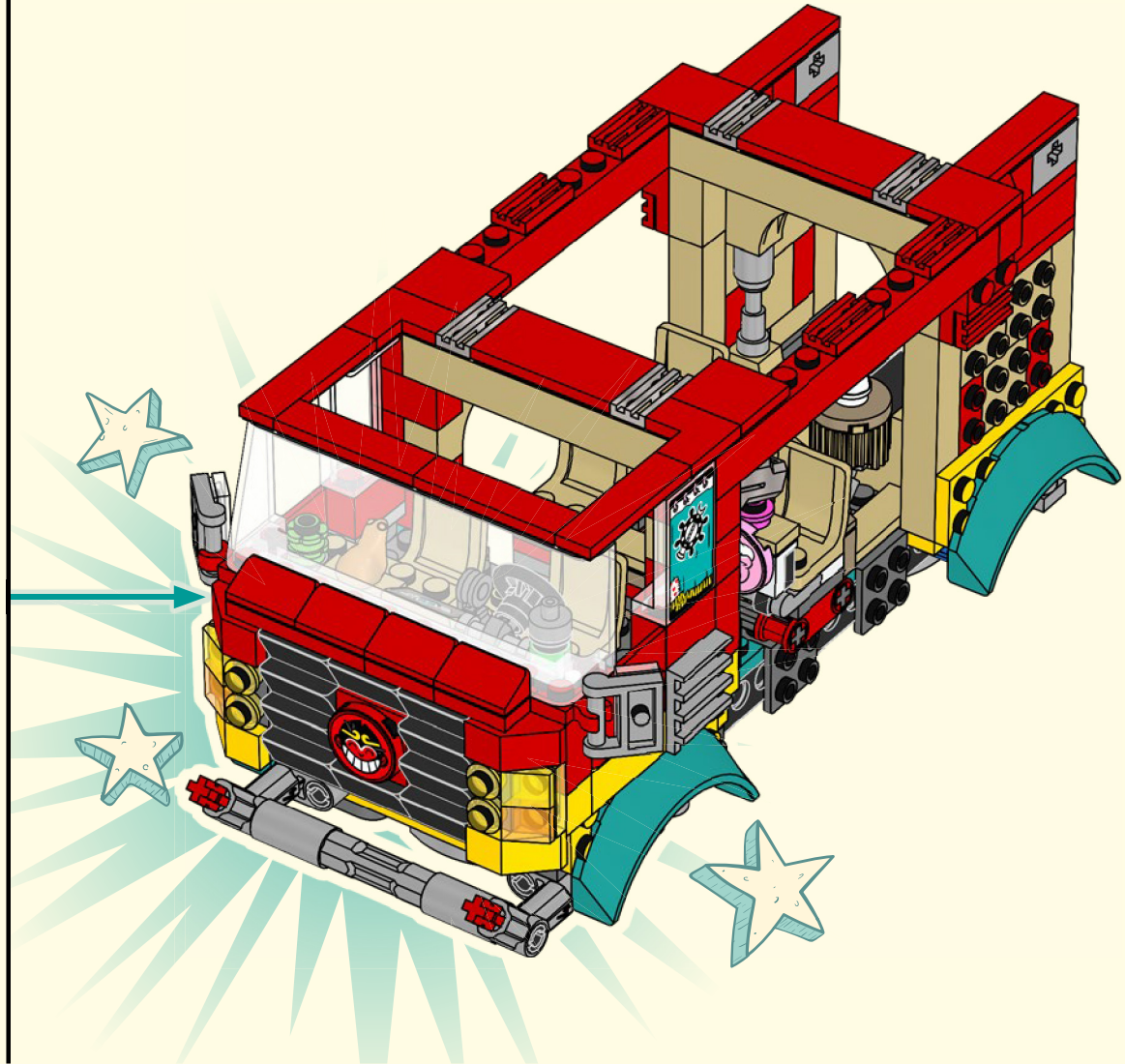

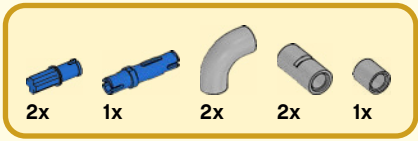

85

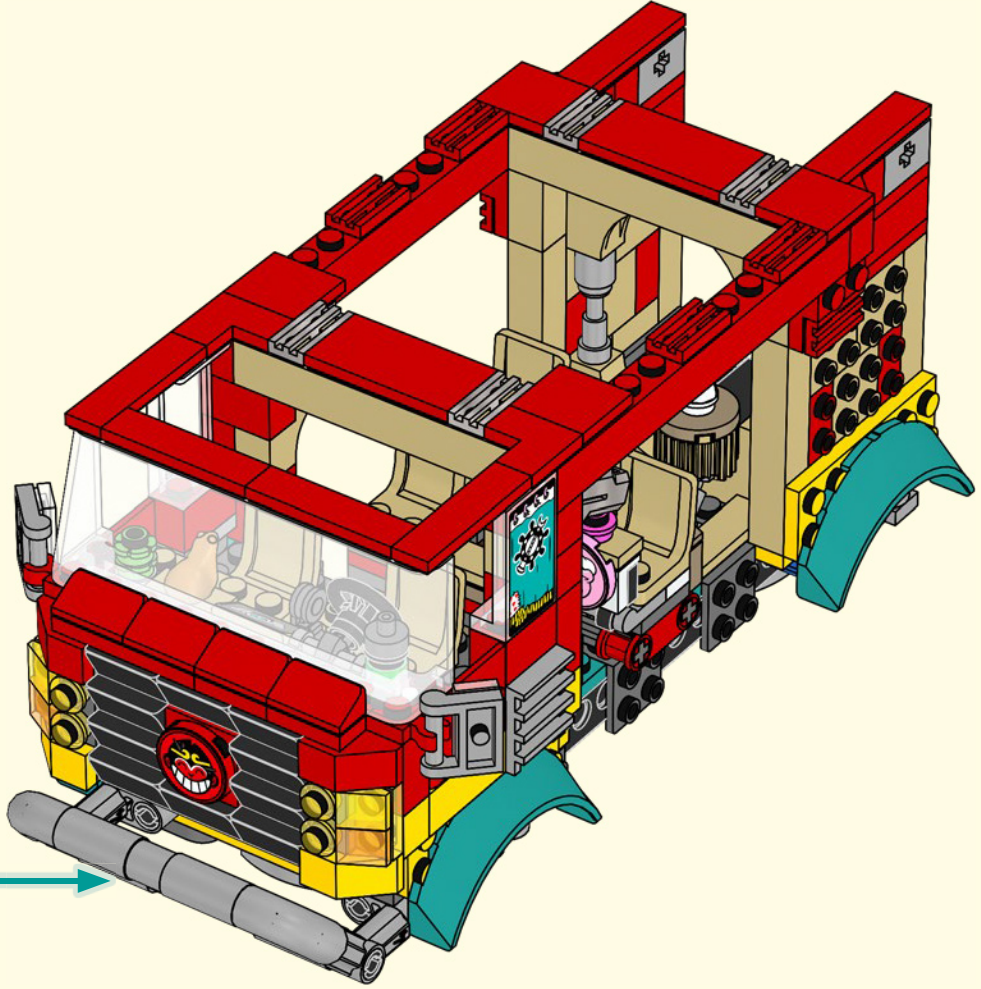
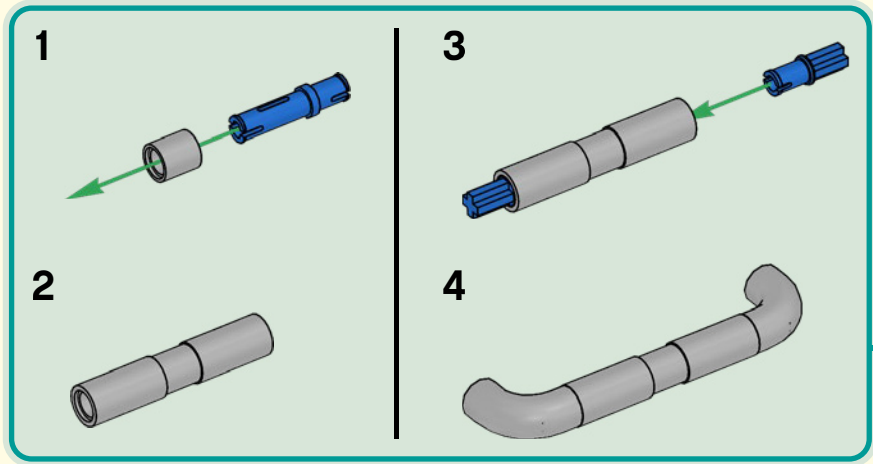

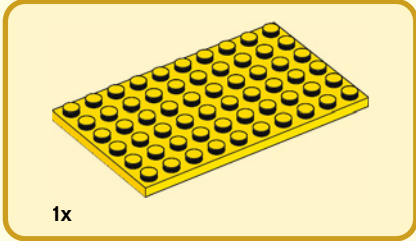

1x

86

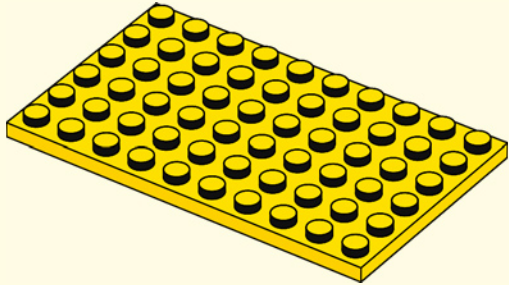

2x

87

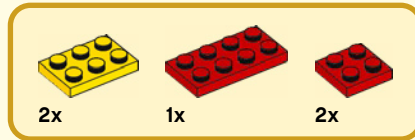
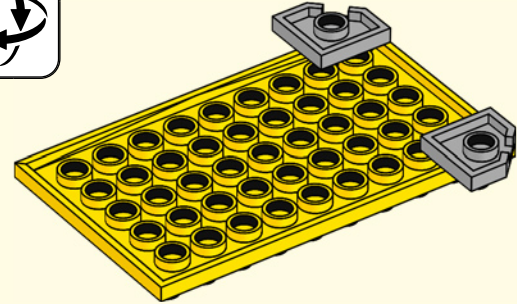
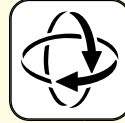

2x

1x

2x

88

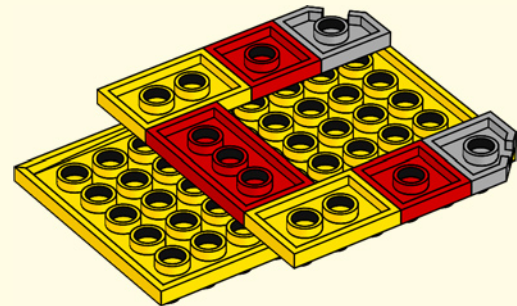

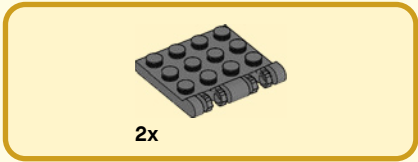

89

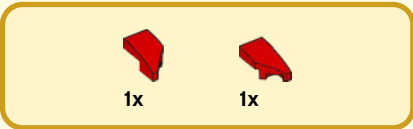
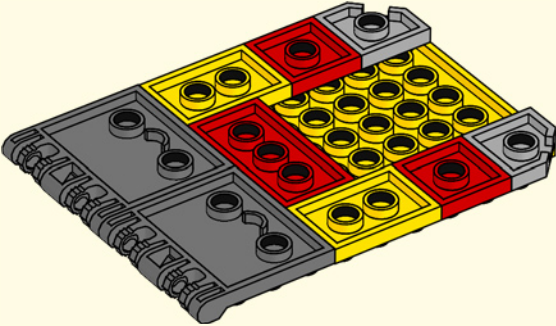

90

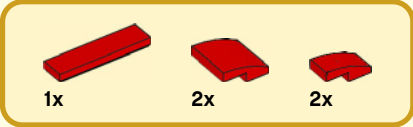
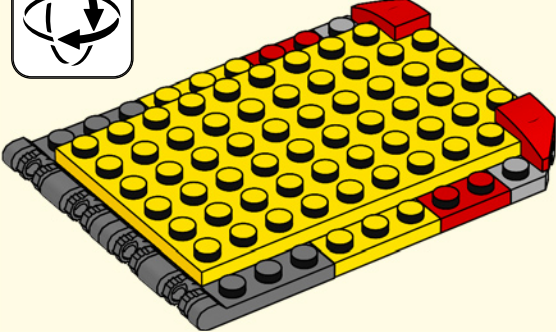

91

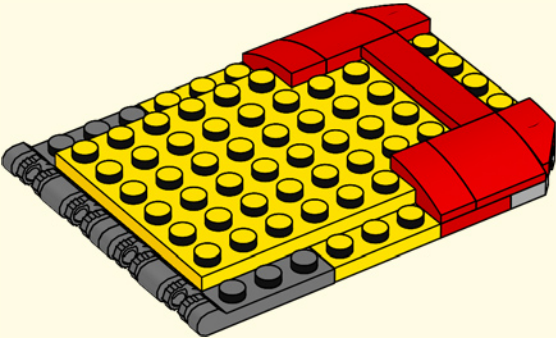



92

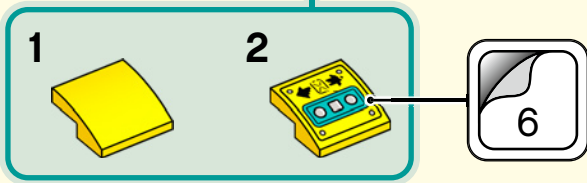
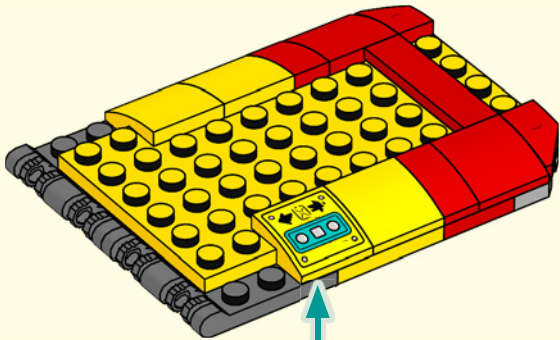

93

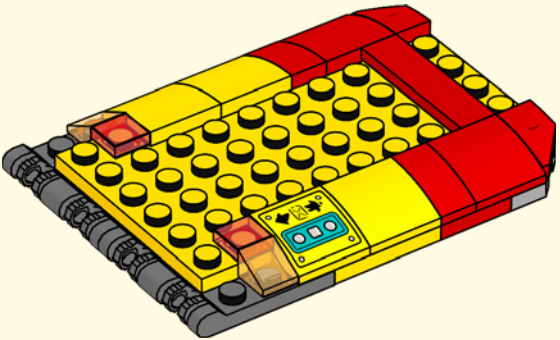



94

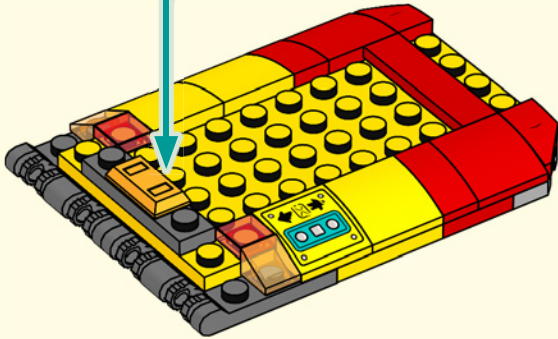
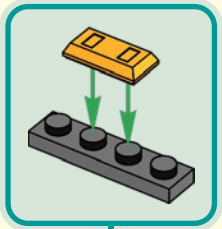

95

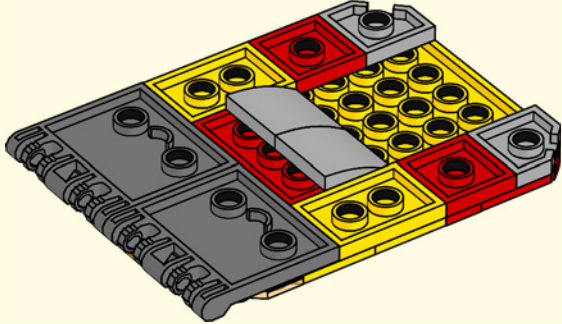

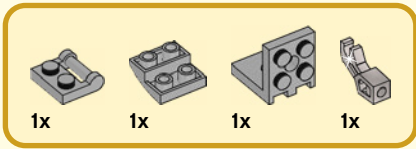

96

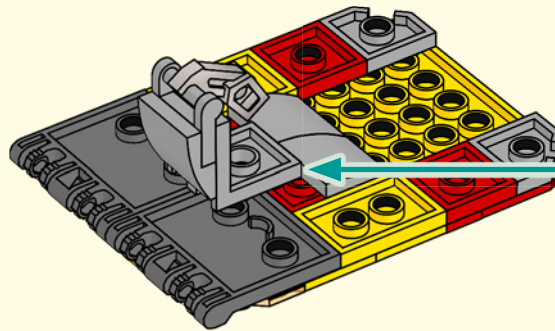
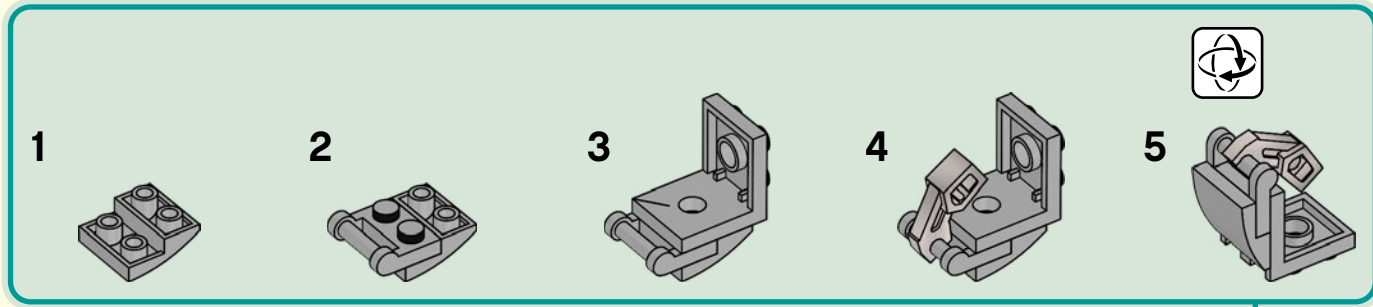



2x

97

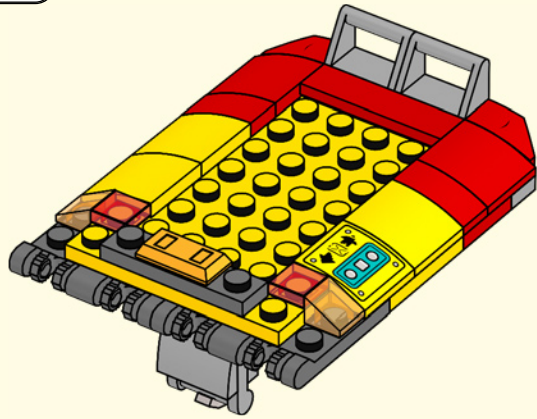

98

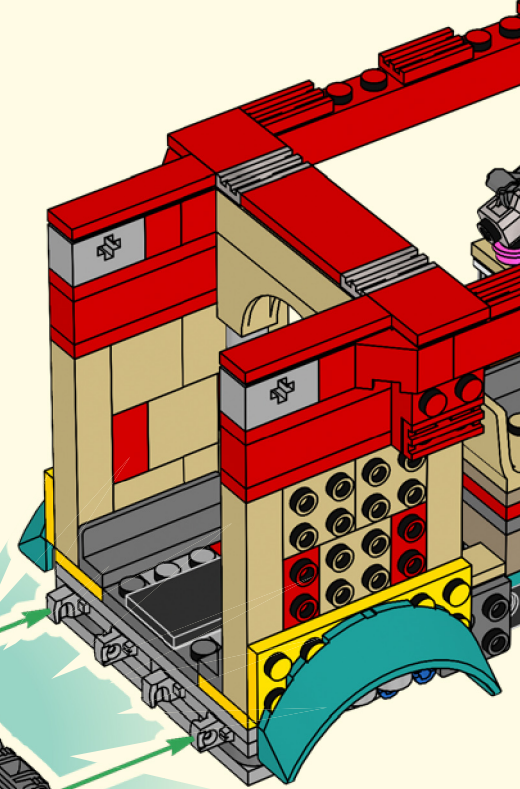
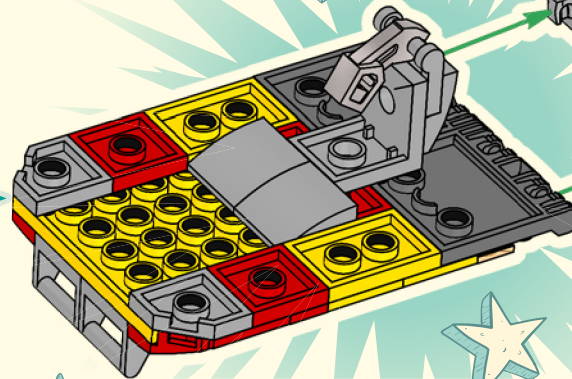
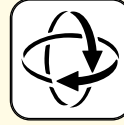

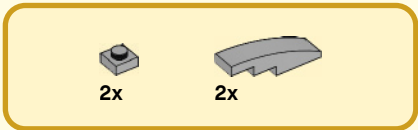

99

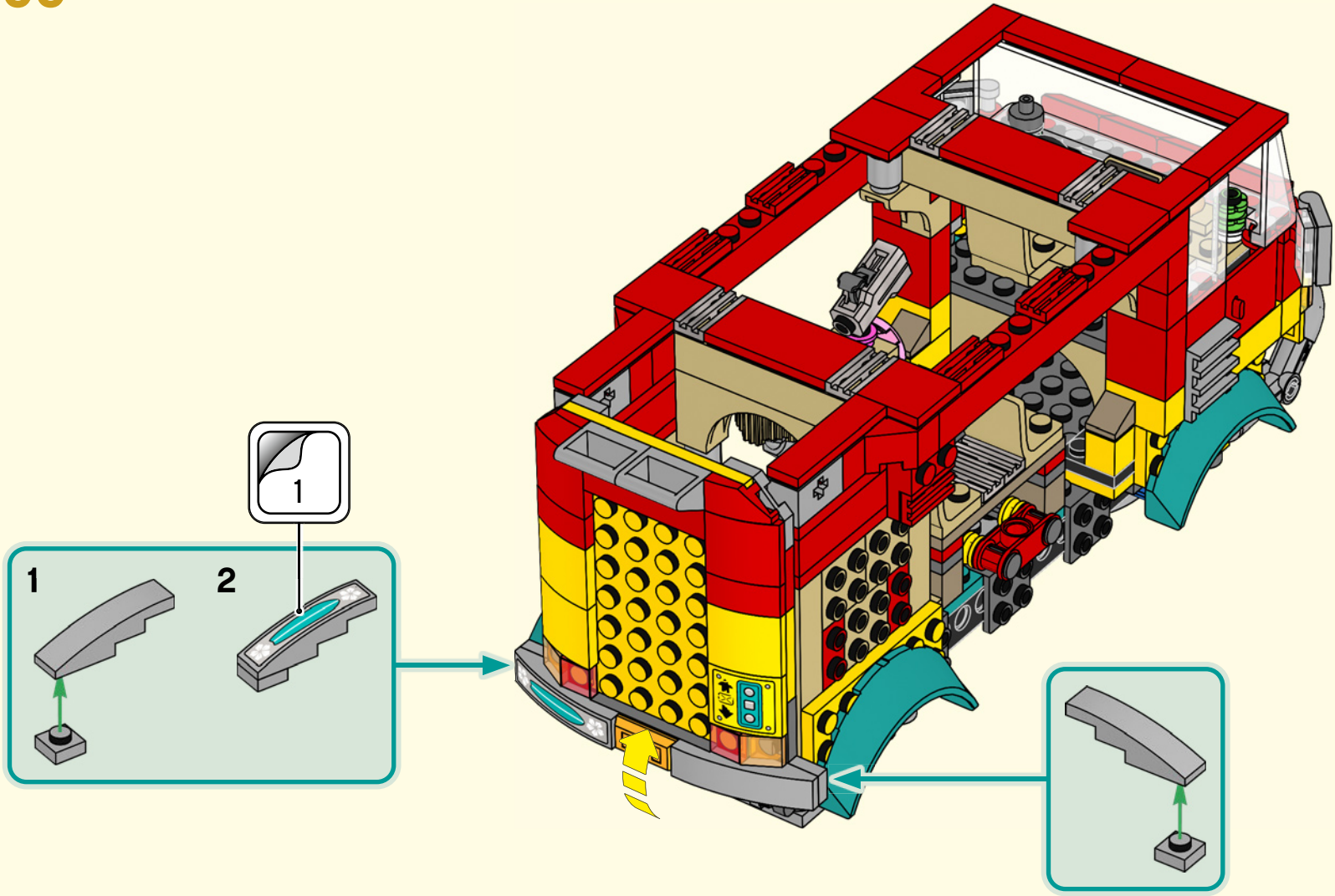

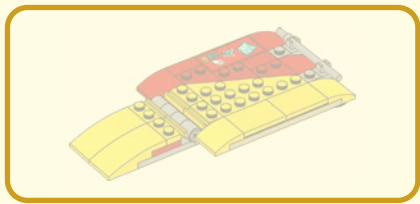

1x

100

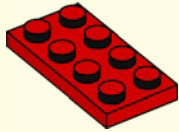

2x

101

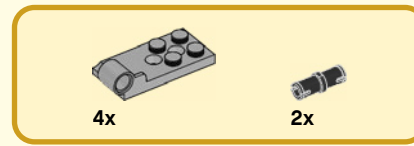
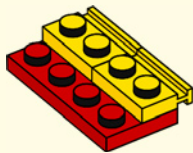

4x

2x

102

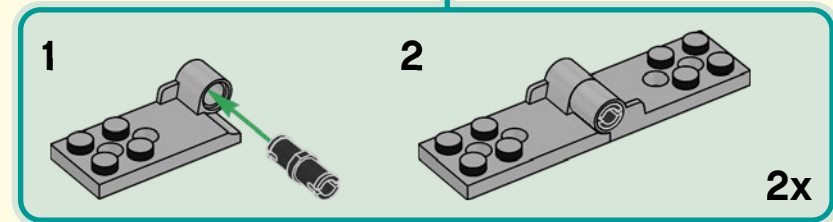
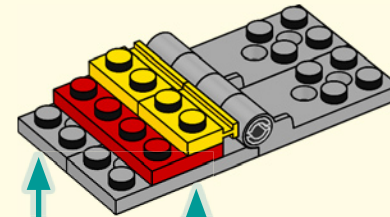

1

2

2x



103

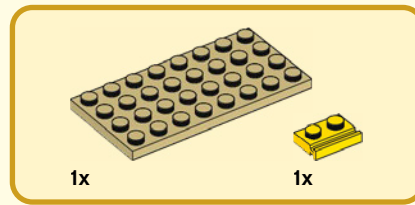
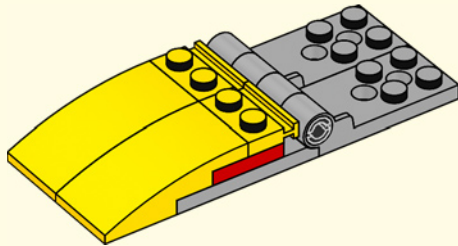

104

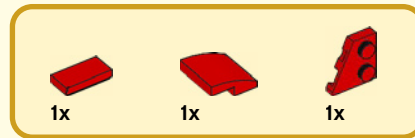
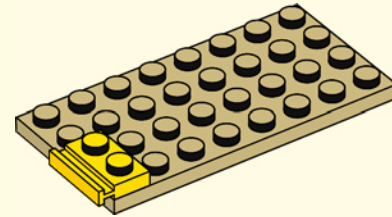

105

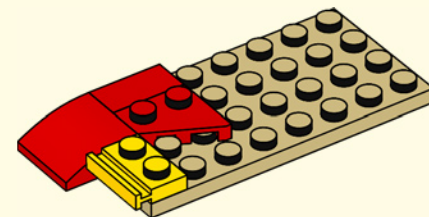

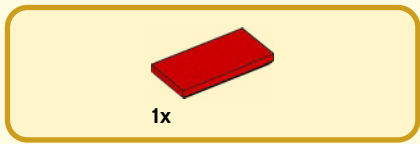

106

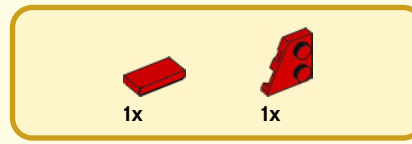
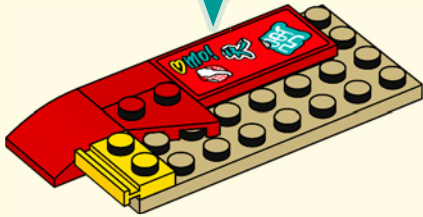
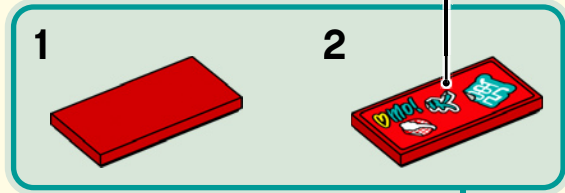

107

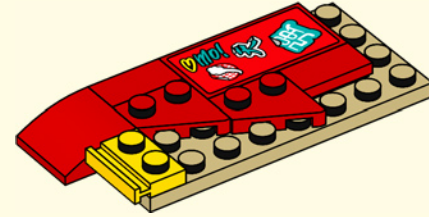

108

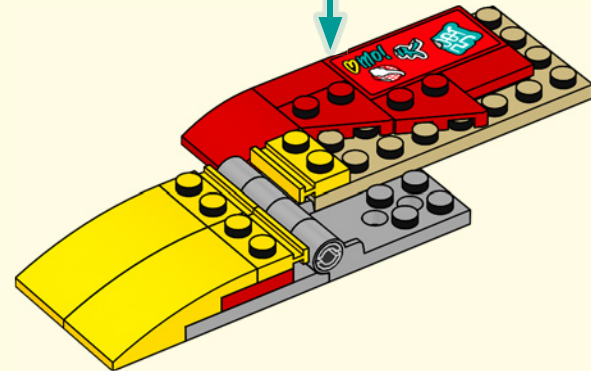

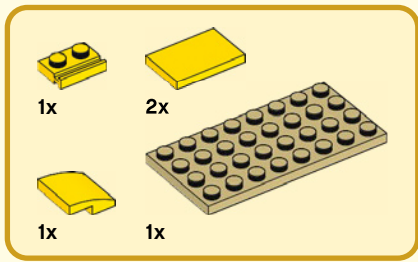

109

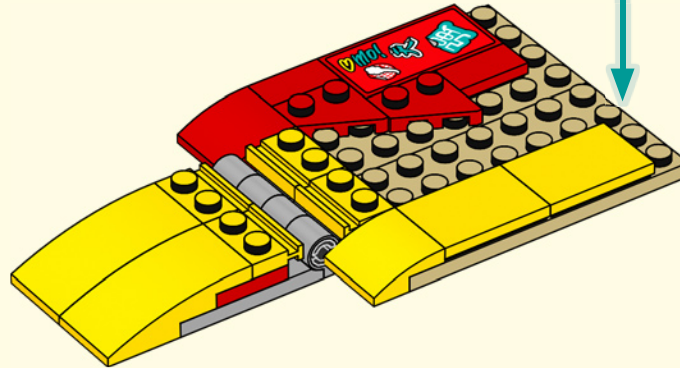
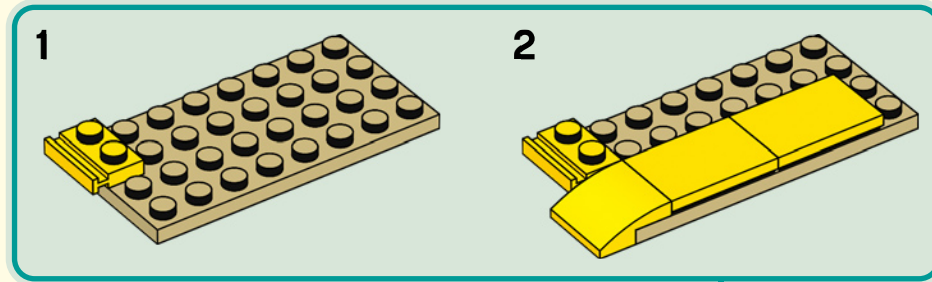



4x

110

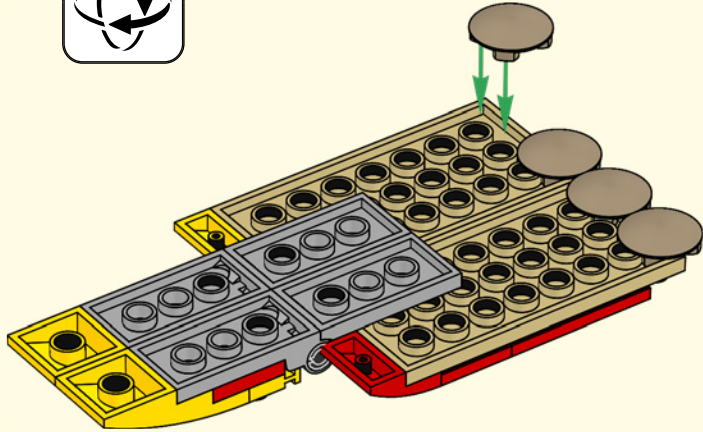

1x

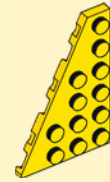

1x

111

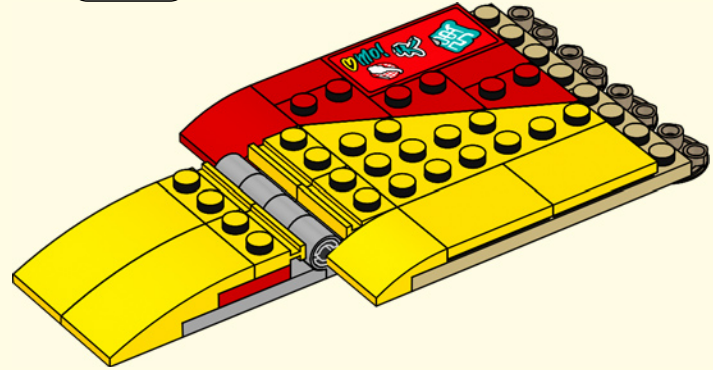
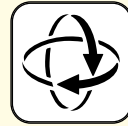

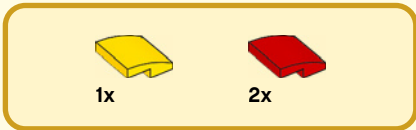

112

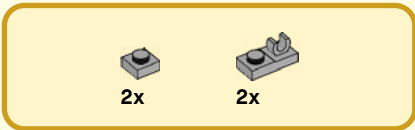
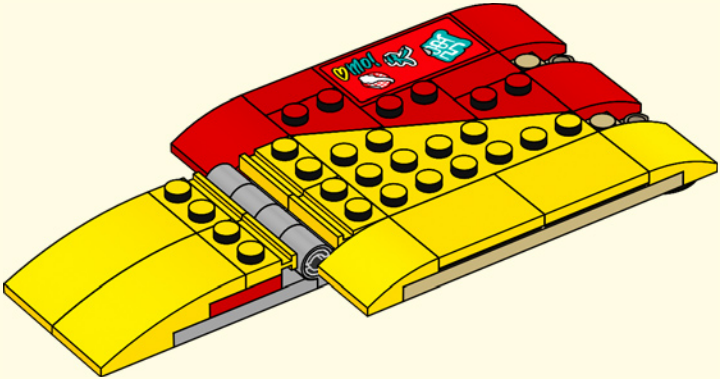

113

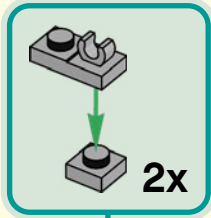

2x

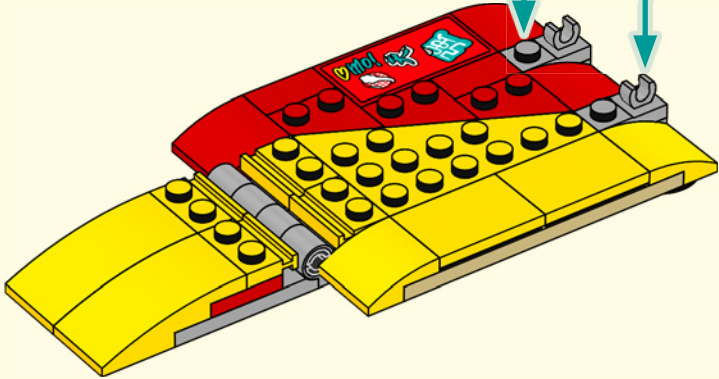



1x

114

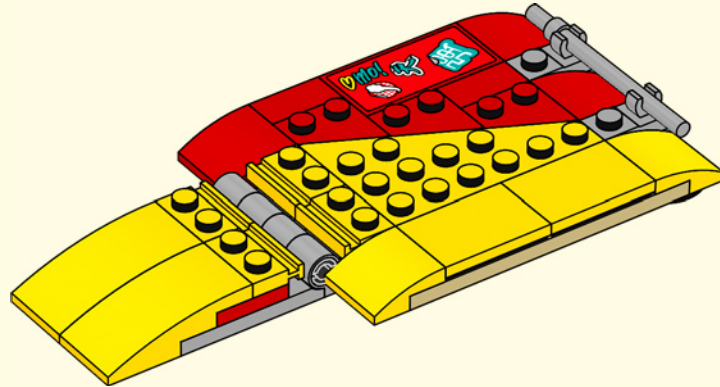

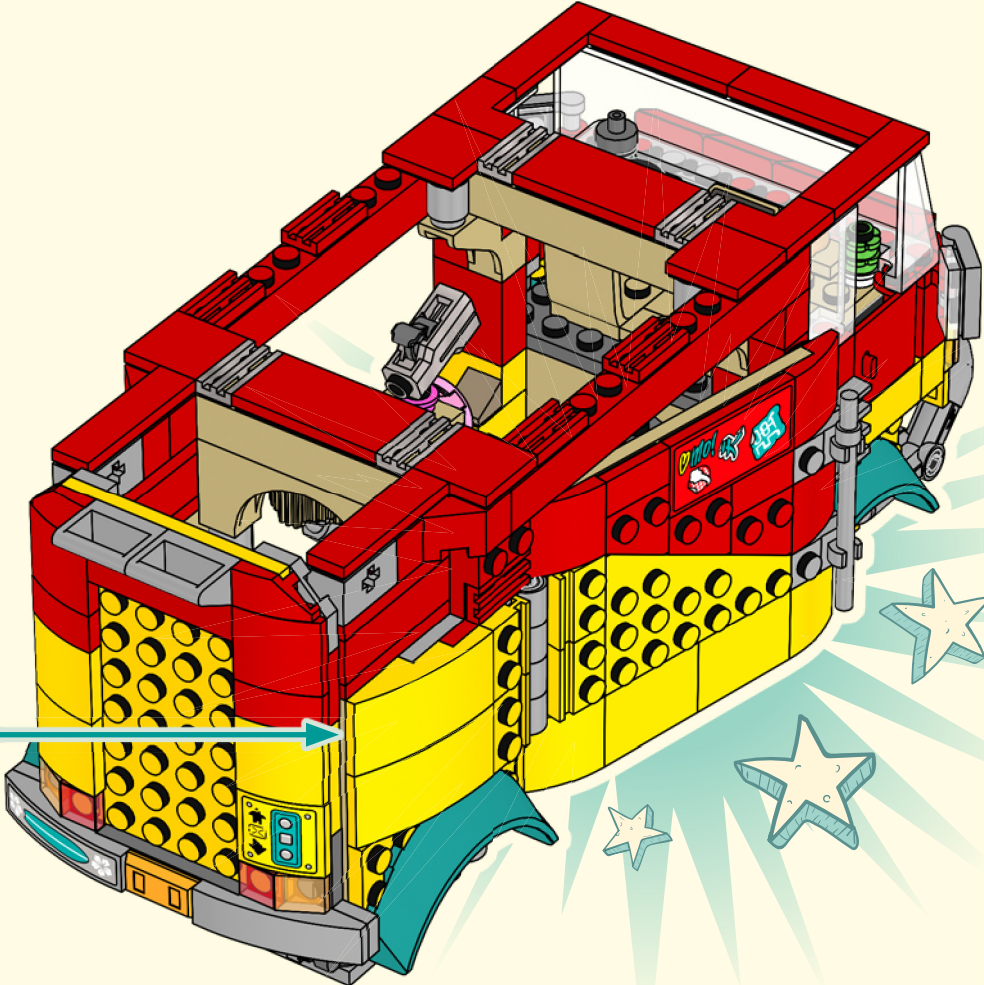

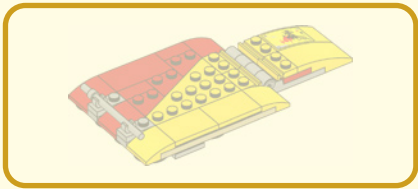

116

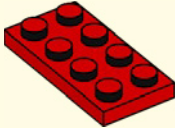

117

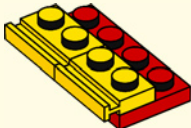

118

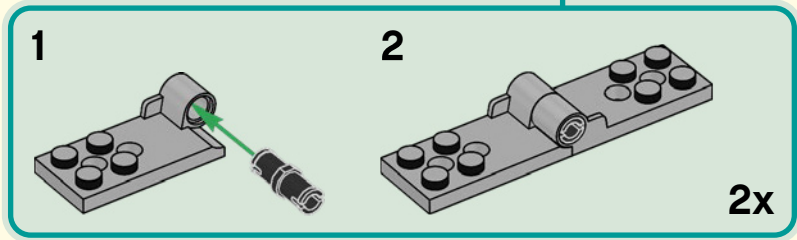
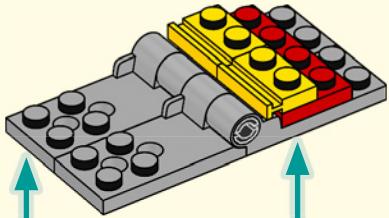



119

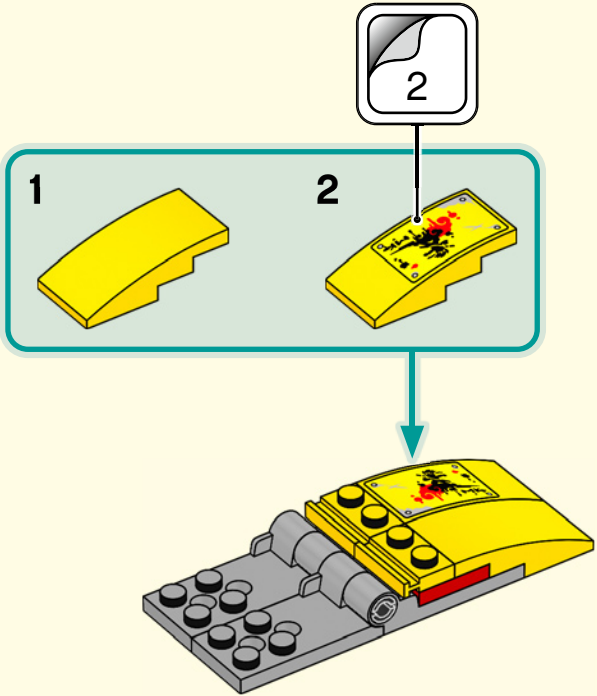

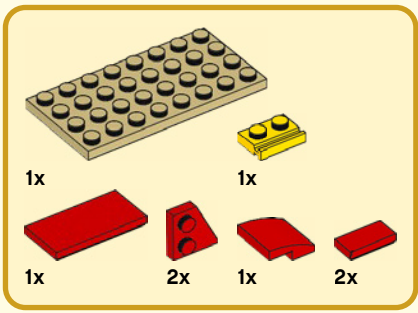

120

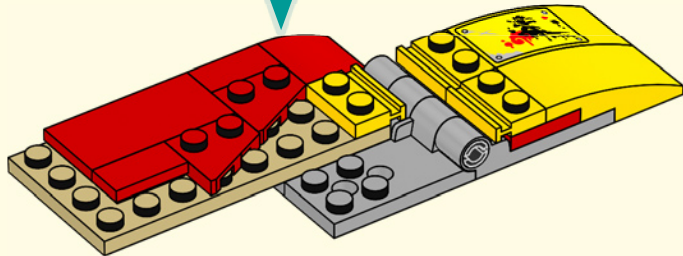
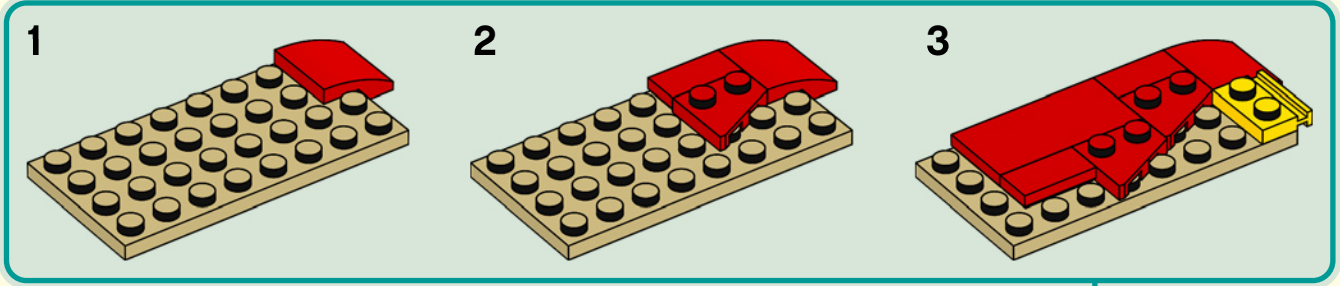

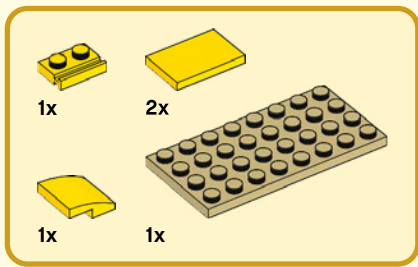

121

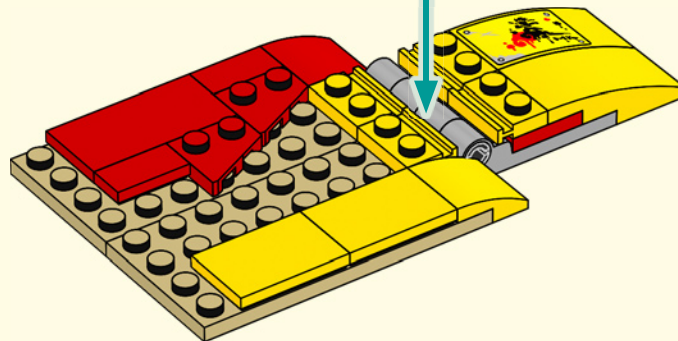
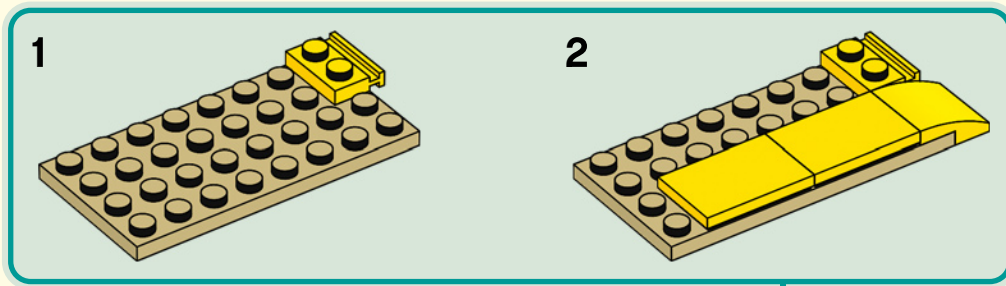



4x

122

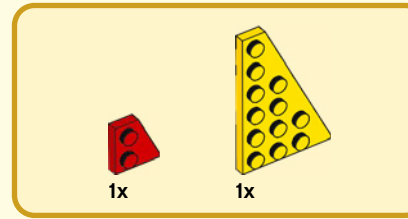
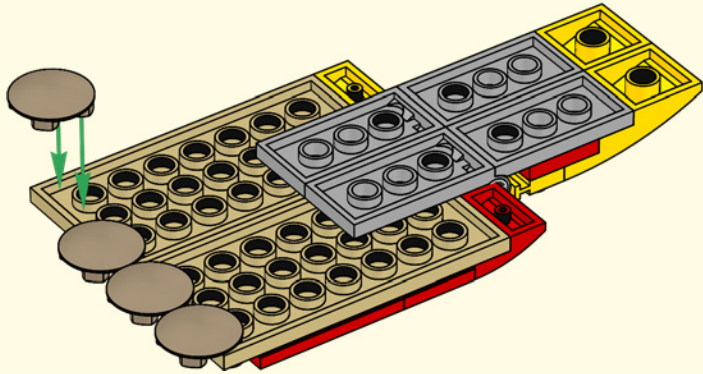

123

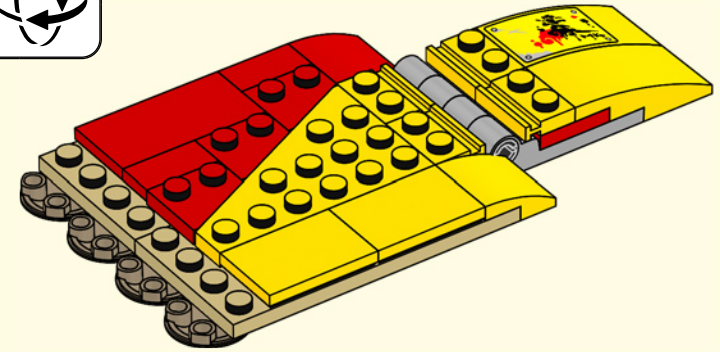
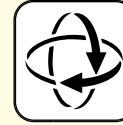

124

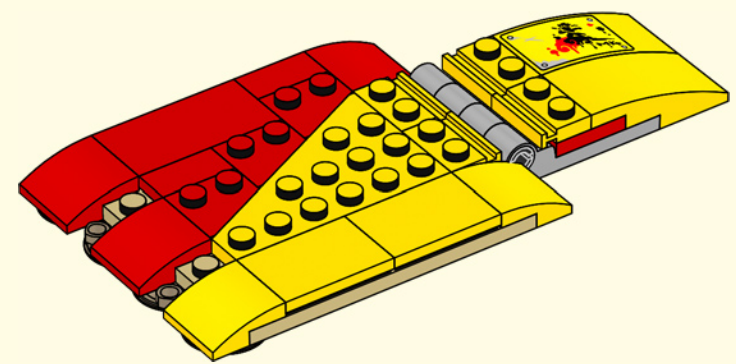

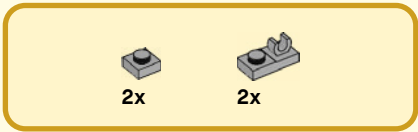

125

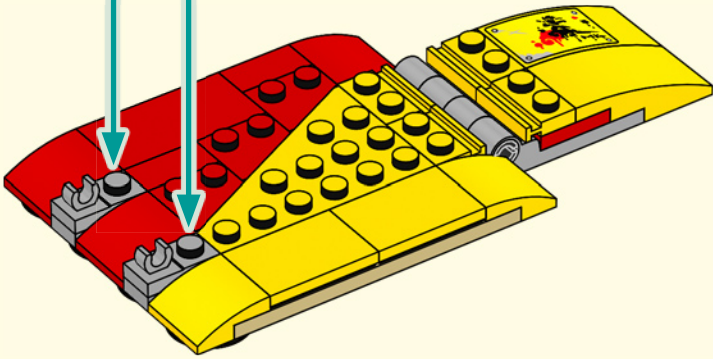
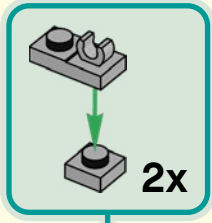

126

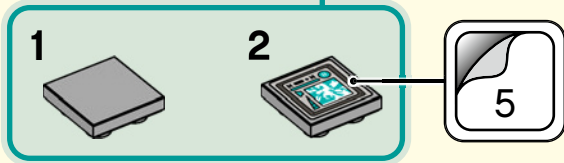
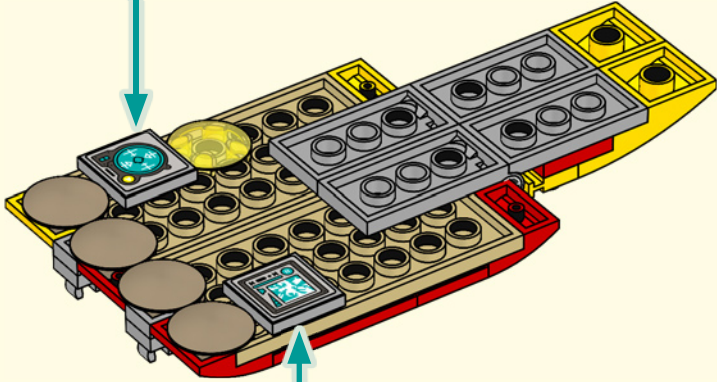
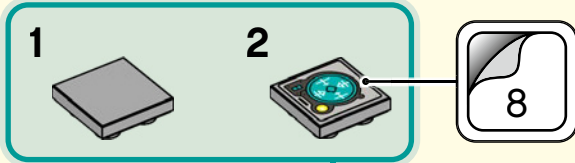



1x

127

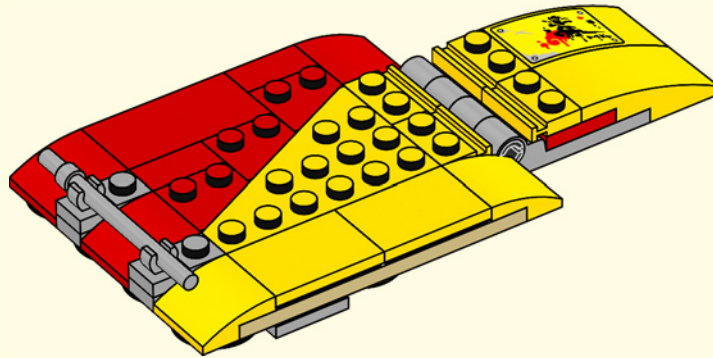

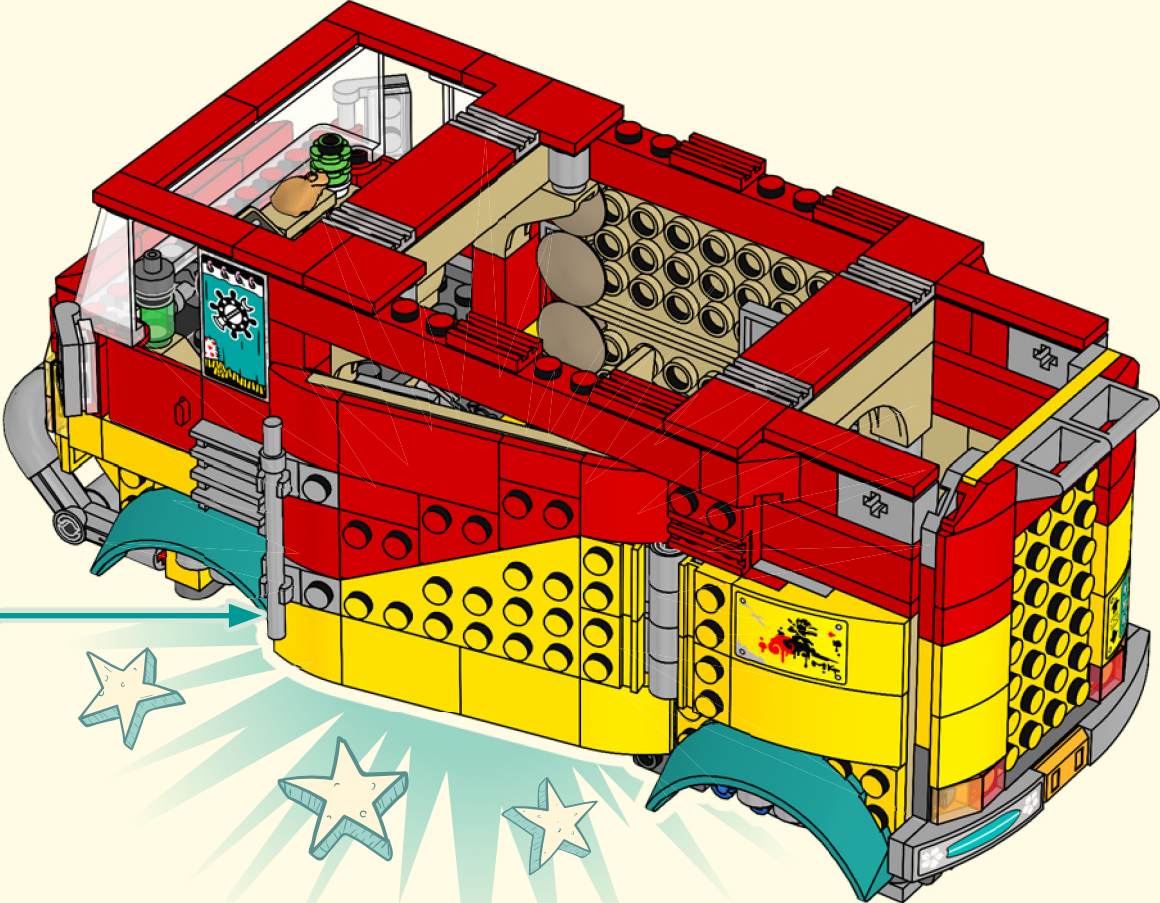



1

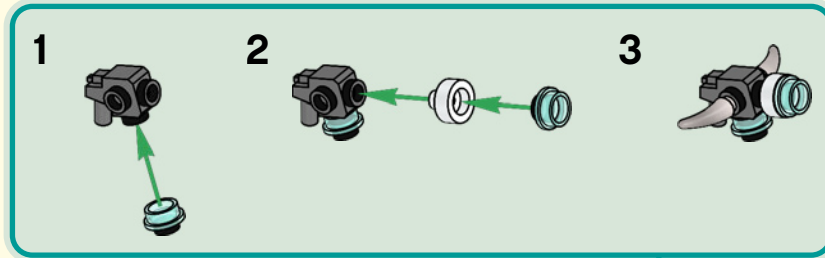
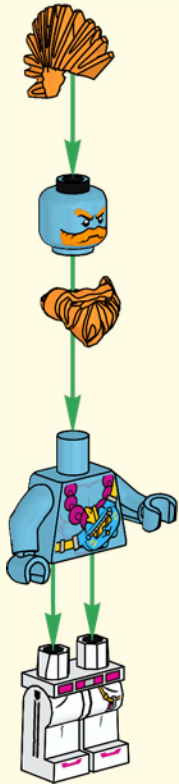

2





2x

129

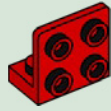

2x

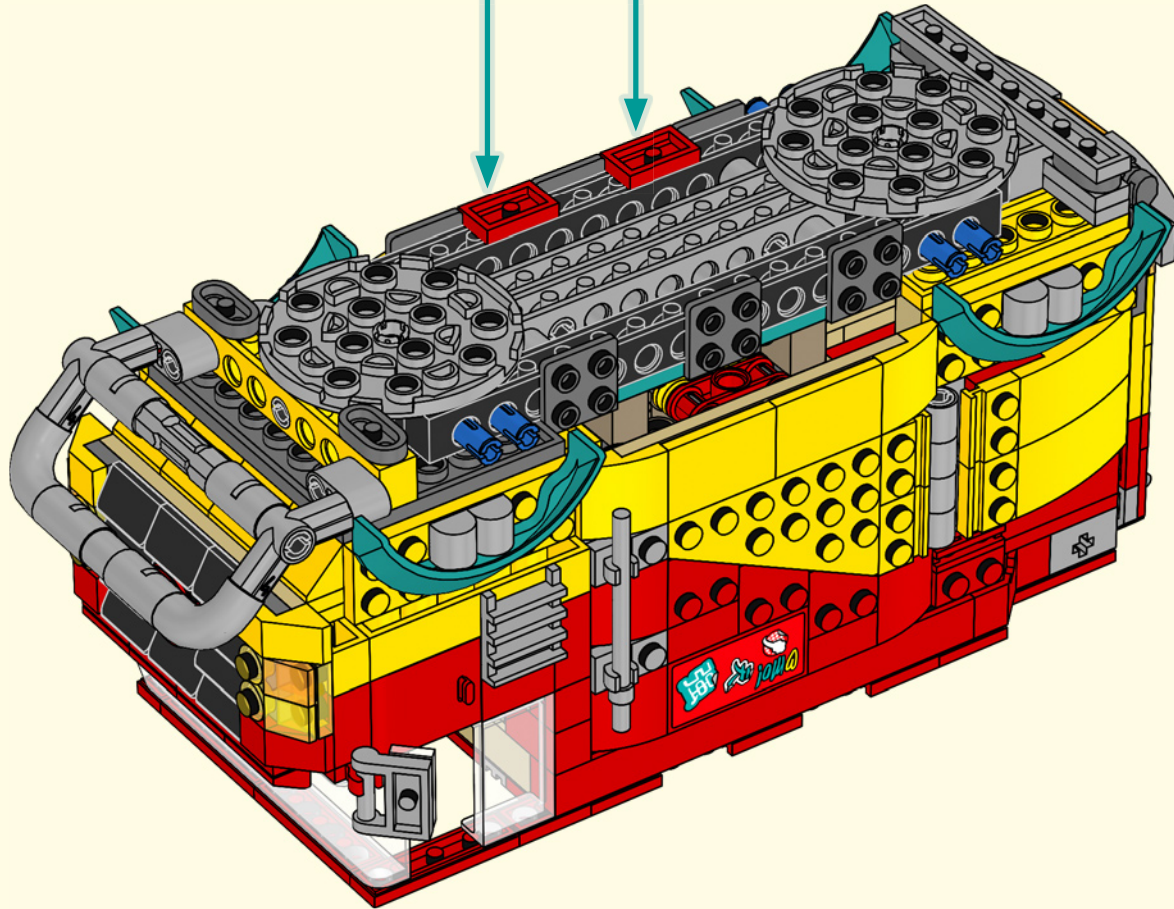

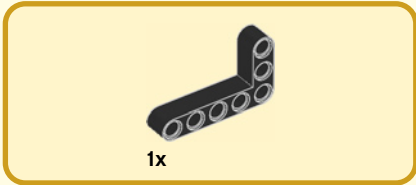

130

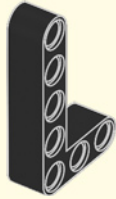

131

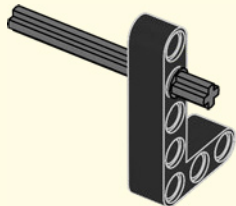
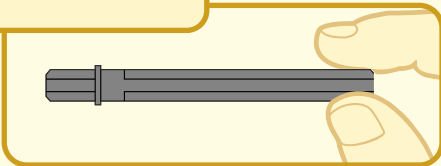

132

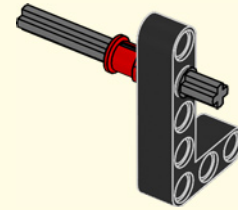

133

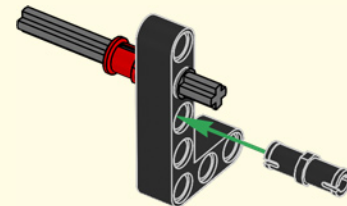



1x

134

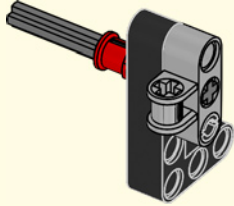

1x

135

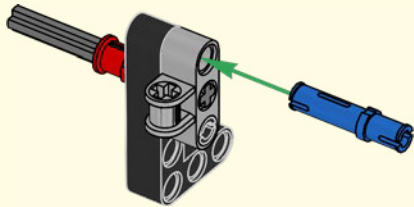

1x

136



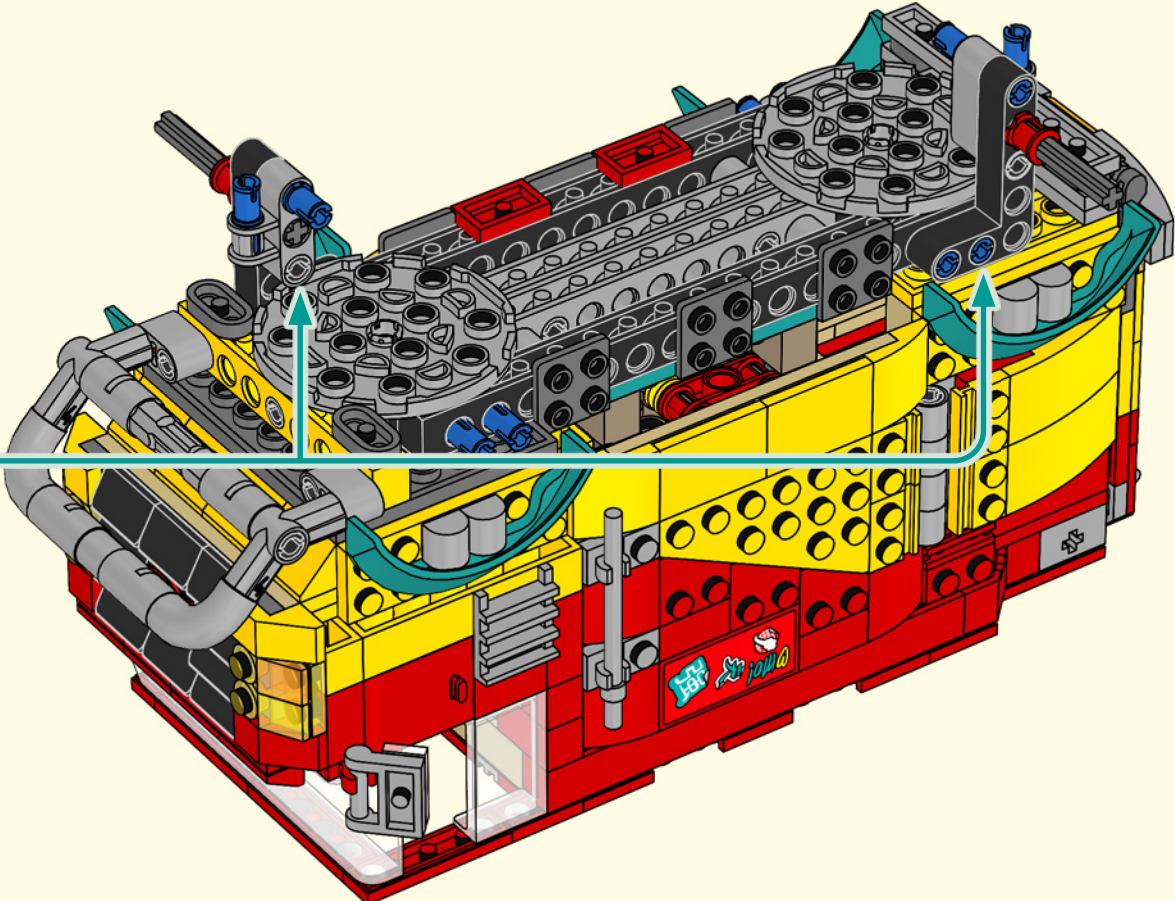

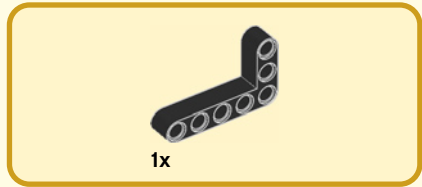
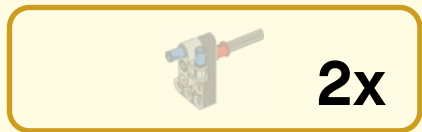

138



139

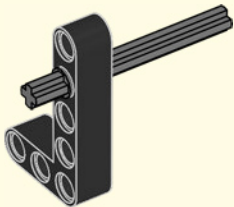
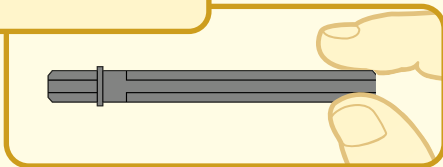

140

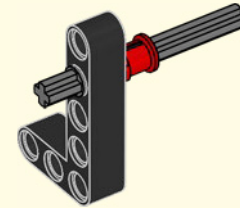

141

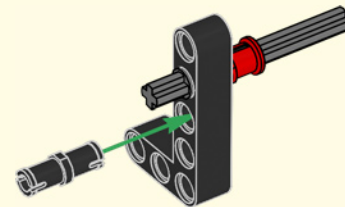



1x

142

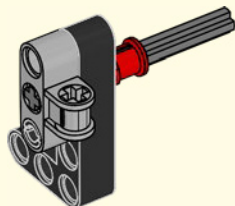

1x

143

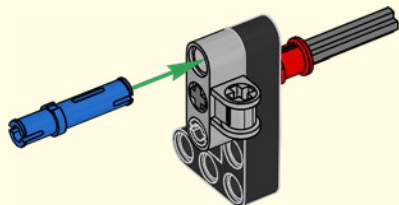

1x

144



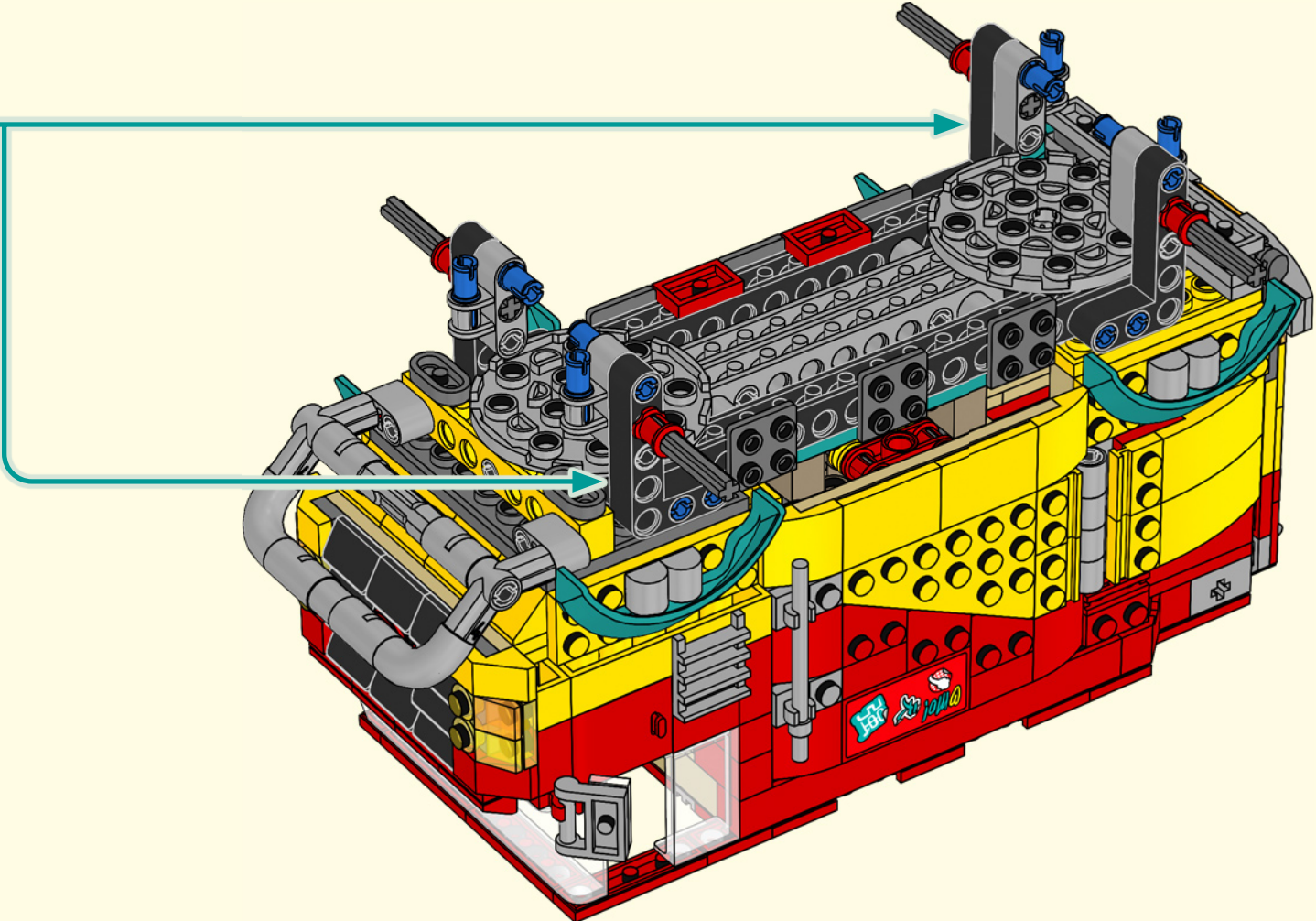

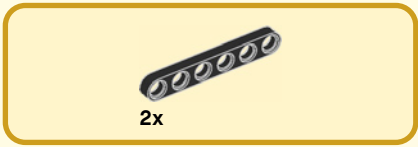

146

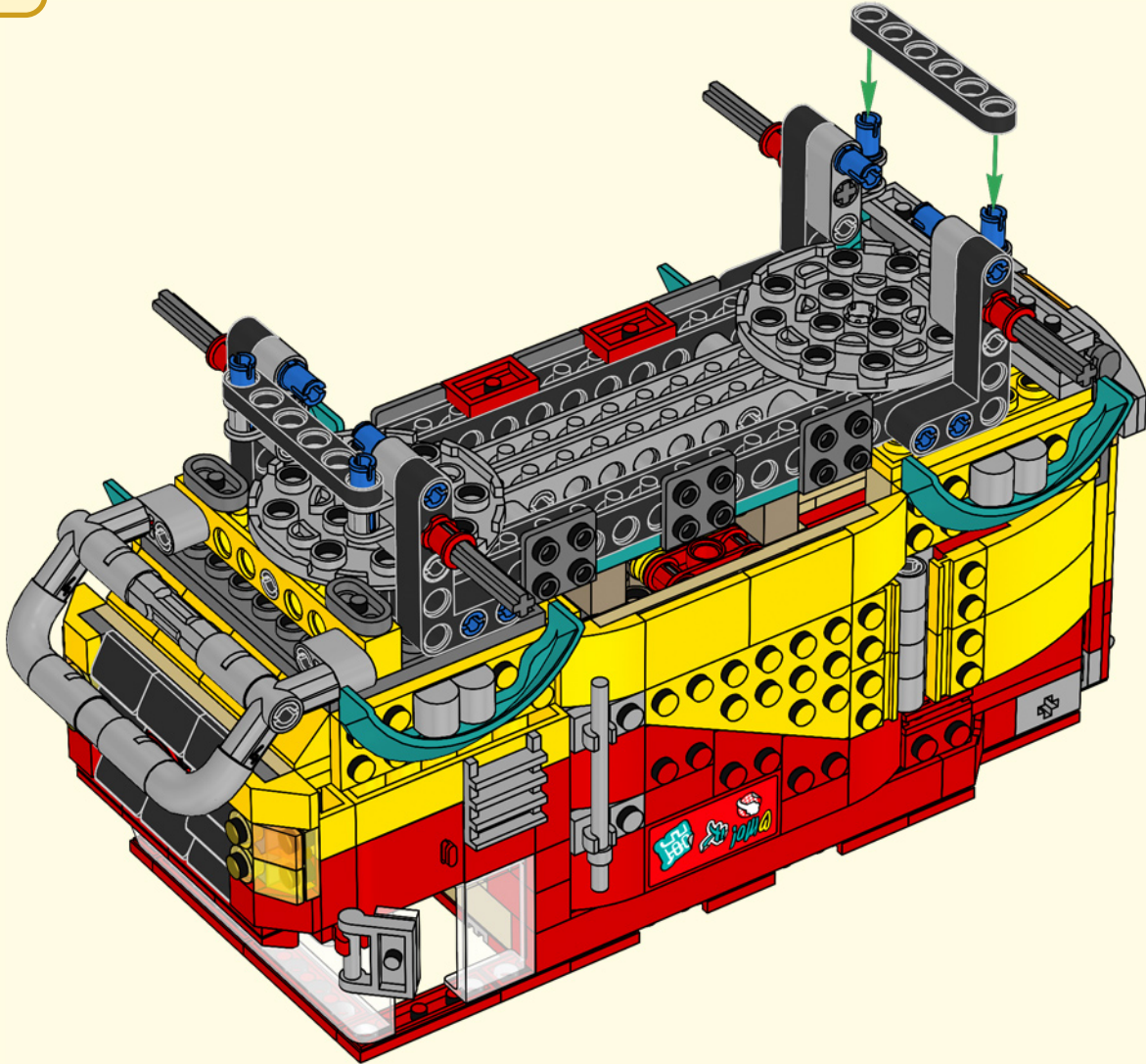



2x

147

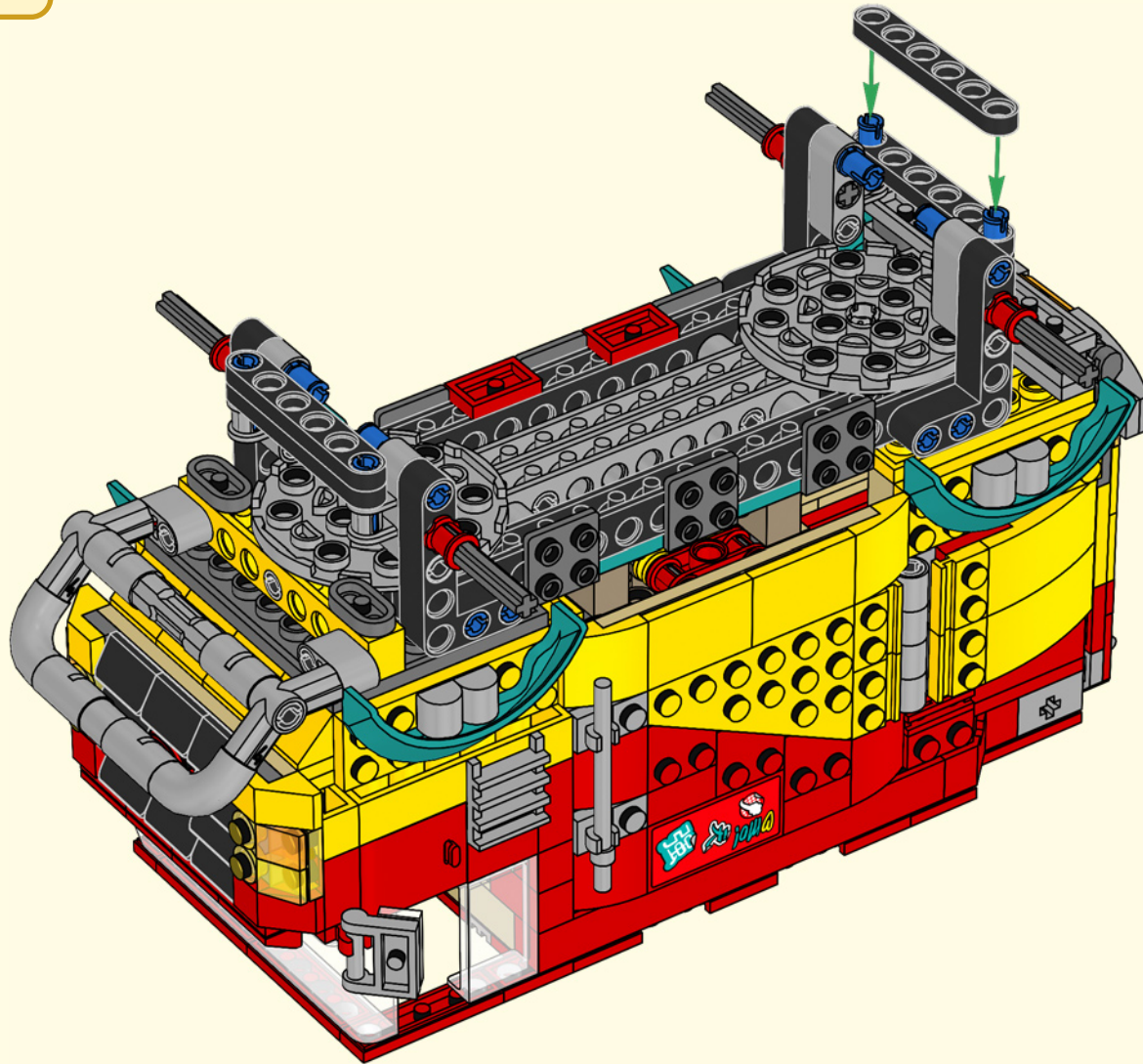

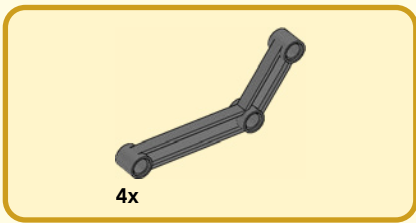

148

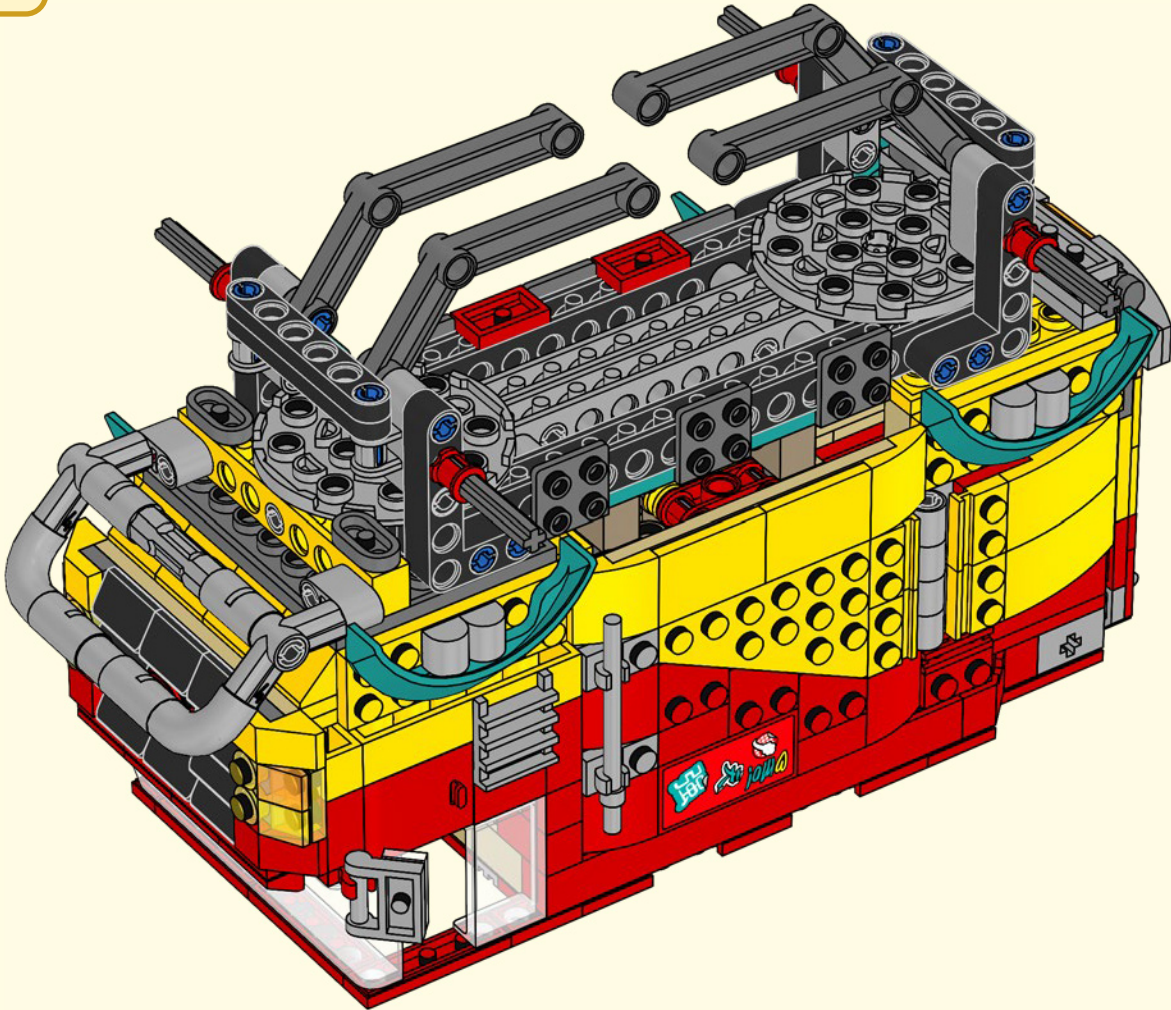

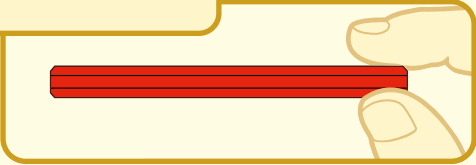
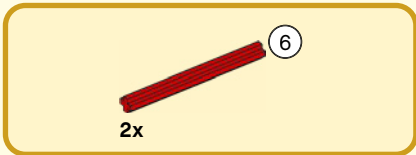

149

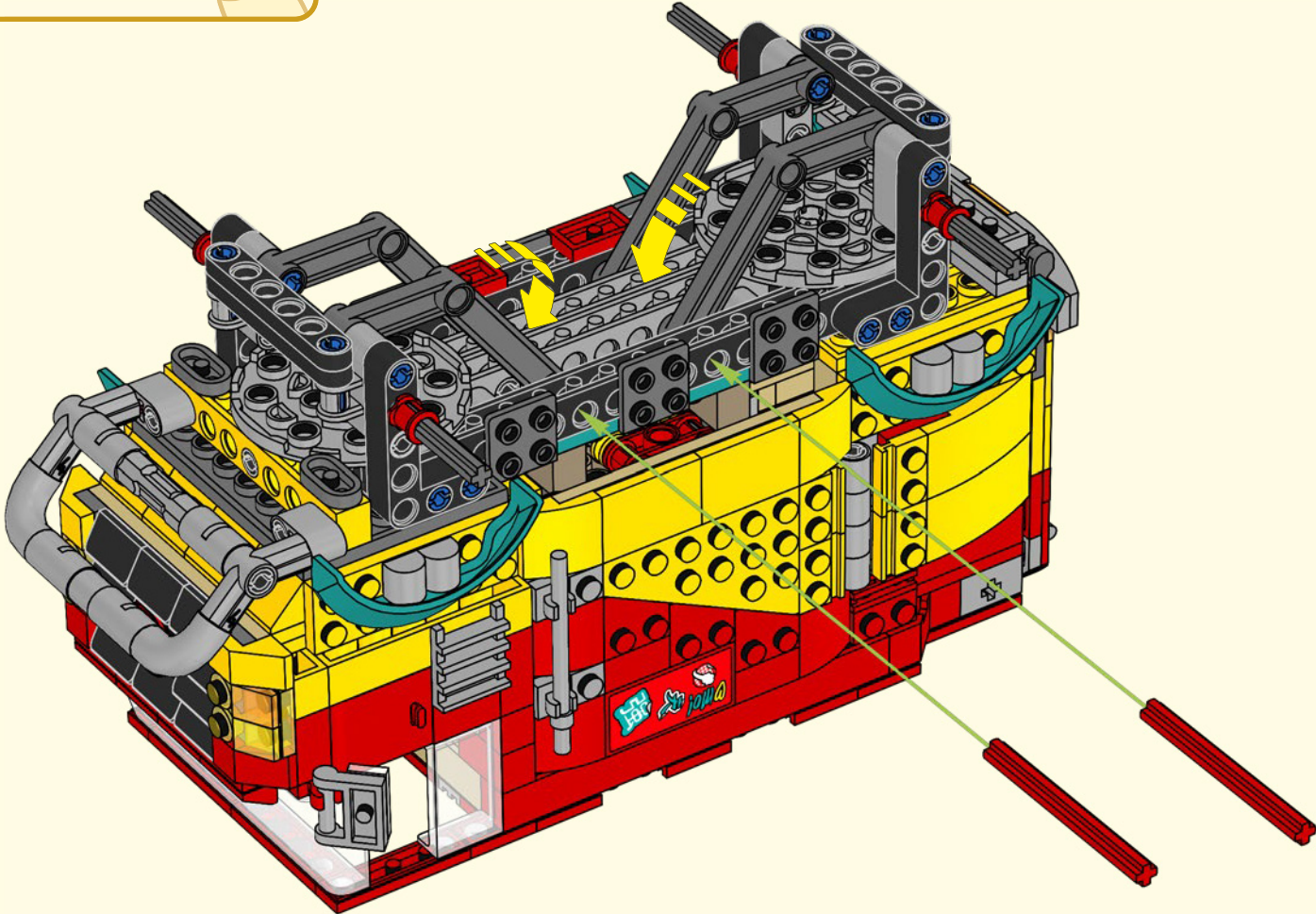



2x

150

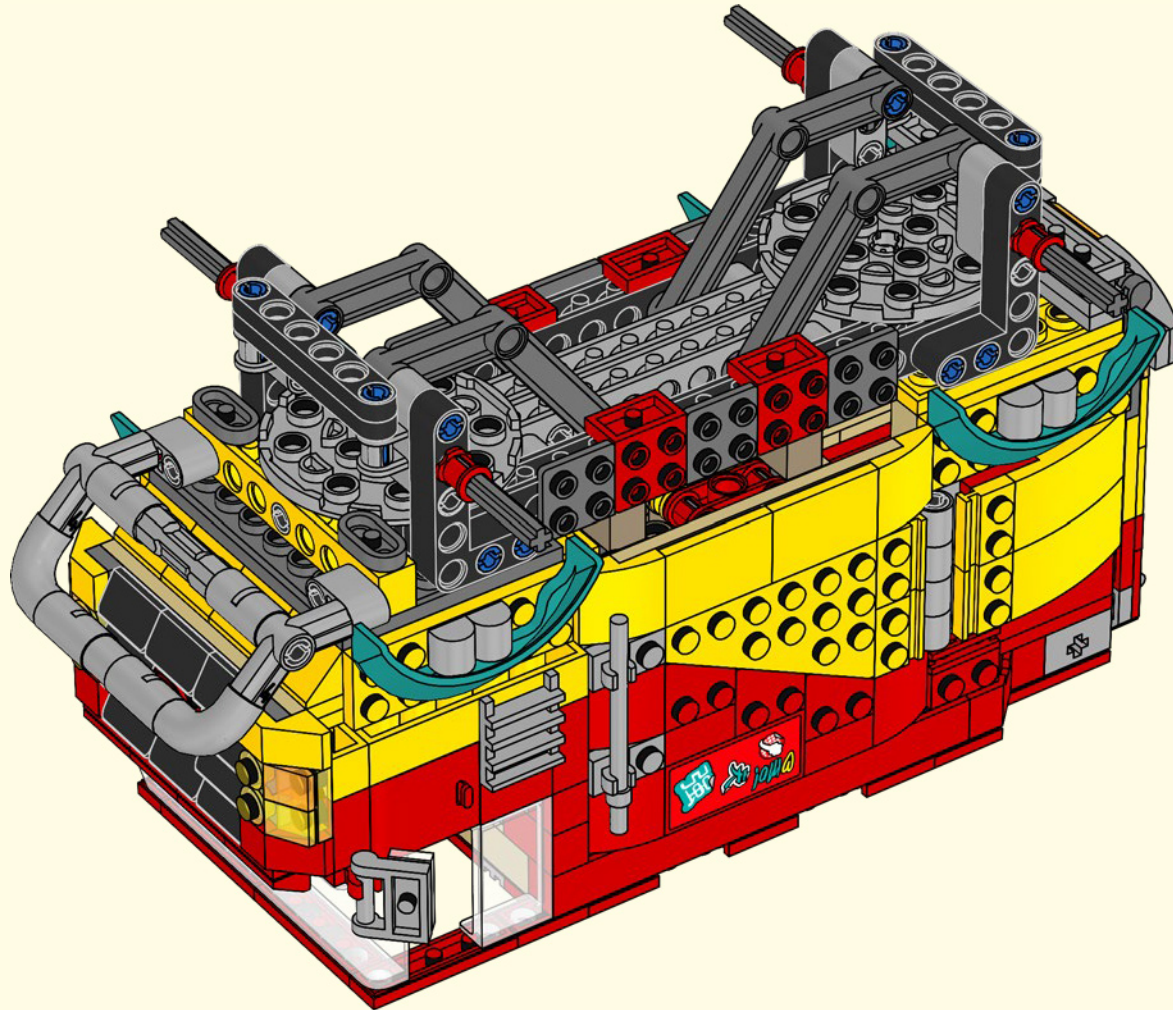

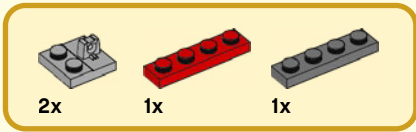

151

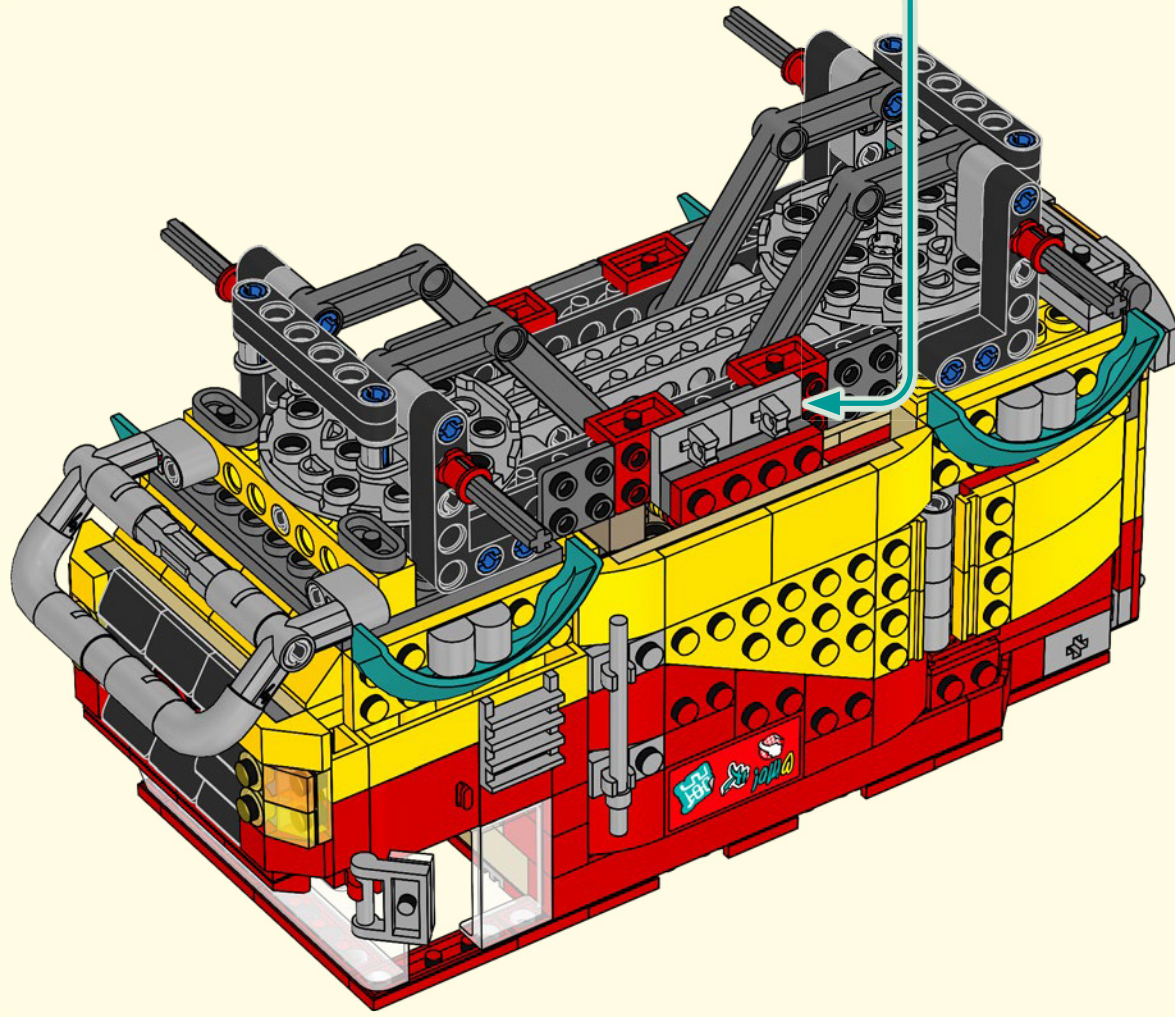
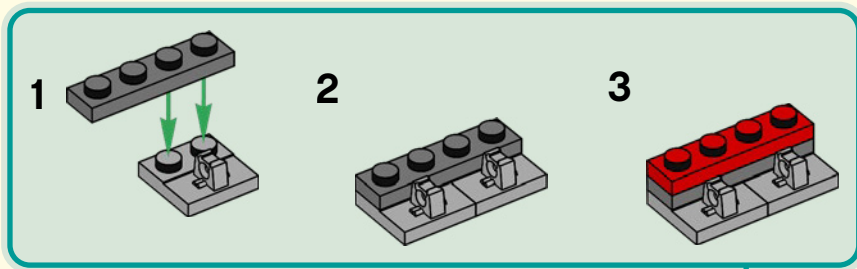



2x

152

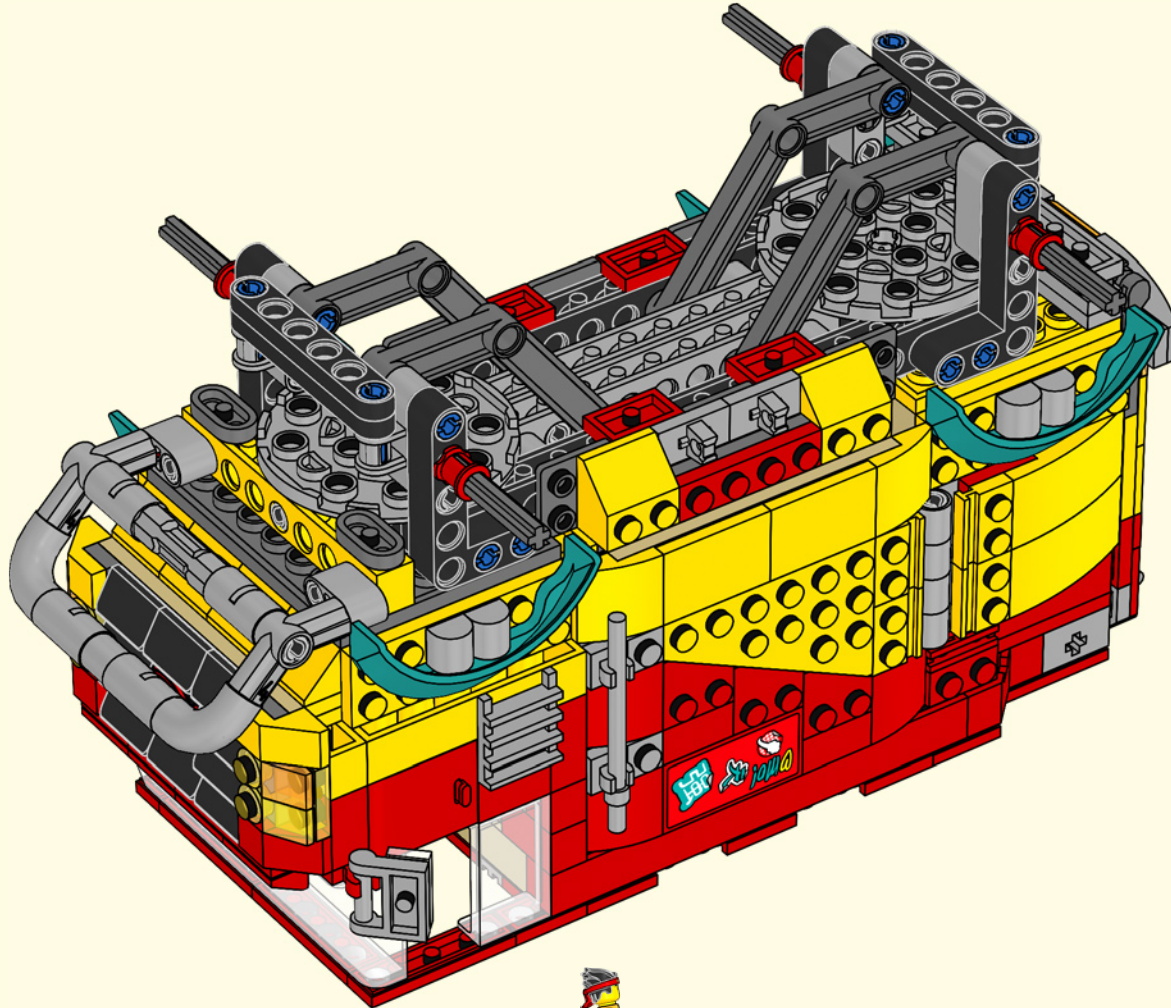



2x

153

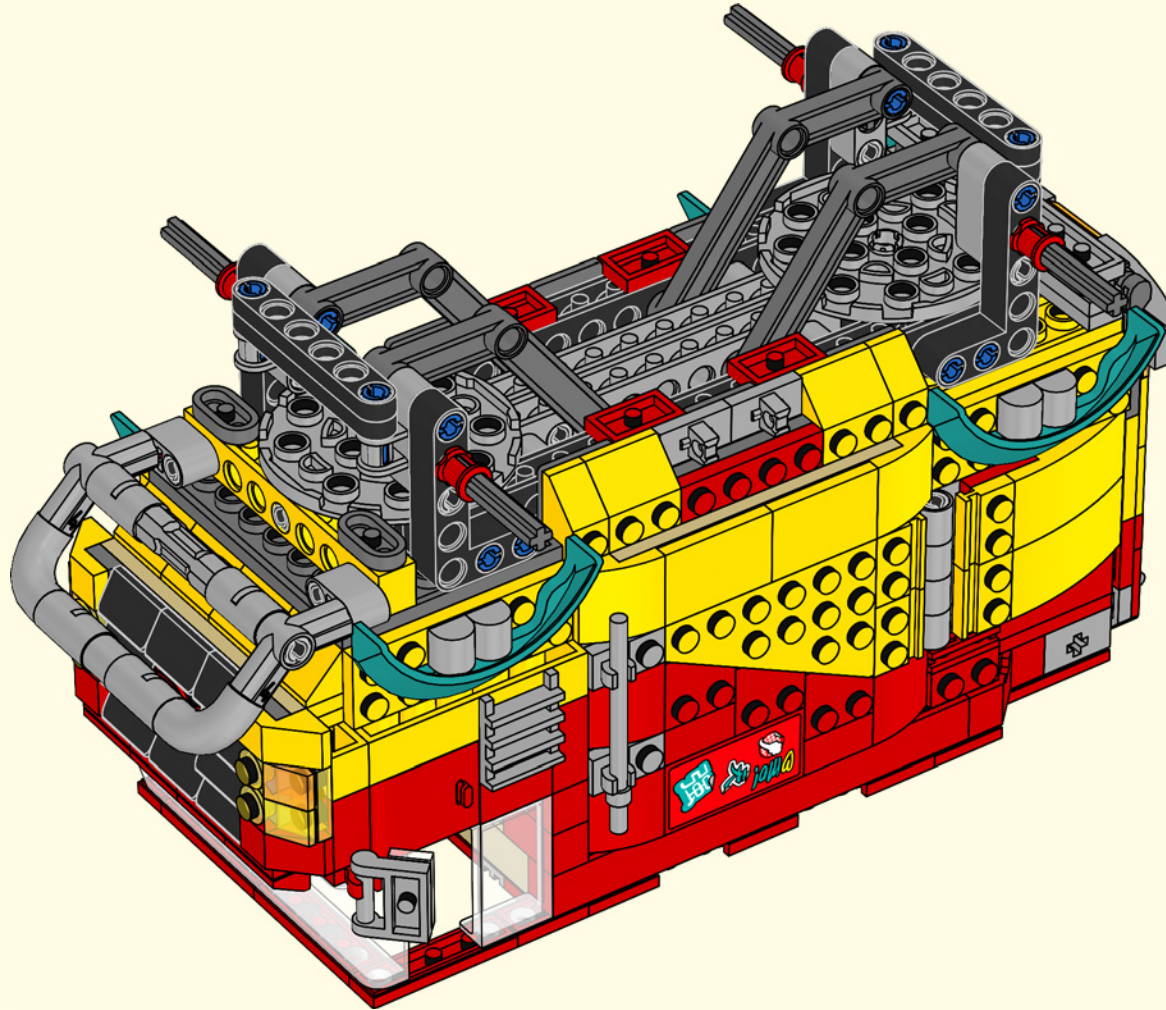

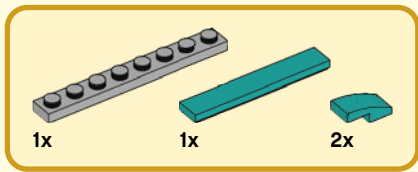

154

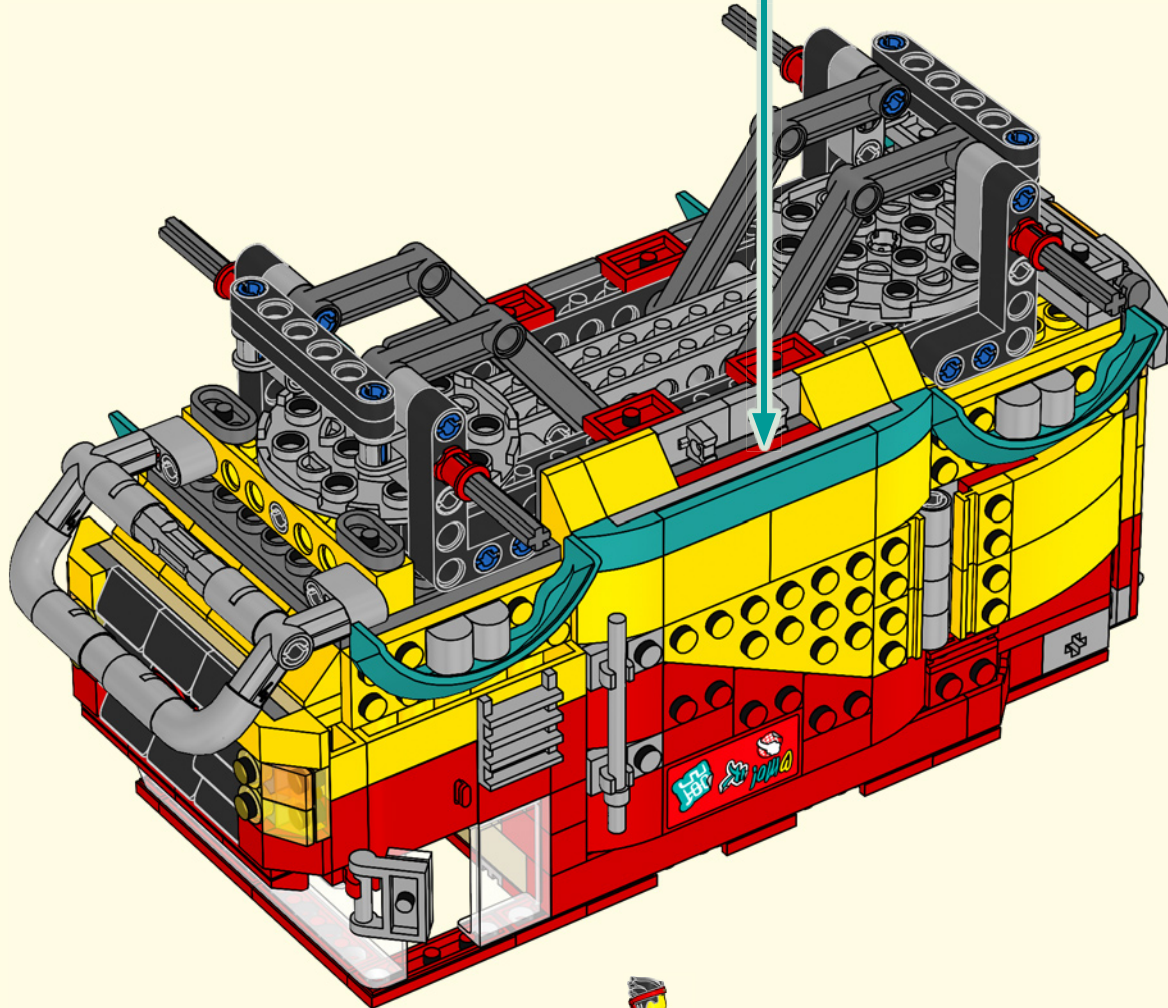
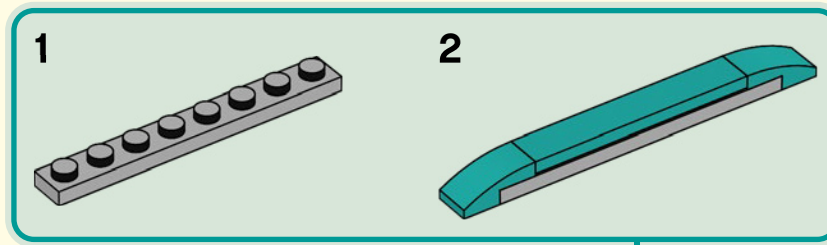

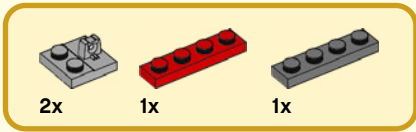

155

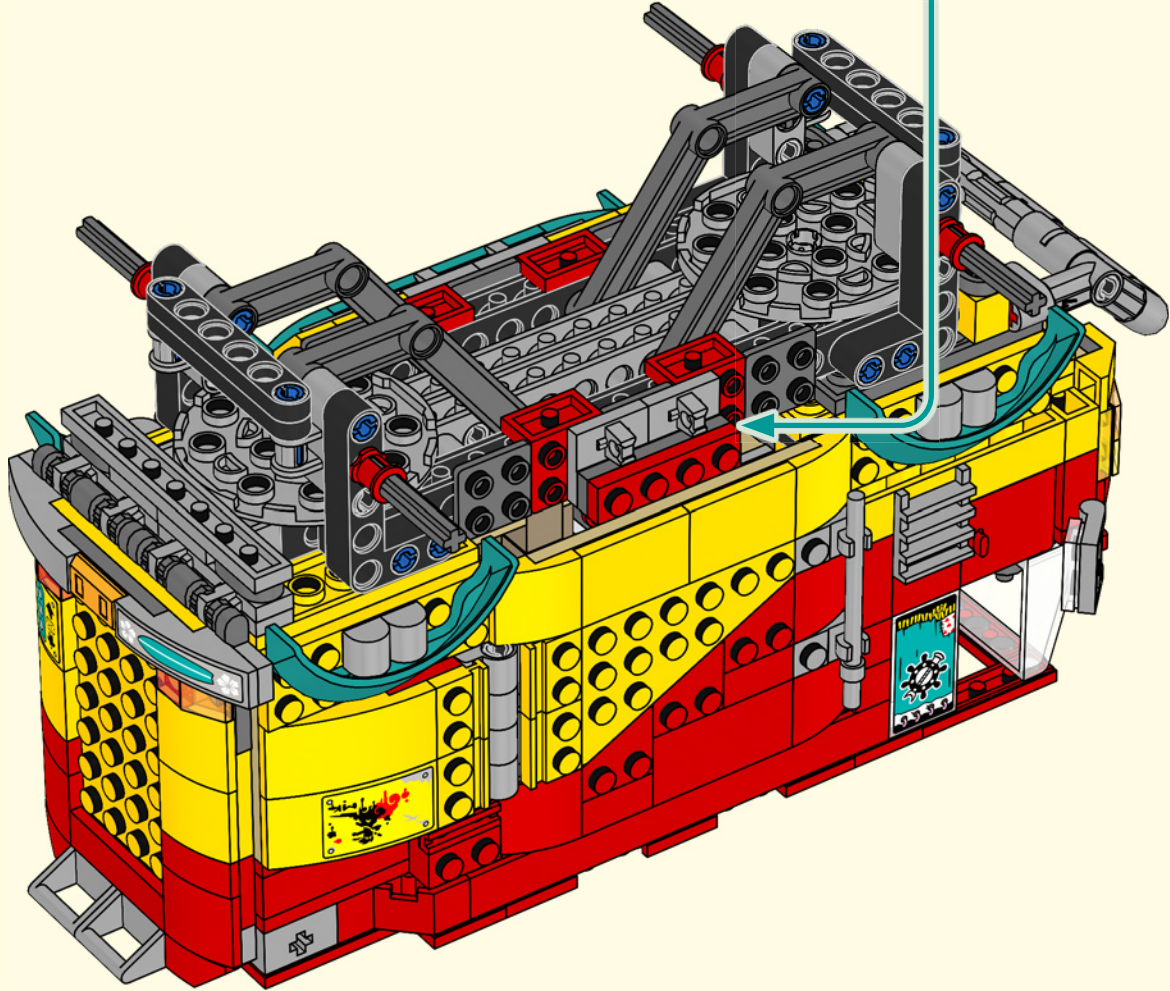
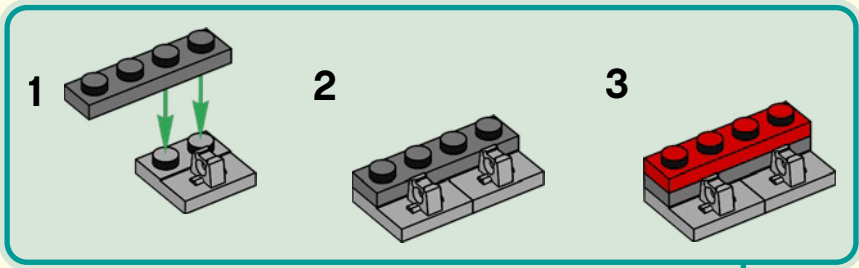



2x

156

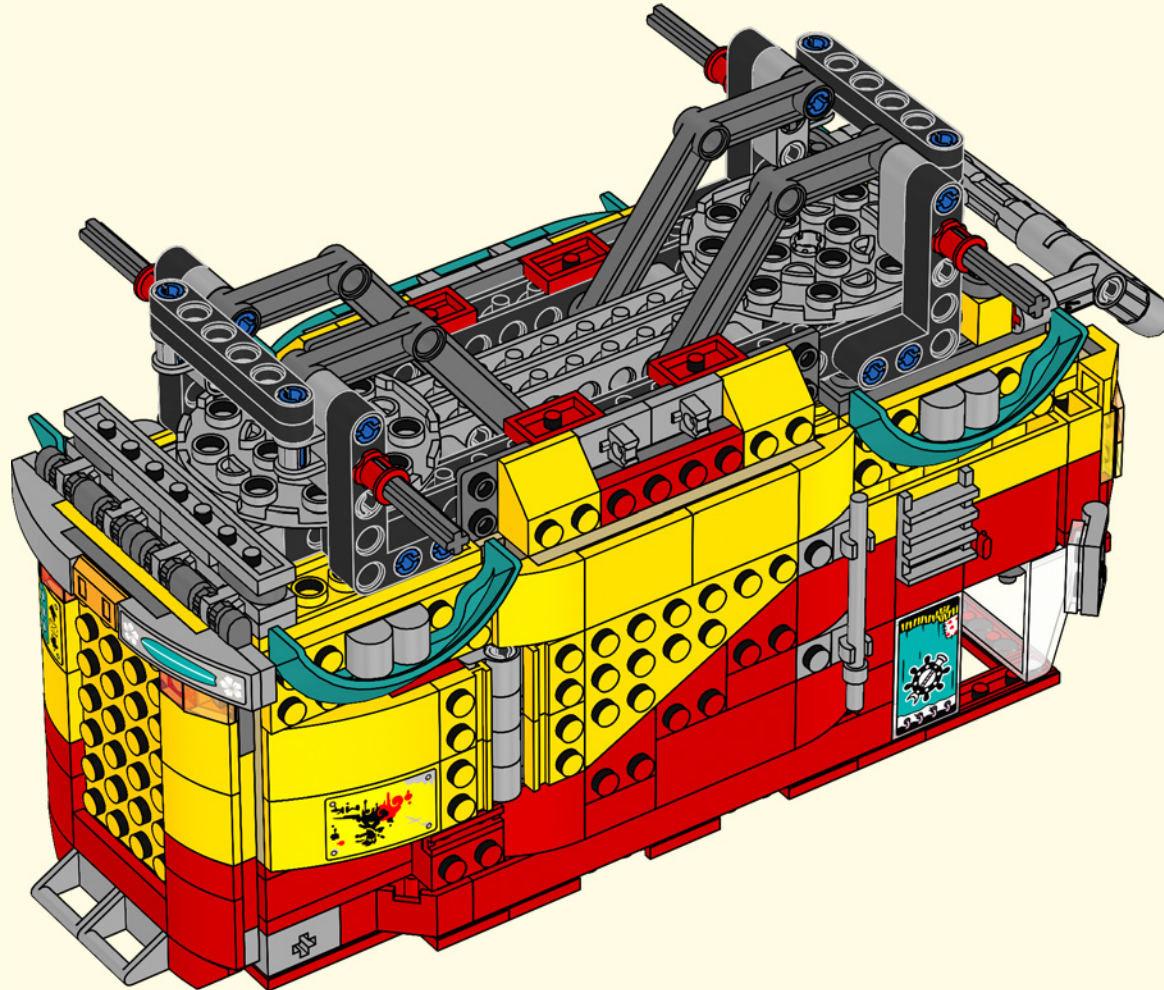



2x

157

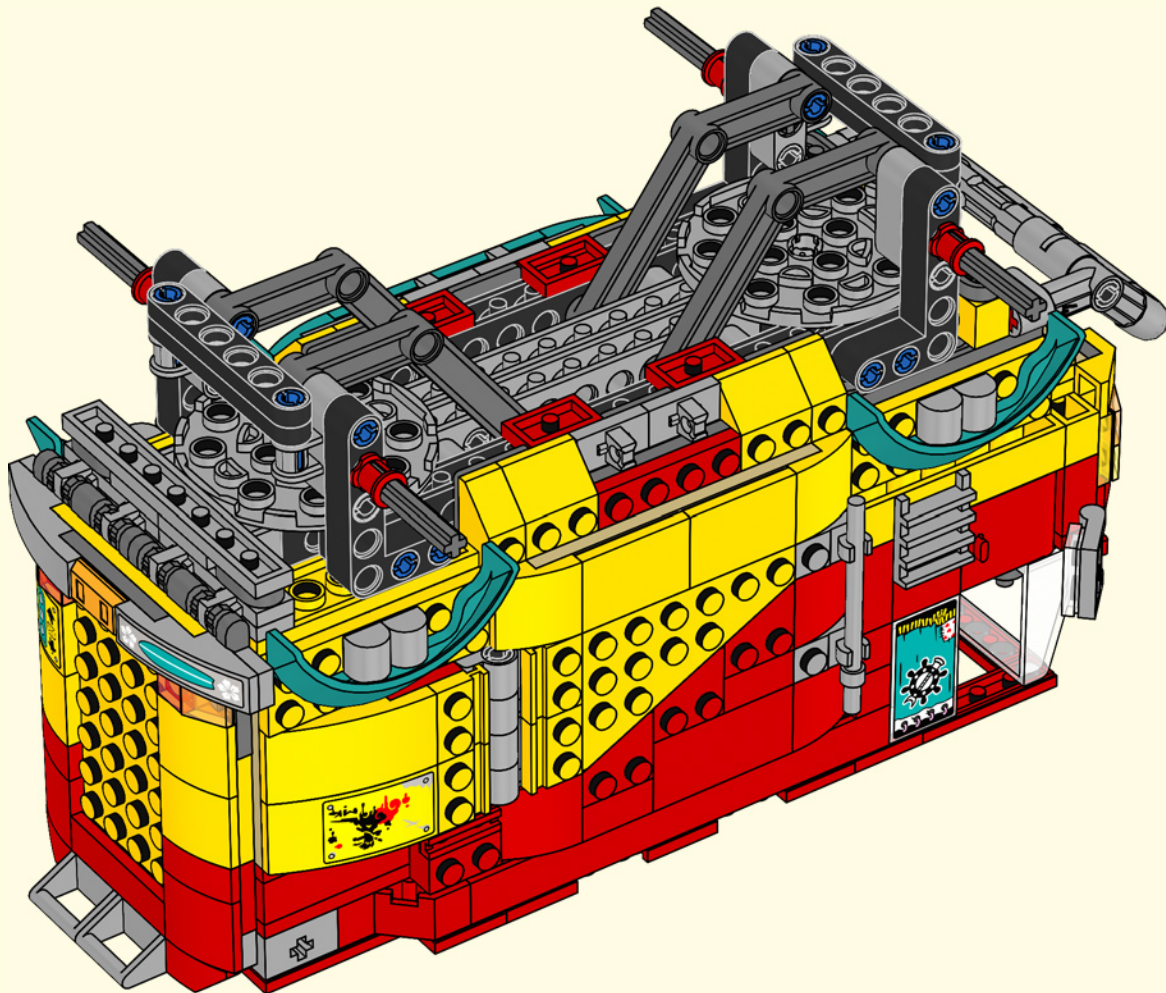

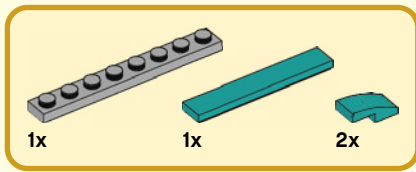

158

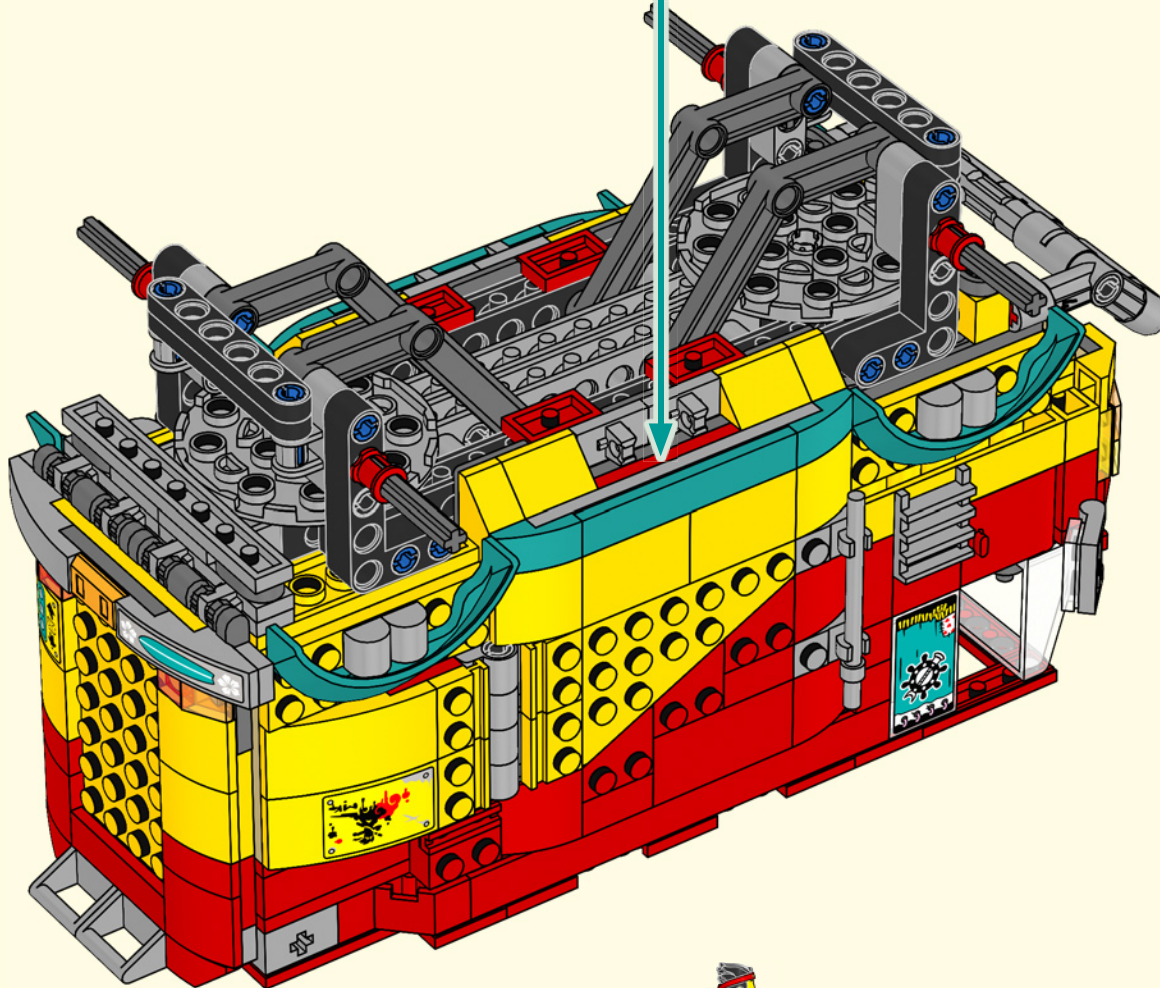
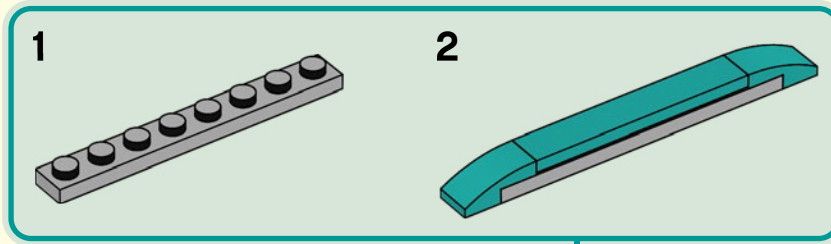

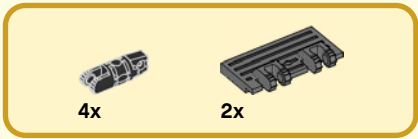

159

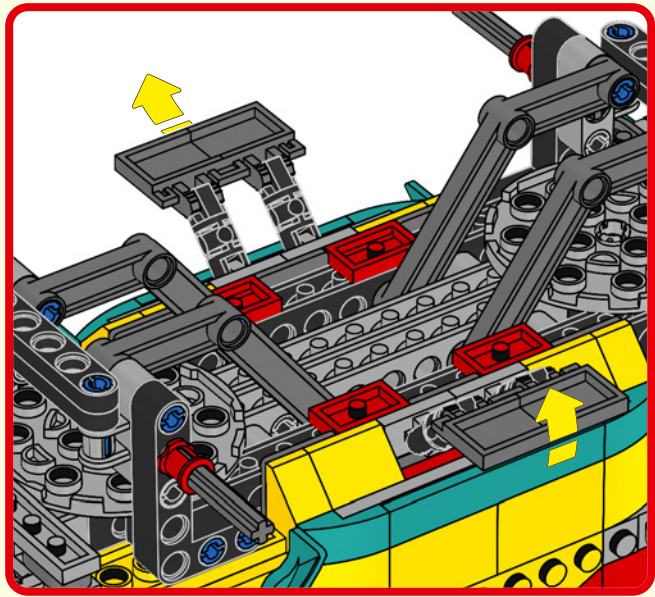
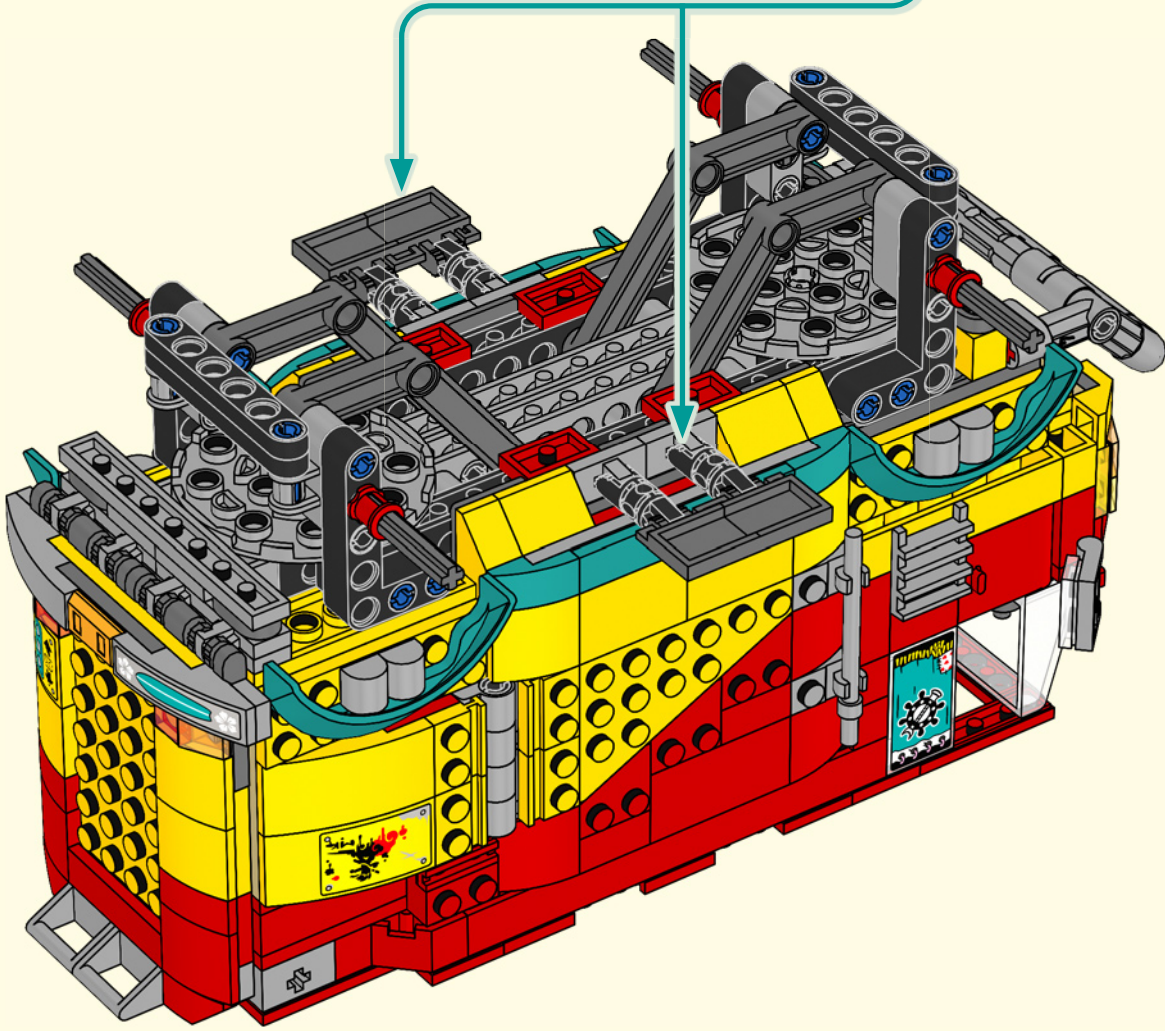
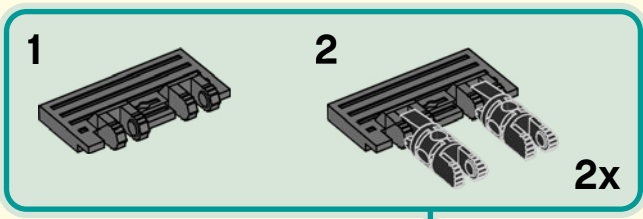



1x

160

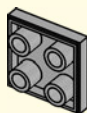

2x

161

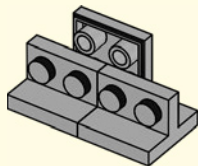

1x

162

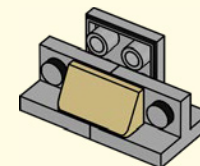

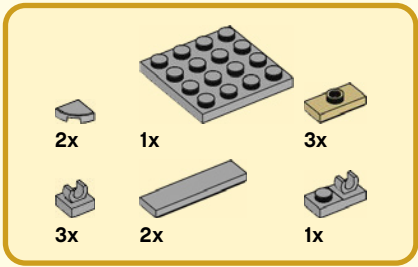

163

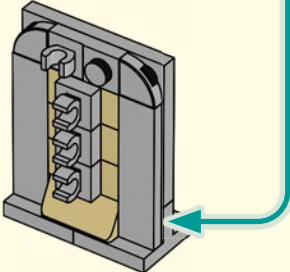
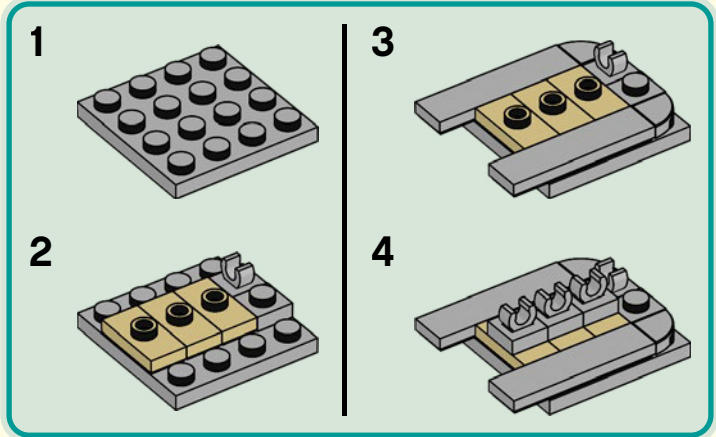

164

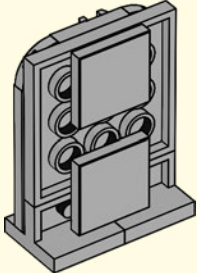

165

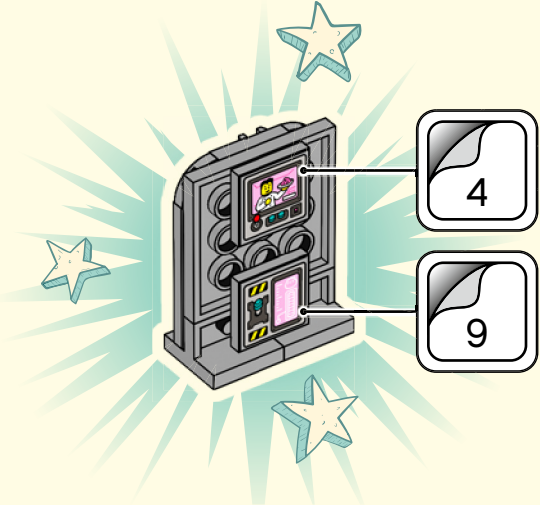

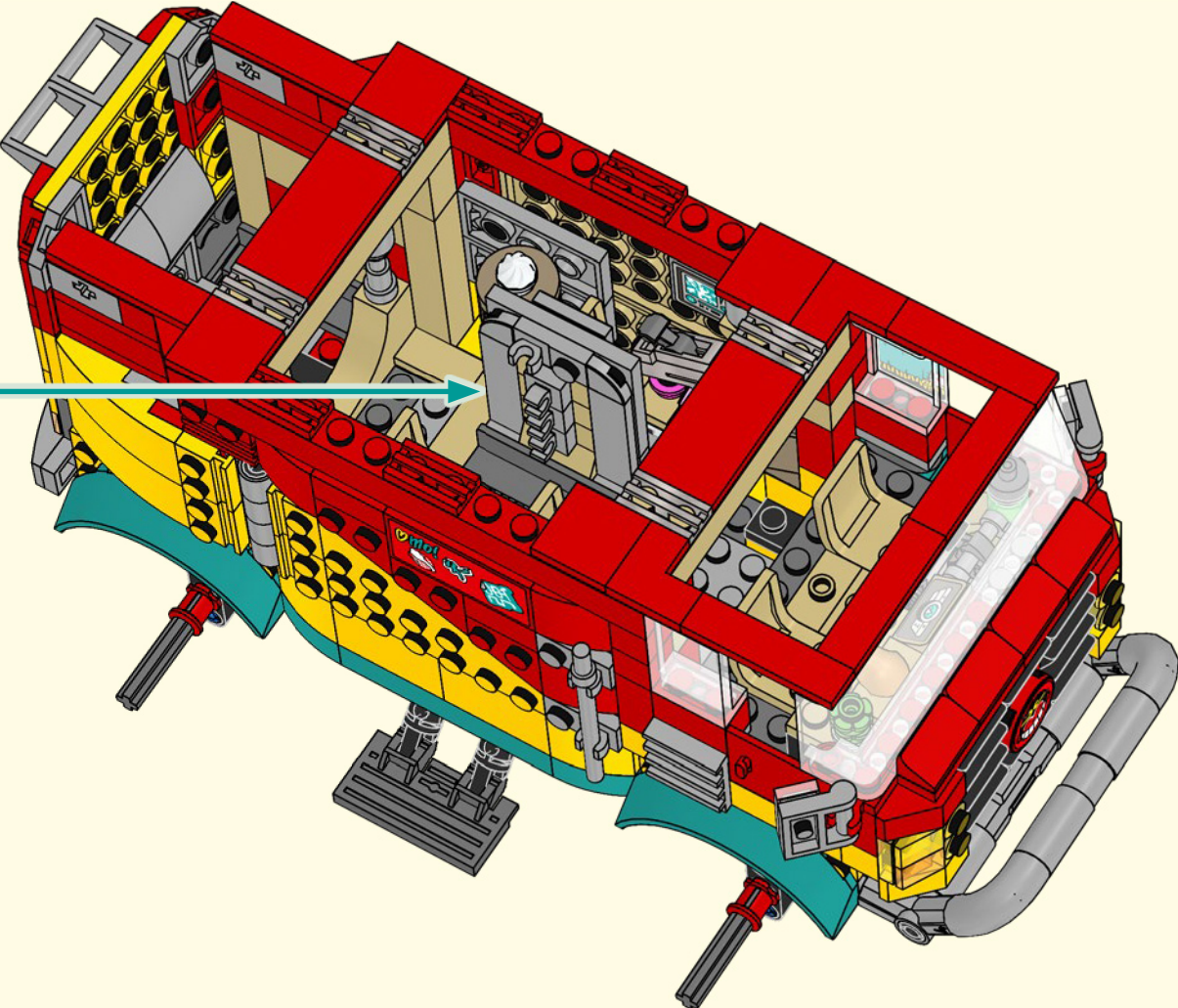

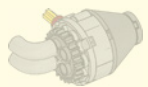

2x



1x

167



2x

168

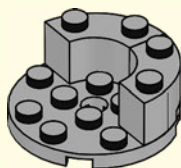

2x



1x



1x

169

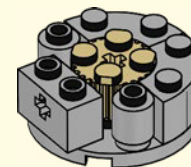

1x

170

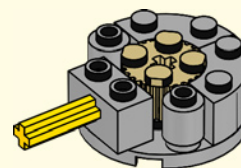
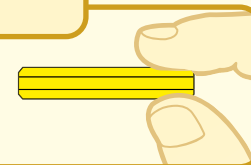



1x

171

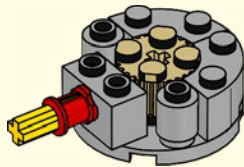

1x

172

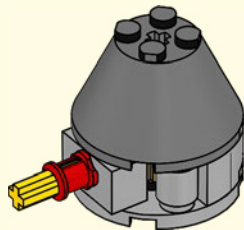

1x

173

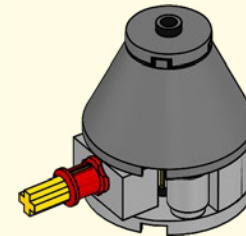

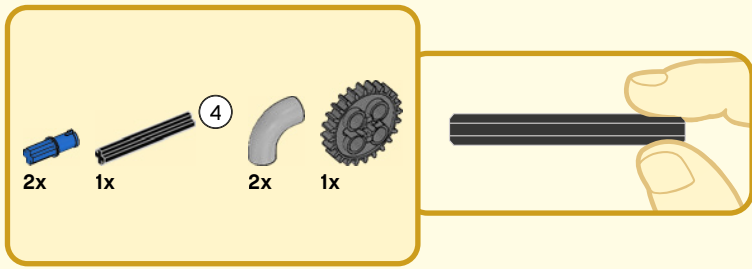

174

1

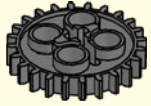

2

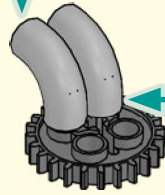

3

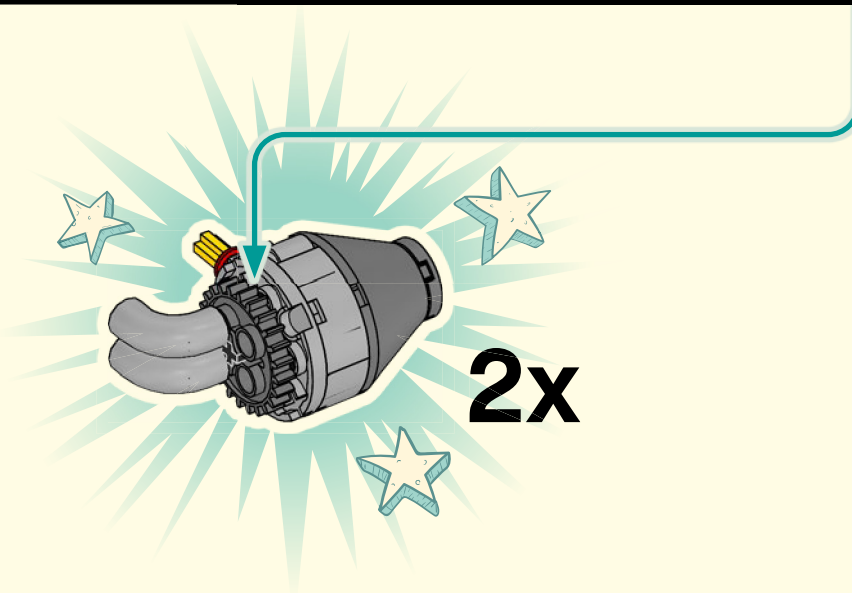
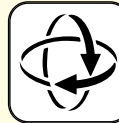
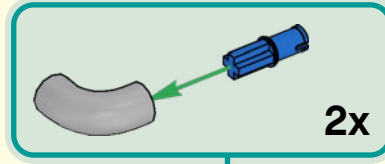
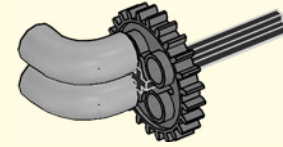



175

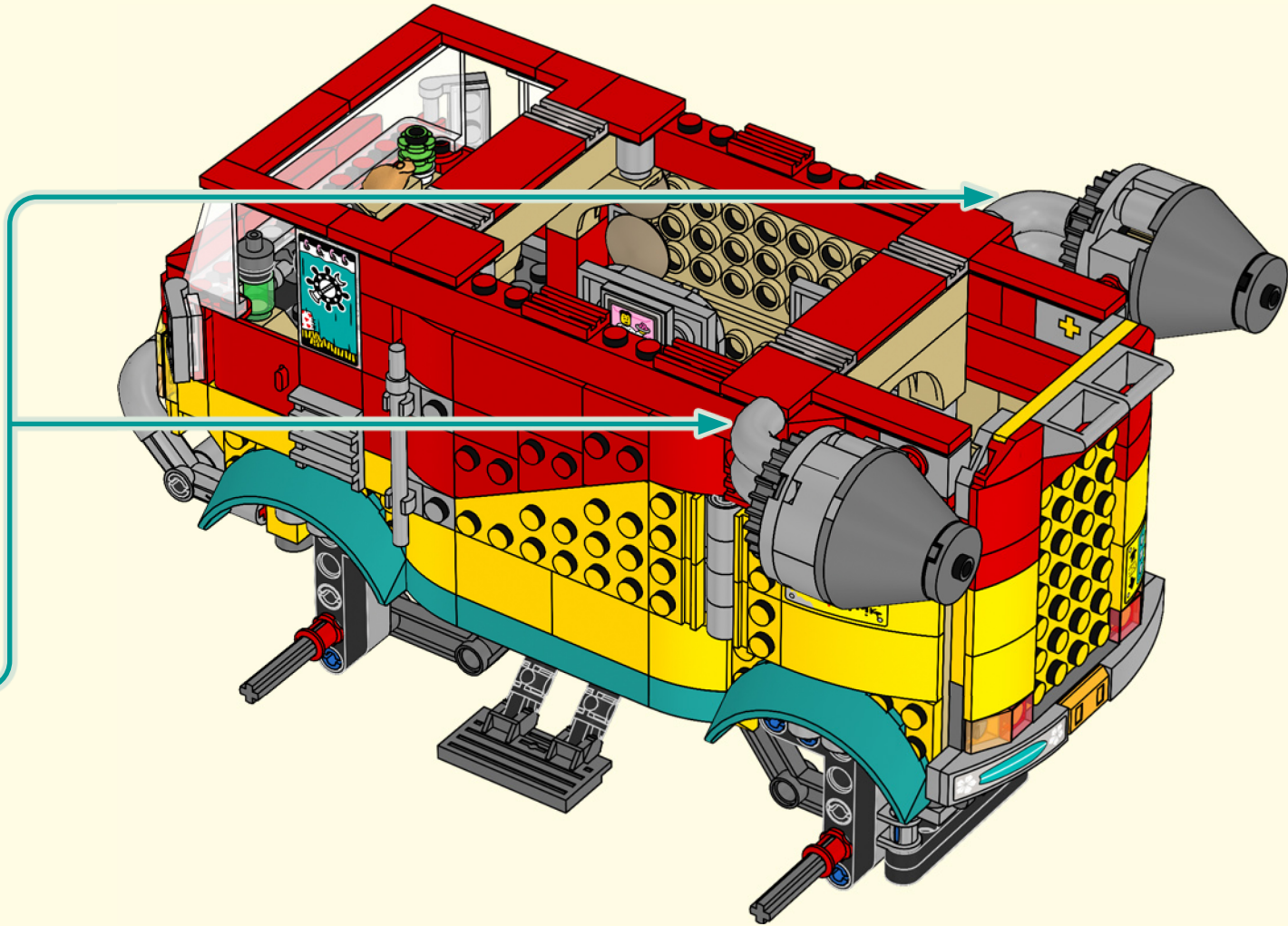



2x

176

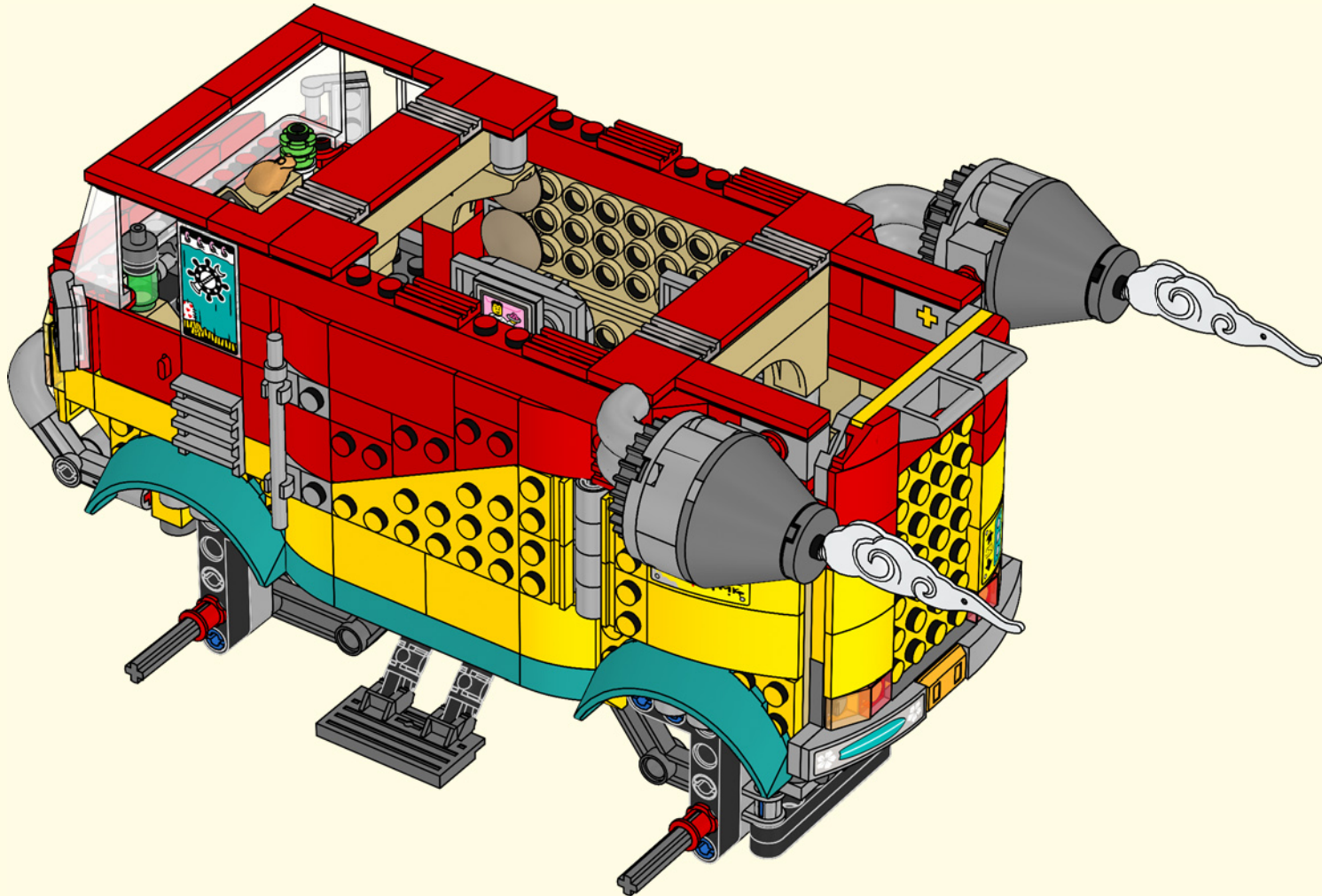

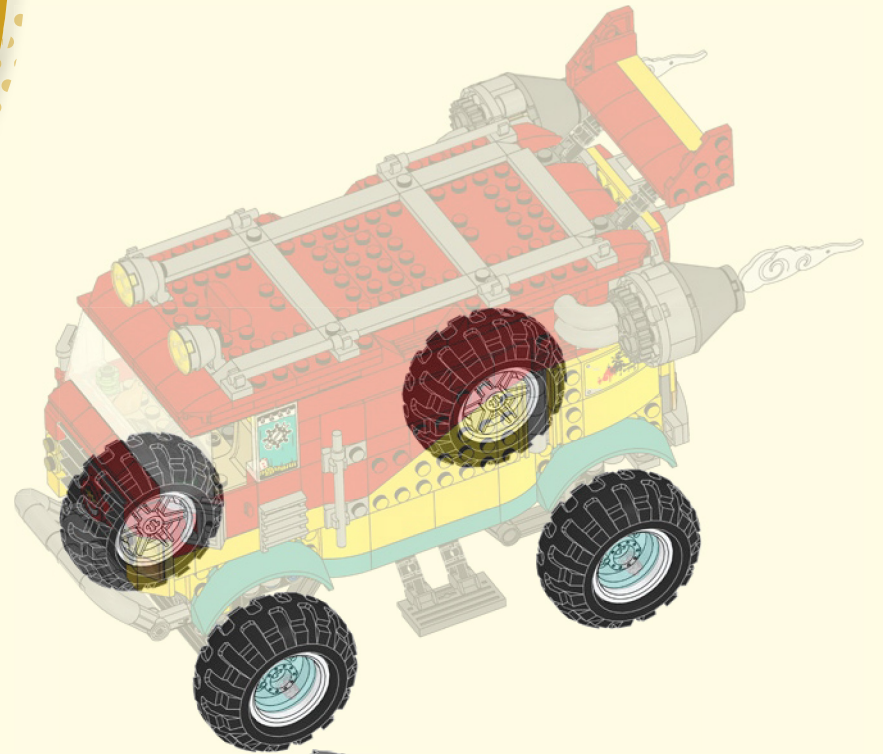

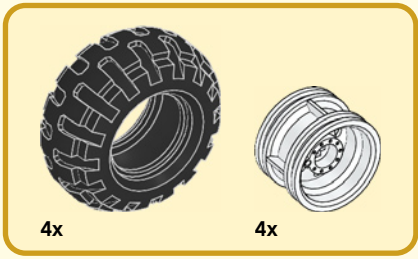

177

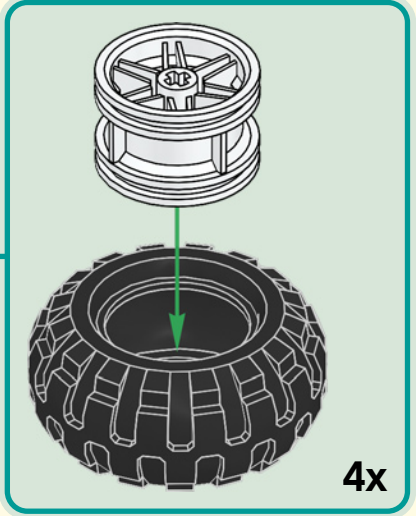
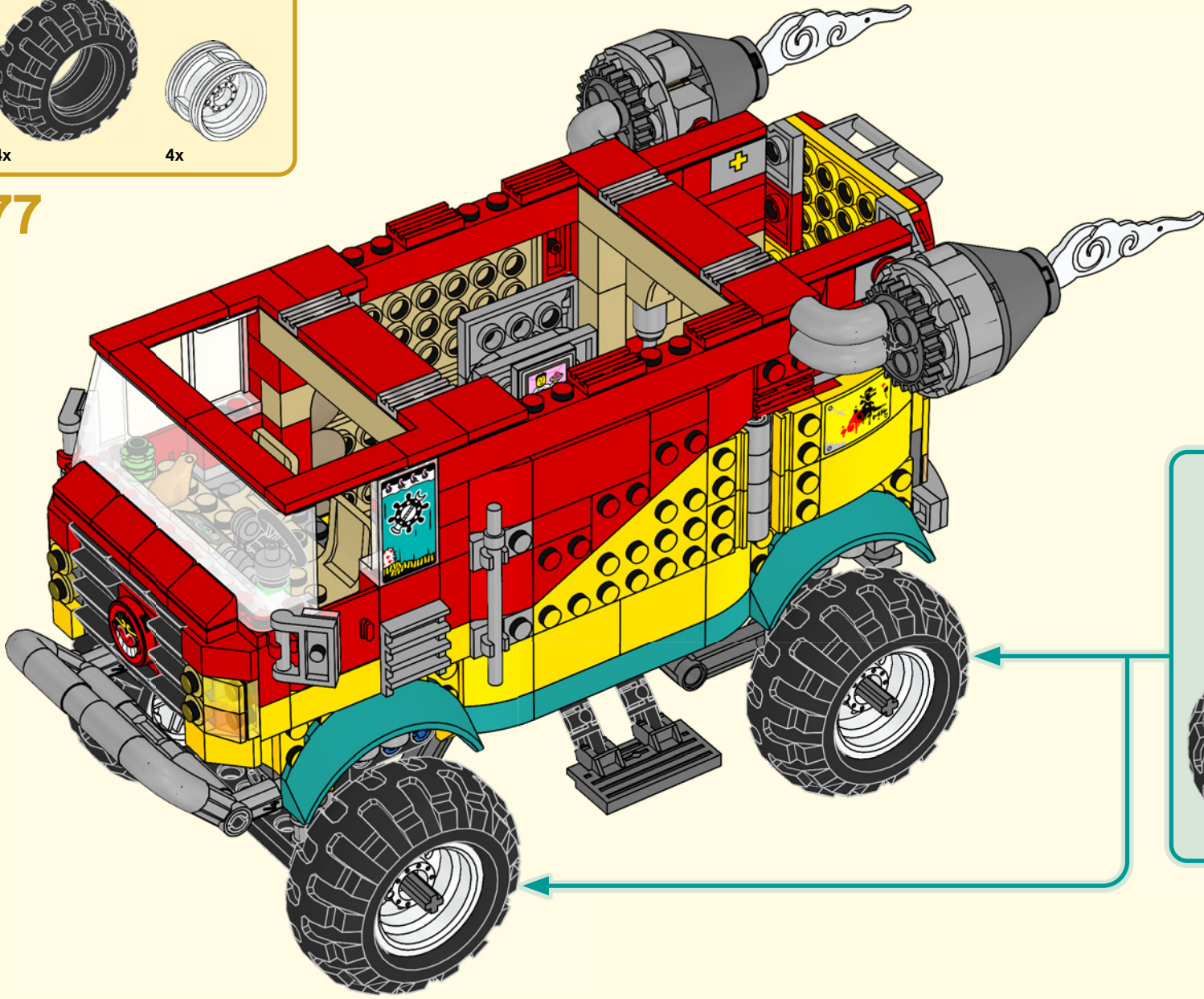

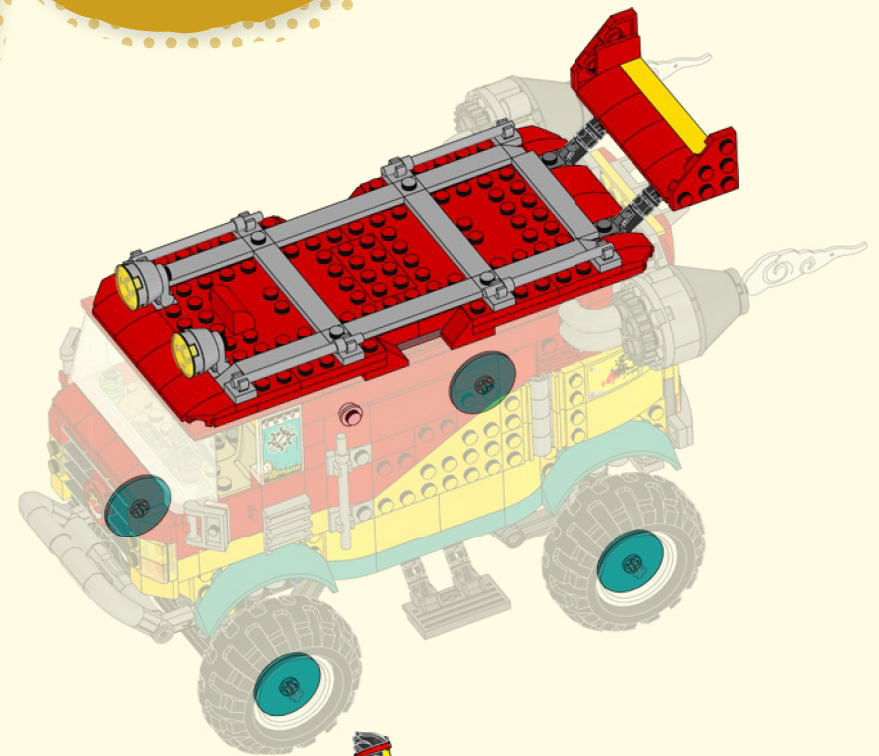
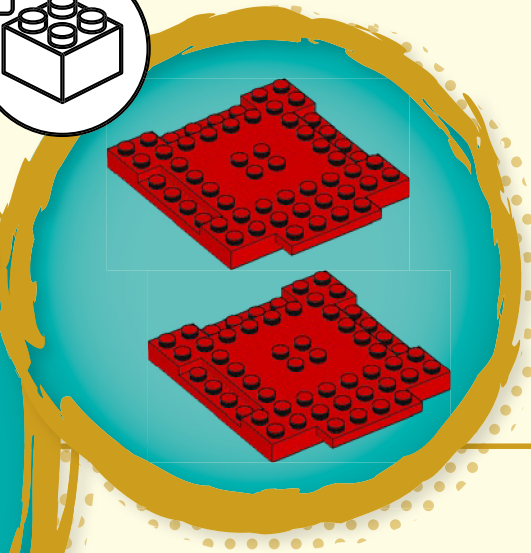
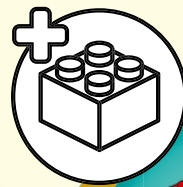



4x

178

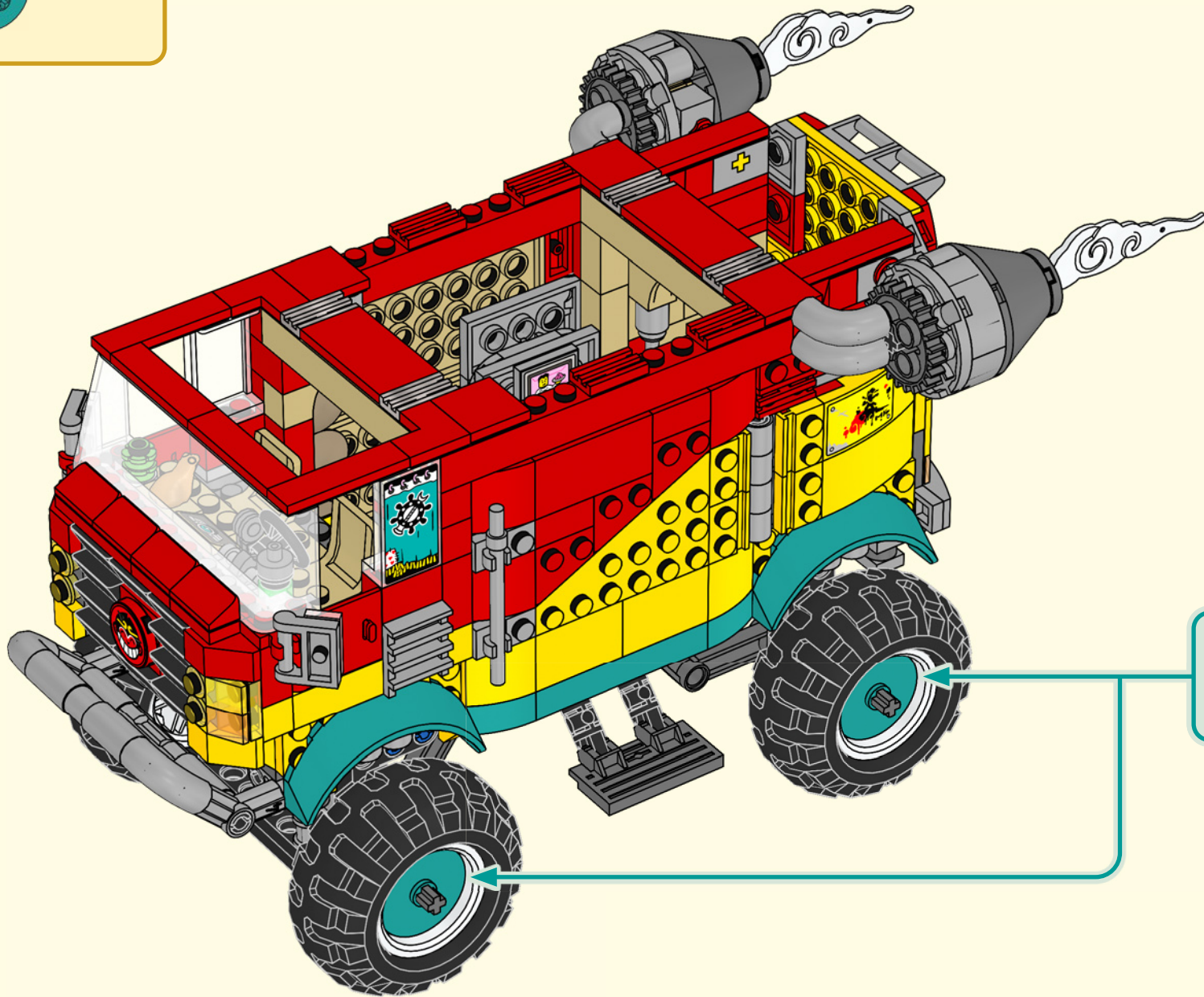

4x



4x

179

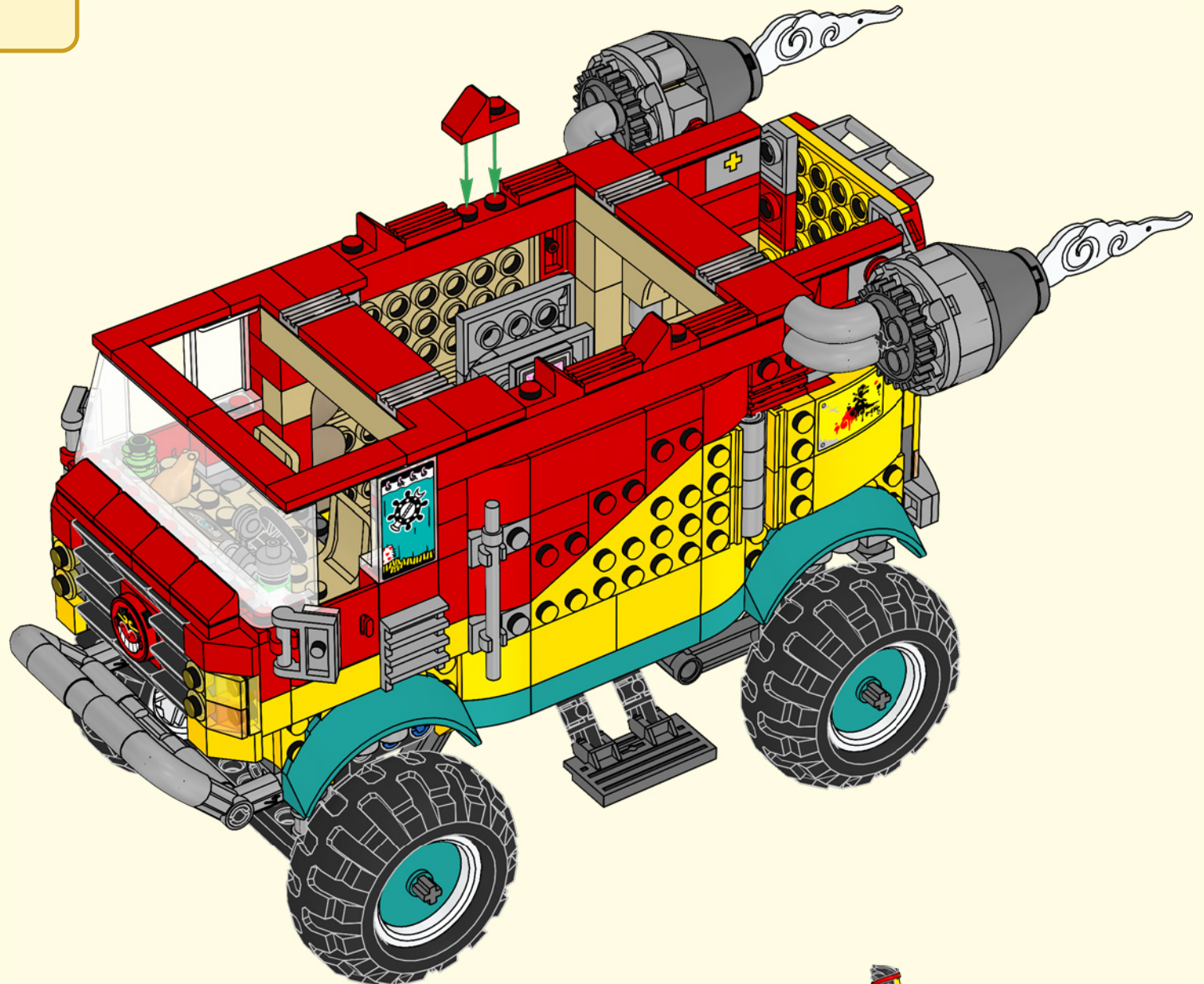

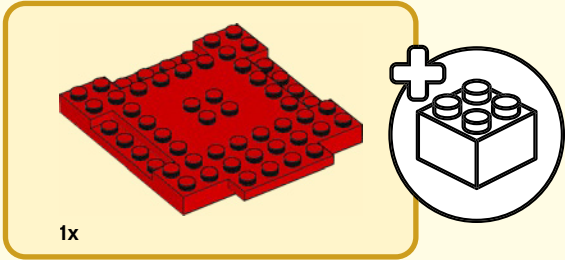
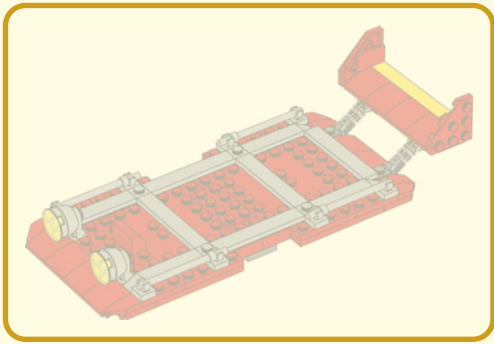

180

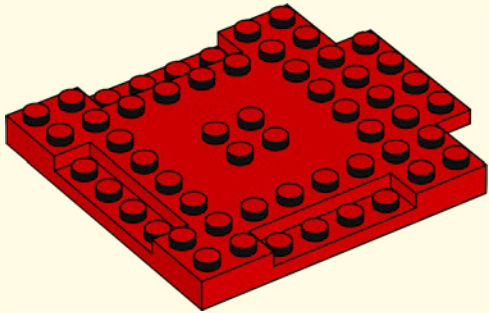

181

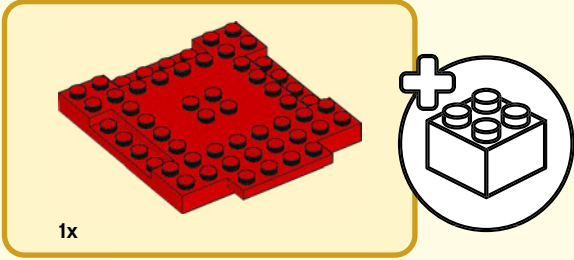
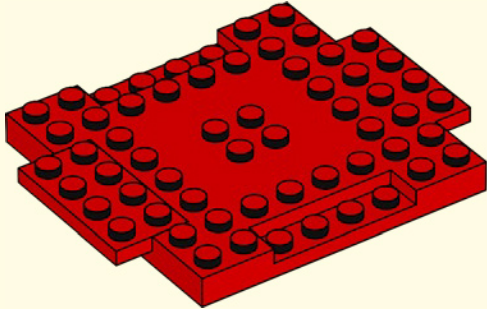

182

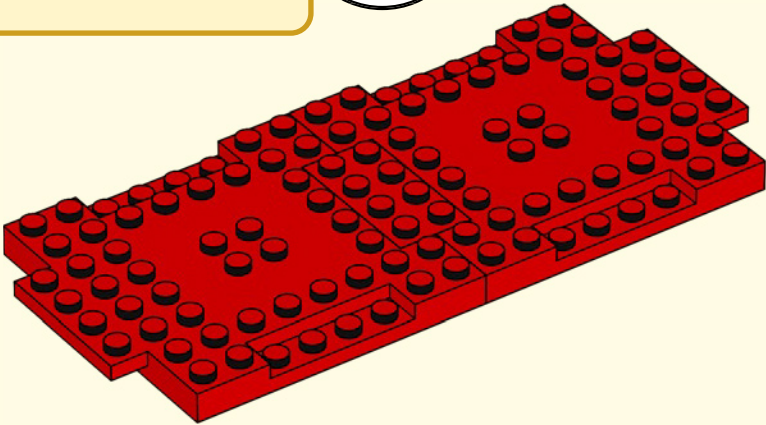

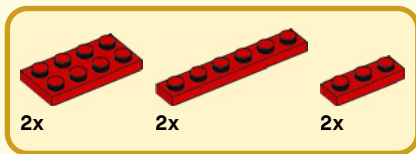

183

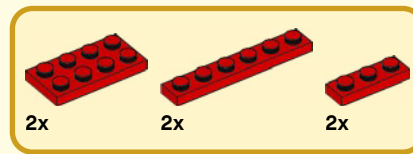
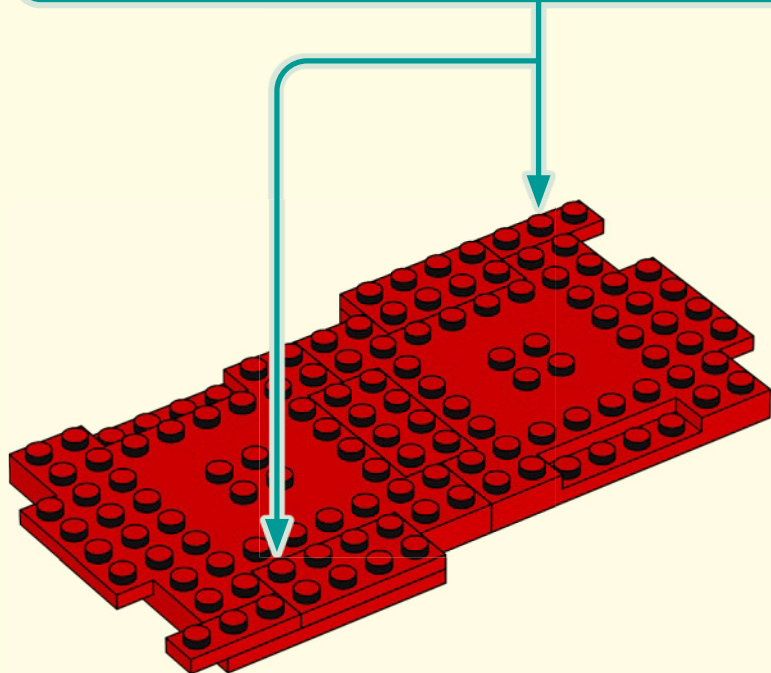
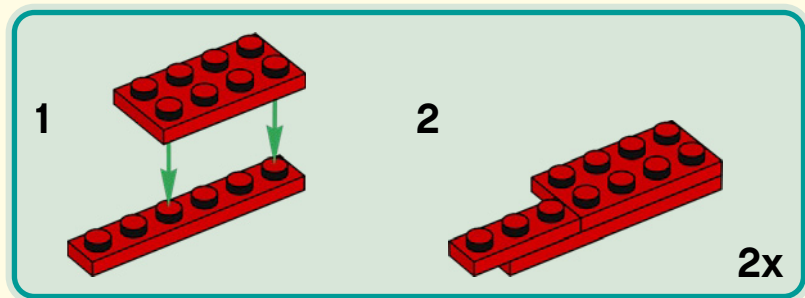

184

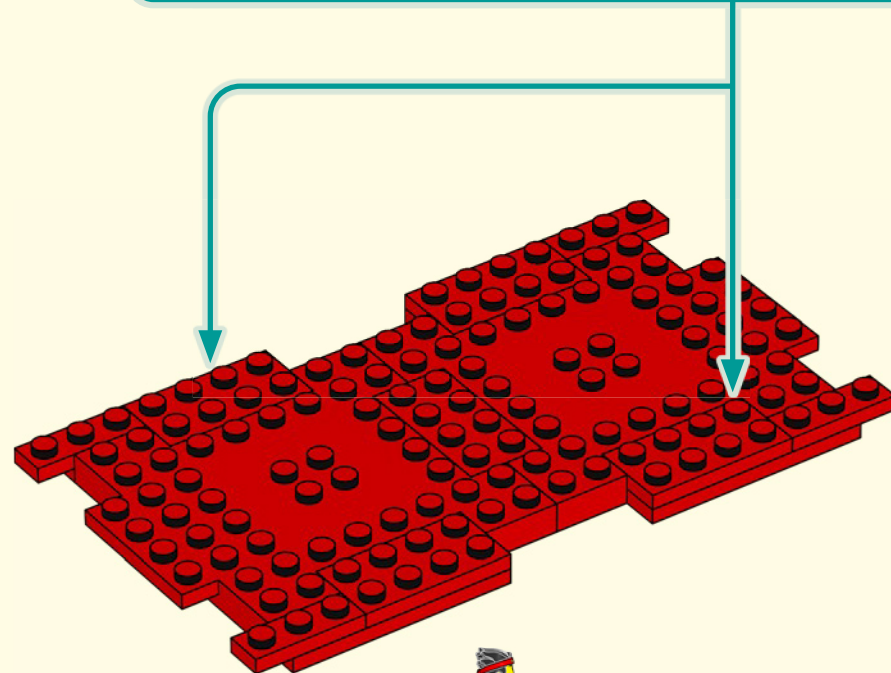
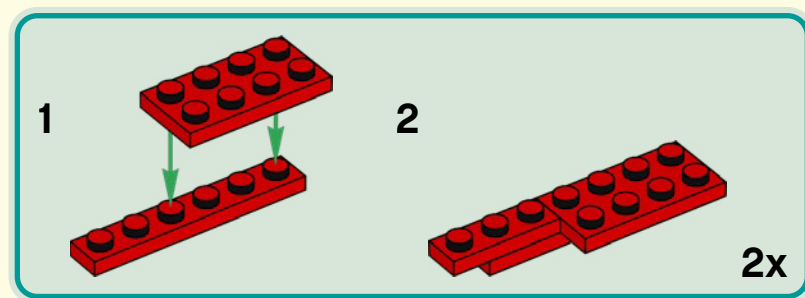

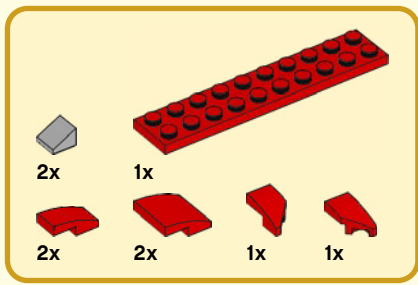

185

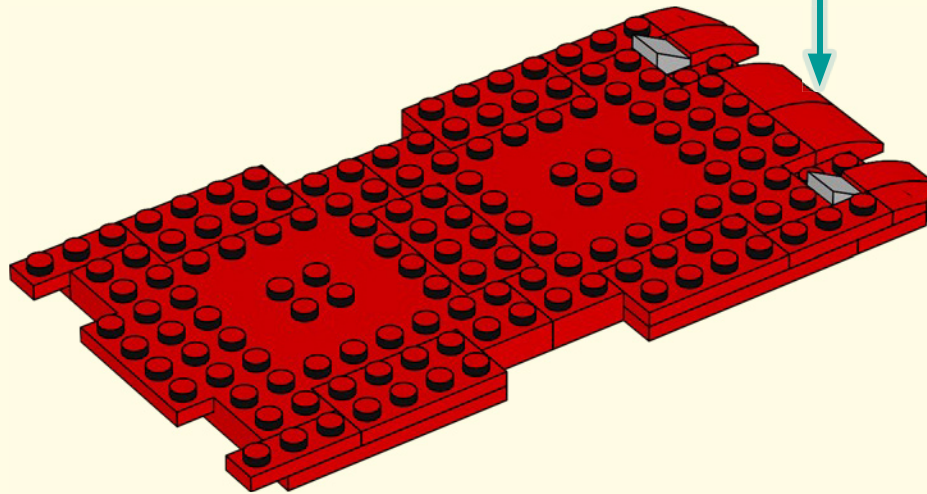
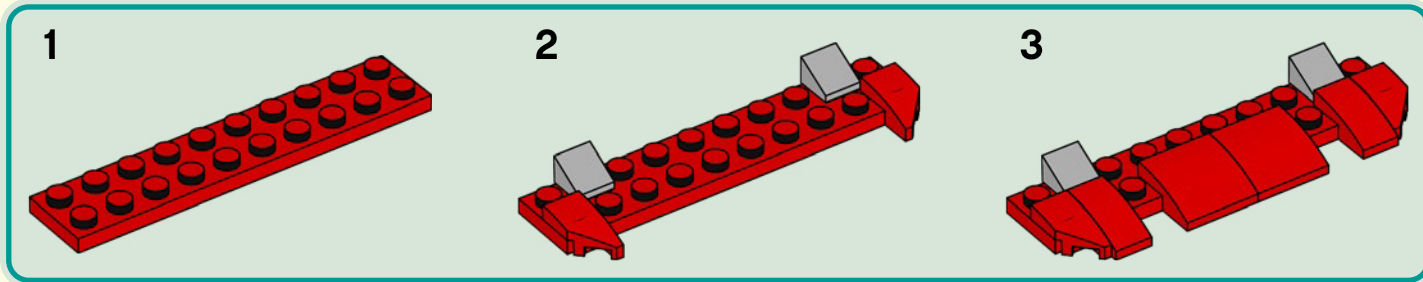



2x

186

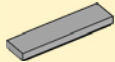
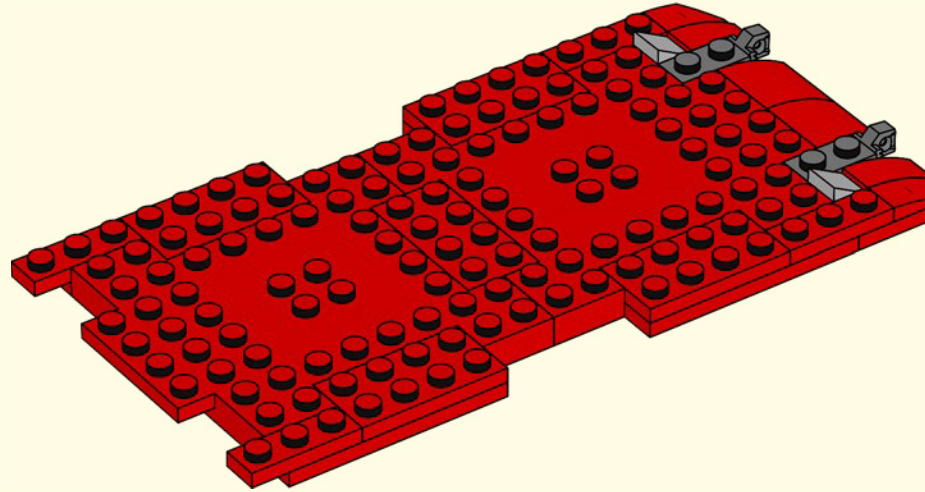

2x

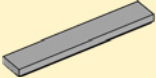

1x



2x

187

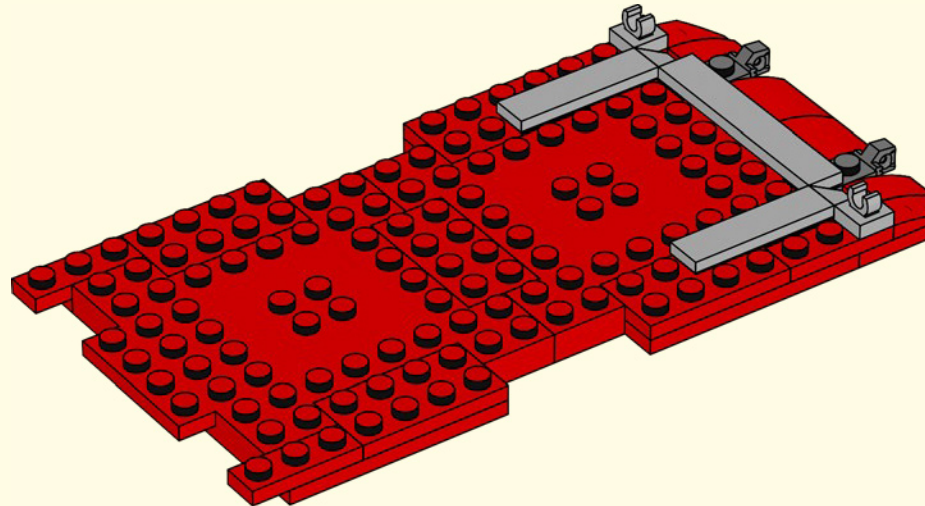

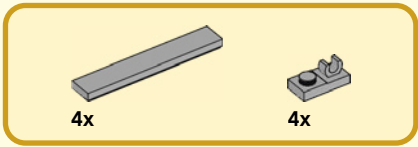

188

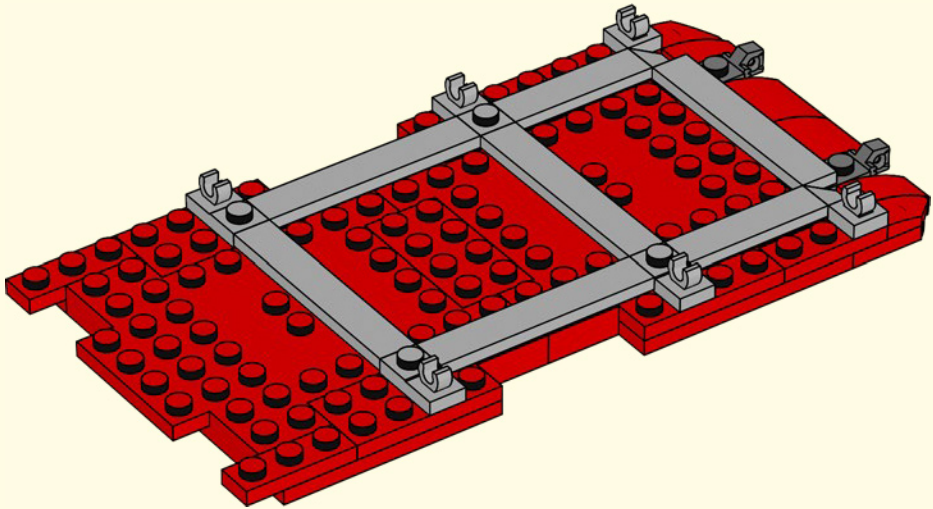

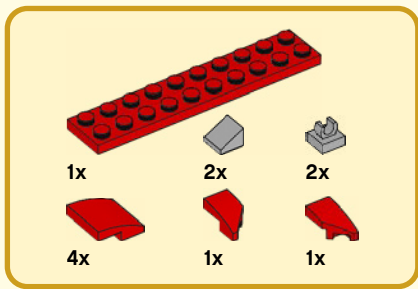

189

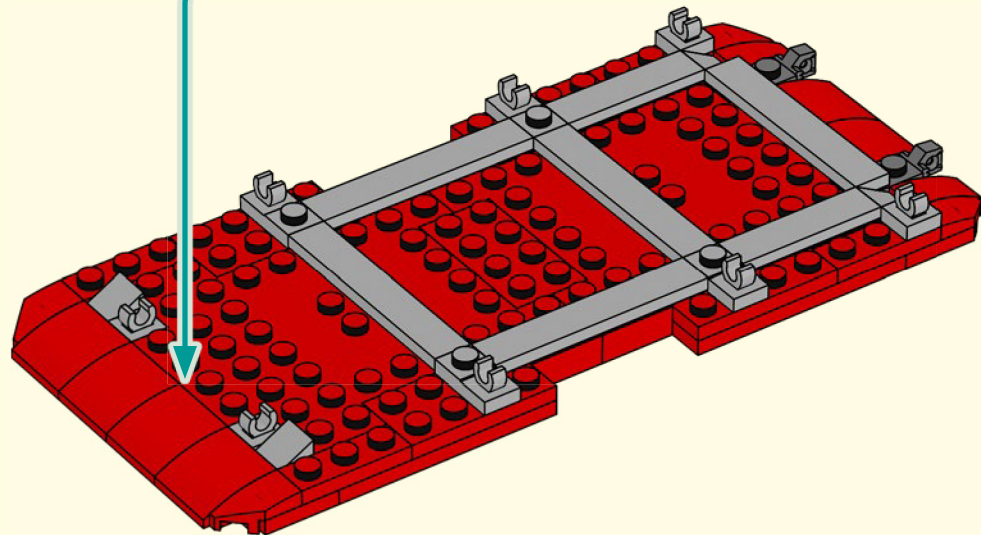
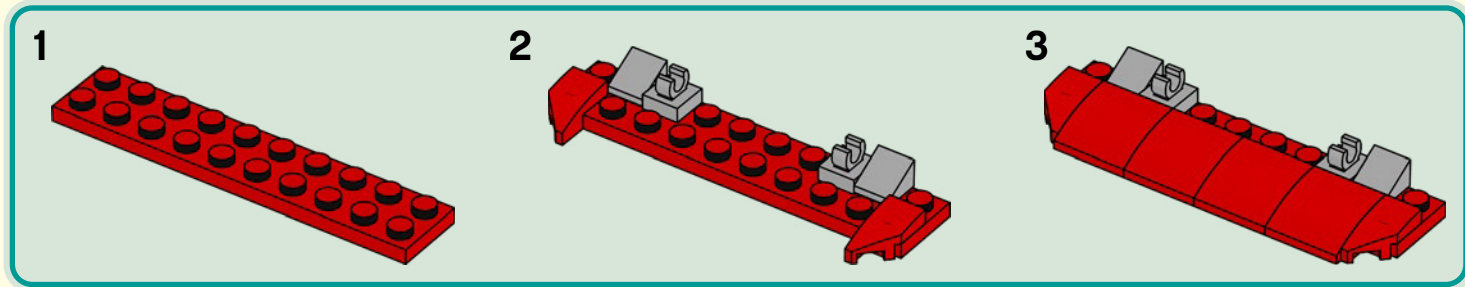

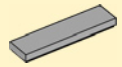

2x



2x

190

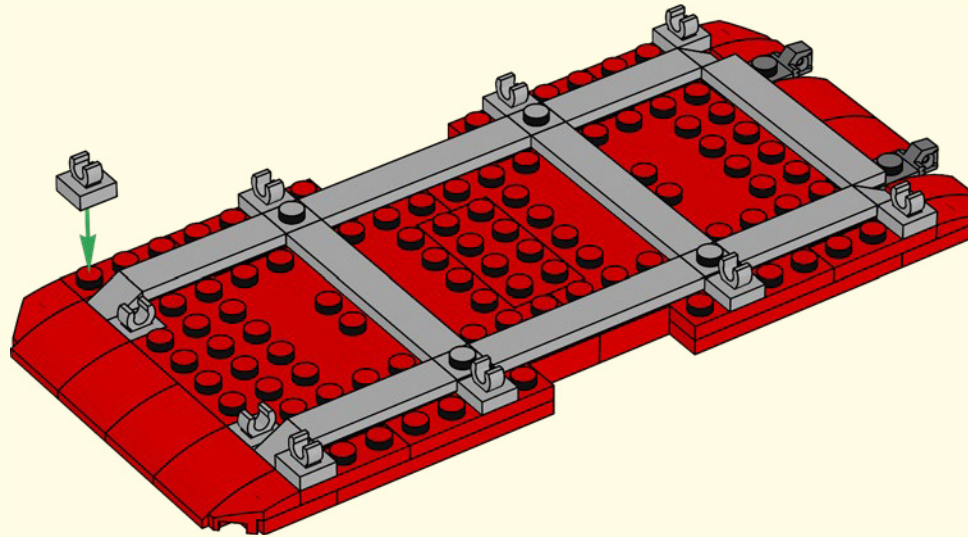

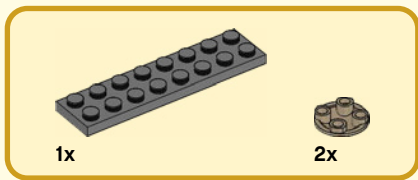

191

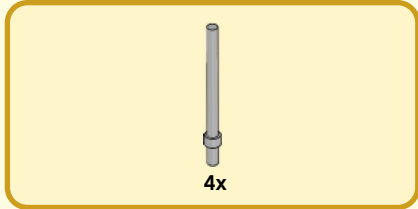
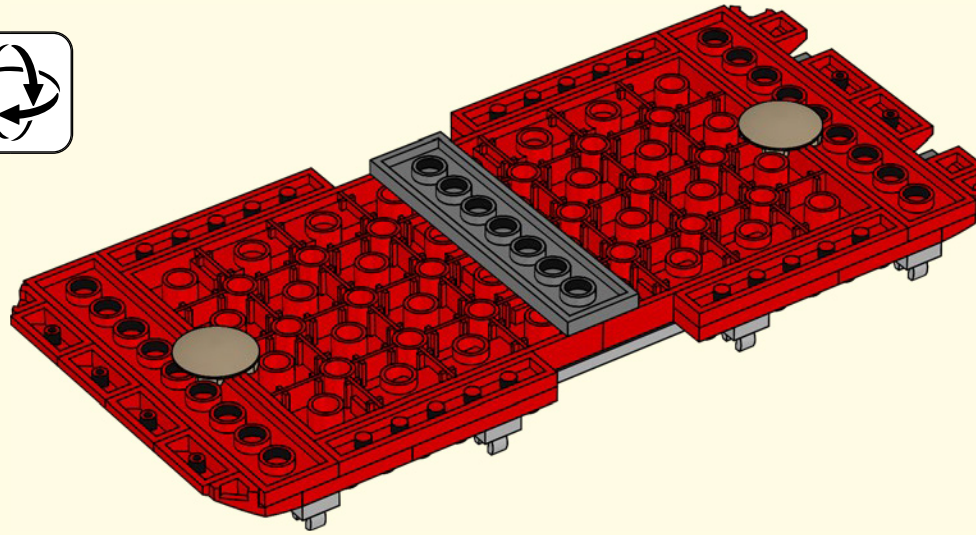

192

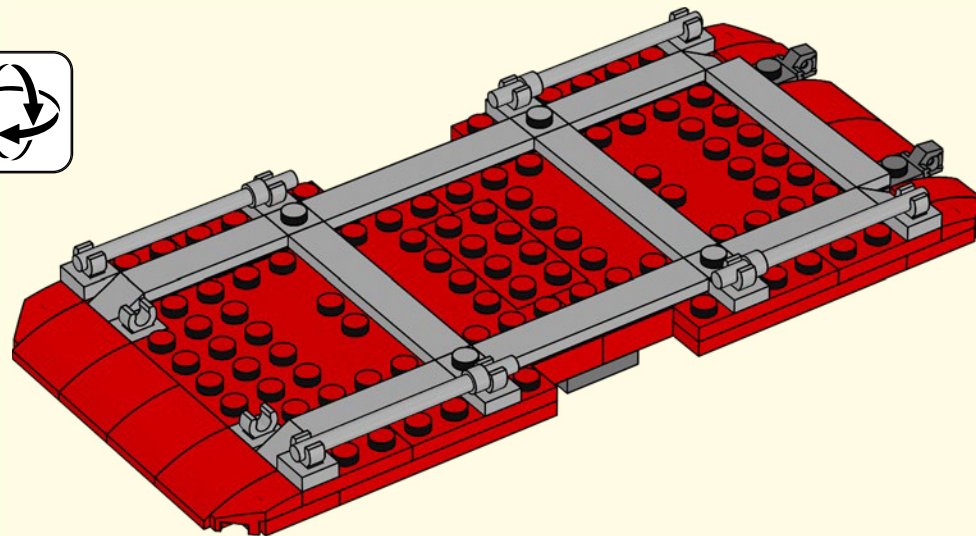



1x

193

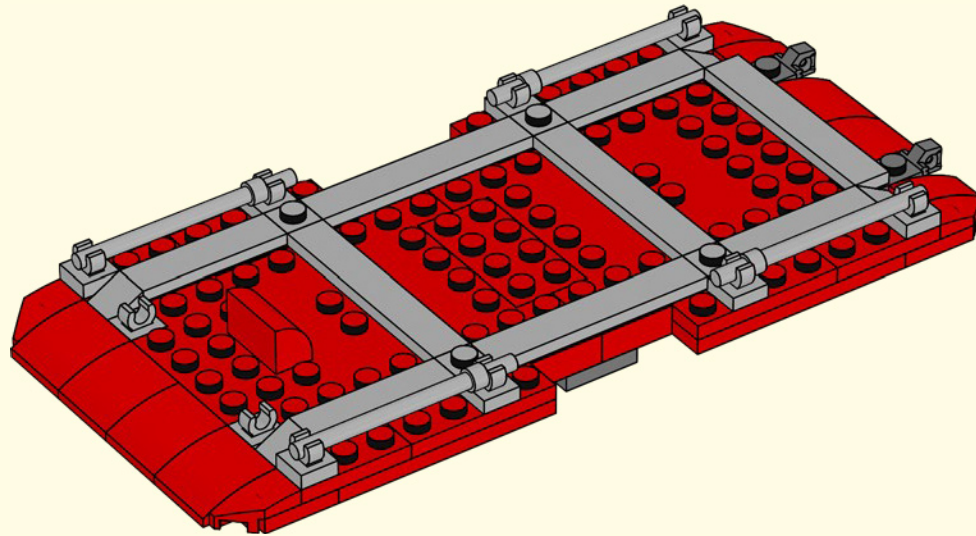



194

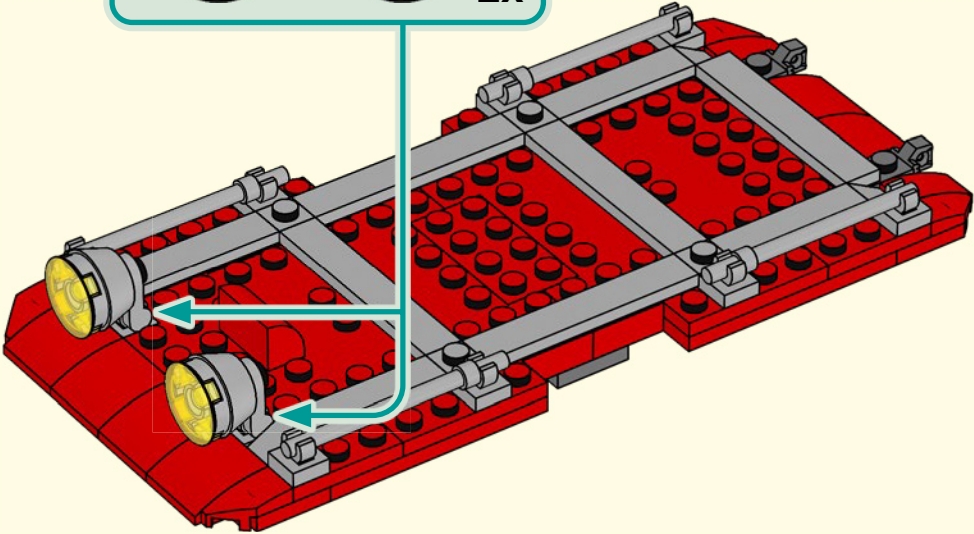
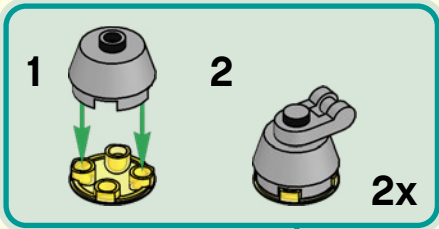

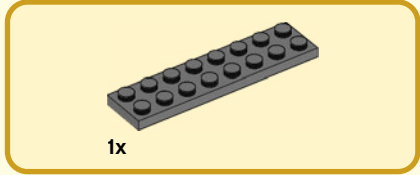
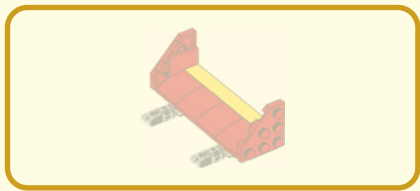

1x

195

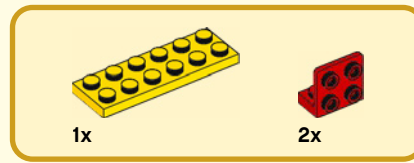
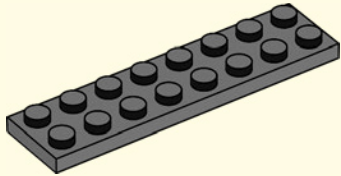

1x

2x

196

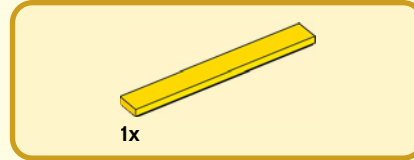
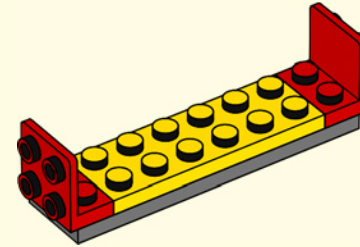

1x

197

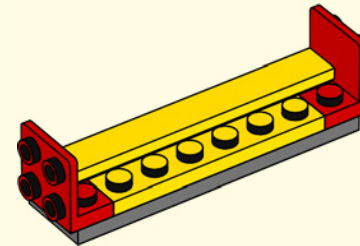



4x

198

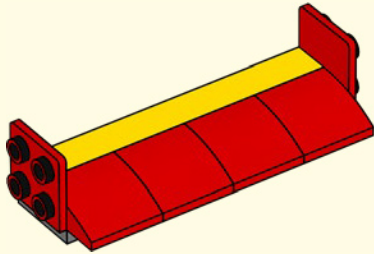

2x

199

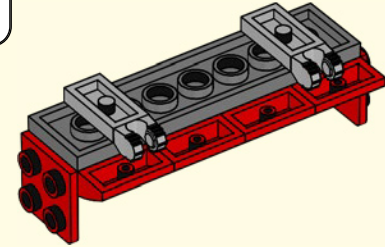
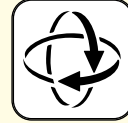

2x

200

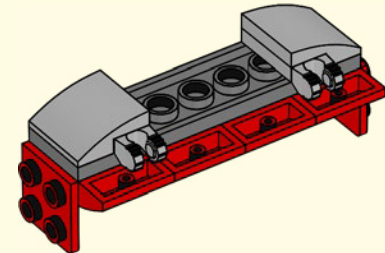



2x

201

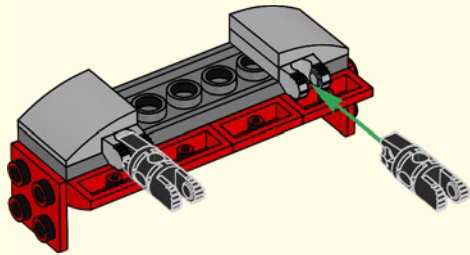

2x

202

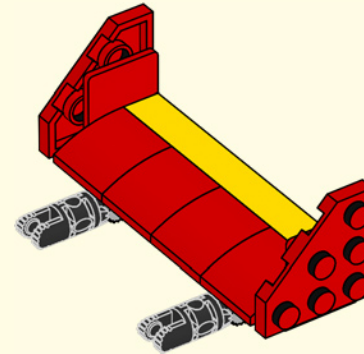
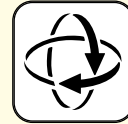

203

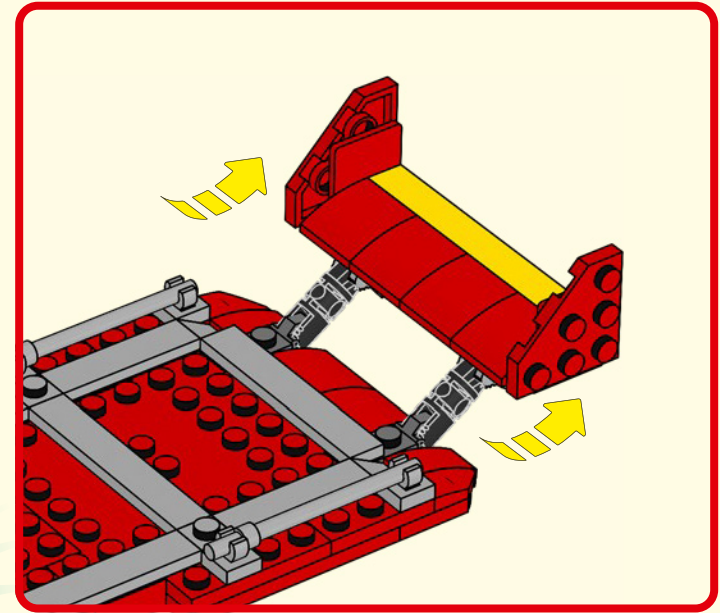
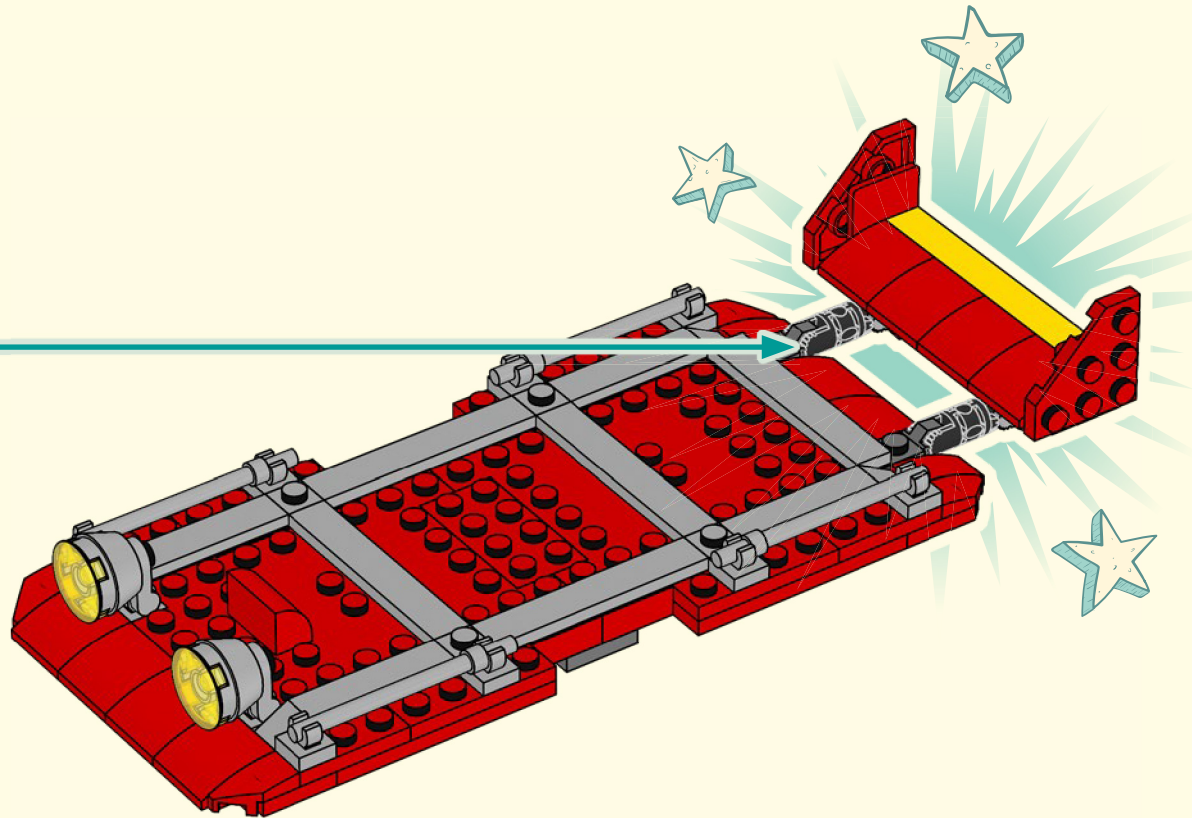

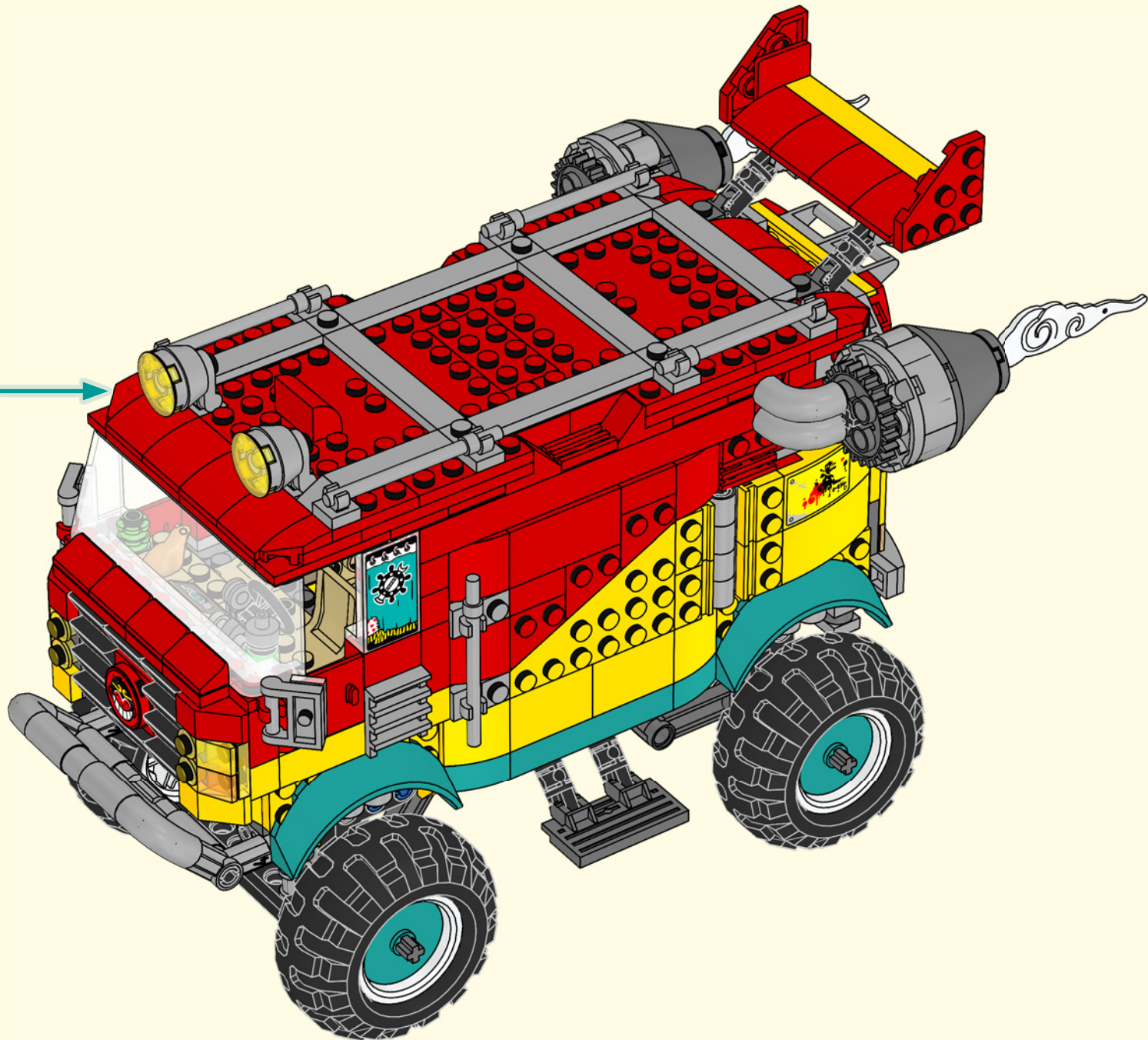

2x

205

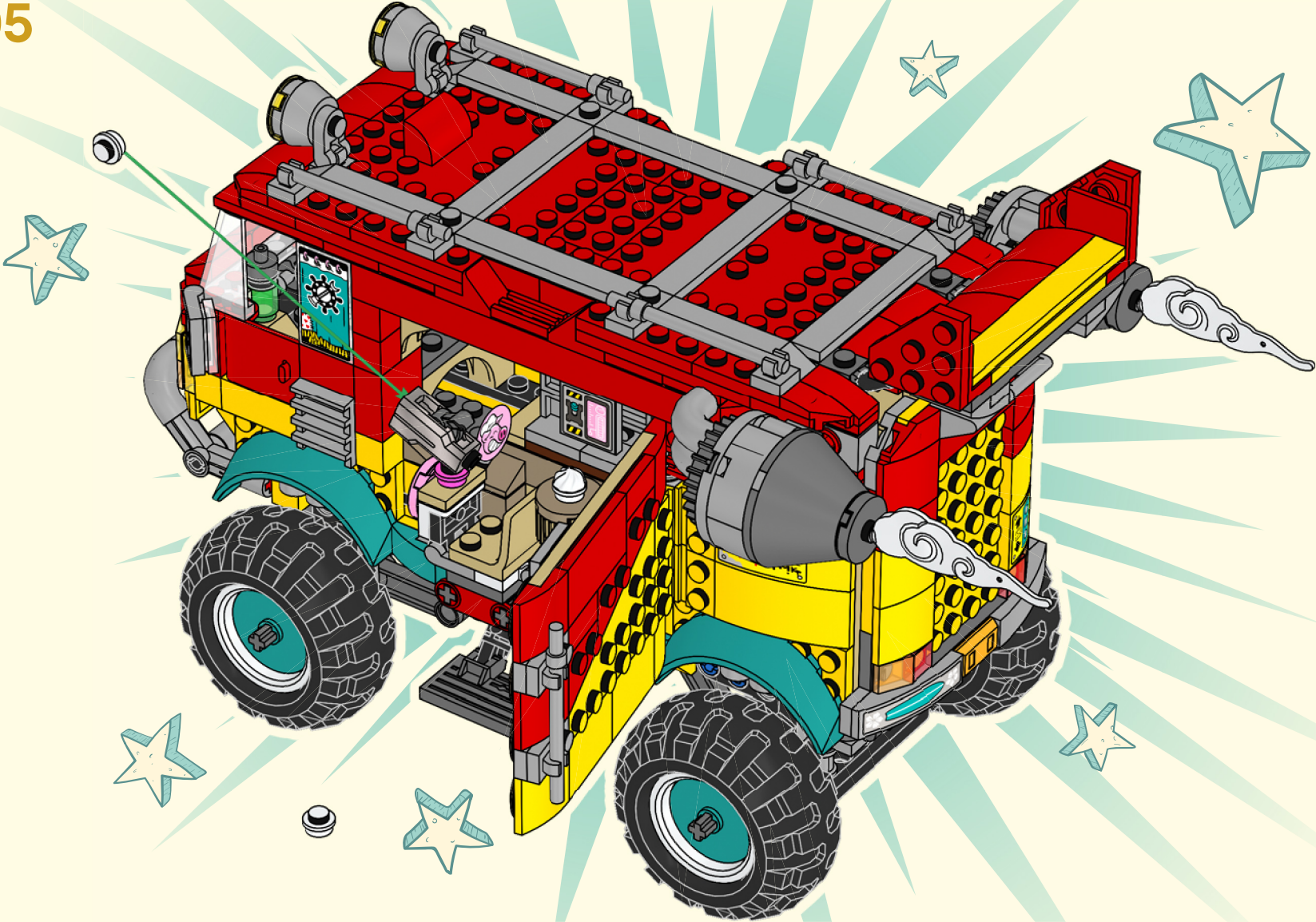

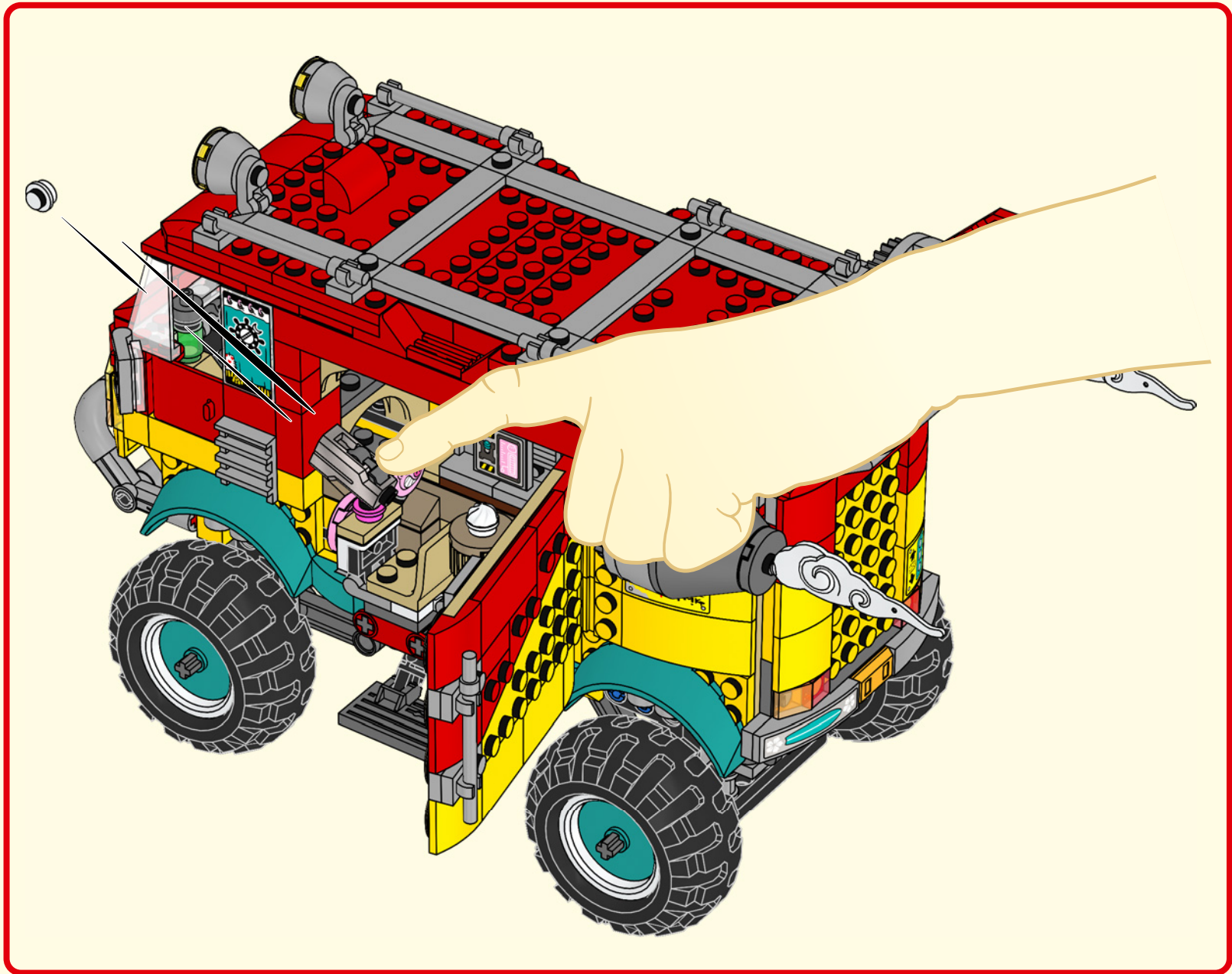

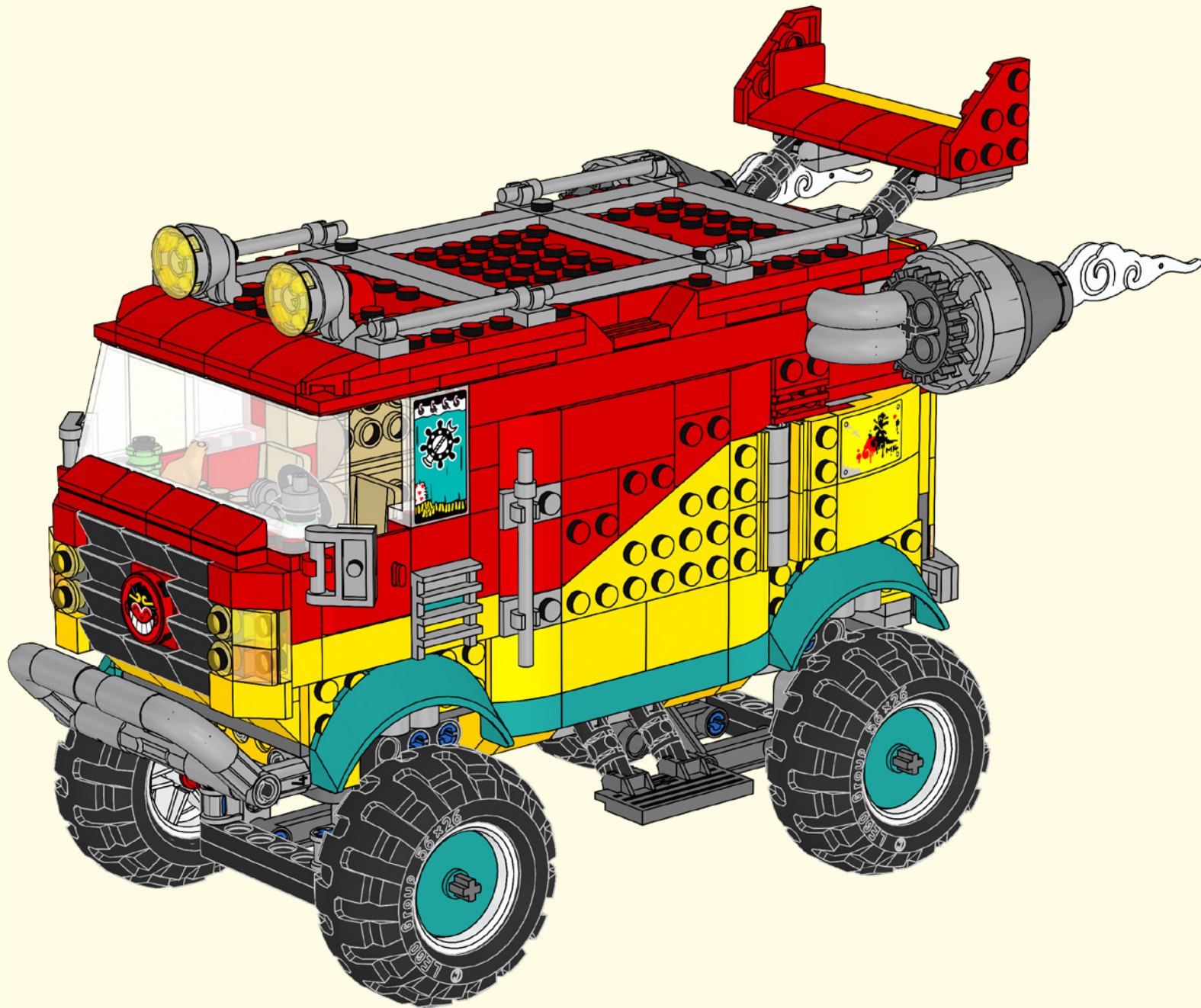

WIN

Terms & Conditions apply

Scan this QR code or go to **LEGO.COM/PRODUCTFEEDBACK** and give us your short feedback about this LEGO® set for a chance to win a cool LEGO prize.



GEWINNE

Scanne diesen QR-Code oder geh auf [LEGO.COM/PRODUCTFEEDBACK](https://www.lego.com/productfeedback)

und gib uns dein kurzes Feedback zu diesem LEGO® Set. Dann hast du die Chance, einen coolen LEGO Preis zu gewinnen.

Es gelten die Teilnahmebedingungen

GAGNE

Scannez ce code QR ou rendez-vous sur [LEGO.COM/PRODUCTFEEDBACK](https://www.lego.com/productfeedback)

pour donner votre avis sur ce produit LEGO® et avoir une chance de gagner un prix LEGO.

Voir Conditions Générales

GANAN

Escanea este código QR o visita [LEGO.COM/PRODUCTFEEDBACK](https://www.lego.com/productfeedback)

y comparte con nosotros tu opinión sobre este set LEGO® para tener la oportunidad de ganar un fantástico premio LEGO.

Términos y Condiciones aplicables

获取奖品

只需扫描此二维码或访问 [LEGO.COM/PRODUCTFEEDBACK](https://www.lego.com/productfeedback),

就这款乐高®套装提供简短反馈, 就有机会赢得很酷的乐高奖品。

《条款及条件》适用

경품 당첨 기회

이 QR 코드를 스캔하거나 [LEGO.COM/PRODUCTFEEDBACK](https://www.lego.com/productfeedback)

페이지에 접속하여 이 레고® 세트에 대한 간략한 피드백을 적어주시고, 멋진 레고 상품을 받을 기회를 잡으세요.

약관 적용

ЗАПОЛНИ АНКЕТУ И ПОЛУЧИ ПРИЗ

Отсканируйте этот код или перейдите на веб-сайт [LEGO.COM/PRODUCTFEEDBACK](https://www.lego.com/productfeedback),

чтобы оставить краткий отзыв об этом наборе LEGO® и выиграть крутой приз LEGO.

Применяются Условия и правила участия