

LEGO

TECHNIC

8445





4



66

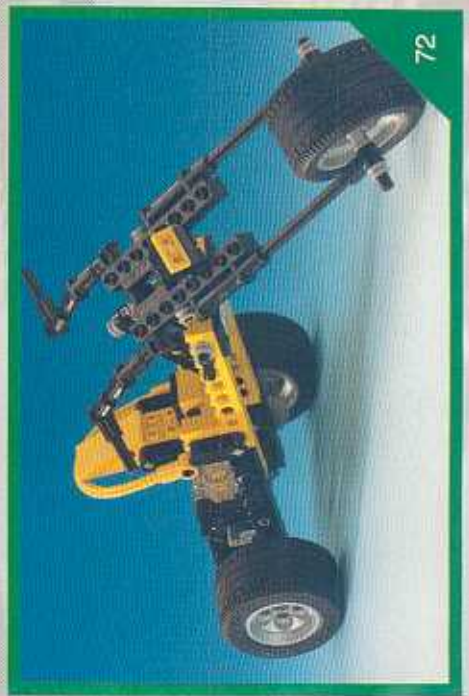

72



96

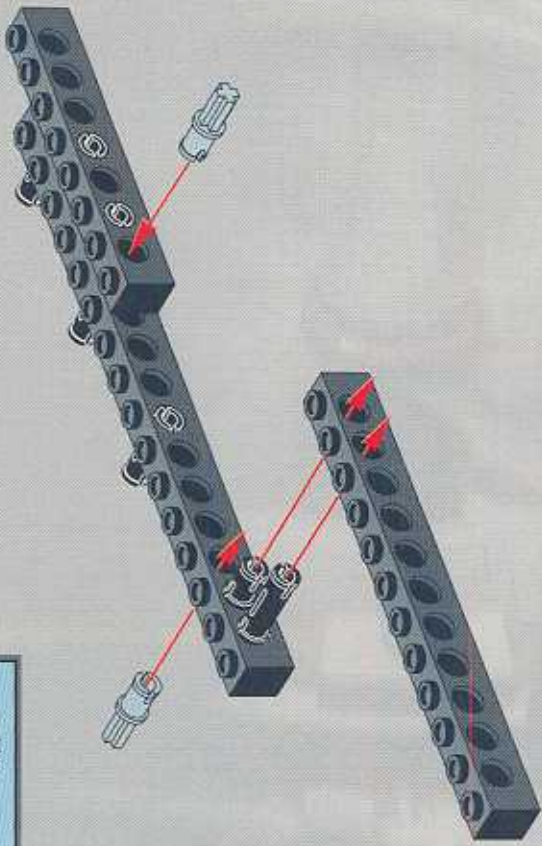
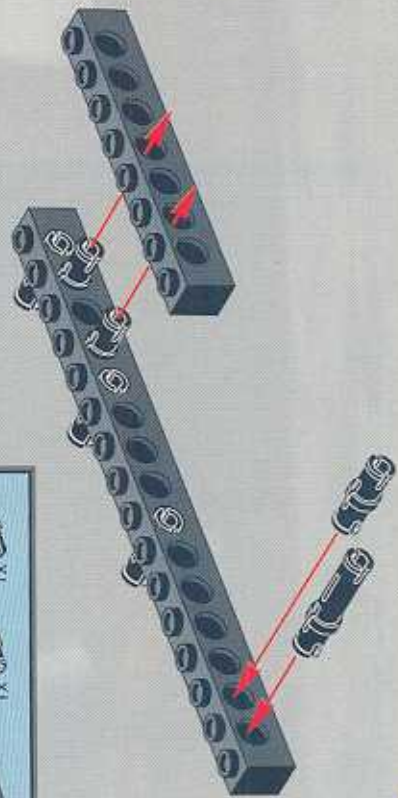
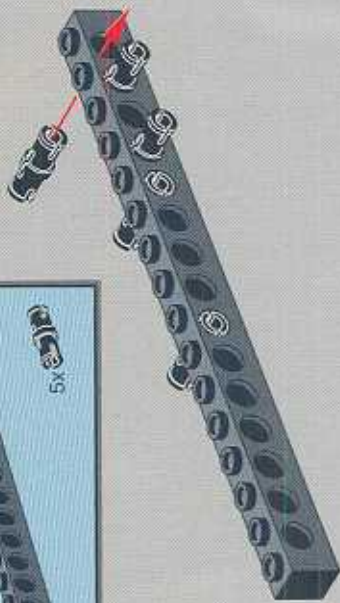
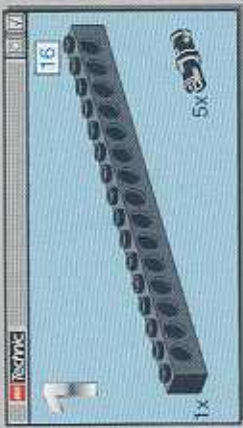

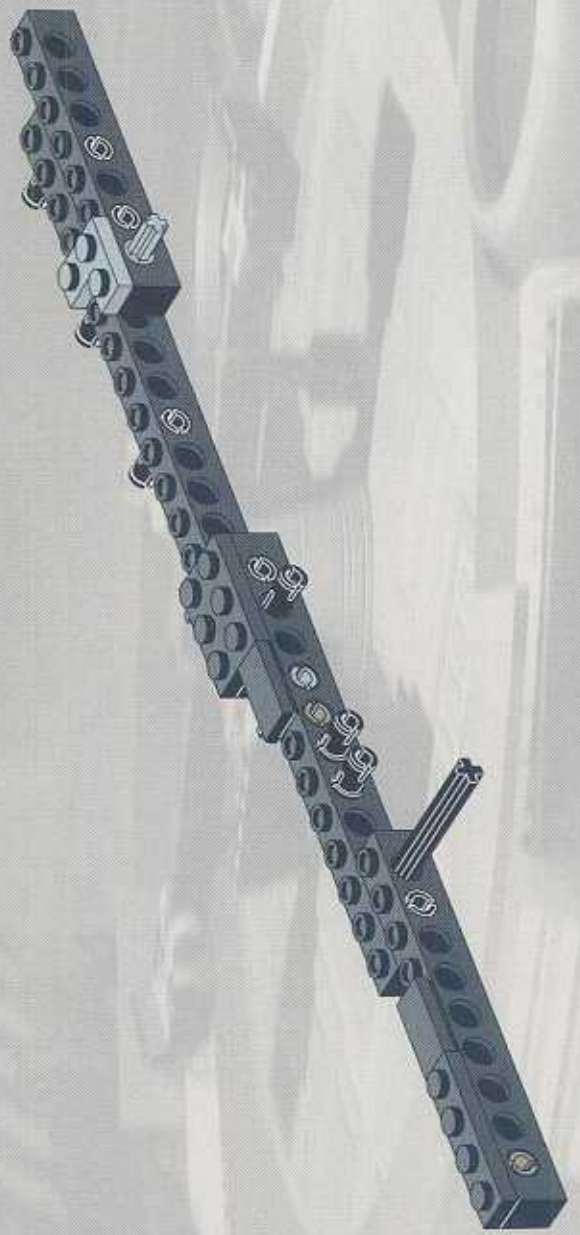
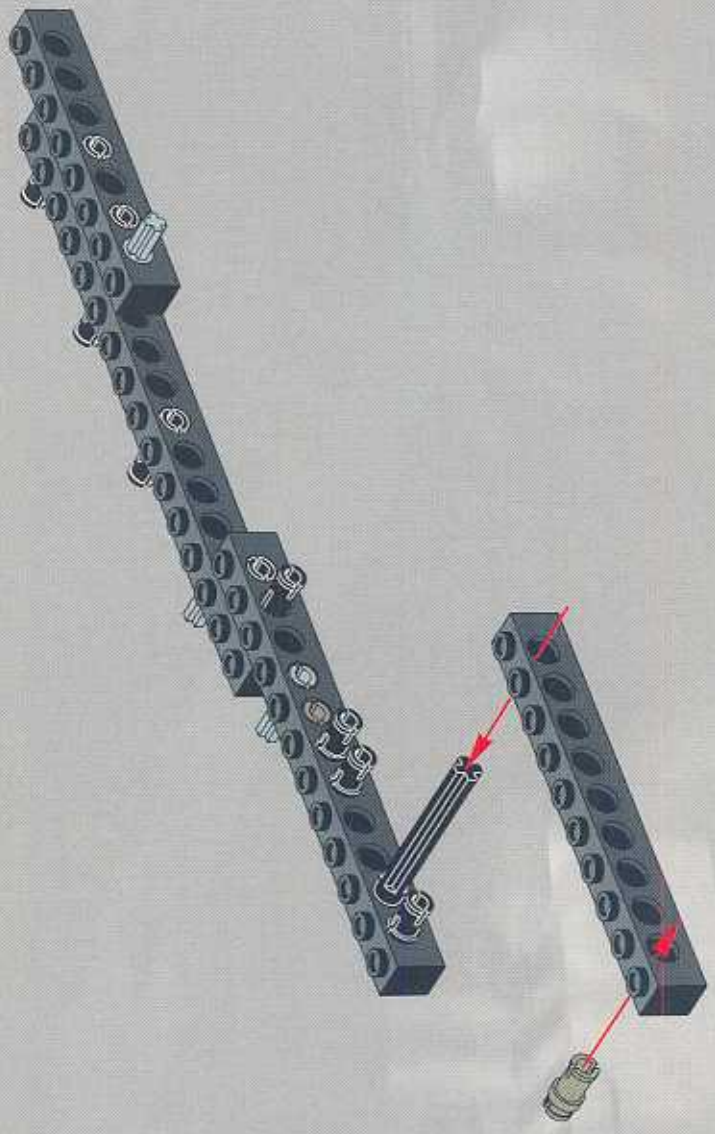
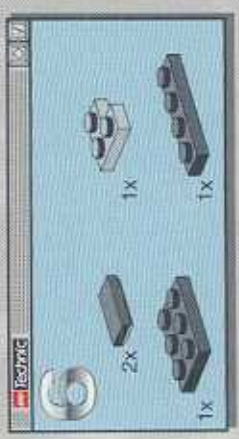
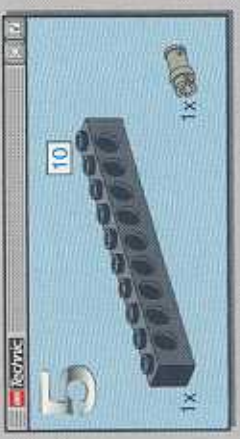

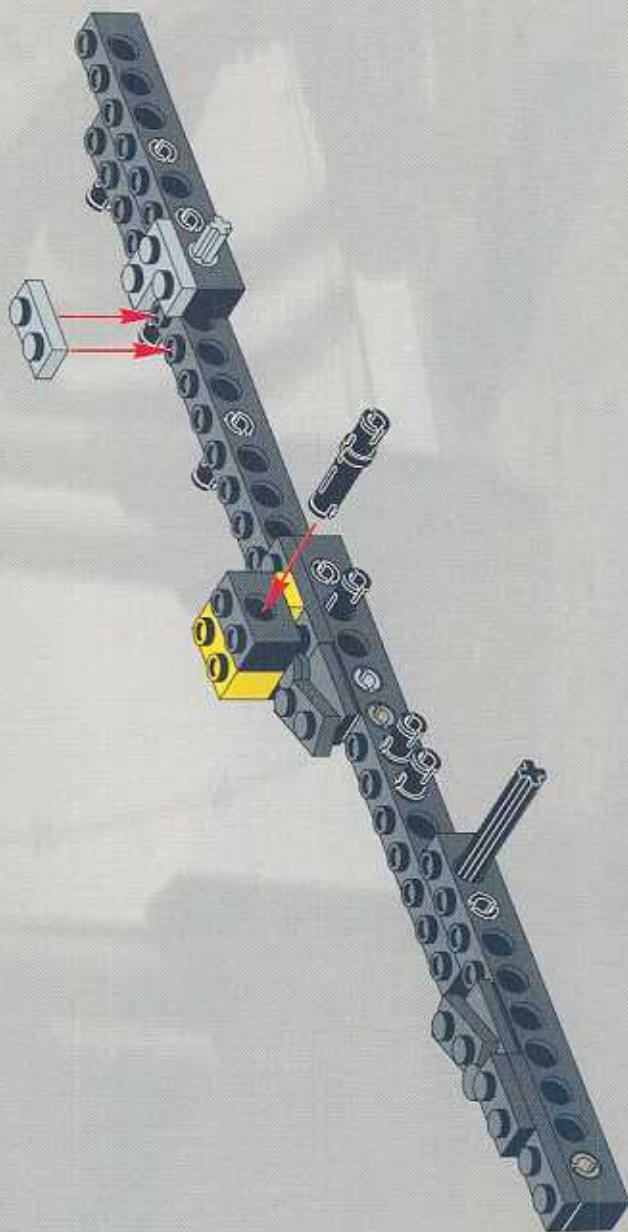

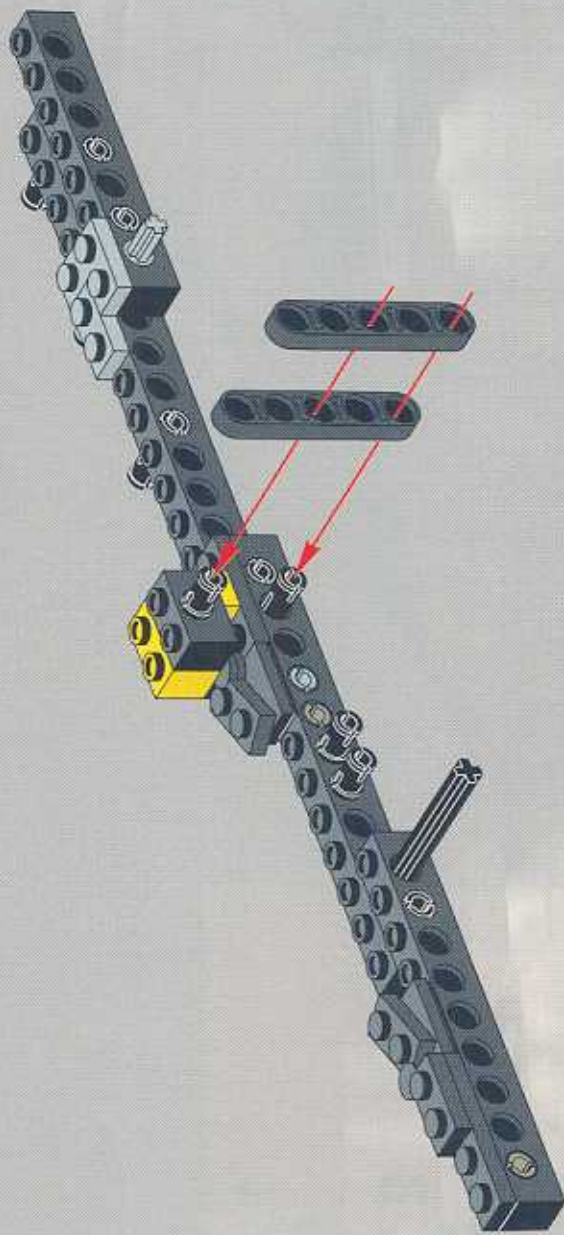

LEGO 9
2x

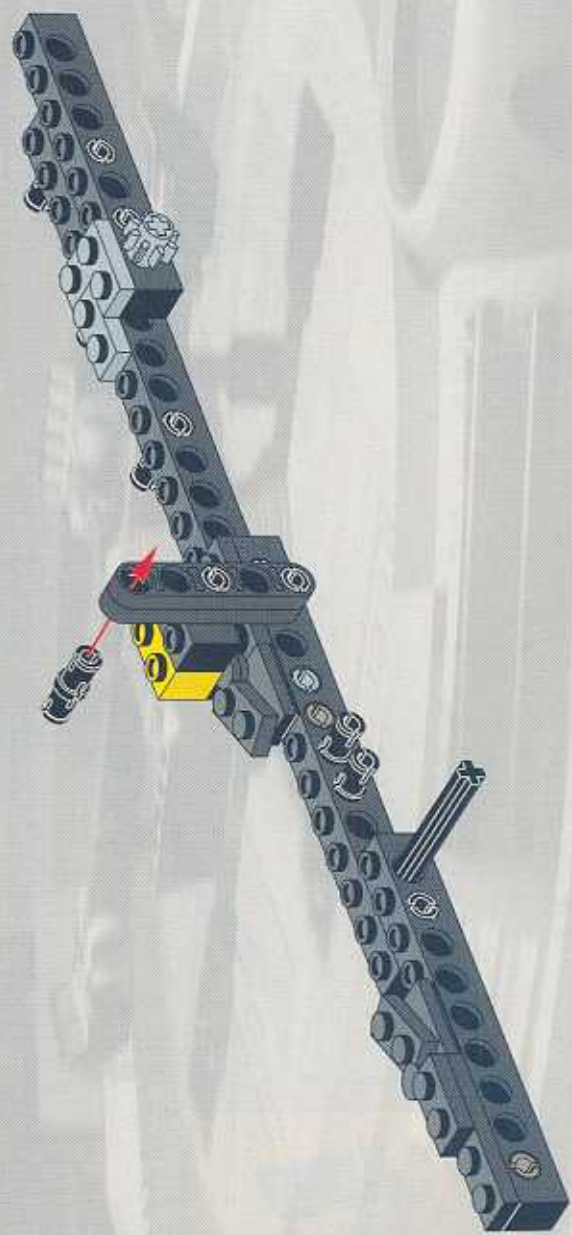

LEGO 10
1x

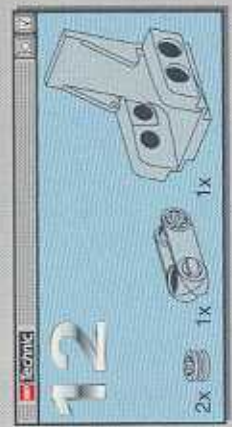
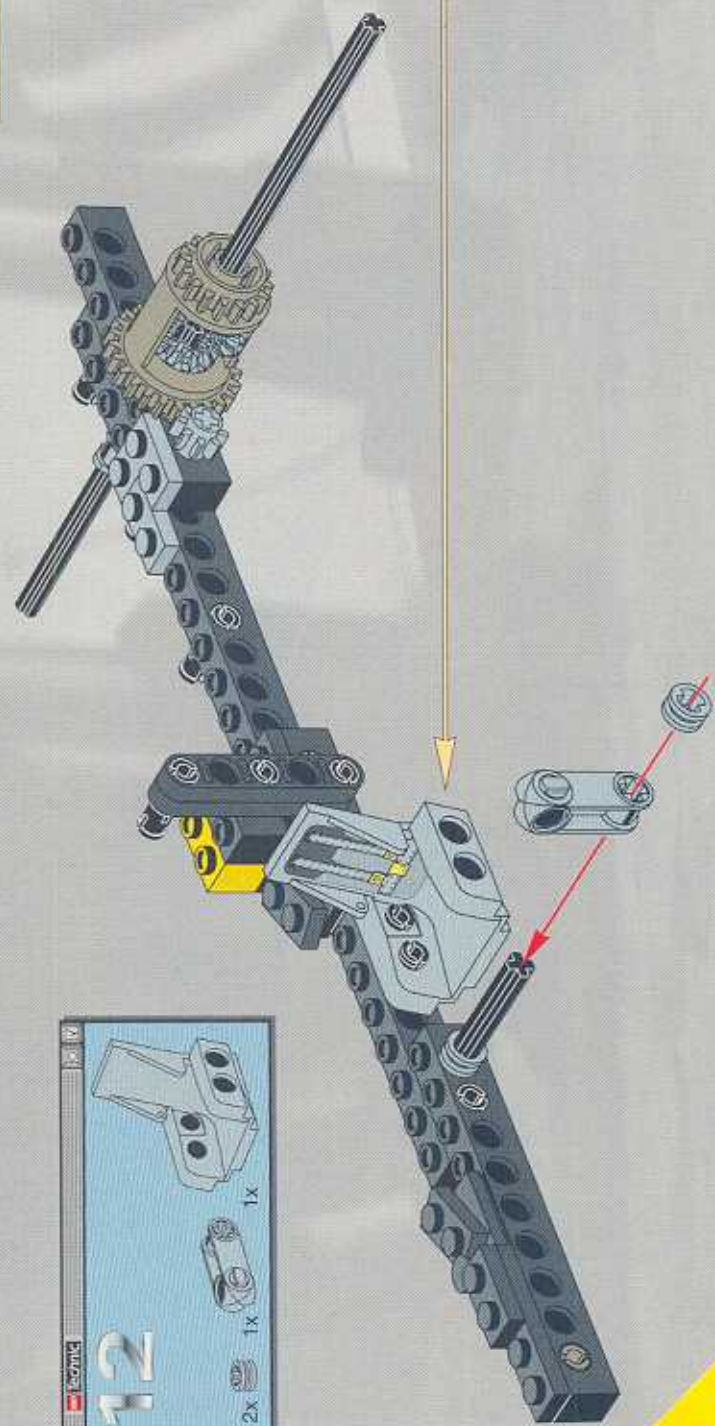
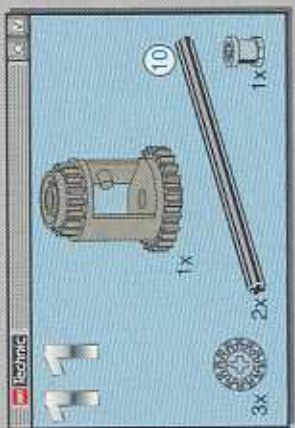
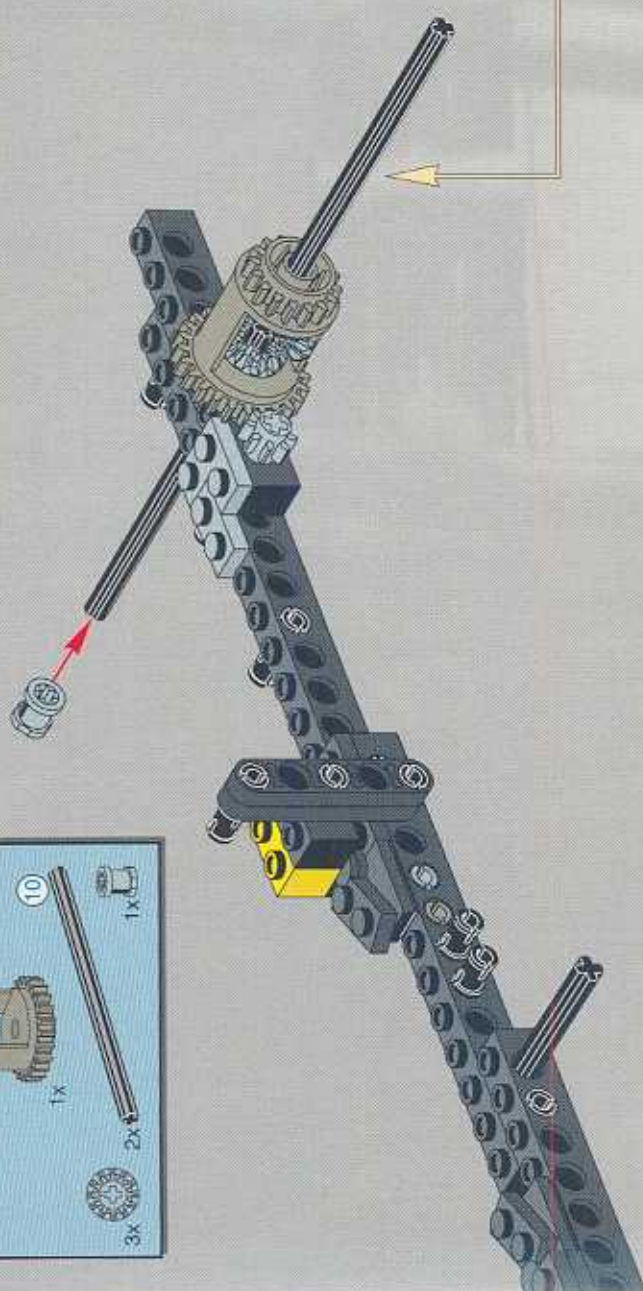
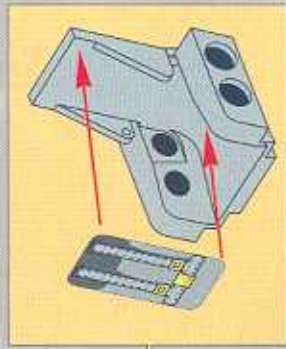
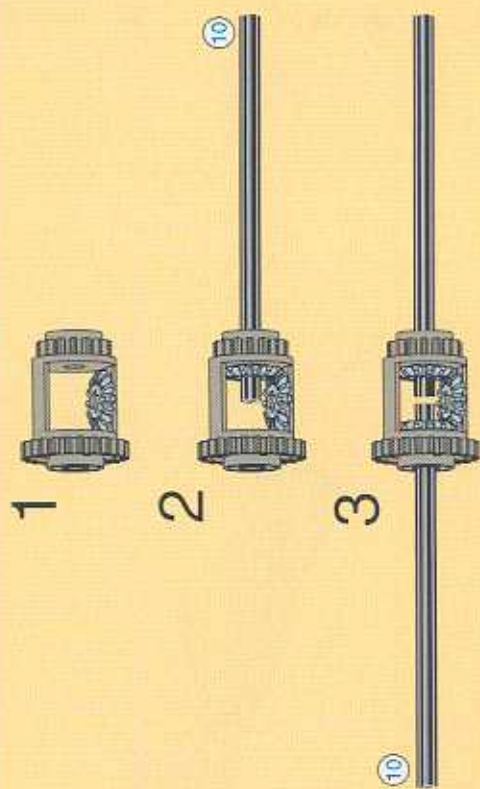

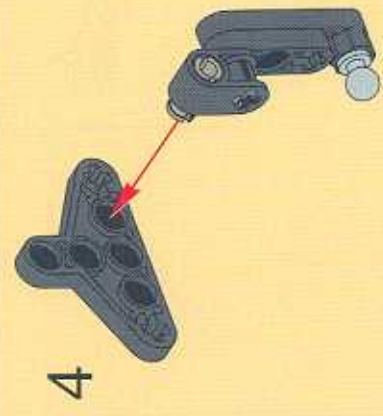

4

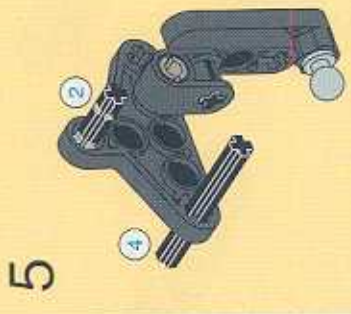

5

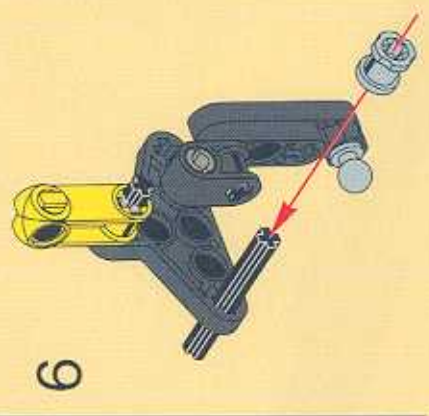

6

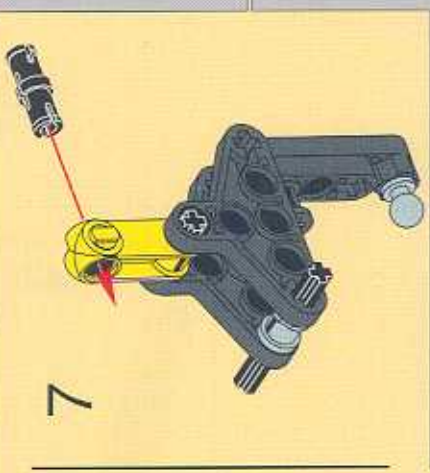

7



1

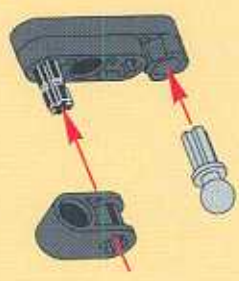

2

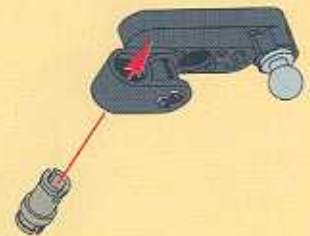

3

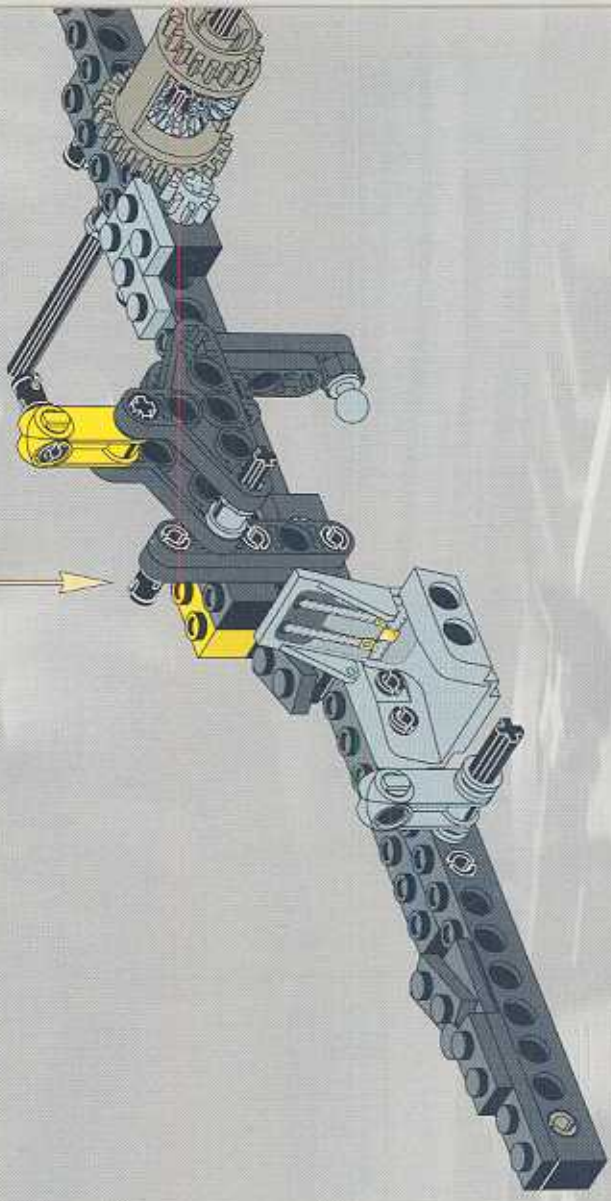

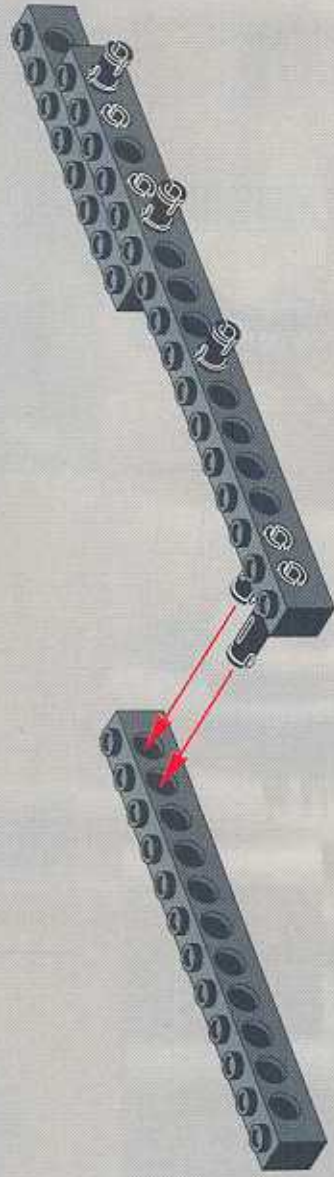
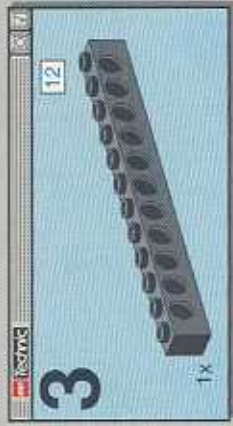
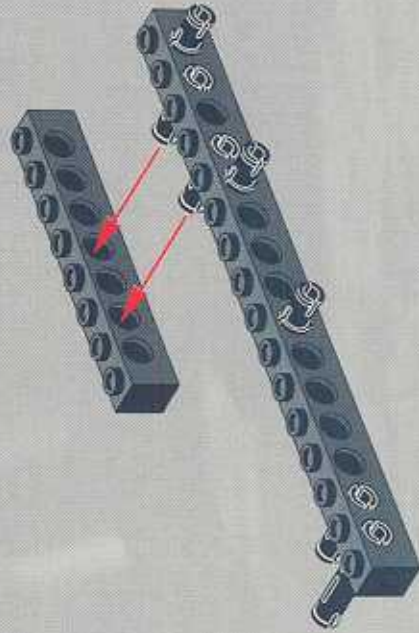
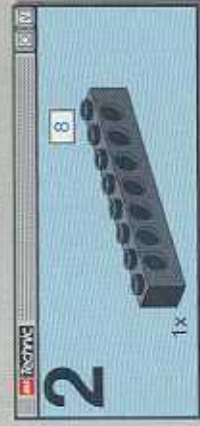
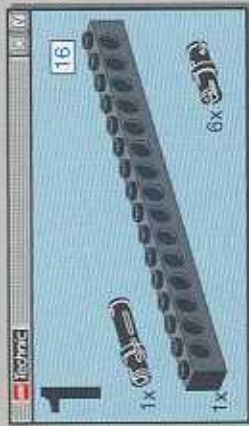

5

1x

10

2x

2x

6

2x

1x

1x

1x

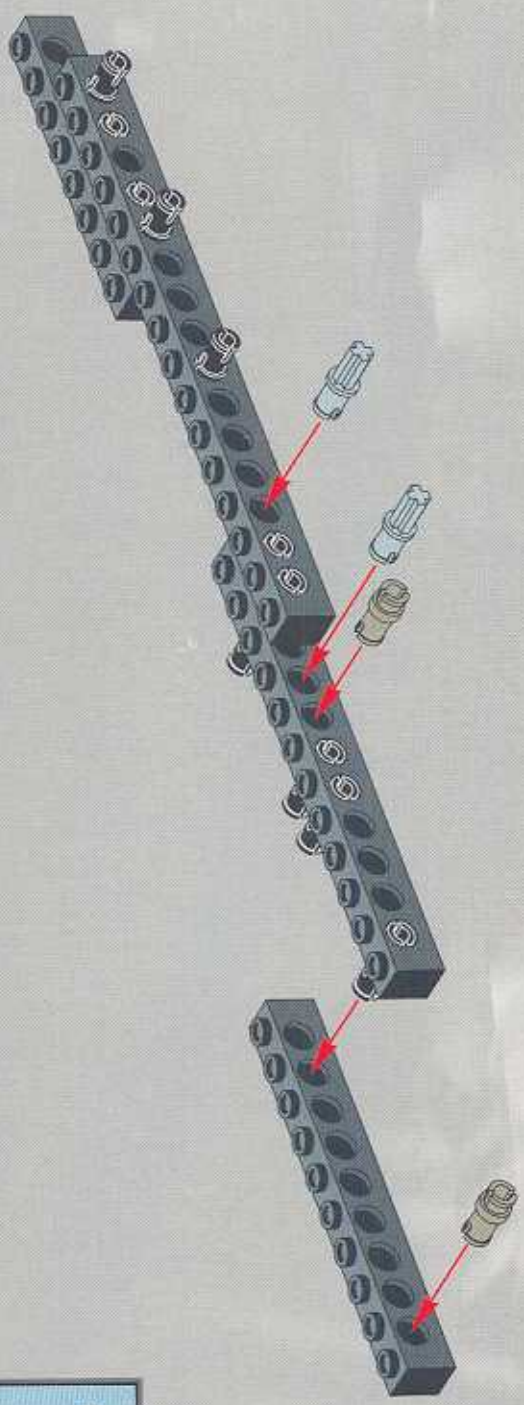

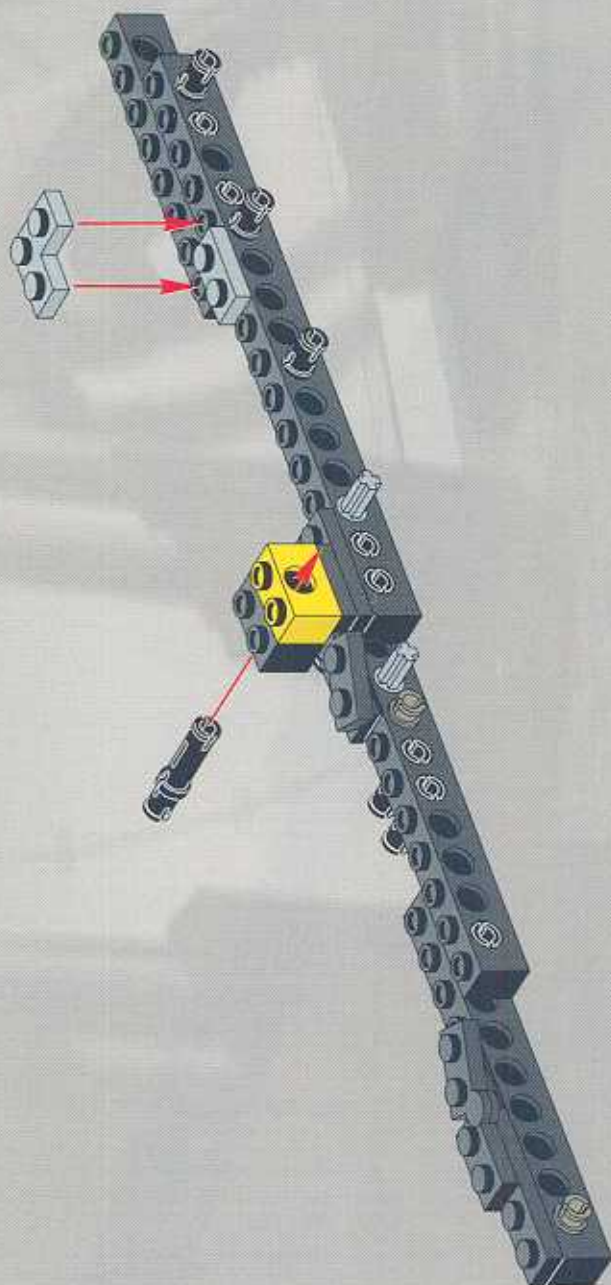
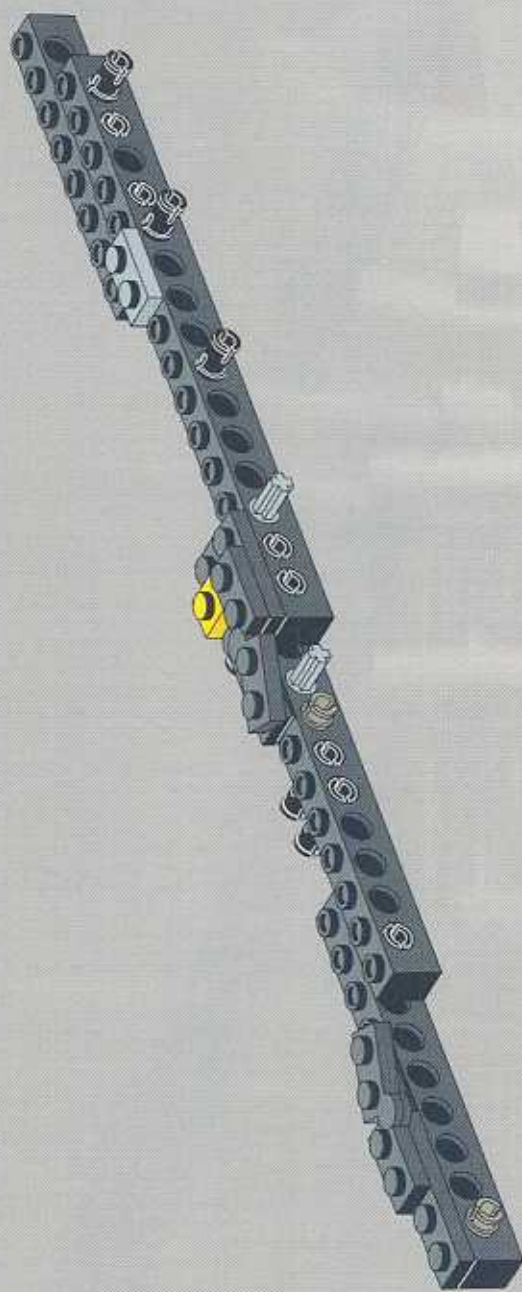
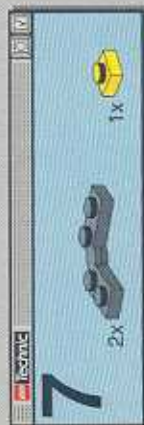

9  2x

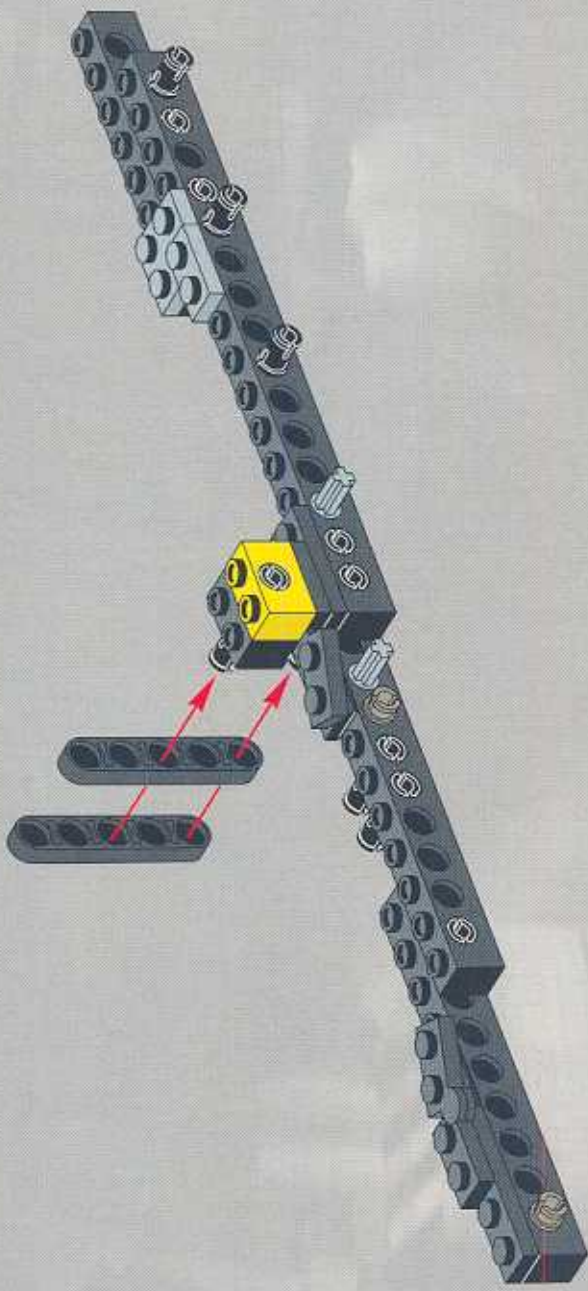

10  1x



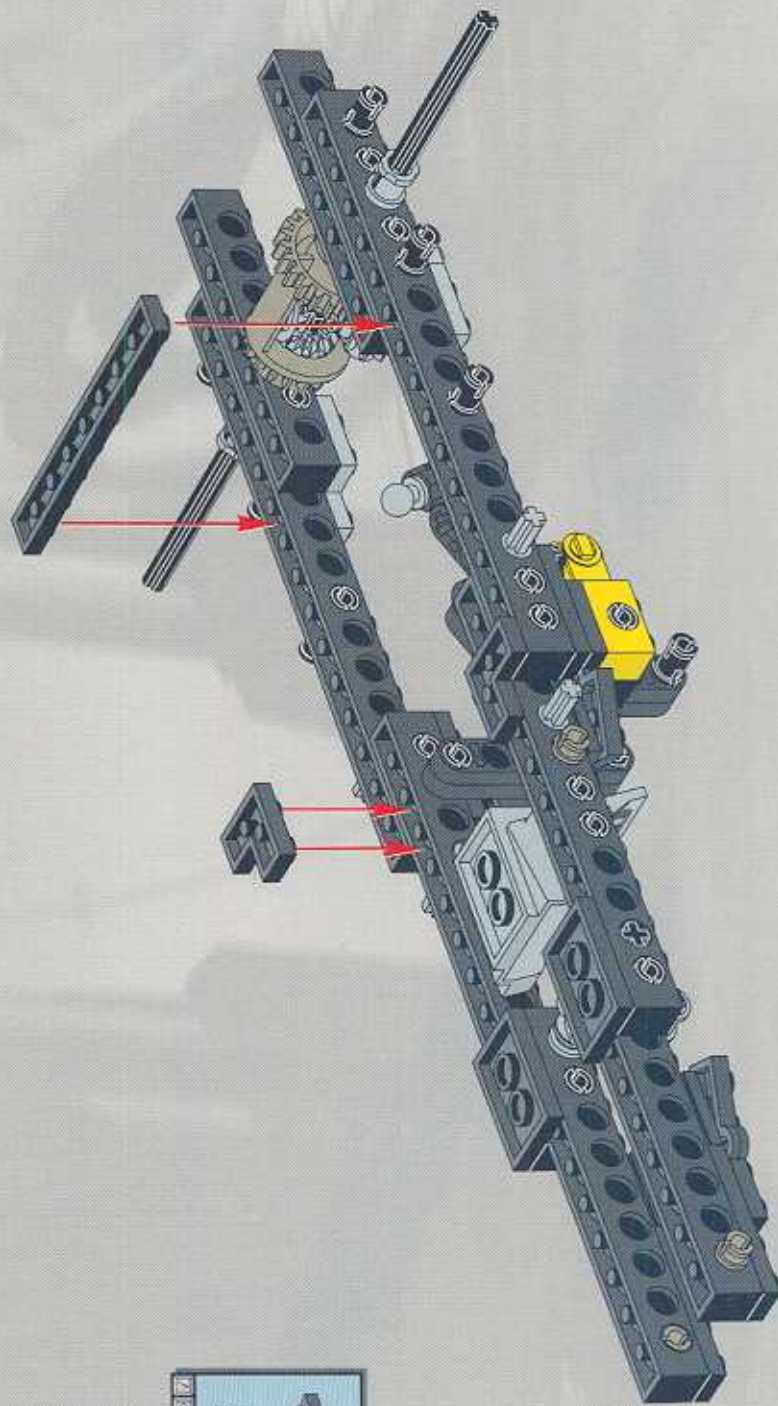
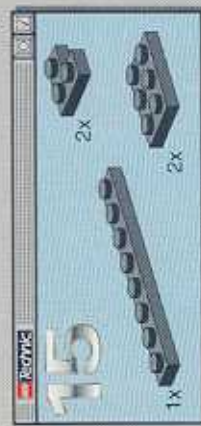
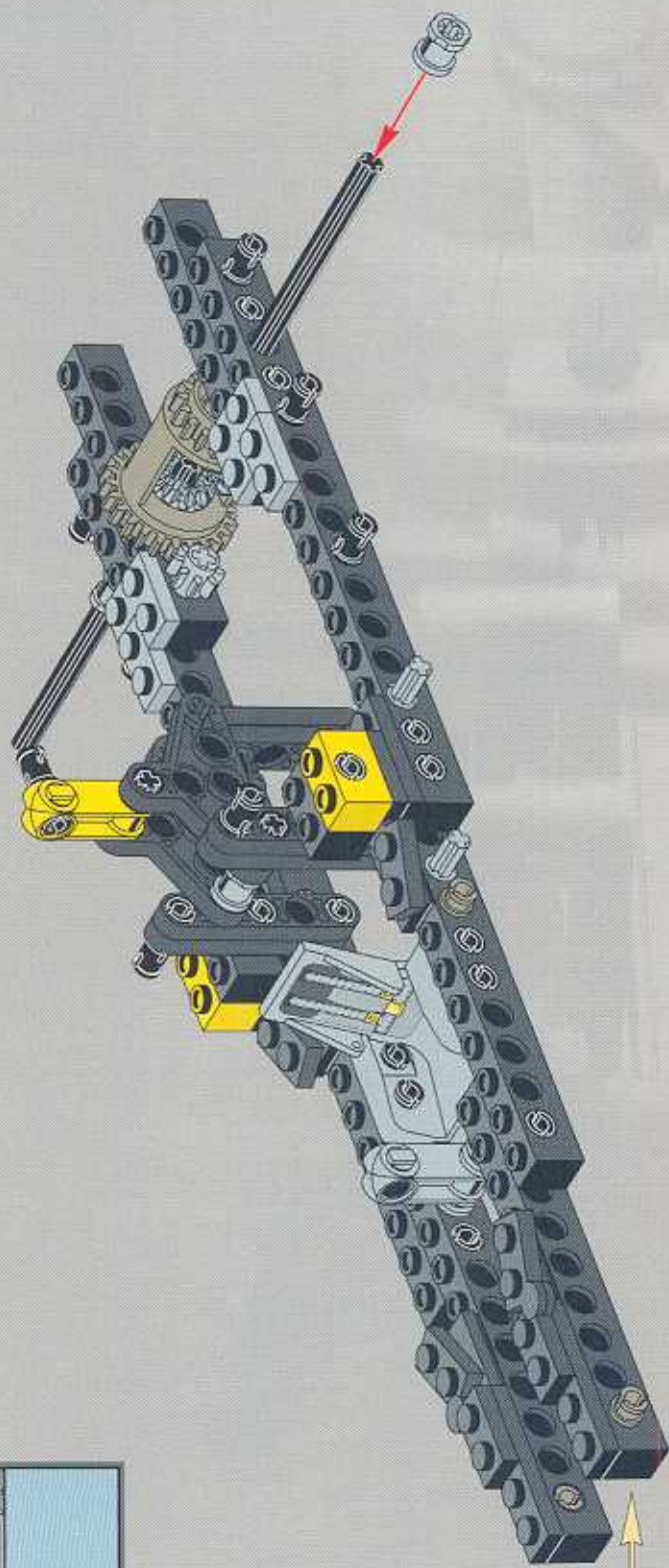

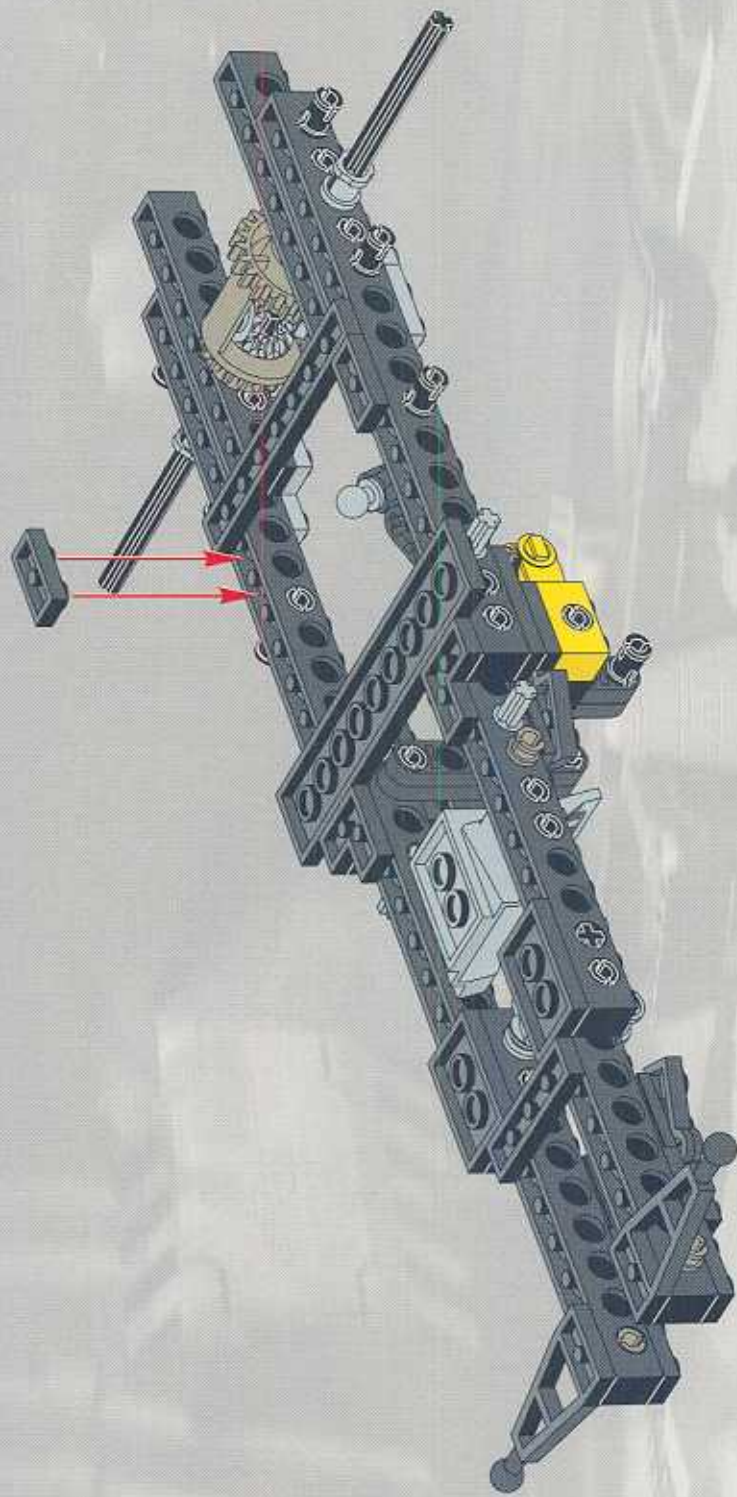
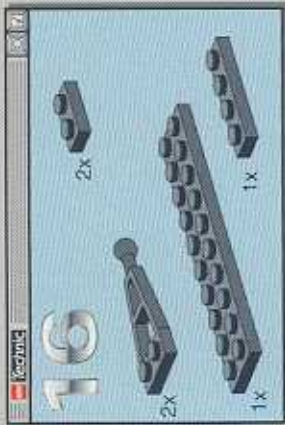

LEGO 118

2x	4x	2x	4x
2x	4x	2x	4x

1

2

2x

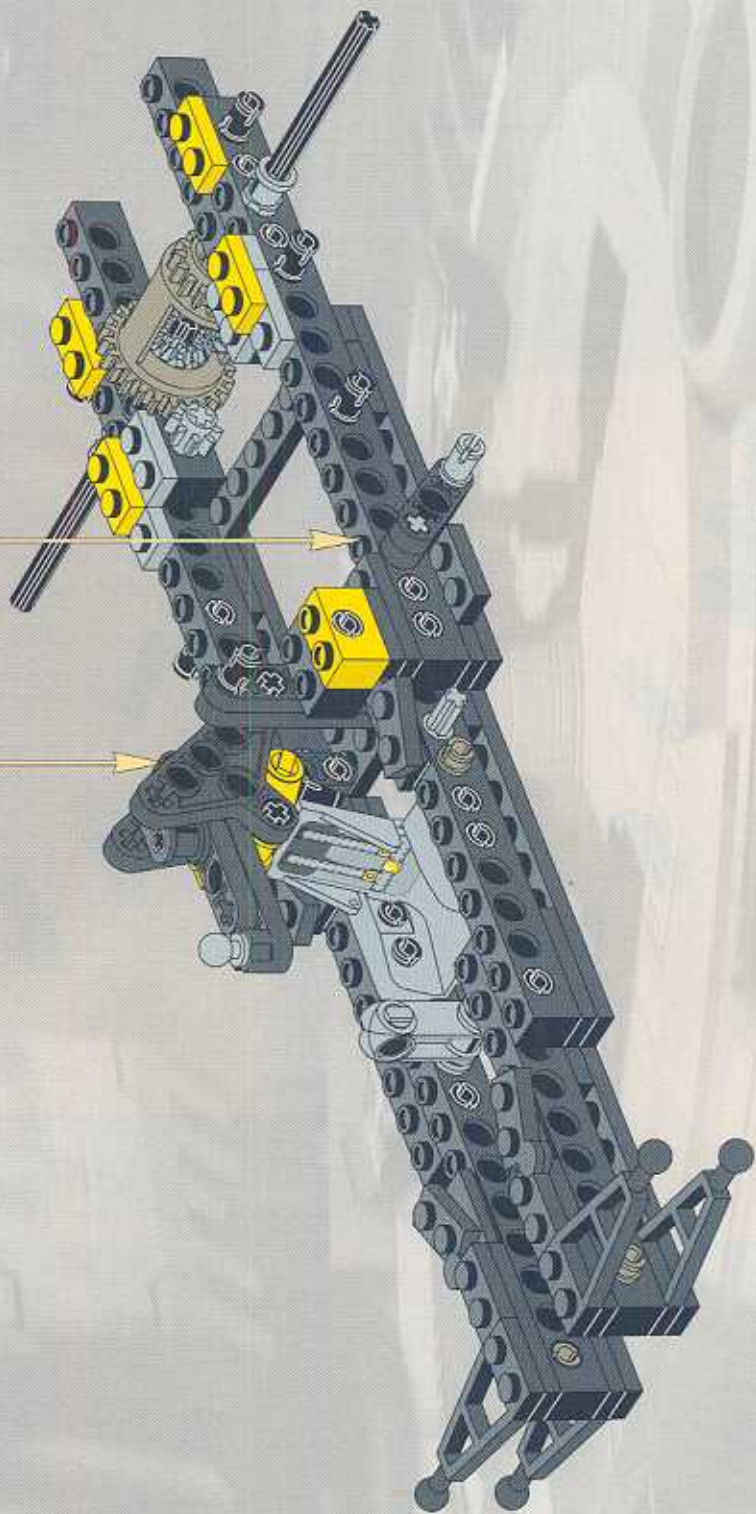

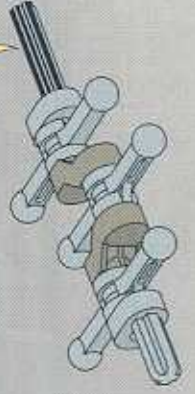
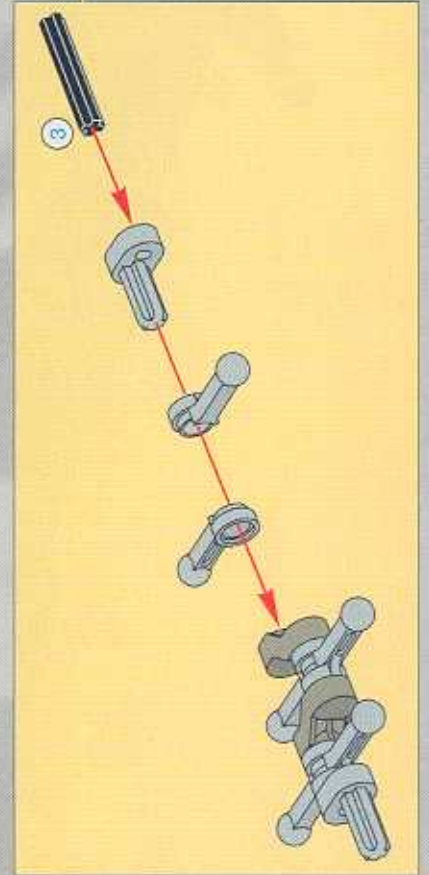
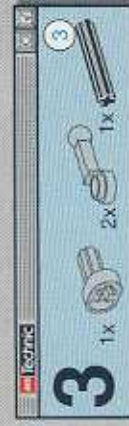
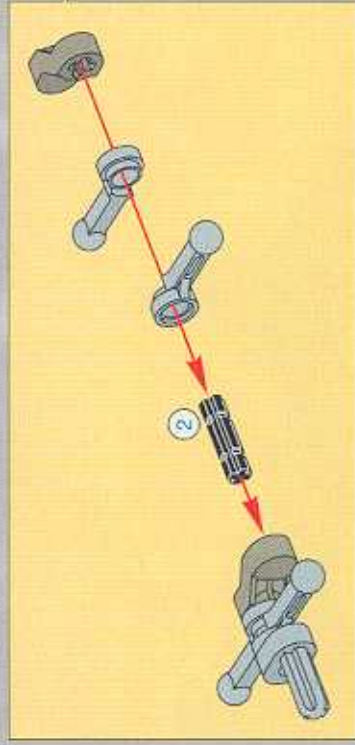
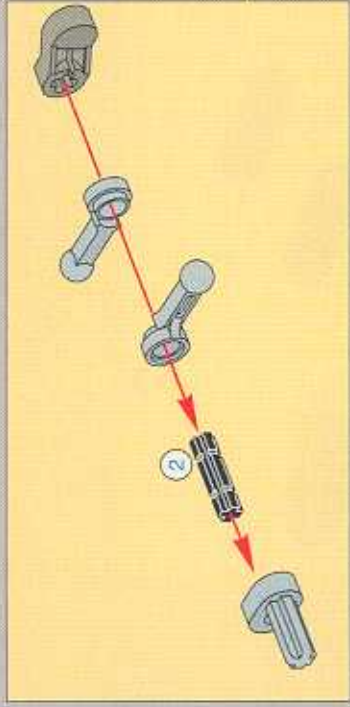
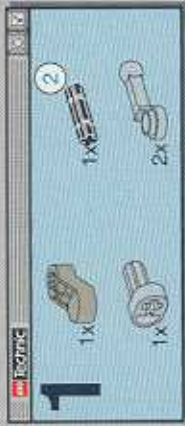

4  6x

5  6x  3x

6  6x  3x

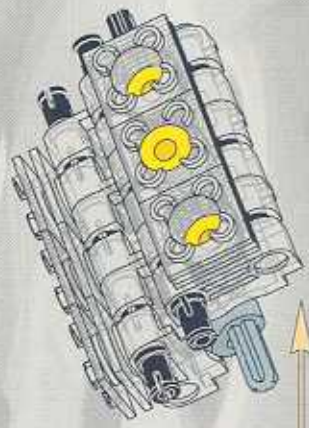
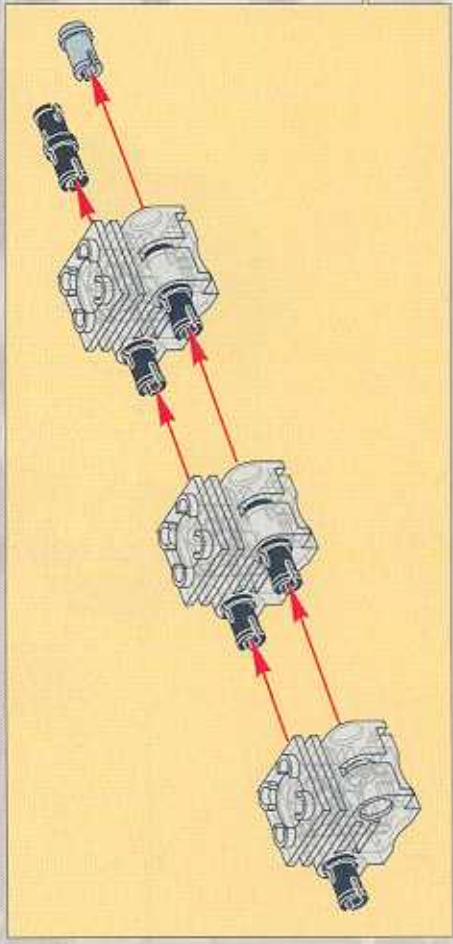
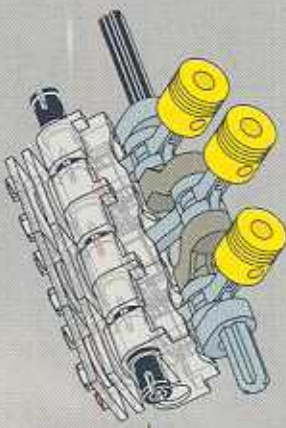
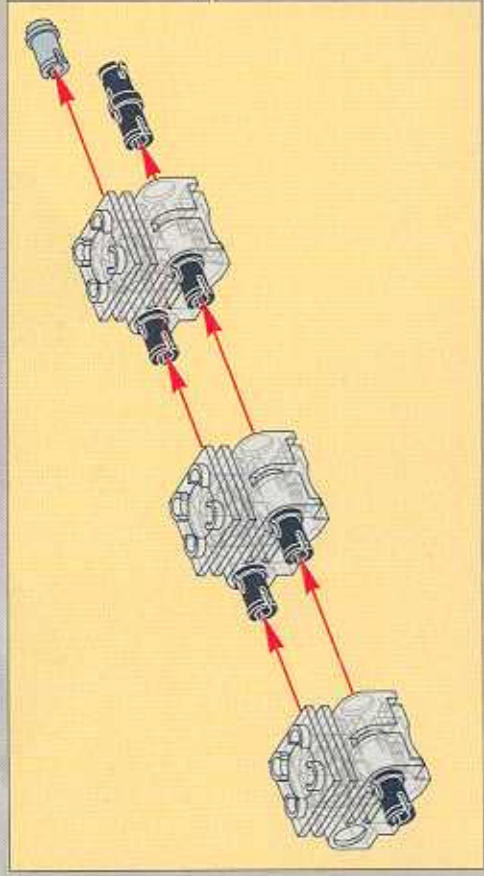
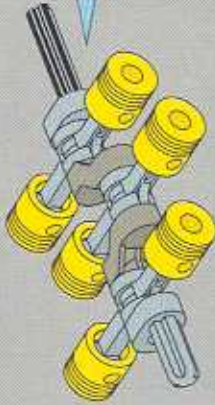
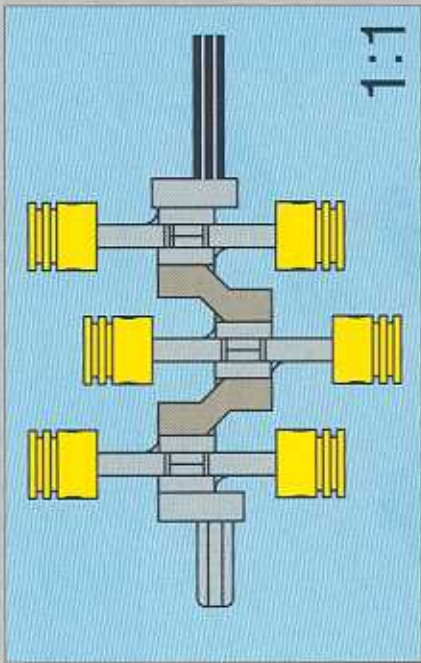

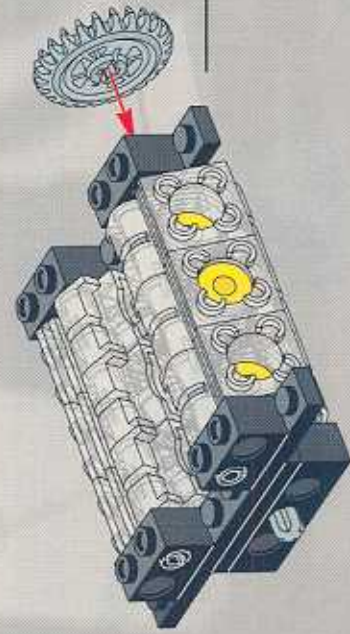
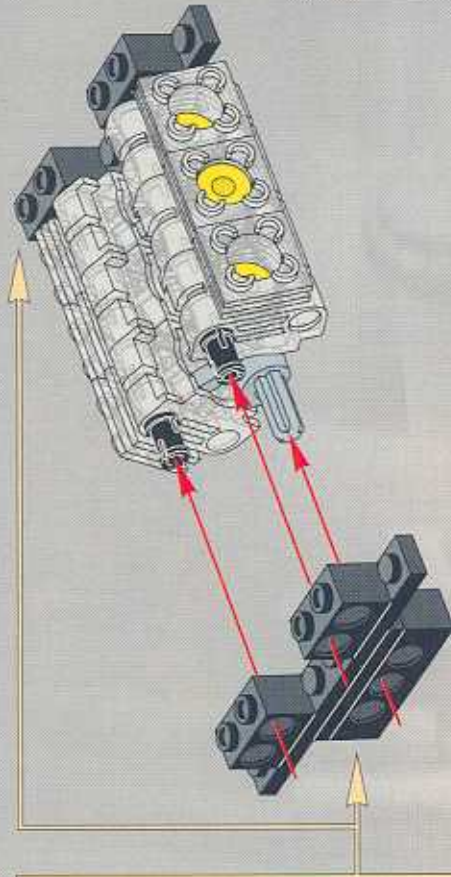
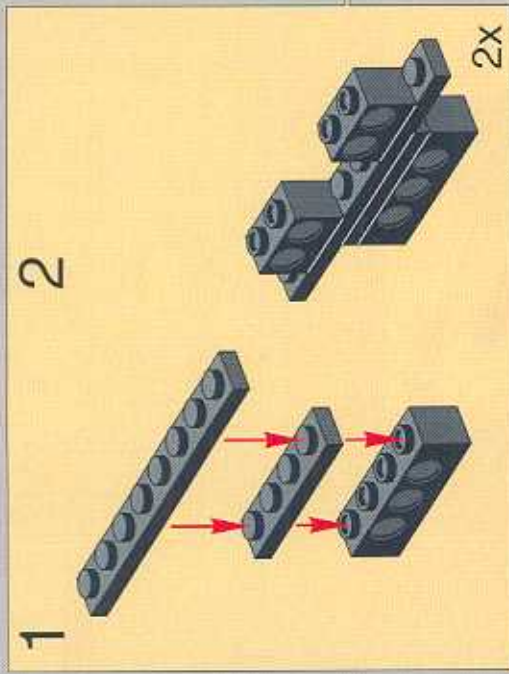
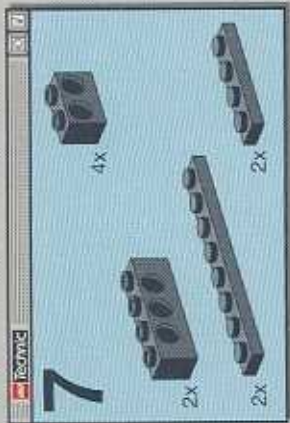

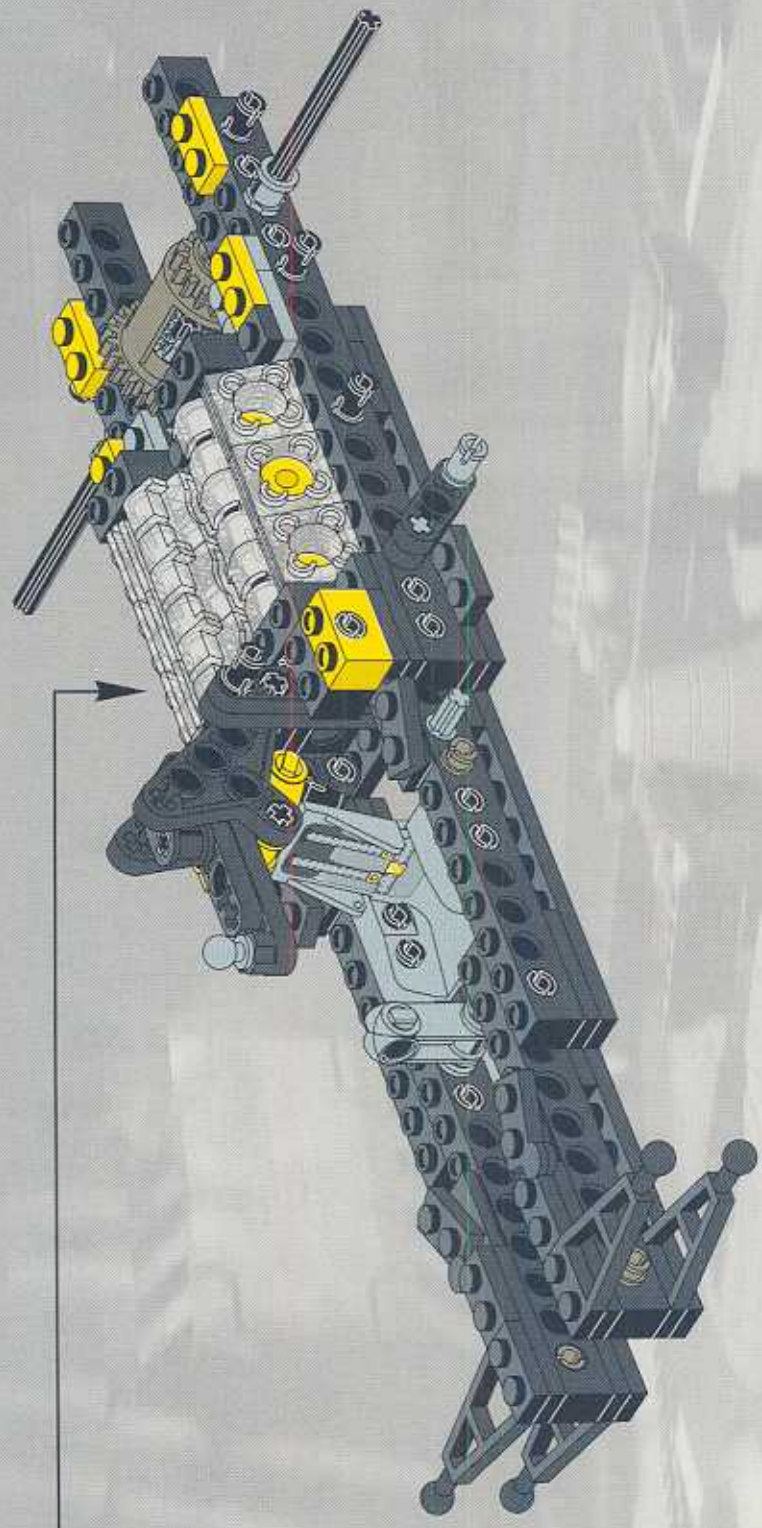

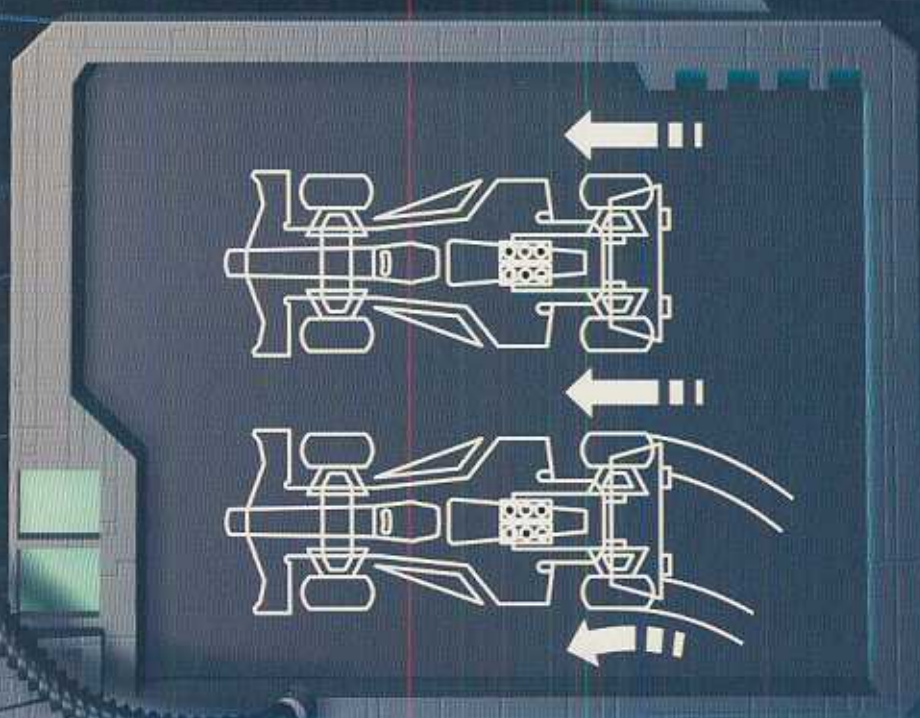
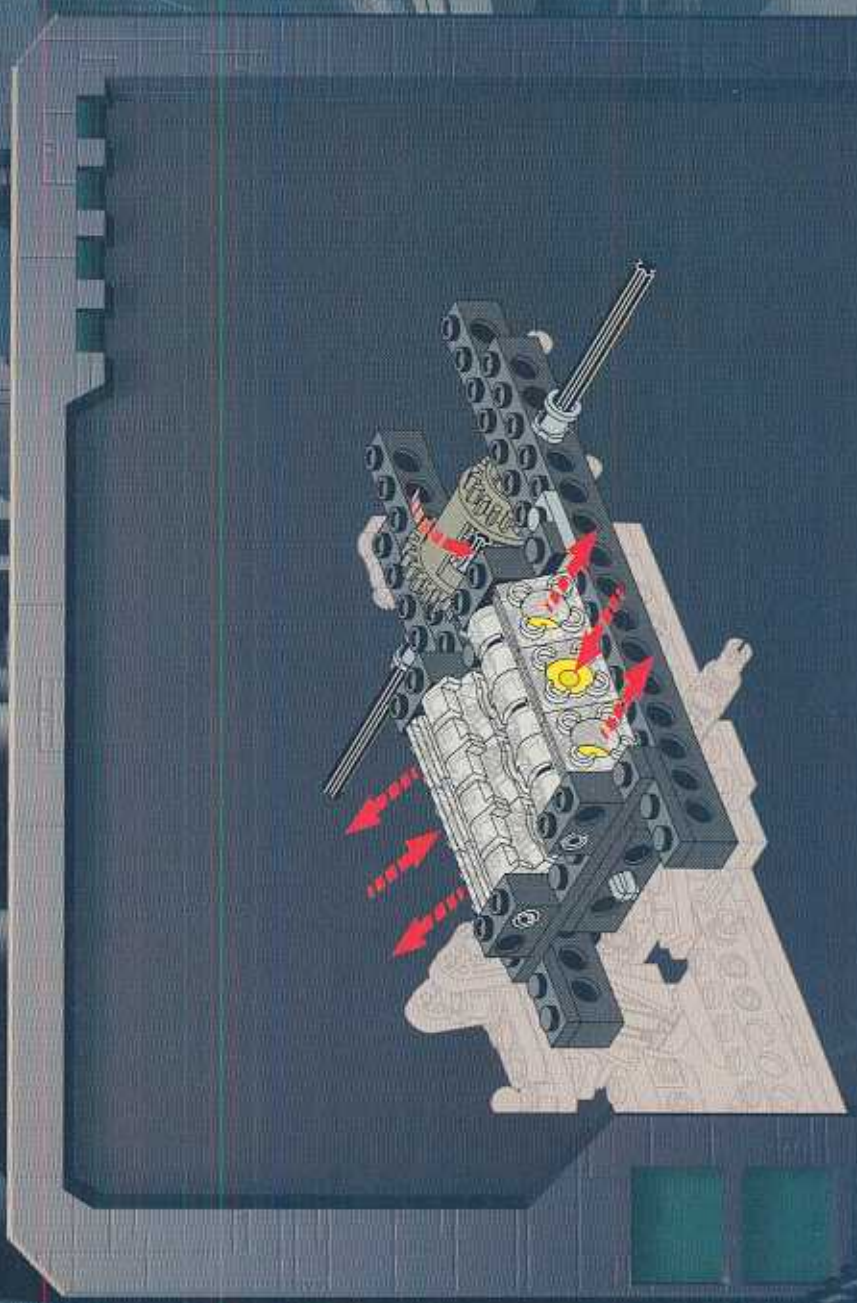



LEGO

20

1x

2x

2x

2x

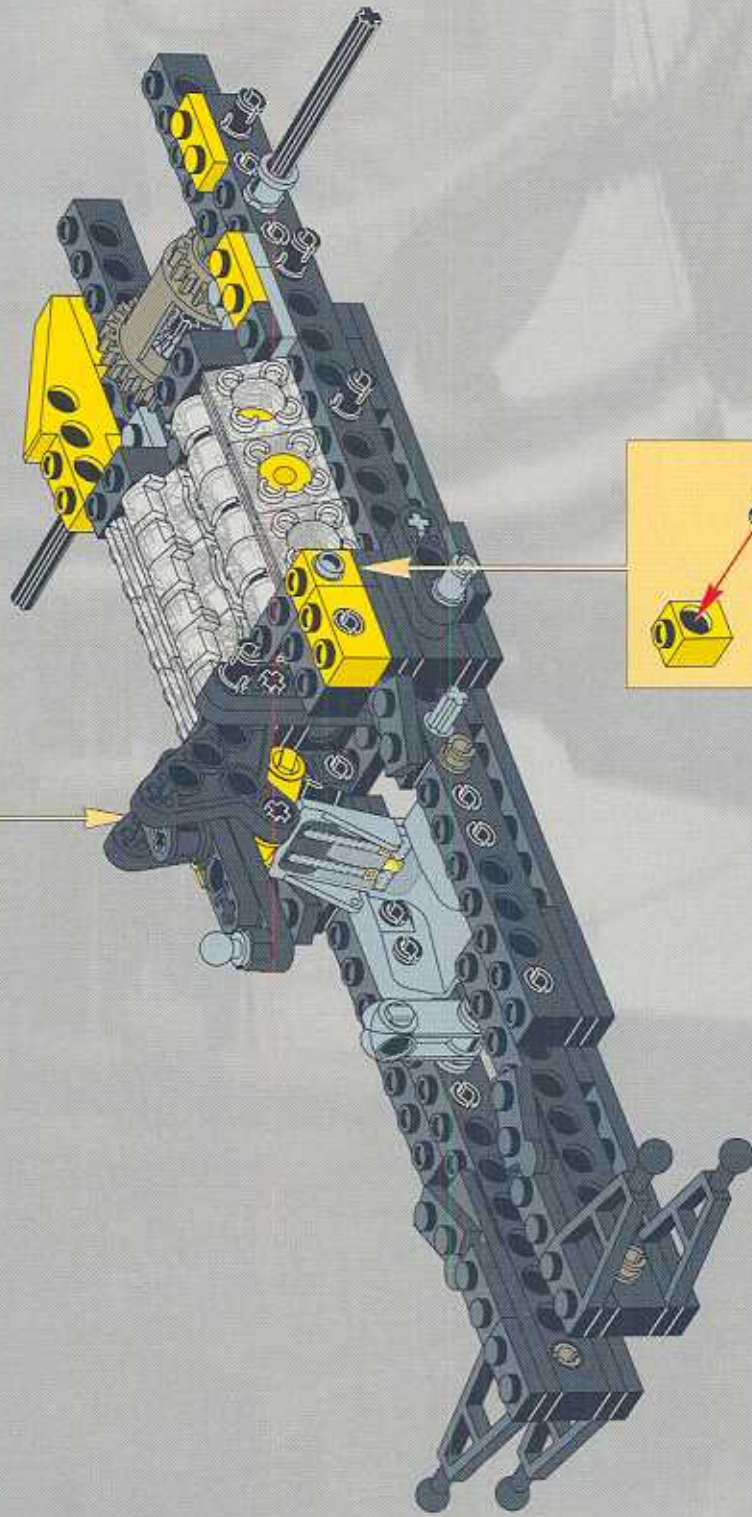

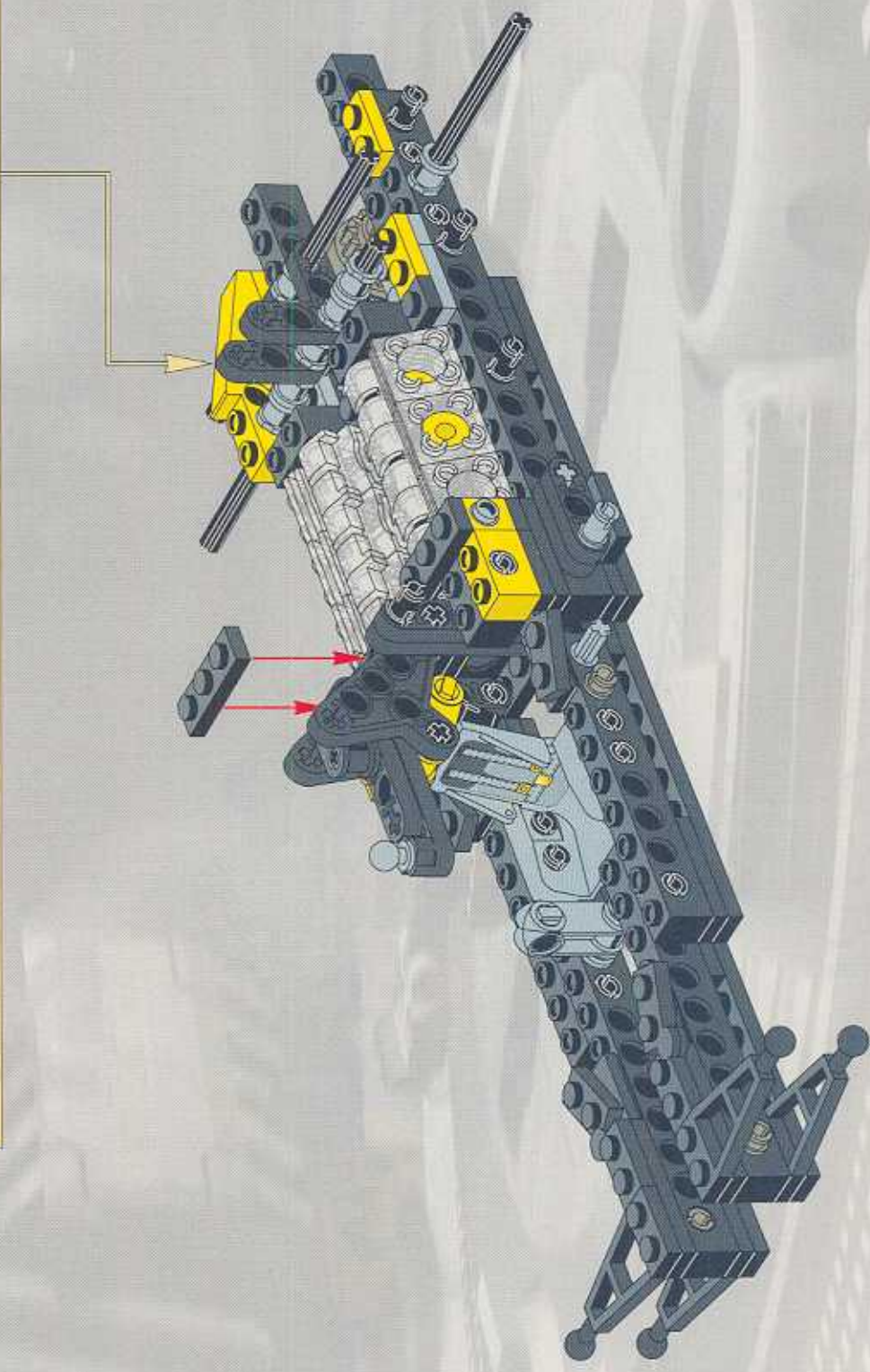
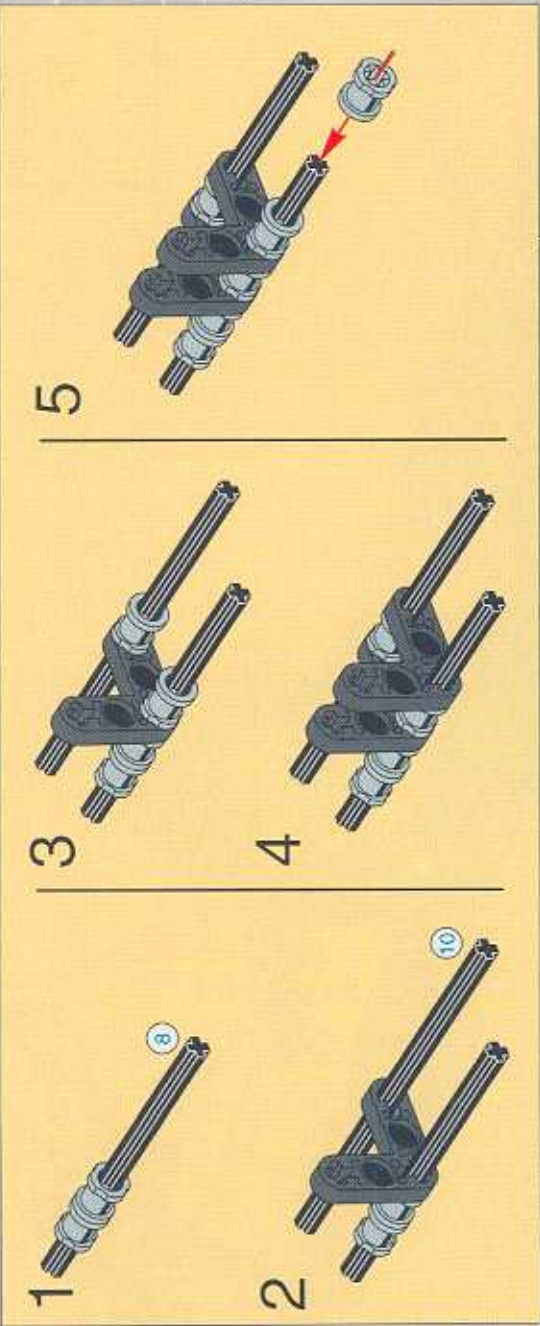
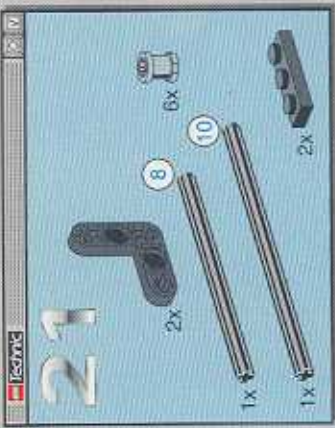

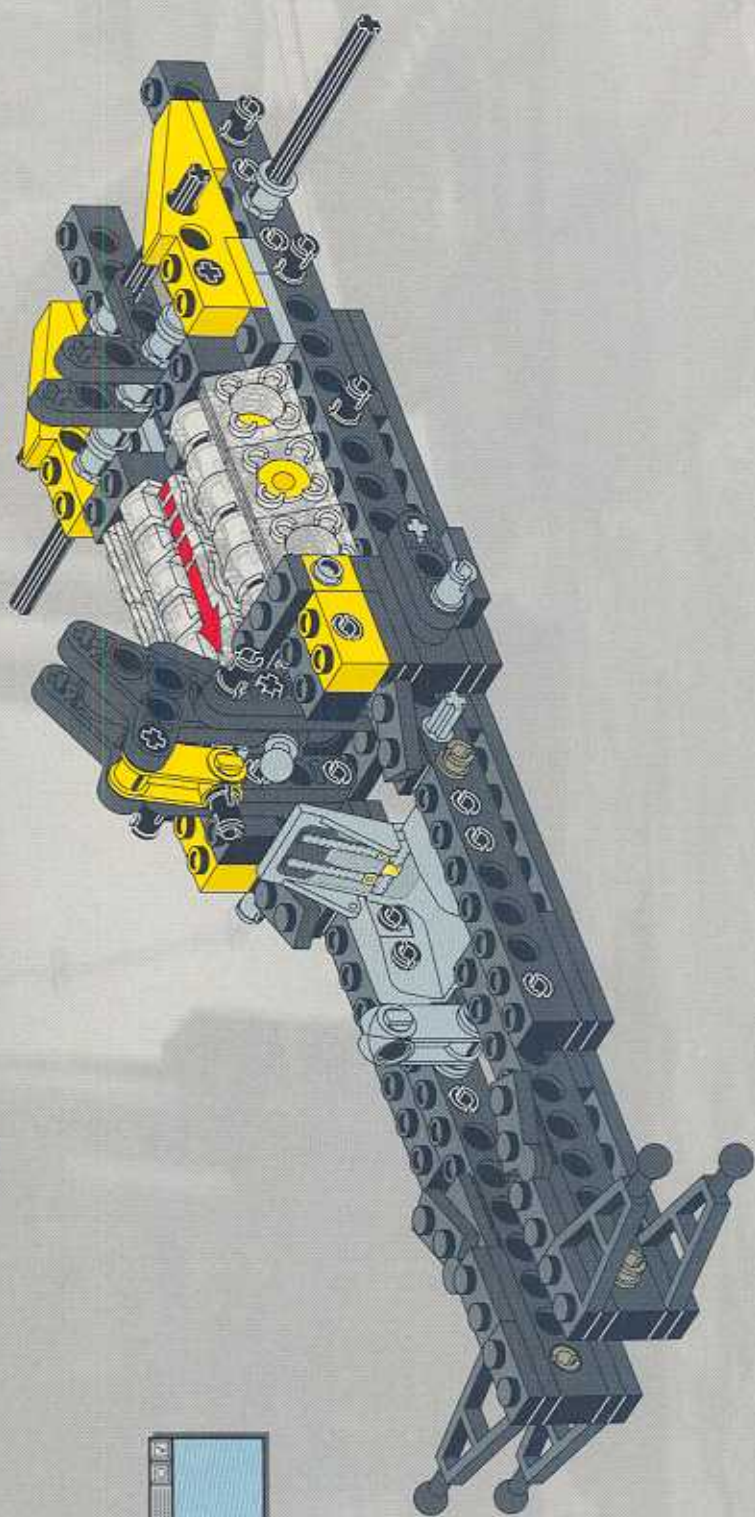
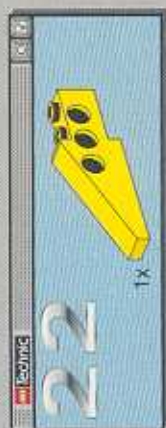
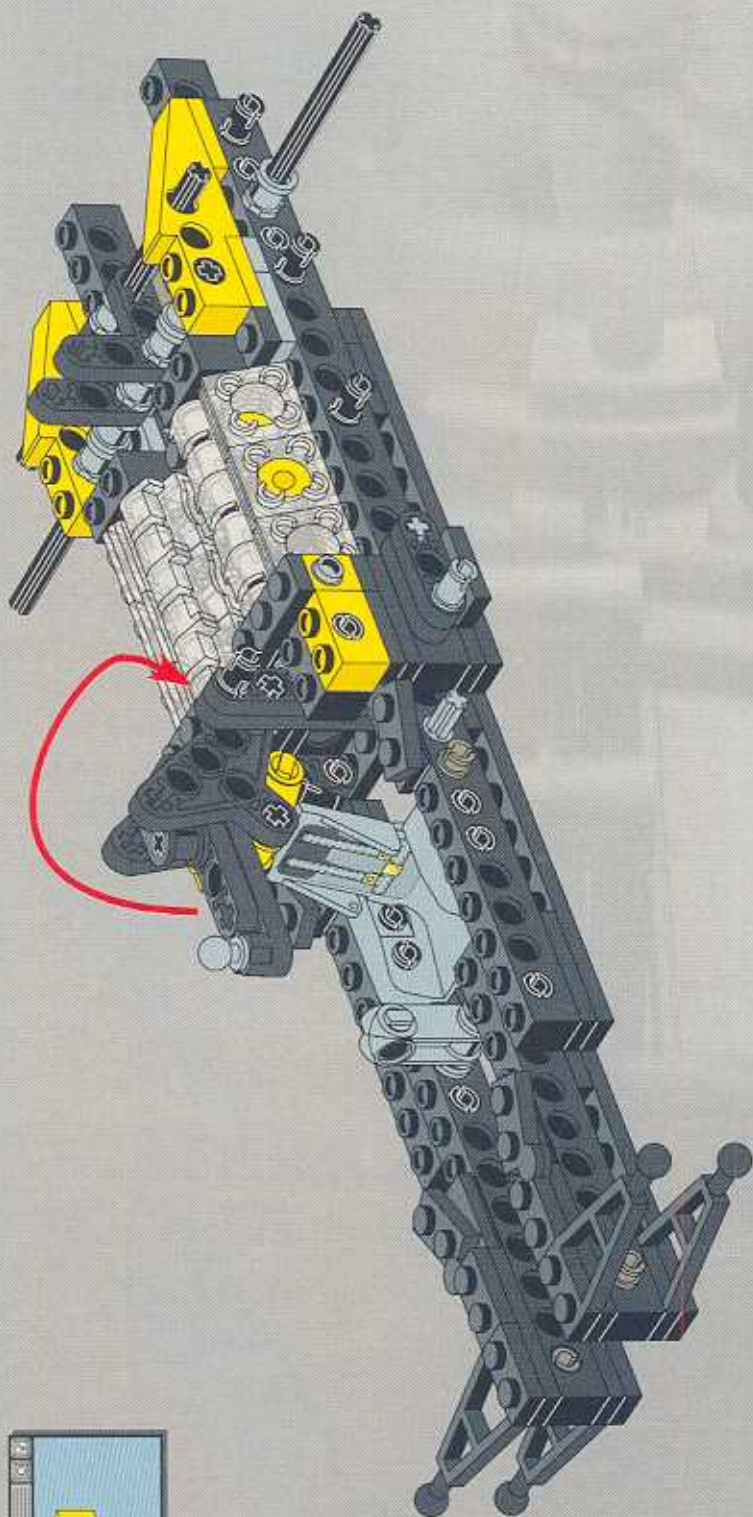

24

2x	1x	1x	1x
2x	1x	1x	1x
2x	1x	1x	1x
3x	2x	1x	4x

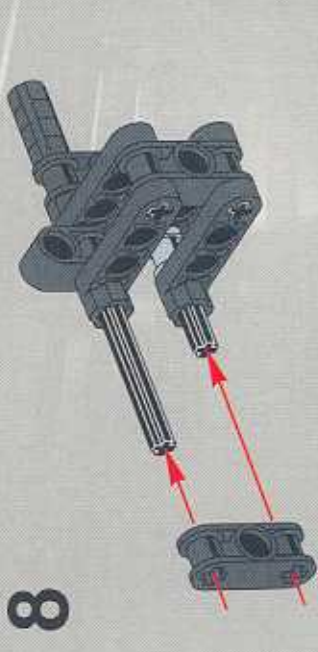
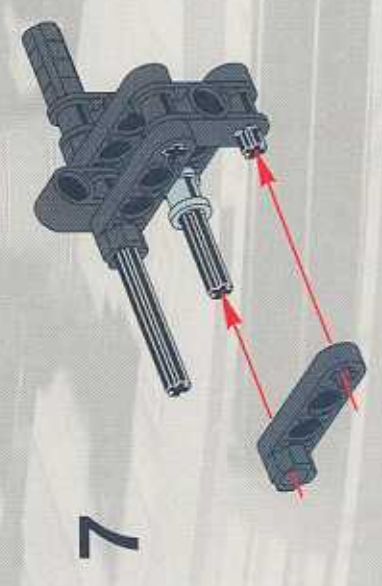
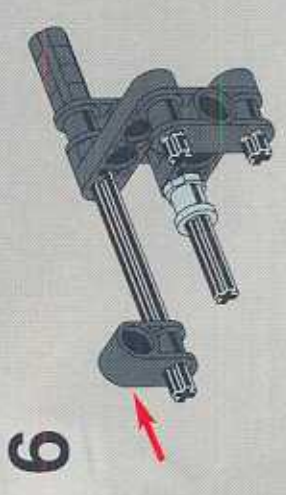
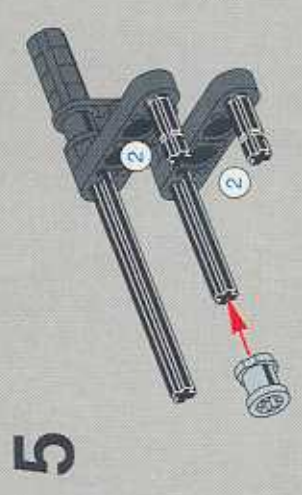
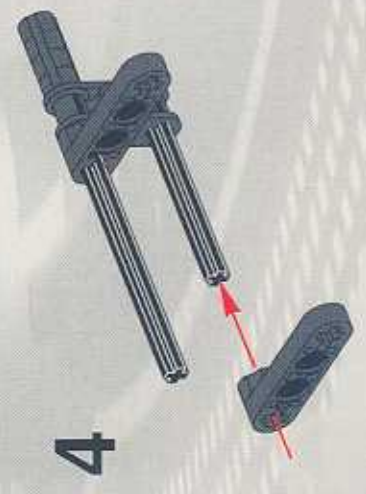

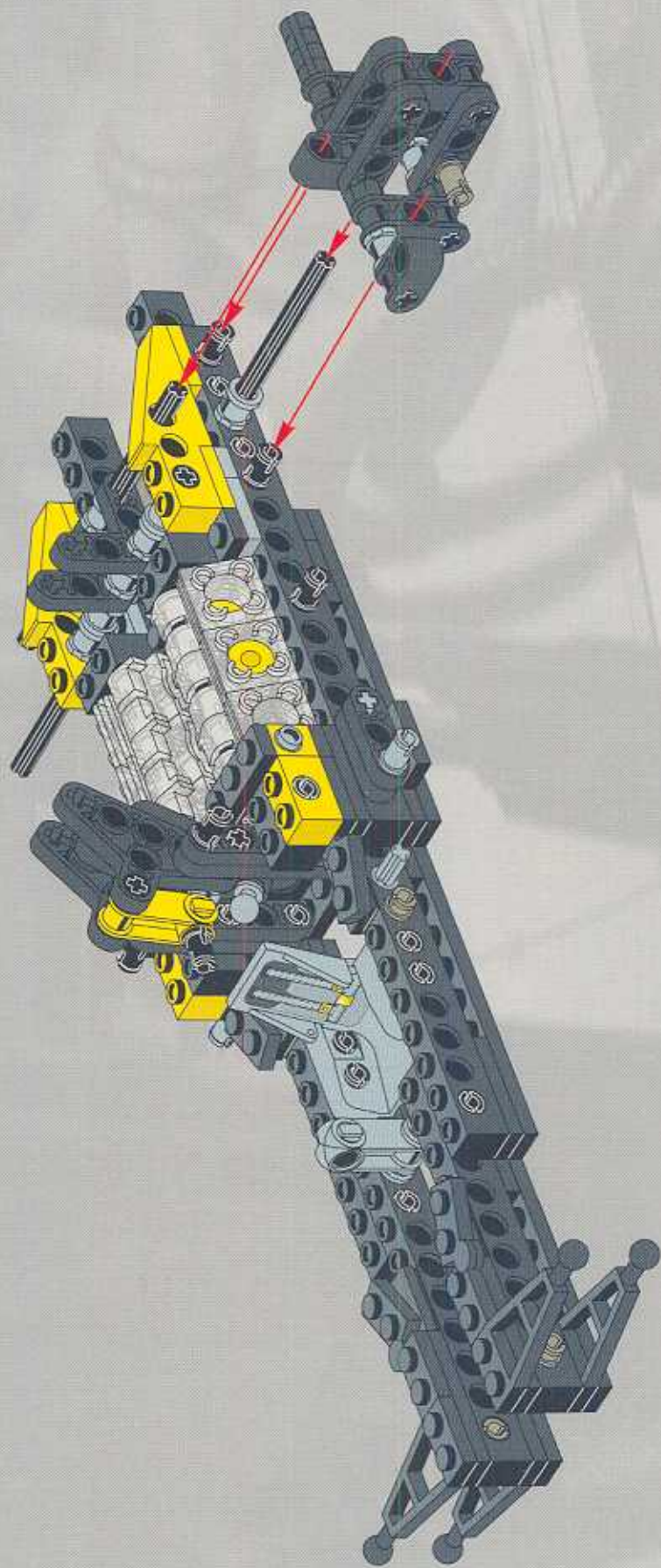

25

2x	2x	3x	2x	1x	4x
2x	1x	1x	1x	1x	1x
2x	1x	1x	1x	1x	1x
1x	1x	1x	1x	1x	1x

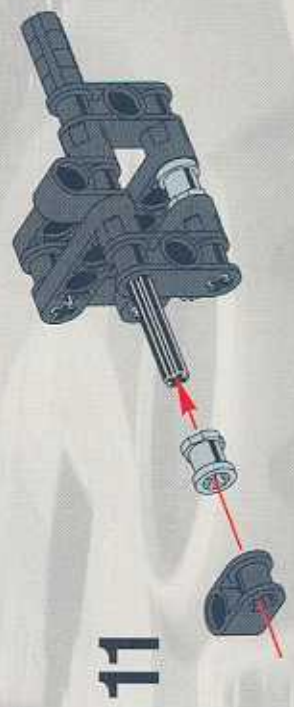
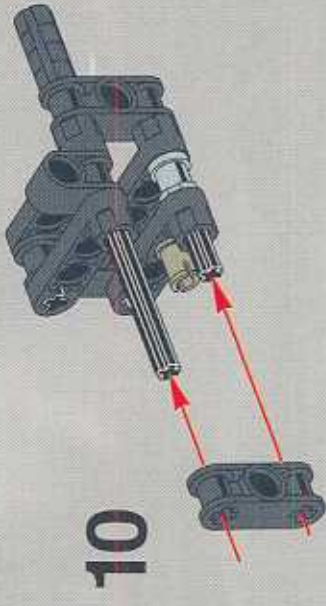
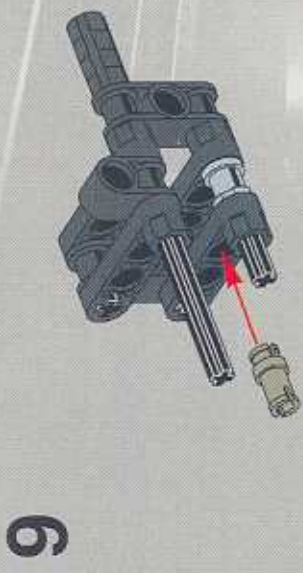
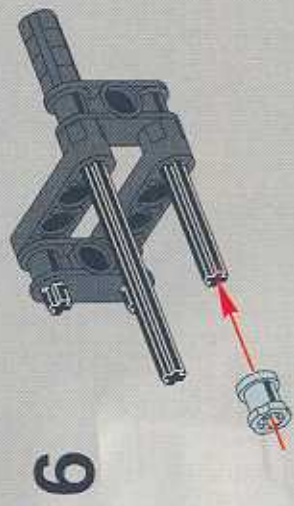
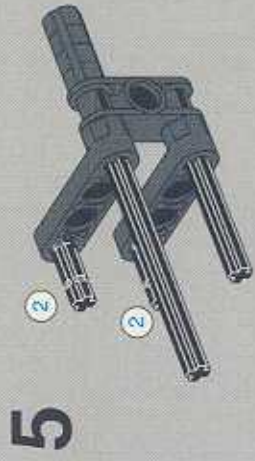

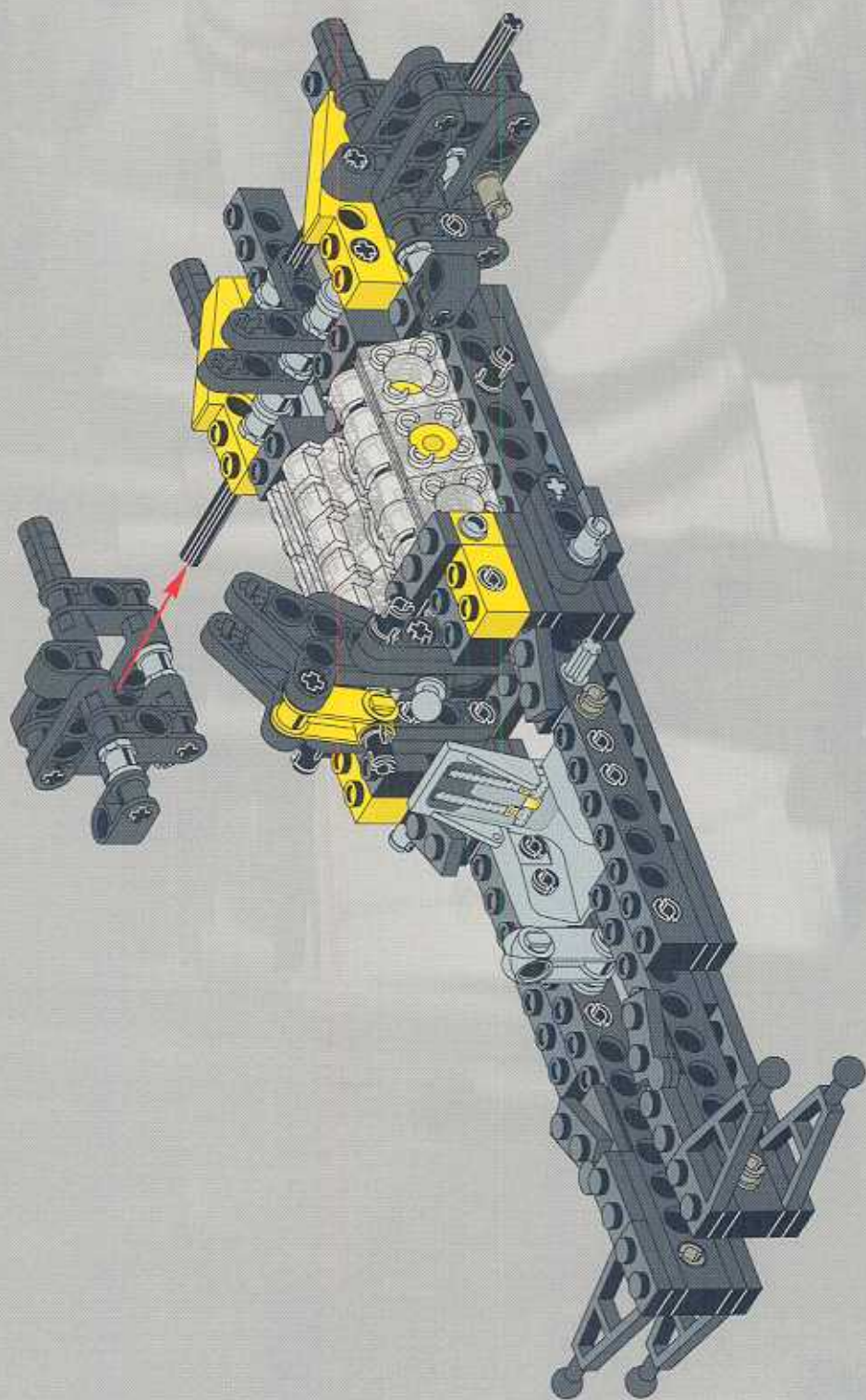





1

1x

1x

1x

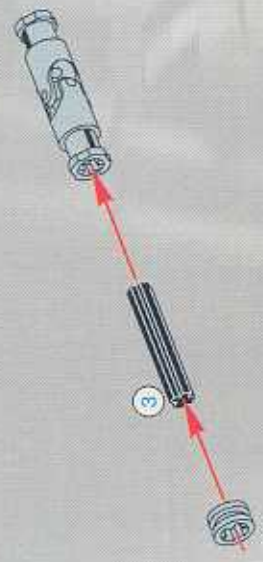

2

1x



3

1x

1x

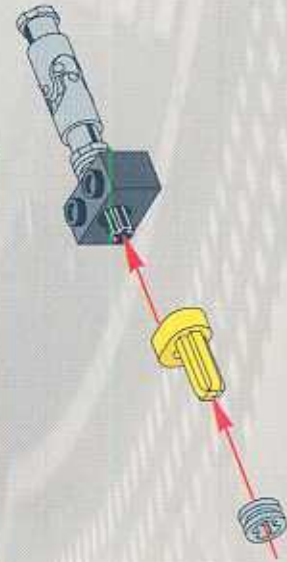

4

2x

2x

1x

2x

1x

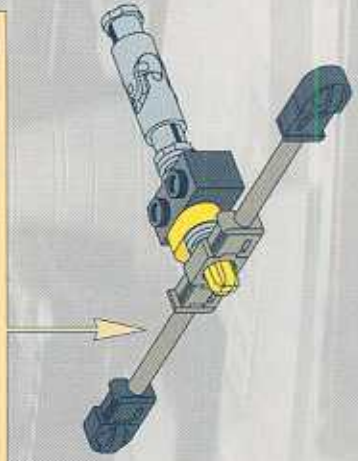
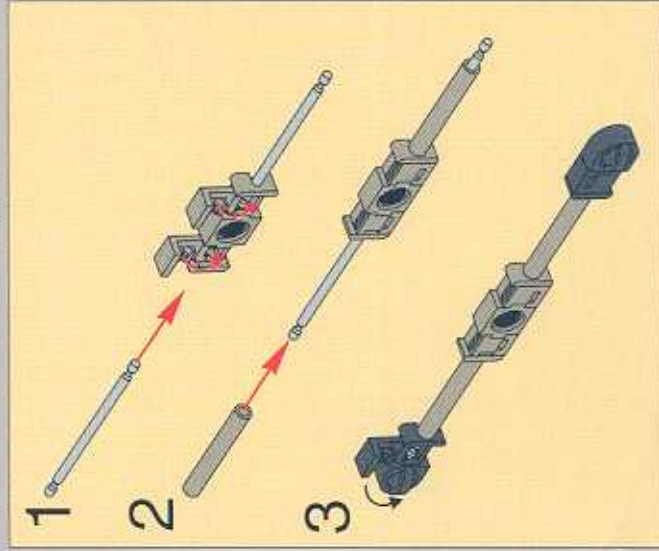

5

2x

1x

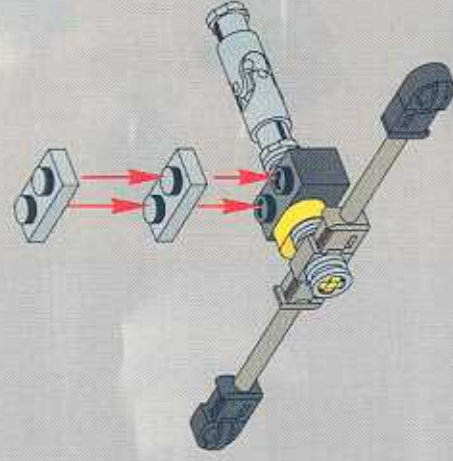

6



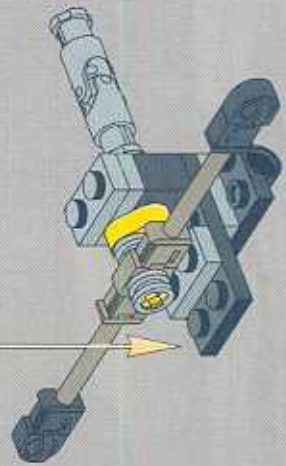

1x	1x	1x	2x

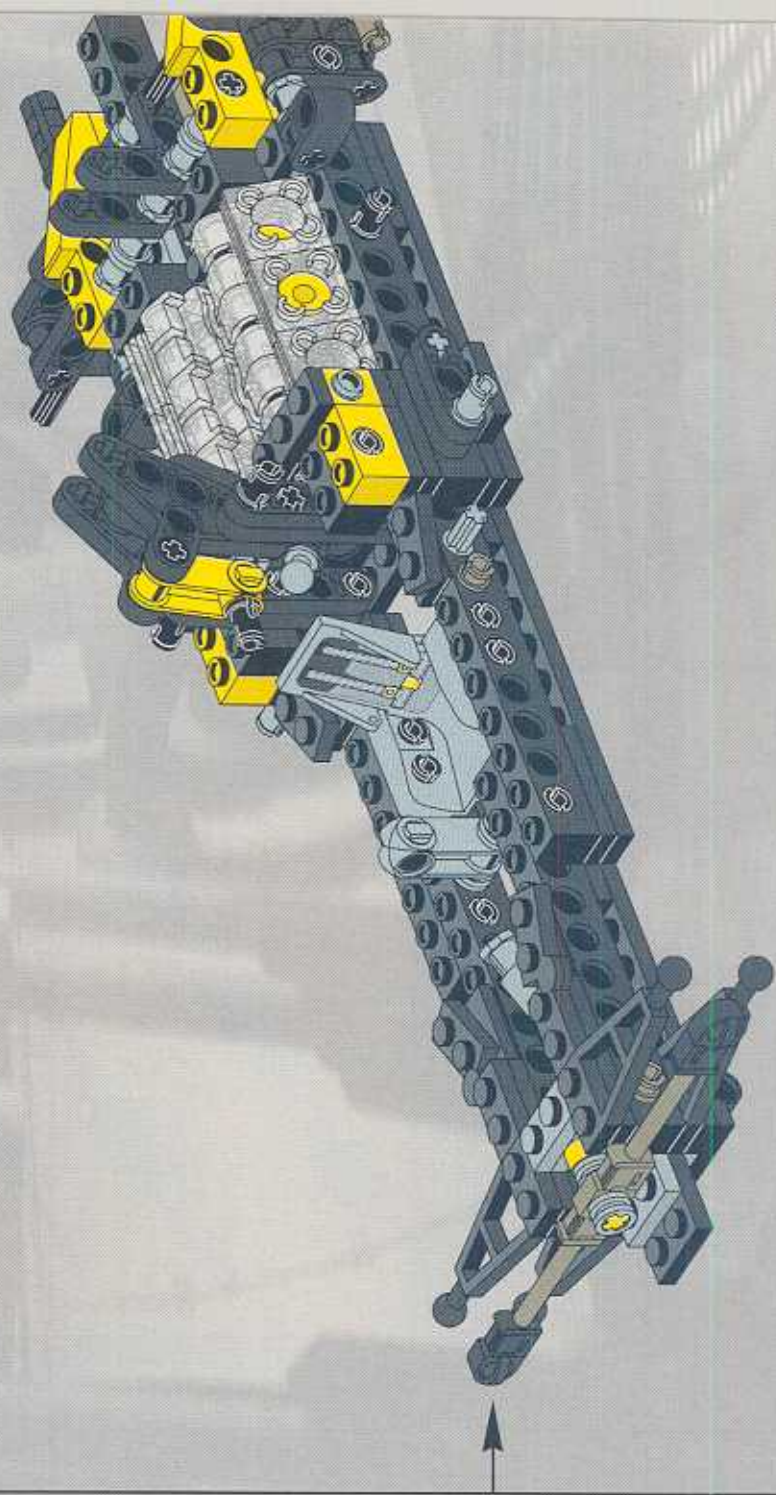

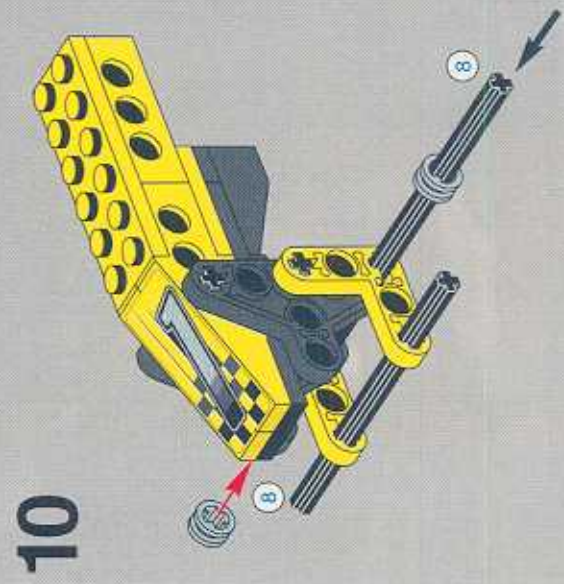
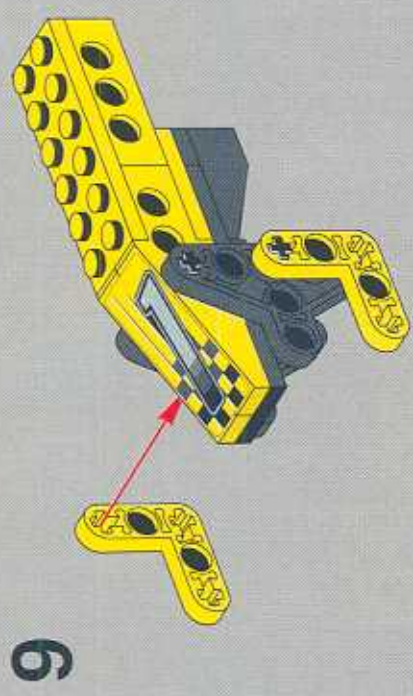
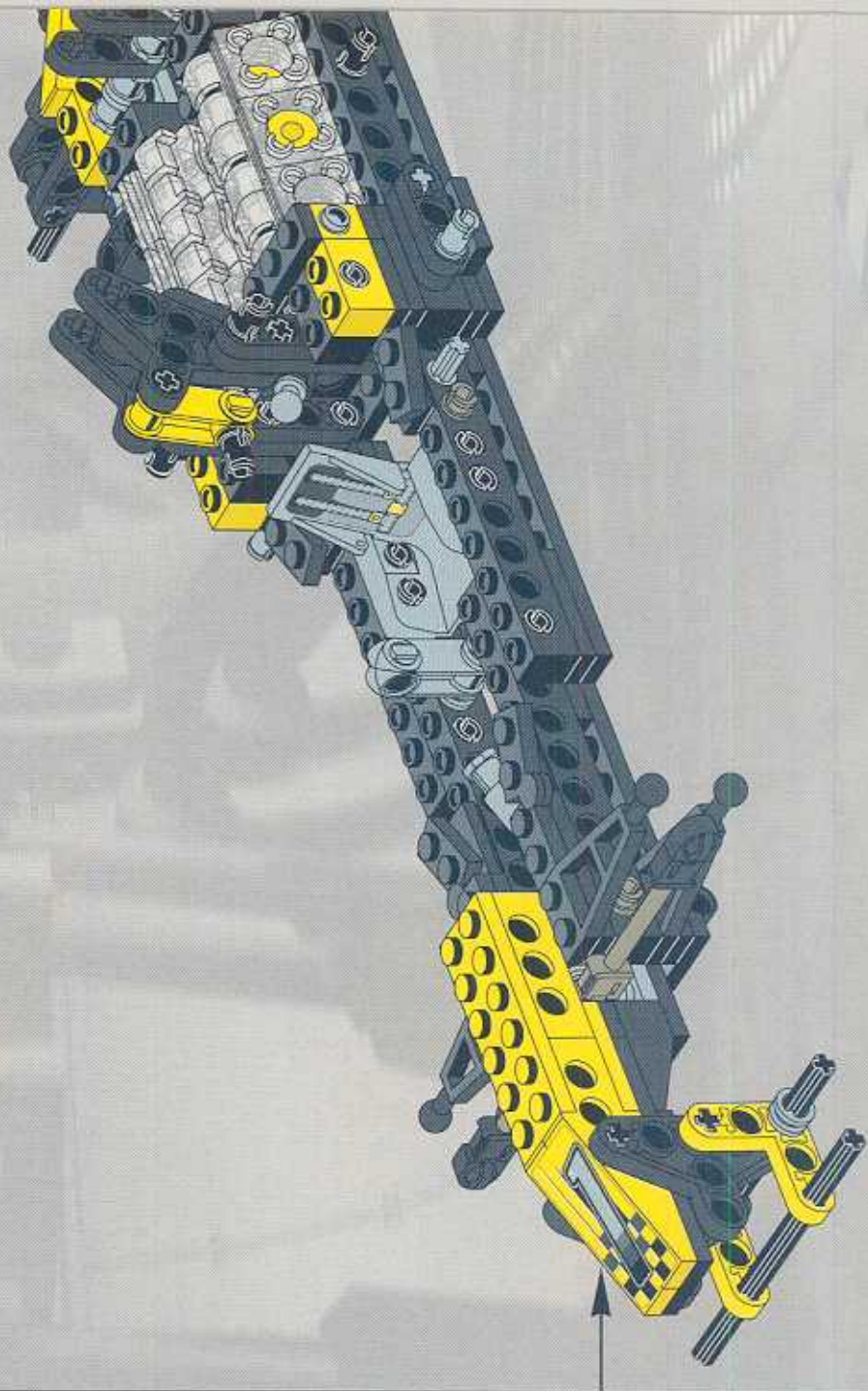
26





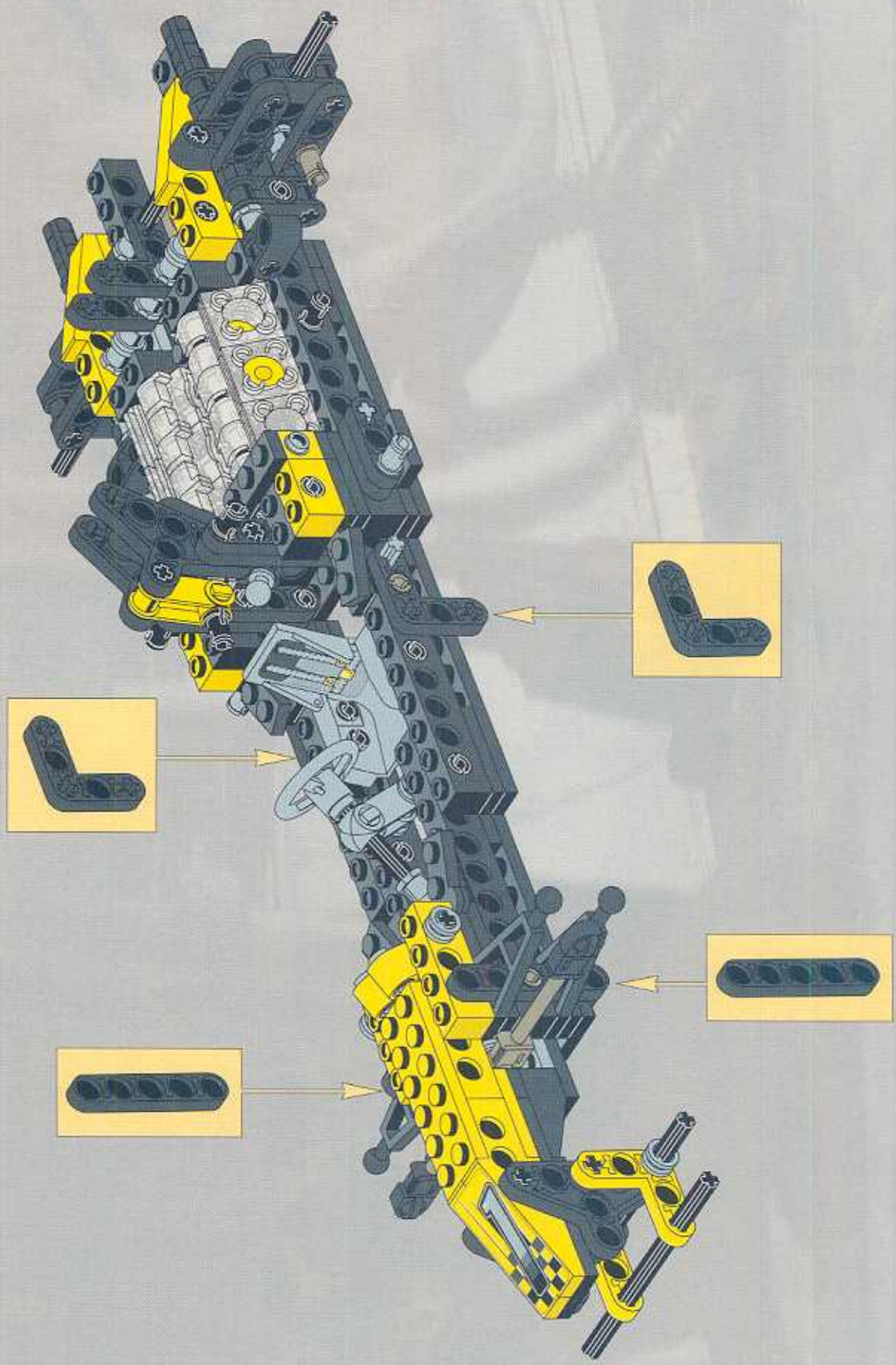

29
 1x
 2x
 2x

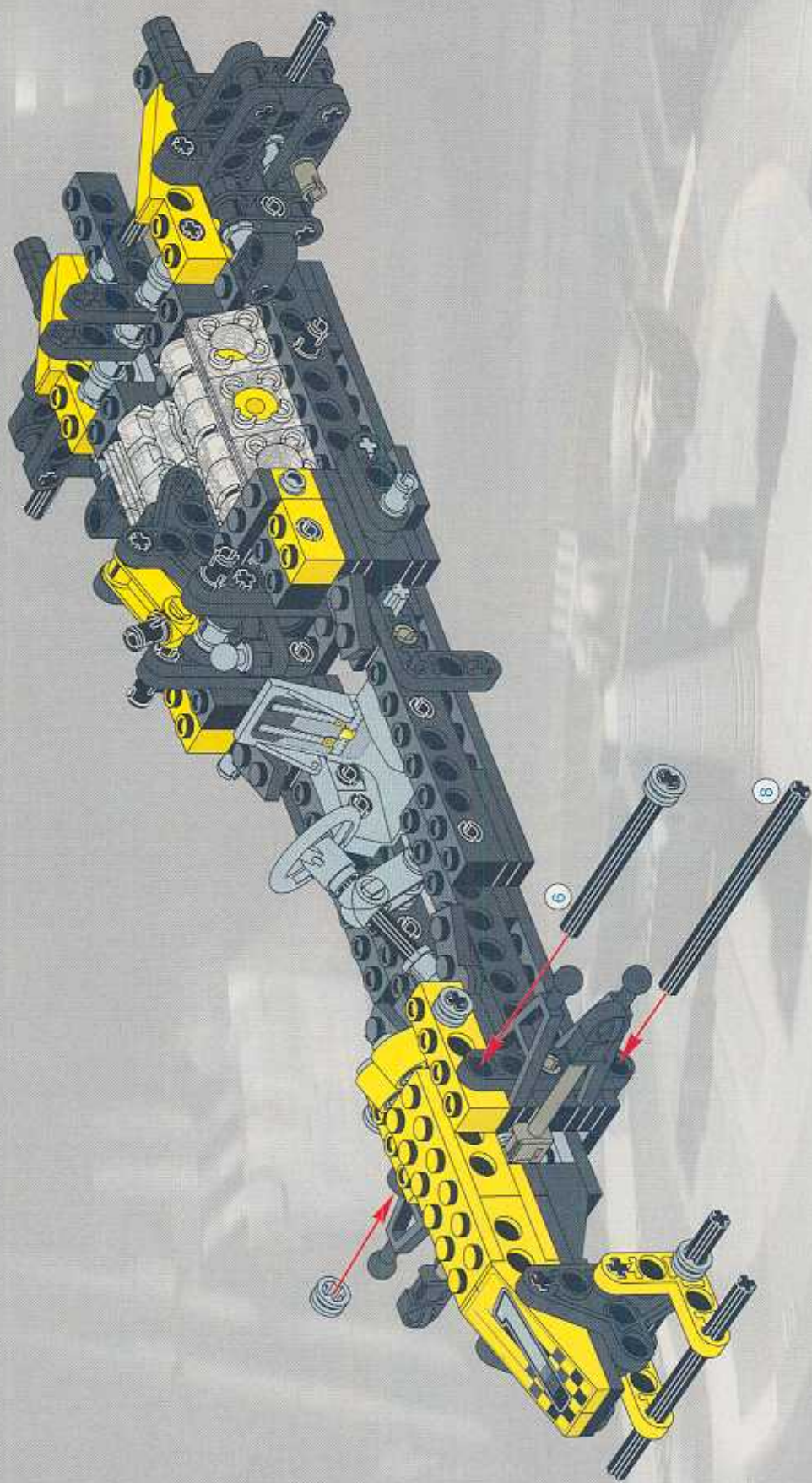



LEGO 30

2x  6

1x  8

1x  6

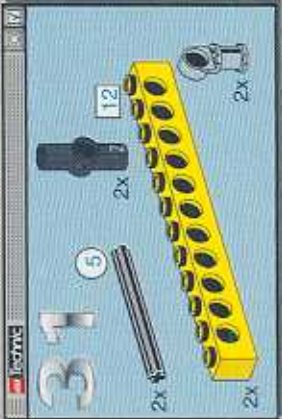
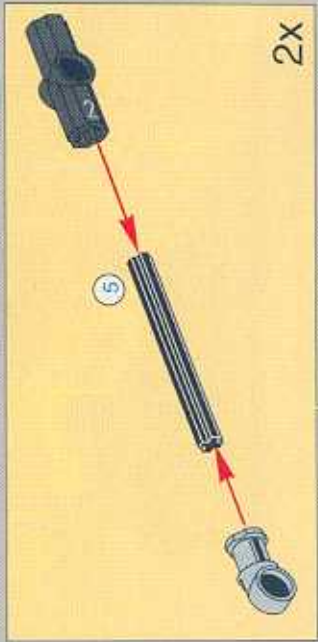
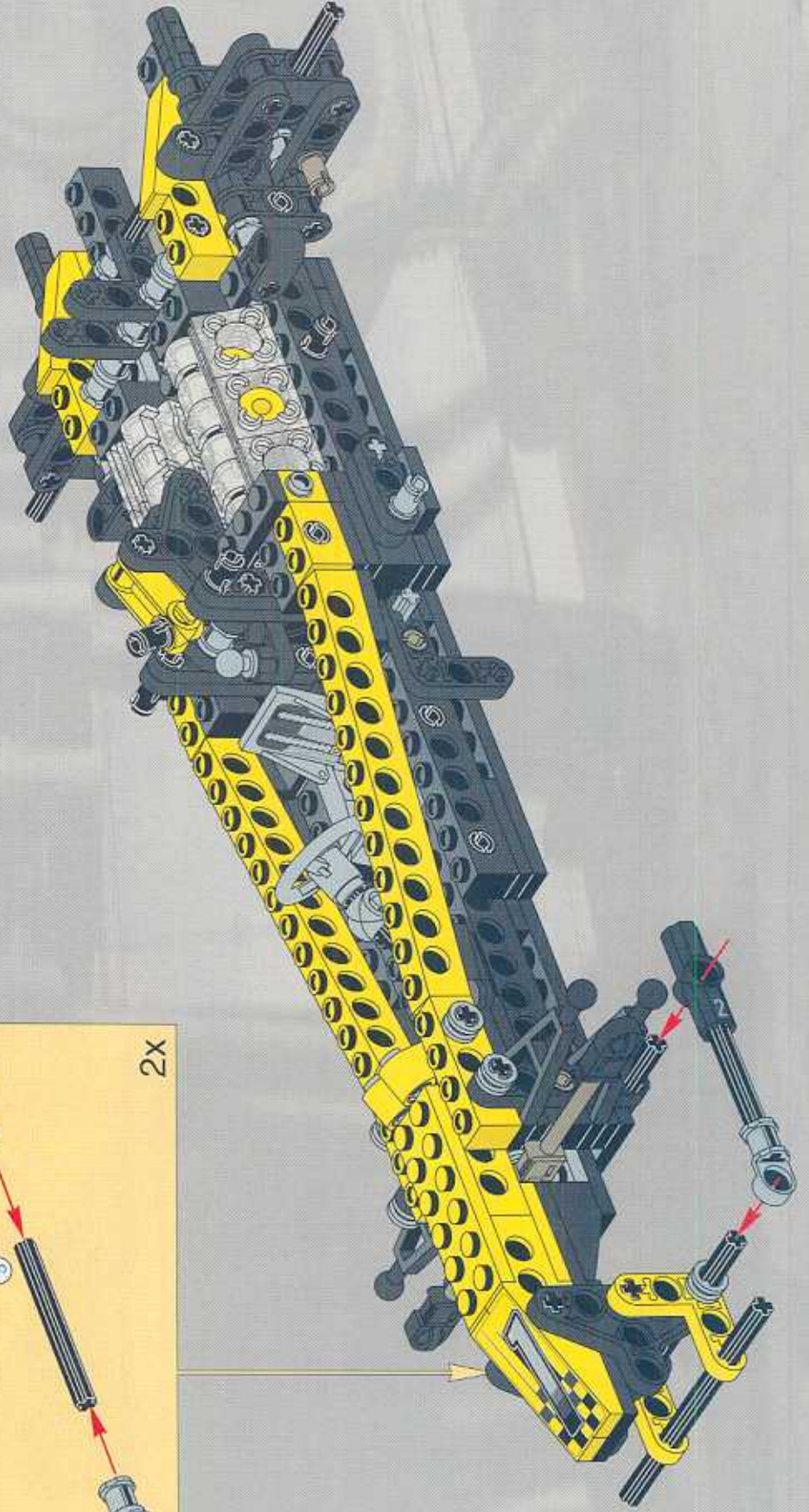

LEGO Technic

32

4x



2x

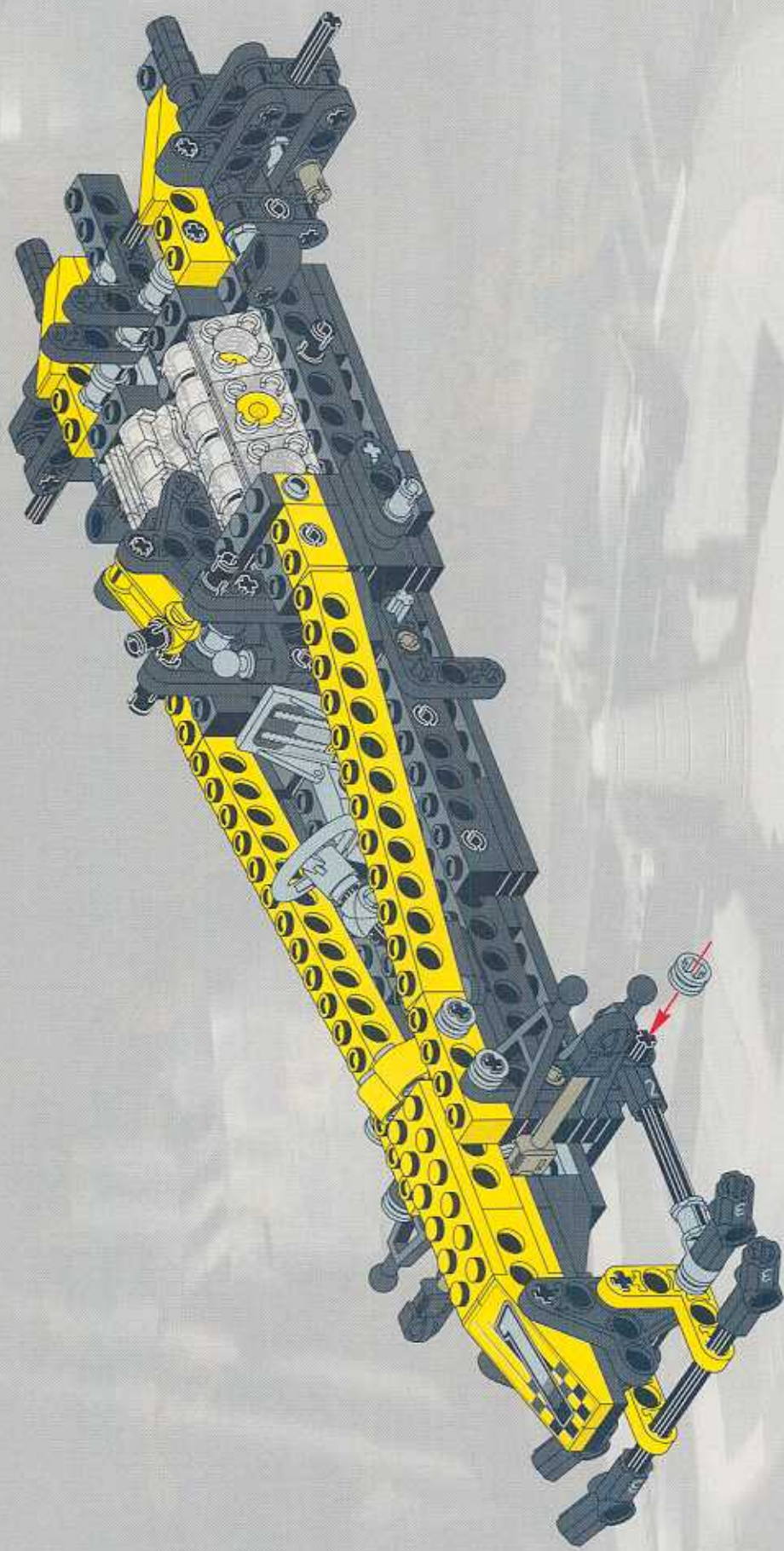

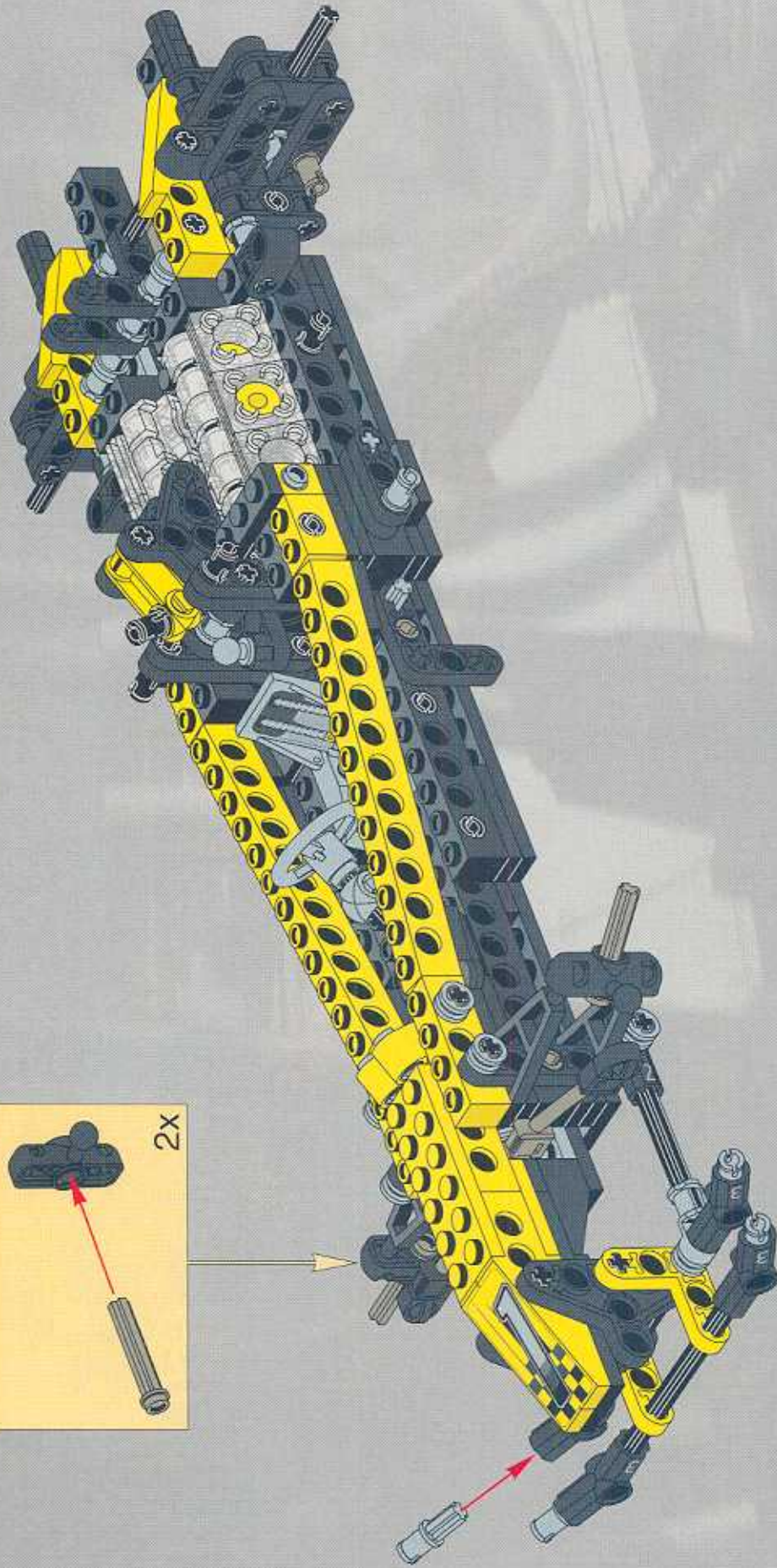
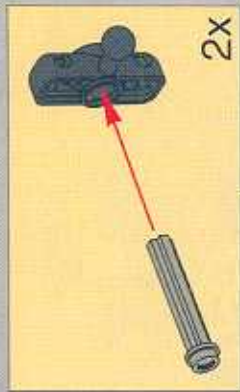
- LEGO 34
- 2x [Yellow Technic Pin]
- 2x [Grey Technic Pin]
- 2x [Black Technic Pin]
- 2x [Yellow Technic Beam 1x3]
- 2x [Black Technic Beam 1x3]
- 4x [Black Technic Wheel]



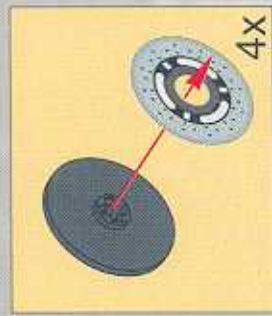
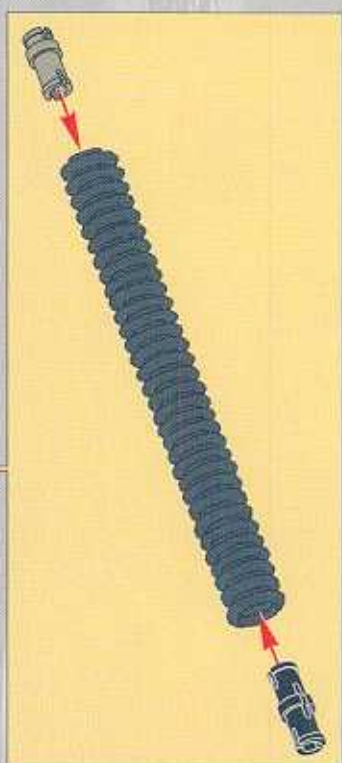
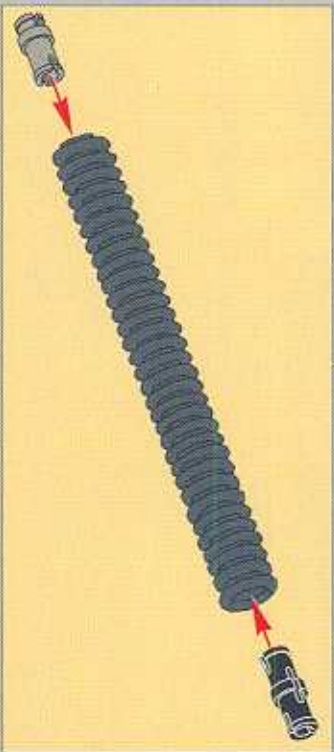

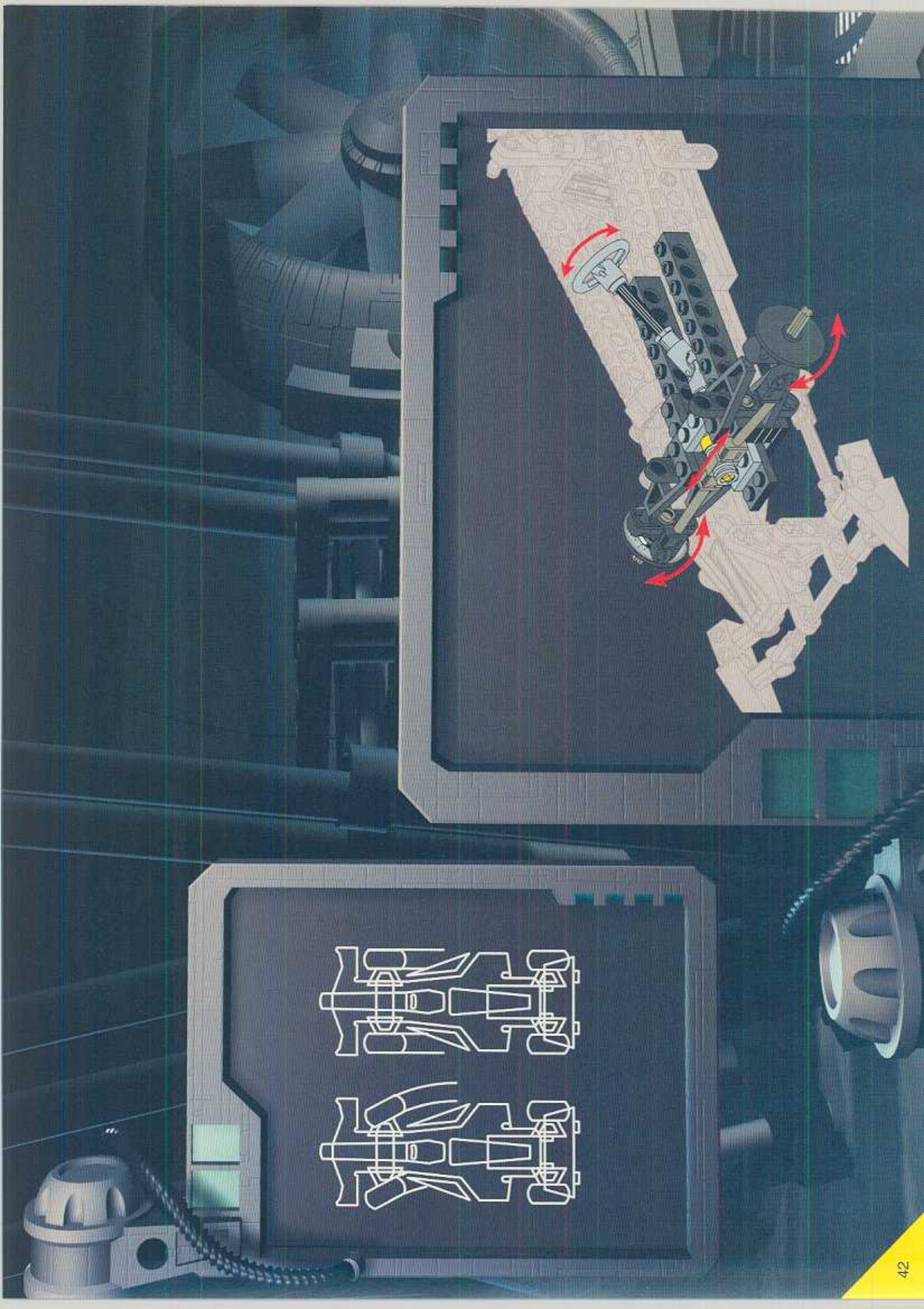

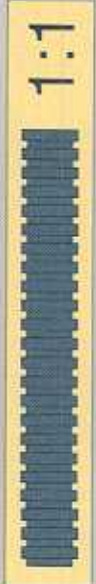
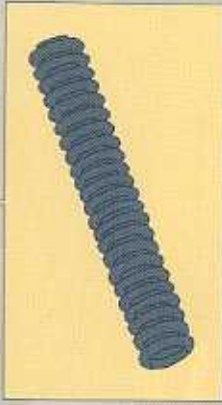

LEGO Technic

35

2x

2x

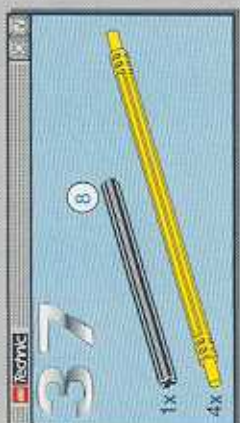

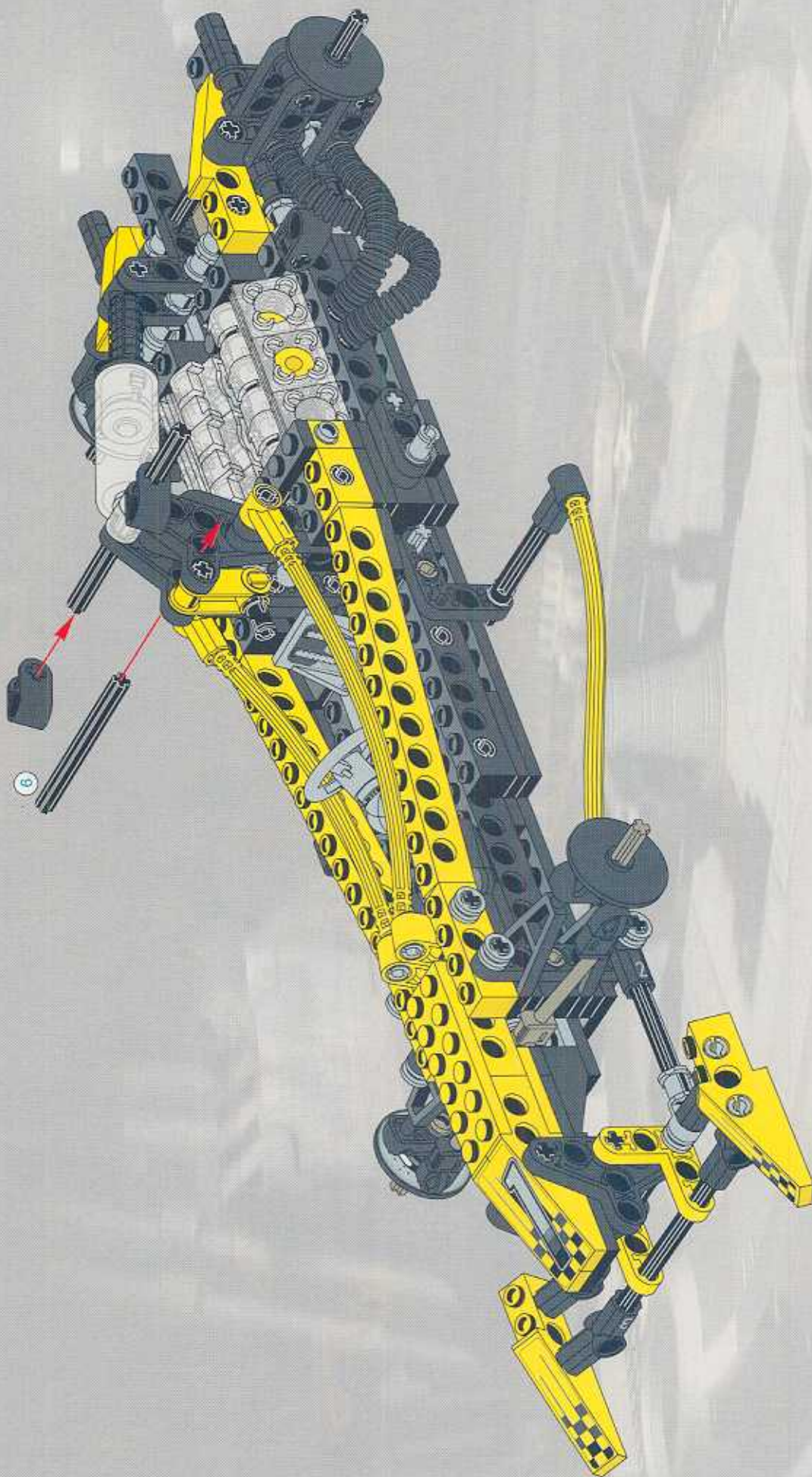

		1x
	6	1x
		2x



39

	2x		2x
	2x		2x

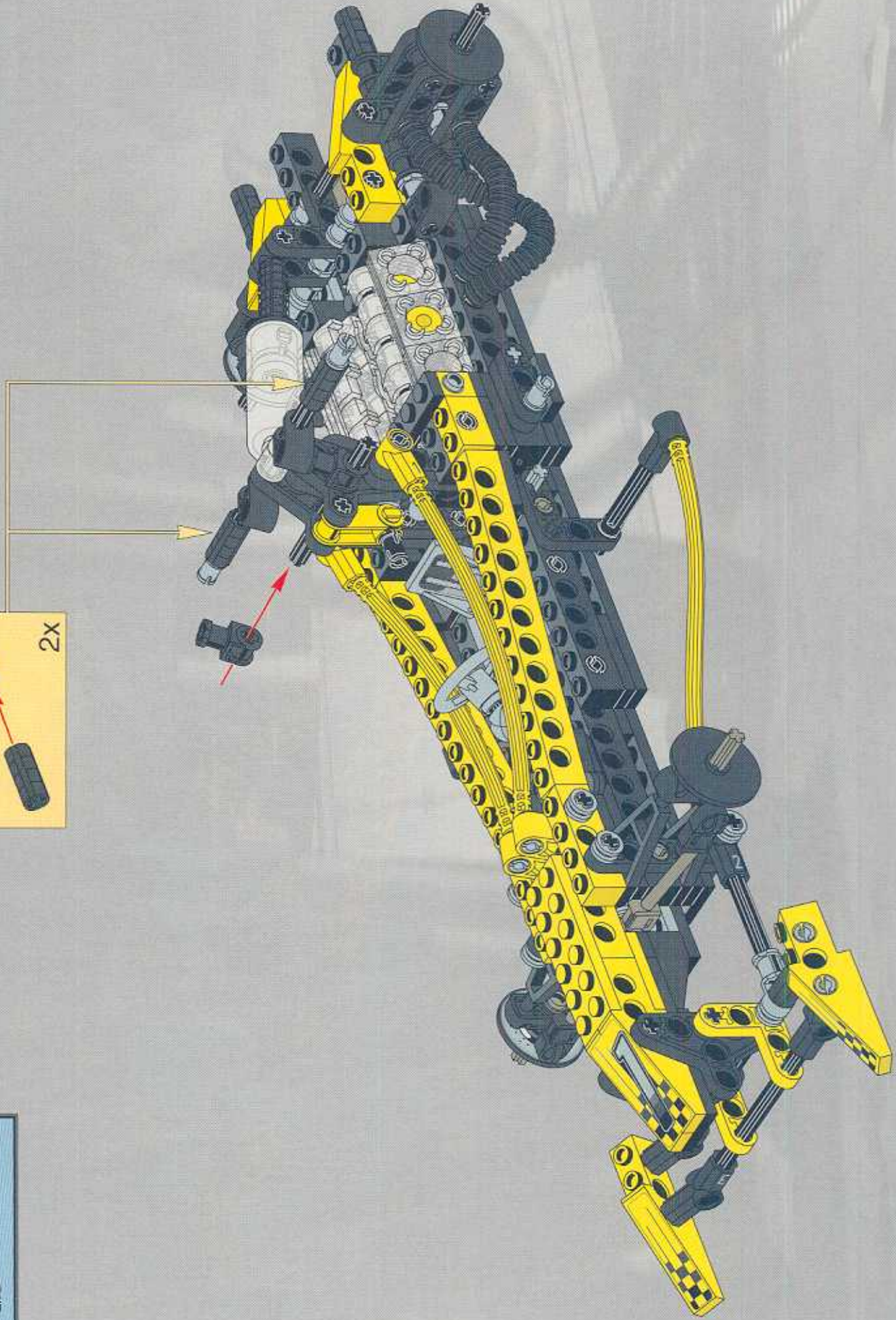

2x

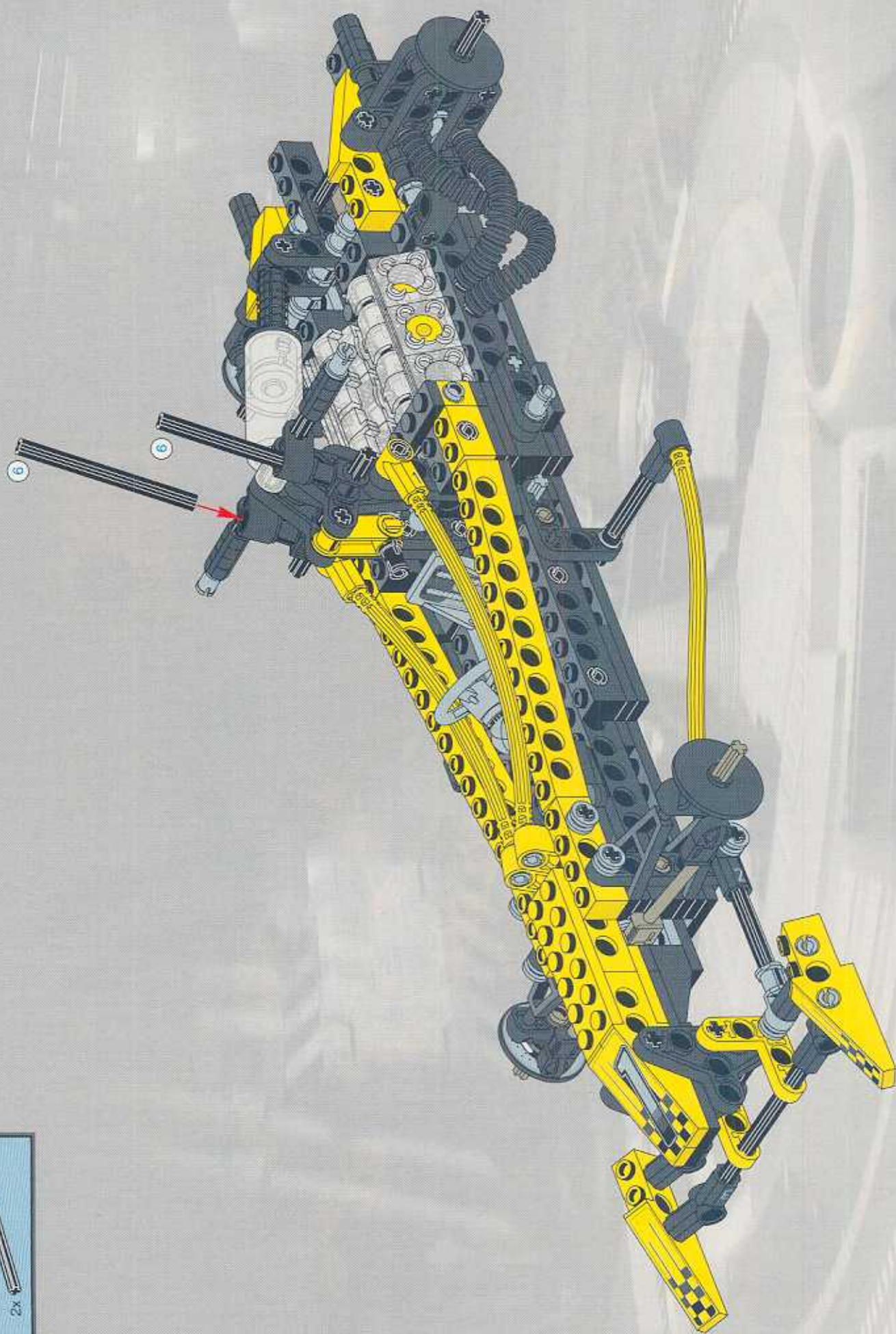



LEGO 40 2x

LEGO TECHNIC

41		2x
2x		2x
2		2x
2x		2x

2x

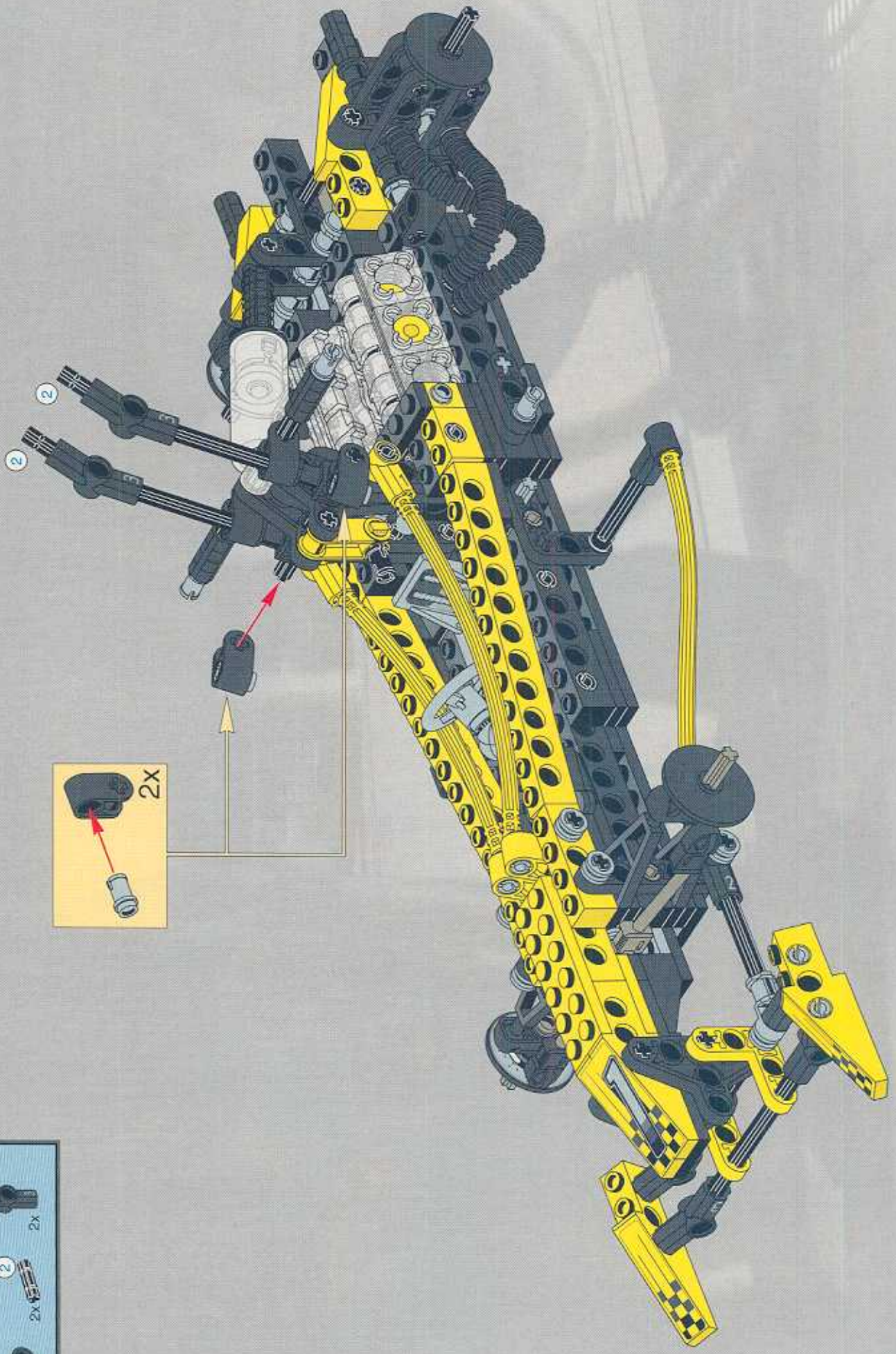



1

1x

1x



2

1x

1x



3

1x

1x



4

1x

1x



5

2x

1x

1x



6

1x

2x

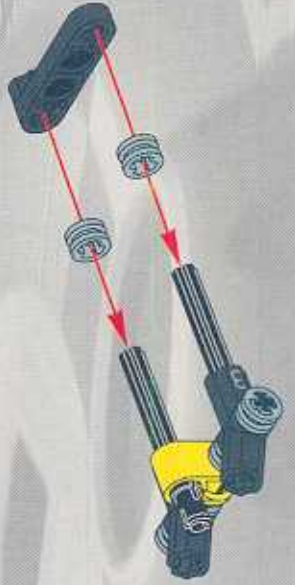

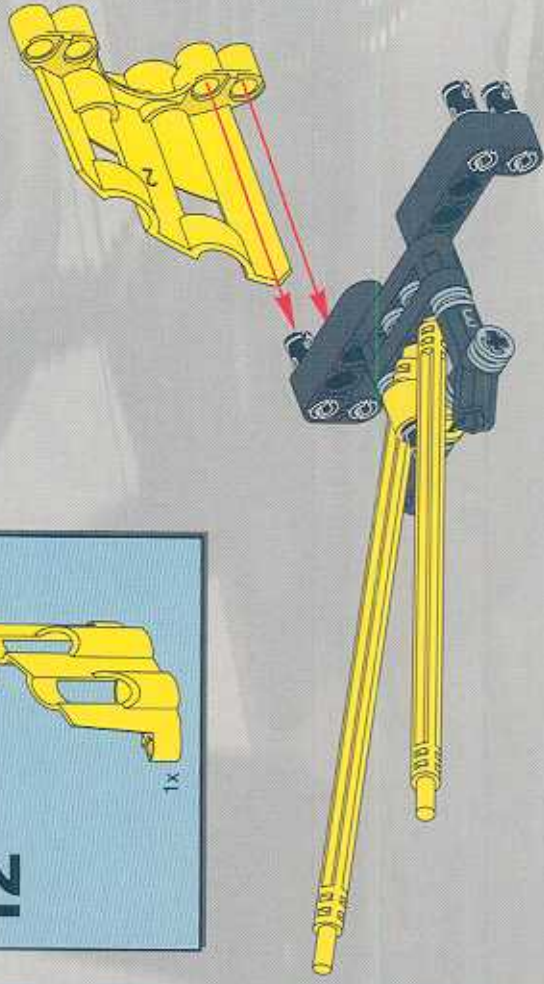
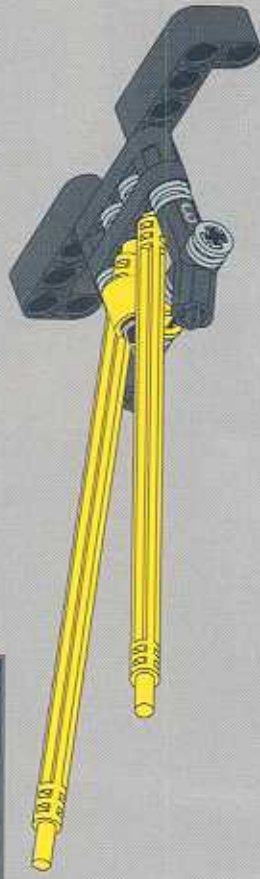
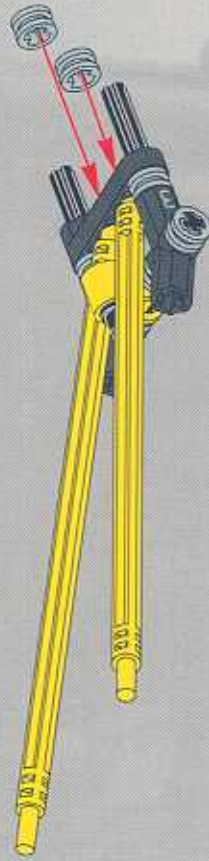
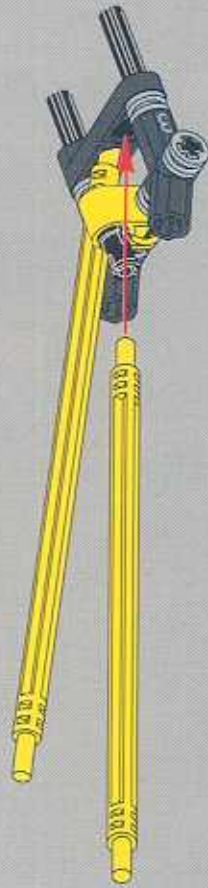
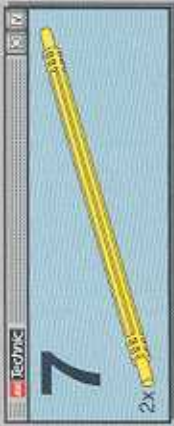

13

- 2x [black bush]
- 2x [black connector]
- 1x [yellow rod]
- 1x [grey rod]
- 2x [black bush]
- 2x [black connector]
- 1x [black bush]
- 1x [black connector]

1

2

3

4

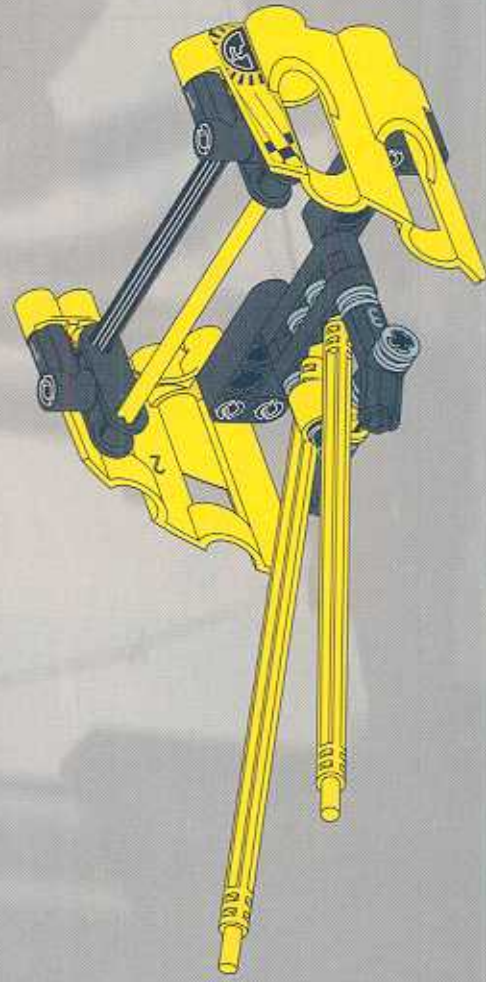
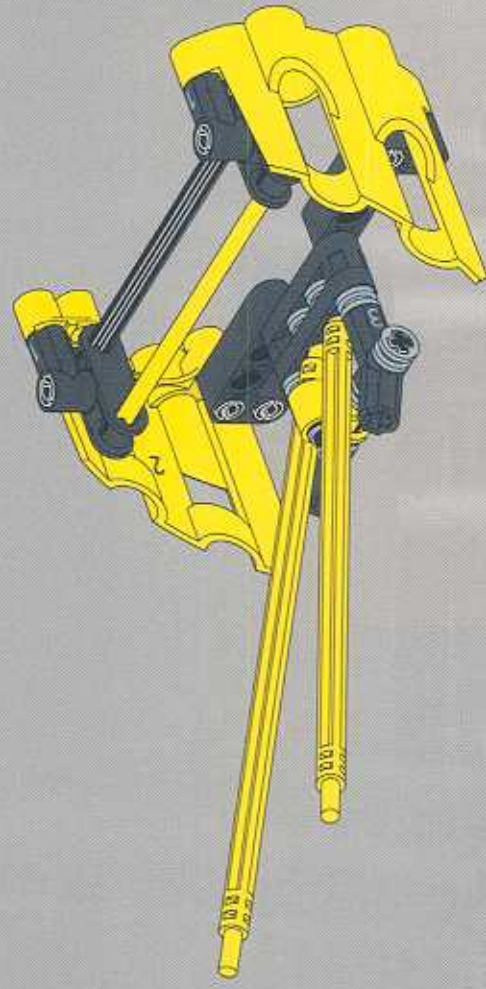

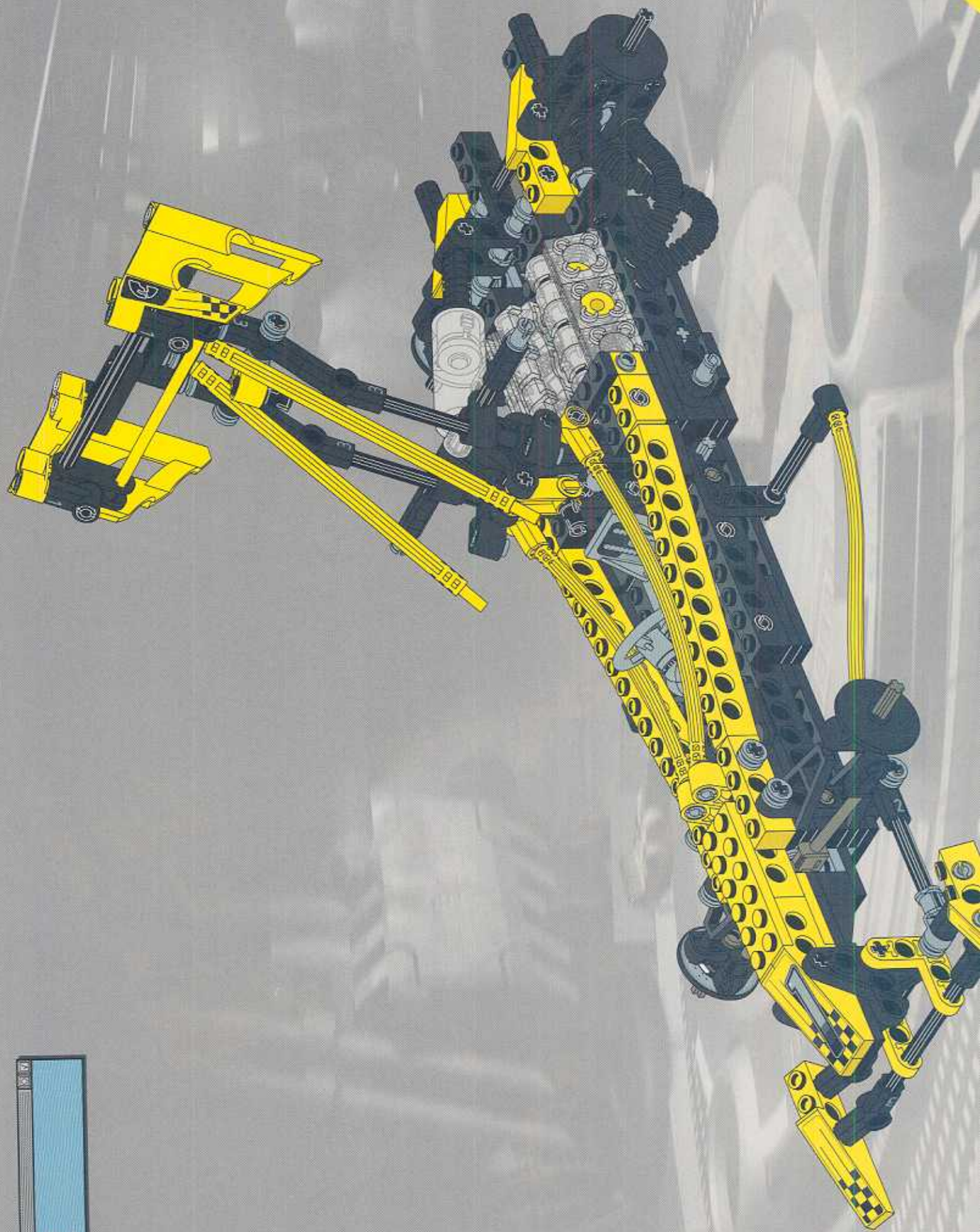

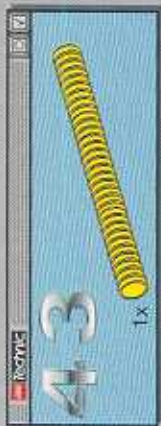
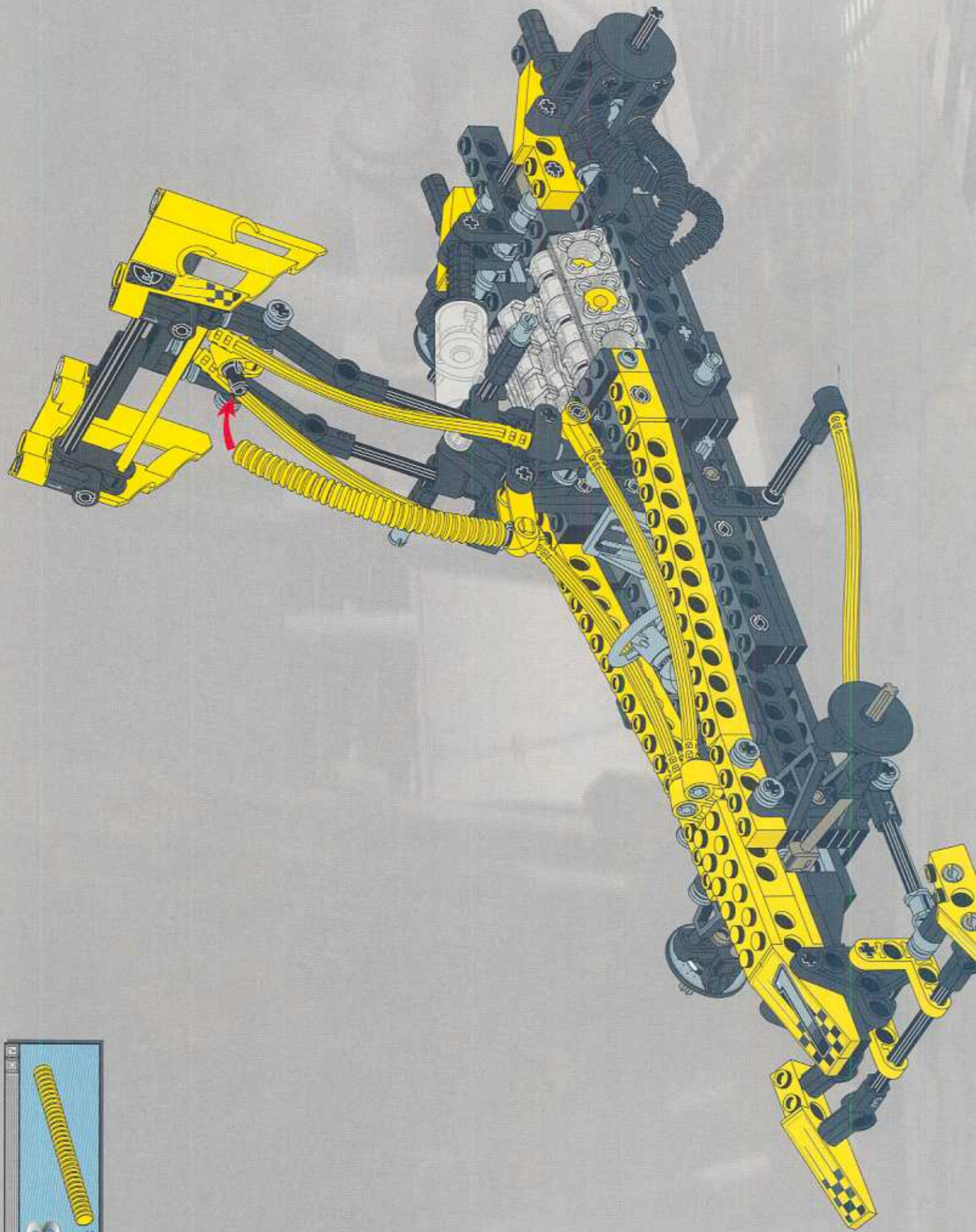



1 1x 1x 1x

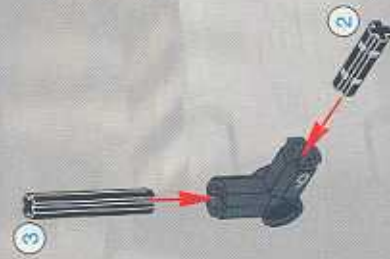

2 2x



3 1x 1x

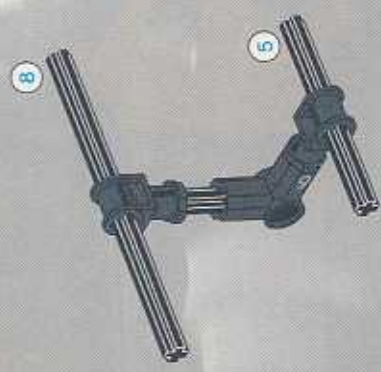

4 1x 1x

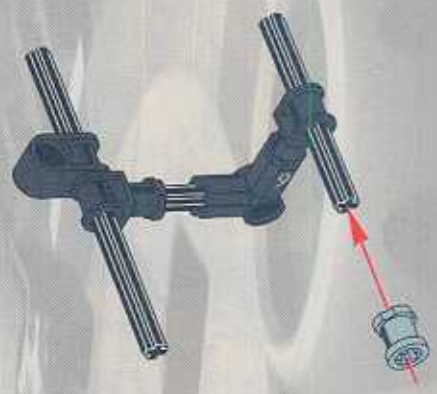

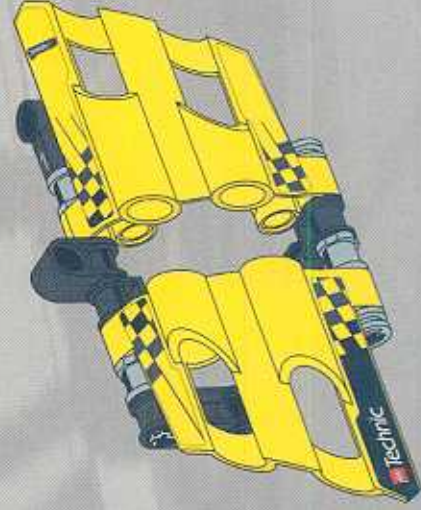
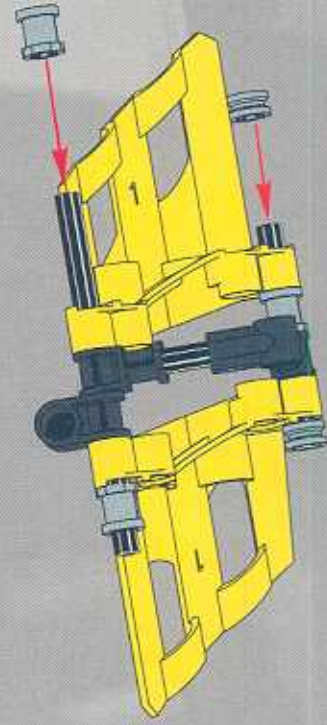
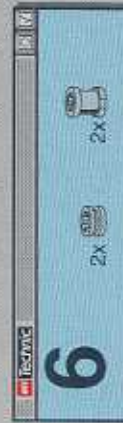
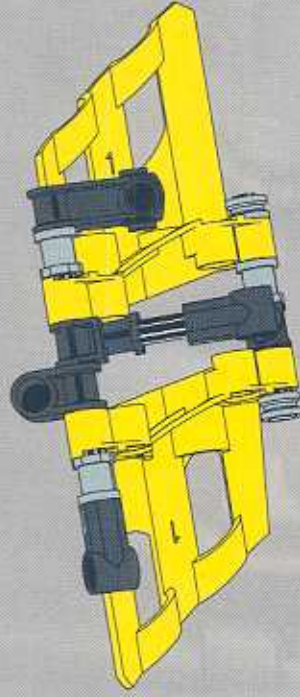
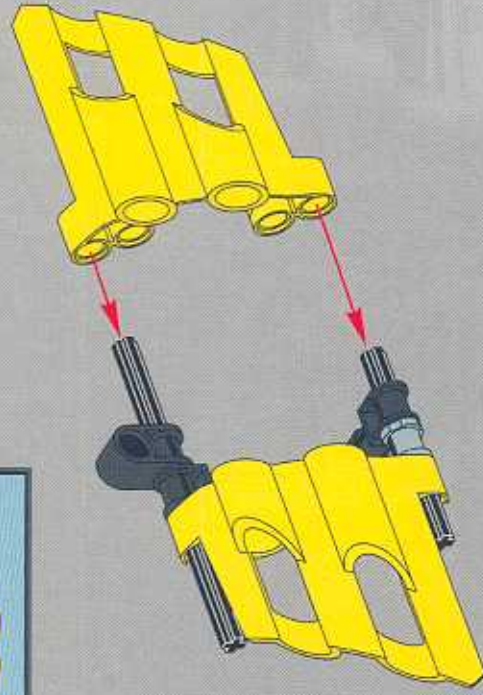

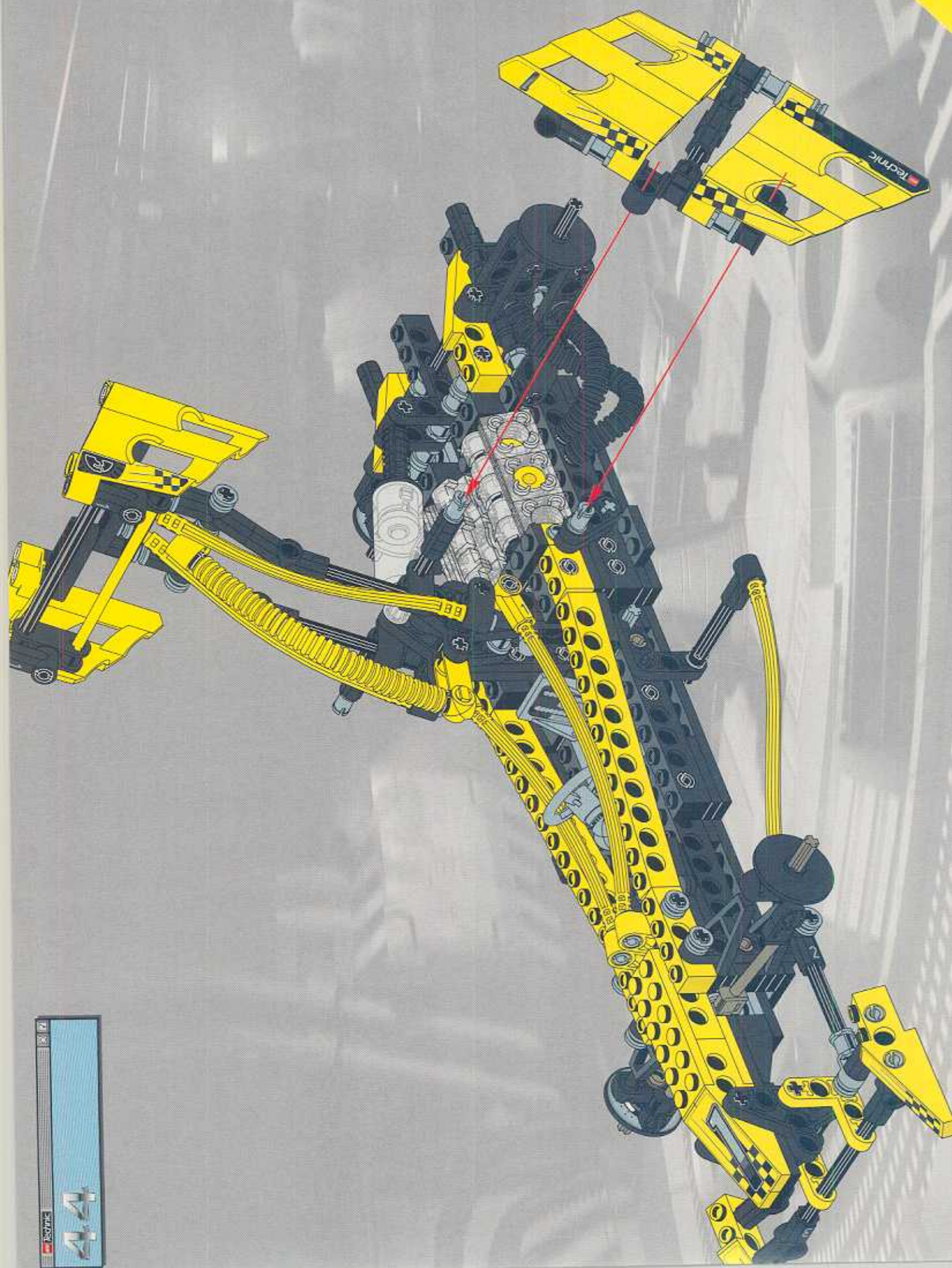

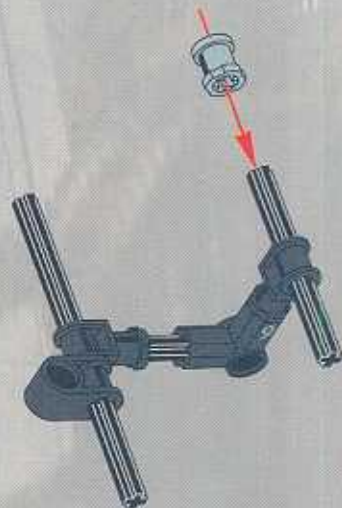
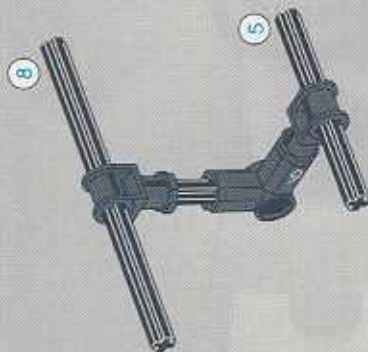
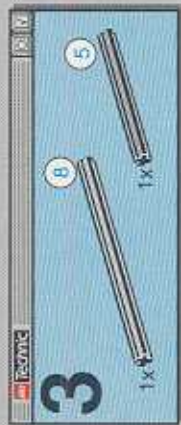
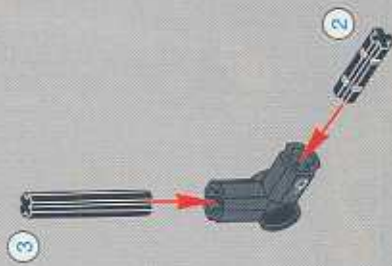
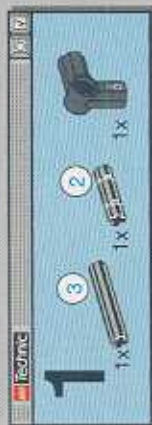

7

1x
1x

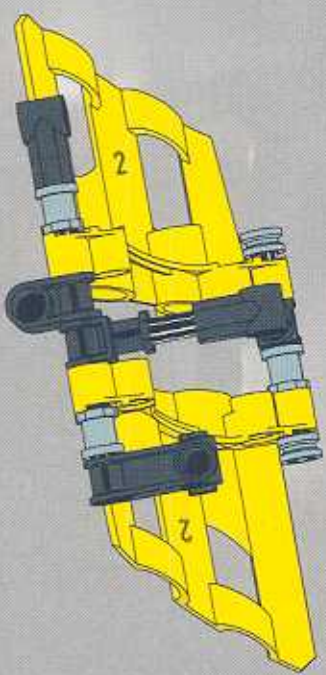

8

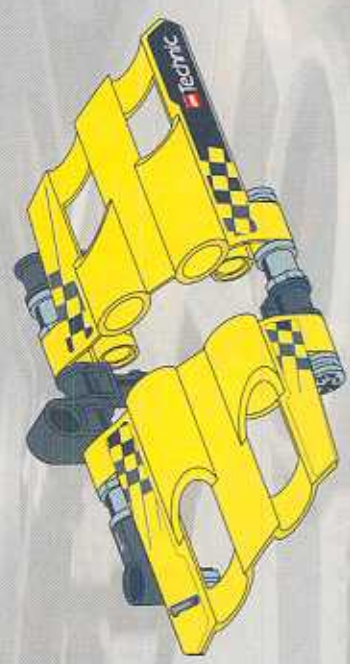

5

2x

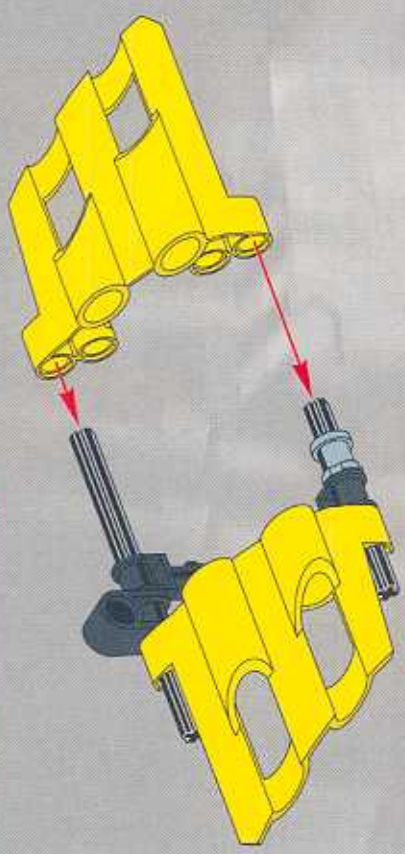

6

2x
2x

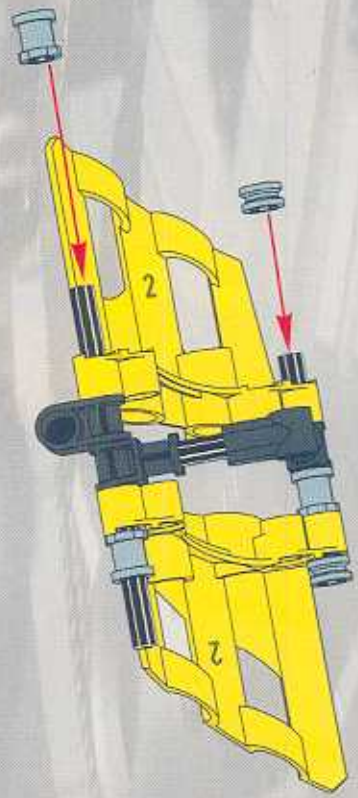

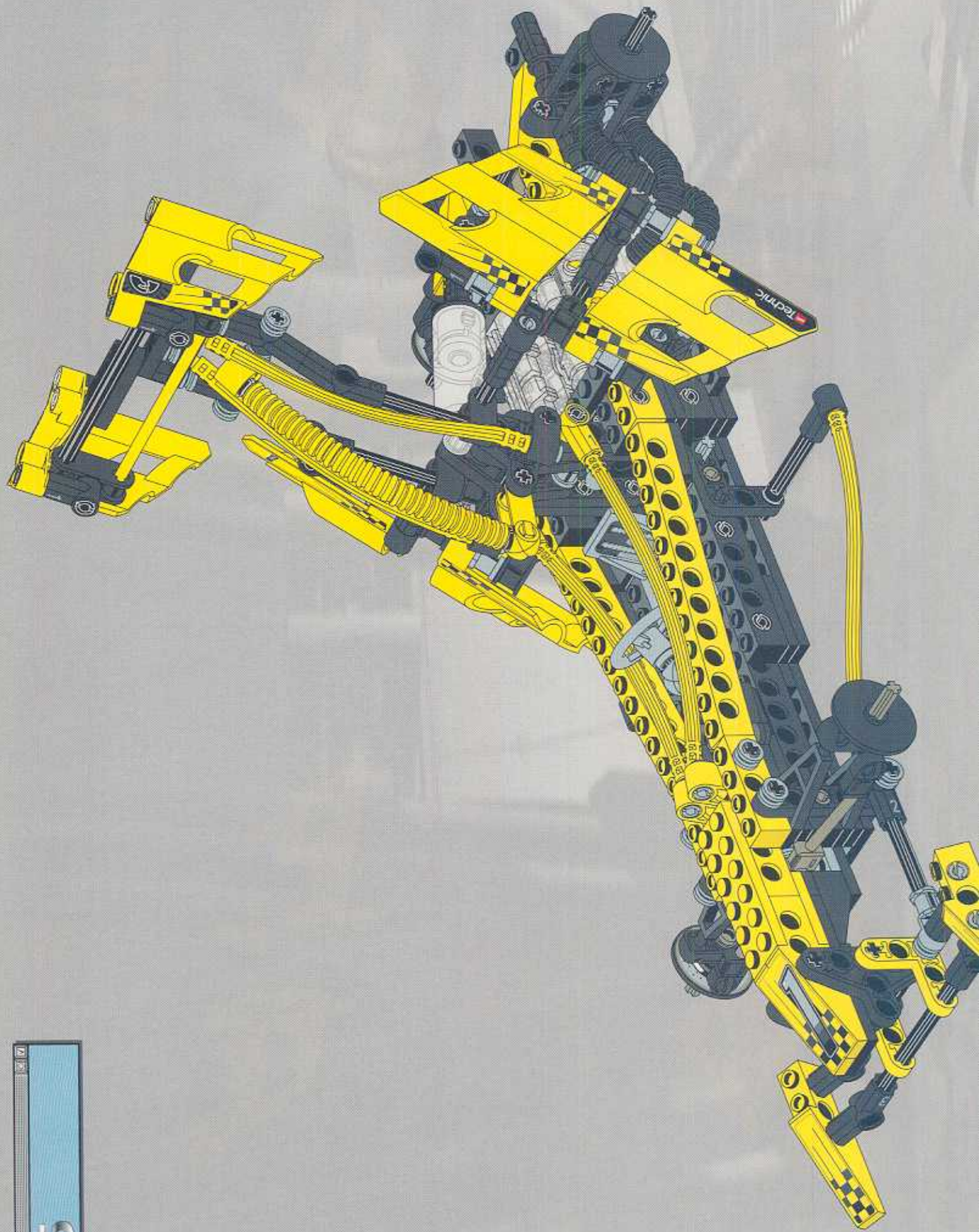



LEGO Technic

46

4x

4x

A parts list for step 46, showing two items: a grey Technic axle with a black rubber tire attached, and a black rubber tire. The number '46' is prominently displayed in a large, stylized font. The quantity '4x' is written below each item.

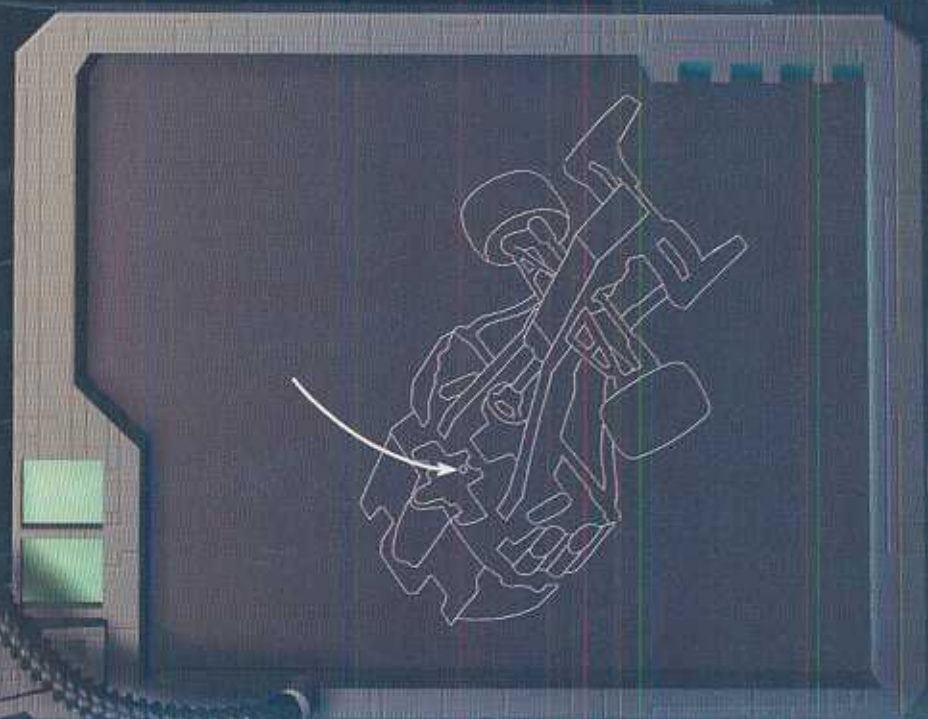
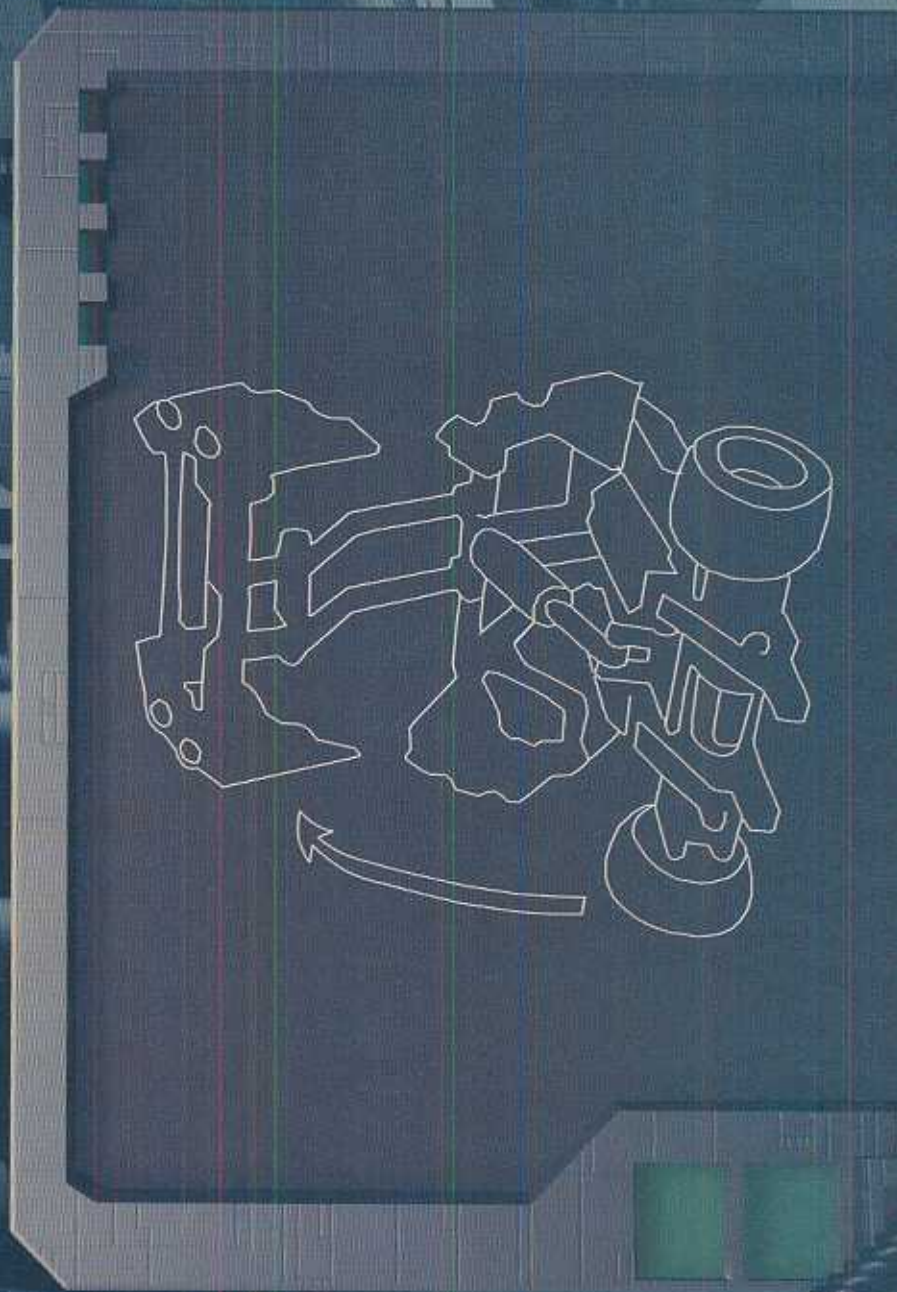

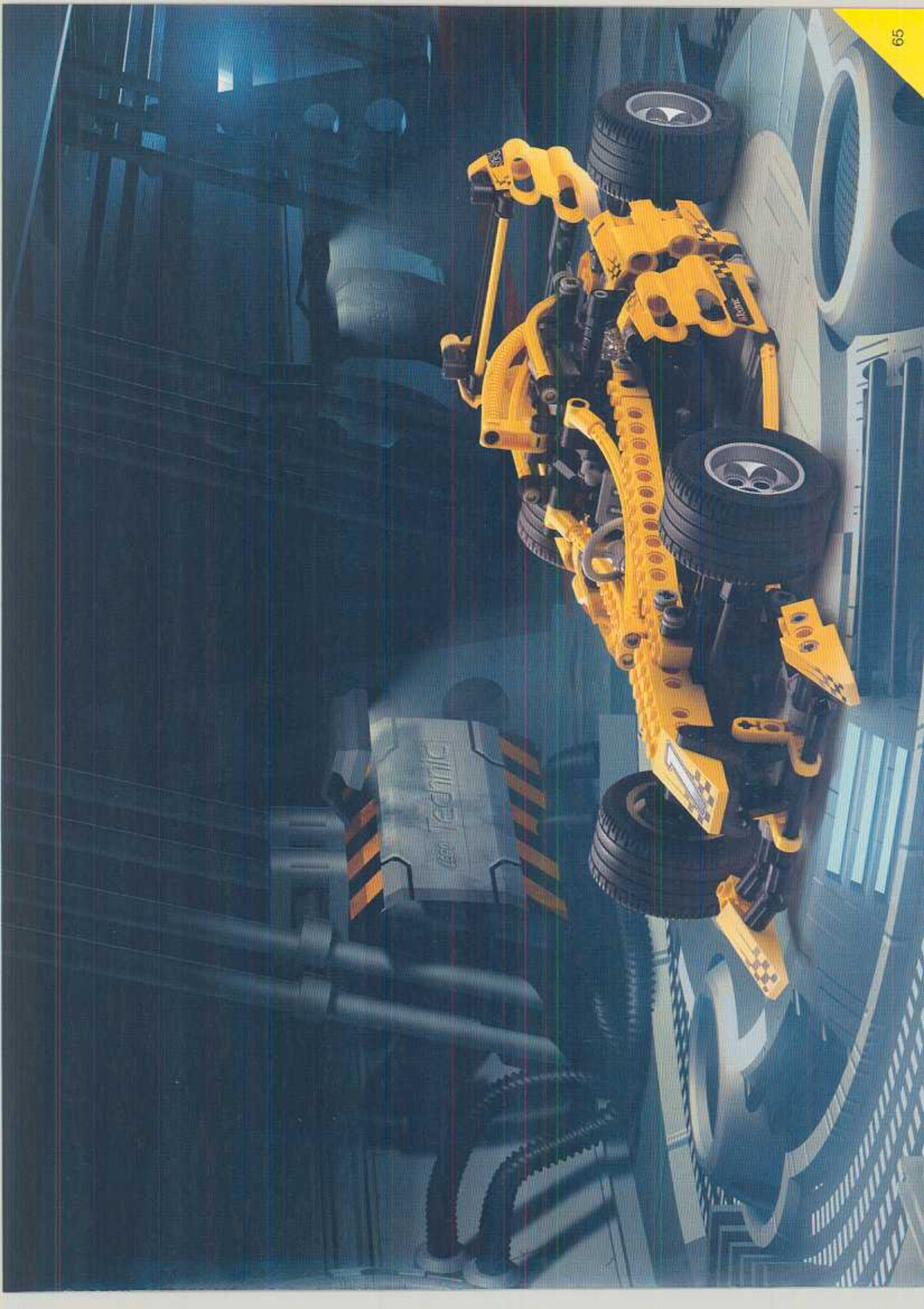



=



+

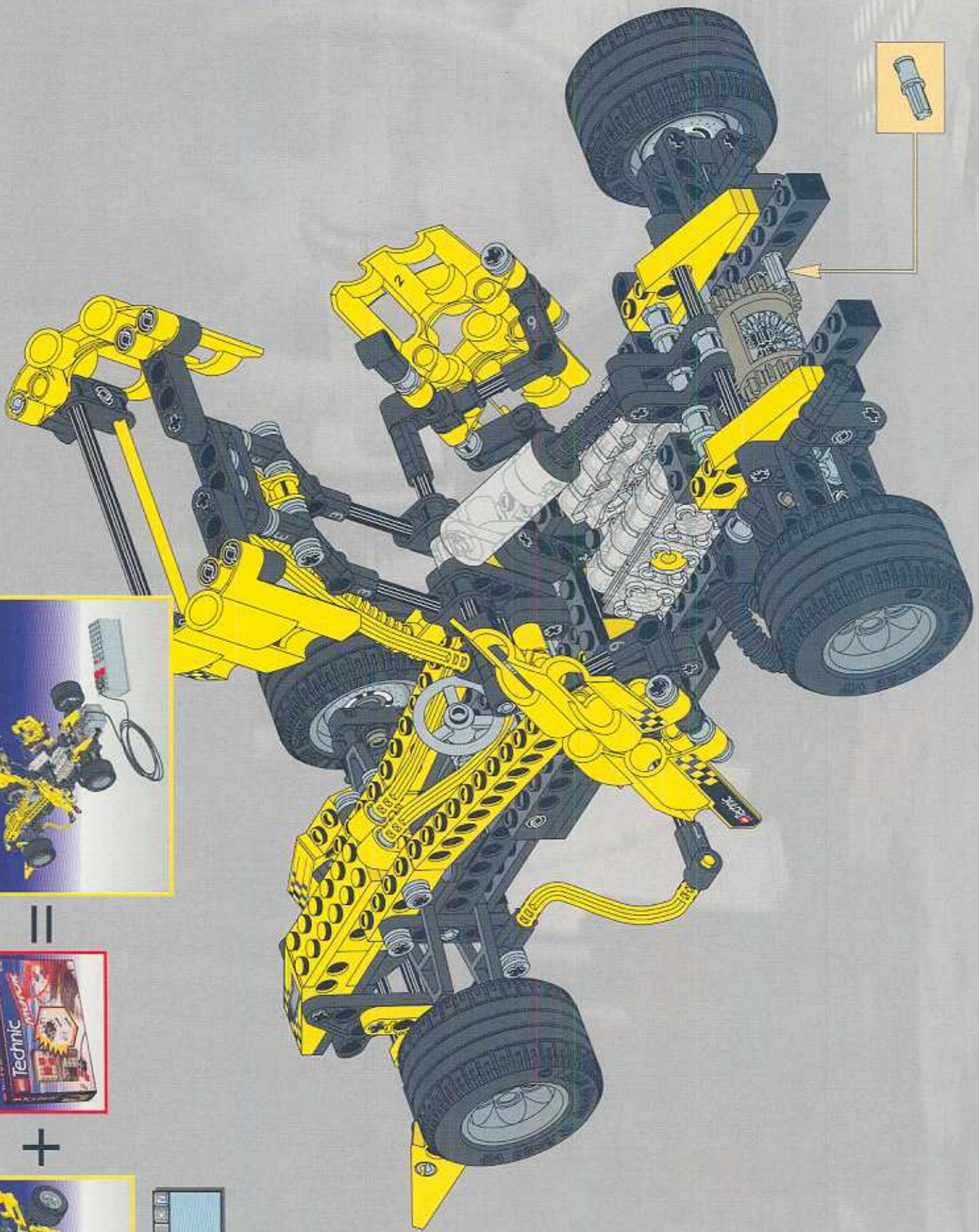
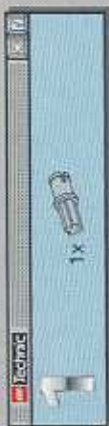

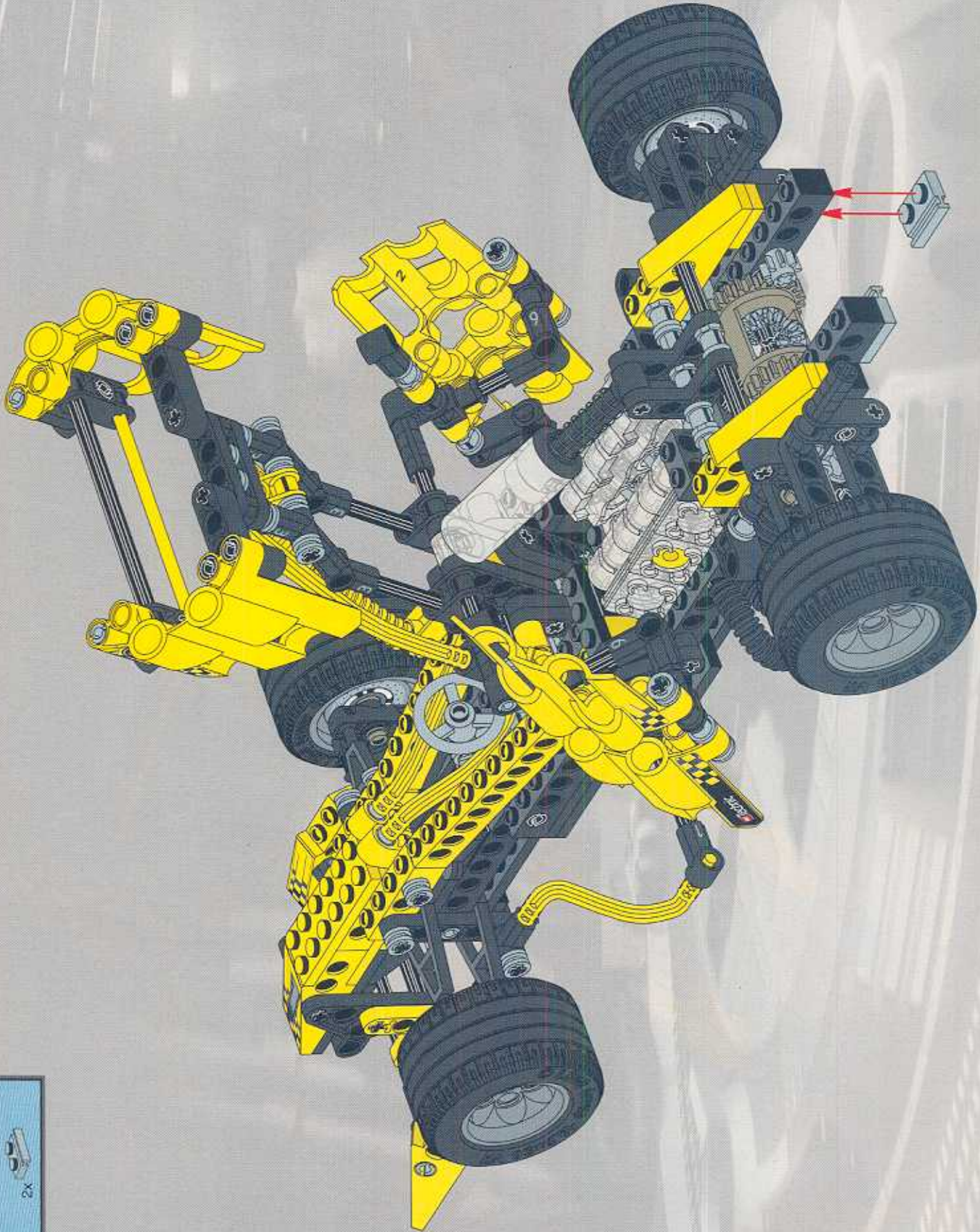

LEGO Technic

2

1x

2x

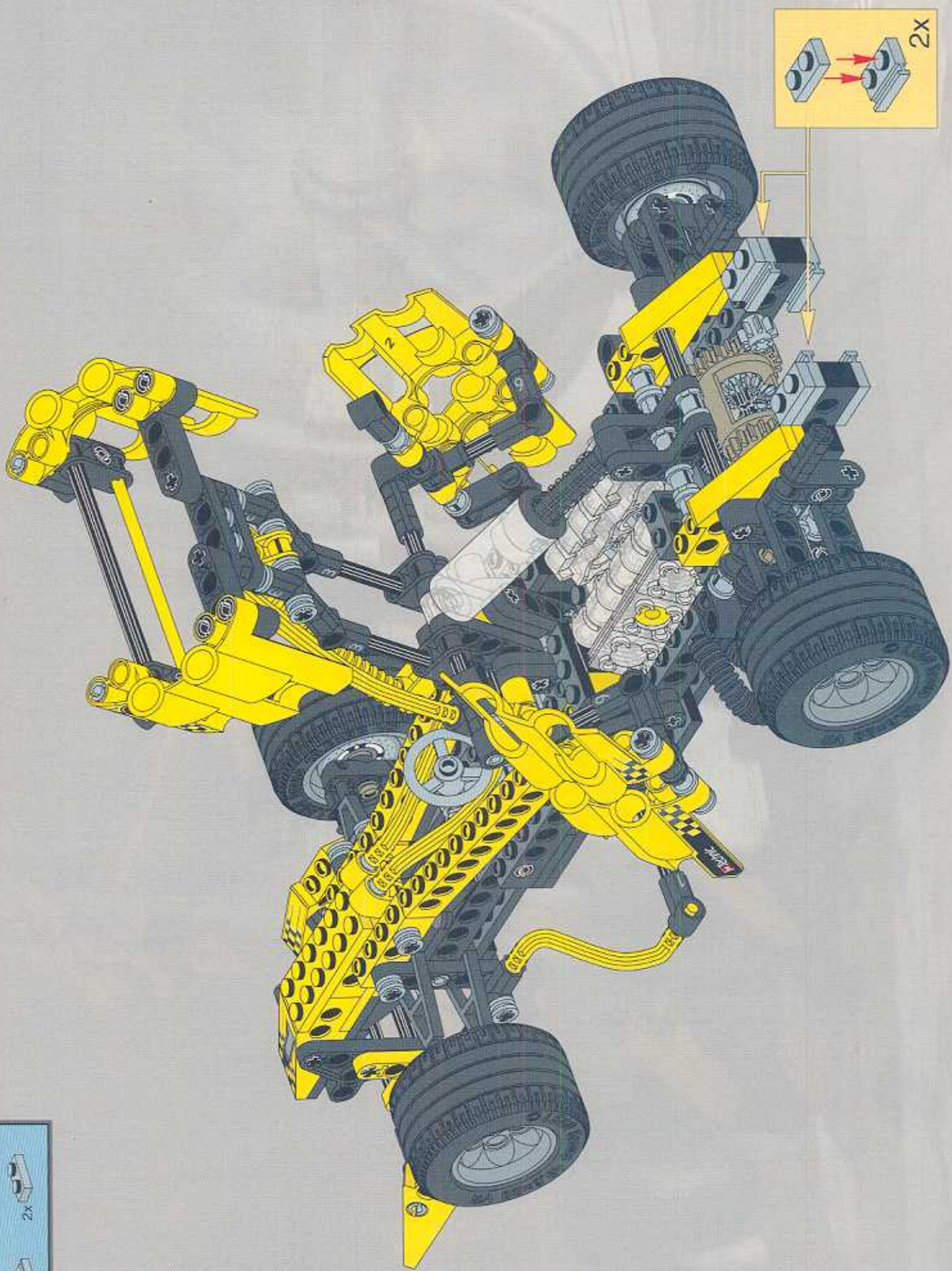
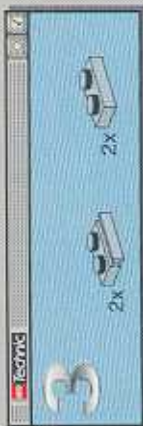

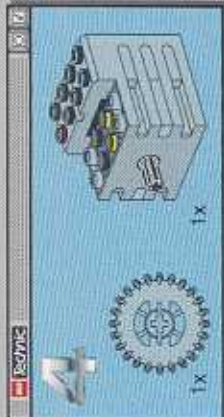
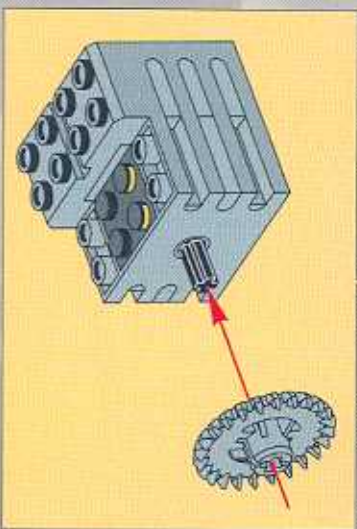
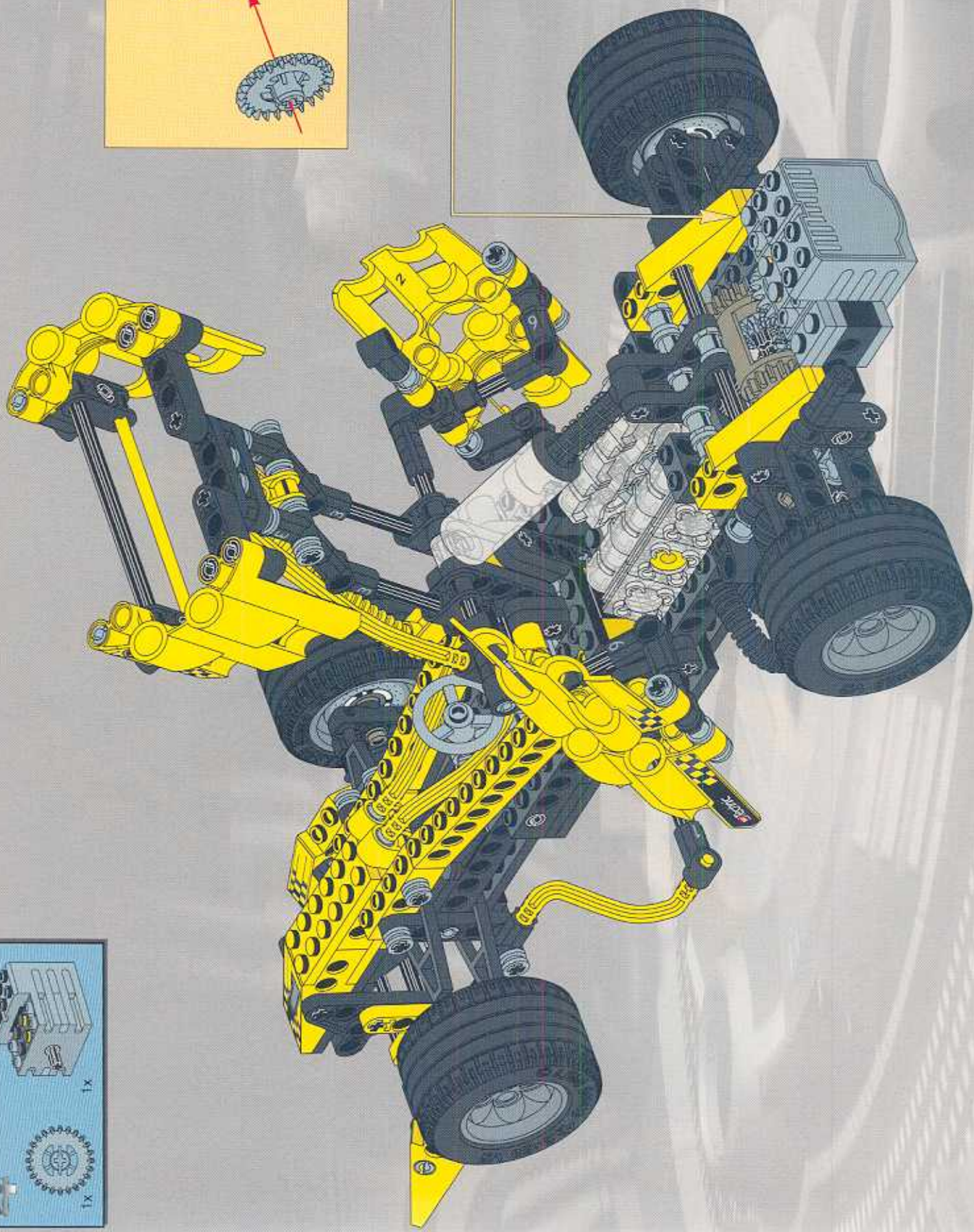

LEGO Technic



2x

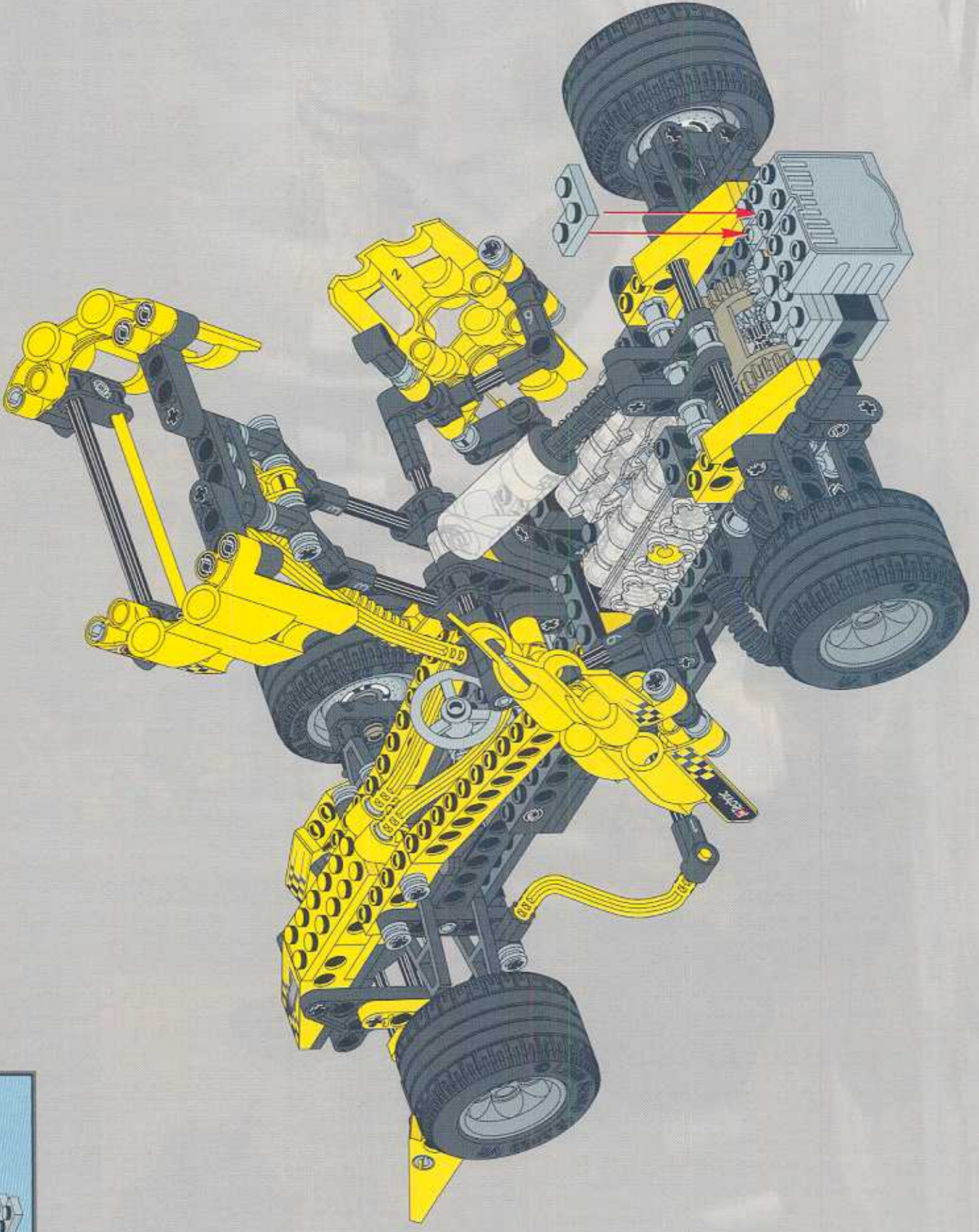

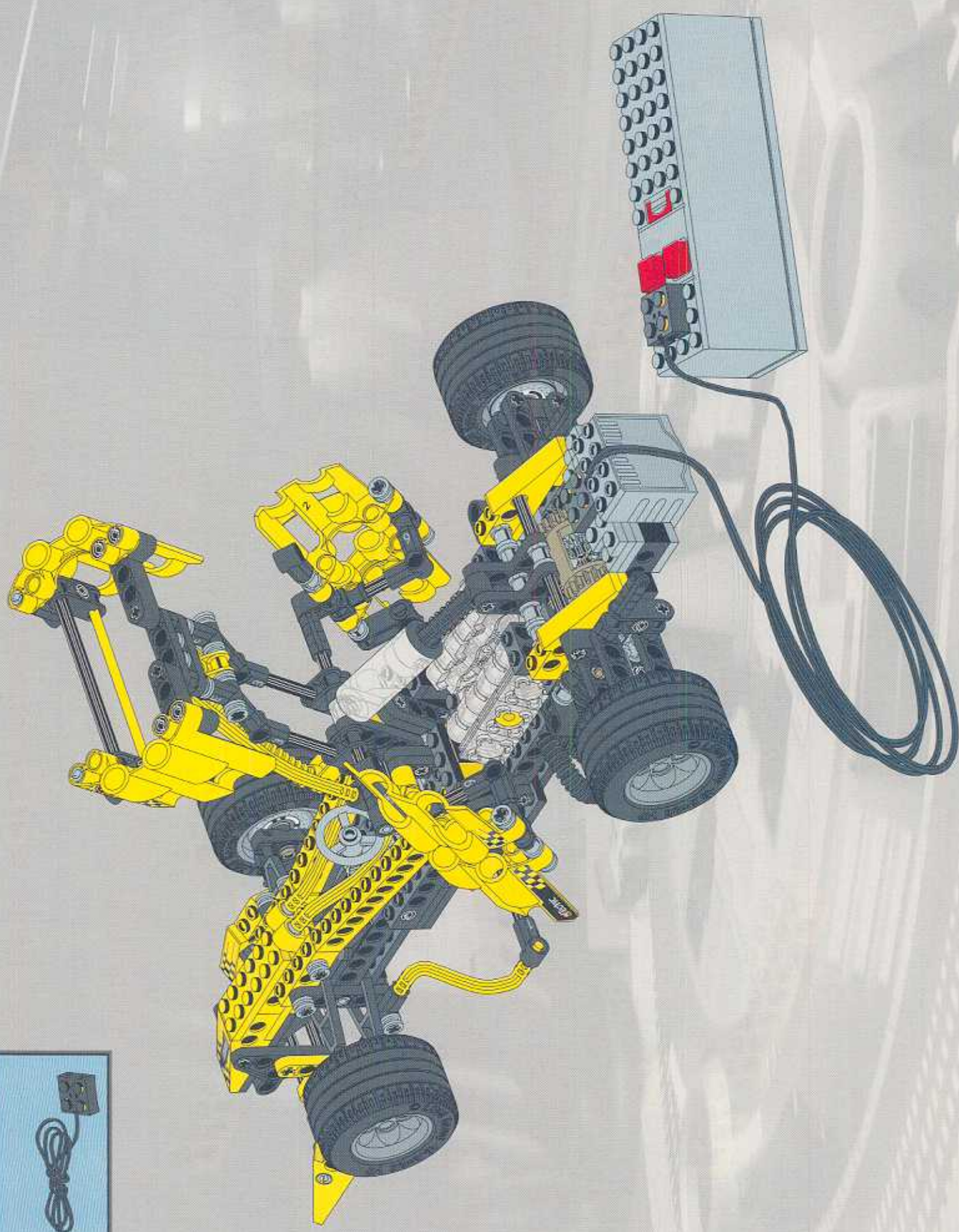

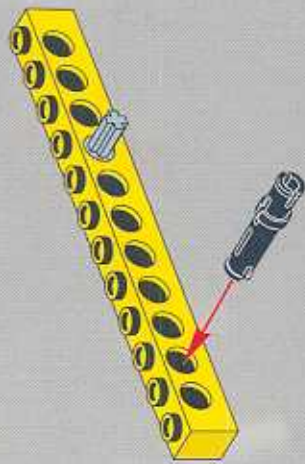
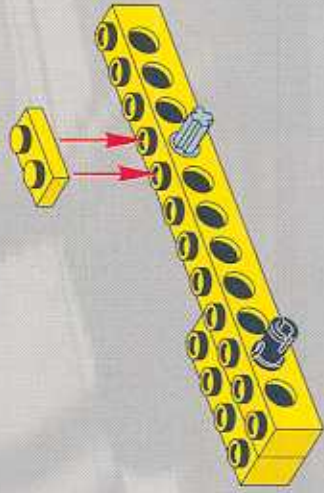

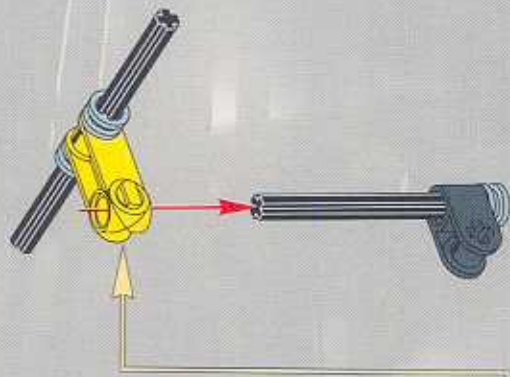
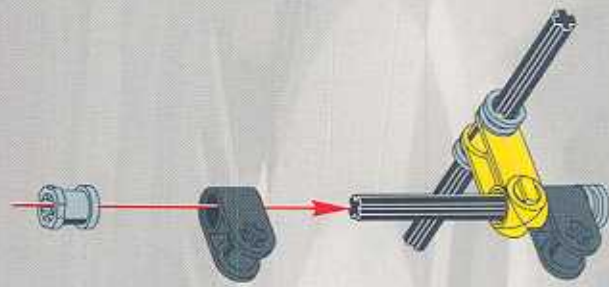
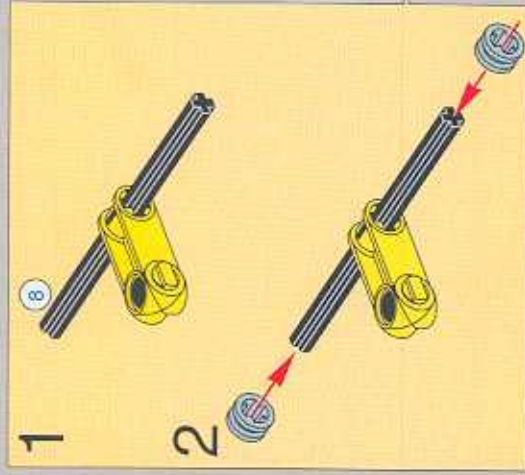
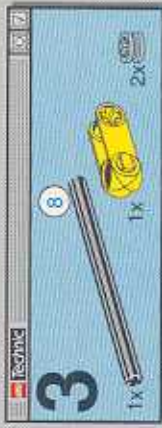

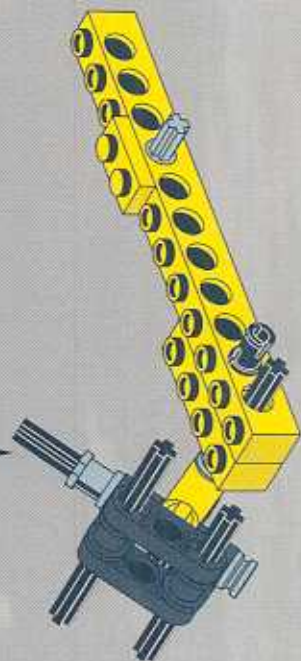
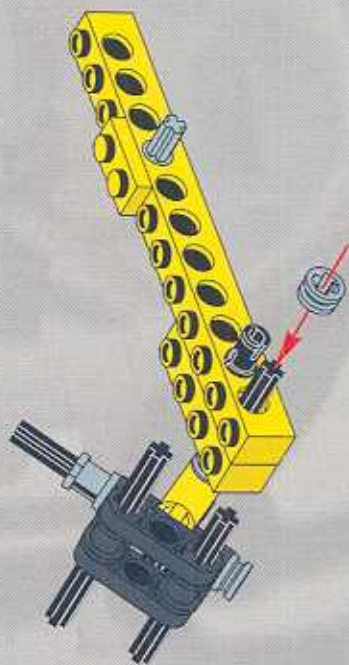
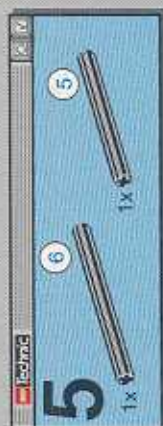
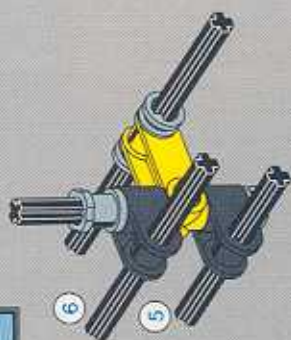

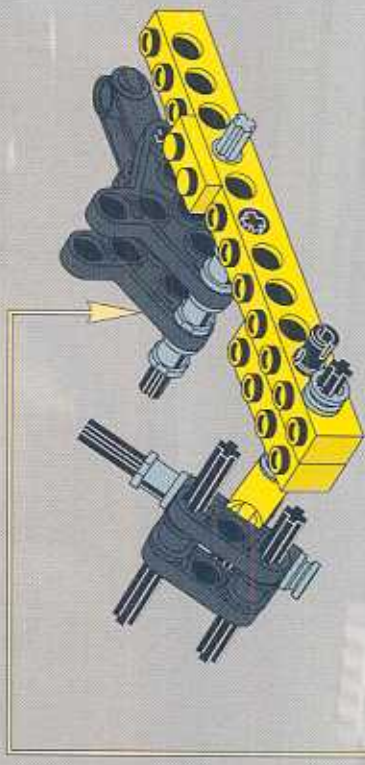
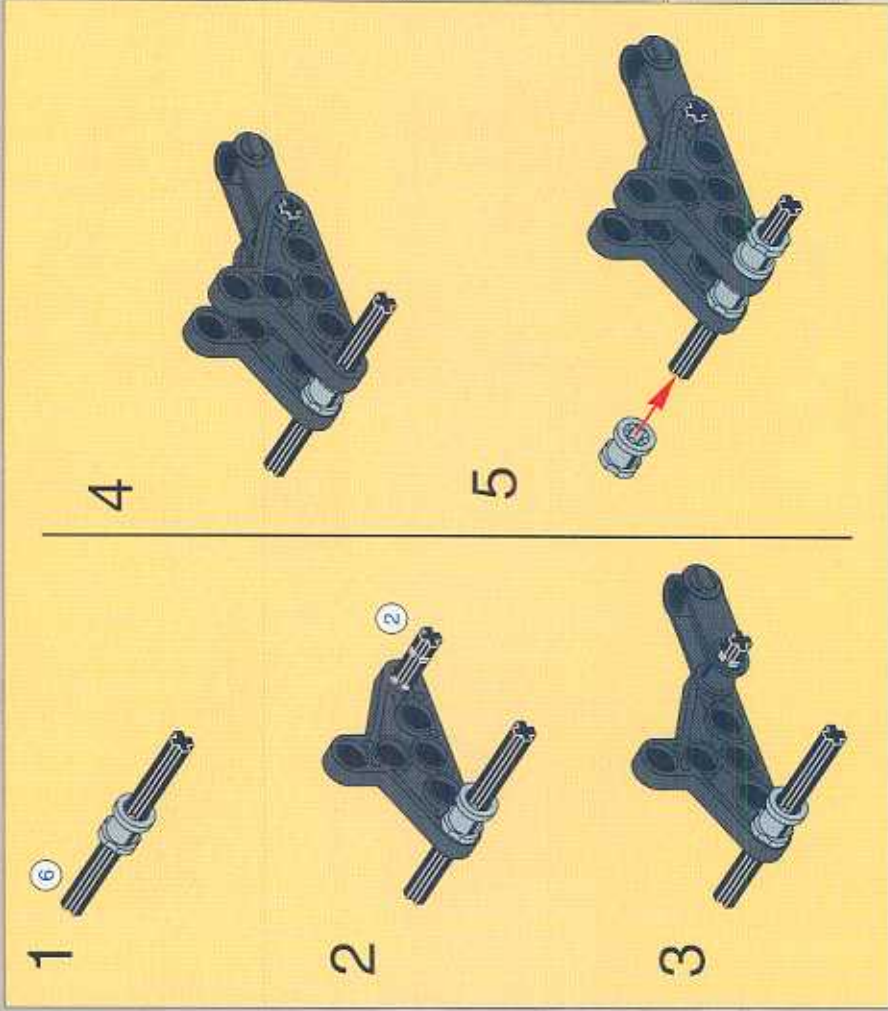
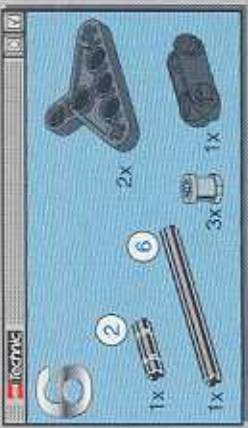



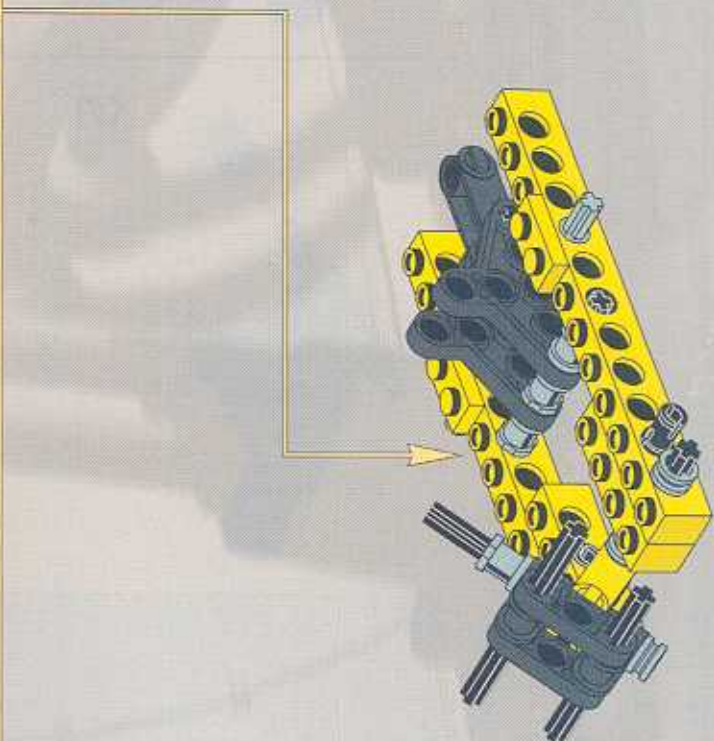
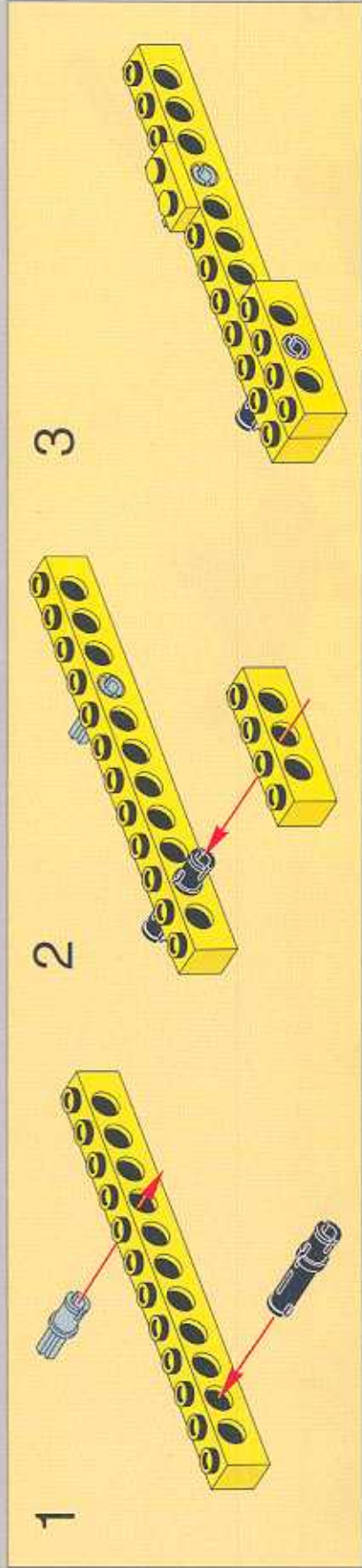
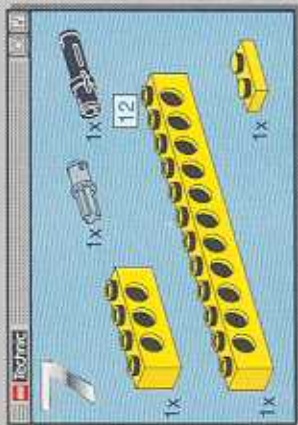

LEGO TECHNIC 10 1x

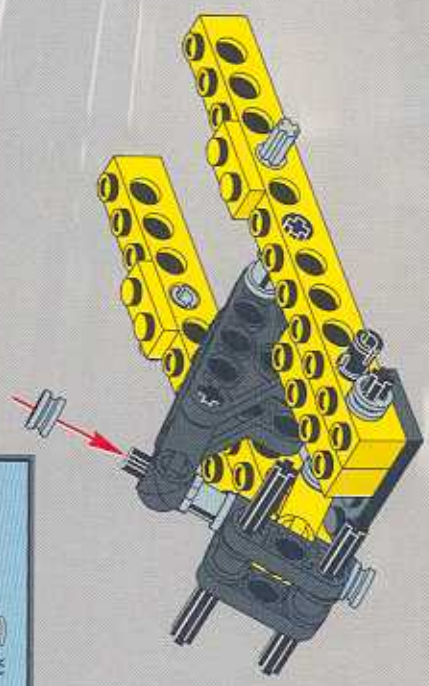

LEGO TECHNIC 8 2x 1x

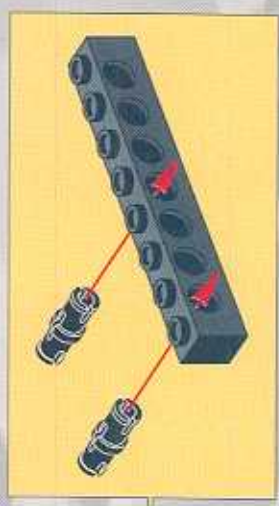
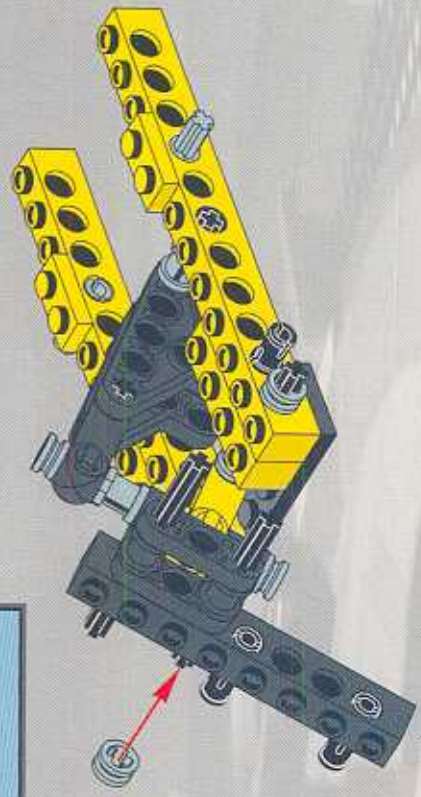

LEGO TECHNIC 8 1x

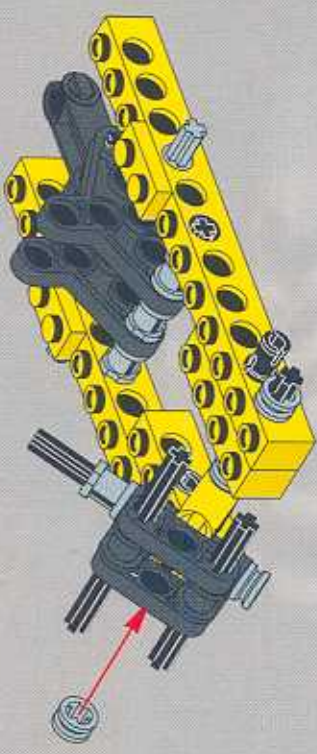

LEGO TECHNIC 9 1x

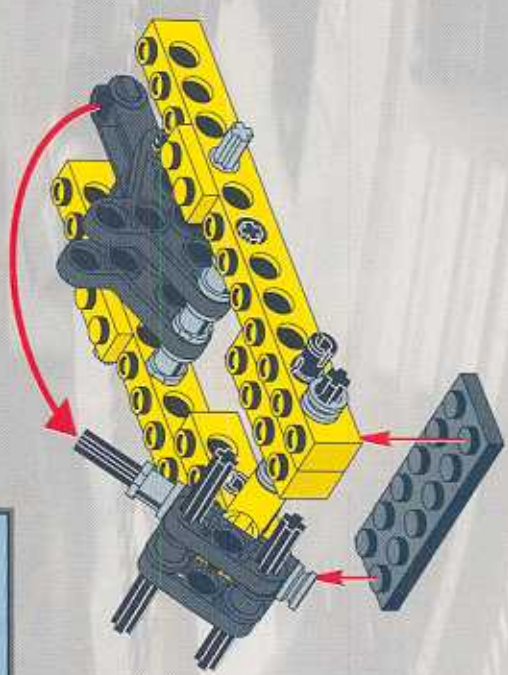

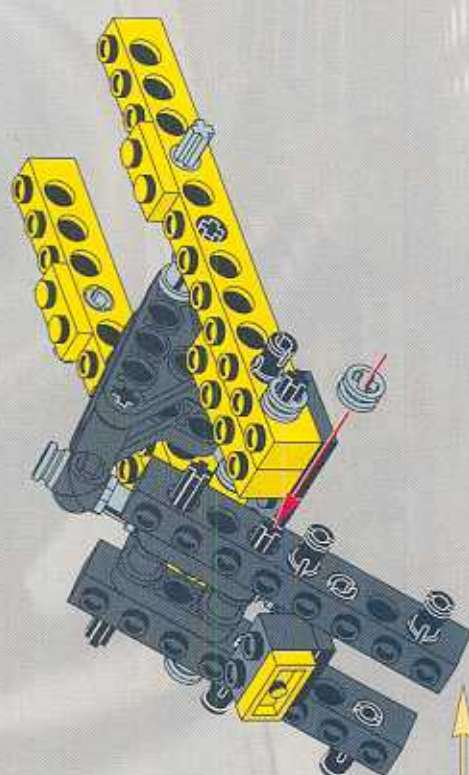
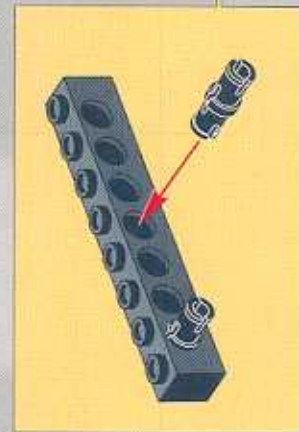
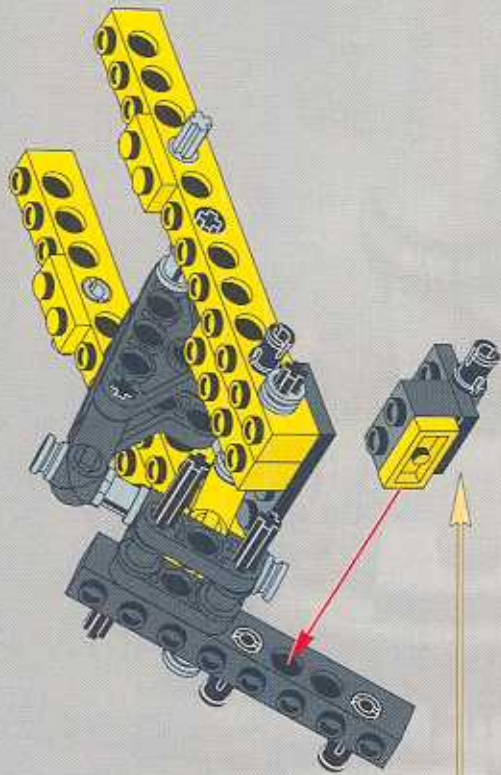
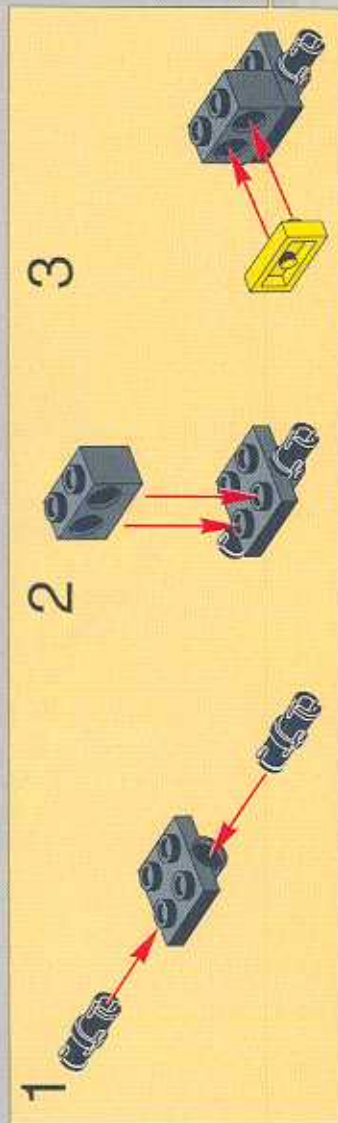



1 1x



2 2x

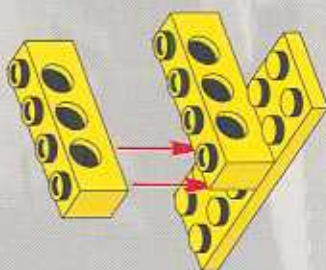

3 4x

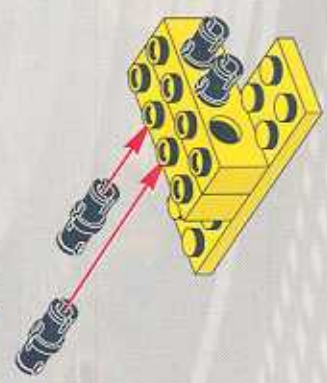

4 1x

2x

5 2x

3x

2x

1

2

3

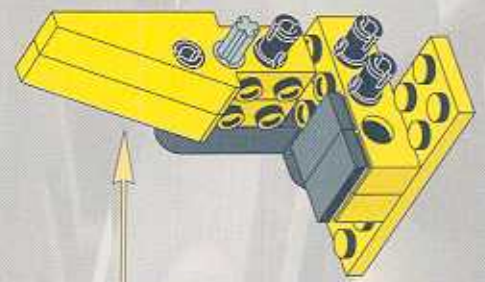
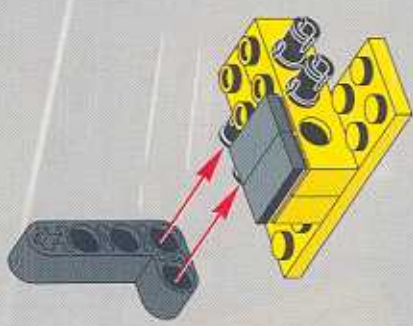

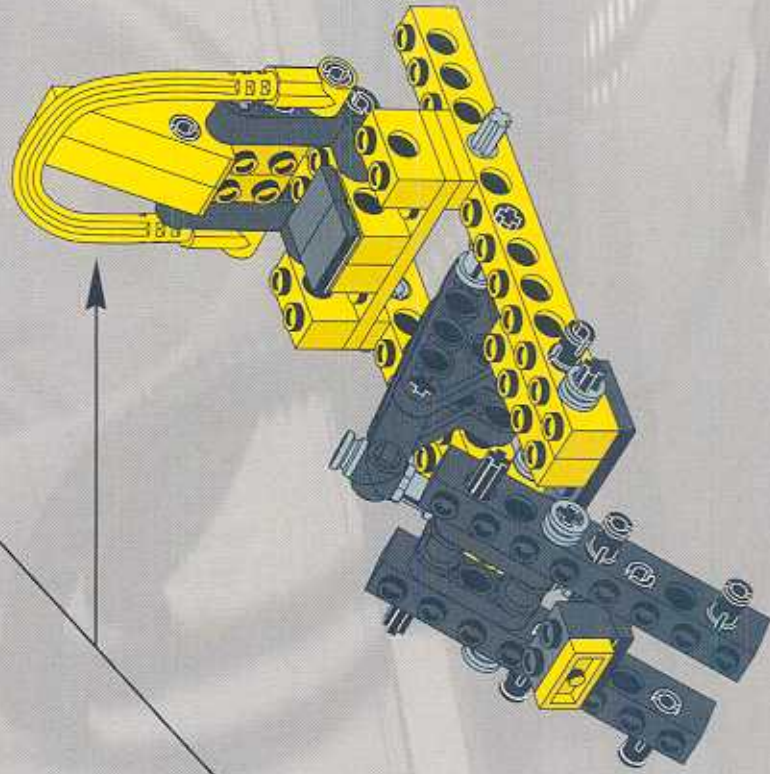
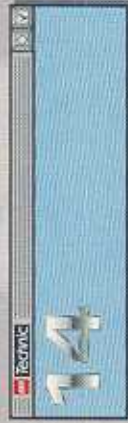
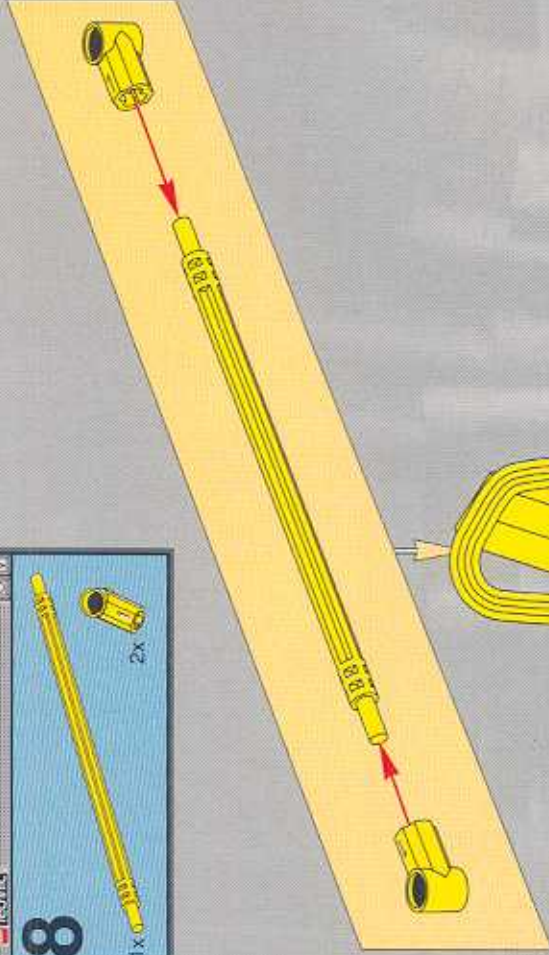
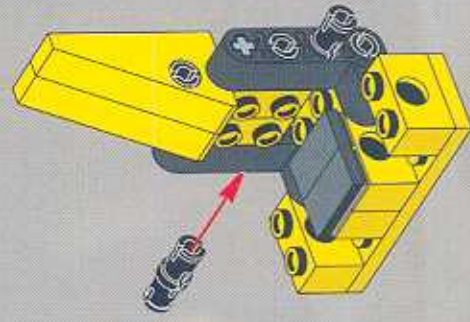
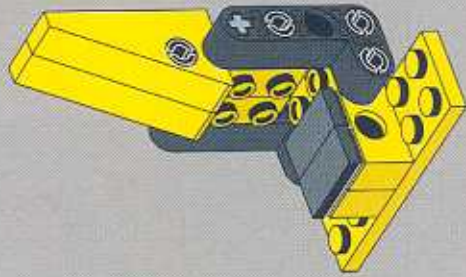

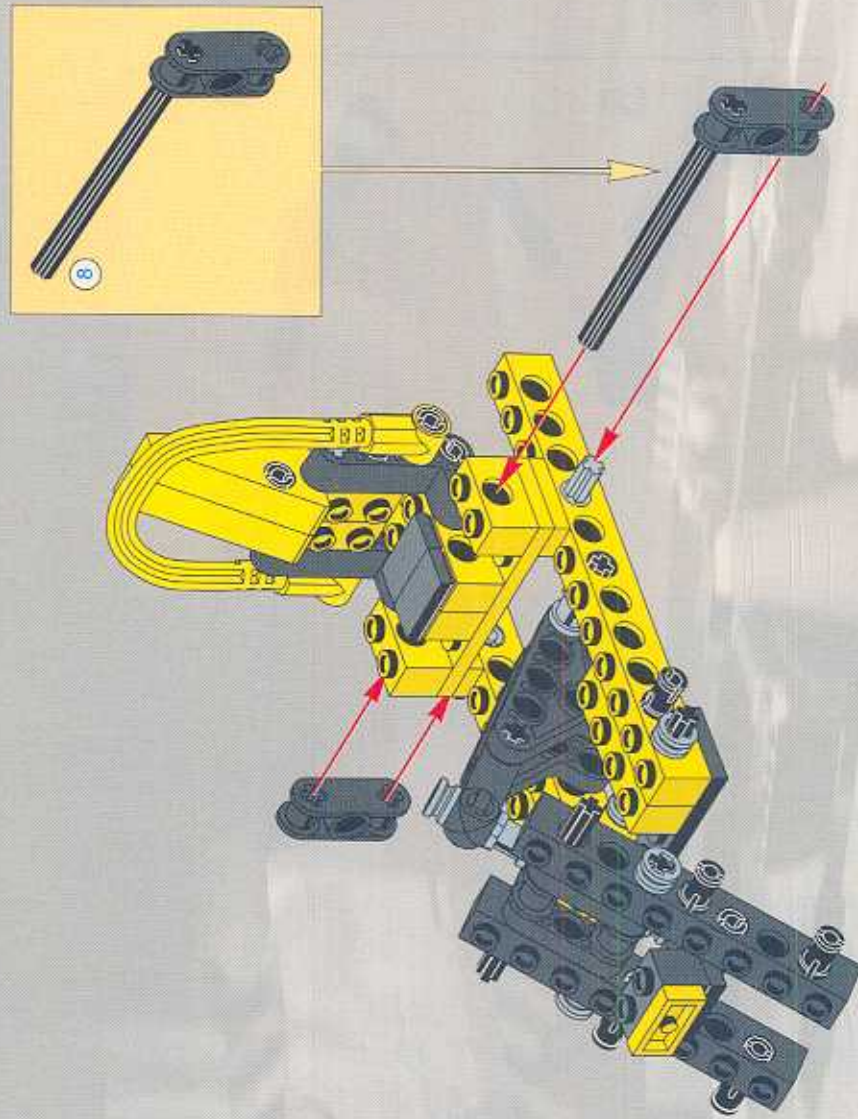
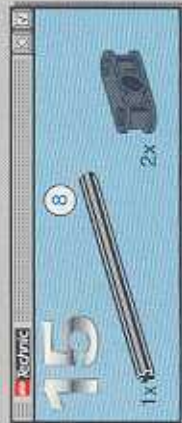

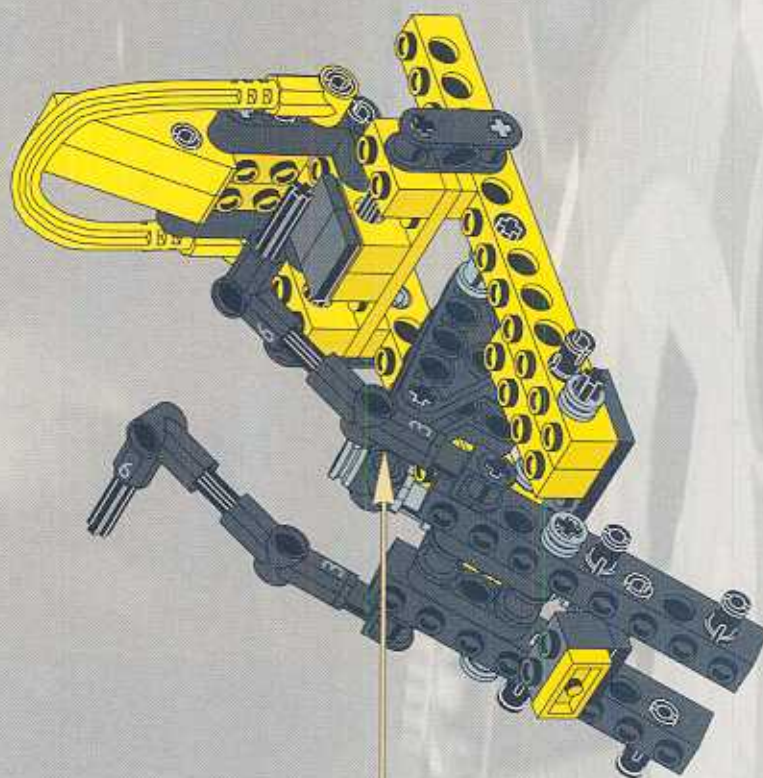
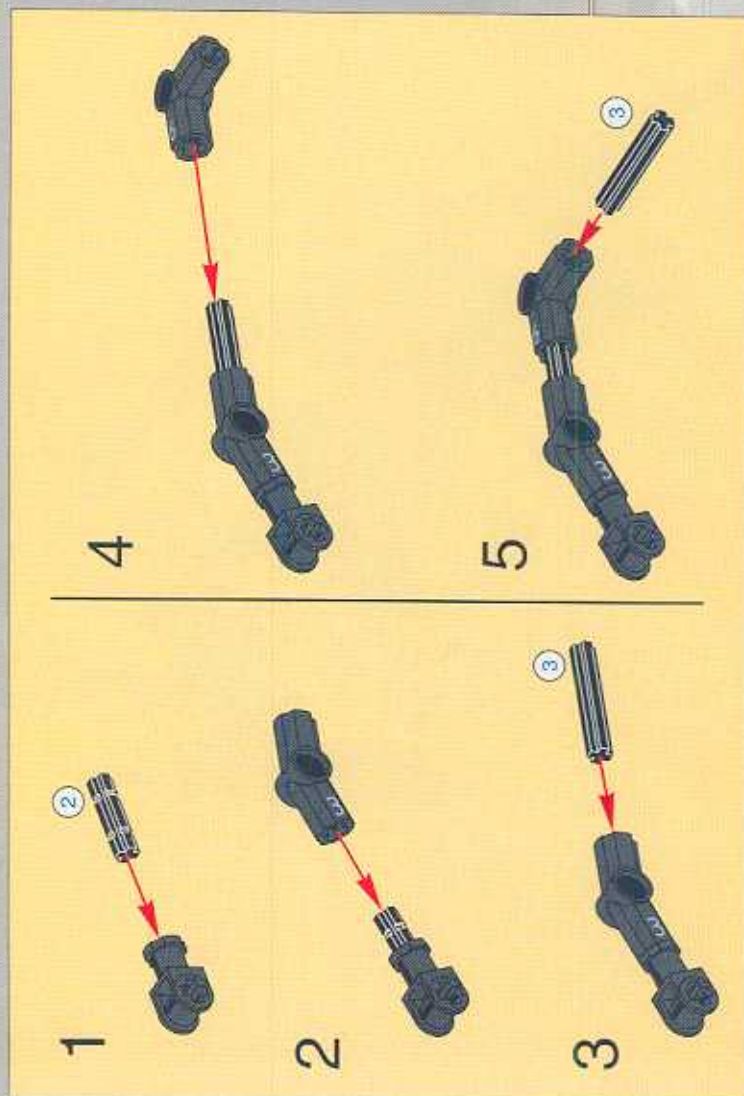
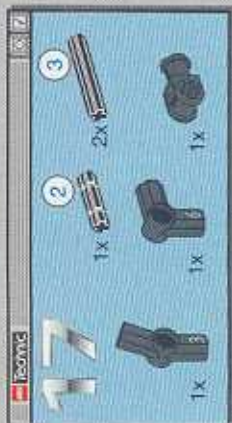

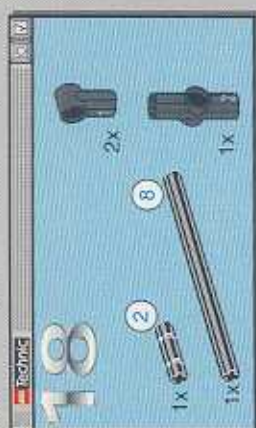
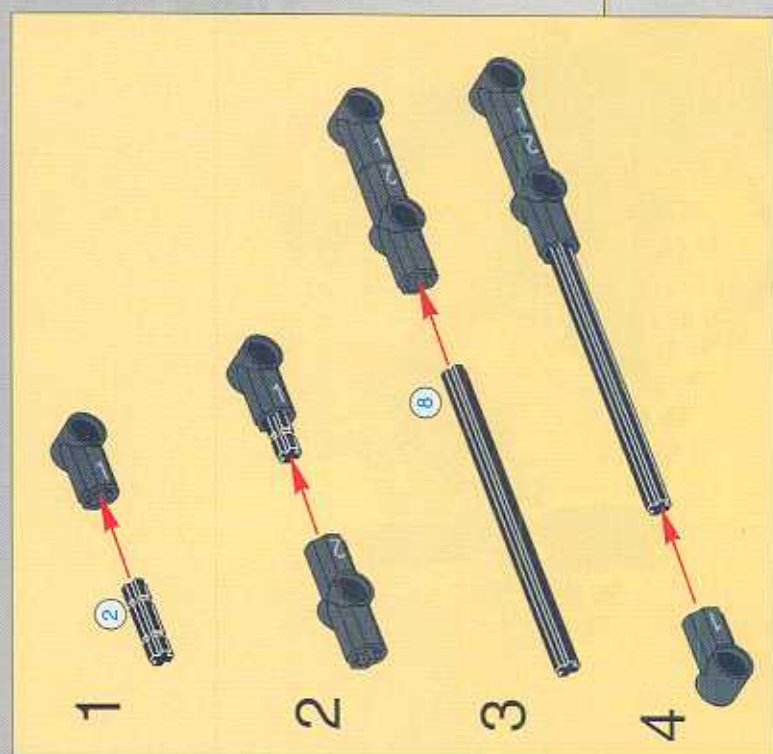
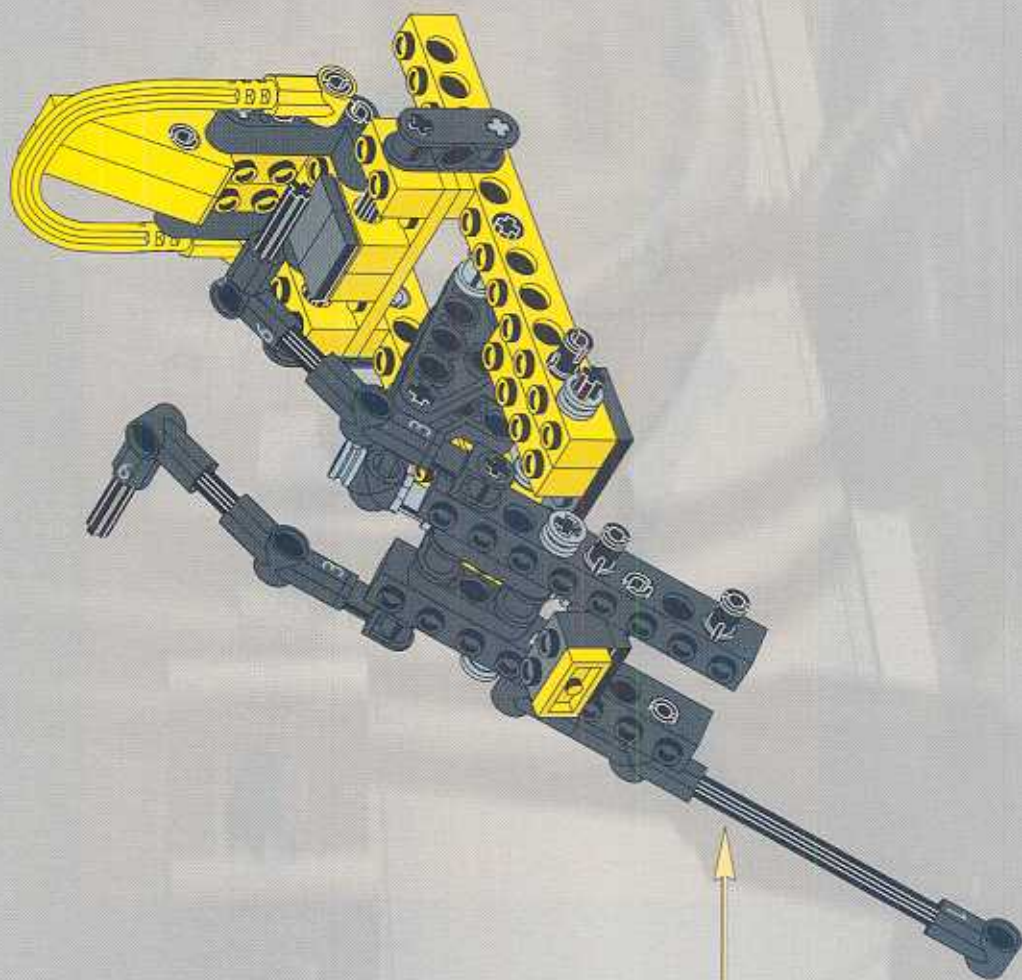

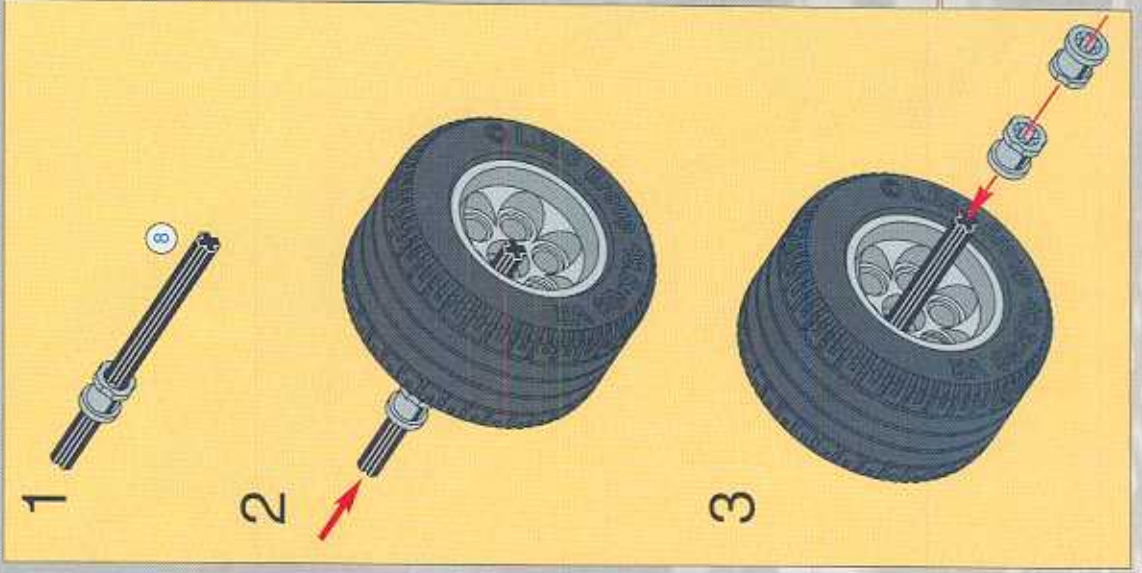

19

- 1x Axle (8)
- 1x Tire
- 1x Wheel
- 3x Bush

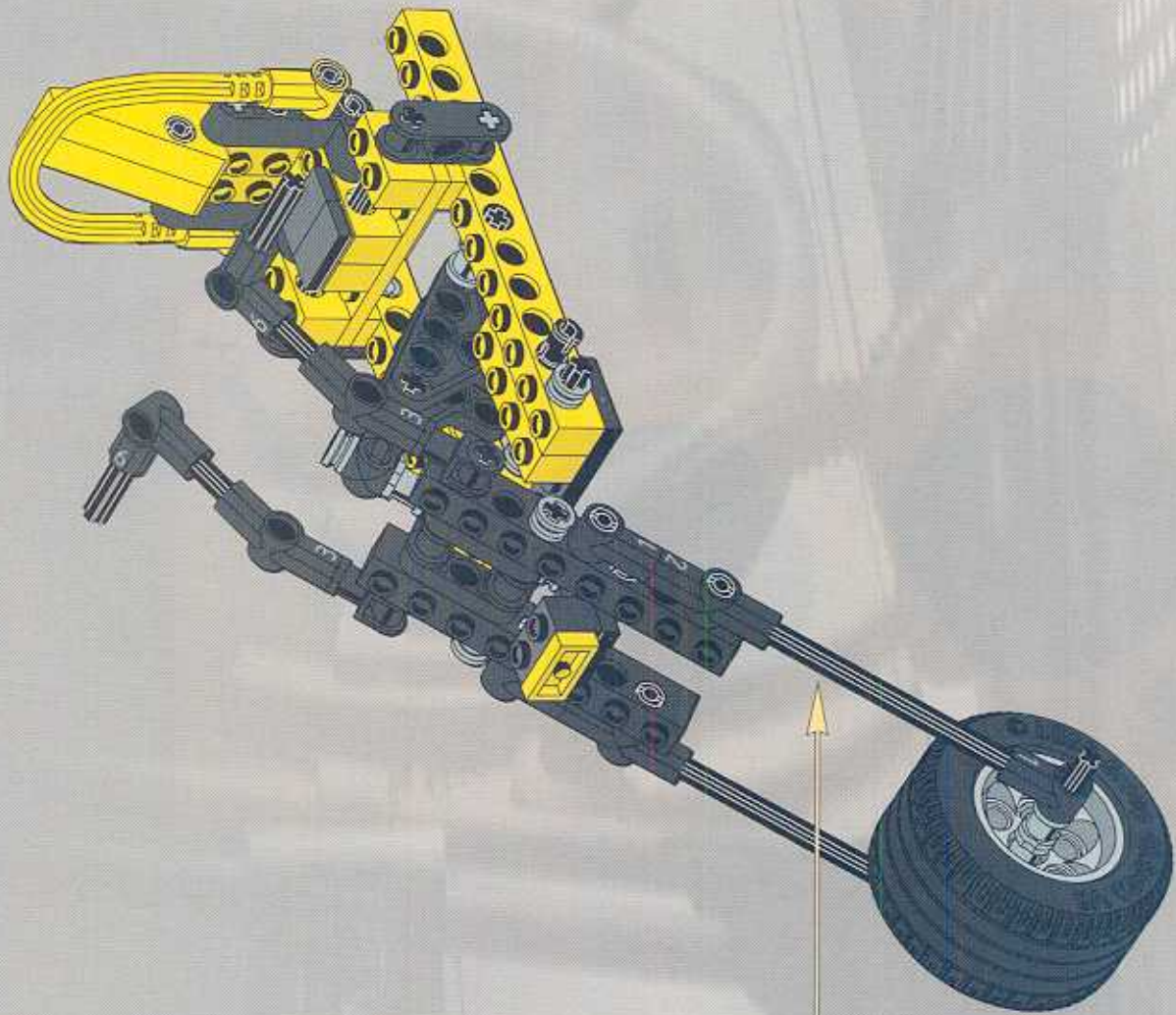
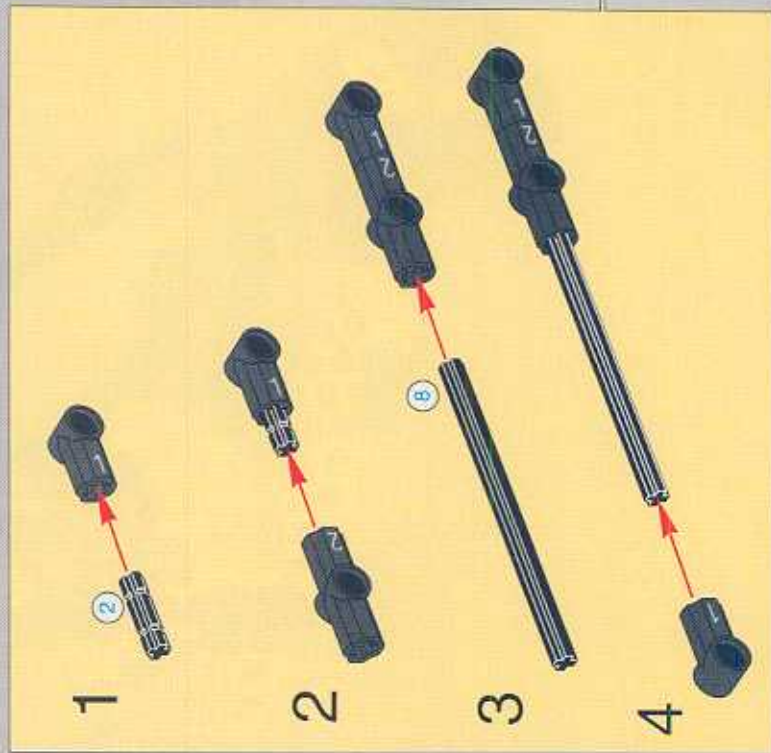
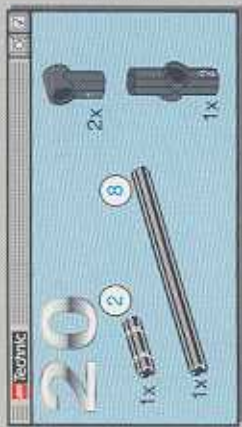



LEGO Technic

21

2x

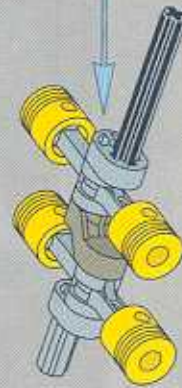
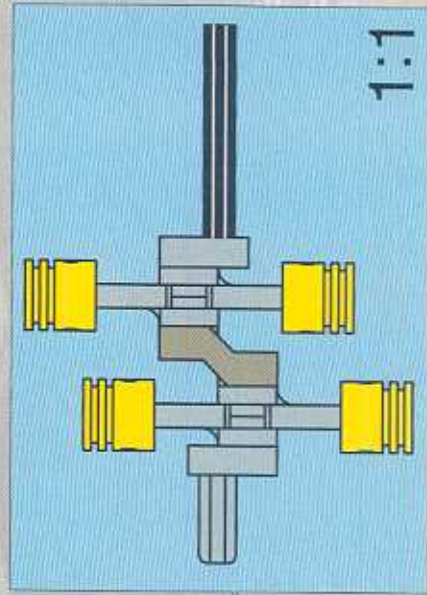
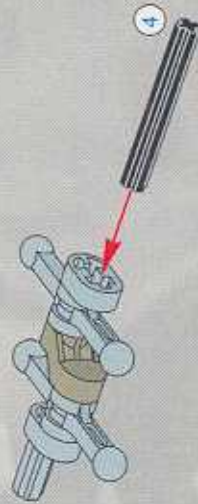
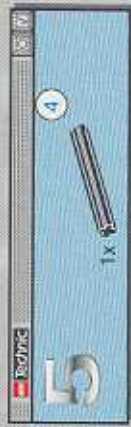
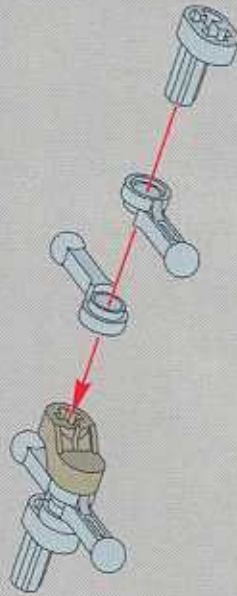
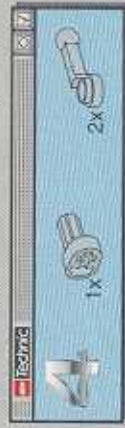
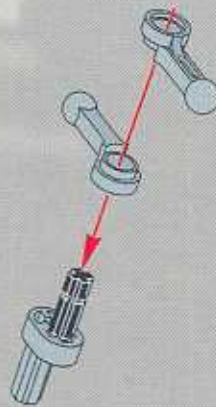
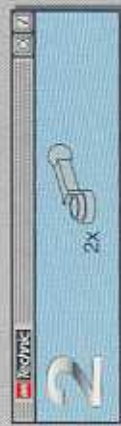
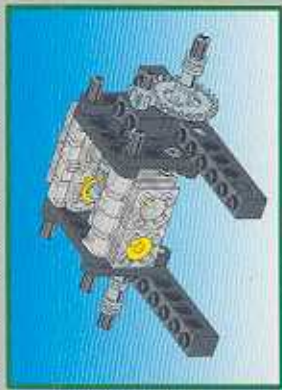

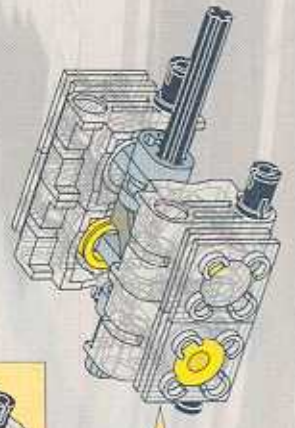
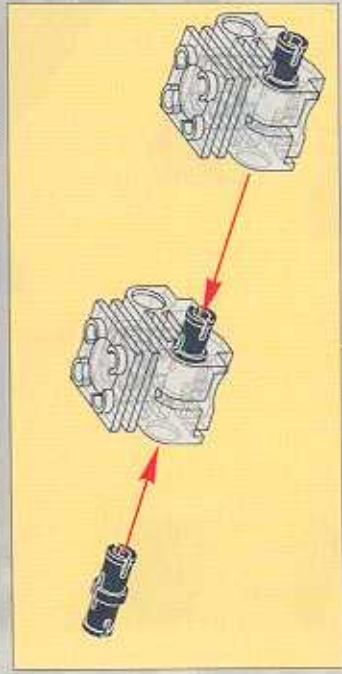
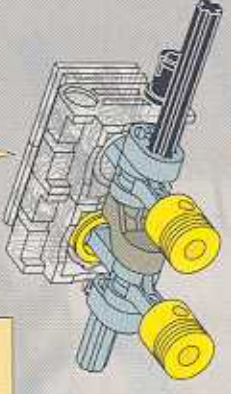
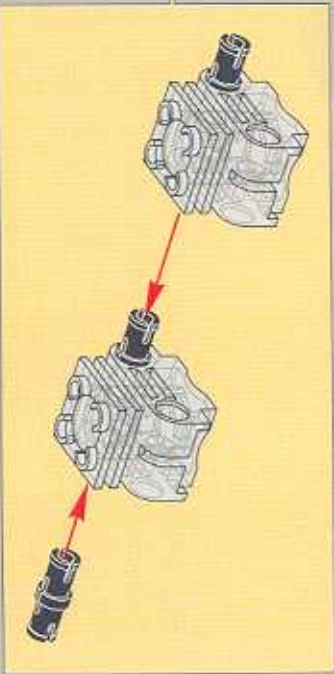
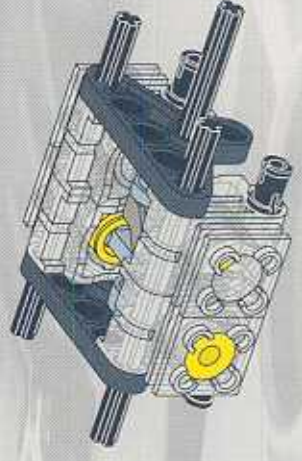
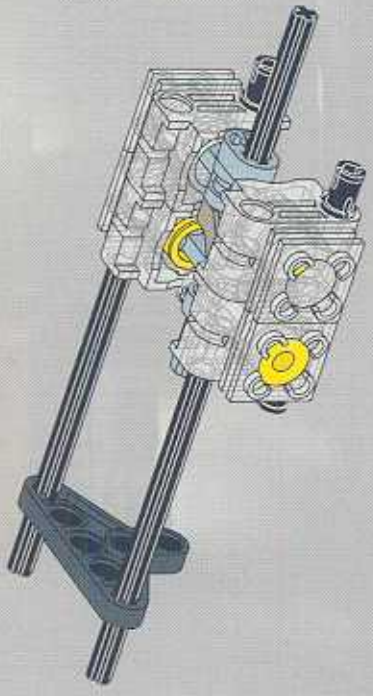

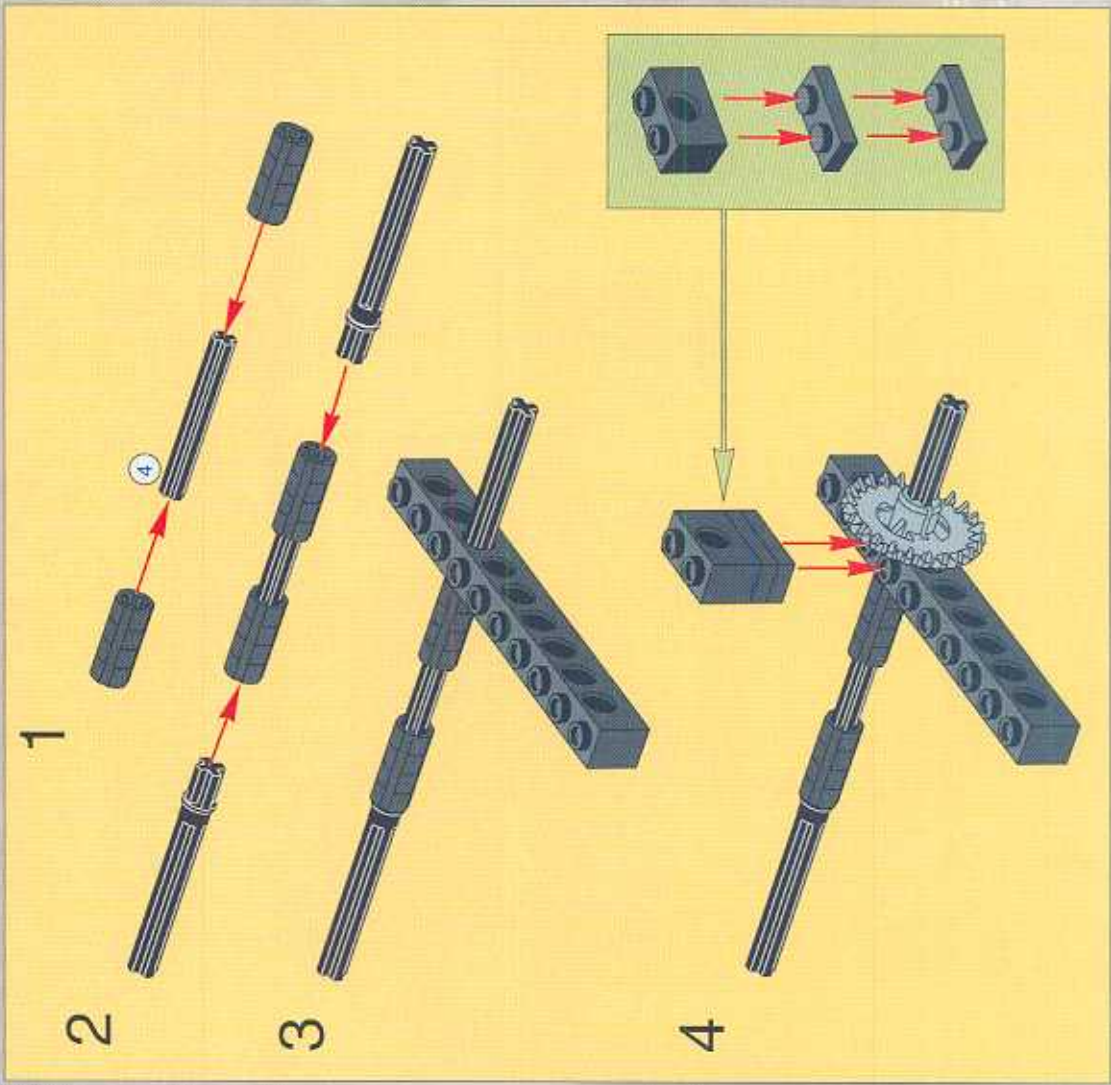
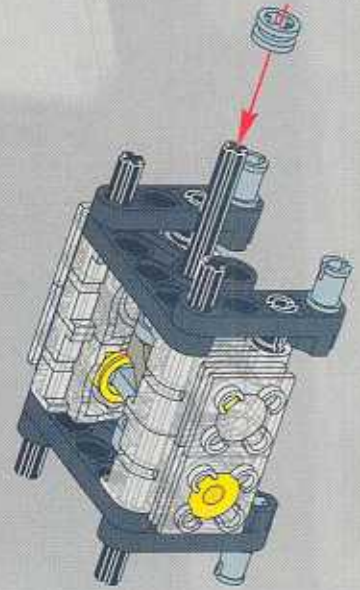
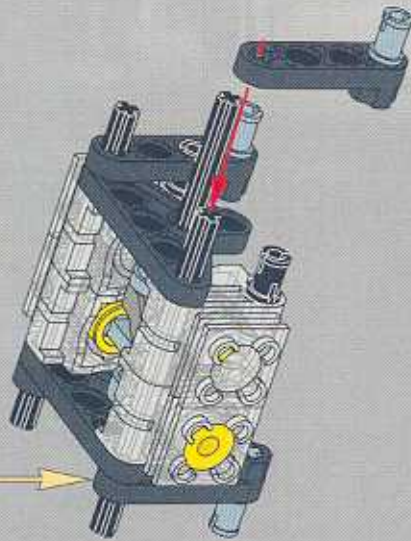
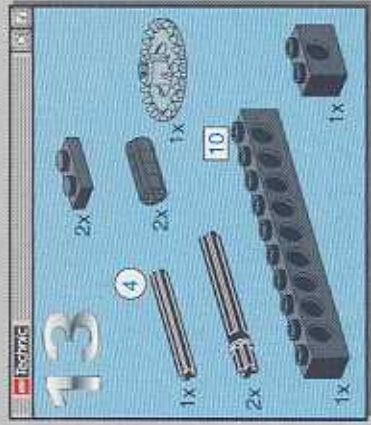

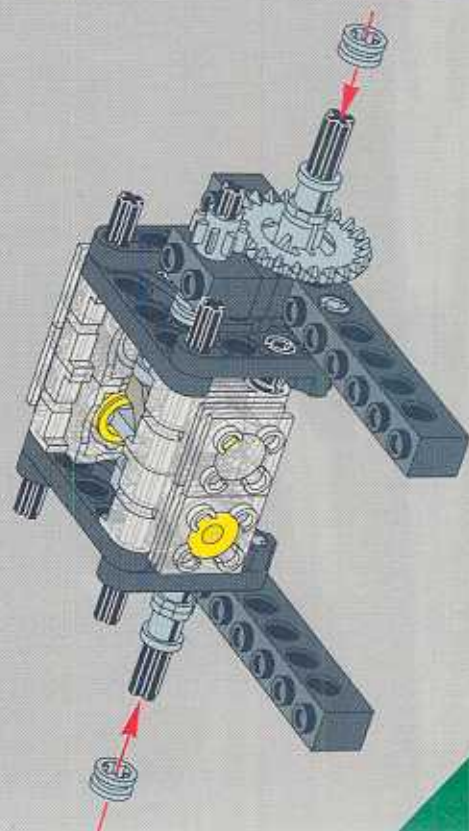
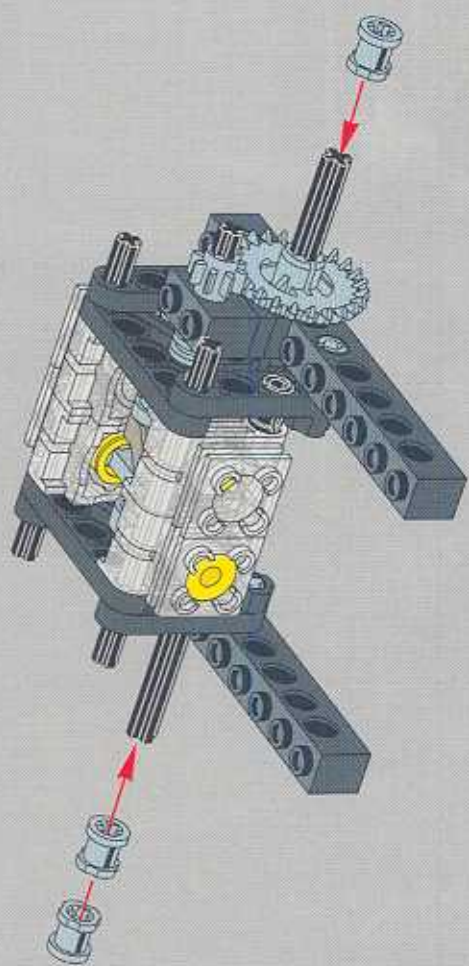
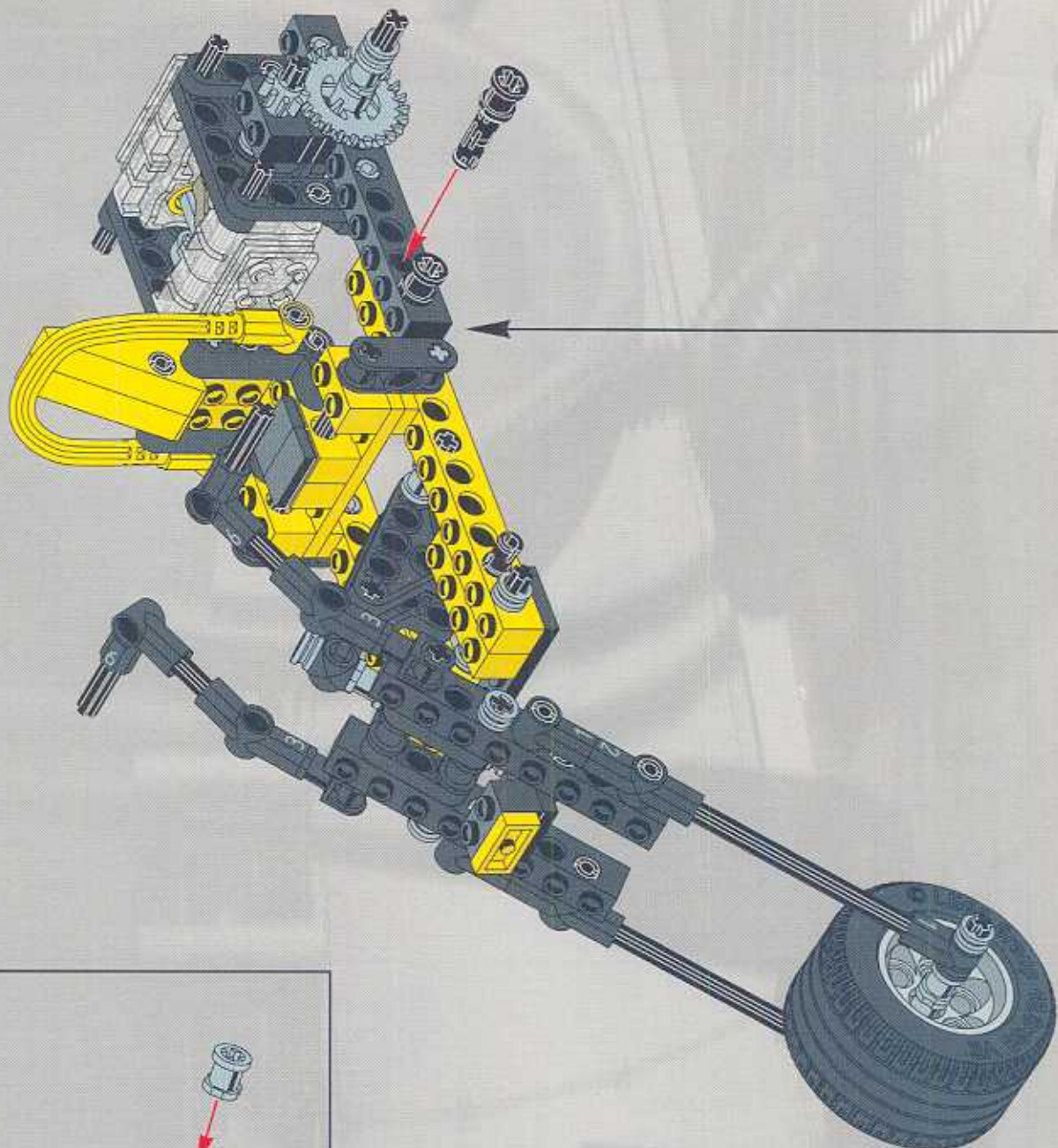



LEGO Technic

18

2x

2x

This inset box contains the parts list for step 18. It features a large number '18' in the top left corner. Below the number, there are two items: a grey axle connector (shown as two views) and a black tire. The quantity '2x' is written to the right of the axle connector and below the tire.

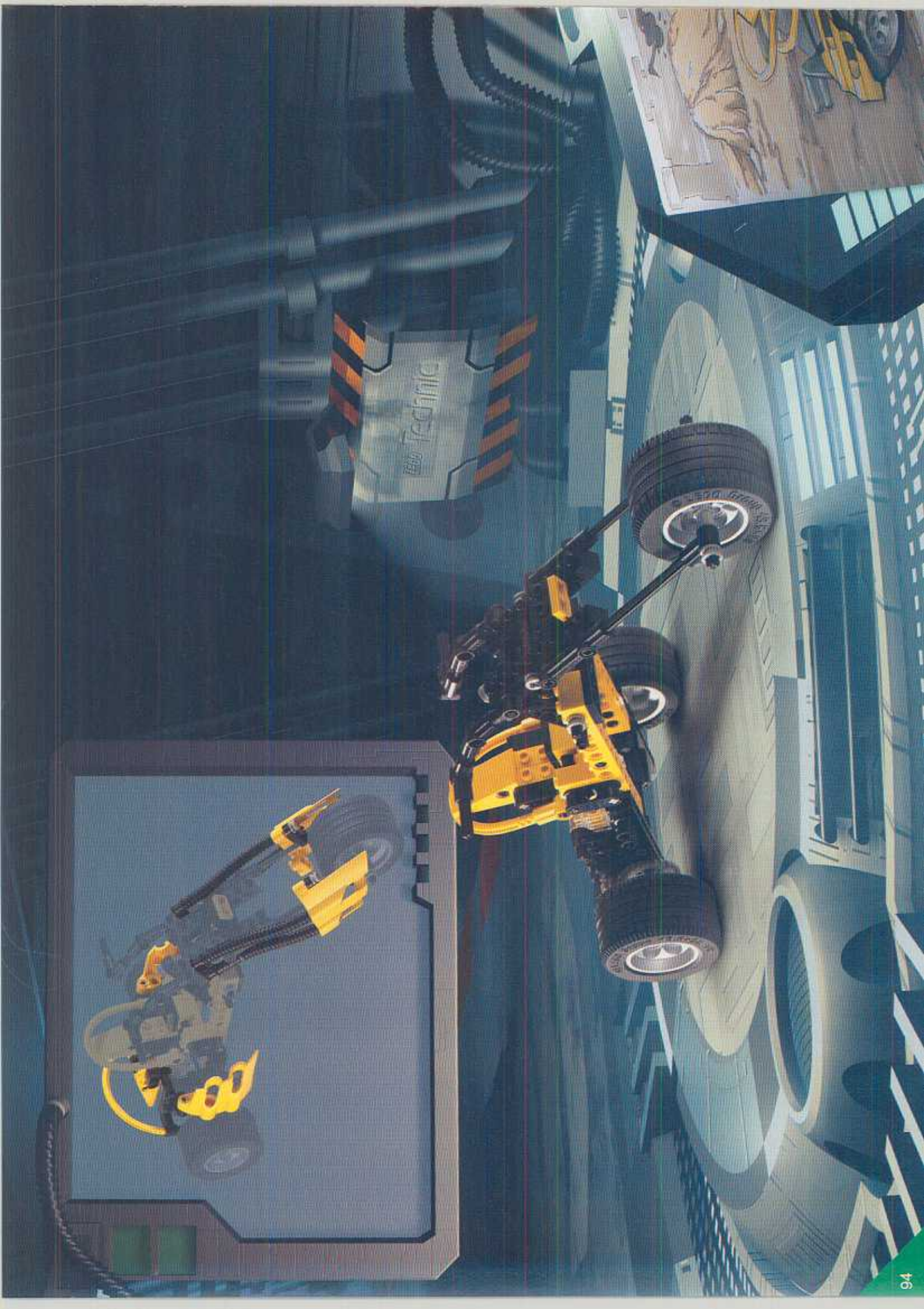



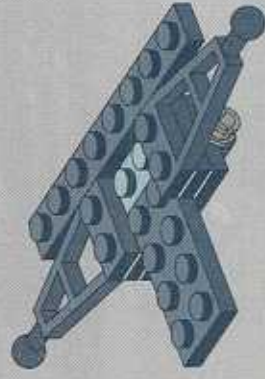
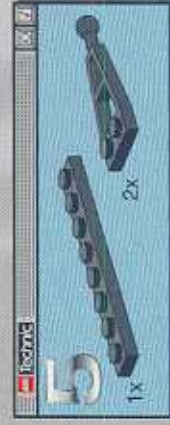
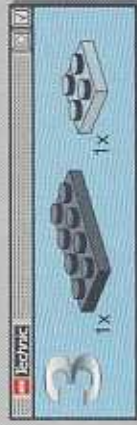
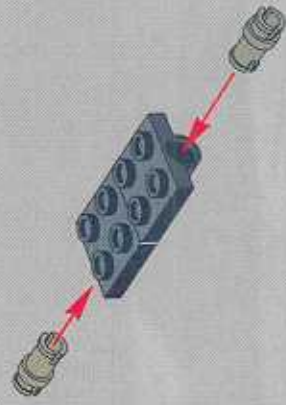
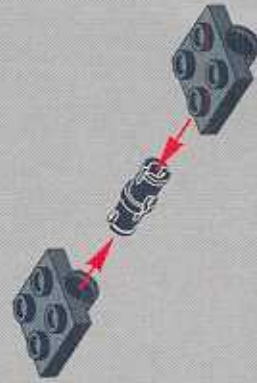

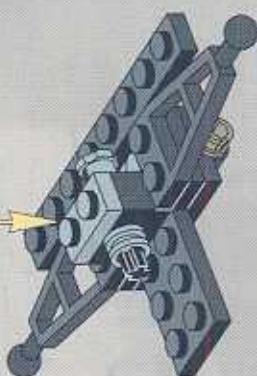
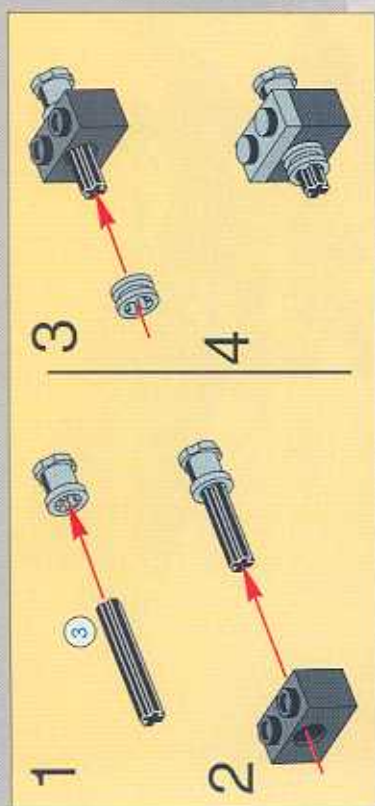
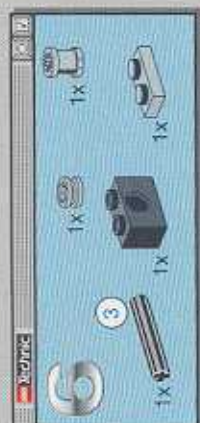

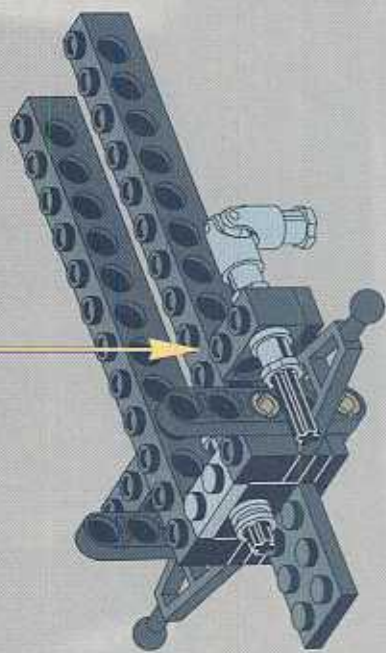
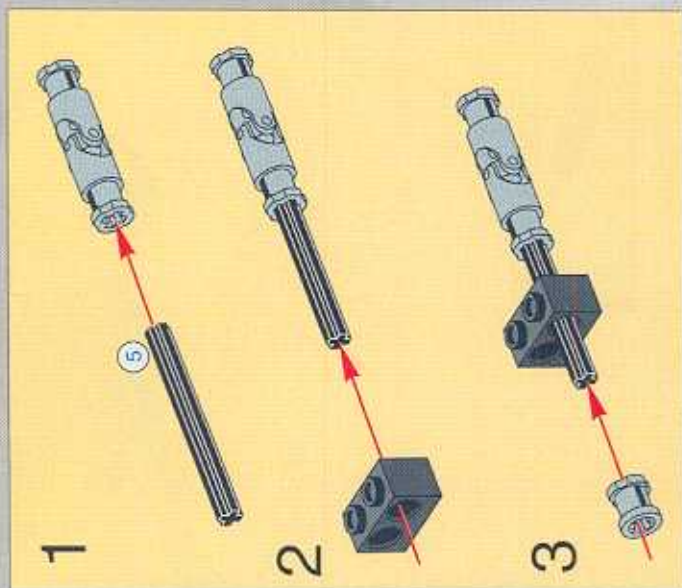
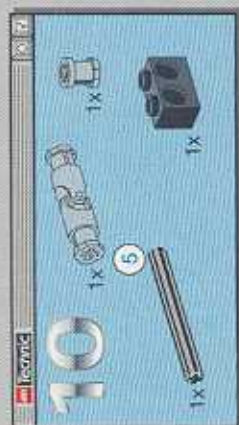
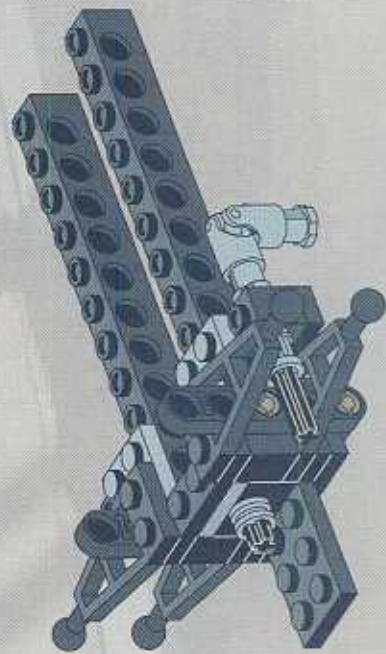
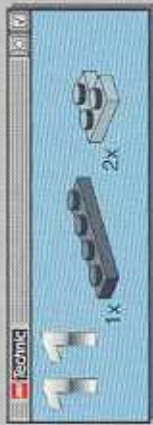

15  2x

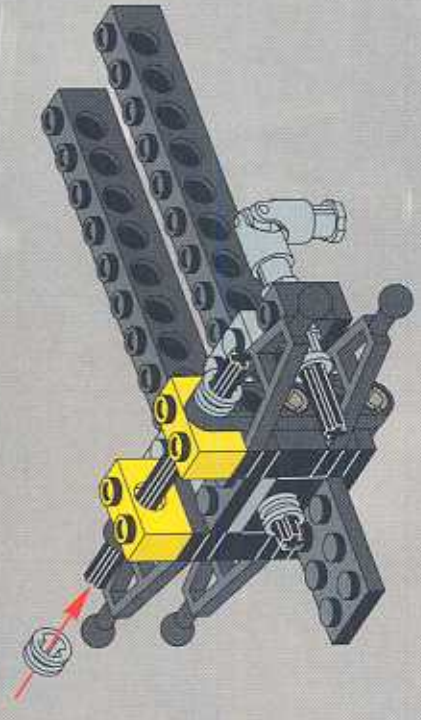

16  2x

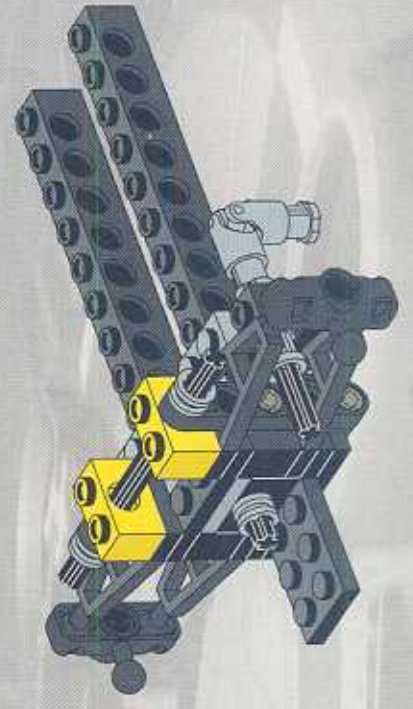

13  2x



14  1x



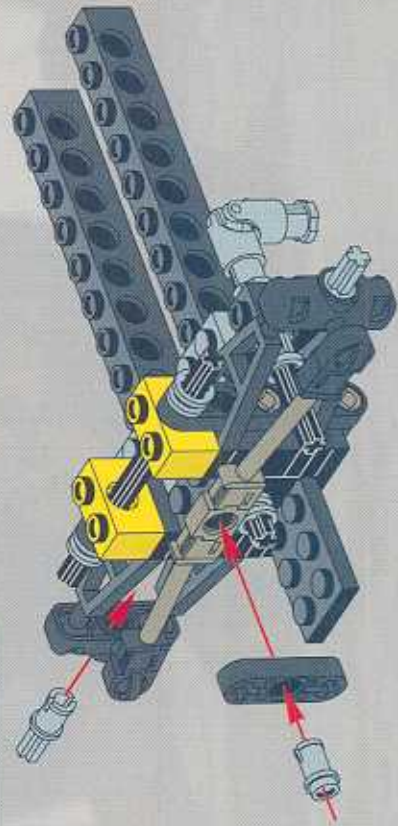
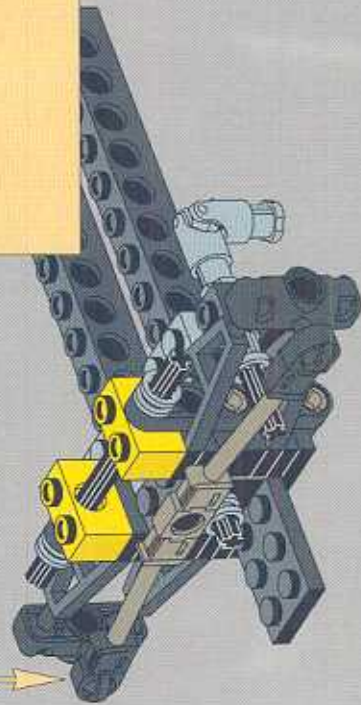
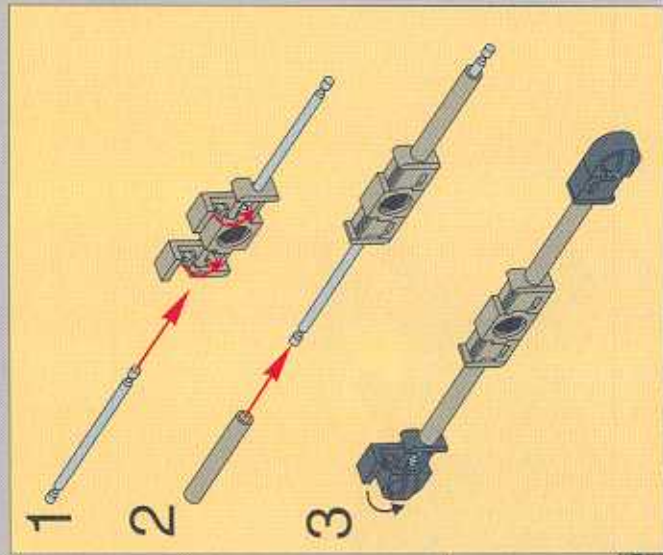
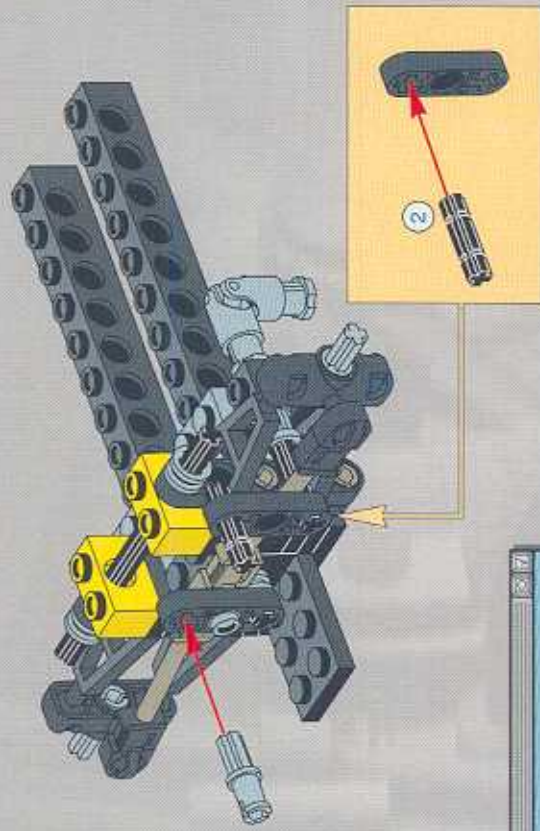

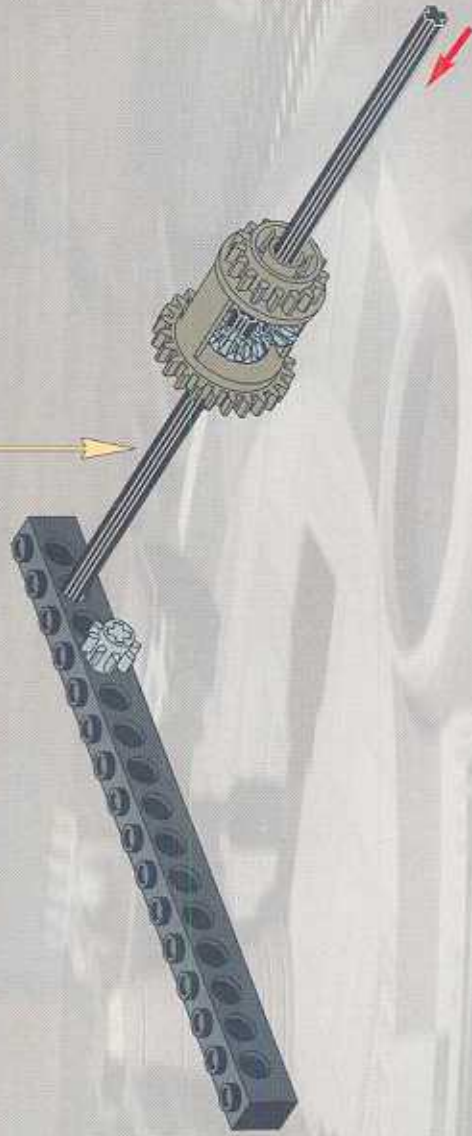
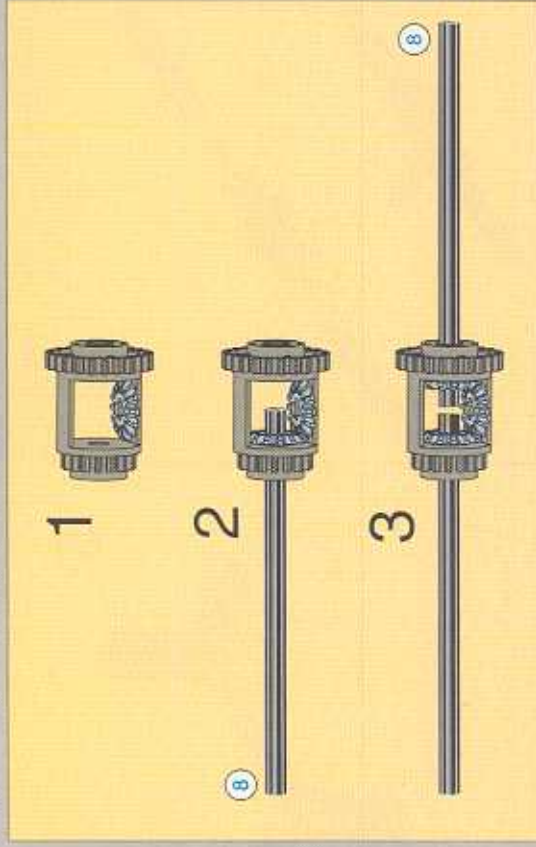
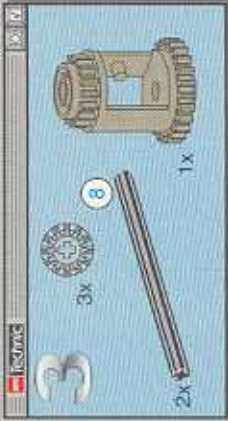

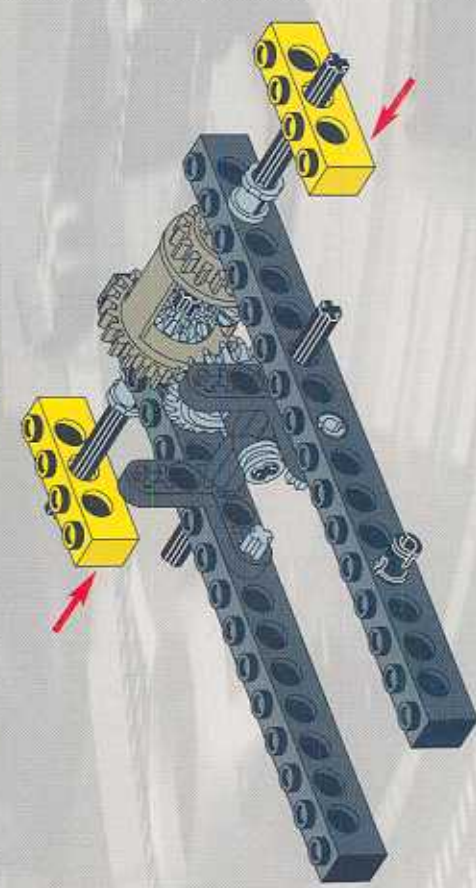
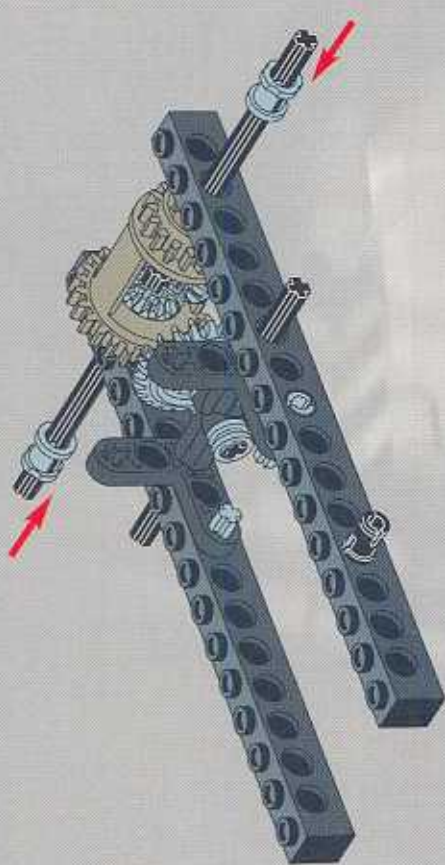
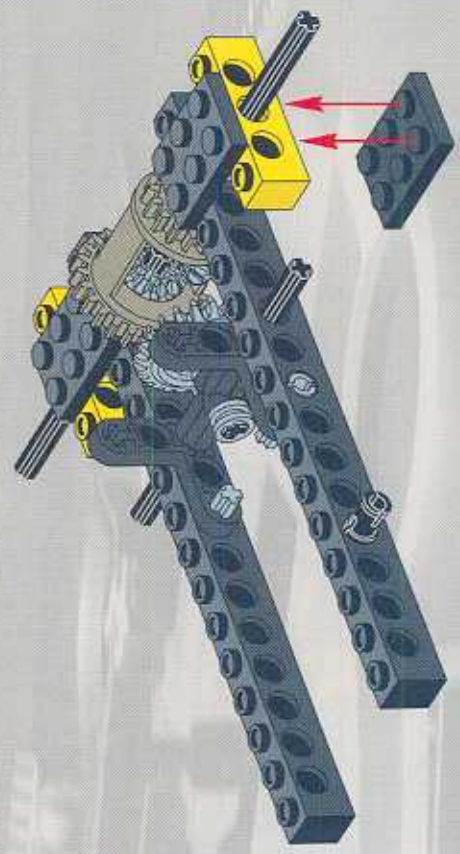
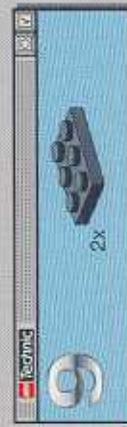
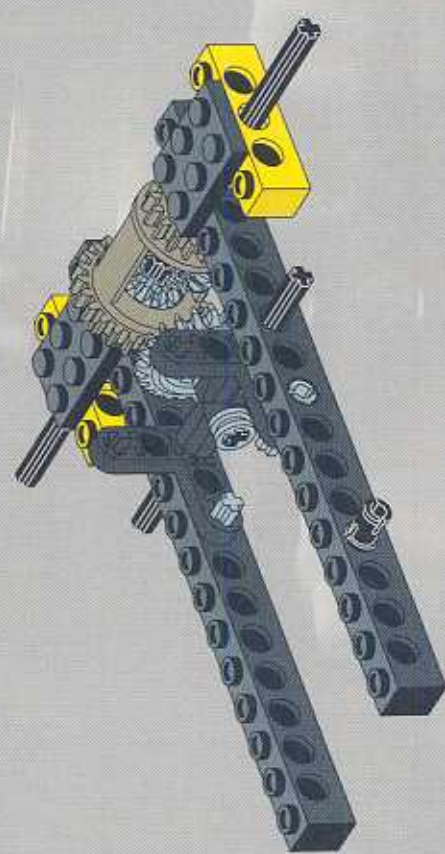

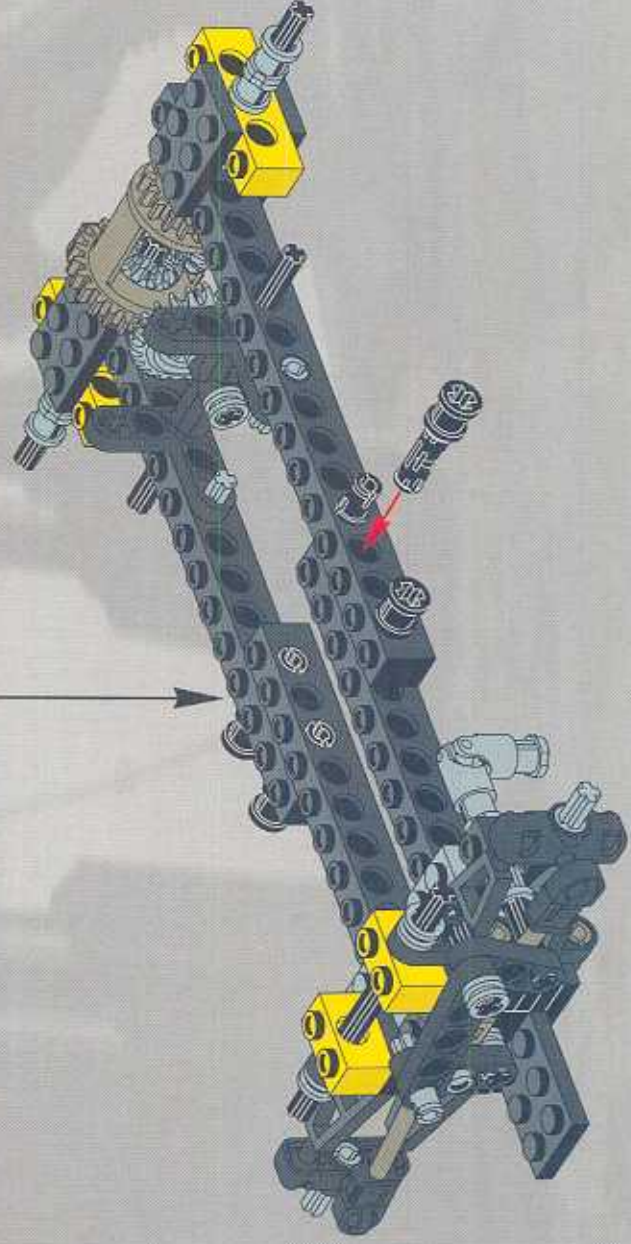
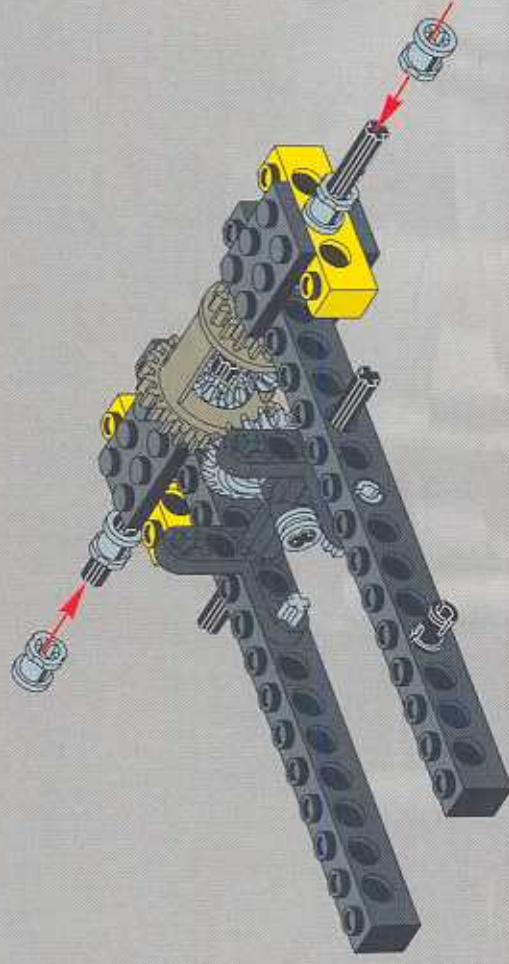
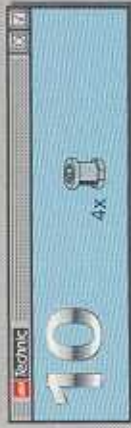

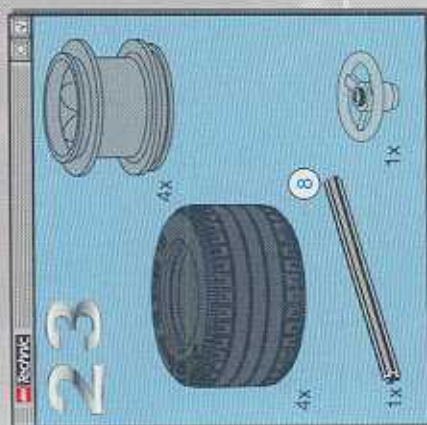
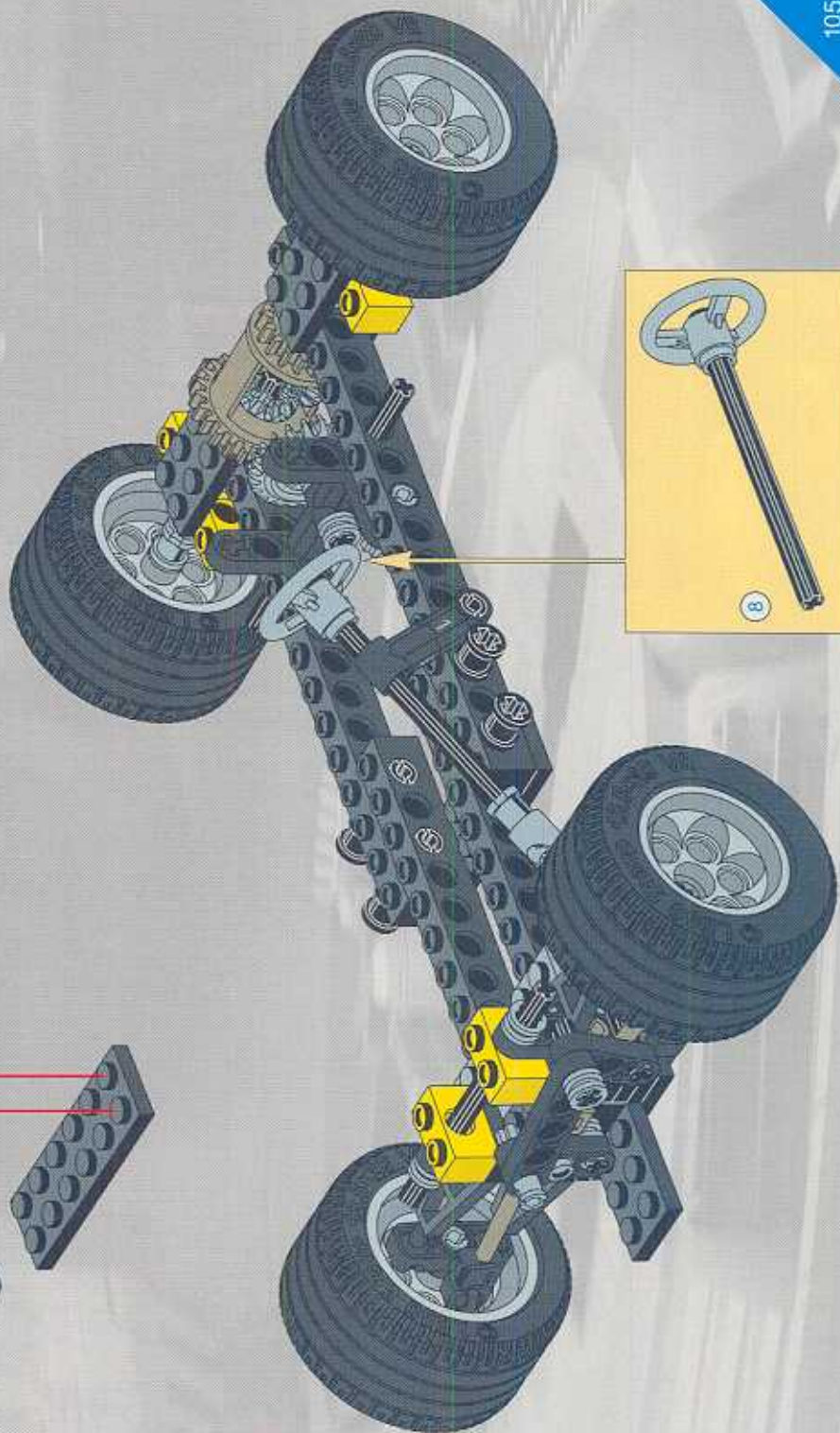
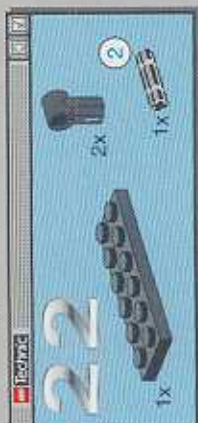
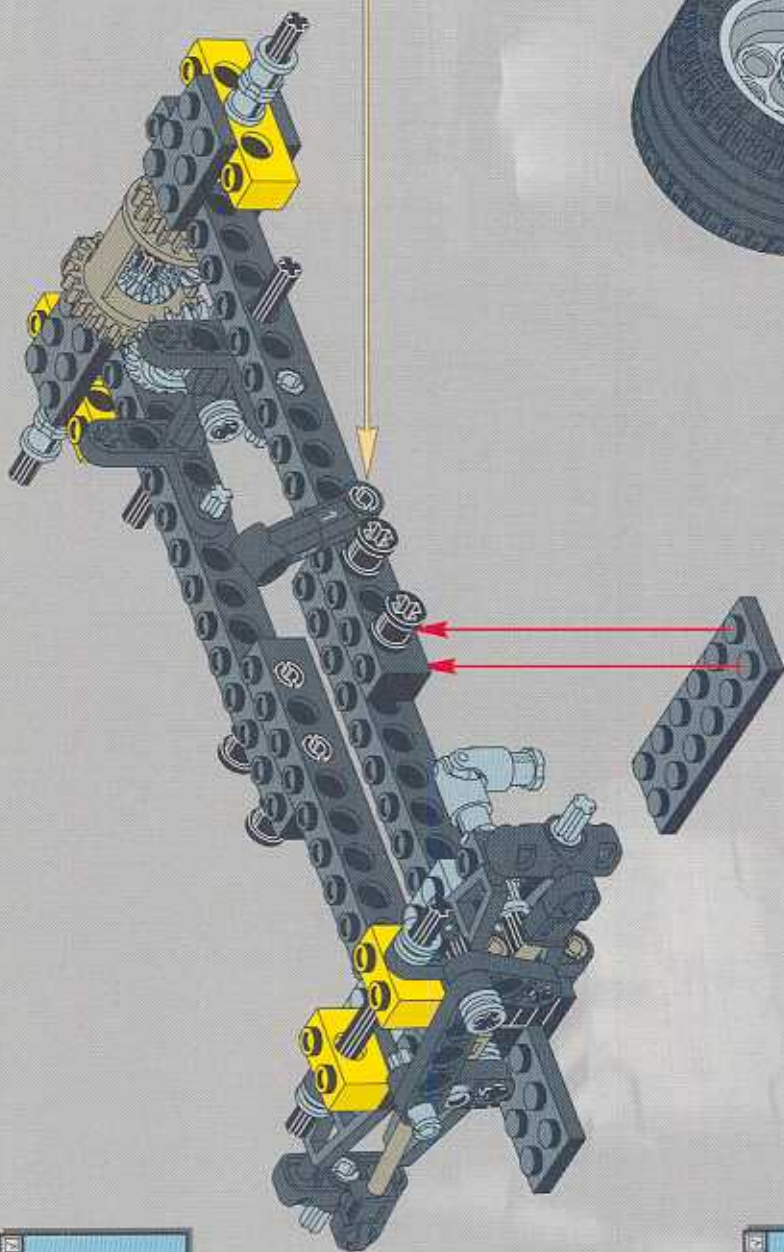
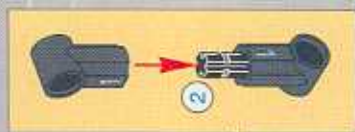

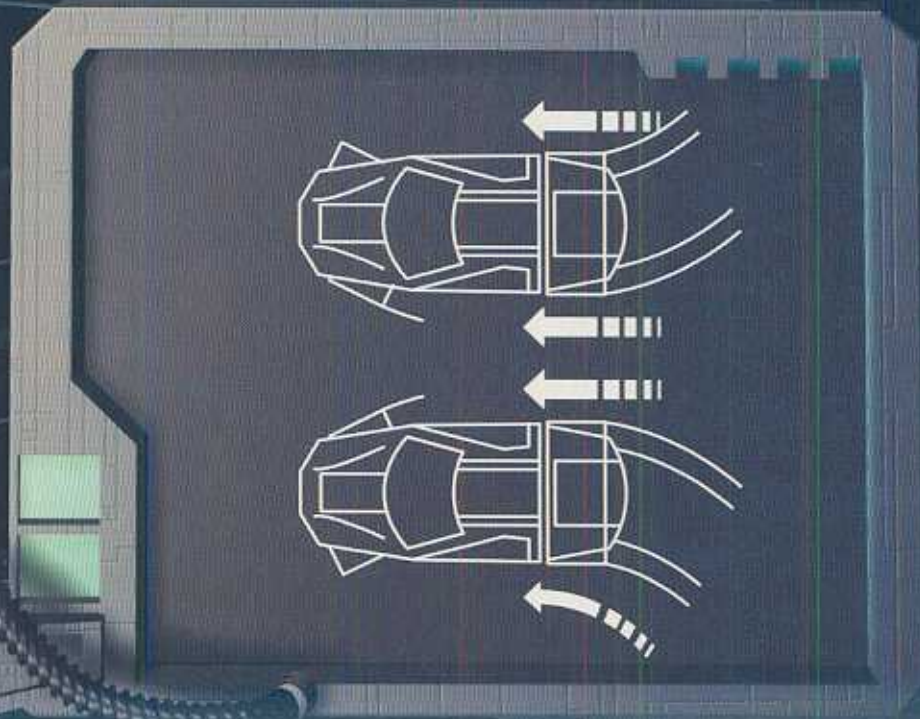
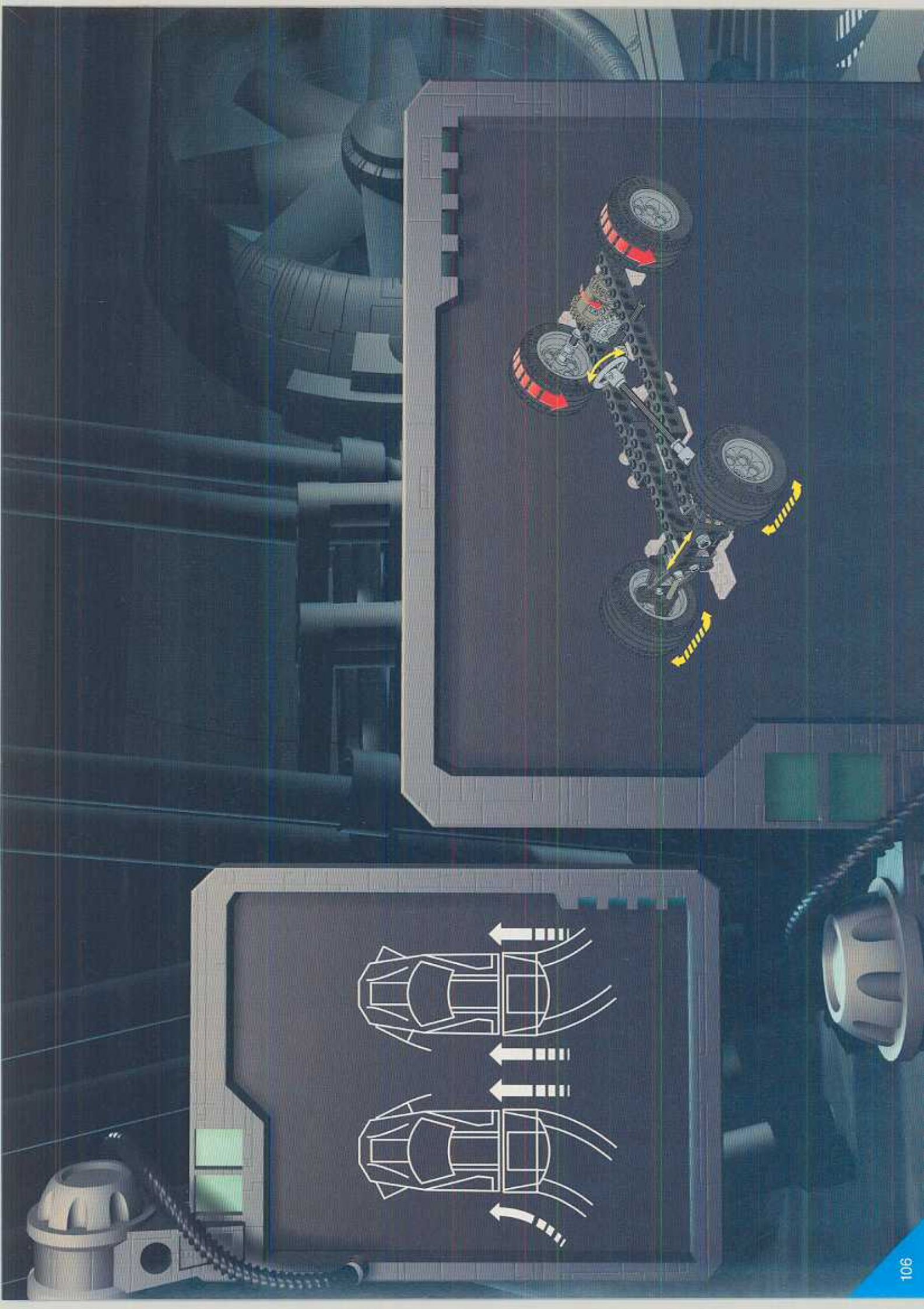

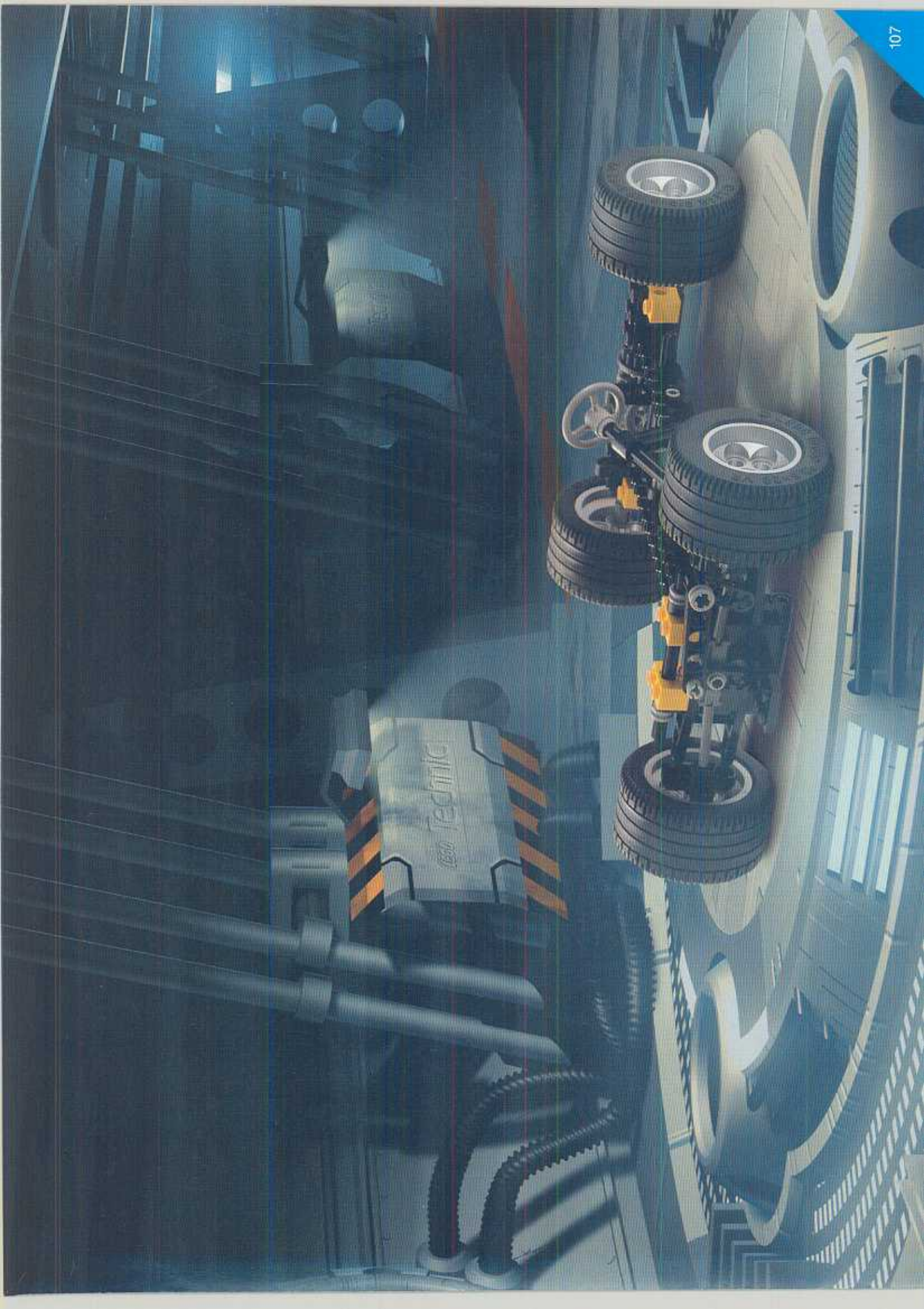

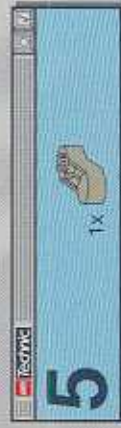
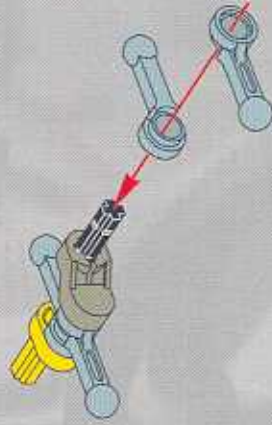
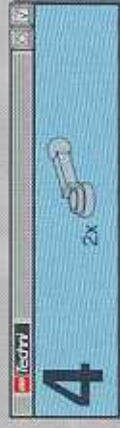
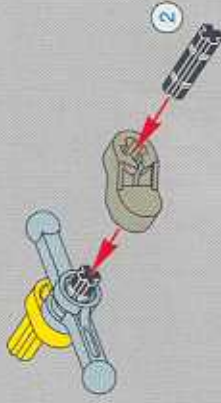
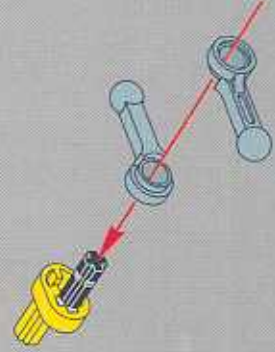
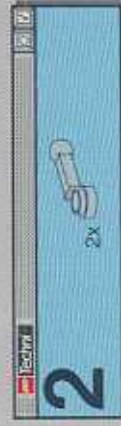

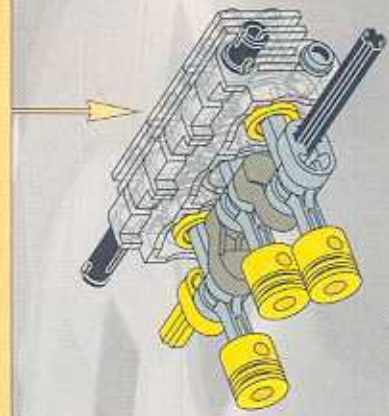
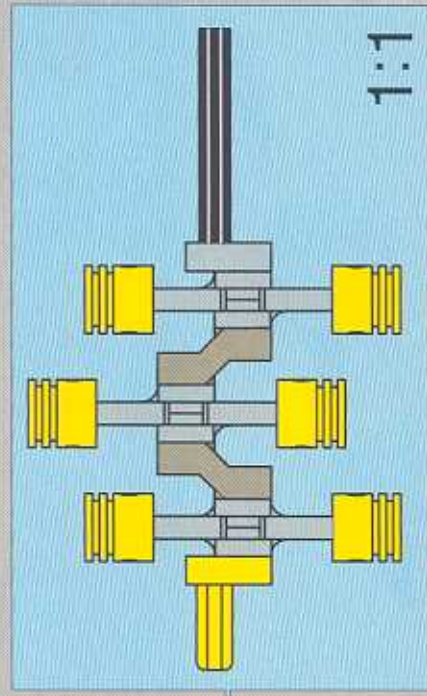

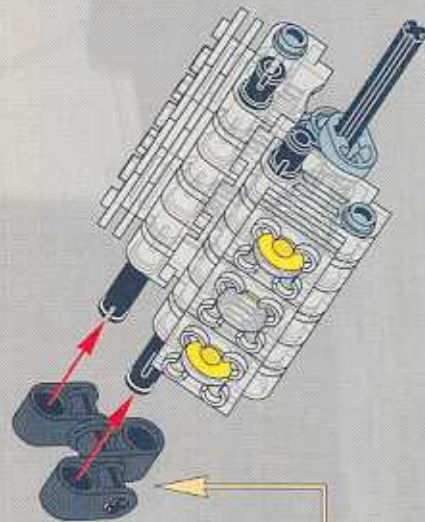
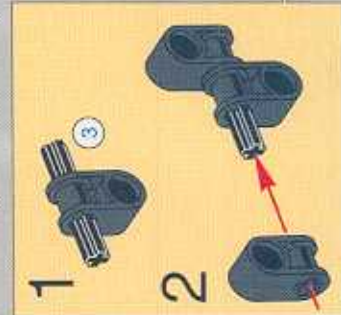
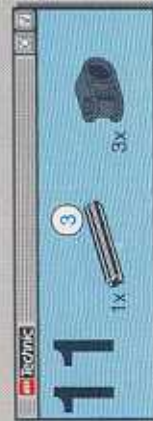
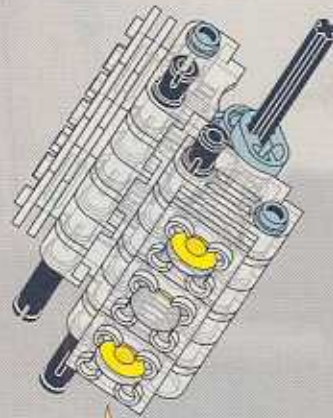
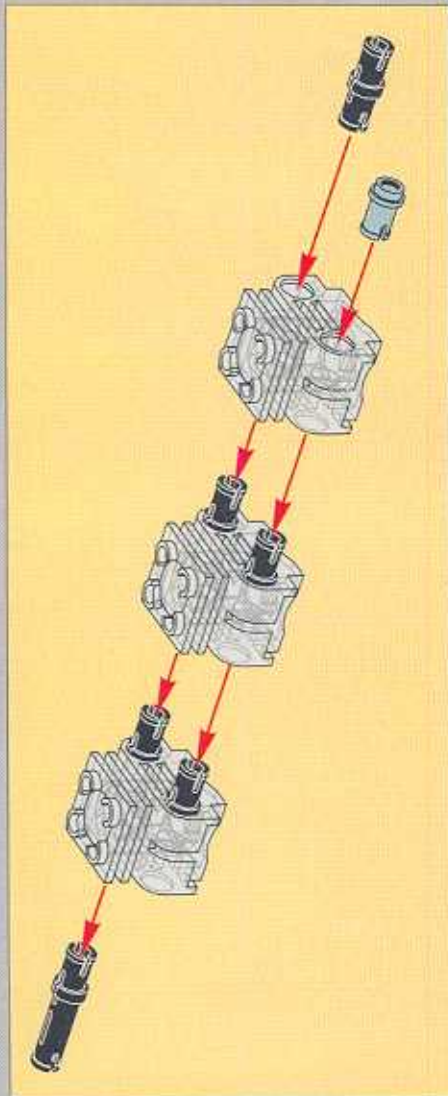
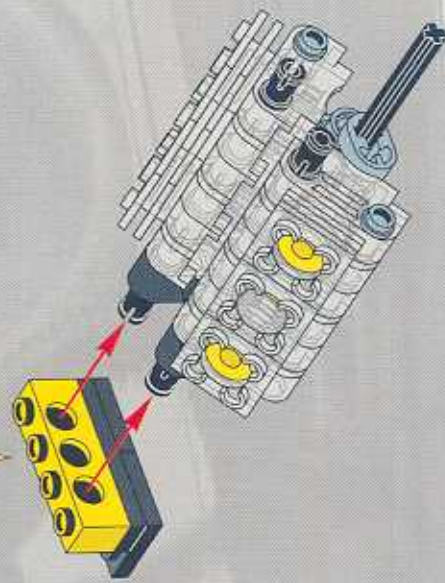
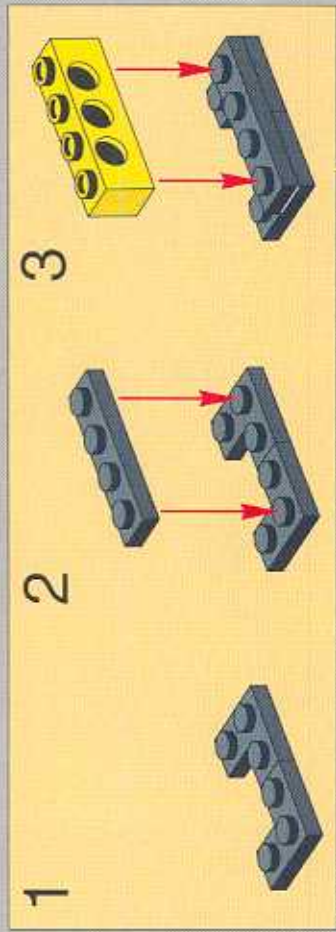
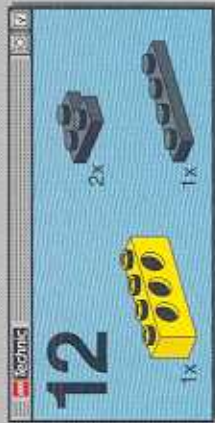

13

1x 1x3 Technic Brick with 2 holes

2x 1x3 Technic Brick with 2 holes

1x 1x5 Technic Brick with 2 holes

1x 1x7 Technic Brick with 2 holes

2x 1x3 Technic Pin



1x 1x3 Technic Pin

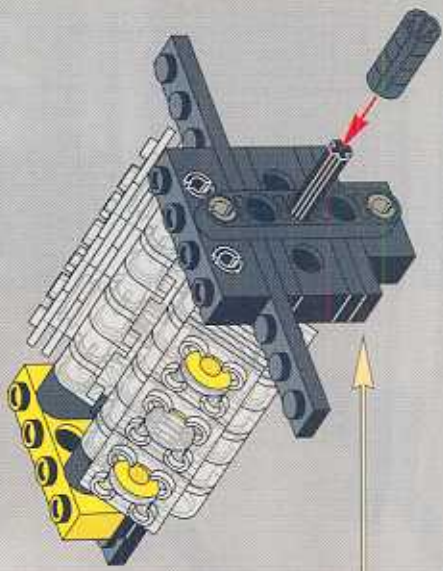
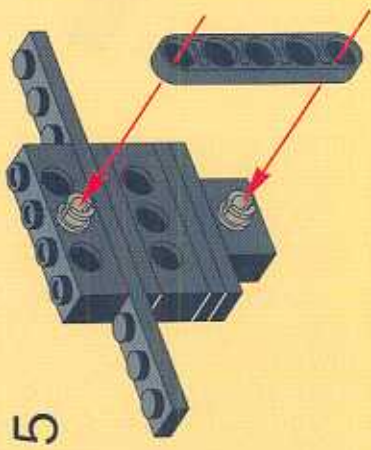
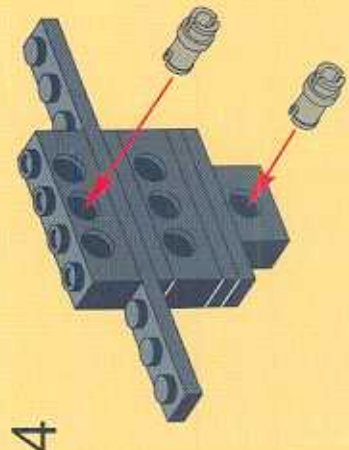
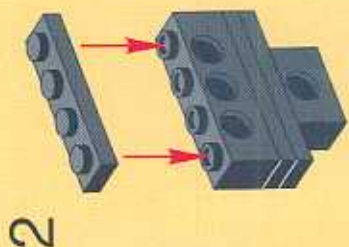
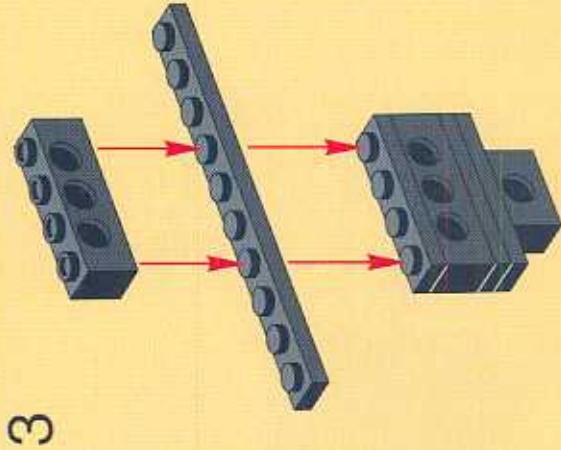
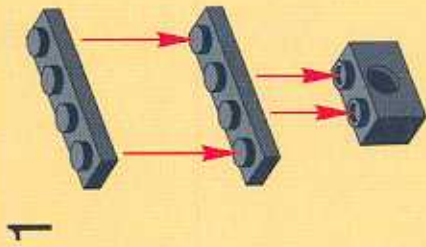

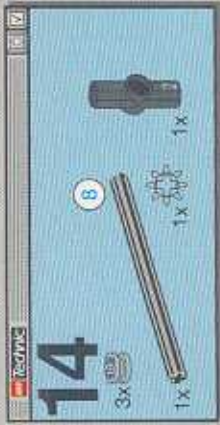
3x 1x3 Technic Pin





14

 3x  1x 

 1x  1x 

 1x 

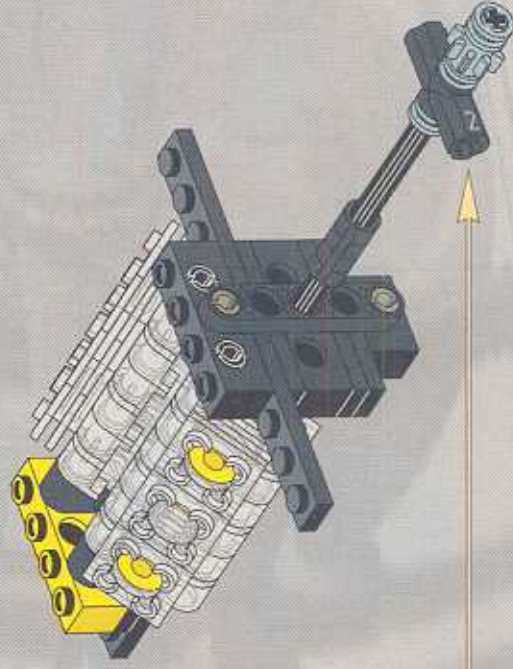
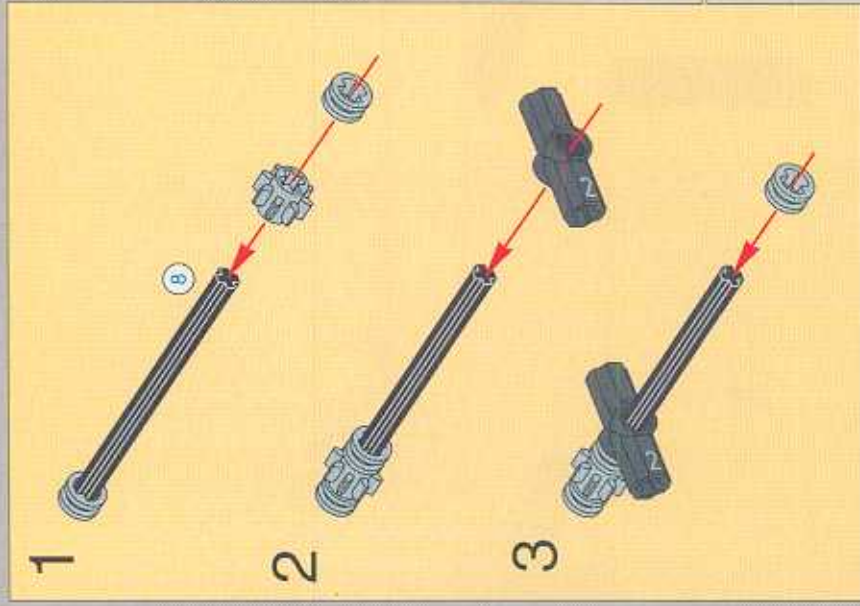

LEGO Technic
24

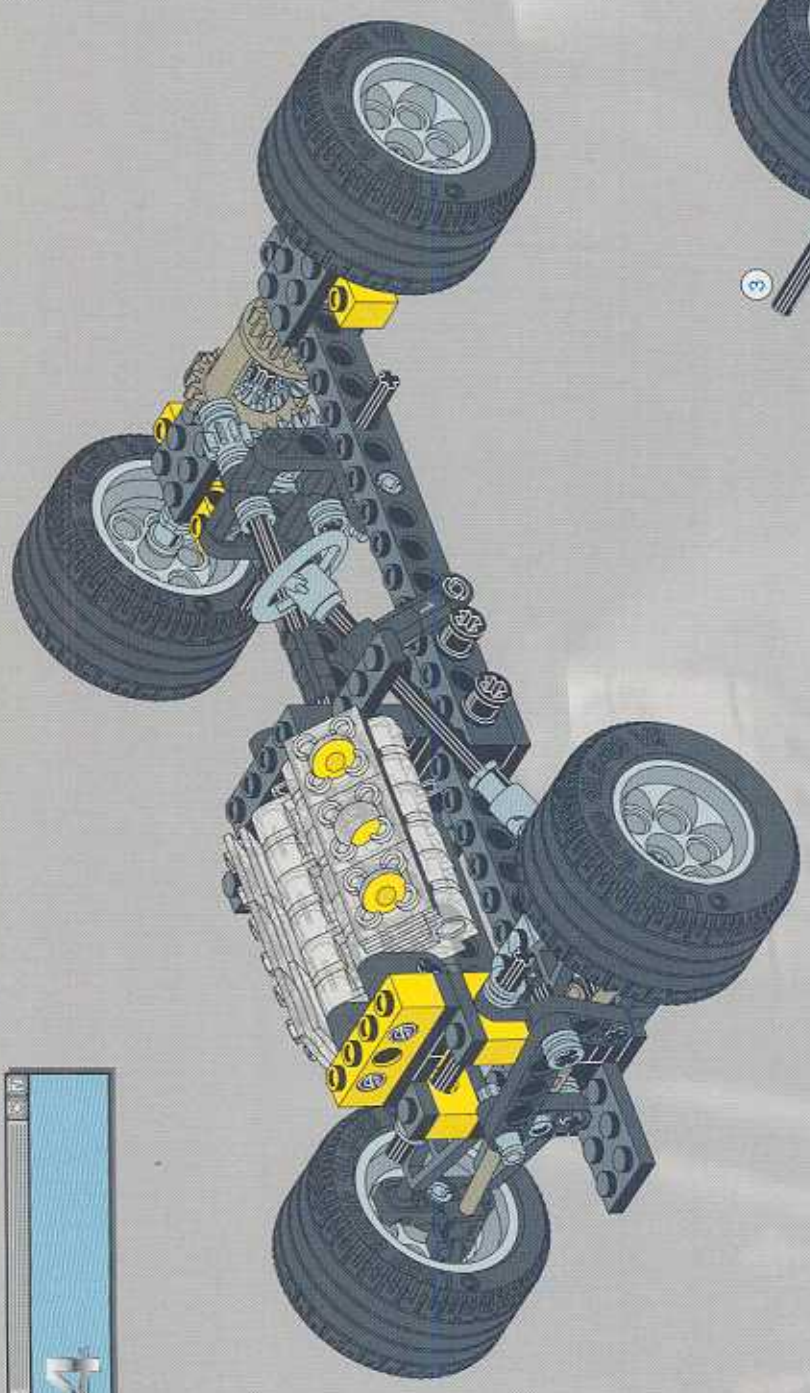

LEGO Technic
25
2x
3

