

8-14

8676

User information in accordance with Article 6.3 of Directive 1999/5/EC

Danish: LEGO Company erklærer herved, at følgende udstyr Sunset Cruiser (8676) overholder de væsentlige krav og øvrige relevante krav i direktiv 1999/5/EF.

Dutch: Hierbij verklaart LEGO Company dat het toestel Sunset Cruiser (8676) in overeenstemming is met de essentiële eisen en de andere relevante bepalingen van richtlijn 1999/5/EG. Bij deze verklaart LEGO Company dat deze Sunset Cruiser (8676) voldoet aan de essentiële eisen en aan de overige relevante bepalingen van Richtlijn 1999/5/EC.

English: Hereby, LEGO Company, declares that this Sunset Cruiser (8676) is in compliance with the essential requirements and other relevant provisions of Directive 1999/5/EC.

Finnish: LEGO Company vakuuttaa täten että Sunset Cruiser (8676) tyyppinen laite on direktiivin 1999/5/EY oleellisten vaatimusten ja sitä koskevien direktiivin muiden ehtojen mukainen.

French: Par la présente LEGO Company déclare que l'appareil Sunset Cruiser (8676) est conforme aux exigences essentielles et aux autres dispositions pertinentes de la directive 1999/5/CE.

Par la présente, LEGO Company déclare que ce Sunset Cruiser (8676) est conforme aux exigences essentielles et aux autres dispositions de la directive 1999/5/CE qui lui sont applicables.

German: Hiermit erklärt LEGO Company, dass sich dieser Sunset Cruiser (8676) in Übereinstimmung mit den grundlegenden Anforderungen und den anderen relevanten Vorschriften der Richtlinie 1999/5/EG befindet". (BMWfi)

Hiermit erklärt LEGO Company die Übereinstimmung des Gerätes Sunset Cruiser (8676) mit den grundlegenden Anforderungen und den anderen relevanten Festlegungen der Richtlinie 1999/5/EG. (Wien)

Greek: **ΜΕ ΤΗΝ ΠΑΡΟΥΣΑ LEGO Company ΔΗΛΩΝΕΙ ΟΤΙ Sunset Cruiser (8676) ΣΥΜΜΟΡΦΩΝΕΤΑΙ ΠΡΟΣ ΤΙΣ ΟΥΣΙΩΔΕΙΣ ΑΠΑΙΤΗΣΕΙΣ ΚΑΙ ΤΙΣ ΣΧΕΤΙΚΕΣ ΔΙΑΤΑΞΕΙΣ ΤΗΣ ΟΔΗΓΙΑΣ 1999/5/ΕΚ ΑΟΙΠΕΣ**

Italian: Con la presente LEGO Company dichiara che questo Sunset Cruiser (8676) è conforme ai requisiti essenziali ed alle altre disposizioni pertinenti stabilite dalla direttiva 1999/5/CE.

Portuguese: LEGO Company declara que este Sunset Cruiser (8676) e está conforme com os requisitos essenciais e outras provisões da Directiva 1999/5/CE.

Spanish: Por medio de la presente LEGO Company declara que el Sunset Cruiser (8676) cumple con los requisitos esenciales y cualesquiera otras disposiciones aplicables o exigibles de la Directiva 1999/5/CE.

Swedish: Härmed intygar LEGO Company att denna Sunset Cruiser (8676) står i överensstämmelse med de väsentliga egenskapskrav och övriga relevanta bestämmelser som framgår av direktiv 1999/5/EG.

Model: Sunset Cruiser transmitter (57823) FCC ID: NPI57823

This device complies with part 15 of the FCC Rules. Operation is subject to the following 2 conditions:

1. This device may not cause harmful interference.
2. This device must accept any interference received including interference that may cause undesired operation.

Warning:

Changes or modifications to this unit not expressly approved by the party responsible for compliance could void the user's authority to operate the equipment.

NOTE:

This equipment has been tested and found to comply with the limits for a Class B digital device, pursuant to part 15 of the FCC Rules. These limits are designed to provide reasonable protection against harmful interference in a residential installation.

This equipment generates, uses an can radiate radio frequency energy and, if not installed and used in accordance with the instructions, may cause harmful interference to radio communications. However, there is no guarantee that interference will not occur in a particular installation. If this equipment does cause harmful interference to radio or television reception, which can be determined by turning the equipment off and on, the user is encouraged to try to correct the interference by one or more of the following measures:

- Reorient or relocate the receiving antenna.
- Increase the separation between the equipment and receiver.
- Connect the equipment into an outlet on a circuit different from that to which the receiver is connected.

Consult the dealer or an experienced radio/TV technician for help.

Model: Sunset Cruiser receiver (57820) FCC ID: NPI57820

Cet appareil est conforme aux exigences de la section 15 des règlements du Conseil supérieur de l'audiovisuel (FCC). Son fonctionnement est soumis aux 2 conditions qui suivent :

1. Cet appareil ne peut causer de brouillage nocif.
2. Cet appareil doit accepter tout brouillage reçu, y compris le brouillage pouvant engendrer un code d'opération non souhaité.

Avertissement :

Les changements ou modifications apportés à cette unité et n'ayant pas été expressément autorisés par l'équipe responsable de la conformité aux règlements pourraient annuler la permission accordée à l'utilisateur quant à l'opération de l'équipement.

REMARQUE :

Cet équipement a été testé et déclaré conforme aux limites définies dans la section 15 de la réglementation FCC et applicables aux appareils numériques de classe B. Ces limites sont fixées pour obtenir une protection satisfaisante contre les interférences nuisibles dans les installations résidentielles.

Cet équipement produit, consomme et peut émettre de l'énergie radioélectrique et il risque, s'il n'est pas installé et utilisé conformément aux instructions, de provoquer des interférences nuisibles avec les communications radio. Il est cependant impossible de garantir que des interférences ne surviendront pas dans une installation particulière.

Si cet équipement est la cause d'interférences gênant la réception de programmes radio ou télévisés, ce qui peut être déterminé en mettant l'appareil hors tension et de nouveau sous tension, il est demandé à l'utilisateur de tenter de remédier au problème à l'aide d'une ou plusieurs des mesures suivantes :

- Réorienter ou déplacer l'antenne de réception.
- Augmenter la distance séparant l'équipement et le récepteur.
- Raccorder l'équipement sur une sortie appartenant à un circuit différent de celui auquel le récepteur est connecté.

Consulter le revendeur ou un technicien radio-télévision expérimenté pour obtenir de l'aide.



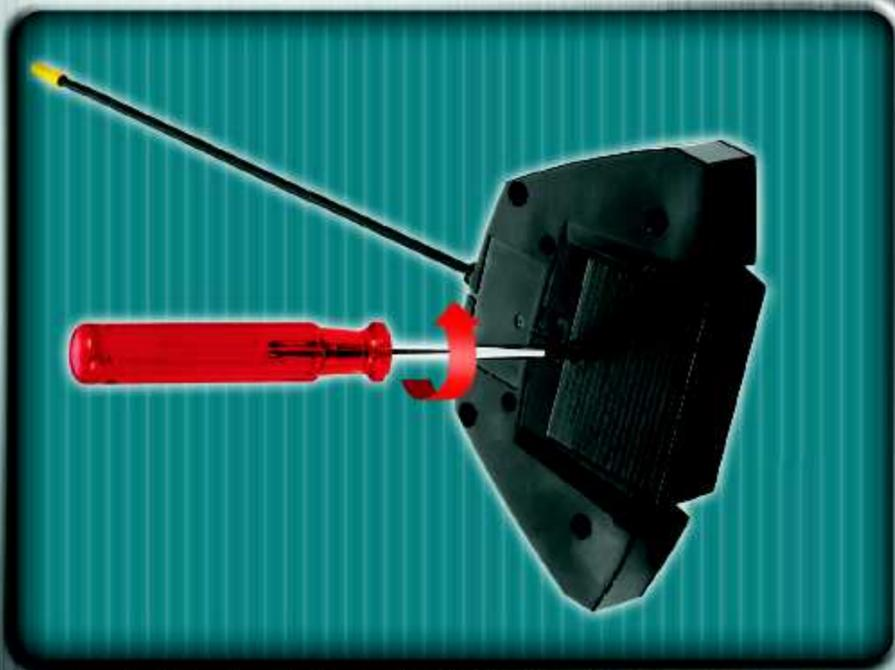
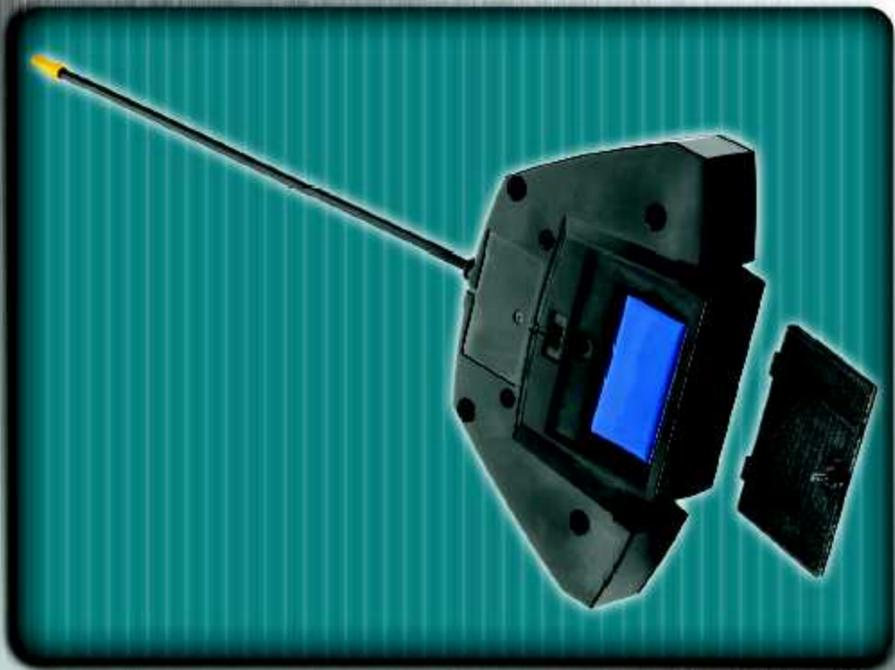
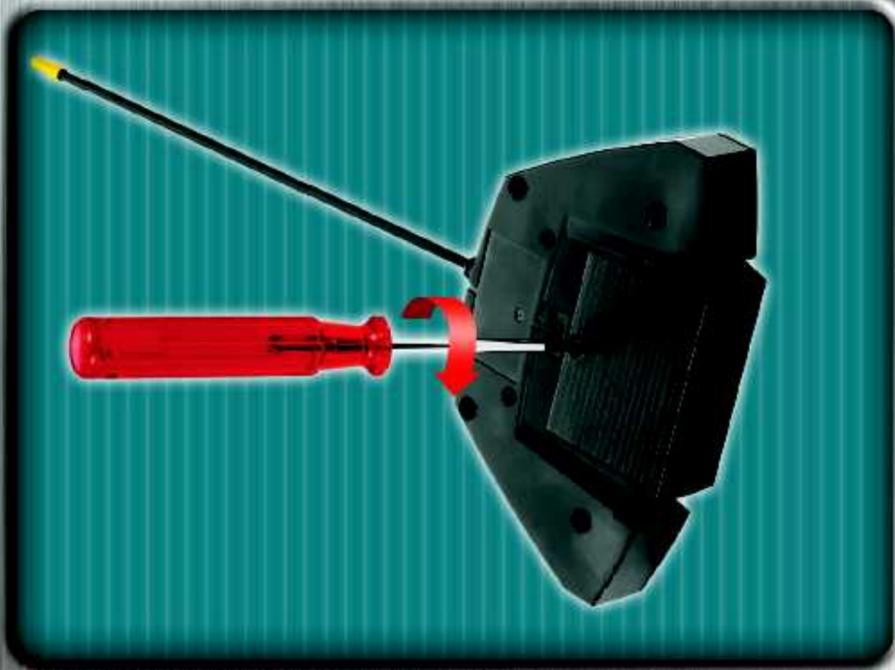

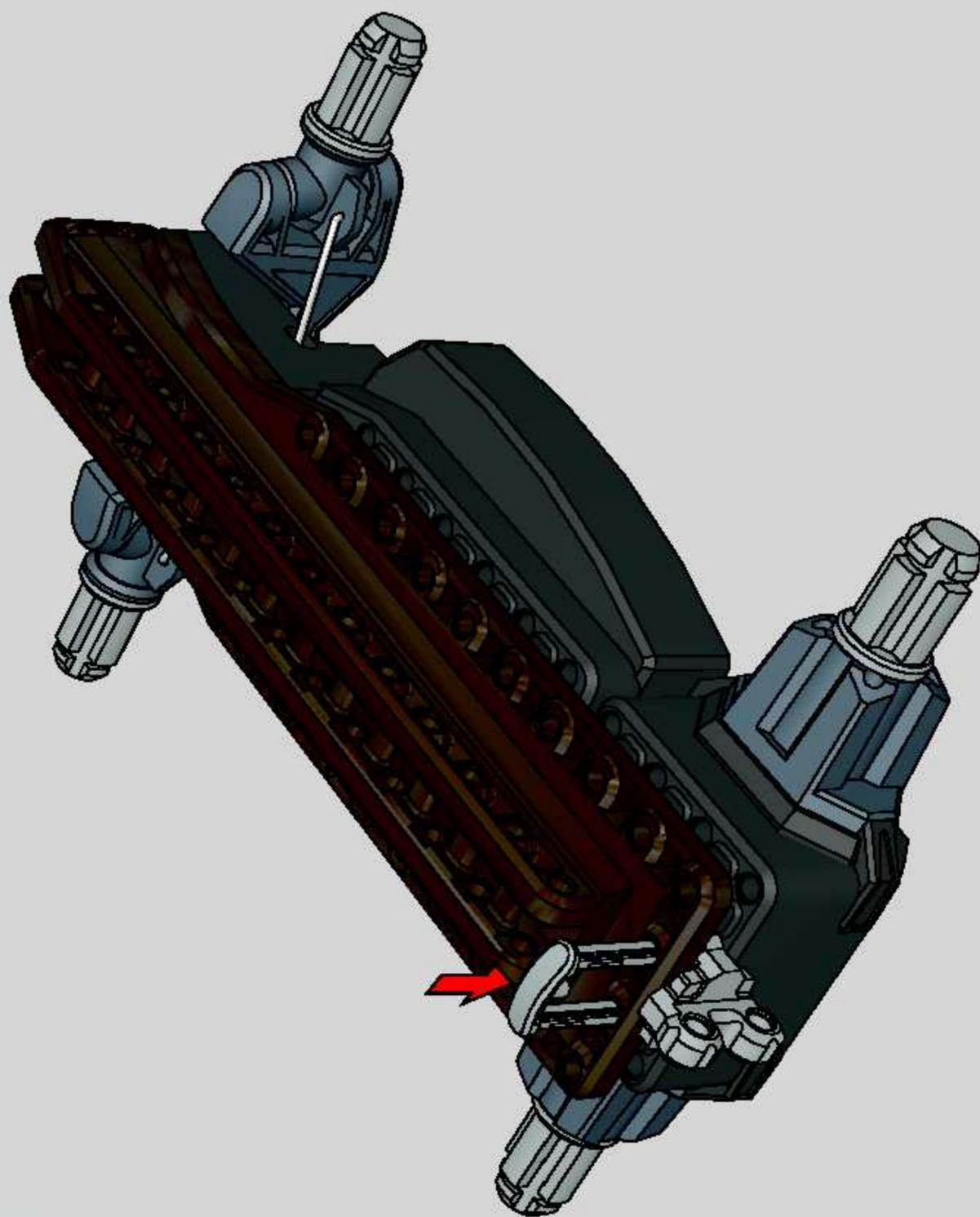

1

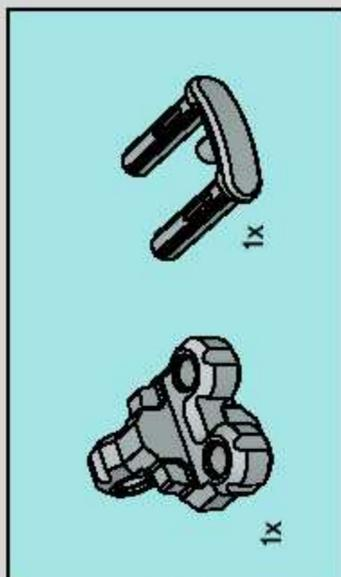

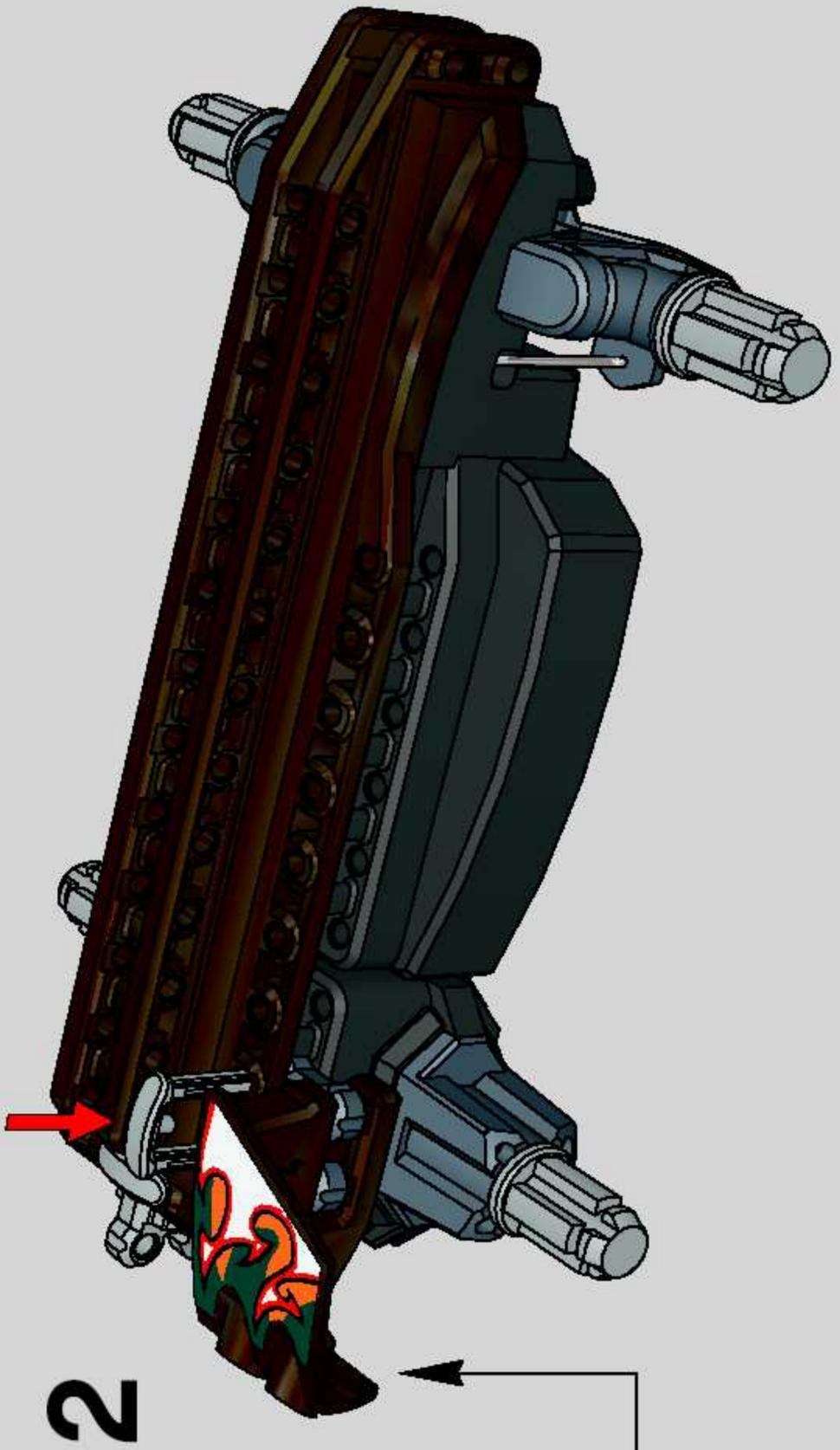

2

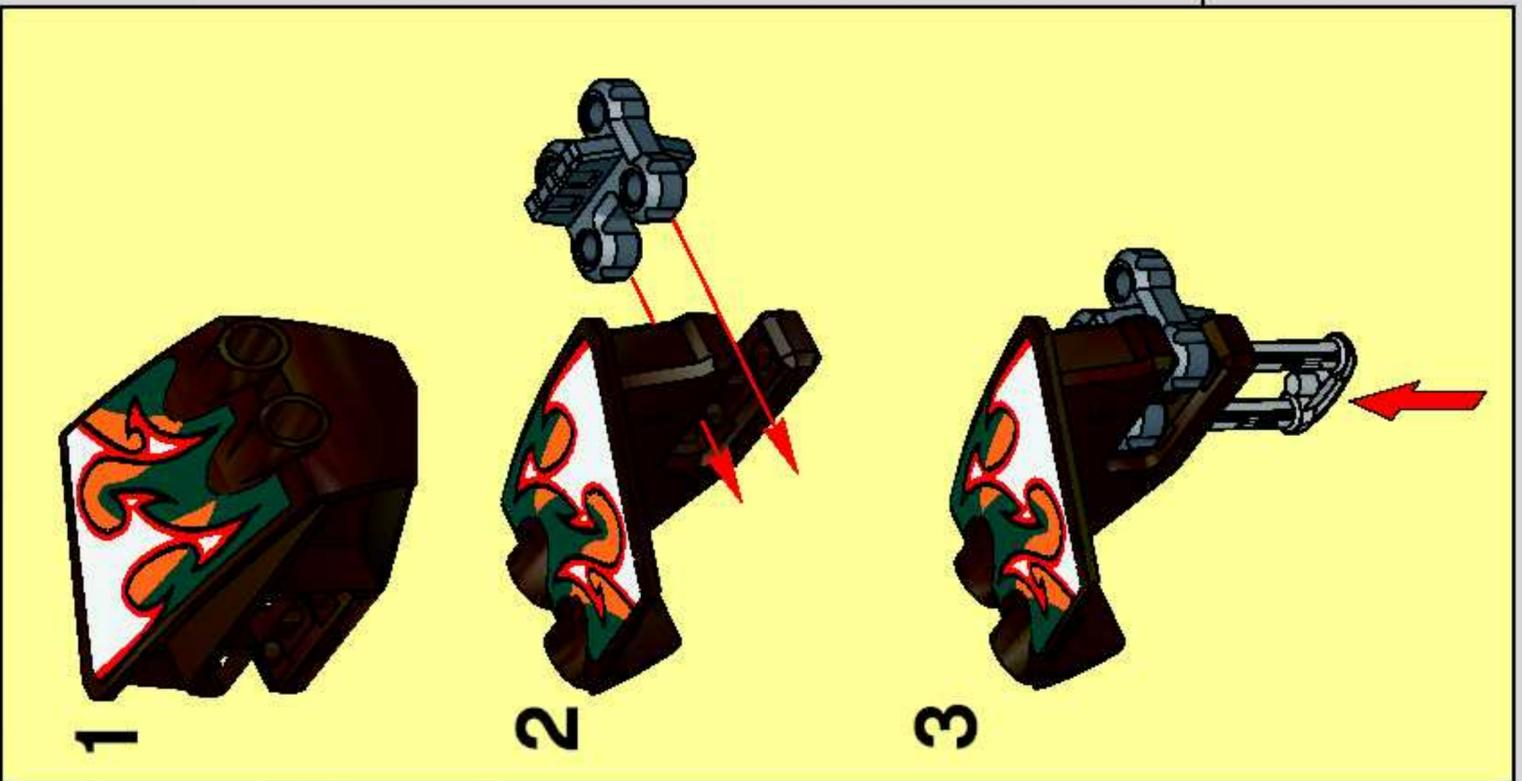

1

2

3

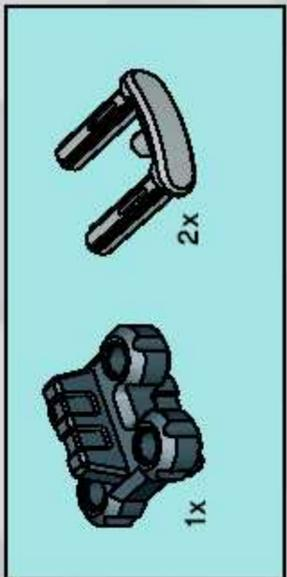

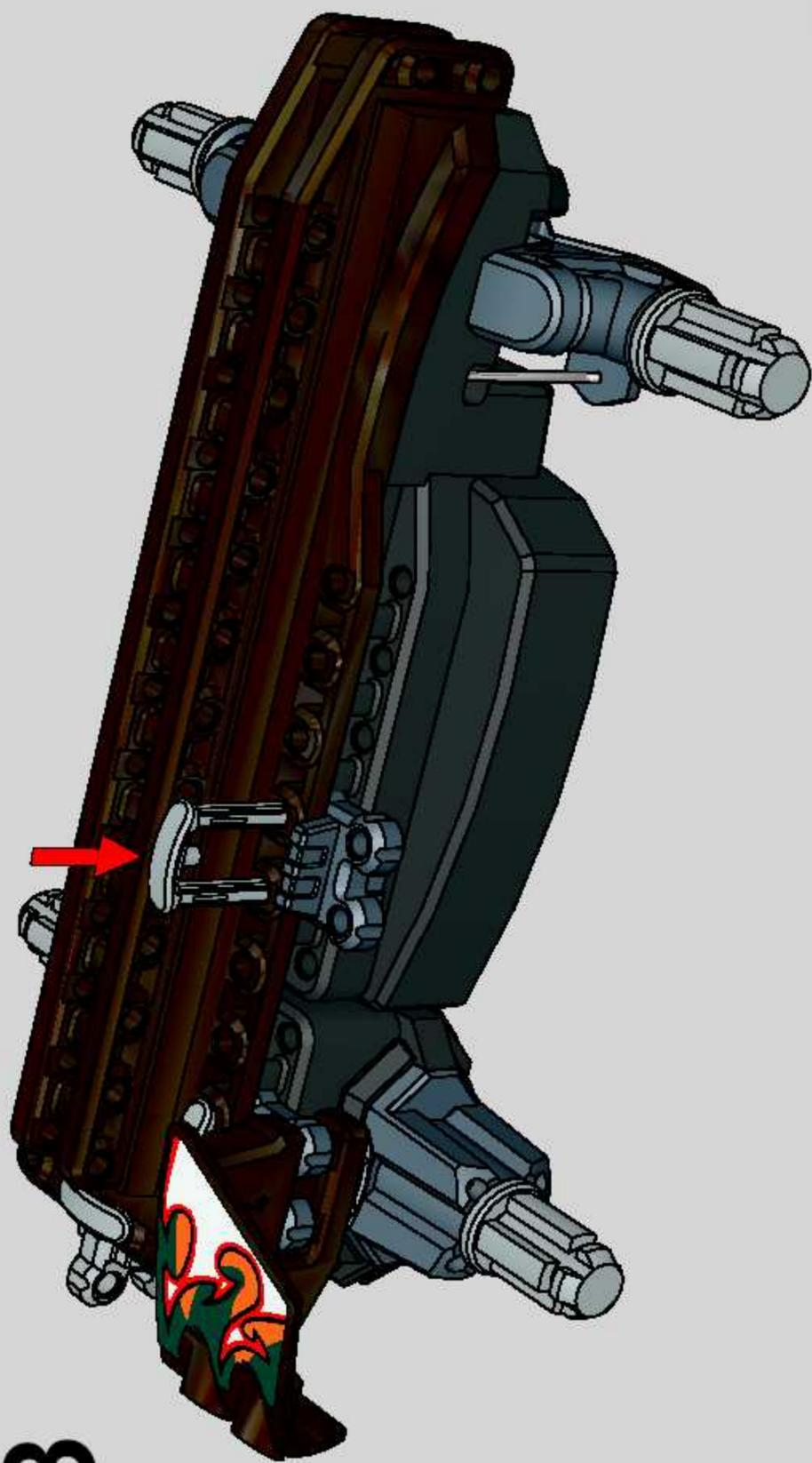

3

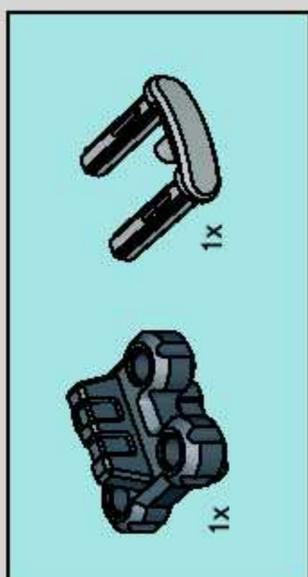

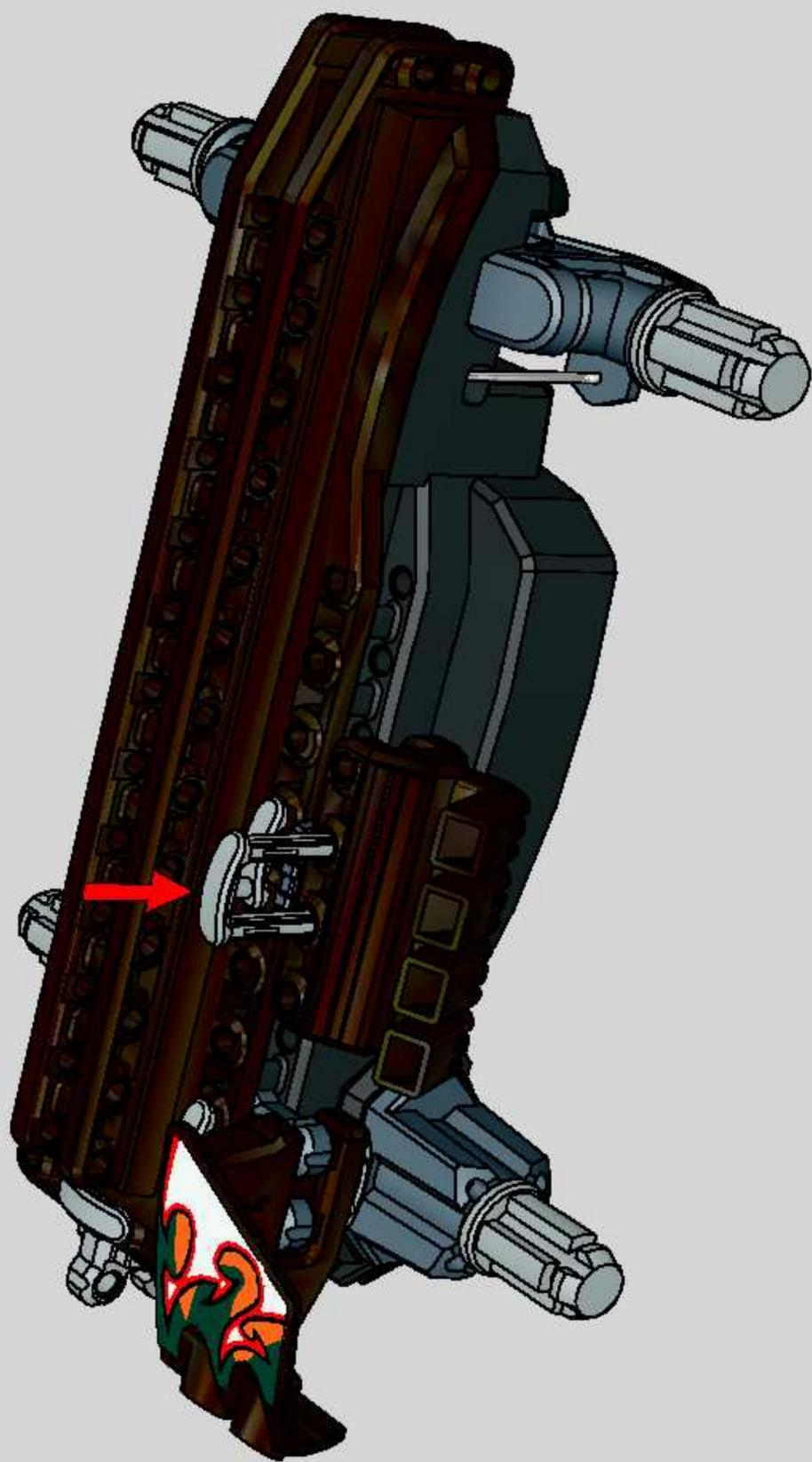

4

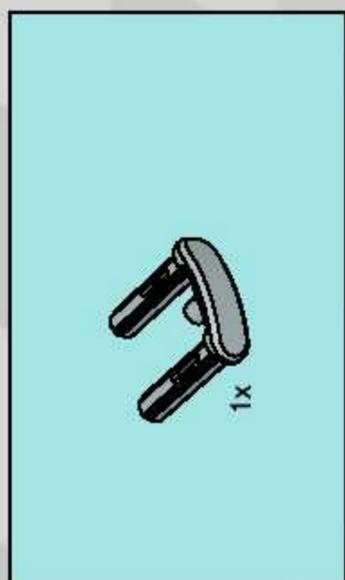



5

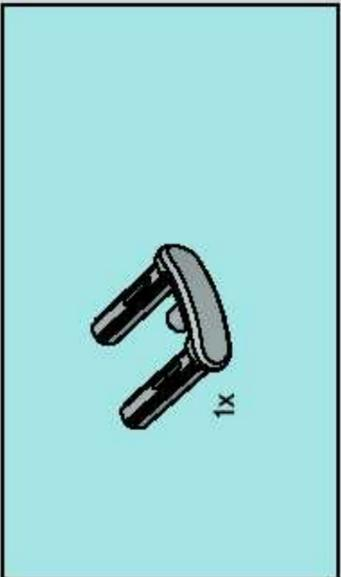



6

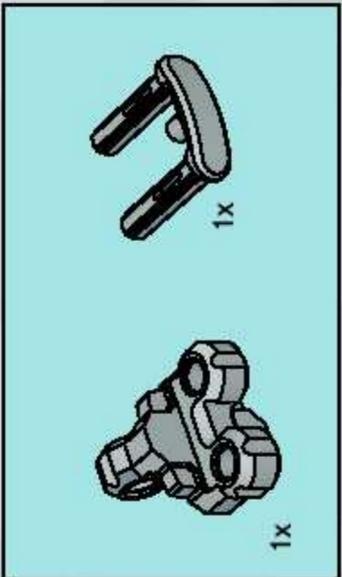

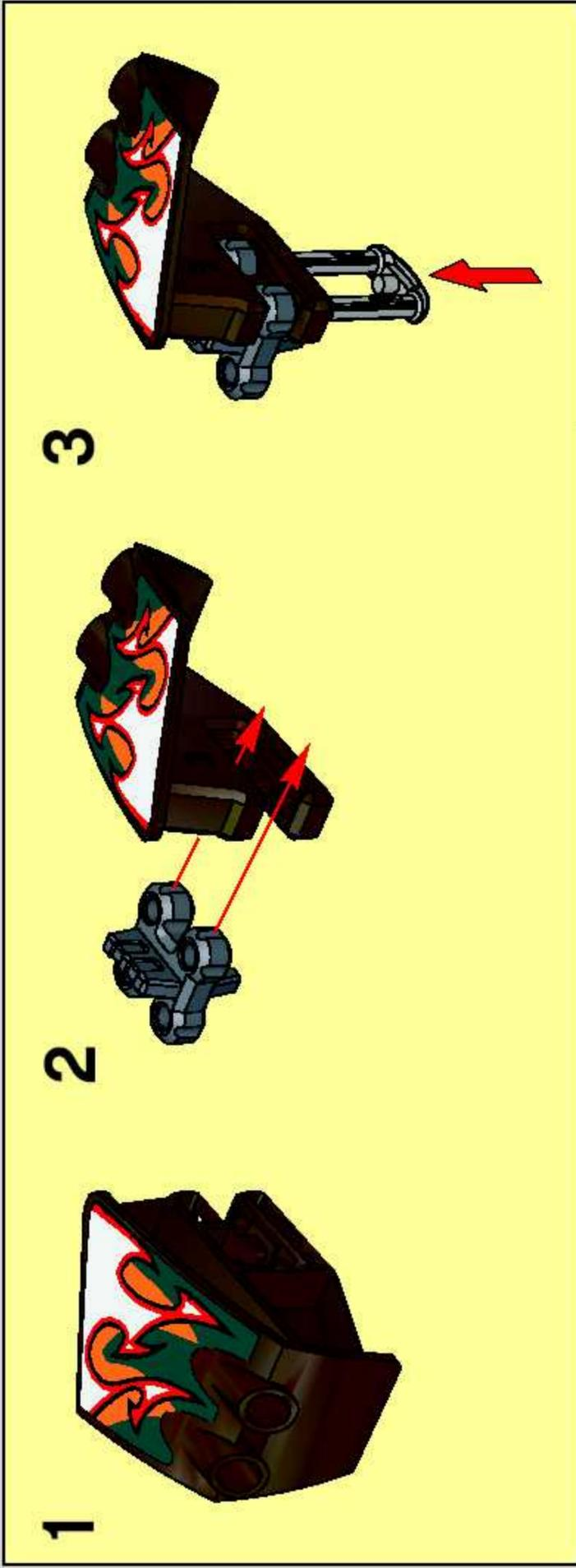
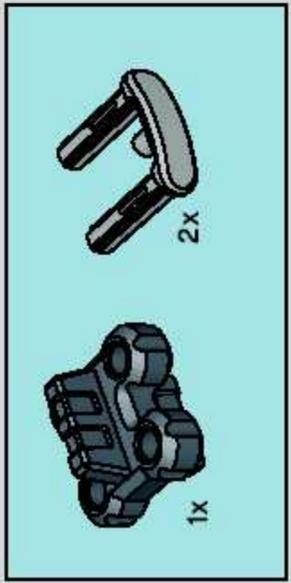

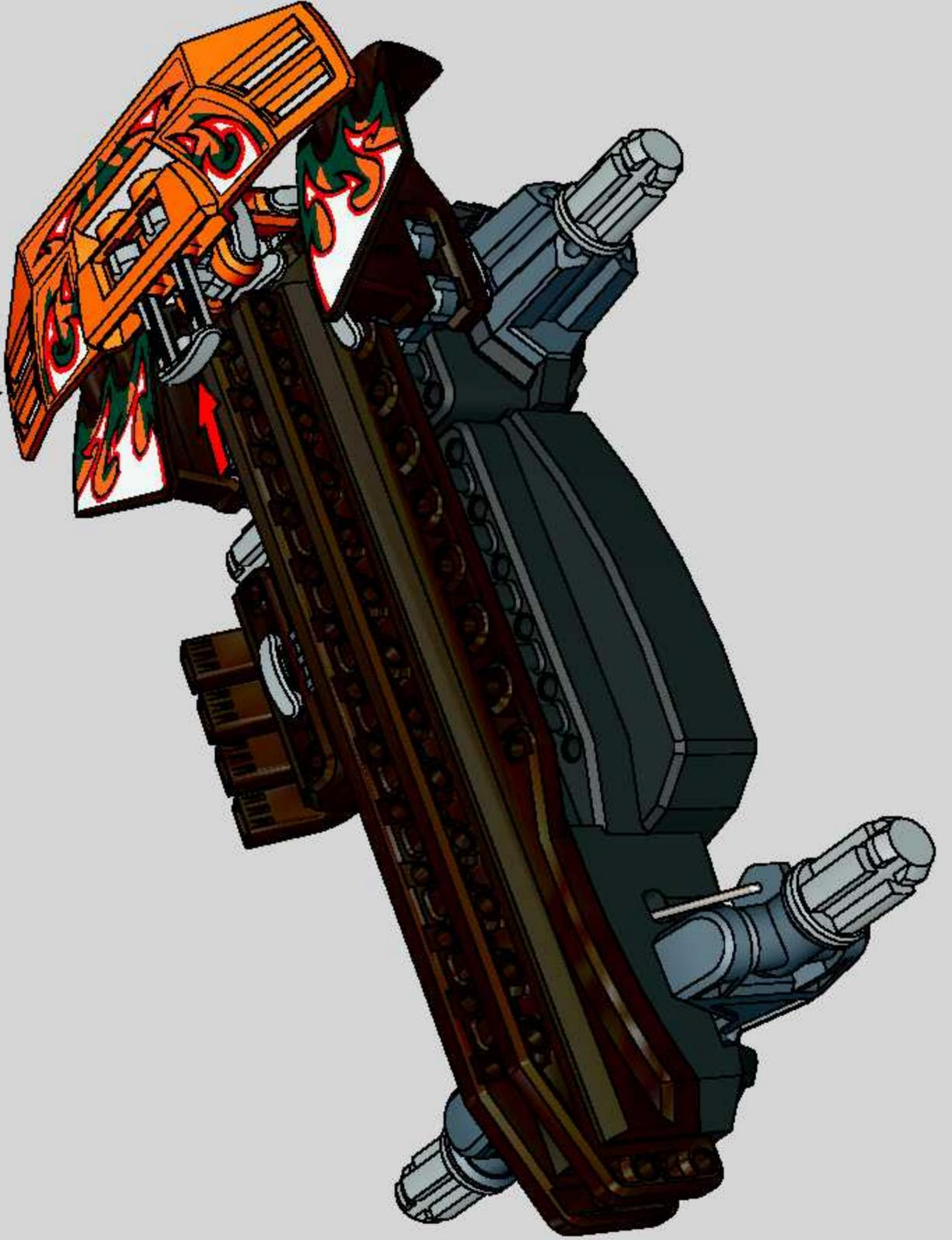
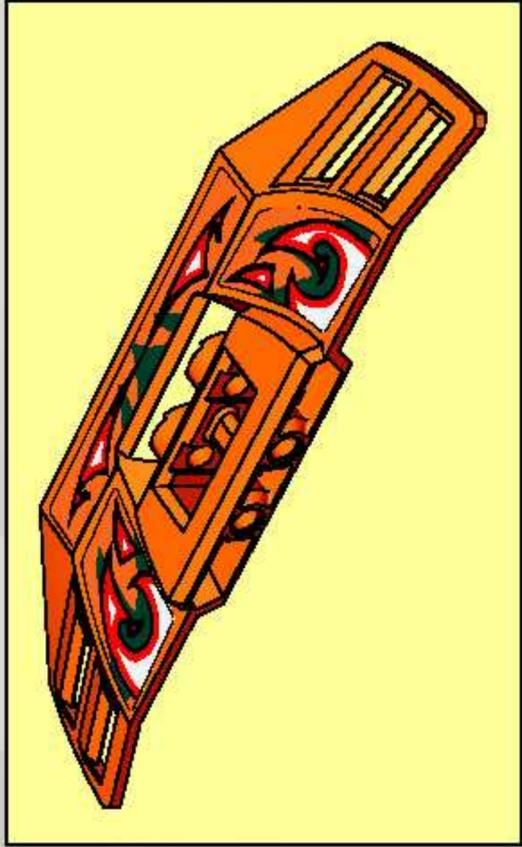

8

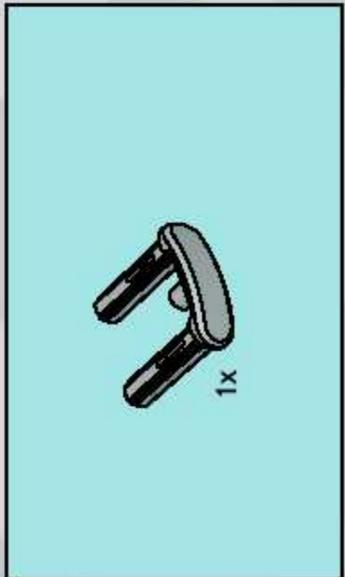



9

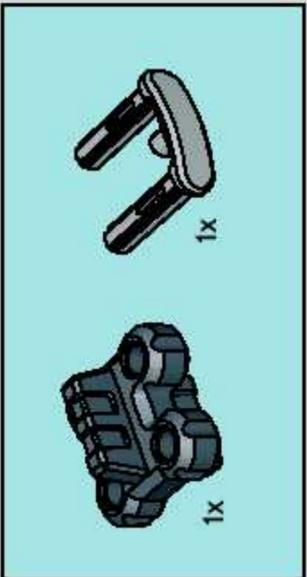

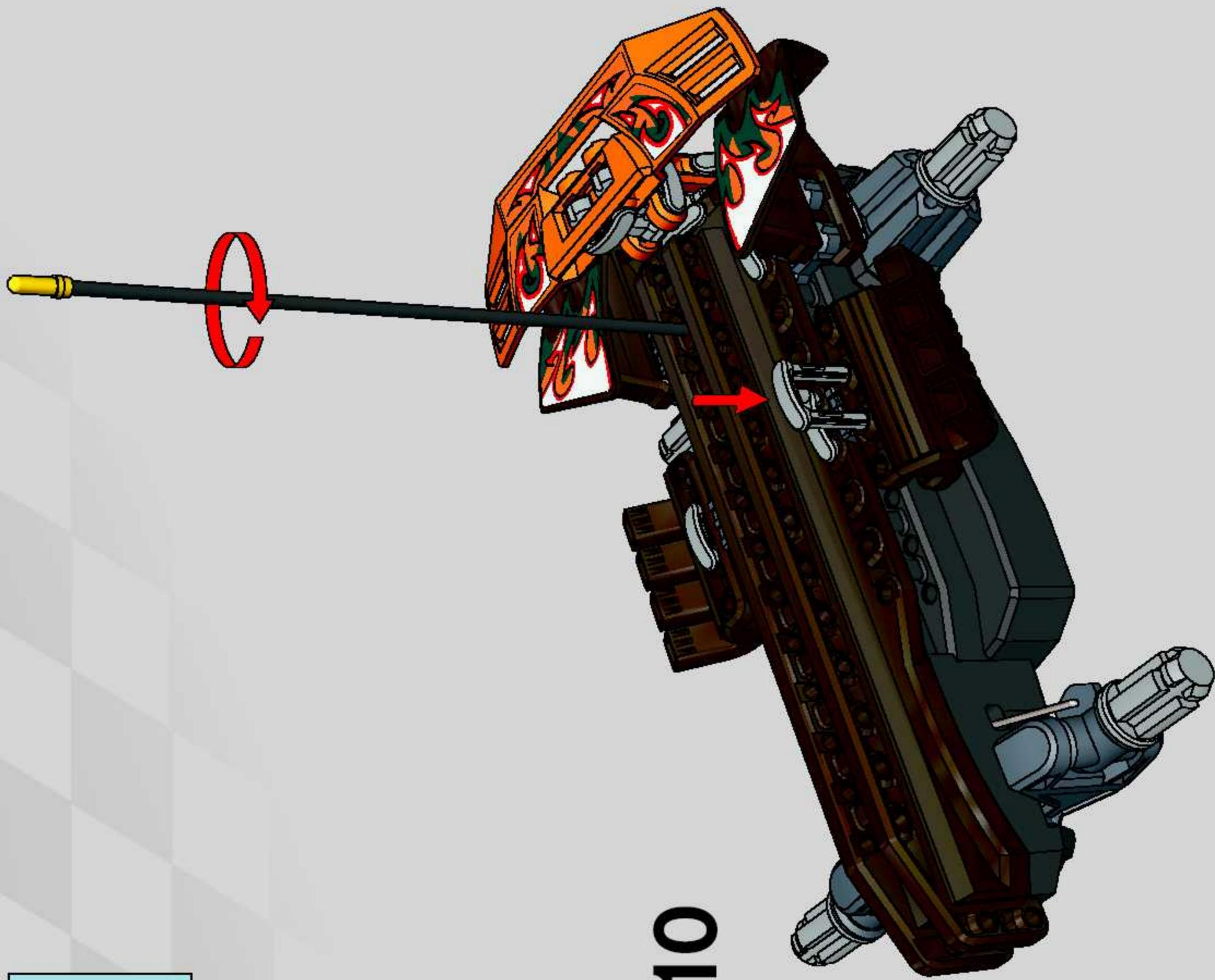

10



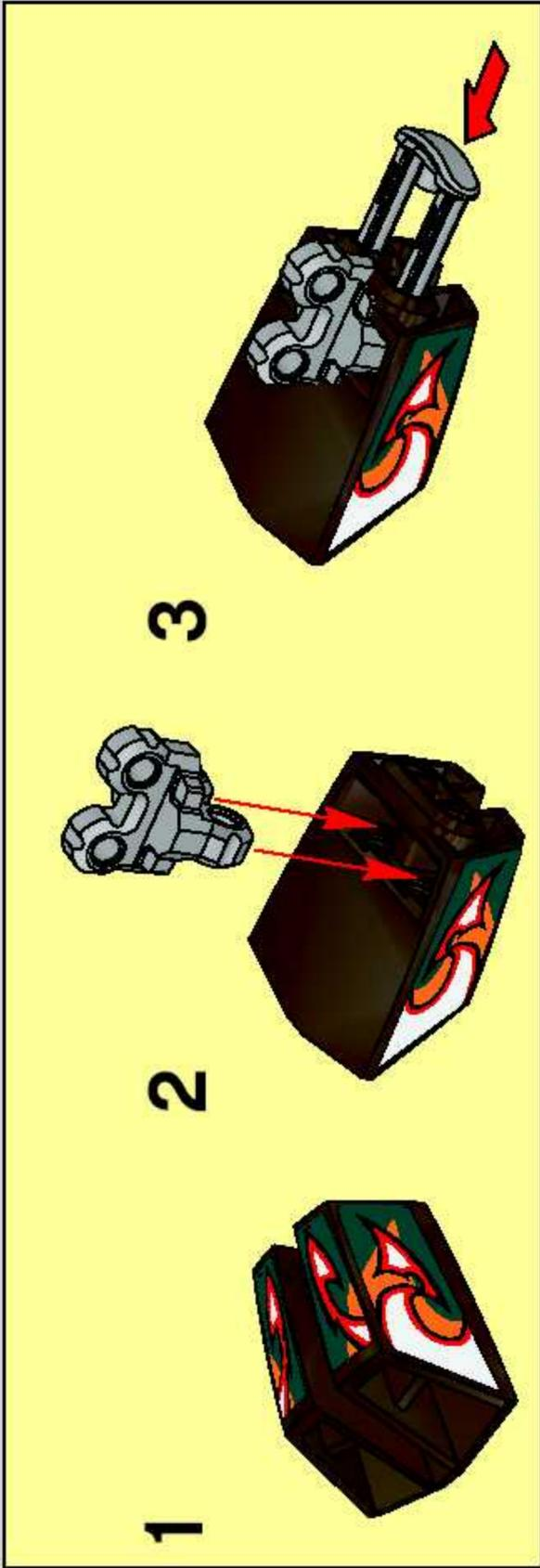
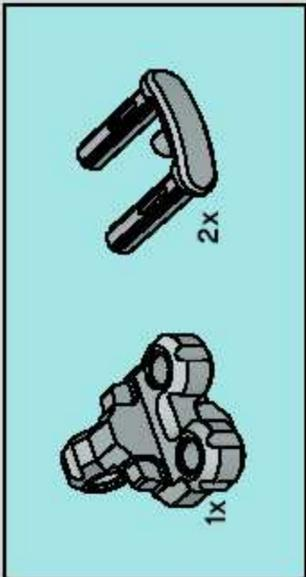

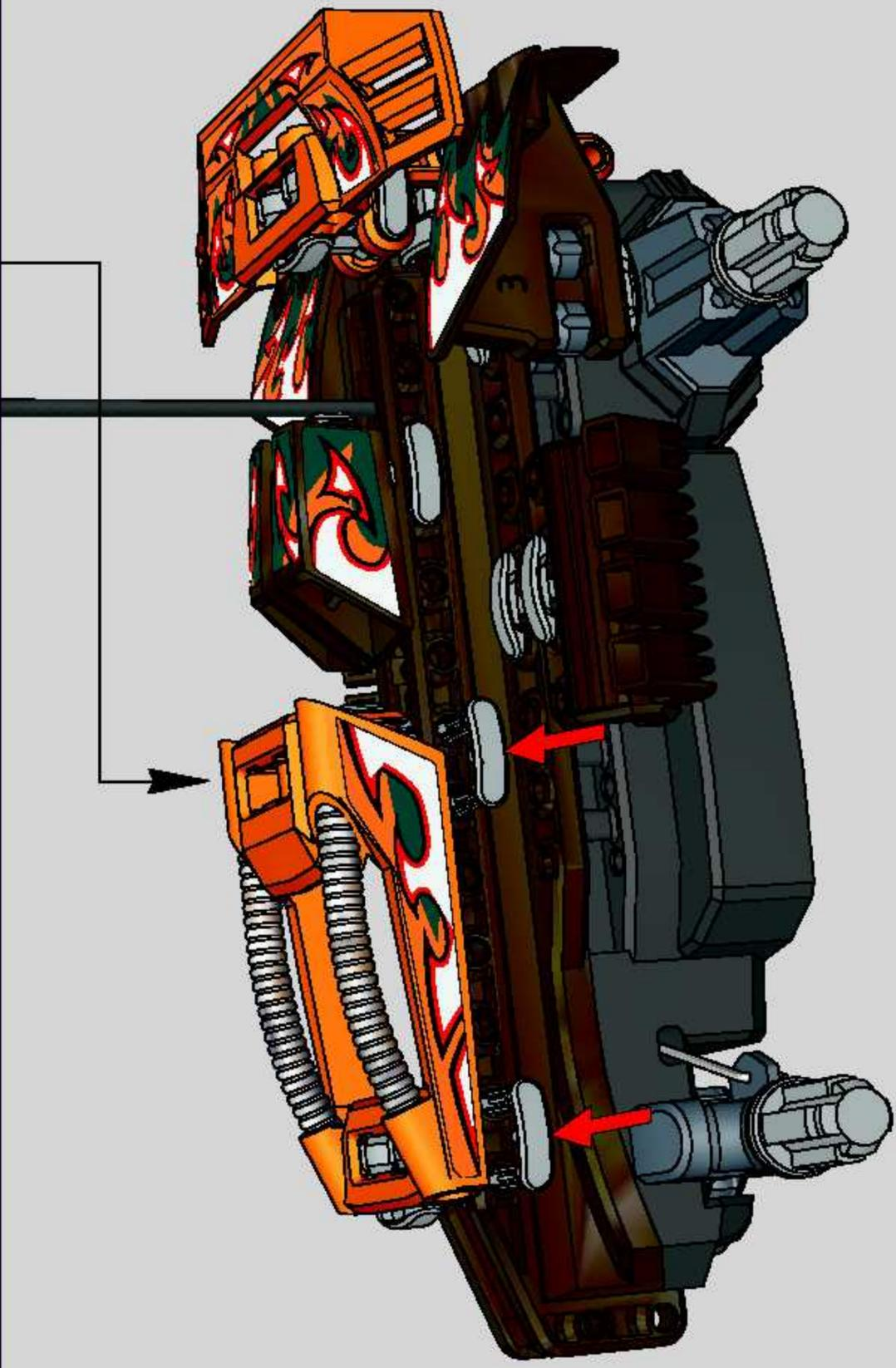
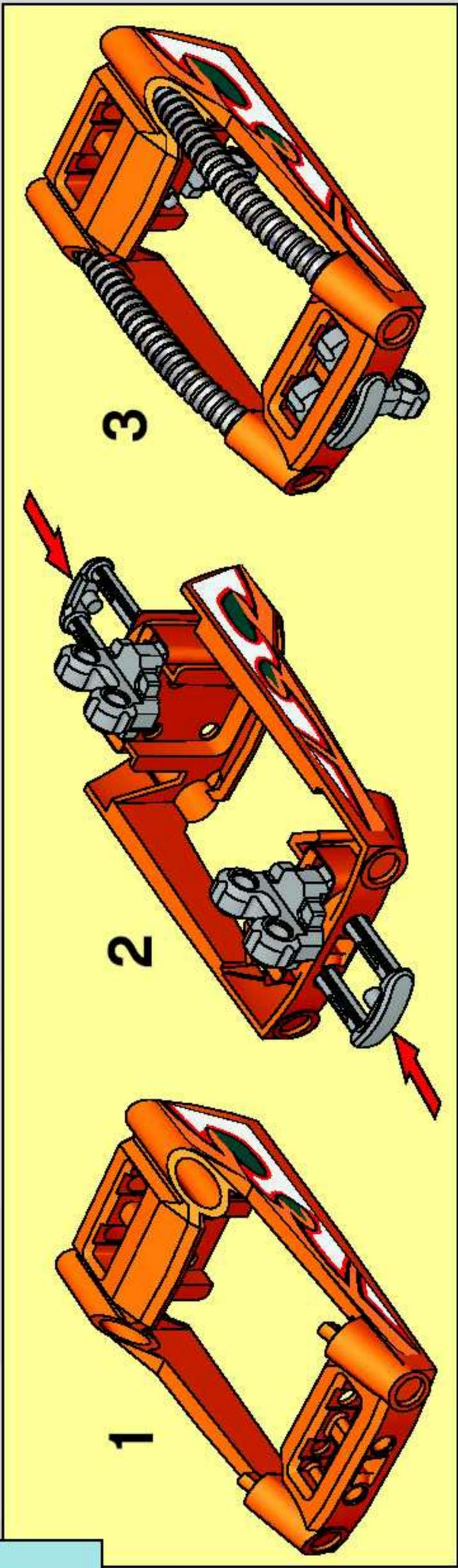
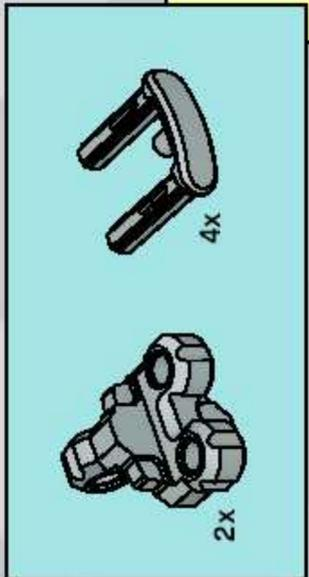

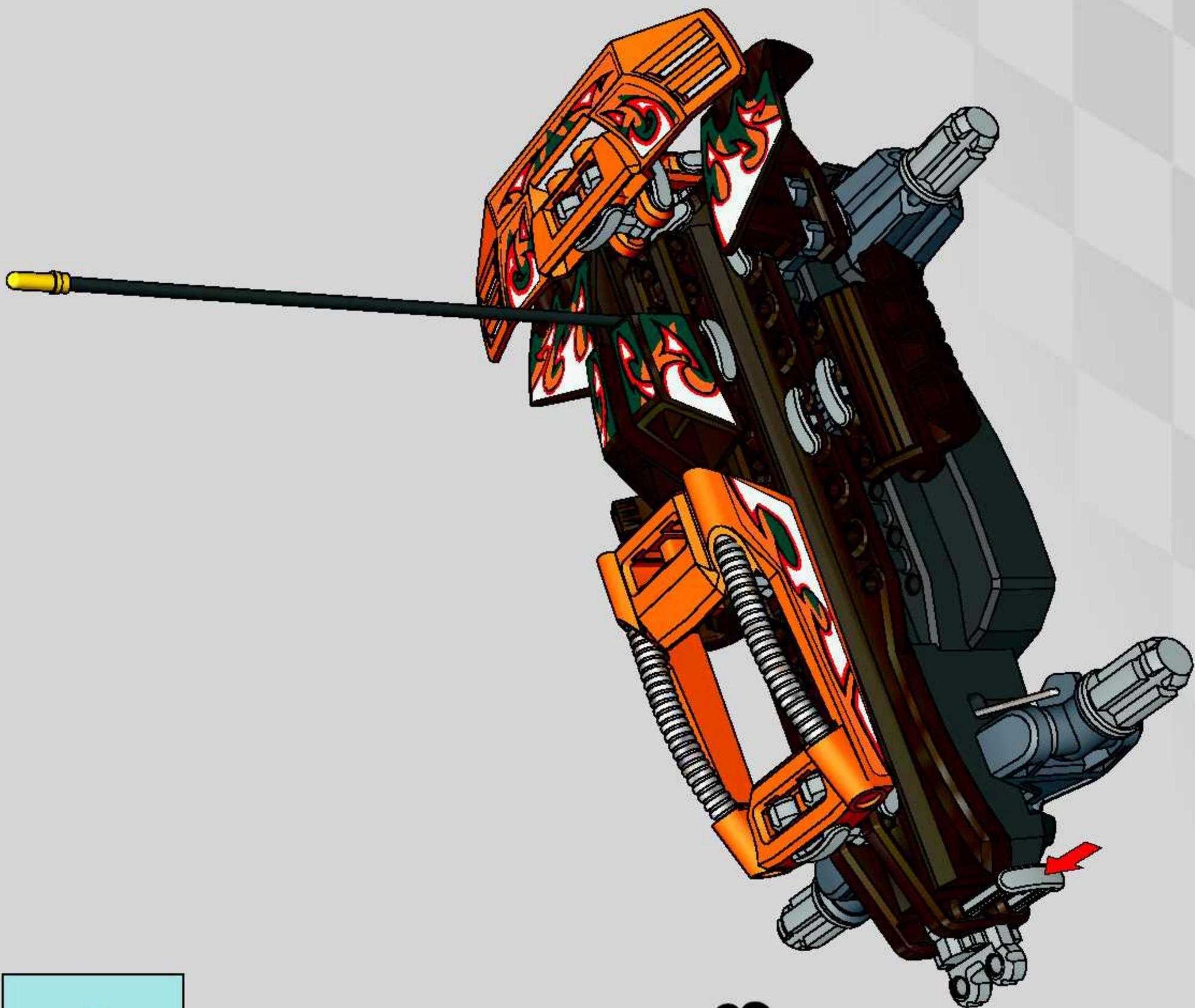

13

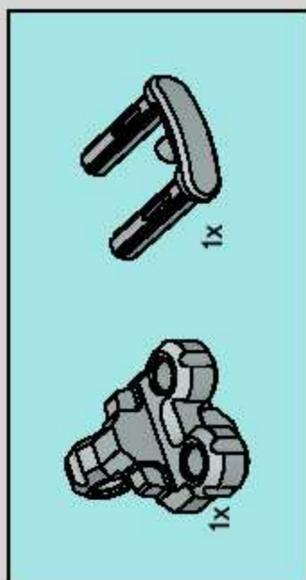

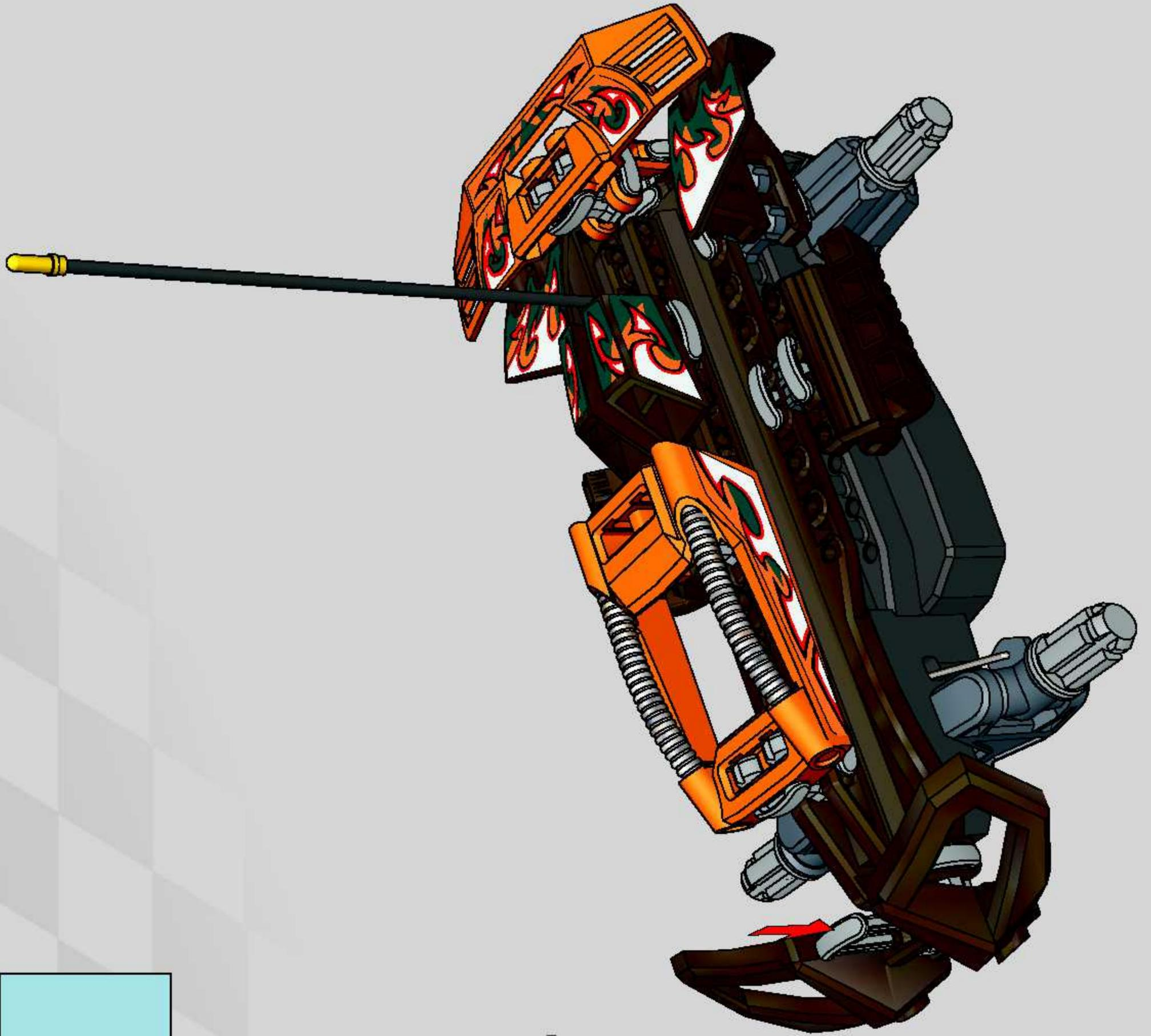

14

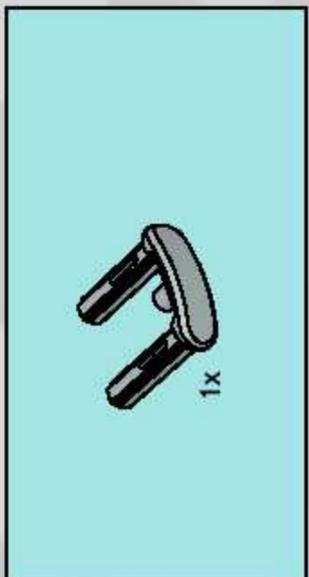

15

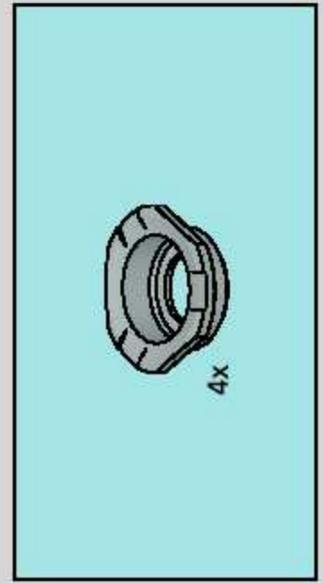
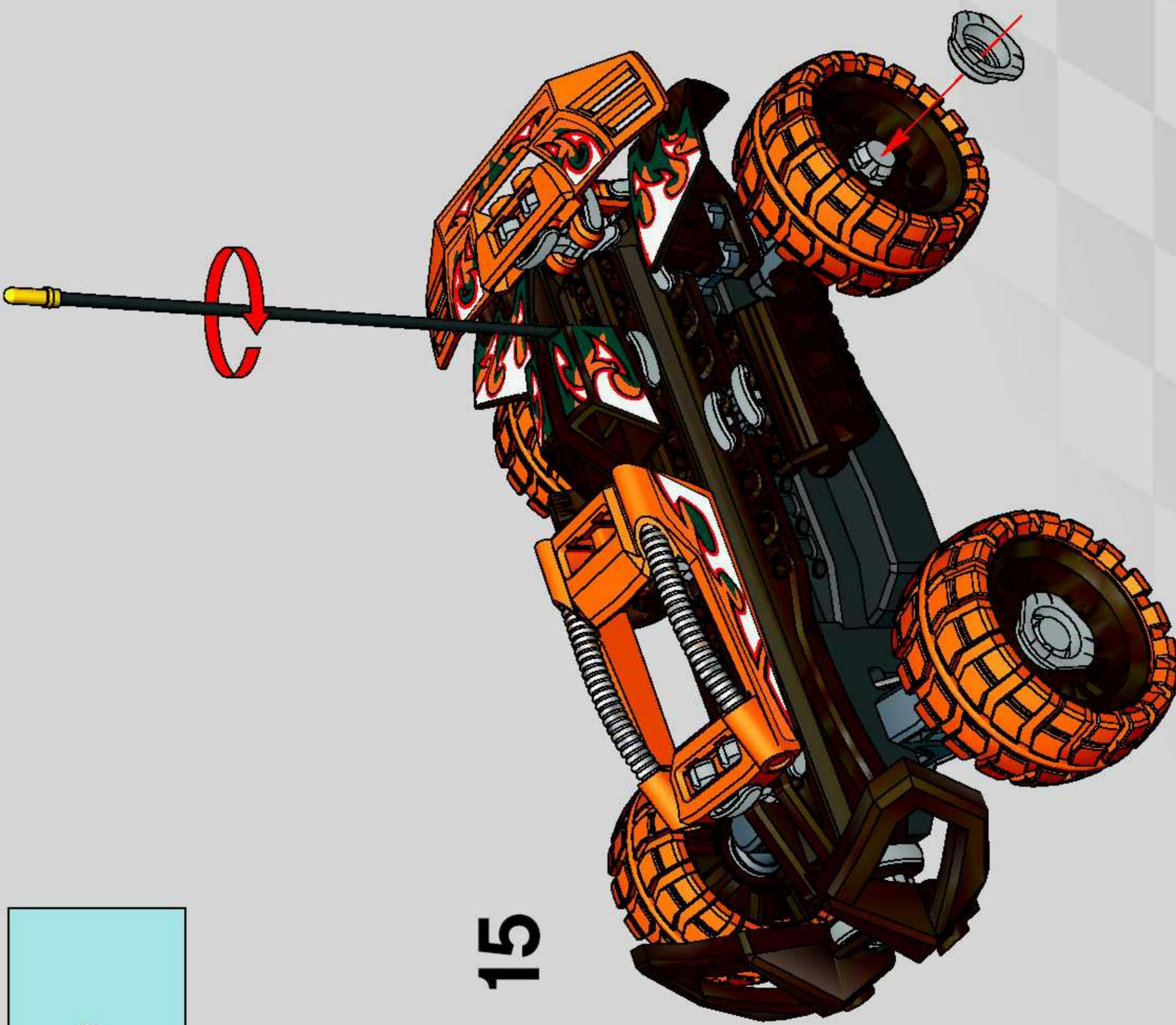



FRIL



Win! Gagne! 当たります Gewinne!

Win LEGO products

We would like to know what you think about your new LEGO product. Log on to the web address below for further instructions.

Gagne des produits LEGO

Nous aimerions savoir ce que tu penses de ton nouveau produit LEGO. Tu obtiendras davantage d'informations en visitant le site Internet indique ci-dessous.

Gewinne LEGO produkte

Wir sind sehr an deiner Meinung über dein neues LEGO Produkt interessiert. Gehe einfach zu der unten angegebenen Webadresse – dort findest du weitere Informationen.

Estimado usuario LEGO

Al contestar algunas preguntas en inglés, francés, alemán o japonés, en el sitio www.acnielsen.aim.dk/lego, podrás participar en el sorteo de algunos valiosos premios LEGO.

Caro Consumidor da LEGO

Ao responder a algumas perguntas em Inglês, Francês, Alemão ou Japonês no endereço www.acnielsen.aim.dk/lego irá participar num concurso para ganhar valiosos prémios da LEGO.

Kedves ifjú LEGO Vásárló

Ha ellátogatsz a www.acnielsen.aim.dk/lego honlapra és ott angol, francia, német vagy japán nyelven megválaszolsz néhány kérdést, akkor részt veszel egy versenyben, amelyben értékes LEGO díjakat nyerhetsz.

抽選でレゴ®製品が当たります

私たちは、皆さんがお買い求めのレゴ®製品についてどんな感想をお持ちか、知りたいと思っています。質問に答えて、楽しいレゴ製品の抽選に応募しませんか。アンケートの回答には、ほんの3分ほどしかかかりません！詳しくは、以下のウェブアドレスまでアクセスしてください。

www.acnielsen.aim.dk/LEGO



Any questions regarding your new LEGO product, please contact:

Customer Service | Kundenservice

Service Consommateurs

Servicio Al Consumidor at

www.lego.com/service or dial



00800 5346 5555



1-800-422-5346

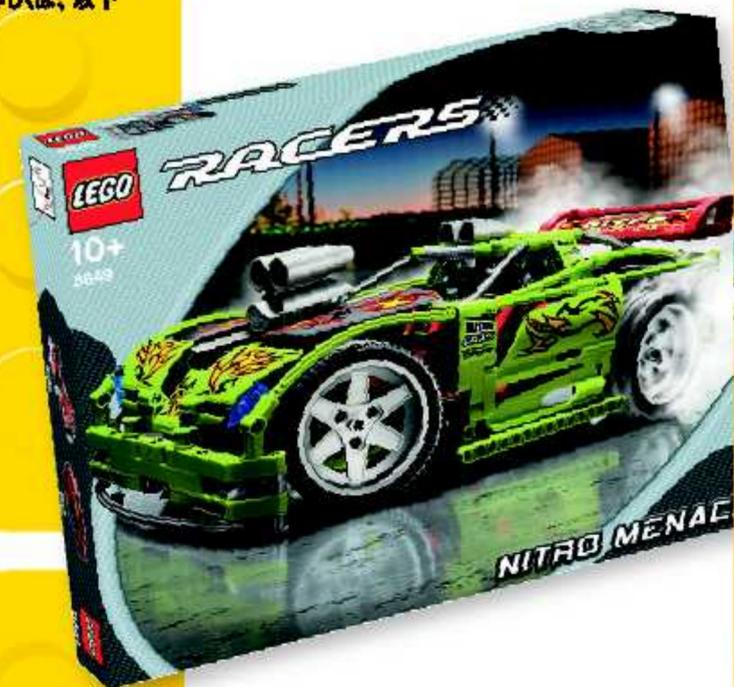

Discover the **LEGO® UNIVERSE!**
 Entdecke das **LEGO® UNIVERSUM!**
 Ontdek het **LEGO® UNIVERSUM!**
 Découvre **L'UNIVERS LEGO® !**



FREE LEGO Magazines
 Des Magazines LEGO GRATUITS !
 GRATIS LEGO Magazine
 KOSTENLOSE LEGO Magazine



Sign up now! Jetzt anmelden!
 Abonne-toi maintenant! Meld je nu aan!
<http://club.LEGO.com/signup>



SHOP at HOME

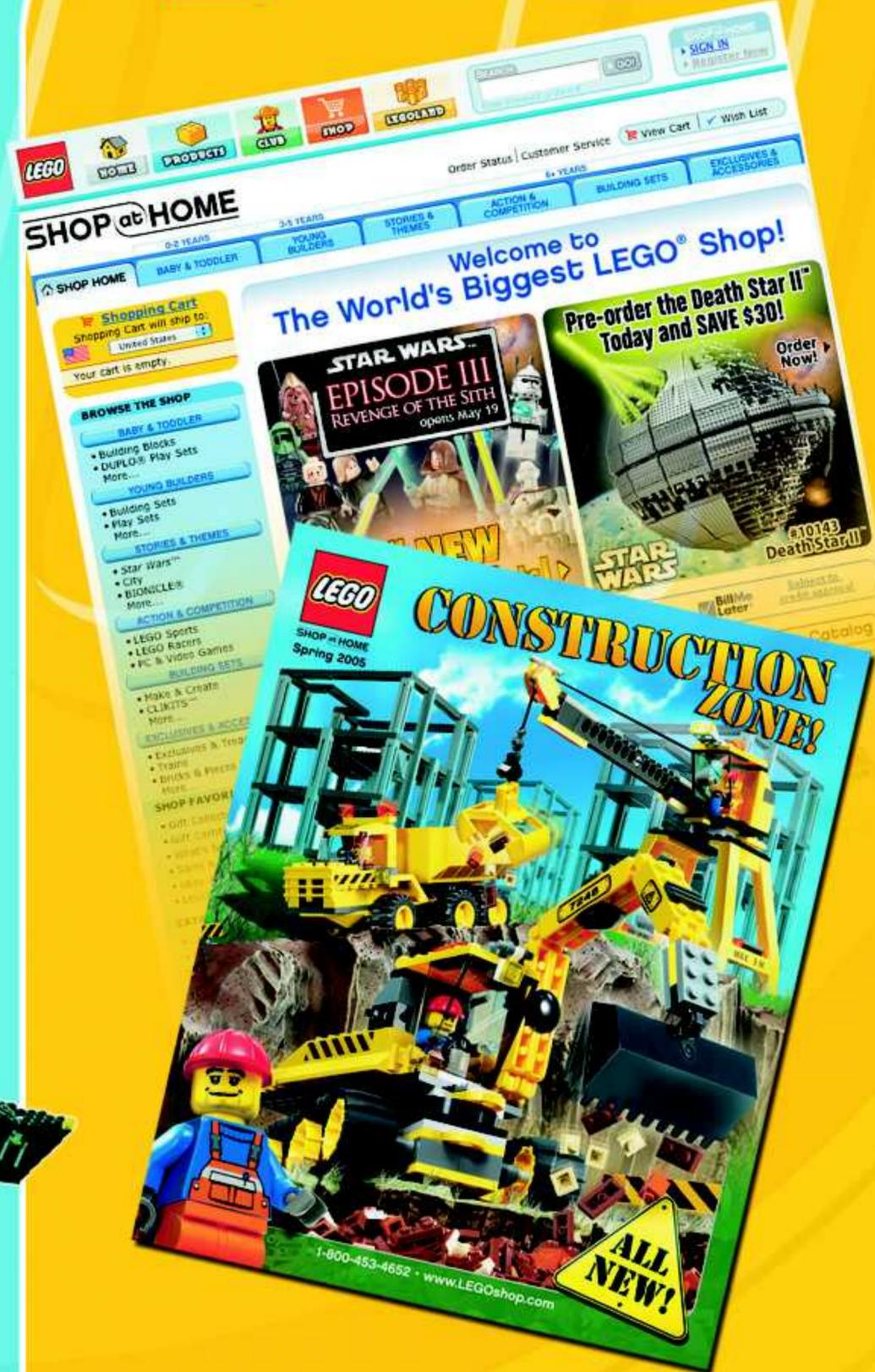

www.LEGOshop.com/catalog



OUTDOOR CHALLENGER

