



MONSTER FIGHTERS

9464



1

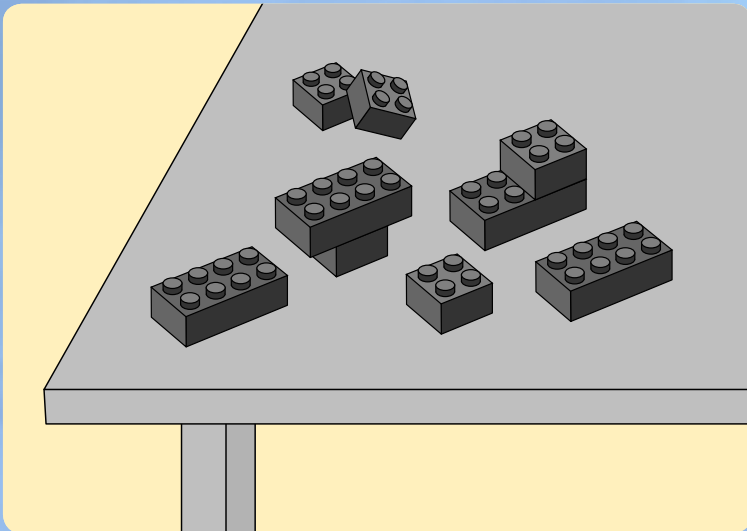
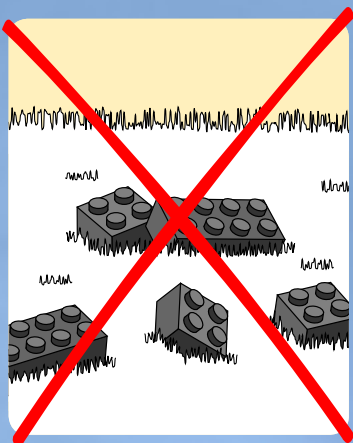

2



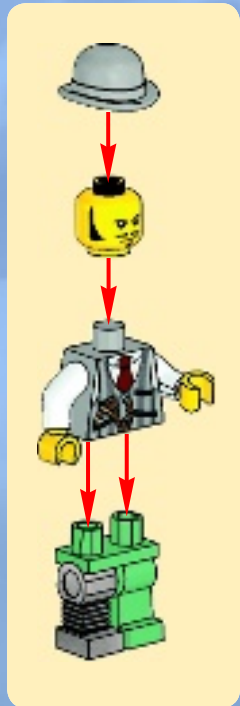
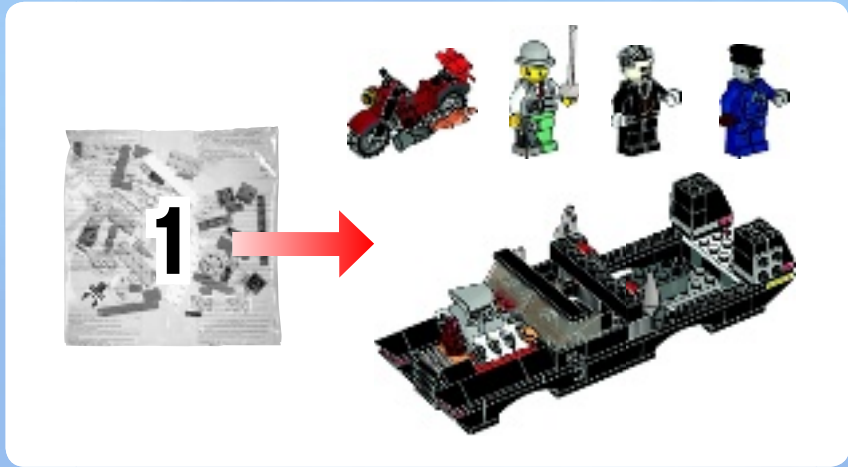



1x

1



1x

2



4



2x



2x

3



1x



1x



1x

4

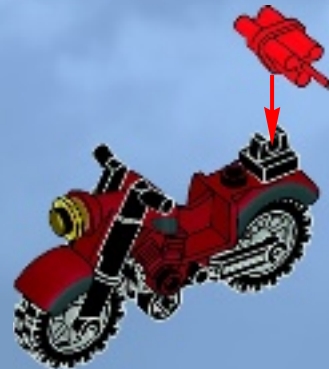



2x



2x

5



2x

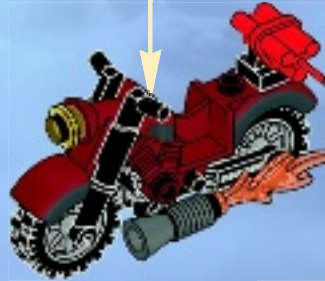

6



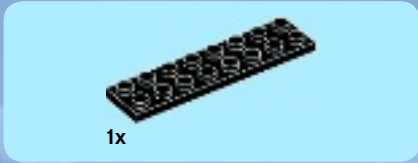
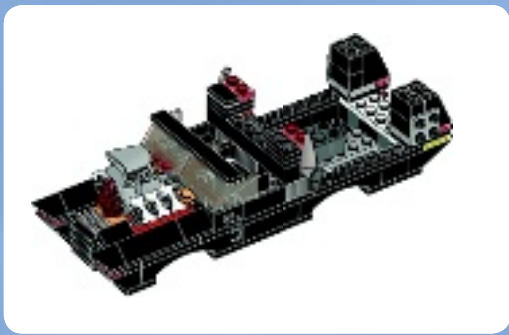

1x

1



2x

2

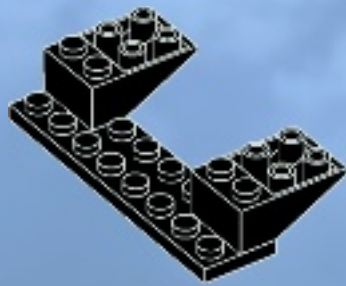

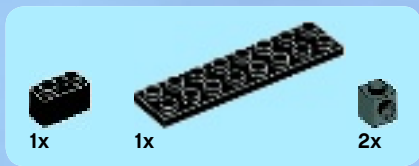

3

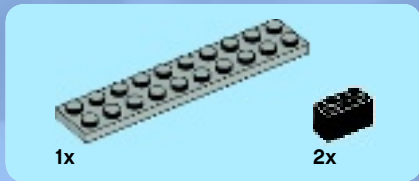
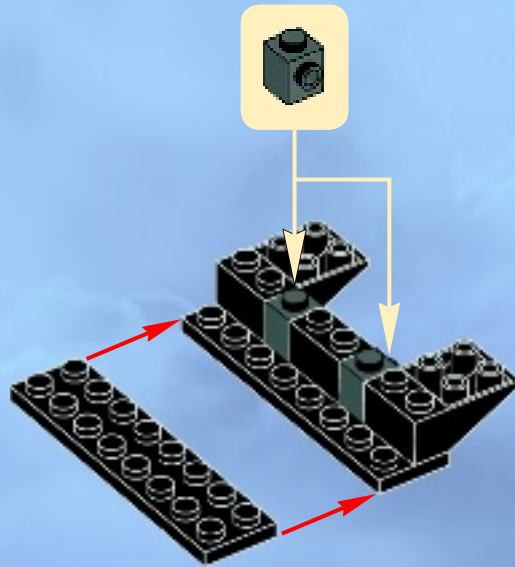

4

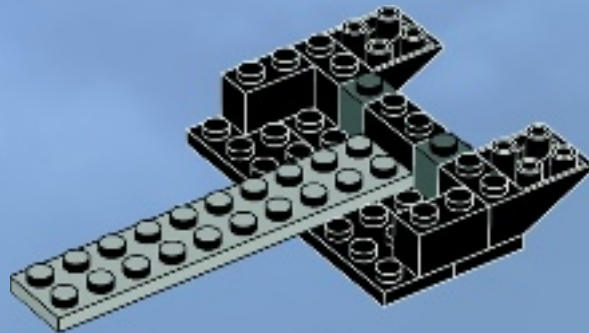

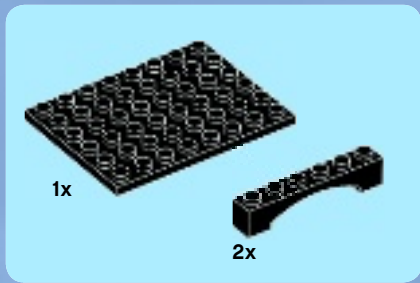

5

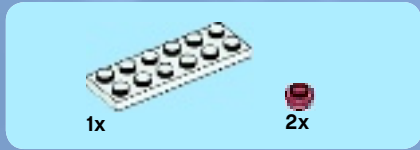
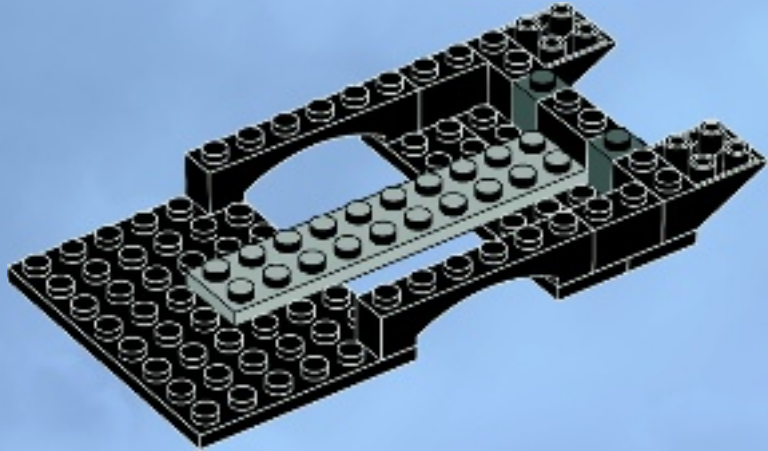

6

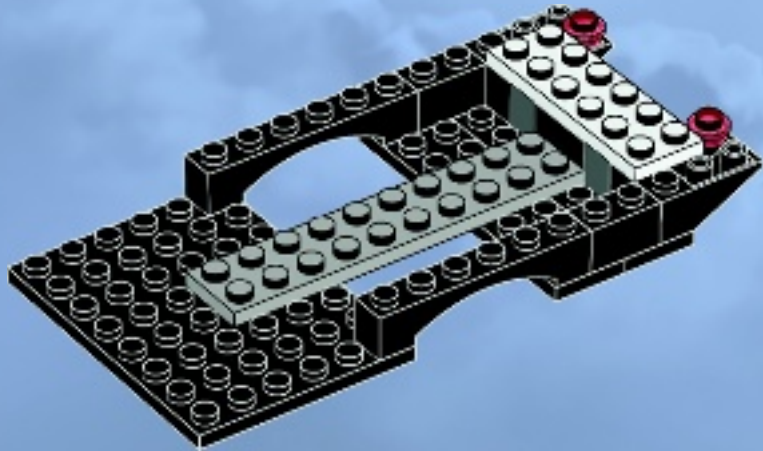



7

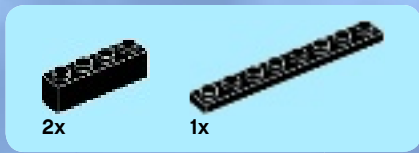
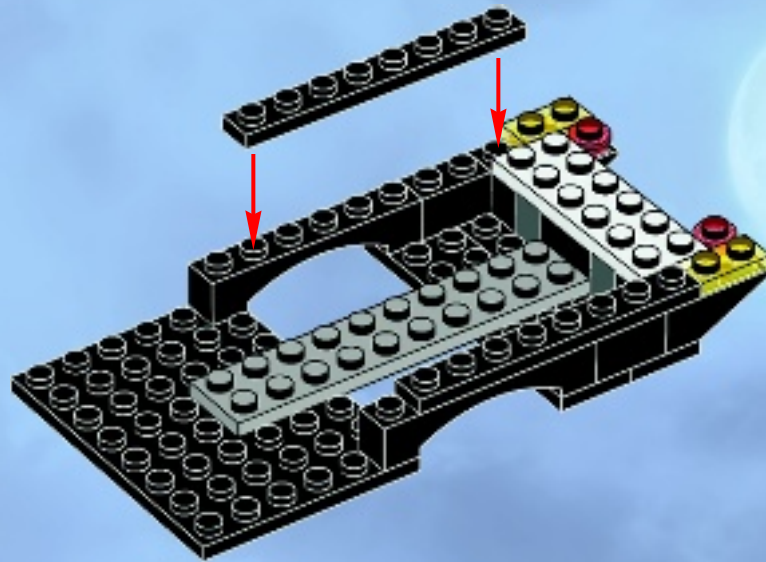

8

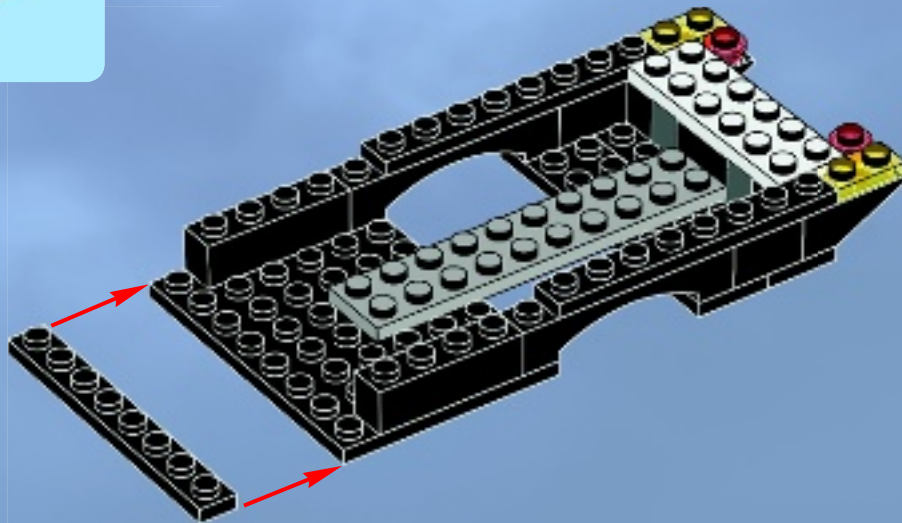



2x

9

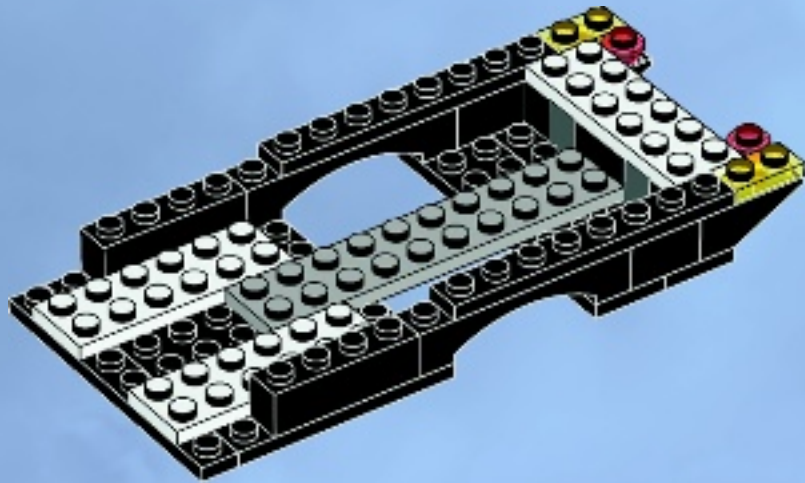

2x



1x

10

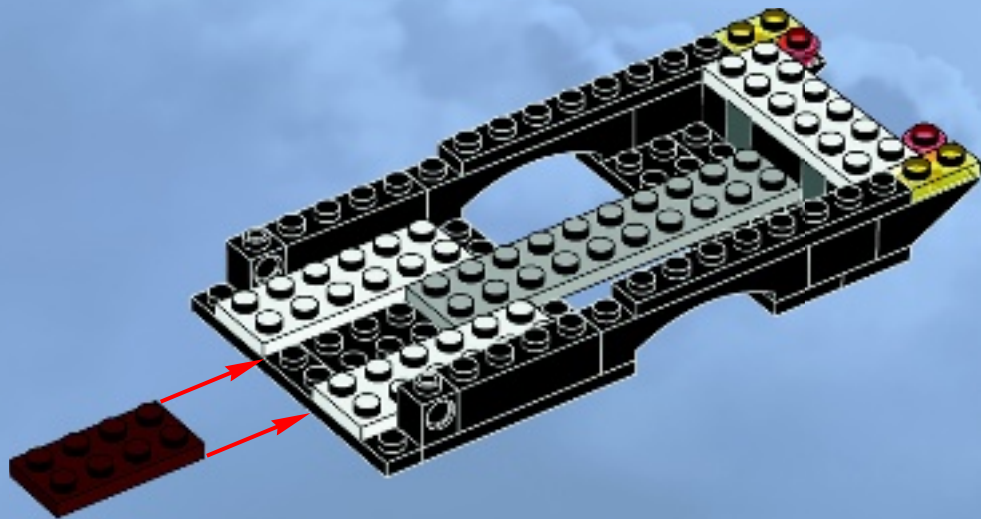

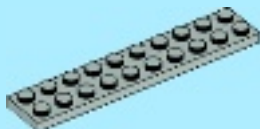

1x

11

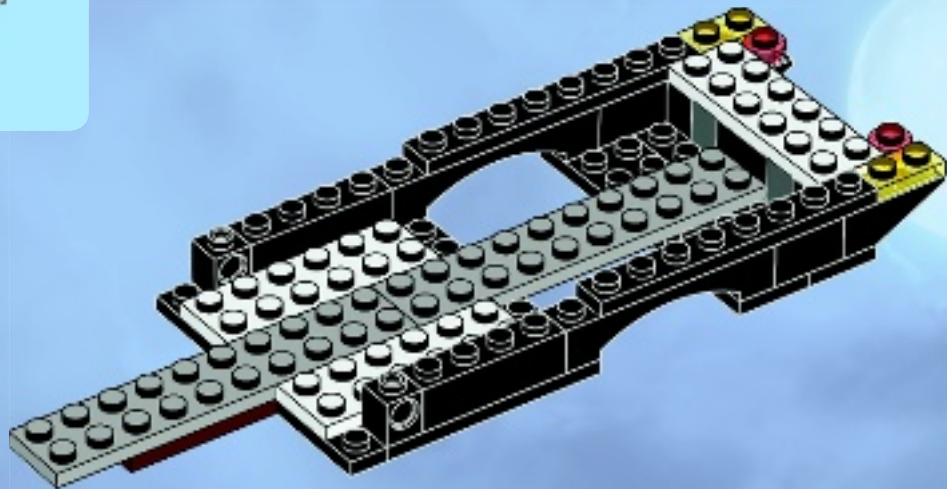

1x

12

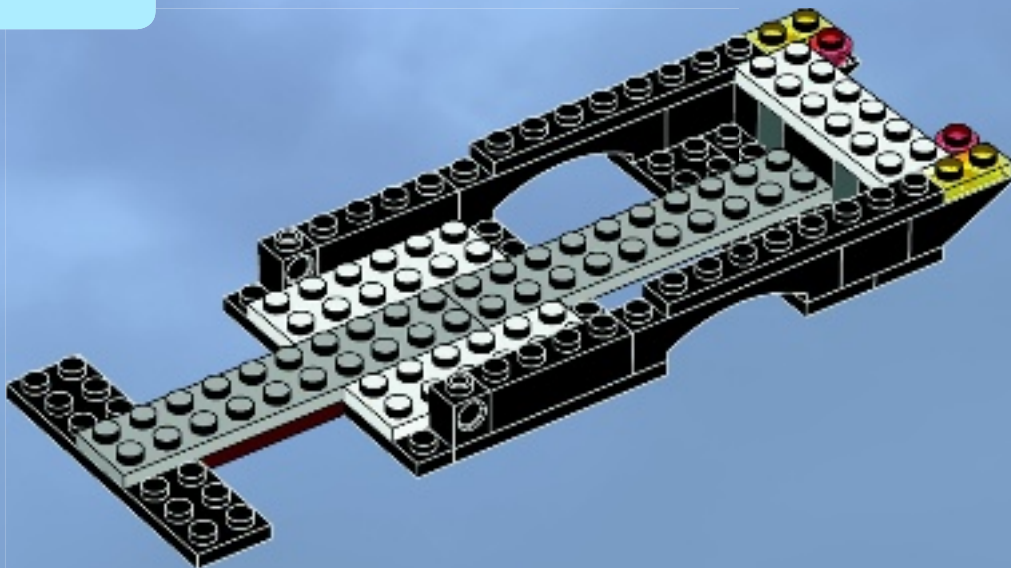



2x

13

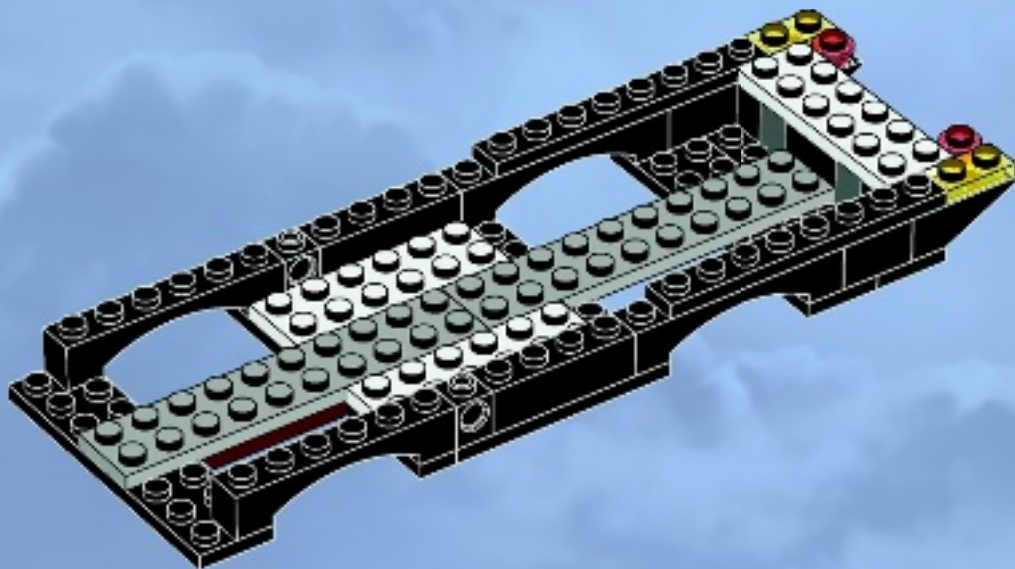



2x

14

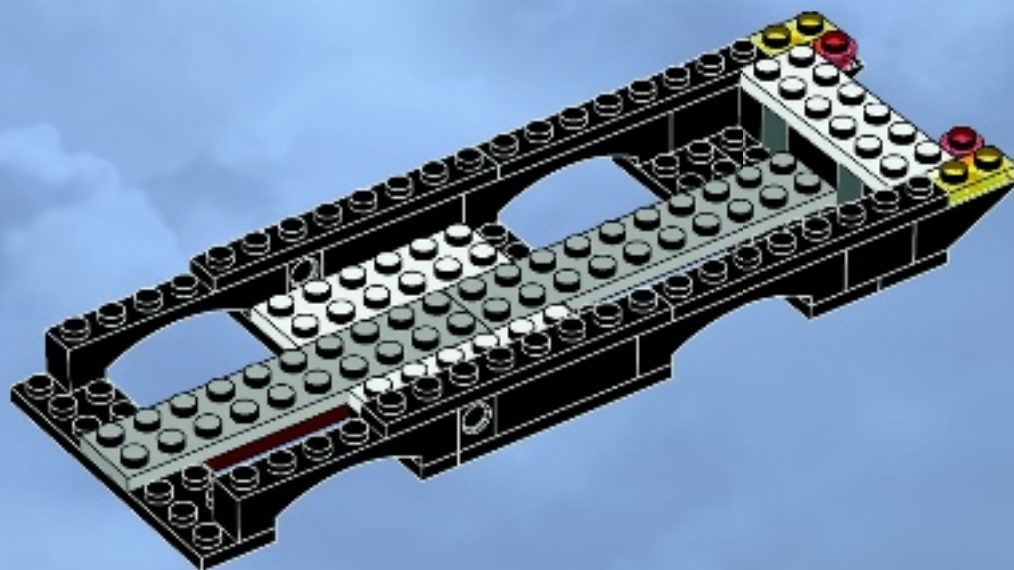



2x



2x



1x

15

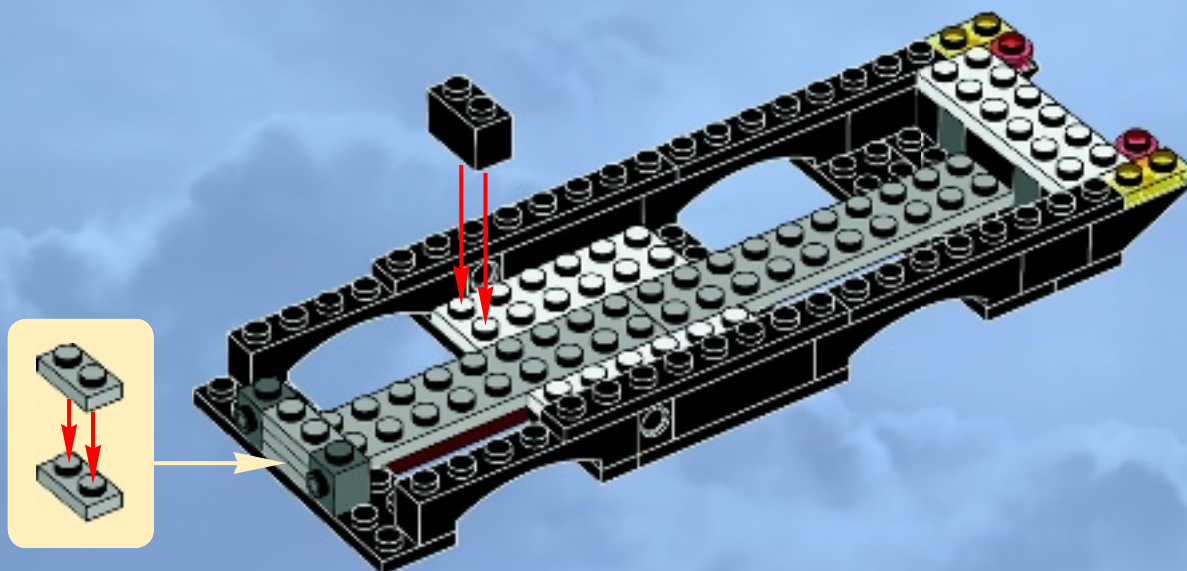



2x

16

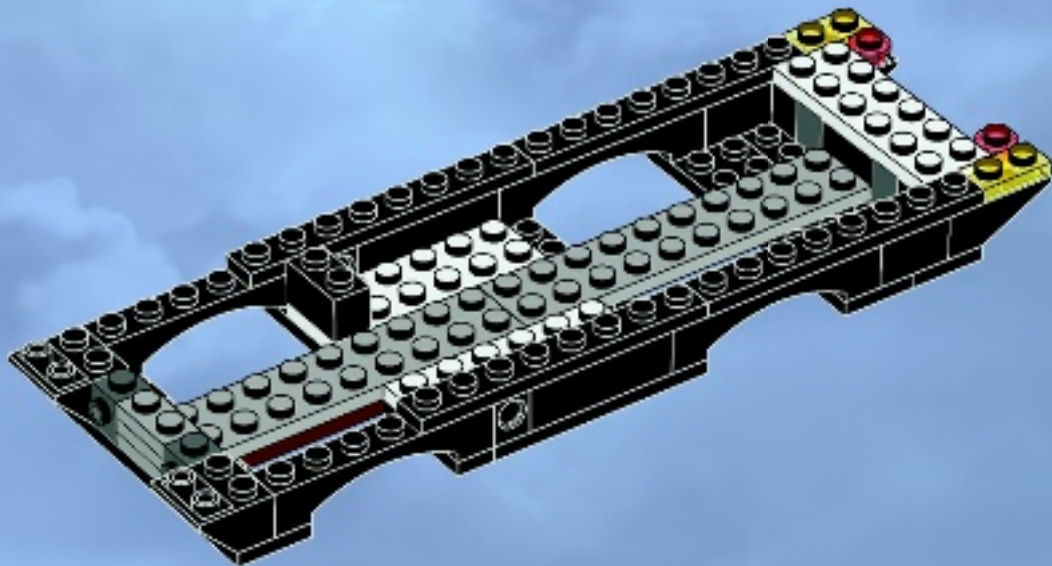



17

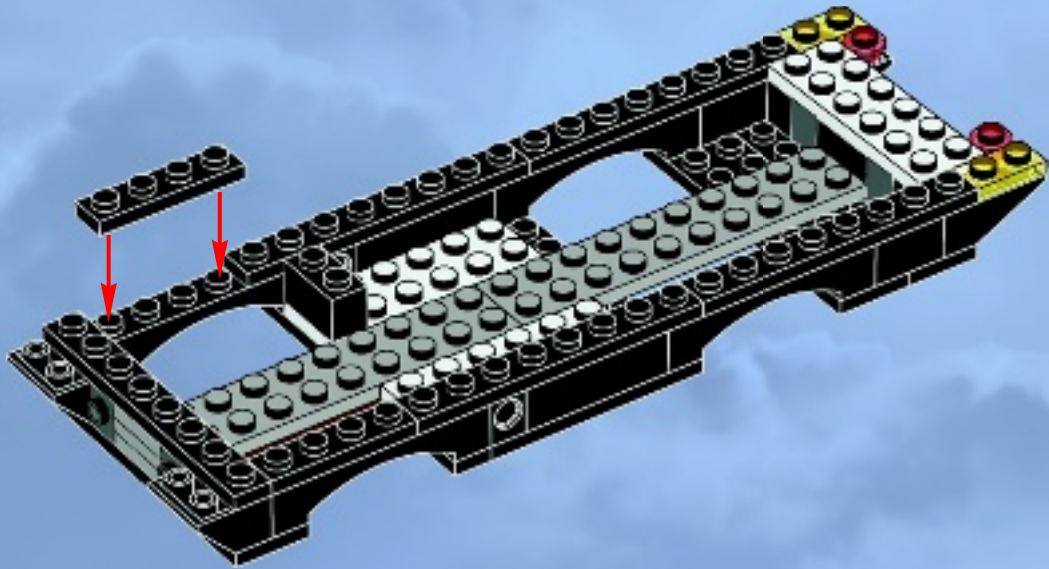



4x

18

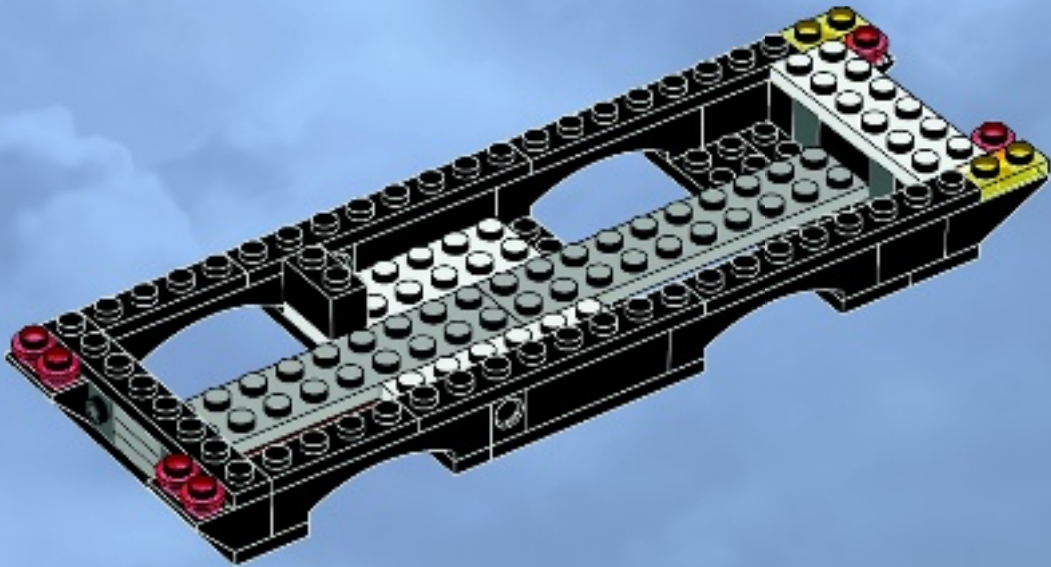



19

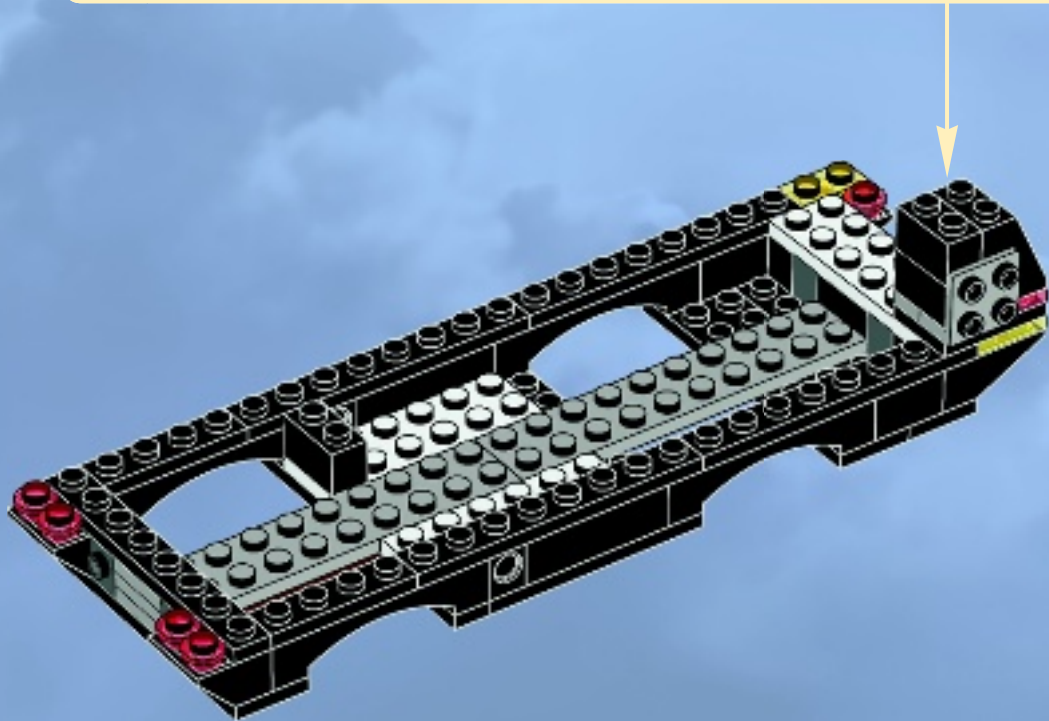



20

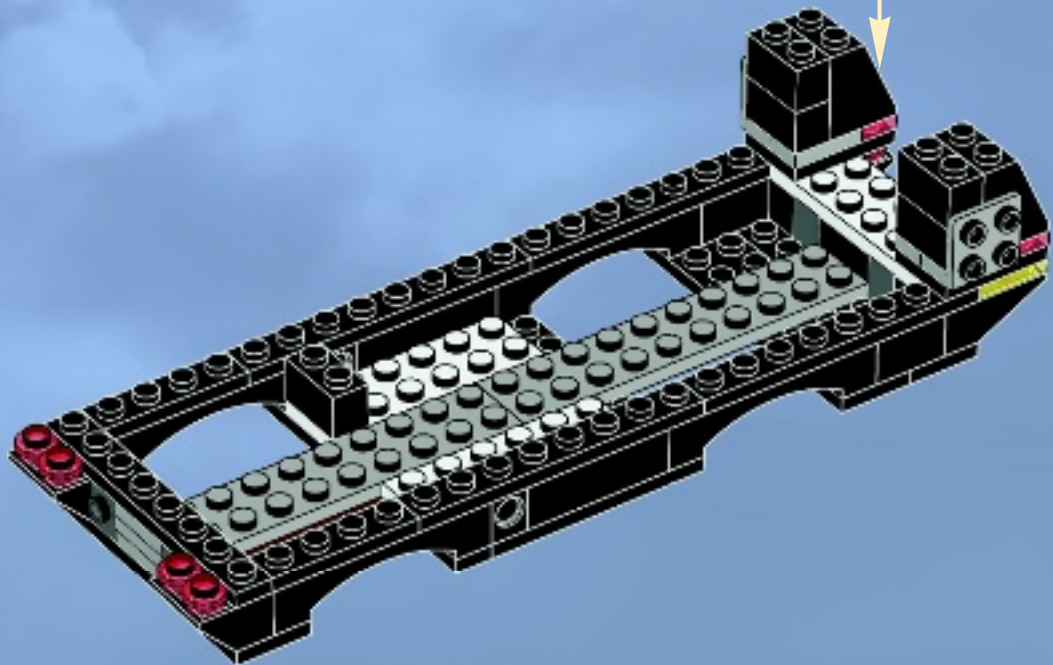
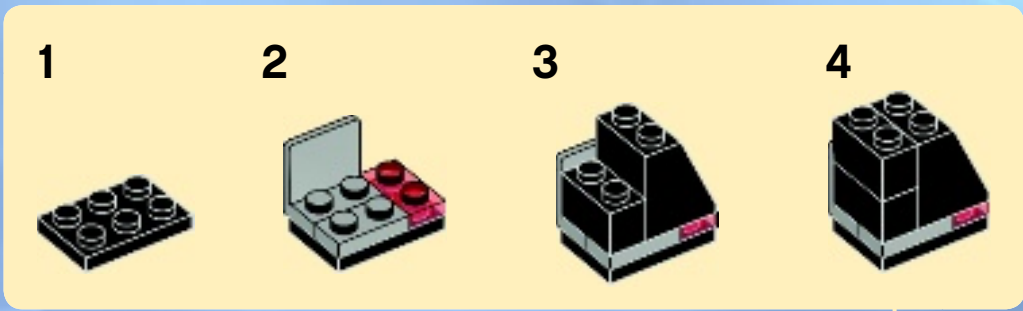



1x



1x



1x

21

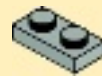
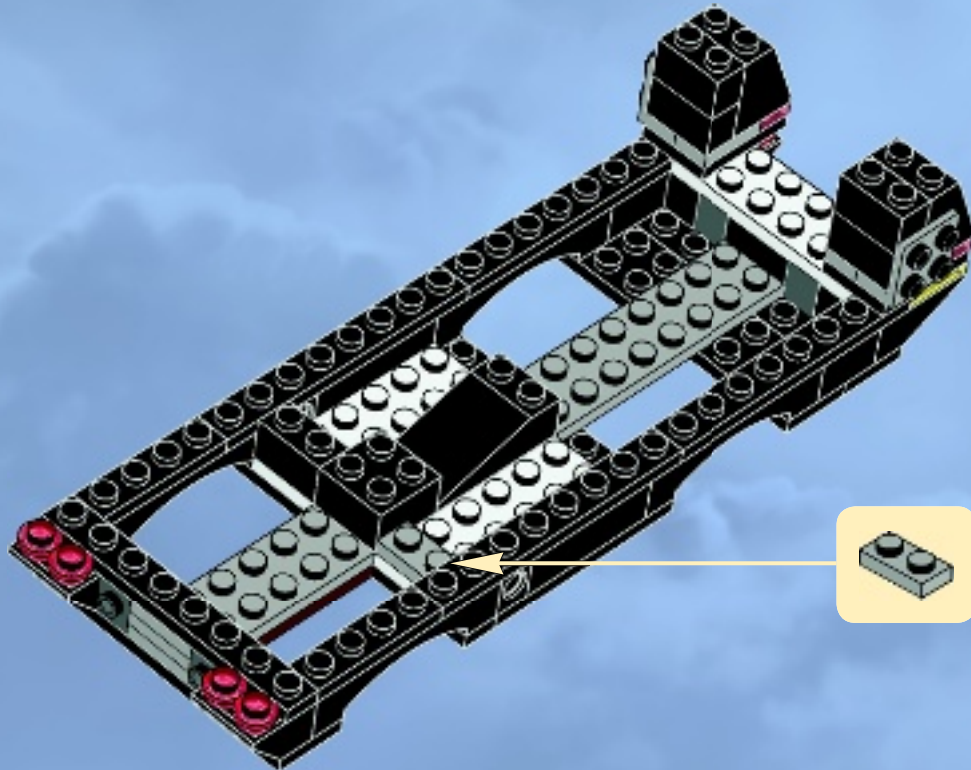



1x



1x



1x

22

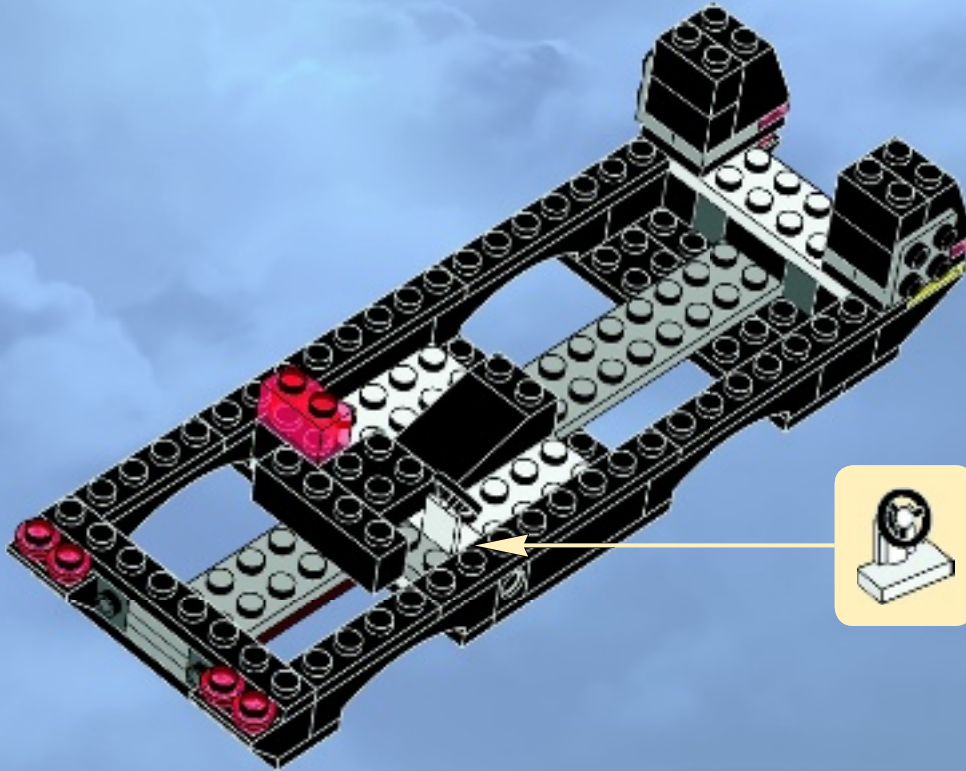



2x



2x



2x

23

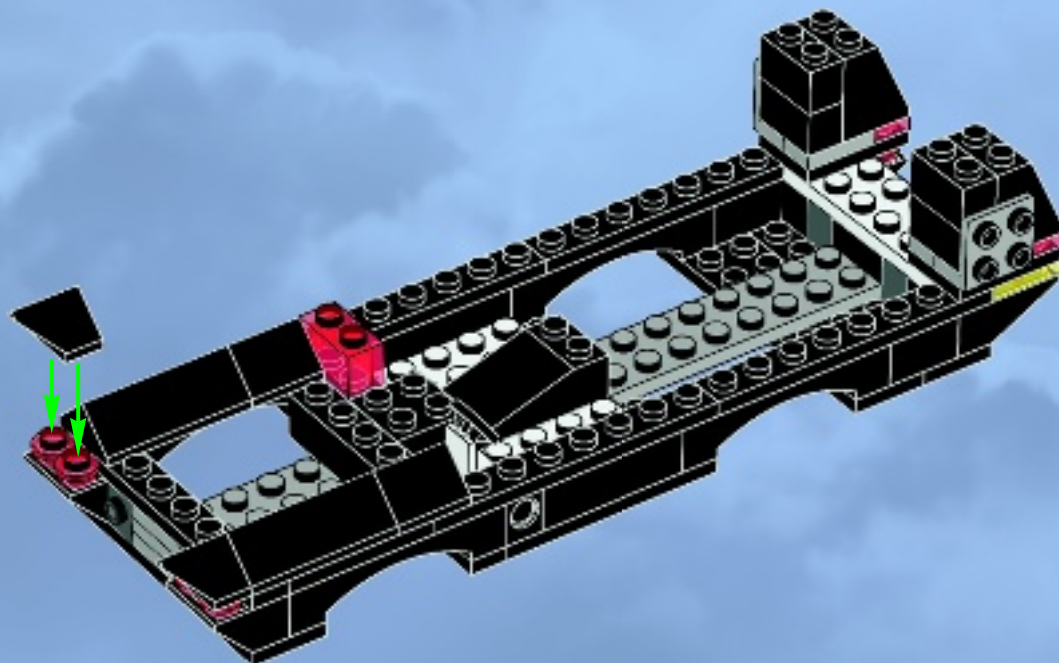



2x



2x



1x



1x

24

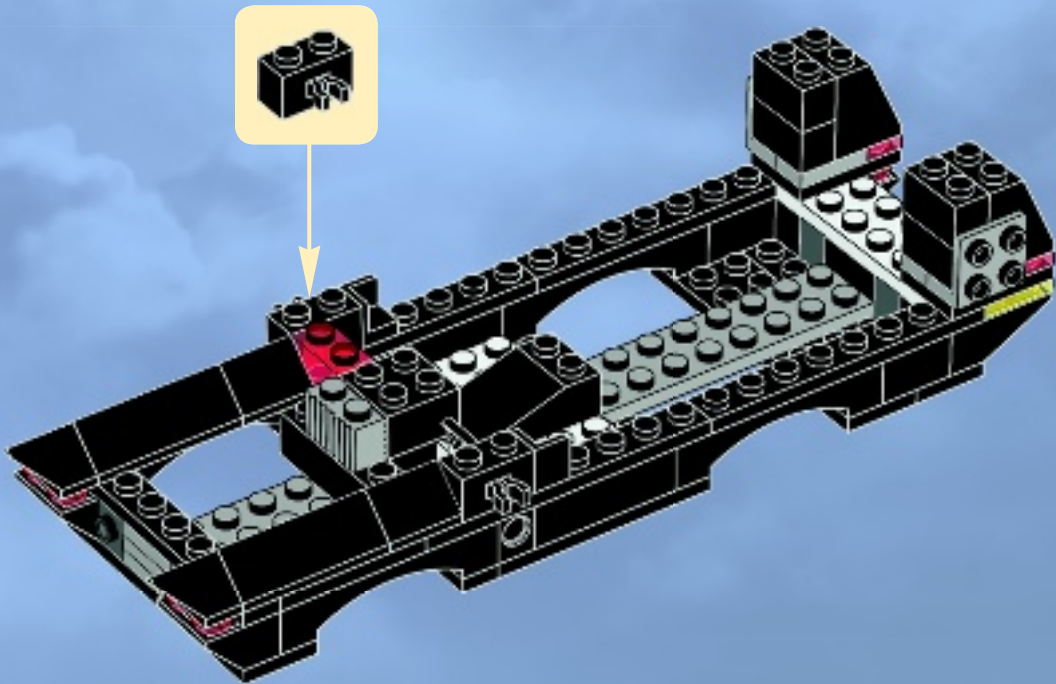



2x



3x

25

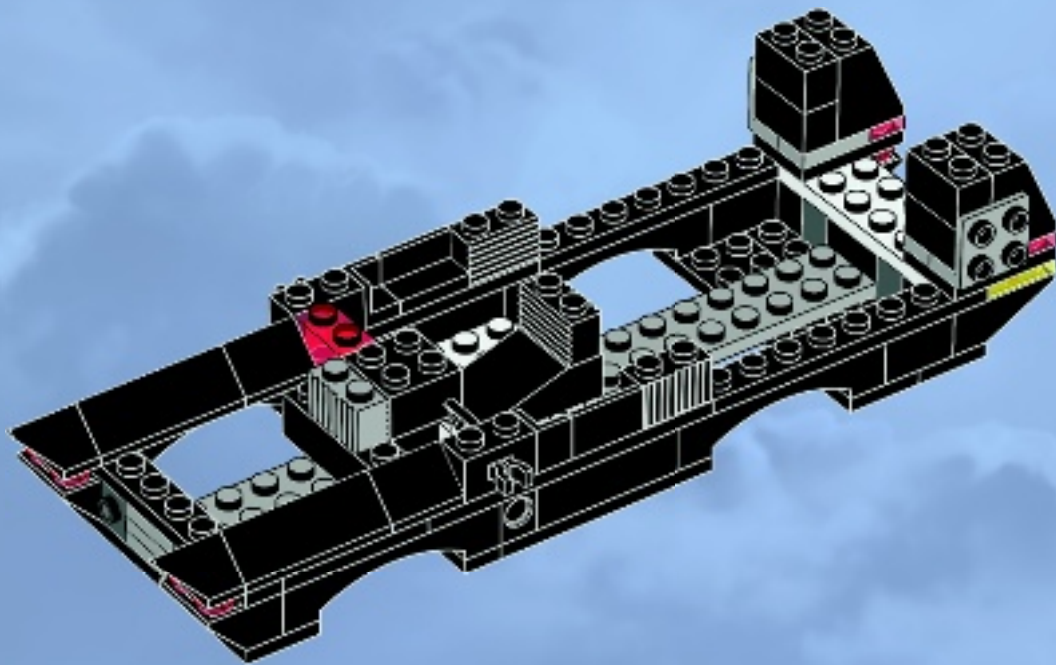



1

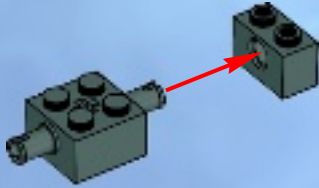

2

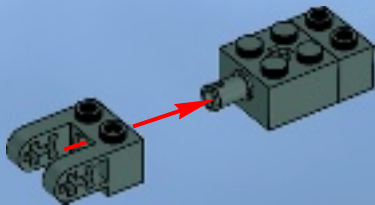

3



4

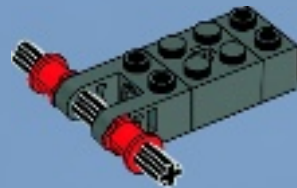



2x

5

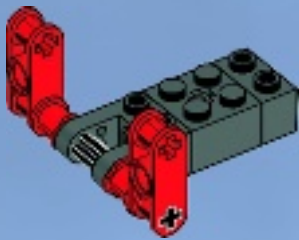

2x



2x



2x

6

1

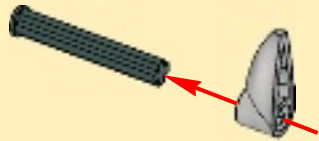

2



2x

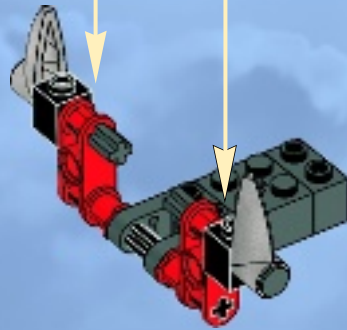

26

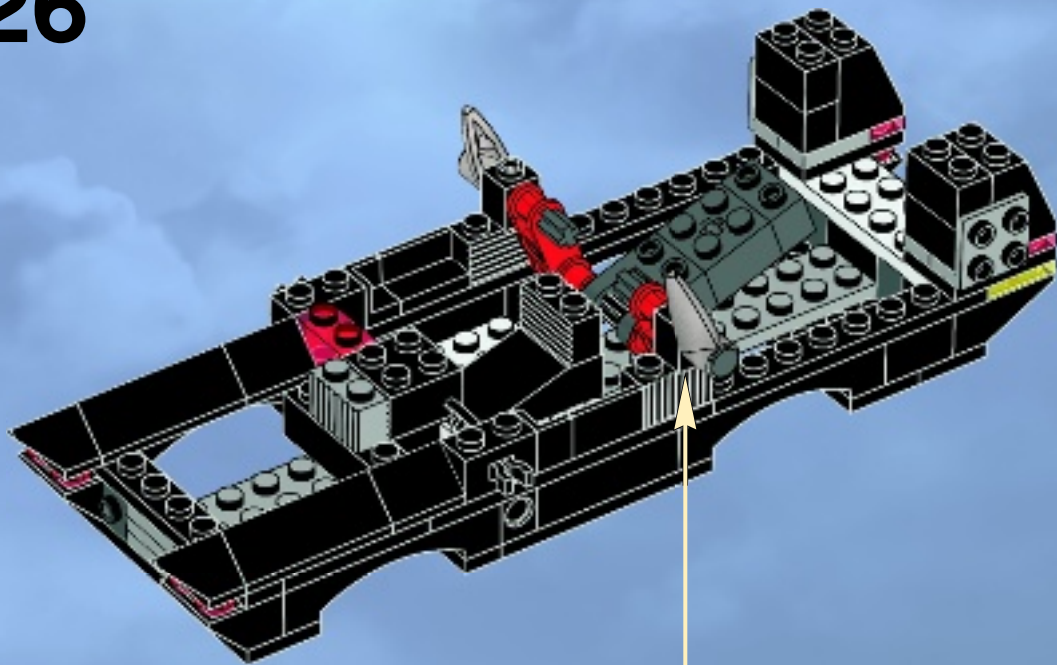



2x

27

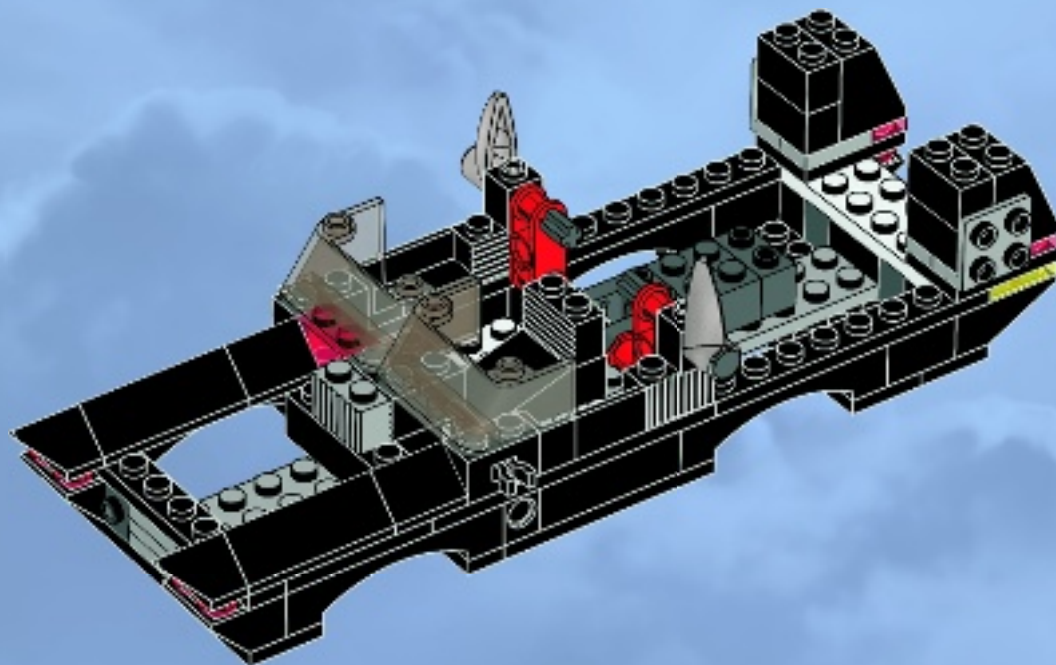

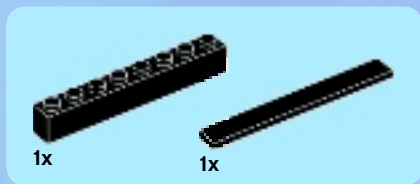

28

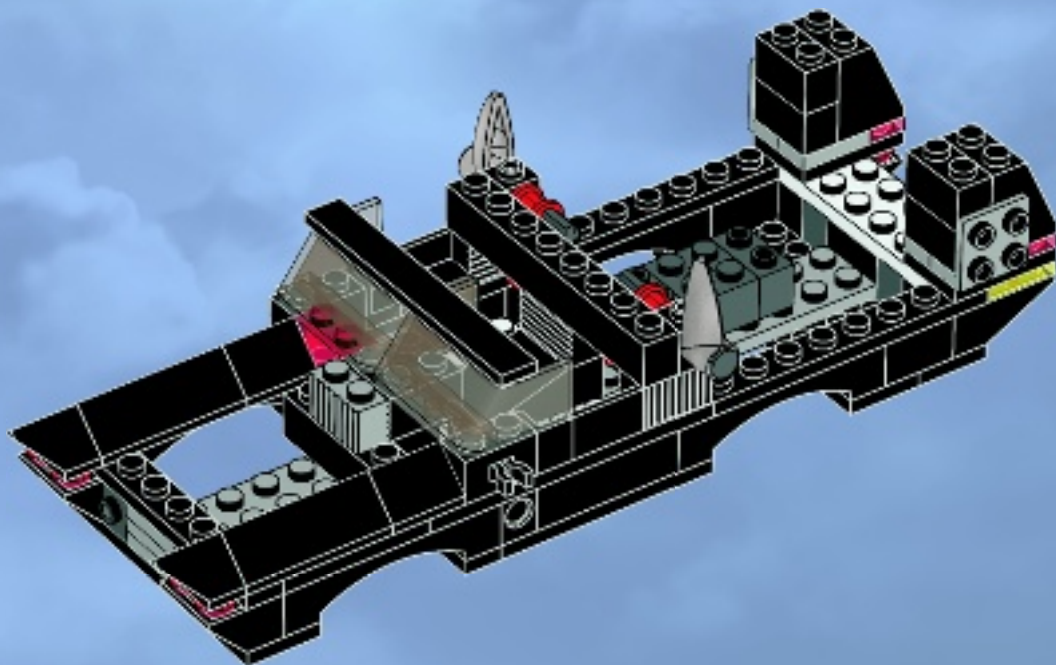

29

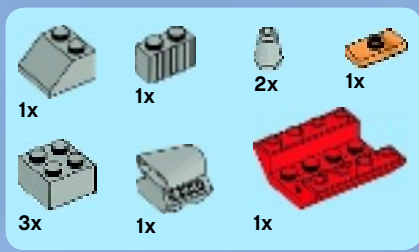

1

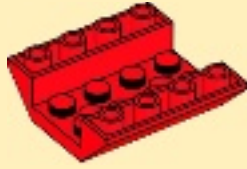

3

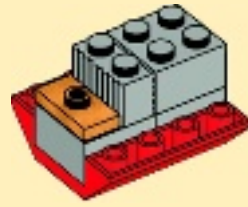

2



4

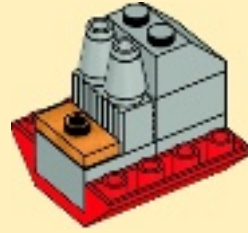

5

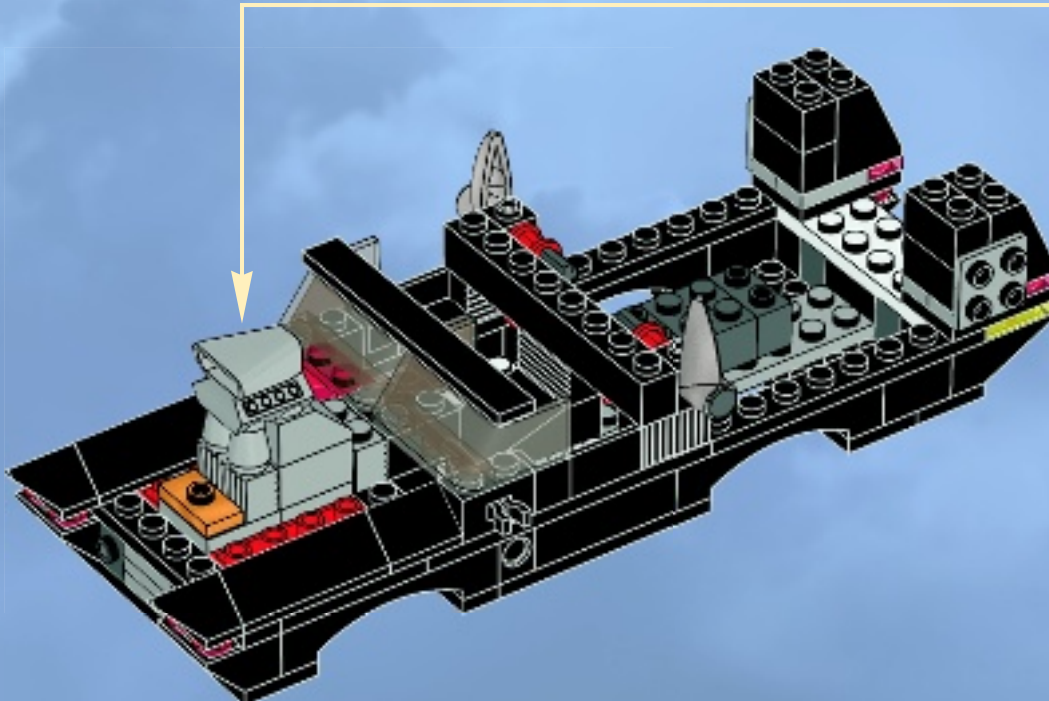
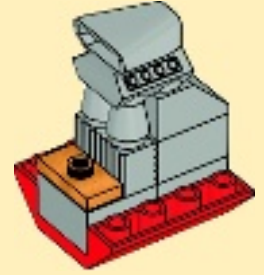



30

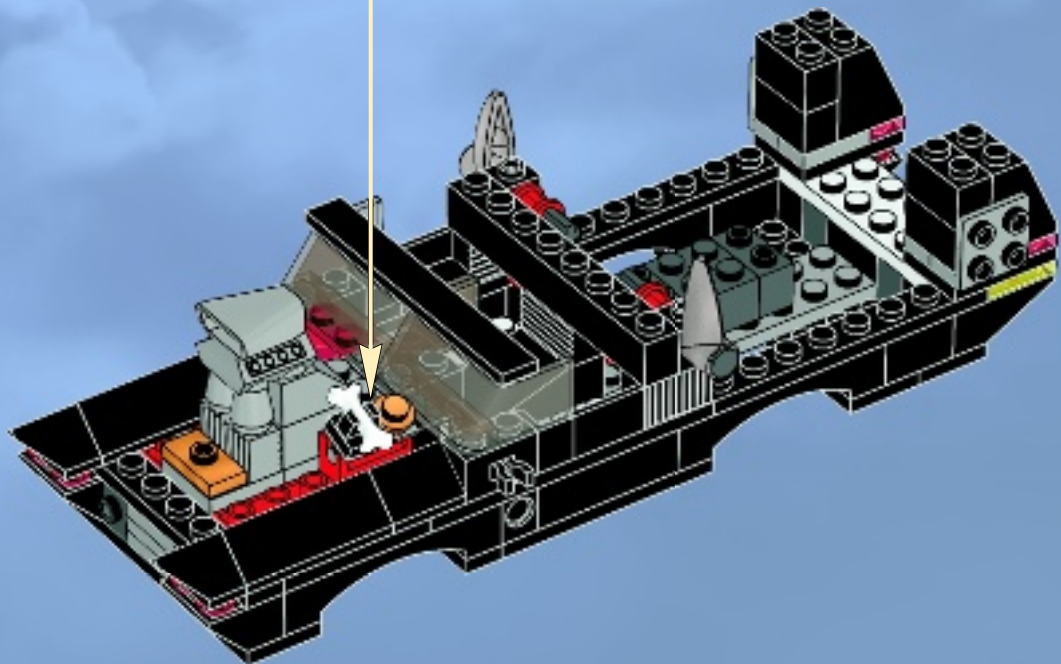
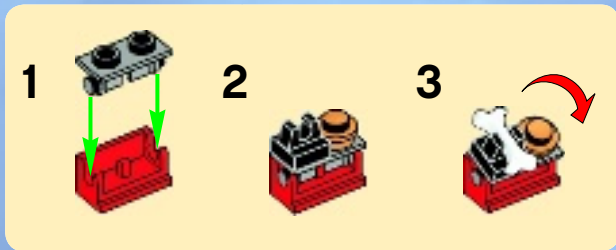

1x



1x

1x

1x

31

1

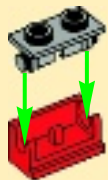

2



3

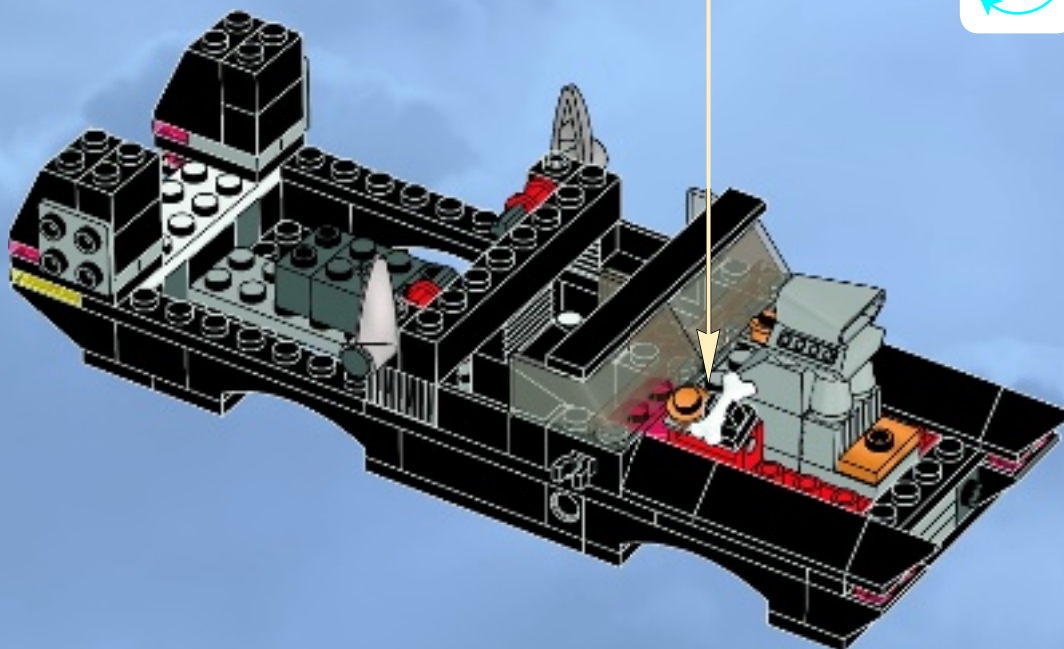
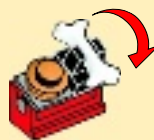



4x



2x



2x



4x

32

1

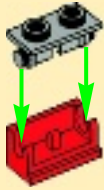

2

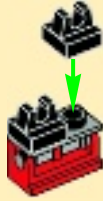

3



4



2x

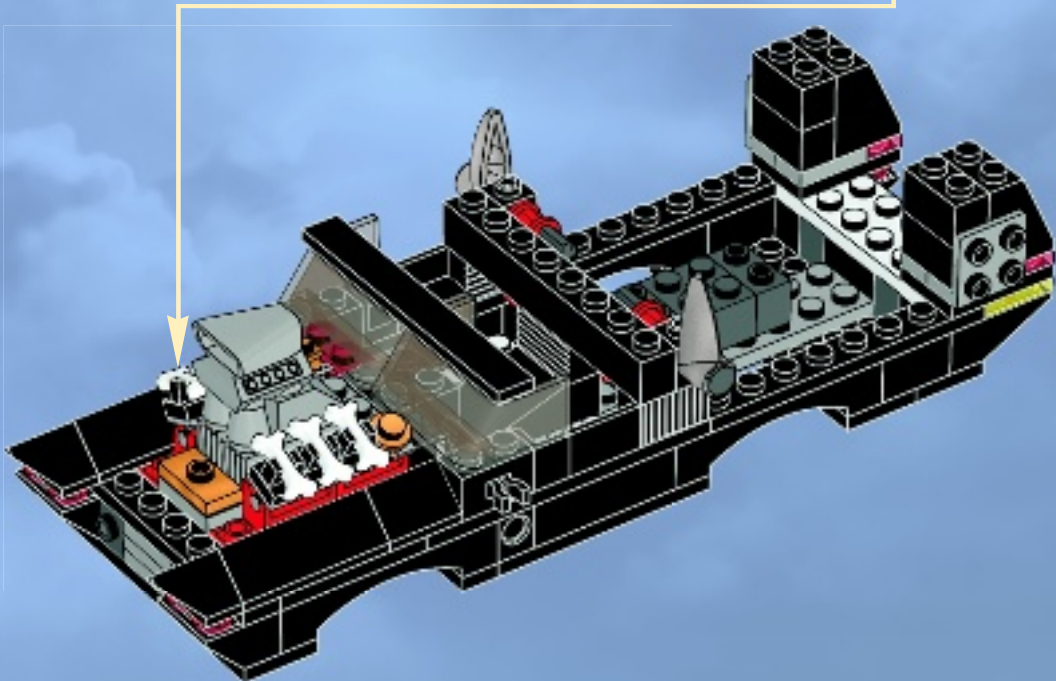



2x



1x

33

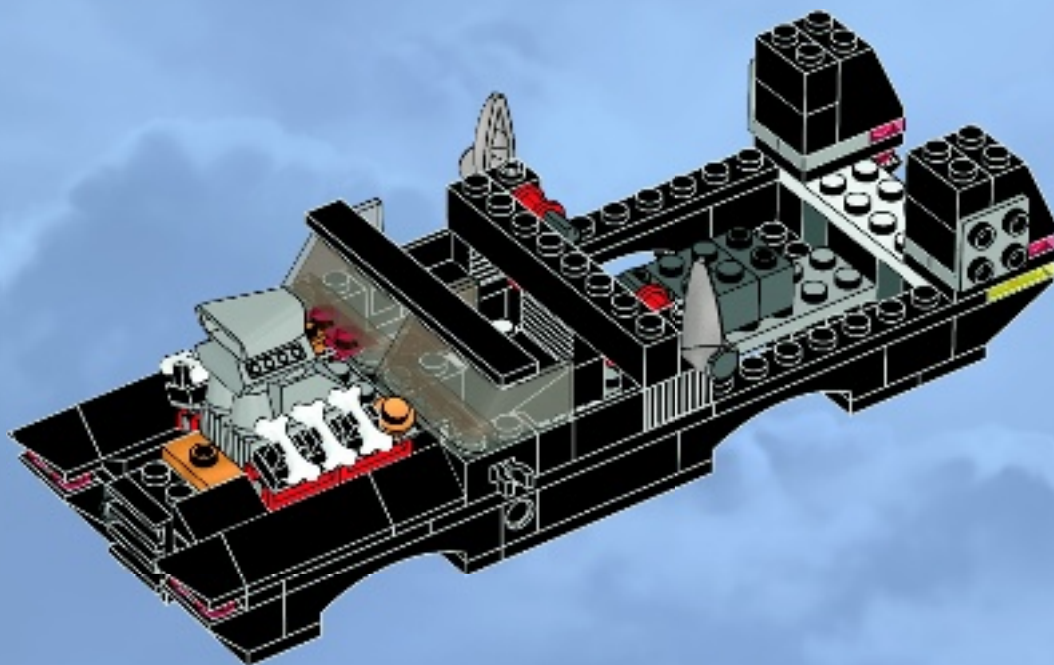



1x



1x

34

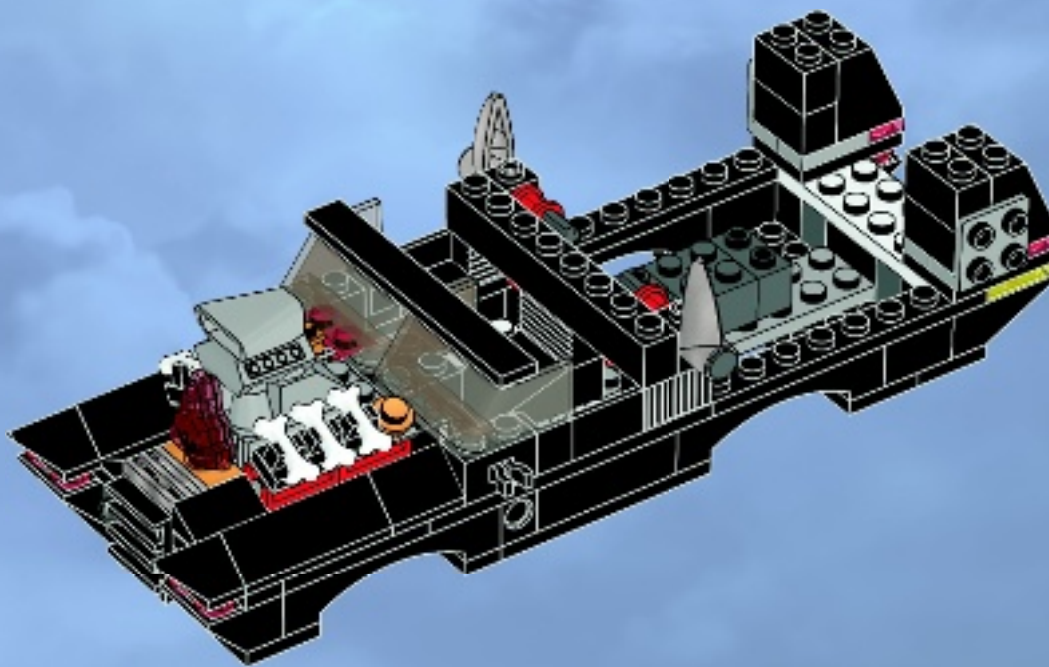

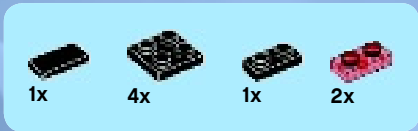
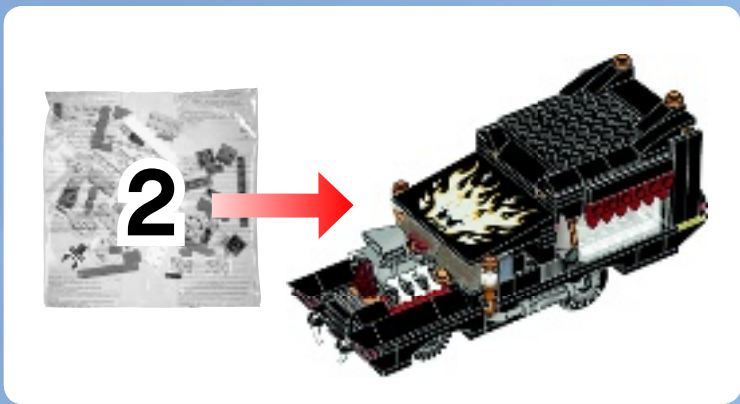

35

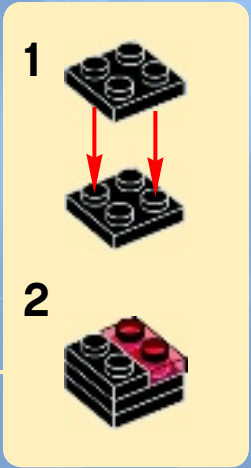
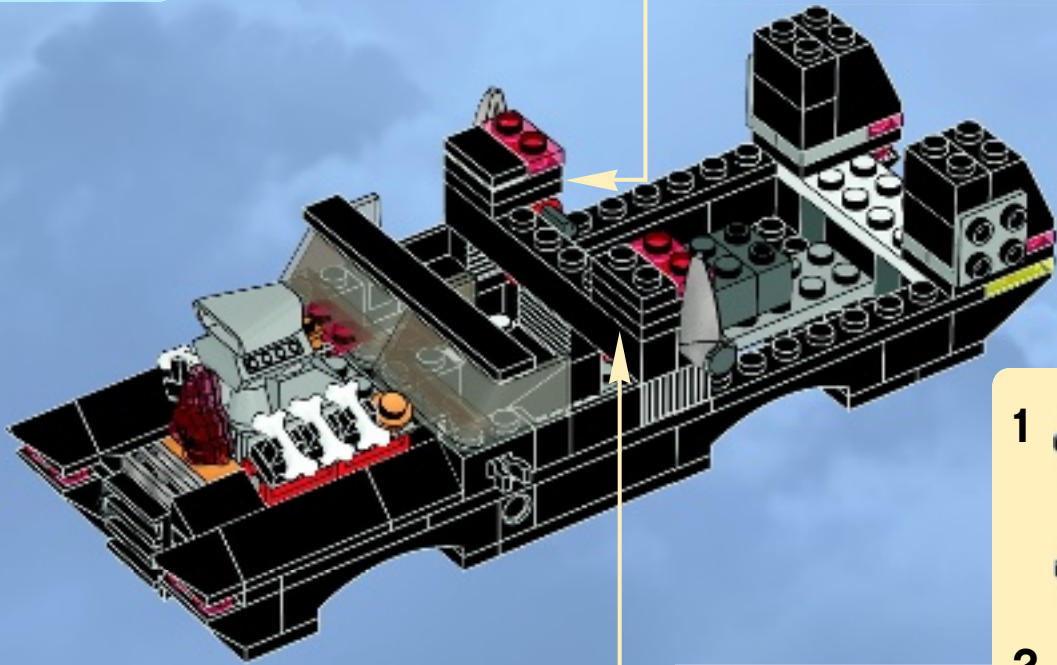



1x



1x

36

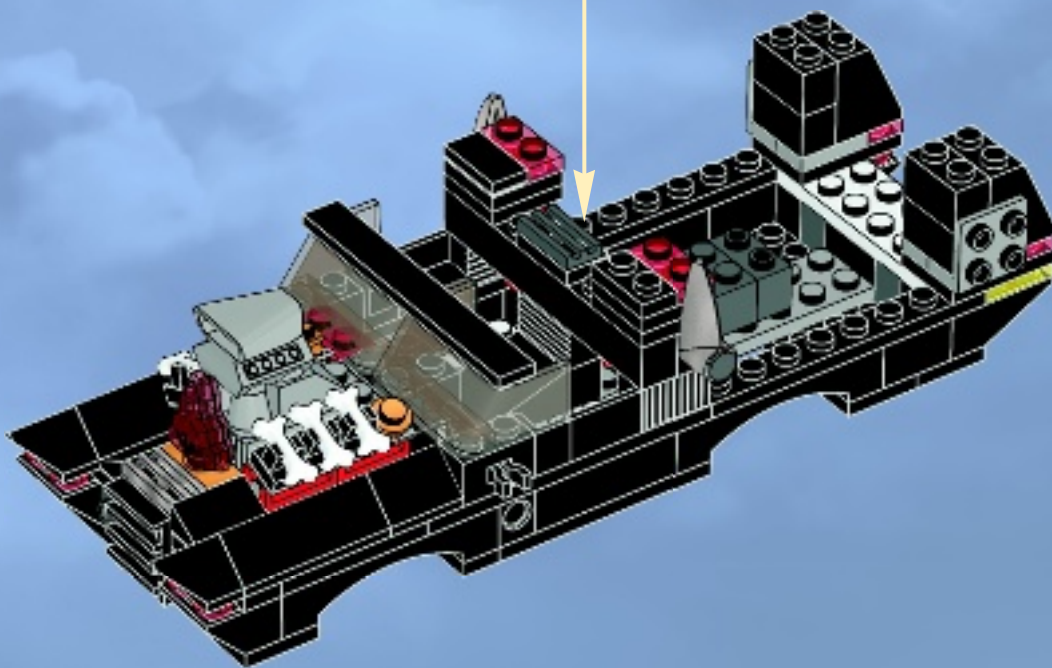
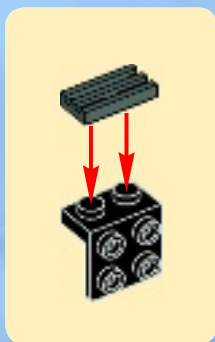

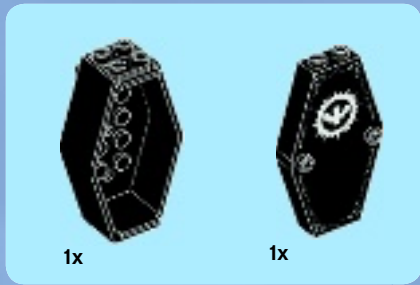

1

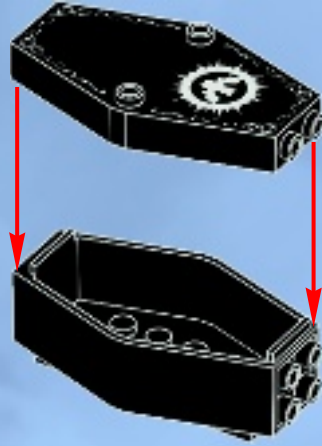

2



3

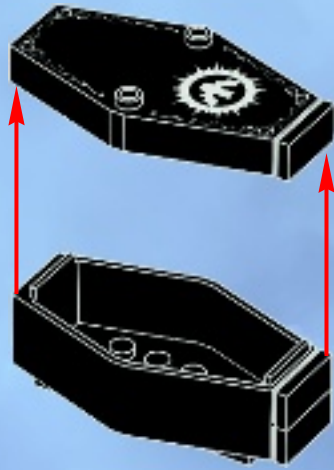

4

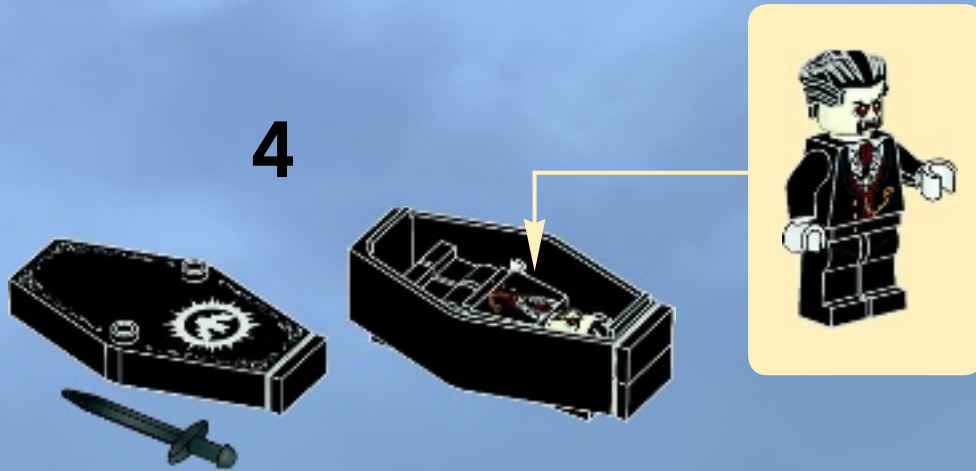



37

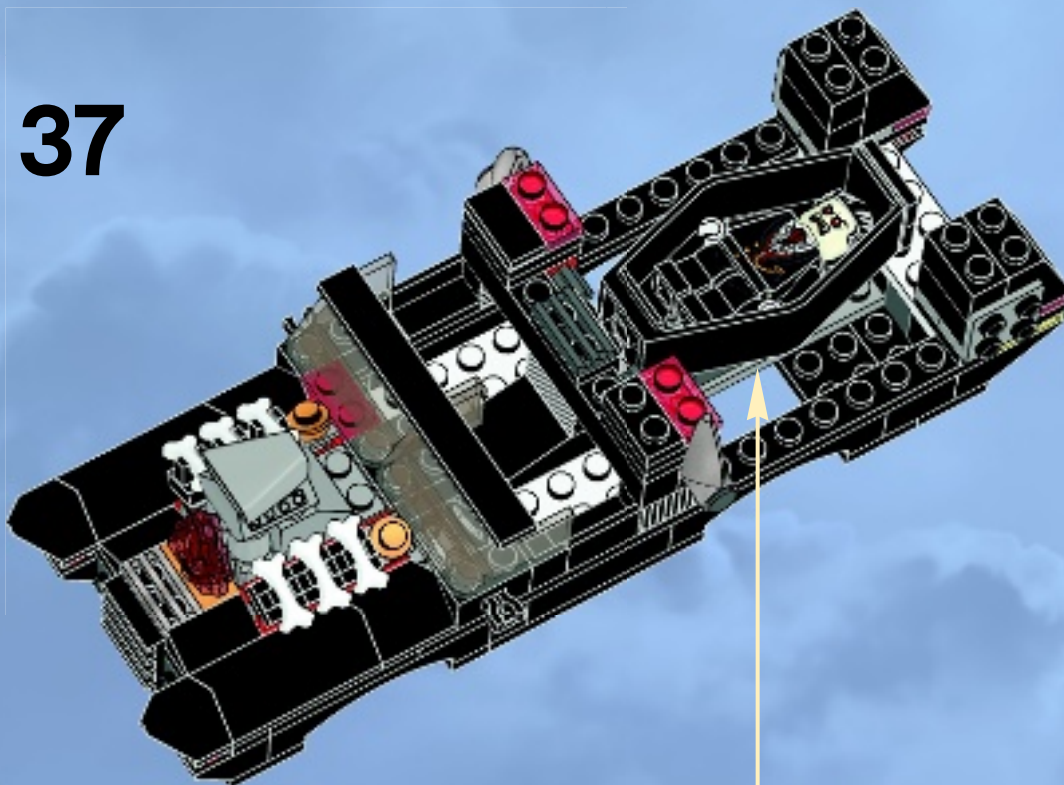



2x



2x

38

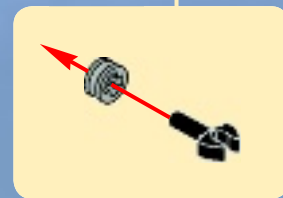
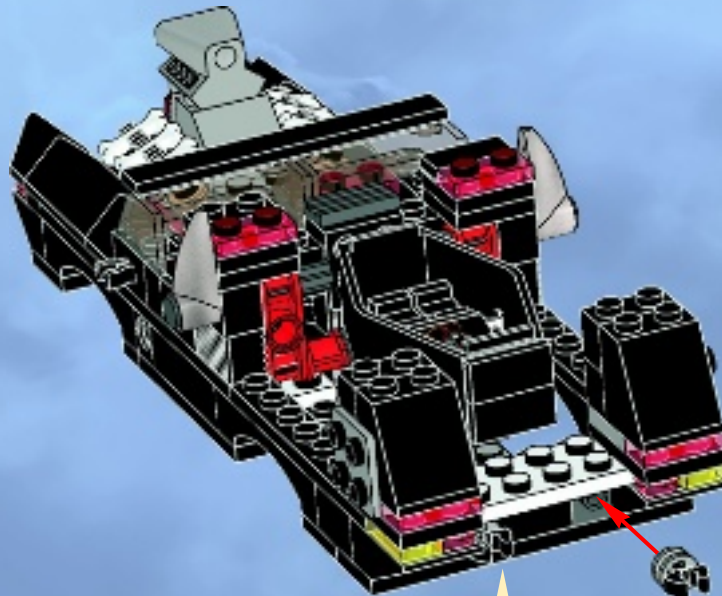



1x



4x



2x

39

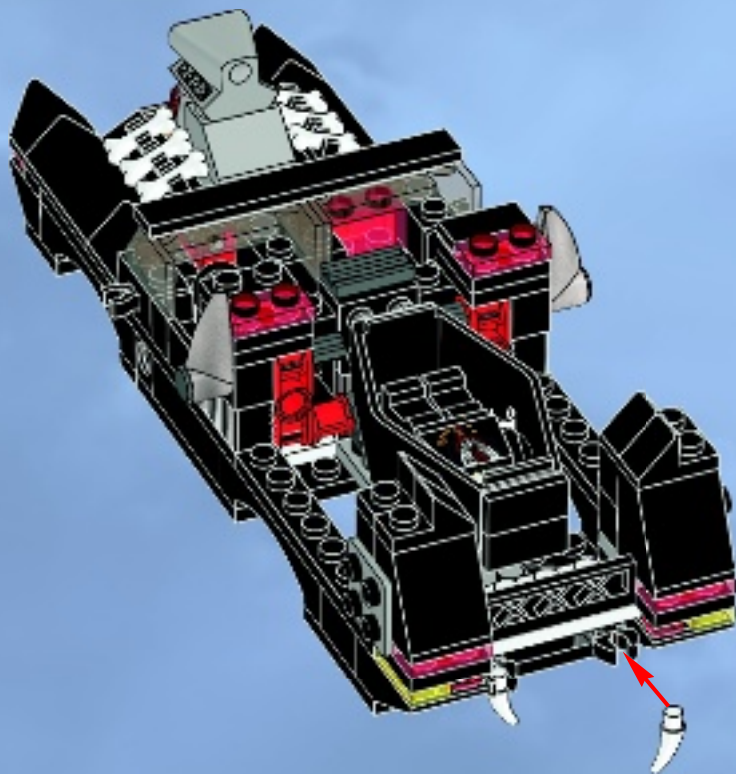



2x



2x



2x

40

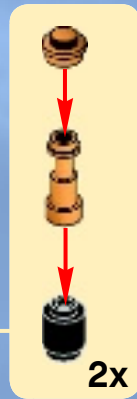
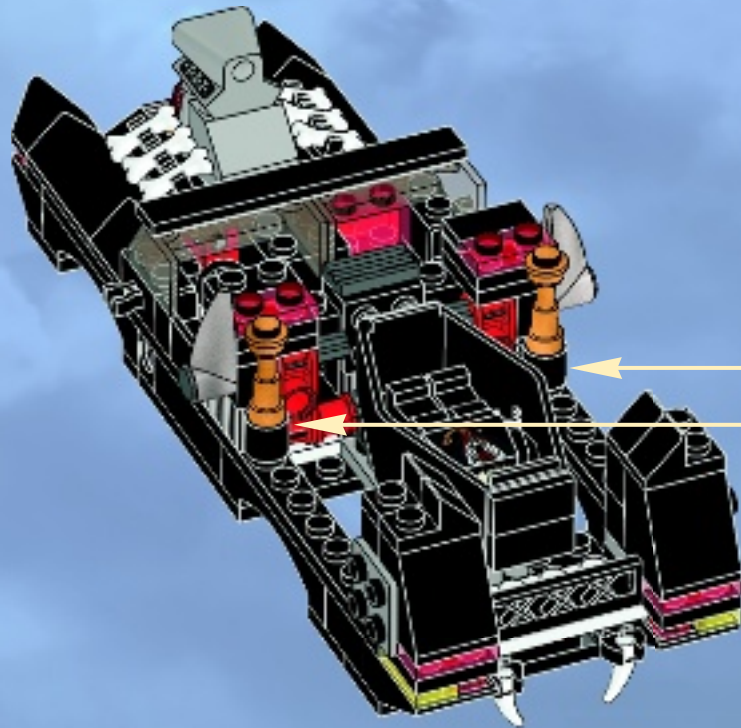



2x

41

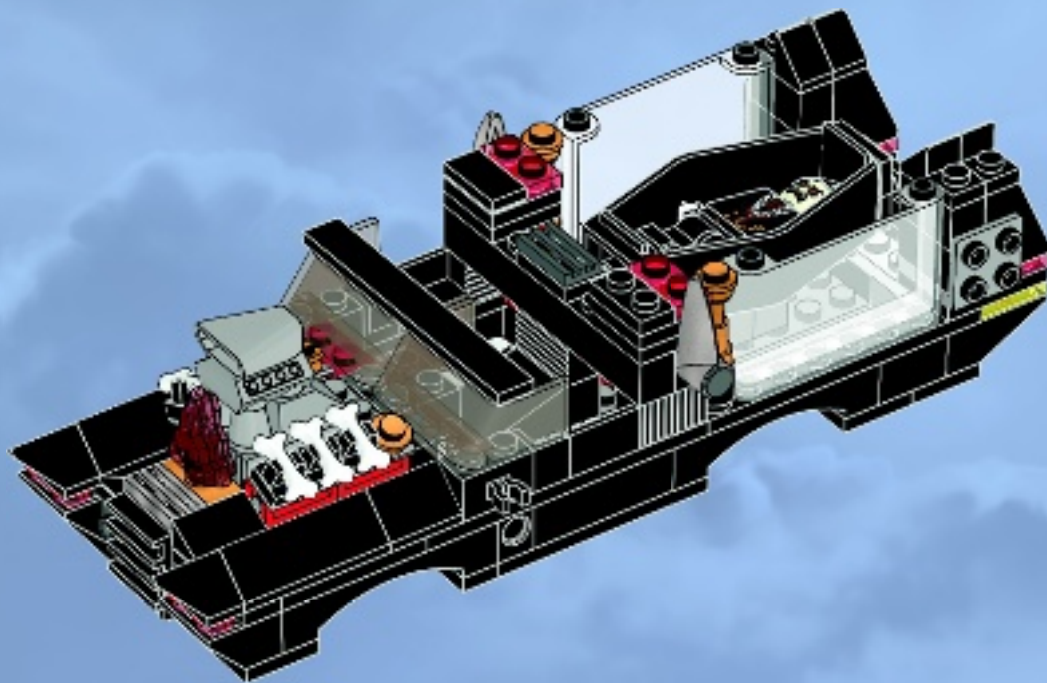



42

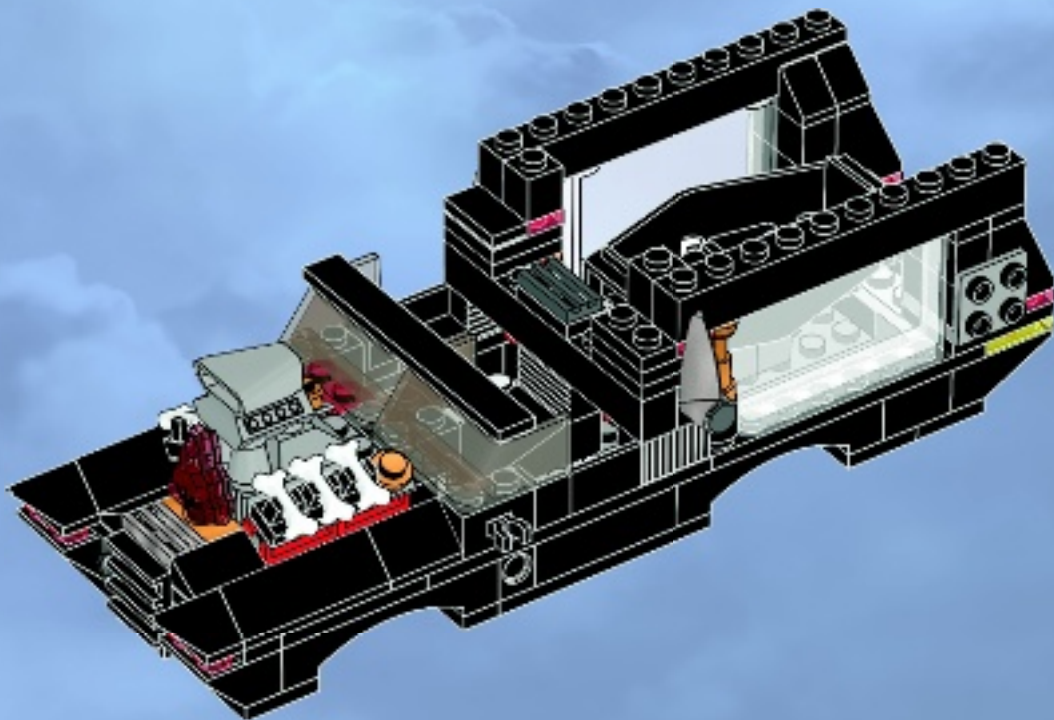



2x



2x

43

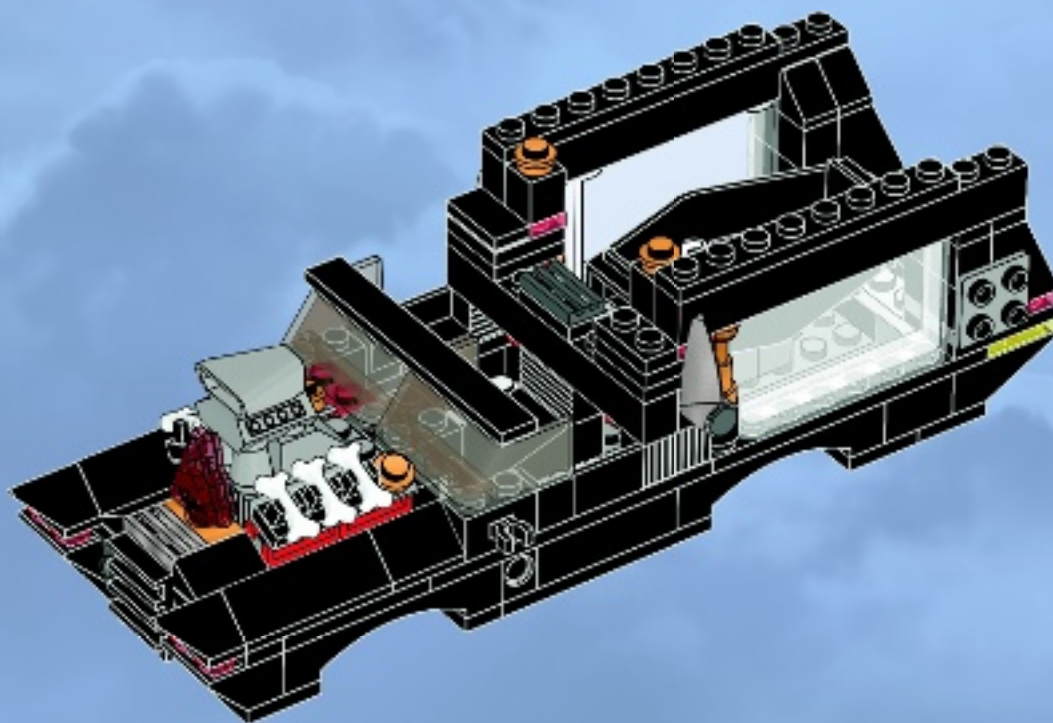



2x



2x

44

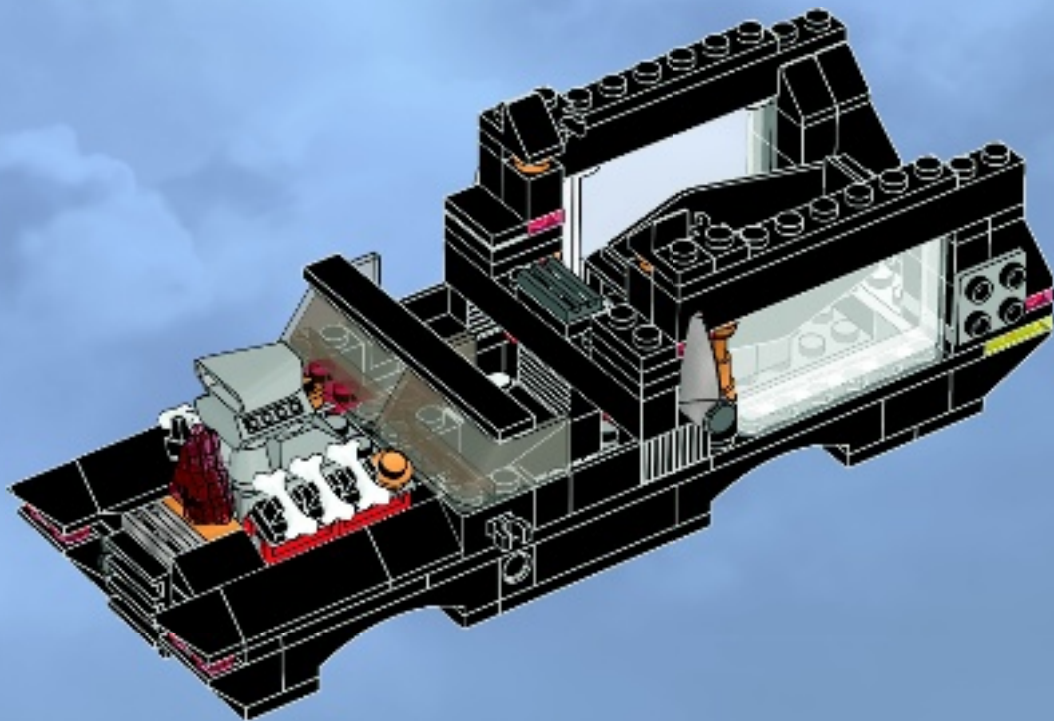



6x

45



3x

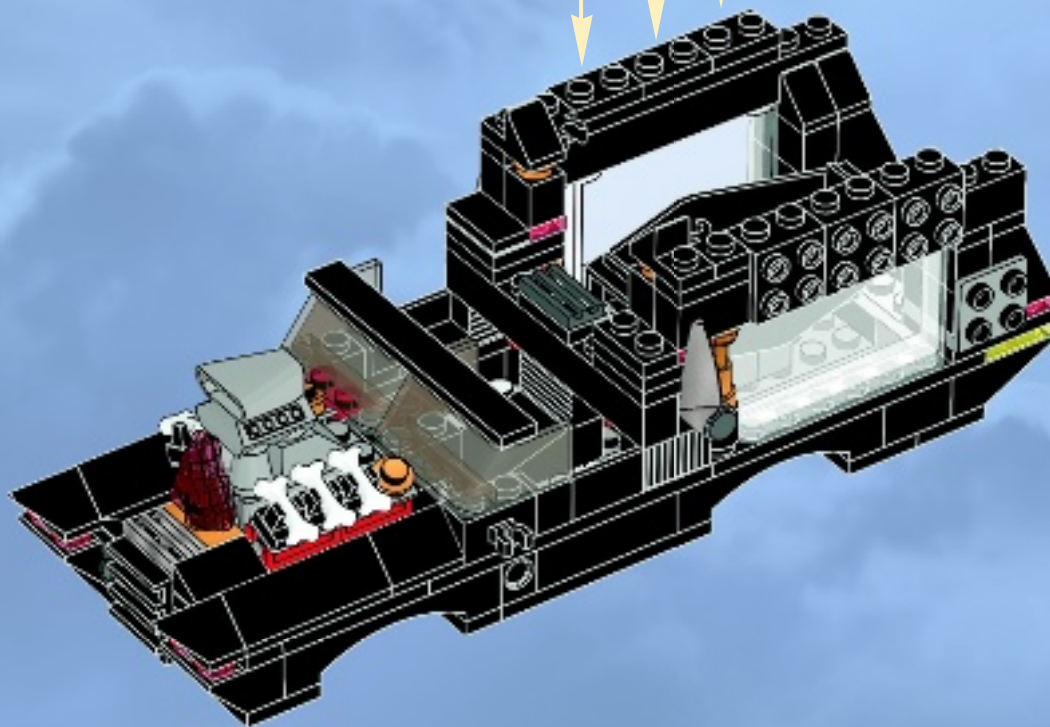



2x



6x

46

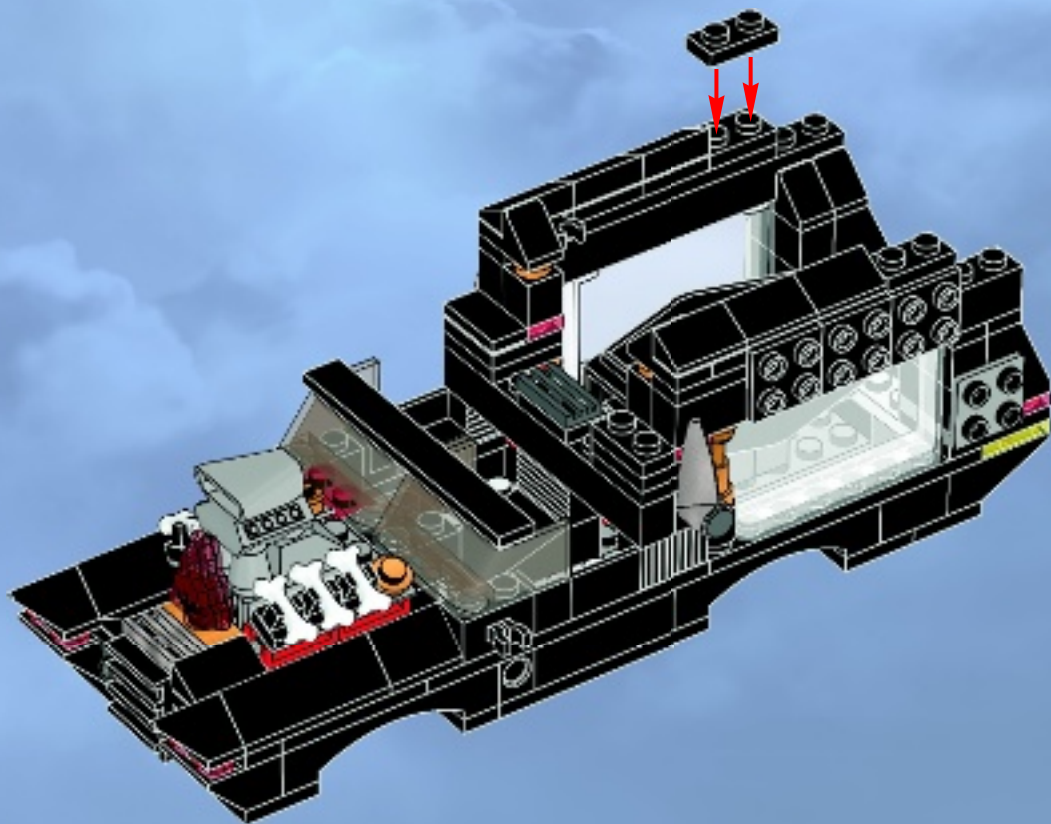

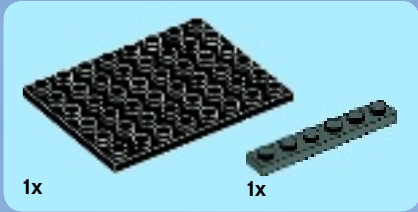

1

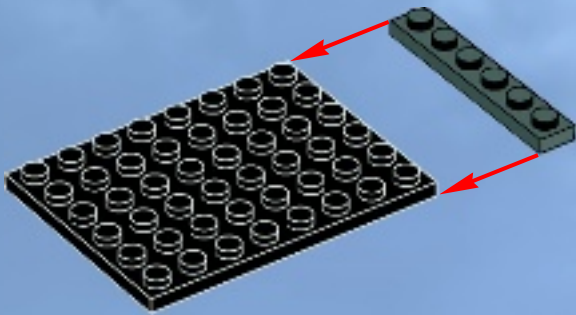

2

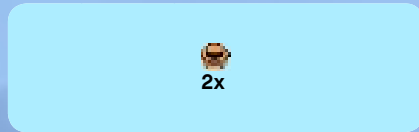

3

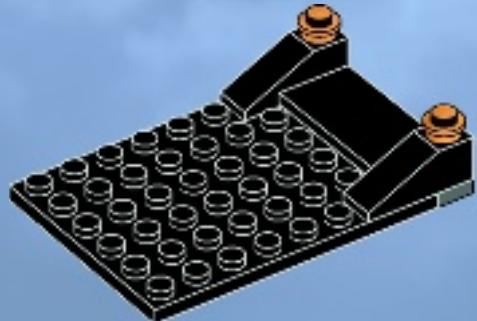



4

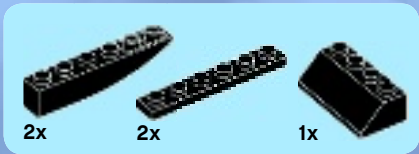
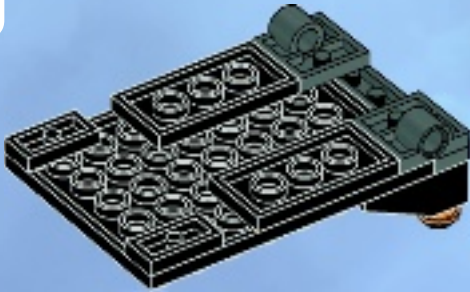

5

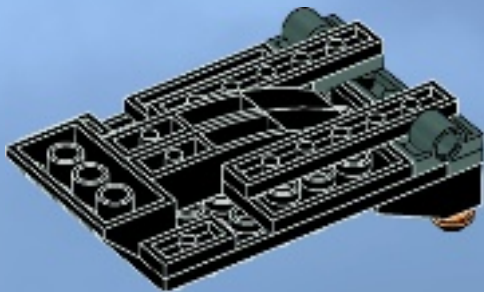

6

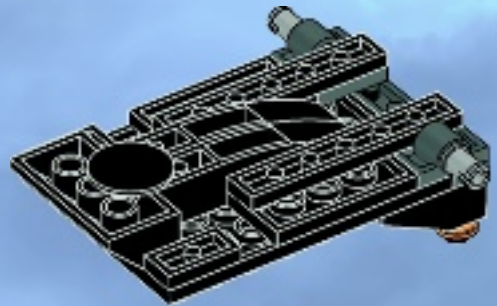

7

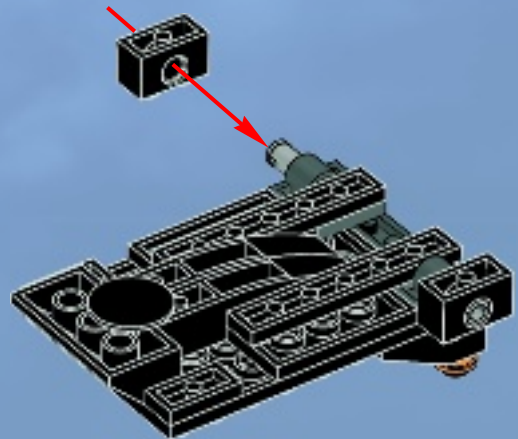



2x

8

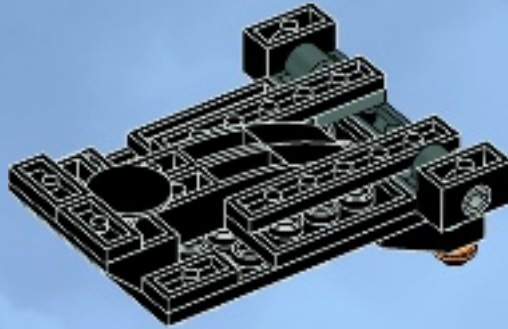

9

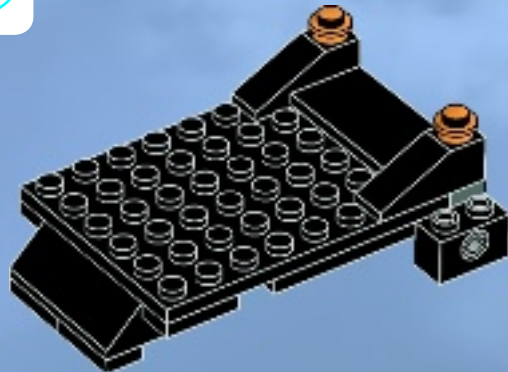

47

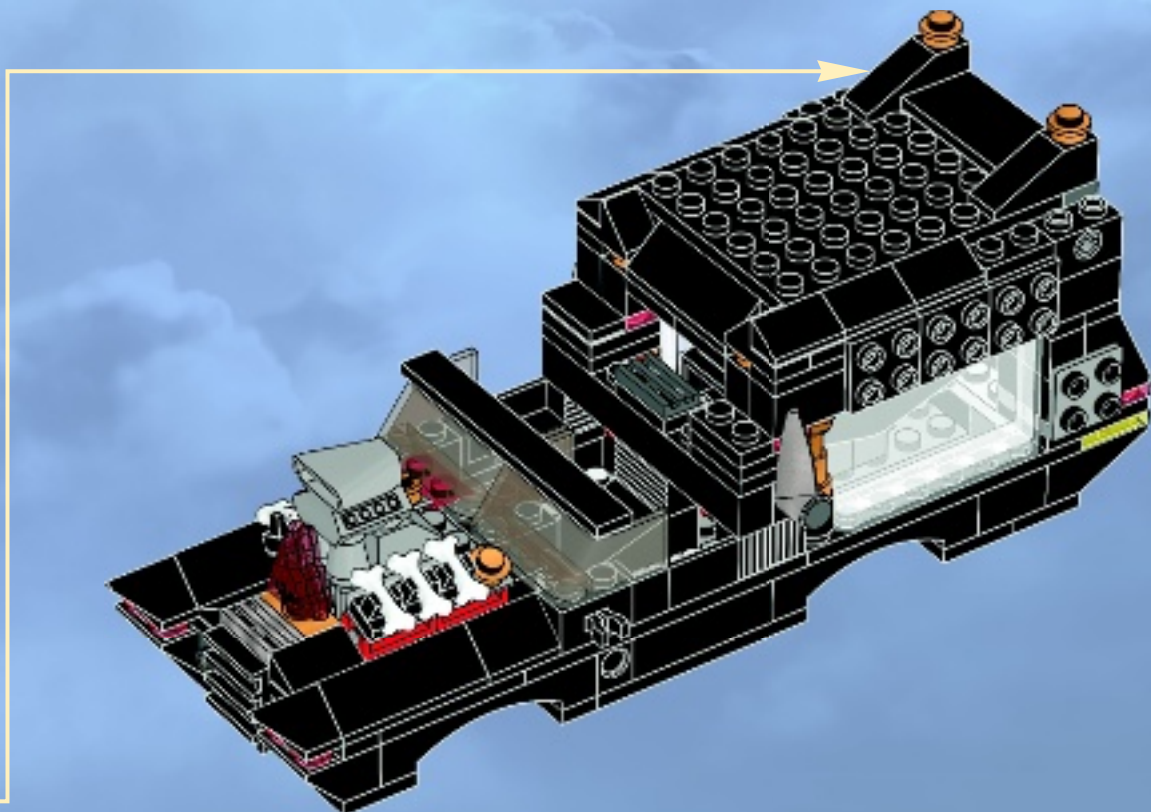



48

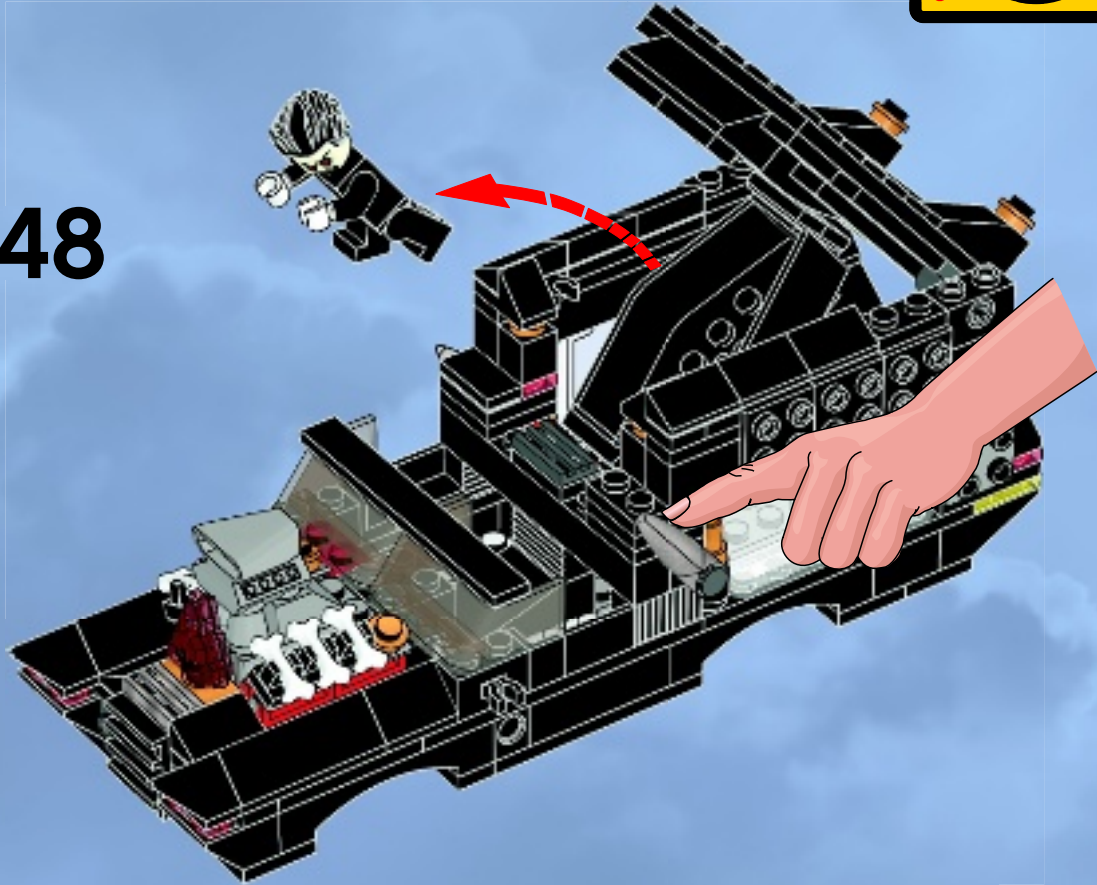



2x

49

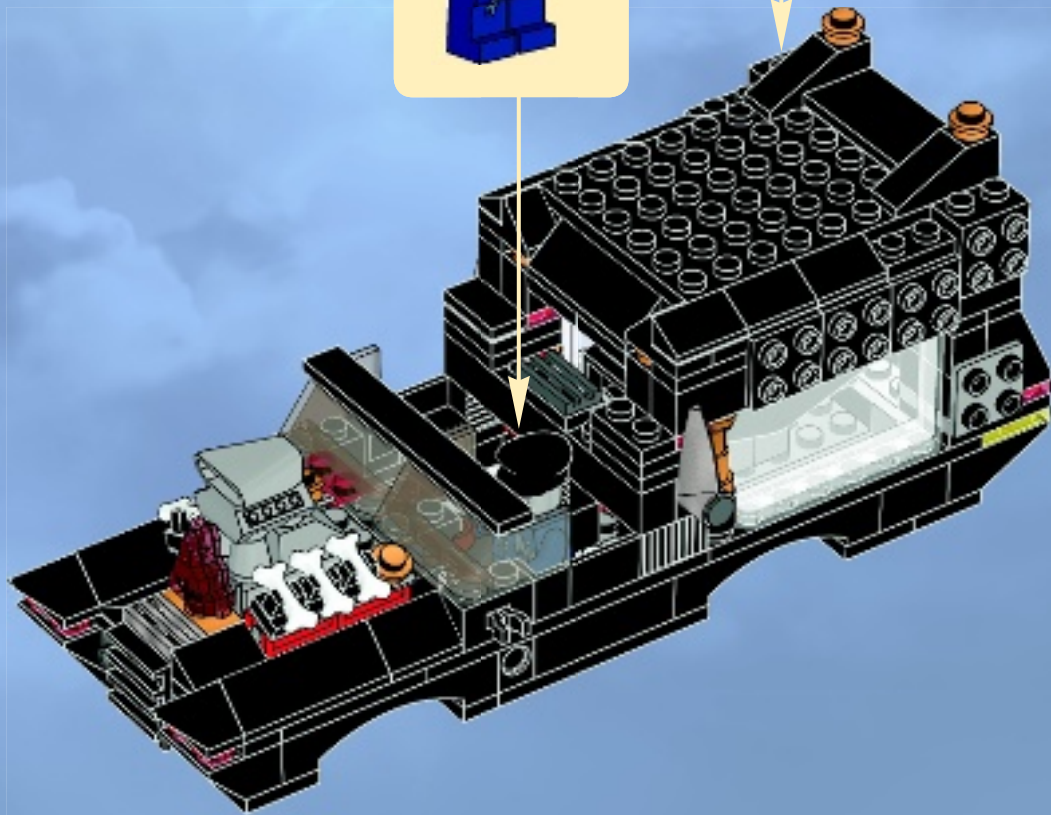



3x



6x

50

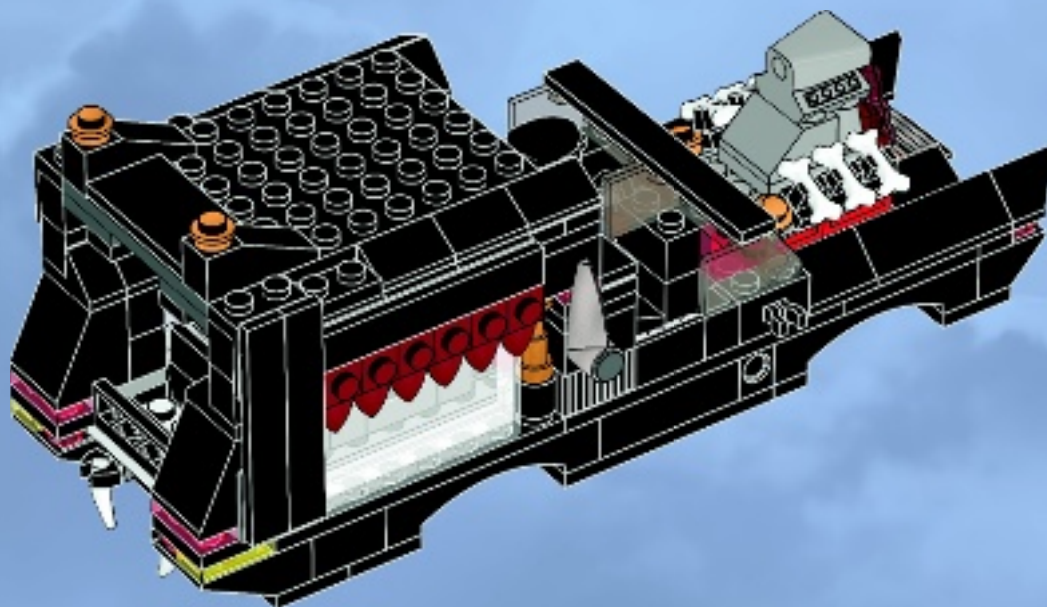



51

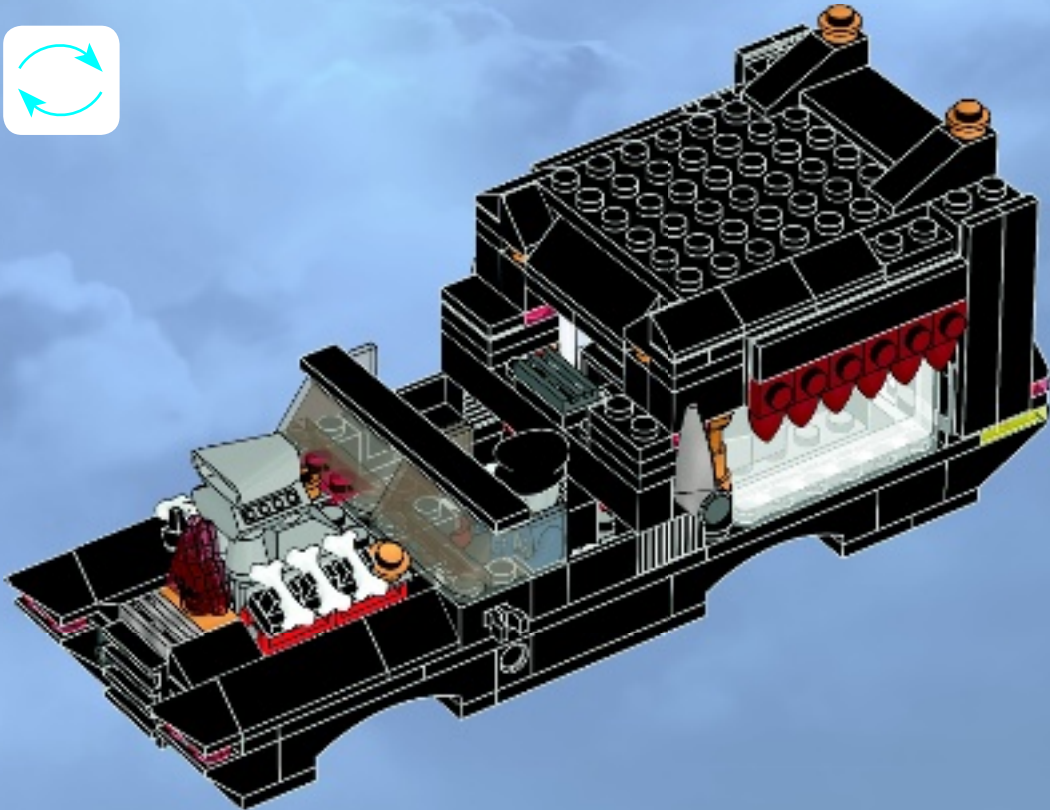



52

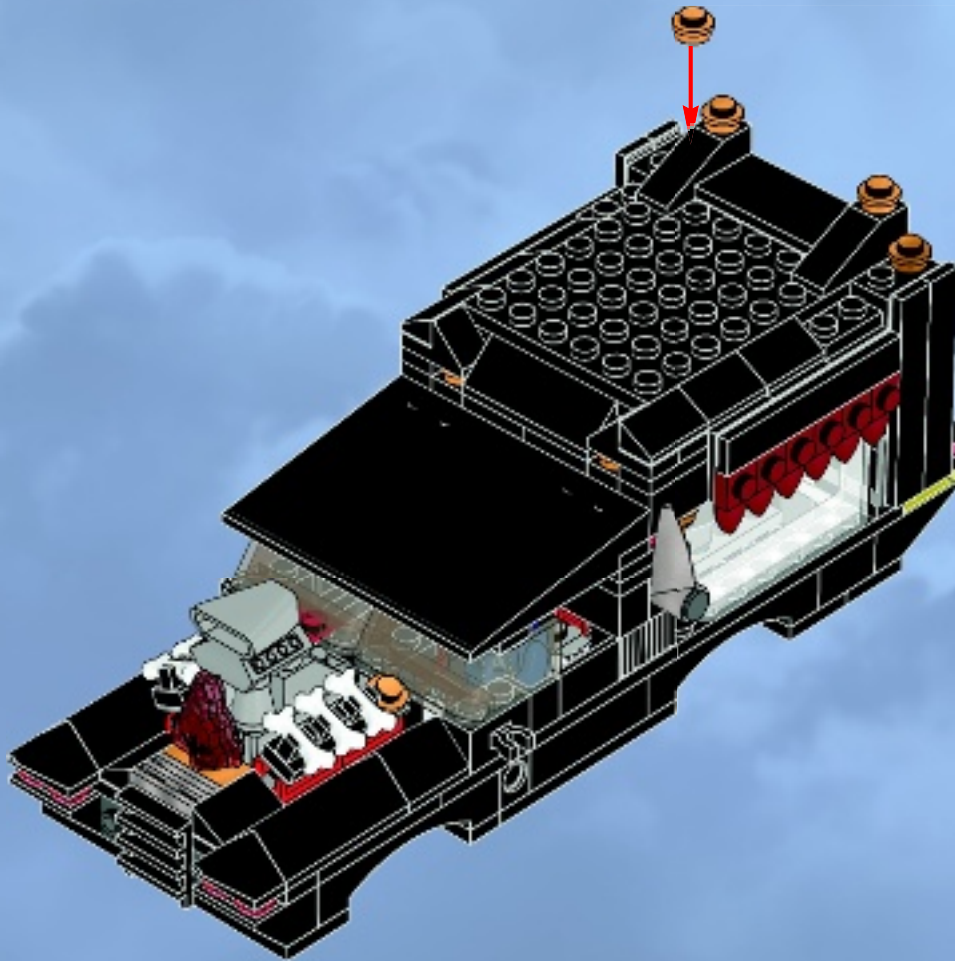



2x

53

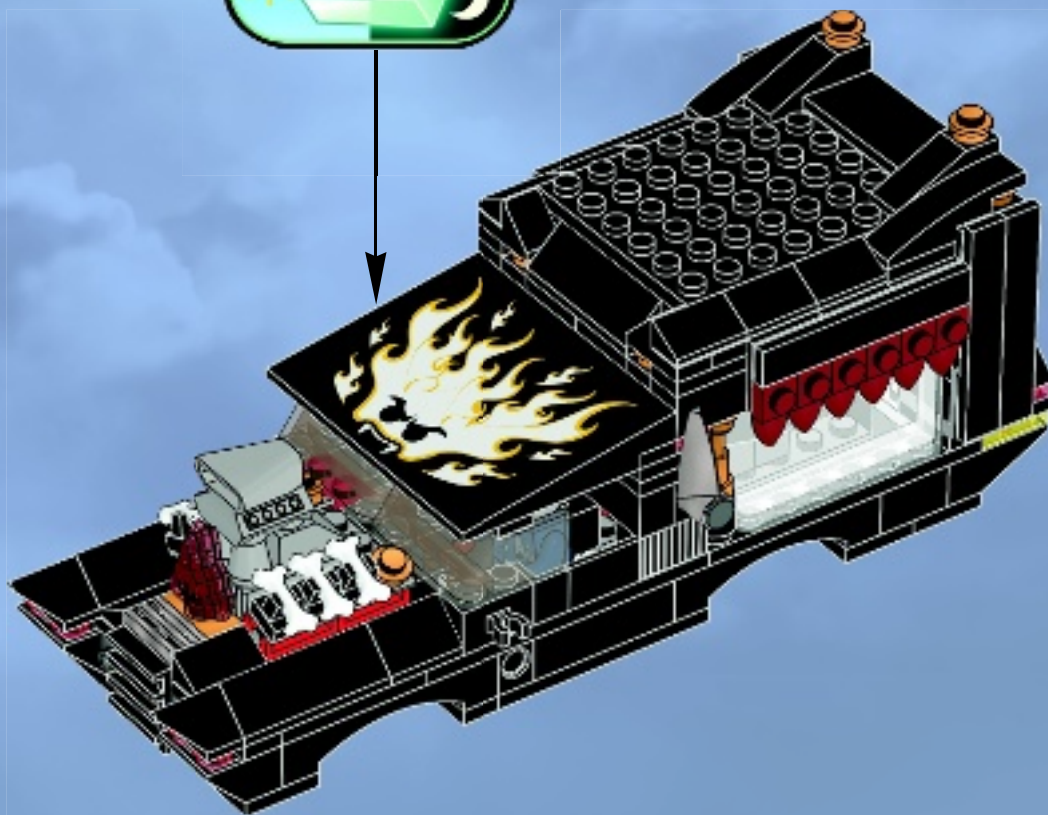



2x



1x



2x

54

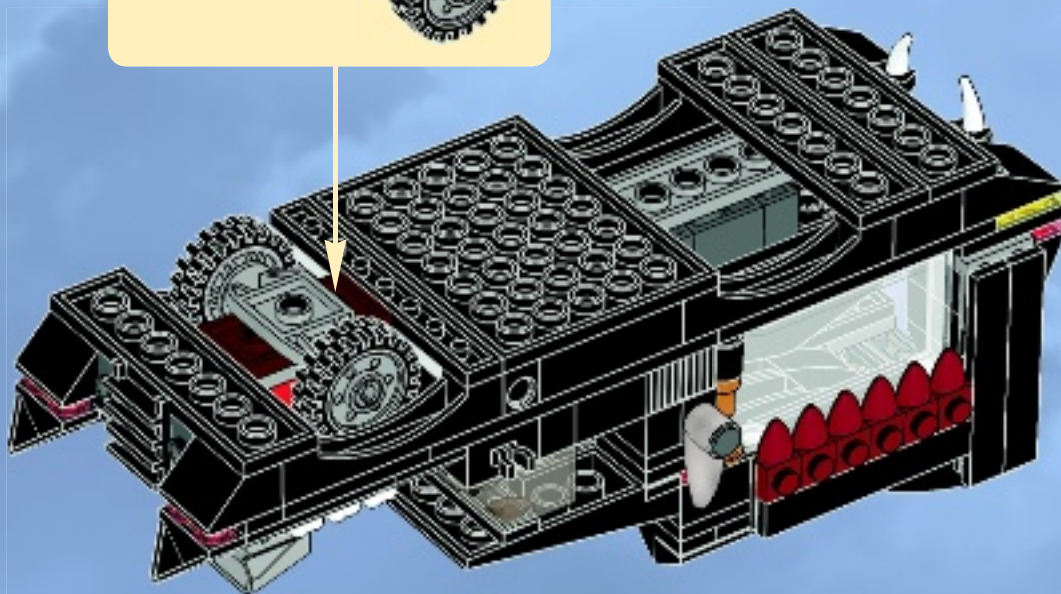
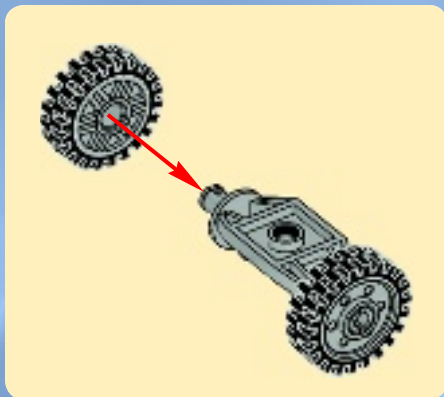



1x

1



1x

2



2x

3



1x

4

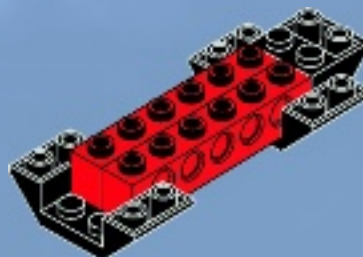



1x

5



6x

6

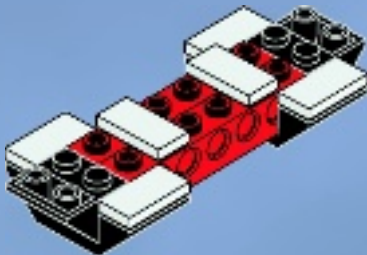

2x



2x



2x

7

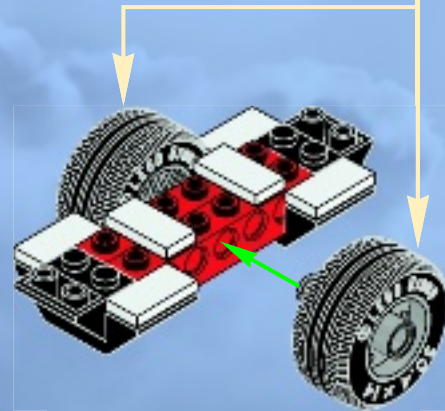
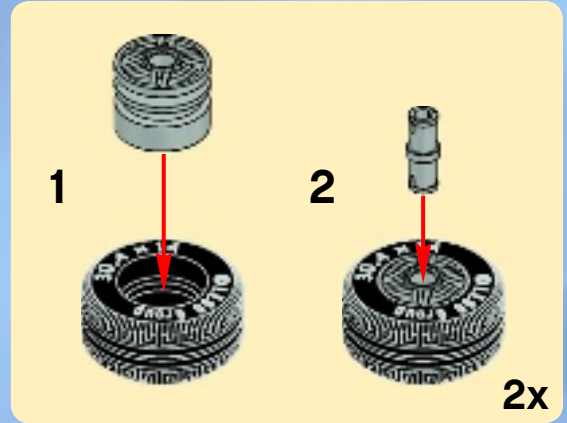

8



55

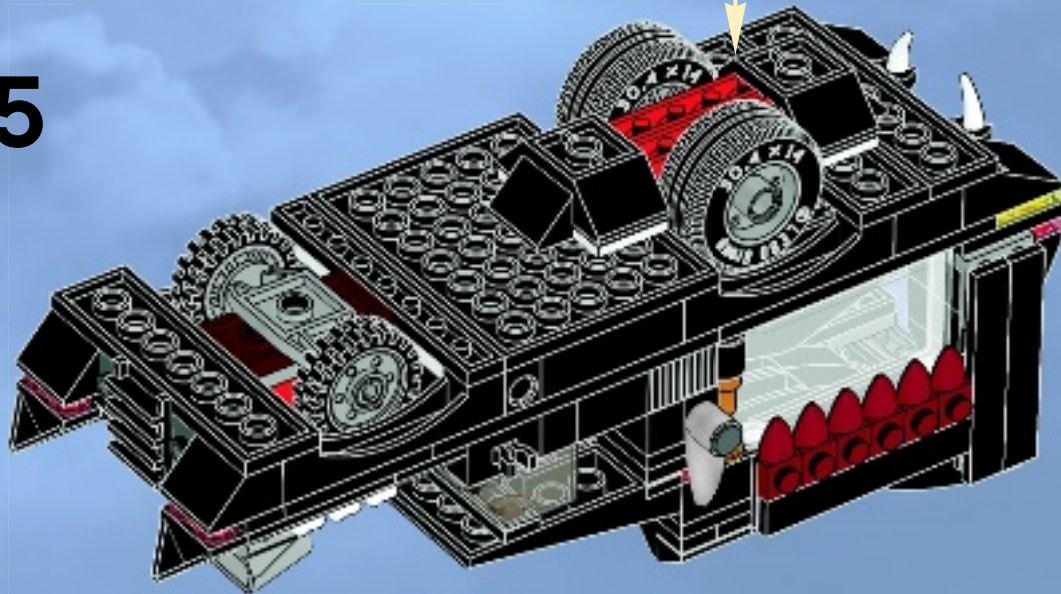



2x

56

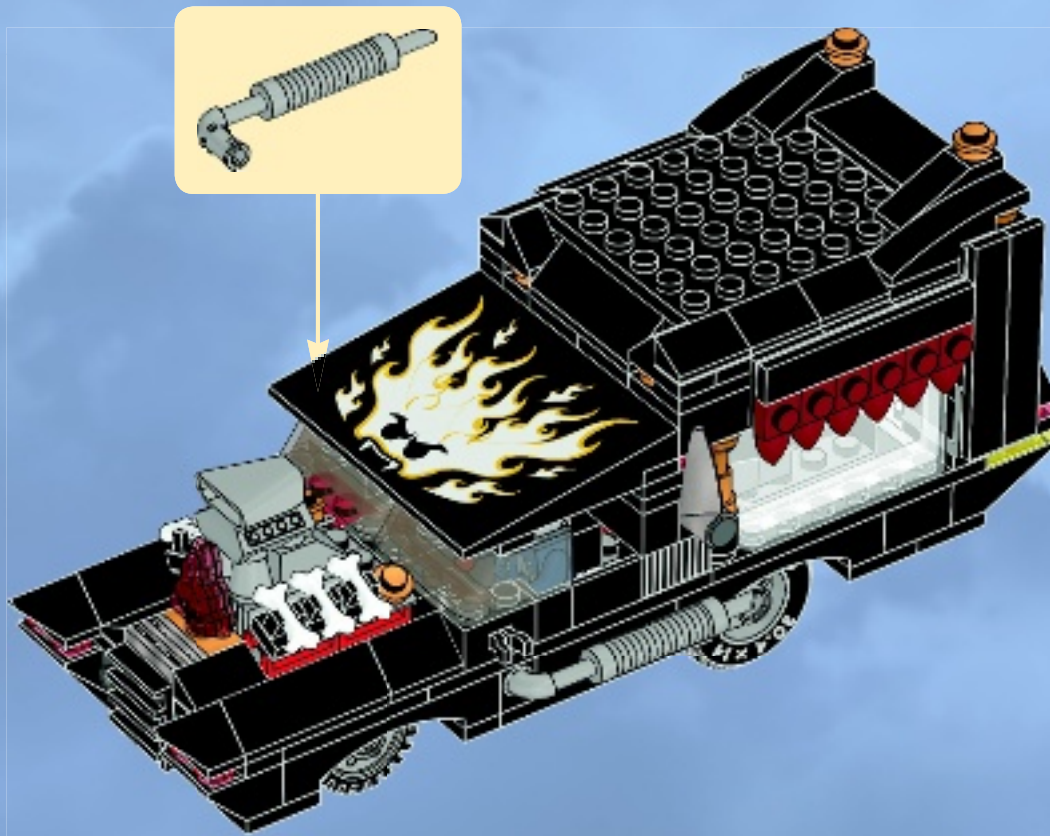



2x



2x



2x

57

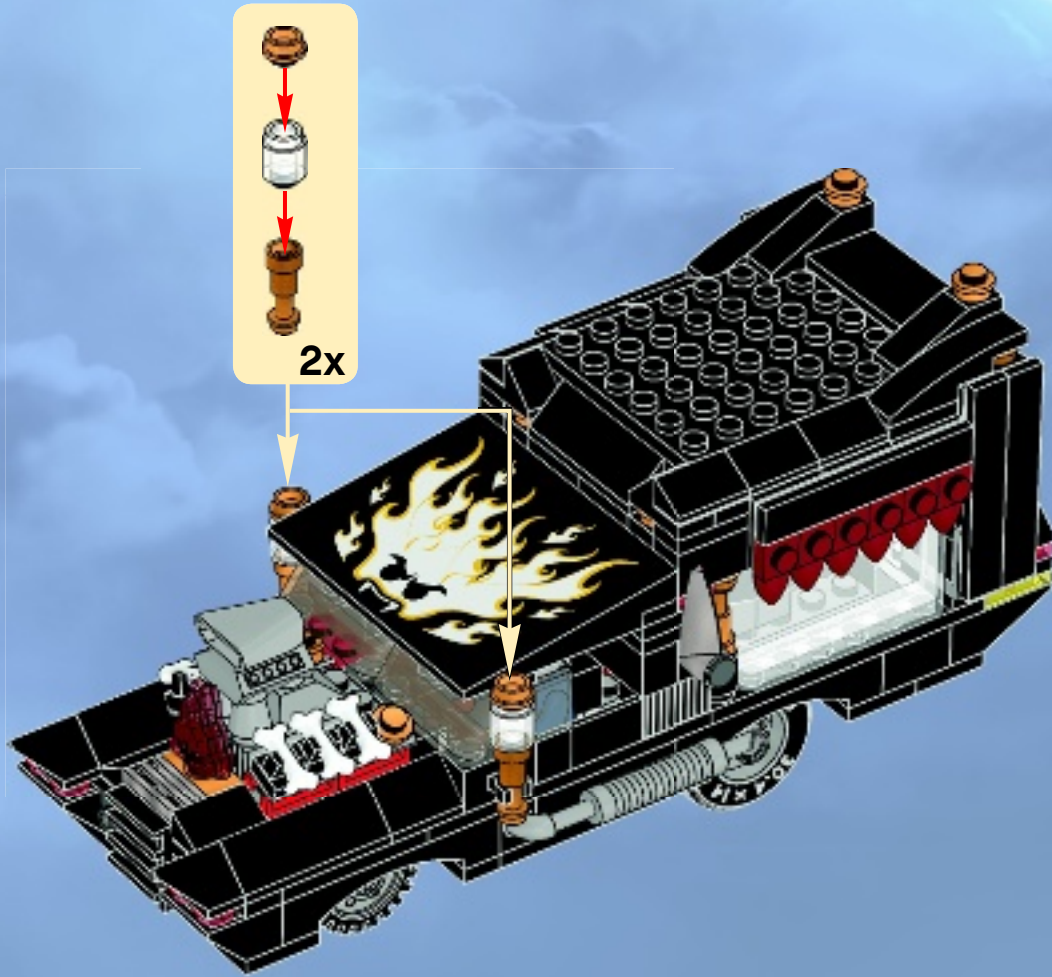



2x



2x

58

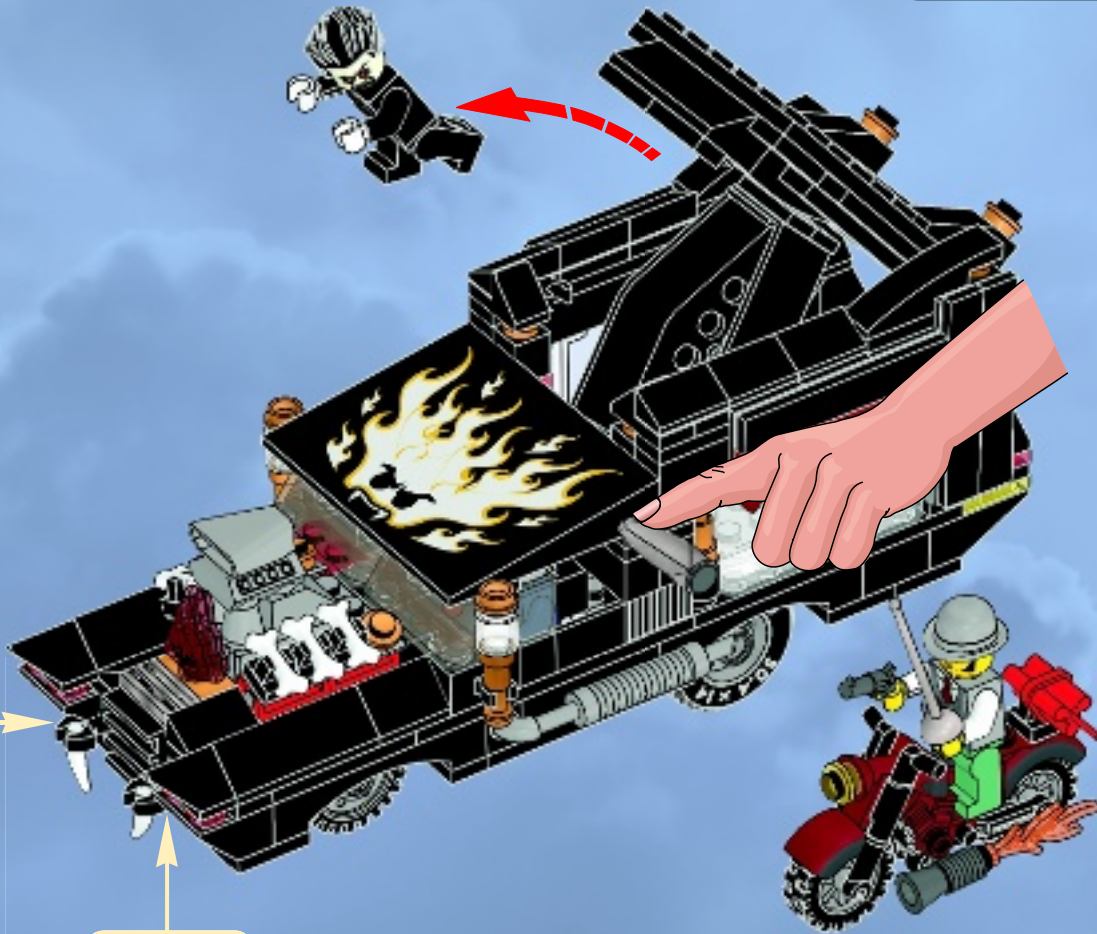





Customer Service
Kundenservice
Service Consommateurs
Servicio Al Consumidor

www.lego.com/service or dial

00800 5346 5555 : 

1-800-422-5346 : 



www.LEGOclub.com/Max

www.LEGOclub.com/Max



LEGO club™

FREE*! GRATIS! GRATUIT!

*Paid subscription in Australia and New Zealand.
*Abonnement payant en Australie et Nouvelle-Zélande.

©2012 The LEGO Group.



MONSTER FIGHTERS



9461



9462



9463



9464



9466



9467



9468



MONSTER FIGHTERS



Use this code in the online game to unlock scary content. If you dare ...

Schalte mit diesem Code den geheimen Inhalt frei. Traust du dich?

Utilise ce code dans le jeu en ligne pour débloquer des contenus effrayants. Si tu oses ...

Usa este código en el juego en línea para desbloquear una terrorífica sorpresa. Si te atreves ...

Usa este código no jogo online para abrires um conteúdo assustador. Se tiveres coragem ...

Ezzel a kóddal nyisd meg az online játékban az ijesztés témát. Ha mered ...



monsterfighters.LEGO.com



WIN!

Go to www.LEGOsurvey.com/product to fill out a survey for a chance to win a cool LEGO® Product.

No purchase necessary.

Open to all residents where not prohibited.



www.LEGO.com



www.LEGOsurvey.com/product

GEWINNE! WIN!

Nimm an der Umfrage auf www.LEGOsurvey.com/product teil und hab die Chance ein cooles LEGO® Produkt zu gewinnen!

Die Teilnahme am Gewinnspiel führt zu keinerlei Kaufverpflichtungen. Teilnahme in allen nicht ausgeschlossenen Ländern möglich.

Ga naar www.LEGOsurvey.com/product, vul een enquêteformulier in en maak kans op een cool LEGO® product.

Geen aankoopverplichting. Iedereen mag deelnemen, uitgezonderd ingezetenden van landen waar een enquêteverbod geldt.

GAGNE! 当てよう!

Visite www.LEGOsurvey.com/product pour répondre à un questionnaire et avoir une chance de gagner un produit LEGO® très cool!

Aucune obligation d'achat. Ouvert à tous les résidents des pays autorisés.

www.LEGOsurvey.com/product にアクセスして、アンケートにご記入ください。当選者にはレゴ®製品を差し上げます。

お買い上げの必要はありません。

禁止されていない限り、すべての皆様にご利用いただけます。