

1

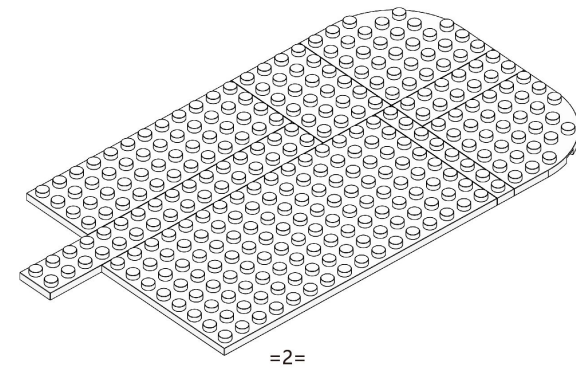

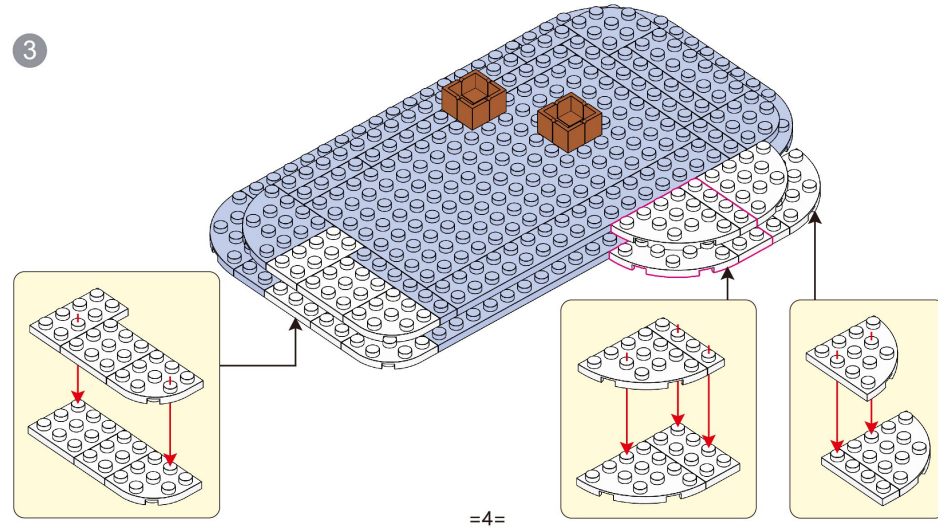

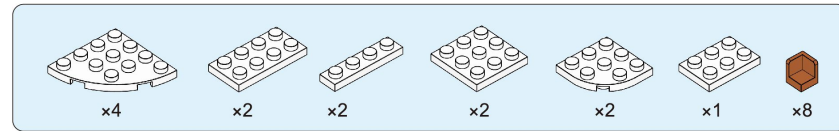

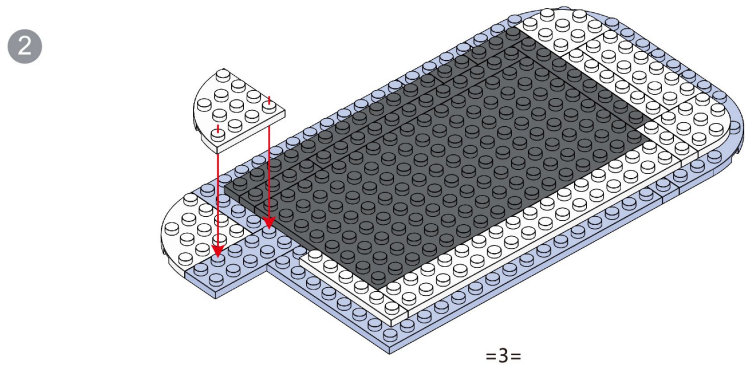
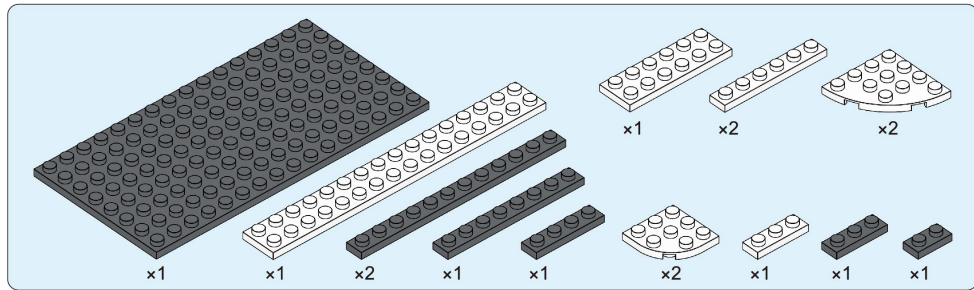



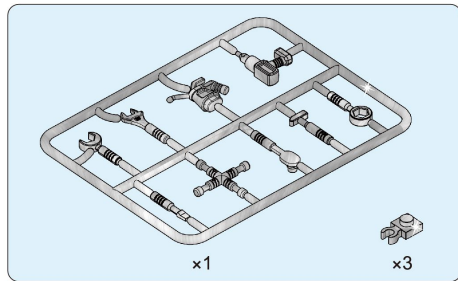

13

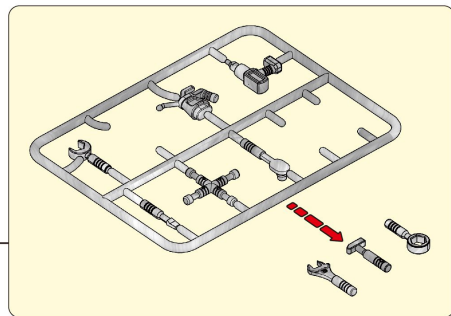
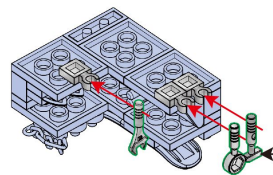

=9=

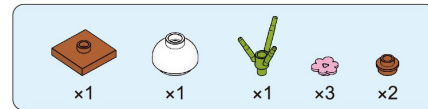

14

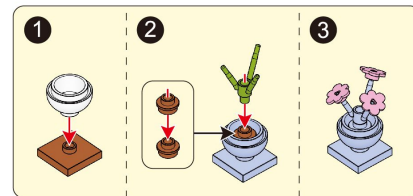

=10=

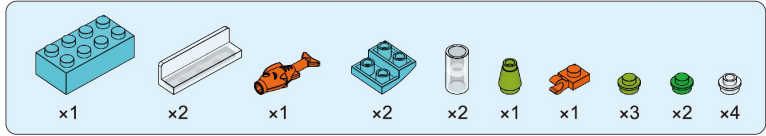

15

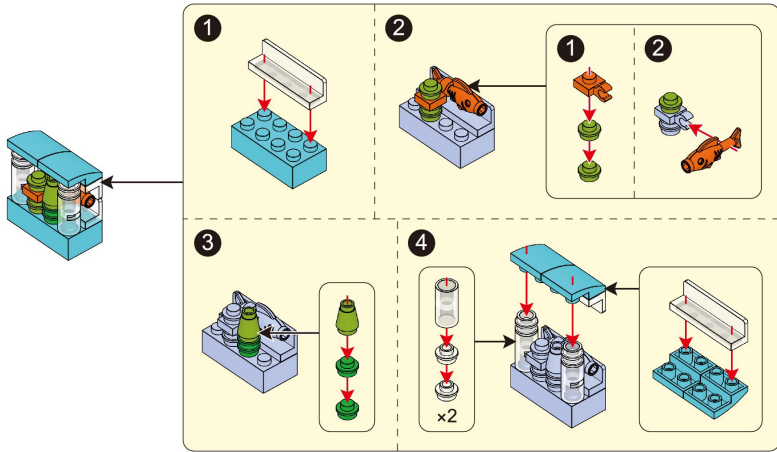

=11=

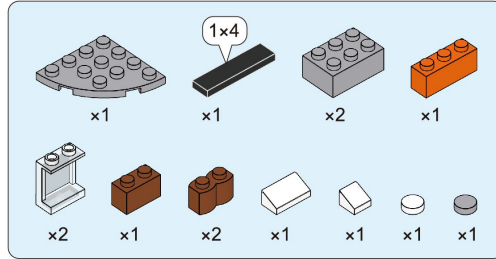

16

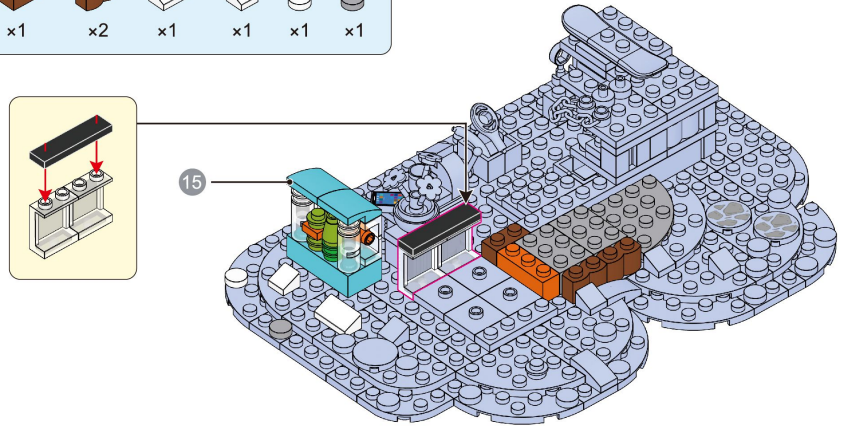

=12=

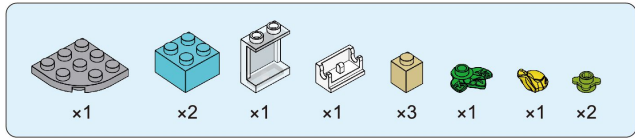

17

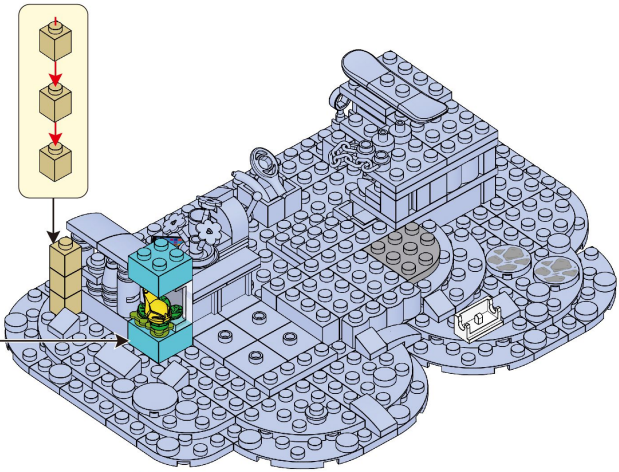
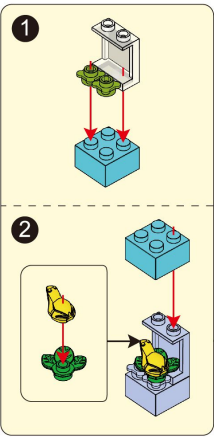

=13=

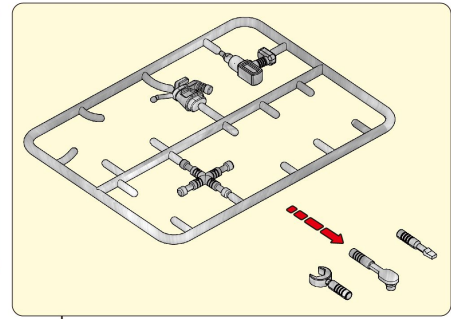
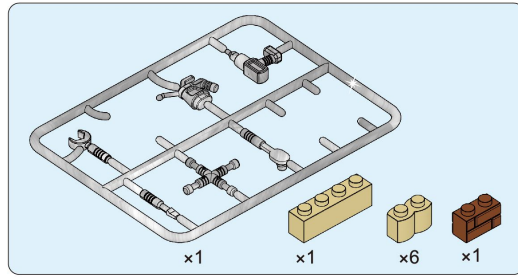

18

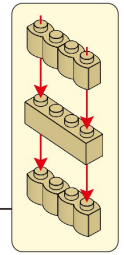
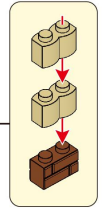
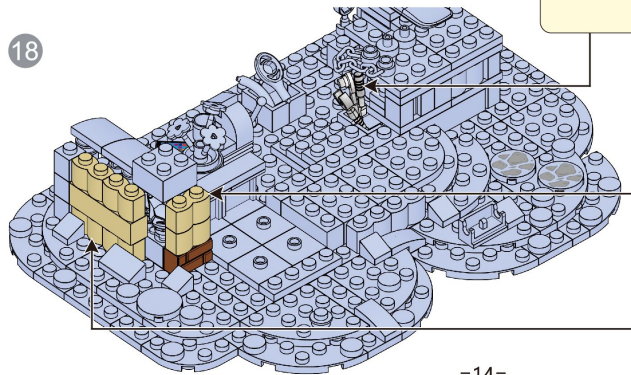

=14=

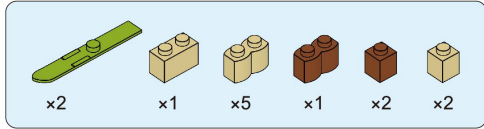

19

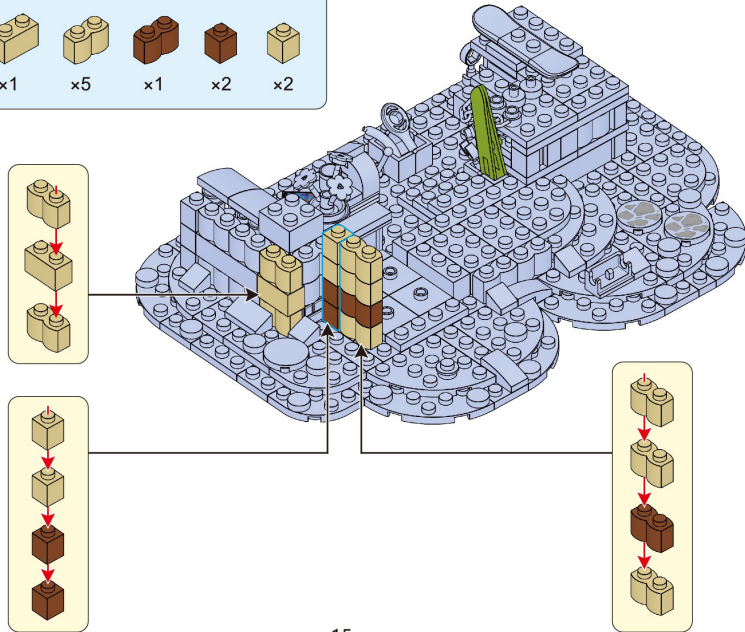

=15=

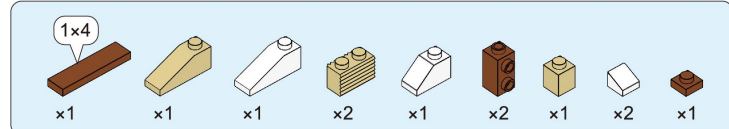

20

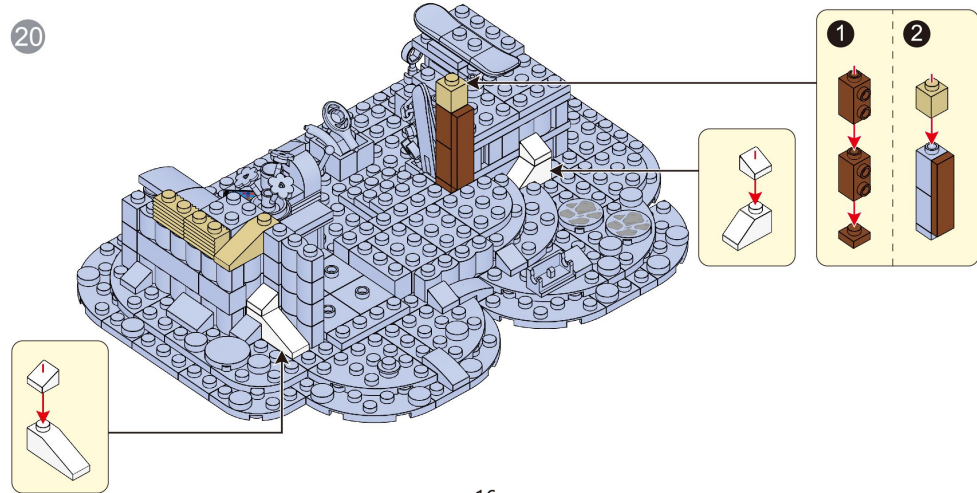

=16=



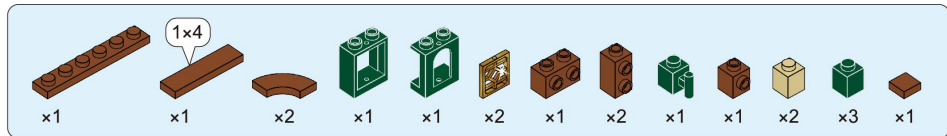

21

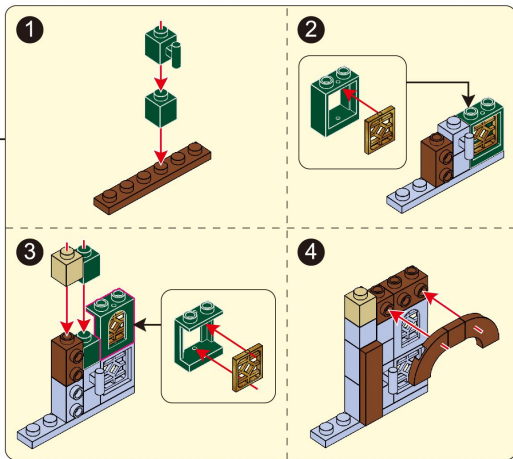
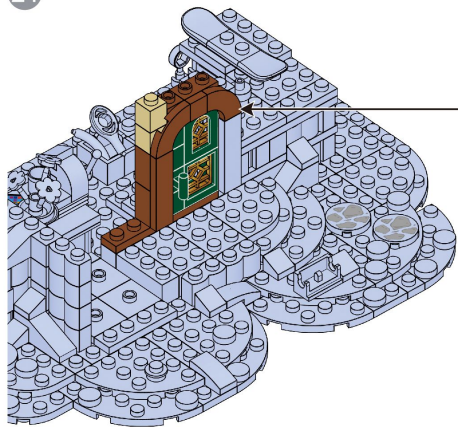

=17=

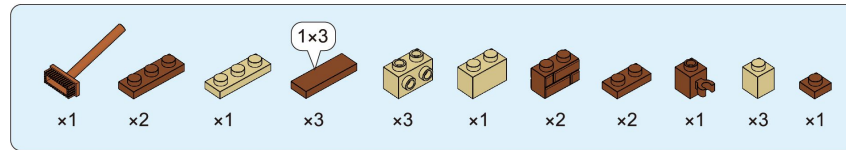

22

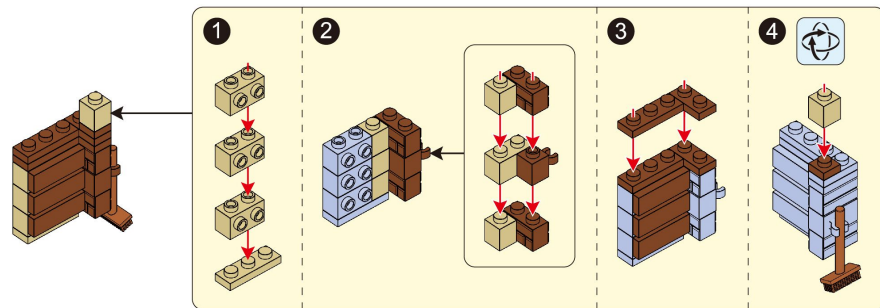

=18=

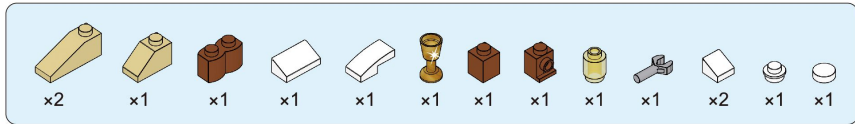

23

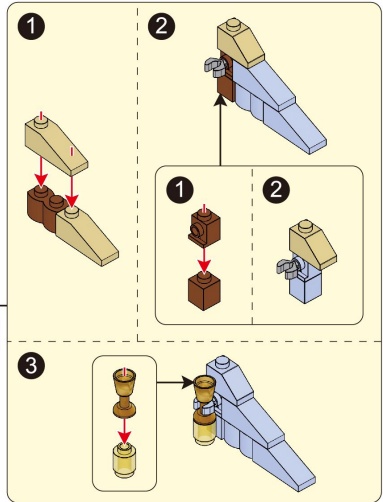
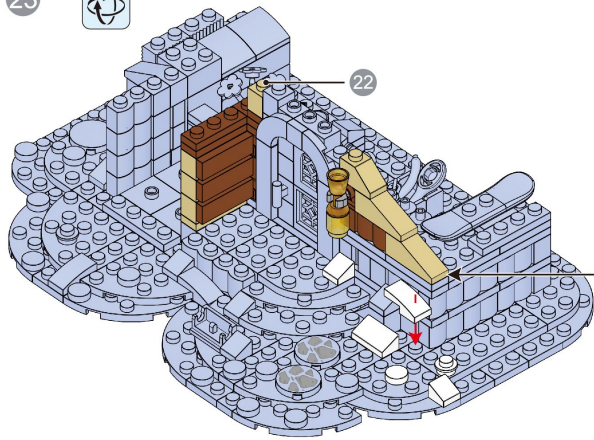

=19=

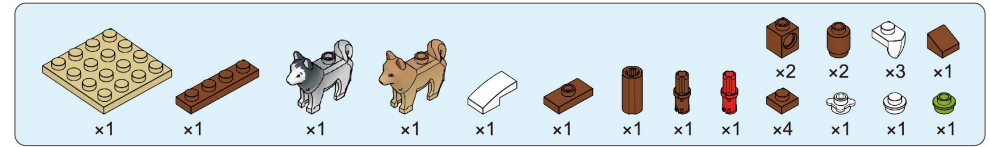

24

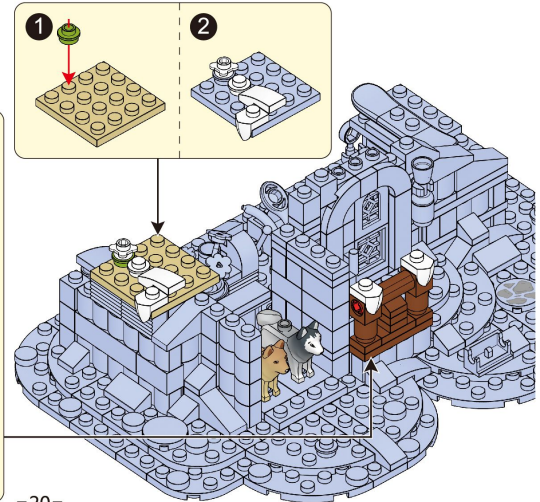
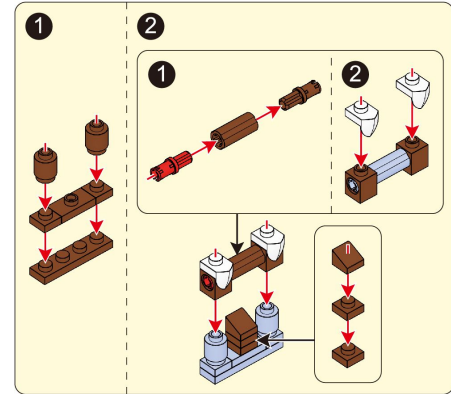

=20=

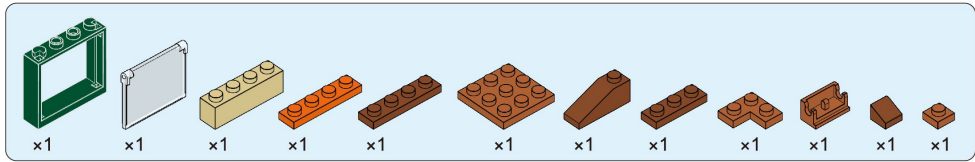

25

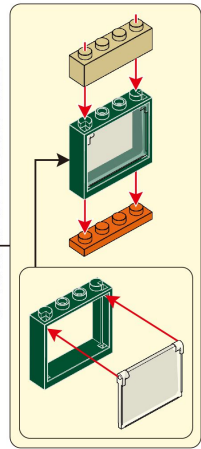
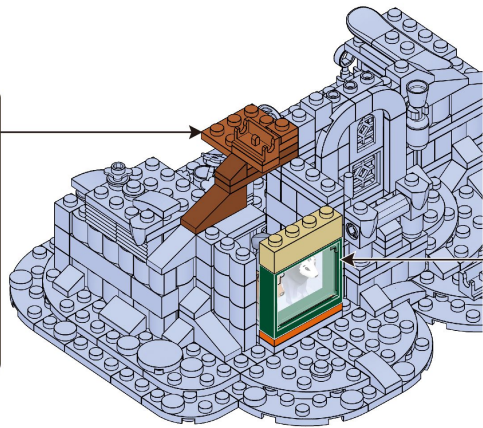
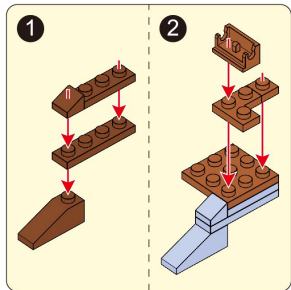

=21=

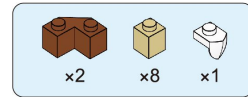

26

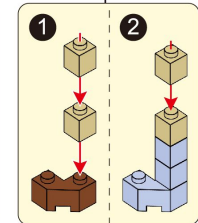
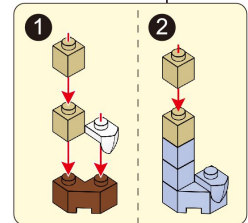
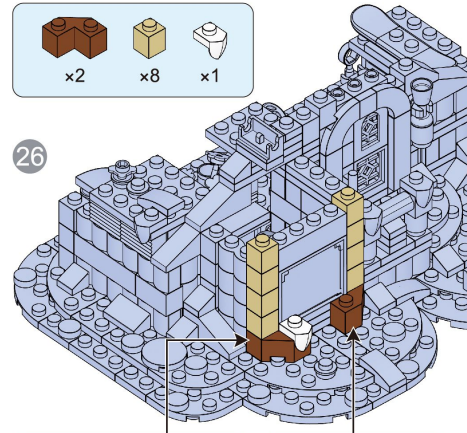

=22=

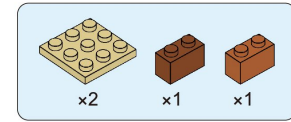

27

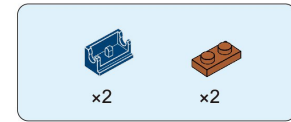
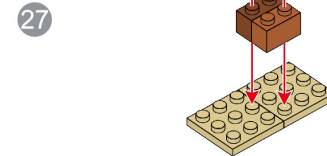

28

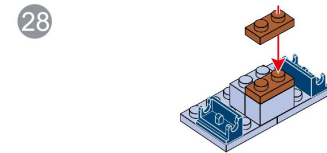

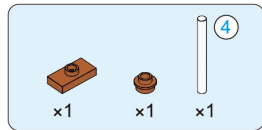

29

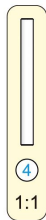
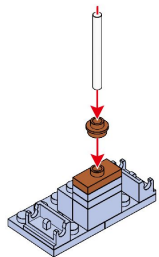

=23=

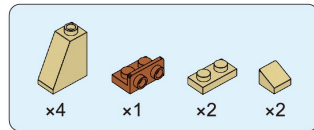

30

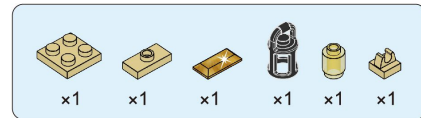
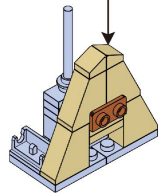
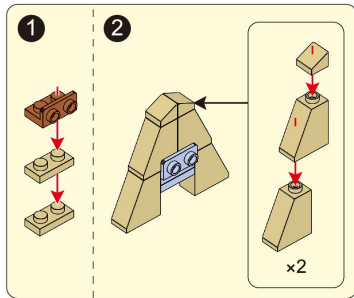

31

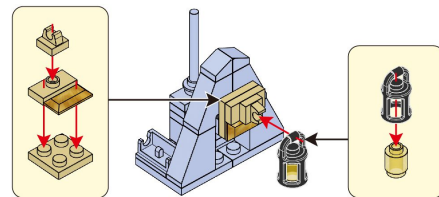

=24=

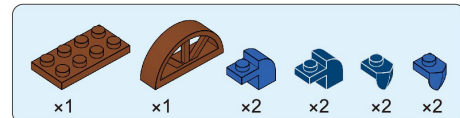

32

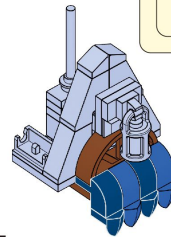
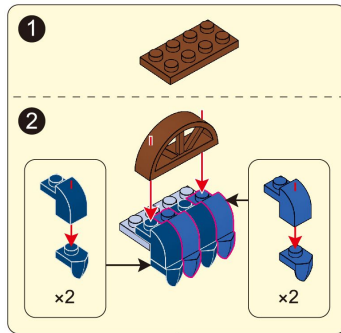



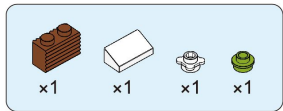

33

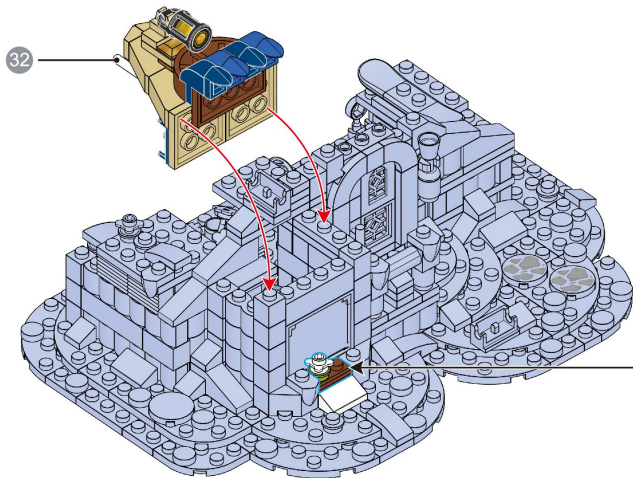

=25=

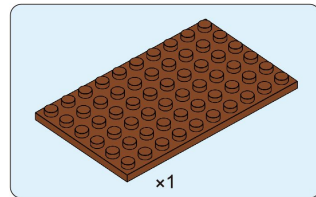

34

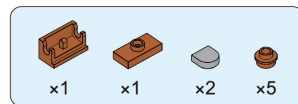
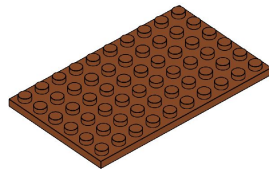

35

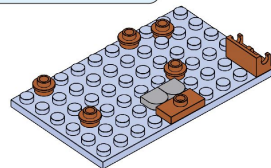

=26=

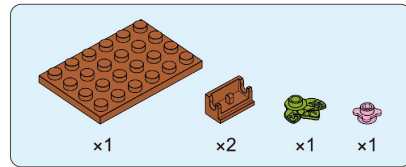

36

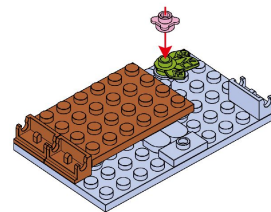

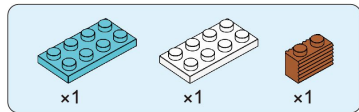

37

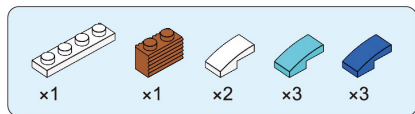
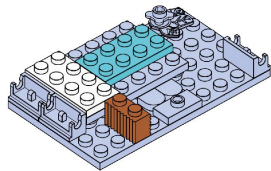

38

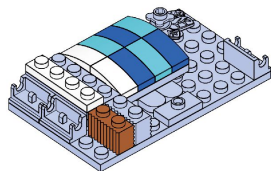

=27=

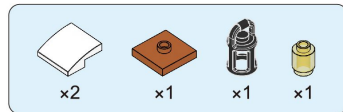

39

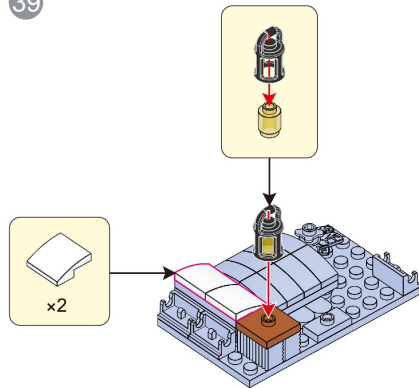

=27=

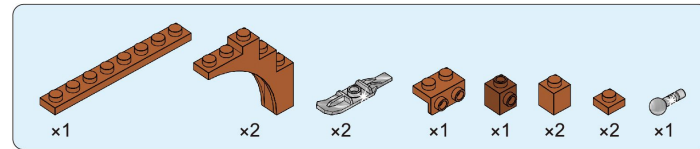

40

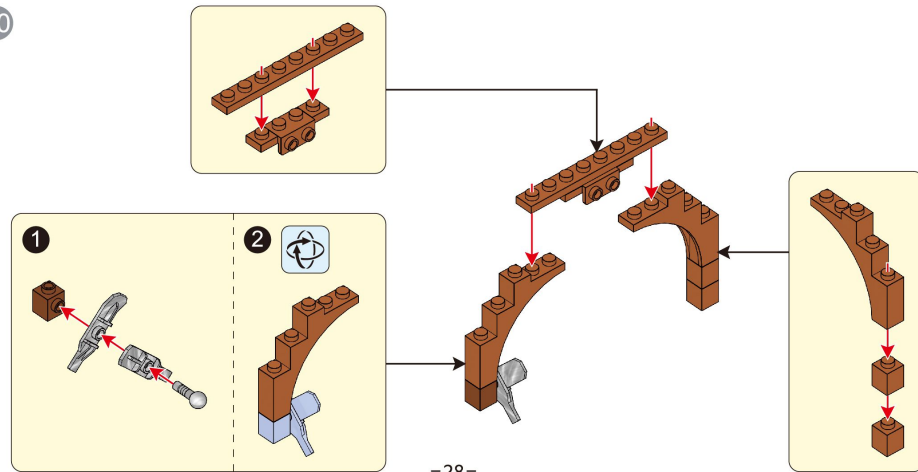

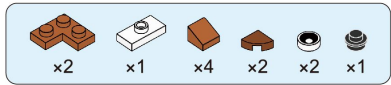

41

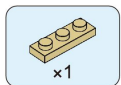
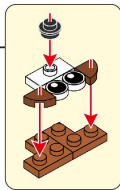
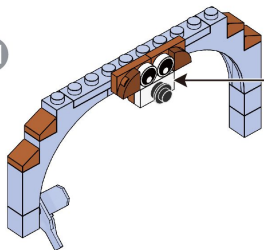

42

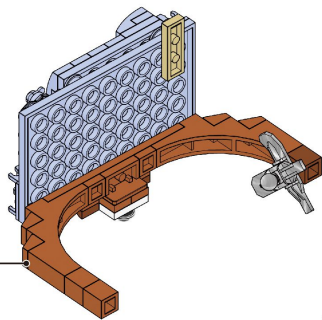

41

=29=

43

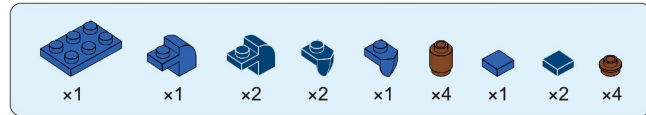
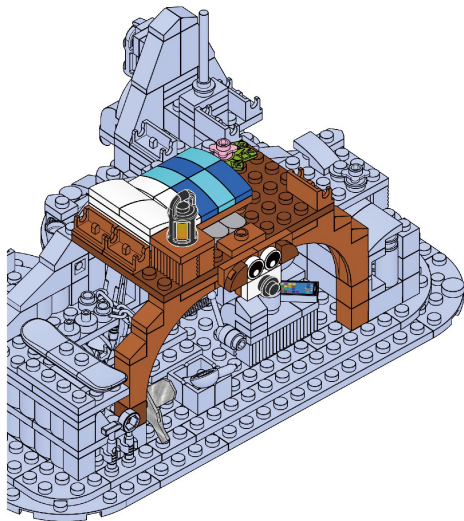

44

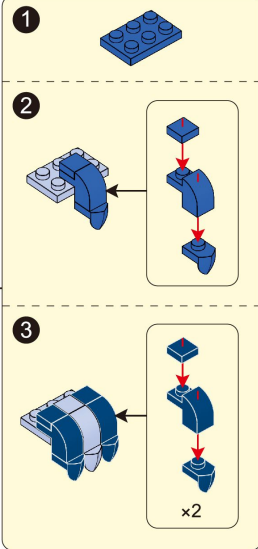
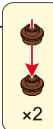
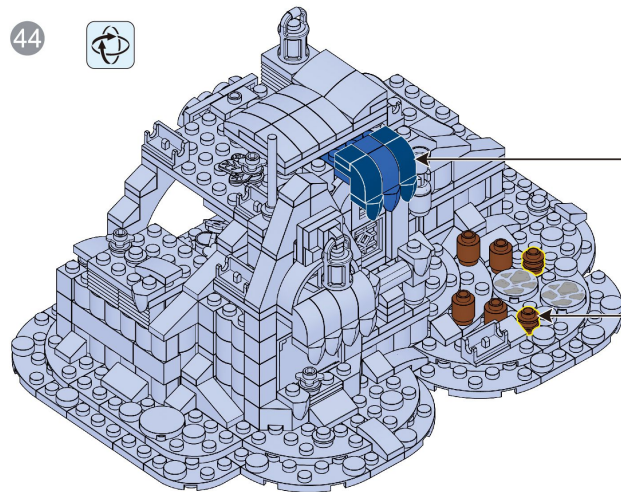

=30=





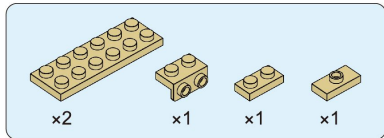

47

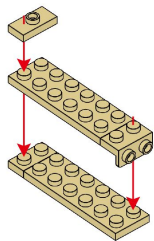

=33=

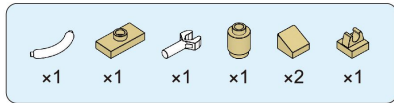

48

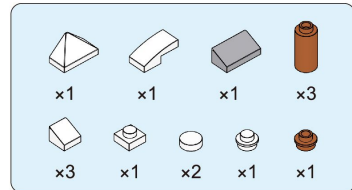
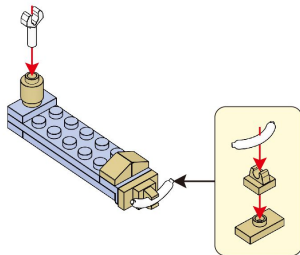

49

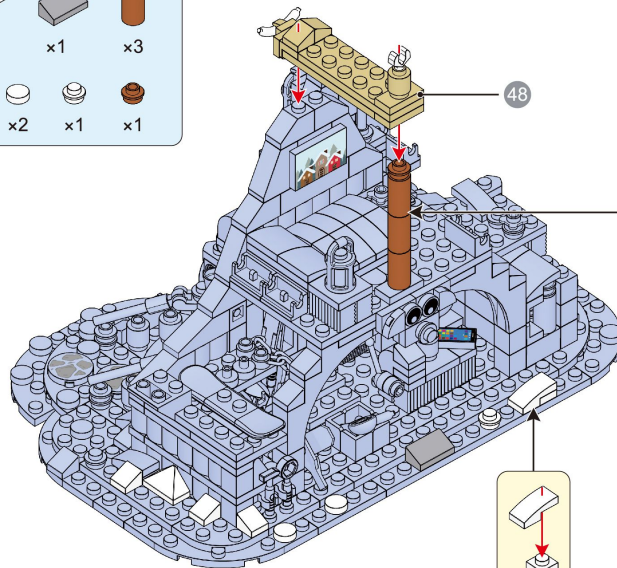

=34=

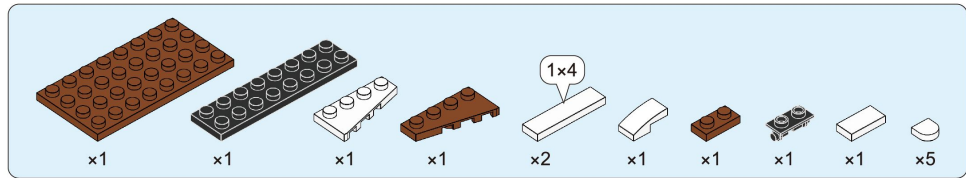

50

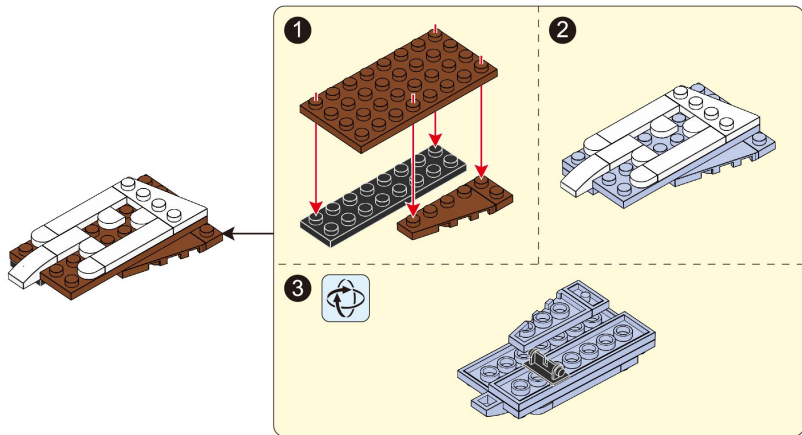

=35=

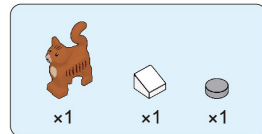

51

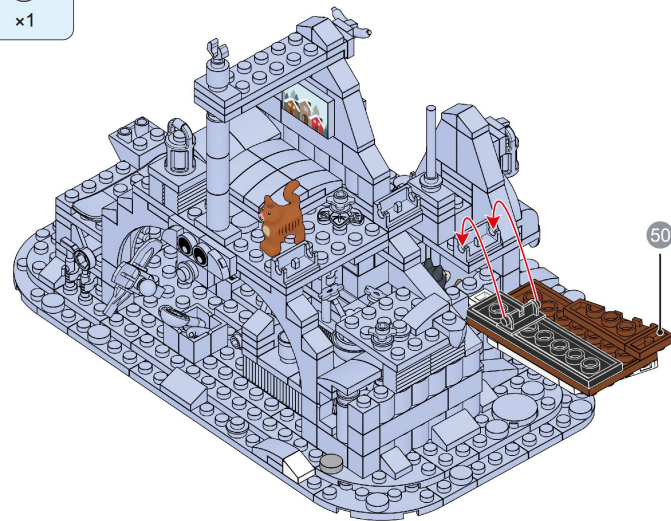

=36=

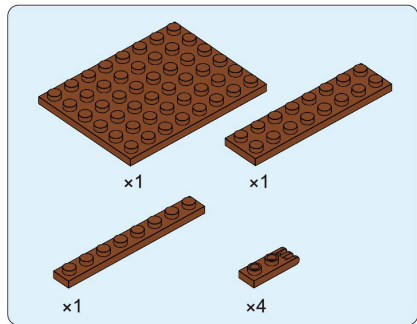

52

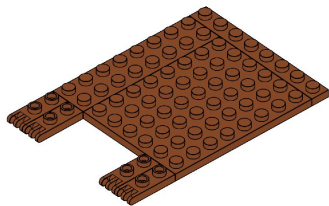

=37=

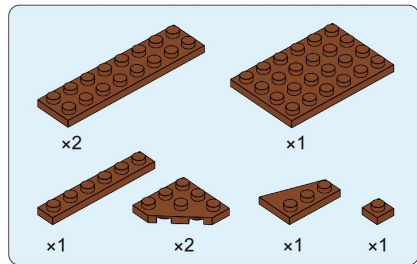

53

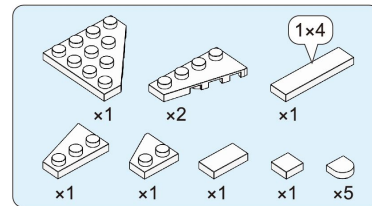
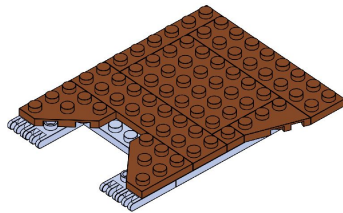

54

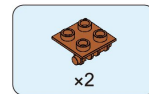
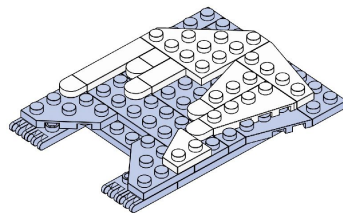

55

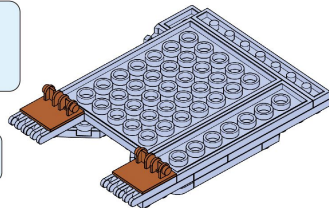

=38=

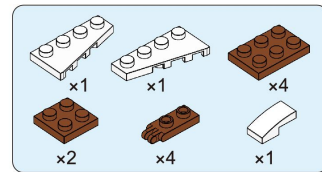

56

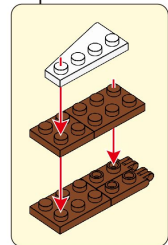
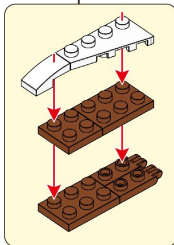
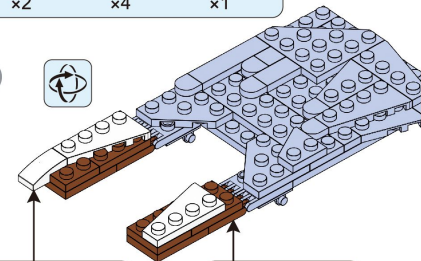

57

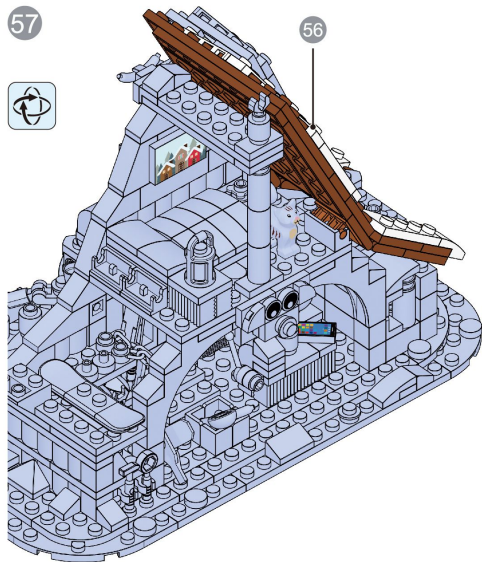

56

=39=

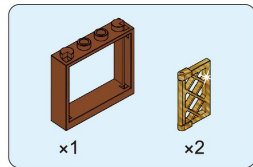

58

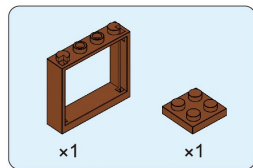
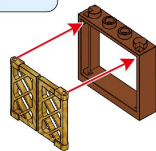

59

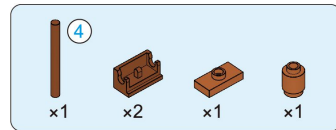
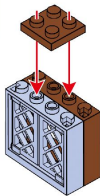

60

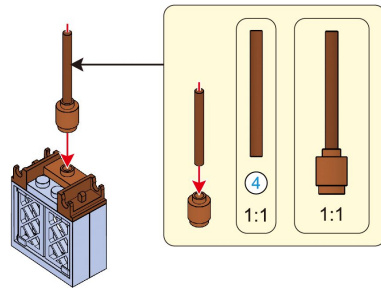

=40=

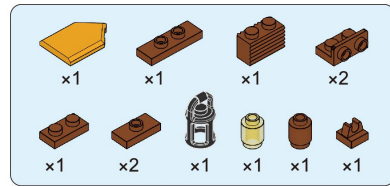

61

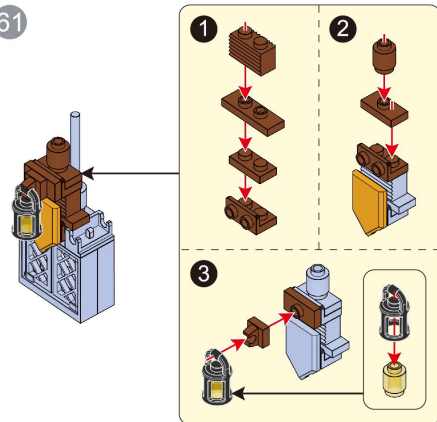



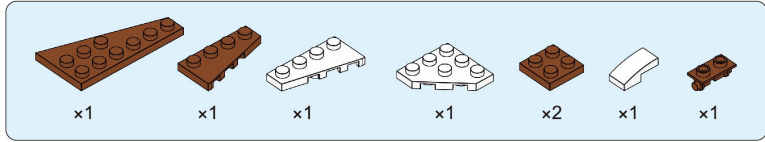

62

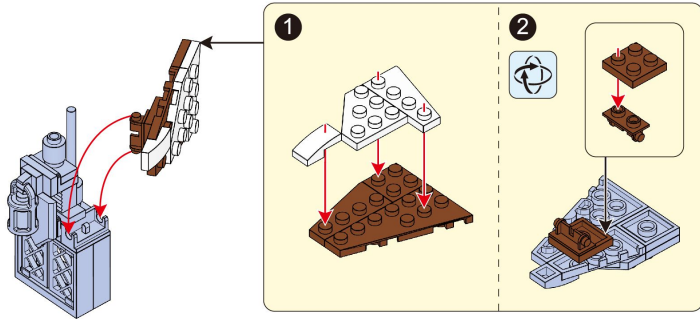

=41=

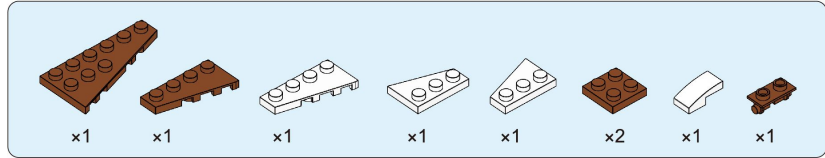

63

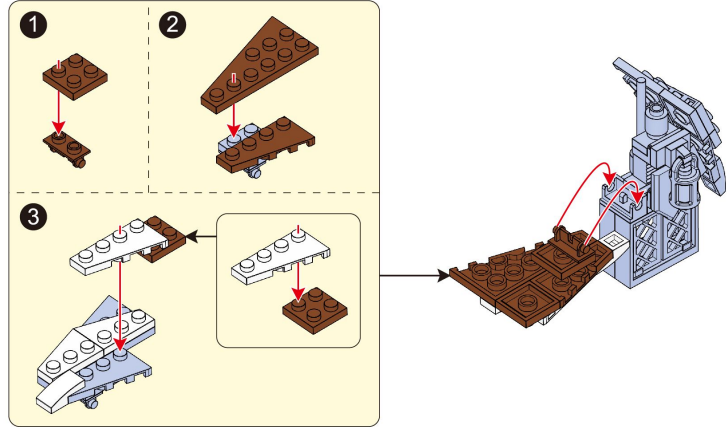

=42=



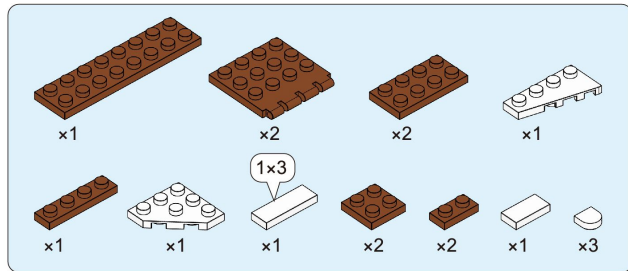

69

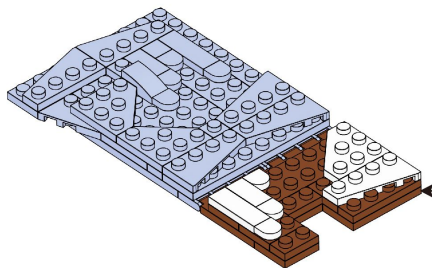

=45=

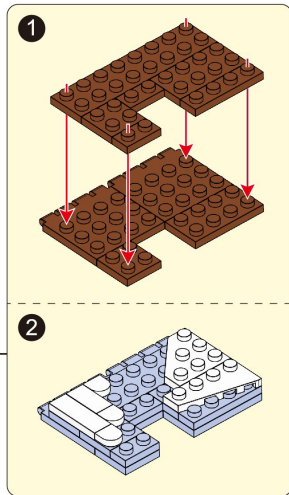

70

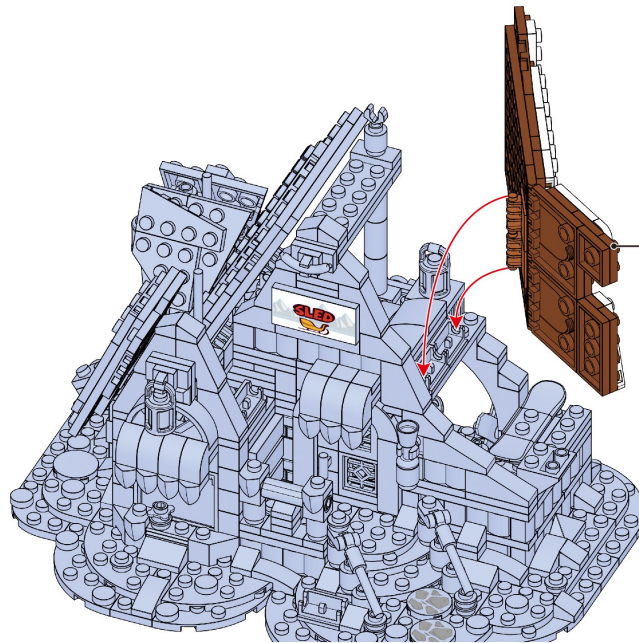

69

=46=





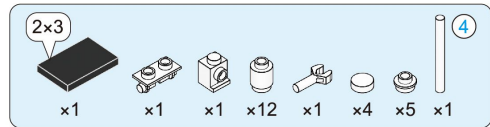

73

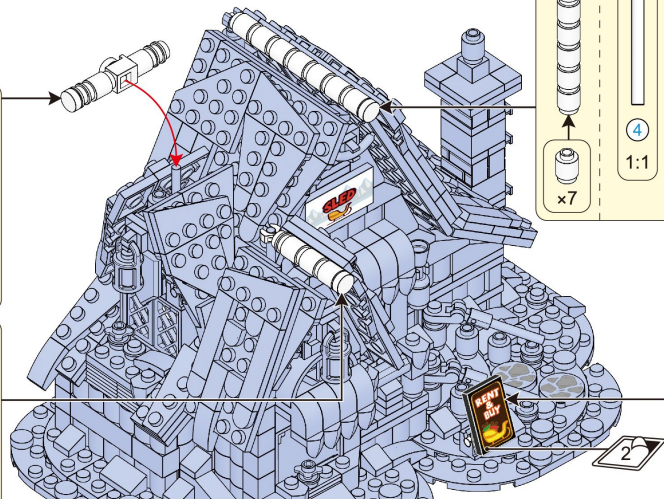
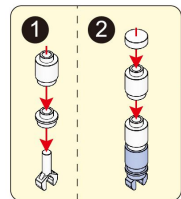
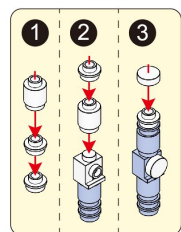

=49=

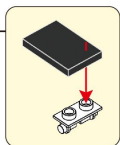
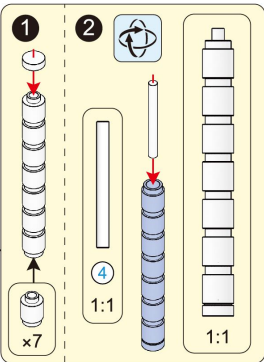

74

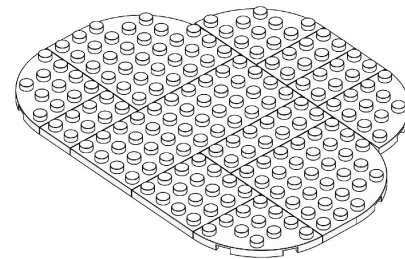
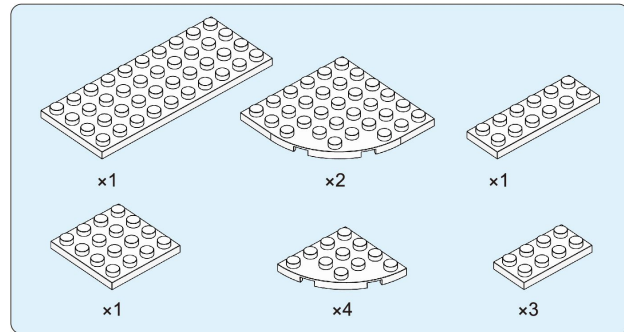

=50=



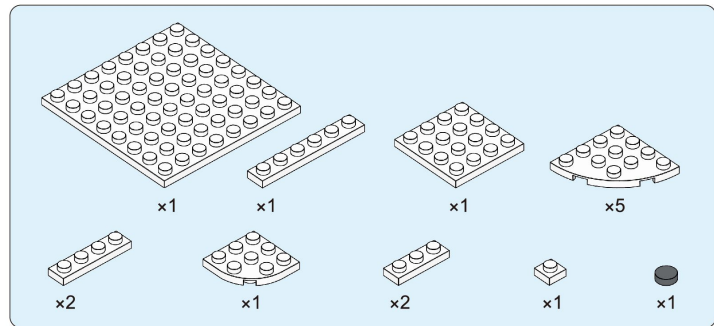

75

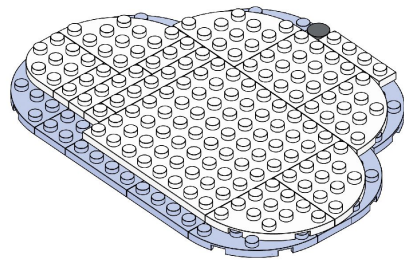

=51=

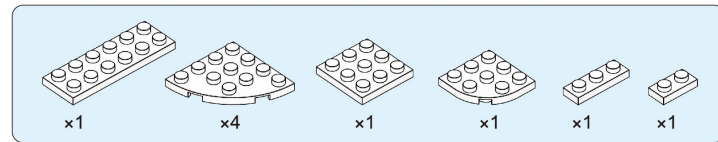

76

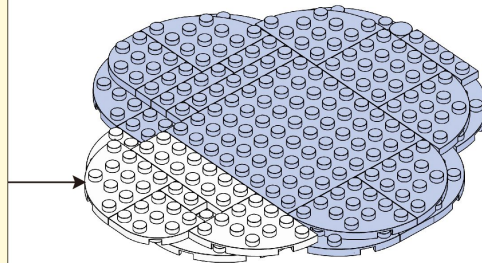
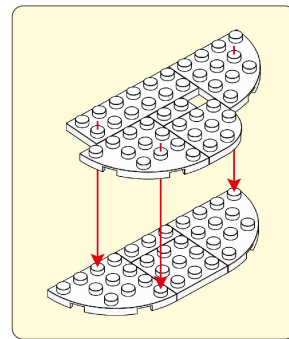

=52=



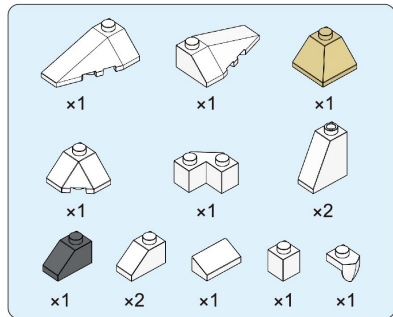

81

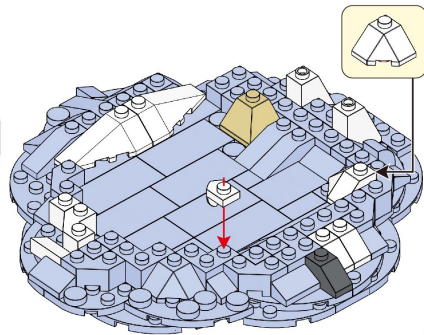

=55=

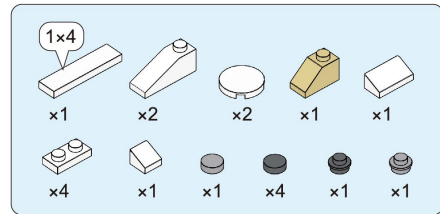

82

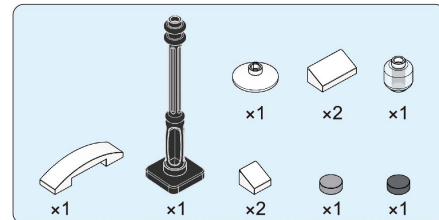
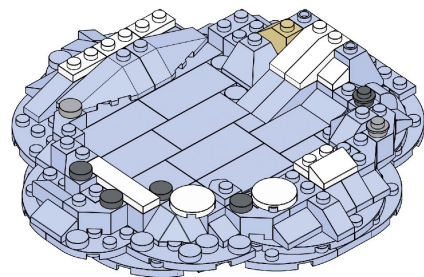

83

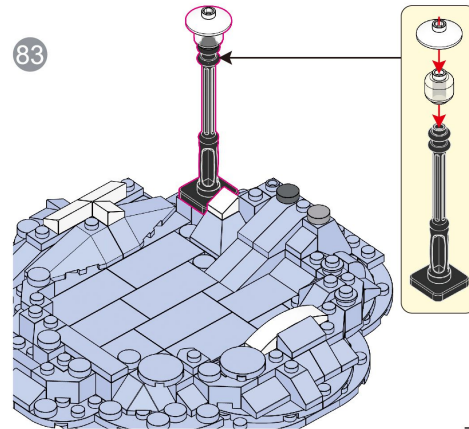

=56=

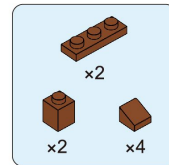

84

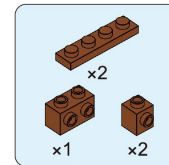
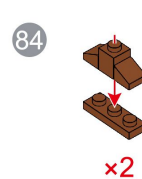

85

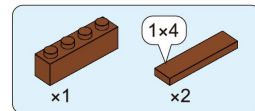
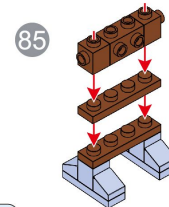

86

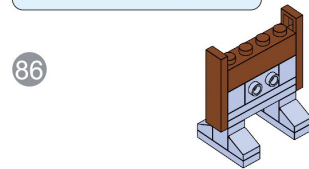

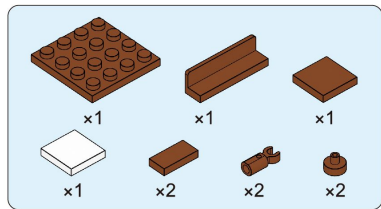

87

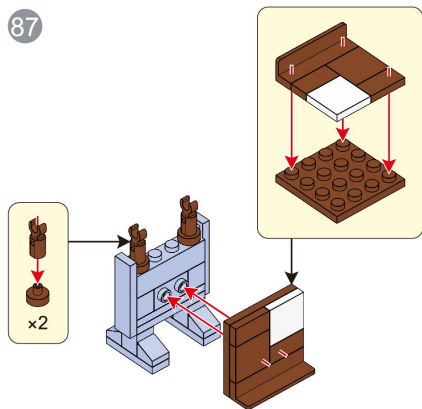

=57=

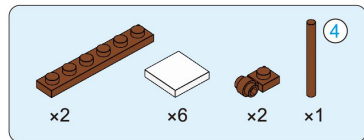

88

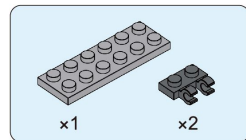
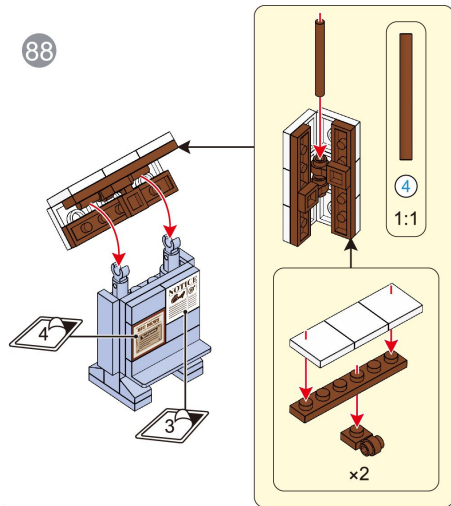

89

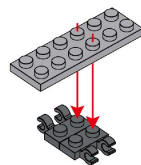

=58=

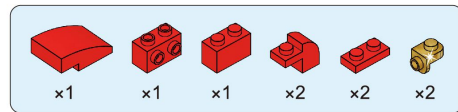

90

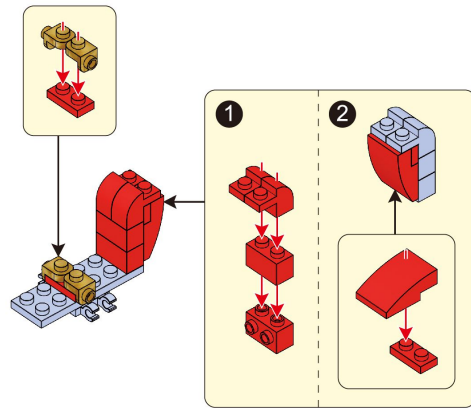

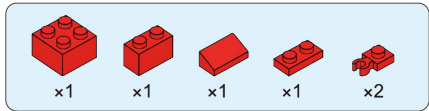

91

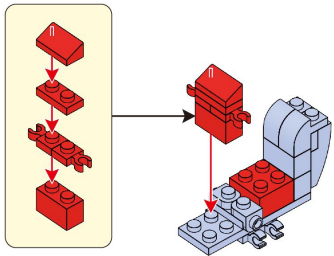

=59=

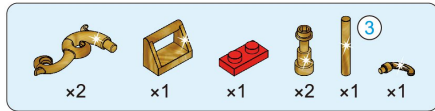

92

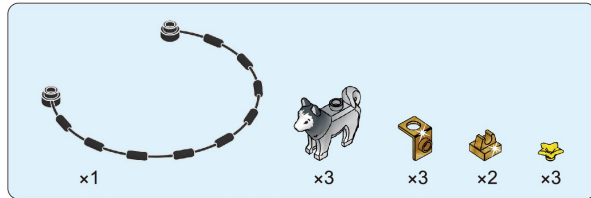
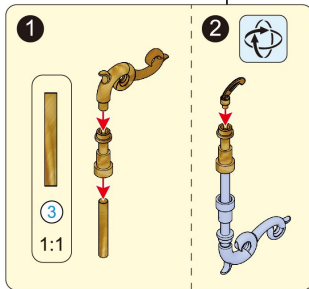
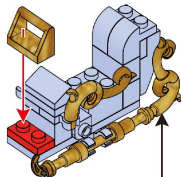

93

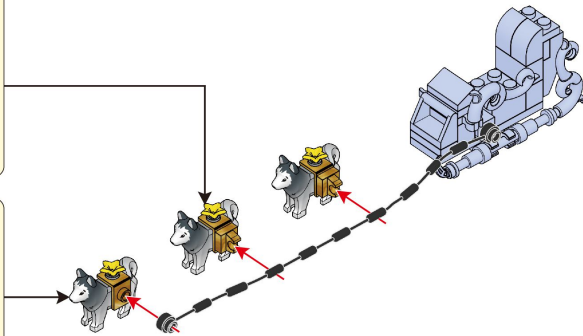
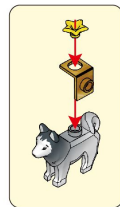
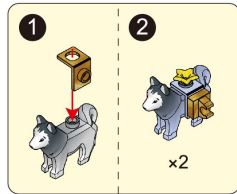

=60=



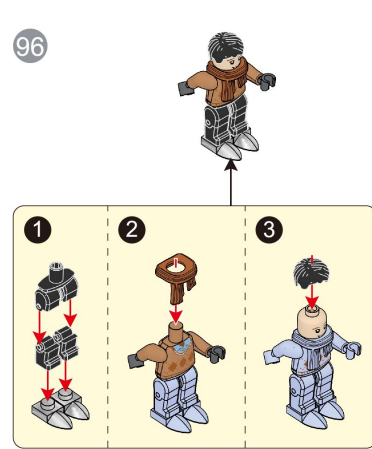
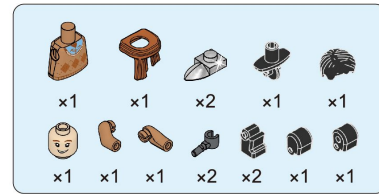
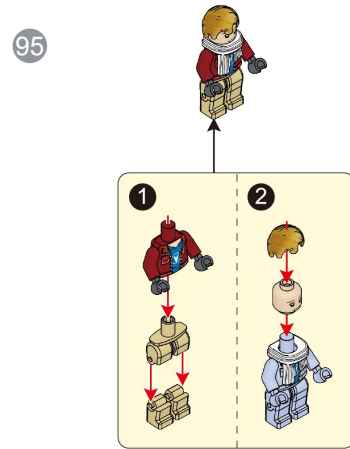
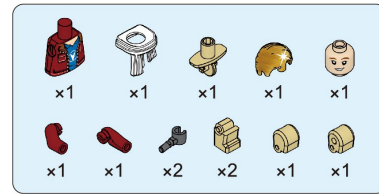
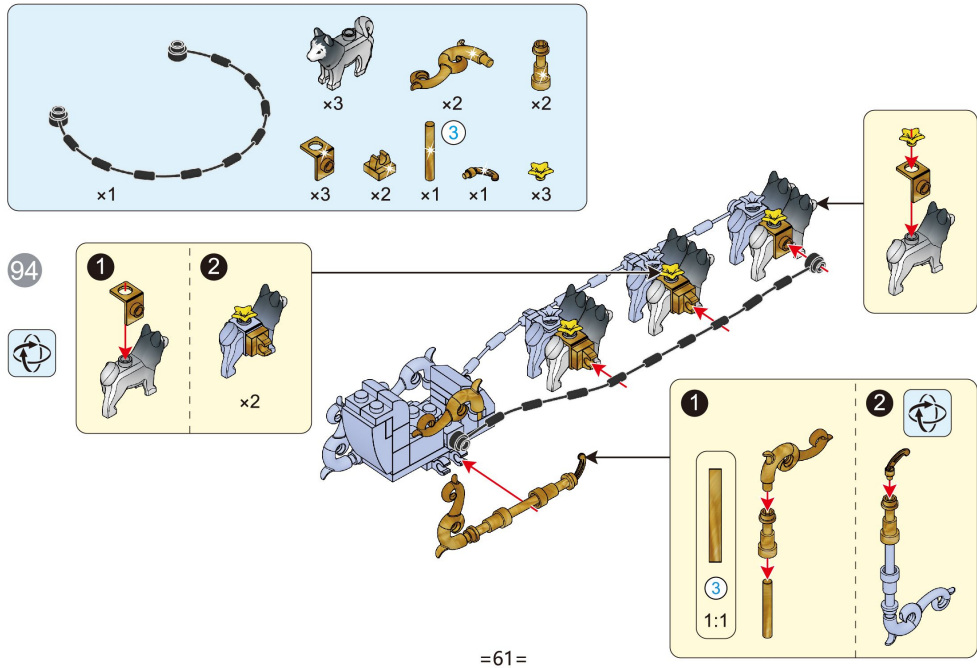

=62=

97



=63=

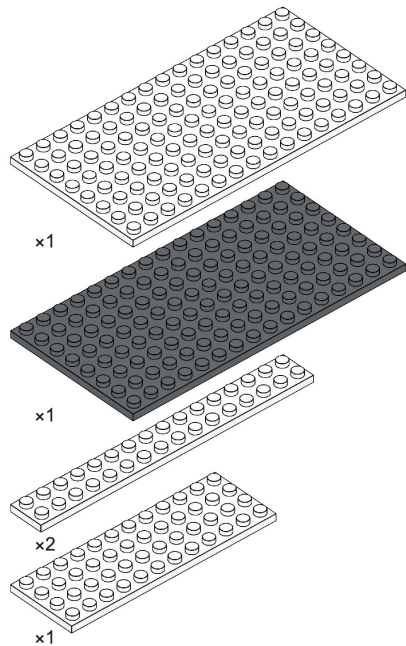

=64=

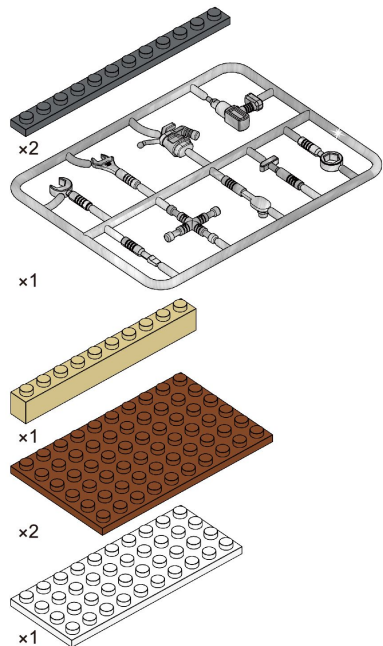

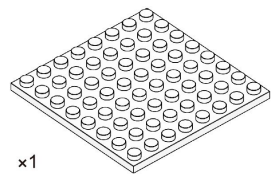

x1

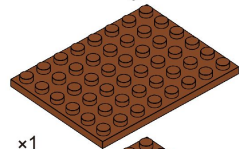

x1

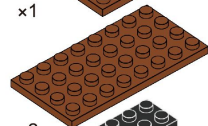

x2

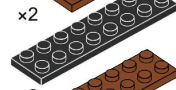

x2

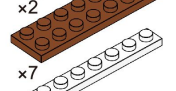

x7



x2

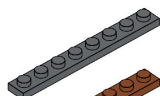

x1

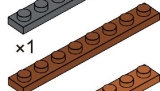

x3

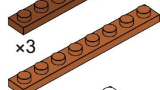

x1

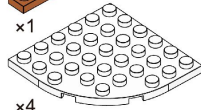

x4

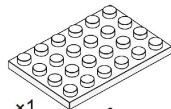

x1

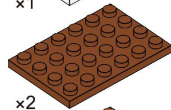

x2

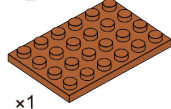

x1

=65=

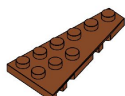

x1

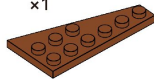

x1

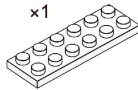

x4

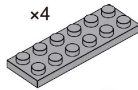

x1

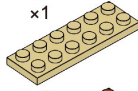

x2

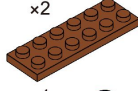

x1

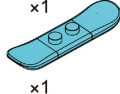

x1

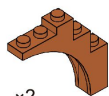

x2

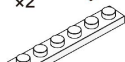

x3



x6



x2



x1

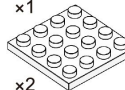

x2

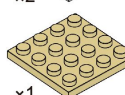

x1



x1

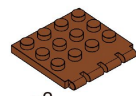

x2

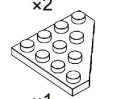

x1

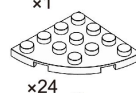

x24

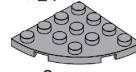

x2

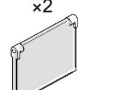

x1

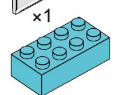

x1

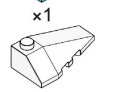

x1

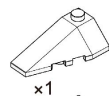

x1

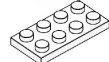

x7



x3



x1

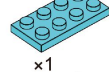

x1

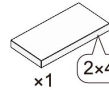

2x4

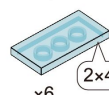

2x4

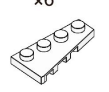

x5



x2



x8



x2

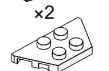

x1

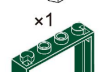

x1

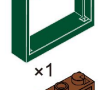

x2

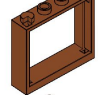

x1

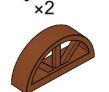

x6

=66=



x2



x2



x1



x5



x4



1x4



1x4



1x4



x2



x7



x1



x1

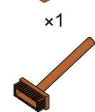

x1



x4



x3



