



LAUNCHER & MISSILE
DRONE

WAR
MACHINE

MARK VI WHIPLASH



1968 | Stark Expo • Expo Stark • Exposition de Stark • Stark tentoonstelling • Parque Stark

- 8x AM01113HJ
- 1x AM01113AJD
- 8x AM01113E
- 2x AM01113AKM
- 3x AM01113ZD
- 4x AM01113X
- 2x AM01113W
- 1x AM01140AGV
- 1x AM15486AGV
- 2x AM04428F
- 2x AM09010AJE
- 4x AM07629AKM
- 2x AM02172AGV
- 3x AM03019AJL
- 2x AM03019AKM
- 3x AM16649AJL
- 2x AM03017AJL

- 1x AM01748AJL
- 2x AM15484F
- 2x AM16679F
- 2x AM09393AKM
- 1x AM16680F
- 3x AM09198F
- 3x AM09198AKL
- 2x AM17070F
- 2x AM17070AKL
- 2x AM17018MM
- 4x AM01314F
- 2x AM07230AKL
- 1x AM01142SF
- 2x AM01142AJL
- 3x AM09267F
- 3x AM09268F

- 1x AM16967AJL
- 1x AM03773F
- 2x AM03773AKM
- 2x AM02250IAKL
- 4x AM03772F
- 3x AM09493F
- 2x AM09493E
- 4x AM09493AJL
- 1x AM09493AKM
- 1x AM04434AKL
- 1x AM04433AKL
- 1x AM01480E
- 2x AM01480AKM
- 2x AM01480AGV

- 6x AM01322AJL
- 2x AM01323AJL
- 4x AM01323AKM
- 2x AM09013F
- 2x AM09013AJL
- 2x AM09013AKM
- 1x AM10273AKM
- 1x AM10273F
- 9x AM10273AJL
- 10x AM01154AJL
- 6x AM04217SE
- 1x AM09023AKM
- 1x AM09023AJL
- 2x AM01139AKM

- 1x AM09106F
- 6x AM09106AKM
- 2x AM01141F
- 1x AM09023AGV
- 1x AM09023F
- 4x AM02783AJL
- 2x AM03091AJL
- 3x AM09033AGV
- 2x AM09033AJL
- 1x AM08416AKL
- 1x AM07225AKL
- 1x AM07224AKL
- 1x AM15352AKM

- 2x AM1087F
- 4x AM1087AJL
- 2x MA1390AGV
- 2x MA1389AGV
- 2x AM09190AKM
- 1x AM16630AKM
- 1x AM16629AKM
- 6x AM09292AKM
- 2x AM01313F
- 3x AS0196808
- 1x AS0196807
- 2x AS0196803

- 1x AM08413MM
- 2x AM09323F
- 2x AM16215AJC
- 4x AM01317AJL
- 4x AM03767AJJ
- 2x AM01355AGV
- 4x AM06618SF

- 3x AM08483F
- 2x MA10233AJL
- 1x AM09185AKM
- 1x AM09184AKM
- 1x AM16647AKM
- 1x AM16648AKM
- 3x AM04985F
- 3x AM04985AGV
- 3x AM09923F
- 1x AM09923AKM
- 1x MA11725F
- 4x MA1172F

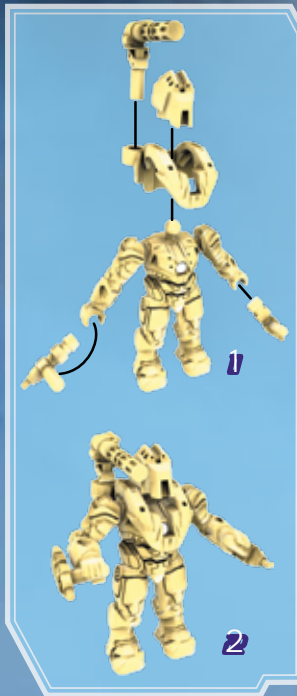
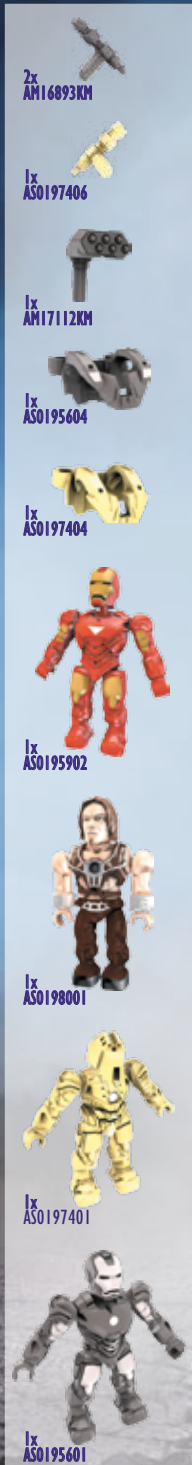
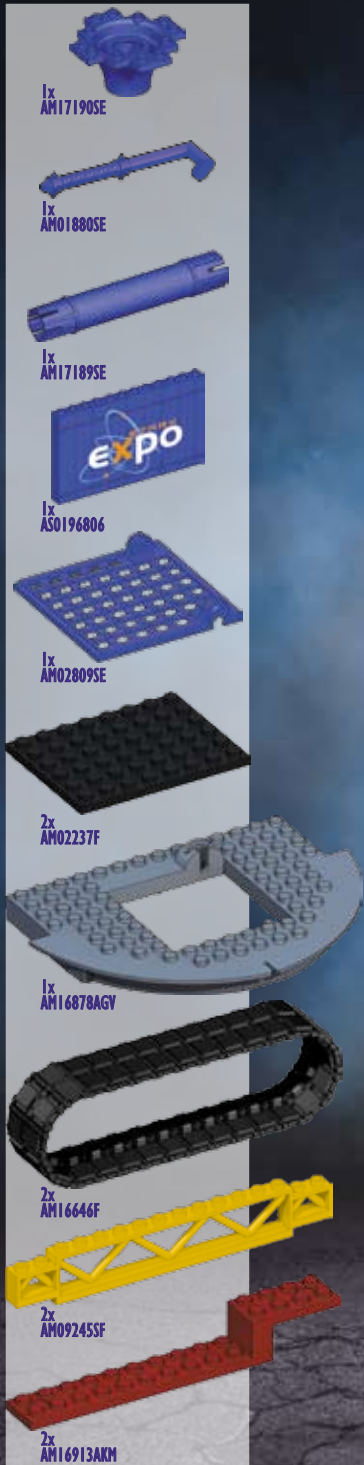

EN Please read these instructions carefully before first use and keep them for future reference.
ES Leer estas instrucciones cuidadosamente antes de la primera utilización y guardarlas para referencia futura. / **FR** Il est recommandé de lire attentivement ce feuillet avant la première utilisation et de le conserver pour référence future. / **DE** Die Gebrauchsanleitung bitte durchlesen und aufbewahren. / **NL** Wij raden u aan deze handleiding zorgvuldig te lezen en te bewaren voor eventuele raadpleging op een later tijdstip. / **IT** Leggere le istruzioni prima di cominciare ad usare il gioco e conservarle per referenze future. / **PT** Leia as instruções antes do primeiro uso e guarde-as para futura referência.

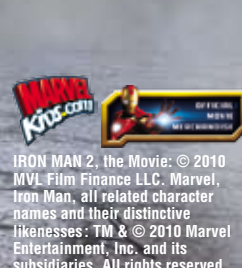

- EN** ⚠ **WARNING :**
CHOKING HAZARD. - Small parts.
Not for children under 3 years.
- ES** ⚠ **ADVERTENCIA :**
PELIGRO DE ASFIXIA. - Contiene piezas pequeñas. No recomendado para niños menores de 3 años.
- FR** ⚠ **AVERTISSEMENT :**
RISQUE DE SUFFOCATION. - Présence de petits éléments. Ne convient pas aux enfants de moins de 3 ans.
- DE** ⚠ **WARNUNG :**
ERSTICKUNGSGEFAHR. - Enthält kleine Teile. Nicht für Kinder unter 3 Jahren geeignet.
- NL** ⚠ **WAARSCHUWING :**
VERSTIKKINGSGEVAAR. - Bevat kleine onderdelen. Niet geschikt voor kinderen onder de 3 jaar.
- DA** ⚠ **ADVARSEL :**
KVÆLNINGSFARE. - Indeholder smådele. Ikke til børn under 3 år.
- EL** ⚠ **ΠΡΟΕΙΔΟΠΟΙΗΣΗ :**
ΚΙΝΔΥΝΟΣ ΠΝΙΞΙΜΑΤΟΣ. - Περιέχει μικρά αντικείμενα. Όχι για παιδιά κάτω των 3 ετών.
- FI** ⚠ **VAROITUS :**
TUKEHTUMISVAARA. - Sisältää pieniä osia. Ei alle 3-vuotiaille lapsille.
- IT** ⚠ **ATTENZIONE :**
PERICOLO DI SOFFOCAMENTO. - Contiene piccole parti. Non indicato per bambini sotto i 3 anni.
- NO** ⚠ **ADVARSEL :**
KVELNINGSFARE. - Inneholder små deler. Kun for barn over 3 år.
- PT** ⚠ **ATENÇÃO :**
PERIGO DE ASFIXIA. - Contém peças pequenas. Não é concebido para crianças de menos de 3 anos.
- SV** ⚠ **WARNING :**
KVÄVNINGSRISK. - Innehåller små delar. Inte för barn under 3 år.
- JA** ⚠ **警告 :**
窒息の危険性 - 小さな部品が含まれています
3歳以下の子供には与えないで下さい。
- ZH** ⚠ **警告 :**
有窒息危险。 - 包含有小部件
不适合3岁以下的小孩玩。
- AR** ⚠ **تحذير :**
خطر اختناق - قطع صغيرة.
غير صالحة للأطفال أقل من 3 سنوات.



IRON MAN 2, the Movie: © 2010
 MVI Film Finance LLC, Marvel,
 Iron Man, all related character
 names and their distinctive
 likenesses: TM & © 2010 Marvel
 Entertainment, Inc. and its
 subsidiaries. All rights reserved.



1

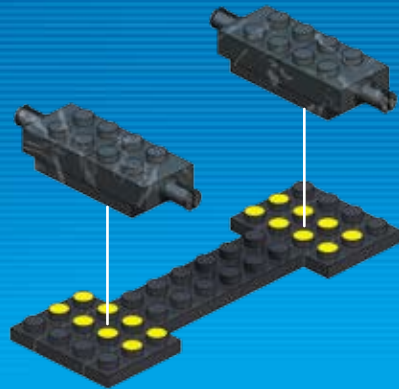

2

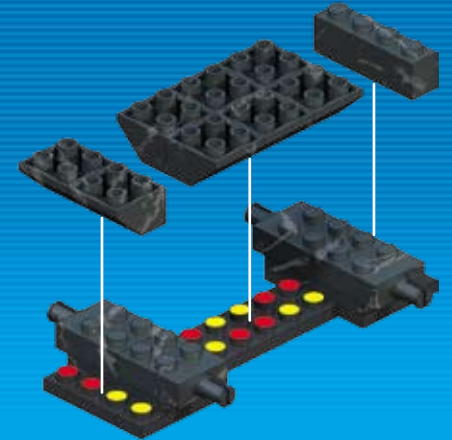

3

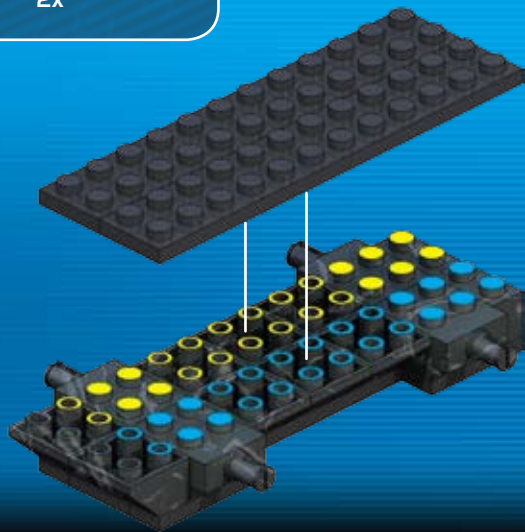

4

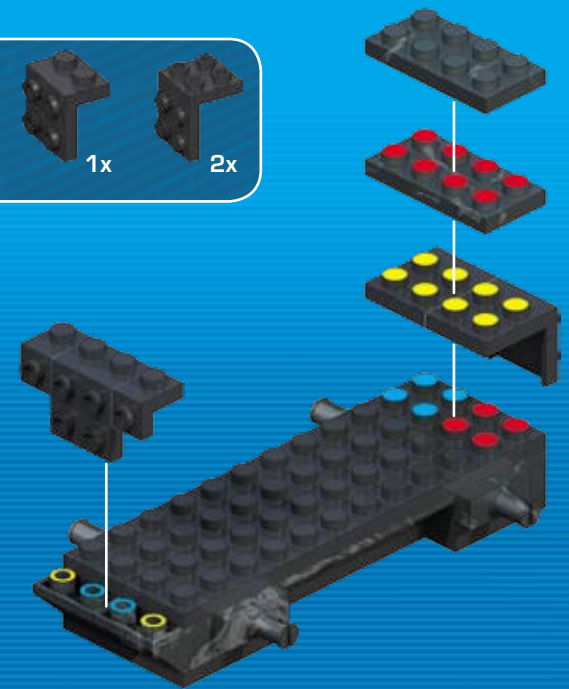

5

- 2x
- 1x
- 2x

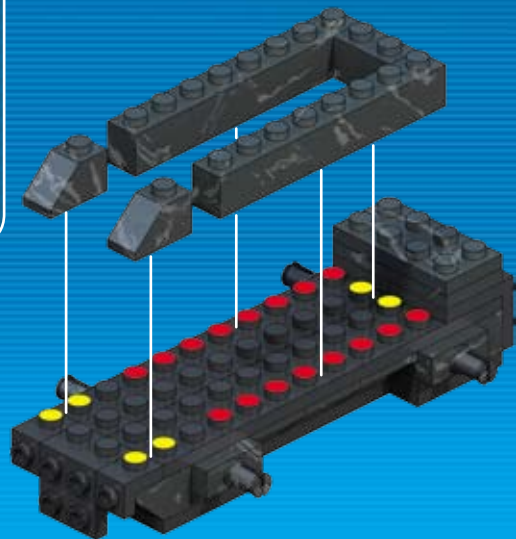

6

- 2x
- 1x
- 1x
- 1x

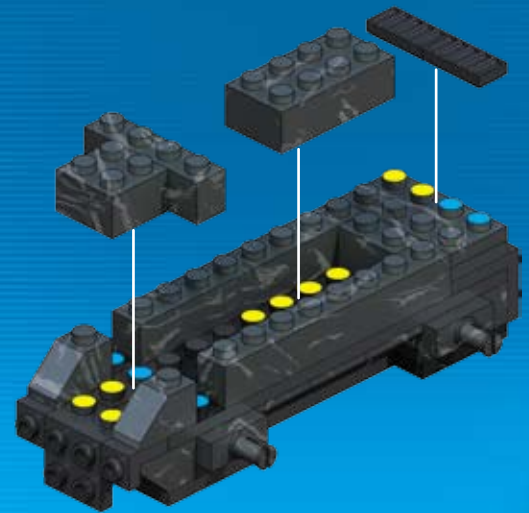

7

- 4x
- 1x



8

- 2x
- 1x
- 1x
- 2x

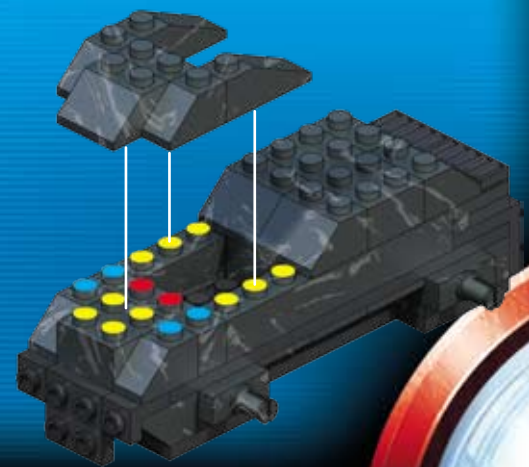

9

2x 1x

10

2x 1x

1x 2x

11

1x 2x 1x 1x 1x

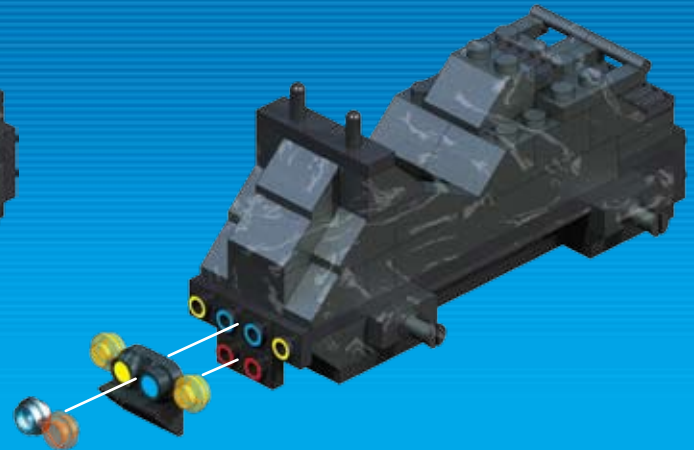
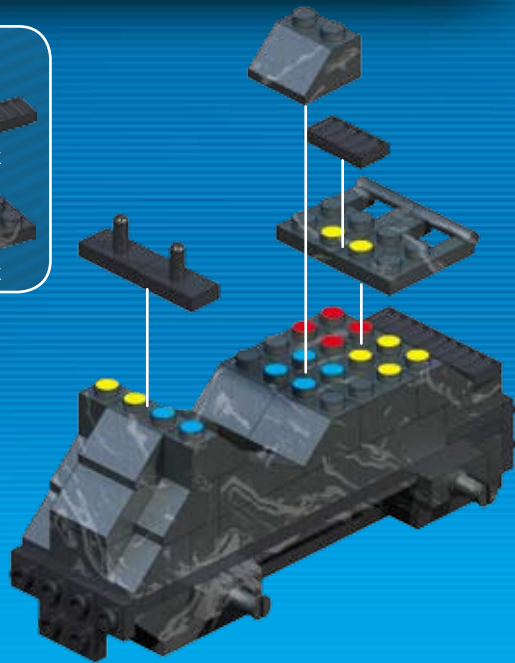
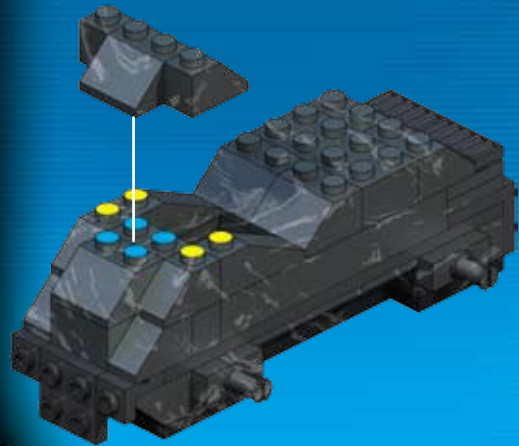

12

2x 2x 1x 2x 2x 1x 1x

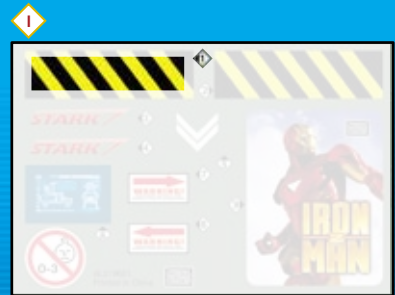
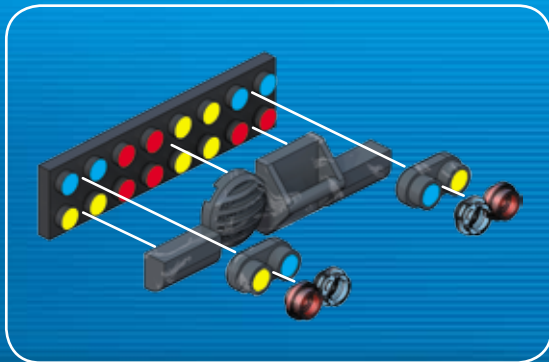

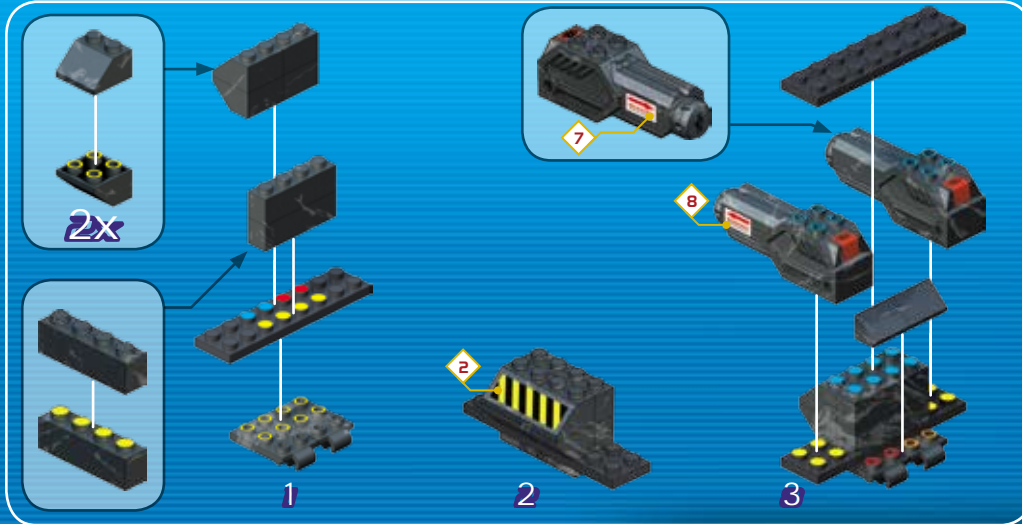
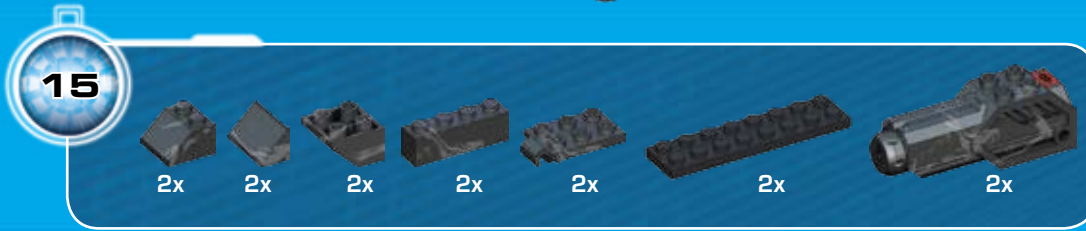
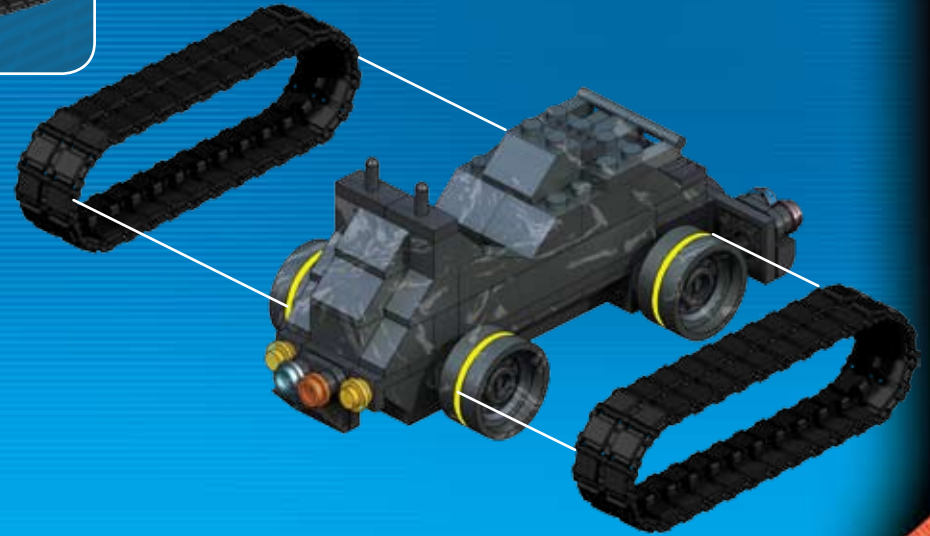

16

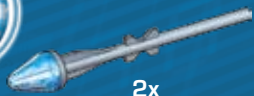

2x



1



2



Working Launcher
Lanzador en funcionamiento
Lanceur en action
Funktionierender Starter
Werkende lanceerinstallatie
Lanciatore funzionante
Lançador operacional

- EN CAUTION!** Do not aim at eyes or face.
- ES ¡ADVERTENCIA!** NO dirigir nunca los proyectiles hacia los ojos o la cara.
- FR ATTENTION!** Ne pas viser les yeux ou le visage.
- DE VORSICHT!** Nicht auf das Gesicht oder die Augen richten.
- NL LET OP:** Niet op ogen of gezicht richten.
- DA ADVARSEL!** Peg ikke i retning af øjne eller ansigt.
- EL ΠΡΟΣΟΧΗ!** Να μην σκοπεύετε προς τα μάτια ή το πρόσωπο.
- FI VARO!** Älä tähtää silmiin tai kasvoihin.
- IT Attenzione!** Non puntare verso gli occhi o il viso.
- NO FORSIKTIG!** Sikt ikke mot øyne eller ansikt.
- PT ATENÇÃO!** Não apontar para os olhos ou o rosto.
- SV VAR FÖRSIKTIG!** Rikta inte med ögon eller ansikte.
- JA 注意!** 目や顔に使用しないで下さい。
- ZH 警告!** 不要对准眼睛或脸。
- AR تنبيه!** لا توجه للعينين أو الوجه



Use only the projectiles included with this toy.
 Utilizar solamente los proyectiles incluidos con el juguete.
 Utiliser seulement les projectiles fournis avec le jouet.
 Nur die mit dem Spielzeug mitgelieferten Projektile verwenden.
 Alleen de met het speelgoed bijgeleverde projectielen gebruiken.
 Utilizzare soltanto i proiettili forniti con questo giocattolo.
 Usar somente os projéteis incluídos com este brinquedo.
 استخدم فقط القذيفة المرافقة لهذه اللعبة



1

- 2x (Small red circular pin)
- 1x (Red 1x2 brick)
- 1x (Red 1x3 brick with 3 pins)
- 1x (Grey Technic axle)
- 1x (Black 1x2 Technic plate)
- 2x (Black 1x4 Technic plate)
- 1x (Black 1x10 Technic plate)
- 1x (Red 1x10 Technic plate)
- 1x (Red 1x10 Technic plate)
- 1x (Red 1x10 Technic plate)

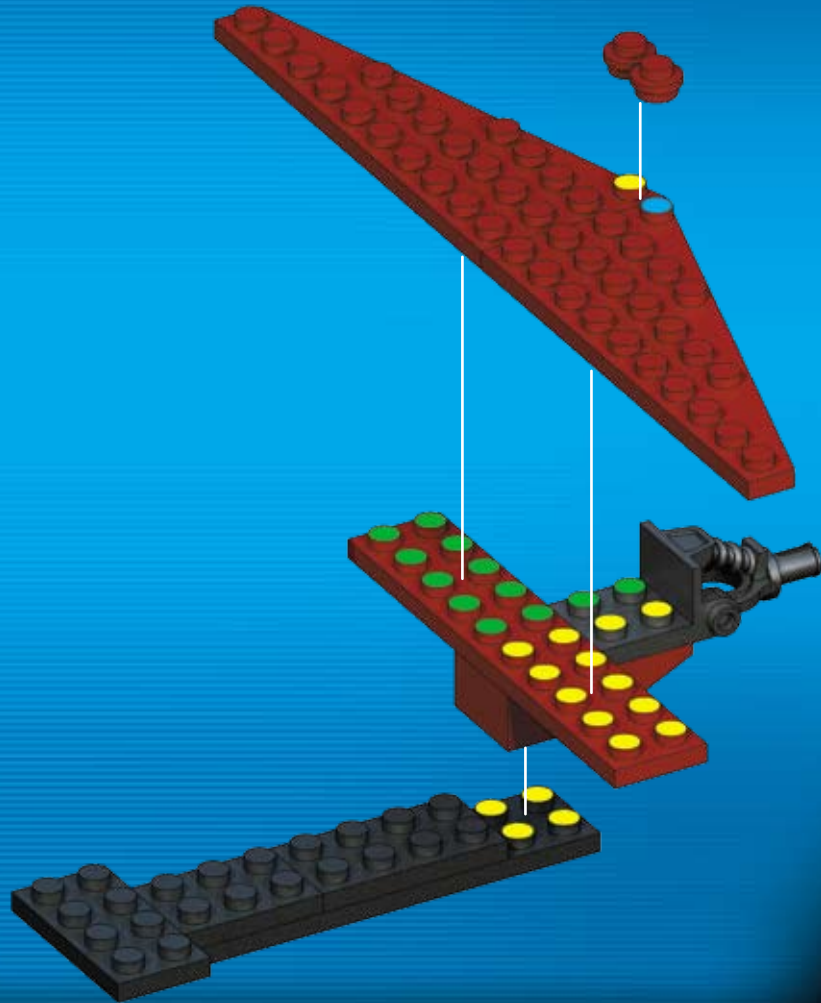
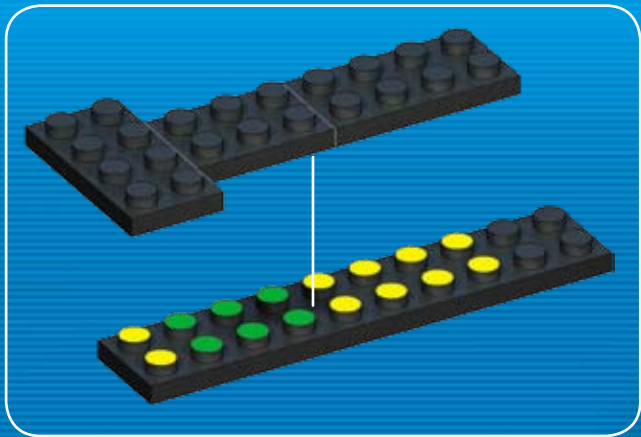
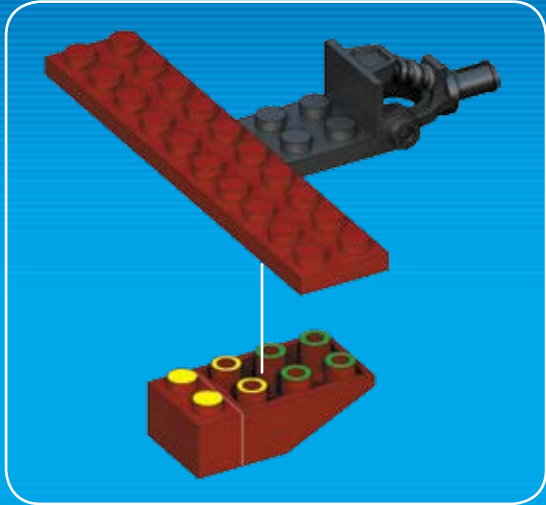

2

1x 1x

2x

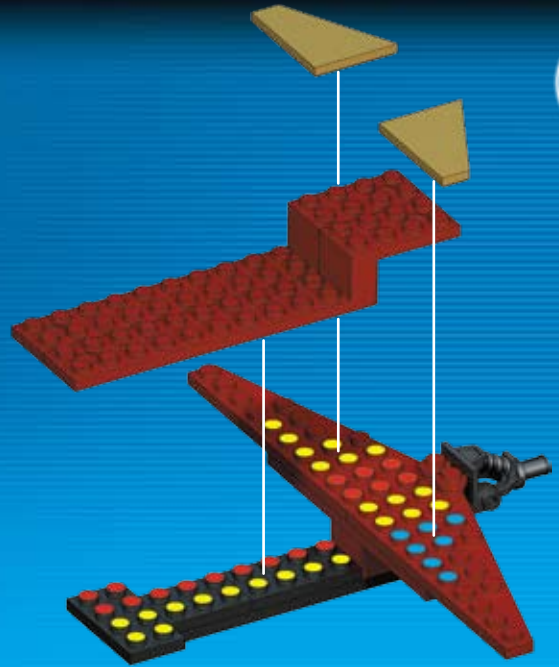

3

1x 1x 2x

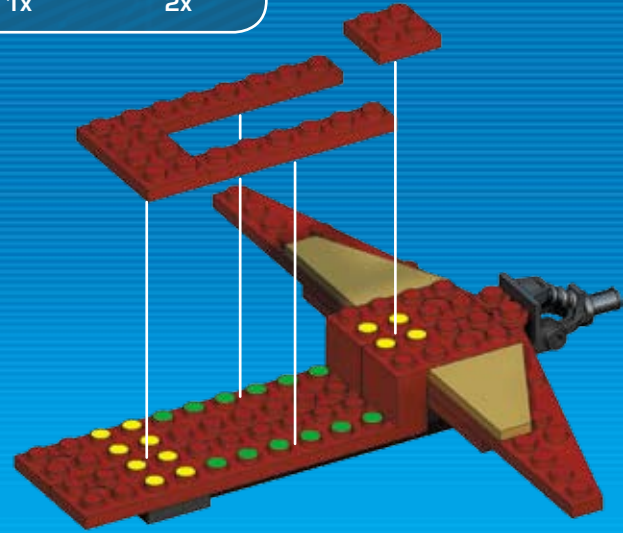

4

2x 4x

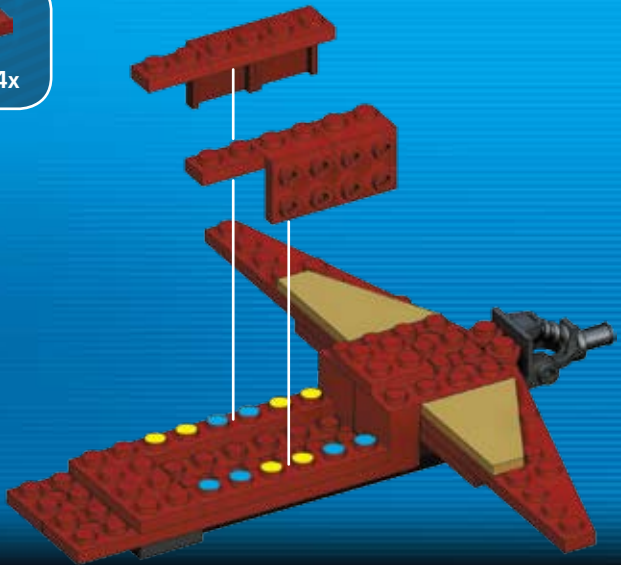

5

1x 2x

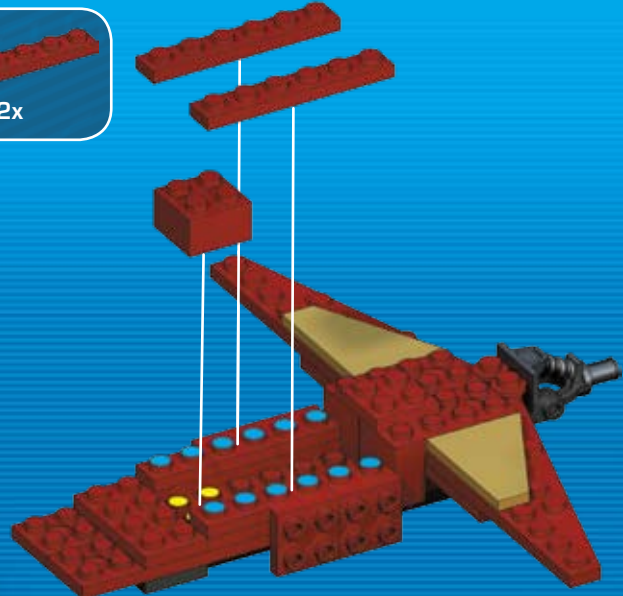

6

- 2x
- 2x
- 2x

7

- 1x
- 2x
- 1x
- 1x

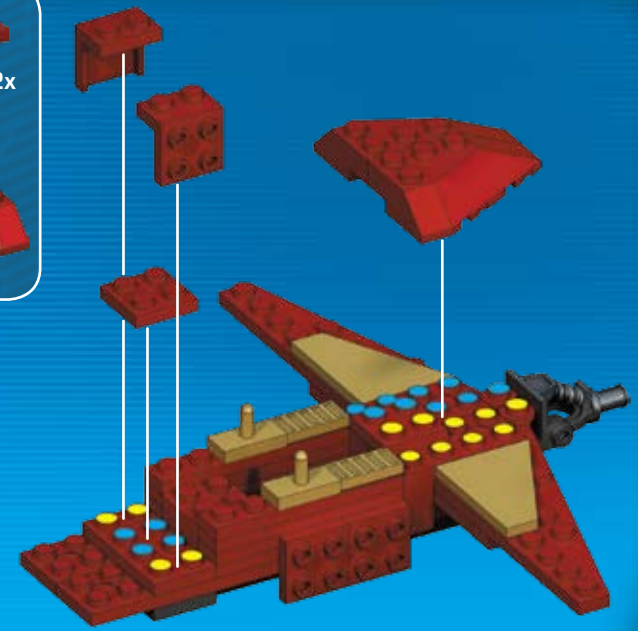
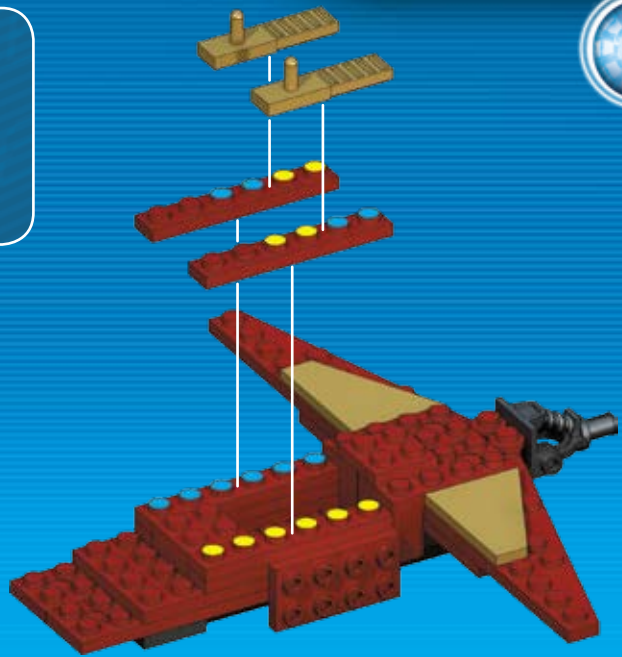

8

- 2x
- 1x
- 1x

9

- 1x
- 1x

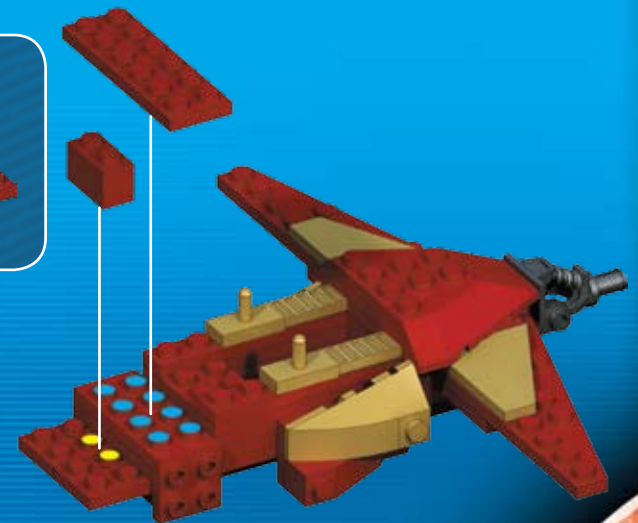
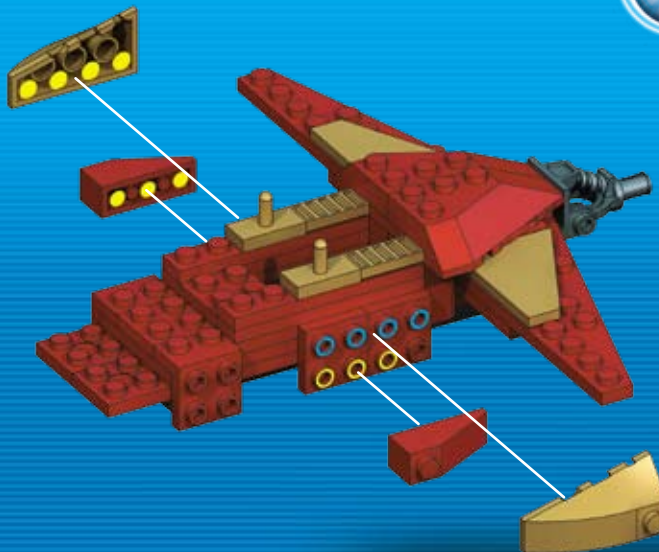

10

- 4x
- 1x

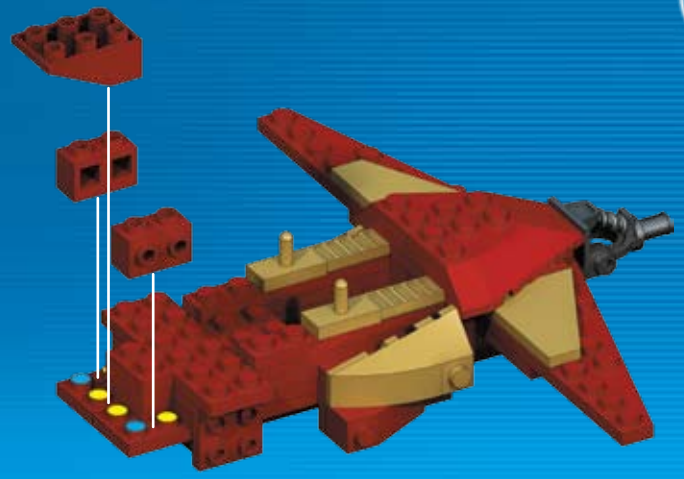

11

- 2x
- 2x
- 1x

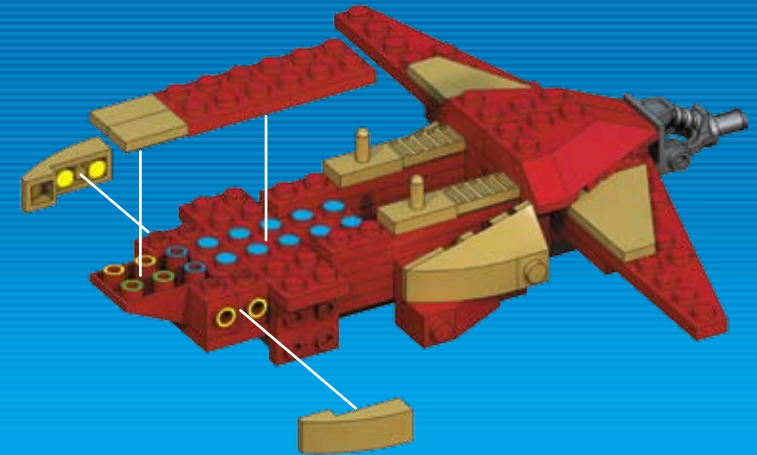

12

- 2x
- 1x
- 1x



13

- 2x
- 1x
- 1x

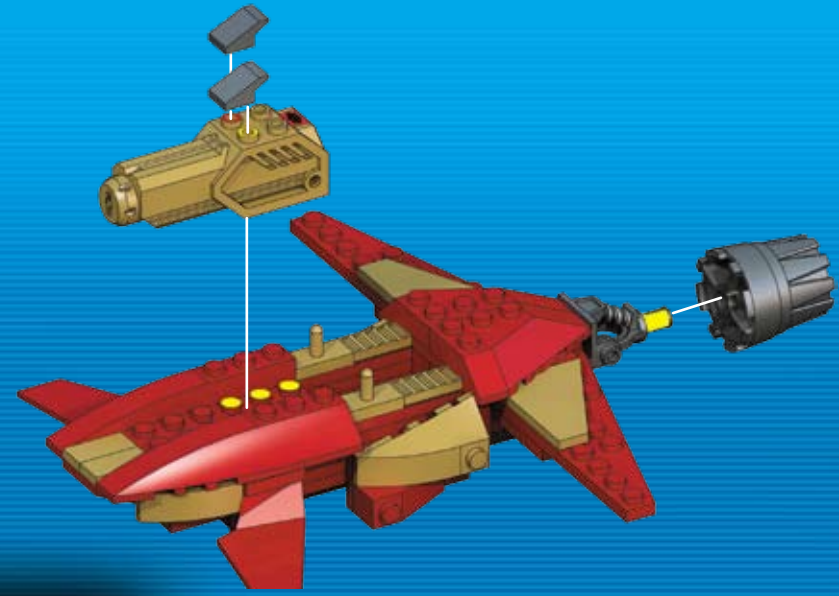

14

1x

2x

1x

1x

3

4

3 4

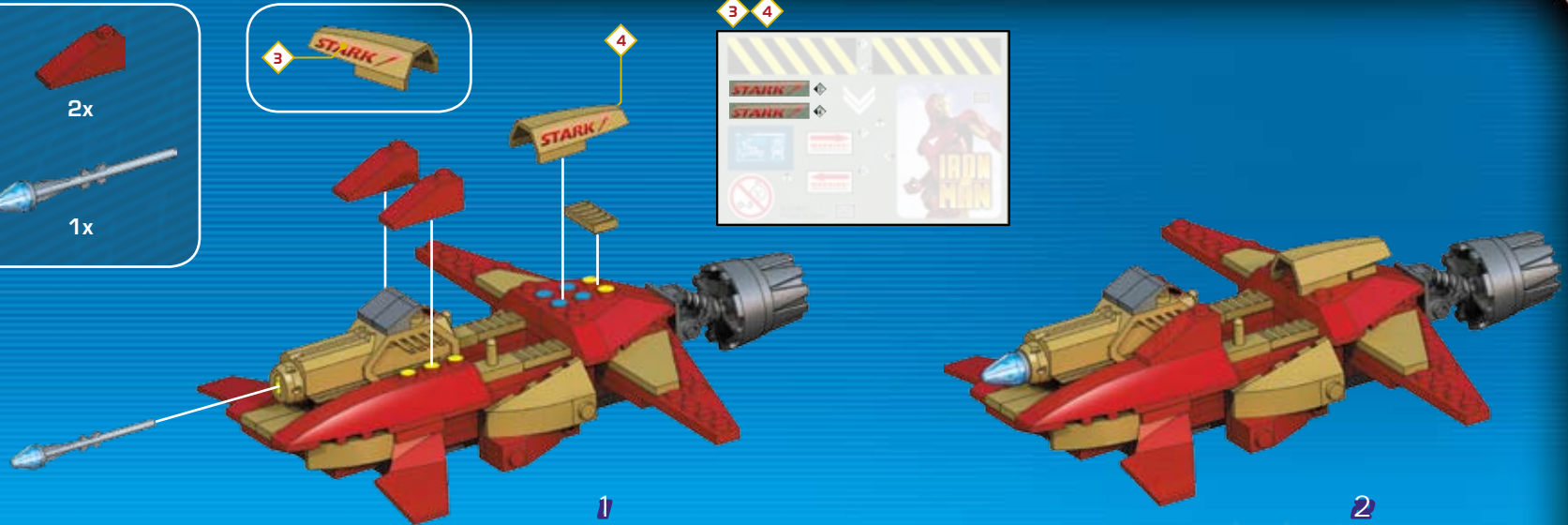

1

2

Working Launcher
Lanzador en funcionamiento
Lanceur en action
Funktionierender Starter
Werkende lanceerinstallatie
Lanciatore funzionante
Lanzador operacional

EN CAUTION! Do not aim at eyes or face.

ES ¡ADVERTENCIA! NO dirigir nunca los proyectiles hacia los ojos o la cara.

FR ATTENTION! Ne pas viser les yeux ou le visage.

DE VORSICHT! Nicht auf das Gesicht oder die Augen richten.

NL LET OP! Niet op ogen of gezicht richten.

DA ADVARSEL! Peg ikke i retning af øjne eller ansigt.

EL ΠΡΟΣΟΧΗ! Να μην σκοπεύετε προς τα μάτια ή το πρόσωπο.

FI VARO! Älä tähtää silmiin tai kasvoihin.

IT Attenzione! Non puntare verso gli occhi o il viso.

NO FORSIKTIG! Sikt ikke mot øyne eller ansikt.

PT ATENÇÃO! Não apontar para os olhos ou o rosto.

SV VAR FÖRSIKTIG! Rikta inte med ögon eller ansikte.

JA 注意！目や顔に使用しないで下さい。

ZH 警告！不要对准眼睛或脸。

AR تنبيه! لا توجه للعينين أو الوجه



Use only the projectiles included with this toy.

Utilizar solamente los proyectiles incluidos con el juguete.

Utiliser seulement les projectiles fournis avec le jouet.

Nur die mit dem Spielzeug mitgelieferten Projektile verwenden.

Alleen de met het speelgoed bijgeleverde projectielen gebruiken.





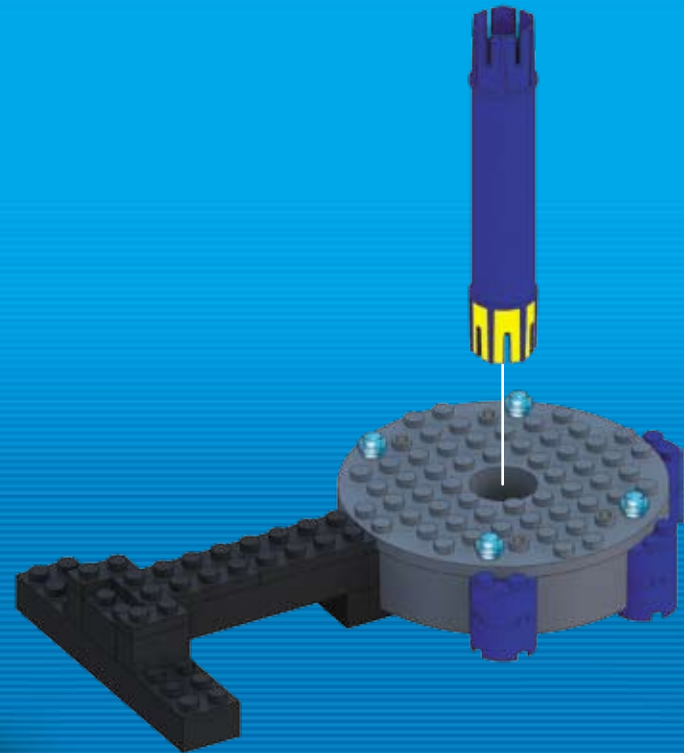
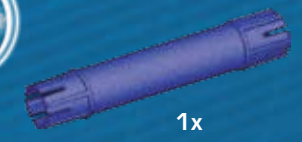
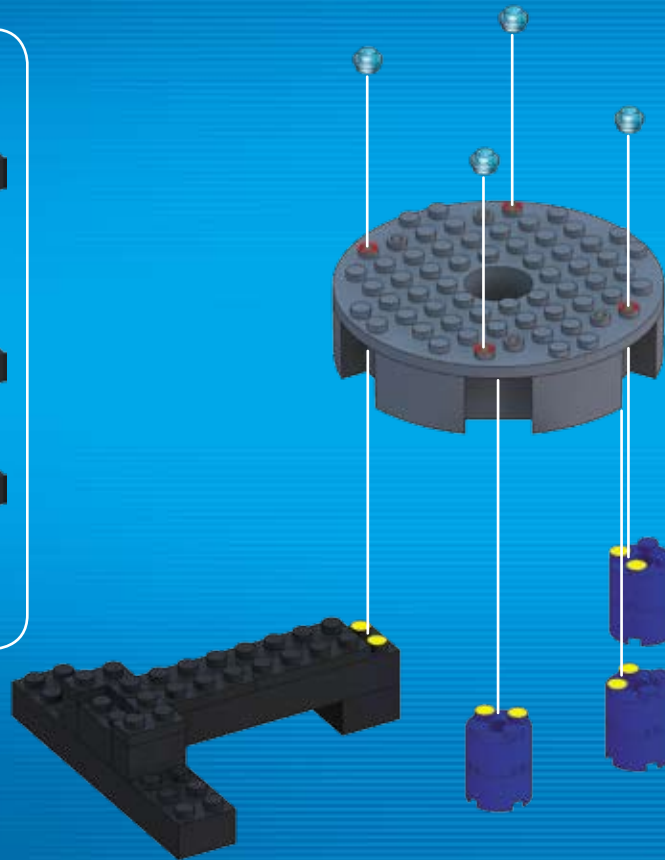
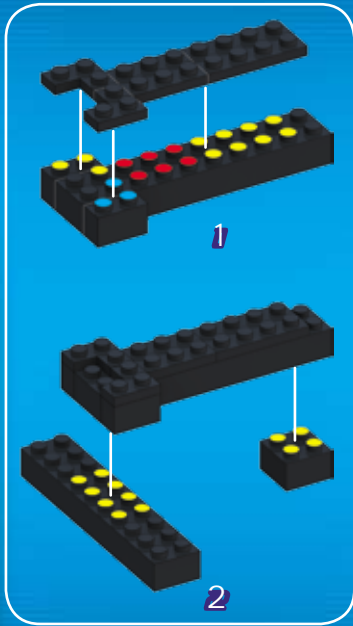
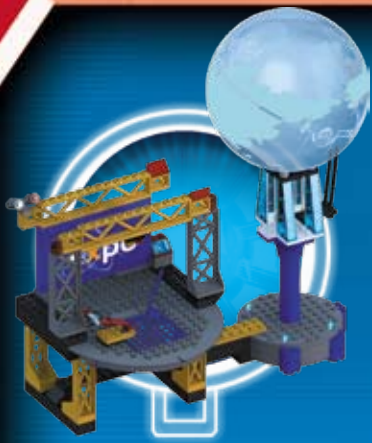

Utilizzare soltanto i proiettili forniti con questo giocattolo.

Usar somente os projéteis incluídos com este brinquedo.

استخدم فقط القذيفة المرافقة لهذه اللعبة



3

- 8x 
- 1x 
- 1x 
- 2x 
- 1x 
- 1x 
- 1x 
- 4x 
- 2x 



1



2



1

2



3



4



4x



5



6

4

3

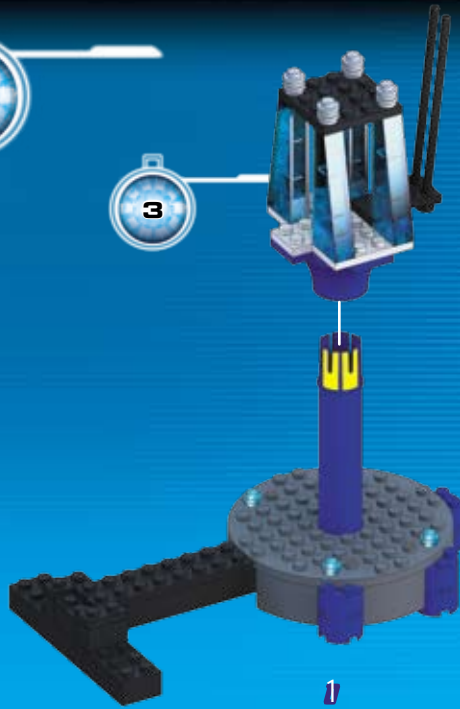

1

5

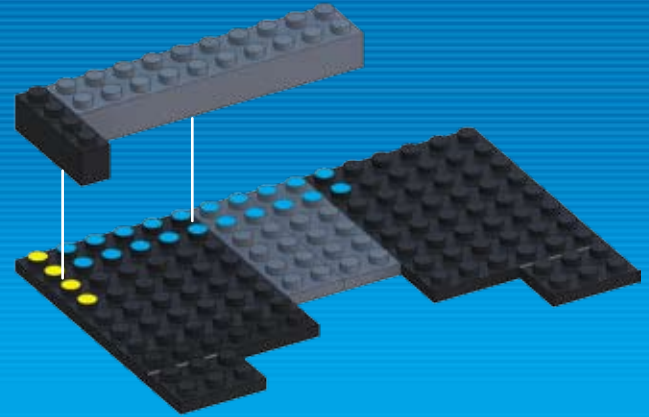
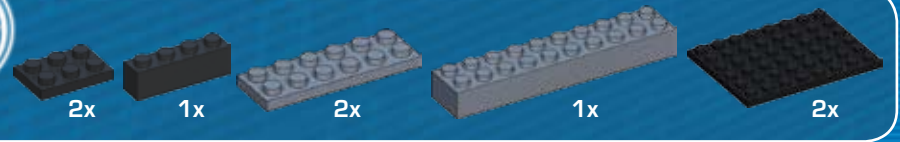

6

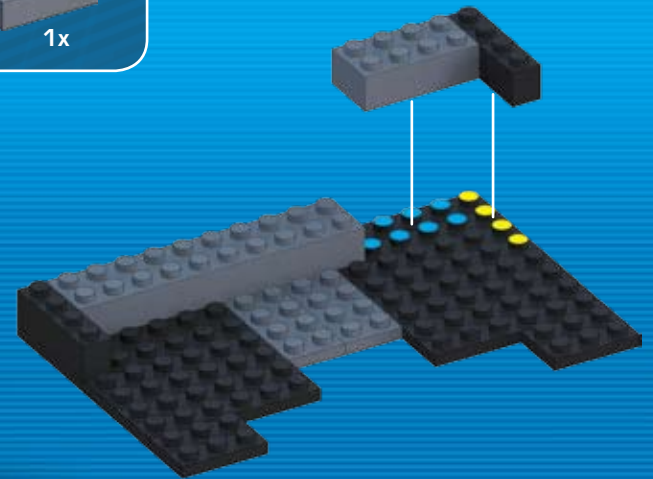
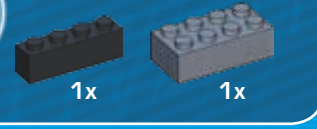

2

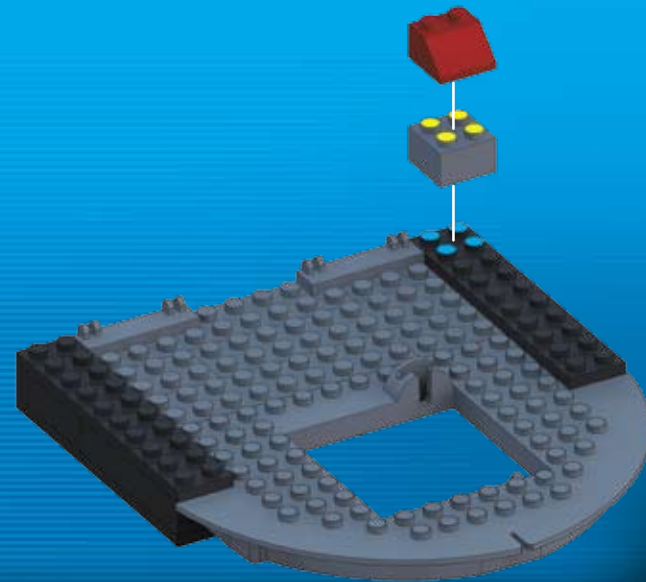
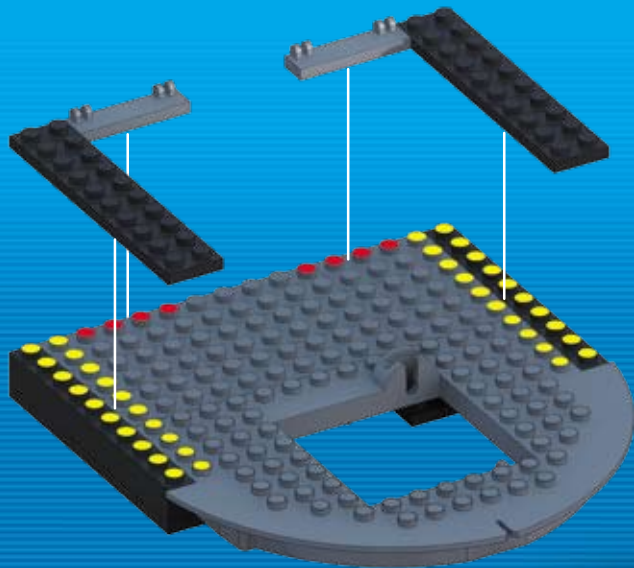
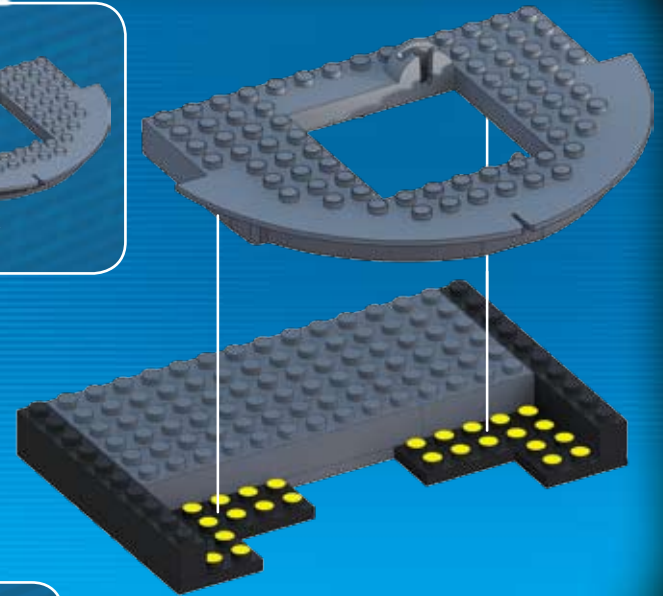
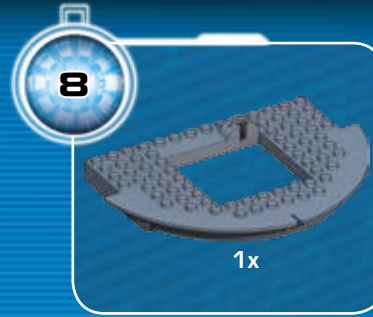
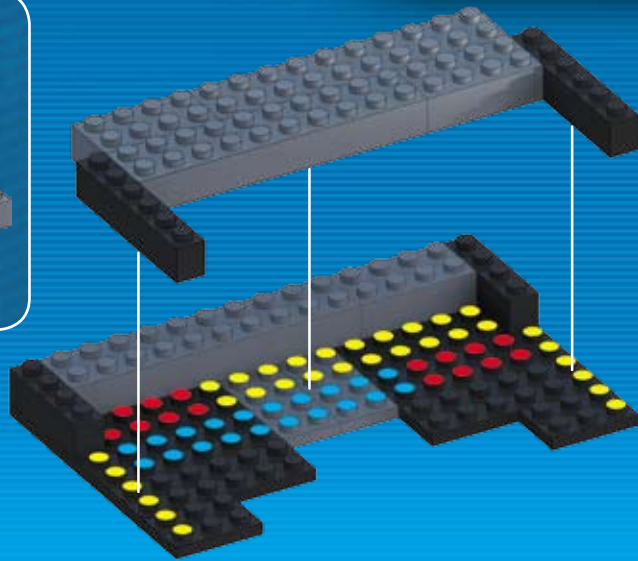
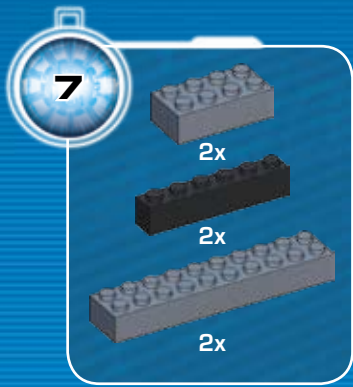

11

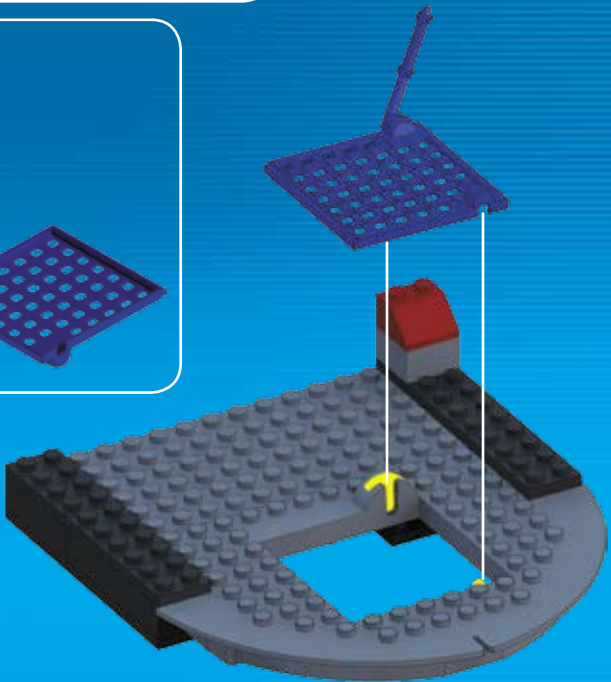
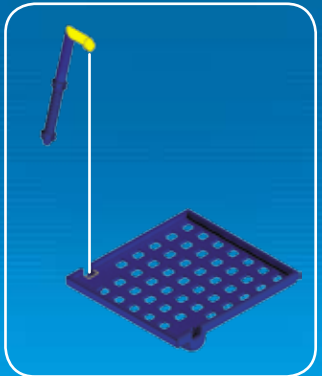
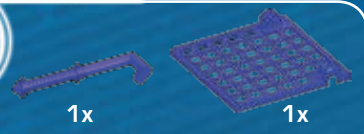

12

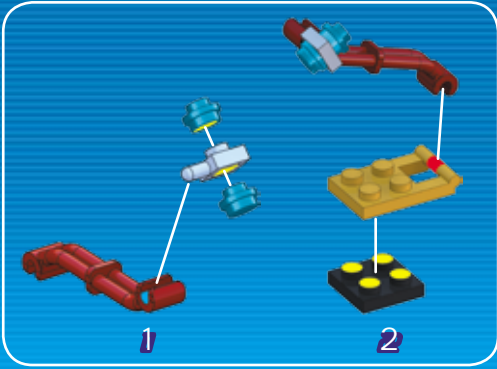

click

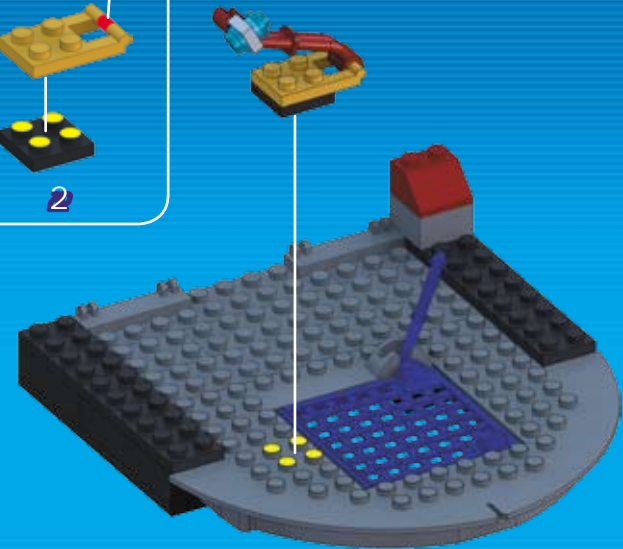

13

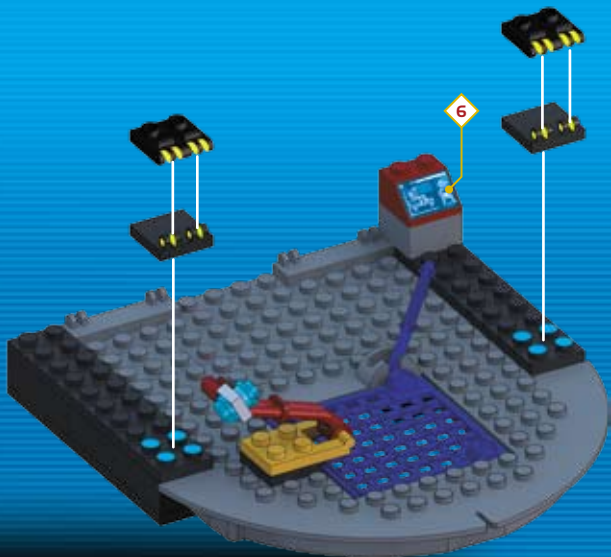

6

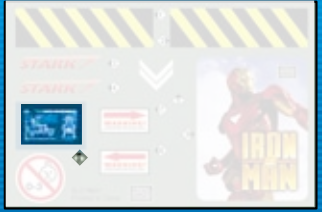

14

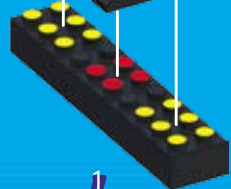

1



2

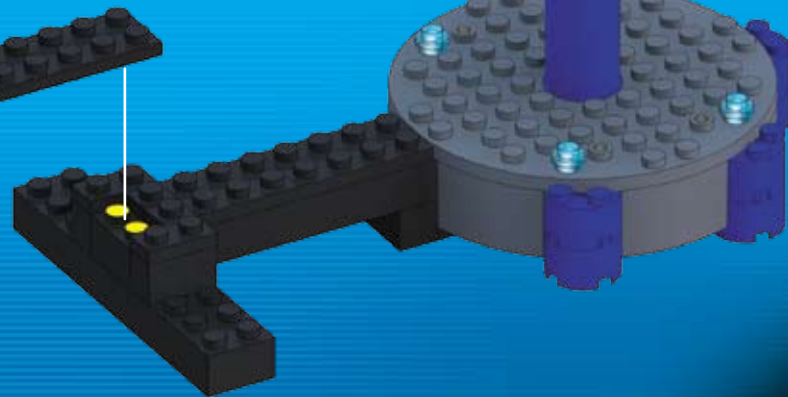
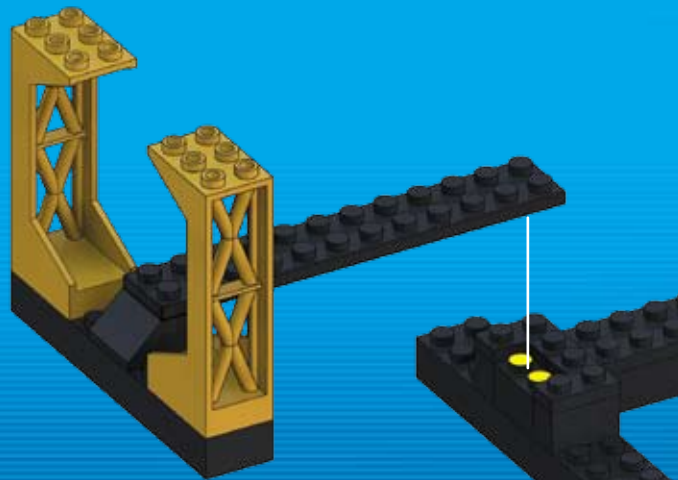

15



1x

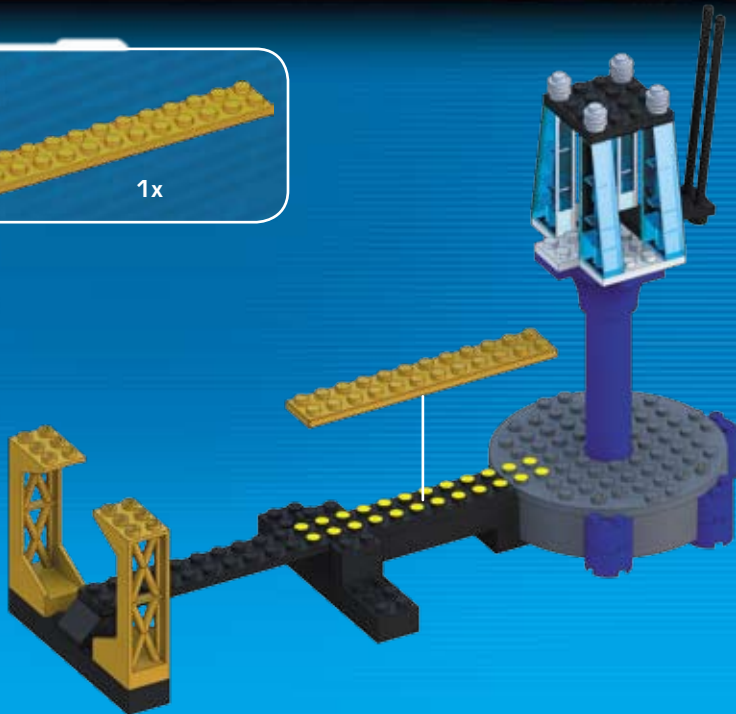

16



2x

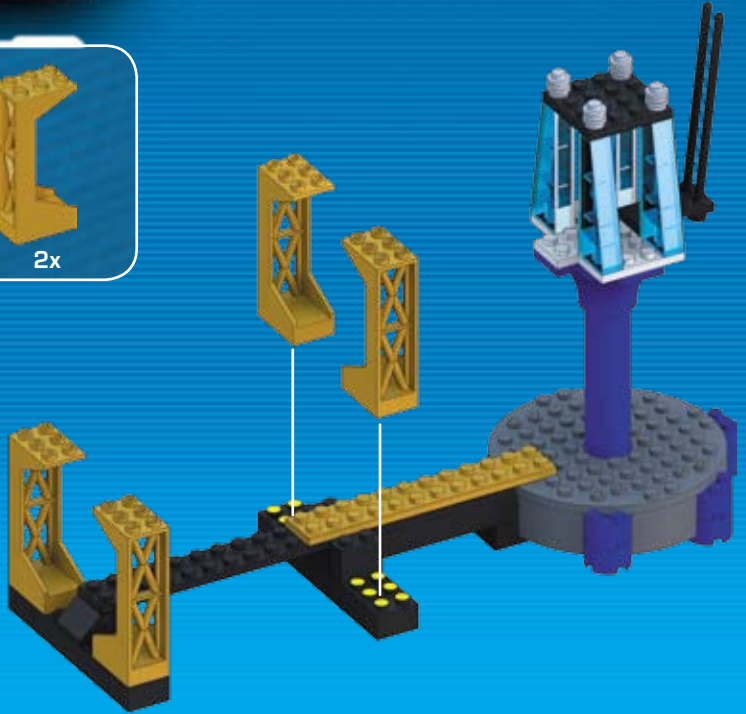

17

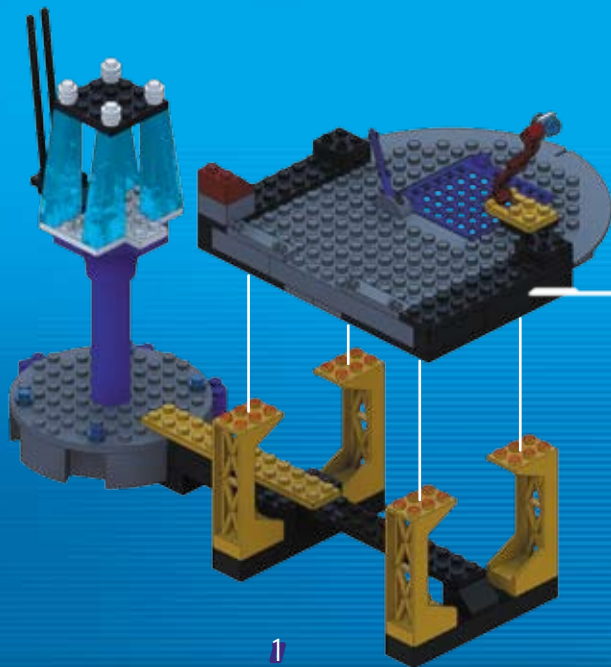

13

1

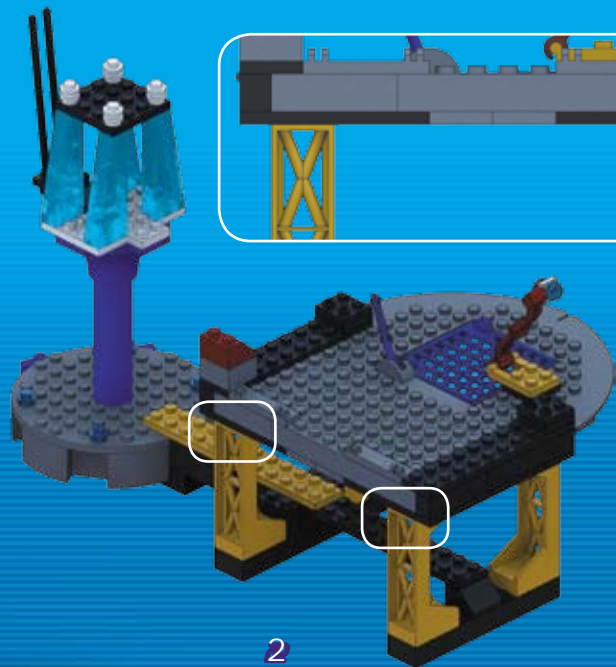
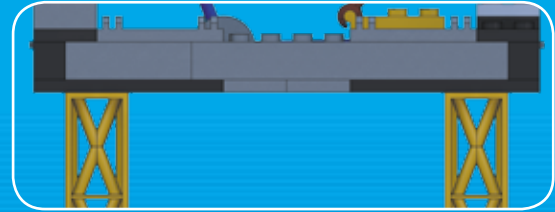

2

18

- 1x [grey ball]
- 1x [red ball]
- 1x [grey ball]
- 2x [grey ball]
- 2x [grey ball]
- 1x [red ball]

- 1x [yellow beam]
- 1x [expo sign]

1

2



19

1x

1x

2x

1x

2x

1x

1x

2x

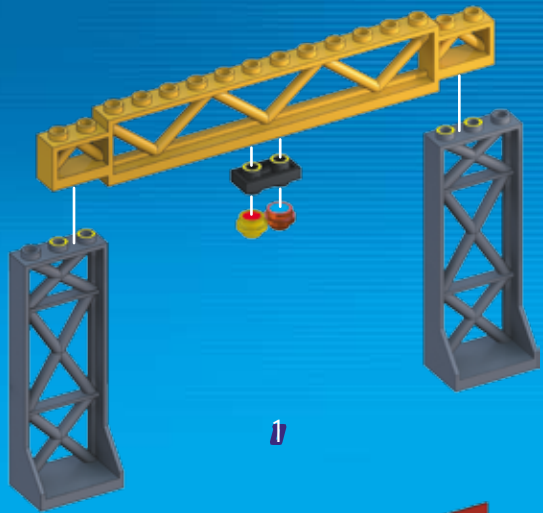

20



1x



1x

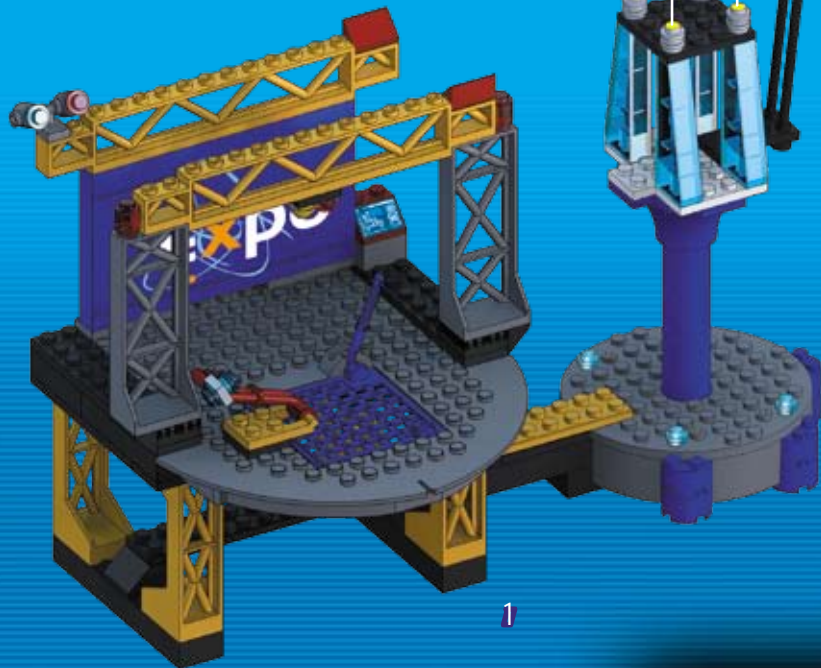
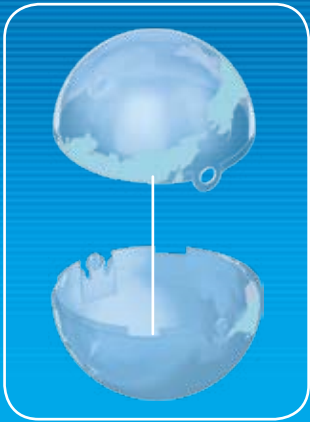

1



2

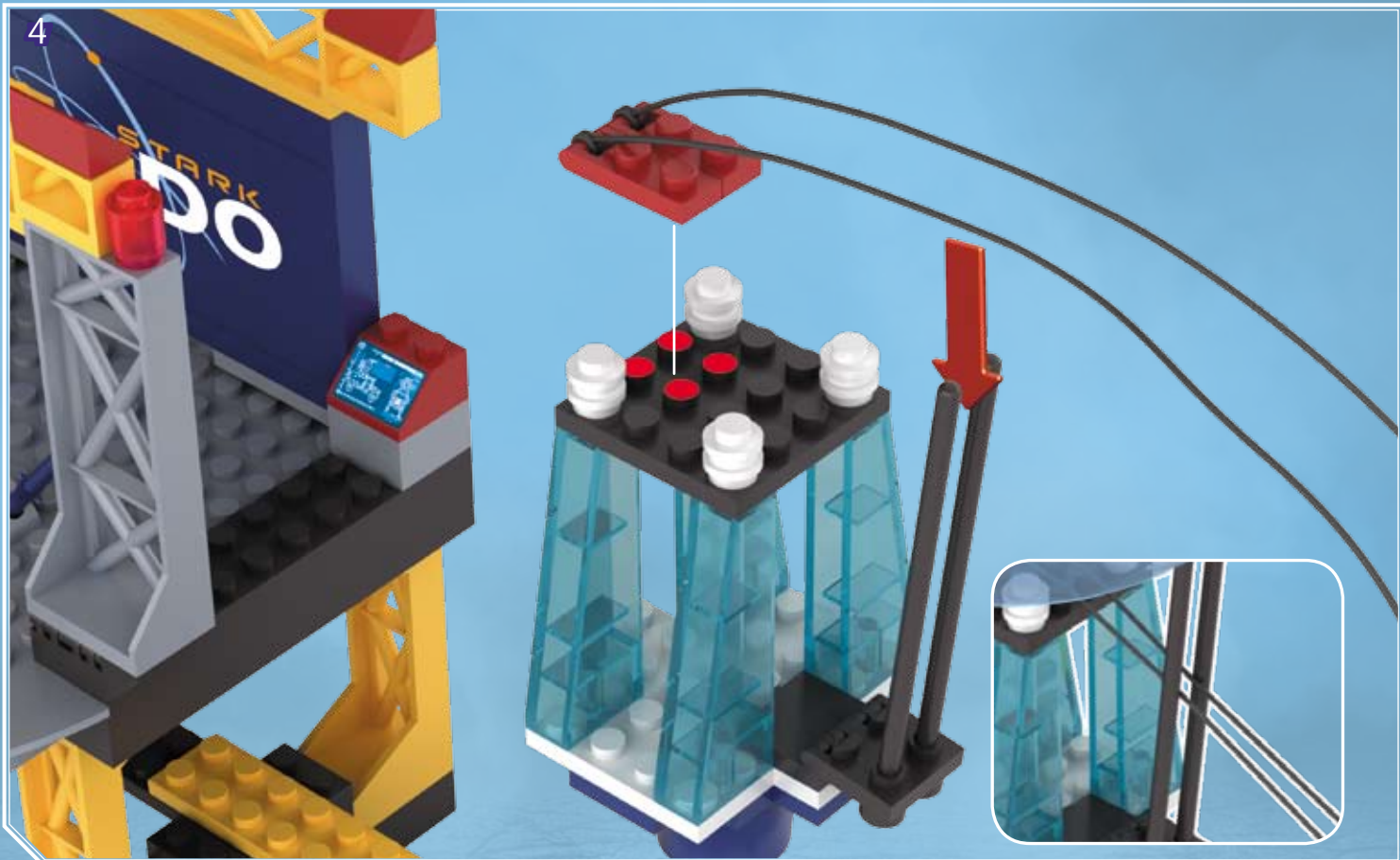
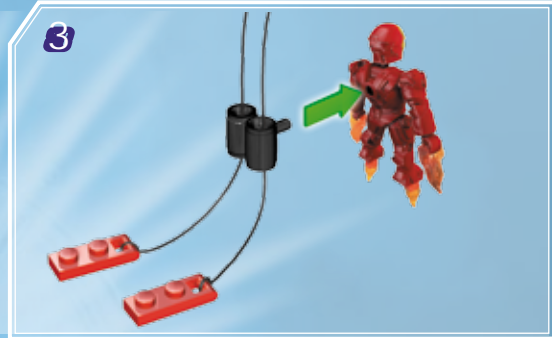
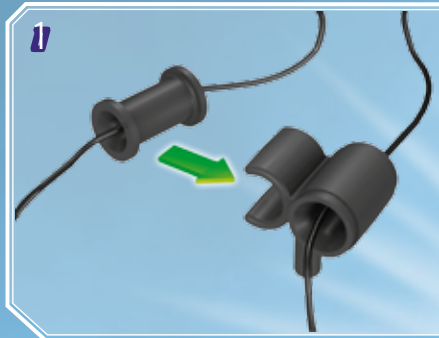

WARNING: Cords could be strangulation hazards. • ADVERTENCIA: Los cables constituyen un peligro de estrangulación. • MISE EN GARDE: Les cordons peuvent représenter des dangers de strangulation. • ACHTUNG: Bei den Kabeln besteht Erstickungsgefahr. • WAARSCHUWING: Koorden kunnen gevaar voor wurging opleveren. • ADVARSEL: Ledninger kan have strangulerings risiko. • VAROITUS: Johto voi aiheuttaa kuristumisriskin. • ATTENZIONE: Questo filo può creare rischio di strangolamento. • ADVARSEL: Ledningen kan utgjøre en kvelningsrisiko. • ADVERTENCIA: As cordas podem causar perigos de estrangulação. • VARNING: Sladden kan försäka strypning. • تحذير: قد تمثل الأسلاك خطر اختناق.

1



2



FLYING STUNT ACTION
ACCION DE VUELO ACROBÁTICO
ACTION D'ACROBATIE VOLANTE
FLUG-STUNT-ACTION / VLIEGENDE STUNTACTIE
VOLO DA STUNT / VOOS ACROBÁTICOS



1

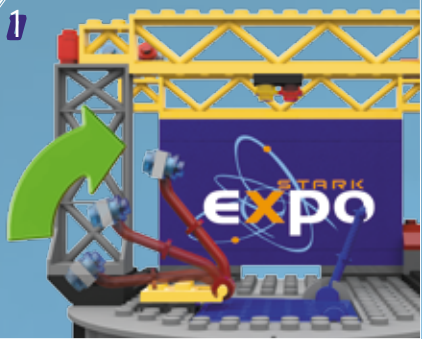

2



**BUILD, DESTROY & RECREATE
THE ACTION AT STARK EXPO**

**CONSTRUYE, DESTRUYE Y RECREA
LA ACCIÓN DE EXPO STARK**

**CONSTRUIS, DÉTRUIS ET RECRÉE
L'ACTION À L'EXPOSITION DE STARK**

**BAUE, ZERSTÖRE UND LASS' DIE ACTION
DER STARK EXPO WIEDER AUFLEBEN**

**BOUW, VERNIETIG EN SPEEL DE ACTIE NA
OP DE STARK TENTOONSTELLING**

**COSTRUGGI, DISTRUGGI E RICREA
L'AZIONE ALLA STARK EXPO**

**CONSTROI, DESTROI & RECRIA
A ACÇÃO NO PARQUE STARK**

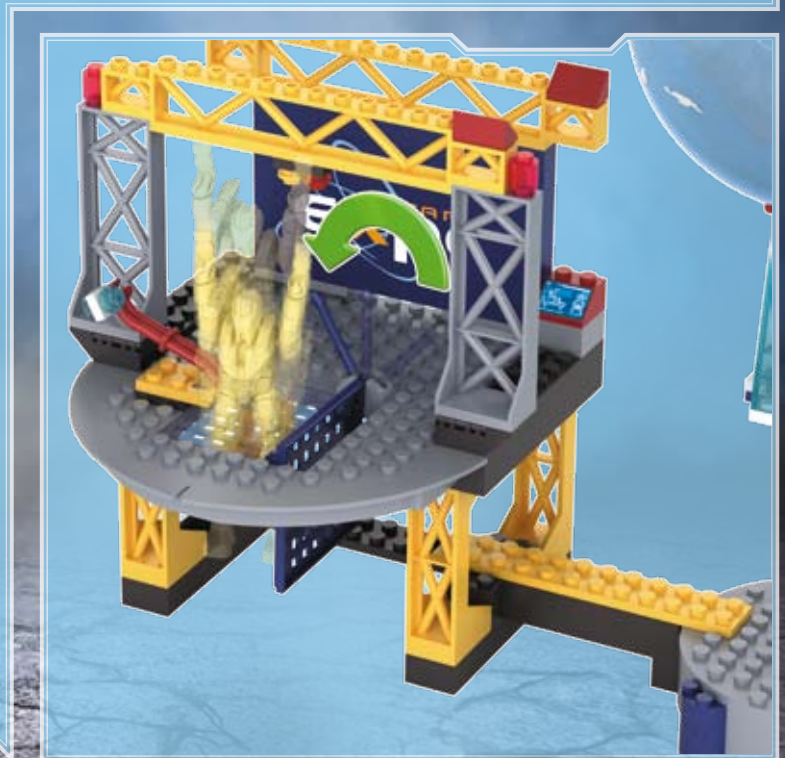

1968
Stark Expo
Expo Stark
Exposition de Stark
Stark tentoonstelling
Parque Stark

STARK INDUSTRY

4+ AVENUE



IRON MAN

1968

STARK INDUSTRIES

BUILD, DESTROY & RECREATE THE ACTION AT STARK EXPO
 CONSTRUYE, DESTROYE Y RECREA LA ACCIÓN DE EXPO STARK
 CONSTRUIS, DÉTRUIS ET RECRÉE L'ACTION À L'EXPOSITION DE STARK
 BAUE, ZERSTÖRE UND LASS' DIE ACTION DER STARK EXPO WIEDER AUFLEBEN
 BOUW, VERNIETIG EN SPEEL DE ACTIE NA OP DE STARK TENTOONSTELLING
 COSTRUGGI, DISTRUGGI E RICREA L'AZIONE ALLA STARK EXPO
 CONSTRÓI, DESTROI E RECREIA A ACCÃO NA PARQUE STARK



FLYING STUNT ACTION
 ACCIÓN DE VUELO ACROBÁTICO
 ACTION D'ACROBATIE VOLANTE
 FLUG-STUNT-ACTION / VILLEGENDE STUNTACTIE
 VOLO DA STUNT / VOOS ACROBÁTICOS



WORKING LAUNCHER
 LANZADOR EN FUNCIONAMIENTO
 LANCEUR EN ACTION
 FUNKTIONIERENDER STARTER
 WERKENDE LANCERINSTALLATIE
 LANZADOR EN FUNCIONAMIENTO
 LANCIATORE FUNZIONANTE

Collect Them All!
 Alle sammeln! • Verzamel ze allemaal! • Coleccionalos todos! • Collectiemer les tous!
 Coleccionarlos todos! • Collectiemer les tous!



INCLUDES BUILDABLE MARK V - WAR MACHINE - WHIPLASH & GROUND DRONE
 INCLUDES BUILDABLE MARK V - WAR MACHINE - WHIPLASH & GROUND DRONE / COMPREND UNE ARMURE MARK II ET UNE ARMURE MARK VI CONSTRUCTIBLES
 ENTHÄLT ERWEITERBARE MARK V- UND MARK VI-BRUSTPLATZ / INCLUDET UTVIDERBARE MARK II & MARK VI
 COMPRENDE MARK II E MARK VI DA MONTARE / INCLUI MARK II E MARK VI MONTAVÉIS



Iron Man 2, the Mark © 2010 MVI Film Finance LLC, Marvel, Iron Man, all character names and their distinctive likenesses, TM & © 2010 Marvel Entertainment, LLC and its subsidiaries. All Rights Reserved.