

IRON MAN 2



WHIPLASH

MARK V



MOTORIZED ACTION
ACCION MOTORIZADA
ACTION MOTORISEE
MOTORFUNKTION
GEMOTORISEERDE ACTIE
FUNZIONAMENTO A MOTORE
ACÇÃO MOTORIZADA

MEGA
BLOKS

1980

Whiplash Showdown • Whiplash Enfrentamiento • Whiplash Épreuve de force •
Whiplash Machtprobe • Whiplash Showdown • Whiplash Confronto diretto • Whiplash Confronto

2x
AM04428AAU

6x
AM07629AAU

2x
AM15484AAU

2x
AM01323AAU

1x
AM09033AAU

2x
AM09731AAU

1x
AS0198006

1x
AS0198007

2x
AS0198010

1x
AM09923AAU

1x
AM17055KM

2x
MA12251KM

3x
AM09393KM

2x
AM09593KM

1x
AM09013KM

2x
AM16384KM

2x
AM01417KM

2x
AM01322KM

2x
AM04217KM

1x
MA1154KM

3x
MA1139KM

1x
AM04497KM

2x
AM09268KM

2x
AM03656KM

1x
AM16917KM

2x
AM09267KM

1x
AM03772KM

2x
AM09106KM

5x
AM09493KM

2x
AM04983KM

1x
AM16654KM

1x
AM16659KM

1x
AS0198004

1x
AS0198003

2x
AM16913KM

1x
AM16912KM

2x
MA1140AKM

5x
AM07590AKM

1x
AM09393AKM

2x
AM01417AKM

2x
AM07629AKM

2x
AM15484AKM

1x
MA0948AKM

2x
AM07230AKM

1x
AM10273AKM

1x
AM09023AKM

1x
AS0198012

5x
AM09593AKM

1x
AM09292AKM

2x
AM01480AKM

2x
AM03772AKM

2x
AM09493AKM

1x
AM15478AKM

1x
AM15479AKM

2x
AM08416AKM

2x
AM03328AGV

2x
AM04428AGV

6x
AM09198AGV

2x
MA1086AGV

2x
AM01417AGV

4x
AM07228AGV

2x
AM16384AGV

1x
AM09593AGV

4x
AM09106AGV

2x
AM1323AGV

2x
AM07230AGV

2x
AM16907AGV

3x
AM09493AGV

2x
AM01313AGV

2x
AM16867AGV

1x
AS0198011

1x
AS0198009

1x
AM16910W

2x
AS0198013

2x
AM01113AJE

2x
AM08412AJC

2x
M1140X

2x
AM01748ZD

2x
AM16635AGV

2x
AX0198001AJC

1x
AM08416AKL

4x
AS0198014

2x
AM16215AJC

1x
AS0198001

1x
AS0198002

1x
AS0198008

1x
AM17089AGV

EN Please read these instructions carefully before first use and keep them for future reference. / **ES** Leer estas instrucciones cuidadosamente antes de la primera utilización y guardarlas para referencia futura. / **FR** Il est recommandé de lire attentivement ce feuillet avant la première utilisation et de le conserver pour référence future. / **DE** Die Gebrauchsanleitung bitte durchlesen und aufbewahren. / **NL** Wij raden u aan deze handleiding zorgvuldig te lezen en te bewaren voor eventuele raadpleging op een later tijdstip. / **IT** Leggere le istruzioni prima di cominciare ad usare il gioco e conservarle per referenze future. / **PT** Leia as instruções antes do primeiro uso e guarde-as para futura referência.

EN ⚠ **WARNING:**
CHOKING HAZARD. - Small parts.
Not for children under 3 years.

ES ⚠ **ADVERTENCIA:**
PELIGRO DE ASFIXIA. - Contiene piezas pequeñas. No recomendado para niños menores de 3 años.

FR ⚠ **AVERTISSEMENT:**
RISQUE DE SUFFOCATION. - Présence de petits éléments. Ne convient pas aux enfants de moins de 3 ans.

DE ⚠ **WARNUNG:**
ERSTICKUNGSGEFAHR. - Enthält kleine Teile. Nicht für Kinder unter 3 Jahren geeignet.

NL ⚠ **WAARSCHUWING:**
VERSTIKKINGSGEVAAR. - Bevat kleine onderdelen. Niet geschikt voor kinderen onder de 3 jaar.

DA ⚠ **ADVARSEL:**
KVÆLNINGSFARE. - Indeholder smådele. Ikke til børn under 3 år.

EL ⚠ **ΠΡΟΕΙΔΟΠΟΙΗΣΗ:**
ΚΙΝΔΥΝΟΣ ΠΝΙΞΙΜΑΤΟΣ. - Περιέχει μικρά αντικείμενα. Όχι για παιδιά κάτω των 3 ετών.

FI ⚠ **VAROITUS:**
TUKEHTUMISVAARA. - Sisältää pieniä osia. Ei alle 3-vuotiaalle lapsille.

IT ⚠ **ATTENZIONE:**
PERICOLO DI SOFFOCAMENTO. - Contiene piccole parti. Non indicato per bambini sotto i 3 anni.

NO ⚠ **ADVARSEL:**
KVELNINGSFARE. - Inneholder små deler. Kun for barn over 3 år.

PT ⚠ **ATENÇÃO:**
PERIGO DE ASFIXIA. - Contém peças pequenas. Não é concebido para crianças de menos de 3 anos.

SV ⚠ **VARNING:**
KVÄVNINGSRISK. - Innehåller små delar. Inte för barn under 3 år.

JA ⚠ **警告:**
窒息の危険性 - 小さな部品が含まれています
3歳以下の子供には与えないで下さい。

ZH ⚠ **警告:**
有窒息危险 - 包含有小部件
不适合3岁以下的小孩玩。

AR ⚠ **تحذير:**
خطر اختناق - قطع صغيرة.
غير صالحة للأطفال أقل من 3 سنوات.

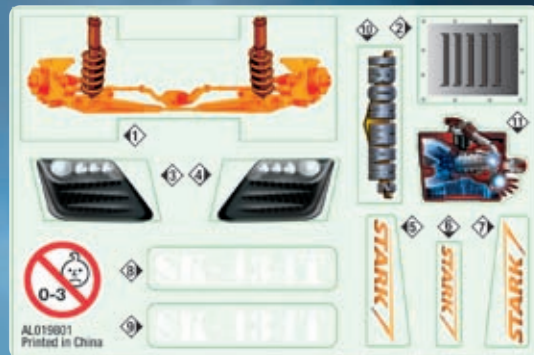
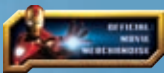

1x
AL019801

IRON MAN 2, the Movie: © 2010 MVL Film Finance LLC. Marvel, Iron Man, all related character names and their distinctive likenesses: TM & © 2010 Marvel Entertainment, Inc. and its subsidiaries. All rights reserved.



1



1x



1x



2x



1x

2



2x



1x

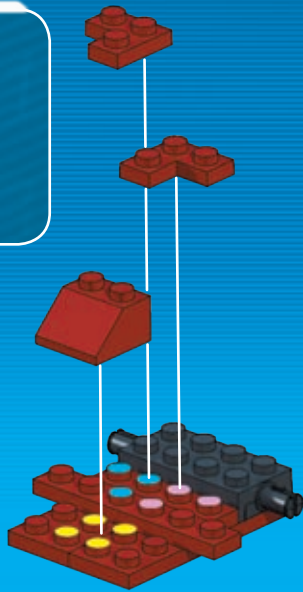
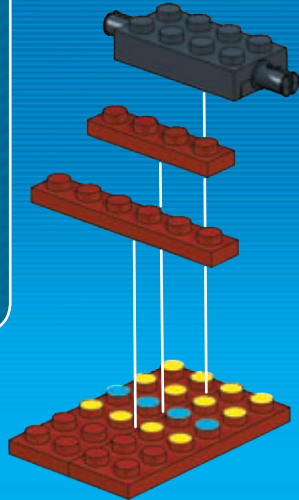

3



1x



1x



1x

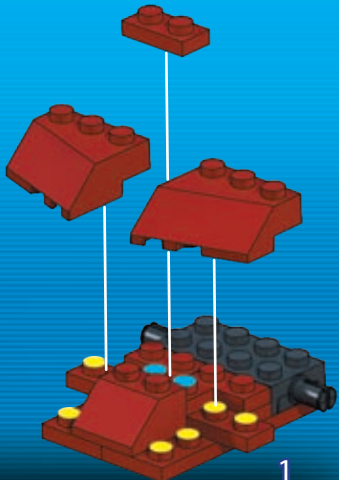

4

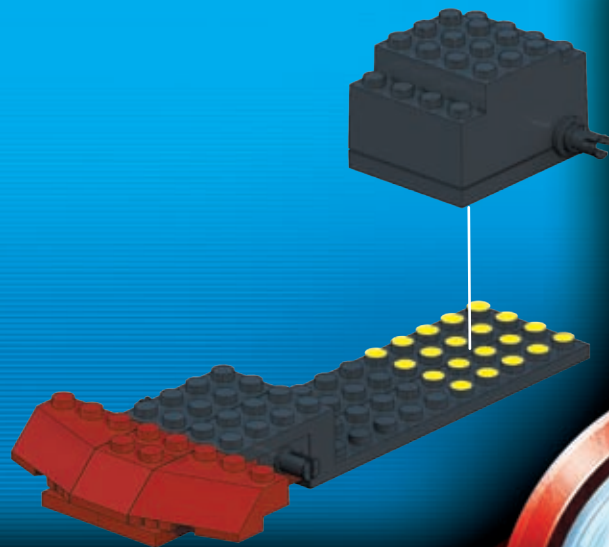
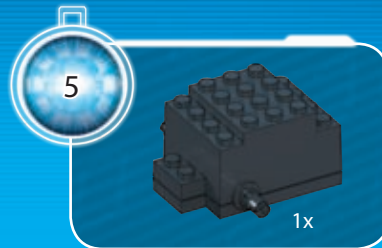
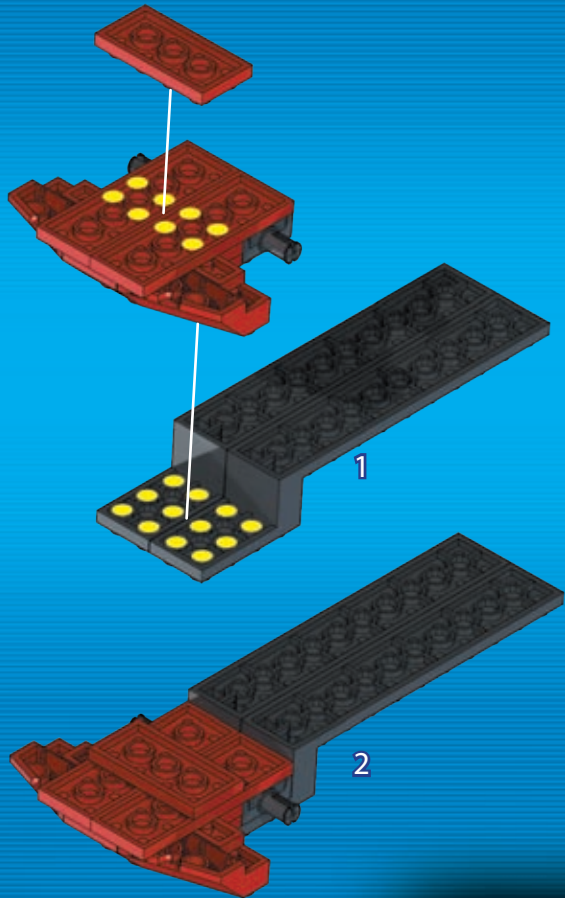
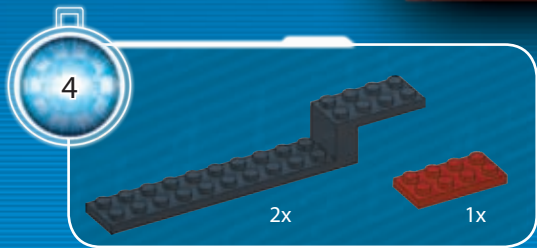

6

- 2x [1x1 grey brick]
- 2x [1x3 grey brick]
- 2x [1x5 grey brick]
- 2x [1x7 grey brick]
- 1x [1x3 red brick]

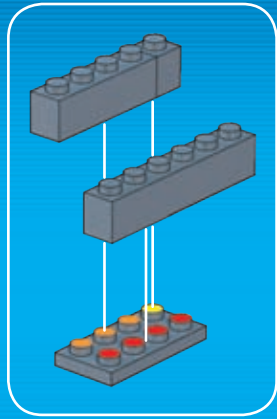
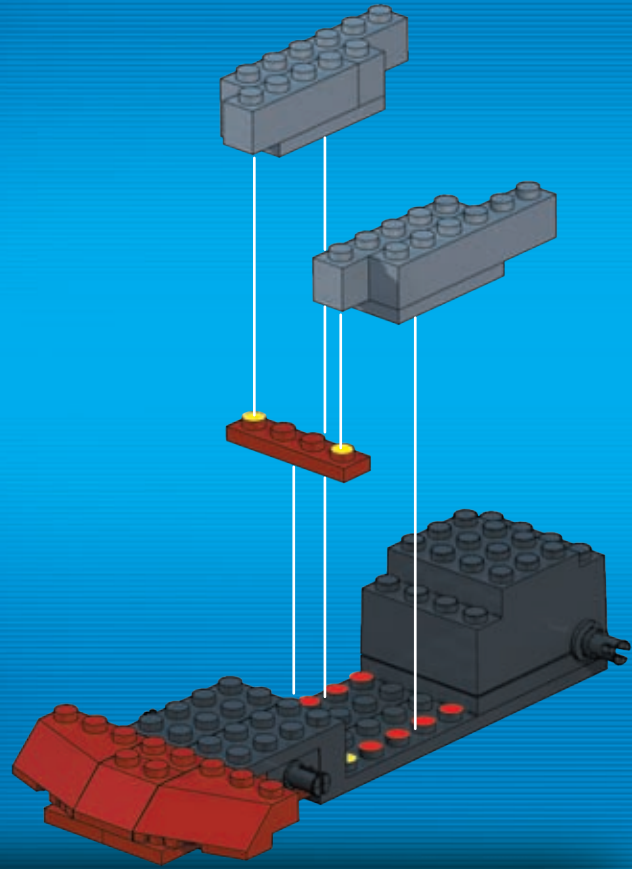
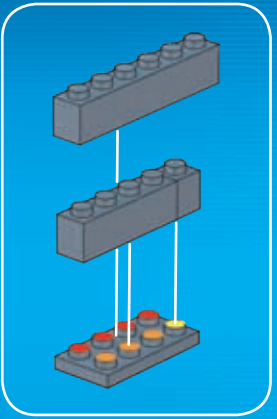

6



2x



2x



1x

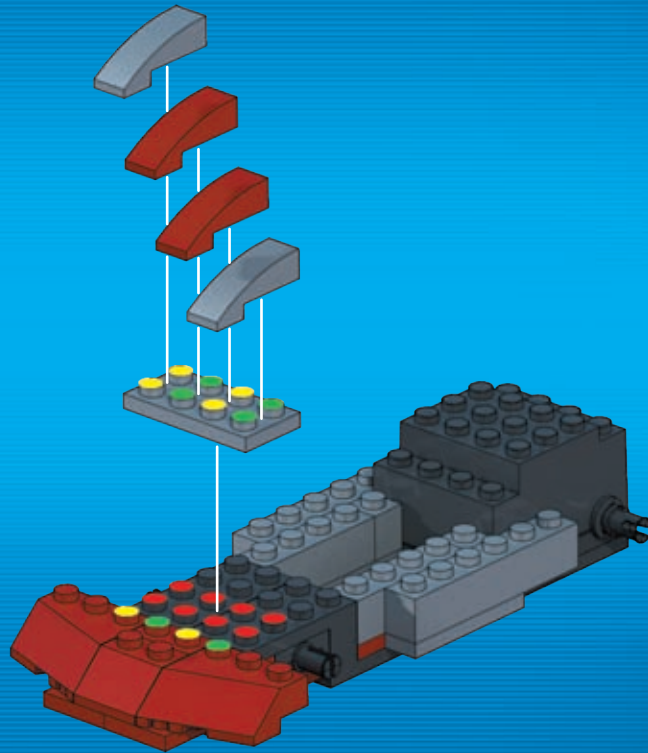

8



1x



4x



2x

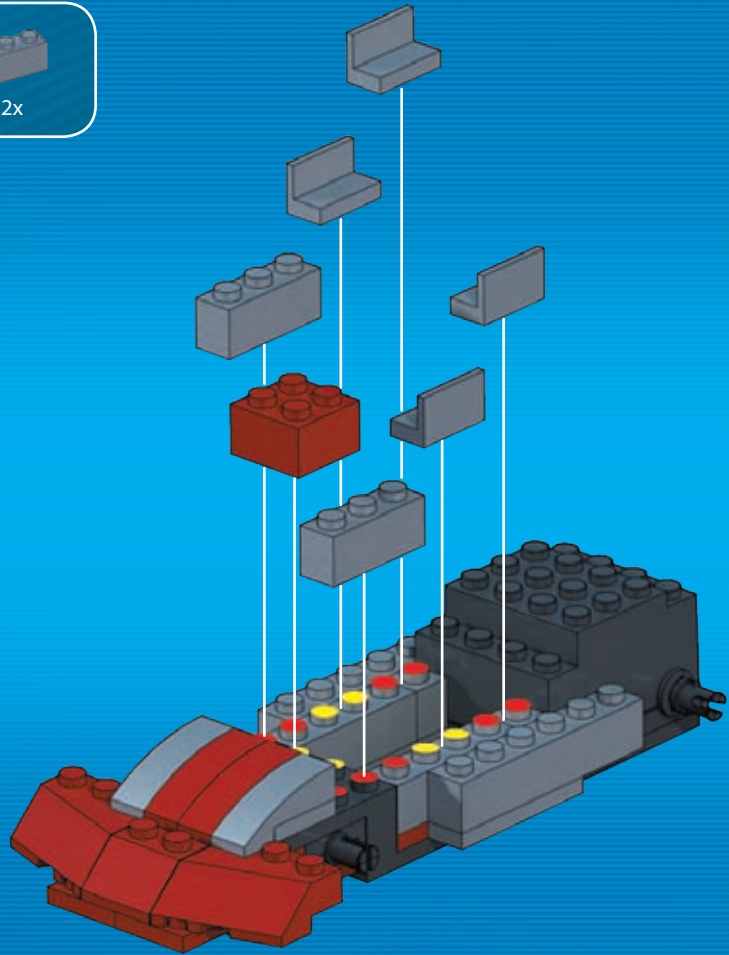

8

9

- 4x
- 1x
- 2x
- 2x
- 2x
- 4x

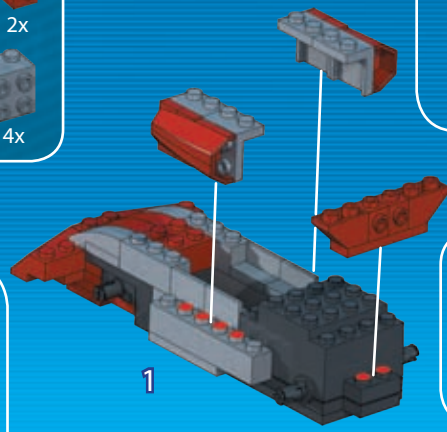
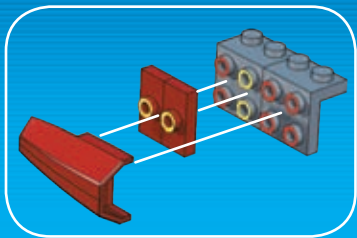
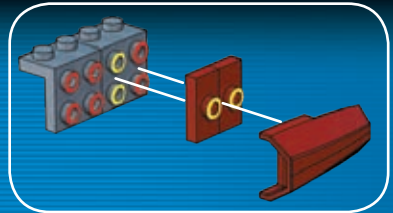

10

- 2x
- 1x

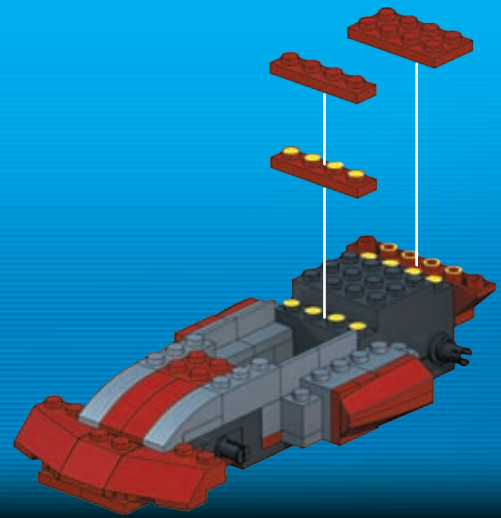

11

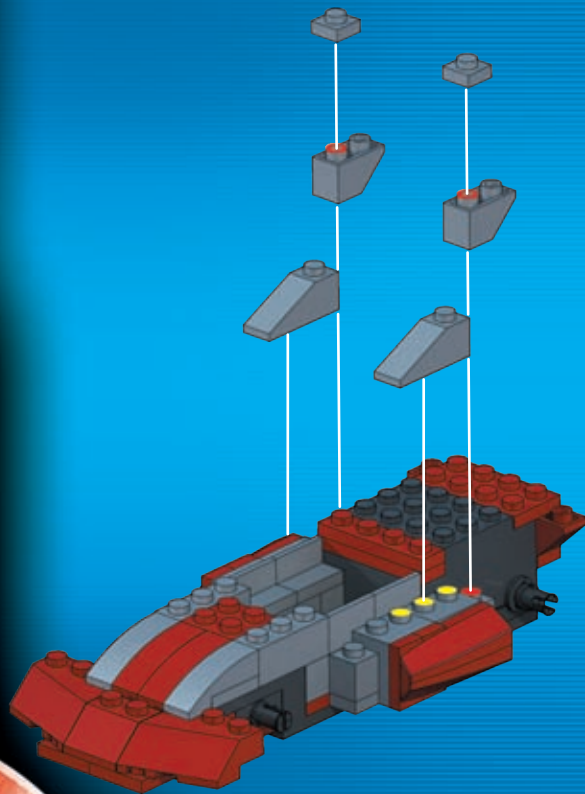

12

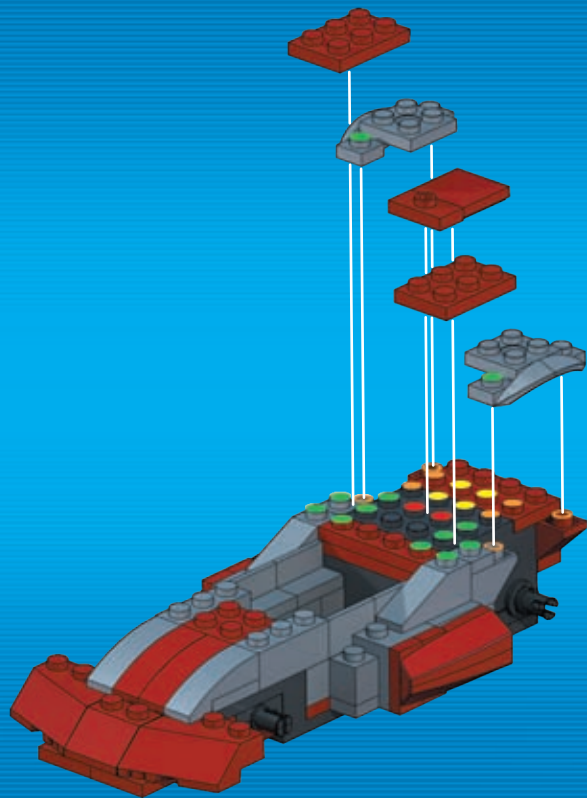
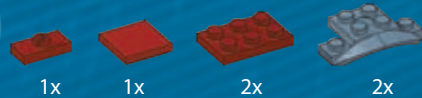

10

13

- 2x 
- 4x 
- 1x 

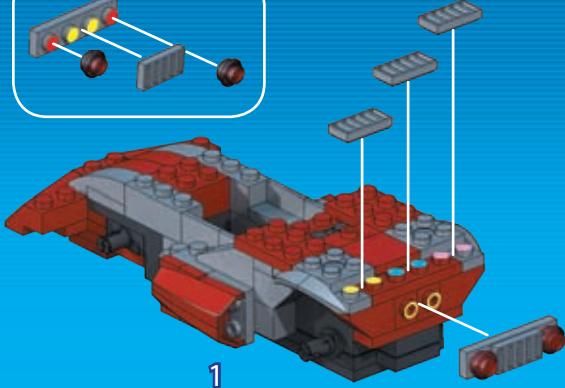
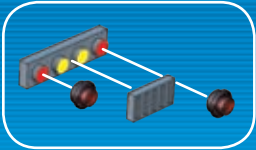

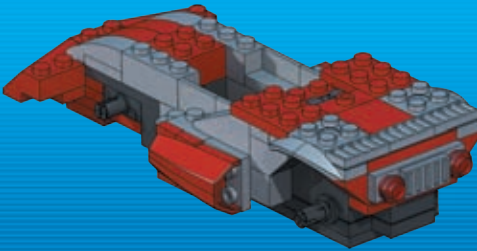

1



2

14

- 2x 
- 2x 
- 1x 
- 1x 

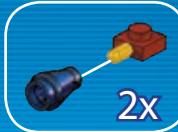

2x

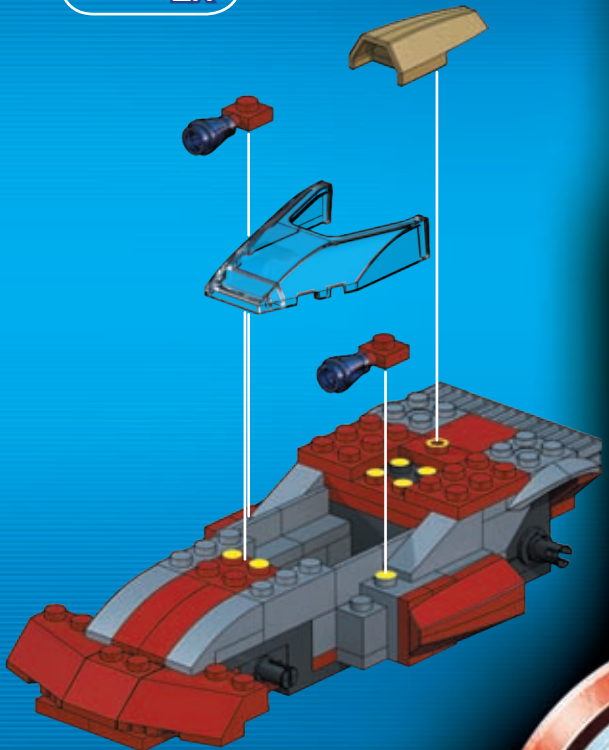

15

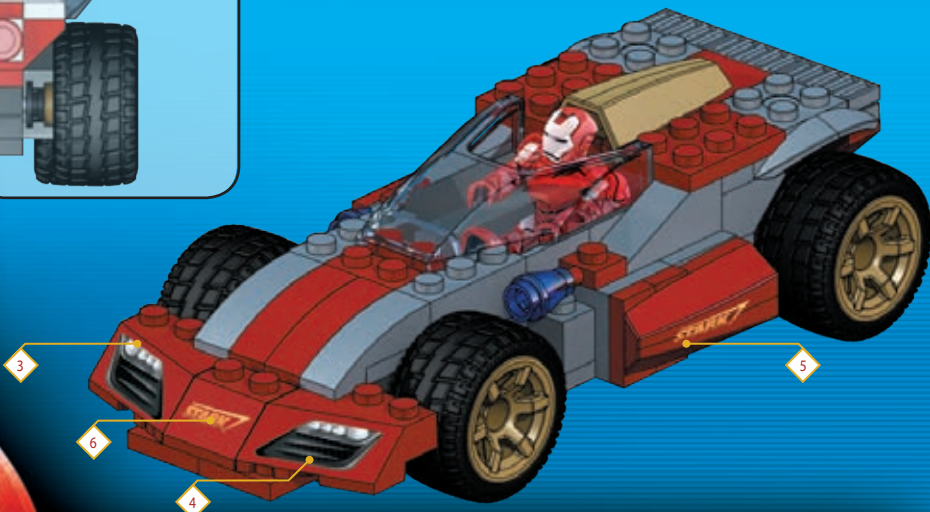
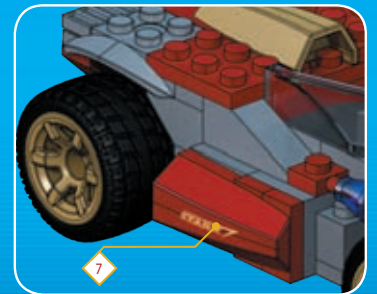
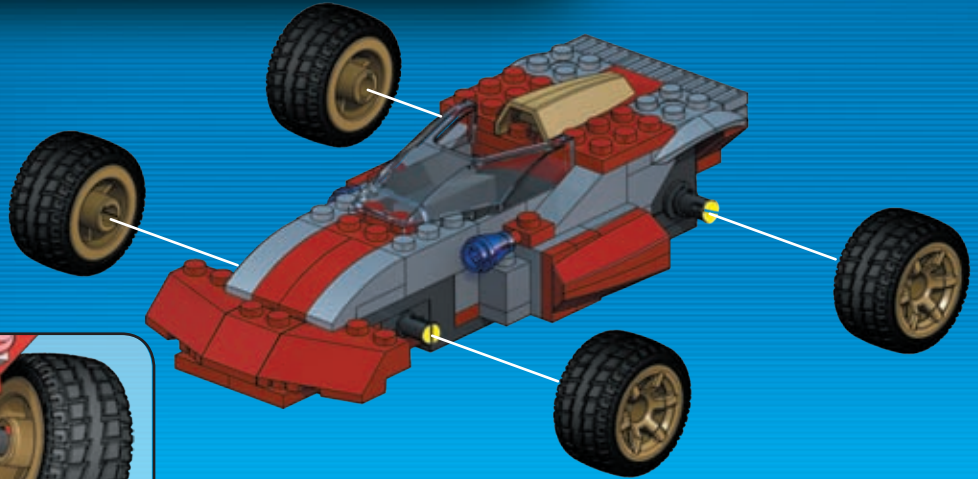

- 3
- 4
- 5
- 6
- 7



1

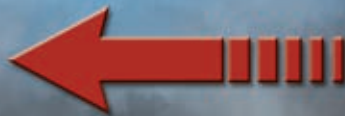

Pull-Back Racer
Racer de retirada
Le Racer à rétro-friction
Aufziehbarer Rennwagen
Pull-Back Racer
Da corsa con carica da dietro Carro
de corrida de puxar atrás

2





1

- 1x Orange 1x4 Technic Brick
- 1x Dark Grey 1x6 Technic Plate
- 1x Dark Grey 1x12 Technic Plate

2

- 1x Dark Grey 1x6 Technic Plate
- 1x Grey Technic Roof Piece



3

- 2x Dark Grey 1x2 Technic Plate
- 2x Orange 1x2 Technic Brick
- 2x Dark Grey 1x3 Technic Plate
- 2x Dark Grey 1x6 Technic Plate

4

- 2x Dark Grey 1x2 Technic Plate with Pin
- 1x Dark Grey 1x6 Technic Plate

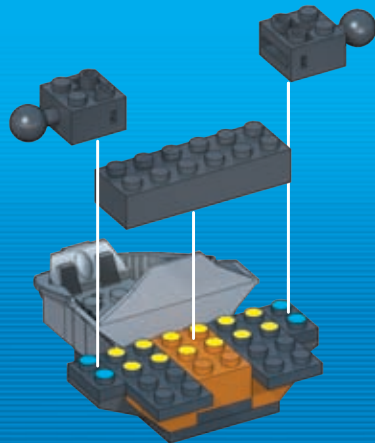
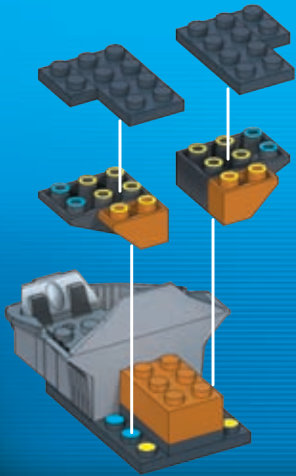

5

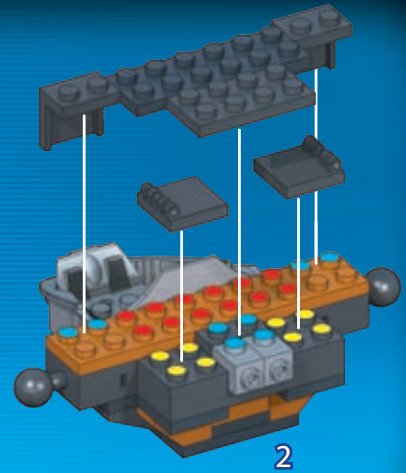
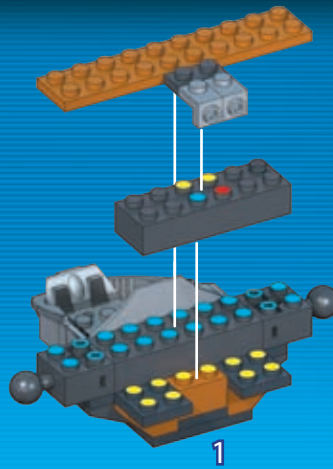

6

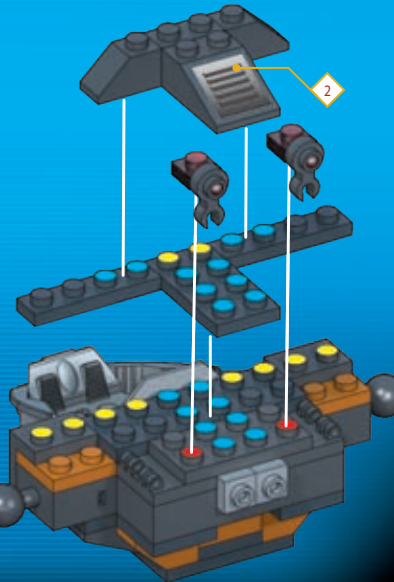
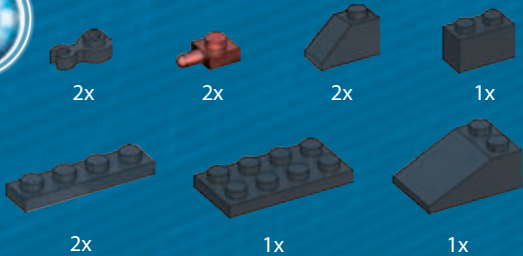

7

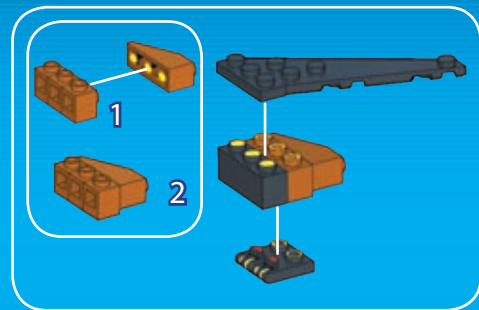
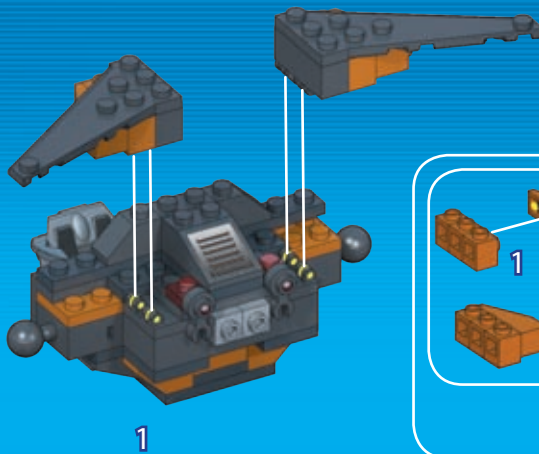
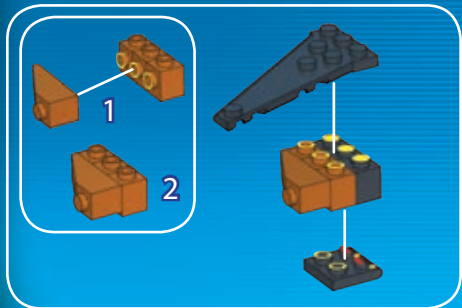

8

2x 1x 2x

9

1x 1x

2x

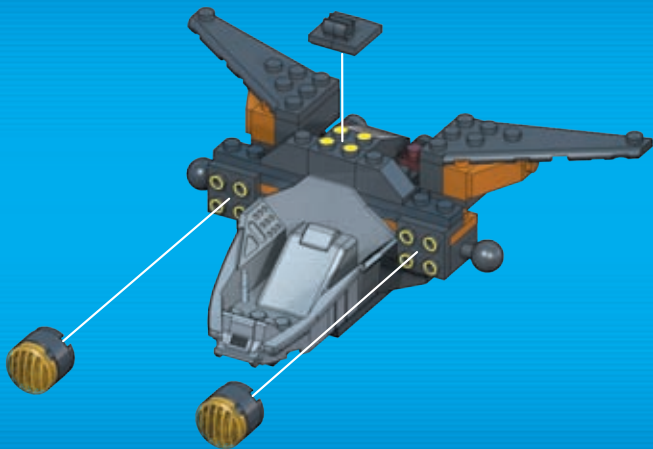

10



2x

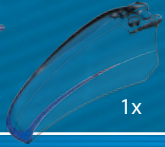

1x



1



2

11

2x

2x

2x

2x

2x

2x

1x

1x

2x

1x

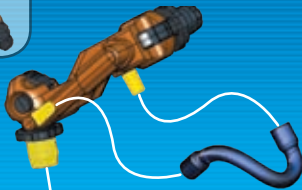

1

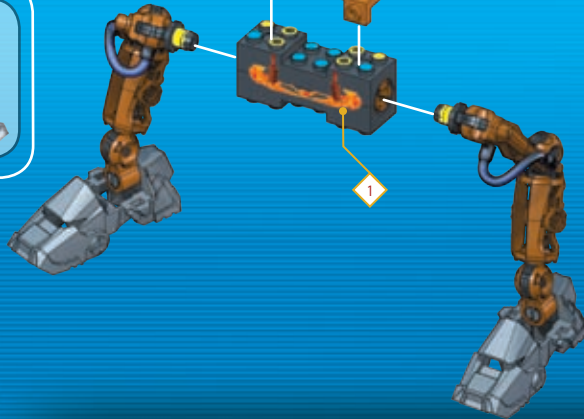
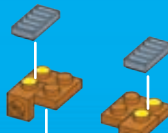

1



12



2x



1x

8 9

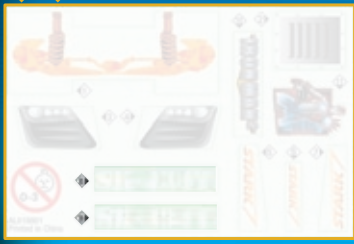

10

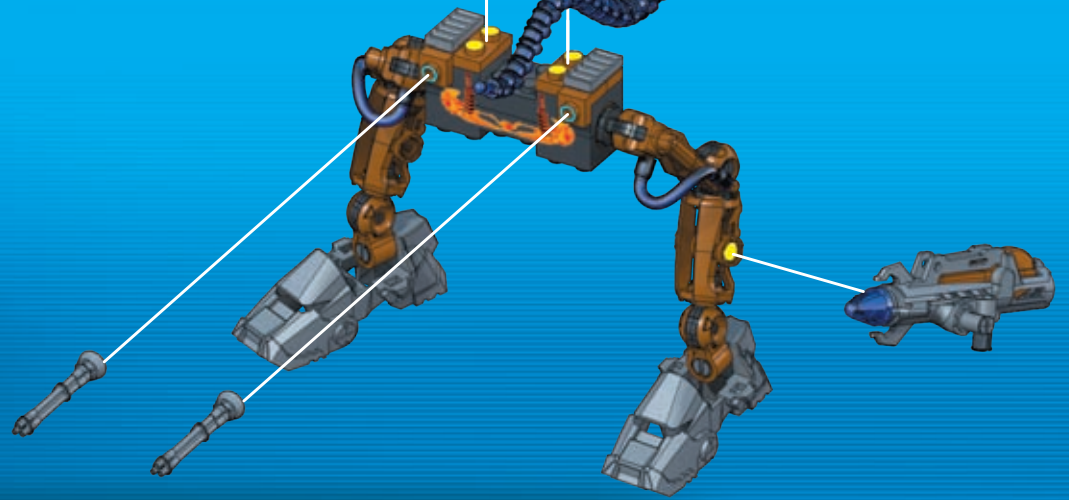

13

1x



Working Launcher
 Lanzador en funcionamiento
 Lanceur en action
 Funktionierender Starter
 Werkende lanceerinstallatie
 Lanciatore funzionante
 Lançador operacional

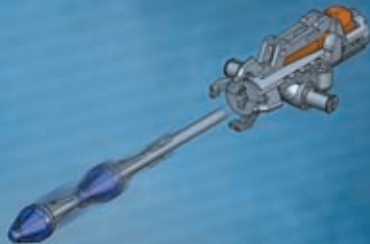

- EN** CAUTION! Do not aim at eyes or face.
ES ¡ADVERTENCIA! NO dirigir nunca los proyectiles hacia los ojos o la cara.
FR ATTENTION! Ne pas viser les yeux ou le visage.
DE VORSICHT! Nicht auf das Gesicht oder die Augen richten.
NL LET OP: Niet op ogen of gezicht richten.
DA ADVARSEL! Peg ikke i retning af øjne eller ansigt.
EL ΠΡΟΣΟΧΗ! Να μην σκοπεύετε προς τα μάτια ή το πρόσωπο.
FI VARO! Älä tähtää silmiin tai kasvoihin.
IT Attenzione! Non puntare verso gli occhi o il viso.
NO FORSIKTIG! Sikt ikke mot øyne eller ansikt.
PT ATENÇÃO: Não apontar para os olhos ou o rosto.
SV VAR FÖRSIKTIG! Rikta inte med ögon eller ansikte.
JA 注意！目や顔に使用しないで下さい。
ZH 警告！不要对准眼睛或脸。
AR تنبيه! لا توجه للعينين أو الوجه

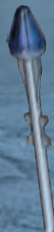

Use only the projectiles included with this toy.
 Utilizar solamente los proyectiles incluidos con el juguete.
 Utiliser seulement les projectiles fournis avec le jouet.
 Nur die mit dem Spielzeug mitgelieferten Projektile verwenden.
 Alleen de met het speelgoed bijgeleverde projectielen gebruiken.
 Utilizzare soltanto i proiettili forniti con questo giocattolo.
 Usar somente os projéteis incluídos com este brinquedo.
 استخدم فقط القذيفة المرافقة لهذه اللعبة

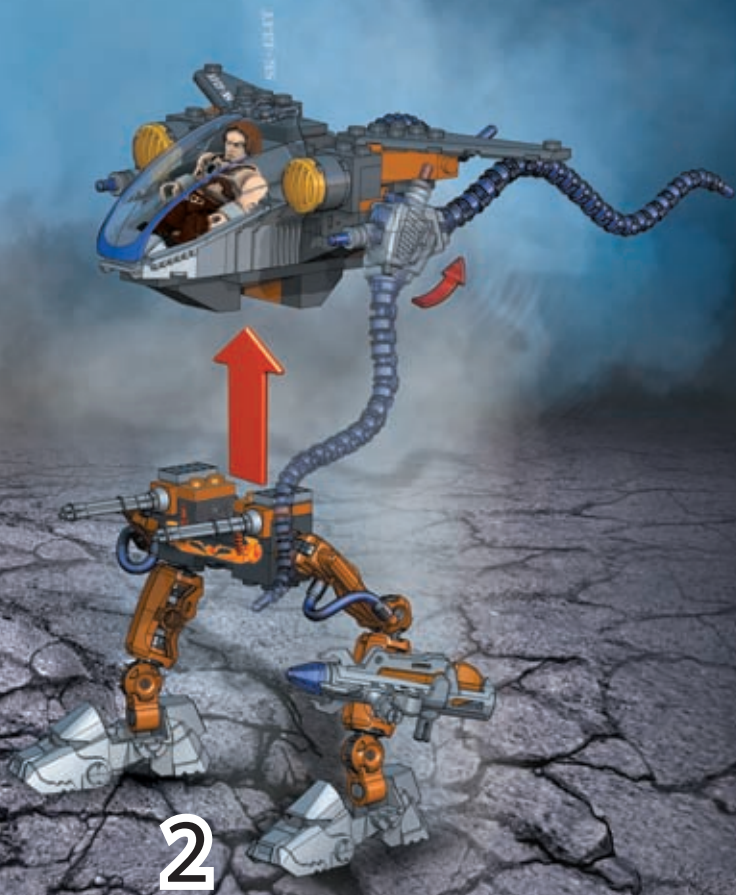

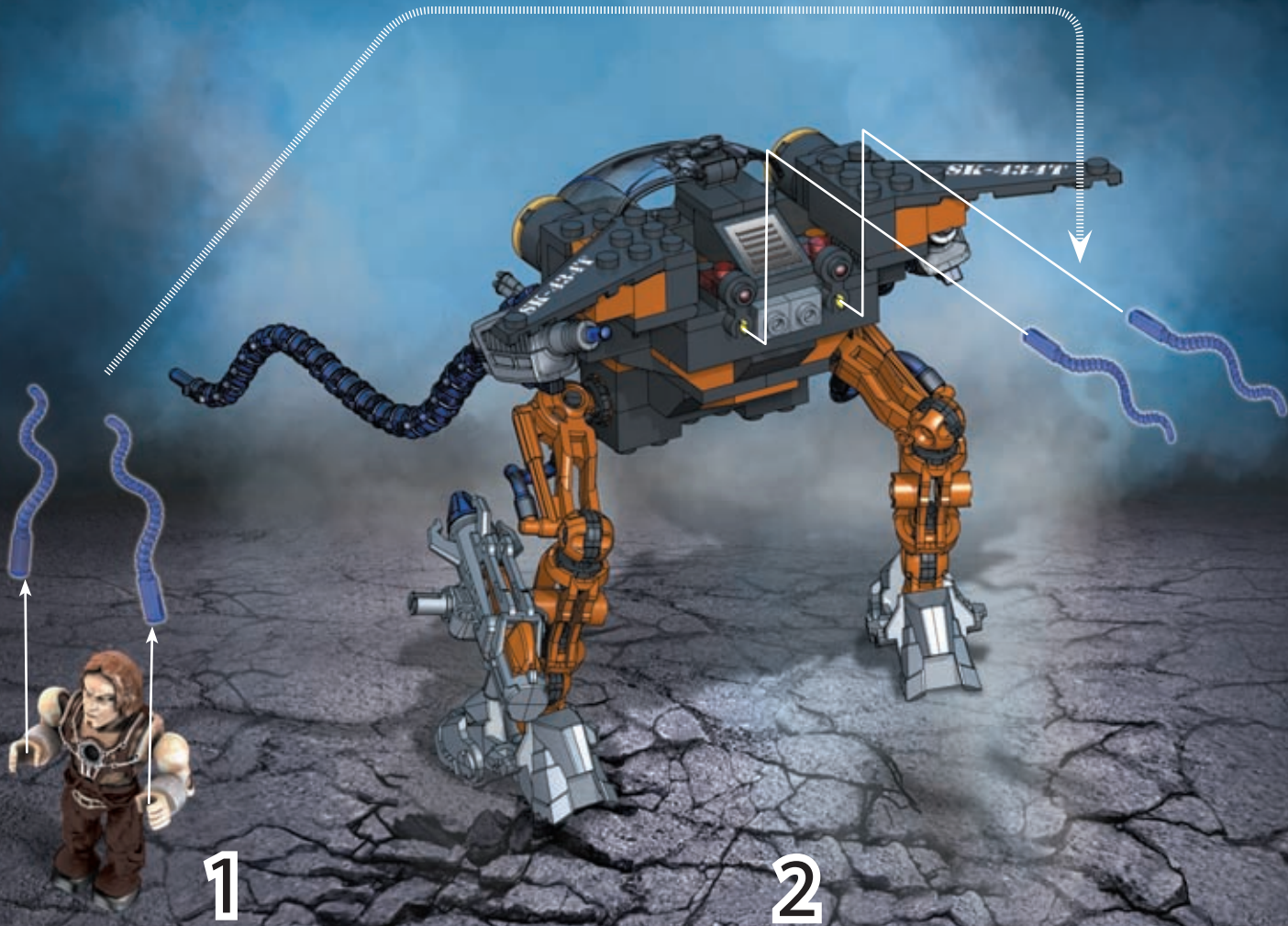

IRON MAN

STARK INDUSTRIES



- BUILD & BATTLE:
STARK RACER VS WHIPLASH WALKER
- CONSTRUIER Y LUCHAR:
STARK RACER CONTRA WHIPLASH WALKER
- CONSTRUIS ET COMBATS:
LE STARK RACER CONTRE LE WHIPLASH WALKER
- BAUEN UND KÄMPFEN:
STARK RACER GEGEN WHIPLASH WALKER
- BRUIDT UIT & VECHT:
STARK RACER VS WHIPLASH WALKER
- COSTRUISCI E COMBATTE:
STARK RACER CONTRO WHIPLASH WALKER
- MONTAR E GUERRAR:
STARK RACER CONTRA WHIPLASH WALKER



BUILDABLE WALKER TRANSFORMS INTO A COOL RACE-POD +
WALKER PARA CONSTRUIR + SE TRANSFORMA EN UNA FANTAS-
TICA VAGNA DE CARRERAS + LE WALKER A ASSIMOLEK SI
TRANSFORME EN FACILE DE COURSE AMUSANTE + DER ER-
WEITERBARE WALKER VERWANPELT SICH IN EIN COOLES RENN-
WÄHRZEUG + JE KUNT DE WALKER PIEK JE IN ELKAAR KIJNT
ZETTEN BRUWEN TOT EEN MOOIE RACE-POD +
LE WALKER CONSTRUIBILI SI TRAS-
FORMA EN UNA EC-
CEZIONALE POSTAZI-
ONE DA CORSA +
WALKER DE MONTAR
TRANSFORMAVEL EN
COOL RACE-POD

WORKING LAUNCHER
LANZADOR EN FUNCIONAMIENTO
LANCIEUR EN ACTION
FUNKTIONIERENDER STARTER
MERKENDE LANCIERONSTALLATSE
LANZADOR EN FUNCIONAMIENTO
LANCIATORE FUNZIONANTE

www.megabrands.com

Collect Them All! • *Alle verzamelen!* • *Reunirlos todos!* • *Collezionele tutti!*



© 2010, MEGA Brands Inc.
 MEGA Brands Inc. and the MEGA Brands Inc. logo are registered trademarks of MEGA Brands Inc.
 MEGA Brands Inc. y el logotipo MEGA Brands Inc. son marcas registradas de MEGA Brands Inc.
 MEGA Brands Inc. et le logo de MEGA Brands Inc. sont des marques de commerce déposées de MEGA Brands Inc.
 MEGA Brands Inc. und das MEGA Brands Inc.-Logo sind eingetragene Warenzeichen von MEGA Brands Inc.
 MEGA Brands Inc. en het MEGA Brands Inc. logo zijn gedeponeerde handelsmerken van MEGA Brands Inc.
 MEGA Brands Inc. ed il logo di MEGA Brands Inc. sono marchi di fabbrica di MEGA Brands Inc.
 MEGA Brands Inc. e o logo MEGA Brands Inc. são marcas registradas de MEGA Brands Inc.
 Printed in China AD019801C

